

FEBRUARY

N.S.E.

25 CENTS

POPULAR MECHANICS MAGAZINE

WRITTEN SO YOU CAN UNDERSTAND IT

REG'D. TRADE MARK. GREAT BRITAIN. No. 410426

REG. U. S. PAT. OFF.



SEE PAGE 198

Copyrighted material

Takes only 50 Days

to get a real job in the Auto and Tractor Business

THE GREAT RAHE SCHOOL



"My garage and Ford Agency is a big success. I owe it to Rahe training."—G. Smith, W. Alexandria, Ohio.



"Rahe training was the best investment I ever made."—Colby Lord, Oakland, Maine.



"I thank Rahe Training for a great job in the best garage in Lima."—Howard Metzger, Lima, Ohio.

Read what these men are doing—here is your big chance to get "on easy street." Come to these great shops on the biggest FREE offer ever made.

Big Firms Need Trained Men

The Auto and Tractor Business is on the boom. Thousands of trained men will be needed during the next few months. I get calls every day from Garages, Battery Stations, Auto Repair, Welding Shops and other successful concerns for Rahe men. When the big fellows need high grade men they know where to come for them. They want Rahe trained men.

My Training Unusual

Scientific tool training—that's the secret. You do things here according to the latest engineering standards. Thousands of dollars have been spent in modern tools and equipment. That's why my men are at home with the biggest shops in the country. If you want to succeed the way Smith and Metzger and the rest have—qualify by the same method.

I'll Pay Your Railroad Fare and Board You!

In order to fill the openings that now exist, I am making an offer no one has ever made before—Free Railroad Fare. Free Board. But even that is not all. I'll tell you about the rest in my letter.

Send for FREE Book My big illustrated training book tells how others are succeeding. It tells many things you ought to know about Autos and Tractors. Write for it and my short time offer NOW. It soon expires.

Auto Tractor and Electrical School
Dept. 141
Ninth and Walnut Sts., Cincinnati, Ohio



Rahe Auto & Tractor School
Dept. 141, Ninth and Walnut Streets, Cincinnati, Ohio

Without any obligation, send me your big free book, "The Evolution of Transportation." Also information regarding special temporary offer.

Name.....

Street.....

City..... State.....

Popular Mechanics Magazine

200 E. Ontario Street, Chicago, U. S. A.

H. H. WINDSOR, Editor

London: Hachette & Co.,
16-17 King William Street, Charing Cross, W. C. 2

Paris: Hachette & Co.,
111 Rue Reaumur

Melbourne, Australia
The Australasian News Co.

ISSUED MONTHLY

SUBSCRIPTION:

SINGLE COPY, 25 CENTS

In United States and its possessions, also Canada, Cuba, and Mexico, per year, postpaid - \$3.00

To all other countries in the Postal Union - 3.50

All subscriptions are discontinued at expiration. Please examine the date printed on your wrapper.

Entered as Second Class Matter Sept. 15, 1903, at the Post Office at Chicago, Illinois, under Act of March 3rd, 1879.

Entered as Second Class Matter at the Post Office Department, Canada.

Published monthly by POPULAR MECHANICS CO.

Copyright, 1924, by H. H. Windsor. Copyright in Australia

Vol. 41

Contents for February, 1924

No. 2

Aerials, Miniature, in Candy Display Hotel's Radio	211	Ducks, City Gives Hotel for, and Supplies Protection	256
Aircraft Hooked Together in Test Flight	211	Dumb Waiters in Store Run from Switchboard	280
Aircraft Skims Above Earth After Raising Itself	195	Dust, Grains of, Are Counted by Government Expert	255
Airships, Sliding Floor Aids in Handling	181	Earthquakes, Wire to Hunt and Forecast	201
Air-Speed Record Limit Officially Fixed	250	Eggs, Holder for, Guards Hand from Steam	279
Aluminum Coated with Gold to Rival Costly Metals	244	Eggs Scoured with Sand to Cheat Public	218
Asia, Facing Death in the Wilds of	267	Eight Hour Clock	215
Atoms too Small to be Seen Are Analyzed	197	Engines, Germs to Help Run, By Producing Gas Fuel	274
Auto Inventors' Tests Keep Government Experts Busy	252	Engines, Peace and War Time, Show Progress	189
Auto, Pedal Jacket on Small Cars Eases Winter Driving	170	Faucet, Water, Cloth Tube on, Acts as Silencer	244
Auto Safety Light Rays Go to Front, Rear and Side	229	Figs, Papier Mache Package Keeps, from Spoiling	201
Auto, Spring Cylinders on, Reduce Bumps	182	"Filling Station" for Pens	215
Auto Stops, When Oil Fails, Pump Controls	283	Fire Loss of Nation Cut by Safety Measures	255
Auto Tail Light and License Combined to Stop Theft	230	Firemen, City Gives, Brooms to Fight Brush Blazes	223
Auto Worth Ten Billions Cost Billion to Run	218	Fish Are Sent in Cans to War on Mosquitoes	228
Autos, Engine Trouble, Oil Line Cleaner Prevents	215	Fish, Scoop Net on Bow of Steamer Swells Catch of	222
Autos, Hydraulic Hoist for, Replaces Bit	193	Flag So Large it Covers Front of Building	175
Balloon, Toy, Travels Four Days over Atlantic	169	Fog, Electric Device to Clear, from Skies of London	256
Barbecue, Electric, Five Thousand Fed at Once	245	Fogs, London, Swell Cost of Laundry Work	185
Bed Folds into Table, Saves Space	230	Forest Fires, Ten Every Day	206
Bed Made into Chair by Adjustable Mattress	273	Freight Car, Concrete	201
Bench Sander, Compact for Small Shop	324	Fur, High Prices Urge Trappers in Quest of	221
Bible Texts, Light on, Sought in an Ancient Scroll	273	Gas Poisons Roots of Trees, Electricity not Harmful	259
Births Outstrip Death Rate in World's Large Cities	237	Gas, Use of, to Trap Animals is Suggested by Edison	195
Biscuit Cutter with Curved Knives Rolls over Dough	173	Glass, Cut, Sparkle of Finest, Due to Worker's Skill	182
Blood, Pocket Chart Tests, by Color Chart	208	Gold Panning Again Popular	181
Blowtorch, Bit Fastened to, Forms Soldering Iron	172	Golf Ball, Speed of Depends on Winding	200
Blowtorch Has Detachable Irons for Soldering	213	Granary, Huge, Holds Year's Grain for Small Nation	279
Blueberries Big as Grapes Result of Cultivation	172	Grapes Are Saved by Spray of Wet or Dry Sulphur	245
Boiler, "Upside Down," Saves Heat and Fuel	237	Grater Fits Dish, Saves Food Particles	218
Books, Library "Doctor" Gives First Aid to Worn	277	Greenbacks Designed to Foil "Bill Raising" Frauds	231
"Bootblack," Coin in the Slot, Shines Shoes	245	Hairpin's Points, Grip Near, Keeps it in Position	212
Bottles, Rubber Caps on Corks Keep, Free from Dust	206	Heel, Rubber, to Help Arches Has Ball Cushion Tread	169
Bread Box, Slicing Board in, Saves Crumbs and Labor	260	Hoist Raises Fifty Times Weight of Operator	259
Bricks, Home-Baked, Proving Popular in England	265	Homes, Million, for Workmen Needed in the U. S.	173
Bridge, Indians Build Hanging, without Nails	197	Hulk Sunk in Sacred Lake Freight with Riches	184
Brooms, Use of, is Increasing	196	Ice-Cream Cones	216
Brush, Shaving, Soap in Handle	200	Ice Now Harvested by Machines	255
Bugs, Not Cold, Take Birds to Southern Climes	222	Insurance, Burglar, Rate Cut by Dog as a Watchman	251
Burbank, Luther, the Plant Wizard	76	Iron, Electric, Heat of, Held by Core of Soapstone	219
Cable Grip, Double Jaws on, to do Away with Knots	273	Japanese See Quake Record While Far from Home	278
Camera to Detect Forgery Snaps Face and Name	245	Jars Kept Dry by Cover Pads	181
Canada's Forest Acres Grow Half of British Timber	252	Jewelry of Elephant's Hair Is Latest Paris Fad	276
Chain, Four Months to Carve, from Block of Wood	172	Kitchen Cabinet, Shelves on, Save Space	278
Chair, Raised, for Children, Fits Theater Seats	252	Lamp, Signal, at Gas Station Shows Amount of Bill	246
Chairs, Folding, Find Favor in Arab Market	284	Lamps, for Streets, Glass Panels Replace Globe on	259
Chemical Workers, Masks and Dust Proof Robes Guard	196	Lantern, Gasoline, has Pump at Base	265
Church, Old, Fragments of Become Souvenirs	174	"Laundry, Steam" for Home Eases Washday Labor	280
Church Spire Chopped Down After It Defies Fire	231	Letters, Five Million, Sent Daily via Tube	184
Church with Folding Steeple and Radio on Wheels	169	Library, Sand, Aids Builders in Choice of Materials	175
Cigarette Case for Auto Adds Light and Puffs	175	Life Ancient, Shown by Bones of Man and Mammal	282
Clocks, Germany's Are Set by Wireless	213	Light, Candle Socket in Cylinder to Give Better	222
Clothing is Made Fireproof by Use of Chemicals	284	Light from Mountain Rocks May be Radio Rays	279
Coal, Soft, Smoke, Cost City Millions Every Year	250	Liners Stern, Shape of, Wins Cargoes in Orient	261
Cobbles Used to Build Novel Prison Fountain	276	Lock, Auto, "Handcuff," Holds Wheels in Line	185
Cook, False Bottom Helps to, Food without Scorching	182	Log Hurlled off Train Splits Tree Apart	206
Cortes' Gardens Still Wonder of Mexico	280	Lumber, Amount of in Tree is Measured Before Felling	251
Cotton, "Hot Lands" Reclaimed for, in Mexico	202	Machinery, American, Leads in South Africa	231
Craftsmen, Army of, Bulwark of Nation	175	Man's Beginnings, Secrets of, to be Sought in Mongolia	207
Crate, Shipping, Council of Experts Building Model	283	Mansion, Mystery, Found in "Spook" Palace	238
Crops, World's, Seen in Tons of Seed	262	Mattresses, Machine Packs, Wraps them in Paper	284
Dam, Lofty, between Cliffs to Form Inland Sea	243	Meter for Loading Chutes Measures Coal or Grain	216
Dirh Drainer is Removable, to Make Cleaning Easy	252	Mexican Revolt, the Tools of	191
Diver in Clutch of Octopus Hauled Up and Freed	243	Milk Bottle and Can Locked to Guard Against Theft	212
Drug Curse Is Fall on Roof of World	248	Mining a River Bed	183

[Continued on Page 4]

This One



GBXC-3JT-9D95

Model, Dress-Form of Paper Makes an Exact	264	Wheels, Rubber Tips on Stem of Dial Measure Speed of	228
Models, Wax, So Real They Deceive the Eye	244	"White Powder" of Two Dams to Yield Farm Riches	274
Monster, Million-Year-Old, in the Movies	219	Wringer on Blacking Bottle Saves Fluid	277
Motor Drill for Sowing Grain Runs Between Rows	242		
Motor of Electric Fan Runs Phonograph	282		
Movie Camera's Films are Fireproof, Four Pound	261		
Movie Titles Given a Voice with Talking Machine	255		
Movies, Night Scenes for, Taken in Sunlight	253		
Music, Century of, Supplied by Bamboo Organ Pipes	250		
Nails, Metal Collars on, Save Lumber and Work	173		
Needle, Wire Hook to Thread, Saves Time, Aids Eyes	184		
Notebook, Slot Takes Place of Rings in Thinner	218		
Optical Illusions, Test for, Planned for Students	245		
Orchestra, One-Man, Used in Home	246		
Pacific Liner Strikes Sea of Jelly Fish	283		
Paintings Hung from Trees When Salon Bars Artist	188		
Panama Canal Ships Tied Up to Clear Slide	202		
Panama Canal Toll Profits for U. S. Grow	222		
Paper, Colored, Serves as Ink for Hand Engraving Press	174		
Paper Defies Flame, Chars but Won't Burn	180		
Park, Big, for Water Sports to be Built in West	173		
Paste for Many Uses Sticks Like Cement or Glue	251		
Pearls Formed in Oysters Left in Lime Solution	283		
Pen, Fountain, Monster	253		
Penknife, Detachable Blades on, Fold in Handle	243		
Phone Wires Hung to Bottles	277		
Photos Sent Through Air by Radio or Over Wires	170		
Photos Taken from Air Show Crop Acreage	274		
Pipes, Tobacco, Smoking Machine Breaks in and Tests	201		
Planes, World's-Flight, to Have Special Landing Equipment	265		
Plating of Aluminum Now Done With Aid of Zinc	283		
Pocket Seal in Watch Case Helps Public Notaries	172		
Pole Base, Concrete, Cuts Replacement Costs	282		
Popular Mechanics' Events of Twenty Years Ago	214		
Printers, Adjustable Line-up Gauge an Aid to	266		
Puzzle, "Can You Name Them," Answers to	277		
Radio Compass Robs the Sea of Many of Its Perils	206		
Radio "Dot" Spans Ocean at Speed of Light	208		
Radio, Glimpse Behind, Broadcasting Scenes	203		
Radio, Photos Sent Through Air by	170		
Radio, Reflector for, Waves Directs them like Light	230		
Radio, Relay Towers to Broadcast, to Fifty Millions	212		
Radio Set for Police Alarm Strapped to "Cop's" Back	216		
Radio Set in Miniature Fits in Pocket	218		
Radio Under Hat Links Mail Flier With the Earth	188		
Roses Cut from Sea Shells	196		
Safe Takes Deposits, Stamps Receipt on Bank Book	243		
Sand Molding Taught as Aid to Soldierly	186		
Scraper, Electric, for Paint does Work of Two Tools	276		
Screen, Half Billion Feet of, in War against Insects	243		
Scrubbrush, Motor, Saves Time and Labor	253		
Searchlights, Monster, are Eyes of Fleet	199		
Shear Sharpener, Wheels on Moves Vise, Turns Stone	250		
Shelf on Handle of Drawer is Aid to Filing Papers	260		
Ships, Silent Sentinels of the Sea Guard Traffic of	216		
Shipwrecked, Rocket Line to Save Lives of	223		
Shoes, "Sand," of Wire End Strain of Travel	202		
Sidewalk Barricade, Arch is Ornamental	246		
Sign, Automatic, for Traffic Proves Itself in Tests	185		
Skyscraper is "Babel" Tower when Tried in Europe	229		
Spark Plug, Shield Protects, from Oil and Carbon	212		
Splinters, Aid in Removing, is Given by Lens	207		
Spotlight is Turned by Rod and Has Extension Cord	261		
Square, Universal, Locks Automatically	324		
Squeegee, Felt Pad Fixed to, Holds Chemical Cleaner	256		
Streets Cleaned by Vacuum Cleaner Built Like Tank	265		
Tackle Blocks Made by Hand Move Girders	284		
"Tank," Land or Water War, Tested by Army	188		
Telescope, Camera, Long, for, to Learn Star Secrets	172		
Thermometer, Red Back of, Aids Quick Reading	171		
Toolpost, Spring, Prevents Chattering	324		
Tongs, Aluminum, Have Forks on Jaws	266		
Tooth Paste Kept in Cabinet Supplied by Turn of Key	237		
"Toothpowder" Mountain Built from Shell	209		
Tree Bearing Oil for Paints to Grow in Florida	229		
Tripod Folds into Cane When Not in Use	189		
Trolley Car, Noiseless, Rides Like an Auto	260		
Twine Cutter Like Hook Protects Hands	197		
Type, Setting, for Music now Task of Machine	171		
Typewriter, Pencil and Eraser Fit on	201		
Umbrella Ribs, Inventor of, Rewarded with a Fortune	228		
Valve Cap, Leakproof, Air Held Prisoner	242		
Ventilator, Lift Top Building, has Storm-Proof Collar	279		
Vessel Kept in Service by Welder's Torch	208		
Vessel off Balance Defies Efforts to Right it	273		
Warship, Six-Foot, Has Guns, Radio and Engines	251		
Watering-Trough for Hogs Can't Freeze in Winter	278		
Weight, Guarding Nation from, Frauds	233		
Whale Rammed by Ship's Bow Halts Vessel's Voyage	211		

SHOP NOTES

Auto Rims, Straightening	294
Babbitt Ladle, Removable Grip for	291
Blower for the Forge, Building	280
Bosses, Facing, to Gauge	296
Box, Self Closing Cover for	304
Casting, Preparing for Welding	291
Charging Indicator, Replacing the	303
Clamps, Level, for Carpenter's Straight Edge	304
Clutch, Jack Aids in Assembling	301
Divider Attachment Marks Gears	293
Drill and Reamer, Combined, A	285
Drill Chuck, Locking	291
Drill Press, Gravity Feed for	300
Flux, Brazing and Soldering	304
Forms, Concrete, Tightening	296
Gas Car, Turning, on Track	296
Gaskets, Curing the Blowing Out of	297
Grindstone, Mounting the	283
Lathes, Small, Boring and Turning Attachment for	301
Lock, for Hand Crank, Simple	298
Lumber Rack, A Substantial	288
Micrometer, Adding to Usefulness of	297
Milling Machine, Centering Round Work on	288
Pipe Bender, Homemade	294
Pulley, Clamping a Grooved	296
Right Angle Attachment for Straight Edge	300
Roofing-Cement Holder	287
Screw Ends, Grinding	293
Screw-Machine, Automatic, Pan Catches Work	297
Shock Covers, Handling	303
Sieve, Motor-Driven, for Foundry	287
Sifter, Ground Feed, A Novel	295
Square for Filing Templates	303
Stamps, Tearing Off	298
Street Pavements, Resurfacing Worn	292
Tank, Moving on Runway	287
Tool, Balancing, Divides Strips	303
Tool Box, Carpenter's Improved	299
Torch Rest, An Acetylene	302
Trailer, Substitute for	302
Valve, Test, Quick-Acting	304
Valves, Cross, Making and Using	290
Vise, Bench, with Universal Base	298
Wire, Cutting, Safely	297
Wrench, A Solid Adjustable	302
Wrench for Welding Torches	286

AMATEUR MECHANICS

Aerial, Safeguarding the	307
Aero-Propeller Shaft Installations	317
Auto Engine, Priming the	320
Bird Houses, Detachable	306
Camera Stand, Wheeled	311
Cellar, Cold, Dug in Bank	312
Coasting on Ice	321
Container, Handy, for Liquids	314
Copy Holder, Simple	307
Cut-Film Holder, Simple	318
Cycling on Snow and Ice	305
Furnace Damper, Closing, Automatically	321
Furnace Grates, Marking	319
Gas-Range Burners, Raising	320
Hay-Fork Holder, Safe	319
Humidity of Air, Increasing	312
Ignition Repair, Emergency	306
Lock, One, Fastens Entire Cabinet	320
Motor, Small, Increasing Utility of	316
Muskat Skins, Tanning	323
Neutrodyne Receiver, Five-Tube, Building A	308
Porch, Inclosing the, for the Winter	323
Request to Readers, A	311
Scraper, Snow, Attached to Rake	307
Slides, Projecting Microscopic	315
Spare Tires, Increasing Life of	321
Table, Kitchen, Folding, A	316
Tank, Auxiliary, Prevents Stalling on Grade	312
Trappers, A Kink for	307
Tube Adapter, Simple	322
Vacuum Bottle, Carrier for	322
Valve, Overhead, Silencing, Assembly	319
"Wampus," The "Walking"	313
Watch Charms, Mechanics	314
Water Supply for Private Garage	315
Weather-Vane-Bearing Protector, A	318

DRAKE'S PRACTICAL MECHANICAL BOOKS

THEY WILL RAISE YOUR PAY— ORDER ON 5-DAY TRIAL

The books listed below will perfect you in your chosen trade — pave the way to the big positions. Written in non-technical language—easy to read and understand. *Every book covers its subject completely. An entire course of instruction condensed into one volume.* Your choice sent postpaid — you benefit 5 days — money refunded in full if not entirely satisfactory. Order direct from this page.



Automobile Books

- Automobile Ignition, by ManlyLeatherette \$2.00
 Automobile Starting and Lighting, by Manly.....Leatherette \$2.00
 Brookes' Automobile Handbook.....Leatherette \$2.00
 Ford Motor Car, Truck and Tractor, by Manly.....Cloth \$1.50
 Starting and Lighting Troubles, Remedies and Repairs, by Manly.....Leatherette \$3.00
 Automobile Battery, Care and Repair, by Manly.....Leatherette \$2.00
 Automobile Catechism and Repair Manual.....Leatherette \$1.50
 Tires and Vulcanizing, by Tufford.....Cloth \$2.00
 Gas and Oil Engine Handbook.....Cloth \$1.50
 Automobile Upkeep and Care, by Manly.....Cloth \$1.50
 Motorcycle Handbook, by Manly.....Cloth \$1.50

Shop Practice Books

- Sheet Metal Workers' Manual.....Leatherette \$2.00
 Oxy-Acetylene Welding and Cutting.....Cloth \$1.25
 Slide Rule and Logarithmic Tables.....Leatherette \$2.00
 Handbook for Millwrights.....Cloth \$2.00
 Modern Blacksmithing.....Cloth \$1.25
 Machine Shop Practice.....Cloth \$2.00

ORDER DIRECT FROM THIS PAGE—ON OUR MONEY-BACK PLAN

The books listed above are only a few of the many in our catalogue, which you will receive promptly after filling out and mailing us the attached coupon. For quick action order direct from this page—cross name of each book wanted and send in with price quoted. We prepay postage and send the books on our money-back plan.

FREDERICK J. DRAKE & CO.

PUBLISHERS

1008 Michigan Ave., Chicago
 Drake Books Are For Sale at All Book Stores

- Mechanical Drawing and Machine Design.....Cloth \$2.00
 Pattern Making.....Cloth \$1.50

Carpentry Books

- Cloth Binding
 Modern Carpentry, 2 vols.....\$3.00
 The Steel Square, 2 vols.....\$3.00
 Wooden Boat and Shipbuilding.....\$1.50
 Modern Estimator.....\$1.50
 Timber Framing.....\$2.00
 Builder's Architectural Drawing.....\$2.00
 Concrete.....\$1.50
 Practical Bungalows.....\$1.00
 Low Cost Homes.....\$1.00
 Roof Framing, by Van Gasbeek.....\$1.50
 Stair Building and Hand Railing.....\$1.50

Electrical Books

- Practical Applied Electricity....\$2.00
 Alternating Current.....\$1.50
 Electric Motor Control Systems.....\$1.50
 Wiring Diagrams and Descriptions.....\$1.50
 Electrical Tables and Data.....\$1.50
 Armature and Magnet Winding.....\$1.50
 Modern Electrical Construction.....\$1.50
 Modern Electric Illumination.....\$1.50
 Electricians' Operating and Testing.....\$1.50
 Motion Picture Operation.....\$1.50
 Drake's Electrical Dictionary.....\$1.50
 Electric Motors, D. & A.....\$1.50
 Electrical Measurements and Meter Testing.....\$1.50
 Drake's Telephone Handbook.....\$1.50
 Easy Experiments.....Cloth \$1.25
 Wireless Telegraph and Telephone Handbook.....Cloth \$1.25
 Telegraphy Self-Taught...Cloth \$1.25

Steam Engineering

- Swingle's Handbook for Steam Engineers and Electricians.....Leatherette \$4.00
 Examination Questions and Answers for Marine and Stationary Engineers.....Leatherette \$2.00
 Steam Boilers.....Leatherette \$2.00
 Swingle's Catechism of Steam, Gas and Electrical Engineering.....Leatherette \$1.50

Painting Books

- Scene Painting and Bulletin Art.....Cloth \$4.00
 A Show at Sho' Cards.....Cloth \$4.00
 Sign Painting.....Cloth \$4.00
 Strong's Book of Designs.....Leatherette \$4.00
 Strong's Art of Show Card Writing.....Cloth \$4.00
 Signist's Alphabets.....Cloth \$1.50
 Modern Painter's Cyclopedia.....Cloth \$2.00
 Automobile Painting.....Cloth \$1.50
 Estimates, Costs and Profits, Painting and Decorating.....Cloth \$1.50
 New Hardwood Finishing.....Cloth \$1.50
 The Amateur Artist.....Cloth \$1.50
 New Stencils.....Cloth \$1.25
 Chalk Talk and Crayon Presentation.....Cloth \$1.25

Farm Books

- Farm Mechanics.....Cloth \$1.25
 Farm Buildings.....Cloth \$1.25
 Farm Engines.....Cloth \$1.25
 Traction Farming.....Cloth \$1.50

Business and Reference Books

- Better Business Letters.....Cloth \$1.00
 Better Business English.....Cloth \$1.00
 Better Advertising.....Cloth \$1.00
 Finger Prints Simplified.....Cloth \$1.25
 Practical Bricklaying.....Cloth \$1.25
 Practical Instruction for Detectives.....Cloth \$1.00
 Practical Plumbing.....Cloth \$1.50
 Hot Water Heating.....Cloth \$1.50
 Elementary Chemistry.....Cloth \$1.50
 Courses in Civil Service.....Cloth \$1.50
 Cyclopedia of Recipes.....Cloth \$1.50
 American Star Speaker...Cloth \$1.50

Modern Languages

- By Prof. P. S. Allen, U. of Chicago
 French without a Teacher.....Cloth \$1.25
 Spanish without a Teacher.....Cloth \$1.25
 German without a Teacher.....Cloth \$1.25
 Everyday French.....\$1.25
 Everyday Spanish.....\$1.25

FREDERICK J. DRAKE & CO.
 1008 Michigan Avenue
 Chicago, Ill.

GENTLEMEN:—Please send me free, postage paid, your illustrated catalogue which lists and describes over 100 Practical Mechanical Books for Home Study.

My name is

and my address

Mail Coupon For Free Catalogue
 Your Guide to Home Study

NEW CHEAP FUEL

The Oliver is made in 16 models to fit any stove or furnace. Installed in an instant. Then just turn a valve and you have much or little heat when and as you want it.

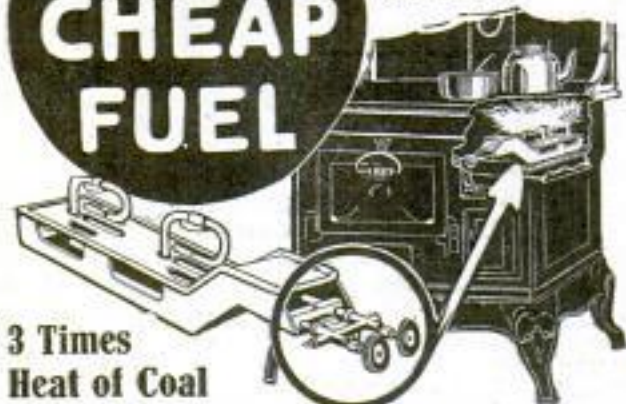

3 Times
Heat of Coal

AMAZING INVENTION

Don't burn coal or wood! A new cheap fuel gives three times the heat of coal—in any range, heating stove or furnace! No more worry about coal shortages or strikes, no smoke, no ashes, no fires to build and tend!

Burns 95% Air **AGENTS!**

An amazing invention—the Oliver Oil-Gas Burner—burns 95 per cent air and only 5 per cent oil, the cheapest fuel there is. The Oliver is simple, absolutely safe, and will last a lifetime. Over 1,000,000 now in use.

Low Introductory Price

Oliver agents making big money—\$500 and more a month—big money now on real cooperation. Write now for exclusive territory and FREE Sample Case Offer.

The Oliver burner has been so thoroughly tested that it is guaranteed, absolutely, to give perfect heating satisfaction. Send letter or passport for free book, "New Kind of Heat," and Special Low Price Introductory Offer now being made. State whether range, heater or furnace.

OLIVER OIL-GAS BURNER

OLIVER OIL-GAS BURNER COMPANY

8-58 Oliver Bldg.

St. Louis, Mo.

DRAW CARTOONS

Cartoonists Trained by W. L. EVANS

MAKE MONEY

SOME of the cleverest cartoonists in America today are former students. They studied during their spare time and are now making good money. Cartoonist Evans' system of teaching is so simple, easy and practical that it is not hard to learn to draw originals. The school has a long established reputation and is recommended by well-known cartoonists because they know the students are handled right.

If you like to draw, send us a sample of your work, either a copy or an original. You may have more ability than you think. We will send you a portfolio of cartoons and full details about the school.

The Course is NOT EXPENSIVE

THE W. L. EVANS SCHOOL OF CARTOONING

821 Leader Bldg.

CLEVELAND, OHIO



Whatever Your Question;—be it the pronunciation of Fascista, the spelling of a puzzling word, the location of Esthonia, the meaning of soviet, realtor, vitamin, etc., this Supreme Authority—

WEBSTER'S NEW INTERNATIONAL DICTIONARY

contains an accurate, final answer. 407,000 Words, 2700 Pages, 6000 Illustrations. Regular and Index-Paper Editions. G. & C. MERRIAM CO., Springfield, Mass.

Write for specimen pages, prices, etc. and FREE Pocket Maps per

POPULAR MECHANICS



FREE BOOK



LEARN PIANO

This Interesting Free Book* shows how you can become a skilled player of piano or organ at quarter usual cost. It shows why one lesson with an expert is worth a dozen other lessons. Dr. Quinn's famous Written Method includes all of the many important modern improvements in

teaching music. Brings right to your home the great advantage of conservatory study. For the beginner or experienced player. Endorsed by great artists. Successful graduates everywhere. Scientific yet easy to understand. Fully illustrated. All music free. Diplomas granted. Write today for free book. Quinn Conservatory, Studio P-982, 150 Columbia Road, Boston 25, Mass.

Delivered to You Free

for 30 days trial on approval. You can have your choice of 44 Styles, colors and sizes of the famous RANGER bicycles. Express prepaid. Factory-to-Rider Prices save you \$10 to \$25 on your bicycle.

12 Months to Pay if desired. Many boys and girls easily save the small monthly payments. Parents—fill advance first payment.

Tires—best quality, at factory prices, express prepaid.

Lamps, wheels and equipment, low prices. Send

No Money, do business direct with makers.

Mead Cycle Company

Dept. 108 Chicago



Write today for free Ranger Catalog, factory prices and marvelous easy payment terms.

TELEGRAPHY

BOTH MORSE AND WIRELESS taught thoroughly. Big salaries; tremendous demand. Oldest, largest school. Endorsed by Telegraph, Railway, Wireless and Government officials. Expenses low—opportunities to our large portion. Catalog free.

DODGE'S INSTITUTE, Jones Street, Valparaiso, Ind.

MINSTRELS

Musical Comedies and Revues, with full instructions for staging. You can stage your own show with our books. Full line of plays, music, cross-fire, monologues, afterpieces, vaudeville acts and make-up. Catalog free.

T. S. DENISON & CO., 623 So. Wabash, Dept. 19, CHICAGO



WANTED!

U.S. RAILWAY MAIL CLERKS

Steady Work—No Layoffs—Paid Vacations
Travel—See Your Country
Common Education Sufficient—Mail Coupon Today—SURE

Get \$1600 to \$2300 a Year

MEN—BOYS 18 OR OVER

MAIL COUPON IMMEDIATELY

Franklin Institute, Dept. F178, Rochester, N. Y.

Sirs: Send me, without charge, (1) sample Railway Mail Clerk Examination questions; (2) tell me how to get a U. S. Government Job; (3) send list of places at which examinations will be held; (4) send copy of illustrated book, "How to Get Government Jobs."

Name.....
Address.....

PRACTICAL ELECTRICITY SELF TAUGHT COMPLETE COURSE IN ELECTRICITY FOR FREE EXAMINATION



HAWKINS ELECTRICAL GUIDES

3500 PAGES—4700 PICTURES—\$1 A VOLUME—\$1 A MONTH—10 VOLUMES

OVER 5000
READERS
HAVE
OWNED
THIS
SET

Know the facts in Electricity. They mean more money and better position for you. Hawkins Guides tell you all you need to know about Electricity. Every important electrical subject covered so you can understand it. Easy to study and apply. A complete, practical working course, in 10 volumes. Books are pocket size; flexible covers. Order a set today to look over.

LEARN ALL ABOUT THESE IMPORTANT POINTS

Magnetism—Induction—Experiments—Dynamamos—Electric Machinery—Motors—Armatures—Armature Windings—Installing of Dynamamos—Electrical Instrument Testing—Practical Management of Dynamamos and Motors—Distribution Systems—Wiring—Wiring Diagrams—Sign Flashers—Storage Batteries—Principles of Alternating Currents and Alter-

nators—Alternating Current Motors—Transformers—Converters—Rectifiers—Alternating Current Systems—Circuit Breakers—Measuring Instruments—Switchboards—Wiring—Power Stations—Installing—Telephone—Telegraph—Wireless—Bells—Lighting—Railways. Also many Modern Practical Applications of Electricity and Ready Reference Index of the ten numbers.

FREE Not a cent to pay until you see the books. No obligation to buy unless you are satisfied. Send Coupon now—today—and get this great help library and see if it is not worth \$100 to you—you pay \$1 a month for ten months or return it.

THEO. AUDEL & CO., 72 Fifth Ave., New York City

Please submit me for free examination, HAWKINS ELECTRICAL GUIDE. (Price \$1 a number). Ship at once prepaid, the 10 numbers. If satisfactory, I agree to send you \$1 within seven days and to further mail you \$1.00 each month until paid.

Name.....

Occupation.....

Employed by.....

Home Address.....

Reference.....

PM Feb. 24



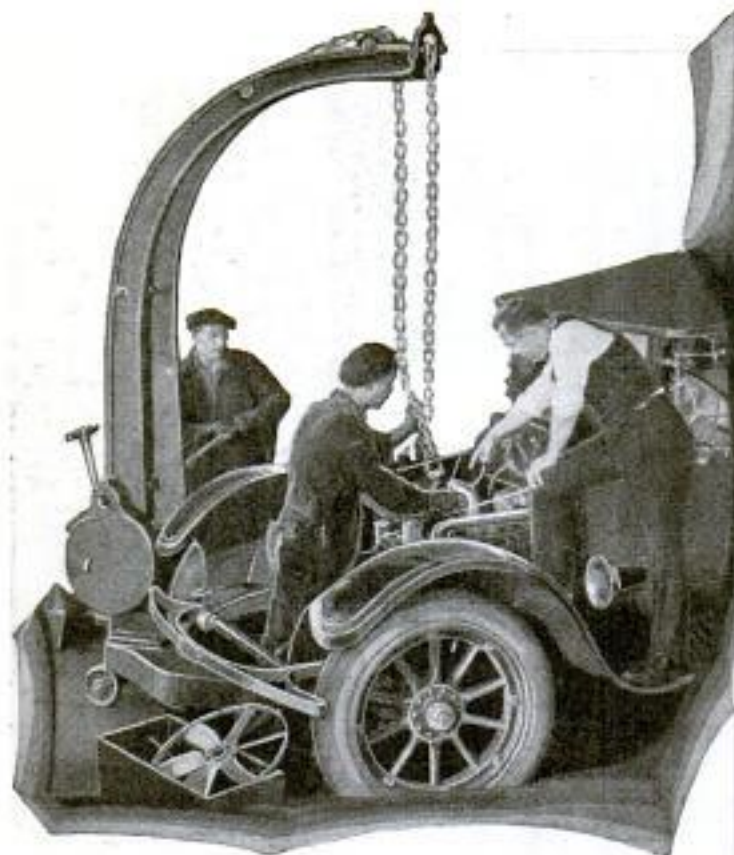

Be An **AUTO EXPERT**
 Make \$75 to \$200
 A WEEK

Learn
 at Home
 to **BOSS**
THE JOB!



B. W. COOKE, Directing Engineer

CHICAGO AUTO SHOPS

I WILL make you a successful **AUTO EXPERT**, prepare you to go into business for yourself, train you for positions paying \$3,000 to \$10,000 a year. Keep your job, stay home — just loan me a part of your spare time. As Directing Engineer of the big **CHICAGO AUTO SHOPS**, I train you the "JOB-WAY"—not with books. Go into the best-paying business on earth—get your share of the thousand million dollars spent every year to keep Autos, Trucks and Tractors running!

I TRAIN YOU

AT HOME!

My home-training makes Auto **EXPERTS!** I prepare you to **BOSS THE JOB!** My "JOB-WAY" instruction makes you **MASTER** of every branch of Automobile work — Mechanical, Electrical, Battery, Ignition, Farm Power plants, Welding, Brazing, Vulcanizing, etc. My training is **COMPLETE!**

Start Now! I'll help you *start* and help you *succeed!*

Inducements you cannot resist *right now* to ambitious men. Easy terms, within reach of everybody. Many Free features. Coupon brings your *greatest* opportunity — mail it to me right away!

B. W. Cooke, Directing Engineer
CHICAGO AUTO SHOPS
 Dept. 216, 1553 W. Madison St., CHICAGO

B. W. COOKE, Directing Engineer
 Dept. 216, 1553 W. Madison Street, CHICAGO

Please send me Free Book and complete information about your "Job-Way" training at home. Tell me about the opportunities today for Auto Experts. I am mailing this promptly to secure **FREE REPAIR OUTFIT** and the reduced prices and special terms you offer now.

..... NAME
 ADDRESS
 CITY STATE
 AGE OCCUPATION

AUTO BOOK FREE!

MAIL COUPON TO-DAY!

EXPERTS WANTED!

\$3,000 to \$10,000 a year!

The "best-paying business on earth" is hungry for **EXPERTS!** Where else can you find such opportunities as in the **AUTO** business? 15 million Autos, Trucks and Tractors to keep going, 50 million tires to repair, 15 million starting, lighting and electric systems to maintain, 15 million batteries to service and replace. *Man alive!* Wake up to this rich money-making opportunity!

FREE OUTFIT

Big repair and testing outfit free to my students! Mail coupon for my remarkable offer. Use it to do my **JOBS**, use it to make money, use it to make this training pay for itself!

FREE JOBS

My big Employment Department helps my graduates get big pay jobs without one penny of cost.

GO INTO BUSINESS!

Make \$5,000 to \$15,000 a year!

There are thousands of opportunities to go into business for yourself, with small capital. Auto Experts run big service stations, make up to \$15,000 a year! The same wonderful opportunity is *waiting for you*. My "Job-Way" instruction prepares you for it.

My "Job-Way" training makes successful high-price AUTO EXPERTS!



"Don't tell me you never had a chance!"

"Four years ago you and I worked at the same bench. We were *both* discontented. Remember the noon we saw the International Correspondence Schools' advertisement? That woke me up. I realized that to get ahead I needed special training, and I decided to let the I. C. S. help me. When I marked the coupon I asked you to sign with me. You said, 'Aw, forget it!'"

"I made the most of my opportunity and have been climbing ever since. You had the same chance I had, but you turned it down. No, Jim, you can't expect more money until you've trained yourself to handle bigger work."

There are lots of "Jims" in the world—in stores, factories, offices, everywhere. Are *you* one of them? Wake up! Every time you see an I. C. S. coupon your chance is staring you in the face. Don't turn it down.

Right now more than 180,000 men are preparing themselves for bigger jobs and better pay through I. C. S. courses.

You can join them and get in line for promotion. Mark and mail the coupon, and find out how

INTERNATIONAL CORRESPONDENCE SCHOOLS Box 5577-D, Scranton, Penna.

Without cost or obligation, please tell me how I can qualify for the position or in the subject before which I have marked an X:

BUSINESS TRAINING COURSES

- | | |
|--|---|
| <input type="checkbox"/> Business Management | <input type="checkbox"/> Salesmanship |
| <input type="checkbox"/> Industrial Management | <input type="checkbox"/> Advertising |
| <input type="checkbox"/> Personnel Organization | <input type="checkbox"/> Better Letters |
| <input type="checkbox"/> Traffic Management | <input type="checkbox"/> Show Card Lettering |
| <input type="checkbox"/> Business Law | <input type="checkbox"/> Stenography and Typing |
| <input type="checkbox"/> Banking and Banking Law | <input type="checkbox"/> Business English |
| <input type="checkbox"/> Accountancy (including C.P.A.) | <input type="checkbox"/> Civil Service |
| <input type="checkbox"/> Nicholson Cost Accounting | <input type="checkbox"/> Railway Mail Clerk |
| <input type="checkbox"/> Bookkeeping | <input type="checkbox"/> Common School Subjects |
| <input type="checkbox"/> Private Secretary | <input type="checkbox"/> High School Subjects |
| <input type="checkbox"/> Spanish <input type="checkbox"/> French | <input type="checkbox"/> Illustrating <input type="checkbox"/> Cartooning |

TECHNICAL AND INDUSTRIAL COURSES

- | | |
|---|--|
| <input type="checkbox"/> Electrical Engineering | <input type="checkbox"/> Architect |
| <input type="checkbox"/> Electric Lighting | <input type="checkbox"/> Blue Print Reading |
| <input type="checkbox"/> Mechanical Engineer | <input type="checkbox"/> Contractor and Builder |
| <input type="checkbox"/> Mechanical Draftsman | <input type="checkbox"/> Architectural Draftsman |
| <input type="checkbox"/> Machine Shop Practice | <input type="checkbox"/> Concrete Builder |
| <input type="checkbox"/> Railroad Positions | <input type="checkbox"/> Structural Engineer |
| <input type="checkbox"/> Gas Engine Operating | <input type="checkbox"/> Chemistry <input type="checkbox"/> Pharmacy |
| <input type="checkbox"/> Civil Engineer | <input type="checkbox"/> Automobile Work |
| <input type="checkbox"/> Surveying and Mapping | <input type="checkbox"/> Airplane Engines |
| <input type="checkbox"/> Metallurgy | <input type="checkbox"/> Navigation |
| <input type="checkbox"/> Steam Engineering | <input type="checkbox"/> Agriculture and Poultry |
| <input type="checkbox"/> Radio | <input type="checkbox"/> Mathematics |

Name.....

Street..... 11-21-23

Address.....

City..... State.....

Occupation.....

Persons residing in Canada should send this coupon to the International Correspondence Schools Canadian, Limited, Montreal, Canada.



Copy This Drawing Table — Get It **FREE**

On My Offer to Students

Any one sending in a sketch of the drawing of draftsman's table shown here, will receive free and postpaid an Ivorine draftsman's pocket rule, and will get the table free as soon as he becomes a student. Be sure to state your age.

Complete Draftsman's Outfit Also FREE

These are the regular working instruments—the kind I use myself. The same kind that you will use when you have completed my course and have become a regular draftsman. Its value is \$25.00. I give them free if you enroll at once. This outfit includes Nickel Silver drawing instruments, drawing board, T square, triangles, French curve, ink, ruler, pencil, besides the free draftsman's table. Send in the coupon for information.

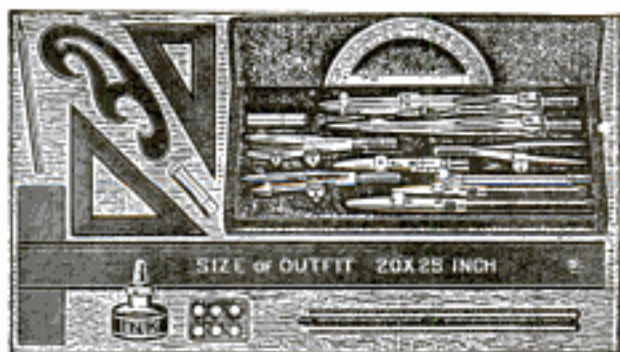

Salaries Up to \$250 to \$300 a Month

Positions paying up to \$250 and \$300 per month which ought to be filled by skilled draftsmen are vacant everywhere. There are in every part of this country ambitious men, who with practical training and personal assistance will be qualified to fill the positions. I can now take and train a limited number of students personally and I will give to those students a guarantee to train them by mail UNTIL placed in a permanent position at a salary up to \$250 and \$300 per month.

\$90 Drafting Course Given Away!

To every student enrolling now I give an opportunity of getting a \$90 drafting course absolutely without cost to him. Even if you don't send in a sketch send in the coupon today and learn all about this offer.

Chief Draftsman, Engineer's Equipment Co.
1951 Lawrence Ave., Div. 83-52 Chicago, Ill.

Without any obligation to me please mail your book "Successful Draftsmanship" and full particulars of your liberal "Personal Training" offer to a few students. Also full information as to how I can get a \$90 Drafting Course Free. Send Ruler to me FREE.

Name.....

Address.....

City..... Age.....

FREE this Rule



for
Sending
Coupon at Once

and also 6 x 9 Book on "Successful Draftsmanship". Act quick.

Chief Draftsman, Engineer's Equipment Co.
1951 Lawrence Ave., Div. 83-52 Chicago, Ill.

We Will Make You An Electrical Expert In 3½ Months At Coyne



Students Doing Actual Work On
Power Transmission Apparatus



Students Working on Massive
A. C. Control Equipment



Students Practicing House-wiring
In Skeleton Houses

**Earn \$65 to \$200 a Week!
Or Go In Business for
Yourself and Make \$3500
to \$15,000 a Year!**

Yes, 3½ months at the **Great School of Coyne**, located in Chicago, The Electrical Center of the World, will make you an **Electrical Expert** capable of commanding big pay. The whole world of electricity is open to the practical man—the man who has had actual experience with electrical apparatus. Coyne gives you a practical training on a stupendous outlay of electrical apparatus, everything from door bells to power plants.

Not a Correspondence School

We don't make you a mere "paper" electrician. We train you by practice on our mammoth outlay of actual equipment. We train you in house-wiring by having you do it exactly as it is done outside—not just by reading about it. The same applies to armature winding, power plant operating, motor installations, automotive work and hundreds of other electrical jobs. That's why we can train you to become a **Master Electrical Expert**.

No Books—No Lessons—You Do Actual Work

The Coyne practical course includes no books, printed lessons or useless theory. We train you to work with your head and hands on the same kind of electrical apparatus as you will find "out in the field." Coyne gives you Free a Life Scholarship which enables you to stay as long as you want without extra charge or return later for more practice, and assists you to a position after graduation. We also include Free a course in radio.

Age, Lack of Experience or Education Is No Hindrance

Our students range from 16 to 60 years of age. No previous training necessary. You don't even have to be a grammar school graduate.

Earn While You Learn!

We help students to secure jobs to earn a good part of their living expenses while studying.

Send For Free Book

Send for the Big Free Book which shows the Great School of Coyne and a great part of our massive electrical equipment. You will be convinced that the only place to get a practical electrical training is in the Great School of Coyne.

COYNE
Electrical School

Endorsed by Electrical Industry

1300-1310 W. Harrison St., Dept. 13-52, Chicago

Coyne Electrical School, Dept. 13-52
1300-1310 W. Harrison St., Chicago

Dear Sir: Please send me free your big catalog and full particulars of your special offer.

Name.....

Address.....

CARPENTERS

LET THIS NEW AUDEL SET SOLVE YOUR PROBLEMS

POCKET SIZE—
FLEXIBLE
COVERS—
3100 ILLUS-
TRATIONS
— 1600
PAGES

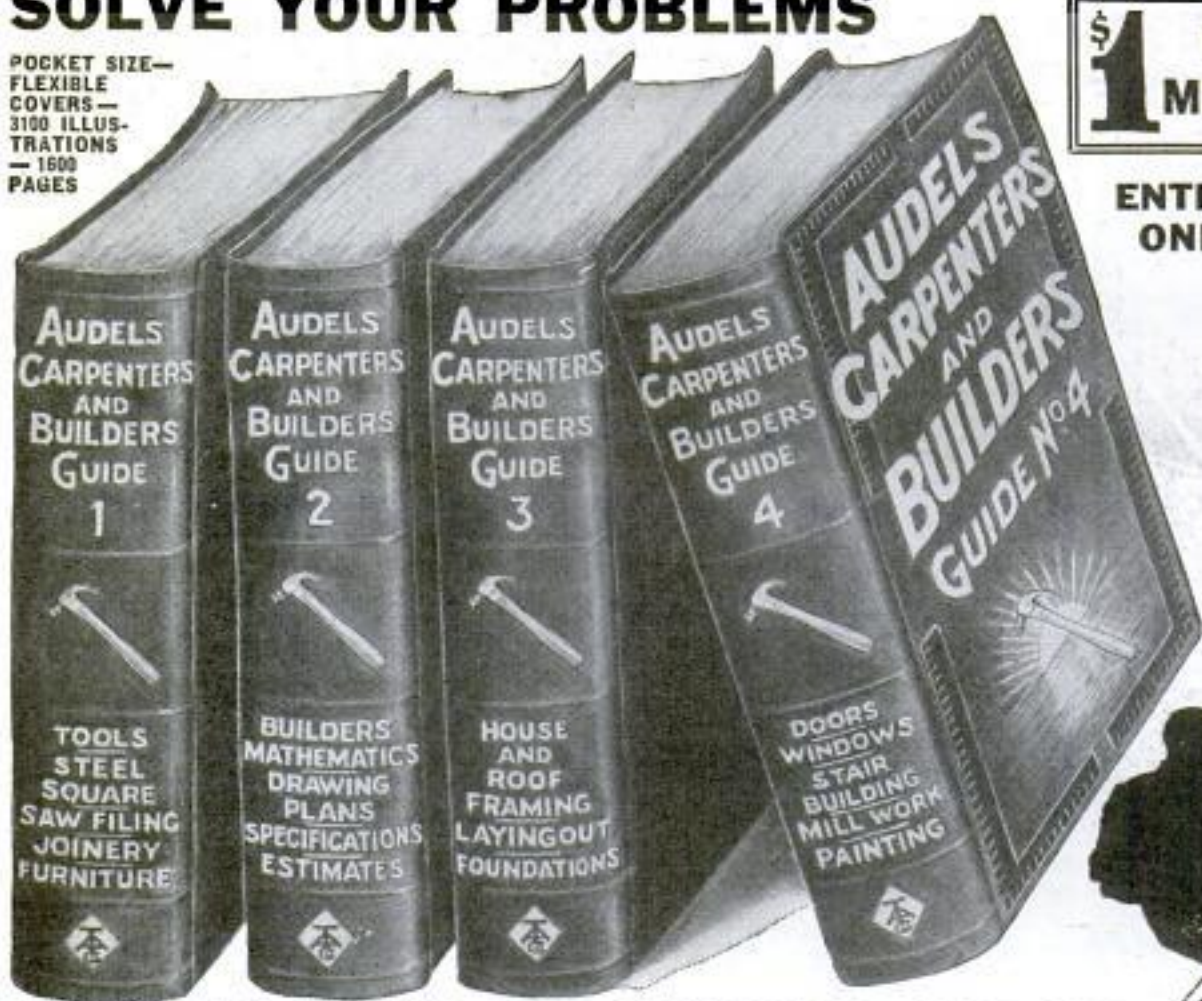

\$1 PER MONTH

ENTIRE SET ONLY \$6

JUST OUT!

Audel's Newest Set, Concise and up-to-date **FOUR Handy Volumes**



QUESTIONS AND ANSWERS—CLEAR ILLUSTRATIONS—SHORT CUTS THAT MAKE YOU A BETTER WORKMAN AND INCREASE YOUR PAY

Just available—Audel's Carpenters and Builders Guides—the short cut, professional information you want. A Guide that keeps you in close touch with your work and shows you how you may increase your earning power. No need to guess or take chances. Every day you have before you in this set, exact, practical, useful information to help you with your daily work.

HOW To Handle the Job That Puzzles YOU

There are thousands of examples of modern construction and building work—new methods, new ideas, proved efficiency plans, short cuts, time saving suggestions, new ways that cover the entire theory and practice of modern carpentry. Every point is easy to read and understand and clearly illustrated with sketches and forms. Inside Trade Informa-

tion for Carpenters, Builders, Joiners, Building Mechanics and all Woodworkers on—Care and Use of Tools—How to Use the Steel Square—File Saws—Make All Kinds of Joints—Draw and Read Plans—Write Specifications—Make Estimates—How to Frame Roofs and Houses—Lay Out Work—Put in Foundations—Full Instruction on In and Outside Building Work—Stair Building—Saw Mill Work—Practical Painting—Thousands of Short-Cuts that save time and money—Information usually obtained only by hard experience.

NO MONEY! MERELY SEND COUPON AND LOOK THE SET OVER AT THEO. AUDEL'S RISK

THEO. AUDEL & CO., 72 5th Avenue, NEW YORK CITY
Send me for free examination of AUDEL'S CARPENTERS AND BUILDERS GUIDES. I will send you \$1 within 5 days and mail \$1 monthly until \$6 is paid.

Name.....
Address.....
Occupation.....
Employed by.....
Reference.....
P. M. Feb. 24

FREE

EXAMINATION

Not a cent to pay until you see the books. No obligation to buy unless you are satisfied. Fill in coupon in pencil. Send now—today—get this great help library for carpenters and builders.



Tighten Your Grip on a Trade

Be An Electrical Expert

At \$75 to \$200 a Week

Every up-to-date fellow knows what a future there is in electricity.

Big pay—fascinating work on land or sea—rapid advancement in a field where jobs are ten times more numerous than trained men to fill them, where \$75.00 a week is just a fair starter, where top notchers pull down ten thousand dollars or more a year—in a field, where any man if he wishes, can easily have a business of his own, have men working for him, **be his own boss!**

But what the average young man does NOT know, is what a simple, easy, A-B-C sort of a job it is to get started.

You Can Start Right Now!

Yes, you. You don't need a thing you don't already have! You can read. You can write. You can figure. You can think. And in your breast is the fire of ambition—the desire to get ahead! All right, that's all you need—we can help you just as you are—just as we have helped scores, yes, thousands of other two-listed young fellows determined to get out of the rut and into the electric field—into work that will be pleasant—easy—and all in your home, during spare time.

Fascinating Home Study As You Hold Your Old Job

With the help we will give you, you can slip right into one of these big pay—be-man jobs and never lose a day's work. After a few weeks' start, you can earn enough in installation and electric repair jobs alone to more than pay for the Course and lay a foundation for an Electrical Contracting or Repair Shop Business of your own. When the proper time comes, we will tell you the easy way to go about doing it.

The Most Practical, Thorough and Condensed Electrical Course Ever Written

This is the only home study electrical course that gives you the combined practical and theoretical training you must have before you can be a successful electrician without which you cannot succeed—with which you cannot fail.

Written not by ONE man, with the narrow one-man viewpoint, but by 22 of the brainiest, most successful, electrical experts ever drawn from the field of practice and theory. Gives you the complete mastery of the subject—qualifies you as electrical expert to boss jobs—fits you right into the kind of a job you want—and does it in shortest time—at lowest cost—with the

Most Binding Guarantee of Results Ever Offered!

Satisfaction guaranteed or no sale! We not only SAY we can make you an electrical expert, we Guarantee it! If you are not absolutely satisfied when you have finished our Practical Electrical Course, we will refund every nickel you sent us.

FREE! Experimental Outfit Worth \$30
 Drafting Course Worth Another \$30
 Big Electrical Library Worth \$25

Find out all about our offer. Find out about the thousands who have taken this course in preference to all others and MADE GOOD. Find out about the Electric Library—four elegant volumes—worth \$25, but free. About the free Drafting Course worth another \$30. The free Experimental and Demonstration Outfit, including a real, not a make-shift Electric Motor, Wheatstone Bridge, etc.—the most scientific, high-grade and complete Experimental Outfit ever supplied with a Course in Electricity. Get all the facts without obligation, without expense! Just send the coupon!

American School

Dept. E-274

Drexel Ave. and 58th Street, Chicago

**FREE
 Electrical
 Coupon**

American School,
 Dept. E-274, Chicago
 Please rush all information relative to your Course in Electricity. This obligates me in no way whatever.

Name.....

Address.....



Be Your Own Boss



Be a Leader



Practical Electricians Earn Big Pay



Own Your Own Electric Shop



Big Money As Power House Boss



Ignition Experts

Head the Pay-Roll

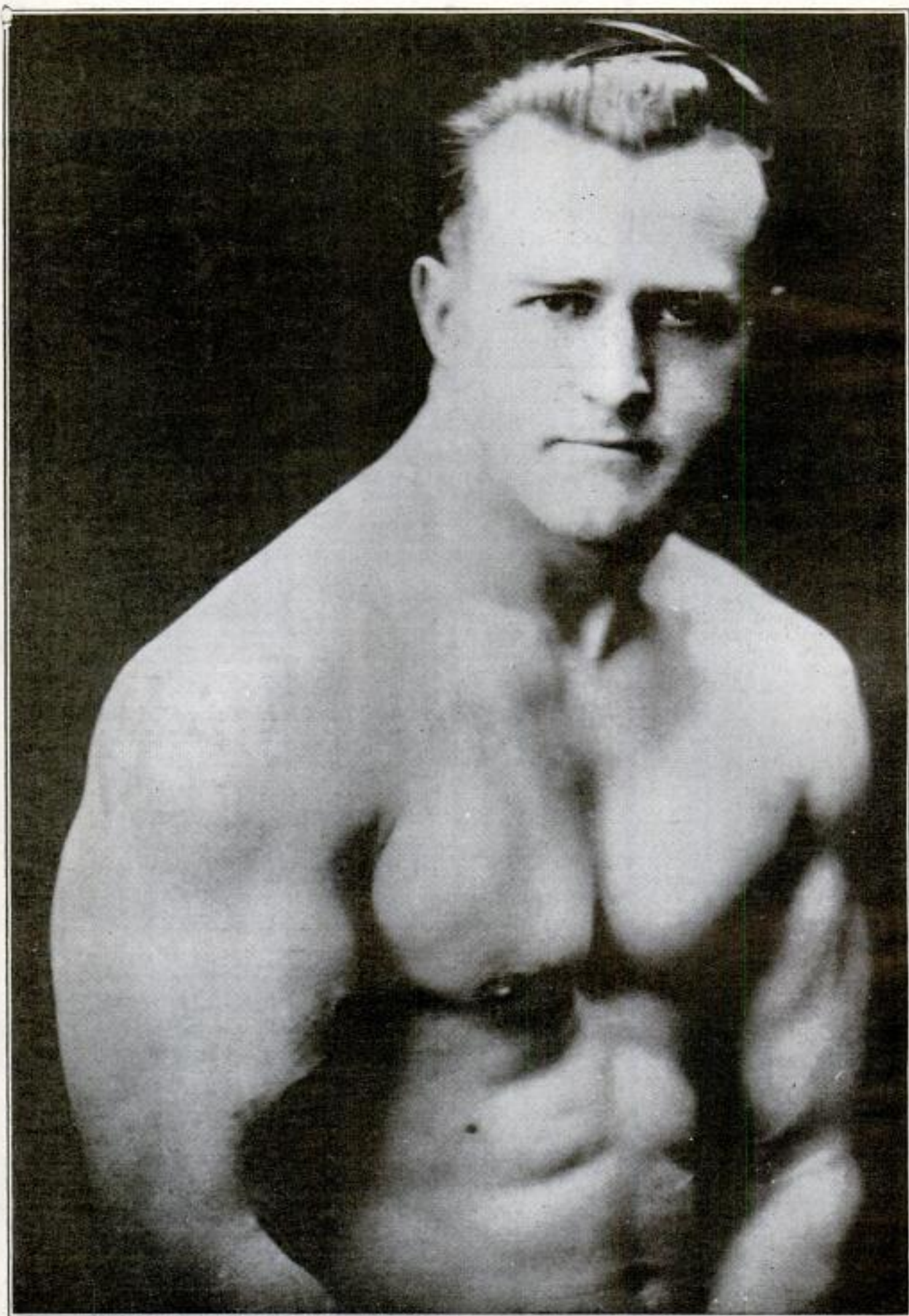

EARLE E. LIEDERMAN, *America's Leading Director of Physical Education*

Are You Ready for the Ash-Can?

Do you realize what it means to neglect your body? Do you know that you will clog up with waste matter and deaden your life just as ashes do in a furnace? Are you going to drag yourself through a life of misery and be ready for the undertaker when you should really be only starting to enjoy life? Come on and brace up. Take a good hold of yourself and shake those cobwebs out of your brain. Give me a chance at that weak backbone of yours and let me put a pair of man-sized arms into those narrow shoulders.

Pills Never Made Muscles

I am not a medical doctor. I don't claim to cure disease. Neither do I put any self-assumed title of Professor before my name. *I am a builder of muscle*—internal as well as external. I claim and can prove that by proper exercise you can even build muscle in and around your heart and every vital organ. The kind that shoots a thrill through your veins and reaches every crevice of your body. I add years to your life, and oh, boy! what a kick you get out of every day you live. And talk about big, brawny arms and legs, or broad backs and husky chests—just take a look through this winter's copies of Physical Culture Magazine and see for yourself. You will see a few pictures of my pupils there—living examples of the Earle Liederman system—doctors, lawyers, business men, but every last one of them good enough to pose as professional strong men. Some are in better shape than men who are now acting as instructors to others.

Pep Up! What are you going to do about it? Don't sit idle and wish for strength. That will never bring it. Come on and get busy. You must have it, and I'm going to give it to you. I don't promise it, I guarantee it. You take no chance with me, so come and make me prove it.

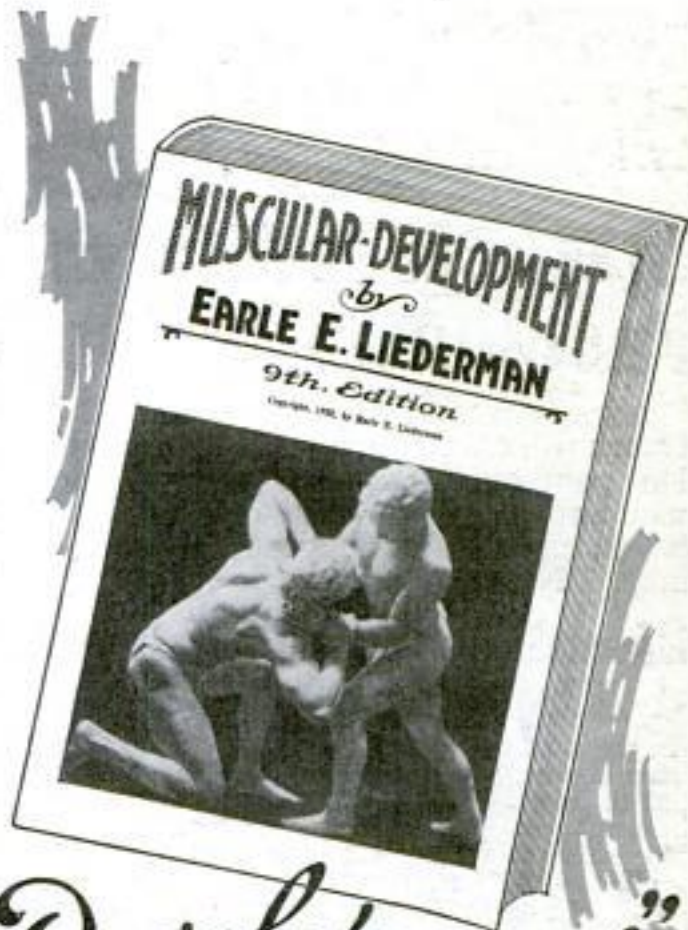

Send For My New
64 Page Book—

"Muscular Development"
IT IS FREE

It contains forty-three full-page photographs of myself and some of the many prize-winning pupils I have trained. Some of these came to me as pitiful weaklings, imploring me to help them. Look them over now and you will marvel at their present physiques. This book will prove an impetus and a real inspiration to you. It will thrill you from cover to cover. All I ask is ten cents to cover the cost of wrapping and mailing and it is yours to keep. This will not obligate you at all, but for the sake of your future health and happiness, do not put it off. Send today—right now, before you turn this page.

EARLE E. LIEDERMAN
Dept. 2002, 305 Broadway, New York City

EARLE E. LIEDERMAN

Dept. 2002, 305 Broadway, New York City

Dear Sir:—I enclose herewith 10 cents, for which you are to send me, without any obligation on my part whatever, a copy of your latest book, "Muscular Development." (Please write or print plainly.)

Name

Address

City State

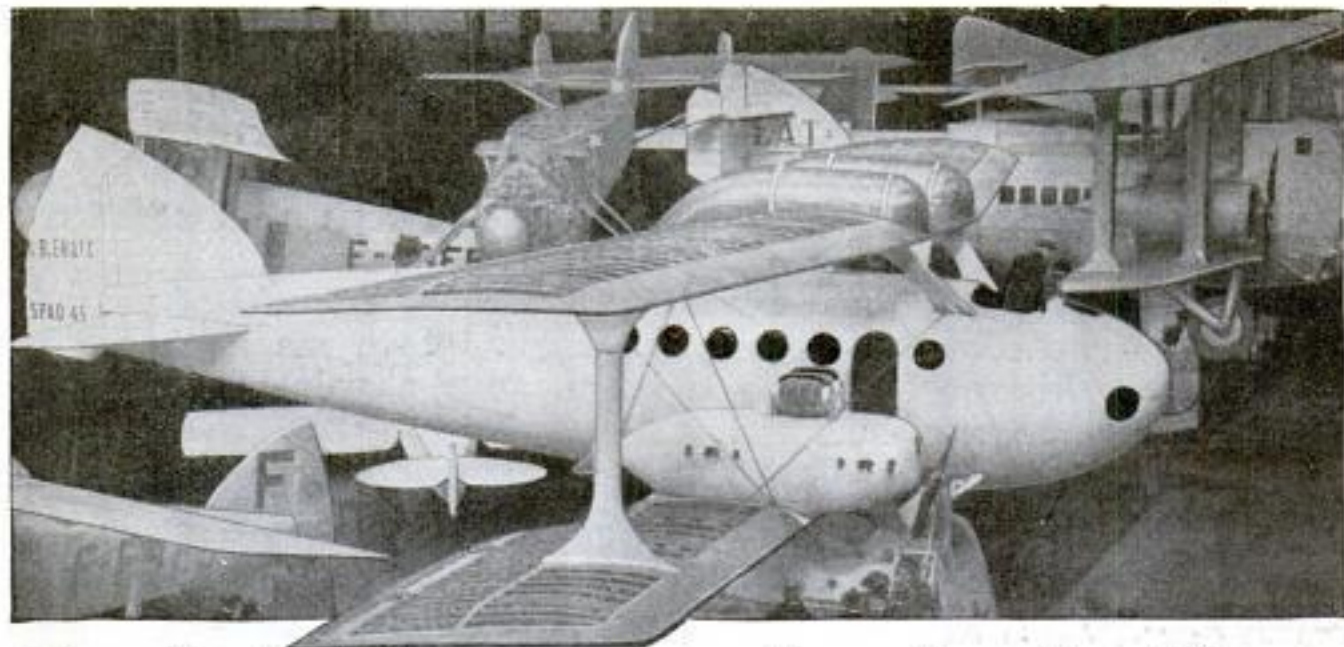

Quick Success in Aviation Fascinating—Daring—Big Paying

To young men of daring, no other field of work will offer such a fascination, such high pay, nor such opportunities for quick success as the field of Aviation. As yet, aviation is practically in its infancy. NOW is the time to get in.

Amazing Opportunities in Airplane Industries

In the automobile industry and in the moving picture business hundreds of men got rich by getting in at the start. They made their success before others woke up. Today, these lines offer no greater opportunities than a hundred and one others. BUT AVIATION IS NEW. Get in while the opportunity is big. All over the country there will be a clamor for trained men. It will not be a question of pay, but of getting capable men.

**HERE ARE REAL
POSITIONS, \$50 TO
\$150 PER WEEK**



View in an Airplane Factory

Aeronautical Instructor, Aeronautical Engineer, Aeronautical Contractor, Airplane Repairman, Airplane Mechanic, Airplane Inspector, Airplane Salesman, Airplane Assembler, Airplane Builder.

AMERICAN SCHOOL OF AVIATION
3601 Michigan Ave., Dept. 1192, Chicago, Ill.

Without any obligation, send me your Free Book, "Opportunities in the Airplane Industry," also information about your Course in Practical Aeronautics.

Name.....
Street.....
City..... State.....

A Sure and Easy Way to Learn Aviation—at Home



A New Job—The Aerial Postman

The study of aviation is almost as fascinating as the actual work. Every lesson is full of interest. That is why it is easy to learn aviation. You do not have to make yourself study—it is like reading an interesting book that tells you things you have always wanted to know. Only one hour each evening will give you the basic training in a surprisingly short time. You need only a common school education.

One of my students, James Powers, Pa., says, "I am indeed surprised that such a valuable Course can be had from such practical men for so little cost."



A New Seven-Passenger Airplane

Personal Instruction by Experienced Men

Men who have had actual experience give you personal attention. They select the lessons, lectures, blueprints and bulletins. They tell you things that are essential in everyday practice. Each lesson is easy to read and understand.

Big Book of Opportunities FREE

Send coupon at left for New Book, just out, "Opportunities in the Airplane Industry." It is interesting and instructive. It will show you many things you never knew before about aviation. Due to shortage of paper we could get only a limited supply of these books—send the coupon before they are all gone.

AMERICAN SCHOOL OF AVIATION
3601 Michigan Ave., Dept. 1192 Chicago, Ill.

If You Want Bigger Pay *Make This* **FREE TEST**



There's a sure way to increase your earning power. And here is such an opportunity. Look into it—you may recognize it as your one chance to earn the biggest money of your life.

ARE you ready for a shock? Then, let me tell you that if you have average intelligence and can read and write, there is a quick and easy way for you to earn enough money to satisfy any average ambition. And after reading this offer, if you do not quickly make more money, you have no one to blame but yourself.

Don't take my word for it. By a simple test—you can make in the privacy of your home—you will know that every word I say is true—or otherwise. The test does not obligate you or cost you one penny. But make it! Then judge for yourself. It has proved to be THE opportunity for thousands. They have found the way to bigger pay—are now earning from five to twenty times as much as formerly. And the beauty of it is they enjoy every minute in the day's work. They are their own bosses.

The thousands who have made this test before you, and who are now making the money you would like to make, are now salesmen. Ninety-five per cent once thought they were not "cut out for selling" that salesmen were "born" and not made. They found it was a fallacy that had kept them in the rut. They discovered that anyone with proper training can sell, and they are making from \$5,000 to \$10,000 a year, because they had the vision to recognize opportunity.

Thousands Have Proved It!

For instance, Ellis Sumner Cook, 20 E. Jackson Blvd., Chicago, left a \$25 a week job and last year made \$9,000! H. D. Miller, another Chicago boy, was making \$100 a month as a stenographer in July 1922. In September, three months later, he was making \$100 a week as a salesman. W. P. Clenny of Kansas City, Mo., stepped from a \$150 a month clerkship into a selling job at \$500 a month. He is making \$850 a month now. M. V. Stephens of Albany, Ky., was making \$25 a week. He took up this training and now makes 5 times that much. J. H. Cash of Atlanta, Ga., exchanged his \$75 a month job for one which pays

him \$500 a month. O. H. Malfroot of Boston, Mass., stepped into a \$10,000 position as a SALES MANAGER—so thorough is this training. All these successes are due to this easy, fascinating and rapid way to master certain invincible secrets of selling.

Simple as A B C

Sounds remarkable, doesn't it? Yet there is nothing remarkable about it. There are certain ways to approach different types of prospects to get their undivided attention—certain ways to stim-

ulate keen interest—certain ways to overcome objections, batter down prejudices, outwit competition and make the prospect act. If you will learn these principles there is awaiting you a brilliant success and more money than you ever thought of earning.

As you will see by the affidavit to the left thousands of reputable selling organizations in America turn to this Association for their Salesmen. We can never take care of all the demands made on us for this

better type of trained salesmen.

Make This Free Test at Once

Don't turn this page until you have clipped the coupon, filled it out, and sent it on its way. The test is contained in a free book, "Modern Salesmanship" which we will gladly send you without obligation. After reading the book through you will ask yourself the questions it brings up. The answers will prove whether this is your opportunity or not. So mail the coupon NOW.

NATIONAL SALESMEN'S TRAINING ASS'N.

Dept. 12-B

Chicago, Ill.

National Salesmen's Training Ass'n.
Dept. 12-B, Chicago, Ill.

Please send me without obligation on my part your free book, "Modern Salesmanship" which will enable me to test my ability at home, and full information about the N. S. T. A. System of Salesmanship Training and Employment Service.

Name.....
Address.....
City..... State.....
Age..... Occupation.....



LEARN Modern Barbering

NEW EASY WAY

Earn \$50 to \$150 EACH WEEK



NO matter what you are now doing, no matter how much you earn, our amazing new system of training for the barbering profession enables you to step into this clean, pleasant, profitable business in a few short weeks. Start right in earning \$50 to \$150 a week.

J. E. McGregor, of New Orleans, writes: "I have never been out of a job since you sent me to the one from the Post Graduate department a year ago. I have saved up a nice bank account. I am glad I learned Modern Barbering with you."
F. Erbat, of Chicago, writes: "I own my own home! I have my own automobile! I am independent! Have made it all since graduating from your school five years ago."

What Moler System Means to You

Our national advertising educates the public to the safety, comfort and economy of Moler post graduate work. It makes you the sought-after barber in your locality. It keeps your chairs filled and turns profits into your pocket. You as graduate are a part of a national institution, which assures steady, profitable business. Through no other method can you get this.

We Equip Your Shop on Easy Terms

If you own your own shop your success is assured. If you are a worker you are assured of steady employment.

Send for This
Free Book
Today

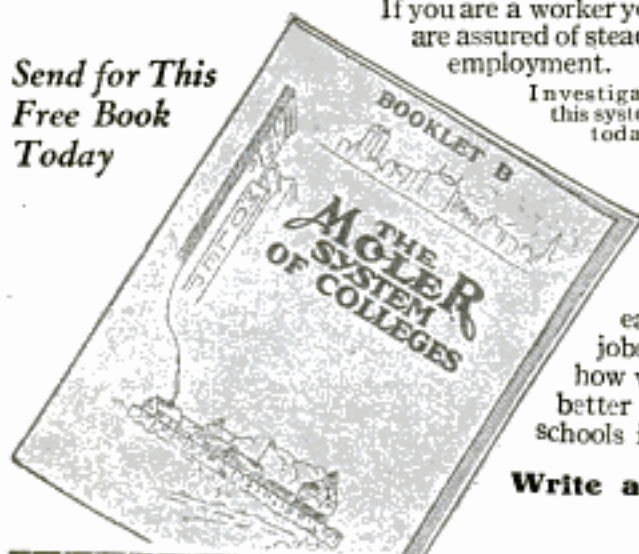

Investigate
this system
today.

We Train You to Be An Expert IN A FEW WEEKS

You want to get ahead—you want to make more money—big money. Our short, practical course gives you a complete training in modern barbering, including the electric hair cutter, the mechanical massage and scientific treatments. It also affords a study, if one desires, on hair and skin—it makes you an expert and expert barbers are always in demand.

Easy Work Always Busy BIG PAY

A trade that enables you to travel and see the world—one that pays in tips and commissions in addition to salaries. Moler System graduates are in great demand and have no trouble in securing good jobs.

Write for Free Book

Our catalog that we mail free tells how we enable you to earn while learning, how we put you into the best city jobs, how we equip your shop on easy payments. In fact, how we take you just as you are, make your life's work easier, better paying and more independent. We have 33 branch schools in leading cities. We have one near you.

Write anyone of the following addresses for our booklet B. Do it today.

MOLER SYSTEM OF COLLEGES

Address Nearest Branch →

Please send me without obligation on my part your Booklet B.

Name.....

Address.....

City..... State.....

The Moler System of Colleges

157 Third Ave. New York, N. Y.	215 Huron Rd. Cleveland, Ohio	23 N. Forsyth St. Atlanta, Ga.
105 S. Wells St. Chicago, Ill.	1045 Cass Ave. Detroit, Mich.	80 N. 2nd St. Memphis, Tenn.
810 N. 6th St. St. Louis, Mo.	1229 17th St. Denver, Colo.	910 Main St. Dallas, Texas
544 Main St. Kansas City, Mo.	110 S. 14th St. Omaha, Nebr.	712 Franklin Ave. Houston, Texas
706 E. 4th St. Cincinnati, Ohio	513 E. Water St. Milwaukee, Wis.	430 W. Houston St., San Antonio, Texas
	1005 Canal St. New Orleans, La.	



Would you like to earn
\$5,000
 or more a year? Be an
AUTO EXPERT!

You may
 have
 your
 choice
 of
 these
 jobs

Turn Your Idle Hours Into Golden Dollars

You want big money—a real job. My training fits you to get both. You don't have to leave home; you don't have to give up your present job; you don't have to risk a single dollar. My system of home training will fit you for a great money-making position in a few short months. All you need to become a master automotive expert is ability to read and write—and ambition to get ahead. I'll do the rest—in fact, when you enroll with me it's just like having

Your Success Guaranteed

Be trained in the only school of its kind headed by a **Practical, Experienced Automotive Expert**. I know the bigness of the field. I know what every man has to know to win. I know how to point out the way to success—and big money. 14,000,000 passenger cars need attention, 2,000,000 trucks demand service. Farmers insist on experts for their tractor repairs. Aviation engineers make enormous salaries and the industry is just starting. There are wonderful positions open in every phase of automotive work—thousands of them—waiting to be filled. You can have your choice if you "know how."

Automotive Expert
\$3,000 to \$8,000



Automotive Electrician
\$3,600 to \$10,000



Manager or Owner
\$3,000 to \$12,000



MEN WANTED!

Thousands of big-pay jobs open right now, all over the U. S. Our Employment Service **FREE** to both students and graduates, reaches employers in every part of the Country. Look at this:

Master Mechanics	\$3,000-\$8,000
Electrical Experts	\$3,600 up
Garage Manager	3,000 up
Battery Expert	2,400 up
Expert Welder	2,400 up
Salesman	3,000 up
Tractor Engineer	2,400 up

My graduates earn money fast enough to go into business. Own your own Garage, Battery Station, Lamination Service, Repair or Welding Plant

LEARN AT HOME THE C.A.I. JOB-WAY

Auto Repairing Automotive Electricity Vulcanizing Welding • Battery

Give me an hour a day and I'll qualify you to pull down a real income. My original C. A. I. Job-Way System of training is the only practical way to learn automotive work. Anyone can understand my lessons. Every lesson makes you expert on some particular job. Experts get the big pay. I can't begin to tell you all of the C. A. I. advantages here. Write today for

This Great Book FREE

It tells all about the most gigantic industry in the world. It tells you how to become a big man in that industry. This book shows exactly what the "Job-Way" system is. It explains my big

FREE TOOL KIT OFFER

It tells of the success which C. A. I. has brought to others. Don't send a penny. Use the postal card or mail the coupon below.

Don't wait, mail the Coupon Today

CHICAGO AUTOMOTIVE INSTITUTE

J. R. Bayston, M. S. A. E., Pres.

Dept. 602, 536 South Clark Street, CHICAGO, ILL.



MAIL Today

THE
\$5,000 COUPON
 USE IT NOW

J. R. Bayston, M. S. A. E., Pres.
 Chicago Automotive Institute
 Dept. 602, 536 S. Clark St., Chicago, Ill.

Without a penny of expense or the slightest obligation, please send me Free Book about your rapid course in Automotive Master Mechanics, and Free Tool Kit offer. Explain your money-back guarantee. I want to see a Free Lesson, too.

Name.....

Address.....

BOYS

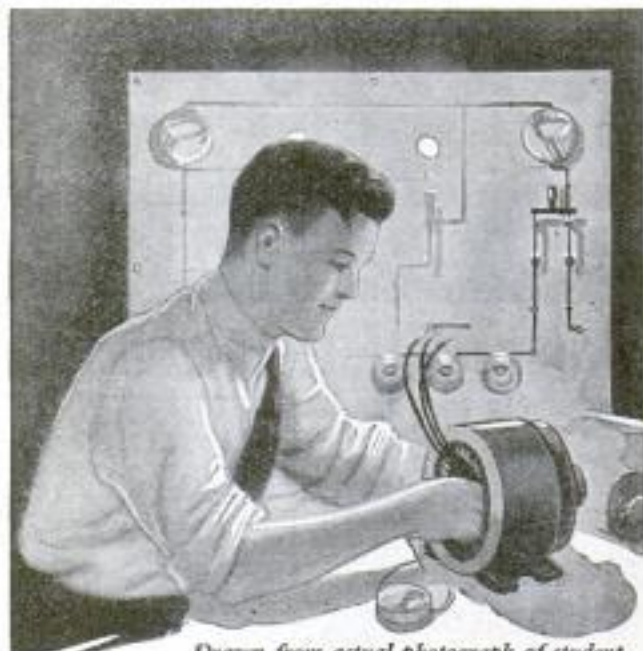

Drawn from actual photograph of student doing spare time electrical work

Learn Electricity Make Big Money

How would you like to earn two or three dollars every evening after school and prepare yourself for a fine big job at the same time? Here's the opportunity of a lifetime for you fellows who like Electricity. Begin right now to prepare yourself for a regular man's size job in this fascinating field. Your chances for a big success are simply wonderful—the pay is big (\$70 to \$200 a week) and advancement comes swift and sure.

I will Train You at Home

With my easily learned, spare time Electrical Course I will train you at home like I have trained hundreds of other boys who are now big successful men. It will not interfere with your school work and you can earn more than the small cost of the course doing odd electrical jobs in your spare time. The Course pays for itself. I will show you how to get this work and how to do it. Some of my boy students make \$10 to \$15 a week this way.

Tools, Apparatus and Radio Course—FREE

Send me the coupon below and I will tell you all about the big outfit of tools, apparatus and instruments and a new Radio Course that I am giving to my students for a limited time. I will send you my big interesting Electrical Book and a sample lesson, too—all Free. You will be tickled with the things I will send you Free. Mail the coupon right now.

L. L. COOKE, Chief Engineer
Chicago Engineering Works
Dept. A-12 CHICAGO

Use This "FREE OUTFIT" Coupon

L. L. COOKE, Chief Engineer,
Chicago Engineering Works,
Dept. A-12 2150 Lawrence Avenue, Chicago

Send me your Free Outfit Offer, your big Electrical Book, Sample Lesson and particulars of your Electrical Course and Free Radio Course. This will not obligate me in any way.

Name.....

Address.....

This Coupon only for use of boys 15 years old or more.

Look What This Boy Is Doing

"Although the School term is coming to a close, and I am pretty busy with my examinations, I manage to keep up with my electrical studies and work.

I guess I forgot to tell you I am now in business for myself. Am doing fine, but owe it all to you. If it had not been for your Course, I, being under age, could not have secured my license in this town. But I get it, and now have all the work I can do, averaging \$20 to \$30 a week, thru spare time work.

I went out on a job tonight after school, on which I made \$3 and brought home another on which I made \$2.50—\$5.50, for 4 hours' work and so material furnished by me."

ROGER SMITH,
1216 Chestnut St.,
Greenville, N.C.

TEN-TEN-TENNESSEE!



THE TENOR BANJO

No Previous Musical Knowledge Necessary—Quick—Easy—Positive
Prof. Barker's method is so simple and easy that you quickly play any and all of the popular dance hits just as you have heard them played in dance or orchestra, on the stage—everywhere.
JAZZ NEW ORCHESTRA STYLE
JAZZ
NEW EASY WAY—FUN GALORE

Just Mail a Post Card for Details of our remarkable FREE Tenor Banjo Offer—simply write: "I am interested"—BUT DO IT TODAY.

First Hawaiian Conservatory of Music, Inc.

Desk 60
233 Broadway
(Woolworth Bldg.)
New York City

Special courses under famous teachers:
Hawaiian Guitar
Viola - - Double
Instrument Free

FREE
A Beautiful
Tenor
Banjo

STAMMER

If you stammer attend no stammering school till you get my large FREE book entitled "STAMMERING, Its Origin and the Advanced Natural Method of Cure," bound in cloth and stamped in pure gold. Ask for special tuition rate and a FREE copy of "The Natural Speech Magazine." Largest, best equipped and most successful school in the world for the cure of stammering, stuttering, etc. No sing-song or time beat. Write today. The North-Western School, 2317 Grand Ave., Milwaukee, Wis.

Learn Watchwork, Jewelrywork and Engraving.

A fine trade commanding a good salary, and your services are always in demand. Address **HOROLOGICAL**, Dent. P. Bradley Institute, PEORIA, ILL., for our latest catalog.

WRITE JOKES

EARN FROM \$50 TO \$150 PER WEEK

Writing jokes, epigrams and humorous stories for publications. Tremendous demand for material. Our short course in Humor Writing teaches you to write humorous material that sells. Learn in your spare time—earn in your spare time. Complete marketing plan and markets furnished. Write for full particulars

AMERICAN INSTITUTE OF HUMOR
Office J, 414 Park Bldg., Cleveland, Ohio

PIMPLY SKIN

made WELL

When a few applications of this wonder-working lotion has cleared faces of pimples, blackheads, acne eruptions on the face or body, barbers itch, eczema, enlarged pores, oily or shiny skin, you can realize why CLEAR-TONE has been tested and approved in over 100,000 Test Cases. The simplicity of the treatment, and The Story of How I Cured Myself are all explained in my free booklet, "A Clear-Tone Skin." Write for your copy today and learn of the results gotten by thousands of men and women.

E. S. GIVENS, 128 Chemical Bldg., Kansas City, Mo.

AUDEL'S GUIDES
ANSWER YOUR
QUESTIONS IN A
PRACTICAL WAY

YOUR FOREMAN
WILL QUICKLY
NOTICE THE SU-
PERIOR QUALITY
OF YOUR WORK

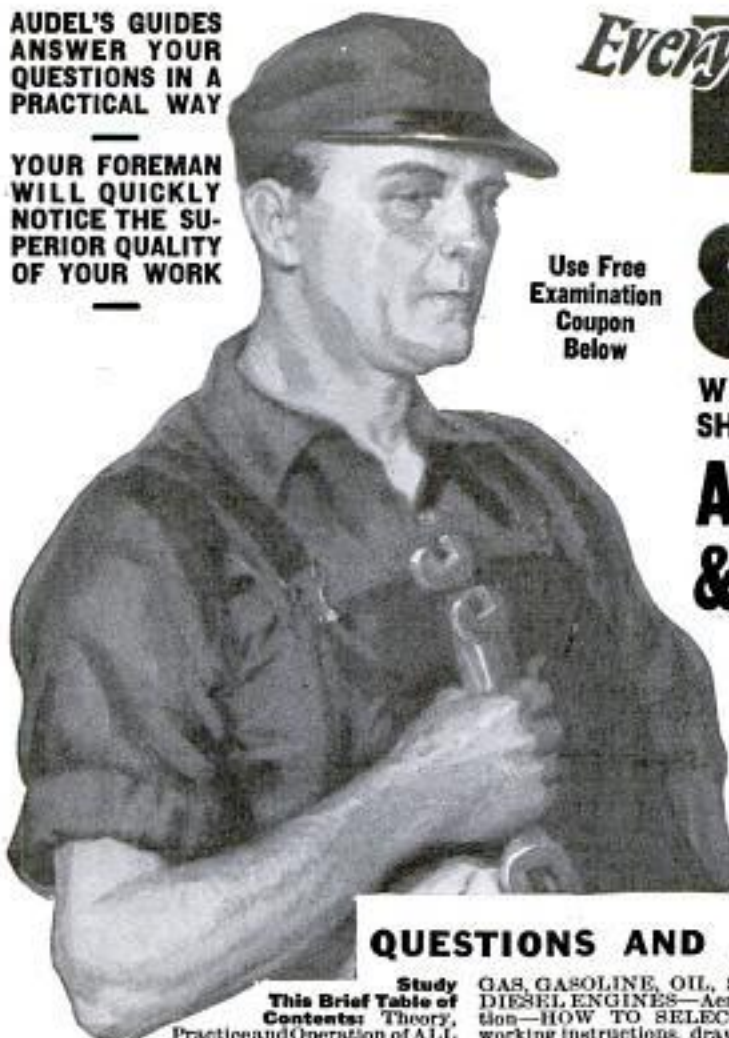

Use Free
Examination
Coupon
Below

Every ENGINEER & MECHANIC

WILL FIND PRACTICAL INFORMATION ON
SHORT CUTS AND MODERN METHODS IN

AUDEL'S ENGINEERS & MECHANICS GUIDES

Every Engineer, Mechanic and Electrical Worker will welcome this new master set. It will answer your problems.

It will help you with your daily work.—A sure source of advancement and higher pay. Complete up-to-date information that is thoroughly and easily explained on every branch of modern engineering and electrical practice. The entire set costs you only twelve dollars—knowledge and instruction that has cost thousands of dollars and years of time—yours for \$12.00—\$1.00 a month.

QUESTIONS AND ANSWERS TEACH YOU QUICKLY

Study This Brief Table of Contents:

Theory, Practice and Operation of ALL Steam Engines, Valve Motions—VALVE SETTING: complete information on All engines and pumps—CORLISS ENGINES and the Theory, Construction and Operation of all Steam Engines, including UNIFLOW and POPPET VALVE ENGINES, and LOCOMOBILES—Locomotive-Marine Engines; Turbines; Rotary Engines—the Indicator—Labelations—PRACTICAL MANAGEMENT. How to use Indicator—

GAS, GASOLINE, OIL, SEMI- and FULL DIESEL ENGINES—Aeroplanes and Aviation—HOW TO SELECT AN ENGINE, working instructions, drawings on STEAM ENGINE DESIGN, including rules and formulae. Theory and Construction of ALL Steam Boilers: Heat-Combustion; Fuel and Flue Gas Analysis—CO₂ recorders—Characteristics of Boilers—Materials—Construction of all types of Boilers. (THE LATEST PRACTICE.)—Boiler Construction—Mechanical Stokers—Oil Burners—Setting—Chimneys—Mechanical Draught—HOW TO SELECT A BOILER—Complete instructions and draw-

ings on BOILER DESIGN based on A. S. M. E. BOILER CODE—OPERATION, including installation, FIRING; care and repair of Steam Boilers—Pipes, Fittings and Pipe Fitting—Heating and Ventilation—Refrigeration—Cooling Towers—Condensers—Distilling Apparatus—Elevators—Cranes and Hoisting Machinery—Ropes and Cables—Splicing—electric wiring in ALL branches; compendium of practical electrical engineering as an aid for engineers and electricians in obtaining a license—57 chapters—ready reference index, covering entire field of Modern Electricity.

AUDEL'S MASTER SET 8754 ILLUSTRATIONS
4750 PAGES

POCKET SIZE—FLEXIBLE COVERS

TURN SPARE TIME INTO CASH
BY STUDYING THE GUIDES

Take a volume with you where ever you go. They can be easily slipped in and out of your coat pocket without damage. Study the questions and answers. Fifteen minutes a day study will increase your pay.

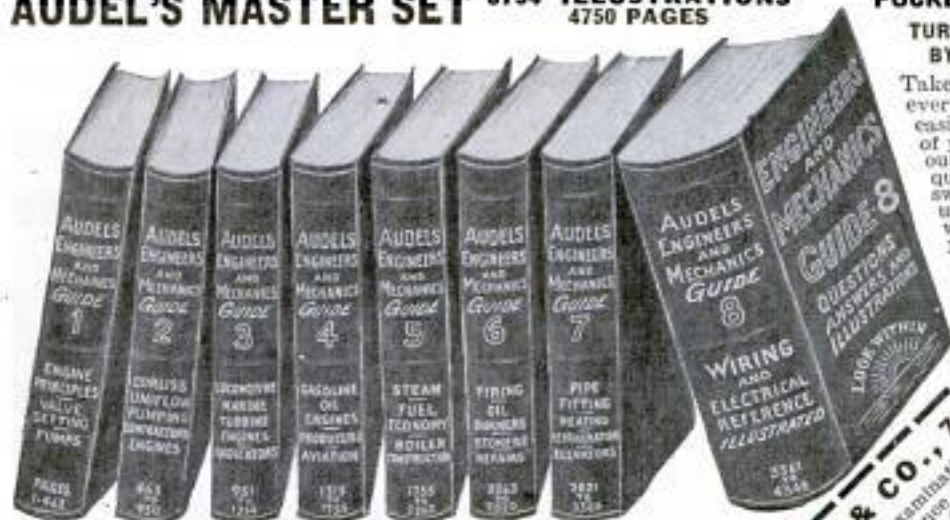

FREE EXAMINATION

Not a cent to pay until you see the books. No obligation to pay unless you are satisfied. Send coupon now—today and get this new master set for engineers.

Pay only \$1 a month.

THEO. AUDEL & CO., 72 Fifth Avenue, NEW YORK CITY

Please submit me for free examination. AUDEL'S MASTER SET FOR ENGINEERS AND MECHANICS. Ship at once prepaid, the 8 numbers, total cost \$12.00. If satisfactory, I agree to send you \$1 within seven days and to further mail you \$1 each month until paid.

Name.....
Occupation.....
Employed by.....
Home Address.....
Reference.....
P. M. Feb. 24



This Man Earns \$3500 to \$5000 a Year

—WORKING WITH A DENTIST—
THREE MONTHS' TRAINING
QUALIFIED HIM TO DO IT

There are thousands of these positions awaiting trained men in this profitable profession. After just a few months of specialized training hundreds of men will have become full-fledged members of the dignified profession of

MECHANICAL DENTISTRY

They will have the technical knowledge and skill to enable them to earn several thousand per year. You can be among them. 2500 more Dental Mechanics are needed right now and the Dental Profession is constantly calling for graduates of the four great schools of this institution; salaries from \$35 to \$45 a week to start, with advancement up to \$125 a week.

FREE PARTIAL SCHOLARSHIPS

In order to meet this urgent demand for the men we train, we are offering for a limited time Free Partial Scholarships. You will want to get in on this exceptional offer—so don't delay. NOW is the time.

JUST COMPARE

Compare the unusual opportunities this profitable professional trade offers with what you are now doing—the earnings, the pleasant, dignified occupation. Compare also our ability to train you and put you in touch with the right opportunity—our four large, well-equipped schools, over 30 years of experience in this one line, our wide acquaintance with the Dental Profession throughout the nation!

SEND FOR CATALOG AND SCHOLARSHIP OFFER

Describes the field and why the demand. Shows how students "Learn by Doing" actual work through practical, individual instruction, day or evening sessions. Shows how you can "Earn while Learning."

BODEE DENTAL INSTITUTE

136 West 52d Street, NEW YORK

PHILADELPHIA BUFFALO BROOKLYN
1305 No. Broad St. 1226 Main St. 15 Flatbush Ave.

BODEE DENTAL INSTITUTE: Without obligation to me send me a Free Copy of your catalog and complete details of the Free Partial Scholarship Plan No. 2.

Name

Address

We Teach COMMERCIAL ART

Meyer Both Company, the largest Commercial Art Organization in the World

offers you an unusual opportunity for practical training, based upon twenty-three years of success. This nationally known organization each year produces and sells to advertisers over 15,000 commercial drawings. Meyer Both instruction is the difference between successful fact and experimental theory. This well paid profession equally open to men and women. Home study instruction.

Get Facts Before You Enroll in Any School

Ask the Advertising Manager of the leading newspapers in your city, anywhere in the United States, Canada, England or Australia about the Meyer Both Company—let them tell you about us. Write for our illustrated book telling about the success of our students—for one-half the cost of mailing—four cents in stamps.

MEYER BOTH COMPANY Department of Art Instruction

Michigan Ave. at 26th St., Dept. 16 CHICAGO, ILL.

Note—To Art and Engraving Firms: Secure practical artists among our graduates. Write us.

LEARN WATCH REPAIRING

Be a watchmaker—you can learn this profitable trade by correspondence in a few weeks in your own home by the DeSelms Chart System. After you complete the course you will know a watch from A to Z. You will know just what the matter is and how to repair one. When you graduate you will be a practical watchmaker and repairer and competent to fill any position. Positions for our graduates. Ask for our free Book. It explains our system and terms.

THE DeSELMS WATCH SCHOOL
23 Perry Street ATTICA, INDIANA



PIANO JAZZ

By Note or Ear. With or without music. Short Course. Adult beginners taught by mail. No teacher required. Self-Instruction Course for Advanced Pianists. Learn 67 styles of Bass, 180 Syncopated Effects, Blue Harmony, Oriental, Chime, Movie and Cafe Jazz, Trick Endings, Clever Breaks, Space Fillers, Sax Sturs, Triple Bass, Wicked Harmony, Blue Obligato, and 247 other Subjects, including Ear Playing and Musical Invention. 110 pages of REAL Jazz, 25,000 words. A Postal brings our FREE Special Offer.

Waterman Piano School, 258 Soerha Theatre Bldg., Los Angeles, Cal.

STAMMER NO MORE

Kill the fear of stammering. Re-education the key. The widely famed Hatfield Method fully outlined in an accurate, dependable, worthwhile book—"HOW TO STOP STAMMERING." It has inspired thousands. Free copy today.

THE HATFIELD INSTITUTE, 109 N. Dearborn, Chicago, Ill.



You've heard your neighbor praise the Pathfinder, the wonderful weekly news and story magazine with over half a million subscribers. Unbiased digest of national and world affairs. Check full of just the kind of reading you want. Fun, fashions, question box, books, health—entertainment and instruction for all. Exciting serial and short stories. Send 15c (coin or stamps) today for this big \$1 paper 13 weeks. Money back if not satisfied. PATHFINDER, 552 Langdon St., Washington, D.C.

"How I Became Popular Overnight!"

"They used to avoid me when I asked for a dance. Some said they were tired, others had previous engagements. Even the poorest dancers preferred to sit against the wall rather than dance with me. But I didn't 'wake up' until a partner left me standing alone in the middle of the floor.

"That night I went home feeling pretty lonesome and mighty blue. As a social success I was a first-class failure. Then I saw your advertisement in a well-known magazine. At first I wouldn't believe that you could teach by mail because I always had the idea that one must go to a dancing class to learn. But I figured I could risk 10c—especially since you guaranteed to teach me.

How Dancing Made Me Popular

"Being a good dancer has made me popular and sought after. I am invited everywhere. No more dull evenings—no bitter disappointments! My whole life is brighter and happier. And I owe it all to Arthur Murray!

"I was astonished to see how quickly one learns all the latest steps through your diagrams and simple instructions. I mastered your course in a few evenings and, believe me, I surely did give the folks around here a big surprise when I got on the floor with the best dancer and went through the dance letter perfect. Now that I have the Murray foundation to my dancing I can lead and follow perfectly, and can master any new dance after I have seen a few of the steps.

"My sister's family have all learned to dance from the course I bought from you, and it would do your heart good to see how fine her little kiddies dance together after quickly learning from your new method of teaching dancing at home without music or partner."

Learn Any Dance in a Few Hours

Whether you want to learn the Fox Trot, One Step, Waltz, or any of the new dances, you won't have any trouble in doing it through Arthur Murray's new Method. More than 90,000 people have learned to dance by mail and you can learn just as easily.

Arthur Murray is the world's foremost authority on social dancing. Through his new improved method of teaching dancing by mail, he will give you the same high-class instruction in your own home that he would give you if you took private lessons in his studio and paid his regular fee of \$10 per lesson.



Posed by Ann Forest, famous movie star, and Arthur Murray, the world's foremost dancing instructor.

Five Dancing Lessons Free

So sure is Arthur Murray that you will be delighted with his amazingly simple methods of teaching that he has consented, for a limited time only to send **FIVE FREE LESSONS** to all who sign and return the coupon.

These five free lessons are yours to keep—you need not return them. They are merely to prove that you can learn to dance without music or partner in your own home.

Write for the five lessons today—they are free. Just enclose 10c (stamps or coin) to pay cost of postage, printing, etc., and the lessons will be sent to you. You will receive: (1) The Secret of Leading. (2) How to Follow Successfully. (3) How to Gain Confidence. (4) A Fascinating Fox Trot step. (5) A Lesson in Waltzing. Don't hesitate. You do not place yourself under any obligation by sending for the free lessons. Write today.

ARTHUR MURRAY

Studio 983, 290 Broadway, New York

ARTHUR MURRAY, Studio 983
290 Broadway, New York City

To prove that I can learn to dance at home in one evening you may send the **FIVE FREE LESSONS**. I enclose 10c (stamps or coin) to pay for the postage, printing, etc.

Name.....

Address.....

City..... State.....

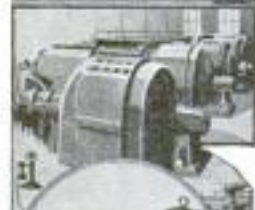

Learn By Doing!

Every phase of all branches of

ELECTRICITY

Taught By Actual Practice

In America's foremost institution for trade training.

Established 1902

No Books Used

Individual Instruction

Start Any Day

A SPECIAL and SEPARATE Course in Ignition, Auto Lighting and STARTER Systems.

Write for FREE 64-Page Catalog

THE NEW YORK ELECTRICAL SCHOOL
44 West 17th Street
NEW YORK CITY



Eliminate the Electrician

Everybody's Electrical Handbook

(new edition) tells how to safely do wiring for bells and lighting, also repair electrical appliances. 90 per cent of trouble in appliances can be fixed in a few minutes, yet you pay dollars to have it done. This is the most complete book on everything electrical in the home.

Send No Money Just your name and address, pay postman \$1.00 plus a few cents postage, or send dollar bill with order. Money back if not satisfied. Circular Free.

HOME BOOK CO., 388 EC Arcade Bldg., Cleveland, Ohio

MUSIC LESSONS FREE

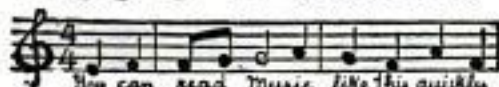

You can read Music like this quickly

IN YOUR OWN HOME

Piano, Organ, Violin, Mandolin, Guitar, Banjo, etc. Beginners or advanced players. One lesson weekly. Illustrations make everything plain. Only expense about 2c per day to cover cost of postage and music used. Write for FREE booklet which explains everything in full.

AMERICAN SCHOOL OF MUSIC, 51 Lakeside Building, CHICAGO

"THERE'S MONEY IN IT"

AT HOME

LEARN TELEGRAPHY

AT HOME

MORSE AND WIRELESS

TEACH YOURSELF

In half usual time, at trifling cost, with the wonderful Automatic Transmitter, THE OMNIGRAPH. Sends unlimited Morse or Continental messages, at any speed, just as an expert operator would. Adopted by U. S. Government, and leading Universities, Colleges and Telegraph Schools. 3 Styles. Catalog free.

OMNIGRAPH MFG. CO., 16-22 Hudson St., NEW YORK

If you own a Radio Phone Set—and don't know the code—you are missing most of the fun.

WANTED—RAILWAY MAIL CLERKS

\$133 to \$192 a Month for Life

Every second week off with full pay—no "lay offs" because of strikes, poor business, etc.—sure pay—rapid advancement to higher positions. City and country residents stand same chance. Common sense education sufficient—no political influence.

TRAVEL—SEE YOUR COUNTRY

DON'T DELAY—ACT AT ONCE

Mail Coupon today—sure. Every day's delay means so much less chance of appointment from the next examinations—write at once.

FRANKLIN INSTITUTE, Dept. F180, ROCHESTER, N. Y.

Take this First Step for
a U. S. Government Job
Use Coupon Before You Lose It

COUPON

FRANKLIN INSTITUTE, Dept. F180, Rochester, N. Y. Kindly send me, entirely free of charge, (1) A full description of the position checked below; (2) Sample examination questions; (3) Free copy of illustrated book "Government Positions and How to Get Them"; (4) A list of U. S. Government Jobs now obtainable; (5) Tell me how to get the position here checked.

..... Railway Postal Clerk (\$1600 to \$2300) Customs Positions (\$1100 to \$2000)
..... Post Office Clerk (\$1400 to \$1800) Internal Revenue (\$1100 to \$2100)
..... City Mail Carrier (\$1400 to \$1800) Rural Mail Carrier (\$1000 to \$2600)
..... Income Tax Auditors..... (\$2000 to \$3000)

Name



This Dental Laboratory Expert earns \$20 a day!

What's the use of training for the old, overcrowded trades? If you're going to prepare for big-salaried jobs or a profitable business of your own GET INTO THE NEWEST PROFESSION — "Laboratory Dentistry." Biggest opportunity for success of the century, because there are ten times as many jobs as men to fill them, because there are a dozen cities crying for Laboratories for each EXPERT capable of operating one!

60,000 DENTISTS NEED LABORATORY WORK!

Only a few hundred Laboratories in all the U. S.—most of them in Chicago and New York. Dentists can't afford to do their own mechanical jobs. They can buy the services of a Laboratory Expert at \$3.00 an hour and sell their own time at \$6 to \$15 an hour. Dentists will encourage you to earn mechanical work, start a "Lab" of your own, give them quicker service than sending to Chicago or New York. Dentists can't wait and keep their patients waiting.

OPEN a LABORATORY of your OWN!

Joe Wilk of Chicago started a couple of years ago ALONE. Today he employs 60 Experts and his Laboratory is one of the biggest in the U. S. Boos in Minneapolis is reported to employ 125 men and to clear \$40,000 to \$50,000 a year. Start with the same tools you use in this big SCHOOL-LABORATORY. Start your own Laboratory with as little as \$100 investment. No limit to profits you can make in this wonderful new profession.

INTERESTING CATALOG—FREE!

Right this minute we can place 150 Dental Laboratory Experts in locations where they can make \$5,000 to \$20,000 a year. But you can't cash in, take advantage of these OPPORTUNITIES until you're TRAINED. Catalog tells you how quickly and easily you can get ready, how hundreds of others have SUCCEEDED! Tells you how you learn in few months BY DOING ACTUAL LABORATORY JOBS under world's greatest Mechanical Dentists! Brings you FREE R. R. Fare offer and other big inducements. Write for free Catalog today!

McCarrie School of Mechanical Dentistry

Dept. 501, 34 W. Lake St., Chicago

McCarrie School of Mechanical Dentistry, Dept. 501, 34 W. Lake St., Chicago

Without obligation, please send me your Free R. R. fare offer and free catalog with complete information about how I may become a Dental Laboratory EXPERT.

Name.....
St. No. or R. F. D.....
City.....State.....

Easiest, pleasantest work you ever saw! Your own boss, money and success yours from the very beginning. You can start with a "shoe-string." We prepare you in a few months to run a business of your own, to do any job. Common schooling, ability to use your fingers ALL YOU NEED!

Jobs at \$60 to \$125 a Week!

In a business where there are many times as many jobs as Experts, salaries are high; hours are easy, opportunities are everywhere! McCarrie-trained Experts always get the preference. Dentists everywhere recognize the high-standing of our graduates. No books here—learn with tools and instruments. Start quick—get ready in 12 weeks for your big opportunity! Mail Coupon today!

RUBBER PLATES

Learn to make partial upper or lower plates with soldered, cast or wire clasps, with palatal bars; with lingual bars. McCarrie-trained Experts learn to make full rubber plates of every type, including Vulcanite base-plates, buttoned gums, carved gums, etc.

CROWNS

Here's only a small part of your practical training in Crown-work: Two-piece, seamless, open-face, Richmond, cast-base porcelain, Carmichael, split-pin, carved (swaged) cusp, cast cusp, etc.

BRIDGE WORK

Complete training in both fixed and removable bridge-work. Interchangeable teeth, gold dummy, Sanitary, porcelain dummy jobs—Roach, Gilmore, Bischoff and all forms of cast-clasp work is taught—not with books but in actual Laboratory.

METAL BASE DENTURES

Cast bases of Aluminum, gold, Watt's metal, etc. are included in your training. Both centrifugal and air pressure casting machines are used. Free Catalog contains complete list of subjects in course.

FREE!
R. R. Fare to Chicago

EARN while you LEARN!

Day students make all or part cost of course by part-time night work. Night students can find plenty of good jobs in Chicago "to see them thru." We'll help you!

Are You the Boss? —or Are You Riley?

THE BOSS gives the orders—Riley takes them and does what he is told. Both started the same, had equal ability to begin with. Riley works harder than the BOSS and gets less money. What is the answer?

Training did it. Your brain is an engine that needs fuel. Study and training supply the fuel that makes it go. And when you mix brains with your work you **SIMPLY CANNOT HELP BUT GET AHEAD.**

Be a Contractor or Builder

Fit yourself for a big job in the Contracting or Building business. Train for it right at home. The Course is easy to learn, is simple but thorough, is taught by experts who have made it their life study. We teach you Estimating, Blue Print Reading, Building Regulation, Use of Steel Square, Water Supply and Drainage, Heating and Ventilating, etc.

The cost is low, terms easy, results quick and sure. Our money-back guarantee insures satisfaction. Thousands are earning **BIG MONEY** in this business today. Get ready to get yours. Fill out the coupon now. Check the Course you are interested in. It costs you nothing but a 2c stamp for full information. It will mean much for your future.

American School

Dept. G-274 © A. S. 1923

Drexel Ave.
& 58th St.
CHICAGO



"Riley—Take up These Bricks"

"All Right Boss"

AMERICAN SCHOOL,
Dept. G-274, Drexel Ave. & 58th St., Chicago
Send me full information on the subject checked.

- | | |
|-------------------------------------|--------------------------|
| .. Architect | .. Business Law |
| .. Building Contractor or Carpenter | .. Lawyer |
| .. Automobile Engineer | .. Machine Shop Practice |
| .. Automobile Repairman | .. Photoplay Writer |
| .. Civil Engineer | .. Mechanical Engineer |
| .. Advertising Manager | .. Shop Superintendent |
| .. Business Manager | .. Employment Manager |
| .. Financial Manager | .. Steam Engineer |
| .. Sales Manager | .. Foremanship |
| .. Cert. Pub. Accountant | .. Sanitary Engineer |
| .. Accountant & Auditor | .. Surveyor (& Mapping) |
| .. Bookkeeper | .. Telephone Engineer |
| .. Draftsman & Designer | .. Telegraph Engineer |
| .. Electrical Engineer | .. High School |
| .. General Education | .. Fire Insurance Expert |
| .. Personal Analysis | .. Wireless-Radio |
| | .. Undecided |

Name

Address

Occupation

Learn to Write

I Teach by Mail

I can make a good penman of you at your home during spare time, no matter where you live or how poorly you now write. My simplified system has shown thousands the way to good penmanship during the past twenty-five years—it CAN and WILL do the same for YOU.

My beautifully illustrated 32-page Book

"How to Become a Good Penman" FREE!!

It contains many beautiful specimens of penmanship showing what others have accomplished by the Tamblin System, with testimonials and general information about our courses. (Your name elegantly written on a card if you enclose stamp for postage.) Ladies taught successfully as men. Write Today. Address

F. W. TAMBLIN
418 Ridge Bldg. Kansas City, Mo., U. S. A.

FREE

\$20 Fine Tone Musical Instruments

We have a wonderful new copyrighted system of teaching note music by mail. To first pupils in each locality we will give free a \$20 superb Violin, Tenor Banjo, Ukulele, Hawaiian-Guitar, Banjo, Mandolin, Banjo-Ukulele, Banjo-Mandolin, Cornet or Banjo-Guitar absolutely free. Also teach Piano and Organ. Very small charge for lessons only. Four lessons will teach you several pieces. Over 100,000 successful players. We guarantee success or no charge. Complete outfit free. Write today, Dept. 168. No obligation.

SLEIGERLAND SCHOOL OF MUSIC, 1815 Orchard Street, CHICAGO, ILLINOIS

"BECOME A LIGHTNING TRICK CARTOONIST"

HAVE MONEY CRACK TALKING. SEND ALSO FOR SHARPER PROGRAM OF TRICK DRAWINGS WITH INSTRUCTIONS BY A PROFESSIONAL CARTOONIST SATISFACTION GUARANTEED. CIRCULAR FREE. BALDA ART SERVICE, Q1 OSHKOSH, WIS.

LEARN ENGINEERING

Great Demand for Practical-Technical Men. Big Salaries. Wonderful Opportunities. Beautiful New Building. Extensive Laboratory and Shop Equipment. Not a trade school but a Practical-Technical College. Faculty of Trained Experts. 3 mo. courses in Practical Electricity and Steam. 1 and 2 year courses in Mechanical and Electrical Engineering. Architectural, Structural, Mechanical Drafting. Day and night. Degrees awarded. 22nd year. Write for catalog D.

FINLAY ENGINEERING COLLEGE, Kansas City, Mo.

STOP FORGETTING

Make Your Mind an Index from which you select facts, figures, names, faces. Develop concentration, self-control, overcome bashfulness, forgetfulness.

Write today for **FREE** memory and concentration test and illustrated booklet, "How to Remember."

PROF. HENRY DICKSON
Dept. 7052 Evanston, Ill.

LEARN WATCH REPAIRING

You can learn by our modern and original system of instruction every part of the **Watch Repairing Trade** at home as good or better than at a shop. You can earn money while learning and secure a well paying position or start in business after completing our course of instruction. Good watch repairers are always in demand and earn from \$30 to \$70 per week. For particulars apply to the **Wisconsin School of Watch Repairing**
166 Mason St., MILWAUKEE, WIS.

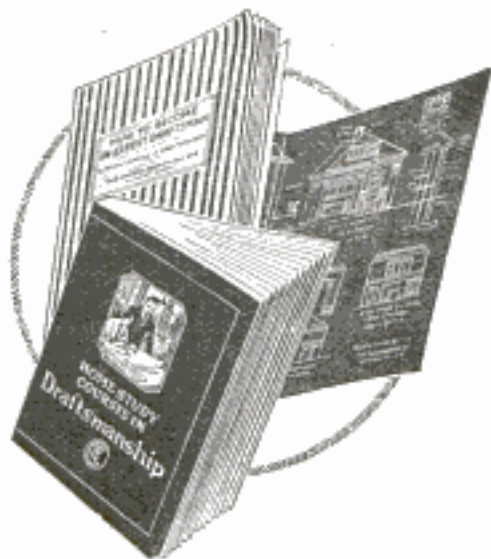

Send for

FREE Trial Lesson in DRAFTING

Just sign and mail the coupon and we will send this Trial Lesson which will show you how well prepared you are to take up Drafting. While other schools ask you to enroll and pay a fee before you receive instruction, we send you this free lesson first. Before you pay—before you even decide about enrolling—you can test your ability and also learn about the Chicago Tech. Method of teaching Drafting by mail. Send today—no money, only the coupon.

Big Salaries for Experts

Everywhere there is a call for capable Draftsmen—men who can take hold of important work and see it through. Men of this kind are always in demand at high salaries by railroads, manufacturers, architects, contractors, electrical works and

other big industries. Chicago Technical training will make you the man wanted for the big positions that are open to highly trained men. Don't waste time in a small job with no future when such an opportunity as this is offered.

Chicago Tech. Will Train You By Mail in Your Spare Time

Soon after enrolling salary increased \$225 a month.

A. S. Ross

Chicago Tech. training increased my salary 300%.

R. L. Cary

Was laborer, now manager because of Chicago Tech. training.

J. A. DaCosta

The Chicago Tech. Home Study Course will make you expert in any branch of Drafting in your spare time at home. Just give a few hours weekly and you prepare for advancement and a high salary.

Get This Practical Instruction

Chicago Tech. instructors are practical engineers. They give you the kind of training that commands the highest pay. No time put in on useless theories. Every lesson deals with actual problems and you are constantly under the personal direction of men who give you the kind of knowledge that counts for most. The success of Chicago Tech. men proves that this course is the short cut to big pay in Draftsmanship.

To Employers

Chicago Tech. men are practical. Write to us when you need Draftsmen.

FREE Drawing Outfit



Students enrolled with Chicago Tech. for home study in Drafting receive this complete Drawing Outfit (retail price \$25) with no extra charge or credit on fees if they have outfits. A regular full size outfit—same as used by practical draftsmen and engineers.

SEND COUPON

Mail the coupon and get the Free Trial Lesson—also catalogs and full information about the Chicago Tech. Method of teaching Drafting by mail. No cost to you—no promise or obligation. Send today.

CHICAGO TECHNICAL COLLEGE

Dept. 230, Chicago Tech. Bldg.
118 East 26th St., CHICAGO, ILL.

Without cost or obligation on me please send instructive matter about opportunities in line I have marked with "X."

Drafting. (The Big Salary Course.) No experience necessary. Free Lesson sent now.

Building Trade Course. For men in the building lines.

Name.....

Address.....

Post Office.....

State.....

CHICAGO TECHNICAL COLLEGE Dept. 230, Chicago Tech. Bldg.
118 East 26th St., Chicago, Ill.

BE A HOTEL EXECUTIVE

EARN \$2500 to \$12,000 PER YEAR



You Can Quickly Secure A Good Hotel Position

Constant requests like the above from leading hotels, asking for men and women trained to give real service, prove that S.B.T.I. graduates and students are making good. They are occupying responsible positions in America's leading hotels. Many more are wanted. Will you put yourself in line?

Will You Be A Trained Hotel Employee?

You can quickly qualify in a few weeks of your spare time through the Hotel Operation and Management Course, consisting of a series of lessons, thorough, concise, easily understood, wonderfully interesting. A position is waiting when you graduate, or even before. Good salary, pleasant surroundings, board and often room furnished. Trained employees earn rapid advancement to highest executive positions.

Mr. Botho Kohlweck writes: "Last week I was promoted to the position of Assistant Manager of the Atlantic Hotel, in charge of the back of the house. I owe it all to your Course." Another letter from Mr. Paul Parrotte says: "I wrote to Mr. Wiggins at your request and was employed immediately in an even better position than was originally open."

We are constantly receiving more applications for S.B.T.I. graduates and students than we can fill. Mail coupon TODAY.

**Standard Business Training Institute
 Carlton Court, Buffalo, N. Y.**

Send me Free Booklet H-166, giving full information about Hotel Operation and Management Course.

Name

Street

City.....State.....

SHORTHAND IN ONE MONTH

Wonderful, Easy System—The BOYD
 Writers hold World's Record

100 to 150 words a minute in 30 days guaranteed. Big demand for trained Stenographers and Private Secretaries. Learn a profession that pays big.

What Students Say:
 "Your Course is Wonderful."—M. R. W.
 "It beats all other Systems."—F. Z.

The Boyd can be learned in one-sixth the time of other systems. It is the NEW WAY in Shorthand. Dictation first week—in 30 days you are ready for a position. Send today for Catalog and Money-Back Guarantee.

CHICAGO HOME-STUDY SCHOOLS
 802 Reaper Block Chicago, Illinois

Music Lessons At Home

With Celebrated Teachers

Our simplified courses are specially prepared for home study. Not a new method. Long established School now celebrating its 20th Anniversary. Send for Illustrated Catalog. Every person who loves music should read this free book. Write which instrument you have. Get details of the lessons and our Anniversary Offer—one which means a cash credit on your tuition. Courses, endorsed by Paderewski: Piano, Harmony, Voice, Public School Music, Violin, Cornet, Mandolin, Guitar, Banjo and Reed Organ. Careful training by Faculty in grading examinations makes the instruction personal for each individual pupil. See for yourself what others have done. You can be sure of same results.

UNIVERSITY EXTENSION CONSERVATORY
 880 Siegel-Myers Building Chicago, Illinois

Anyone CAN LEARN

no talent or experience necessary. Fascinating work. Pays big money. Complete instruction book tells about: Alphabets, Colors, How to Memorize, Show Cards, Window Board and Wall Signs, Handy made letters, Gliding, Tricks of the Trade, also gives 100 Alphabets and Designs. Book bound in flexible first leather-bound edges, and four ball bearing Show Card Pans. Sent postpaid \$3.00. (C. O. D. 10c ex.)
 Globe Pub. Co., 57 Nass St., Dept. 50, N. Y. City

**EARN MONEY IMMEDIATELY—
 WE FURNISH EQUIPMENT TO START!!**

HOW TO BECOME A PROFESSIONAL PHOTOGRAPHER

EARNING \$35 TO \$125 A WEEK
 Three to six months' course. Motion Picture, Commercial, Portraiture. Practical instruction. Modern equipment. Ask for Catalog No. 49.

N. Y. INSTITUTE OF PHOTOGRAPHY
 NEW YORK CHICAGO BROOKLYN
 141 W. 36th St. 630 So. Wabash Ave. 505 State St.

MEN WANTED

Prepare as Firemen, Brakemen, Electric Motormen, and colored Train Porters. Hundreds put to work. No experience necessary. 500 more wanted. Name position you want.
RAILWAY INSTITUTE Dept. 35 Indianapolis, Ind.

HOME STUDY Become More Efficient

through courses in Chemistry, History, Mathematics, English, Psychology, Education, Business and 35 other subjects which the University gives by mail. They command credit toward a Bachelor degree and may be begun at any time.

The University of Chicago 15 Ellis Hall Chicago, Ill.

Repair Any Auto ^{or} Auto Truck

Examine These **FREE** NEW AUTO BOOKS

Be an expert auto repair man. You can have the skill that makes every complicated trouble as easy to fix as taking out a spark plug. Learn every detail of all makes of cars and trucks. Know exactly how to find what's wrong and how to make all repairs quickly. These great new Auto Books show you how.

Make Money Repairing Autos

Over 9 million cars are in operation and thousands of men are needed to keep them in good going condition. There are more jobs open than there are good men to fill them. Never before have expert auto repair men been in such great demand and made so much money. Now is your great money-earning opportunity in the auto repair business. Every mechanic, every chauffeur, every car owner needs this great New Library of Automobile Engineering.

Tells About

Explosion Motors, Welding, Motor Construction and Repair, Carburetors and Settings, Valves, Cooling, Lubrication, Fly-Wheels, Clutch Transmission, Final Drive, Steering Frames, Tires, Vulcanizing, Ignition, Starting and Lighting Systems, Shop Kinks, Public Garage Design, Equipment and Operation, Electrics, Storage Batteries—Care and Repair, Steam Cars, Motorcycles, Commercial Trucks, Glossary. More than 100 blue prints Wir'g Diagrams.

75c a Week If You Decide to Buy

Let us send you the complete six-volume set of Automobile Engineering for one week's examination. Read the simple directions for repairing every automobile trouble. Six thick volumes 5½x 8¾ inches, flexibly bound and stamped in gold, 2,650 pages, 2,100 illustrations, wiring diagrams, etc. Everything in plain, every-day language simple to understand. If you decide to keep them, send only \$2.80 in seven days, and \$3 a month thereafter until the special introductory price of \$21.80 has been paid. The regular price is \$45.00, so you save \$23.20 by acting at once.

Send No Money

Don't send a penny! Your name and address in the coupon brings the six books to you at once for seven days' trial.

Mail Coupon NOW

American Technical Society

Dept. A-219 Chicago, U. S. A.



Starting and
Lighting



Welding



Transmission



Motors

AMERICAN TECHNICAL SOCIETY

Dept. A-219, Chicago, U. S. A.

Please send me the six-volume set of Automobile Engineering for seven days' examination, shipping charges collect. If I decide to buy, I will send \$2.80 within seven days and balance at \$3.00 a month until \$21.80 has been paid. Then you will send me a receipt showing that the set of books are mine and fully paid for. If I think I can get along without the books, I will return them, after 7 days, at your expense.

To insure prompt shipment fill out all lines.

Name _____

Address _____

Employed by _____



JUST OFF

The Science of Wrestling

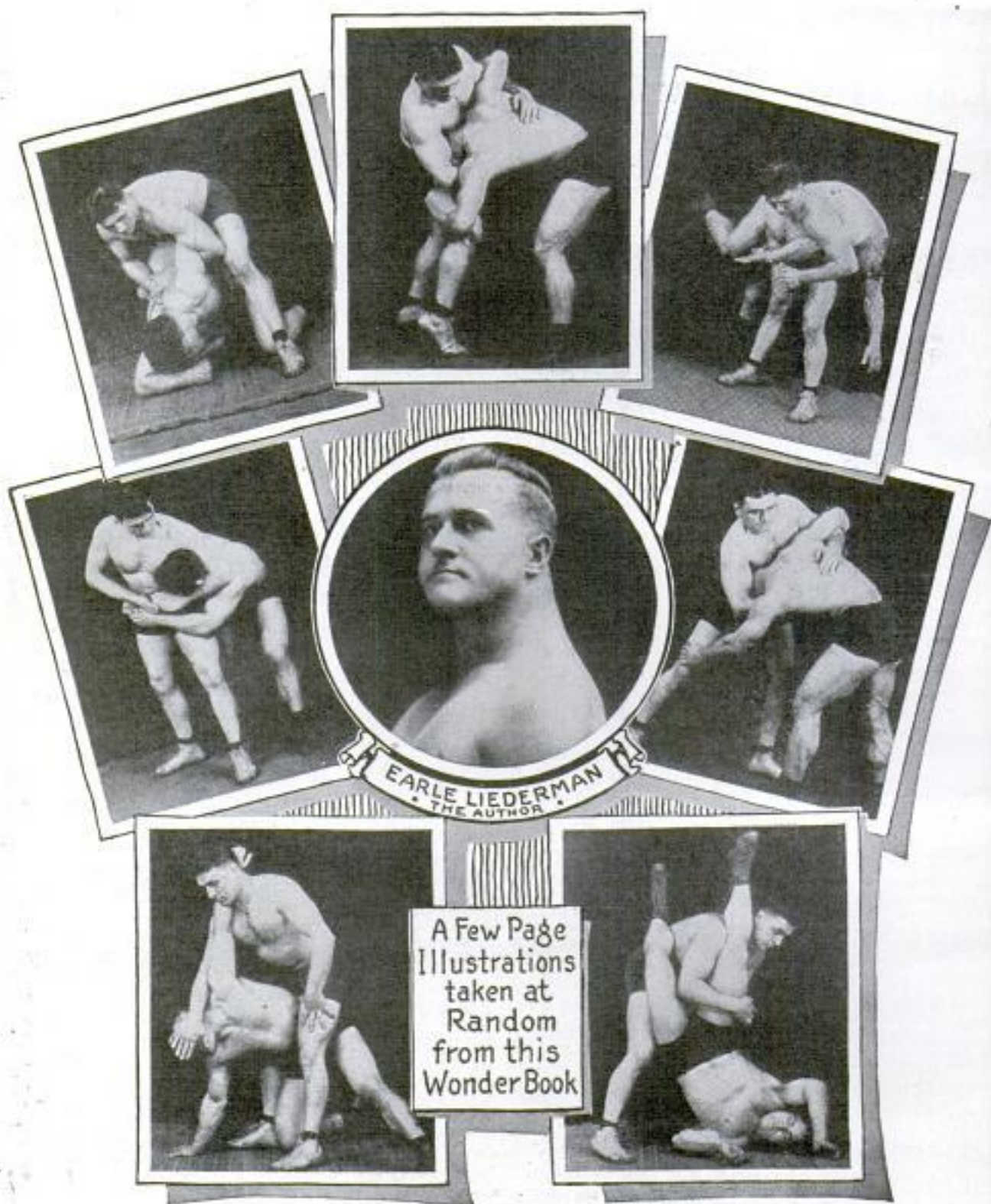

EARLE LIEDERMAN
THE AUTHOR

A Few Page
Illustrations
taken at
Random
from this
WonderBook

THE PRESS

and the Art of Jiu Jitsu

And the Best Man Won!!

Crack! His fist landed squarely behind the bully's ear and down he fell in a heap. Quick as a flash he turned facing the other hold-up man, whose arm was ready to strike with a black-jack. With a deft movement he grabbed the up-raised hand. Another thud and another limp form lay on the ground. Quivering with tense excitement he stood over the two huge prostrate figures waiting to grab them should they rise, but they did not move. Both were knocked cold. Smilingly his sweetheart came toward him and, patting him on the back, she said: "I am proud of you, but I knew you could do it." A small crowd gathered. Admiring and envious eyes watched the young man and his sweetheart slowly move away.

How Did He Do It?

"I can thank Earle Liederman for that," was his first remark as they walked away. "Six months ago I would never have dared to face one man, and certainly not two. That wrestling book of his taught me how to handle any situation and now I never know what it is to be afraid."

What Would You Do?

Suppose someone tried to bully you, would you run away or do you possess the knowledge and the courage to resist an insult? What would your wife or sweetheart think if they found, in a circumstance like the above, that you played the part of a coward? There is no excuse for it. Any man may now fortify himself and be prepared to cope with any emergency.

THE SCIENCE OF WRESTLING and THE ART OF JIU JITSU

A book that has startled the athletic world. The most elaborate instructions in wrestling ever produced; highly illustrated from life, together with a most detailed course in Jiu Jitsu—the most dangerous art of self-defense ever practiced by mankind. Each and every hold, if fully executed, means a broken bone or fatal results. With such knowledge in your possession you need never fear attack, whether your opponent be armed or unarmed. The Jiu Jitsu education is so complete and so simply described that this alone is worth far more than the price asked for the entire book.

The course in wrestling is complete to the minutest detail. It is also a startling revelation. I am exposing secrets heretofore known only by professionals. No doubt you have frequently wondered how a professional wrestler has thrown a man twice his size. There are numerous tricks and holds known only to the American professional wrestlers, and which they have held as their prize possessions. These trick holds are here explained in simple words.

The Secret Told

I have been severely criticised for revealing these secrets, but I ignore unjust criticism. I am determined to present the facts as I know them.

Possibly you have already had considerable experience in the science of wrestling, but I doubt very much if you have been intimate enough with the men higher up to learn these secret tricks of the game. Suppose this very night some thug should attack you? Suppose a man many pounds heavier than you and well armed should attempt to hold you up, what would you not give to know how to immediately place him at your mercy? You will find just such information as this in "The Science of Wrestling."

Special Offer

Do not confuse or compare this volume with other wrestling books or wrestling courses now on the market. It is a classic and I am most proud to be its author. The regular price of this book is \$5, but as a special introductory offer I am giving it at the special price of \$3. If you will send for your copy now and use the coupon below, you will save \$2. The edition is limited; first come, first served. Should the demand exceed the output, it will simply mean a delay until another edition is printed; so use the coupon below, save \$2—and get your book immediately. I prepay all packing and mailing expenses.

This book is not for sale at book stores or newsstands. It cannot be bought anywhere in the world except from me, for it is a private edition.

Positively no more than one to each person. Do not send more than \$3, as I will be obliged to return any excess amount.

This book will prove a revelation to you. You will marvel at it. It contains nearly two hundred full-page photographs, the size of each page being 6x9 inches. It is handsomely bound in leatheroid cover, embossed in blue and gold, and is worthy of a prominent place in anyone's library collection.

Is Your Life Worth \$3.00?

Think of it! Two hundred and twenty-four intensely interesting pages containing secret information never before revealed to the public. The phenomenal and marvelous holds to offset attack by a gunman make it impossible to set its value in money, for surely you would not place a value of \$3 on your life!

Cut Out Coupon and Save \$2.00

It is new—just off the press; everyone who gets this book will be the first to know of these mysterious holds. I have spent many months in the preparation of this book, and all the knowledge I possess in wrestling and Jiu Jitsu is revealed within its pages.

EARLE E. LIEDERMAN
Dept. C 305 Broadway NEW YORK

EARLE E. LIEDERMAN, Dept. C
305 Broadway, NEW YORK, N. Y.

Dear Sir:

Enclosed herewith please find \$3.00 for which you are to send me immediately "THE SCIENCE OF WRESTLING AND THE ART OF JIU JITSU."

Name

Address

Electricity

*—the Big Pay Field
is calling YOU!*



Be an Electrical Expert EARN \$3500 to \$10000 a Year

Now you earn \$20 or \$30 or \$40 a week. In the same six days as an Electrical Expert you can make \$70 to \$200 and make it easier—not work half so hard. Why then remain in the small-pay game, in a line of work that offers no chance, no big promotion, no big income? Fit yourself for a "Bossing" job—be an "ELECTRICAL EXPERT!"

**\$3,500 to \$10,000 a Year
Is Easy to Get**

Today even ordinary Electricians—the "screw driver" kind—are making money—big money. But it's the trained man—the man who knows the whys and wherefores of Electricity—the "Electrical Expert," who is picked to "boss" the ordinary Electricians—to boss the Big Jobs—the jobs that pay.

Get in line for one of these "Big-Pay Jobs" by enrolling now for my easily-learned, quickly-grasped, right-up-to-the-minute, Spare-Time Home-Study Course in Practical Electricity.

**Age or Lack of Experience
No Draw-Back**

You don't have to be a High School graduate—it isn't even necessary that you should have finished the grades. As Chief Engineer of the Chicago Engineering Works, I know exactly the kind of training you need, and I will give you that training. My Course in Electricity is the most simple, thorough, successful and

practical in existence, and offers every man, regardless of age, education, or previous experience, the chance to become, in a few short months, an "Electrical Expert," able to make from \$70 to \$200 a week.

Earn While You Learn

With me you do practical work—at once. In my first few lessons I show you how to make money doing Electrical work in your spare time. (Over half of my students are paying for their Course in this way.) I show you, also, how to get started in business for yourself, and then help you to get started.

**FREE Electrical
Working Outfit**

To do spare time work you'll need tools, etc. These I give you—Free—a whole kit, including measuring instruments, a real electric motor (no toy), and other things—the greatest value ever given by any School.

**Your Satisfaction Guaranteed by
a Million Dollar Institution**

I absolutely guarantee to return every penny paid me in tuition if, when you have finished my Course, you are not satisfied in every way with my instruction. And back of me, in my guarantee, stands the Chicago Engineering Works, a million dollar institution.

**Nothing Like "Cooke"
Training Anywhere**

"Cooke" training is different because it's the most practical and most successful. It's best because it's backed by the greatest Service to students ever known. It's this Service, plus "Cooke" training, that makes the "Cooke" trained man the "Big-Pay" man everywhere. Become a "Cooke" Trained Man yourself, and earn \$12 to \$30 a day—\$70 to \$200 a week—\$3,500 to \$10,000 a year.

Investigate! Mail Coupon

Get the Vital Facts. Let me send you free my big new book on The Future of Electricity. Let me tell you more about the big demand for "Cooke" trained Electrical Experts. Sign and send me Coupon below.

L. L. COOKE, Chief Engineer
Chicago Engineering Works, Inc., Dept. 12
2150 Lawrence Ave., Chicago, Ill.

CHIEF ENGINEER COOKE
Chicago Engineering Works
Dept. 12, 2150 Lawrence Avenue
Chicago, Ill.

You may send me, entirely free and fully prepaid, a copy of your book, the "Vital Facts" and particulars about your Home Study Course in Electricity.

Name.....
Address.....
Occupation.....

The "Cooke" Trained Man is the "Big Pay" Man

Classified Advertisements

WORLD'S BEST WANT AD MEDIUM

Advertisements in this section, 25 cents per word, each insertion, minimum 10 words, payable in advance.
To be inserted under proper classification in March issue, copy should be in our office January 18th.

ADVERTISING AGENCIES

TO secure agents or salesmen or for selling farms and reaching investors, use classified (want) ads in largest newspapers and magazines. Price list No. 30 sent free. Ankrum Advertising Agency, 20 W. Jackson Blvd., Chicago, Ill. The largest classified advertising agency in the U. S.

25 WORDS—355 Rural Weeklies \$14.20. Ad-Meyer Agency, 4112-M Hartford, St. Louis.

A SERVICE agency for magazine and newspaper classified advertisers. Complete advertising service free of charge. We edit and place your copy. Send for our free list and explanation. Sweet & Phelps Advertising Agency, 212 E. Ohio St., Chicago.

FOR ADVERTISERS

INCH Display—175 magazines, \$4.00. Thrice \$12.00. Particulars 10c. Klesse Service, East 89th, New York.

ADVERTISE in 24 Big Sunday Newspapers, 24 words \$15.00. Catalog listing 1,900 leading Dailies, Weeklies, Magazines, 4c stamps. Union Advertising, Baltimore Bldg., Chicago.

24 WORDS 70 Magazines Thrice \$2. 12% Banking Plan 25c. Arthur Machemer, Sinking-Spring, Penna.

INCH Display 100 magazines thrice \$8. Beck, 5406 Alaska, St. Louis.

INCH display hundred magazines \$4.00, three issues \$8.00. Pennell Company, Covington, Ky.

SALES PROMOTION

25 YEARS' Experience developing \$50 to \$50,000 daily sales by mail, magazine, newspaper campaigns. Letters, circulars, booklets written. \$13,540 profit second quarter followed \$2,130 loss preceding quarter after client adopted my direct-mail plans and copy. Submit details of sales problems for free preliminary diagnosis. Ten years Sales Promotion Manager Larkin Co., a thirty-million dollar corporation. James C. Johnson, 118A Woodbridge Ave., Buffalo.

400 FORCEFUL, Effective, Business-getting Letters, prepared in typewritten form. Covers practically every kind of business. \$5.00 prepaid. Particulars free. J. Rodgers Heggard, Windsor, N. C.

AUTOMOBILE SUPPLIES

USED parts for Dodge Brothers Cars, 50% from list. Satisfaction guaranteed or money refunded. Harris Motor Car Company, Cape Girardeau, Mo.

AIR Compressors, Fully Automatic, Guaranteed, \$20 monthly, paid by increased business automatic air service brings. Particulars free. Hobartson, Troy, Ohio.

SPARK Plugs, Champion X for Fords 49c, other cars 57c. Boyce Motometers Universal \$7.50. Other bargains. R. O. Helwig, 792 S. LaSalle St., Chicago.

AUTOMOBILE parts for all cars. Lowest prices. Save money; get our wholesale catalogue. State make of car, model and parts wanted. Parts shipped immediately from stock. We refund your money if not satisfied. Mechanics Gear Co., 3706 No. Halsted St., Chicago.

AUTO and Truck Parts. Save 25-30%. New and used motors, gears, axles, bearings, springs, generators, \$10 up. New Zenith, Johnson, Rayfield, Stromberg carburetors, \$7.50 up; new waterproof Simms and Berling magnetos, \$15; Ford retopping, \$4-\$6; other cars, \$12 up. Brightman Auto Exchange, 321 Windsor Ave., Hartford, Conn.

NEW improved Aluminum alloy pistons Complete with rings and pins, for Fords and Chevrolets, \$14.50 per set. Made for all cars and trucks. Egge, 7704 S. Main St., Los Angeles, Calif.

AUTOMOBILE owners, garagemen, mechanics, send for free copy America's popular motor magazine. Contains helpful, money-saving articles on repairing, overhauling, ignition, carburetors, batteries, etc. Automobile Digest, 507 Butler Bldg., Cincinnati.

AUTOMOBILE Parts—Used parts for most any car at half factory list prices. Allen, Briscoe, Buick, Cadillac, Chalmers, Chevrolet, Dodge, Dort, Grant, Hudson, Hupmobile, Oakland, Overland, Oldsmobile, Reo, Studebaker and many others. Send list of parts wanted. Maxwell Bros., 4106 Olive St., St. Louis, Mo.

REMANUFACTURE Fords—most profitable business on earth—\$14,355.00 Made on 200 complete jobs. \$850.00 completely equips shop with tools recommended by Ford Motor Company. Circular, K. R. Wilson, Buffalo.

RECHARGING Batteries Paying Big Profits With Constant Potential 8-Hour System. Profits \$100 to \$400 monthly. Easy \$20 monthly payments bring this Equipment. Start your own money-making business. Write Hobartson, Troy, Ohio.

E. Z. BRAKE Silencers insure safety and comfort. No squeaking, chattering or grabbing. 50c set. E. Z. Bushings eliminate rattle and hammer of steering post. State make of car. Sample 50c. Money-makers for distributors or salesmen. Kerstone Sales Co., Pacific Bldg., San Francisco, Cal.

AUTOMOBILES

BUILD It Yourself—A Real Automobile that any handy man or boy can build. A low-slung, speedy cycle car. Power supplied by famous 2 1/2 H. P. Shaw Motor. Send stamp today for Descriptive Circulars or send 25c for Complete Book of Easy-to-Follow Plans. Shaw Mfg. Co., Dept PM-1, Galesburg, Kans.

\$1 WILL buy a positive Headlight Tell-tale. H. D. S. Co., Somerville, Mass.

PATENTS—Write for our Guide Books and "Record of Invention Blank" before disclosing inventions. Send model or sketch and description of your invention for our free opinion of its patentable nature. Highest references. Reasonable terms. See advertisement on page 157, Victor J. Bruns & Co., 185 Ninth, Washington, D. C.

MAGNETO Recharger, Alternating, \$55. Magneto Speed tester \$6. Magneto Bench tester \$3. Adjustable Gasoline sign \$5. Adjustable Intensifiers 8c. Glass Intensifiers 10c. Reliable, 310 Jay, Ultra, N. Y.

AUTOMOBILE owners, garagemen, mechanics, send for free copy America's popular motor magazine. Contains helpful, money-saving articles on repairing, overhauling, ignition, carburetors, batteries, etc. Automobile Digest, 507 Butler Bldg., Cincinnati.

PATENTS Procured. Send sketch or model today for examination, prompt report and advice. No charge for preliminary advice. Write for free Booklet and blank form on which to disclose your idea. Highest references. Promptness assured. Clarence A. O'Brien, Registered Patent Lawyer, 55-B Security Bank Building, Directly across the street from Patent Office, Washington, D. C.

DYKE'S Automobile Encyclopedia, 13th edition, new, greater than ever, entirely rewritten and rearranged. Contains greatest array of automobile facts ever published in one volume. Separate books containing same information cost \$21. Over 1,200 pages and 4,100 illus. Cloth \$6. Flex. Amer. Motor \$7.50 postpaid. Popular Mechanics Book Dept., 206 E. Ontario St., Chicago.

RACING Bodies for Fords and Chevrolets 190. Send for free particulars. Our book "How to Build a Ford Racer" sent on receipt of 25c. Central Auto Supply Company, Dept. 120-C, Louisville, Ky.

M. P. LAUGHLIN—Patents—Engineer—Attorney—Specializing Power-Automotive Inventions. 48 East 41st St., New York.

LEATHER Coats, U. S. Aviators, \$10 to \$15. Wonderfully warm. 28 H. P. airplane motors, new, \$100. Smith, 403 Goggin Bldg., Houston, Texas.

FOR FORD OWNERS

FORD Owners, Fill your gasoline tank without lifting cushion! Have a gasoline gauge always in sight! Kirstin Fil-O-Meter is a Gauge and Filler combined. \$5.00 Retail. Salesmen wanted. Write today. A. J. Kirstin Co., 16 Kirstin Bldg., Escanaba, Mich.

WONDERFUL New Spark Plug patented. Burns kerosene and oil. Distinctly different from all other plugs; starts easy, more heat, life, pep in motor, ideal for motors pump oil, guaranteed. Sample \$1.50. Agents wanted. Motor Spark Co., Monongahela, Pa.

UNDERSLING with "RKO" Swing Lo Irons. See "Red-i-Kut" ad page 141.

FORD Repair Book Free: A very complete and well illustrated book explaining how to make repairs on most every part of your Ford. We offer this book free with a nine months' subscription to Ford Owner and Dealer Magazine—at only \$1.00. Everyone interested in the Ford car should read this big magazine of about 200 pages monthly. It clearly explains the things you want to know about cutting down the cost of operation, the engine, ignition, transmission, carburetor, etc. Send Today and get the valuable Repair Book Free. Ford Owner and Dealer Magazine, 538 Montgomery Bldg., Milwaukee, Wis.

FORDS Get 25—45 Miles With Reid's Automatic Vaporizer. Guaranteed. Send today. Price \$3.50. Agents wanted. R. A. Reid, 19 Burget Ave., Medford, Mass.

SAFETY Steering Control: best insurance against accident from tire or steering gear troubles; stops shocks, vibrations, the rod buckling, wheel locking, wobbling. Driving comfortable—turn quickly, safely. Installation easy. Money-back guarantee. Limited offering; postpaid on receipt \$5.40, or sent C. O. D. Circular if requested. Dunbar Company, 808 N. Fountain, Springfield, Ohio.

FORD Owners—New Timer for all model Fords and Tractors. Insures immediate starting on Magneto in zero weather. Runs with or without oil. Makes your timer shell last the life of your car. Takes only five minutes to install, end all ignition trouble. Only \$1.00 on basis of money back if not satisfied. M. F. Mfg. Co., Washington, D. C.

FORD owners, stop that ruinous chatter on your car. Install Bredar's Ball Shim. Price, \$1.10. Write for Information. Nic Bredar's Son Mfg. Co., Rock Island, Ill.

AUTOMOBILE owners, garagemen, mechanics, send for free copy America's popular motor magazine. Contains helpful, money-saving articles on repairing, overhauling, ignition, carburetors, batteries, etc. Automobile Digest, 507 Butler Bldg., Cincinnati.

MAKE your old car look new; one hour, dries two hours. Retail \$2.50. Sunshine Autoemamel Co., 2909 Mayfield, Cleveland, Ohio. Agents outfit retails \$10.00. Postpaid \$5.00.

MOTORCYCLES, BICYCLES AND SUPPLIES

SAVE Money on motorcycle accessories and salvage parts; all leading makes. Big discount. Send for catalogue. Tulsa Motor & Cycle Co., 202 So. Lansing, Tulsa, Okla.

MOTORCYCLE Riders make big money Demonstrating and Selling Internationally Famous Fixable Silencers and other products in open territories. Special Discount on Demonstrating car and Special Commissions on Sales. Fixable Co., 328 Water Street, Loudonville, Ohio.

DON'T buy a Bicycle Motor Attachment until you get our new catalogue and prices. Also runs washers, pumps, and shop machinery. Shaw Mfg. Co., Dept. 27, Galesburg, Kans.

WONDERFUL bargains in reconditioned motorcycles. Priced as low as \$35. Sidecars from \$25 up. Every one expertly rebuilt and guaranteed in absolutely first-class condition. Don't delay. Send 2c for big, new catalog showing 1924 bargains. Agents wanted everywhere. Western Supplies Co., 359 Hayutin Bldg., Denver, Colo.

INDIANS!! 1917—\$40.00, 1918—\$50.00, 1919—\$70.00; excellent condition. Engines \$14.00. Natanna, 104 Colvin St., Baltimore, Md.

SEND for our Bargain Bulletin and Money Saving Message. It will save you money on Motorcycles, Side Cars, Motor wheels, Repair Parts and Accessories. Some used parts at less than half. Cleveland and Ace Motorcycles our specialty. See our ad on page 132. American Motor Cycle Co., 2943-5-7 W. Chicago Ave., Chicago.

LARGEST Assortment of Used Motorcycles and Parts in America. Lowest Prices. Indian Motorcycles Sales & Service Co., 1331 Jackson Blvd., Chicago, Ill.

1922 HARLEY-DAVIDSONS, \$135; 1921, \$115; 1920, \$85; 1919, \$65; 1917, \$50; 1916, \$45; 1915, \$40; 1914, \$35. Guaranteed. Money refunded if not satisfied. Circular free. Wisconsin Cycle Sales Co., 726 National Ave., Milwaukee, Wis.

MOTORCYCLE Sidecars—Bargain Prices on Experimental and Discontinued Models. Write Fixable Co., 328 Water Street, Loudonville, Ohio.

USED parts for all motorcycles, cheap. State wants, Schuck Cycle Co., 1922 Westlake, Seattle, Wash.

'19 INDIAN 3 Speed \$75.00. '20 Indian 3 Speed \$95.00. '21 Indian 3 Speed \$125.00. Howard A. French Company, Baltimore, Md., Washington, D. C.

OVERSTOCKED—200 Used Motorcycles. Must be sold at once. We have Harley-Davidsons, Indians, Hendersons, Excelsiors, Clevelands. Prices \$25.00 Up. Write for our Bargain List. Myer Brothers, Dept. B, 15, Berkeley St., Boston, Mass.

AVIATION

SPEEDY motorcycle-motored aerocled. Drawings \$1.00, 15 H. P. motors \$75.00. Burke Aircraft Co., Downers Grove, Ill.

INDIAN power-plus motors complete with air propellers, high tension magnetos and carburetors. Ready for sled mounting, \$75.00 each. Sled blue prints \$1.75. Jersey airtor helmets 95c; resistal goggles \$2.90. Heath Airplane Co., Chicago, Ill.

"BUILD an Airplane." Motorcyle Engine Monoplane Plans, \$1. "Spoutford" Biplane Plans, \$2.50. "Knockdown Planes," \$100 up. Illustrated Circular Free. Aviation Engineering Co., Lawrence, Kansas.

BE An Aviator—Instructions as you want them, or thirty-day course. Elemen hours Air Time \$200. Solo guaranteed. Miller Aviation School, Benton, Ill.

SEND 10c for our latest aeronautical catalog, listing a complete line of airplane goods at reduced prices. Ford or Motorcyle motored airplane catalog, 4c each. Heath Airplane Co., Chicago, Ill.

PATENTS Procured. Send sketch or model today for examination, prompt report and advice. No charge for preliminary advice. Write for free Booklet and blank form on which to disclose your idea. Highest references. Promptness assured. Clarence A. O'Brien, Registered Patent Lawyer, 58-B Security Bank Building, Directly across the street from Patent office, Washington, D. C.

LEARN This Winter. Aviators and Builders Instruction Course, \$100. Aviation Engineering Co., Lawrence, Kansas.

AIRPLANES, new or slightly used, \$300 to \$1,250. Motors, wings and propellers—Bargains. Leather Coats, \$10 up. Smith Machinery Co., 403 Grogan Bldg., Houston, Texas.

THE American School of Aviation announces a new correspondence course in Mechanics of Aviation. A thorough training in Practical Aeronautics. American School of Aviation, Dept. 1868, 3601 Michigan Ave., Chicago, Ill.

TEN lessons in the air, of twenty minutes each, will make you a pilot, by our advanced method of training. This together with our five week shop course at \$100.00 makes America's oldest aircraft factory the most popular flying school. Work after class hours guaranteed. Heath Airplane Co., Inc., Chicago, Ill.

SEND one dollar for beautiful pair of sterling silver wings mounted on stick or bar pin with safety catch. Wear one to boost aviation. Money refunded if not absolutely satisfactory. Wallace Aero Company, Davenport, Iowa.

THREE foot model aeroplane. Small cost. Circulars free. Aero Shop, 3850 Hurbit Ave., Detroit, Mich.

BIGGEST, best catalogue Model Aeroplanes, Parts and Supplies; 5c Postpaid. Ideal Aeroplane Co., 72½ Green St., New York.

HEATH propellers represent the most efficient method of aerial drive. Each propeller individually designed for the particular work to be done, as laid out by America's oldest aeronautical engineers. Propeller catalog, 4c. Heath Airplane Co., Chicago, Ill.

WELDING

ACETYLENE Brazing and Soldering Torches, \$2.00. Light welding and lead burning torches, \$7.00. Postage prepaid upon receipt of price. Marshall Mfg. Co., Kansas City, Mo.

BOOKS AND PERIODICALS

500 THINGS To Sell by Mail. Remarkable new publication, workable plans and methods. Loose-leaf, cloth binder. Prepaid \$1.00. Charles International Co., Box 297, 1416 Broadway, New York City.

WONDERFUL Reference Album Lays and Stays flat when opened. Will bind large quantity clippings, papers, etc., on gummed hinges. 3 sizes, fabricoid cover, 16 in. x 11¼ in.—\$3.50; 11¼ in. x 10¼ in.—\$3.25; press-board cover 11¼ in. x 10¼ in.—\$1.25. Write for particulars of other up to date filing devices. Zeta-Be Company, 30 East 42nd Street, New York City.

SEND card for free literature opposing the Evolution theory. S. O. Bryant, Bethany, Mo.

"LIGHTS, Colors, Tones and Nature's Finer Forces," covering Vibrations; Odor-Auras; Cold-lights; Radio; Inventions; 270 pages. Satisfaction guaranteed; \$2.00. Circulars Free. M. Stevens, Publisher, 242 Powell, San Francisco.

IF interested in art publications, send postal to Dunbar, Boston 24, Mass.

SECOND-HAND book bargains. Catalog free. Nedwick's, 346 N-Clark Street, Chicago.

SIXTH and Seventh Books of Moses, Albertus Magnus, Pow-wows, Egyptian Secrets, black art \$1.00 each. P. M. Collins Co., 197 Fulton Street, Brooklyn, N. Y.

USED Books, Extra Bargains. Lists Monthly. Higens's, A244 Post, San Francisco.

FREE—Send for my Newthought, Self-culture, Occult, Mystic and Scientific book literature. Martens Publisher, Burlington, Iowa.

JOURNALISM—A digest of most fascinating of professions by an editor of long newspaper experience. Helpful to experienced writers and instructive to those desirous of entering newspaper work. One dollar. John A. O'Hearn, 7 Whitman Street, Lawrence, Mass.

WRITERS: Study at home. Thirty textbooks, and criticism and advice regarding markets for manuscripts. Catalogue. Correspondence invited. James Knapp Reeve, Editor, Franklin, Ohio.

INDUSTRIAL Alcohol Wright's book everybody wants. Full directions for making with drawings of necessary apparatus. \$2.50 postpaid. Spoon & Chasoberlain, 120 P. M. Liberty Street, New York, N. Y.

AMERICA'S greatest employment magazine wants co-publishers everywhere. Rare money-making opportunity. Particulars and copy of magazine, 10c. Employment News, Hyannis, Mass.

ELECTRICIANS' Examination book of questions and answers, with diagrams, symbols, tables, notes and formulas, for preparation for license. \$1.25. Address Reade Pub. Co., 296 Broadway, New York.

PICTURES AND POSTCARDS

JOIN Live Postcard club; Membership list, including Catalog, 10c. Harvey Teeple, Decatur, Ind.

ZEE Gabriel Moulin's beautiful, chic, girl fascinating studies. Two staplers; Catalogue; Literature; 30c. 20 Extraordinary Prize Winners, \$1.47. Smith's Novelty Co., M9 145-47 Bishop St., Chicago, Ill.

EXCHANGE Postcards, Fascinating Magazine; information, 5c. "Universalist," 1634P West Eighteenth St., Chicago, Ill.

JOIN the Old Reliable Card Club. Membership, 10c. Riverside Club, Frederick, Md.

NOVELTIES, CURIOS, ETC.

TRICKS, magic, caris, books. Catalog free. C. Fenner, 2401 Jefferson, Louisville, Ky.

IMPORTED Japanese Wonders, dropped into water, expand five times original size, turning into fish, flowers, animals, babies. Pretty package twelve assorted, 15c. \$14 50c. Thirteen \$1.00. Prepaid. Hootch Insurance Policy, latest Prohibition joke, free, each order. Heinemann, 7242 Pingree, Chicago.

THE Universal Multicode; 312 Codes in One. Something new. Makes your messages undecipherable. Send for yours today. 50c postpaid. Charles L. Smith, 8114 Crockett Blvd., Los Angeles, Calif.

"SPICEBOX" Imported Novelty, Thrills, Pleases, Amuses, Amazes, 50c. Arterraft, Box 33, Omaha.

GAMES, ENTERTAINMENTS AND PLAYS

VENTRILQUIISM taught almost anyone at home. Small cost. Send 2c stamp today for particulars and proof. George W. Smith, Room M-825, 125 N. Jefferson Ave., Peoria, Ill.

GREATEST mind reading act ever sold. Not a toy. Easily mastered. Cannot be detected. Postpaid for \$1.00. The Benfills Co., P. O. Box 797, Macon, Ga.

"TREASURE Island"—The great game! Fun and Excitement for all. Your Toy Store or Post Paid \$1.00 (Canada \$1.25). Satisfaction guaranteed or Money Back. Gem Publishing Co., 1313 Engineers Bldg., Cleveland, O.

EASY way to play mouth organ, 25c. Merratus, Box 1422, Indianapolis.

200 KINDS Iron, wood and wire puzzles. Leader and illustrated list 10c. Western Puzzle Works, St. Paul, Minn.

PLAYS, musical comedies and revues, minstrel music, blackface skits, vaudeville acts, monologs, dialogs, recitations, entertainments, musical readings, stage handbooks make-up goods. Big catalog free. T. S. Denison & Co., 622 So. Wabash, Dept. 11, Chicago.

CRYSTAL Gazing, Scientific Fun. List free. Otto Waldman, 1450 First Ave., New York.

MAGIC TRICKS, BOOKS, AND JOKERS' NOVELTIES

THIRTY thrilling, true detective stories. A new book "In the Shadows," by Detective Nick Harris, including "Bluebeard" Watson and Father Heslin murders, Witherell kidnapping, trunk bandit, Jimmy the Rat and Queen of Safe Crackers stories, proving "Why Crime Doesn't Pay." Send \$2.00 today, 900 Pantages Bldg., Los Angeles.

MAGICIAN'S Nickeled Pistol \$1.00. Seven tricks and four catalogs 25c. Gilmaglio, Morgan Park, Chicago.

NEW and Original Magic, Massey, 205 pages, 28 page plates. \$3.15 postpaid. Spoon & Chamberlain, 122 P. M. Liberty Street, New York.

MAGIC—Tricks, Books and Supplies. For Amateurs as well as the great professionals. Anyone can learn through our instructions. Feature Acts in Mind Reading, Spiritualism, Rope Ties, etc. Large illustrated Professional Catalog, 10c. Chicago Magic Co., 140 S. Dearborn St., Dept. B, Chicago, Ill.

"VENTRILQUIISM"—Complete instruction book, 10c. G. Elsea, Bowling Green, Ohio.

TRICKS, puzzles, jokes, magical apparatus, plays, stage supplies, mind-reading, sensational escapes, 160-page illustrated professional catalog, 10c. Oaks Magical Co., Dept. 348, Oshkosh, Wis.

STAMP COLLECTING

BEST one-cent approvals in America. F. P. Hand, 1117 So. 60th St., Philadelphia, Pa.

FREE—"Leader" Pkt. to approval applicants sending 2c stamp. Earl Stamp Co., 1811 26th Ave., North, Minneapolis, Minn.

STAMPS, 100 all different. Postage 2c. Lists free. P. M. Quaker Stamp Co., Toledo, O.

CHINA 12 var. 2c with approvals. Henry B. Hunt, Rt. 2, Compton, Calif.

STAMP cataloged \$2.00 and 500 mixed 25c. Walter Oliver, 811 Richmond, Buffalo, N. Y.

START a Stamp Collection—70 different stamps from 70 different foreign countries, including Africa, Asia, Australia, Europe, West Indies, etc. Our pamphlet which tells "How to make a collection properly," and price list of albums, packets and sets all for only 16 cents. Queen City Stamp Co., Room 36, 604 Race St., Cincinnati, O.

SET German Air Post, Eight different China Ships, and 50 different unused Hungary, cataloging over \$1.50. Millimetre scale, ruler, and perforation gauge. To those requesting our new Sudden Service approvals—5c. Fennell Stamp Co., Dept. P2, Fullerton Bldg., St. Louis.

\$2,500 WORTH pre-war value, of German stamps given free during January to purchasers of our 15c packet of scarce stamps from South and Central America having catalog value of over \$7. Fenway Stamp Co., Box 81, Fenway Station, Boston, Mass.

20 STAMPS Free, to Applicants of our approval sheets. Frank Thomas, 1311 Bushwick Avenue, Brooklyn, N. Y.

2,000 DIFFERENT stamps \$5.35; 1,000, \$1.45; 500, 45c; 300, 25c. Micheal, 5353 Calumet, Chicago.

FREE! A wonderful little collection of 500 all different stamps cataloging over \$10.00, to serious approval applicants who furnish satisfactory references and purchase at least one dollar's worth of stamps from my Old Dominion approvals. If you like sets and hard-to-get stamps, write at once. Hugh Argenbright, Staunton, Va.

\$3.00 FOR 12¢ 100 different Neurope, Catalogued \$2.00 Red Cross set, Airplane set, Perforation gauge, Millimetre scale, Fine waltz, 5 approval sheets, 250 hinges scarce packet from Nyassa, Abyssinia, etc., price list and approvals—all for 12¢ to approval applicants. Atlanta Stamp Co., Box 532, Atlanta, Ga.

APPROVALS 50% cash premium vouchers free. International Stamp Co., 129 East 59th St., New York City.

CHINA, current \$5.00 stamp used, only 60¢. U. S. Price list free. Voorhees, 25 N. Dearborn St., Chicago.

ON Approval: Jumbo books containing 500 different at one cent each. Also books of two, three, four, five, eight and ten cents each. 20,000 varieties. \$5 deposit required, returnable on demand. Cheapest and best way of enlarging collection. Lee Tubbs, 4621 First, San Diego, Calif.

STAMPS sent on approval at 70% discount. Reference required. Emory Renoll, Hanover, Pa.

UNIVERSAL Packet, 100 varieties, all over the world, 10 cents. Corvett Stamp, 39 State, Rochester, N. Y.

\$25 KAUCH All Different, 100 Germany, 100 Austria, 100 Hungary, 25 Chile, 50 Sweden. Fred Onken, 630 70th Street, Brooklyn.

LIBERIA, 1918, complete (Nos. 163-175), \$2.00. Better grade approvals. F. Buffham, Lake Ave., Racine, Wis.

BIG \$4.00 outfit and premium to approval applicants 10¢. Buckley, 712 Bowen, Dayton, Ohio.

300 FOREIGN 25¢; 25 stamps free, including stamp and coin list. A. McCroery, Chatham, Ontario.

8 LATVIA free to approval applicants. Rae, Storm Lake, Iowa.

25 DIFFERENT Poland 10¢; 50 different U. S. 10¢; 30 different Sweden 10¢; 1,000 different stamps \$1.50. R. H. Carlton, 304 W. So. Temple, Salt Lake City, Utah.

100 DIFFERENT foreign and Bargain Stamp Paper 3 mos. 10¢. Stanton, Niantic, Conn.

STAMPS on approval ¼ cent up. Free Premiums. Herbert Kelgwin, Middletown, N. Y.

WHOLESALE: Lists free. \$10.00 catalog value for \$1.00; fine stuff. Grossman, 1568 First Avenue, New York City.

FREE rare stamp to approval applicants. Albert Behnke, Davenport, Iowa.

25 DIFF. Bulgaria 8¢. Approvals. Fryrear, 1411 4th Ave., Cedar Rapids, Iowa.

MILLION mark unused German stamps. Prewar value \$238,000.00 each. Guaranteed genuine. One variety alone; four different 25¢. Cannon Company, Davenport, Iowa.

IRELAND—2 varieties 10¢; 6 varieties 15¢; 10 different 35¢. All scarce items. All guaranteed genuine. Cannon Company, Davenport, Iowa.

\$5.00 FOR 10¢, 200 all different (mostly unused) from Latvia, Trinidad, Newfoundland, etc.; Red Cross set, airplane set, small album and bargain lists—all for 10¢ (stamps will do) to approval applicants. Victoria Stamp Co., London, Canada.

FREE—55 Diff. Ireland, Barbados, Bermuda, Dominican, Malay, etc., large premium, for 2¢ postage. 100 Diff. U. S. 22¢—25 Bulgaria 9¢. Hawkeye Stamp Co., Cedar Rapids, Iowa.

DANZIG Airplane Set also 200 different stamps for 18¢. Jacob Fischer, 4230 Crystal St., Chicago.

100 STAMPS 2¢ to approval applicants. Charles F. Jewett, 726 Hickory St., Syracuse, N. Y.

APPROVALS for more advanced senior collectors. Discounts to 80% of catalogue. Reference. International, 2117 Regent Pl., Brooklyn, N. Y.

300 RARE Stamps 40 cents. Satisfaction Guaranteed. McColgan, Grass Lake, Mich.

143 VAR. including Danzig-Ukraine, 250 hinges—ruler—1 blank approval sheets—15 cents. Heatherdale, 4040 Lyndale So., Minneapolis, Minn.

300 DIFFERENT stamps 15¢; 500, 35¢; 1,000, 75¢; 2,000, \$2.50. 100 different unused, 15¢; 250, 55¢. Money order, please. R. Benno, 1531 N. California, Chicago.

FREE—"Leader" Pkt. to approval applicants sending 2¢ stamp. Earl Stamp Co., 1811 26th Ave., North, Minneapolis, Minn.

FREE—50 varieties to approval applicants sending 2¢. Richard P. Lamprocht, Valparaiso, Ind.

250 MIXED stamps and souvenir photo, 10¢. Phil Lunsted, Cape Cottage, Maine.

GERMAN Air Mail Set Free to applicants for my 1 cent to 15 cent net approvals; also high priced stamps at 50% discount. Reference Required. Chas. W. Schmidt, 3227 Bremer St., Westmoreland, Philadelphia, Pa.

FREE—25 different U. S. Stamps with 60% approvals to reliable parties. 75 different U. S. stamps 25¢. C. Seidenberg, Meriton, Wis.

ZAMBESIA, Zanzibar, Abyssinia, Herzegovina, Allenstein stamps, menagerie collection, hinges, 10¢. Liberty, 3974 Arsenal, St. Louis, Mo.

500 DIFFERENT Stamps 32¢. 1,000, \$1.20, to approval applicants. Stadler, 437 Beach Ave., Bronx, N. Y.

PACKET of 23 stamps, no two countries alike. Packet hinges. Set of \$1 and \$2 U. S. Rev., all for 5¢. Mention paper. Miami Stamp Co., Toledo, Ohio.

PACKET Free to Approval Applicants. Dan Reid, 630 Rhodes Ave., Toronto.

STAMPS, 50 varieties, Africa, Brazil, Peru, Cuba, Mexico, etc. 10¢. 50 different U. S., 25¢; 1,000 mixed, 40¢; 1,000 hinges, 10¢. List free. C. Stegman, 5948 Cote Brillante, St. Louis, Mo.

FREE! Loose Leaf Postage Stamp Album at rate of 8 pages each month given with subscription to monthly Journal. Send 2¢ stamp for prospectus. United Stamp Co., Marquette Bldg., Chicago, Ill.

24 VARIETIES Cuban stamps, 10 cents. List of 5,000 low-priced stamps free. Address Chambers Stamp Co., 111P, Nassau St., New York City, N. Y.

20 UNUSED stamps free. All different. Postage, 2¢. Fisk Stamps, Toledo, Ohio.

158 GENUINE Foreign Stamps, Mexico War Issues, Venezuela, Salvador and India Service, Guatemala, China, etc., only 10¢. Finest approval sheets 50 to 60%. Agents Wanted. Big 73-p. Lists Free. We Buy Stamps. Estab. 29 years. Hussman Stamp Co., Dept. 51, St. Louis, Mo.

FREE—Two sets Nyassa, 20 Diff. British Colonies Barbados and Jamaica pictorials and a packet of hinges—all for a request for my 1, 2 and 3¢ net approvals, none better. Chas. T. Egner, 4821 Frankford Ave., Frankford, Phila., Pa.

FREE—10 unused stamps sent to approval applicants on approval at 66½% discount from standard catalogue prices. J. De Jong, 515 West 162d Street, New York, N. Y.

165 CHINA, etc., stamp dictionary, list, 2¢. Album (500 illustrations), 3¢. Bullard, Sta. A, Boston.

FOREIGN Stamp Collection Sent Free. Cornish Company, Schenectady, N. Y.

100 VARIETIES Europe, Cat. over \$2.00, for only 12 cents to new approval applicants sending A-1 reference. Perforation gauge and min. scale free. Pathe Stamp Co., 521 Woodward Ave., Atlanta, Ga. Member: Stamp Trade Protective Association.

NYASSA Giraffes and packet of 52 different scarce stamps. Flame Triangle, large \$1.00 U. S. Rev., millimetre scale, perforation gauge and ruler for only 9¢. To introduce our Sudden Service approvals. Fennell Stamp Company, Dept. P, Fullerton Bldg., St. Louis, Mo.

100 DIFFERENT New Europe Free to approval applicants sending return postage. Anselink Co., 2110 Prairie, Milwaukee, Wis.

100 DIFFERENT stamps free to applicants for our Popular Approvals. Postage 2 cents. Christensen, Sycamore Bldg., Milwaukee, Wis.

DANZIG Free—Nice Set Danzig Stamps with Biggest Lists Issued, 2¢ postage. Midland Stamp Co., Station E2, Toronto, Canada.

FRENCH Colonies Free—Pretty Picture Set, Native Chiefs, Tigers, 2¢ Postage. Empire Stamp Company, 342 Lippincott, Toronto, Canada.

BIG Variety Packet Foreign Stamps Free for 2¢ postage. Gray Stamp Company, Station E10, Toronto, Canada.

FREE! 100 different world-wide, many unused, to approval applicants enclosing 4¢ postage. Walter Medding, Rolla, Mo.

MYSTIC'S "Mysterious" Packet! Contains stamps from the hands of cannibals, heathens, sun worshippers, and wild savages. Included are Transcave, Malay, Dutch Indies, Liberia, Slam, Africa, Abyssinia, North Borneo, Nyassaland, Zanzibar, etc. This wonderful packet containing 110 all different (mostly unused) for only 8 cents to approval applicants. Mystic Stamp Co., Dept. 8, Camden, New York.

FREE, Dollar Stamp Free to applicants for my 60% approvals. Norman Shultz, Colorado Springs, Colo.

RARE COINS

GET Large Old U. S. Copper Cent nearly as large as half dollar, curious and interesting, and large 50-page Illustrated Coin Catalog for Ten Cents—just as a "get acquainted offer." Send for one Now. Some \$25,000 worth of coins in stock. Get on my list for free catalog free to my customers. B. Max Mehl, Numismatist, Mehl Bldg., Dept. P, Fort Worth, Texas. Largest rare coin establishment in the United States.

ONE Billion German Marks 50¢. Price List on Request. Craig Dare, 440 55th, Brooklyn, N. Y.

10 NEW Copper Coins Different Countries and German Paper Bill 25¢, 6 German Marks and Pfennigs 25¢, Nickel 2¢ and 2¢ 15¢. Price List and Wild Cat Bill 6¢. California Gold ¼ 27¢, ½ 53¢. Al E. Bonsall, Richmond, Ind.

CHINESE and Netherlands coins 10¢. Durso, 25 Mulberry St., N. Y. City.

10 DIFFERENT Foreign Bills 50¢, 44 different coins \$1.00. Otto Oddehon, Independence, Mo.

40 OLD coins all different \$1.00, 25 coins from 25 countries \$1.00, bargain list free. Claud Denney, Box 315, Dallas, Texas.

55 DIFFERENT Foreign coins, \$1.00. Two-cent piece, Lists 10¢. Vogel, 417 East Jefferson St., Fort Wayne, Ind.

CALIFORNIA gold Quarter 27¢; Half 52¢; 1817 cent 20¢; Confederate \$100 15¢. A. Wylie, Wheaton, Ill.

OLD Money Wanted. We paid \$2,500.00 for one silver dollar to Mr. Manning of Albany, N. Y. We buy all rare coins and pay highest cash premiums. Send 4¢ for large Coin Circular. May mean much profit to you. Numismatic Bank, Dept. H, Fort Worth, Texas.

\$2 TO \$500 each paid for hundreds of Old Coins. Keep all Odd or Old Money. It may be very valuable. Send 10¢ for New Illustrated Coin Value Book, 4x5. Get posted. We pay cash. Address Clarke Coin Co., Ave. 2, Le Roy, N. Y.

OLD Coins. Large Spring selling catalogue of coins for sale, free. Catalogue quoting prices paid for coins, 10¢. William Hesslein, 101 A Tremont St., Boston, Mass.

CALIFORNIA gold, ¾ size, 27¢; ¾ size, 52¢; three-cent-piece and catalogue, 10¢. Norman Shultz, Colorado Springs, Colo.

U. S. CENT over 100 years old, 25¢ with Bargain list. Fred Greenclay, 335 16th St., Denver, Colo.

FOR BOYS

COMPLETE Boxing Instructor, 25¢. Etiquette and Politeness, 25¢. Square Dance Instructor, 25¢. 150 Song Parodies, 10¢. 250 Magic Tricks, 10¢. Ford Jokes, 10¢. All for \$1.00. G. Elsea, Bowling Green, Ohio.

Do you want a 3-tube Radio Receiving Set and Loud Speaker without cost? See page 90 for particulars.

BOOKS—"Ventriloquist," "Toy-maker Book," "Boy Electrician," 10¢ each, all for 25¢. G. Elsea, Bowling Green, Ohio.

MOUTH-ORGAN Instructor, 25¢. Learn in one hour. G. Elsea, Bowling Green, Ohio.

CAMERAS AND PHOTO SUPPLIES

HAVE You a Camera? Write for Free sample of our big magazine, showing how to make better pictures and earn money. American Photography, 116 Camera House, Boston, 17, Mass.

PHOTOGRAPHIC equipments and accessories of every description are listed and illustrated in our 178-page catalogue. It will pay you to secure a copy which is issued free, as our prices are low. We also deal in used goods which are sold under the same guarantee as new goods. Ask for our Bargain Book. Central Camera Co., Dept. E-78, 124 S. Wabash Ave., Chicago, Ill.

FILMS developed, prints made. Write for Price List. Z. Koscielniak, 17214 Lambert, Detroit, Mich.

CAMERAS, Lenses. Largest stock imported lines. Retiring from business. State exact wants. Montreal Photo Supply, Montreal, Canada.

IMPROVEMENT suggestions. Three year prints criticized 25¢. Colorphotography explained 10¢. "Non-touch" Autochrome method 20¢. Blake Whiting, Bradford, Conn.

SUPERIOR quality finishing and enlarging. Trial offer: Any size 6 exposure roll developed and printed, 25 cents. 8x10 enlargement unmounted, 30 cents. Carhuff Photo Finishing Co., 2129 W. Van Buren St., Chicago, Ill.

SEND \$1.25 for an 8x11" Hand Oil-painted Picture, "A Summer Sunset." The Finest painted photo print picture on the Market. Waterproof and resembles canvas painting. Satisfaction guaranteed. Otto Hueener, 4336 No. Lincoln St., Chicago, Ill.

BIG Money Saved on Photographic Lenses and Apparatus—goods exchanged; repairing done. Ralph J. Golsen, 1128 Argyle St., Chicago, Dept. P.

MODERN Photography in all its branches now taught by mail. New Successful Method. Students earning \$300.00 while learning. Big Opportunity. Write for particulars and unusual offer open for short time. Dept. 3431, International Studios, Inc., 3600 Michigan Ave., Chicago.

KODAK Films—Special trial offer; your next Kodak film developed, 5c—prints, 2c each. Moser & Son, 1917 St. James Ave., Cincinnati.

FILMS Developed, Special Trial Offer. Any Size Kodak film developed 5c, prints 3c each. Trial 6x10 Enlargement in handsome folder 40c. Overnight Service. Roanoke Photo Finishing Co., 269 Bell Ave., Roanoke, Va.

MOTION PICTURES

ACT Quick! Only a few more left—Motion Picture Projectors, Mazda Illuminated, with 1,000 feet of film, \$37.50, worth double. Send for photograph. Shipped C. O. D. for examination on receipt of deposit. DeFranne Importers, 109 North Dearborn St., Chicago, Ill.

FOR Sale—Five reels of Film \$40.00. Write, Herbert Johnson, Hyde Park Blvd. and Dorchester Ave., Dorchester Hotel, Chicago.

WONDERFUL Opportunities for Making Fortunes in this Business. No Experience needed. Complete Theatre Outfits sold on Easy Terms. Free Catalog. Monarch Theatre Supply Co., Dept. P, Memphis, Tenn.

O BOY! The Bass "Bargaingram" for this month will astonish you. Think of a complete Professional Motion Picture Camera, Tripod, Film, ready to start in a new weekly studio or commercial motion-picture film for only \$74.50. Dozens of other items just as good. Write for your copy at once. Hundreds of Bass' customers have become financially independent making motion pictures. The 57-page "Cinema Handbook" for only \$1.00 postpaid. The 52-page "Bass Catalogue" is free! Write or wire at once! Bass Camera Company, 105 North Dearborn St., Chicago, Ill.

MOVIE Films for Home, School, Church and Theatres. Comedy, Drama, Cartoon, Cowboy, Indian, Jungle, Religious, Historical, Fairy, Travel, Voodoo and Educational subjects, \$5.00 per reel up. Complete List. Monarch Theatre Supply Co., Dept. G, Memphis, Tenn.

NEW \$250 suit case, motor driven Projector, \$55. New 1,000 foot Projector, \$37.50. New \$50 Projector \$15. Movie Screens half price. Pathoscope \$210 Projector, \$110. 100 feet Film \$1 postpaid. 800 feet \$3. Comedies, \$5. Movie Cameras, \$65. Tripod, \$5. Ray, 324 Fifth Avenue, New York.

HENRI DEFRANNE announcing that he has purchased 500,000 feet of film consisting of one-reel comedies, educational, news weekly subjects and two-reel comedies, also five-reel features. The greatest offer—1,000 feet of single reels at \$5.00. Two-reelers at \$10.00 to \$15.00 and five-reelers for \$25.00 to \$100.00. A marvelous opportunity! Write or wire your needs, all films in perfect condition. DeFranne Importers, 109 North Dearborn St., Chicago, Ill.

AMERICA'S Greatest Fortunes made in the Motion Picture Business. We furnish complete Theatre Equipment on easy payments. Openings everywhere. Catalog Free. Monarch Theatre Supply Co., Dept. P—74 South Wabash Ave., Chicago.

FREE to Writers—A wonderful little book of money-making hints, suggestions, ideas; the A B C of successful story and play writing. Absolutely Free. Just address Authors Press, Dept. 12, Auburn, New York.

MAKE money writing photoplays; details free to beginners. No correspondence course. Producers League, 229 Wainwright, St. Louis.

BIG Money Nightly—Good assortment. Complete Outfits, installment plan. Splendid Home Outfit, \$25.00. Ralph J. Golsen, Dept. M, 1128 Argyle St., Chicago.

\$\$\$ FOR Ideas. Photoplay plots accepted any form; revised, criticized, copyrighted, marketed. Advice free. Universal Scenario Corporation, 266 Security Bldg., Santa Monica and Western, Hollywood, Calif.

ONE and two reel western film, \$5.00 per reel. One reel Broncho Billy western film \$10.00 per reel. Mutt and Jeff cartoons \$10 per reel. Monarch Theatre Supply Co., Dept. S W, 724 South Wabash Ave., Chicago.

\$35.00 PROFIT nightly. Small capital starts you. No experience needed. Our machines are used and endorsed by government institutions. Catalog free. Atlas Moving Picture Company, 482 Morton Bldg., Chicago.

SCENERY TO RENT

SETTINGS for Opera, Plays, Minstrels. Flush drops. Address Amelia Grain, Philadelphia.

EDUCATIONAL AND INSTRUCTION

CAN You Draw? Make money giving Chalk-Talks. Particulars. Truman's Studio, Box 585, Perryville, Ohio.

MEN'S Clothes, Ladies' Suits and Coats. We teach you by mail how to cut and make. Particulars Free. Ford, 3805 Masside, Richmond, Va.

WORLD-ROMIC System, Masterkey to All Languages. Primers, \$1.94 each language: Cantonese, English, French, German, Italian, Portuguese, Russian, Spanish, Swedish. Pronunciation-Tables, 39c each language. Dictionaries, grammars, 4,000 languages, of 1,700,000,000 people: Afrosenitic, Amerindic, Eurindic, Indopacific, Siberic, Sinitic. Languages Publishing Company, 8 West 40th Street, New York.

ROPP'S Calculator and Short-Cut Arithmetic shows the answer as quickly as a watch shows the time to all problems likely to occur in office, store, shop, bank, farm or factory. Price, pocket size, paper 35 cents; cloth 50 cents; leatherette \$1. Desk size, cloth, \$1.50 postpaid. Popular Mechanics Book Dept., 206 E. Ontario St., Chicago.

HOMESTUDY, Law, Shorthand, Typewriting, Real Estate, Secretary, 1552 Broadway Avenue, Grand Rapids, Mich.

WRITE articles, stories, news, in spare time for newspapers and magazines. Big pay. Copyright book free. Press Syndicate, 572, St. Louis, Mo.

YOU can have a business profession of your own and earn big income in service fees. A new system of foot correction; readily learned by anyone at home in a few weeks. Easy terms for training; openings everywhere with all the trade you can attend to. No capital required or goods to buy, no agency or soliciting. Address Stephenson Laboratories, 1 Back Bar, Boston, Mass.

BE a Laboratory Expert. Earn \$300.00 to \$500.00 a month. Study Microbiology, Bacteriology, Laboratory Technology, Sanitation, Interesting Extension and Residential Courses. Diplomas and Degrees granted. 71-piece Urinalysis Outfit Free to students. Write for Free 48-page Prospectus Today. Int'l Physicians and Surgeons College of Microbiology, Room 953, 550 Garfield Ave., Chicago, Ill.

DOUBLE Entry Bookkeeping mastered in 60 hours with 8 keys; guaranteed; diploma. Our graduates lead in bookkeeping, auditing, accountancy, balance sheets, and financial statements. International Bookkeeping Institute, Dept. 8, Springfield, Mo.

USED books and educational matter bought, sold, exchanged. Bulletin free. Instruction Correspondence Exchange, 1909 Broadway, New York.

MATHEMATICS and Drafting taught by mail. Courses in Arithmetic, Algebra, Geometry, Mensuration, Trigonometry, Logarithms, Mechanics, Mechanical Drafting, and Tool Designing. Harding School, Box B, Highland Park, Mich.

3,000 COLORS—Painters, Printers, Etc. Book gives proportions, \$1.00. Fine Arts Publishers, Box 1182, Indianapolis, Ind.

LEARN Penmanship; instructions 25c (silver). Prince, 130 W. 104, New York.

USED educational matter, books, etc., sold, rented and exchanged. Big list free. Lee Mountain, Pisgah, Ala.

ARTIFICIAL Marble, sanitary flooring instructions, ornamental casting, concrete plaster, papier-mache decorations, garden furniture, statuary, Rubber-moulds, Electrometallurgy, particulars and 200 illustrations free. Chris Mahler, Box 122, Huntington, N. Y.

BOOKKEEPING in a Week, \$1 Postpaid. Dukes, 1817 Walton Ave., New York.

EARN \$4,000 to \$10,000 per year. Men and Women we will train you in twenty weeks at home to be expert salesmen. We guarantee graduates position in City or Traveling. Particulars free. Address Dept. P. M., Chicago Salesmen's Training Institute, 2709-11 Bosworth Ave., Chicago, Ill.

VEST-pocket Bookkeeper—Complete instructions for the correct keeping of books of accounts. Shows an entire set of books based on actual transactions. 160 pp. Leatherette. \$1 postpaid. Popular Mechanics Book Dept., 206 E. Ontario St., Chicago.

"WHAT to Invent for Profit" free. Patent News-N, Washington, D. C.

WHAT'S Your Future? Develop Winning personality, be popular. Personality makes success. Free literature. Write today. P. S. Bureau, Box 349, West Palm Beach, Fla.

SHOW Card Writing, a pleasant, profitable profession. Quickly and easily learned through our new, simple method. No canvassing or soliciting. We show you how, no matter where you live. Full particulars and booklet free. American Show Card System Limited, 263 Adams Building, Toronto, Canada.

USED books and educational matter bought, sold, exchanged. List 1,000 items free. Students' Exchange, 47-A West Forty-second Street, New York, N. Y.

STUDY a Profession at the Distinctive University. We will make you an expert Bacteriologist, Chiropractor, Osteopath, Chiroprist, quickly. National University, 2925 Michigan, Chicago.

RADIO OUTFITS AND SUPPLIES

GET the most out of Radio. Join The American Radio Relay League, the National, non-commercial Amateur Organization which Does Things. Yearly membership dues \$2.00, including 12 issues of "QST," the magazine which tells clearly the how and why of everything best in radio. Write, enclosing dues, to American Radio Relay League, Kennedy Building, Hartford, Conn.

MANUFACTURE synthetic radio crystals from our formulas. Easily made without special apparatus. Sensitive over entire surface. Complete instructions and two sample crystals, one dollar. Ritter Mfg. Co., 314 Washington Street, Brooklyn, N. Y.

DICTIONARY of Radio words and terms, electrical symbols, wiring diagrams, radio diagrams and complete electrical dictionary, new, up-to-the-minute, just published. 188 pages, cloth cover, vest-pocket size. 35c postpaid. Popular Mechanics Book Dept., 206 E. Ontario St., Chicago.

SATISFIED? If not, change your crystal set into a loud speaker, by using our remarkable long-distance circuit and a few standard parts. Complete blueprint 25c. Cooper Laboratories, 2125 Gaylord, Denver, Colo.

"REPEATER" phones, very sensitive and clear tone, \$3.15 postpaid. Cram's Radio Map free with order. Derby, 1164 Marquette, Minneapolis, Minn.

FREE—Complete price list Aitken Radio Co., 504 Superior St., Toledo, Ohio.

2,650 MILES Distance with one tube. Any Service understands our Simplified Instructions, including Panel Layout and Photo 25c. Vesco Radio Shop, Box PM-117, Oakland, Calif.

RECHARGING Radio Batteries Pays Big Profits. Full particulars free. Radio Hobart, Troy, Ohio.

ONE Magnavox Loud Speaker. Price \$27.00. The Wehrle Co., Newark, O.

CRYSTAL Radio Receiving Set. Only 50c postpaid. Receives 50 miles. Quantity prices to dealers. Tru-Blu Supply Co., 104 Lake, Rochester, N. Y.

FEDERAL Junior Broadcast Receiving Set. Circular free. King, 646 McMahan, Monessen, Penna.

RADIO Record Book. Easy way keeping permanent records what you hear. Complete list stations corrected Nov. fifteenth, one dollar, two copies. Radio Progress Press, Union, S. C.

LOOK! These 4 tube Radio sets complete with tubes, phones, loud speaker batteries, etc. Nothing more to buy; \$100 while they last. Wm. Wambach, 159 Franklin St., Paterson, N. J.

1-TUBE long range radio set. Coast-to-coast reception, assembled in cabinet, \$9.50; complete with tube, phones, batteries, aerial, etc., \$19.25. Nothing else to buy. World's biggest radio buy. Send for folder. State Radio Co., 6418 State St., Chicago.

AUTOPLEX Circuit: One tube set works loud speaker, no aerial or ground; complete parts with diagram, instructions, etc. \$18.50 tube free with every order. List of other bargains on request. Royal Mfg. Co., Dept. 501, World Bldg., New York.

QUEEN-B Radio Receiving Tube \$15.00. Crystal \$3.00 Sets. Arthur Schumacher, Lockland, O.

COMPLETE Radio set for receiving broadcasting, postpaid \$3. Includes receiver, headphones, aerial, and insulators. Specialty Sales Bureau, 1429B Milton St., Grand Rapids, Mich.

RADIO Generators, 500 Volt, 100 Watt, \$28.50 each. Battery Chargers \$12.50. High Speed Motors, Motor-Generator Sets, all sizes. Motor Specialties Co., Crafton, Pa.

LOUD Speaking Crystal Set. Broadcastings heard throughout house. Easily constructed. Instructions complete 25c. Catalog free. Steinmetz Wireless Mfg. Co., Eastend, Pittsburgh, Pa.

TELEGRAPHY

TELEGRAPHERS are in demand. \$165 to \$250 monthly. We place our graduates with Railroads, Commercial and Brokerage concerns. Learned in short time. Can earn part of expenses doing temporary work. Small payment on tuition starts you. Central Telegraph System, 200 Consumers Bldg., Chicago.

TELEGRAPHY—Both Morse and Wireless—taught thoroughly and quickly. Tremendous demand. Big salaries. Wonderful opportunities. Expenses low; chance to earn part. School established fifty years. Catalog free. Dodge's Institute, H St., Valparaiso, Ind.

TRADE SCHOOLS

PAINT Automobiles, Trim Automobiles. Become a Certified Electrician, Auto Battery Builder, Ignition Expert on Starting and Lighting, Metal Finisher, and a complete course in Auto-Repairing, Bricklaying and Plastering. We fit you for a big money job. Make you an expert able to step right into a position paying \$45 to \$100 per week. You are paid while learning. Come to Detroit, the Automobile hub; the world's wonder City. Write today. Standard Trades School, 416 Woodward, Detroit, Mich.

YOU can't do better for Your Future Than Learn a Big Paying Trade. Write for our Free Catalogue of Sign Painting, Show Card Writing, Pictorial Painting, Decorating, Paperhanging, Graining and Marbling, Auto Painting. Chicago Painting School, 148 West Austin Ave., Chicago, Ill.

BE a Bricklayer; Good pay, outdoor work that is always interesting. Course is eight hours a day, five days a week, for six months. Tuition is \$100.00, one-half payable on entrance and one-half in three months. We have openings for a limited number of day students. Send for circular and give your age, and previous work. Associated Building Employers, Grand Rapids, Mich.

BUSINESS OPPORTUNITIES

GREAT Wheat Secret. There's a powerful Natural force causing the upswing and decline in wheat. You can tell them days in advance. Send for information today. Market Forecaster Co., Dept. 12, Topeka, Kans.

LEARN Candy Making. Make big profits at home or in shop. Big demand for good candy. Easily, quickly learned through our correspondence course. Write today for booklet 1-2. The Candy Institute, Sixty West Fiftieth Street, New York.

BE Wealthy. Ten one-hundred thousand notes German marks 50c, price list other samples 25c. Di Foti Adv. Co., 561 Washington St., Akron, Ohio.

FIFTY "Money-makers" for Mail Dealers. 500% profit. K. Home, 1957 Warren, Chicago.

INVENTORS—Write for our Guide Book, "How to Get Your Patent" and Evidence of Invention Blank. Send model or sketch of your invention for our prompt opinion of its patentable nature. Randolph & Co., Dept. 435, Washington, D. C.

FREE Booklet describes four methods of making money. \$50 starts you. Dept. M, Paul Kaye, 149 Broadway, New York.

MAKE Money at Home—making toys. We show you how. Send \$1 for complete working drawings and instructions. DeKalb Designing Co., Decatur, Ga.

THE Mail Order Review—Leading Mail Order Journal published, 24 pages of money-making ideas, plans, schemes, formulas. Year \$1.00; sample 10c. A. Oswald Pforr, Baltimore, Md.

START a Brake Retuning Service Station. Millions of cars all require retuning. My Hi-Speed methods get the business and make you money. Give a (30) minutes service on Fords, without removing transmission cover. Write me today for facts about a New Business Opportunity that will make you independent. M. L. McQuay, 54 South Street, Washington, Pa.

FREE Book—Start little mail order business anywhere; home employment evenings; beginner's working outfit furnished; 500 circulars, samples, things to sell; you deal direct with manufacturers; no stock to carry; instructive booklet free. Pier, 557 Cortland St., New York.

MEN who are willing to work up to a General Agency, appoint agents, organize territory for line of specialties sold direct to consumer. Very small amount of capital required. Advancement sure for workers. Mac-O-Chee Company, Room 2582, Cincinnati, Ohio.

REAL Estate Business of your own or position worth \$3,500? Our Graduates can choose. Training at home prepares you in short time and we aid you to make good. Bulletin free. Penn Realty School, 19th and Ellsworth, Philadelphia, Pa.

PUNCHBOARD. Following beautiful containers, packed full of High Quality, soft creamy centers, Hand-dipped Chocolates Supreme, 5 Chinese Baskets, elaborately decorated with Chinese Coins, Silken Tassels, Beads, Value \$2 to \$10. 18 Finely Decorated Metal Containers, assorted sizes, designs, most desired latest novelty. 39 Artistic 8 1/2 boxes. 1200 Hole Board Free, specially arranged for quick sale, 5c or 10c punch, takes in \$60 or \$120. Price \$38 Express Prepaid for all cash. Or send \$10 and we ship collect. C. O. D. balance. Checks not accepted. Satisfaction Guaranteed. Avery Graham, 1255 Gaylord, Denver, Colo.

ATTENTION! You can have a business of your own. Establish and operate New System Real Estate Business, brokerage and insurance agency in your community. Office at home. Earn \$5,000 year. Representatives wanted everywhere. Send stamp for free booklet. Hayes Realty Association, Cincinnati, Ohio.

MADE Big Money Spare Time Evenings. Mail Order business, booklet for stamp tells how. Sample and plan, 25c. Free 12 articles worth \$3. Alpine Scott, Cobos, N. Y.

I HAVE over 150 stores paying \$5 monthly; you can do the same in your city. Only one person in each community chosen. Midnight (Burglar) Alarm System, 2945 Algonquin, Detroit, Mich.

WANTED—Dealer or business man to act as local distributor for a well known paste hand soap. Opportunity for live man to increase his earnings. Send particulars to The Skat Company, Dept. A, Hartford, Conn.

LEARN sign painting, gold letter making, show card writing; easy process. Outfit free. Clark, 505 Line Ave., Ellwood City, Pa.

CONVERT each spare moment into cash. My dignified methods, requiring no merchandise nor peddling, will enable you to increase your income tremendously, without study, capital, experience or delay. Clark, Box 798, Dallas, Texas.

HUNDREDS of choice free homesteads still vacant in the Great Peace River District. All near railroad. Complete information two fifty. Locator, Box 96, Peace River, Alta, Canada.

CASH Grocery is the Business for You. Good anywhere. Small Capital. Our Practical Copyright Course tells you all about it. \$5.00 postpaid. John F. MacDonald, Box 15, Detroit, Mich.

PUBLISH small magazine of your own; start Mail Order Business. 50 Magazines and ad cost \$1.00. You get half on orders. Sample magazine and plan 10c. Harvey Temple, Deratur, Ind.

MAKE \$5 hourly; Electric Lawn Mower Sharpening. 415 South Lawndale, Kansas City, Mo.

PATENTBOOK, 129 mechanical movements and illustrations, sent free. Labinere, 3 Parkrow, New York.

SLOT Machines; Headquarters for Premium Machines, 1016 Germantown Ave., Philadelphia.

I MADE \$30 a Week Home. French Breadmaking. 15 years' experience; Free Booklet tells. Ashbrook 67, Marengo, O.

FINANCES supplied quickly. \$5000 to \$500,000. Details free. Write; Box 60-591, 32 Union Square, New York.

688 WAYS to Make Money—2,716 Formulas "Encyclopedia Business Opportunities," 3 volumes, \$1. Ideal Book Shop, 5501-E2, North Bober, Chicago.

PATENTS Procured; Trade Marks Registered—A comprehensive, experienced, prompt service for the protection and development of your ideas. Preliminary advice gladly furnished without charge. Booklet of information and form for disclosing idea free on request. Richard B. Owen, 39 Owen Bldg., Washington, D. C., or 2276R Woolworth Bldg., New York.

PATENTS Procured. Send sketch or model today for examination, prompt report and advice. No charge for preliminary advice. Write for free Booklet and blank form on which to disclose your idea. Highest references. Promptness assured. Clarence A. O'Brien, Registered Patent Lawyer, 58-B Security Bank Building, Directly across the street from Patent office, Washington, D. C.

FORMULAS, Processes, Trade-Secrets—Different, dependable, profitable. Catalog free. H. Thaxly Co., Washington, D. C.

"FORTY Famous Business Plans" \$1.00. Process for manufacturing many fast selling necessities, selling plans, where to buy materials. Gilmore, 4450 West End, Chicago.

PROFITABLE Mail-Order Selling—All-year Greeting and Motto Cards—50 cards 25c—300 cards \$1.00 postpaid; 200 different mottoes. Master Card Co., 816-18 Chestnut, St. Louis.

BIG profits for men who are artistically inclined and like pleasant, independent work. Experience unnecessary. Send self-addressed envelope for particulars. Zell, 68 Hudson Street, Hoboken, N. J.

\$3,000 BUSINESS from Odd-Job Contracts. Character, industry and handiness essential. Openings limited. Williams Service, 3836 Clinton, Minneapolis, Minn.

A MAIL-ORDER business of your own, selling movie patrons all year anywhere; free circulars. Wondo, M 31 Times Plaza, Brooklyn, N. Y.

GREATEST Fortunes in Motion Picture Business. Small Capital starts you with Complete Outfit. Details Free. Monarch Theatre Supply Co., Dept. F, Memphis, Tenn.

BARBERS earn \$40.00 to \$50.00 per week. Copyrighted course \$2.00. Sent C. O. D. Gem Tomorrorium Co., Knoxville, Tenn.

EARN \$20.00 Daily. Be an Expert Automobile Refinisher—Manufacture Auto Supplies—Specialties. Big Demand. We teach you how at Home. Start shop; small outlay. Autoremotes, Sheboygan, Wis.

SIGNS, Cards, Banners Easily Painted with Letter Patterns. Samples Free. Outdoor Adv. Service, Lockport, N. Y.

MANUFACTURE Extracts and other necessities, 200% profit; we tell you how. Write White Manufacturing Drug Co., 1325 Laidlaw Ave., Cincinnati, O.

NICKEL plate automobile accessories, hardware, electrical parts. Big profits. Requires no capital. Simple battery process. Write today. Webster Engineering Co., Webster Groves, Mo.

FOR territory and machine to manufacture 20,000 Eclipse Rubber Wrapping Bands per hour of inner tubes, address C. B. Martin, 1129 6th, N. W., Canton, Ohio. Small investment required.

START a pressing, cleaning and dyeing shop, excellent field, splendid profits. We tell you how. Write for booklet. Ben-Vonde System, Dept. C, Charlotte, N. C.

PATENTS—Write for our Guide Books and "Record of Invention Blank" before disclosing inventions. Send model or sketch and description of invention for examination and instructions. No charge for the above information. See advertisement on page 157. Victor J. Evans & Co., 192 Ninth, Washington, D. C.

53 BUSINESS Plans. Start in business with small capital. Particulars 2c. Pioneer Sales Co., Box 214, Marietta, Ohio.

INCH Display Advertisement 166 Magazines Thrice \$15. Year \$50. Page \$100. Wood's Popular Services, Atlantic City, N. J.

SILVERING Mirrors! My exclusive French Tartaric method opens enormously profitable business. Booklet free. H. Barstow, 514 24th Street, Oakland, Calif.

MAIL Order Business is your opportunity. Breniser's Famous Handbooks teach how to start small, grow big. Sell merchandise, service, ideas; enormous profits. Spare time to begin. Get complete set, 11 books, \$3.00, and be posted. Breniser, 335 Walnut, Philadelphia. Descriptive Catalog and big batch interesting mail order information, 25c. None free.

"HOW to Sell Patents" free. Patent News-H. Washington, D. C.

EARN big money, making and selling signs and house numbers. Easy to make. They sell at sight. Full instructions, \$2.00. F. O. Armstrong, 149 N. Essex Ave., Orange, N. J.

BIG money writing photoplays, stories, poems, songs. Send for free copy America's greatest magazine for writers. Tells you how to write and sell. Writer's Digest, 603 Butler Bldg., Cincinnati, Ohio.

EXCEPTIONAL Opportunity for Sales Manager capable of handling state distribution. Marvelous new Adding Machine. Retail \$15. Work equals \$50 machine. Tremendous possibilities. Unlimited profits. Write quick for details. Lightning Calculator Co., Dept. B., Grand Rapids, Mich.

"GET into the Specialty Manufacturing Business" or "Why Work for Others?" may sound good to you, but you won't succeed in that business unless you possess Formulas that are absolutely reliable, the same required by leading manufacturers supplying the Best. Don't be Bunked into buying a Collection of cheap "Formulas" and expect to succeed. Send today for my valuable literature and Formula Lists and Real Money-Makers in the Specialty Manufacturing Business. 26 years supplying the Best. Miller, Chemist, 885 De Leon St., Tampa, Fla.

GOOD money easily earned at home spare time silvering mirrors; no capital. Free instructive book tells how. Patterson & Co., Brooksville, Ky.

WE Start You in Business, furnishing everything; men and women, \$30.00 to \$100.00 weekly operating our "New System Specialty Candy Factories" anywhere. Opportunity lifetime; booklet free. W. Hillyer Ragsdale, Drawer 4, East Orange, N. J.

ENTER a new business. Earn \$3,000 to \$6,000 yearly in professional fees making and fitting a foot specialty, openings everywhere, with all the trade you can attend to; easily learned by anyone at home in a few weeks, at small expense; no further capital required, no goods to buy, job hunting, soliciting or agency. Address Stephenson Laboratory, (1) Back Bay, Boston, Mass.

RAISE guinea pigs. Pay better than poultry or rabbits; easy to raise; little space required. We guarantee market. Particulars and booklet how to raise free. Cavies Distributing Co., 3102 Grand Ave., Kansas City, Mo.

GO into the Crispette business. Everybody likes Crispettes. You can make a lot of money. We start you. Write for facts. Long Rakins, 1959 High St., Springfield, Ohio.

DOLLARS Yearly in your Backyard No mushroom dope. Particulars free. Metz, 313 East 89th, New York.

START a Real Estate Office of your own. Earn from \$1,500 upwards. Our course of 21 lessons tells you how. Booklet M. on application. Frederick Jenkins, Corlaer Heights, Schenectady, N. Y.

"SCHEMER Magazine." Alliance, Ohio, prints big profit schemes; one subscriber making \$25,000 from three; another \$10,000 from one. Try your luck. Year, only \$1.00; three months, 25c.

MARBLE mixing instructions, covering wood or cement flooring 1/2 inch thick, fire-proof, waterproof, low cost, sanitary, all colors. Particulars, 200 illustrations free. Chris Mahler, Box 122, Huntington, N. Y.

EARN \$10 daily silvering mirrors, plating and refinishing metalware, autos, chandeliers, bedsteads, headlights. Outfits furnished. E. Dele Laboratories, 1133 Broadway, New York.

START clean business manufacturing our Acme Doughnut Flour. Makes pure, wholesome, delicious doughnuts. Ready Sales. Full directions Two Dollars. American Cereal Company, Everett, Wash.

STOP Plodding! Be Successful. Operate a Tire Repair Shop. Make big profits in any locality. We teach you and furnish complete equipments \$100.00 up. Book of Opportunity free. Haywood's, 1385 South Oakley Avenue, Chicago.

LEARN the collection business. Good income, quick results. Interesting booklet, "Skillful Collecting" free. National Collectors Assn., Long St., Newark, O.

\$3,000 To \$6,000 Yearly. Want it? Others are making it. Send check or money order today for our invaluable books "How to Sell Real Estate" \$3.00—and "How to Conduct Real Estate and Insurance Business" \$1.50. Absolute satisfaction guaranteed. Free catalogs. Realty Book Co., Dept. 52, Cleveland, Ohio.

CHEMICAL Expert furnishes manufacturing formulas with complete working directions, resulting products possessing distinct individuality and merit. Processes perfected. All lines. No lists of worthless stock formulas but reliable individual service. Charges reasonable, correspondence invited. Dr. Arthur VanHeeden, 398 South Oakley Boulevard, Chicago.

MANUFACTURE Ready-Made Gold Window Sign Letters. Unlimited Profits! We furnish complete instructions, accurate patterns. Absolutely no experience required. Wonderful Business Opportunity! Particulars. Wiltberding, 3151 Abbott Court, Chicago.

"WHAT to Invent for Profit" free. Patent News-C, Washington, D. C.

MONEY-MAKING Opportunity; learn how; valuable information; send stamp. Skarm, 2926 Lorina, Berkeley, Calif.

LEARN destroying superfluous hair permanently without scar. Complete instructions \$1. Beni. Zitka, Fairview, Mass.

OPEN a rental bureau in your city under unique "Personal Inspection" plan. No capital required. Ask for details. Washington Service Bureau, District National Bank Bldg., Washington, D. C.

START and Operate Your Own Business. Our System proprietary specialty manufacturing offers wonderful opportunity to make \$100 to \$500 weekly. Openings everywhere. Either men or women. We furnish everything and show you how. Big explanatory book, "The Open Door to Fortune" free. Write for it now. National Scientific Laboratories, 208 Monroe, Richmond, Va.

FREE Advice: How to be successful in real estate. Particulars, Macdonald Co-operative Realty Co., San Diego, Calif.

EARN \$3,000 to \$20,000 yearly. You can be a Professional man in Bacteriology, Pharmacy, Osteopathy, Chiroprody, Resident and Home courses. Begin now. National University of Sciences, 2923 Michigan, Chicago.

CHEMISTRY

CHEMICAL analysis honestly and correctly done by L. E. Tenney, Potsdam, N. Y., 13 Bay St.

PRODUCTS formulated, duplicated, improved, cheapened. Ethical. Harding, Box 1029 P, Chicago.

YOUR chemical problem solved and working process furnished Five Dollars. Write me. W. Stedman Richards, Consulting Chemist, address, Box 2402, Boston, Mass.

CHEMICAL Service. Formulas, analysis, methods, experiments. Jacob Snyter, Chemist, 2525 East St., Davenport, Iowa.

EXPERIMENTERS—Complete supplies for the chemical laboratory. Catalogue 5c. National Scientific Supply Co., 241 Pa. Ave., Washington, D. C.

CHEMICAL Processes, Analysis, Research. Technical Information. Consulting Chemist, Madison, Maine.

TRY our laboratory service, write for reasonable rates. Doris Chemical Laboratories, East Cleveland, Box 59, Cleveland, Ohio.

CHEMICALS—for all purposes. Chemists Supply Co., 61 East Lake St., Chicago.

FORMULAS AND TRADE SECRETS

FORTY Famous Formulas, fast selling necessities, \$1.00. Gihner, 4450 West End, Chicago.

1,000,000 FORMULAS, 1,616 pages, \$2.50 Formulas Free if you order quick. Ideal Book Shop, 5501-M2, North Robey, Chicago.

500 FORMULAS resilvering mirrors, valuable collection, 20c. Universal, 4017-P2, North Whipple, Chicago.

BIG, interesting formula catalog free. National Scientific Laboratories, 208 Monroe Street, Richmond, Va.

FORMULA for tanning Free to any address. B. N. Gilley, Carlton, Texas.

500 FORMULAS, including Luminous Paint—Renewing Dry Batteries—Mechanics Soap—Gas Tonic—25c. Catalog Free. Ideal Book Shop, 5501-P2, North Robey, Chicago.

5,000 RECIPES, \$1.25. Best formulas and processes for every business, trade or occupation are in "Youman's Guide." Many never before published. Worth \$1.25 each. 500 pages. Paper cover \$1.25. Cloth \$2.00, postpaid. Book catalog free. Wells and Edwards, Department X, 852 George, Chicago.

HOW to make leather. Instructions \$1.00. Herbert Clefisch, Garber, Iowa.

FORMULAS—Guaranteed. Catalog Free. Bestoval Laboratories, 4017-P2, North Whipple, Chicago.

10,000 SELECTED chemical, technological and practical recipes and processes, including hundreds of so-called trade secrets for every business, alphabetically arranged in one large volume of 800 pages. Price \$4 postpaid. Popular Mechanics Book Dept., 206 E. Ontario St., Chicago.

500 VALUABLE Formulas 25c. Circular free. Harvey Teeple, Decatur, Ind.

FORMULAS—Best that Chemical Science can devise. Not "Better Sort" Formulas, but Guaranteed Reliable processes in all lines. Stamp brings Valuable Literature and Latest Summer Sellers from an Analytical Chemist, Miller, Chemist, 807 De Leon, Tampa, Fla.

AGENTS WANTED

SALESMEN—Get into the tailoring game—one of the most profitable of all lines in the selling field. Experience isn't necessary. We show you how to take measures, teach you how to sell our line and supply you with everything necessary to go out and make from \$10.00 to \$20.00 a day from the very first day. Our selling outfit is the finest of its kind ever gotten together, and shows more than 100 large cloth samples of finest wools. You do no delivering. You just write your orders. We do the rest. Your profits run big and you get them cash with order. If you want to get into this most profitable of all lines, write us quick. Address Dept. 758, Goodwear Chicago, Inc., 844 W. Adams St., Chicago.

WHY Work for others? Start and operate your own business. Our system proprietary specialty business offers wonderful opportunities to make \$100 to \$500 weekly. Openings everywhere. We furnish everything and show you how. Booklet free. National Scientific Laboratories, 208 Monroe, Richmond, Va.

MAKE \$31.00 Profit—Cost you \$1.50. Complete Gold Monogramming Outfit. Transferred Instantly on Automobiles, Trunks, Bags, Windows. Experience Unnecessary. Free Samples. NuLife Monogram, Hartford, Conn.

\$5 TO \$15 daily easy—Introducing New Style Guaranteed Hosiery. Must wear or replaced free. No capital or experience required. Just show samples, write orders. Your pay in advance. We deliver and collect. Elegant outfits furnished. All colors—grades including silks, lises, heathers. Mac-O-Chee Mills Company, Ross 2562, Cincinnati, Ohio.

AGENTS, Salesmen, Demonstrators, you will have the devil's own time trying to find a better seller than "Zippo." If there was such a thing we'd have it. Splendid profit on 50c "Go Getter" repeat article that sells on ten second demonstration. Works While You Watch It. Demonstrates value, while others waste time making claims. New Discovery! Greatest Scientific Triumph of the age. It's the berries. Haven't room to tell our story here. Write immediately. Karan-Smith Co., 602 Bozart St., Ft. Wayne, Ind.

FORMULAS—Dependable manufacturing formulas with complete working directions. Charges reasonable. Write me. S. Vignias, Chemist, 135 Meadow St., Pittsburgh, Pa.

PORTRAITS, photo pillow tops, frames, sheet pictures, medallions, merchant's signs, water-proof and tea aprons, guaranteed hose, toilet requisites, luminous crucifixes; catalog, 50 specialties free, 30 days' credit. Jas. C. Bailey Co., Desk A-2, Chicago.

WONDERFUL Invention—Eliminates all needles for phonographs. Saves time and annoyance. Preserves records. Lasts for years. 12,000,000 prospects. \$15.00 daily. Free sample to workers. Everplay, Desk 223, McClurg Bldg., Chicago.

AGENTS "Cleaning Up." Housewives everywhere talking about wonderful new invention—Perfection Pressure Cooker. Saves money, time, labor. Easy to sell. Write quick. Jubilee Mfg. Co., 33 Station C, Omaha, Nebr.

DISTRICT Salesmen wanted to establish sub-agents for handling our complete line—212 articles—food flavors in tubes, toilet preparations, padding powders, stain removers, etc. Goods well known. Big demand, large commissions. C. H. Stuart & Co., 5267 Broadway, Newark, New York.

AGENTS—\$15 a day—Easy, quick sales—Free Auto—Big weekly Bonus—\$1.50 premium Free to every customer. Simply show our Beautiful 7-Piece Solid Aluminum Handle Cutlery Set. Appeals instantly. We deliver and collect. Pay daily. New Era Mfg. Co., 803 Madison St., Dept. 21-W, Chicago.

AGENTS to sell men's hats direct from factory. Guerin Hat Co., South Orange, N. J.

AGENTS: New Portable Talking Machine. Does more than machines costing five times its price. Carry it with you anywhere. Built in just like a suitcase. Biggest seller ever put on the market. Low priced. Write for sample and territory. Perry-Ludlow Co., Class 1862, Dayton Ohio.

TERRITORY open for electrical necessity. Sells for 25c, 50% profit. Write for particulars or send one dollar for samples and supply. Relite Fuse Co., 2919 Bay St., Los Angeles, Calif.

AGENTS: Biggest money taking orders for newest style written guaranteed hosiery. Complete line, men, women, children, including silks. No competition. Not sold in stores. Written guarantee with each pair. You display samples and write order. We deliver and collect. Pay you daily in advance. No experience necessary. Spare time satisfactory. Write for samples. Jennings Mfg. Co., Dept. 868, Dayton, Ohio.

AGENTS Wanted—Quick easy seller. Tremendous money maker. Newest, greatest mechanical invention. Nothing like it. Unlimited guarantee. Make \$3.21 per sale. Snap it up. Don't delay. Write for details at once. W. H. Orr, 1369 N. Wells St., Chicago, Ill.

\$75 WEEKLY selling Nustile Guaranteed Hosiery. Your pay daily. You write orders, we deliver and collect. Special monthly bonus. Sample outfit furnished. Nustile Hosiery Mills, Dept. 175, Phila., Pa.

EVERYBODY likes pecan meats. Increase your income selling Lone Star fresh shelled pecan halves. Good Profits. Constant repeater. Write for agency proposition. Lone Star Pecan Company, Cisco, Texas.

ALASKA Novelties—Agents, newsdealers, storekeepers, profitable sideline. Send Dollar for samples. Grohman, Thane, Alaska.

AGENTS—Start the New Year right with a profitable big line of Rubber Goods, \$60 to \$100 weekly easy. Free 1924 Catalogue now ready. Write American Rubber Products Company, Dept. 108, Pittsburgh, Pa.

TAILORING Men: Make More Money—Sell Men's Made-to-Measure Quality Clothes! \$55.00 suits for \$32.50. \$5.00 profit to you. Beautiful all wool, pre-shrunk fabrics. Highest quality and fit guaranteed. Complete line containing more than 150 big samples, actual coat front, and special measuring device furnished free to producers. Write quick for details. Robert E. Bradley, Inc., Dept. P. M. 1, Indianapolis, Ind.

WAYSIDE Battery Restorer makes old sulphated batteries operate like new. Guaranteed. Price One Dollar. Agents wanted. Wayside Corp., Sibley, Mich.

MONEY! Silvering Autolights, Radiators, Mirrors, tableware, stores, Outfits. Methods free. Clarence Sprinkle, Dept. 28, Marion, Ind.

WANT laundry solicitors everywhere. Trouble your income. Francis Shure, Denver.

AGENTS: Travel by auto, distribute soap samples, \$8.75 a day full time, or we can pay you \$1.25 an hour spare time. Write today for free samples and big offer. Harley Co., Dept 153, Dayton, Ohio.

AGENTS: Your Suit Free. Take orders for our fine tailored-to-measure suits all at one amazing low price. Every order pays you big profit. We supply wonderful swatch line outfit showing big assortment of finest quality fabrics in large size samples all put up in handsome carrying case. We give every active agent his own suit absolutely free. Tailoring, raincoat and side line men, get our powerful proposition at once. Address Dept 292, Knickerbocker Tailoring Company, 131 So. Peoria Street, Chicago.

EARN valuable premiums selling aspirin. Write William Fulton, Paducah, Ky.

AGENTS make big money selling new metal polish. Fast seller on a demonstration. 150% Profit. Reginald Pulson, Box 697G, Randolph, Mass.

\$8 TO \$16 daily easy. New Patented Cutlery and Carving Set. You take orders, we deliver and collect. Your pay daily. No experience necessary. Not for sale in stores. Full or spare time. Mac-O-Chee Company, Stand 1102, Cincinnati, Ohio.

TWO-IN-ONE-LINE—Something new for Tailoring or Raincoat agents. Great for men who have been waiting to break into this profitable business. Union made-to-measure suits or overcoats at \$23.50. Raincoats \$3.95. A money maker from start to finish. Big repeater. Satisfied customers guaranteed. Real sales help. Offer will soon be withdrawn. Agency equipments are limited. Get in line for one of our \$100.00 a week jobs. Elliott Bradley, Inc., 1028 W. Van Buren, Dept. A23, Chicago.

THESE Advertisements of mine have appeared in Popular Mechanics for sixteen years. Hundreds of Successful Manufacturers today owe their success to my formulas and valuable information. Majority started with practically nothing. You can do the same—write today for my valuable literature relative to my Guaranteed Manufacturer's Formulas for making Non-Thermic Ice-Saving Cloths, Delicious Beverages for Home, Bottlers and Fountain sale. Pure Food Products, Non-Alcoholic Flavors, Launderite Washing Marvel, Zest, greatest stain remover, Sta-Combed, Marcel Hair Curler, and latest Toilet specialties. Mexican Yucca Soap, Laundry Soaps, Flynox, Senses, and all latest disinfectants. Amazon Tire Repair, Toy Rubber Balloons and all latest selling goods in all lines. Don't compare these with "junk" commonly offered. Analytical work carefully done. Highest references. Miller, Chemist, Tampa, Fla.

WHY Work for others? Start and operate your own business. Our system proprietary specialty business offers wonderful opportunities to make \$100 to \$500 weekly. Openings everywhere. We furnish everything and show you how. Booklet free. National Scientific Laboratories, 208 Monroe, Richmond, Va.

YOUR Pay in Advance. \$10-\$15 daily selling High Grade Hosiery direct to wearer, 26 numbers. Full Fashioned Silks, Chiffons, Lace Clox, Glove Silk Fancies, Silk and Wool, all Wool; also Pure Silk—1 pair \$5.50. Some territory open for State and District Managers. Donde Hosiery Co., 417 Standard Trust Bldg., Chicago.

AMERICAN Woolen Mills Co., Dept 2975, Chicago, are making a free suit for one agent in each community to introduce their fine tailored to order suits at \$18 and up. Write them today for their offer.

AMAZING money maker. Only device of its kind. No competition. Money-back guarantee. The Peerless Trap catches, kills rats and mice automatically and continuously. Used by U. S. Government, Armour & Co., Pillsbury Flour, thousands of others. Creates sensation everywhere shown. Enormous field—farmers, stores, warehouses, factories, are quick buyers. Minute demonstration brings order. Never fails. Big profit on each sale. \$15 to \$25 a day easy. S. Seelman made \$6,000.00 this year. High-class proposition—a winner. Automatic Trap Co., 639 W. Jackson Blvd., Dept. 14, Chicago.

NEW Office Specialty. Minute Demonstration means sure sale. 100% repeater. Big Profits. Odiorne, 119 South Fourth, Philadelphia, Penna.

WRINGER Mop—We Have the Best Wringer Mop Made and can offer high-grade mop and brush salesmen exclusive territory and liberal profit. M. C. Newton, 1338 West 104th, Cleveland, Ohio.

AGENTS—Make big money taking orders for Insole Tyres. Positively prevent punctures and blowouts. Double tire mileage, any tire, old or new. Old worn-out castings give 3 to 5 thousand miles more service. Use over and over again. Low priced. Big demand. One customer brings four others. Big money saver. Write for terms. American Accessories Co., B-678, Cincinnati, Ohio.

"SPOTGO"—Something New; Magic Spot Remover. Spots disappear instantly. Works while you watch it. Demonstration sells. 300% profit. Sample Free. Amerco Products Co., 4917-H North Whipple, Chicago.

TAILORING Agents. Make \$50 to \$100 a week selling all wool 2 piece suits at \$21.50. Also our famous virgin wool suits at \$31.50—none higher. Commissions daily. Beautiful assortment of 600 swatches free. No experience needed. Can use spare time workers—if hatters. Write J. B. Simpson, Inc., Dept. 750, 813 West Adams St., Chicago. See page 185.

CLARKE Earned \$716.00 Selling Pull-em-up Kuff Buttons. Fifty other meritorious Jewelry Specialties that sell like wildfire. Master Jewelers, Sheboygan, Wis.

AGENTS—\$75 to \$100 weekly selling new patented corn popper. Every housewife buys on sight. Send 25c for sample. International Sales Co., 1929 Wabash, Chicago.

\$20 A DAY, easy, selling Senior Knife and Scissors Sharpener. Every home and office your customer. Send 25c for returnable sample and full particulars. Senior Manufacturing Company, 692 Commonwealth Building, Pittsburgh, Pa.

AGENTS, Experience unnecessary. 18 beautiful Neckwear numbers, 150% commission; we deliver. Write for free samples. 10 Hosiery numbers. Dept. 1103, The Lexington Co., Lexington, Ky.

AGENTS—Distributors—make easily \$100 to \$200 a week. Be a "Filetrench Man." Get into a permanent business with growing profits. Sell the marvelous Eifel-Flash Filetrench Tool Kit—Guaranteed to Do The Work better, quicker, and easier of 60 pounds of the best other tools costing \$30.00. Only kit that does all work around Home, Car, and Shop. Weighs 1½ Pounds. Sells quickly, when shown, at \$5.50. On market 3 years—thousands sold. Extra good for agents with cars. Fine side line—carry in pocket. State how you sell, territory wanted. The Flash Sales Corp'n., Dept. P, 489 North Ashland Ave., Chicago.

GET posted—Good prices paid for butterflies, insects. See Sinclair display advertisement, page 78.

VEST-POCKET Magnetic Extractor, removes foreign bodies from the eyes. Agents' sample 50c. 3 for \$1.00. Gem Extractor, 531 So. Dearborn St., Chicago.

AGENTS—Wonderful household articles, every home a prospect; new plan makes sales easy. Big profits. William Ward & Co., Dept. B, 54 East Fifth Ave., Columbus, Ohio.

AGENTS—Patented Automatic Instrument Starts Engine Instantly in Cold Weather—"Removes Carbon from Running Motor"—Saves Money Three Ways—Automobilists Astounded—Wonderful Necessity every engine "Needs"—Distinctly Different—Enthusiastic Users Everywhere—Only \$5.00 Postpaid—Installed in a few minutes—Outlasts Automobile—Money Back Guarantee—Unbeatable proposition. Your Opportunity for Tremendous Success—Experience Unnecessary. Investigate Immediately—Complete Description Interesting. Instructive—Immensely Profitable Spare or Whole Time. You're read our advertisements many months—Write Today for Exclusive Territory. Wizard Manufacturing Company, Rochester, N. Y.

AGENTS, both sexes, we manufacture and control new household article. Fast seller. Big Profits. Exclusive territory. Write now. Connolly, 123 Liberty St., New York.

\$100 WEEKLY is nothing unusual for men and women selling the Kelly Chemical Indoor Closet. Has given service and satisfaction for more than 15 years. Easily sold to every suburban, rural and farm home without sewer connection. No plumbing, carpentry, water-works or cesspool. Easier to install than a stove. Write—Kelly Mfg. Co., 4294 W. Adams St., Chicago.

CASH in on this quick seller. Wingo cleared \$1,050 with Neter Fall Razor Sharpener in six weeks; Purdy, \$40.50 first day. Applewhite, also inexperienced, six orders in thirty minutes. No end to ready buyers. Exclusive territory for quick workers. Be first. Address Neter Fall Company, 159 Allen Bldg., Toledo, Ohio.

WHY Work for others? Start and operate your own business. Our system proprietary specialty business offers wonderful opportunities to make \$100 to \$500 weekly. Openings everywhere. We furnish everything and show you how. Booklet free. National Scientific Laboratories, 208 Monroe, Richmond, Va.

AGENTS: Largest line of metal household specialties. Quick, easy. Big Profit Sellers. Write now. General Products Co., 348 Mulberry Street, Newark, New Jersey.

AGENTS—Make \$10 to \$20 daily selling the famous Nerv-Ease Foot Comforts. Big demand. Over 100% profit. Write today. Manhattan Products Co., 2320D Bailey Ave., New York.

AGENTS—Something New—fastest sellers and quickest repeaters on earth. Permanent, easy, profitable business. Good for \$12 to \$18 a week. Address, American Products Co., 1792 American Bldg., Cincinnati, Ohio.

AGENTS—\$50 a week taking orders for guaranteed hosiery for men, women and children. Must wear 12 months or replaced free. All styles and finest line of silk hose. Write for sample outfit. Thomas Mfg. Co., Class 262, Dayton, Ohio.

AGENTS—Big money, \$8 to \$16 a day. Aluminum handle cutlery set. Brand new. You display and take orders. We deliver and collect. Pay you daily. Sample free. Try it out. Jennings Mfg. Co., Dept. 1663, Dayton, Ohio.

\$12 DAILY easy, Introducing Ladies' and Men's sweaters in silk, wool and artificial silk. 23 colors. Latest novelties. Going like wildfire. You simply show samples we furnish; take orders; we deliver and collect. Your pay daily. Mac-O-Chee Mills Company, Form 1162, Cincinnati, Ohio.

AGENTS—Sell full line Interlock guaranteed hosiery for men, women, children. All styles, colors, 12 months' demand. Satisfaction or money-back guarantee. Full or spare time. Samples to start you. Parker Mfg. Co., Sample 578, Dayton, O.

HERE they are—fifty fast sellers. Everybody needs and buys. Fifty Dollars weekly easily made. B. & G. Rubber Co., Dept. 564, Pittsburgh, Pa.

BRING Home the Bacon—selling Stuart's Stain Remover. Removes ink, iron rust, grass and fruit stains. Write for free samples and terms today. C. H. Stuart & Co., 3667 Broadway, Newark, New York.

AGENTS, our suits retail \$19.50 and up. You make \$3.00 to \$12.00 on each sale. Free suit, cash bonus and big special rewards to agents who will sell one suit a week or more. Details free. Chicago Tailors' Ass'n., Dept. 377, Sta. C, Chicago.

27,000 RECORDS Guaranteed with one Everplay. Wonderful invention eliminates needles for phonographs. New; different. Cannot injure records. \$15.00 daily easy. Free sample to workers. Everplay, Desk 26, McClurg Bldg., Chicago.

ASTOUNDING invention starts Fords instantly, coldest weather, doubles mileage. Big profit. Super, 1206 Fondulac, Milwaukee, Wis.

MAGIC Polishing Cloth—great seller—big profit. Get our proposition. Newton Co., 61 Main St., Newark, New York.

FLORISTS' Plant Food Promotes Growth. Large Size and 25 Valuable Formulas 25 Cents. DeMuth, Camden, Mich.

AGENTS sell Dan-D. Iron Rust, Spot and Stain Remover, 150% profit; sample 20 cents. Particulars free. Dan-D Products Co., Box 69, Augusta, Ga.

DISTRICT Managers to appoint Agents. Big side line. Box 22, Paragould, Ark.

MEN'S Shirts Easy to Sell. Big demand everywhere. Make \$15.00 daily. Undersell stores. Complete line. Exclusive patterns. Free Samples. Chicago Shirt Manufacturers, 211 W. VanBuren, Factory 211, Chicago.

PORTRAIT Agents. Linder Art Company is known the world over for Good Work. Exact Likeness. Speedy Service. We make a portrait that delivers without schemes, kicks or arguments. Your customer pays you cheerfully. Try us—seeing is believing. Linder Art Company, 519 Washington St., Chicago.

DARN E-Z selling system will double agent's income, regardless of what you sell. Every agent or district manager needs this plan—Details free. Address Darn E-Z Laboratories, Department P. M. 4, Mutual Home Bldg., Dayton, Ohio.

ANY man handy with paint brush or light tools can start new mechanical business on nearly nothing; needed everywhere; nearly all profit; experience not required. John Brageland, 1457 So. Ninth, Philadelphia, Pa.

FREE Sample. "Rain Shield Wiper." Retail \$1.00—Costs (25c). Sold, Clear and Rainy Days. No Cloth—No Paste—No Attachment. (1) Rub keeps Windshield Clear (18) Hours. Experience unnecessary. NuLife Corporation, Hartford, Conn.

MOST Wonderful Seller. 96c profit every dollar. No stock to carry. License unnecessary. Sample free. Mission Factory PM. 519 No. Halsted, Chicago, Ill.

GENUINE Gold Leaf Letters anyone can put on store windows. Guaranteed to never tarnish. Large profits. Enormous demand. Free samples. Write today. Metallic Letter Co., 438-A North Clark, Chicago.

???????? IF you are big enough to fit, this is a corking fine opening. Would you like to become associated with the largest playlet and commercial motion picture studio in the United States—Selling our Publicity service to merchants, banks, etc.? Somebody in Illinois will be enjoying this position soon. Will it be you? Well! Alexander Film Company, 3391 So. Broadway, Denver, Colo.

AGENTS—Sell the best mop wringer made. \$1.00 profit on each sale. Other fast selling specialties. Write today. Newton, 1338 West 104th, Cleveland, Ohio.

You can make \$75.00 to \$100.00 a week selling our big line of 150 articles, used constantly in every home. Write us, we will send you our handsome \$15.00 Sample Case Outfit on trust. Federal Pure Food Co., Dept. PP, Chicago.

WONDERFUL Composition. Preventive of Rain-Blurred Windshields, cake form. Agents earn money; 25 cents, Doz. in parcels \$1.00. Prepaid. Marvel Wax Company, Sheboygan, Wis.

PORTRAIT Agents. Dealers, get your Portraits and Bromide Prints direct from Manufacturer. Lowest prices, prompt service. Lincoln Portrait Co., 1923 Hudson Ave., Chicago, Ill.

BE your own boss—take orders for guaranteed hosiery; average profit 40c pair, \$1 hour, samples free. Hopkins Hosiery Co., 433 Washington St., Boston.

300% PROFIT: Whirlwind Seller. Tremendous repeater. "Kleanrite." Marvelous Discovery. Washes clothes without rubbing. Premiums for customers. Sells 25c. You make 18c. Free samples make easy sales. Write quick. Bestever Products Co., 1941-K2 Irving Park, Chicago.

WANTED County Distributors for World Fastest Selling Automobile Accessory. Write C. Brenson Co., 384 East 144th Street, New York.

SHEEP Wool Moccasins, Polishers, Dust-ers. Box 26, East Boston, Mass.

FORTUNE Maker—Thread-Cutting Thimble. Live wires only. Sample, 15c. Automobile Mfg. Co., 3753 Monticello, Chicago.

GET out of low wage rut. Make \$12-\$50 day. Positions everywhere. Demand greater than supply for qualified automobile painters. We teach you in 8-10 weeks. Get facts. Have eyes open to wonderful new opportunity. Investigate. Write. Detroit Auto Painting School, 1406 Van Dyke, Detroit, Mich.

AGENTS, Newly patented combined cigarette and match case. Sells on sight to cigarette users. Write for particulars or send 50c for sample and proposition. All-in-One Sales Co., 1931 Park Ave., Minneapolis, Minn.

ABSOLUTELY free, box Bassett's Native Herbs sent to introduce. For constipation, indigestion, rheumatism, headache. Big money selling all or part time. Established 1870. Bassett, Dept. I, Columbus, Ohio.

EIGHT dollars for seven hours! Peek's Rives quickly mend leaky kitchenware. Sell everywhere on sight. Samples free. Box 25c, Peek Company, Medina, N. Y.

\$3.50 AUTOMATIC Adding Machine. Quick, profitable seller. Guaranteed accurate as highest priced machines. Exclusive territory granted. 75,000 already sold. Can be sold anywhere to anyone having adding of any kind to do. Act quick. Bassett Co., 1458-D Hollywood Avenue, Chicago.

SELL Glads. Quickly relieves stomach and catarrh troubles. 25c. Agent's outfit 15c. Cochran, Grayville, Ohio.

AGENTS—New household necessity. Sample 10c. Leon Church, Herkimer, N. Y.

LIVE Hustlers! Supply attractive, catchy article to movie shows, stores, etc. New business with big possibilities. Only small investment. Big profits. Hundred-thousands will be sold. Write immediately. Kraft, Box 890-Pas, San Francisco, Calif.

AGENTS—If you have formerly sold felt rags, write for our new proposition concerning new goods. It's a winner. Newark Felt Rug Company, 27-C 16th Ave., Newark, N. J.

BIG Money and Fast Sales. Every owner buys Gold Initials for his auto. You charge \$1.50; make \$1.35. Ten orders a day easy. Write for particulars and free samples. American Monogram Co., Dept. 40, East Orange, N. J.

EXCLUSIVE agents \$225 weekly. Genuine gold letters for store windows. Free samples; selling instructions. Chicago Window Sign System, 6226-A Kimbark Avenue, Chicago.

AGENTS: Big Money Selling Great Household Necessities. Sample 25c. Webster Co., 2545 N. Clark St., Chicago, Ill.

EVERYBODY wants our Imported "Fountain Pen," self-filling \$1.10. "Kitchen Set" fourteen pieces \$1.75. "Wonder" Cigarette Case—just out—makes cigarettes by closing cover. \$1.25. Send for samples (20% discount) and agent's proposition. Pitts Novelty Sales Co., 561 W. Washington St., Chicago.

USE our handsome catalog; get orders from every home for Dr. Blair's famous home products. Liberal pay. Dr. Blair Laboratories, Dept. 523, Lynchburg, Va.

ROBERT H. INGERSOLL, originator of the dollar watch, of which over fifty million have been sold, has now invented the wonderful Ingersoll Dollar Safety Razor Stripper, and says that anyone can make \$5, \$10, \$15 or more per day selling it. The greatest thing since the dollar watch. Try this Stripper yourself first, and be convinced. Sample 60c postpaid. State make of razor used. Address Robert H. Ingersoll, President, 476 Broadway, New York.

AGENTS—Make \$3.00 an Hour. New, Quick-selling specialty that's breaking all Records; particulars Free; sample 12c. Taylor's Novelty Shop, Columbia City, Ind.

30 SUCCESSFUL Money Making Enterprises free. Stearlins Company, Waltham, Mass.

AGENTS \$75 Weekly. Highest Commission Paid. Quality Goods. Exclusive Territory. Neway Brush Co., Hartford, Conn.

200% PROFIT. Valuable inside information free. Mail-order men, beginners, agents. Nite Mail Order Supply Co., 609 27th St., Denver, Colo.

AGENTS make \$50.00 a week selling our Daily Purchase and Sales Record. Indispensable for making Income Tax Report. Profitable side line. Small sample. Easy seller. Pershing & Co., Dept. C, South Bend, Ind.

FORMULAS, Processes, Trade-Secrets—Different, dependable, profitable. Catalog free. B. Thaxly Co., Washington, D. C.

PATENTS Procured. Send sketch or model today for examination, prompt report and advice. No charge for preliminary advice. Write for free Booklet and blank form on which to disclose your idea. Highest references. Promptness assured. Clarence A. O'Brien, Registered Patent Lawyer, 58-B Security Bank Building. Directly across the street from Patent office, Washington, D. C.

LIVE Agents make \$10 day selling Eureka Strainer and Splash Preventer for every water faucet. Takes on sight. Widely advertised and known. Get details today. A. B. Seed Filter Company, 73 Franklin, New York.

AGENTS wanted to sell leather bill folds. Universal Sales Company, Box No. 152, Springfield, Ill.

AGENTS to sell Men's knitted neckwear. No investment necessary. Write Meltsner Neckwear Co., 24 East 21st St., New York.

WONDERFUL Scientific Discovery: "Blue-White Sapphires" rival finest diamonds, \$3 carat. "Rainbow Sapphires" changes color, greenish purple to ruby red, \$3 ct. "Meteor Sapphires" like golden diamonds, \$2 ct. Pearls, Watches, Diamonds, solid gold mountings; new sales idea; wholesale prices; be our agent. Pauer (Insurper), 152 DeWitt, Buffalo, N. Y.

MAKE \$1 hour selling Vegetal Shampoo Soap. The Soap with million bubbles. Henry Moritz, 1909 West 77, Cleveland, Ohio.

AGENTS—Make \$5 an hour; our beautiful silk knitted neckwear sells on sight; latest New York styles direct from mill to you; popular price; instant sales; steady all year round proposition; big repeater. Write today. Knit-Art Silk Neckwear Co., Rochester, N. H.

AGENTS—Don't answer this ad if you don't mean business. But if you're out to make money, and want a fast-selling proposition, address The Horsey-Bassett Co., Inc., Dept. P-2, Crisfield, Md.

MAKE \$75.00 a week and up selling our fine made-to-measure, all-wool suits at \$31.50 retail, direct to wearer. Biggest values—positively sell on sight. Biggest commissions, paid in advance. We attend to delivery and collections, and scratch samples furnished free. W. Z. Gibson, Inc., Dept. B-41, 161 W. Harrison St., Chicago.

AGENTS: Send for sworn proof of \$5 to \$15 daily, introducing New Strle Guaranteed Hosiery. 57 styles, 17 colors. No capital or experience required. Just write orders, we deliver and collect. Your pay daily, also monthly bonus. Free auto offer besides. Complete outfit furnished. All colors—grader including silks. Mac-O-Chee Hosiery Company, Room 2902, Cincinnati, Ohio.

WHY Work for others? Start and operate your own business. Our system proprietary specialty business offers wonderful opportunities to make \$100 to \$500 weekly. Openings everywhere. We furnish everything and show you how. Booklet free. National Scientific Laboratories, 268 Monroe, Richmond, Va.

PORTRAIT agents earn big money selling our Photo medallions. Photo medallion clocks, Religious medallions, Photo pocket mirrors, Photo buttons, Photo jewelry, and Fraternal Photo medallions. Send for free catalogue. Satisfaction guaranteed. Four-day service. Address Gibson Photo Jewelry Co., Apartment 7, 608 Gravesend Ave., Brooklyn, N. Y.

CALIFORNIA Rosebuds selling like hot cakes. Agents coinng money; new stuff. Big profits. Catalog free. Mission Factory PM, 519 No. Halsted, Chicago, Ill.

AGENTS—Best seller: Jen Rubber Repair for tires and tubes; supercedes vulcanization at saving of over 800 per cent; put it on cold, vulcanizes itself in two minutes, and is guaranteed to last the life of the tire or tube. Sells to every auto owner and accessory dealer. For particulars how to make big money and free sample, address Amazon Rubber Co., Amazon Bldg., Philadelphia, Pa., Dept. 505.

SUCCESS in Business and Personal Affairs! Read character by handwriting and features. Conlin System. Low price for entire course. Write, H. E. Conlin, Dept. B, 21 St. John's Place, Buffalo, N. Y.

AGENTS—Steady income. Large manufacturer of handkerchiefs and dress goods, etc., wishes representative in each locality. Factory to consumer. Big profits, honest goods. Credit given. Send for particulars. Freeport Mfg. Co., 59 Main St., Brooklyn, N. Y.

AGENTS Wanted—Something New—Fire Fighter sells easily. Makes a spectacular demonstration; car owners, homes, factories, stores, practically buy on sight. Our men make \$10.00 to \$50.00 a day; exclusive territory. If you wish to establish a business of your own with unlimited possibilities for making big money, write us today. Fyr-Fyter Co., 103 Fyr-Fyter Bldg., Dayton, Ohio.

LARGE Corporation wants a Service Man in every town to paste up its signs on store-keepers' windows. Excellent opportunity for reliable party. Steady work. No experience necessary. We also have attractive proposition for agents and salesmen. Guarantee Sign Service, 363 West Superior, Chicago.

AGENTS—Stamping names on Pocket Key Protectors; sample Check with your name and address, 25c. Stamping Outfits, Emblem Checks, Check Fobs, Name Plates, Hart Mfg. Co., Desk 2, 303 Degraw St., Brooklyn, N. Y.

AGENTS make 500% profit handling Auto Monograms, New Pictures, Window Letters, Transfer Flags; Novelty Signs. Catalog Free. Write Hinton Co., Star City, Ind.

RUSSIAN, German, Austrian, Soviet money. Sensational sellers. Cheap, attractive, giveaway advertising for Agents. Merchants. Big Circular Free. 100 banknotes \$2.00, splendid assortment. Hirsch Importing, 70 Wall St., New York.

AGENTS—Our soap and toilet article plan is a wonder; get our free sample case offer. Ho-Ro-Co., 2725 Dodier, St. Louis.

MAKE money silvering mirrors, all kinds plating, knives, spoons, auto headlights. Outfits furnished. Free booklet. International Laboratories, Dept. 25, 311 Fifth Ave., New York.

INSTANT Weld Repairs largest punctures without cement or heat. Lemm's profit one day, \$36. Write quick. Free sample; territory going fast. Tourists' Pride Mfg. Co., Desk T, Minneapolis, Minn.

PORTRAIT and Medallion Agents—Our Goods Will Make You Big Profits; delivery guaranteed; prompt shipments; low prices; send for latest catalog. Adam J. Kroll & Co., 602 Blue Island Ave., Chicago.

SELF-THREADING Needles find sales in every home. Fine sideline, easy to carry. Big profits. Sample free. Prentice-Lee, 145 East 23rd St., New York.

CARD Signs for every business. Big profits for agents. Sample, 10c. Signs, 819 St. Louis, New Orleans.

AGENTS: Can start you in Mail Order Business immediately. Been at it 17 years. Small capital needed. Particulars stamp. Home Business Expert, Valdosta, Ga.

\$60-\$200 A WEEK. Genuine Gold Letters for store windows. Easily applied. Free samples. Liberal offer to general agents. Metallic Letter Co., 438-D, North Clark, Chicago.

AUTO owner tire agent wanted each locality to use and take orders for handmade Mellinger fabric and cord tires; guarantee bond 8,000 and 12,000 miles (no seconds); shipped prepaid on approval; get your tires free; no capital or experience required; make \$100 to \$300 weekly. Write for wholesale prices and sample kit. Address, Mellinger Tire Co., Dept. 100, Kansas City, Mo.

WE PAY \$50 a Week and expenses and give a Ford Auto to men to introduce poultry and stock compounds. Imperial Co., D-23, Parsons, Kan.

AGENTS—Good salary and commission selling "Ratskill," new rat and mouse exterminator; ready for use; no bait required; non-poisonous; rodents die outside premises; no odor. Empire Specialties Co., 1549 N. Wells, Dept. 391, Chicago, Ill.

AGENTS sell Wolverine Laundry Soap. Wonderful repeater and good profit maker. Free auto to buyers. Wolverine Soap Co., Dept. B37, Grand Rapids, Mich.

NEW Wonderful Seller. Over 100% profit on every sale of Harper's Ten-use Set. Needed in every home. Washes and dries windows, sweeps, scrubs, soaps, etc. Greatest year 'round seller. Write Harper Brush Works, 132 2nd St., Fairfield, Iowa.

GET Our Free Sample Case—Toilet articles, perfumes and specialties. Wonderfully profitable. La Derma Co., Dept. A, St. Louis, Mo.

AGENTS—Clever Invention! Inkspoon makes every pen a fountain pen. Fast office seller; big profit, demand increasing everywhere. Exclusive territory offered. Sample free. H. Marul Company, Tribune Bldg., New York, N. Y.

AT Last—World's Greatest Adding Machine. Almost human. Retail \$15; work equals \$300 machine. \$500 monthly easily made, demonstrating to stores, offices, garages, factories. Simple, easy; adds, subtracts, multiplies, divides automatically. Speedy, accurate, durable, handsome. Five year guarantee. Tremendous demand, amazing profits. Liberal trial offer. Protected territory. Write quick. Lightning Calculator Corp., Dept. F, Grand Rapids, Mich.

SELL Madison "Better Made" Shirts direct from our factory to wearer. No capital or experience required. Easily sold. Big profits. Write for Free Samples. Madison Mills, 563 Broadway, New York.

BUILD a lasting business in your own community, with the Waterizer—big profits—cumulative—clean cut. James B. Lund, Manufacturer, 19 S. LaSalle, Chicago.

AGENTS, \$10 to \$25 a day. No investment. Free outfit. Best values. Largest commissions. World Railroad Co., 630-B Morris Park Ave., New York.

AGENTS:—Men and Women. Stop! Look! Wonderful opportunity! Make \$3.00 per hour easy. Fancy Hemstitched stamped Buffet sets 50c. Center Pieces 60c. Iron Board Covers. Rubber Aprons. Sanitary Aprons. Fancy embroidery dainty. Linen and Satin Aprons. Austrian Cloth Bed Spreads. Free working sample! Write us quick. Dept. P, American Brading Co., 329 Monroe, Chicago.

POLMET—The Wonderful Polishing Cloth that cleans all metals without liquid, paste or powder. Approved by "Good Housekeeping" and "Modern Priscilla"—sells fast at 25c. Sample free. Gale & Co., Inc., 15 Edinboro St., Boston.

OIL or Coal "The Burning Question." Interesting booklet discusses high efficiency low-priced residence oil burners. Copy free. Write E. L. Miller, Manufacturer Climax Burners, 33 Climax Bldg., Kansas City, Mo.

DISTRICT Managers wanted every city and county in U. S. to manage branch offices. No experience required; we teach you how to earn \$100-\$200 weekly. Must appoint sub-agents, salesmen. Firelite sells to every home, store, factory, office, garage, hotel, public building, etc. Lifetime opportunity for men with few dollars capital. Your territory open. Write Firelite Co., Masontown, Pa.

AGENTS: W. F. Omels, just an ordinary fellow, made over \$5,000 during 1922 selling our \$1.50 kitchen specialty. He is now a district manager. We are offering you the same proposition—an opportunity as big as you want to make it. You can do what Omels did. Write today. M. H. Tyler Mfg. Co., Dept. M-1, Muncie, Ind.

WE start You Without a Dollar. Soaps, Extracts, Perfumes, Toilet Goods. Experience unnecessary. Carnation Co., Dept. 291, St. Louis.

MAIL-ORDER houses and distributors; we pack big profit beauty creams, face powders, perfumes, toilet preparations with your label. Chemist, 944A No. Clark, Chicago.

AGENTS clear \$50.00 weekly selling Opaline Portraits. Expense money advanced. Credit given. Big line now ready. Samples and Catalog free. Consolidated Portrait Co., Desk 2, Chicago.

\$8.00 TO \$20.00 per day. A wonderful seller. Any man, woman, boy or girl can make big wages Selling Crimp Grip Clothes Line Fasteners. It is a perfect rope holder and can be used for many purposes. Crimp Grips are a simple, time-saving device. They last a life time and will not rust; it holds the line tight, and saves time on wash days. Every buyer is a booster. Send 50c for Mounted Sample and one pair of Crimp Grip Clothes Line Fasteners. Write for particulars. Crimp Grip Company, Belvidere, Ill.

PATENTED Cigar Lighters with Glass Advertising Front. Also Electric Cigar Moisteners. Wonderful Sellers. No Competition. Big Steady Profits. Proof, Cash. Sales Plan Free. Drake Mfg. Co., Dept. M, Milwaukee, Wis.

EVERYBODY uses extracts. Sell Duo Double Strength Extracts. Complete line household necessities. Big repeaters. Write today. Duo Co., Dept. E1, Attles, N. Y.

WE have the finest needle case. \$50.00 to \$200.00 weekly. Send 10c for sample; sells 25c. Empire Specialties Co., 1549 N. Wells, Dept. 301, Chicago.

AGENTS. Sell Anti-Mist Compound. Keeps rain, steam and snow off of windshields and eye glasses for 24 hrs. Send 25c for sample and particulars. A. W. Brust, 210 S. Secley Ave., Chicago, Ill.

MEN Wanted. We have positions open now that will pay from \$45 to \$100 a week. We are organizing a sales force to introduce the Cole Visible Gasoline Gauge, a low-priced, scientifically accurate instrument for Ford and Chevrolet cars. Prevents running out of gas. Guards against short measure. Fits on instrument board—always in sight. Big selling records. We want one good man in each county. Campaign is just beginning. We will help you start. Capital not necessary. Territory going fast. Write quick to The Stemo Engineering Co., 119 Webb St., Dayton, Ohio.

WANTED—Tailoring salesman, make \$60 to \$125 per week. Biggest merchants in many towns have started with our lines. We are the largest made-to-measure tailoring house in the country, furnishing elaborate sample equipments, including 500 all wool fabrics and guaranteed absolute satisfaction, perfect fit, best workmanship, or no sales. Write me for line and all accessories to be sent free. Tell us all about yourself. Address G. H. Mitchell, Sales Manager, Box 483, Chicago, Ill.

A SERVICE agency for magazine and newspaper classified advertisers. Complete advertising service free of charge. We edit and place your copy. Send for our free lists and explanation. Sweet & Phelps Advertising Agency, 214 E. Ohio St., Chicago.

MAKE \$8 a day selling Imported Bamboo Fountain Pen. Whirlwind seller. Free sample. Mohler, Dept. 5, 416 S. Dearborn, Chicago.

AGENTS sell made to measure gabardines, whipcords, \$14.50; reversible raincoats; \$13-100 weekly. Outfit free. Standard Raincoat, Dept. 5, 129 W. 17 St., New York.

"HOW to Sell Patents" free. Patent News-O, Washington, D. C.

CLARKE made \$18 an hour selling rest-pocket windshield cleaner needed by every autoist, motorman, engineer; one rub keeps glass clear 24 hours; 60,000 sold; amazing proposition free. Security Mfg. Co., Dept. 20, Toledo, Ohio.

GENERAL Distributors—Make \$100 to \$150 weekly as Distributor for World's Greatest Automobile Polish. Easily demonstrated, wonderful results, sure repeater. Sell to consumers, sub-agents, dealers. Big money-making proposition to hustlers. Write quickly for exclusive territory. The Armo Mfg. Co., N-150 Goodale, Columbus, Ohio.

AGENTS: Big returns, fast office sellers; particulars and samples free. One Dip Pen Co., 2 Daily Record, Baltimore, Md.

AGENTS: \$60.00 weekly selling newest sensation; Leather Link Belts going over big. Easy, quick sellers. Big profits. Write quick. Victory Belt Co., 1772 Wilson, Chicago.

AGENTS—Silk fibre knitted neckties sells the whole year round; send \$26.00 for a gross, 100% clear profit; dozen \$3.25; if you can't sell them we will refund your money. Raymond Mfg. Co., 132nd St. and Madison Ave., New York.

MAKE \$17 daily—Finest Extracts, Food Products, Toilet Preparations, Household Necessities. Credit: Sample Case Free. Write for amazing offer. Perkins Products, B-6, Hastings, Nebr.

AGENTS: Big profits. Best and cheapest window letters made. Easily applied. Dime brings five samples. Particulars free. Staibrite Co., 1115 Second Ave., New York.

MAKE Big money selling rubber rugs, duplicating rag rugs in appearance; every home a prospect. Write or wire Trump Bros. Rubber Co., Akron, Ohio.

EVERY home a prospect. Zenith Cleaner and Polish for Automobiles and Furniture. Agents make 100%. Sample 25 cents, refundable first order. Absolute repeater. Zenith Products Company, 202 Clay Ave., Rochester, N. Y.

AGENTS: Big money Monogramming by Transfer Method. Catalog Showing Over 50 Styles and Particulars Free. Motorists' Accessories Co., Mansfield, Ohio.

Agents: Where to buy 12,000 articles. Wholesale. Actually worth \$50. Emboss stamp. Wholesale Supply Co., Valdosta, Ga.

DUSTLESS Sponge Cloth. New Invention. Retail \$50c—costs (16c). (1) Rub Cleans. Polishes Automobiles, Pianos, Furniture. NuLife Sponge, Hartford, Conn.

GOLD Leaf Sign Letters; make and sell; profits exceed 1,000%; immense demand; particulars free. Johnston Co., Quincy, Ill.

MAGICAL Necklace. "Shines in the Dark." Absolutely new. Be the first to sell this charming and captivating necklace, 100% to 400% profit. Send \$1.00 for sample and territory protection. W. G. Haman Co., Dept. E, 57 E. 18th St., Chicago.

AGENTS. Make \$10 to \$20 daily, selling small kitchen necessity. Over 200% profit. Sells rapidly everywhere to nine out of ten women. New plan make sales easy. Premier Mfg. Company, Dept. 813, Detroit, Mich.

WONDERFUL discovery. Charges batteries in ten minutes. Galvanic free to Agents, Radcliffe Co., St. Paul, Minn.

WANT Distributing Agents everywhere for Hanslick, the new original powdered handsoap. Removes grease, grime, ink, paint, and most anything from the hands without injury to the skin. Every mechanic and auto-owner, everybody who gets his hands dirty will be a customer. A great opportunity for a hustler to get in business for himself. Full information free. Send 10 cents, coin or stamps, for liberal sample can. Solar Products Company, 122 West Lake Street, Chicago.

MAN in each town to plate auto parts, reflectors, bathroom fixtures, refinish beds, mirrors, chandeliers; by new method. No capital or experience required. Simple plan of manufacturing at home starts you in big money-making business. Outfit furnished. Free particulars and proofs. Gun Metal Co., Ave. H, Decatur, Ill.

EARN \$10 daily silvering mirrors, plating and refinishing metalware, autos, chandeliers, bedsteads, headlights. Outfits furnished. E. Deete Laboratories, 1133 Broadway, New York.

WE pay \$200 monthly salary, furnish car and expenses to introduce our guaranteed poultry and stock powders. Bigler Company, X368, Springfield, Ill.

RUG Salesmen—Get next to the biggest seller of the year—Loomrite Felt Rugs. Sell at sight at \$2.50, cost \$15 dozen. Big, complete Rug Catalog, Free. Malsley-Payne Mfg. Co., 104-D Hanover St., Boston, Mass.

MAKE \$25 to \$50 Week, representing Clows' Famous Philadelphia Hosiery, direct from mill—for men, women, children. Every pair guaranteed. Prices that win. Free book "How to Start" tells the story. George Clows Company, Desk 31, Philadelphia, Pa.

OUR Ex-Cel Luminous Crucifix "shines brilliantly in the dark." Sells on first demonstration. Big profits. Free Selling Talk with first order. W. G. Hannan Co., Dept. B, 57 E. 18th St., Chicago.

AGENTS Everywhere! Women's and children's guaranteed shoes direct to wearer. We deliver. A. P. Condon, Sales Manager, The Allen Shoe Co., 110 Summer St., Boston, Mass.

EARN big money fast applying gold initials to autos. Every owner buys—\$1.35 profit on \$1.50 sale—particulars and samples free. Write quick. Lithogram Co., Dept. 17, East Orange, N. J.

EASY, pleasant work for Mechanics, Shop Men, Clerks, during spare hours; will add many dollars to their salaries. Also want persons who can give full time. Big wages assured. Novelty Cutlery Co., 67 Bar St., Canton, Ohio.

SELL Necessities. Everybody needs and buys the "Business Guide." Bryant cleared \$890.00 in July. Send for sample. It's free. Nichols Co., Box 4-B, Naperville, Ill.

AGENTS get Kioskink the newly invented door spring. Whirlwind seller. Retailers for 50c. You make 100% or more. Sell 50 to 80 a day easy. Write for 1c sample and easy starting offer. Kioskink Mfg. Co., Dept. A, 17 West 42nd St., New York.

HIGH-GRADE SALESMEN WANTED

SALESMEN. We pay larger commissions than any other Brush House in the country to men selling our line of Sanitary twisted-wire brushes. Sanitary Wire Grip Brush Co., 15 Mercer St., New York.

SALESMEN—Crew Managers. You will have the devil's own time trying to find a better seller than "Zippo." If there was such a thing we'd have it. Splendid profit on 50c "Go Getter" repeat article that sells on ten second demonstration. Works While You Watch It. Demonstrates value while others waste time making claims. New Discovery! Great scientific triumph of the age. It's the berries. Haven't room to tell our story here. Write immediately. Karam-Smith Co., 6692 Bozeman St., Fort Wayne, Ind.

SPLENDID proposition—sell gummed tape. Rapidly replacing twine. \$50.00 to \$150.00 weekly—full or part time. Sager Company, Manufacturers, Dept. 8 162, 1637 Roosevelt Road, Chicago.

SALESMEN—Crew Managers—Agents: Get our Assortment High Grade Toilet Articles. Guaranteed product. Big ten worth \$5.40 prepaid for \$1.60. Big-Six worth \$2.85 prepaid for 85c. Midwest Drug Co., 185 E. Naghten St., Columbus, Ohio.

TAILORING salesmen and merchants everywhere write for Spring 1924 line. Our double pants suits at \$29.50 and up, are the biggest money-making values in the tailoring market, \$5.00 to \$12.00 profit on each order; we supply large swatch line showing over 250 samples. Write today giving full details and secure exclusive territory. Jay Rose & Co., Dept. 590, 411 So. Wells St., Chicago.

WE have some desirable territory open for salesmen who are in the \$5,000 per year class. We prefer men who have sold mill supplies. Kingsley Manufacturing Co., Indianapolis, Ind.

SELL Greeting Cards. Unusual opportunity to earn \$300.00 to \$500.00 monthly selling Business Greeting Cards. Side Line or full time. Weekly payment. Samples free. Selling experience unnecessary. Get details. Dept. E, John A. Hertel Co., 9 So. Clinton St., Chicago.

EVERYONE Buys Every Day some part of our line. You can take orders for complete line of groceries, paints, roofing, motor oils, tires and radio sets, from institutions, boarding houses and private families. We deliver and collect. Our goods are nationally known and guaranteed quality; just show samples and secure large orders. No capital or selling experience necessary. Heavy reorders make a steady profitable business. Address Hitchcock-Hill Company, Dept. 226, Chicago. Reference: any bank or express company.

SALESMEN—You can easily make \$40 to \$80 weekly taking orders for best fitting, rich looking, all wool, made to order men's suits and overcoats (guaranteed) \$18.50 and \$27.50; each garment "Larver" Moth Proofed; same goods sell in retail stores at \$35—\$50; we deliver, collect and furnish advertising. Tailoring experience unnecessary. Spring outfit shipped for free examination. Give experience and two business references for full particulars. Wholesale Direct Tailors, Dept. 102, Buffalo, N. Y.

SALESMEN wanted to sell Auto Headlight Testlites. H. D. S. Co., Somerville, Mass.

SALESMEN—to sell nationally advertised line of Feed accessories to garages and Ford owners. Liberal Commission. Process Products Co., 508 S. Sangamon St., Chicago.

SALESMEN—You can make \$130 per month in your spare time selling only one policy a day! Five policies a day pays you \$730 monthly! Policy pays \$5,000 death and \$25 weekly benefit for sickness or injury. Total cost \$10 yearly. You get amazing results using our Direct-by-Mail Selling Plan. Address Underwriters, Dept. RL, Bonnell Bldg., Newark, N. J.

MAKE \$120 Weekly in Spare Time. Sell what the public wants—long distance radio receiving sets. Two sales weekly pays \$120 profit. No big investment, no canvassing. Sharpe of Colorado made \$955 in one month. Representatives wanted at once. This plan is sweeping the country—write today before your county is gone. Ozarka, 802 Washington Blvd., Chicago.

SALESMEN and agents can make liberal commissions (never less than \$40 per sale) by following up our heavy advertising campaign on Ajax Chemical Fire Engines on wheels. Used by factories and mills, lumber yards, warehouses, general stores, schools, hospitals, and town and village fire departments. This is a permanent, profitable business opportunity; not a catch-penny scheme. Ajax is approved by underwriters; used by Standard Oil, U. S. Steel, General Motors, and U. S. Government. Our advertising has done the missionary work; you close the orders. We furnish sales outfit; no capital required. Any real worker can sell two machines a week, and make about \$5,000 annually; a hard-working, clever salesman can do much better than this. Ajax Fire Engine Works, 888 Third Avenue, Brooklyn, N. Y.

"PEERLITES"—Just what the name implies. The best lighting unit at a price to reach every class of trade. Exclusive territory to live salesmen. Stuart Products Corporation, 663 Washington, Chicago.

DISTRIBUTORS. Salesmen, Agents wanted everywhere to handle the Morey Rim Tool; quick, easy sales; big profits; chance to earn \$200-\$500 monthly; trade and consumer buy on sight; monopoly rights to those who mean business. Get opportunity folder today. Morey Rim Tool Co., Blissfield, Mich.

SAFETY Ink washes from clothing; indelible paper. Enormous profits. Acidproof Ink Co., Newtown, Philadelphia, Pa.

SALESMAN: If you think in terms of \$6,000 this year write me. Strong retail store line. Advertised nationally. Established company. Liberal weekly advance to producer. The Continental Co., 1920 Euclid Ave., Cleveland, Ohio, Dept. 208.

\$200 WEEKLY making five sales daily. Sells on 15 minutes' demonstration to stores. Big advertising and utility value. Retail \$15. Duplex, 72 W. Washington St., Chicago.

SALESMEN, Sell New Road Maps to advertisers everywhere. Easy to sell. Liberal commission. Pocket samples. Standard Map Company, 125 West Ohio St., Chicago, Ill.

"FORGET-ME-NOT" Memo Recorder. Every store and office needs one. Patented. No competition. Sells popular price. Big commission. Selling outfit free. Memo Manufacturing Co., 2153 West Warren Ave., Detroit, Mich.

ASKO—Salesmen to sell Auto acc. as side line; can carry sample in vest pocket; sells on sight. Big comm. Write for sample. Allen Specialty Co., 2751 West Lake Street, Chicago.

WHY Work for others? Start and operate your own business. Our system proprietary specialty business offers wonderful opportunities to make \$100 to \$500 weekly. Openings everywhere. We furnish everything and show you how. Booklet free. National Scientific Laboratories, 208 Monroe, Richmond, Va.

WORLD'S Fastest Selling Auto Accessory! County distributors wanted; write today. G. L. W. Spring Oiler Co., San Diego, Calif.

SALESMEN; can increase their income each week selling Salesbooks. Used by every Merchant. Write for proposition. The F. D. Crane Company, Box 246, Canisteo, N. Y.

BEST Seller: Jem Rubber Repair for tires and tubes; supersedes vulcanization at saving of over 80%; put it on cold, vulcanizes itself in two minutes, guaranteed to last life of tire or tube; sells to every auto owner and accessory dealer. Get particulars how to make big money and free sample. Amazon Rubber Co., Philadelphia, Pa., Dept. 510.

SALESMEN—Advertising Pencils, Ready Sellers. Excellent side-line. Write for proposition. North American Pencil Works, 32 So. Clinton St., Chicago.

SALESMEN Wanted. Amazing Invention—almost human. The Little Draftman—a wonderful labor saver, automatically opens furnace or boiler while owner sleeps. Pays for itself in fuel saved. Simple, efficient, can be installed by anyone in five minutes. 100% profit. Thousands being sold. \$25 daily easily made. Act quick. Address: Little Draft-Man Co., Dept. A, Grand Rapids, Mich.

FOUR \$7.50 sales to merchants net you \$20.00 daily. Sayers Systems, 2803 Sheffield Ave., Chicago, Ill.

SALESMEN (main, sideline)—Sell "Zim's Peerless Collector." Quickest seller; surest collector. Creditors' Association, E-312 McKnight Bldg., Minneapolis, Minn.

\$50-\$200 A WEEK. Genuine Gold Letters for store windows. Easily applied. Free samples. Liberal offer to general agents. Metallic Letter Co., 428-B North Clark, Chicago.

CALIFORNIA Rosebuds selling like hot cakes. Agents coining money. Absolutely new. Big profits. Catalog free. Mission Factory 8P, 519 No. Halsted, Chicago, Ill.

SALESMEN Can make \$5.00 a day selling our Calendars, Pencils, Signs, Advertising Novelties, Yardsticks, Whistles, etc. Liberal terms. Sells entire year. Fine side line. Local and traveling agents. Model Calendar Co., Dept. 226, South Bend, Ind.

1,000 DOLLARS monthly proposition. Particulars free. A. Yonover, 1637 Roosevelt Road, Chicago.

TAILORING Salesmen—Fastest selling line, suits, overcoats, made to measure—\$32.50—one price, all wool. Profits in advance. Biggest old reliable house. W. D. Smith & Co., Dept. 66, established 1895, Chicago.

SALESMEN—Sideline pays five to ten dollars a day taking orders for Specialty printed gummed advertising and Match Box Stickers. Write for proposition, samples, etc., today. Beardley's Printery, Rock Island, Ill.

A WONDERFUL Seller! Any man, woman, boy or girl can make big wages. Some agents make from \$8.00 to \$20.00 per day. Crimp Grip Clothes Line Fasteners are a simple, time-saving device for holding a rope—also used for many other purposes. It pays for itself quickly in time saved on wash days. No knots—it fastens and releases quickly. Every home a prospect. Every housewife who uses Crimp Grips—and there are thousands of them—is a booster. There is but one Crimp Grip. Write for particulars, or send 50c for one pair and a mounted sample, with full particulars to agents. Crimp Grip Company, Belvidere, Ill.

TRAVELING Salesmen calling on retail stores wanted by large manufacturer to sell unique line of business-boosting articles. Year round, fast selling, main or side line. If not earning \$150 weekly, address Elsasser Works, 222 Charles St., Boonville, N. Y.

\$1.00 PROFIT on Every \$5.00 sale. "Free Sample"—New Specialty. (Money Getter.) Every Storekeeper, Doctor, buys quickly. Experience unnecessary. Territories open. Box 596, Hartford, Conn.

HELP WANTED

WHY work for others? Start and operate your own business. Our system proprietary specialty business offers wonderful opportunities to make \$100 to \$700 weekly. Openings everywhere. We furnish everything and show you how. Booklet free. National Scientific Laboratories, 298 Monroe, Richmond, Va.

SHOES—Become our local salesman, selling high-grade shoes direct to wearer. Quick seller and good commission. Experience not required. Tanners Shoe Mfg. Co., 474 C St., Boston, Mass.

FREE Sample Automobile Lessons. Become experts. Big Money. Write immediately. Franklin Institute, Dept. F-401, Rochester, N. Y.

FIREMEN. By a k e m e n. Baggage men, Sleeping car, train porters (colored). \$140-\$200. Experience unnecessary. 810 Railway Bureau, E. St. Louis, Ill.

MONEY! Silvering Autolights, Radiators, Mirrors, tableware, stoves. Outfits. Methods free. Clarence Sprinkle, Dept. 28, Mar- Jun, Ind.

\$5 TO \$15 daily easy. Introducing New Style Guaranteed Hosiery. Must wear or replaced free. No capital or experience required. Just show samples, write orders. We deliver and collect. Your pay in advance. Outfit furnished. All colors, grades including silk. Mac-O-Chee Mills Company, Room 2602, Cincinnati, Ohio.

REPRESENTATIVE in each community to take subscriptions on our special offer. Very liberal commission paid at time of sale. You can make \$2 to \$5 an hour in spare time. Write for free outfit. Popular Mechanics Magazine, 204 East Ontario, Chicago.

LOCOMOTIVE Firemen for railroads nearest their homes—everywhere; beginners \$200, later as Locomotive Engineers, \$100-\$400 monthly. Best paying positions in Railroad Service. Railway Association, Desk M, Brooklyn, N. Y.

SALESMEN—Become Independent. Own your business; experience unnecessary; selling our \$7,500 Accidental Death, \$50 Accident, \$25 Sick Weekly Benefits; \$12.50 yearly; other amounts proportionate. Guaranteed steady income from renewals. \$250.000 deposited Insurance Department, Registration Dept. A, Newark, N. J.

STEADY work. No strikes. No layoffs. Commence \$113 month. Raise to \$192 monthly. Become U. S. Government Railway Postal Clerks. Pleasant work. Traveling constantly. See your country on Government time. Vacation with pay. Common education. List positions free. Men—boys, 18 up, write immediately, now. Franklin Institute, Dept. F-3, Rochester, N. Y.

MEN wanting Forest Ranger, Railway mail Clerk and other Govt. positions, write for particulars. Mokane, B12, Denver, Colo.

SALESMEN—Sell "Amess" Radioux Shirts, guaranteed to wear 1 year. Big commissions. Earn \$60 weekly up. Get our proposition first. Menzin Shirt Co., 481m East Tremont Avenue, New York.

INSTRUCTIVE, concise course in modern business covering principles for accumulating wealth. Everyone desiring to achieve success should have these facts. Write for free information. Danford Institute, Monongahela Bank Building, Pittsburgh.

\$133 MONTHLY, Railway Postal Clerks wanted. Steady. List positions—free. Franklin Institute, Dept. F-20, Rochester, N. Y.

BE a Finger Print Expert. Write, American Finger Print System, 1966 Broadway, New York.

GET posted—Good prices paid for butterflies, insects. See Sinclair display advertisement, page 78.

EARN \$10 daily silvering mirrors, plating and refinishing metalware, autos, chandeliers, bedsteads, headlamps. Outfits furnished. E. Devle Laboratories, 1123 Broadway New York.

MEN—Age 18-40, wanting Railway Station-Office positions, \$115-\$250 month, free transportation, experience unnecessary. Write Baker, Supt., 74 Wainwright, St. Louis.

WANTED, names men—boys, 18 up wishing become Railway Mail Clerks, \$133-\$192 month. Travel—see your country. Answer immediately. Franklin Institute, Dept. F-20, Rochester, N. Y.

ALL men, women, boys, girls, 17 to 65, willing to accept Government Positions, \$117-\$250 traveling or stationary. Write Mr. Oment, 101 St. Louis, Mo., immediately.

WANTED: Railway Mail Clerks—\$1,000 to \$2,300. Exams everywhere. Write today for full information. Patterson, Civil Service Expert, Box 4025, Rochester, N. Y.

WRITE articles, stories, news. In spare time for newspapers and magazines. Big pay. Copyrighted book free Press Syndicate, 532 St. Louis, Mo.

MAKE money writing Photo-plays; details free to beginners. No correspondence course. Producers' League, 236 Wainwright, St. Louis.

U. S. GOVERNMENT wants Railway Mail Clerks, \$123 month. List positions free. Write immediately. Franklin Institute, Dept. F-20, Rochester, N. Y.

INVENTORS desiring to secure patents should write for our book "How to Get Your Patent," tells our terms and methods. Send sketch for our opinion of its patentable nature. Randolph & Co., Patent Attorneys, 620 F. Washington, D. C.

OUR genuine gold window sign letters are an excellent money-making proposition for handy men. Slann Sign System, Besham Ave. E., Detroit, Mich.

SILVERING Mirrors, French plate. Easily learned; immense profits. Plans free. Address, Wear Mirror Works, Excelsior Springs, Mo.

YOU Are Wanted. U. S. Government Jobs, \$100-\$250 month. Many openings. List free. Write immediately. Franklin Institute, Dept. F-20, Rochester, N. Y.

CLERKS for Government Postal and other good positions. \$1,100-\$2,300 yearly. Experience unnecessary. Full particulars free by writing G. W. Robbins, Civil Service Expert, 411 Burebell Bldg., Washington, D. C.

WANTED—Railway Mail Clerks, \$1,000. Experience or correspondence course unnecessary. Write Mr. Selby, D08, Willow Hill, Ill.

RAILWAY Mail Clerks—Start \$123 month; expenses paid. Specimen examination questions free. Columbus Institute, E-2, Columbus, Ohio.

STORIES, poems, plays, etc., are wanted for publication. Good ideas bring big money. Submit manuscripts or write Literary Bureau, 522, Hannibal, Mo.

\$60-\$200 A WEEK. Genuine Gold Letters for store windows. Easily applied. Free samples. Liberal offer to general agents. Metallic Letter Co., 428-C, North Clark, Chicago.

FINGER Print Experts—Excellent paying positions; particulars free. Finger Print Headquarters, 188 East 79th, New York.

INFORMATION

COMPLETE, accurate, information on any subject \$1. National Information Bureau, 142X Milton St., S. E. Grand Rapids, Mich.

GUARANTEED information, any subject \$1.00. Doris Chemical Laboratories, East Cleveland, Box 50, Cleveland, Ohio.

BUSINESS SERVICE

START the New Year right. Stop worrying and let us help you with any legal information, investigations or service. Pacific Co-Operative Service Bureau, 823 Loew State Bldg., Los Angeles, Calif.

TYPEWRITERS AND SUPPLIES

TYPEWRITERS All Makes. Save one-half. Thoroughly rebuilt in our factory by the famous "Young Process." Fully guaranteed. Free trial. We handle all standard makes. Cash or sold on easy terms. Write for Catalog. Young Typewriter Co., Dept. 5022, Chicago, Ill.

UNDERWOOD Typewriters at far less than manufacturers' price; rebuilt, all worn parts replaced, guaranteed good as new. Cash. Installment payments. Write for Catalog 1512, Shipman-Ward Mfg. Co., estab. 1892, Montrose and Ravenswood Ave., Chicago, Ill.

ALL Makes, rebuilt, refinished and guaranteed ten years, shipped privilege 30 days' trial. Oliviers, Remingtons, Underwoods, others, \$15.00 up. Get our prices and agents' proposition. Typewriter Exchange, 2316 University Ave., New York City.

TYPEWRITERS, all standard makes, \$10 up. Fully guaranteed. Free trial. Write for complete illustrated lists. Northwestern Typewriter Exchange, 320 West Goethe Street, Chicago.

ADDING MACHINES

NEW \$2.50 Automatic Adding Machine. Makes adding easy for anyone. Guaranteed accurate as highest priced machines. 75,000 pleased owners already. Capacity \$999,999.99. Postpaid \$2.50. Baccett Co., 1458-C Hollywood Avenue, Chicago.

FREE Trial. Marvellous new Adding Machine. Adds, Subtracts, Multiplies, Divides, automatically. Work equals \$350.00 machine. Price only \$15.00. Speedy, durable, handsome. Five-year guarantee. Used by largest corporations. Write today for catalogue and free trial offer. Lightning Calculator Co., Dept. E, Grand Rapids, Mich.

DUPLICATORS AND DEVICES

STENCIL Duplicators—Note \$3.00, Letter \$4.00. Hand Use, Typewriting—Handwriting. On Approval. Primos Specialty Co., 3-34, Primos, Pa.

YOU can make 50 to 100 copies of a letter, notice, etc., at a cost of three cents on a Hoyer Quality Duplicator. Write for free trial offer. The Hoyer Duplicator Co., 11 S. Wells St., Chicago, Ill.

"MODERN" Duplicators save Time, Labor, and Money. Gets business. Reproduces Typewritten or Panned Letters, Drawings, Lessons, Music, Memos, Bids, Notices, Specifications, Maps or anything in one or more colors. Prints Two per minute. Special Sale On 30 Days' Free Trial. \$2.25 up. Booklet Free. J. E. Durkin-Reeves Co., Pittsburgh, Pa.

PRINTING, ENGRAVING AND MULTIGRAPHING

GILT lettered Advertising—Pencils for you. Buy direct; save entire middleman's profit. Samples free (no agents). Address S. Mustal & Co., 10-12 Lincoln St., Yonkers, N. Y.

CATCHY two-color letterheads. Make them yourself. Ordinary office or home equipment only essential. Complete instructions, \$1. A. M. Benner, Olympia, Wash.

AUTOMATIC Carpal presses—print 100 cards minute. Circulars free. Habben, 3127 Locust, St. Louis.

5,000 5 1/2 x 8 1/2 CIRCULARS, \$9.50; 5,000 2 1/2 x 5 1/2 Envelope Slips, \$1.50; 5,000 Post Cards, \$9.00. All Printing Low Prices. Bargain List—Samples Free. Good's Printery, Harrisburg, Pa.

200 SHEETS 6x7 Hammennill bond, 100 envelopes, printed, blue ink, \$1.00, postpaid 3rd zone; \$1.15 beyond. Spillane, Red Lake Falls, Minn.

150 EACH Letterheads; Envelopes, C. O. D. \$2. Jacobus Service, Irvington, N. J.

500 TWO-COLOR Letterheads \$2.75. Sample free. "Superior", 1825 Roosevelt, Indianapolis.

2,000 LETTERHEADS or Envelopes \$6.25 prepaid, 3rd zone. Samples Free. Quality Printshop, Marietta, Ohio.

500 GUMMED Labels. Name and Address, 20c. Eastern Label Co., Clintontille, Tenn.

QUALITY Printing! Reasonable Prices! Tell us your wants and let us quote our Money-Saving prices. Best Work. We print anything. Ernest Fantus, 525 South Dearborn Street, Chicago.

PRINTING Outfits—Presses, type supplies, type galleys. Send stamp for catalogue. Model Press, York, Penna.

JOB Printing, All Kinds—Cards to Catalogs. Quality work. Smith-Roberts Printing Co., Watoka, Ill.

250 BOND Letterheads or Envelopes \$1.50. Greer Printing, Box 886A, Dayton, Ohio.

PRE-CASED Printing Presses, Type and supplies. List for stamp. Popular Bargains, Richland, Pa.

WE print everything. Stationery, Booklets, Catalogs, Circulars, Samples. Commercial Press, Batavia, Ohio.

250 LETTERHEADS, 250 white envelopes, printed and mailed, \$3.00. Samples printing free. Sunco, Mohawk, N. Y.

1,000 LETTERHEADS or Envelopes, \$3.00. Sent Prepaid. Samples Free. Monitor Press, Morrisville, Pa.

EMBOSSED Stationery, business or personal. Samples for stamps. Daniels Co., Pittston, Pa.

225 BOND letterheads, envelopes, billheads, cards, \$1.25 each. Combination, \$4.00. Economic Press, Leonia, N. J.

EVERYTHING Printed. Samples free. Franklin Press, B-32, Milford, N. H.

FOR MEN

ARE you old at forty? See our advertisement on page 129 of this issue. The Electro Thermal Company, 2129 Main St., Steubenville, Ohio.

FOR SMOKERS

SMOKE "Sirena" Cigars. Supreme quality Portorican tobacco. Delightful taste. Fragrant aroma. 5 1/2" Twenty-five, \$1 postpaid. Hundred, \$3.50. Send Money Order. Rivalto Company, Cayey, Porto Rico.

HOMESPUN Tobacco, chewing 5 lbs. \$1.65; 10 lbs. \$2.00; smoking, 5 lbs. \$1.25; 10 lbs. \$2.00; 20 lbs. \$2.25. Receipt free. C. Scott, Sechala, Ky.

GUNS, SPORTING GOODS, ETC.

GUNS repaired, reblued, rechoked, re-stocked. Broken stocks repaired. Prices reasonable. Page Repair Co., Republican City, Neb.

BOATS AND LAUNCHES

19' ROWBOAT easily made. Construction blueprint 30c. Weeshe-Uco, West Market, Detroit.

RAZORS AND BLADES

BLADES resharpened, 3c any make; guaranteed service. Standard Safety Razor Corp., Pittsburgh.

BLADES, resharpened, one edge 2c; double 3c. New York Edge Co., Glen Cove, N. Y.

FURS

HAVE your raw furs made into beautiful garments. Enormous savings. Catalog free. Arthur Felber Fur Co., 25 N. Dearborn St., Dept. P. M. 4, Chicago, Ill.

DIAMONDS, WATCHES AND JEWELRY
WATCHMAKERS: Earn highest wages. Understand adjusting thoroughly. Circular free. Write Walter Kleinlein, Publisher, Waltham, Mass.

PEARLS—South Sea Island—50c. McKenzie, Box 9, Long Beach, Cal.

OPTICAL GOODS

FOR Quick Sale! One Carl Zeiss Prism Telescope 12, 24 and 42 Power, Complete with Heavy Leather Carrying Case and Especially Adapted Panoramic Tripod, \$137.50. One Bausch and Lomb Student Microscope Complete, \$27.50. Send for Photograph. De-Franco, Importers, 169 N. Dearborn St., Chicago, Ill.

FOR THE HOME

GRANDFATHER Clock Works, \$5.00. Build your own case; Instructions free; make good profits selling your friends. Clock works with chimes for old or new cases. Write for full particulars. Clock Co., Ruffner St., Philadelphia.

LINOLEUM or Congoleum Varnish. Quart can, one dollar postpaid. Elliot Donner, Florence, N. J.

LOOMS—Only \$9.90—Big money in weaving rugs, carpets, portieres, etc., at home, from rags and waste material. Weavers are rushed with orders. Send for free loom book, it tells all about the weaving business and our wonderful \$9.90 and other looms. Union Loom Works, 480 Factory St., Housville, N. Y.

ANTIQUES, WAR RELICS AND INDIAN GOODS

RELICS from Europe's Battlefields. Firearms, helmets, medals, etc. Illustrated catalogue with sample War Photographs. 25c. Lieut. Walsh, 2117 Regent Pl., Brooklyn, N. Y.

HUNTING Bows, relics, minerals, geology, stamps, butterflies. Thousand Indian articles. Catalogue 10c. Indiancraft—P—Co., 456 Connecticut, Buffalo, N. Y.

INDIAN Baskets, Blankets, Wampum Mats Wholesale. Catalogue, Gilham, Kelseyville, Calif.

PHONOGRAPHS AND RECORDS

BUILD a genuine Choralphon phonograph and save over half. Big profit building and selling. We furnish motors, tone-arms, full instructions and all necessary parts. Send for catalog and free blueprint offer. Choralphon Phonograph & Radio Co., 224 11th St., Elkhart, Ind.

BUILD Your Own Phonograph. We furnish everything. Write for catalog and free Blueprint offer. American Phonograph Co., 3515 North Crawford, Chicago.

BUILD Your Phonograph. Quality phonographs. Quality Serenade motor and motors of other types. Electric Motors, tonearms, reproducers, amplifiers, case materials, necessities. Free blueprints and building instructions. Big saving. Wonderful results. Prompt delivery. Catalog mailed for ten cents. Hoosier Manufacturing & Supply Co., 313 Baldwin Block, Indianapolis, Ind.

BUILD your own phonographs. We can supply you with motors, tone arms and all accessories at wholesale prices. Write for catalogue AX. Pleshing Sound Phonograph Co., 204 East 112th St., New York, N. Y.

SUPERIOR equipment at lowest price for building fine phonographs. Superior Phonographs Co., Erie, Pa.

MUSIC AND MUSICAL INSTRUMENTS
PIANO Jazz; Teaches Chimes, Blues, Negro Harmony, Ear playing, etc. Particulars sent free. Write to "Piano Bill," 211 Ossington Ave., Toronto, Canada.

WRITE Songs. Big money and reputation. Write for information, J. Gordon Pub. Co., 201 N. Hoyne Ave., Chicago.

"MUSIC Composed" to words. Bauer Bros., (formerly of Sousa's Band), Oshkosh, Wis.

CORNETISTS—Trombonists—Saxophonists—Clarinetists. Send for "Free Pointers No. 2." Name instrument. Virtuoso Music School, Concord, Mass.

I WANT Song Poems. Casper Nathan, 1252 Bryn Mawr, Chicago.

VIOLINS, Deep, Mellow, Soulful—on credit. Easy terms for wonderful instrument. Get details today. Gustav F. Henning, 2424 Gaylord St., Denver, Colo.

COMPLETE, easy self-instructors—Harmonica, Violin, Piano, Drum, Ocarina, Mandolin, Accordion, Saxophone 25c each. G. Ebes, Bowling Green, Ohio.

PATENT ATTORNEYS

BEFORE patenting, technical experts and inventors expecting to manufacture their inventions should write for information and reference based on service rendered on validity reports and research work. Horace L. Woodward, 704 9th, Washington, D. C.

MONROE MILLER, Ouray Bldg., Washington, D. C. Patent Attorney; Mechanical, Electrical Expert. Free Blue Book gives candid advice.

INVENTORS: Record invention legally before disclosing to others. Our invention-record and data sheet shows how. Sent free and valuable information given on patent procedure, costs, etc. Report on patentability includes copies of patents nearest your idea. O'Connell & O'Connell, Jenifer Bldg., Washington, D. C.

H. F. LOWENSTEIN, Registered Patent Attorney, Technical expert. McLachlen Building, Washington, D. C.

MILLIONS spent annually for ideas! Hundreds now wanted! Patent yours and profit! Write today for free books—tell how to protect yourself, how to invent, ideas wanted, how we help you sell, etc. 500 Kresge Bldg., American Industries, Inc., Washington, D. C.

PATENTS and Trade-marks obtained. Prompt service. Write for our new book on patents. Established in 1889. D. Swift & Co., 289 7th St., Washington, D. C.

INVENTORS—Send for form "Evidence of Conception" to be signed and witnessed. Form, fee schedule, information free. Lancaster and Albino, 221 Ouray Bldg., Washington, D. C.

PATENTS Procured; trade marks ready for examination, prompt report and advice. No charge for preliminary advice. Write for free Booklet and blank form on which to disclose your idea. Highest references. Promptness assured. Clarence A. O'Brien, Registered Patent Lawyer, 58-B Security Bank Building, Directly across the street from Patent office, Washington, D. C.

PATENTS Procured; trade marks registered—A comprehensive experienced, prompt service for the protection and development of your ideas. Preliminary advice gladly furnished without charge. Booklet of information and form for disclosing idea free on request. Richard B. Owen, 39 Owen Bldg., Washington, D. C., or 2276R Woolworth Bldg., New York.

THE Patentee is free. A liberal education in patents. Anderson & Son, attorneys, estd. 1865. 625 F St., N. W., Washington, D. C.

PATENTS—My own attention to all business. Twenty years' experience. Charges reasonable. Booklet on request. C. E. Trainor, 808 H Northwest, Washington, D. C.

SAFETY—Before disclosing your invention or applying for patent, get our "Bulletin 5"—rital to the man who wants every dollar his invention is worth. It's free. American Patents Corporation, Barrister Building, Washington, D. C.

PATENTS—Write for our Guide Books and "Record of Invention Blank" before disclosing inventions. Send model or sketch of your invention for Examination and Instructions. No charge for the above information. See advertisement on page 157. Victor J. Evans & Co., 934 Ninth, Washington, D. C.

LACEY Patent Sense. See page 156.

PERCY S. WEBSTER, Savings and Loan Building, Stockton, California. Long established organization. Send for free book on Patents.

COMMERCIALIZE your ideas according to My Cooperative Plan before patenting. Booklet Free. Ralph Burch, Patent Lawyer, Jenifer Building, Washington, D. C.

INVENTORS: Careful Patent Office searches safeguard against applying for patents on unpatentable inventions; they aid in determining the commercial value of inventions, and the extent of protection which patents will afford. Read the free treatise, "Reducing Inventions to Property Rights." Lester E. Barrett, 629 F Street, Washington, D. C.

INVENTORS should write us for our book, "How to Obtain a Patent," which clearly sets forth what may be patented and the necessary steps to protect an invention; it describes the procedure in patent office and tells about assignments, licenses and trade marks, and gives many useful facts about patents which every inventor should know; many persons well versed in patent matters have pronounced the book the best of its kind they have ever read; it is written so you can understand it; copy free upon request. Talbert & Talbert, Patent Lawyers, 481 McGill Bldg., Washington, D. C.

"INVENTOR'S Advisor," the valuable Patent book with 159 mechanical movements and illustrations, sent free upon request. MM. Labiner, Patent Attorney, 3 Parkrow, New York.

PATENTS, Trademarks, Copyrights procured; all countries; Booklet Free; 20 years' experience; very reasonable; my personal attention to every case; ask about Free Sales Service. H. Sanders, Registered Patent Attorney, 7 Rand-McNally Building, Chicago, Ill.

INVENTORS: Send sketch or model of invention for opinion concerning patentable nature and exact cost of patent. Book "How to Obtain a Patent," sent free. Tell what every inventor should know. Established twenty-eight years. Highest references. Prompt service. Reasonable charges. Address Chandee & Chandee, 456 Seventh, Washington, D. C.

PATENTS promptly procured. Personal, careful and efficient service. Highest references. Moderate fees. Send sketch or model for actual search and advice. George P. Kimmel, Master of Patent Law, 54-B Loan and Trust Bldg., Washington, D. C.

INVENTORS—Write for our Guide Book, "How to Get Your Patent" and Evidence of Invention Blank. Send model or sketch of your invention for our prompt opinion of its patentable nature. Randolph & Co., Dept. 430, Washington, D. C.

INVENTORS—"How to sell ideas before getting patents," and Evidence of Ownership document free on request. Inventor's Economy Guide Company, 3 Pendall Building, Washington, D. C.

PATENTS. Booklet free. Highest references. Best results. Promptness assured. Send model or drawing for preliminary examination. Watson E. Coleman, Patent Lawyer, 844 G Street, Washington, D. C.

PATENTS, Trade-Marks, Copyrights and Patent Litigation. Write for advice and instructions how to proceed, costs, etc. Hand Book with illustrations of 100 Mechanical Movements sent free on request. Albert E. Dieterich, Patent Lawyer and Solicitor, 621 Ouray Bldg., Washington, D. C.

UNPATENTED Ideas can be sold. I tell you how and help you make the sale. Particulars free. Write W. H. Greene, Jenifer Building, Washington, D. C.

HERBERT JENNER, patent attorney and mechanical expert, 696 F Street, Washington, D. C. I report if patent obtainable and exact cost. Send for circular.

"INVENTOR'S Guide" free on request; gives valuable information and advice for all who have original ideas or improvements. Frank Ledermann, Registered Attorney and Engineer, 15-P Park Row, New York.

PATENTS. Trade marks, copyrights. Prompt, personal, reliable service. Over 39 years' active practice. Write for terms. Book free. Address E. G. Siggers, N. U. Bldg., 218 F St., Washington, D. C.

FOR INVENTORS

PATENTS. If you have an invention which you wish to patent you can write fully and freely to Munn & Co. for advice in regard to the best way of obtaining protection. Please send sketches, or a model of your invention and a description of the device, explaining its operation. All communications are strictly confidential. Our vast practice, extending over a period of seventy-seven years, enables us in many cases to advise in regard to patentability without expense to the client. Our Handbook on Patents is sent free on request. This explains our methods, terms, etc. In regard to Patents, Trade Marks, Foreign Patents, etc. "Scientific American" contains Patent Office Notes, Decisions of interest to inventors and particulars of recently patented inventions. Munn & Co., Solicitors of Patents, 623 Woolworth Bldg., New York; Scientific American Bldg., Washington, D. C.; 801A Tower Bldg., Chicago, Ill.; Hobart Bldg., San Francisco, Calif.

MONROE MILLER, Ouray Bldg., Washington, D. C. Patent Attorney; Mechanical, Electrical Expert. Before proceeding, read free Blue Book.

PATENTS Procured; trade marks registered—A comprehensive, experienced, prompt service for the protection and development of your ideas. Preliminary advice gladly furnished without charge. Booklet of information and form for disclosing idea free on request. Richard B. Owen, 30 Owen Bldg., Washington, D. C., or 2276R Woolworth Bldg., New York.

PATENTS Procured. Send sketch or model today for examination, prompt report and advice. No charge for preliminary advice. Write for free Booklet and blank form on which to disclose your idea. Highest references. Promptness assured. Clarence A. O'Brien, Registered Patent Lawyer, 58-B Security Bank Building, Directly across the street from Patent office, Washington, D. C.

CASH paid for practical ideas or patents for useful automobile accessories. Dept. 106, Hayes-Ionia Service Co., Grand Rapids, Mich.

WE Develop your ideas into commercial shape for presentation to purchasers, making working models, drawings, experiments or tests. Courtesy, efficiency, secrecy and ample equipment; 30 years' experience. Durcorron-Rish Engineering Co., 564 Pacific Mutual Bldg., Los Angeles, Calif.

INVENTORS—If you have a practical, useful invention to sell, write us today. American Patents Corporation, Barrister Building, Washington, D. C.

INVENTIONS appeal to manufacturers when designed for economical production. Designing and Improvements. R. B. Older, Danville, Ill.

THE Inventors Institute bulletin explains patent thefts, "Sealed Evidence" protection, and our working plan. Write 511 Star Bldg., Washington, D. C.

INVENTORS—Write for our Guide Book and "Record of Invention Blank" before disclosing inventions. Send model or sketch of your invention for our free opinion of its patentable nature. See advertisement on page 157. Victor J. Evans & Co., 157 Ninth, Washington, D. C.

PATENT Sense—"The book the inventor keeps." Free. See Lacey ad, page 156.

PATENT Application on simple invention prepared for \$15. Further particulars free. A. M. Benner, Olympia, Wash.

INVENTORS should write us for our book, "How to Obtain a Patent," which clearly sets forth what may be patented and the necessary steps to protect an invention; it describes the procedure in patent office and tells about assignments, licenses and trade marks, and gives many useful facts about patents which every inventor should know; many persons well versed in patent matters have pronounced the book the best of its kind they have ever read; it is written so you can understand it; copy free upon request. Talbert & Talbert, Patent Lawyers, 495 McGill Bldg., Washington, D. C.

HAVE You an invention? If so, write for our free book, "How to Get Your Patent" tells our terms and methods. Send model or sketch for our opinion of its patentable nature. Randolph & Co., Dept. 114, Washington, D. C.

GET your own patents. Application blanks, complete instructions \$1. Cutting Sons, Campbell, Cal.

INVENTORS' Educator: 900 Mechanical Movements, 50 Perpetual Motions, How to procure and sell patents. Mechanical Movements greatly assist inventors, suggest new ideas, explains how to select an attorney and avoid Patent Sharks. Price \$1.50. Postage Free. Albert E. Dieterich, 621 Ouray Building, Washington, D. C.

UNPATENTED ideas can be sold. I tell you how and help you make the sale. Particulars free. Write W. T. Greene, Jenifer Bldg., Washington, D. C.

TO sell your Patent. Write me; experienced handling, immediate action. Address Arthur S. Billings, Suite 401 Dekum Bldg., Portland, Ore.

SPECIALIZED service for inventors. You furnish the idea, we'll work it out. Expert machine designing. Drafting. Opinions given on practicability of ideas. Confidential dealings. Your ideas fully protected. Write for full particulars. Otis Engineering Co., Desk C D, Omaha, Neb.

MODEL Making and experimental work. Modern Shop; expert workmen. Manufacturing. Lamson Electrical & Mfg. Co., 625 W. Jackson, Chicago.

PATENT Application Blanks free to inventors. Patent News-D, Washington, D. C.

PATENTS FOR SALE

PATENTS Applied For.—Sale.—Automobile Accessory; can be retailed very reasonably, fit most well known cars. H. G. Jorgensen, Hampton Rd., Erie, Pa.

WANTED Manufacturers to Make Disinfecting Steel Repair Washers. Royalty or lowest price for cash. Patent 1,459,014. Peter Berglof, Isanti, Minn.

ATTENTION, Patent Buyers: Electric Reversible Park and Lawn Trimmer for Sale Outright. Thomas W. Martin, No. 5 Mahoning Location, No. Hibbing, Minn.

PATENT on Automobile Hood for sale. C. Christiansen, 119 West 5th Street, Duluth, Minn.

MANUFACTURERS of Dredging Machinery. For sale: United States and Canadian Patents for an Automatic Clam Shell operated on one Cable. One hundred per cent efficient. Saves time and labor. If interested apply, Edward Woolley, 322 Atlas Ave., Toronto, Ont., Canada.

ROYALTY wanted. Folding ironing-board. Malleable. No wobbling. Manufactured cheap. Convertible into table. Detachable from wall. Trade-Marked. Earl Sanders, Pawnee, Ill.

UNIQUE novelty, used chewing gum receptacle. Cost little to manufacture. Asking \$1,000 outright. Burnie L. Bevil, Waurika, Okla.

FOR Sale—Changeable campaign button; he a Republican one minute, a Democrat or Prohibitionist the next; a catchy novelty; inexpensive to handle. Coming election offers excellent field. Richard Laux, 1428 Washburn Ave., Fort Wayne, Ind.

FOR Sale or Royalty—Banner or Blade for Ice Skate. Patent applied for. Prevents sore, broken-down arches. Gives complete freedom to foot while skating. Have working model to demonstrate. Carl Casperson, 1127 Lipon St., Denver, Colo.

PATENT on Cuspidor lifter and carrier. Will sell direct for \$400 cash; no brokers. Jos. N. Buron, Santa Barbara, Calif.

CEMENT Building Without Form. Stops Fire, Frost or Vermin. Outright or royalty. James Angus McKenzie, 276 Gore Street, Fort William, Ontario.

VALUABLE patent for Sale outright. Burglar Trap that locks when Catches. No. 1,380,295. J. Hicks, 3129 N. Croskey St., Philadelphia, Pa.

PATENT For Sale—"The Auto Cooker." C. M. Daly, 538 West 29th St., New York—See Page 840 of the December 1923 issue of Popular Mechanics Magazine. You will find an illustrated description of the "Auto Cooker," patented July 31st, 1923, U. S. 1,463,576; Canadian Nov. 1923.

NOVEL and useful case for carrying all kinds of cards. Outright or royalty. W. G. Cook, Alberta Provincial Police, Lethbridge, Alberta, Canada.

IMPROVED clothes dryer for sun drying—a necessity in every house. Outright or royalty. Patented U. S. A. 381,562, and Canada 273,317. J. E. Pieterick, Cayuga, N. Dak.

IMPROVED Rail-Joint. Number 1,272,498. Railway Tie. Number 1,266,139. Outright or royalty, or will exchange for other property. Full particulars. M. S. Monday, Deputy Court Clerk, Atoka, Okla.

YOU have a worth-while patent, haven't you. Why don't you tell our two million readers about it? Most of them are specially interested in patents and new inventions. Ask me to tell you how other inventors successfully sold their patents. Geo. F. Baker, Manager, Classified Advertising, Popular Mechanics Magazine, Chicago, Ill.

PATENT on Modeling Dress Form. I. F. Koblinsky, 462 Columbus Ave., Bay City, Mich.

AUTO Robe Protector—never anything like it on market; no more stolen robes. Sell outright or on royalty. Chas. Lamberton, P. O. Box 877, East Akron, Ohio.

PATENTS For Sale: To sell, buy or obtain patents, write Patent News-P, Washington, D. C.

SURVEYING INSTRUMENTS

NEW and used surveying instruments direct from factory. Satisfaction guaranteed or money refunded. Wissler, 619 Broadway, St. Louis.

MODELS AND MODEL SUPPLIES

WE build models, design, develop, and manufacture articles in large or small quantities. Hunsayer Machine Products & Mfg. Co., 1387 E. 17th St., Cleveland, Ohio.

MODEL Making and experimental work; Modern Shop, expert workmen. Manufacturing. Lamson Electrical and Mfg. Co., 625 W. Jackson, Chicago.

PATENTS Procured. Send sketch or model today for examination, prompt report and advice. No charge for preliminary advice. Write for free Booklet and blank form on which to disclose your idea. Highest references. Promptness assured. Clarence A. O'Brien, Registered Patent Lawyer, 58-B Security Bank Building, Directly across the street from Patent office, Washington, D. C.

SPECIAL machine builders, tool and die makers, inventors' models, production work of all kinds. Let our factory be your factory and save money. Quality Hardware & Machine Co., E. Ravenswood and Thorndale Aves., Chicago, Ill.

INVENTORS—Write for our Guide Books and "Record of Invention Blank." Send model or sketch of inventions for our free opinion of patentable nature. See advertisement on page 157. Victor J. Evans & Co., 165 Ninth, Washington, D. C.

MODELS and Patterns made. Light manufacturing. Address H. W. Hathorn, Mason City, Iowa.

MODELS and Tools. Send sketch for estimates. Arthur Schmidt, 394 Canal Street, New York.

WE make working models for inventors and do experimental work and carry a complete stock of brass gears and model supplies. Send for catalogue. The Pierce Model Works, Tinley Park, Ill.

DIES, Tools and General Manufacturing. Models and Manufacturing of new inventions our specialty. Logan Machine Co., 222 S. Clinton St., Chicago, Ill.

BEFORE you buy model engines, boilers, send stamp for our new illustrated list of machined castings, parts for boilers, boat fittings. Model Machine Shop Co., 417 East 71st St., New York City.

FOR MANUFACTURERS

IF you want dies and metal stampings write us. Lyons Machine Works, Lyons, Ia.

JAR Lid Remover—clever specialty. Will lease. Attractive terms. Paul Gerhart, Exeter, Calif.

WANTED—Metal Stamping and Model work taken on contract basis. We are ideally located and equipped to develop patents. Meyers Company, Box 326, Bedford, Ind.

MANUFACTURING

METAL-CRAFT!—Eventually Metal-Craft. Competent Engineers, Designers, and Producing Organization await your commands on dies, stamping, die-casting, deep pressing, screw machine and wire products. Plating, Enameling, Burnishing, Wrapping and Packing to your specifications. Very reasonable. Large, completely equipped plant. "Your problem is our challenge to serve." Metal-Craft Manufacturing Company, Box 259-b, Chicago.

WE design and build special machinery, make models, dies, stamping tools, do general machine work and light manufacturing. Marshall Mfg. Co., Kansas City, Mo.

WIRE goods made to order. Cooley Mfg. Co., 324 N. Western Ave., Chicago.

METAL Specialties manufactured, dies and special tools made to order. Punch press, screw machine and plating work solicited. Jubilee Mfg. Co., Omaha, Neb.

EXPERIMENTS developed, dies, models and manufacturing machine designing. Estimates and information promptly given. Address Schroyer Bros. Machine Works, 512 East 25th Street, Kansas City, Mo.

LET Us Manufacture It For You. We will cooperate with you in every way possible. Our experience in developing, simplifying and selling new devices at your disposal. Ideas worked out and developed. Models made. Metal parts made to drawing or sample. Special Machinery designed and built. Dies and other special tools for manufacturing furnished. Simplex Tool Company, Woonsocket, R. I.

PATENTED Articles, Models, Brass Work, Machine Construction; Dies Made. Baum's Metal Specialties, Kansas City, Mo.

LONG established manufacturer of auto accessories which are daily sold by practically all wholesale and retail accessory houses will consider manufacturing and distributing new automobile products, capable of equally wide sale through same channels. Patented articles preferred. Address Auto Accessory Manufacturer, 1512 North American Bldg., Chicago, Ill.

SCREWS, nuts, screw machine products, all metals. Autosew Works, 355 West Broadway, New York City.

IRON, Brass, Aluminum Castings, Models, Patterns. Light Manufacturing. Welch Brothers Co., North Chicago, Ill.

WE can design and manufacture special machinery of every description, automatic or semi-automatic. Jigs, fixtures, punches, dies, and special production tools of all kinds. The John Steptoe Company, Stock Yards Station, Cincinnati, Ohio.

MANUFACTURING—Our Well-Equipped Factory Can Handle Your Job. We Specialize in Small Work. Inventions Developed and Made Practical. Prices Right. Sheldon Tool Company, Rosedale, Kans.

PATTERNS, wood and metal. Models, rolls and dies. Brass, bronze, aluminum and iron castings. Screw machine work, production work of all kinds. Write Modern Machine & Pattern Co., Terre Haute, Ind.

MACHINERY, TOOLS AND SUPPLIES

CONCRETE Building Block Machines and Molds. Catalogue free. Concrete Machine Co., 33 South Third St., St. Louis, Mo.

LARGE assortment of pneumatic drills, ring machines, riveting hammers, and dipping hammers—ready to ship. Write for list. Machinery & Supply Corporation, Dept. 3, Joplin, Mo.

MICROMETER (New Type) as accurate as 1/1000000 in. Easier to read. Endorsed by all leading mechanical and scientific magazines. Features 2 1/2 to 5 inches. Price, \$1.00. Robert L. Schnap, 356 Cumberland Street, Brooklyn, N. Y.

6-11"x1" ARTISIAN engine lathes brand new. Price \$156.00 each, 16" Davis Shaper 75.00. We handle everything in machinery and supplies. Write us. Cincinnati Machinery Supply Co., 218 E. Pearl St., Cincinnati, O.

LATHES, Shapers, Hacksaws, Drill Presses, Marine Boat Engines, Reverse Gears, Motor Motors. Write for Prices. Tempa Bros., 4-8-10 Leo Place, Brooklyn, N. Y.

STEPHENS medium priced line of Shapers, Milling Machines, Lathes, and Die Slotters will reduce your manufacturing costs. Established since 1845. Catalog upon request. The John Steptoe Company, Stock Yards Station, Cincinnati, Ohio.

ENGINES, MOTORS AND DYNAMOS

FOR SALE—Less than wholesale, for rest of stock while it lasts: New engines, 1 1/2 horsepower \$45; 3 horsepower \$65; 12 horsepower 195. Garden tractors \$75; Farm tractors \$95. Lorch Machinery Co., Jersey Shore, Pa.

BIJUR Generators, brand new, 6 volts, maximum output 22 amperes at 2000 r. p. m. Government paid \$45.00 each, our price \$10.00. General Sales Company, 1919 S. Michigan Avenue, Chicago, Ill.

MOTORS—G. E. 1/2 hp. \$15.00—1/4 hp. \$2.50—1 hp. \$32.50. Generators 8v. 10 amp. 15—32 v. 500 watt \$30. Other sizes low prices. Motor Specialties Co., Crafton, Pa.

GOVERNORS to control Auto Engines when used as stationary engines. Circuits. Candee-Smith Governor Co., Springfield, N. Y.

ELECTRICAL

NEW, up-to-the-minute Electrical Dictionary including radio terms and diagrams, just published. 188 pages. Cloth cover, red-pocket size. 35c postpaid. Popular Mechanics Book Dept., 206 E. Ontario St., Chicago.

ELECTRICAL Experimenters—Here is the book you have been waiting for—"How to Make Things Electrical." 256 articles, 427 pages, 353 illustrations. Price \$2 postpaid. Popular Mechanics Book Dept., 206 E. Ontario St., Chicago.

CONCRETE Handbook, for the Amateur. We have just published a book describing 173 ways of using concrete in the home, shop and on the farm, with full directions for doing these things yourself with ordinary tools. 128 illustrations. It is "written so you can understand it." Price 50 cents, postpaid. Popular Mechanics Book Dept., 206 E. Ontario St., Chicago.

FOR MECHANICS

PATENTS—Write for our Guide Books and "Record of Invention Blank" before disclosing inventions. Send model or sketch of your invention for examination and instructions. No charge for the above information. See advertisement on page 157. Victor J. Evans & Co., 184 Ninth, Washington, D. C.

SCIENTIFIC, Practical, Automobile, Radio Books, Safety Scale Clips, Drill and Wire Gauge, Handfiles, Hacksaw Blade Clamp. Sample 15c. One each 50c. Agents Wanted. Catalog Free. F. A. Corson, Jersey Shore, Penna.

MECHANICS, Carpenters, Contractors, Send for a Master Folding Rule. Made of Selected, Seasoned, Flexible Hard Wood, with Solid Brass Patented Joints, 5 ft. 50c; 1 ft. 6c. No Stamps. Master Folding Rule, 2148 W. 127th St., Cleveland, Ohio.

1,000,000 **INDUSTRIAL** Facts, Calculations, Receipts, Processes and Trade Secrets for every business are contained in the 1,916 page book "Measures Universal Assistant and Complete Mechanic," 500 Engravings, Cloth, Price \$2 postpaid. Popular Mechanics Book Dept., 206 E. Ontario St., Chicago.

BLACKSMITHS

BLACKSMITHS, Listen! Make more money doing hard jobs easy with Toy's Modern Methods of Master Machine Blacksmithing, Forging and Solid Welding, Tool Dressing and Tempering to a standard with colored tempering charts. All for One Dollar. Samples Free. W. M. Toy, Sidney, Ohio.

FOR THE SHOP

JUST Out! Shop Notes Book for 1924 comprising the 559 articles that have appeared in the Shop Notes section of Popular Mechanics during the past year. Bigger and better than ever. 242 pp. 453 illus. 50 cents postpaid. Popular Mechanics Book Dept., 206 E. Ontario St., Chicago.

MECHANICS! You will seldom if ever get stuck on a job if you keep on hand for quick reference a 16-volume set of Popular Mechanics Shop Notes. At the price of 50 cents a volume, any one of the several thousand time and labor-saving kinks may save you the cost many times over. Any of the volumes may be purchased separately at the same price. Popular Mechanics Book Dept., 206 E. Ontario St., Chicago.

FOR SALE—MISCELLANEOUS

SELL or Exchange—8-Penny-in-the-Slot Weighing Scales. What have you? Box 123, Brentwood, Md.

100 MILLIONS German Mark Banknotes \$5.00. Rivers Hicks, Kentville, Nova Scotia.

FINE Emblem Pocket Knife, \$1.00. Will make ring \$2.75. Good shaving set \$1.00. Titus the Jeweler, Lock Box 22, Waverly, N. Y.

ALL sizes printing presses, type and materials; make easy money printing for self and others. Watson, 160 William St., New York.

A SET of Watchmaking tools for sale at a Bargain. R. Jaegermann, 5815 Easton Ave., St. Louis, Mo.

POCKET Maps. We will send you a reliable and comprehensive Rand-McNally indexed pocket map, tourists' and shippers' guide of any state in the union, Canadian provinces, Alaska, Mexico or Central America, postpaid, upon receipt of 35 cents; also a splendid pocket reference map of practically any foreign country at 50 cents postpaid. Popular Mechanics Book Dept., 206 E. Ontario St., Chicago.

ADDRESSGRAPHS, Letter Folders, Multigraphs, Envelope Sealers, Duplicators, less than half price. Guaranteed. Fruit Co., 170 N. Wells, Chicago.

GASOLINE Lamps and Lanterns. Catalog Free. Little Wonder Light Co., Terre Haute, Ind.

BUY—Exchange—Sell! Many of our readers have for sale or exchange the article you are looking for—and lots of them are looking for the very items you want to turn into cash. Get together! Let our two million readers know your wishes—they'll help you! Send your ad today to Geo. F. Baker, Manager Classified Advertising, Popular Mechanics Magazine, Chicago.

WANTED—MISCELLANEOUS

CASH for old gold, silver, platinum, watches, diamonds, magneto points, gold crowns, false teeth, and other valuables. Merchandise returned if offer unsatisfactory. Busch Products, Dept 50, 144 Fifth Ave., New York.

ELECTRIC drills, small lathes, motors, bought sold repaired. F. M. Rodlick, 42 Auburn Street, West Newton, Mass. Formerly with American Electric Tool Company.

CASH Via Wire—Within One Hour. Simply Mail Jewelry, Diamonds, Old Gold, Platinum Points, Unused U. S., Canadian, Postage, Thrift, Stamps, Bonds, Silver, Teeth, Job-Lots, Anything Valuable. Valuables Held Returnable Ten Days if Price Unsatisfactory. L. Simon, Reliable Refiner, 315 Hippodrome Bldg., Cleveland, Ohio.

WANTED—Copies of Popular Mechanics Magazine of September and October, 1922. Must be in good condition. Will pay 25 cents per copy. Address, Room 311, Popular Mechanics Bldg., 200 East Ontario, Chicago, Ill.

MAIL us your discarded Jewelry, Gold, Crowns and Bridges, Watches, Diamonds, Silver, Platinum, and old False Teeth. Money promptly mailed. Goods returned if offer refused. United States Smelting Works, (The Old Reliable), Dept. 71, Chicago.

REAL ESTATE, FARM AND ORCHARD LANDS

BUY these bargains by mail; \$73 for 122 acres choice lake frontage. \$75 for 25 acres, trout stream accessible, \$97 for 50 acres, beautifully wooded—shooting. \$105 for 50 acres, hunting camp site. \$19 for small acreage, Georgian Bay, \$125 for good acreage, big game district. \$215 for large acreage, hunting camp site. \$285 for mining claim, may be worth a million. Also beautifully situated hunting camps and fishing lodges, where there is real hunting and fishing. Summer cottage sites, islands of all sizes, heavily wooded acreages all situated in Muskoka, Georgian Bay District, with its ten thousand islands, Algonquin Park with its 300 lakes, Highlands of Ontario, Lake of Bays, and the famous Muskoka Lake region. All offered at 10 cents on the dollar of their value, and on easy monthly payments of \$5.00 and upwards. Send for illustrated list of the above and one hundred other properties seized and sold for taxes. If you are interested in the forthcoming boom in Canadian Gold and Silver mines, and would like a mine all your own for two or three hundred dollars send for list 240A. Every property is fully described and offered at a stated price. Send no money. Send for list today, so you will have first chance. If you wish you may make the payments to your local trust company. Tax Sale Service, 72 Queen Street, West, District 15, Toronto, Ontario, Canada.

DEVELOP Your Own Florida Orange Grove in Lake County's highland lake section. Orange groves are paying 20% to 40% on money invested. The Lake County Land Owners' Association, 93 Orchard Ave., Fruitland Park, Fla., an Association of resident orange growers, not land agents, have worked out a plan by which you can secure land and orange trees to plant it for what trees alone would cost you elsewhere, just to encourage development. Ten acres planted to grove will cost you \$1400. Free book of actual photographs and facts only to those ready to buy. Others please don't write. This is your opportunity if you mean business. No time for curiosity seekers, children or purely tourists.

FOR Sale—Three full sections in McKenzie County and two sections in Billings County, North Dakota. Each section contains land suitable for crops, balance for cattle. Each section has valuable deposits of lignite which some day will alone be worth many times the present value of the land. This part of the state is developing very rapidly with good schools within easy access. As owner cannot use this land himself, will sell one or more sections at a price which almost anyone can afford to pay. Address W., care Popular Mechanics, 206 East Ontario St., Chicago.

\$500 GETS 53 Acres with Horses, Cows, Furniture, Implements, 20 T. hay, 100 bu. oats, 150 bu. potatoes, 100 bu. corn, 50 bu. buckwheat, etc.; good buildings; near town. All \$1,700. Page 51 Free Catalog—Bargains many states. Copy free. Strout Farm Agency, 150P Nassau St., New York City.

ATTENTION—"Get acquainted." Cash for your property, Farm, Hotel or Retail Store, no matter where located; confidential service. Hayes' Business Agency, Cincinnati, Ohio.

LAND Opportunity! 20, 40, 80 acres; lower Michigan; only \$10 to \$30 down; balance long time. Write for free illustrated booklet giving full information. Swigart Land Co., P-1259 First Nat'l Bank Bldg., Chicago.

MONEY in California real estate. Get our descriptive lists of property now in the market. \$1.00 per hundred. Pacific Co-Operative Service Bureau, 825 Low State Bldg., Los Angeles, Calif.

REAL Estate Educator—The most valuable, concise and comprehensive work on real estate selling, buying, advertising, appraising, investing, leasing, sub-letting, transferring, insuring, mortgaging, etc., ever compiled. 208 pp. Cloth. \$2 postpaid. Popular Mechanics Book Dept., 206 E. Ontario St., Chicago.

BIG returns from Pecan, Orange and Fig Groves. Guaranteed care. Small monthly payments. Dept. M, Suburban Orchards Co., Biloxi, Miss.

SELL your property quickly for cash, no matter where located. Don't pay big commission. Particulars free. Real Estate Salesmen Co., Desk B., Lincoln, Neb.

\$5.00 DOWN, \$5.00 monthly; 10 acres unimproved poultry, fruit, stock, woodland; \$100; Ozarks, Fishing, hunting, trapping. Alfred Zimmerman, 1800 N. Fifth, Kansas City, Kan.

FARM Wanted—Sell for cash, in any state. No big commissions. R. A. McNown, 312 Wilkinson Bldg., Omaha, Neb.

DOGS AND PETS

LARGE Black Newfoundlands. The child's dog supreme. Eulogized in poetry and story. Registered puppies from America's leading kennel; males \$40, females \$25 delivered. Sent C. O. D. to reliable parties. Bert Carmony, Shelbyville, Ind.

FOR Sale—Broken Rabbit hounds. J. R. Thomas, Booneville, Miss.

DOGS and Birds of all kinds. Wm. Bartlett, Woodson, Ill.

COLLIES for Sale. Training Book 35c. Sunnyside Kennels, Bloomington, Ill.

SILVERBLACK Foxes \$200.00. Muskrats. Time Payments. Arthur Schumacher, Lockland, O.

HUNDRED Hunting Hounds Cheap. Trial. C. O. D. Kaskennels, P.M.C., Herrick, Ill.

POULTRY

CHICKS: Leading varieties. Our big illustrated chick book free. Comfort Hatchery, Box 132, Windsor, Mo.

PIGEON KEEPER—Biggest and best illustrated monthly magazine, \$1.50 for 12 months, 15c a copy. American Pigeon Keeper, 736-P, Cornelia Ave., Chicago, Ill.

BABY Chicks—Prices Low. Catalogue Free. White Leghorns, Rocks, Reds, Oringtons. Goshen Poultry Farms, Goshen, Ind.

PLANS for Poultry Houses. All styles, 150 illustrations; secret of getting winter eggs, and copy of "The Full Egg Basket." Send 25 cents. Inland Poultry Journal, Dept. 74, Indianapolis, Ind.

PERSONAL

UNUSUAL Horoscope—Six pages, consisting of extensive four-page Special Horoscope, Astro-Analysis, and two-page valuable guide giving daily and monthly advice covering entire year. Send 50c and birth date. Money returned if dissatisfied. Prof. Bolles, Box 5, Fordham Station, New York, N. Y.

CARTOONISTS—Improve your style by following the work of the greatest cartoonists found in the bound volumes of Cartoons Magazine. Three volumes, each covering six months, Jan.-June 1919 to Jan.-June 1920, inclusive. 1,200 cartoons, 900 pages to a volume, 7 by 9½ in., 3 in. thick. New books, durable and attractive binding. Sold separately at \$2 per vol. postpaid. Supply limited. Send at once. Popular Mechanics Book Dept., 206 E. Ontario St., Chicago.

ASTROLOGY—Stars Tell Life's Story. Send birth date and dime for trial reading. Clements, No. 3 South Union St., Room 10, Rochester, N. Y.

ARE You Old at Forty? See our Advertisement on page 139 of this issue. The Electro Thermal Company, 2129 Main Street, Steubenville, Ohio.

TOBACCO Kills manly Vigor. Quit easily. Cigarettes, chewing, smoking, snuff conquered or no charge. Small sum if satisfactory. Stops craving; harmless. Full treatment on trial. Perkins Co., 34-A, Hastings, Neb.

TOBACCO or Snuff Habit cured or no pay. \$1.00 if cured. Remedy sent on trial. Superba Co., TP, Baltimore, Md.

ARE you bashful, self-conscious, easily embarrassed? These troubles overcome. Send dime for particulars. C. Veritas, 1400 Broadway, New York, N. Y.

FREE—Information of a scientific nature that has brought happiness through perfect health to thousands. No charge; no obligation. Enclose stamp for reply. C. O. Wood & Co., Colorado Springs, Colo.

FREE—Stop using tobacco. We will give free information how to conquer habit easily and permanently. Results guaranteed. Anti-Tobacco League, Box K, Omaha, Neb.

YOUR Horoscope—Business, Character Changes, Friends, Enemies. Send birth date and ten cents (stamps) for remarkable test reading. Zanya, 292-C, W. 105th St., New York City.

MISCELLANEOUS

LOCKSMITHING, complete 500 tricks of the trade, new edition, many added features, \$1.50; money back if dissatisfied. H. Rouison, 3406 Andover St., Oakland, Calif.

PEARLS—South Sea Island. 50c. McKenzie, Box 9, Long Beach, Cal.

AUTOMATIC Adding Machines \$3.50, delivered. Guaranteed accurate as highest priced machines. Quick, easily operated. Bassett, 1458-E Hollywood Avenue, Chicago.

ARE You Old at Forty? See our advertisement on page 139 of this issue. The Electro Thermal Company, 2129 Main Street, Steubenville, Ohio.

RADIO Map of the U. S.—Government Radio Stations, Broadcasting Stations, Commercial Stations, Call Letters, Wave Lengths, etc. 35c postpaid. Popular Mechanics Book Dept., 206 E. Ontario St., Chicago.

GET posted—Good prices paid for butterflies, insects. See Sinclair display advertisement, page 78.

ART Metal Workers—You will find our book "Metal Work and Etching" a complete manual on making book ends, desk sets, pad corners, paper knives, letter openers, stationery racks, rocking blotters, desk calendars, arts and crafts jewelry, etc.; 96 pp. illus. Price 50 cents postpaid. Popular Mechanics Book Dept., 206 E. Ontario St., Chicago.

ARTIFICIAL Eyes, \$3. Booklet free. Denver Optic, 559 Barclay, Denver, Colo.

HOMEOPATHIC and Biochemic preparations sent postpaid to all parts of the world. Manual and booklets free. Halsey Bros. Co., 111 N. Wabash Ave., Chicago, Ill. Established 1835.

CUTS anybody can make. Simple, cheap process, \$1. Specimens, particulars, 2c stamp. M. Day, Windfall, Ind.

WELDING Encyclopedia—New Third Edition. Complete training course for operators in all welding processes; oxy-acetylene, electric arc, electric resistance and thermit. Welding of all weldable metals fully discussed. 437 pp., 609 illus. The accumulated experience of the welding brains of America is yours for \$5. Money back if not satisfied. Popular Mechanics Book Dept., 206 E. Ontario St., Chicago.

ROCKS and Minerals for sale—hundreds of varieties—price List Free. Peter Zodar, 157 Wells St., Peekskill, N. Y.

MONEY in Minerals. Many common minerals have market value. List 10c. Minerals tested. Mineralogist, Joplin, Mo.

REPAIRING Ford Cars, Trucks and Tractors in the most proper and efficient way is explained in a new 229-page book by the former director of the Ford Motor Co. Service School. This information is otherwise unavailable outside of the Ford plant. Written more especially for the mechanic and repairman. Price \$2 postpaid. Popular Mechanics Book Dept., 206 E. Ontario St., Chicago.



AGENTS

Ye Gods—Some Seller I Made \$215 Today" Writes Bentley

Read what these Oliver agents say:

\$660 a month

"Have averaged \$660 profit a month for last six months."

A. M. Russell, Conn.

\$1000 in 4 weeks

"Am making \$1,000 per month. I have made big money before, but did not expect so much. Your burner is just the thing."

J. Carnegie, S. Dak.

Buys car with Profit

"Have earned enough in one month to buy me a new auto."

S. W. Knappen, Col.

In spare time only, our agents everywhere are cleaning up \$25 a day. There is no limit to what you can make—only one order a day means \$75 a week. All over the country this amazing invention is doing away with old fashioned dirty and expensive methods of heating. Our men say it

Sells Itself

Think of the appeal you can make in every home. It does away with ashes, soot, dirt and smoke—carrying and lifting coal and wood. It gives three times the heat of coal, yet burns 95% air and only 5% oil, the cheapest fuel there is. Solves the fuel problem. Cuts housework in half.

Protects health. Makes any range, heater or furnace a real gas stove—much or little heat when and as you want it by simply turning a valve. Absolutely safe—lasts a lifetime.

1 Minute to Demonstrate

You can slip this wonderful device in any stove, without changes, in one minute. Show any woman what it will do in her own stove and the sale is made. \$12 in 15 minutes.

Free Sample Case Offer

We will show you how to clean up. Start at once spare or full time. Exclusive territories. Real cooperation. Some Oliver agents make as high as \$1,000 a month. By writing at once you will be entitled to a Free Sample Case Offer. Address

OLIVER OIL-GAS BURNER

OLIVER OIL-GAS BURNER COMPANY, B-56, Oliver Bldg., St. Louis, Mo.

Canadian Distributors, B-56, Oliver Bldg., Toronto, Ont.

Oldest and largest manufacturers of oil-gas burners in the world.

Professor Harry S. Six, for 21 years head of music dept. of New York University, who personally teaches you. His new picture method enables you to play a real piece of music the first day.



You can play this Tenor Banjo Same Day You Get It! I'LL SHOW YOU HOW!

My New Picture Method

of teaching TENOR BANJO is so easy that you will play a real piece of music the first day. Pupils say, "Why didn't anyone think of such an easy way before? We never knew we could learn to play so quickly. Your course is wonderful." No knowledge of music needed.

I Play It for You First

This is the only course in existence that gives you free phonographic records of myself playing the piece you are learning. It's just as if you were getting the lessons from me in person. You learn to play by my quick and easy method, and then on the phonographic record I play it for you.

Be Popular

Remember that you get my personal attention all through your full course of 52 lessons. Every letter you get will be signed by me—Professor Harry Six—because it's my job to see that you learn to play right away. You will play right off with my method—next week you'll be in more advanced pieces—and in a short time you'll be playing Bee's Knees, Crying for You, You've Got to See Mama Every Night, and all the popular airs.

Popular Songs FREE

With each of the 52 lessons we give absolutely free a popular song, so you will know all the favorites.

Professional Full Size Tenor Banjo FREE!

For a limited time only to students who enroll in our conservatory we will give absolutely free \$18.00 full size professional tenor banjo. This is a big offer for people who love music and who have never been able to produce it. Send us your name and address on a post card for circular giving full particulars on just how Professor Six has been able to teach thousands to play—and how he can teach you so you will play from the first lesson on. Send the post card today, as Professor Six can give his personal attention to a limited number only, and you want him.

NEW YORK CONSERVATORY OF MUSIC
212 Fifth Avenue, Desk 1-F, New York

Our BUREAU OF INFORMATION will answer all questions regarding articles appearing in this magazine.



WHY NOT IMPROVE YOUR PERSONAL APPEARANCE?

Send for booklet showing photos of Men with and without the PERFECT LEG FORMS for BOW LEGS and KNOCK-KNEES. Also BRACES for children for PERMANENT CURE.

Perfect Sales Co. 140 N. Mayfield Ave. Dept. S. Chicago, Ill.



WANTED

RAILWAY MAIL CLERKS

\$1600 to \$2300 Year

MEN — BOYS 18 UP.

MAIL COUPON IMMEDIATELY

Steady work. No layoffs. Paid Vacations

Common education sufficient:

TRAVEL—SEE YOUR COUNTRY

Electricity

A Practical Training

in this great profession will make your successful future a certainty. The School of Engineering of Milwaukee has specialized for 19 years in training young men for

Electrical Engineering

With a B. S. Degree in 3 Years.

Institute of Electrotechnics—12 months to 30 months, depending upon previous education. Graduates are technically trained electrical experts. Commercial Electrical Engineering—1 year for high school graduates. Automotive Electricity—a 3 to 6 months' course will make you a highly paid specialist on all types of starting, lighting and ignition systems. Armature Winding—and Motor Generator Repair—thorough 3 months' course. Practical Electricity—6 to 12 months' course to become a Master Electrician.

We will aid you EARN YOUR WAY THROUGH COLLEGE, through our practical plan of cooperative industrial employment. Board and room at cost. Student activities, orchestra, daily broadcasting WIAD.

NEW TERM OPENS APRIL 1st. Write NOW for latest catalog and full details. Mention age, education, and course of interest.

SCHOOL of ENGINEERING of Milwaukee

PM2-24, 415 Marshall Street, Milwaukee, Wisconsin



THIRTY-FIVE EASY LESSONS IN RADIO 50c

A systematic course of elementary principles written in a simple and concise lesson course, easily understood. Thousands have taken up Radio for entertainment and are operating their own amateur sets.

This book embodies all the principles and application of everyday radio for the home and in business. Paper cover.

Price postpaid 50c

SHREWSBURY PUBLISHING COMPANY
5311 West Lake Street CHICAGO, ILL.

THIS WONDERFUL INVENTION



converts any ordinary cook stove into a gas stove. OXO-GAS is made from kerosene and air. Cheaper, cleaner and more efficient than coal. Responsible distributors wanted.

GLORIA LIGHT CO.
114 N. May St. Chicago, Ill.

LEARN TO GET DOLLARS OUT OF WATCHES.

WATCH-REPAIRING. ENGRAVING. JEWELRY REPAIRING.

WRITE NOW.

ENICAR TRADE SCHOOL
530 W MONUMENT SQUARE, RACINE, WIS.



FRANKLIN INSTITUTE, Dept. F179, Rochester, N. Y.

Sirs: Send me without charge, (1) Sample Railway Postal Clerk Examination questions; (2) List of government jobs now obtainable; (3) Send free illustrated book, "How to Get Government Jobs."

Name.....

Address.....

LEARN AUTO

AND TRACTOR BUSINESS
THE PRACTICAL WAY
PAYS \$150 — \$400 MONTH
I Personally Give You



I GUARANTEE TO TRAIN YOU

I guarantee to teach you this big pay trade, the practical way only, with real tools; no books, studies, or blackboard work. Kerr jumped from \$1,248 to \$2,496 a year; Loos jumped from \$24 week to \$75 week; Hartmann's profits average \$400 monthly; I trained them and will do the same for you. Come to my big school shop and work with real tools on actual jobs on automobiles, tractors, trucks and aeroplanes. Just think! 14,000,000 automobiles need attention. You can see the wonderful opportunity awaiting you as a practical, trained mechanic. Send for my FREE 72-page copyrighted Catalog.

GARAGE OWNERS MAKE FROM \$2,000 TO \$10,000 YEAR

You, too, can own a business of your own, the same as many of my students are doing, who are making more money than they ever dreamed of making before they took my practical training course. THINK!—you make money for others—why not for yourself? I will show you how.

THIS IS WHAT YOU GET WHEN YOU COME TO MY SCHOOL

My complete auto and tractor course covers all branches of the automobile business. I teach you all about automobiles and tractors, how to build, repair and run them, how to repair tires and radiators, battery repairing, the care and repair of farm lighting plants, welding, salesmanship and garage management, and I give you a complete electrical course which covers every electrical apparatus on automobile, tractor and aeroplane.

MY BOYS IN BIG DEMAND

Ohio State Practical trained men are in tremendous demand everywhere, because everybody knows they are trained right. This is your life's opportunity, as I positively guarantee to teach you the business in every department. No previous experience necessary and common education is sufficient.

I MAKE A SUCCESS OF YOU

I will make a success of you. You are trained under my personal supervision, and in eight weeks you will be ready to take a big pay job, or to start a business of your own. My big FREE Catalog tells you EVERYTHING you want to know about this wonderful field of opportunity—send for it NOW. The man who acts is the man that succeeds.

WHITE STUDENTS ONLY

Ohio State Practical
Motors School

D 10-2 Cincinnati, Ohio



Students Get Actual Work



Work on Real Tractors



My Students Own Their Own Garages and Repair Shops

Sworn Proof
of Success
in 8 Weeks
IN AUTO BUSINESS

MY BIG CATALOG FREE!

Use the COUPON below—mail it today sure—then I will send you your personal copy of my big 72-Page Copyrighted Book, "Sworn Proof of Success in 8 Weeks." This wonderful, illustrated Catalog is full from cover to cover of pictures of my students at work on actual repair jobs in my big practical training school and contains letters from boys I trained and some of whom are making as high as \$10,000 a year.

D 10 2

Send me your FREE 72-Page Copyrighted
Catalog of Sworn Proof of Success
in 8 Weeks in Auto Business.

Name

Street or R. F. D.

Town..... State.....

Mail this Coupon NOW →



"I'm as Good a Man as Jim!"

"They made him manager to-day, at a fine increase in salary. He's the fourth man in the office to be promoted in the last few months. And all were picked for the same reason—they had studied in spare time with the International Correspondence Schools and learned to do some one thing better than the rest of us.

"I've thought it all out, Grace. I'm as good a man as any of them. All I need is special training—and I'm going to get it. If the I. C. S. can raise other men's salaries it can raise mine. See this coupon? It means my start toward a better job and I'm going to mail it to Scranton to-night!"

Thousands of men now know the joy of happy, prosperous homes because they let the I. C. S. prepare them in spare hours for bigger work and better pay.

Why don't you study some one thing and get ready for a real job, at a salary that will give your wife and children the things you would like them to have?

You can do it! Pick the position you want in the work you like best and the I. C. S. will prepare you for it right in your own home, in your spare time.

Mail the Coupon To-day

INTERNATIONAL CORRESPONDENCE SCHOOLS Box 5581-D, Scranton, Penna.

Without cost or obligation, please tell me how I can qualify for the position or in the subject before which I have marked an X:

BUSINESS TRAINING COURSES

- | | |
|--|---|
| <input type="checkbox"/> Business Management | <input type="checkbox"/> Salesmanship |
| <input type="checkbox"/> Industrial Management | <input type="checkbox"/> Advertising |
| <input type="checkbox"/> Personnel Organization | <input type="checkbox"/> Better Letters |
| <input type="checkbox"/> Traffic Management | <input type="checkbox"/> Show Card Lettering |
| <input type="checkbox"/> Business Law | <input type="checkbox"/> Stenography and Typing |
| <input type="checkbox"/> Banking and Banking Law | <input type="checkbox"/> Business English |
| <input type="checkbox"/> Accountancy (Including C.P.A.) | <input type="checkbox"/> Civil Service |
| <input type="checkbox"/> Nicholson Cost Accounting | <input type="checkbox"/> Railway Mail Clerk |
| <input type="checkbox"/> Bookkeeping | <input type="checkbox"/> Common School Subjects |
| <input type="checkbox"/> Private Secretary | <input type="checkbox"/> High School Subjects |
| <input type="checkbox"/> Spanish <input type="checkbox"/> French | <input type="checkbox"/> Illustrating <input type="checkbox"/> Cartooning |

TECHNICAL AND INDUSTRIAL COURSES

- | | |
|---|--|
| <input type="checkbox"/> Electrical Engineering | <input type="checkbox"/> Architect |
| <input type="checkbox"/> Electric Lighting | <input type="checkbox"/> Blue Print Reading |
| <input type="checkbox"/> Mechanical Engineer | <input type="checkbox"/> Contractor and Builder |
| <input type="checkbox"/> Mechanical Draftsman | <input type="checkbox"/> Architectural Draftsman |
| <input type="checkbox"/> Machine Shop Practice | <input type="checkbox"/> Concrete Builder |
| <input type="checkbox"/> Railroad Positions | <input type="checkbox"/> Structural Engineer |
| <input type="checkbox"/> Gas Engine Operating | <input type="checkbox"/> Chemistry <input type="checkbox"/> Pharmacy |
| <input type="checkbox"/> Civil Engineer | <input type="checkbox"/> Automobile Work |
| <input type="checkbox"/> Surveying and Mapping | <input type="checkbox"/> Airplane Engines |
| <input type="checkbox"/> Metallurgy | <input type="checkbox"/> Navigation |
| <input type="checkbox"/> Steam Engineering | <input type="checkbox"/> Agriculture and Poultry |
| <input type="checkbox"/> Radio | <input type="checkbox"/> Mathematics |

Name.....
Street.....
Address..... 11-21-23

City..... State.....

Occupation.....

Persons residing in Canada should send this coupon to the International Correspondence Schools Canadian, Limited, Montreal, Canada.

LEARN The BUSINESS of Advertising



QUICKLY BY MAIL

We guarantee to teach you. It's easy to learn—and easy to get into! Make the start *this week*. This free book tells how.

\$75 to \$100 a Week

—frequently paid beginners. There is no limit to opportunities which men and women trained in advertising meet on every hand.

FREE AD-WRITER'S COMPLETE WORKING OUTFIT

Wonderful outfit of working instruments given free on special offer. Write for details before offer expires. We will also send you free and prepaid this stirring book on advertising. Tells you everything you want to know about getting into this fascinating field.

Write today. Postcard will do.

Page-Davis School, Dept. A38, Chicago

INSTRUCTION BOOKS, MUSIC



These books are illustrated and gotten up to make the method of self-teaching so simple that any one without any knowledge of music could learn to play any of the following:

SAXOPHONE - 25c	MANDOLIN - 25c
ACCORDEON - 25c	PIANO - 25c
BANJO - 25c	UKULELE - 25c
GUITAR - 25c	VIOLIN - 25c

The above prices are postpaid. Any above 5 titles, \$1.00, postpaid.
J. C. DORN, 725 So. Dearborn St., Dept. 17, CHICAGO, ILL.

Capper's Weekly 10 Cents

Capper's Weekly will entertain the whole family. You will enjoy and profit by the editorials and articles by U. S. Senator Arthur Capper. Your wife will profit by the household hints and fashion page, and the children and grown-ups, too, will delight in the children's page. Its health articles by Dr. Copeland will prevent

much suffering in your family. All will enjoy the stories and snappy articles and cartoons by famous artists. A journal of progress and welfare and champion of a square deal for all the people. For a short time we will send CAPPER'S WEEKLY for a term of 8 weeks for only 10 cents. Address CAPPER'S WEEKLY, Dept. 27, Topeka, Kan.



What is your Zodiac Sign? What does it mean to your future?—happiness in marriage?—friends, enemies, success in all undertakings?—and other important questions? We tell you FREE.

Your future is governed by Astrology, the science that has foretold events with almost unflinching accuracy since 1200 years before Christ. The dependability of its truths has been investigated.

Let us give your Astrological interpretation. To cover packing, enclose TEN CENTS (stamps or coin) your name, address, exact birthdate and receive yours by return mail. Learn the truth. A big surprise. Write today. DO NOT FORGET TO ENCLOSE YOUR BIRTHDATE.

ZODIAC RESEARCH SOCIETY
415-58 St. Suite 303 Brooklyn, N. Y.

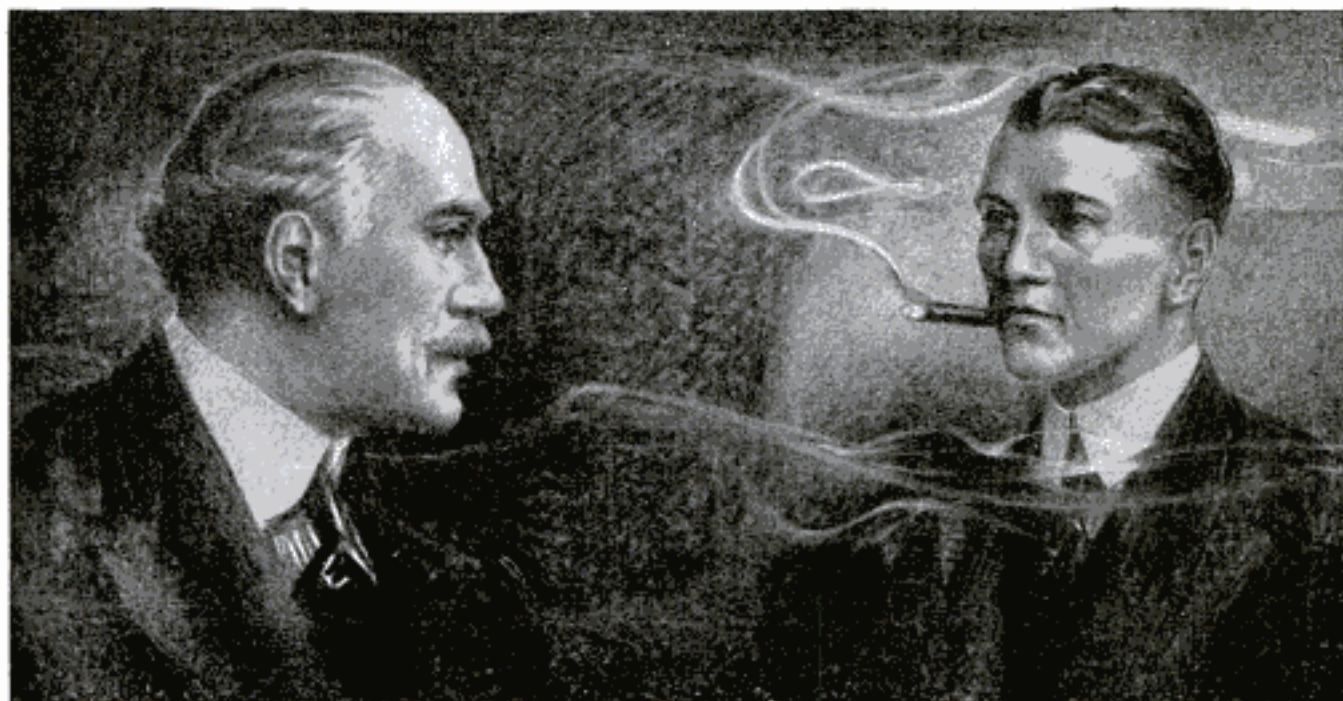

Tobacco Is Hurting You

Look at the facts square in the face, Mr. Tobacco User. You may think tobacco is not hurting you.

That is because you haven't as yet, perhaps, felt the effects of the nicotine poison in YOUR system. For you know that nicotine, as absorbed into the system through smoking and chewing tobacco, is a slow working poison. Slow, yes—but sure.

Tobacco is lowering your efficiency. It slows a man down. Makes it harder for you to concentrate your mind on your work. You haven't near the amount of "pep" and energy you would have if you stopped using it. There's many a man twice as old as you in years who's twice as young in energy, simply because he lets tobacco alone.

Some day you will realize to what an alarming extent tobacco has undermined your system.

When your hands begin to tremble—
and your appetite begins to fail—
and your heart seems to "skip a beat" now and then—
and slight exertion makes you short of breath—
then you have a right to suspect that
TOBACCO is getting the upper hand.

Any well-informed doctor will tell you that these are only a few of many symptoms of tobacco poisoning.

And YOU know that the use of tobacco in any form is an expensive, utterly useless habit. You know you ought to quit.

Tobacco Habit Banished Let Us Help You

It doesn't make a particle of difference whether you've been a user of tobacco for a single month or 50 years, or how much you use, or in what form you use it—whether you smoke cigars, cigarettes, pipe, chew plug or fine cut or use snuff—**Tobacco Redeemer** will positively remove all craving for tobacco in any form in a very few days. Not the slightest shock to the nervous system. Your tobacco craving will usually begin to decrease after the very first dose—there's no long waiting for results.

Tobacco Redeemer contains no habit-forming drugs of any kind and is marvelously quick, scientific and thoroughly reliable.

It is in no sense a substitute for tobacco. After finishing the treatment you have absolutely no desire to use tobacco again or to continue the use of the remedy. It helps to quiet the nerves and make you feel better in every way.

Results Guaranteed

A single trial will convince you. Our legal-binding, money-back guarantee goes with each full treatment. We will refund every cent you pay for the treatment if after taking it according to the easy-to-follow directions, it should fail to banish the tobacco habit completely.

SEND Free Proof

Let us send you our free booklet on the deadly effects of tobacco, together with testimonial letters from men all over the country telling how they have been absolutely freed from the tobacco habit by this simple home treatment. You could not ask for stronger proof that **Tobacco Redeemer** will free you from the habit than the evidence we will gladly send on request. Just mail the coupon—or a postal will do.

NEWELL PHARMACAL CO.

Dept. 300

St. Louis, Mo.



Free Book Coupon

NEWELL PHARMACAL CO.

Dept. 300

St. Louis, Mo.

Please send, without obligating me in any way, your free booklet regarding the tobacco habit and proof that **Tobacco Redeemer** will positively free me from the tobacco habit or my money will be refunded.

Name

Street and No.

Town..... State.....



IS it Hopeless?

Does your life look like a hopeless, endless, grind? By trick of fate, or possibly your own carelessness, did you fall into one of those "dead jobs"—jobs with no future, no present, no anything, but just grinding away. Is there no let up? Are you doomed to this forever? Is there nothing but dullness in life ahead? Is it hopeless?

You May Be Gone

Does your body ache and your head feel dull? Do you wake in the morning aching for more rest, and come home at night too tired to think? There is hope. You may be tired, worn out, dull. Your health may be failing. You may have lost interest. You may lack ambition, or the power to think, or imagination. You may lack the power for action. Your habits may have the best of you. But,

THERE IS HOPE!

Get the Haddock System for Success. New ambition will arouse you. New desire will spur you. You will get out of the rut. Your imagination will awake. Confidence will be yours. You will see things in a new light. Your personality will be dynamic. You will have magnetism. You will have will power, jobs, money, admiration and friends.

STRIKE OUT! WIN!

You will get a new power that will make you strike out in a bold strong way for the success, money—everything that you want and that is yours to have, if you will but strike out and go after it.

Get MORE Money

It costs you nothing to try. You can have the clothes, the little luxuries, everything you have longed for. Send for the system. Take five days to examine it—to try it—see for yourself that it will do what we say. You take no risk. Before it is too late.

MAIL THE COUPON
SEND NO MONEY

HADDOCK'S SYSTEM FOR SUCCESS

(For Men and Women, Young and Old)

4 Haddock Building, Meriden, Conn.

Sirs: You may send me your "Haddock's System for Success" in three volumes on five days' free trial. Within 5 days of receipt I agree to either send \$5 or remail the system.

Name.....

Street.....

Town and State.....

RESULTS

Over 525,000 people have purchased and praised Haddock's system. Some of the great men are: Judge Ben B. Lindsey; Supreme Court Justice Parker; Wu Ting Fang, Ex. U. S. Chinese Ambassador; Asst. Postmaster Gen. Britt; Gov. McKelvie of Nebraska; Gen. Mgr. Christeson of Wells-Fargo Express Company; E. St. Elmo Lewis, former Vice Pres. Art Metal Construction Co.; Ex-Gov. Ferris of Michigan, and many others of equal prominence.

Read what others say:

"Due to suggestions received from Haddock's, I have increased my financial returns from \$40 to \$150 a week."—H. D. Ferguson, Hot Springs, Ark.

"The character of Haddock's is such that he who reads and puts forth effort will soon find himself out of the common herd."—F. A. Good, President of Nebraska Lumber Dealers' Assn., Cowles, Neb.

"The study made a great change in my life. Was earning \$19 a week and have just signed a contract as superintendent at \$3,000 a year."—J. H. Siegel, St. Louis, Mo.

PROOF!

We Train You to Earn

\$6000.00 A YEAR
as an ELECTRICAL AND AUTO EXPERT

Big Money Being Made by Hundreds of Our Graduates

From all over the country graduates write us telling us of the successes they have made thru our training. Many own their own garages.

Get Your Share of the Big money made in the Auto, Truck and Tractor repair business.

We Pay Your Fare to Pittsburgh. Enroll in our school, one of the most complete of its kind in the country.

Established Over 14 Years

Pittsburgh School of Automobile Engineering
Dept. 342 405 Penn Ave., PITTSBURGH, PA.

Get This Beautiful Instrument

FREE—\$20 Value
Excellent Tone



Act Quickly! and get this beautiful high-grade VIO- LIN absolutely FREE. Only 1000 instruments given to introduce Prof. Schneider's wonderful guaranteed Course. No red tape—no strings to this amazing offer. Just a few cents a day for lessons. You learn to play or pay nothing. This simple system teaches you to master any one instrument, and enables you to play all three.

PLAY BY NOTE IN TWO LESSONS

So easy—so simple—so thorough in this master course that Prof. Schneider absolutely guarantees that you can play by note in two lessons, or so pay. Many students play for money in 6 months. Become popular. Play at socials and parties. Only course qualifying you to teach.

MAKE YOUR CHOICE NOW! Select your favorite instrument. If you have a Phonograph, get our best lesson record. If you have no phonograph, request our first lesson on Conservatory Correspondence Course. Either one sent on 30 days' free trial. The instrument is given absolutely FREE. Write for School of Music, 228 Vermont St., Dept. B-2, Blue Island, Ill. (A Branch of Chicago)



Get
Factory
Prices

Home Heating Plans FREE!

Write and get factory-to-you prices on the finest quality furnace made—pipe or pipeless style of installation. Blue prints free.

\$10 Down—Easy Payments
Quick shipment. Money back guarantee. Save 1/3 to 1/2. Bargain Book Free—Write Today. Stoves, ranges, furnaces, etc. More than one-half million booster customers. Write today.

Kalamazoo Stove Co.
391 West Rochester Ave.
Kalamazoo, Michigan

5,000,000 Men Are After the Routine Jobs—

*Break Away From
This Competition—*

Command Big Pay!

When business slackens, can your employer "let you go"—and tomorrow hire almost any routine man from this army of 5,000,000 men and find him competent to take your place?

Observe that when a business trims its crew, it is almost never the big-pay men who walk the plank.

Not only are the specialists retained—the Accountants, Production Managers, Traffic Managers, and, in fact, the managers of any of the important departments of a business—but they are frequently promoted. Other concerns are in need of their ability, and come bidding for their services.

Many of these men who today are going rapidly ahead were no better off than you, several years ago. Today, while others walk the streets, these men walk into the better jobs.

There is no mystery about their swift advancement. There is a way that's interesting and practical whereby any man of average intelligence can get the training that will put him in the big-pay class. Literally thousands of ambitious men have found this way in the LaSalle Problem Method. They have chosen the line of work that most appealed to them—then, right in the quiet of their own homes, without losing an hour from work or a dollar of pay, they have solved the problems they today are meeting in the better jobs.

Situations which they face today are identical with those they faced in spare-time study. They have been shown exactly how to meet them—guided every step of the way by some of the ablest business men, in their respective fields, in America.



Read these statements, typical of over 1,000 which we will send you in booklet form and which represent but a small part of the many thousands of similar letters in our files:

"The most efficient and most rapidly promoted men in our whole organization are LaSalle-trained."

"Promoted to General Manager."

"Now a director in two banks."

"From bookkeeper advanced to chief accountant—salary increased 500%."

"Passed bar examination with highest grade, in competition with many resident school graduates."

"The Problem Method increased my income \$2,500 a year."

"Passed C. P. A. examination. You will be interested to know that 50% of the successful candidates were LaSalle-trained men."

An analysis of the letters from 1,193 LaSalle members reporting definite salary increases during 3 months' time shows an average increase per man of 80%.

While the axe hangs over every business office, it's the time of all times to free yourself forever from the treadmill jobs.

Mark on the coupon the training that attracts you, sign and mail it to the University. It will bring you full information, together with particulars of our convenient-payment plan; also your free copy of the inspiring book—"Ten Years' Promotion in One."

Break away from the crowd of routine pluggers. Find out today what YOU must do to put yourself among the men who command big money. Mail the coupon NOW.

INQUIRY COUPON

LASALLE EXTENSION UNIVERSITY, Dept. 264-R CHICAGO, ILLINOIS

Please send me catalog and full information regarding the course and service I have marked with an X below. Also a copy of your booklet, "Ten Years' Promotion in One," all without obligation to me.

- | | | | |
|---|--|--|---|
| <input type="checkbox"/> Business Management | <input type="checkbox"/> Law—Degree of LL. B. | <input type="checkbox"/> Banking and Finance | <input type="checkbox"/> Expert Bookkeeping |
| <input type="checkbox"/> Modern Salesmanship | <input type="checkbox"/> Commercial Law | <input type="checkbox"/> Personnel and Employment Management | <input type="checkbox"/> Business English |
| <input type="checkbox"/> Higher Accountancy | <input type="checkbox"/> Industrial Management Efficiency | <input type="checkbox"/> Modern Foremanship & Production Methods | <input type="checkbox"/> Commercial Spanish |
| <input type="checkbox"/> Traffic Management | <input type="checkbox"/> Modern Business Correspondence and Practice | <input type="checkbox"/> C. P. A. Coaching | |
| <input type="checkbox"/> Railway Station Management | | | |

Name..... Present Position.....

Address.....

YOU
 Can mystify
 Be popular
 Make Money
 Go
 into vaudeville

Be Right in the
SPOTLIGHT

Invited Everywhere by
 Everybody
 Be a real entertainer with real MAGIC

Our professional tricks make it easy

No. 141. THE HUMAN VOLCANO. MAKE VOLUMES OF SMOKE WITH EASE. ALWAYS A SENSATION.
 HARMLESS
 Price WITH FULL DIRECTIONS 30¢



No. 46. WONDERFUL INK AND WATER TRICK. PERFORMED BY THE LEADING MAGICIANS.
 Price 75¢



No. 119. THE RISING PENCIL TRICK. AT COMMAND THE PENCIL RISES TO ANY ANGLE YOU DESIRE. A VERY MYSTIFYING TRICK THAT ALWAYS MAKES A HIT.
 Price 25¢



all postage

MENTAL TELEPATHY. THE PERFORMER FINDS ANY ARTICLE CONCEALED BY A COMMITTEE.
 GREAT FOR PUBLICITY WORK.
 3 methods in complete detail
 Price 75¢



prepaid

MONEY MAKING MACHINE. WITH THIS OUTFIT YOU CAN PASS A PIECE OF WHITE PAPER THROUGH THE HOLLERS AND FROM THE OTHER SIDE A DOLLAR BILL WILL COME!
 Price complete 35¢



No. 190. THE WONDER BOTTLE. YOU CAN ALWAYS CONTROL IT. THE OTHER FELLOW CAN NEVER MAKE IT LIE DOWN.
 Price 12¢ INCLUDES FULL DIRECTIONS



PICTURE OF THE NAKED TRUTH
 ONE OF THE BEST AND FUNNIEST JOKES WHEN OPENED THE EXPECTED FIGURE ENTIRELY DISAPPEARS LAUGH EVERY TIME
 Price 15¢



No. 178. THE HUMANATONE
 THIS WONDERFUL INSTRUMENT CAN BE PLAYED BY THE SMALLEST CHILD. - 48 SWEETER MUSIC CAN BE FOUND
 Price each 20¢ 2 for 35¢



SHOOTING FLASHLIGHT SHOOTS WHEN BUTTON IS PRESSED
 Price 25¢



HEANEY made for WORLD TRADE
 VERY AMUSING AND GREAT FOR MASQUERADES AND PARTIES
 NIGGER OUTFIT - To Fool YOUR FRIENDS
 Price complete 75¢



OUR LARGE FREE CATALOG contains hundreds of CARD TRICKS SURPRISE JOKES NOVELTIES MAGICAL STAGE APPARATUS Sensational Escapes MIND READING CRYSTAL GAZING GOODS. PLAYS AND Everything FOR ENTERTAINMENT
 WRITE TODAY

Large catalog of wonders absolutely FREE

HEANEY MAGIC CO.
 Berlin Wisconsin

FREE!



—The Book That Is Bringing Thousands Big Money in ELECTRICITY

by the great Lincoln Institute of Technology. When you enroll you know you are backed by a great institution. You receive free employment service and expert advisory service as long as you live.

THERE is no field in the world that offers such great money-making possibilities to trained men as electricity. Thousands are qualifying the new way by actual S. & H. Shop Type training. A few weeks during spare time in your own home, then you are equipped to step right into jobs paying from \$50 to \$150 per week. Get this wonderful book, which tells you just how you can do this. Sent free.

Train at Home for \$3,000 to \$10,000 Jobs

Don't stand back on account of education, experience, age, or location. No matter where you live, or what you are now doing, through my course you have the chance to become in a very short time a big pay "electrical expert."

Actual Shop Methods in Your Own Home

For I have devised a wonderful new system that gives you the benefit of actual shop experience in your own home. Never before has this been possible. But now, after finishing my training you will be at home in the biggest electrical plant, in a sub-station, in a battery station, or with expert maintenance men, or on automobile and tractor starting, lighting and ignition work because you will have had actual experience, which means everything.

Backed by Lincoln Institute of Technology

This new system of teaching electricity has proved so successful that it has been highly recommended and endorsed

FREE OUTFIT

There is such a call for men now that we are giving free an electrical outfit for experimental and practical home use if you enroll now. Think what it will mean to leave forever the low pay rut to become a trained, efficient electrical technician, capable of managing and supervising ten or five hundred men on the biggest jobs; to travel, to be a man of influence — to have a salary of \$5000 to \$10,000 per year. Find out now how you can do this. You cannot afford to delay a day. Send right now for this wonderful free book that is pointing the way for thousands to big money in electricity. The coupon brings you this book entirely free, without obligation. Fill it out.

S. & H. ELECTRICAL WORKS
Affiliated with the Lincoln Institute of Technology
Dept. B-1, 1422 W. Monroe St., Chicago, Ill.

Free Book—Free Outfit Coupon

S. & H. ELECTRICAL WORKS
Division of Lincoln Institute of Technology
Dept. B-1, 1422 W. Monroe Street, Chicago, Ill.

Please send me at once your big book "How to Get the Better Jobs in Electricity," and full particulars of your course in practical electricity, your free outfit and your free employment service offer. I am not obligated in any way.

Name.....

Address.....

City..... State.....

Give age if under 16.....

Free latest BOOK on HEALTH and BEAUTY

VIOLET RAYS



Only \$1.00 DELIVERS now *to Your Home*

ONLY \$1.00 brings this complete, scientific Violet Rays outfit to you. Treat yourself and family at home, save delay, costly doctors and medicines. Thousands use Violet Rays at home to relieve pain and sickness. The identical outfits doctors have bought from us for years and with which they successfully treat many ailments.



QUICK RESULTS—No Medicine

Violet Rays work quickly, it's scientific, goes after the cause. That's why results are quick, permanent. Dr. Duncan, Kewanee, Ill. writes, "Violet Rays is the finest thing I ever used . . . to relieve pain, treatments are so pleasant all my patients like it." Use it yourself at home, you save Doctor's bills.

BEAUTY AID

Brings natural, magnetic beauty of health, no dieting, exercise or drugs. FREE book tells in detail how high priced beauty specialists use it to improve scalp and skin.

EARN CASH

Men, women, without experience earn liberal profits in spare time showing Violet Rays to neighbors. Proves results first demonstration. Sells on sight. Get attractive offer and wholesale prices now.

SEND FOR FREE BOOK

Explains how Nikola Tesla discovered Violet Rays, how it works, why it heals. Tells what doctors and plain folks accomplish in conquering pain, disease and nervous trouble with Violet Rays.

Reveals **Marvelous Scientific Discovery** Shows charts of human body, explains where pains start, how to banish them. Offered FREE for a limited time only, to introduce Violet Rays. Send for FREE copy.

Mail Coupon—Send No Money

VI-REX ELECTRIC COMPANY
326 West Madison St., Dept. 22, Chicago
Please send me without cost or obligation your free book describing your VI-REX Violet Ray outfit, and details of your \$1.00 offer.

Name _____

Address _____

City _____

State _____

NO.1 NO.2
\$2.63 \$3.25

NO.3 NO.4
\$5.90 \$4.98

WEAR SEVEN FREE DAYS

OUR MARVELOUS MEXICAN DIAMONDS

have delighted thousands of customers for 18 years. They positively match genuine diamonds. Same perfect cut, same dazzling play of rainbow fire. Stand intense acid test of side by side comparison with genuine. **Meted experts positively need their experience to detect any difference whatever.** Perhaps the gems you admire on your closest friends are MEXICAN DIAMONDS and you never knew it. **Wear a MEXICAN DIAMOND FREE; you risk nothing.** Wear it seven days side by side with a genuine diamond. If you see any difference, send it back; it won't cost you a cent.

HALF PRICE TO INTRODUCE

To introduce to new customers, we quote these prices which are all you pay and just half our catalog prices.

No. 1—Ladies 1 ct. Solitaire, fine 18k gold \$2.63
No. 2—Gents Heavy Tooth Belcher, 1 Ct. gem. 14k gold \$3.25
No. 3—Ladies 3 stone Duchess ring, fine platinum finish, two 5/8 ct. first water Mex. diamonds, one blue sapphire. \$5.90
No. 4—Gents Hr. Heavy Gyger ring, platinum finish, black inlay on sides; 1 5/8 ct. first water Mex. Diamond \$4.98

SEND NO MONEY paper that meets around ring finger to show size. Say which ring you want. We ship promptly. On arrival, deposit price with postman. If you decide not to keep it, return in 7 days and we'll refund your money. Write **TODAY**, Agents wanted.

MEXICAN DIAMOND IMPORTING CO.
Dept. 17 LAS CRUCES, N. MEX.
Exclusive Controllers of Mexican Diamonds for 18 years.

GOVT. JOBS OPEN

Railway Mail Clerks, \$1600 to \$2300; Postoffice Clerks and Carriers, \$1400 to \$2000 per year. Many other vacancies, \$1440 up to \$3600. Annual vacation and sick leave with full pay. Common education sufficient. Our 36 page booklet tells how to obtain one of these desirable lifetime positions. Write immediately.

Chicago Civil Service College, A-51 Kesner Bldg., Chicago

QUIT TOBACCO OR SNUFF RUINING YOUR HEALTH WASTING YOUR MONEY

Harmless treatment quickly overcomes craving for cigars, cigarettes, pipe, chewing or snuff. Sent on trial. Costs \$1.00 if it cures, nothing if it fails. Used by over 400,000 people. Superba Co. H-2 Baltimore, Md.

Try This on Your Hair 15 Days



Then let your mirror prove results

Write Today for FREE Trial Offer.

Your hair need not thin out, nor need you become bald, for there is a way to

destroy the microbe that destroys the hair. This different method will stop thinning out of the hair, lifelike hair, remove dandruff, darken gray hair or threatened or increasing baldness, by strengthening and prolonging life of the hair for men and women. Send your name now before it is too late for 15 days' free trial offer.

AYMES CO., 3932 N. Robey St., M390 Chicago



Physical Magnetism Yours

Increase your personal power, develop your power of will. Secure great physical magnetism. Stand out from the humdrum crowd as a MAN among men. Attain superb and radiant health. Send NOW for my amazing 64-page book full of extraordinary pictures that will thrill you and make you want to be the man or woman you should be. Send at once for this wonderful book, which fully reveals these astounding secrets. Enclose a dime to cover wrapping and mailing. Grasp this opportunity of learning the rare secrets of becoming physically perfect, and do it now. Address

PROF. CHARLES ATLAS
96 Fifth Ave., Suite 724, New York City

PROF. CHARLES ATLAS
Twice pronounced the world's Most Perfect Man, receiving two \$1,000 First Prizes. No other living man can claim this title.

Learn an Auto Trade

**Big
Pay
Jobs
Open**
in
California

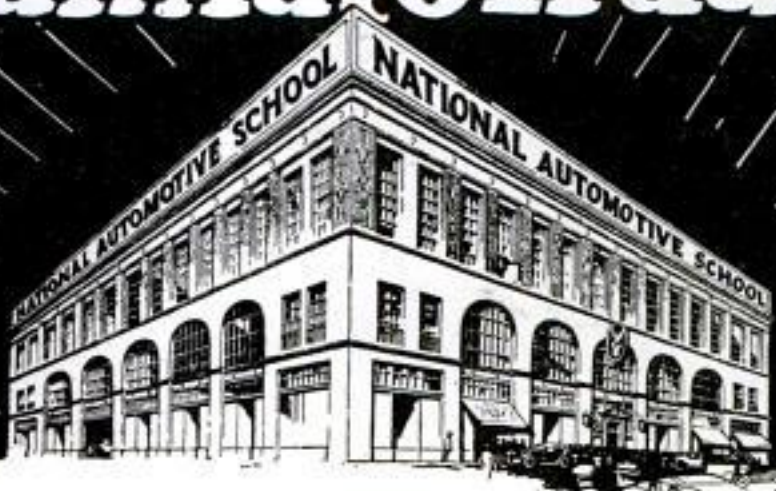

Auto Experts Needed Everywhere
California Offers Greatest Opportunities. Learn
Right at National Automotive—Los Angeles—
Many Unusual Advantages—No Extra Cost

RIGHT now is the greatest opportunity in years for you to get into the fastest money-making business in the world today. Auto industry is making fortunes for thousands. Men are rich who were penniless five years ago. Big concrete garages stand today where small repair shops started some men to success. Get into auto business now. Auto experts are needed and needed badly. Garage owners want men who know autos. Men who have trained at National Automotive.

Over a Million Autos in California
No Winter Weather to Stop Business

Sooner or later you will want to come to sunny California—to Los Angeles—why not now? Words cannot tell you of this wonderful country where the ocean, the mountains, the city and country are closely connected by miles and miles of wonderful paved highways; where sunshine warms the winter winds and ocean breezes cool the summer sun. And its new big opportunities for everyone, for you.

No Age Limit—No Education Required

You can become an auto mechanic, electrician, ignition expert, garage foreman, salesman-demonstrator, or used car appraiser after a few short weeks' training at National Automotive. No previous education necessary; no age limit. You can fill a big pay job.

A New and Finer National Assures Success

Tremendous demand for National trained experts made necessary a bigger, finer and greater National Automotive. Many new and wonderful advantages for you. Thousands and thousands of dollars' worth of modern equipment. Practical shop practice trains you right. Actual construction

work on all types of motors—Packards, Cadillacs, Fords, etc. Ignition, battery and lathe work; driving, vulcanizing and salesmanship. Special advanced electrical course **Free**. Expert mechanic instructors to train you. You **know** autos when you finish **National** training. **Now**, special reduced tuition offer. Mail coupon for full information.

Like college life at new National Automotive—right across the street from 130-acre Exposition Park. Ball grounds, gymnasium, swimming pool, world's largest stadium, amusements—everything **Free** to you. Right in the heart of a big city—Los Angeles. **No other city in America like Los Angeles; no other school like National.**

Earn Room and Board

Jobs guaranteed to earn your room and board while learning. Think of it. You can become a big-pay auto expert at practically no expense, except small tuition cost; no extras; no tools to buy, no books used. Unlimited **Free** employment service.

And then your reward—big pay, steady work, a good job for life. Hurry! Get into the auto business at once.

Send for FREE Auto Catalog

Mail coupon for big free auto catalog. Explains everything. 84 pages of auto facts. Scores of photo illustrations of auto construction. Tells why any man of any age can learn at **National**. How National Special Employment Service finds your job for you. Send for this wonderful free book today—now. Read about Paul Briggs, 6th and Madison St., Portland, Ore., who is making \$4,000 a year in auto work. How National has placed hundreds of men just like you in big pay jobs. There's a job at big pay waiting for you now. Mail coupon at once. Hurry.

NATIONAL AUTOMOTIVE SCHOOL

Dept. 57, 4004 So. Figueroa, LOS ANGELES, CAL.

FREE Catalog—Mail Coupon

National Automotive School,
Dept. 57, 4004 S. Figueroa, Los Angeles,
Cal.

Please send me, absolutely free, your big,
84-page illustrated auto catalog.

Name.....

Address.....

City.....State.....

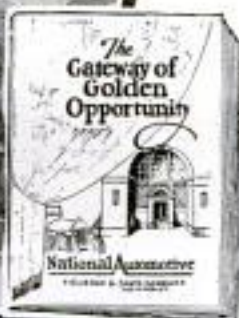



"There's One Man We're Going to Keep"

"Ed Wilson, there, is one of the most ambitious men in the plant. I notice that he never fools away his spare time. He studies his International Correspondence Schools Course every chance he gets.

"It's been the making of him, too. He hasn't been here nearly so long as Tom Downey, who was laid off yesterday, but he knows ten times as much about this business.

"I'm going to give him Tom's job at a raise in salary. He's the kind of man we want around here."

HOW do you stand in your shop or office? Are you an Ed Wilson or a Tom Downey? Are you going up? Or down?

No matter where you live, the International Correspondence Schools will come to you. No matter what your handicaps or how small your means, we have a plan to meet your circumstances. No matter how limited your previous education, the simply-written, wonderfully-illustrated I. C. S. textbooks make it easy to learn.

This is all we ask: Without cost, without obligating yourself in any way, put it up to us to prove how we can help you. Just mark and mail this coupon.

INTERNATIONAL CORRESPONDENCE SCHOOLS Box 5580-D, Scranton, Penna.

Without cost or obligation, please tell me how I can qualify for the position or in the subject before which I have marked an X:

BUSINESS TRAINING COURSES

- | | |
|--|---|
| <input type="checkbox"/> Business Management | <input type="checkbox"/> Salesmanship |
| <input type="checkbox"/> Industrial Management | <input type="checkbox"/> Advertising |
| <input type="checkbox"/> Personnel Organization | <input type="checkbox"/> Better Letters |
| <input type="checkbox"/> Traffic Management | <input type="checkbox"/> Show Card Lettering |
| <input type="checkbox"/> Business Law | <input type="checkbox"/> Stenography and Typing |
| <input type="checkbox"/> Banking and Banking Law | <input type="checkbox"/> Business English |
| <input type="checkbox"/> Accountancy (including C.P.A.) | <input type="checkbox"/> Civil Service |
| <input type="checkbox"/> Nicholson Cost Accounting | <input type="checkbox"/> Railway Mail Clerk |
| <input type="checkbox"/> Bookkeeping | <input type="checkbox"/> Common School Subjects |
| <input type="checkbox"/> Private Secretary | <input type="checkbox"/> High School Subjects |
| <input type="checkbox"/> Spanish <input type="checkbox"/> French | <input type="checkbox"/> Illustrating <input type="checkbox"/> Cartooning |

TECHNICAL AND INDUSTRIAL COURSES

- | | |
|---|--|
| <input type="checkbox"/> Electrical Engineering | <input type="checkbox"/> Architect |
| <input type="checkbox"/> Electric Lighting | <input type="checkbox"/> Blue Print Reading |
| <input type="checkbox"/> Mechanical Engineer | <input type="checkbox"/> Contractor and Builder |
| <input type="checkbox"/> Mechanical Draftsman | <input type="checkbox"/> Architectural Draftsman |
| <input type="checkbox"/> Machine Shop Practice | <input type="checkbox"/> Concrete Builder |
| <input type="checkbox"/> Railroad Positions | <input type="checkbox"/> Structural Engineer |
| <input type="checkbox"/> Gas Engine Operating | <input type="checkbox"/> Chemistry <input type="checkbox"/> Pharmacy |
| <input type="checkbox"/> Civil Engineer | <input type="checkbox"/> Automobile Work |
| <input type="checkbox"/> Surveying and Mapping | <input type="checkbox"/> Airplane Engines |
| <input type="checkbox"/> Metallurgy | <input type="checkbox"/> Navigation |
| <input type="checkbox"/> Steam Engineering | <input type="checkbox"/> Agriculture and Poultry |
| <input type="checkbox"/> Radio | <input type="checkbox"/> Mathematics |

Name.....

Street.....

Address..... 11-21-23

City..... State.....

Occupation.....

Persons residing in Canada should send this coupon to the International Correspondence Schools Canadian, Limited, Montreal, Canada.

STOP USING A TRUSS

Do Away With Steel And Rubber Bands

FREE TRIAL



Inner surface is made adhesive to secure the PLAPAO-PAD firmly to the body, keeping the PLAPAO continually applied and the pad from slipping. No straps, buckles or springs attached. Soft as velvet—easy to apply.

It's the Non-Slipping, yet Non-Rigid Pad and What is Within It That Counts

FREE to 5,000 Truss Sufferers

To the extent of 5,000 sufferers who may apply I will send, ABSOLUTELY FREE, a sufficient quantity of the Plapao to positively convince them that this is the only logical, common-sense way of treating rupture. Plapao is a highly astringent medication placed within the Plapao-Pad and being absorbed through the skin, creates a wonderful feeling of relief and at the same time tends to strengthen the weakened muscles and thus permanently close the rupture opening. The process of recovery is natural, so you'll have no use for a truss—you can throw it away forever! Old and young have testified under oath that the Plapao-Pads cured their rupture—many of them long-standing, aggravated cases—without delay from work. Patent allowed in U. S. and foreign countries. Awarded Gold Medal at Rome and Grand Prix at Paris.

Send No Money—for a sufficient quantity of the Plapao is sent without charge to enable you to give it a thorough test; you pay nothing for this trial now or ever. Write for it and full information today. Address: Plapao Laboratories, Block 1427 St. Louis, Mo.

Deafness



Perfect hearing is now being restored in every condition of deafness or defective hearing from causes such as

Relaxed or Sunken Drums, Roaring or Hissing Sounds, Perforated, Partially Destroyed Drums, etc.

Wilson Common Sense Ear Drums

"Little Wireless Phones for the Ears"—require no medicine but effectively replace what is lacking or defective in the natural drums. They are simple devices, which the wearer easily fits into the ears where they are invisible. Soft, safe and comfortable to wear at all times.

Write today for our 168 page FREE book on DEAFNESS giving you full particulars and plenty of testimonials.

WILSON EAR DRUM CO., Incorporated
596 Inter-Southern Building LOUISVILLE, KY.

NO MORE BALD HEADS



WHEN our VACUUM CAP is used a few minutes daily. We accept no pay until you have tried the Cap 60 days and are satisfied. The Vacuum Cap is an appliance that draws the blood to the Hair Roots and starts a new healthy crop of hair. It stops Dandruff, stops the hair from falling out.

Bought by Doctors and men who know that it is the only reasonable HAIR GROWER known to science. No Drugs Used. Write for application blank, testimonials, and booklet on "HAIR," sent sealed in plain envelope, FREE.

THE MODERN VACUUM CAP CO.

S 559 BARCLAY, DENVER, COLO.

10 Weeks Automobile Training then \$3000⁰⁰ to \$5000⁰⁰ a Year!



Success doesn't just happen. People are divided into two classes. Those who go ahead, "take the bull by the horns" and do something, and those who sit and wonder why success doesn't come. The first are the successful men—the others are the failures.

GET OUT OF THE RUT!

Now is the time and this is the opportunity for you to take a big step forward, to snap yourself out of the rut and to start on the road to success.

Remember that when proper training is backed up by determination nothing is impossible. Half of greatness is quick decision and action.

DECIDE NOW

If you are not earning at least \$50 to \$75 or more a week—with a business of your own in sight—this message is intended for you. It is now possible for any average man, regardless of education or experience, to be trained at the Stewart Auto School for a big pay job in a few weeks. There is a crying demand for good men right now—But you must act quickly.

YOU CAN NOW LEARN THE AUTO TRADE IN TEN WEEKS IN NEW YORK

And earn your living while you learn. In the big, splendidly-equipped shops of the Stewart Automobile School you can master all kinds of repair work in only 10 weeks' time. Here you can lay the foundation for a successful career in the world's largest industry. You can learn how to be your own boss—and can step right into a big pay job soon after you graduate.

There is no mystery—it is not difficult in any way—as you will see in our catalogue. You can do it easily. The Stewart Automobile School has thousands of successful graduates.

THE STEWART SYSTEM MAKES LEARNING EASY

Stewart Instructors—all hand picked men—have perfected the

"personal instruction" policy of this school. Each beginner is studied—his individual characteristics noted—then he receives his instruction in the way that will be most valuable to him and easiest to grasp.

The course of training is thorough—no one is rushed and every point is driven home. The complete catalogue (which you will receive as soon as you send in the attached coupon) contains a guarantee that you can remain until you are entirely satisfied.

A LIVING WHILE YOU LEARN

Our Employment Department will find a job for you while you are taking the course—while you are shaping your future career in the heart of New York, the greatest automobile centre in the world.

NOW—Special Business Management Course—FREE

For a limited time only the Stewart Automobile School offers a business course—free. In this course you will learn how to sell your own services; how to manage a garage, service station or sales business of your own. It will teach you the fundamentals of bookkeeping and how to figure "overhead," how to systemize your work, finance yourself, how to keep cash and charge sales records. Find out immediately about this special course in Business Management. Write now before this offer closes.

FREE BOOK—SEND FOR IT

You can open up the way to newer and better things by a mere scratch of the pen or pencil. You can take advantage of the great opportunities in the rapidly expanding automobile business. Investigate now. It costs you nothing and does not obligate you to buy anything. But find out—investigate—take a new lease on life. Send the coupon for our new big FREE book which explains all details. Here is the Coupon. Send it now!

STEWART AUTOMOBILE SCHOOL 225 W. 57th St., Dept. 1772, New York, N. Y.

Please send me your free book that describes your school and the opportunities in the Automobile Business. I am under no obligation.

Name.....

Address.....

City.....

State.....

Learn Cartooning



BRANNER

WINNIE WINKLE
When I consider the small investment I made in taking your course and the enormous profits I am making now I feel like a profiteer.
M. M. Branner.



Gene Byrnes

REG'LAR FELLERS
I attribute my success to the thorough and highly competent course I received from you.
Gene Byrnes.



Freckles

FRECKLES
More words cannot express my appreciation of the course of lessons I received from the Landon School.
Merrill Blosser.



Edwina

"CAP" STUBBS
No one could take your course and regret it—your instructions made it possible for me to do the work.
Edwina Duxon.

At Home in Your Spare Time by the World Famous Landon Picture Chart Method

YOU can learn to make original drawings with the aid of this remarkable method, just as easily as you learned to write. A series of big picture charts with each lesson of this great course, explain step by step, just how to proceed in making original drawings of your own. Every detail of cartoon drawing is fully covered throughout this complete course. Instructions on originating cartoon ideas are also included. A complete criticism service gives you the full benefit of the experience of one of America's foremost newspaper artists.

Newspapers want more cartoonists and comic artists trained to do snappy original work. That's why they are constantly employing Landon-trained cartoonists, who are now earning from \$50 to \$200 and more a week.

RESULTS TELL THE STORY

Here are four of the famous characters created by Landon students who have attained national reputations as Comic Strip Cartoonists. Hundreds of former students of this School are producing cartoons on political and national affairs, sports, comic strips, etc., for leading newspapers and syndicates all over the United States and Canada. Many newspapers now employ from two to five students of this School; one big newspaper employs nine. Many successful students who prefer to work at home are selling their drawings by mail. The record of results produced by this School has never been equalled or even approached by any other correspondence course.

Send NOW for complete information and sample Picture Chart to test your ability. Please state your age.

The Landon School
1238 National Bldg., CLEVELAND, O.

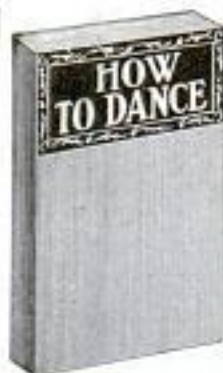

How to Dance 50c and What to Dance POSTPAID

This is the latest book published and will teach you the latest jazz, the one-step, the waltz, with the best variations of the fox-trot, all of which when danced properly are graceful and pretty. In addition it also contains some of the older and well known dances. The steps are so simply explained that these can be learned very easily, and for 50c you can become a modern and expert dancer. The information given in this book will make it unnecessary to take expensive lessons. Bound in Kraft paper covers. Size 4 3/4 x 7 3/4". Pages 128. Postpaid 50c.
SHREWSBURY PUBLISHING CO.
5311 West Lake Street, Chicago, Ill.

BE THE "BOSS"! DON'T WORK for OTHERS

\$60

to \$100 weekly writing SHOW CARDS



Learn to make Show Cards—by Miller Mail Method in 60 days—no experience needed. We establish you in own shop, any locality, worth \$60 weekly, up; furnish all material and plan to secure orders from local merchants to do right at home, evenings, if desired. Get into this fascinating, easily learned, profitable business. Cost low—terms easy. Illustrated matter & terms FREE.

EMPIRE INSTITUTE
151 W. 42nd St. New York



Buchstein's Fibre Limb

is soothing to your stump—strong, cool, neat, light. Easy payments. Braces for all deformities.
D. BUCHSTEIN CO.
610 3rd Ave., So., MINNEAPOLIS, MINN.

Electrical Course

In Book Form

Here is the quickest, easiest, cheapest way to learn electricity. Think of it! A complete electrical course in book form. No tiresome lessons with a lot of mathematics. Just plain everyday electrical facts—the very things and the only things you need know to hold down a good paying job. Written and simplified by 27 of the biggest men in the electrical field. 8 big books—4100 pages and 3300 pictures.

Electricity Means Success

—Good Pay and a Good Job. You can succeed in electricity. It's one of the best paying fields open to young men who know.

You do not have to give up your present position, just a few pleasant hours spent in the evenings on this subject, and success is yours.

FREE TRIAL!

Just mail the coupon—don't send a cent. We send books for a week's free use. Look them over yourself, and see how thoroughly and completely everything about electricity is explained in them.

American Technical Society
58th St. & Drexel Ave. Dept. E-219

American Technical Society, Dept. E-219 Chicago

Send me your 8 volume set of Electrical Books for a week's free use. I will either return the books in 7 days or remit \$2.50 and pay you \$3.00 each month until a total of \$29.50 is paid.

Name

Address

Employed by

Copy this coupon on larger sheet if more convenient

It Was REAL FUN

-Learning to Play the Piano in 90 Days

By A Wife

WE had been married only three years, and already Bob's love for me was slipping. Instead of remaining in evenings, he used to spend his time elsewhere, or devote his time to playing on his violin, entirely indifferent to me. Frankly, I was living through days of misery.

One day, while reading a magazine I came across an amazing story—of a woman who had learned to play the piano in 90 days! Was it possible? Fascinated, I read on and on, and learned how she had mastered the piano by herself, in her spare time, without a teacher.

I stopped. A wonderful thought had occurred to me. Why couldn't I do what this woman had? And—how happy I could make Bob by accompanying him on the piano! Full of enthusiasm, I wrote to the U. S. School of Music, for their course. I, who had never known a single thing about music, was absolutely astonished at the remarkable simplicity of their print-and-picture method. As easy as the A. B. C.!

My progress was wonderfully rapid, and soon I was rendering selections of music which pupils who study with private teachers for years can't play. You see, through this amazing short-cut method, all the difficult, confusing, tiresome parts of music are eliminated and the playing of melodies is reduced to a simple, easy-to-understand method that any one can follow with ease.

But my greatest happiness came the day that Bob found out. Words can't describe his look of astonishment. And what a change seemed to come over him as he eagerly drank in my story. Then it was I realized what music had meant to him. As he expressed it, playing the violin was absolutely flat without the accompaniment of a piano.

Today Bob finds new delight in his violin, and I have kept right on with my piano studies. Our musical evenings are a marked success and we are able to offer our friends entertainment they enjoy.

Do you like music? Do you like to listen to it? Hum it? Do you find yourself tapping with your foot or drumming with your fingers when



music plays? Then by all means, write to the U. S. School of Music for a copy of the booklet,

"Music Lessons in Your Own Home," together with an illustrated folder, explaining our easy print-and-picture method. The booklet gives complete information about this wonderful course in music, also about our special short-time Reduced Price Offer.

Remember, you can master any instrument through this wonderful course. Whatever your favorite instrument, you can learn to play it in your spare time, through this short-cut method. Send the coupon—the book and illustrated folder will come AT ONCE.

U. S. School of Music, 72 Brunswick Building, New York, N. Y.

U. S. School of Music,
72 Brunswick Bldg., New York City

Please send me your free book, "Music Lessons In Your Own Home," with the folder illustrating your easy print-and-picture method, also full particulars of your special short-time offer. I am interested in the following course:

(Name of Instrument or Course)

Name _____
(Please Write Plainly)

Address _____

City _____ State _____

Play Your Favorite Instrument

Piano	Voice and
Organ	Speech Culture
Violin	Automatic
Drums and	Finger Control
Traps	Cello
Banjo	Piccolo
Tenor Banjo	Harmony and
Cornet	Composition
Mandolin	Sight Singing
Clarinet	Ukulele
Flute	Guitar
Saxophone	Hawaiian Steel
Trombone	Guitar
	Harp

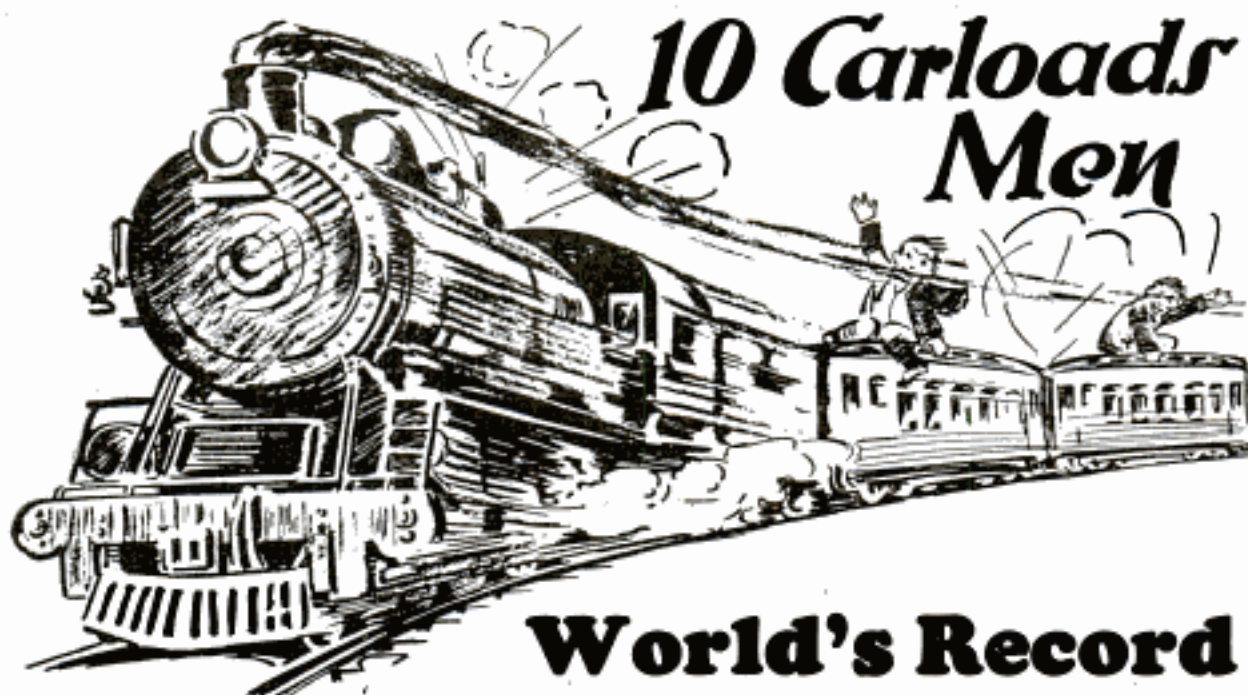

10 Carloads Men

World's Record

One day alone in January Sweeney students arriving in Kansas City filled ten special cars, these men riding free from all points: Boston, New York, Norfolk, Va., Montgomery, Ala., San Antonio, Tex., Denver Col., Billings, Mont., North Dakota, Minneapolis, St. Paul, Milwaukee, etc.

Why Have Sixty Thousand Men Come ^{to} the Sweeney School?

Because a man will travel around the world to get what he wants. A young man mechanically inclined wants to get into the automotive business. He wants a real job and then to get into business for himself. To do this he must be taught by practical experience. The success of Sweeney Trained Men, over 20,000 of whom now run their own business, proves that the Million Dollar Sweeney School is the place to get their training. The tuition is low, we have no extras, and you don't have to worry about the mileage.

We Will Send You a Free Railway Ticket to Kansas City

When you think that the Russian Government, the Japanese Government, the United States Government and many other governments have sent men here; that men have paid their own expenses all the way from South Africa or the Philippines, for the opportunity of learning their trade here, and that now you can ride free from any place in the United States, do you wonder that on one day alone in January we broke all world's records for attendance by welcoming ten trainloads of fine young fellows seeking the world's best and most practical automobile education.

FREE!

Send Name Today for
Catalog,
Sweeney News,
My Big Special
Offer
and how I send you a
Free Railway Ticket
to Kansas City

LEARN
Sweeney
AUTOMOTIVE &
1265 SWEENEY BLDG.

in One Day Bring to the Sweeney School!



Listen You Easterners: FREE

Some of you can't believe that living is so good and cheap here in Kansas City. Do you know that you can get a fine meal here for twenty-five cents? The same meal would cost 75 cents in New York. Do you know you can have good board and room for \$8 a week? Do you realize that this mighty western metropolis offers at the same time a thrilling, brimming activity and business opportunity that opens your eyes? That the huge Ford plant here is expanding incredibly. That auto mechanics are wanted everywhere? That the parks and drives and amusements and wealth and culture here make Kansas City a most attractive place to get your automobile schooling? And that finally, our wonderful system of teaching with tools, not books, perfected by years of successful operation, turns you out in a few brief weeks, not a green hand but a trained mechanic. You know when you leave here you can hold down a real job or run your own garage, repair shop, tire shop, travel and see the world as a chauffeur, etc. Just as soldiers go to West Point, just as art students go to Paris, just as the rich man's son goes to Harvard or Yale for his collegiate education, so the ambitious, energetic young man mechanically inclined comes to Kansas City, the Heart of America, the world's center of automobile teaching, for the practical training that will make him a success.

THE MOTOR BUSINESS NOW TOPS ALL

It surely is the business for you. Four million new cars produced in 1923. Four hundred thousand trucks. Three billion-dollar output. Nearly fourteen million passenger cars and trucks now in use. People driving everywhere. Jobs everywhere. Mechanics needed everywhere. Choose your own climate, travel, see the world. The trained man is sure of a job everywhere. And the Sweeney School diploma is known everywhere as a certificate of proficiency. Why there are about 20,000 prospective employers who are Sweeney graduates themselves and looking for Sweeney trained helpers, partners, associates.

EMORY J. SWEENEY, Pres.

A TRADE
new
ELECTRICAL SCHOOL
KANSAS CITY, MO.

Simply send name today for my big 64-page catalog. Shows hundreds of pictures of men at work in the school. Tells all about wages, profits, opportunities in auto and tractor business. Explains step by step how you learn. Interesting letters from graduates telling how they made good. Shows how men come from all over the world to this big school. Makes you want to join the crowd. Tells everything you want to know. No costs, no obligation. Clip the coupon, or a postcard will do. Get the catalog now—that's the first step. Don't put it off one minute. No colored students accepted.

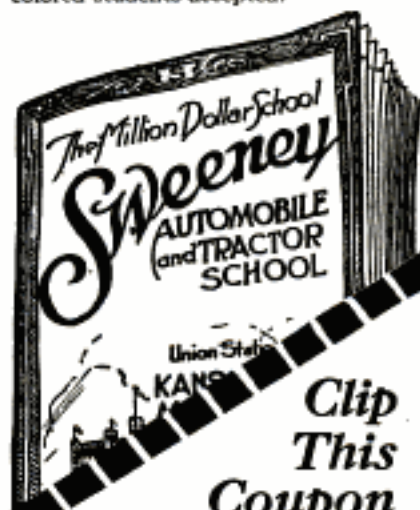

Clip
This
Coupon

EMORY J. SWEENEY
President

Dept. 1265, Sweeney Bldg.
KANSAS CITY, MISSOURI

Please send me free without any obligation on my part your 64-page catalog and your Sweeney School News. Tell me of the opportunities in the Auto and Electrical Business.

Name.....

P. O.

State.....

BE A RAILWAY TRAFFIC INSPECTOR



POSITION GUARANTEED

**Earn Up to \$250⁰⁰ per Month
EXPENSES PAID**

Many fine opportunities for trained Railway Traffic Inspectors. Steady, pleasant outdoor work; travel or remain near home.

Easy to Qualify

Prepare in three months' spare-time study at home. Position then guaranteed at not less than \$110 per month and expenses, with many chances for advancement through contact with big railway officials.

"My Experience — Most Gratifying"

Read what Mr. Leo Banning says:

"Words are inadequate to express the deep sense of appreciation for the many favors and acts of kindness extended by you during my training period. It is needless to say that I am proud of my diploma and shall consider it one of my most valued possessions.

"My experience with the Standard Business Training Inst. has been most gratifying and absolutely satisfactory in every respect. The treatment and cooperation received from the faculty members is all that it should be to conduct a proper appreciation among the students of its policy and intent. Any success I shall have with this work can be largely attributed to the knowledge secured from your course."

GUARANTEE

Our guarantee states that tuition will be refunded to you if, upon graduation, position is not obtained for you, paying at least \$110 per month and expenses.

You Take No Risk

Read Our Guarantee Notice—If position is not obtained for you, entire enrollment fee is refunded without question. You have nothing to lose.

Send coupon for details and booklet No. D-63

**STANDARD BUSINESS TRAINING INST.
BUFFALO, N. Y.**

— MAIL TODAY —

Date.....

Standard Business Training Inst., Buffalo, N. Y.

Send me, entirely free, Booklet No. D-63, giving full particulars about course in Railway Traffic Inspection.

Name.....

Street.....

City..... State.....

PICTURES HAWAIIAN GUITAR

Show you how to play

in half an hour!

Greatest musical invention of the age. You don't have to know any music at all. Only four motions to learn. No previous musical knowledge necessary. We show you pictures of these so clearly that in half an hour you can play the famous Hawaiian song ALOHA OE and other popular favorites.

HAWAIIAN TEACHERS GIVE YOU PERSONAL ATTENTION

No wonder our pupils say "Easiest, quickest way to play we ever heard of!"

ONLY COURSE GIVING FREE PHONOGRAPH RECORDS

So You Know You Are Playing Right

No wonder thousands have learned this quick easy way. So can you. Just send us your name and address on a postcard, and we will send you circular in colors, giving full details of entire course, so you can prove to yourself right away that this easy picture method is the course which will teach you to play Hawaiian Guitar right away. Send the postcard now. **32 PIECES POPULAR MUSIC FREE.**

If you are interested in learning to play the Tenor Banjo, write us for circulars.



**FREE
\$18 Hawaiian
GUITAR**

of beautiful tone and genuine Hawaiian correct model with full equipment for a limited time only to students who enroll in our conservatory.

New York Conservatory of Music
Desk 52-F, 212 Fifth Avenue, New York



\$100⁰⁰ EARNED BY YOUNG ARTIST IN 2 DAYS

Well-trained artists earn splendid incomes. The Federal home-study Course is a proven result-getter. If you like to draw, send 5c in stamps for 56-page book, "Your Future."

FEDERAL SCHOOL OF COM'L DESIGNING
698 Federal Schools Building
Minneapolis, Minn.

ELECTRICITY LEARN AT HOME

Send for catalog which tells how Burgess Home Training enables men and boys to get good jobs and keep them.
BURGESS ELECTRICAL SCHOOL, Dept. P2, 741 E. 42nd Street, CHICAGO



How to Box 40c

By Terry McGovern, James J. Corbett, J. Gardner Smith, M.D., Arthur P. Keeley and Gus. E. Keeley.

How to Box to Win, How to Build Muscles, How to Punch the Bag and How to Stand, Walk or Run.

This interesting book written by experts is known also as "The Book of Health and Strength." It will greatly assist everyone in keeping fit, in putting them in condition to master a strenuous undertaking either physical or mental.

63 illustrations. Size 4 1/2 x 7 1/2 in. Paper copy, 126 pages

SHREWSBURY PUBLISHING CO.
5311 West Lake Street, CHICAGO, ILL.

LEARN SPANISH on your phonograph

Learn to speak Spanish as if you were living in Spain. Records fit any phonograph. New Conversational Method evolved in Europe and introduced in America by the I. C. S. School of Languages. Endorsed by the Spanish Embassy.

Write to-day for
descriptive literature.

International Correspondence Schools,

Box 5585-D, Scranton, Penna.



Your Copy of this great book



*You can Boss
the Job*

NOW—AS NEVER BEFORE Your Chance Lies in the High-Pay Electrical Field

You may think that there isn't as big an opportunity for you—in electricity—as we tell you there is.

But the bare facts—the cold statistics of the industry—show that there's a real and startling SHORTAGE of trained electrical workers. The facts show that this great industry is growing so fast that the shortage of men can't be overcome in five years, at least.

The chance is there for you now, as never before. Don't let anyone tell you it isn't. Don't let yourself be led to say "it can't be done" before you have gotten the actual facts.

The proof—in overwhelming measure—is in our book on Electrical Opportunities. Get it! Write for it now—if you want solid proof that electricity really *does* offer high-pay positions that you can train yourself to hold.



FREE Send for it TODAY

This handsome, profusely illustrated book will tell you of the astonishing growth of the great Electrical Industry, and of the thousands of big money jobs and opportunities waiting for trained men.

More important, it will tell you of the great Associated Electrical Engineers—chartered by the State of Illinois, as an institution for the advancement of every phase of Electrical Science. Not a mere school, but a great National organization of Electrical Experts and Specialists, who have developed the MOST REMARKABLE SYSTEM ON EARTH for HOME TRAINING IN ELECTRICITY.

We Train You At Home in your spare time, quickly and surely, by our EXCLUSIVE AND COPY-RIGHTED METHOD to qualify to **Earn \$75 to \$200 a Week** as an Electrical Expert or in business for yourself—and

We Help You "Cash In" through our Placement Department and our great FREE BUSINESS COURSE, which will show you how to get the big-money Electrical jobs and how to establish your own independent, profitable Electrical business.

Our Book Tells the Story Our BIG 64-PAGE ILLUSTRATED BOOK will tell you fully about every one of the 9 remarkable features of

Associated Electrical Engineers' Service, and how they will be the stepping stones for you from futureless, low-paid jobs up into the limitless, big-money opportunities in Electricity.

Don't Let Lack of Education Stop You

If you have the AMBITION to succeed and make big money as an Electrical Expert, we will guarantee the rest.

Mail the Coupon NOW

Get this remarkable book. It is FREE. You will incur no obligation in asking for it. We want every ambitious man in America to have one and receive this great message. Your copy is ready. Send for it TODAY.

Here's Opportunity's Wide Open Door

Send this coupon to

**Associated Electrical Engineers of America
Dept. 124, 537 S. Dearborn St., Chicago, Ill.**

Without obligation, send me your 64-page illustrated book on Electricity, together with full details of your remarkable plan of home training and membership in the A. E. E.

Name

Address

City

Associated Electrical Engineers OF AMERICA



High School Course in Two Years!

You Want to Earn Big Money!

And you will not be satisfied unless you earn steady promotion. But are you prepared for the job ahead of you? Do you measure up to the standard that insures success? For a more responsible position a fairly good education is necessary. To write a sensible business letter, to prepare estimates, to figure cost and to compute interest, you must have a certain amount of preparation. All this you must be able to do before you will earn promotion.

Many business houses hire no men whose general knowledge is not equal to a high school course. Why? Because big business refuses to burden itself with men who are barred from promotion by the lack of elementary education.

Can You Qualify for a Better Position

We have a plan whereby you can. We can give you a complete but simplified high school course in two years, giving you all the essentials that form the foundation of practical business. It will prepare you to hold your own where competition is keen and exacting. Do not doubt your ability, but make up your mind to it and you will soon have the requirements that will bring you success and big money. YOU CAN DO IT.

Let us show you how to get on the road to success. It will not cost you a single working hour. Write today. It costs you nothing but a stamp.

American School

Dept. H274, Drexel Ave. and 58th St., Chicago

American School

Dept. H274, Drexel Ave. and 58th St., Chicago

Send me full information on the subject checked and how you will help me win success.

- | | |
|------------------------------|----------------------------|
| Architect | Lawyer |
| Building Contractor | Machine Shop Practice |
| Automobile Engineer | Photoplay Writer |
| Automobile Repairman | Mechanical Engineer |
| Civil Engineer | Shop Superintendent |
| Structural Engineer | Employment Manager |
| Business Manager | Steam Engineer |
| Cert. Public Accountant | Foremanship |
| Accountant and Auditor | Sanitary Engineer |
| Bookkeeper | Surveyor (& Mapping) |
| Draftsman and Designer | Telephone Engineer |
| Electrical Engineer | Telegraph Engineer |
| Electric Light & Power | High School Graduate |
| General Education | Fire Insurance Expert |
| Vocational Guidance | Wireless Radio |
| Business Law | Undecided |

Name.....

Address.....

MY 3 NEW INVENTIONS

Will Enable You to Quickly Learn

VIOLIN

You have always longed to play the sweetest of all music—the Violin. Now with the aid of my 3 new inventions—masters of the Violin is easily within your reach! My system of teaching by written and pictured instructions is far advanced over any other method! Endorsed by the foremost violinists of the country! I make it so simple and easy that

You Will Play a Complete Piece Your First Lesson

Just think of it!—you play real music at once! No boring scales—no long, dreary hours of practice. Under my instruction you will actually play a complete piece your very first lesson—and a new piece each succeeding lesson.

FREE VIOLIN OUTFIT

Most Complete Violin Outfit Ever Offered—furnished free to my students with the complete Conservatory course of 62 lessons. No extra to buy—everything is furnished. Outfit includes: splendid toned imported Violin, Bow, Extra Strings, Tuning Pegs, Mute, Rosin, handsome nickel trimmed Carrying Case exactly as shown, and my 3 remarkable inventions.

Write Me Today

—and I will gladly tell you all about my 3 New Inventions and how I guarantee to teach you Violin quickly and thoroughly. Here is the opportunity you have waited for so write me RIGHT now.

Prof. A. Hinchcliffe—First Hawaiian Conservatory of Music, Inc.
Dept. 70 Woolworth Bldg. 233 Broadway, New York

FREE
This \$20.00 Outfit



Learn Auto and Tractor Business

EARN \$150 TO \$400 A MONTH

Greater opportunities than ever for Rahe Trained Motor Mechanics. Learn here in Six to Eight Weeks. WRITE TODAY for special low tuition rate. Free R. R. fare and board and room offer. No colored enrollments.

RAHE AUTO & TRACTOR SCHOOL

Dept. 1750, 11th & Locust Sts., KANSAS CITY, MO.
Dept. 1750, 916 Forbes Street, PITTSBURG, PENN.

LEARN TO DRAW

AT HOME—IN YOUR SPARE TIME

From the school that has trained hundreds of successful cartoonists and illustrators—now earning from \$50 to \$200 and more a week. The Landon Picture Chart Method of teaching makes original drawing easy to learn. Send 6c in stamps for full information and chart to test your ability. Also state your age and what kind of drawing you like to do.

THE LANDON SCHOOL 1438 Nor't Bldg. CLEVELAND, O.



WANTED—Railway Postal Clerks

TRAVEL—See the Country

\$1600 First Year

Men — Boys

18 Up

Mail Coupon Immediately

FRANKLIN INSTITUTE

Dept. F182, Rochester, N. Y.

Send me, without charge, (1) specimen Railway Postal Clerk Examination questions; (2) list of government jobs now obtainable; (3) tell me how to get a government job.

Name.....

Address.....



He Starts at \$5,200 a Year

One hundred dollars a week! And only a few years ago his weekly wage was less than \$30. Didn't dream he could do it when he first took up the study of Higher Accounting under the LaSalle Problem Method; but he just couldn't help getting ahead—so he wrote—because he found it the most interesting thing he ever tackled.

Knew nothing about bookkeeping, but LaSalle quickly gave him the necessary foundation. Then, step by step, he was trained in the practical work of Cost Accounting, Auditing, Business Law, Organization, Management, Finance, Income Tax Procedure—not theoretically, mind you, but by the solving of actual problems lifted bodily from business life. As a result, he sits as Auditor at a big mahogany desk and commands a salary of \$5,200 a year.

Unusual Opportunities in Accounting

Typical, this man's experience, of that of thousands of ambitious men who have found their path to success in the LaSalle Problem Method. Never in the history of business has the need for trained accountants been so great or the rewards so attractive. The files of LaSalle Extension University contain literally thousands of letters reporting rapid advancement—incomes doubled, tripled and quadrupled as the result of home-study training. During three months' time, 1,193 LaSalle members wrote to the University telling of the "raises" they had got as a result of their training. *The average increase per man was 89 per cent.*

These men were not unusual; they had no "pull" or "luck;" they got their start by signing just such a little coupon as appears directly below this text. Mark the coupon, sign and mail today—and get the facts. We will promptly send you complete information regarding the training you are interested in; also a copy of that inspiring book, "Ten Years' Promotion in One." "Get this book," said a prominent Chicago executive, "even if you have to pay five dollars for it." We will send it free.

Remember, the cost of LaSalle training is small and can be covered in easy monthly payments, if you so desire. The decision that you make this moment is important. Mail the coupon now.

LaSalle Extension University

The Largest Business Training Institution in the World
Dept. 264-HR Chicago, Illinois

Please send me catalog and full information regarding the course and service I have marked with an X below. Also a copy of your book, "Ten Years' Promotion in One," all without obligation to me.

Higher Accountancy

Training for positions as Auditor, Comptroller, Certified Public Accountant, Cost Accountant, etc.

Other LaSalle Training Courses

LaSalle is the largest business training institution in the world. It offers training for every important business need. If more interested in any of these courses, check here:

- | | |
|--|--|
| <input type="checkbox"/> Business Management | <input type="checkbox"/> Banking and Finance |
| <input type="checkbox"/> Modern Salesmanship | <input type="checkbox"/> Modern Foremanship and Production Methods |
| <input type="checkbox"/> Traffic Management | <input type="checkbox"/> Personnel and Employment Management |
| <input type="checkbox"/> Railway Station Management | <input type="checkbox"/> Expert Bookkeeping |
| <input type="checkbox"/> Law—Degree of LL. B. | <input type="checkbox"/> Business English |
| <input type="checkbox"/> Commercial Law | <input type="checkbox"/> Commercial Spanish |
| <input type="checkbox"/> Industrial Management Efficiency | <input type="checkbox"/> Effective Speaking |
| <input type="checkbox"/> Modern Business Correspondence and Practice | <input type="checkbox"/> C. P. A. Coaching |

Name.....

Present Position

Address

Get Into This

You Can

Follow in the lead of Navarre, shown on the opposite page, and scores like him who have taken advantage of the amazing money-making possibilities in the automobile, truck and tractor business. Here is a chart of facts—authentic figures which point out the opportunities. If you are ambitious and seeking a money-making opening, here's your chance—a chance to cash-in to a degree that will satisfy your highest aims.

Thousands of competent garages, battery shops, auto electrical shops, tire and welding shops are needed now. Trained men can run them.

14,000,000
Automobiles in U.S.
70,000,000
Tires to be repaired.
12,000,000 Batteries,
14,000,000 Ignition
Systems and only
50,000 Garages.

Learn Autos, Trucks and Tractors in the Heart of the Industry

Without any previous experience—just a liking for mechanics—you can learn the auto business from A to Z in a few weeks at the Michigan State Automobile School—the factory endorsed school in Detroit—the heart of the industry. Then step out, equipped with knowledge and training, to a future of certain, big money making. You have distinctive advantages, learning the business here. It's the fountain head of the automotive industry. You are taught under factory endorsed methods. You learn both theory and practice on latest equipment. Go through the great Ford plants. Visit the other auto factories—learn their methods first hand—and it all means greater opportunities and more certain success. The Michigan State Automobile School, in Detroit, the automobile center, is the logical place to learn the automobile business.

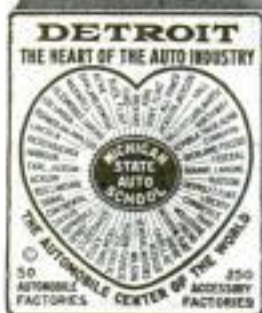

Read What Factories Say:

DODGE BROTHERS

INCORPORATED
DETROIT, U. S. A.

"We believe the Michigan State Automobile School of this city to be an exceptionally high class school, and no doubt a diploma from this school would assist materially in obtaining employment with high class automobile dealers."



BUICK MOTOR COMPANY

"We believe the MICHIGAN STATE AUTO SCHOOL, Detroit, would best meet your requirements, as its course of technical training is most thorough and complete in every detail."

THE STUDEBAKER CORPORATION

OF AMERICA

"We do not know of a better automobile school than the MICHIGAN STATE."

PACKARD MOTOR CAR CO., DETROIT

"We do not believe you would make any mistake in attending this school if you wish to become thoroughly experienced in the automobile business."

Learn in a Few Weeks—Start Now

A thorough training in Detroit, at the M. S. A. S., is the thing that fattens the pay envelope if you are working for others, or puts more profit in business for yourself. You can take a full Automotive Course, or specialize in any one of its money-making branches; you can be an Auto Electrician; a Tire Expert; a Battery Service Man; a Repair-Man; a Welder; a Machinist; or specialize in motorized farming, with truck, tractor and farm electric-lighting and farm engine training. Course includes training in Garage Management, Business Methods and Selling. Classes are always open. You need make no special arrangements—you can start at once—now—and that's the thing to do.

Life Scholarship Your enrollment entitles you to a life membership, with privilege of our service any time you want it. Many students come back to brush up on latest automotive ideas and new equipment. It doesn't cost a penny extra. The position of the M. S. A. S. (The Detroit Auto School) in the heart of this industry, insures most thorough, most practical, systematic training, at a cost so low and terms so easy that any man, anywhere, can afford it.

Earn While You Learn If necessary we can assist students to secure part time work to earn a small amount each week. Or students who wish to take our evening course will be assisted to full time day jobs. Ask for details, and when writing please explain your circumstances fully.

MICHIGAN STATE AUTOMOBILE SCHOOL

302 Auto Bldg.

DETROIT, MICHIGAN

The Factory Endorsed School

Big Money Business

Have Success Like This

Here is Navarre—merely one of thousands of M. S. A. S. students who have achieved success far beyond their fondest hopes. What these men have done you can do. The opportunities are now greater than ever. There are more autos—more trucks—more tractors and every year adds to the money-making possibilities. You have ambition—you want success. Success is certain if you are willing to work for it. You can have independence—be your own boss—stop the plodding and get into work you like. You can earn big money, be prosperous, happy and independent. Navarre is no exception. We have graduates who have made as high as \$10,000 in less than a year. These records may seem amazing, but they are true. It is all done through head and hand training at the M. S. A. S. Decide now to give yourself the training that will pay you big and establish you in a successful life work.

Detroit-Trained Auto Men Earn More Money

Detroit-trained men are preferred. Your diploma from the M. S. A. S. is a valuable money-making asset—an advantage that you can get from no other school. The Michigan State Automobile School is known the world over. Wherever autos are used—Detroit-trained men get the best jobs, highest pay. Auto, truck, tractor factories employ M. S. A. S. graduates. Leading factories, dealers, service stations, garages, shops and farms want men who have trained their heads as well as their hands—the M. S. A. S. Detroit-kind.

Good Positions Open

The demand for men who know automotive mechanics and electricians is greater than the supply. We have more calls than we can fill. The business training included in our courses makes our graduates especially valuable. The years ahead are predicted to be the biggest years of the industry. Every Detroit plant has increased its production. Most are working over-time. All are behind on orders, and that means certain money-making advantages to men who start in the business now.

Mail This Coupon

Get all the interesting facts from our big catalog. It's a book of information concerning your future that you must not fail to get. It gives complete information about all courses. It's illustrated with photos of classes, school, equipment and graduates. It tells you how you can get a good paying job—how you can go into business for yourself with little capital. Let us send it to you FREE without obligation. Mail the coupon or send us a postcard today. Write now. (We do not enroll colored students, except for our Home Study Course.)

Michigan State Automobile School
A. G. ZELLER, Pres. and Gen. Mgr.
302 Auto Bldg., 3729 Woodward Avenue
DETROIT, MICHIGAN

Service Manager

Ronceverte, W. Va.

Mr. A. G. Zeller,
Detroit, Michigan

Dear Sir:

It has been a long time since I have told you how I am getting along since leaving the school. I believe the last time I wrote you I was in charge of the Service Dept. of the Capitol City Supply Co. of Charleston, W. Va., who are Dodge Bros. Dealers. From Charleston, Dodge



Bros. moved me to Ronceverte, W. Va., to take charge of their Service Dept.

Since I left the school in the fall of 1919 I have found out that it takes M. S. A. S. training to get ahead in the world. I have worked with men who have had fifteen years experience as mechanics, but my schooling put me up with them, and sometimes ahead of them.

While I have been in charge of the Dodge Service in Ronceverte, I have met several M. S. A. S. boys, and they are all making good.

Since I left the school I have always tried to do good work, and treat the car owner fair, and it has brought me more work than the shop can take care of. Good work can be given to the car owner only by knowing first what to do, and then not waste a lot of time at guess work. So nothing but the thorough training of the M. S. A. S. will do it. I send all the fellows I can to your school for I know I have done them a big favor, and it will mean a whole lot to them later for I know that M. S. A. S. training is the only kind.

If I had everything to do over again I would be on my way to the School ten years earlier than I was.

J. R. NAVARRE.

FREE



Mail Coupon To Day

Michigan State Automobile School 302 Auto Building
DETROIT, MICHIGAN

Send me FREE and without obligation your 100-page catalog and Auto School News, giving complete information about Detroit-training to make the most money.

Name

Street or R. F. D.

City State

Do you prefer to start your training at home

or at our School in Detroit?



An Easy Way to Learn PHARMACY AT HOME

Graduate pharmacists are always in demand. The work is interesting and pleasant and salaries are good. Many young men open drug stores of their own and become independent.

There's an easy way to learn pharmacy right in your own home in spare time, without losing a day or a dollar from your present work.

The International Correspondence Schools course in Pharmacy supplies the knowledge which it will be necessary for you to have in order that you may pass your State Board Examination.

Just mark and mail the coupon printed below to the International Correspondence Schools, Box 5578-D, Scranton, Pa., and full particulars about the Pharmacy Course or any other work of your choice will come speeding to you by return mail.

INTERNATIONAL CORRESPONDENCE SCHOOLS Box 5578-D, Scranton, Penna.

Without cost or obligation, please send me full information about the subject below which I have marked an X in the list below:

TECHNICAL AND INDUSTRIAL COURSES

- | | |
|--|---|
| <input type="checkbox"/> PHARMACY | <input type="checkbox"/> Civil Engineer |
| <input type="checkbox"/> Chemistry | <input type="checkbox"/> Surveying and Mapping |
| <input type="checkbox"/> Automobile Work | <input type="checkbox"/> Mine Foreman or Engineer |
| <input type="checkbox"/> Navigation | <input type="checkbox"/> Steam Engineer |
| <input type="checkbox"/> Agriculture and Poultry | <input type="checkbox"/> Gas Engine Operating |
| <input type="checkbox"/> Mathematics | <input type="checkbox"/> Wireless <input type="checkbox"/> Airplane Engines |
| <input type="checkbox"/> Electrical Engineering | <input type="checkbox"/> Architect |
| <input type="checkbox"/> Electrician | <input type="checkbox"/> Contractor and Builder |
| <input type="checkbox"/> Mechanical Engineer | <input type="checkbox"/> Architectural Draftsman |
| <input type="checkbox"/> Mechanical Draftsman | <input type="checkbox"/> Concrete Builder |
| <input type="checkbox"/> Machine Shop Practice | <input type="checkbox"/> Structural Engineer |
| <input type="checkbox"/> Railroad Positions | <input type="checkbox"/> Plumbing and Heating |

BUSINESS TRAINING COURSES

- | | |
|---|---|
| <input type="checkbox"/> Business Management | <input type="checkbox"/> Salesmanship |
| <input type="checkbox"/> Industrial Management | <input type="checkbox"/> Advertising |
| <input type="checkbox"/> Personnel Organization | <input type="checkbox"/> Better Letters |
| <input type="checkbox"/> Traffic Management | <input type="checkbox"/> Foreign Trade |
| <input type="checkbox"/> Business Law | <input type="checkbox"/> Stenography and Typing |
| <input type="checkbox"/> Banking and Banking Law | <input type="checkbox"/> Business English |
| <input type="checkbox"/> Accountancy (including C.P.A.) | <input type="checkbox"/> Civil Service |
| <input type="checkbox"/> Nicholson Cost Accounting | <input type="checkbox"/> Railway Mail Clerk |
| <input type="checkbox"/> Bookkeeping | <input type="checkbox"/> Common School Subjects |
| <input type="checkbox"/> Private Secretary | <input type="checkbox"/> High School Subjects |
| <input type="checkbox"/> Business Spanish <input type="checkbox"/> French | <input type="checkbox"/> Illustrating <input type="checkbox"/> Cartooning |

Name.....
Street.....
Address.....

City..... State.....

Occupation.....

Persons residing in Canada should send this coupon to the International Correspondence Schools Canadian, Limited, Montreal, Canada

Please Mention Popular Mechanics

AGENTS WHAT DO YOU EARN NOW? We'll Double It!

Every wise woman wants a burner, which mixes one part of coal oil (kerosene) with TWENTY parts of FREE air and makes gas cheaper than city gas. Ends expense, dirt and drudgery of coal and gives three times the heat. Heats instantly at a twist of the wrist. Installed in a minute in any heater, range or furnace. Cuts housework in half.

Agents have cleaned up fortunes on very first kind of burner. Now latest discoveries cut out useless parts and make a better burner at a price every home can afford. Absolutely safe. Ironclad guarantee. 30 days' Free Trial. Just let your neighbors know about it and tell them the new price, and orders fairly roll in.

Make \$50 to \$200

a week. Full or spare time. Personal co-operation. Write quick for exclusive territory and free sample case offer. Hurry.



The biggest money-maker ever sold—some agents make \$200 a week

WADE HILL MFG. CO., Dept. B40, St. Louis, Mo.

MUSIC LESSONS FREE

IN YOUR OWN HOME
You can read music like this quickly.
Piano, Organ, Violin, Mandolin, Guitar, Banjo, etc.

Beginners or advanced players. One lesson weekly. Illustrations make everything plain. Only expense about 2c per day to cover cost of postage and music used. Write for FREE booklet which explains everything in full.

AMERICAN SCHOOL OF MUSIC, 50 Lakeside Building, CHICAGO

Ride A Ranger

The finest bicycle ever built. 44 Styles, colors, sizes; made in our new factory. SAVE \$10 to \$25 by direct from the factory purchase.

Delivered free on approval, express prepaid, for 30 Days' Free Trial. 12 MONTHS to PAY, if desired.

Tires and repairs at unusually low prices. Send No Money, do business direct with makers.

Mead Cycle Company
Dept. G-108 Chicago

Write today for free Ranger Catalog, factory prices and marvelous easy payment terms.



\$1000 REWARD!!

Big awards like this are being made every day to the trained Finger Print Expert. Share in these rewards. There is a wonderful opportunity for the trained Finger Print man. Besides, high grade secret service men are usually Finger Print Experts. Enroll now under my personal training and I will give you a fine professional Finger Print Outfit and a valuable course in Secret Service Intelligence—both FREE.

Write today I will send you Free Secret Service Reports and tell you about the fine jobs waiting for the trained Finger Print Expert. Write Today.

U. S. SCHOOL OF FINGER PRINTS
7003 North Clark Street Dept. 13-52 CHICAGO, ILL.

Learn to PAINT SIGNS and SHOW CARDS

Big field—unlimited possibilities—increasing demand for men with creative ideas. Our course develops ability and originality. Work is intensely interesting.

EARN \$25 TO \$75 WEEKLY

You can do it if ambitious. Successful graduates everywhere. Our course thoroughly covers every phase of work. Our graduates command big salaries. Write for catalog, samples, guarantee and Free Outfit Offer. Detroit School of Lettering, 622 U. S. L. Bldg., Detroit, Mich.



Look Here!



I WILL MAKE YOU A DRAFTING EXPERT



If you're earning less than \$100 a week GO INTO DRAFTING. I guarantee to train you AT HOME, the JOB-WAY, with actual Drafting Room jobs. Send for my free book, find out about the wonderful opportunities to earn big money in this easy, fascinating business. Drafting Experts are close to the Boss, are first in line for promotion to executive positions.

\$250 to \$400 a MONTH!

Common schooling all you need. I train you by my copyrighted "JOB-WAY" instruction. I cover every branch of Drafting by giving you actual Jobs to do. Most complete training on earth, only instruction that makes Drafting EXPERTS. No books or lessons or useless theory to waste your time. My graduates are SUCCESSFUL—employers prefer Coyne-trained Draftsmen. So I guarantee to satisfy you or to refund your money.

Learn at Home!

Thousands of big-salaried jobs, all over the country, looking for DRAFTING EXPERTS! Railroads, factories, builders, architects, ship-yards, auto plants, Cities, Countries, States, the U. S. Government—all hungry for Drafting Experts. Man alive, wake up to your biggest opportunity!

Experts' Outfit FREE!

"JOB-WAY" training makes you a DRAFTING EXPERT quick because you learn to do actual jobs with the same professional instruments you will use when employed at a big salary. To encourage you to START RIGHT NOW, I will give you with my course this costly outfit without one penny of cost! Coupon brings complete information.

DRAFTING BOOK FREE!

Mail Coupon Today!

Address CHIEF DRAFTSMAN
COYNE SCHOOL OF DRAFTING

1-9 S. Ashland Ave., Dept. 219
CHICAGO, ILL.

Chief Draftsman
COYNE SCHOOL OF DRAFTING
1-9 S. Ashland Ave., Dept. 219, Chicago, Ill.

Without obligating me in any way, please send me your book, "Drafting, the Foundation of Industry" absolutely free. Also complete information of your rapid home-study Drafting course, free instruments and other features.

Name.....

St. No.....

City..... State.....

FREE!



MAIL COUPON TO-DAY!

Would you start across the ocean in a leaky, cranky boat?

Suppose you wanted to go to Europe or Asia, would you be apt to start out in a frail, badly-built boat, leaking at every seam, hard to steer, topheavy and apt to "turn turtle" in any little breeze, with rusty machinery and worn bearings, engine all clogged up with grease and dirt and likely to break down on the slightest provocation?



PROF. HENRY W. TITUS
as he is today

Sounds Absurd, Doesn't It?

You wouldn't think of trusting your life to any such ramshackle affair on those thousands of miles of deep and stormy ocean.

THEN WHY DO WHAT IS STILL WORSE—try to navigate life's rough sea with a weak, inefficient body—sluggish and clogged with bile and poisons—flabby muscles, no pep nor punch, apt to be knocked over by the slightest exposure or everyday ailment that comes along?

Yet that's what millions of people are doing continually. Every day many are sinking before their journey is half over. Others are drifting like a crippled vessel, without aim or purpose, without prospect of ever doing anything worth while, simply because they haven't the physique to sustain them.

Are YOU one of these helpless, drifting vessels? It may be that you are and don't know it. Thousands of people are below par physically and don't realize it. They know that something is wrong—they know that they aren't getting anywhere in life—but they don't know that some bodily weakness is responsible for their failure to reach their goal.

Don't Try to Travel in a Leaky Boat!

The only way to insure Success and Happiness is to start at the beginning by making your body sound and strong. Then all other things are possible. A strong Body means a stronger Brain, increased Ambition and Confidence, Greater Power.

During my 20 years of experience I have made thousands of people fit for life's journey. I have helped them to Success and Prosperity in all lines of human endeavor. I can help YOU, too. Why don't you challenge me to try it?

To show what I can do in the way of building a new body for you, I will assert that I can add an INCH to your arm measurements WITHIN 30 DAYS. In three months you will hardly realize that you are the same being. Don't take my word for it—read what the world's greatest athletes—Saxon, Rolandow, Barnes, Waring, and many others—say about me and my system.

My New Book Will Tell You All About It

This book, "Building Better Bodies," is the clearest and most interesting treatise on Health and Strength ever written. It contains many photographs and testimonials of famous athletes and strong men who have actually been MADE by my System.

My own weight-lifting records are mentioned—and remember, I trained by the self-same system which I am offering to you. I owe my great strength and my lifelong good health to it.

To get this book you need send me only 10c to help pay postage, wrapping, etc., and it will come to you by return mail. Don't delay. Fill out the coupon and mail it TODAY.

PROF. HENRY W. TITUS

Dept. 729, 105 East 13th Street, New York City

PROF. HENRY W. TITUS

Dept. 729, 105 East 13th Street, New York City

Dear Sir: I enclose 10 cents, for which please send me at once your book, "Building Better Bodies." It is understood that there is no obligation on my part whatsoever.

Name.....

Street No.....

City.....

State.....

Make Money Taking PICTURES



Got \$100 for Flood Pictures

"I took pictures of a flood and sold them for \$100. I have been able to buy my house and lot from the sale of pictures."

C. M. COLE,
Washington.

\$97 in Two Days!

"I made \$225 in December. Went out two days last week on home portrait work and made \$97."

A. G. HUGHES,
Kentucky.

Tremendous, big-paying opportunities are open for ambitious men in Modern Photography. This is the picture age. Magazine and newspaper publishers buy thousands of photographs each year. Every manufacturer sends out high priced pictures of his products. Every home wants portraits. Photography is a business running into millions of dollars each year. And there is a great shortage of trained photographers.

EARN \$3,000 to \$10,000 a YEAR

Hundreds of men are earning big money and establishing their own businesses. Even during spare time, while training,

you can make \$75 a week easily—no matter where you live!

Amazing New Easy Method

I show you, at home, how to do the kind of work turned out by the big studios in New York and Chicago! I show you how to make big money within 30 days! C. M. Cole bought a home with money he had made when only half way through his training. So well do I know what I can do for you that I guarantee under bond to return every cent of your tuition if you are not thoroughly satisfied.



Professional View Camera FREE!

Write at once for Free Camera Offer—I give you, free, a splendid professional view camera. You will be astonished and delighted. This offer open for short time only—so act quick! No obligations.

INTERNATIONAL STUDIOS, Inc.
Dept. 1192, 3601 Michigan Ave., Chicago, U. S. A.

LEARN PIANO TUNING

MAKING TRIALS
OF TRUE TONE

By
TUNE-A-
PHONE



We furnish our accurate teaching device with tools, action model and lessons. Diploma given graduates. 25th year teaching this art by correspondence. Write today for free booklet and guarantee plan.

NILES BRYANT SCHOOL 30 BRYANT BLDG. AUGUSTA, MICH.

ELECTRICAL men with training are in demand. For more than a quarter of a century this school has been training men of ambition and limited time, for the electrical industries. Condensed course in Electrical

ENGINEERING enables graduates to secure good positions and promotions. Theoretical and practical Electricity, Mathematics, Steam and Gas Engines, Mechanical Drawing. Students construct dynamo, install wiring and test electrical machinery. **COURSE IN ONE YEAR** Course with diploma, complete



Thoroughly equipped fireproof dormitories, dining hall, laboratories, shops. Over 3000 men trained.

Write for catalog. 31st year begins Sept. 26, 1923.

BLISS ELECTRICAL SCHOOL

104 TAKOMA AVENUE, WASHINGTON, D. C.



Gov't Help Needed

All men, women, boys, girls, 17 to 65, willing to accept Government Positions, \$117-\$250, traveling or stationary, sign name and address below and mail this ad to Mr. Orment, 111 St. Louis, Mo. immediately.

NAME.....

ADDRESS.....

YOU CAN PLAY THE HAWAIIAN GUITAR

Just Like the Hawaiians!

Because Our Native Hawaiian Instructors Will Show You How!

Be the Most Popular Member of Your Set, Play "When You Walked Out," "Ten Ten Tennessee," "Stella," "Louisville Lou." All the Late Song and Dance Hits. You can play First Selection in Half an Hour and Harmonious Chords AT ONCE.

Here is your chance to get in the swim—to learn to play the most fascinating of all instruments, the Hawaiian Guitar, just as the Hawaiians do, and in an amazingly short time. Our method is so simple, plain and easy that you begin a piece your first lesson. In half an hour you can play it! Thousands of successful students prove this to be true. It is quite astonishing to find the ease with which you can master the Hawaiian Guitar—no matter how little your knowledge of music may be you can positively learn to play by our plain and easy method.

Expert Hawaiians Teach You to Quickly Master Their Secrets of This Fascinating Music

The instructions you receive from such world famous experts as Lawrence Kalahiki, Walter Kolomoku, Frank Ferrer, Carl Seville and others are invaluable. No other Conservatory can even begin to give you the expert teaching and knowledge you gain through us. And remember, while it is conceded that the Hawaiian Guitar produces the sweetest music, yet its mastery by you will be simple and quick, since there are

ONLY 4 EASY MOTIONS

to learn to be able to play any music—popular, dance, classical, native Hawaiian airs, or old time melodies and hymns. Just think of it! You need never have read a musical note in your life! For that matter, even though you haven't the slightest knowledge of any musical instrument we guarantee to teach you how to play just like the Hawaiians!

A Complete Conservatory Course!

Never before has such a complete and easily understood Conservatory Course in Hawaiian Guitar been offered. We are able to grant you this opportunity of quickly learning how to play the Hawaiian Guitar through acquiring the services of real Hawaiians to teach you.

How well this has been accomplished is proved by the fact that this is the only Conservatory teaching Hawaiian Guitar exactly as played by the Hawaiians. It is your good fortune as well as ours, that these Native Masters of Hawaiian Guitar came to this Conservatory to teach—and best of all

We Furnish Everything

When you enroll as a student in this Conservatory you receive FREE a handsome, expert-toned Genuine Hawaiian Guitar—valued at \$15.00—52 especially arranged lessons and 52 carefully selected pieces of music, as well as all necessary picks, Steel Playing Bar, etc. There is nothing extra to buy, everything is furnished.

SEND FOR DETAILS TODAY

of this remarkable course—simply fill in the coupon, mail to us and we'll gladly send you full details of our complete Conservatory Course and FREE Hawaiian Guitar Offer! We know you will not let another day go by without enrolling as a student in this Conservatory, once you learn how quickly and easily you can master this most popular of all instruments—the Hawaiian Guitar—So mail the Coupon NOW.

First Hawaiian Conservatory of Music, Inc.
Dept. 48, 233 Broadway (Woolworth Bldg.) N. Y.

Special Courses Under Famous Teachers: TENOR-BANJO
VIOLIN, BANJO-UKULELE and UKULELE



FREE

This Genuine
HAWAIIAN
Guitar—

A Real
\$15.00
Value



MAIL THIS COUPON NOW!

First Hawaiian Conservatory of Music, Inc.
Dept. 48, 233 Broadway, (Woolworth Bldg.) New York

Please mail at once full details of your 52 easy lessons and FREE Hawaiian Guitar offer. This, of course, does not obligate me in the least.

Name

Address

City State

(Please PRINT name and address clearly)



American Machinists' Library



THE day of the trained machinist is here! On every hand employers are calling for him—*bidding* for him! They are looking for men who really *know* machine shop practice—men who are capable of handling *all kinds* of machine shop work equally well.

The all-round knowledge that is in demand today is the kind of knowledge you get in the new American Machinists' Library.

The latest and most practical books in the machine shop field

THIS library—just off the press—is without a doubt the most complete—the most thorough—the most practical set of books ever published in its field.

The authors are all recognized authorities in the machine shop world, and they have packed their books to the covers with sound advice and helpful data on every phase of machine shop work. The set should be in the hands of every man who wants to make himself a master of modern machine shop practice.

American Machinists' Library 6 VOLUMES

2000 pages—
2500 illustrations

- Vol. 1—Machine Tools and Their Operation—Part I
- Vol. 2—Machine Tools and Their Operation—Part II
- Vol. 3—Punches and Dies
- Vol. 4—Jigs and Fixtures
- Vol. 5—Tool and Gage Work
- Vol. 6—Working of Steel

Machine shop work as experts know it

Within these six volumes will be found everything that the machinist and toolmaker wants to know about modern machine shop work. All the latest methods—all the latest machines—all the finer points of machine shop work—are described and pictured for you in clear, interesting text and illustrations.

With these books a man can know machine shop practice as experts know it and fit himself to earn an expert's pay.

Free Examination—Only \$1.00 in 10 days and \$2.00 a month for 7 months

Fill in the coupon below and we will send you a set of these books for 10 days' Free Examination. No expense—no obligation. We pay carrying charges both ways. If you find the books to be what you want, send us \$1.00 in ten days and the balance in monthly installments of \$2.00 until the special price of \$15.00 has been paid.

FREE EXAMINATION COUPON

McGRAW-HILL BOOK CO., Inc.
370 Seventh Avenue, NEW YORK

Send me for ten days free examination your American Machinists' Library, all charges prepaid. If satisfactory, I will send \$1.00 in 10 days and \$2.00 a month until I have paid your special price of \$15.00 for the set. If they are not what I want, I will write for return shipping instructions.

Signature.....

Res. Address.....

City and State.....

Your Employer.....

Your Occupation.....

PM 3 '31



Learn to Draw at Home

Trained artists earn from \$50 to over \$250 a week. Tremendous demand right now for good art work. Magazines, newspapers, advertisers, printing houses, etc.

Become an artist through wonderful new easy method—right at home in spare time. Learn Illustrating, Designing and Cartooning. Actual fun learning this way. Individual attention by mail from one of America's most famous artists. Learn to draw and earn big money.

Send for FREE BOOK

Just printed—a new book which describes the latest developments and wonderful opportunities in Commercial Art, and gives full details on this new easy method of learning to draw. Tells all about students—their successes—what they say—actual reproductions of their work—and how many earned big money even while learning. Write for this Free Book and details of special free offer. Mail postcard or letter now.

WASHINGTON SCHOOL OF ART
Room 302, 1115-15th St. N. W. WASHINGTON, D. C.



We have a wonderful new copyrighted system of teaching note music by mail! To first pupils in each locality we will give free a \$20 superb Violin, Tenor Banjo, Ukulele, Hawaiian-Guitar, Banjo, Mandolin, Banjo-Ukulele, Banjo-Mandolin, Cornet or Banjo-Guitar absolutely free. Also teach Piano and Organ. Very small charge for lessons only. Four lessons will teach you several pieces. Over 100,000 successful players. We guarantee success or no charge. Complete outfit free. Write today, Dept. 107. No obligation. SLINGERLAND SCHOOL OF MUSIC, 1815 Orchard Street, CHICAGO, ILLINOIS

"STAMMERING

Its Cause and Cure"

You can be quickly cured if you stammer. Send 10 cents, coin or stamps, for 288 page cloth bound book on Stammering and Stuttering. It tells how I cured myself after Stammering and Stuttering for 20 years. BENJAMIN N. BOGUE
6908 Bogue Building, 1147 N. Ill. St. Indianapolis

LEARN WATCHMAKING AND ENGRAVING

Earn while learning. Most practical watch school. Individual instructions. Graduates in great demand. Book free. Chicago School of Watchmaking, Dept. 20, 4849 Lincoln Ave., Chicago



WANTED

MAIL CARRIERS

\$1400 to \$2600 YEAR

Men 18 to 45. Steady. Common Education sufficient. Write immediately for free list of many U. S. Government positions now obtainable.

FRANKLIN INSTITUTE, Dept. F 326, ROCHESTER, N. Y.

C.J. Buckwalter, President, the man behind the remarkable instruction which has astonished the teaching profession and which offers wide-awake men a 50-day short-cut to big earnings.



1923 SEPTEMBER 1923						
1	2	3	4	5	6	7
8	9	10	11	12	13	14
15	16	17	18	19	20	21
22	23	24	25	26	27	28
29	30	31				

1923 OCTOBER 1923						
1	2	3	4	5	6	7
8	9	10	11	12	13	14
15	16	17	18	19	20	21
22	23	24	25	26	27	28
29	30	31				

50 days - then \$132 a week

In New Automotive Electrical Business

The shortest road to big earnings ever known. Scarcity of experts makes positions certain and pay high. A remarkable new system of training enables you to earn \$132 a week in less than two months. And we can prove it. Get my free book.

THINK of it! Only 50 days training puts you in a position to earn \$132.00 a week! All because there is an enormous demand for Automotive Electrical Experts and there are far from enough. Employers are ready to snap up our graduates at once. Our free employment service helps you to get the very "pick" of such positions. See facts and figures in my free book.

Experience Not Necessary

You don't need to know about Automobiles or Electricity at the start. Nor do you need any more education than the ability to read simple English. We give you all the knowledge you need—teach you completely—in 50 days. My book explains everything free.

Amazing New Way to Train

When the government needed Auto-Electrical Experts for the war there was no time to waste. Men had to be trained 100% right and sent out almost overnight. The man who invented the 50 day method was the man to whom Uncle Sam went for help. Results were amazing. Never before had such a thing been accomplished by anyone. A complete practical thorough training in 50 days. So remarkable that after the war and at a great cost it was made available to Ambu students only. Ambu has even improved on the original plan by not admitting more than 20 men to a class. No other school does this and the smaller the class the more you learn.

Get Out of the Grease

All my graduates are masters of their profession. And they are so enthusiastic over the way in which they've stepped from their former poor-pay jobs into this delightful, big-pay profession that I am glad to have you write them. I'll give you their names. They will tell you how fine it is to get out of the grease into big money.

Unusual Short Time Offer

I have a most remarkable offer to make for a short time to those who send for my free book at once. It will be a revelation to you. So be sure to mail the coupon at once, while this offer is in force. Write me personally.

C. J. BUCKWALTER, President
AMBU ENGINEERING INSTITUTE
 Dept. 12 2632 Prairie Avenue, CHICAGO

BIG JOBS OPEN FOR AMBU MEN

78% of all auto troubles occur in the electrical system—battery timing, wiring, etc. And the ordinary automobile mechanics will fiddle around for 10 hours without discovering a trouble which an Ambu man will locate and repair in 15 minutes. No wonder Automotive Electrical Experts are in such big demand and the pay is so large.



Makes 4 Times His Former Salary
 "I was making \$40 a week as Head Bookkeeper when I took up your training. Last week I made \$170, including overtime, and hardly a week passes in which I don't make about \$160. No hard work either—I locate the trouble and make the mechanics do the hard work."
 "Henry L. Ludlow, Jr."

Makes \$1,000 a Month
 "I started with you people 7 weeks, if you remember; then started right to work with big garage. Averaged about \$150 a week. After 8 weeks of this I opened a shop of my own. Will a few batteries but work my big money on electrical repairs. Find it easy to get any price I charge. Clearing over \$1,000 a month."
 "M. J. Ellard, Can."



Come to Chicago or Stay At Home

For those who cannot come to Chicago I have prepared a home study course. Makes you as proficient as a resident course at Chicago. So easy a child can master. Learn in spare hours. Positively fascinating. Personal coaching given by mail by the instructor to whom we assign you. Hundreds of our graduates are "home study" men and they are just as expert and their earnings are as large as those who trained in Chicago.

FREE BOOK Explains all about this new field. Shows why there is such a big demand for Automotive Electricians and why the pay is so large. Tells what our graduates are making and repeats copies of their own graded letters. Shows how you get paid for your head work rather than hard-work. And how you can do the directing while others perform the labor, and handle the dirt and grease. Get this remarkable book at once.

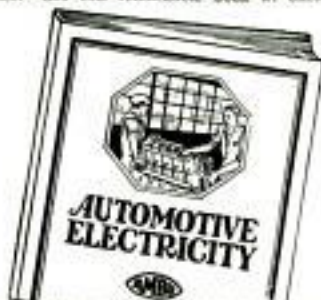

C. J. Buckwalter, Pres., Ambu Engineering Institute,
 Dept. 12, 2632 Prairie Ave., Chicago, Illinois

Please send me FREE Book and complete information about the big-pay uncrowded field of Automotive Electricity. Explain also your remarkable short time offer. I am interested in

Home Study Course
 Resident Course at Chicago

Name.....
 Address.....
 City..... State.....



"I Made Myself HEAD

"I used to be one of the hands.

Luck? Pull? There's no such thing in business! Training is everything. Only three years ago I had your very job! A. T. S. books put me where I am today!

"Take a tip from one who knows. Buy a set of A. T. S. books and let them fit you for a big job, as I did. They're crowded with pay-raising facts written by noted experts. They are easy to read, too—charts, diagrams and illustrations make them as simple as A. B. C.

"But don't take my word for it. Investigate for yourself—it won't cost a cent!" Pick the set you want, mail the coupon and the books will be shipped to you for 7 days' free inspection.

PAY RAISING BOOKS at Greatly Reduced Prices

Automobile Engineering, 6 volumes, 2800 pages, 2000 pictures. Was \$45.00.....	Now \$21.00
Carpentry and Contracting, 5 volumes, 2138 pages, 1000 pictures. Was \$37.50.....	Now 19.50
Civil Engineering, 9 volumes, 3900 pages, 8000 pictures. Was \$67.50.....	Now 34.50
Business Management, 8 volumes, 2500 pages, well illustrated. Was \$52.50.....	Now 28.50
Fire Prevention and Insurance, 4 volumes, 1100 pages, 600 pictures. Was \$30.00.....	Now 14.50
Electrical Engineering, 8 volumes, 3800 pages, 3000 pictures. Was \$50.00.....	Now 29.50
Machine Shop Practice, 6 volumes, 2300 pages, 2500 pictures. Was \$45.00.....	Now 21.50
Steam and Gas Engineering, 7 volumes, 3300 pages, 2500 pictures. Was \$52.50.....	Now 24.50
Law and Practice (with reading course), 13 volumes 6000 pages, illustrated. Was \$97.50.....	Now 49.50
Telephony and Telegraphy, 4 volumes, 1725 pages, 2000 pictures. Was \$30.00.....	Now 14.50
Sanitation, Heating and Ventilating, 4 volumes, 1454 pages, 1400 pictures. Was \$30.00.....	Now 14.50
Drawing, 4 volumes, 1575 pages, 1000 pictures, blue-prints, etc. Was \$30.00.....	Now 14.50
Employment Management and Safety Engineering, 7 volumes, 1800 pages, 540 illustrations, charts and diagrams. Was \$52.50.....	Now 24.50

SEND NO MONEY Shipped for 7 Days' Trial

You be the judge of these books. Don't send us a penny, but mail the coupon and we'll ship you any set you want for 7 days' free examination. Use them a whole week. If you don't want them, return the books at our expense. If you decide to keep them, remit only \$2.50 at the end of the week and \$5.00 a month until the balance is paid. Take the step toward bigger pay today. Mail the coupon—NOW!

American Technical Society, Dept. G-219 Chicago, U. S. A.

American Technical Society,
Dept. G-219 Chicago, U. S. A.

Please send me set of.....

for 7 DAYS' examination, shipping charges collect. I will examine the books thoroughly and, if satisfied, will send \$2.50 within 7 days and \$5.00 each month until I have paid the special price of..... If I decide not to keep the books I will return them at your expense at the end of one week. Title not to pass to me until the set is fully paid for.

Name.....

Address.....

Employed by.....

(Please fill out all three lines)

Do You Want? to Make Money

Would you like to break into the selling game? If so, we've got a proposition for you that will enable you to do both these things without in any way interfering with your present work. You can add from \$25.00 to \$50.00 a week or more to your present income and at the same time train and prepare yourself for salesmanship so thoroughly and so quickly that before long you can give up your present job entirely and devote yourself altogether to this pleasanter and better-paying proposition of ours.

Many of our very best and most successful salesmen started in just this way. You can do the same. You don't have to have any selling experience whatever, just so you're ambitious to get ahead and make money. If you are, we'll take you and train you so thoroughly and so quickly that you can't fail to get results from the very first day you start.

Remember, you take no chances whatever. We don't ask you to give up your present job for an uncertain one. All we say to you is: Here's a way for you to make more money—to add \$25.00 a week or more to your present income and at the same time train and prepare yourself for a better job, so that when the time does come that you want to step out, you can do it with perfect safety and assurance.

Don't make up your mind about this proposition one way or another in advance. If you're ambitious, want to make money and get ahead—investigate. It won't cost you a penny to do so and it won't obligate you in any way. So write for the FACTS—at once. Address Dept. 757.

GOODWEAR Chicago, Inc.

West Adams Street at Peoria

CHICAGO

LEARN AUTOS AND TRACTORS



Wonderful opportunities constantly offered trained men—we train you thoroughly to start your own business, or to make good money as motor expert, driver, shop foreman, etc. This is the pioneer auto school.

Over 7000 graduates making good.

Catalog free.

CLEVELAND AUTOMOBILE SCHOOL, 1814 East 24th Street, Cleveland, Ohio



Wonderful, new device, guides your hand; corrects your writing in few days. Big improvement in three hours. No failures. Complete outline FREE. Write C. J. Ozment, D-34, St. Louis, Mo.



THE BART CHALK-TALK

If you can draw a little, you can do the Bart Chalk-Talk. Send 4c in stamps for Chalk-Talk folder and complete catalog of art and Chalk-Talk Supplies.

Bart Supplies, Ellis Bldg., Minneapolis, Minn.

BE A JAZZ MUSIC MASTER



PLAY PIANO BY EAR

Play popular song hits perfectly by ear. Hum the tune, play it BY EAR. No tedious, ding-dong daily practice—just twenty brief, entertaining lessons which you can master

At Home in Your Spare Time

Send for the FREE BOOK.

It tells how to start if you want musical ability at which friends will marvel.

NIAGARA SCHOOL OF MUSIC,
Dept. 627 Niagara Falls, N. Y.

Send for this Free Book



Follow this Man!

Secret Service Operator 38 Is on the Job

Follow him through all the excitement of his chase of the counterfeit gang. See how a crafty operator works. Telltale finger prints on the lamp stand in the murdered girl's room! The operator's cigarette case is handled by the unsuspecting gangster, and a great mystery is solved. Better than fiction. It's true, every word of it. No obligation. Just send the coupon.

FREE The Confidential Reports No. 38 Made to His Chief

And the best part of it all is this. It may open your eyes to the great future for YOU as a highly paid Finger Print Expert. More men are needed right now. This school has taken men just like you and trained them for high official positions. This is the kind of work you would like. Days full of excitement. Big salaries. Rewards.

Earn \$2500 to \$10000 a Year *You study at home in spare time*

No advance education is needed. Any man who can read and write, and think can make good. A wonderful book tells all about what others have done. Shows pictures of real crimes and the men who solved them. We'll send you a FREE copy with the free reports. Get the special offer now being made. Mail the coupon.

UNIVERSITY OF APPLIED SCIENCE
1920 Sunnyside Ave., Dept. 13-52 Chicago, Illinois

UNIVERSITY OF APPLIED SCIENCE
1920 Sunnyside Ave., Dept. 13-52 Chicago, Illinois
Gentlemen:—Without any obligation whatever, send me your new, fully illustrated Free book on Finger Prints and your offer of a FREE course in Secret Service Intelligence and the Free Professional Finger Print Outfit.

Name.....

Address.....

Age.....

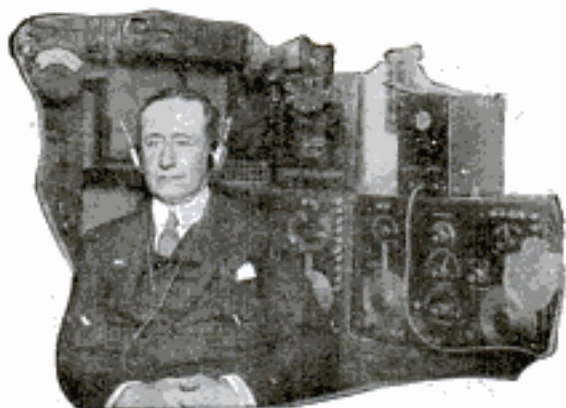

Guglielmo Marconi, as he appears today.
Signor Marconi is Honorary Chairman
of the Radio Institute of America

Success for You —in RADIO

The big men in radio today started—almost all of them—as radio operators. Very many of them are graduates of the Radio Institute (or Marconi Institute, as it was formerly called).

The demand for trained radio men today is too great to fill. Beginners are needed—and positions are open all the way up the ladder to the top. Train now. Radio is swiftly growing. And the opportunities grow with it.

Study at home

You can start now—at home—from the very beginnings of electricity—with the same guidance and instruction that has built the reputation of the Radio Institute. In a few months you can be fitted for your Government operator's license—and your first job.

The Radio Institute is under the auspices of the Radio Corporation of America, which places more men in radio than any other organization in the world—and gives preference to our graduates. Your opportunity is limited only by your ability.

Radio Institute of America

(Formerly Marconi Institute)
Established 1909

326A Broadway, New York City

Indicate by a cross X the course you are interested in:

Radio Institute of America,
326A Broadway, New York.

Please send me full information about radio opportunities today, and your Complete Radio Course.

Name.....

Address.....

Write for Information Today



John Davey's organization needs young men

John Davey's organization, The Davey Tree Expert Co., Inc., has a limited number of openings for ambitious young men between 20 and 30 years of age, single men preferred. The opportunity is unusual, offering good pay at the start, permanent employment in the Davey organization, and thorough scientific training in the profession of Tree Surgery. Advancement rapid, according to merit. The work is fascinating, offers chance to travel extensively, and association with fine fellows. Only clean, red-blooded young Americans, lovers of the outdoors, need apply. Write, giving full information to The Davey Tree Expert Co., Inc., 56 City Bank Bldg., Kent, Ohio.

Learn Expert Auto Painting



There is Big Money in auto painting and refinishing. Our Home Study Course in Practical Auto Painting will enable you to do the finest work and earn big wages. Wonderful opportunity for new money-making business of your own.

FREE circular tells all about this big new business. Be first. Write quick.

CHICAGO COLLEGE OF AUTO PAINTING
Dept. 24, 140 S. Dearborn St., CHICAGO, U.S.A.

WHY NOT spend Spring, Summer and Fall gathering butterflies. Insects? I buy hundreds of kinds for collections. Some worth \$1 to \$7 each. Simple outdoor work with my instructions, pictorial, price-list. Send 10¢ (not stamped) for my Illustrated Prospectus before sending butterflies.

MR. SINCLAIR, Dealer in Insects, Dept. 6, OCEAN PARK, CALIF.



BE AN ARTIST

Comics, Caricatures, Commercial, Newspaper and Magazine Illustrations, Travel Crayon Portraits and Pastels. Our simple method quickly develops your talent in spare time. By Mail or Local Classes. Write for terms and list of successful students.



WANTED
Railway Mail Clerks
\$1600-\$2300 Yr.
MEN - BOYS 18 UP
Mail Coupon Immediately

Franklin Institute, Dept. F198, Rochester, N. Y.
Give: Send me without charge (1) Specimen Railway Mail Clerk Examination questions; (2) list of Government jobs obtainable.

Name.....
Address.....

From WEAKLING to HERCULES

Mr. J. E. Woodrow of 2510 Western Avenue, Peoria, Ill., wrote us as follows:

"I am sending you two pictures showing the development I got from your course. The half-length picture was taken just before I started, and the full-length picture was taken after I had been practicing for sixteen months. The first two months I saw little improvement, but after six months' training I hardly knew myself when I looked in a mirror. I wanted health, strength and development, and I got them—and more."

There is more to Mr. Woodrow's letter, and you can read it, and other letters just as startling, in the booklet mentioned below. We are naturally proud of the development that Mr. Woodrow acquired. His pictures show the way his body grew. Comment on his muscles is therefore unnecessary, but

there are two points you might overlook—namely his face and his neck.



The Neck Is the Index of Vitality— The Face Is the Index of Condition

A thin, scrawny neck is a sign of low vital powers. Hollow cheeks and a drawn face are a sign of lack of condition. Compare Mr. Woodrow's face and neck in the two pictures. Consider them not only in regard to his improved personal appearance, but also as signs of health, and you will understand why we are even more proud of improving his health and appearance than we are of developing his muscles.

If He Could Do It—So Can You!

The fact that you are reading this advertisement is proof that you are interested in the improvement of your body. Granting that, ask yourself just what have you accomplished so far. Take stock of your physical condition. Are you what you would like to be? Have the methods you have been following produced satisfactory results?

Have You the Least Idea of Your Own Possibilities

in the way of development? As most people have not, we suggest that you send for the booklet described in the "special" on this page. It will be an eye-opener to you. The last time we advertised this the demand in the first few days cleaned us out of pamphlets. We now have plenty on hand. Did you get your copy?

We have been teaching our system of Progressive Bar Bell exercise for twenty years. We have brought thousands of men to physical perfection. You can read about many of them in our big booklet.

HEALTH, STRENGTH and DEVELOPMENT and HOW TO OBTAIN IT

Sent Free on Request

THE MILO BAR BELL CO.

Diamond and 3rd Streets
PHILADELPHIA, PA.

Special

When writing for our booklet be sure to ask for your copy of the pamphlet:

"How Much Should I Weigh and How Much Should I Measure?"

MILO BAR BELL COMPANY
Diamond & Third Sts.
PHILADELPHIA, PA.

Gentlemen: Please send me without obligation on my part your free booklet, "Health, Strength and Development and How to Obtain It." Also your pamphlet entitled, "How Much Should I Weigh and How Much Should I Measure?"

Name.....

Address.....

City.....

State.....





"I'm making real money now"

SEE that coupon? Remember the day you urged me to send it to Scranton? It was the best thing I ever did. "Mr. Carter called me in to-day. Said he'd been watching my work for some time—ever since he learned I was studying with the International Correspondence Schools.

"Then he asked me if I thought I could take over Bill Stevens' job. I told him I was sure that I could—that I had had that goal in view ever since I started my I. C. S. course.

"I start to-morrow, Mary, at an increase of \$60 a month. It's wonderful how spare-time study helps a man to get ahead."

FOR thirty-two years, the I. C. S. has been helping men to win promotion, to earn more money, to get ahead in business and in life.

You, too, can have the position you want in the work you like best. Yes, you can.

All we ask is the chance to prove it. Without cost, without obligation, just mark and mail this coupon.

INTERNATIONAL CORRESPONDENCE SCHOOLS Box 5582-D, Scranton, Penna.

Without cost or obligation, please tell me how I can qualify for the position or in the subject before which I have marked an X:

BUSINESS TRAINING COURSES

- | | |
|--|---|
| <input type="checkbox"/> Business Management | <input type="checkbox"/> Salesmanship |
| <input type="checkbox"/> Industrial Management | <input type="checkbox"/> Advertising |
| <input type="checkbox"/> Personnel Organization | <input type="checkbox"/> Better Letters |
| <input type="checkbox"/> Traffic Management | <input type="checkbox"/> Show Card Lettering |
| <input type="checkbox"/> Business Law | <input type="checkbox"/> Stenography and Typing |
| <input type="checkbox"/> Banking and Banking Law | <input type="checkbox"/> Business English |
| <input type="checkbox"/> Accountancy (Including C.P.A.) | <input type="checkbox"/> Civil Service |
| <input type="checkbox"/> Nicholson Cost Accounting | <input type="checkbox"/> Railway Mail Clerk |
| <input type="checkbox"/> Bookkeeping | <input type="checkbox"/> Common School Subjects |
| <input type="checkbox"/> Private Secretary | <input type="checkbox"/> High School Subjects |
| <input type="checkbox"/> Spanish <input type="checkbox"/> French | <input type="checkbox"/> Illustrating <input type="checkbox"/> Cartooning |

TECHNICAL AND INDUSTRIAL COURSES

- | | |
|---|--|
| <input type="checkbox"/> Electrical Engineering | <input type="checkbox"/> Architect |
| <input type="checkbox"/> Electric Lighting | <input type="checkbox"/> Blue Print Reading |
| <input type="checkbox"/> Mechanical Engineer | <input type="checkbox"/> Contractor and Builder |
| <input type="checkbox"/> Mechanical Draftsman | <input type="checkbox"/> Architectural Draftsman |
| <input type="checkbox"/> Machine Shop Practice | <input type="checkbox"/> Concrete Builder |
| <input type="checkbox"/> Railroad Positions | <input type="checkbox"/> Structural Engineer |
| <input type="checkbox"/> Gas Engine Operating | <input type="checkbox"/> Chemistry <input type="checkbox"/> Pharmacy |
| <input type="checkbox"/> Civil Engineer | <input type="checkbox"/> Automobile Work |
| <input type="checkbox"/> Surveying and Mapping | <input type="checkbox"/> Airplane Engines |
| <input type="checkbox"/> Metallurgy | <input type="checkbox"/> Navigation |
| <input type="checkbox"/> Steam Engineering | <input type="checkbox"/> Agriculture and Poultry |
| <input type="checkbox"/> Radio | <input type="checkbox"/> Mathematics |

Name.....

Street.....

Address..... 11-21-23

City..... State.....

Occupation.....

Persons residing in Canada should send this coupon to the International Correspondence Schools Canadian, Limited, Montreal, Canada.

Representatives WANTED

POPULAR MECHANICS MAGAZINE

offers you

An opportunity to represent it in taking subscriptions in your community. Because of the fact that we are now equipped with additional press facilities in our own plant, we are prepared to materially increase the production of Popular Mechanics Magazine. For this reason we are able to offer

VERY LIBERAL COMMISSIONS

to responsible parties to act as our agents in their community taking subscriptions to Popular Mechanics Magazine on our

UNUSUAL SPECIAL OFFER

If you cannot devote your entire time to this work you will find it a very profitable way of spending your leisure hours.

Our agents, some with little or no previous experience, are earning from \$2 to \$5 an hour during their spare time.

Write us today for full particulars.

Popular Mechanics Magazine
210 East Ontario Street
CHICAGO



YOU ARE WANTED FOR A BETTER JOB

That was the good news they brought him just a few short months ago. Then, he held an ordinary job working long and hard on small pay. Today he is a high salaried Draftsman earning nearly \$100 a week. How did it happen? It isn't a long story, because it's all so simple, so easy. You can do just what he has done if you'll start by reading every word—clear down to the coupon that marks your way to better pay.

It all started one evening while he was sitting at home—reading. He saw the advertisement of the COLUMBIA SCHOOL OF DRAFTING and he knew it was his opportunity to earn from \$50 to \$100 a week, in an uncrowded field with a big, sure future. He sent in the coupon. Later he enrolled for the COLUMBIA course. Today he's making real money. His brain is working, as well as his hands. He's standing on the threshold of a brilliant future with all that it means—**independence—money—success—happiness.**

Made \$275 EXTRA in 3 Days

He recently received \$275 for one drawing that he made in spare time in three days.

How About You? Are you working up hill or down? Count the money in your pay envelope next pay day. You'll find the answer there.

Make \$50 to \$100 a Week. COLUMBIA will train you to be an expert Draftsman in your spare time at home by mail. There's lots of room for you if you act now.

Promotion is Quick. We'll Qualify You for a high-salaried position in the Drafting field and keep you in touch with openings for Draftsmen in the big machine shops, industrial plants and United States Government departments. Men who start as Draftsmen are often advanced to Chief Draftsmen, Chief Engineers, Production Managers and so on.

Get the RIGHT Training. Mr. Claffin, the founder and director, stands personally in back of the COLUMBIA SCHOOL OF DRAFTING. You spend no time in long-winded theories—useless and expensive to you. You start on actual drawing work the day you receive your first lesson.

You Need No Previous Training. The course is easy to understand and easy to follow. Many students are qualified even before they complete the course.

Success Calls Men of Action Only. If you are a man of action clip the coupon now and show that you are a man of action. Keep right on top of this opportunity to make real money. Don't go looking for a pair of scissors. Tear the coupon off and mail it right now. Get started now.

WHAT WE GIVE YOU

Practical Problems. You are carefully coached in practical Drafting work.

We Help You Get a Job. We help you get a position as a practical Draftsman, as soon as you are qualified.

Personal Instruction and Supervision Throughout the Course. You receive the personal instruction and help of Roy C. Claffin, President of the COLUMBIA SCHOOL OF DRAFTING and a practical Draftsman of many years' experience.

Draftsman's Equipment. We furnish you with a full set of First Class Drawing Equipment and Drafting Instruments as shown in the picture below when you enroll. You keep both sets on completing the course.

Consultation Privileges. You are free to write us at any time for advice and suggestions regarding your success.

Diploma. The diploma we give you on completing the course attests to your proficiency as a Draftsman. It is an "entering wedge" to success.

Free Subscription to Drafting Publication, "The Compass." You are given free a subscription to our helpful, inspiring publication, "The Compass."

U. S. Civil Service Commission Needs Draftsmen. The following are a few of the many positions open in Government Departments from time to time. The salaries are starting salaries, subject to increase. Practically all of them carry a bonus of \$240 a year additional: Architectural Designer, \$4,000; Chief Draftsman Naval Aircraft Factory, \$15.04 per day; Aeronautical Draftsman, Field Service of Navy Dept., \$5.20 to \$12 per day.

Free Book. Send in this coupon today. Immediately on receipt of it we will send you our book, "Drafting—Your Success," which tells about Drafting and its opportunities for you as well as the special easy method of learning Mechanical Drafting through COLUMBIA methods.

THE COLUMBIA SCHOOL OF DRAFTING

ROY C. CLAFLIN, President

Dept. 2278 14th and T Sts., N. W.

WASHINGTON, D. C.



FREE DRAFTING OUTFIT
We give you Free, with our course, this professional Drafting outfit. It is yours to keep when you complete the Course.

— — — — **FREE BOOK COUPON** — — — —

COLUMBIA SCHOOL OF DRAFTING,
Dept. 2278, 14th and T Sts., N. W., WASHINGTON, D. C.

Please send me without charge your free illustrated book on Drafting, telling me how I can secure your complete Home Study Course and your help in securing a position as Draftsman.

Name.....

Address.....

City.....State.....

I Can Train You For A \$3500 Hotel Job in 20 weeks



The Hotel Business offers wonderful opportunities to the trained man or woman! Now fourth largest industry in America. Hundreds of high-salaried executive positions now standing open—waiting for the trained worker. You can easily qualify for one of these big-paying jobs—in your spare time at home. No previous experience necessary.

I Guarantee to Teach You

In my 50-lesson home-study course on hotel work, all that the leading hotel experts know about the business—men making from \$5,000 to \$50,000 a year! My students are eagerly sought by the biggest and best hotels in the country. You won't have to look for a job. Big pay, fine living, free meals and apartment, fascinating work—these are only a few of the many advantages of hotel work.

Send for FREE Book

20 Years' Experience in 20 Weeks is what this wonderfully complete course gives you. Course prepared by Clifford Lewis, a hotel expert of national reputation. Endorsed by managers of such hotels as Biltmore, Waldorf-Astoria, Copley-Plaza, Commodore, etc. Interesting free book explains all. Send for it today.

LEWIS HOTEL TRAINING SCHOOLS

Founded 1916. The Original Hotel Training School
CLIFFORD LEWIS, President

Room 330 Washington, D. C.
The National Institute for Hotel, Restaurant and Tea Room Training



U. S. Government Needs Men!

Wonderful opportunities in Civil Service. Thousands of men and women appointed every year as Income Tax Auditors, Bookkeepers, Railway Mail Clerks, Postmen, Deputy Collectors, etc. Generous salaries, short hours, liberal vacations. Positions open in Washington and in every other city of this country as well as in Porto Rico, Alaska, Hawaii and the Philippines. Write for 48-page FREE BOOKLET on CIVIL SERVICE.

Mail the Coupon To-day

INTERNATIONAL CORRESPONDENCE SCHOOLS
Box 5583-D, Scranton, Penna.

Without cost or obligation, please send me a copy of your 48-page CIVIL SERVICE BOOKLET, which tells how I can secure a good-paying position with the U. S. Government.

Name.....

Address.....

MONEY IN POULTRY



RAISE POULTRY for PROFIT

We teach you how. Easily learned at home. We have successful students in all parts of the world. Our guarantee methods make success certain—endorsed by leading Agricultural Colleges. Send today for Free Book, "How to Raise Poultry for Profit."

THE NATIONAL
POULTRY INSTITUTE
Dept. 312-A
WASHINGTON, D. C.

LAW BOOK FREE

Send for it today

Whether you are a corporation president or a clerk, capitalist or wage earner—whatever your ambition is—this book will be of vital interest to you—be of direct positive value. It tells you frankly about the amazing secrets of successful lawyers and law trained men in business. It proves conclusively how a law education will quickly fit you for a better position and larger pay. It shows how quickly you can learn at home in your spare time. It tells true stories of successful men who before taking this course aimed for practically nothing. Three year course covers preparation for examination. Degree of LL. B. conferred. Earn

\$5,000 to \$12,000 a Year

as a lawyer or law trained man in business. Read at home—aided by reading course. Moneyback guarantee if not satisfied upon completion. Low fee, easy monthly terms includes complete up-to-date 12 volume library by the highest authorities. Send for free book now. No obligation to you whatever.

HAMILTON COLLEGE OF LAW
431 S. Dearborn St., Dept. 62
CHICAGO, ILL.



DON'T WEAR A TRUSS

BE COMFORTABLE—

Wear the Brooks Appliance, the modern scientific invention which gives rupture sufferers immediate relief. It has no obnoxious springs or pads. Automatic Air Cushions bind and draw together the broken parts. No salves or plasters. Durable. Cheap. Sent on trial to prove its worth. Beware of imitations. Look for trade-mark bearing portrait and signature of C. E. Brooks which appears on every Appliance. None other genuine. Full information and booklet sent free in plain, sealed envelope.

BROOKS APPLIANCE CO., 215 State St., Marshall, Mich.



MR. C. E. BROOKS

FINE SUIT FREE

Tailoring Agents Wanted

Spare time will do. Big Pay. Easy work. No experience needed. Only two sales a day gives you \$50.00 a week. I give every active agent a beautiful made to measure suit for himself absolutely free, so he can wear it and show the fine class of tailoring we make. You get this fine suit free, really free, in addition to your big cash profits, just as soon as you take a few orders.

We supply you with the finest tailoring outfit with over 200 big cloth samples, everything you need and full instructions to start right in making from \$50.00 to \$100.00 a week. Write quick for this new sensational tailoring offer, the best ever put out. Tailoring agents everywhere get my new offer. If you want to make big money and get a fine suit free, address

L. E. ASHER, President

BANNER TAILORING CO., Dept. 126
CHICAGO



MEN WANTED

FOR AUTO BUSINESS

We have hundreds of jobs open for ambitious men who want to learn to make \$50 to \$125 per week in the **AUTOMOBILE BUSINESS**. Many employers have asked us to supply men for these high paid jobs. With our training we **GUARANTEE** that you will be one of the chosen men. And we **GUARANTEE** a **JOB** to help you while you train. Get this proposition firmly in mind!

JOBS GUARANTEED

For a limited time we **GUARANTEE** to get you an "earn-while-you-learn" job paying up to \$30 per week or more *from the start*. You make only a small payment down on your instruction, and pay balance from time to time from your earnings. While you earn you learn the Automobile Business in every detail. When you graduate we **GUARANTEE** to place you in a well paid automotive position. Opportunities like this are few. Accept this one **NOW**, while it is before you!

We Pay Your Railroad Fare to Chicago

This special offering is made to fill the many jobs we now have open. Within ten blocks of our new seven story building, which is filled with training shops from top to bottom, there are at least 40 large Automobile Sales Agencies. Throughout the city are approximately 5,000 Garages and Repair Shops. Here is the place to train and to secure high paid employment: In Chicago the opportunities for trained men are unlimited. Mail the coupon *at once* for **FREE** Book "How to Succeed in the Automobile Business," and let us give you **ALL** the information about getting you a job and finding you a home.

Greer Automotive Training Shops
2072 S. Wabash Ave., Chicago, Ill.

**Mail this
COUPON
At Once**

ERWIN GREER, Superintendent
2072 S. Wabash Ave., Chicago, Ill.

Please send me **FREE** Book "How to Succeed in the Automobile Business," and full information about your "earn-while-you-learn" proposition.

NAME

ADDRESS



He Earns \$200 a Week

Seems like a lot of money to the man in the routine job—\$200 a week—but not to the trained salesman.

Today, any number of men—and they're not unusual, either—are earning salary and commissions better than \$10,000 a year. They travel from one big city to another—live comfortably at the best hotels—mix daily with successful business men—and they are continually growing in a business way.

Perhaps you have thought that selling required some special gift. But it *isn't true!*

The successful salesman succeeds because he knows his line—and because he is master of the principles and methods of scientific salesmanship.

And you, too—if you have average intelligence—can acquire that understanding and you can go out and increase your earnings in a way that will actually amaze you

FREE—Send for the book "Modern Salesmanship"

LaSalle training in Salesmanship is by the home-study method and is based on the successful experience of more than a thousand outstanding salesmen. An important part of the training consists in the solving of actual sales problems furnished by many of the leading sales organizations in the country. These companies have generously turned over to LaSalle their most effective sales methods—have revealed in detail the scientific selling processes responsible for their success.

Commenting on the LaSalle course in Modern Salesmanship, C. J. Jones, of Canada, writes:

"The first two texts have given me so much that I am firmly convinced that if I never learned anything more from the course, I would have a full return for the entire investment, and I will tell you frankly that I would not take \$25,000 for my contract if another could not be had."

If you are in a routine job with limited possibilities and have a real desire to become a salesman—or if you are now actually in the selling field and anxious to build your earning capacity to the highest possible point—you will find it greatly to your advantage to send for "Modern Salesmanship."

The coupon will bring it to you promptly and without obligation. Put it in the mail TODAY.

LASALLE EXTENSION UNIVERSITY

The Largest Business Training Institution in the World
Dept. 264-5R Chicago, Illinois

Gentlemen: Send without obligation to me information regarding course indicated below:

Modern Salesmanship

LaSalle is the largest business training institution in the world. It offers training for every important business need. If more interested in any of these courses, check here:

- | | |
|--|--|
| <input type="checkbox"/> Business Management | <input type="checkbox"/> Modern Business Correspondence and Practice |
| <input type="checkbox"/> Higher Accountancy | <input type="checkbox"/> Modern Foremanship and Production Methods |
| <input type="checkbox"/> Traffic Management—Foreign and Domestic | <input type="checkbox"/> Personnel and Employment Management |
| <input type="checkbox"/> Railway Station Management | <input type="checkbox"/> Expert Bookkeeping |
| <input type="checkbox"/> Law, Degree of LL.B. | <input type="checkbox"/> Business English |
| <input type="checkbox"/> Commercial Law | <input type="checkbox"/> Commercial Spanish |
| <input type="checkbox"/> Industrial Management | <input type="checkbox"/> Effective Speaking |
| <input type="checkbox"/> Efficiency | <input type="checkbox"/> C. P. A. Coaching |
| <input type="checkbox"/> Banking and Finance | |

Name.....

Present Position.....

Address.....



600,000 men and women work for me now. I have splendid positions for thousands more—for YOU!

It's easier to get a job in the Civil Service than in any private concern. Thousands wanted for over six hundred different kinds of positions. Work for Uncle Sam in a job you can't lose for personal reasons. Pay \$1600 to \$2600 to start. Steady work, easy hours, yearly raises, rapid promotion. No strikes, no hard times, no layoffs.

FREE BOOK No experience necessary to get Government position. All you need is to pass examinations. Arthur R. Patterson, 8 years an Official Examiner, trains you so you surely pass—guarantees that you get position or your money back. Write for free book describing how you can become Railway Mail Clerk, Postmaster, Mail Carrier, Customs Inspector, or any one of hundreds of other positions open and how you can easily qualify. Write NOW.

PATTERSON CIVIL SERVICE SCHOOL
Dept. 82, Wisner Building ROCHESTER, N. Y.

Learn to Mount Birds

Learn at home by mail, to mount birds, animals, game heads; tax furs, make rugs and robes. Complete lessons. Easily and quickly learned by men, boys and women.

FREE Write today for Free Taxidermy Book. Tells all about it. Every Sportsman, Hunter, Trapper and Nature lover should know this wonderful fascinating art. Save your trophies. Big profits. Success guaranteed. Our school is 20 years old—25,000 graduates. Investigate today. Write for Free Book.

Northwestern School of Taxidermy 1772 Elwood Bldg., Omaha, Neb.

Musical



Novelty Instruments

Not toys—but high-grade practical instruments for Symphony or jazz orchestras. Great for solo work at Club, Lodge or Legion gatherings or home entertainments. Anyone can play with a few simple lessons, furnished with each instrument.

Musical Pitch Fork Glesaphone Jazz-O-Nette
Mando-Zi Harp Musical Saw Hohner Sax

Free Trial Try any of these instruments for 15 days. If not satisfied, if you can't learn to play it quickly and easily, return at our expense. Remarkably low prices. Easy Time Payments. Send today for new, illustrated catalog describing complete line.

MUSSEHL & WESTPHAL
481 S. Water Street Ft. Atkinson, Wis.

A New and Sensational Discovery

A Million Dollar Secret

A New Joy

THIS new and startling discovery of a supreme natural law of life, health and pleasure is joyfully revolutionizing the lives of thousands of men and women all over the world. It is bringing them a new kind of pleasure, happiness, health, strength, confidence, energy and power of personality and success. It is giving them such marvelous energy of mind and body, and they enjoy life so fully, so intensely, so dominantly, and so thoroughly, that the old life to which they were accustomed appears totally inferior in every respect.

The possession of this new and mysterious natural law gives a new idea of how truly vital, alive, joyful, healthy and happy a human being can be—how easily one can be overflowing with life, energy, bubbling vitality and the fire of triumph. Although thoroughly natural and simple, nevertheless it accomplishes seemingly impossible results without sacrifice, active effort or cost.

A new life with a unique thrill is yours when you possess this newly discovered natural law of supreme life, health and pleasure. It is no longer necessary for any one to spend money for treatments and drugs and dieting and books and pills and devices, because perfect and supreme health and life are absolutely free through this marvelous natural law.

Why be weak, why be ill, why be fat, why be thin, when you may, absolutely free, become in every way perfect and supreme through this sensational natural law?

This extraordinary natural law yields amazing nerve force, amazing energy, amazing vitality and amazing power of every character of mind and body—a new and superior life.

Through this sensational natural law, you may have all of the benefits of exercise without exercise; all of the benefits of conscious deep breathing without conscious deep breathing; the full and complete benefit of every vitamine and organic iron without drugs or dieting; all of the benefits of medicine and drugs without medicine and drugs; all of the benefits of auto-suggestion, hypnotism and psychology without auto-suggestion, hypnotism and psychology; all of the benefits of dieting, and every other kind of treatment, device or assistance without those treatments.

Through this amazing natural law, anyone can rid self permanently of every human weakness. This unique natural law gives immunity from every disease of the inferior life. No matter who you are, this natural law can demonstrate to you that you do not yet know the full meaning of joy, pleasure, happiness, vitality and gratification.

This natural law is ready to give you a new realization of the meaning of life and enjoyment.

This extraordinary and Universal Law does not require you to actively do anything or give up anything. It requires no exercise, no time, nor conscious deep breathing—no stretching, dieting, drugs nor medicines.

This natural and supreme law must not be confounded with hypnotism, auto-suggestion, psychology, spiritual science, psychic science, science,

mental science, nor with electricity, osteopathy or any other method—mental or physical—ever devised in the past.

No self-hypnotizing phrases to repeat—no yielding, no recession, no giving up of anything, nothing to study, nothing to actively practice, no books to buy, nothing to memorize, no self-deception—nothing but truth—reality—Natural Law.

Perfect health cures every known and conceivable disease. This startling natural law is guaranteed to give perfect health.

If you are not enjoying life to the full—if you are in any way handicapped—if you are not in possession of all the powers of mind and body to the highest degree, you owe it to yourself to at once procure for yourself free of charge this revolutionary natural law.

Through this supreme natural law, anyone may have the health and vitality of a lion or tiger.

Remember that demonstration and results are immediate and free.

This powerful natural law transforms the gloom of disease into the bloom of health, as the rays of the spring sun transforms the dead soil into a "sea" of luxuriant vegetation. It is destined to revolutionize human health and happiness—Humanity.

This natural law is most marvelous, most simple, most subtle, and most powerful. It is the Law of Creative Power.

Remember there is nothing active to do, nothing to study, nothing to believe, no time to waste, no habits to give up, nothing to lose—there is no mystery—it is merely natural law.

This secret is offered to you absolutely free. There are no "conditions" or "strings" attached to this offer.

You would not be without this secret if you could imagine how delightfully transformed your life would be through the possession of this new and deeper realization of happiness, pleasure, joy and gratification.

Anyone—male or female—above eighteen years of age is eligible to receive this marvelous secret absolutely free.

Swoboda has a priceless secret for every human being who wishes to be happier, healthier, more vital and successful in a new degree.

ALOIS P. SWOBODA,

1213 Berkeley Building, 21 West 44th Street,
NEW YORK CITY

Send me free the Swoboda Natural Law of Supreme Life and Health.

To help cover cost of publishing and mailing, I enclose postage. (Not more than ten cents, please.)

Name.....
(Write Plainly)

Address.....

City..... State.....

Special Note: Many individuals who have obtained this secret claim it is absolutely priceless—worth millions.

Earn BIG MONEY



Be an Automotive Expert

Why slave and earn small pay when a thirty to sixty day course will double or triple your salary.

THE MAN WHO KNOWS AUTOMOTIVE MECHANICS ELECTRICITY WELDING·BATTERY

steps right ahead and soon becomes shop foreman and then owner.

The "Modern" is one of the largest practical trade schools in America—conveniently located in three cities—operating day and night classes.

It is one of the few automobile and tractor schools that was approved and employed by the United States government for the training of soldier auto-mechanics.

We have experienced instructors who have been through the mill. You learn by actually doing the work on the machines and using the most modern equipment. This is why our graduates are sought after and have their pick of positions.

You don't have to leave when your term is up—you can stay as long as you want to, until you are satisfied that you have mastered every branch of trouble-spotting and shooting.

Mail the coupon to our nearest school for a free copy of our catalogue—NOW—it is your first move for more money.

MODERN AUTOMOBILE AND TRACTOR SCHOOLS

2512 University Ave. St. Paul
125 9th Street San Francisco
700 Mercer Street Seattle

Kindly send me a free copy of your catalogue.

Name _____

Address _____

City _____

IS YOUR ENGLISH A HANDICAP?

Every time you speak or write you show just what you are. Mistakes in English reveal you as a person who lacks education and refinement. Lack of language power prevents you from presenting your thoughts in the strongest possible way. No matter what you do, real command of English will help you to your goal. Stop making mistakes in spelling, punctuation, pronunciation. Increase your vocabulary.



WONDERFUL INVENTION

Only 15 minutes a day with Sherwin Cody's New Invention—and you can actually SEE your English improve. It teaches by HABIT—makes it easier to do the RIGHT way. Wonderful self-correcting lessons include Spelling, Punctuation, Grammar, and Expression.

FREE BOOK ON ENGLISH AND 15 MINUTE TEST

Lack of language power may easily be costing you thousands of dollars every year. See what Mr. Cody can do for you; it costs nothing to find out. Mail a postal card or letter this very minute for free book, "How to Speak and Write Masterly English," and 15 minute test, which you can take in your own home. It will prove a revelation to you. WRITE NOW. Address

Sherwin Cody School of English, 52 Searle Bldg., Rochester, N.Y.

THIS WONDERFUL INVENTION



converts any ordinary cook stove into a gas stove. OXO-GAS is made from kerosene and air. Cheaper, cleaner and more efficient than coal. Responsible distributors wanted.

GLORIA LIGHT CO.
114 N. May St. Chicago, Ill.

STAMMERS

I can teach you to speak normally. Send for free booklet telling how. BOSTON STAMMERS' INSTITUTE, FOUNDED 1887 Samuel A. Robbins, Director, 246 Huntington Ave., Boston 17, Mass.

SONGS

Clean, catchy hits that everybody likes. Ballads, comic songs, novelty songs, coon songs; full sheet music with beautiful colored covers. Ideal for public entertainment or home diversion. Hundreds of plays and entertainment books. Big catalogue free.

T. S. DENISON & CO., 623 So. Wabash Ave., Dept. 200, Chicago



"From This Day You Get Bigger Pay"

"And so I was promoted. The boss seemed surprised, until I told him I had been studying nights—to learn more about my job, and how to do it better." An American School Course will put you in the way of earning big money in the line of work you like best. Look over the Coupon, check the Branch you want to learn, mail it and we will send you full information FREE. Pay no money until you know all about what we can do for you. The cost is low, the terms easy and the results insured by our money-back guarantee. The pay increases you will get will more than pay for your course in a few week's time. We have thousands of successful graduates holding big jobs today. You can join this money-making class. Fill out the coupon, mail it today. Get your start in life.

American School, Dept. C-274A Drexel Ave. & 58th St., Chicago, Ill.

American School, Dept. C-274A Drexel Ave. & 58th St., Chicago

Send me full information on the subject checked.

- | | | |
|-------------------------------------|--------------------------|--------------------------|
| .. Architect | .. Accountant & Auditor | .. Employment Manager |
| .. Building Contractor or Carpenter | .. Bookkeeper | .. Steam Engineer |
| .. Automobile Engineer | .. Draftsman & Designer | .. Foremanship |
| .. Automobile Repairman | .. Electrical Engineer | .. Sanitary Engineer |
| .. Civil Engineer | .. General Education | .. Surveyor & Mapping |
| .. Advertising Manager | .. Personal Analysis | .. Telephone Engineer |
| .. Business Manager | .. Business Law | .. Telegraph Engineer |
| .. Financial Manager | .. Lawyer | .. High School |
| .. Sales Manager | .. Machine Shop Practice | .. Fire Insurance Expert |
| .. Cert. Pub. Accountant | .. Photoplay Writer | .. Wireless Radio |
| | .. Mechanical Engineer | .. Undecided |
| | .. Shop Superintendent | |

Name _____

Address _____

New Hair for You in 30 Days

-or Your Money Instantly Refunded

My amazing guarantee means just exactly what it says! I don't care how thin your hair is—I don't care if you are completely bald—if new hair fails to grow after using my method—then the test costs you absolutely NOTHING! The astonishing proof of what I have done for others is now yours—entirely free. Simply mail the coupon below.

By ALOIS MERKE

Founder of Famous Merke Institute, Fifth Avenue, New York

NO matter how long you have been bald—no matter how many different treatments you have taken without results—I have discovered a startling new treatment for baldness which I absolutely guarantee will grow new hair in 30 days—or every penny you have paid me will be instantly—and gladly—refunded.

No one has ever dared to make such a sweeping guarantee before! But do you suppose that I could make it unless I was absolutely confident that my treatment would do all I claim? Never! I would be out of business in a week. But I KNOW what my method will do. For its remarkable value is shown by actual statistics covering thousands of cases treated—only three people in every hundred asking the return of their money!

Not One Penny's Risk!

Now I realize that you have perhaps wasted a lot of time and money on treatments which could NEVER restore your hair. Very likely you are skeptical. All right. I don't blame you. And I'll admit right here that my treatment may not help you either. For your case

may be one of the three in every hundred that is absolutely hopeless. In any case, I want you to try my treatment at my risk—and if after 30 days you are not more than delighted with the results produced—then just tell me so, and without asking a single question I'll mail you a check refunding every cent you have paid me. I don't want a cent of your money, unless I *actually grow hair on your head!* You, of course, are to be the sole judge.

Actual Results

(Dozens of letters like the following are received every day by the Merke Institute)

"In the short time I have used your treatment I have gained remarkable results. Dandruff has disappeared entirely. My scalp is now all full of fine new hair. I would not part with my treatment for 10 times its cost." A. W. B.

"The top of my head is now almost covered with new hair about one-half inch long. I have been trying five years, but could never find anything to make my hair grow until your treatment." T. C.

Entirely New Method

My treatment is the result of 17 years of experience gained in treating thousands of cases of baldness. This included many long years in such famous centers of scientific research as Heidelberg, Berlin, Paris, Geneva, and Buenos Ayres. My method is entirely different from anything known or used before—no massaging—no singeing—no "mange cures"—no unnecessary bother of any kind. Yet results are usually noticeable even after the very first treatments.

My treatment proves that a big percentage of baldness is caused—not by dead hair roots—but by dormant hair roots, which can now be awakened and made to grow hair again. The reason other treatments failed is because they did not penetrate to these dormant roots. To make a tree grow you would not rub "growing fluid" on the bark. Instead you would get right to the roots. And so it is with the hair. In all the world there is only one method I know about of penetrating direct to the roots and getting nourishment to them. And this is embodied in the treatment that I now offer you on my guarantee of satisfactory results, or no cost.

Already great numbers of men and women who only recently were bald or troubled with falling hair have, through this method, acquired healthy hair that is the admiration of all their friends. As for dandruff, this in many cases disappears so quickly that it seems almost magical. The treatment can be used in any home in which there is electricity.

Free Booklet Explains Treatment

If you will merely fill in and mail the coupon below I will gladly send you—without cost or obligation—an interesting 32-page booklet, describing my treatment in detail.

This booklet contains much helpful information on the care of hair—and in addition shows by actual photographs what my treatment is doing for thousands of others.

No matter how bald you are—no matter if you are completely bald, this booklet will prove of deepest interest to you. So mail the coupon now—and it will be sent you by return mail.

Allied Merke Institutes, Inc.

512 Fifth Avenue, Dept. 162, New York City

Allied Merke Institutes, Inc.
Dept. 162, 512 Fifth Avenue, New York City

Please send me, without cost or obligation on my part, a copy of the new booklet describing in detail the Merke Institute Home Treatment.

Name.....
(State whether Mr., Mrs. or Miss)

Address.....

City..... State.....





A Pinning Hold

That Makes An Opponent Helpless

This is one of the greatest of all holds practiced in wrestling. You have your opponent's right arm barred with your left hand and his left arm barred with a leg scissor hold. He is helpless. It is a good hold for self-defense, where you might wish to hold your man under control for some time. Try it on your brother or a friend today and see how completely you have him in your power.



Wrestling Secrets

Revealed by Champions Frank Gotch and Farmer Burns

This picture illustrates only one of thousands of wrestling holds which vary from simple grips to the deadly strangle hold. How would you like to know them all?

This is precisely what you can do! You may learn the regular holds—the blocks and breaks for them—many secret tricks never revealed before—all from two of the greatest world's champions who ever lived—Frank Gotch and Farmer Burns!

Written instructions, telling you exactly what to do, and large clear photographs, showing you exactly how to do it, will make you as much these champions' pupil as if they were by your side.

Vigor—Endurance—Bravery!

These lessons will train you speedily to be an athlete, a wrestler, a man! Wrestling breeds quickness, vigor, endurance, bravery—all the manly qualities men defer to and women admire. It develops every muscle in your body. It gives you poise. Be vigorous, successful, self-reliant! Wrestling will help you. Do not put it off. **Begin Today!**

Farmer Burns School

1772 Railway Exchange Bldg., Omaha, Neb.

Please send at once, without any obligation on my part, your free book on **Scientific Wrestling, Physical Culture, Self-Defense and How to Win.**

Name

Address

Age

Free Book!

Send Coupon

The first step is to send the coupon for Farmer Burns' free illustrated wrestling book. It is packed full of information about wrestling and wrestlers. Valuable tricks are shown. A book that every boy should have. You will be under no obligation. The book is free. Just put your name and address in coupon and mail now. Be sure to give age.

FARMER BURNS SCHOOL
1772 Ry. Exchange Bldg., Omaha, Neb.

What Others Say:

"I threw a fellow who was older and weighed 20 pounds more than I did. He could throw me easily before I took your lessons."—Billy Jones, South Dakota

"Your course saved my life. A highwayman tried the 'hold-up' stunt on me with a pistol, but I successfully took the gun away from him with the trick shown in the sixth book of lessons."—D. B. Cox, Alabama.

"I have won everyone of eighteen contests since completing your course. All my opponents were heavier."—J. Malcevic, New York.

LEARN Penmanship

I Teach Penmanship by Mail

Small Cost. Spare Time. Write for my Free Book, "How to Become an Expert Penman." It contains specimens and tells how others became expert writers by the Tevis Method. Your name written on card if you enclose stamp. Write Today.

T. M. TEVIS, Box 25K, CHILlicothe, MO.



LEARN WATCHMAKING

and become independent. Good-paying positions secured.

Easy to learn. Send for FREE CATALOG.

ST. LOUIS WATCHMAKING SCHOOL, Dept. 5, ST. LOUIS, MO.

ART SUPPLIES

giving prices on all kinds of practical ART SUPPLIES. PENCRAFT SUPPLY SERVICE, Dept. P, 949 Broadway, NEW YORK CITY

ELECTRICITY HANDBOOK

HERE'S just the book on Electricity that you need to answer your many questions—to solve your knotty problems, to teach you new kinks, to be your memory for tables, rules, formulae, and other Electrical and Mechanical facts. Contents:—

Electricity and Magnetism; Batteries; Circuits; Magnets; Direct and Alternating Currents; Dynamos and Motors; Belts; Shafting; Electroplating; Electrical Measurements; Meters; Arc and Incandescent Lamps; Mercury-Arc Rectifiers; Transformers; Insulation; Electric Cars; Single and Multiple Unit Control; Transmission; Weights and Measures; Chemistry; Properties of Metals.

Just slip a dollar bill into an envelope and mail it with the coupon to the International Correspondence Schools, Box 5584-D, Scranton, Pa. This 414-page Electrical Handbook will come to you by return mail.



Only \$1

238 ILLUSTRATIONS
414 PAGES

INTERNATIONAL CORRESPONDENCE SCHOOLS
Box 5584-D, Scranton, Penna.

I enclose One Dollar. Please send me—post-paid—the 414-page I. C. S. Electrical Handbook. It is understood that if I am not entirely satisfied I may return this book within five days and you will refund my money.

Name

Address

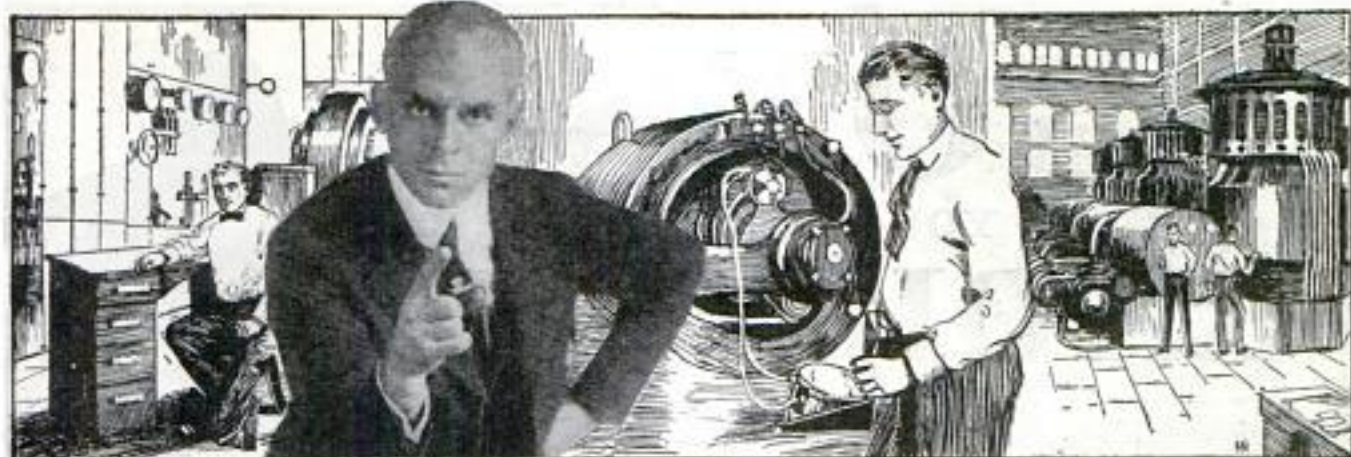

Electricity Needs You

I WILL TRAIN YOU AT HOME

Stop right here. This is YOUR opportunity! Electricity is calling you, and the Electrical Business is in for a tremendous increase. But it needs more trained men—at big pay. By my Home Study Course in Practical Electricity I can train you for these positions.

FREE!

BIG ELECTRICAL OUTFIT

A fine outfit of Electrical Tools, Instruments, Materials, etc., absolutely FREE to every student. I will also send you FREE and fully prepaid—Proof Lessons to show you how easily you can learn Electricity and enter this splendid profession by my new, revised and original system of Training by Mail.

RADIO COURSE FREE

Special newly-written wireless course worth \$45.00 given away free. Full particulars when you mail coupon below.

Earn Money While Learning

I give you something you can use now. Early in my Home Study Course I show you how to begin making money in Electricity, and help you get started. No need to wait until the whole course is completed. Hundreds of students have made several times the cost of their course in spare time work while learning.

Earn \$70 to \$200 a Week

You've always had a liking for Electricity and a hankering to do electrical jobs. Now is the time to develop that talent; there's big money in it. Even if you don't know anything at all about Electricity you can quickly grasp it by my up-to-date, practical method of teaching. You will find it intensely interesting and highly profitable. I've trained and started hundreds of men in the Electrical Business, men who have made big successes. YOU CAN ALSO

Be a Big Paid ELECTRICAL EXPERT

What are you doing to prepare yourself for a real success? At the rate you are going where will you be in ten years from now? Have you the specialized training that will put you on the road to success? Have you ambition enough to prepare for success, and get it?

You have the ambition and I will give you the training, so get busy. I am offering you success and all that goes with it. Will you take it? I'll make you an ELECTRICAL EXPERT. I will train you as you should be trained. I will give you the benefit of my advice and 20 years of engineering experience and help you in every way to the biggest, possible success.

Valuable Book Free

My book, "How to Become an Electrical Expert," has started many a man on the way to fortune. I will send a copy, free and prepaid, to every person answering this advertisement.

Act Now! Good intentions never get you anywhere. It is action, alone, that counts. NOW IS THE TIME TO ACT.

L. L. COOKE, Chief Engineer
**CHICAGO
ENGINEERING
WORKS**

2150 LAWRENCE AVENUE
Dept. 512 Chicago, U. S. A.

Chief Engineer Cooke
Chicago Engineering Works
Dept. 512, 2150 Lawrence Avenue
CHICAGO, ILL.

Dear Sir: You may send me, entirely free and fully prepaid, a copy of your book, "How to Become an Electrical Expert," and particulars about your Home Study Course in Electricity and the Free Radio Course.

Name.....

Address.....

City..... State.....

BOYS!

DO YOU WANT THIS RADIO SET?

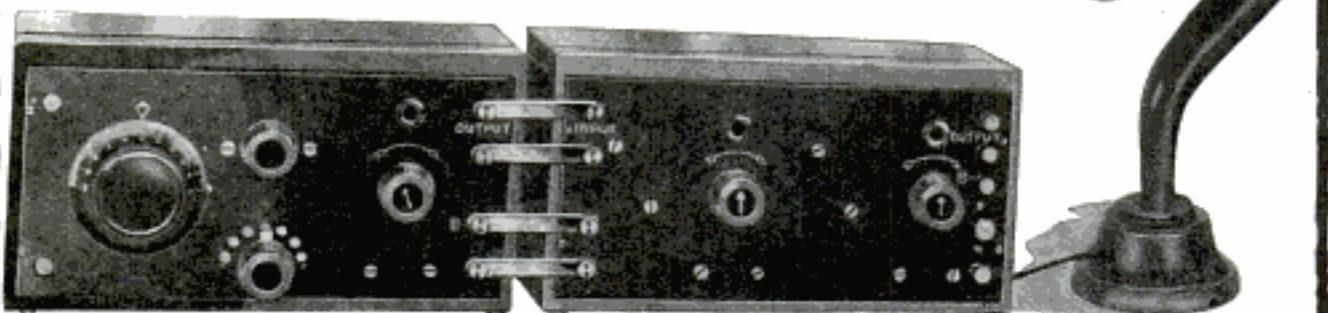

Of course you do, so that you can pick up any broadcasting station within a radius of from 1,200 to 1,800 miles. You can secure one of these sets, *easily and quickly*, by acting as our representative in your community. This set is one of the best on the market, of the two-step amplifier type, and

ALL EQUIPMENT IS SUPPLIED

**We Make an
UNUSUAL
OFFER**

to Boys who already
have a receiving set
and want a Loud
Speaker.

(batteries, tubes, head phones, insulators, and antenna), so that you will not have to buy a single part; even a high-grade

Loud Speaker Is Included

If any boy wants only the One-Tube Detector unit of this set, it can be his for a few hours' work during his spare time.

Fill out and mail us attached coupon immediately for our

SPECIAL RADIO SET OFFER TO BOYS

**POPULAR MECHANICS MAGAZINE,
Room 408, 200 East Ontario St., CHICAGO**

Please send me, without obligation, full particulars about your SPECIAL RADIO SET OFFER TO BOYS.

Name

Street

City State

Popular Mechanics building is devoted exclusively to the production of this great magazine.



In Every Corner of the Earth

*Science is Watching and
Working to Disclose the Secrets
of Nature*

Out on the deserts of Egypt and in the dense jungles of the tropics—high up in the mountain observatory, and down on the deep sea bottom—amid the perils of Arctic exploration and in the quiet of the laboratory—everywhere science carries on its quest for the key to Nature's mysteries. And out of these great adventures has come the most thrilling romance in the world—the story of man's conquest of the Universe through his amazing scientific achievements.

At last this romance is yours—told for the first time in one flowing story that throws open to you the whole wonder world of science.

A Striking Book Free for You

*That tells the Whole
Amazing Story of—
The Outline of Science*

Because every man, woman, and child in America ought to know about this epoch-making work, the publishers have prepared, for free distribution, a most interesting and strikingly illustrated brochure that tells the wonderful story of *The Outline of Science*. With four plates in full color and over thirty half-tone pictures of scientific marvels it shows how this splendid work tells of all the miracles of science since the beginning of time—how it reveals for you The Romance of the Heavens; Man's Rise From His Earliest Ancestry; Marvels of Insect, Plant, Animal, and Bird Life; Miracles of Electricity, of Chemistry, of Aviation, and a thousand more things of absorbing interest.

Here, indeed, is the most amazing story ever written—the cream of the world's scientific genius. Don't fail to get your copy of this splendid booklet with its remarkable story and fascinating pictures. It entails no cost or obligation on you whatever. The coupon brings it immediately. Mail it now.

G. P. PUTNAM'S SONS

Dept. 217

2 West 45th Street

New York

This Coupon Brings Your Copy

G. P. Putnam's Sons, Dept. 217
2 West 45th Street, New York

Send me by mail, without cost or obligation on my part, the free booklet with four color plates and over thirty half-tone illustrations, describing *The Outline of Science*.

Name.....

Street and No.....

City and State.....

Occupation.....

\$90 Drafting Course FREE

**\$300 a Month Salary—
\$450 on the Side at Home**



Chief Draftsman Dobe

That's the kind of money my drafting students make. Read what this one says:
"As a beginner I am doing fine. Am earning a salary of \$300 per month, besides I made over \$450 at home the last two months, drawing plans for private parties. The practical drafting training you gave me by mail put me where I am in less than six months' study. Thank you for all your personal interest and help you gave me so far."

—(Signed) J. B. (Name and address upon request).

I Guarantee to Train You
until you are holding a position paying
up to \$250 and \$300 a month!

I do this by a method that is entirely original with me. I give you personal training at home by mail until you are actually placed in a position paying up to \$250 and \$300 a month. Write for full particulars.

Drawing Table FREE!

I am giving this practical folding Chief's Own drawing table to each of my students positively without cost. I am making this offer to get men everywhere interested in the great future which a draftsman has. More draftsmen are in demand today—right now—than ever before. It has been estimated that there are 6,000 calls for draftsmen every month.

So, I want students to enroll early.

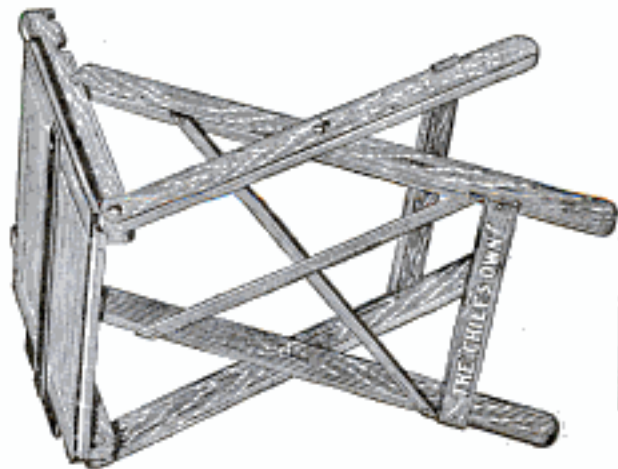

Pocket Rule FREE!

To everyone who writes now for the offers which I am making, I will send this Ivorine pocket rule free. All you need tell me is that you are more than 16 years old and that you are interested in becoming a draftsman. I want you to have this reminder of the great future which will be in store for you if you become a draftsman.



Drawing Outfit FREE

To every student enrolling now I give an opportunity also of getting a regulation draftsman's outfit made up of the very same instruments which I use myself. The outfit contains everything necessary for the performance of your work in drafting. Every student gets this splendid set without cost. I am making this splendid offer because all men who want to become draftsmen working under fine, clean conditions and with opportunities for fast advancement should enroll NOW!



Chief Draftsman, Engineers' Equipment Co.
1951 Lawrence Ave., Div. 13-52, Chicago, Ill.

Without any obligation to me please mail your book "Successful Draftsmanship" and full particulars of your liberal "Personal Direction" offer to a few students. Also full information as to how I can get a \$90 Drafting Course Free.

Name.....

Address.....

Age.....

← Send Coupon

Send coupon for my free book, "Successful Draftsmanship". Also full information as to how you can get a \$90 Draftsman's Course Free. Send coupon now for free book.

Chief Draftsman, Engineers' Equipment Co. Div. 13-52, Chicago, Ill.

Why haven't
you
clipped this
coupon

TEAR OUT HERE

INTERNATIONAL CORRESPONDENCE SCHOOLS
Box 5579-D, Scranton, Penna.

Without cost or obligation, please tell me how I can qualify for the position or in the subject before which I have marked an X:

BUSINESS TRAINING COURSES

- | | |
|--|---|
| <input type="checkbox"/> Business Management | <input type="checkbox"/> Salesmanship |
| <input type="checkbox"/> Industrial Management | <input type="checkbox"/> Advertising |
| <input type="checkbox"/> Personnel Organization | <input type="checkbox"/> Better Letters |
| <input type="checkbox"/> Traffic Management | <input type="checkbox"/> Show Card Lettering |
| <input type="checkbox"/> Business Law | <input type="checkbox"/> Stenography and Typing |
| <input type="checkbox"/> Banking and Banking Law | <input type="checkbox"/> Business English |
| <input type="checkbox"/> Accountancy (including C.P.A.) | <input type="checkbox"/> Civil Service |
| <input type="checkbox"/> Nicholson Cost Accounting | <input type="checkbox"/> Railway Mail Clerk |
| <input type="checkbox"/> Bookkeeping | <input type="checkbox"/> Common School Subjects |
| <input type="checkbox"/> Private Secretary | <input type="checkbox"/> High School Subjects |
| <input type="checkbox"/> Spanish <input type="checkbox"/> French | <input type="checkbox"/> Illustrating <input type="checkbox"/> Cartooning |

TECHNICAL AND INDUSTRIAL COURSES

- | | |
|---|--|
| <input type="checkbox"/> Electrical Engineering | <input type="checkbox"/> Architect |
| <input type="checkbox"/> Electric Lighting | <input type="checkbox"/> Blue Print Reading |
| <input type="checkbox"/> Mechanical Engineer | <input type="checkbox"/> Contractor and Builder |
| <input type="checkbox"/> Mechanical Draftsman | <input type="checkbox"/> Architectural Draftsman |
| <input type="checkbox"/> Machine Shop Practice | <input type="checkbox"/> Concrete Builder |
| <input type="checkbox"/> Railroad Positions | <input type="checkbox"/> Structural Engineer |
| <input type="checkbox"/> Gas Engine Operating | <input type="checkbox"/> Chemistry <input type="checkbox"/> Pharmacy |
| <input type="checkbox"/> Civil Engineer | <input type="checkbox"/> Automobile Work |
| <input type="checkbox"/> Surveying and Mapping | <input type="checkbox"/> Airplane Engines |
| <input type="checkbox"/> Metallurgy | <input type="checkbox"/> Navigation |
| <input type="checkbox"/> Steam Engineering | <input type="checkbox"/> Agriculture and Poultry |
| <input type="checkbox"/> Radio | <input type="checkbox"/> Mathematics |

Name.....

Street.....

Address..... 11-21-23

City..... State.....

Occupation.....

Persons residing in Canada should send this coupon to the International Correspondence Schools Canadian, Limited, Montreal, Canada.

\$50-\$300 a Week



Paint Cars in Auto Plants



Repaint Cars For Dealers



Own Your Own Shop



Be Head of Big Business

You, too, can make this by learning the highest paid work in the whole motor car industry—Auto Painting. Over 2,000,000 new cars each year—13,000,000 cars in use need repainting in 12 months. Only trained men can do this. Factories, dealers, custom shops, all bidding for men. Demand exceeds supply everywhere.

We Fit You for Big Pay in Few Weeks
This thoroughly equipped school—approved by big auto plants—teaches you in 8 to 12 weeks. Personal instruction by experienced, practical auto painters. Every branch covered, including big-money specialties—stripping and lettering. Go right from here to position. You can hold high-pay job or run your own shop—be the head of big business.

Get Facts Today

Write us today for facts about this wonderful trade and our methods. Don't delay! This is the greatest opportunity in any industry. Demand is growing faster than supply. Write today for details—then you be the judge.

Detroit Auto Painting School
1405 Van Dyke Ave. Detroit, Mich.

LAW STUDY AT HOME
Become a lawyer. Legally trained men win high positions and big success in business and public life. Greater opportunities now than ever before. Lawyers earn \$3,000 to \$10,000 Annually. We guide you step by step. You can train at home during spare time. Let us send you records and letters from LaSalle students admitted to the bar in various states. Degree of LL.B. conferred. Thousands of successful students enrolled. Low cost, easy terms. We furnish all text material, including fourteen-volume Law Library. Get our valuable 120-page "Law Guide" and "Evidence" books FREE. Send for them—NOW.
LaSalle Extension University, Dept. 264-L, Chicago, Ill.



WE GIVE YOU

THIS BEAUTIFUL WRIST WATCH for only a few minutes' time each day disposing of 24 elegant large pictures at 25c each in connection with our great magazine. Pictures are 16 inches high and 20 inches wide. Many people will take four or five. They are so beautiful. We give credit and guarantee satisfaction. Write today. MOTHER'S-HOME LIFE, 630 W. Jackson Boulevard, Dept. 1772, Chicago, Ill.



WANTED MEN AND WOMEN TO LEARN PHOTOGRAPHY!

Photographers and Photo-Engravers earn \$200 to \$500 a month. The field is uncrowded. Learn these profitable and fascinating professions. Taught by largest and best college of its kind in the world. Established over 30 years. Demand for our graduates far exceeds supply. Good positions secured. Tuition and living expenses low.

Get this FREE Book! Write today for free beautifully illustrated book describing wonderful opportunities in this field.

Illinois College of Photography, Box 424, Effingham, Ill.

"THE AIR IS FULL OF THINGS YOU SHOULDN'T MISS"

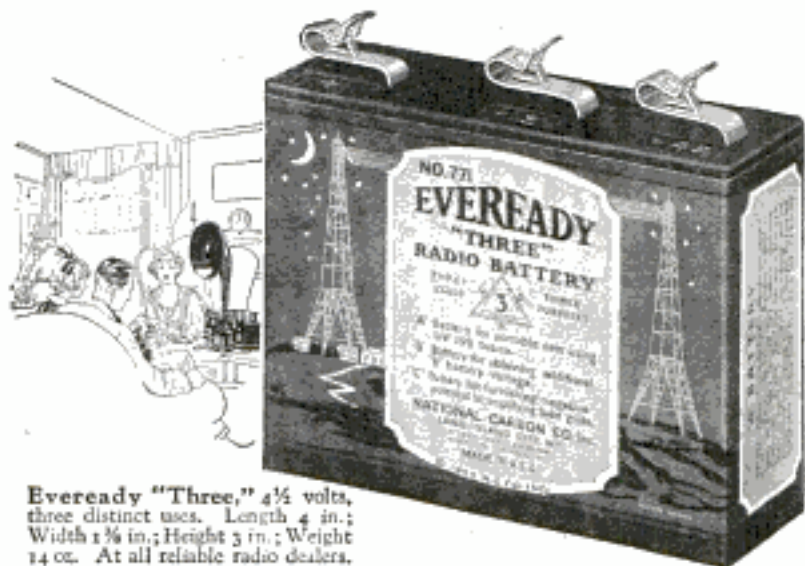

Eveready "Three," $4\frac{1}{2}$ volts, three distinct uses. Length 4 in.; Width $1\frac{1}{2}$ in.; Height 3 in.; Weight 14 oz. At all reliable radio dealers.

This "C" Battery is a Wonder Worker

YOU can make the loud speaker respond with a new fullness and naturalness of tone. You can save money by adding months to the life of your "B" Batteries. These things you can do by using the new Eveready $4\frac{1}{2}$ volt "Three" as a "C" Battery.

You already have an "A" Battery for the filament and a "B" Battery for the plate. A "C" Battery is connected to the third element of your vacuum tube, the grid, affording a control that is marvelous in action on audio frequency amplifiers.

As a "C" Battery the Eveready "Three" prevents distortion and excessive flow of current from the "B" Battery, lengthening its life. It is a wonder worker that saves its small

cost many times over. Connect it in your audio frequency amplifier and note the difference. Full directions on the label and in "How to Get the Most Out of Your 'B' Battery," a booklet on "B" and "C" Batteries, sent free on request.

This triple-use battery can also be used as an "A" Battery in portable sets. Light and full of pep. Its third use is as a "B" Battery booster.

Use the Eveready "Three"—a tested product of the world's leading electro-chemical battery laboratory. It serves more radio uses and effects more economies than any radio battery heretofore developed.

If you have any battery problem, Radio Battery Information Headquarters will solve it for you. Write G. C. Furness, Manager, Radio Division, National Carbon Company, Inc., 207 Manley St., Long Island City, New York.

NATIONAL CARBON COMPANY, Inc., New York and San Francisco
Headquarters for Radio Battery Information

CANADIAN NATIONAL CARBON CO., Limited. Factory and Offices: Toronto, Ontario

EVEREADY
Radio Batteries
—they last longer

4335

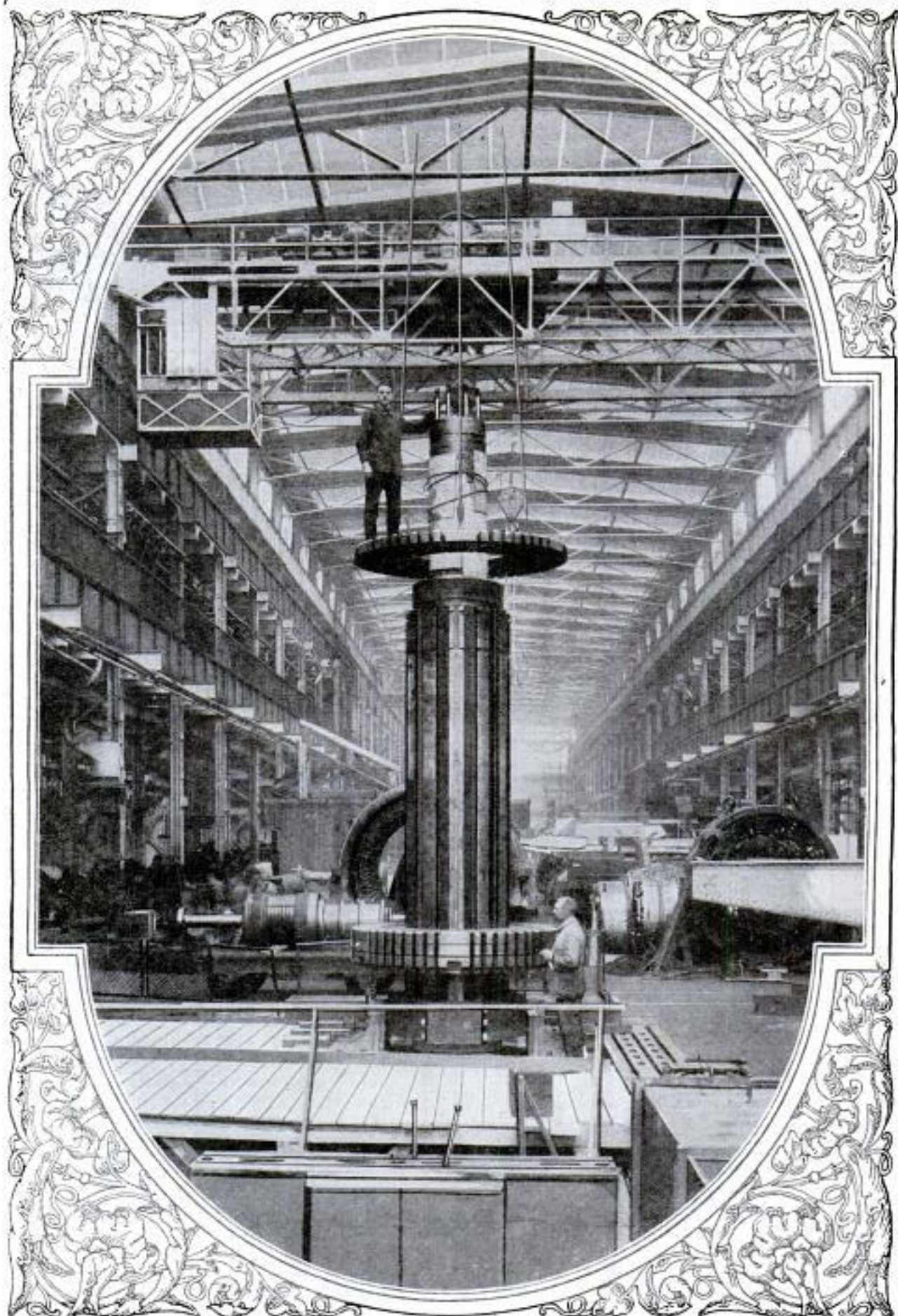

Putting the Finishing Touches on a Great Turbine Shaft in a German Erecting Shop—a Real, Man-Sized Task, Calling for the Highest Degree of Skilled Craftsmanship

Popular Mechanics Magazine

REGISTERED IN U. S. PATENT OFFICE

WRITTEN SO YOU CAN UNDERSTAND IT

Vol. 41

FEBRUARY, 1924

4335

No. 2



Army of Craftsmen Bulwark of Nation

By JAMES J. DAVIS

United States Secretary of Labor

Washington, D.C.



THE dignity of labor has been the subject of unusual discussion ever since the time of the carpenter of Nazareth.

But, due to false ideals, misguided conceptions of service, and wrongly interpreted ambitions, today the desire of many to enter the trades is being thwarted by a mistaken impression that work of the hands is to be despised.

This has resulted in an increasing drift toward "white collar" occupations. Even some professions are being overcrowded with young aspirants who possess inherent, but suppressed, tendencies toward lines of endeavor that require the utensils of the artisan rather than the "book learning" of higher education.

Craftmanship is a vital need of the nation. More than 90 per cent of our popu-

lation is made up of farmers and industrial workers. Less than 10 per cent, it has been pointed out, are in professional life. And yet, while millions are being spent for education, little of it is going to teach boys to use their hands in a useful way.

Why train 100 students for professional activities, when only one in every ten can possibly hope to make an adequate living in these lines? Probably this is due to false pride and the idea that work with the hands is menial and degrading. And yet it is upon the flannel-shirted army of hand toilers that the responsibility ultimately rests for the nation's property and social and economic progress.

With the restriction of emigration, the opportunities offered by the trades are greater now than ever before. While there is an oversupply of slide-rule engineers and bookish lawyers, every craft is crying for workers and apprentices at record-breaking wages. For instance, in 1910, according to government figures, there were 817,120 journeyman carpenters in this country and 6,069 apprentices—136 journeymen to each apprentice. Ten years

later there were 887,000 journeymen to 4,805 apprentices. As the population of the country increased 15 per cent during the same period, it is clear that the carpenter's trade is losing ground, although wages have been more than tripled. Then again the introduction of materials exterior to the woodworkers' calling into the building industry may help to cause the decrease. But, the crying need of the market for such craft contradicts that, in a measure.

With plasterers, the finished craftsmen numbered 47,682 in 1910 and dropped to 38,225 in 1920—a loss of 9,457 workers. And here change of material has not affected the demands for skill. On the other hand, with demands for brick and stone masons constantly increasing, there was a loss of 38,138 men from 1910 to 1920. Painters, glaziers, and varnishers doing building work also showed losses. The single exception to this situation was in the electrician's craft where the number of workers increased from 120,155 a decade ago to 212,964. Here the general growth of electricity has added the recruits to the ranks. Factory and household, and railroad and marine transportation afford to it a marvelous field that appeals because of its problems and possibilities.

Probably there will always be those who believe in letting their brains keep their hands soft, even at an economic loss, forgetting the age-old truth that man has always been blessed in the work of his hands. Carnegie started as a telegraph messenger boy. Edison was a train

"butcher." Schwab carried water in a steel plant. Ford was a stationary engineer and a machinist. Lack of a college education, or so-called "higher learning" did not stop their rise to fame, fortune, and riches. Nor did it interfere to any visible degree with the accomplishments of such men as Luther Burbank.

With libraries, night schools and correspondence courses everywhere available, no youth need feel handicapped by the lack of university training, because, with proper industry and ambition, he can obtain its equivalent and at the same time get an earlier start in the race toward success and worthwhile achievement. What the world needs is practical men—workers who can supply the constantly increasing demands of civilization.

To the adventurous, even, manual toil offers thrills which rarely come to men outside of the labor world. Who will deny that all the daring, all the sensations, and all of the delights of the professional mountain climber, are not experienced every day in the life of the structural iron worker who looks down upon us from a perch on a lofty steel skeleton of a big city sky-scraper? Who among us would not give a great deal to feel the throb of the giant engine that lifts tons of stone and timber, in the twinkling of an eye, to the men with hammers and trowels, plying their trades up near the clouds. To the man on the street, it is a breathless moment as the heavy mass goes sailing upward, yet, the stationary engineer who controls the lever of the hoist by dint of training and experience, commands the movement that elicits the onlookers' praise.

Romance awaits the recruit to the service of the hands. Therein lies happiness, a gratifying return in consciousness of power to create beauty from the rough, and a remuneration never before equaled in the history of toil. Freedom of body and soul are there, too. With the merry din and rattle of the tools of manual labor, there comes peace to the mind, leaving it to dwell full on the task, and exercise of the body fabric is reflected in better health, clearer eyes, and more ruddy cheeks than has he who has given himself to confined effort of mind alone within the narrow walls of an office.

In the trade school, the young man who loves mechanics will obtain a foundation upon which to build a career that will be of the greatest value. He will acquire dexterity in the use of tools and a knowledge of the operation of trade machinery. He will obtain a knowledge of trade theory and of drawing. With these advantages, he



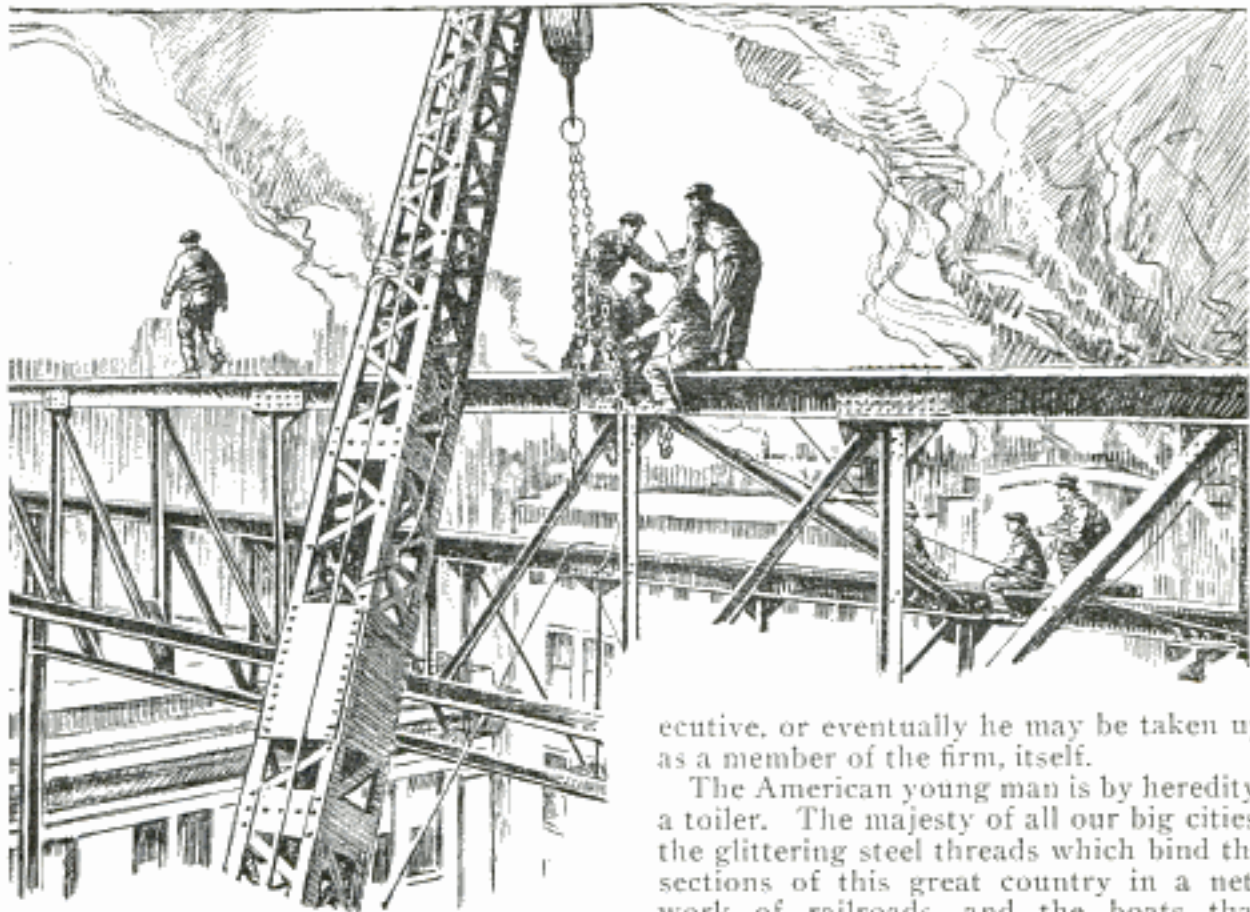

will be of real value to his employer from the outset. Speed of execution and facility come only with the experience obtained in actual trade employment. An alert mind in command of dexterous hands is a factor that defies defeat. Attainment of its object, is merely a matter of time and application. Couple with this, then, natural business qualities, and they are frequently found in the trades, and we have a combination that halts only when the highest rung of the ladder has been reached.

If the young man does not take a trade-school course, the chances are that he will have to "pick up" his trade as best he can during an apprenticeship period, because the employer does not have the time to personally supervise his training and the foreman or workman under whom he works may have no personal interest in seeing that the apprentice becomes a good mechanic. Thus, it is likely that he will be kept at one kind of work indefinitely, and by the time he has served his time, he will be more of a specialist than an all-around workman.

While all of the skilled trades offer excellent livelihoods to the expert and dependable mechanic, advancement is certain if he has or acquires the ability to direct other men and lay out work. In the latter case he may become a foreman or an ex-

ecutive, or eventually he may be taken up as a member of the firm, itself.

The American young man is by heredity, a toiler. The majesty of all our big cities, the glittering steel threads which bind the sections of this great country in a network of railroads, and the boats that plow their way through the rivers, are but the labors of our fathers. Wherever man has placed one stone upon another or riven log upon log, there is an expression of the greatness and dignity of the work of the hands.

In Egypt, great pyramids of stones, colossal in size, have defied the warring elements of time, and have communicated to modern civilization a silent counsel from a once lordly people, a race that worked with its hands. What if these massive piles of hewn and joined rock were raised to memorialize the pomp of dead rulers? Labor built them. And it is of labor that the observer thinks when he contemplates their mysterious origin after thousands of years in the midst of barren wastes whose very atmospheres are painful to ordinary men.

During the past few generations we have built the best system of schooling that has ever been devised. But in spite of our tremendous strides, we have allowed the convictions to grow, that education is a substitute for work, rather than a tool to work with; that merely a good education should provide the means of life and happiness. The dire conviction that an education unfits a man for work that must be done with his hands has been permitted in the very face of a world that is crying aloud for doers.



The educational advance has been rapid, but it has been all in one direction. The practical need has almost been ignored, and excluded in mistaken efforts toward absorption of classical knowledge.

The ultimate end, with such a system, if it be permitted to continue without correction, would be the creation of a nation where every citizen would have the learning of books, and none would have the learning of the hands which is vital to the progress and prosperity of any country. The American artisan, when he is properly trained, excels in every way the efficiency of the natives of every other nation. However, there is no reason why proper attention should not be paid to both the hand training and the education of mind, combining both to the end that one can help and direct the other.

Now that labor of the hands has risen to monetary value beyond the fondest dreams of workmen of a half-century ago, material reward is assured the beginner who enters upon a career of manual toil. He first should have primary instruction in the needs of the everyday man as a foundation for the more serious task of ab-

sorbing knowledge of greater and more immediate return. His way should be chosen in keeping with his proclivities and natural leanings. If woodworking, such as cabinet making, appeals to him, steps should be taken to provide him with the instruction that promotes early progress in the art. If it is steel that calls to him, a chemical course of sufficient volume should be accorded him to acquaint him with the fabrication of that metal. In short, the idea should be to place the student-apprentice on familiar terms with the material he chooses as a background for his career. Stone, brick, wood, paper, and cement all have wonderful stories for the youth who allies himself with them. And what better can be done for the eager mind than to permit the laboratory and the school to impart this preliminary information? Armed with these romantic histories that daily grow in marvel, the energy of mind is augmented by the abilities of the hands in the shaping of the masses into beauty of architecture and strength of commercial and industrial equipment.

It is but a step from the exercise of genius to the sweat of the brow. The "white collar" and the "boiled shirt" should not beguile youth, falsely, from the thrum of industry and the strident song of steel and wood. The man of labor has not attained dignity—he never lost it. His march is still upward. The overall remains a royal raiment and as Solomon of old called to the King of Tyre for skilled artisans to raise temples toward the heavens, so today does the world cry out for the denim-clad doers—blessed workers with hands.

James J. Davis



adobe 12/7/23

HOUSE WALLS OF PACKED SOIL MAY REDUCE BUILDING COST 4402

Revival of the use of earthen walls for houses, a practice known several thousands of years ago, may greatly reduce the cost of homes of today, is the opinion of a government scientist studying the process. Such structures are made of earth tightly packed and "cure" in a short time. The method, he says, produces a building that is not only sturdy in construction but is warm in winter and cool in summer. Houses erected of soil have been known to become so strong in a few months, that to cut openings in the earthen wall required the same tools used to penetrate rock. Structures of the kind put up 200 years ago have practically turned to stone, in imitation of the work of nature in forming hard substances from exertion of great pressure on sand and clay mixtures. "Rammed earth," as the material is called, needs little treatment and can be prepared by unskilled persons. Its cost is but a fraction of that of brick, wood, or concrete.

TOY BALLOON TRAVELS FOUR DAYS OVER ATLANTIC 4354

A small balloon floating in the Atlantic Ocean several miles off Pemaquid Light, Maine, was discovered by the editor of this magazine while on a recent cruise.

The balloon which was about two-thirds its original size, bore the legend, "Souvenir Cortland County Fair, 1923." As there is no county by that name in Maine, Mayor Hollister, of Cortland, N. Y., was written to among other Cortlands, and the fact was mentioned in

a local newspaper. As a result correspondence was had with Mr. and Mrs. O. W. King of that city, ending in the identification of the balloon and the tag attached to it as undoubtedly the one which had escaped from the hands of their four-year-old daughter, at the fair. The balloon was picked up on the afternoon of August 25, 1923, which was almost four days after its escape, during which time it must have traveled at least 300 to 400 miles. It now rests in this magazine's museum.



CHURCH WITH FOLDING STEEPLE AND RADIO RUNS ON WHEELS 4336

For doing missionary work in out-of-the-way places a miniature house of religious worship has been mounted upon the



Church on Automobile Chassis that Has Folding Spire and Radio for Its "Congregations"

chassis of an automobile. This little traveling temple is fully equipped with everything that can further its mission: radio, for the entertainment of the audience, a drop platform for the minister, and a collapsible spire terminating in a cross which is lighted at night by electricity generated in a storage battery. It is nondenominational in its teachings.

RUBBER HEEL TO HELP ARCHES HAS BALL-CUSHION TREAD 4050

To support the arches and give spring to the step, a rubber heel with a hollow ball cushion in the center of the tread has been made. The front is beveled toward the sole of the shoe, and is equipped with two small knobs, which are said to be helpful to those having trouble with the bones of the feet. Due to the perforations in the upper side, these articles are very flexible. They come in either brown or black stock.



More than 300,000,000 envelopes are expended in handling the business of the United States government each year.

Mr. H. C. Ho

Emb. A. N. Hollingsworth 168 Marlborough St Boston, Mass
Subscribed 9/7/28
Rubber Heel Co., Geo. N. Clark, Chicago
Copyrighted material

PHOTOS SENT THROUGH AIR BY RADIO OR OVER WIRE

4229

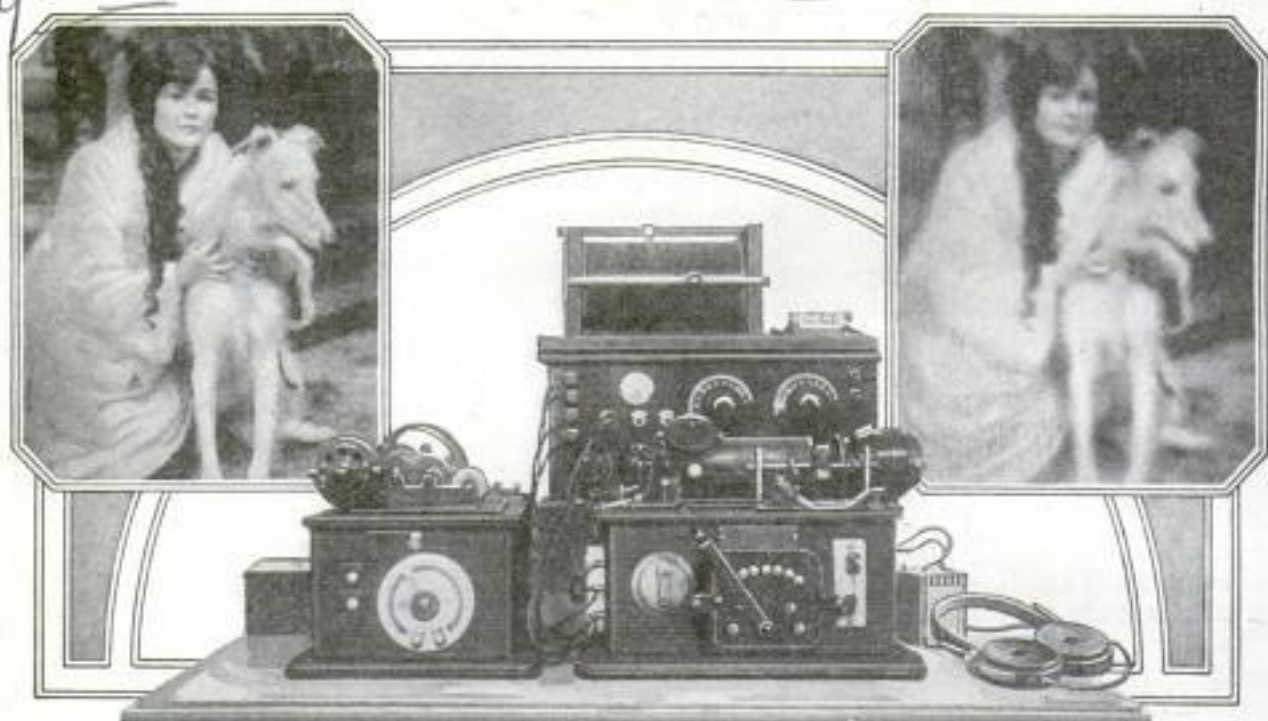

Picture, at Right, as It Appeared after Being Flashed through the Air by Radio, and, at Left, as It Originally Appeared. The Apparatus Used Is Shown in Center

Flashed through the air just as the radio broadcasts songs or stories, or dispatched over wires as messages are relayed by telegraph, photographs of important events or of criminals and their signatures or fingerprints may be sent hundreds of miles and exactly reproduced on an instrument perfected by an eastern newspaper man. The apparatus consists of two identical machines closely resembling radio sets, one for transmitting and the other for receiving. A zinc or copper print is prepared from the photograph, the lines running from left to right. This is

placed on the cylinder of the sending machine, made to revolve, and a needle passing over the surface opens and breaks an electric circuit. These impulses, flashed over a wire or broadcast through the air, are recorded on the receiving instrument, which has a cylinder revolving at exactly the same speed as that of the transmitter. The impressions are traced on chemically treated paper so that an exact duplicate of the original plate is obtained. The outfit is portable and has been used to send photographs 900 to 1,000 miles by radio and nearly 400 miles by wire.

*Sturbee - Atwood Co. } Milwaukee
40 Wilder St. } Minn.*

4220

Auto Access

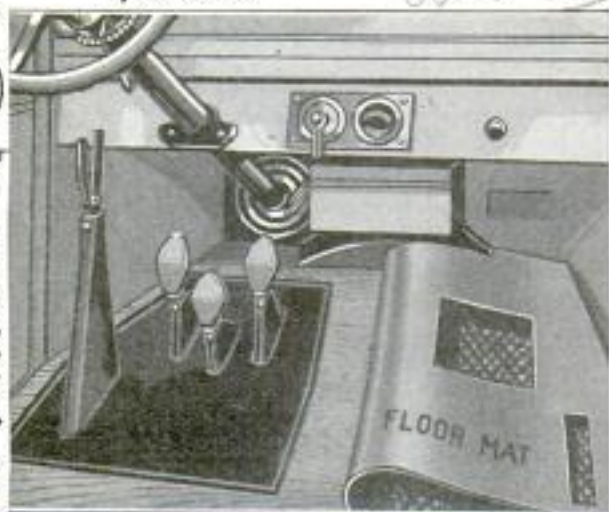

Snug Jackets Button Tightly Around Gear Pedals and Clutch to Keep Out Cold

PEDAL JACKET ON SMALL CARS EASES WINTER DRIVING

To prevent cold air, snow, and water from entering small cars through openings near the clutch and brake pedals, a jacket of soft rubber sheeting, which fits securely about the parts and under the regular floor mat, has been placed on the market. The covering is buckled quickly in place and does not interfere with the operation of the car.

Popular Mechanics Magazine does not publish the name of maker or seller of any device described in its pages, but this information is kept on file and will be furnished free by addressing our Bureau of Information.

4105 *Amos Martin L. Germany*
Simmons College, Abilene, Texas.

Pearl E. Robinson, Box 515,
SETTING "TYPE" FOR MUSIC TASK OF MACHINE
North Worth, Texas.



SEPARATE TYPE PIECES COMBINED INTO MUSIC STAFF
 VARIOUS CHARACTERS AND SYMBOLS OUTLINED



MANNER IN WHICH METAL TYPE LINES ARE MOUNTED ON THE MACHINE FOR PRINTING MUSIC COMPOSITION



METAL TYPE UNIT WITH DOUBLE STAFF

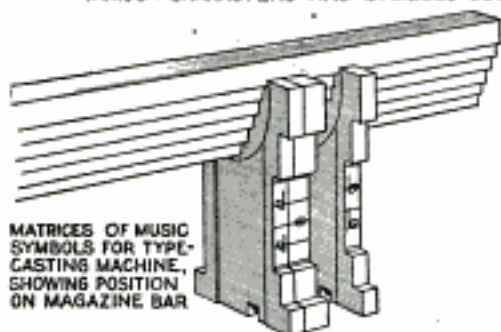

MATRICES OF MUSIC SYMBOLS FOR TYPE-CASTING MACHINE, SHOWING POSITION ON MAGAZINE BAR

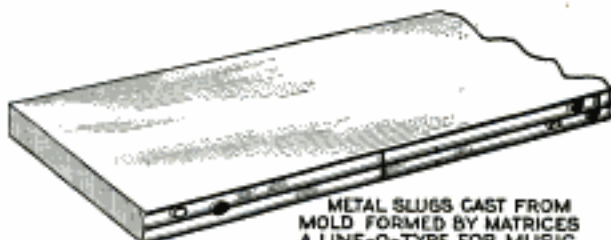

METAL SLUGS CAST FROM MOLD FORMED BY MATRICES A LINE-O-TYPE FOR MUSIC

Engraving costs and expenses in connection with the hand-setting of type characters for the printing of music are expected to be eliminated by a process that sets the notes and symbols in their required order as they come from a typesetting machine. After it has been "locked up," the form may be used either on a power press or adapted to one of the smaller hand devices, provided either has a curved cylinder on which the composition can be placed.

In spite of the fact that the hand process requires about 3,000 characters, it is claimed that the mechanical method will employ not more than 25. Each piece of type under the recent plan will consist of the symbol and the lines of the staff and will form a perfect union with those preceding and following it. Since the ordinary alphabetical characters seen on all typesetting machines will not be interfered with during the composing of the musical form, the words of the piece can be set at the same time, in position corresponding with their notes.

It is believed that the perfection of the machine music-setting system will open up a new branch of the printing industry, as well as permit a composer to publish his own matter. The number of copies that can be run off a form will be limited only by the life of the metal.

The characters are molded from the ordinary metal in use with typesetting machines, and are produced in the usual

"slug" shape. Where the rotary cylinder is to be used for printing, the characters are curved, with T-shaped flanges to fit in the grooves that hold them in position on the drum. The paper stock can then pass under the revolving form, or the cylinder can be made to move across the paper.

RED BACK OF THERMOMETER
4376 AIDS QUICK READING

With a broad strip of bright red glass back of the mercury-filled bore, a legible and accurate thermometer, now on the market, can be read at a glance. As the column of silvery liquid moves up or down, it hides or exposes the brilliant background. The temperature readings are plainly recorded at the bottom of the scarlet streak which contrasts sharply with the metallic gray of the fluid. The instrument is said to be more accurate than those with colored liquids of various kinds. The figures are large, and distinct, and can be seen from almost any angle, making it unnecessary to turn the device about in order to learn the reading. The red line extends from the top down to the bulb, and forms the rear of the channel of the tube.

With the largest lighthouse organization in the world, the United States maintains 16,373 aids to navigation

Amos M. L. Germany
1811 Pearl E. Robinson
North Worth, Texas
Brooklyn, N. Y.
C. J. Jaghobine
18-333 Thirty-third St.

*Samuel Karelitz, 1450 Fifth Ave.
New York City*

4349

4143 FOUR MONTHS TO CARVE CHAIN FROM BLOCK OF WOOD

Carved from one block of wood, a watch chain of complicated design has been turned out by an artist who spent four

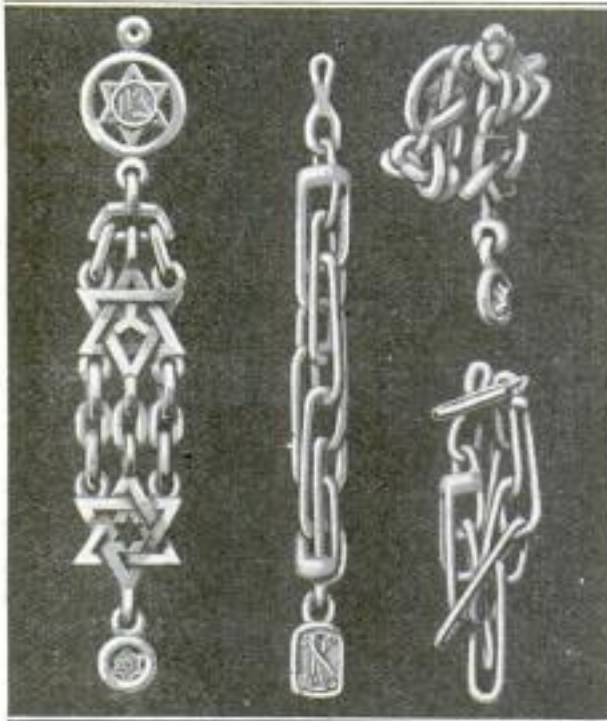

Watch Chains Carved from Single Pieces of Wood that Required Many Months to Complete

months on the task. Small enough to fit into the palm of the hand, it is perfect in every detail and without a single mark of a tool. Other similar chains required three weeks in the making. One of them carried a six-pointed star which interlocked with a double triangle and pendant.

4256 POCKET SEAL IN WATCH CASE HELPS PUBLIC NOTARIES



built into a strong, closed case, finished in gold plate over a heavy metal base.

As easily carried in the vest pocket as a watch, which it somewhat resembles, a seal has been made for public notaries and other officers whose duties compel them to take legal acknowledgments at a distance from their places of business. Replacing the usual bulky device, this convenience is

no price

LONG TELESCOPE FOR CAMERA TO LEARN STAR SECRETS

Accurate measurements, by means of a huge photographic telescope, 36 feet long, to determine the direction of the stars' movements, are planned by scientists of an eastern university. An expedition equipped with the tube, said to be the third largest in the world, is preparing to go to points in the southern hemisphere where atmospheric conditions will be favorable to the task. Included in the outfit is a camera with a 26-inch lens. Data to be obtained are expected to clear up some perplexing problems of the skies.

*Photo. Public Ledger
12/2/23*

3825 BIT FASTENED TO BLOWTORCH FORMS SOLDERING IRON

Fastening a detachable bit to the nozzle of a blowtorch now on the market, converts it to a soldering iron. The head can be placed either in a straight position or at right angles. Gasoline is used to produce the flame and is stored in the hollow handle. In order to protect the hands against excessive heat, the grip is composed of a perforated metal shell, which forms a cover for the fuel tank. The entire soldering head can be removed by loosening one screw, and unfastening another permits the point to be taken out.

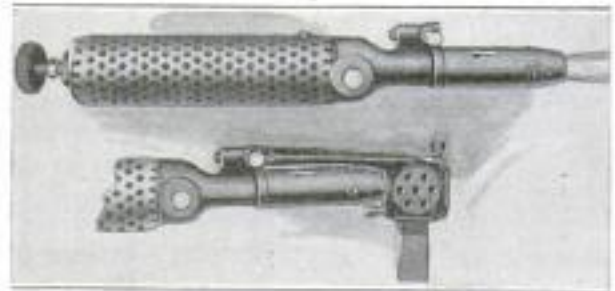

Blowtorch that Becomes a Soldering Iron with the Addition of a Detachable Tool

The device is especially convenient in electrical and automobile-repair work.

*Mr. Ernest C. Cheswell,
Malden, Mass.*
**BLUEBERRIES BIG AS GRAPES
RESULT OF CULTIVATION**

4394
Tamed, and taught to grow under cultivation, the shrub of the wild swamp huckleberry of New Jersey has been improved until it yields a fruit as large as a grape. The seeds have grown smaller, but the flavor and sweetness of the new product have been increased. To distinguish it from the wild upland variety, it is now called "blueberry."

*Literary Digest
12/1/23*

*Case Seal Co., Chicago
145 N. Clark*

4062

*E. H. H. Dunn, 2722
Prinice St., Berkeley,
Calif.* 173

POPULAR MECHANICS

BIG PARK FOR WATER SPORTS TO BE BUILT IN WEST

With a protective harbor for pleasure boats, an aquatic park is to be built soon near the old exposition site in San Francisco. The basin will be about 1,500 feet in diameter, with a maximum depth of 30 feet, shoaling gradually to the beach. Two curving stone piers, each with a pavilion and light at the outer end, will supply protection, and a reinforced-concrete breakwater will span the outer gap, leaving a channel at either end, and furnishing a pool for every variety of sport, including boat races.

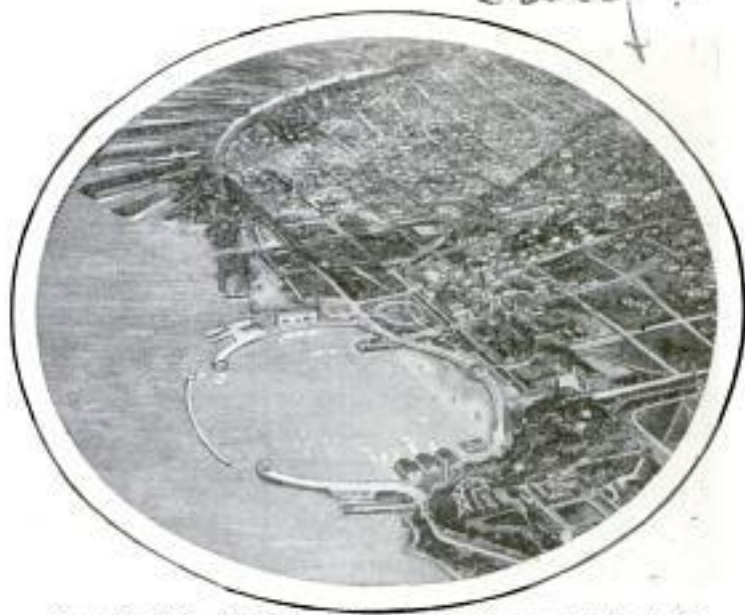

Aquatic Park for Water Sports and Pleasure Boats to Be Constructed at San Francisco

MILLION HOMES FOR WORKMEN NEEDED IN THE U. S.

4381

About 1,000,000 more houses are needed in the United States to relieve the present shortage, investigators studying the problem report. In spite of the various "building booms" in many parts of the country, only one city shows a surplus of residence buildings. It is held that the type of houses for the workingman must be changed, so as to bring about cheaper construction. This alone, it is said, would increase the proportion of home-owners by 30 per cent. Building codes, it is contended, must also be modernized.

Detroit News 12/6/23

BISCUIT CUTTER WITH CURVED KNIVES ROLLS OVER DOUGH

4224

Two curved blades on a biscuit cutter recently placed on the market give the utensil a wheellike motion as it is passed over the dough.



With each complete revolution the knives cut out a perfect circle. The tool is of use in making cookies, muffins, and other small, round cakes. Its strong, light construction permits it to be drawn back and forth with very little effort, and it is plated to prevent rusting.

forth with very little effort, and it is plated to prevent rusting.

*Peoples Lead Light Co.
Chicago*

METAL COLLARS ON NAILS SAVE LUMBER AND WORK

4501

To avoid waste of lumber used in concrete forms, scaffolding, and the like, a metal collar that slips over the body of the nail and makes it easy to draw, has been patented. The device tapers to a diameter

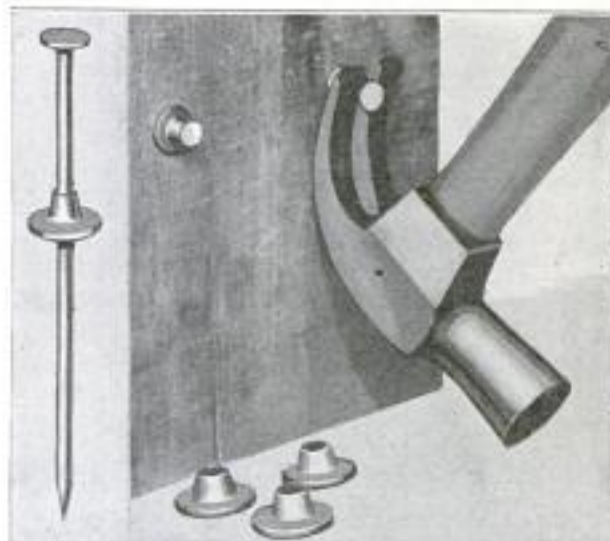

Metal Collar Slipped Over Body of Nail Makes Pulling Easy and Saves Lumber

smaller than that of the nail head, and insures the claw hammer a good grip. It gives additional rigidity where used, and saves times in dismantling.

So great was the popularity of the nickel last year, that the Philadelphia mint alone turned out approximately 30,000,000 of the small coins.

*Precision Metal Workers
3100 Carroll Ave, Chicago*

FRAGMENTS OF OLD CHURCH BECOME SOUVENIRS

Remains of the old brick tower, which formed the fortress portion of the first church edifice erected in Jamestown, Vir-



Bits of Church Tower Erected at Jamestown, Virginia, in 1609; Bouquet of Vines Grown on Edifice

ginia, are fast crumbling away and disappearing. This magazine recently, through the courtesy of George T. Boski, Bluefield, W. Va., was presented with a few fragments of the building, which it has placed in its museum. Among the first settlers, who came from England to this country, a hardy band in 1609 entered the mouth of the James River and located on an island which they called "James Towne." For the first ten years they suffered great hardships, depending largely on supplies from England for their food and clothing. It was not until the introduction of tobacco-growing as a business that they began to prosper. The early date of the founding of Jamestown insures the fact that the old church tower is among the oldest, if not the oldest, structure of its kind in the eastern tier of states.

Living in the larger Chinese cities is generally hand-to-mouth. Food is purchased from so-called restaurants, and hot water is sold by dealers who specialize in it.

"HEAT MILL" SAVES ORCHARDS FROM BLIGHT OF FROST

To save orchards from frost, a "heat mill" has been developed that consists of an airplane engine, propeller, and a distributor through which the wind stirred up by the whirling blades is forced under the trees. The device may also be used to cool the atmosphere when the heat is too great. The machine is expected to replace many of the smudge pots.

TEN THOUSAND PRAYERS "SAID" BY WHEEL IN A SECOND

Buddhist priests, or lamas, of Tibet say as many as ten thousand prayers a second with the aid of a revolving wheel. The supplications, closely printed on long strips of paper wound tightly inside a cylinder, are considered "said" each time it revolves.

COLORED PAPER SERVES AS INK FOR HAND EMBOSSEING PRESS

To emboss showcards and other stiff paper, without the use of heat, glue, or ink, a hand press, said to operate at a fraction of the cost of printing, and which needs no expert feeders, has been recently made. Brass type furnished with the machine can be set up in an easily locked form by inexperienced persons. The cardboard and sheets of paper of the color desired are inserted in the device. Pressure on a lever causes the press to



Hand Embossing Press that Prints Letters in Colored Paper and Needs no Expert Operator

close down on the papers, cutting out the letters and fastening them to the background.

Tracemaker Corp.
Copyrighted material
price
ben

*cl. no. Mr. Waterman
Conna, Calif.*

41374

4320

4579
Journal - Post, 12/2/23

4333

4225

Illustration

FLAG SO LARGE IT COVERS FRONT OF BUILDING

During a celebration recently held in a mid-western city a large American flag was unfurled down the side of an office building, hiding almost the entire wall of the structure. Each stripe of the gigantic "Old Glory" was nearly 7 feet wide. The blue field measured little less than 50 feet square and the entire emblem was 90 feet wide and 150 feet long. It was stretched between two heavy ropes and was fastened to the building every few feet to prevent damage by winds. Beside it a flag of ordinary size was placed. This was completely dwarfed by the larger one.

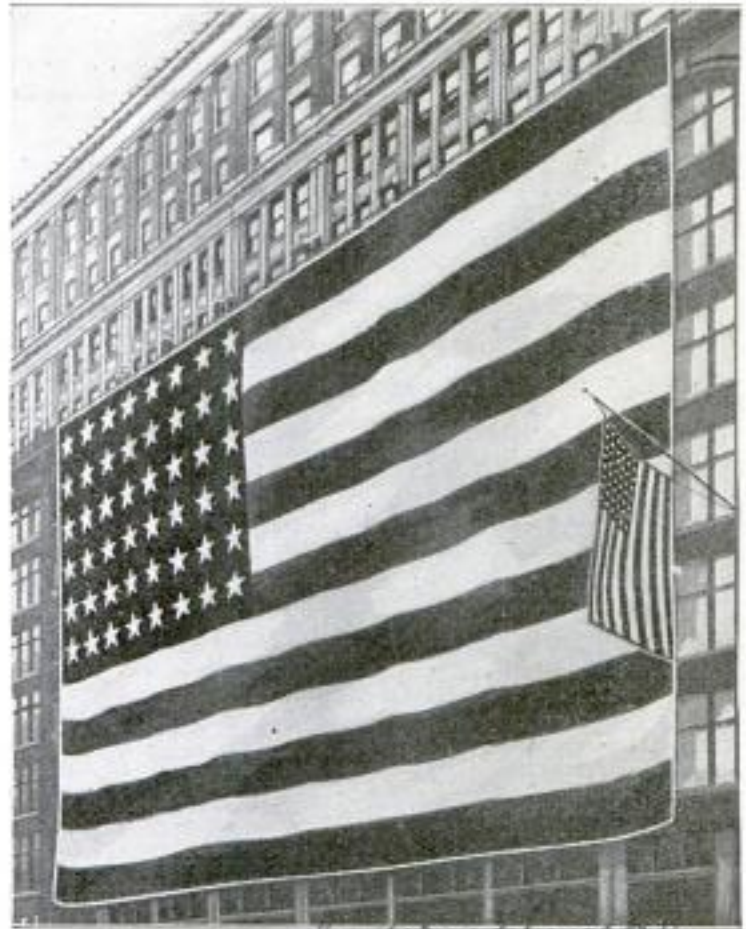

Almost Concealing Front of Large Building, this Giant "Old Glory" Marked a Recent Celebration

4369
Scientific care of terrapin has been so perfected that the death rate is said to be lower during the first year than it is among chickens on the average poultry farm. In recent experiments, special attention was given to the production and proper handling of the specimens and the best method of hatching the eggs.

CIGARETTE CASE FOR AUTO ADDS LIGHT AND PUFFS

Lighting a cigarette before it is taken from the holder is a service rendered by a container for fastening on the instrument board of an automobile. The device, which was recently put on the market, operates from the battery and engine of the car. A turn of a small spring lever delivers a cigarette from the supply compartment into a groove where, by a slight pull on another handle, one end is pressed into a suction tube and the other end against an electric

lighter. At the same time current is started into the heating unit and air is drawn through the "smoke." After a few puffs the tobacco is lit and ready for the smoker. By eliminating the need of attention from the driver, the device is said to make slowing up of the car unnecessary and to prevent risk of accident from neglecting the wheel while lighting with a match.

SAND LIBRARY AIDS BUILDERS IN CHOICE OF MATERIALS

Accessible to builders and contractors who want to know the value of various grades of material for construction purposes, a "library" of 2,800 bottles of sand, each marked with the results of tests to determine the suitability of the samples for commercial purposes, forms an important part of the scientific collection of a Chicago school. Specimens of sand from practically every state in the Union and from foreign countries have been gathered during the ten years since the "library" has been compiled. Records have been kept and pasted on the bottles as to the source of the material and grading.

Concrete Nov. 23, 1923

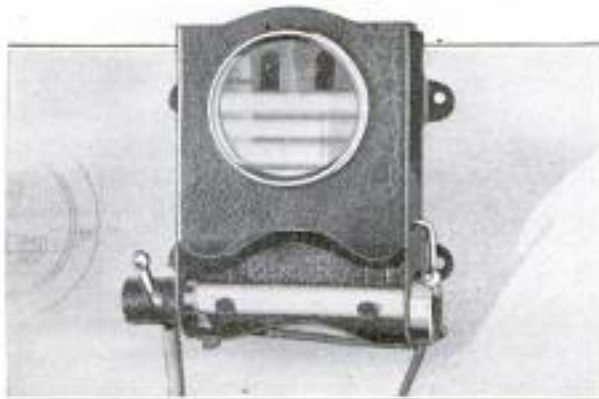

Cigarette Case for Automobile that Lights and Puffs "Smoke" Until Removed by Motorist

Splendor Electrical Co., Newark, N.J.

Structural Materials Library Lewis Institute

Price \$9.00. Canada \$9.00.



Luther Burbank.

Luther Burbank, the "Plant Wizard," Is Still Poor After Making Others Wealthy

the cotton plantations of Louisiana, and from the apple orchards of New Hampshire to the plum groves of California, hundreds of thousands of dollars of increase in the value of more than 2,000 products of the soil are pouring every year because of his efforts.

It is estimated that his addition of two grains to an ear of standard wheat has added more than \$5,000,000 to the annual wheat crop of the world. He reduced the size of the pit in a plum, and from two valleys in the West last year there went out more than half a million dollars' worth of these plums, larger in meat, finer in flavor, better equipped to resist shipment and change of climate. The artists of France wanted a flaxseed which would furnish a pure white oil for their paints. Burbank produced it, and increased the oil content by 20 per cent. The Japanese producers asked him for a mulberry tree which would furnish better and more food to the leaf for their silkworms. He evolved such a tree, with leaves three times the size of those of the then-known mulberry, and, just for good measure, brought it to development in two years, instead of the seven to ten years the best of the old-time mulberries required.

Ever since men have had feathered chickens, and jewelers have made delicate chronometers, sunflowers have been grown to produce seeds for the fowls and oil for the instruments. But all sunflowers—until Burbank showed them the error of their ways—grew on tall stalks and turned their faces to the sun, devoting most of their energy to getting up into their places in the sun, and the small remainder to producing seeds. The plant philanthropist took several sunflowers on his botanical knee and taught them first, to grow close to the ground; second, to devote their strength to seed production; and, third, to turn their faces away from the sun, so that the wild birds should not be able to gather the seeds. Now, these same sunflowers are down where the

By H. H. DUNN, 2722

Prince H. Burbank, Calif.

MOST men making millions for themselves carry other men into fortunes with them. But it is doubtful if there is more than one man in the world who, from his own creations, in one of the least explored fields of human endeavor, has piled up millions for other men and, at the same time, little more than a livelihood for himself.

To have done this willingly, to have sought the satisfaction of the sower, rather than the remuneration of the reaper; to have seen the ripened grain from his cultivation piled in the granaries of others, and yet to be contented with the knowledge that by his work the world has been made largely better as a place in which to live, is the story of this man's life, which this year passed the third quarter of a century. He is Luther Burbank, often called the "weed wizard," but who would be renamed the "plant philanthropist," were his lifework better known.

Probably from the time Burbank sold his first plant development, the potato which bears his name, for \$150, through all the fifty years of his activities along these lines, he has actually given away more in dollars and cents than any other man who ever lived. Yet he is today comparatively a poor man, while all around him, from the wheat fields of the Saskatchewan to

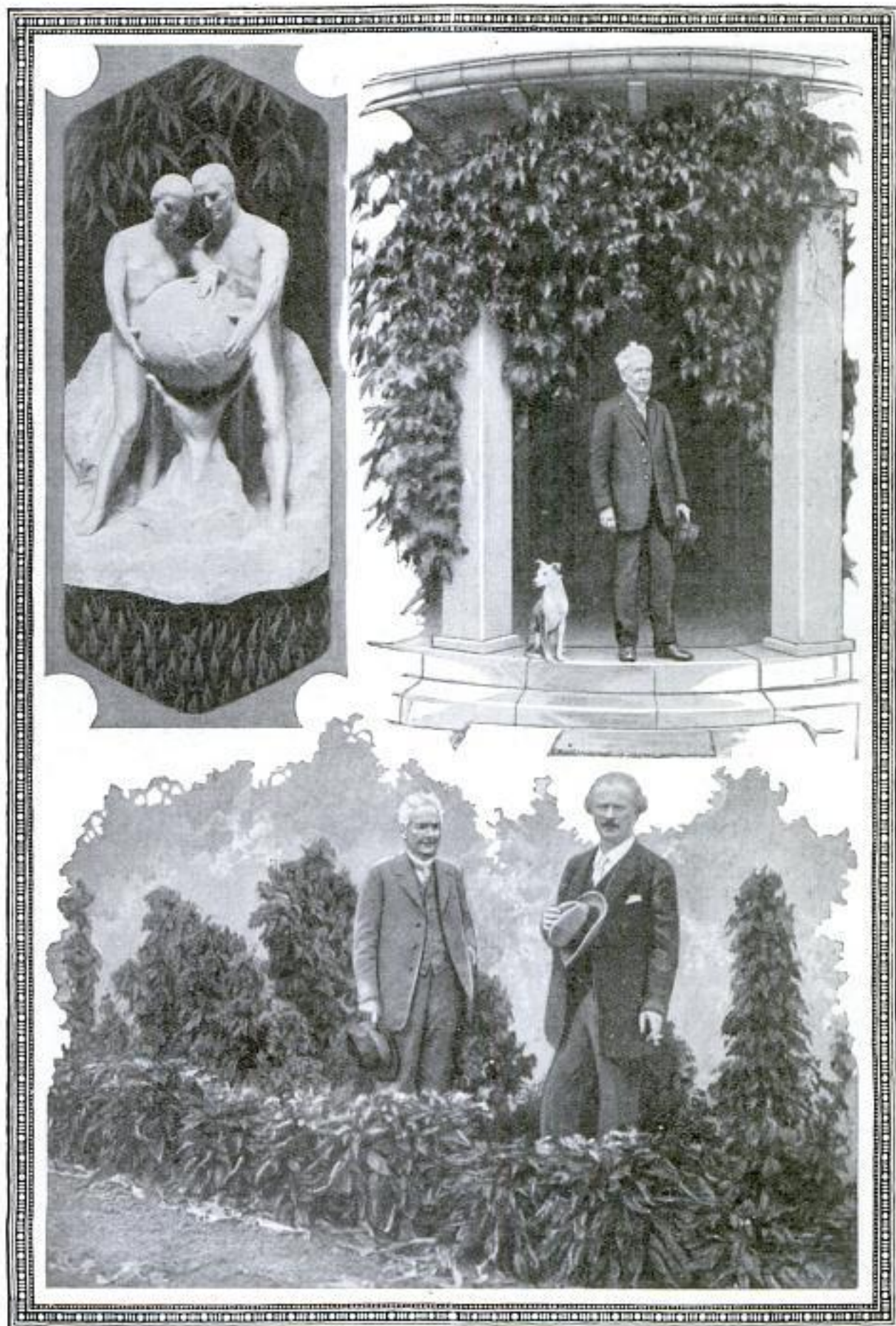

Luther Burbank and Paderewski, the Pianist, His Friend; and, Above, the Noted Naturalist and His Dog.
A Model of Proposed Memorial Statue Is Shown at the Left

chickens can harvest them; they produce blossoms nearly two feet in diameter, and each seed is three times as large and contains twice as much oil as did the seeds of those first sunflowers which Mr. Burbank took as pupils in his California School for Plants.

A man, who is still living near Santa Rosa, some forty years ago wanted 25,000 prune trees, in time for the next year's setting-out. Burbank took 30,000 almond seeds, planted them under wet burlap, grew almond trees more than a foot high, budded them to prunes, and delivered the tremendous order, when everyone else said the job could not be done. Those trees are growing and bearing today. A firm of American vegetable packers sought a small, sweet-flavored field pea, like the French petit pois, which would ripen uniformly over a large acreage. Burbank took a gallon of seeds of the large American field pea, and six years' time brought forth a small pea, of which more than 6,000,000 cans were packed and sold last year.

When black walnut began to disappear as a commercial wood, the plant philanthropist developed a black walnut which grows, in ten to twenty years, to the same height and diameter as the wild black walnut does in forty to fifty years. The wood is as dark in color and as fine and close in grain as its wild prototype. Just for fun, among several thousand other plant experiments, Burbank guided the lives of several chives—you have met the chive, like an onion, only smaller and without the onionesque perfume—until they bore fragrant flowers like freesias, and became, in addition to edible vegetables,

sweet-scented flowering plants for borders. He noticed that Nature, when she made the petunias, overlooked blue as a color, so he introduced blue to the petunia family, and, just to give it a prominent place, made the blue petunia four or five inches in diameter across the blossom.

Those who have been trained to eat artichokes usually consider themselves slighted if they get less than one of the buds to an order. Burbank has produced an artichoke, however, which is large enough for the ordinary family, since the blossom is 14 inches in diameter when the bud has opened. An ever-blooming sweet pea, a perennial poppy, a sweet-scented verbena, a primrose nearly five inches in diameter, and a brilliant-red California poppy, not to mention the well-known Shasta daisy, are among the results of his excursions into the flower garden.

With him into the realms of weeds and grasses and fruits and flowers, the noted naturalist has carried a sense of humor. Aside from taking the thorn off the blackberry, he put more pop in popcorn, so that now it puffs out to three times the size of the ordinary "popper," while there are more kernels to the ear than in the ordinary kind. He is undecided whether the joke was on the potato or the tomato when he crossed the two and presented the world with a plant which grows potatoes above ground, and another which grows tomatoes on the vine and potatoes on the root. It should be said that both are freaks, and not commercially valuable. Thinking that most chestnuts are too old before they begin to show results, he developed a chestnut tree which attains its growth in two and one-half years, instead

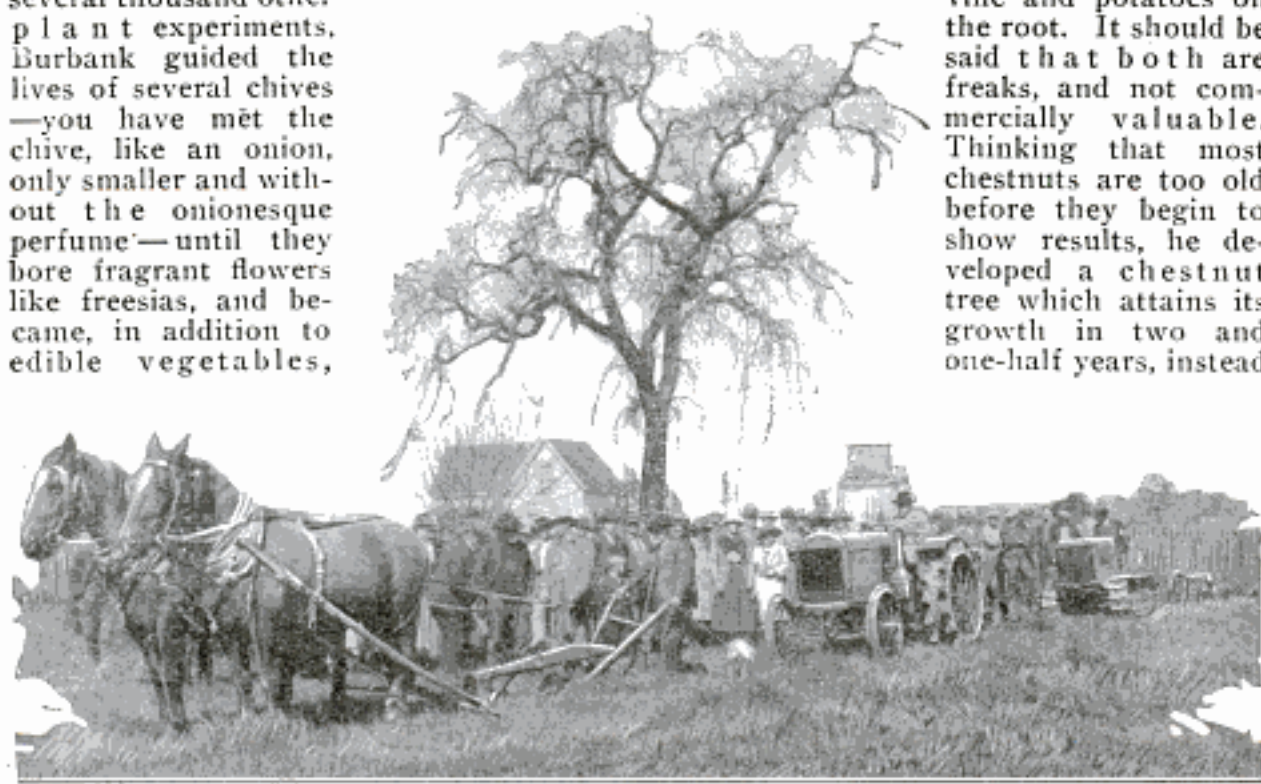

Noted Naturalist Heading Ground-Breaking Procession at the Commencement of Work on the Burbank Memorial Park in California, Where a Collection of His Creations Are Kept

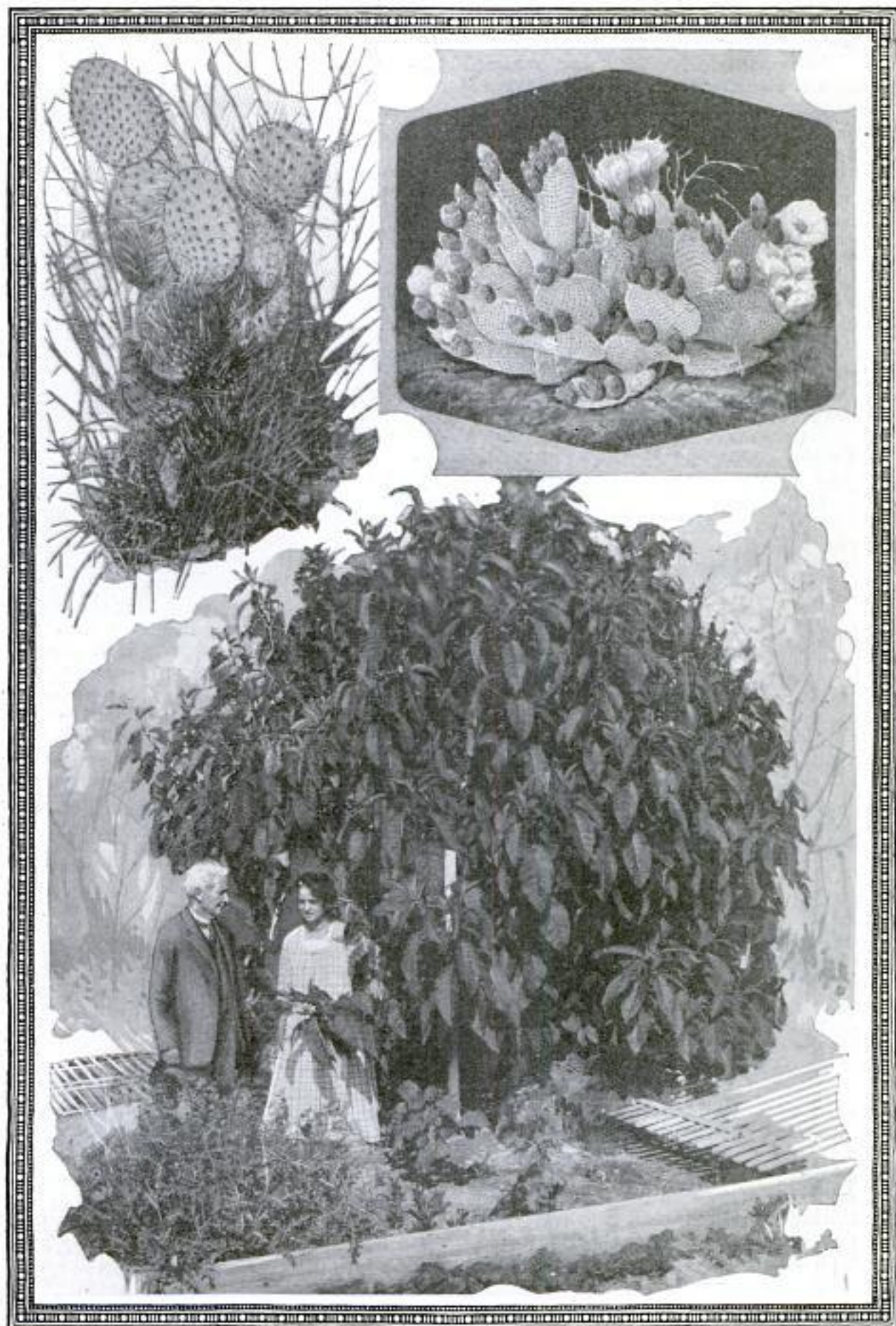

Quick-Growing Mulberry Tree Developed by Burbank to Aid Silk Producers, and, Above at Left, the Original Spined Cactus Contrasted with the "Spineless" Variety at Right

3785
of the ten or fifteen years required by the common chestnut.

It is doubtful if Burbank has realized \$100 on the average for each of these developments. In 1922 there were shipped out of one western state alone 182,400,000 pounds of cereals, vegetables, fruits and nuts he has developed from more primitive and less productive forms. It is reasonable to estimate, though no figures are available, that the entire world produced ten times this amount of foodstuffs for whose development the "weed wizard" has been responsible.

At the end of half a century of plant development, he has just sold two of his experimental farms near Santa Rosa, to obtain money with which to carry on further experiments. The reason for this is not far to seek. Take, for example, a pearl white wheat, the earliest of all grains and the best resistant to diseases. The sales of this wheat for seed, by Burbank himself, were limited to a few hundred dollars, but it is estimated that more than \$200,000 worth of it has been sold for seed by farmers and others who grew it from the original few pounds furnished by its producer. Once a pound of seed passes from his hands, he cannot control the seed of the plants this pound produces, and so has been unable to "cash in" on his productions.

In all his work, Burbank has tended toward the one idea often expressed in his addresses and his books: "The world is ours to mold by helping the hand of nature." This ideal is embodied in a statue which is to be erected to him in the midst of Burbank Memorial Park, at Santa Rosa—yet difficulty is being experienced in raising \$25,000 necessary to complete it.

One of the most interesting features in the life and in the present work of this almost-unrewarded assistant to nature, is his constant optimism. Today he is in the midst of more than 2,500 experiments looking to the greater production of a better quality of foodstuffs and materials for the clothing of mankind. Simply enough he says, as he turns to the economic problem of production and consumption:

"It is not necessary to produce more food, but to produce more food per acre, so that fewer men, with improved machinery working on our farms, may feed more people who are devoting their attention to distribution and to manufacture."

Names and addresses of manufacturers of articles described in this magazine will be furnished free by our Bureau of Information.

Jackie Coogan
Productions, Inc.,

Hollywood, Calif.
WORLD IN MAGAZINE DELIGHTS
YOUTHFUL FILM STAR

Marie
B. etc.
When Jackie Coogan is not hard at work under the studio lights, he enjoys a few moments to himself reading about the



Jackie Coogan Was too Deeply Interested to Smile when this Picture Was Taken

latest happenings in the world of inventions and discoveries, and he likes to look at pictures that weren't "acted out." The grown-up world has a fascination for Jackie and he finds relief from work in the studio in the pages of his favorite magazine.

PAPER THAT DEFIES FLAME CHARS BUT WON'T BURN

4270
Treated with a chemical that makes it fireproof, paper suitable for printing purposes is being manufactured by an eastern company. Although it chars and becomes black when subjected to continued heat, it will not burst into flame. Printed or written matter it may contain is fairly legible after the paper has been held in fire. The fireproofing process does not prevent the absorption of ink. The danger of spontaneous combustion or blazes caused by carelessly tossed matches and cigarette stubs, is materially lessened by the new method. Valuable records and documents prepared on the stock run little risk of complete loss in case of fire. Inside pages of magazines bound in fireproof covers of the material can be insulated from contact with flames. The process is also adapted to making fireproof curtains, rugs, carpets, and in the protection of paintings and valuable fabrics.

Mozyre Products Co.
500 Fifth Ave. New York.
copyrighted material

4268 *Chas. John Mason,*

POPULAR MECHANICS 181
1840 *n. Wallington St. Philadelphia Pa*
SLIDING FLOOR AIDS IN HANDLING AIRSHIPS

To simplify the task of handling dirigible aircraft, an eastern inventor is at work on a ~~hangar~~ designed that only eight men will be needed to launch a ship or place it in the shed.

form the floor. They run on a track to the outside of the shed when the craft is to be released, and are moved back after it has landed and has

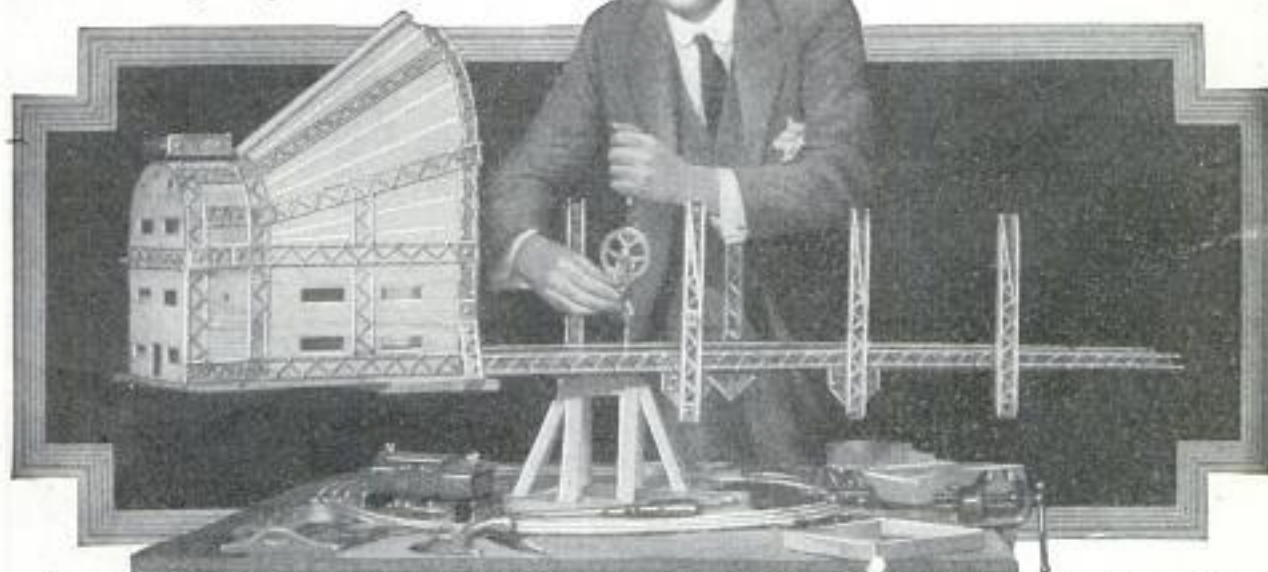

Model of Hangar Showing Construction of Hood and Floor which Will Support Sliding Platforms for Handling Dirigible Airships: One Section of the Roof Is Shown Completed

Hundreds of helpers are sometimes necessary for this task with the ordinary type of such buildings. Sliding platforms over 700 feet long, to which the craft is anchored,

been fastened to its moorings. The walls and roof are 150 feet high and are supported by braced steel girders. The cost of the hangar is moderate.

Mining
GOLD PANNING OF EARLY DAYS AGAIN POPULAR IN WEST

3679
Revived from the early boom days, when thousands of pioneers were borne westward on the backwash of a rumor of fabulous riches to be had for the mere taking, gold panning again is becoming one of that section's industries. Even streams which were worked many years ago are being made to yield a second harvest of the precious metal. Most of it is found, not in the present courses, but in the dry, abandoned channels. The panner throws out the "muck" from the old watercourse until he reaches what at one time was bed rock. This is carefully washed and brushed and placed in the pan with the material just overlying it. From the brook, the utensil is filled with water and the mixture agitated with a stick, some of the top poured off, and the process repeated again and again until nothing remains but the gold, which sinks to the bottom because of its weight. Discovery of paying "dust" after panning is often followed by placer operations or dredging where practicable.

J. M. Blair, Dept. of Physics, University of Colorado, Boulder, Colo.

4756
JARS KEPT DRY BY COVER PADS THAT ABSORB THE MOISTURE

Provided with a mineral-salt pad which absorbs moisture, a jar cover has been invented for keeping crackers, candies, and other foods from spoiling in humid or wet weather. The pad is held in a perforated metal container fitted to the inside of the lid. It is said to dry out the air which enters when the cover is taken off and removes dampness from sticky candies and other articles



placed in the jar. At intervals of a few months the pad can be dried by baking.

Amid a desert of white snow, the Hospice of St. Bernard in Switzerland, celebrated its thousandth anniversary some time ago.

The Bridger Co., Denver, Chicago. 5795th & Chittenden, Chicago.

Edw. Frederick E. Clemens.

182

POPULAR MECHANICS

SPRING CYLINDERS ON AUTO REDUCE BUMPS

4042

Indianapolis, Ind.

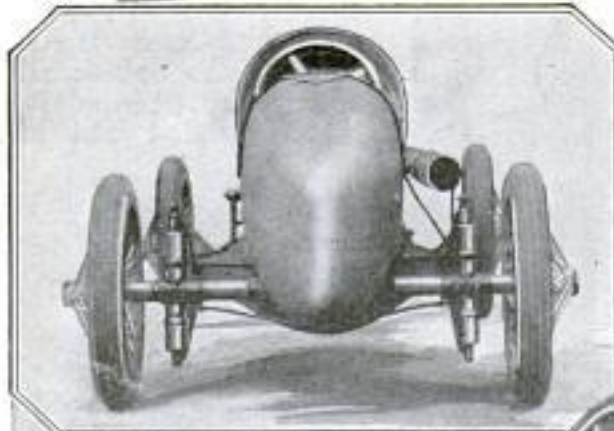

To aid in making the driving of racing cars and other automobiles more comfortable, an eastern inventor has produced a suspension device which it is claimed will reduce shocks to a minimum. It consists of telescoping cylinders on each side of the car which contain coiled springs fastened vertically above and below the rear axle. A yoke bracket attached to the chassis hold the ends of the cylinders.

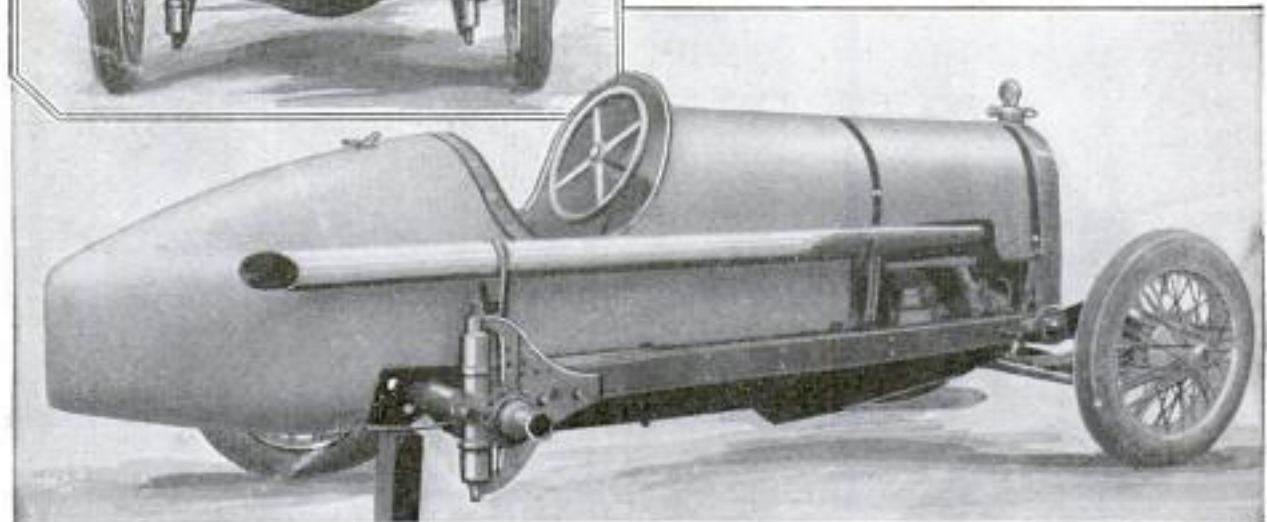

How the Telescoping Spring Cylinders on the Rear Axle Are Attached to the Racing-Car Chassis on a Yoke Bracket to Reduce Shocks While Speeding

SPARKLE OF FINEST CUT GLASS DUE TO WORKER'S SKILL

Craftsmen with skill almost equal to that of diamond cutters are required to give cut glass the sparkle of sharp edges, the intricate designs and the brilliant finish that distinguish pieces of superior quality. This fine workmanship is the result almost entirely of the worker's accurate eye and deft hand, only the simplest machinery, in general, the same kind of tools that were used generations ago, aiding him in his task. In cutting the finer pieces, the plain blank, or unfigured dish, is held by hand against a revolving iron disk. As the wheel turns, grains of carborundum, mixed with water, flow upon the glass, cutting out the pattern as the worker guides the piece by a few lines lightly sketched on the surface. The cuts are next smoothed with abrasive materials and then the high polish is obtained against a rapidly revolving wheel of poplar wood with the aid of rouge and a fine powder. In general, there are two grades of cut glassware, the inferior being cut from blanks on which the design has already been stamped or pressed by machinery. Sharp

Emb. Edwin Jarvise, The Harragat, Washington D.C.

edges, smooth inside surfaces, and a ringing tone when the dish is snapped with the finger, distinguish the better pieces.

FALSE BOTTOM HELPS TO COOK FOOD WITHOUT SCORCHING

Lessening the liability to scorch vegetables, and doing away with the trouble of scraping burned food from the utensil in which it was cooked, a kettle bottom, made from wire mesh and set into a metal hoop, is now on the market. The device is of a size and depth suitable for the purpose for which it was intended. It is equipped with a handle which facilitates its use as an egg boiler, a toaster, berry washer, and the like. When used as a kettle base the handle is turned down.



One-third of the silk used in the United States is said to be artificial.

Hamblin + Russell
Mfg. Co.,
Worcester, Mass.

Copyrighted material

Mining a River Bed

While clearing the channel of a river in England recently, a dredge uncovered a rich vein of coal just beneath the surface of the stream's bed. Preparations were immediately made to mine the deposit and a floating digger with an endless chain of buckets was anchored over the spot to raise the black mass and load it into barges. Owing to its contact with the water, the coal is soft enough to permit the blades of the conveyor easily to scoop it up. As it passes swiftly upward most of the dirt and fine particles are washed out, leaving a clean grade of fuel.

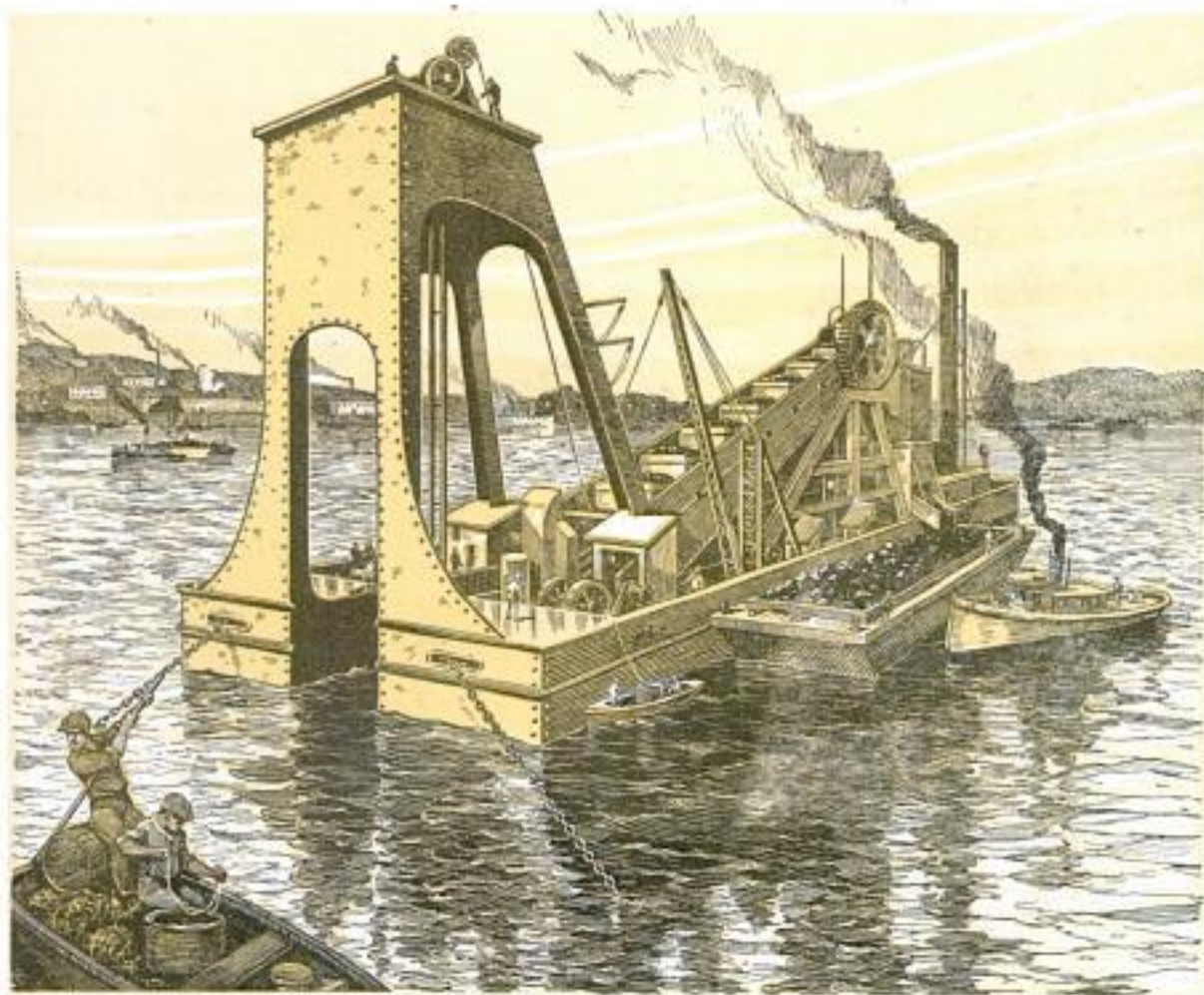

4233

FIVE MILLION LETTERS DAILY SENT VIA TUBE

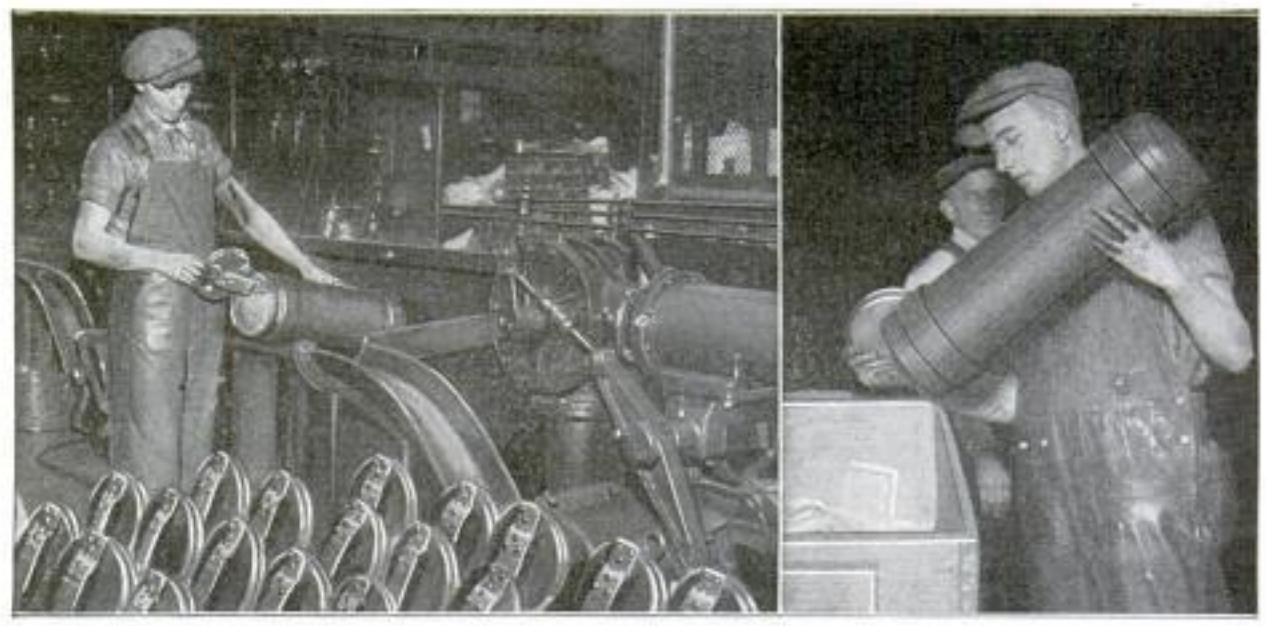

Left: Leather Carrier Loaded with Bundles of Letters and Ready for the Chute. Right: Emptying Packages from a "Car" which Has Just Arrived through the Tube

Winding about beneath New York streets is an intricate subway system of pneumatic tubes connecting the main post-office with substations for the delivery of first-class mail. The "cars" are leather carriers into which packages of letters are placed for distribution to the various stations. Silently and swiftly and on carefully

timed schedules, these boxes shoot along under high pneumatic pressure through the twenty-six miles of the system. They are tightly sealed with lock tops when filled, and are oiled to permit easy passage through the tubes. Approximately 5,000,000 letters are handled daily on this busy line below the pavements.

WIRE HOOK TO THREAD NEEDLE SAVES TIME, AIDS EYES

To save time in threading a needle, a device has been patented in Europe re-

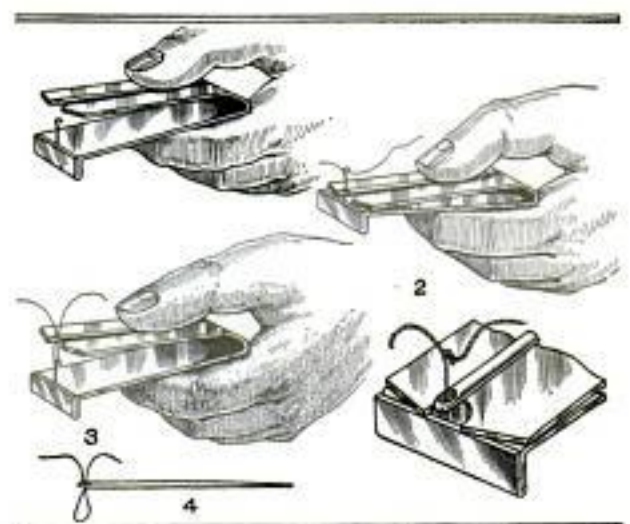

Needle Threader that Saves Time and Does Not Require a Steady Hand or Good Light

cently that performs the operation quickly, even in poor light. A slight pres-

sure of the fingers pushes a hooked wire through the eye of a needle that has first been placed on top of a small spring. Then the strand is put on the hook, which can be done by an unsteady hand, and as the grip is released the wire passes out of the needle eye, carrying the thread with it through the hole.

HULK SUNK IN SACRED LAKE FREIGHTED WITH RICHES

Roman bronzes of beautiful workmanship have been recovered from a vessel lying submerged in the waters of Lake Nemi, in Italy, long known as the "Mirror of Diana." The bronzes were mooring rings, six in number, representing the heads of lions, wolves, and tigers, a beautiful Medusa, and other designs. A piece of lead pipe, bearing the legend "Tiberio," was also found, leading to the belief that the hulk was of the age of Tiberius or Caligula.

Shoes of aluminum with wooden soles are now being used by workmen in German chemical factories.

Mr. H. A. Brown, Jagtvej 109, C. Copenhagen S., Denmark.

One sold by Rapid Needle Threaders, 516 N. La Salle Chicago

The Mc Kenzie Co

Box 9.

Long Beach Calif

Pacific + Atlantic
185

**PAPER COVER ON TOOTHBRUSH
KEEPS BRISTLES CLEAN**

Guarding toothbrushes from infection is the purpose of specially made, heavy waterproof paper covers lately introduced to the trade. They fit snugly over the bristles, keeping them clean. Used either at home or while traveling, the guards are said to last for several months. They are also employed for advertising purposes.

**LONDON FOGS SWELL COST
OF LAUNDRY WORK**

Damage done to various fabrics and the special laundering occasioned by a single London fog, according to a recent estimate, cost the residents of that city as much as \$5,000,000. Quantities of soot are deposited as the moist cloud hangs over the streets sometimes causing almost complete darkness at noonday. Lower temperatures are usually recorded in the mist-surrounded areas, a difference of fifteen degrees being noticed recently between London and an adjacent city where the sun was shining.

**"HANDCUFF" AUTO LOCK HOLDS
WHEELS IN LINE**

Fastened to the steering wheel of an automobile, a recently invented lock holds the wheels so they cannot be turned. This prevents towing or driving, but permits of the car being moved a short distance in an emergency or to comply with police regulations. Boring a small hole in the steering column is all that is necessary in

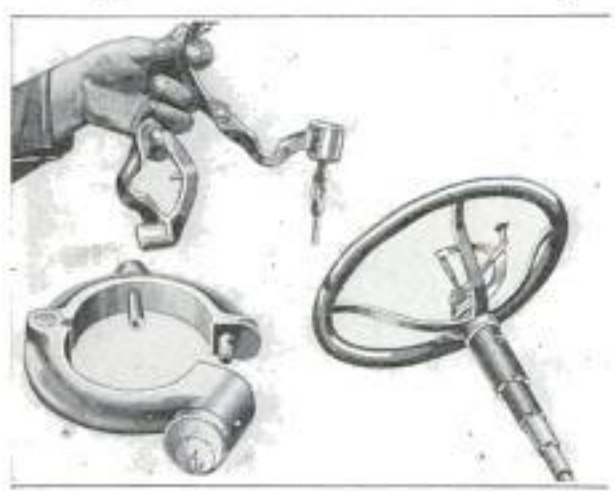

Auto Lock and Screws that Hold It Like a Handcuff to Steering Column

order to attach the device. The lock is removed while the car is in operation, thus avoiding any danger of accidental locking.

Handcuff Auto Lock Co.
1107 Merchants Exchange Bldg.
San Francisco, Calif

**AUTOMATIC SIGN FOR TRAFFIC
PROVES ITSELF IN TESTS**

Designed to speed up traffic and safeguard pedestrians, automatic traffic-control devices that look like the targets on



Automatic Traffic-Guide Signals which Motorists Can See in Time to Obey Them

railroad switches have been installed at street crossings in several cities. In addition to the arm, the machine is equipped with "change," "stop," and "go" lights, in amber, red, and green. Operation is through a series of gears driven by an electric motor. They can be set to close and open for any desired length of time. Recent tests in Chicago showed that they were better obeyed by motorists than were traffic officers. This was attributed to the fact that they are visible at greater distances.

**GAS IS SUPPLIED LAKE BARGE
THROUGH FLEXIBLE PIPE**

For convenience in supplying gas to a yacht club located on a barge in Lake Michigan, a flexible hose was used. This allowed for any movement of the hull through action of the wind and waves. Ordinary 4-inch pipe was laid along the pier leading to the clubhouse, the final connection being made through the tubing.

Chicago
National Original Co
Chamber of Commerce Bldg.
Chicago
Pleasant-Sea Club
11/11/23

Com. William Thompson, of
186 E. H. Young, West Camp
38/18 Ulster Co., NY



Class of Army Men Receiving Instruction in Sand Molding from Engineer Officers Who Train Their Charges in the Use of Fortified Structures as Aids to Military Tactics

Sand Molding Taught as Aid to Soldierly

AS an aid to the study of army tactics, engineer officers connected with the Armenian Legion on duty in northern Africa, are teaching the men how to build toylike, fortified walls, emplacements, and buttresses with wet sand. Miniature structures that rival in beauty those seen in the neighborhood of the barracks are cleverly worked up by the students under direction of the teachers, who then use the figures to train the soldiers in methods of attack and defense.

Many of the men have become highly experienced in molding such forms and make copies of the stonework and statuary that grace the old temples and churches seen throughout the territory. While some confine their efforts to small objects, others build gigantic forms of the same size as the originals. As a result, the area surrounding their quarters is filled with quaint sculpture work. Figures of sphinxes may be seen sprawling at the feet of some Egyptian monarch "carved" from wet sand and cop-

ied from an original that probably was cut from stone in dim ages of a past greatness.

Oriental citadels with spires and domes express the trend of the artists for architectural beauty. Or, perhaps, the subject will be one side of a narrow street of a village, the overhanging balconies of the tiny houses hugging the walls in faithful imitation of the real. Occasionally, several of the men take live models for their subjects, such as a horse and rider, and soldiers in various poses.

When the classes in military tactics are in session, however, only those things that have a bearing on the training of the soldiers are dealt with. Areas are laid out and walled towns are set up in sand miniatures. After these have been completed, the instruction in problems of warfare is carried out. Most of the practice work

has to do directly with the territory in which the army is at the time occupied. Plans of action are first laid out on paper and from this, the zone of action is set.



Living Models Are Sometimes Posed as Subjects for the Sand Artists to Copy

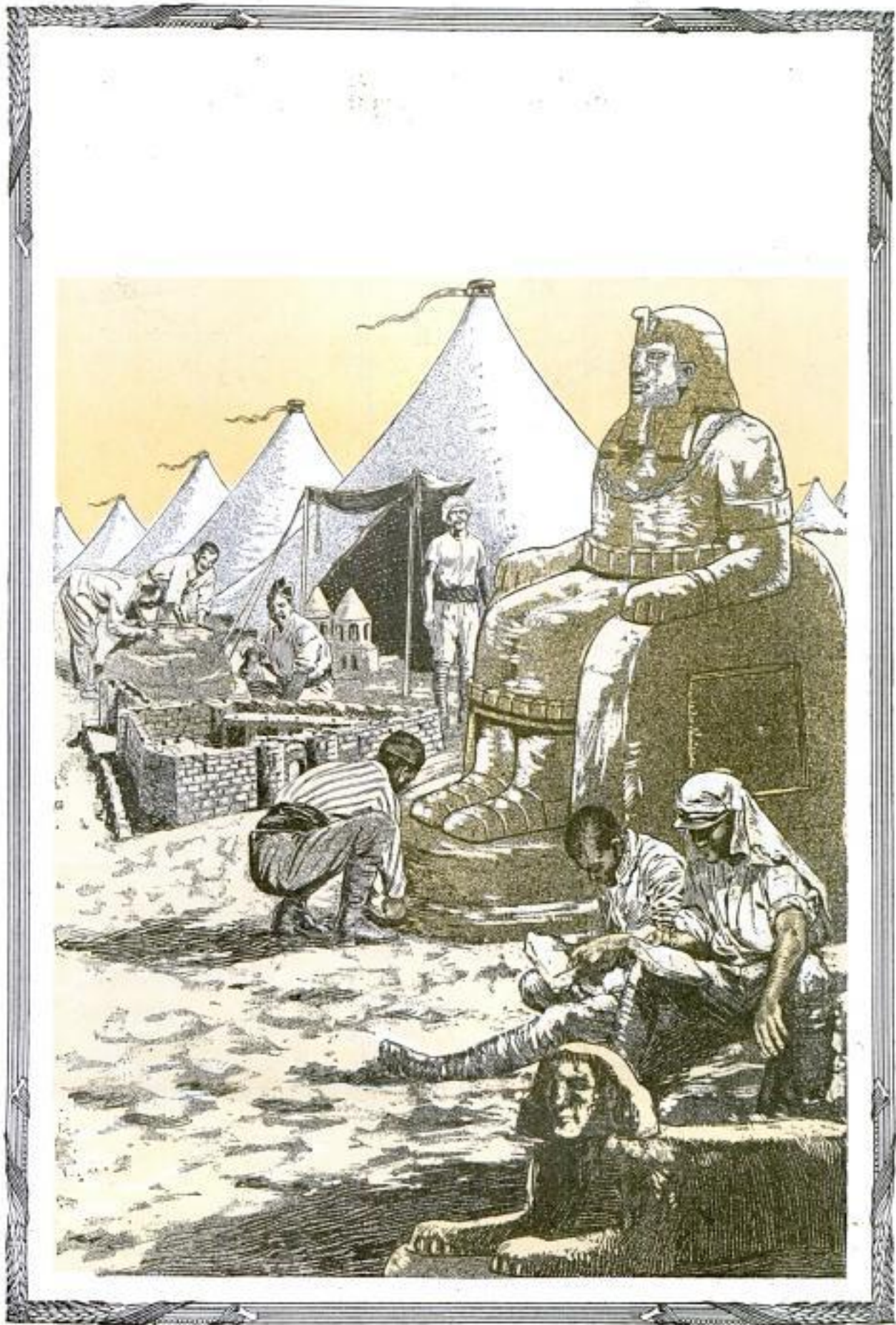

Statuary Sculptured by the Ancient Art of Old Egypt Found Scattered Among the Desert Ruins Is Truthfully Imitated by Soldier Craftsmen Who Work with Wet Sand

**PAINTINGS HUNG FROM TREES
WHEN SALON BARS ARTIST**

Failing to gain a place in the Paris salon, an artist recently entered his pictures in the "Fair of Crusts," a sort of "no-jury"



Art Gallery on a Boulevard Tree by which a Painter Attracted Buyers for His Works

organization designed to further the interests of the less successful painters. The artist exhibited his paintings by hanging them from the branches of a tree on the boulevard down which the crowds walked to attend the "gallery" exhibition, seeking in this way to get a market for his work, and recognition from the public.

**"SOAP HOLES" OF COWBOY DAYS
BECOME VALUABLE CLAY**

"Soap holes," once thought by cattle rangers of the West to be dangerous mires of worthless slime, have become mines of mineral clay of great commercial value. Bentonite, as the substance taken from the deposits is called, has been made into an ingredient to give body and weight to paper and to aid in the mixing of wall plaster and pastes. Soap makers experimenting with it are said to have found it possessed of good cleaning qualities and beneficial to the skin. Many of the clays and massage

Bureau of Mines
Report # 2289

creams used by beauty parlors are mixed with it as a base. In the raw state it lies near the surface and is similar to brittle shale rock. Since it absorbs almost seven times its volume of water, it forms a soft, slippery mass where the deposits are in low ground.

**RADIO UNDER HAT LINKS MAIL
FLIER WITH THE EARTH**

Aerial mail pilots in transcontinental flights will soon be accessible from ground stations, according to postal experts, who have been working out a one-man sending and receiving radio set for use in the service. The receiver will be carried under the pilot's helmet and the transmitter on his breast. This will make it unnecessary for an operator to accompany the airplane. The whole mechanism, including batteries, weighs 170 pounds.

No. 4 Series 11/6/23

**LAND OR WATER WAR "TANKS"
ARE TESTED BY ARMY**

Designed to cross lakes and rivers as well as to maneuver over rough ground, armored tractors equipped with propellers in addition to powerful belt treads have been tested by army officials. One weighing about 800 pounds, carries a driver and one passenger, and is capable of a speed of from two to sixteen miles an hour on smooth roads. It is self-propelling in water. A larger type can go from three to twenty miles an hour over level ground.



Copyright, Underwood & Underwood
Army Land and Water Tractor Entering Stream After Having Traveled Over Dirt Roads

Both models are steered by folding rudders while in the water, and the bodies are built wide and flat so that they will not easily capsize.

Mrs. D. O. Peterson
Box 394, Bell Flouche
South Dakota

PEACE AND WAR-TIME ENGINES SHOW PROGRESS

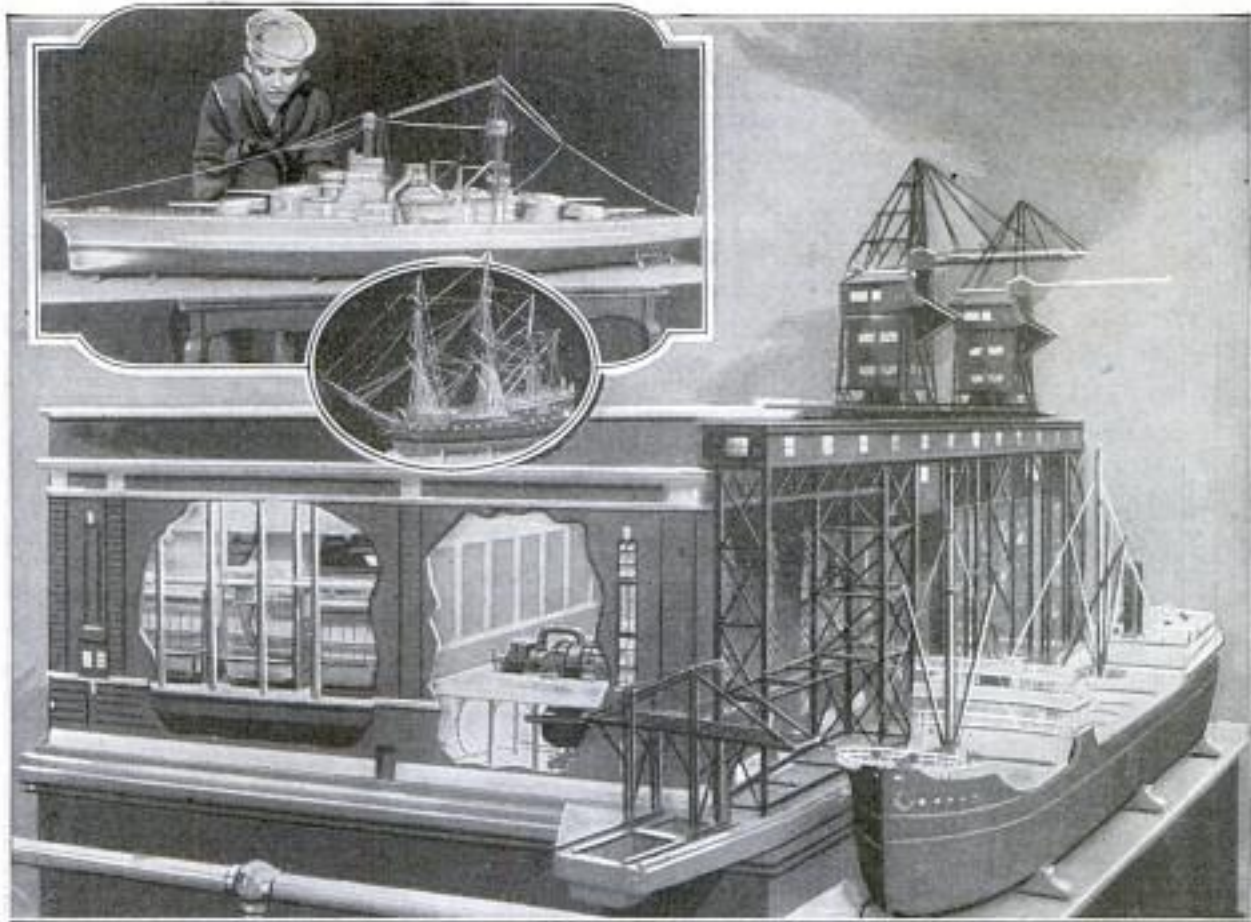

Above: How Electrically Driven Dreadnaught Appears beside Old Sailing Vessel Pictured in Inset. Below: Model of Huge Electric Power Plant and Loading Cranes

Showing progress of electrical research, two giant engines, one for peaceful purposes and the other for war, have recently been completed. They are an enormous

power plant in the West, having a capacity of 300,000 kilowatts, and the motors of a monster electrically driven dreadnaught of the U. S. Navy.

TRIPOD FOLDS INTO CANE WHEN NOT IN USE

Among recent English inventions is a tripod for cameras which closes up so compactly that it may be used as a cane. It weighs only fifteen ounces, and opens automatically when the knob which forms the top is unscrewed. The legs require no adjusting when opened, and form a rigid support. When the camera is removed, they close quickly.



SHIP IS SENT BY PARCEL POST FOR USE IN AFRICA

Shipbuilding has been reduced to a science so precise that it is now possible to construct vessels in such a manner that they may be taken to pieces, the parts shipped, and finally reassembled into a seaworthy craft at the destination. Each part is numbered and ticketed, and full instructions accompany it, a vital necessity, as the engineer is often compelled to make use of native labor, which always must be under his eye if he is to secure satisfactory results. The steamship "William MacKinnon," the first to be launched on Lake Nyanza, Central Africa, reached Mombasa by parcel post from England. Then the parts were transported through 500 miles of jungle to the lake, on the heads of 5,000 Kaffir porters. The boilers were dragged by oxen.

Messrs Adams & Co. Carving Cross Road London England

no further information

Handwritten notes on the right margin: "Building", "1/164", "The 'William MacKinnon' is a...

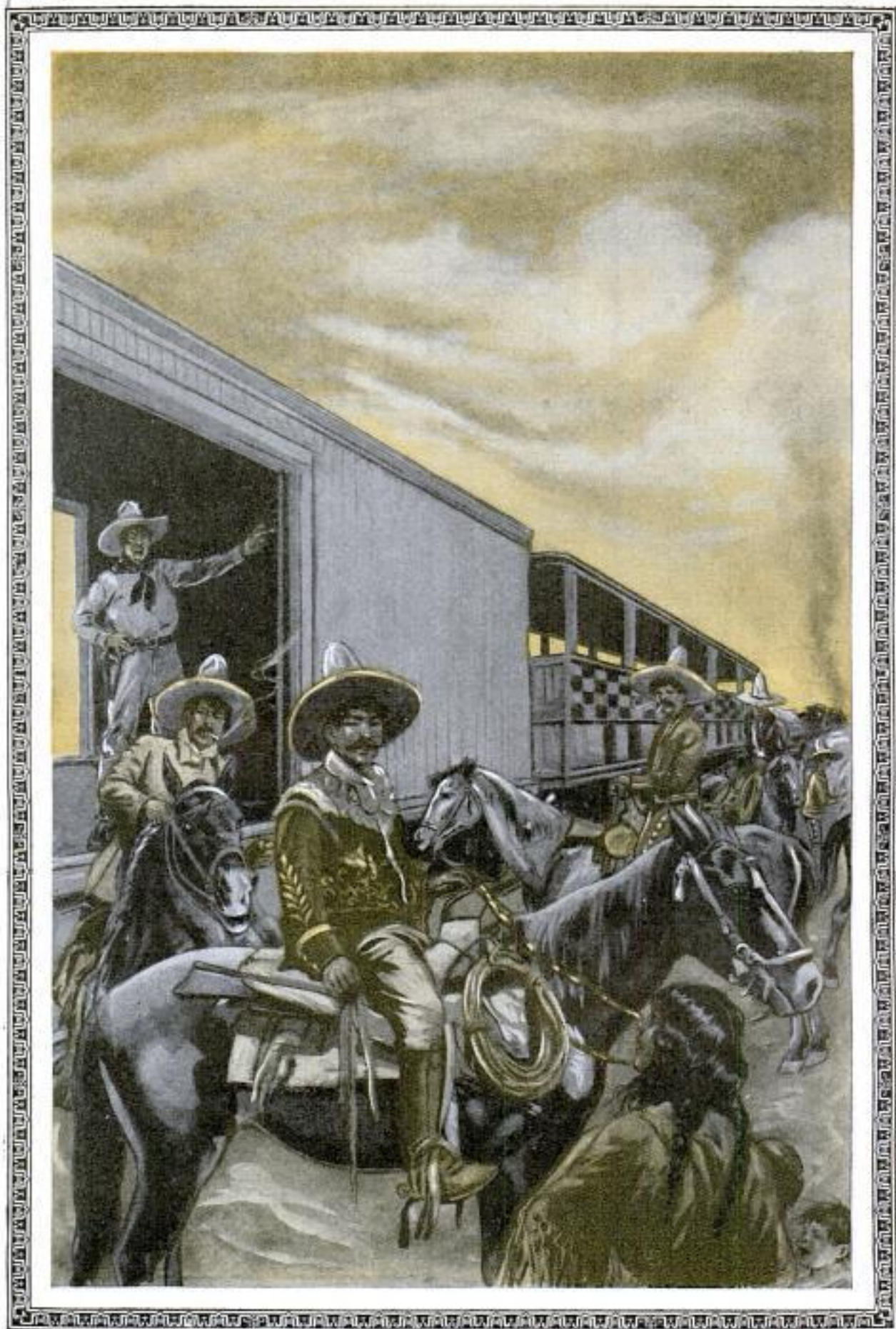

Checkerboard Armor on Gondola Car, Roofed Over to Protect Soldiers Guarding Passenger Trains During Mexican Revolutions, and Troopers Starting on Bandit Hunt

31704

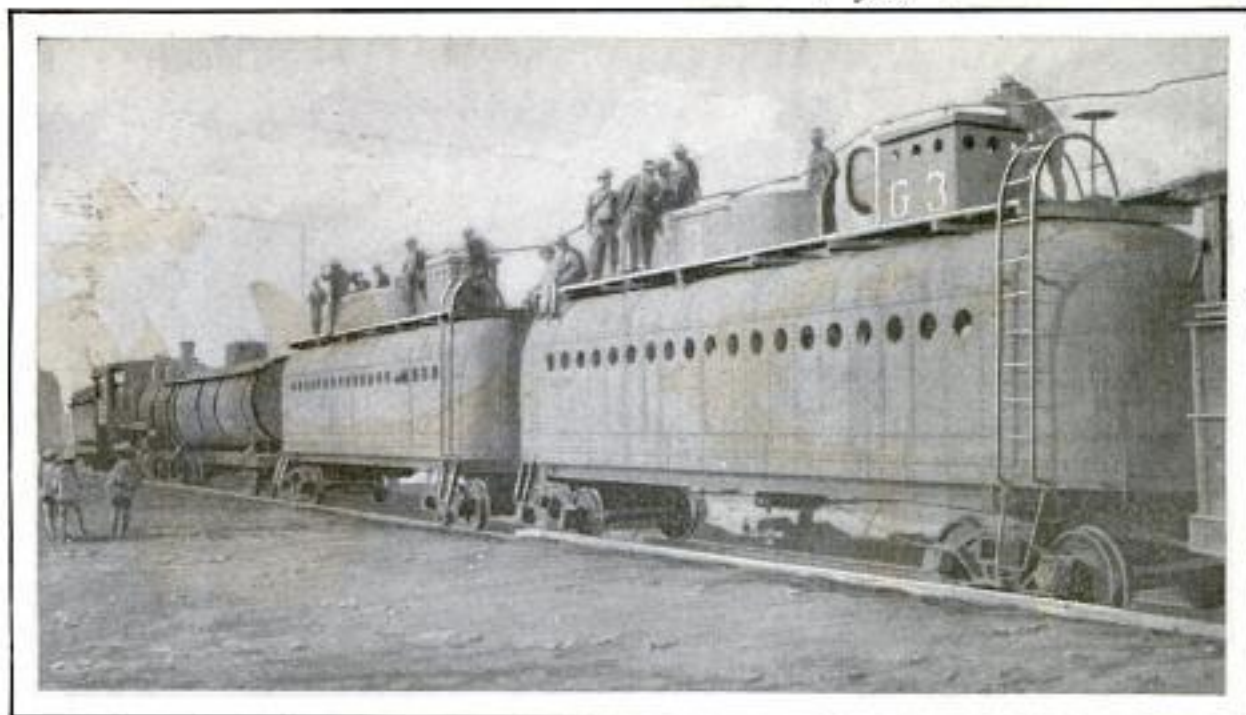

Two Modern Armored Cars Used in Pursuing Pancho Villa

THE TOOLS OF MEXICAN REVOLT

Crude Armored Cars Aid Ragged Troops in Treks Across Plains in Five-Week Campaign Against Villa's Outlaws

By SIDNEY McNEILL SUTHERLAND

1370. Estes Ave.
Chicago

WHEN Mexicans fare forth to war their accoutrements are usually as astonishing as their methods are primitive and ineffective. The numberless revolutions that have desolated that unhappy country have finally worn out and destroyed the really splendid equipment that Porfirio Diaz had provided for his forces; and the war secretaries and quartermasters and "generales" and "armies" that succeeded him in endless array have been forced to exercise the most amazing ingenuity to replace with homemade weapons the fine military implements the great president left.

Experiences, when duplicated, can be summarized. The five-weeks' campaign on which I accompanied Gen. Joaquin Amaro in his pursuit of the late Francisco Villa across the state of Chihuahua in June and July of 1920, was typical of many expeditions in which it was my fortune to participate during the ten years of revolution that spanned the interim between Diaz and Alvaro Obregon.

Following the assassination of President Venustiano Carranza on May 21, 1920, the Chicago newspaper which had sent me to Mexico, instructed me to join the 29-year-old general in the northern part of the republic. I reached Jimenez, then Amaro's

headquarters, on June 10, presented my credentials, and was invited to make his private car my home as long as I cared to stay. Later, we gave up the little Pullman for a box car, in which we placed cots, tables, chairs, filing cabinets, and a charcoal stove for the barefooted and exceedingly dirty chef to use in the concocting of mysterious, fiercely spiced, and crudely served dishes.

The private car was on a siding. On half a dozen other tracks in the yards of this junction of the Mexican Central and the Parral railroads, were seven long freight trains. These contained Amaro's forces, about thirty-five hundred nondescript soldiers, their women and children, cavalry horses, dilapidated artillery, ammunition, hay, and water tanks, the latter a significant item in a campaign about the deserts of Coahuila and Chihuahua.

A Mexican army is like none other in all the world. For one thing, it has no commissary! A private gets fifty centavos a day (25 cents American money), and with this he must supply himself with food and clothing. The combination of his routine duties, sudden summons to battle, long treks across the plains, his inherent sloth and his amorous nature make the functions of quartermaster and cooking

3704

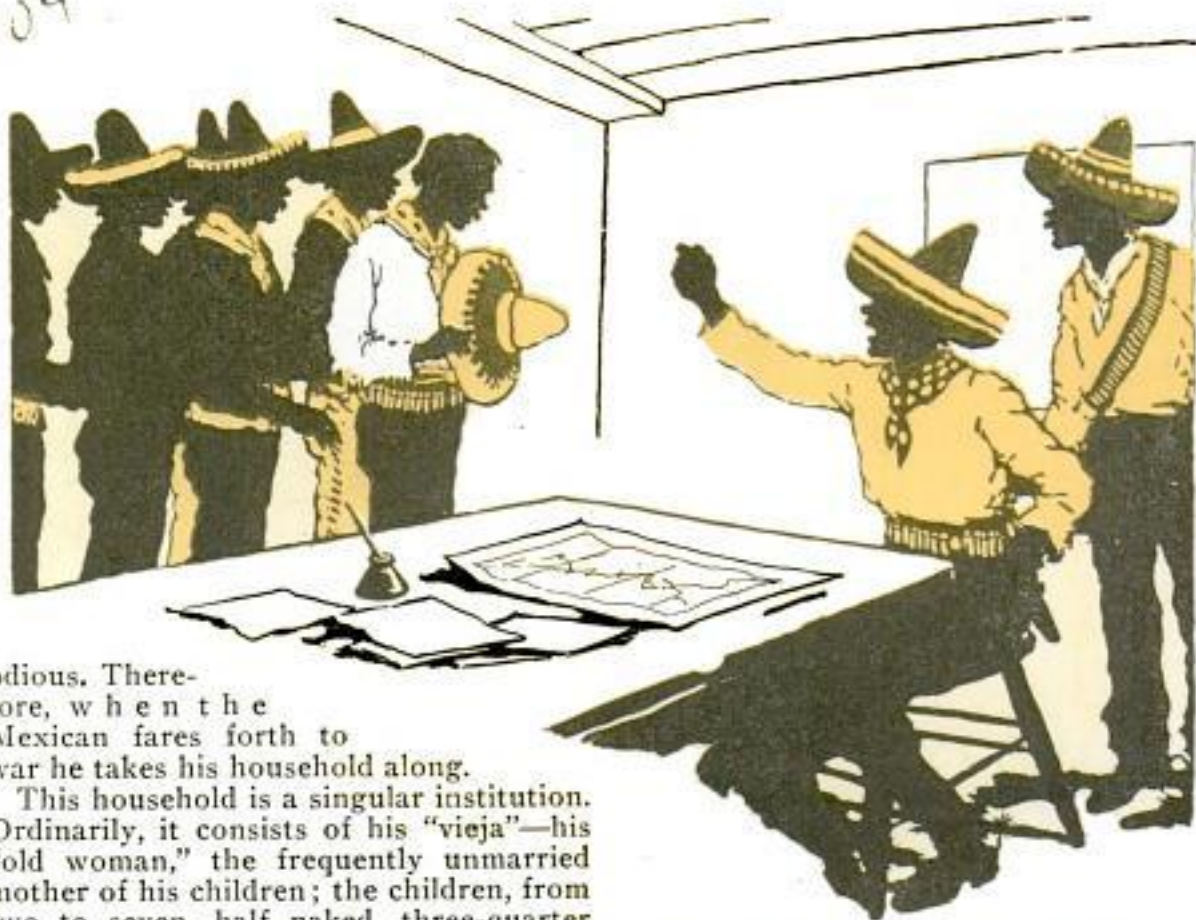

odious. Therefore, when the Mexican fares forth to war he takes his household along.

This household is a singular institution. Ordinarily, it consists of his "vieja"—his "old woman," the frequently unmarried mother of his children; the children, from two to seven, half naked, three-quarter starved, wholly filthy urchins; a tiny charcoal cooking apparatus; a bundle of the rags they call clothes; a crate containing a pig, a goat, three or four chickens, a parrot or two, a mocking bird, and a tame rabbit. Another article in this series will chronicle this amusing phase of Mexican militarism.

Thirty-five hundred lazy, ragged, indifferent, poorly armed, hungry patriots thus accompanied comprise an extraordinary caravan of military impotence, picturesque chaos, and hopeless confusion.

For five weeks we chased the homicidal and elusive arch-bandit in vain. Amaro's tactics, based on the reports of scouts and spies as to Villa's movements, were approximately as now set forth.

A courier dashes in, for example, at day-break of June 27, with a story that Pancho had been seen in the western foothills of the mountain range about Presidio, on the Rio Grande. Instantly, the camp is astir. Amaro claps his hands and excited members of his staff respond. With crisp and highly profane sentences he gives his commands, and orderlies dash away to summon the "generales" and their staffs.

In a few moments the bepistoled rascals were running hither from the huts and trees in whose shade they had been snatching a "siesta." Soon the private car is cluttered with officers bending above

the maps Amaro has spread on his table.

"How is the blacksmith doing with your battalion?" he asks Arnulfo Gomez.

"Senor, I think he is—"

"You think! Why the devil don't you know?" the commander in chief roars. Gomez scratches his head.

"Well, general," he stammers. "He has shod sixty horses, and there remain forty to be—"

"There remain forty!" The youthful chieftain pounds the table. "He and his assistants have had three days to finish your hundred animals. If you had not been swilling tequila with him two nights ago at Esteban Morales' gambling house he'd be through now. You fool, I ought to have you executed!"

Gomez, like the others, wonders again, as he has often wondered before, how his brilliant young jefe learns his secrets.

"Never mind," Amaro continues. "You put your sixty peones in the saddle in half an hour. Get 100 rounds of ammunition and five pesos from the paymaster for each man, and leave within an hour for the Loma Azul ranch. You will arrive at sundown. Post sentries, pass the night there, and at 3 in the morning be on your way toward the Valverde Peak. When you arrive there day after tomorrow at noon, comb an area thirty kilometers square, and then proceed to the Rancho

Gutierrez. I will have orders for your next move awaiting you there.

"Here is a list of thirty men and two women. You will find them in the ranches and towns along your route. Catch them and hang them to the nearest tree—they are Villista aids or sympathizers. And tell those sixty men of yours to leave their families here; they will be allowed ten centavos a day and charcoal.

"Now get out of here, and if you deviate one inch from these orders, I'll have you shot the next time I see you. No; I'll shoot you myself."

"General" Gomez—and those present—know this is no idle threat; and, presently, Amaro's orders to the others (orders which, if correctly obeyed, should encircle Villa in the center of the converging cavalry columns) are interrupted by the oaths of men saddling restive horses, by the coyotelike wails of deserted "viejas," and the shrieks of brown-bellied babies.

"Tell those women I'll run every one of them out of camp if they don't stop that infernal screaming," Amaro cries to an orderly; and soon the lamentations cease; and extended clouds of dust in every direction tell of horsemen off on the routes Amaro has traced on his map to trap the wily outlaw and his men.

After the troops had departed and the women had been consoled by each other and by the remaining officers, Amaro gave orders to prepare a military train for a trip up the line to Santa Rosalia de Camargo, a lovely little town on the great Concho River. By moving his headquarters there, the general would be directly west of, and at the town nearest, the point where Villa was reported to be hiding.



General Espiridion Rodriguez Squatting Beside a Huge Dynamite Bomb That Failed to Explode Under Passenger Train Near Estacion Concho

In less than an hour the patched-up switch engine was making up the train. The private car was placed near the switch on a siding; two checkerboard armored gondolas were coupled to it; four flat cars with aged 3-inch guns and pup tents for the artillerymen, were added; fifteen box cars filled with horses and saddles and hay, and carrying forty privates on their roofs, were shunted in; the only two modern armored cars in the republic were brought up; a heaving, protesting, and oft and crudely repaired engine was attached, and the train was ready.

Carrying the general's own bodyguard, the two gondolas next to the Pullman were unique propositions. Sheets of half-inch boiler plate were nailed to the outside, separated by about six inches from the sides of the car. The iron was painted like a checkerboard, about fifteen of the black squares on each side having been chiseled out. A small wooden chute led from each of these loopholes to similar holes sawed in the gondola's sides, and the 6-inch space was filled with gravel and sand, making an effective 9-inch barrier to any rifle bullet. The members of the escort kneel, which brings their heads below the top of the armor, thrust the muzzles of their rifles through the 4-inch apertures, and fire at their foes beyond the right of way. The latter, a couple of hundred yards away, have trouble in deciding which of the checkerboard squares to shoot at.

We reached Santa Rosalia by sundown, went into a siding, and looked the town over. The next morning, while loafing and wondering what progress the cavalry



Tiny Sopwith Airplane Being Assembled at Jimenez, Chihuahua, for Use in Search for Villa

3704 194

columns were making, we were stunned by a telegram from Estacion Concho, forty miles north, that Villa had dynamited the daily south-bound passenger train. As we made feverish preparations to entrain, Amaro cursing homericly the deceptive report that had sent a thousand of his men on a goose chase into the mountains, further details of the raid on the railroad were sent by the telegraph operator at Concho.

The passenger train, it seemed, was in a deep cut about a mile north of the Estacion, when a bomb was exploded with terrific force under the first armored gondola, immediately back of the engine tender. A

of days later I saw the twelve hanging by their necks from trees along the road Villa took in his flight to the mountains. They were his "compliments" for Amaro's pursuers.

Amaro reached the scene by noon. He embraced and rewarded the sergeant who had con-



second sooner and the infernal machine would have wrecked the engine, which was Villa's intention. The checkerboard car was twisted

and torn and thrown off the tracks, the engine coupling was broken, and the engineer had put on all steam to Concho.

In a moment the bandits hiding in the brush had crawled up to the embankment and were pouring volleys into the passenger coaches and at the armored car on the rear of the train. The guard there put up a heroic resistance and really kept the Villistas from capturing the train. The latter, anathematizing the luck that had let the engine escape to give the alarm, finally retreated, carrying with them a dozen captives from the wrecked gondola. A couple

ducted the defense of the train by making him a captain. Then, while soldiers filled up the great hole in the tracks and laid down ties and new rails, we examined the Villista's companion bomb which had failed to explode under the last gondola. It was a 5-gallon sheet-iron "can" filled with dynamite sticks, its covers kept on by a large bolt running through it. Two slender electric-light wires attached to the cap had been detached in some manner by the detonation forward. The wires ran from the bomb across the right of way, up the embankment, along the ground and out through the chaparral for a hundred yards to where a bandit operated a telegraph key and a small dry battery.

By sunset the five or six dead had been buried, small crosses being erected above their graves; the wounded soldiers and passengers had been given first-aid treatment; the pursuit was organized; couriers were sent to recall the misguided columns far to the south; the tracks were repaired, and the trains proceeded to Santa Rosalia, where another period of watchful waiting began.

Villa finally surrendered in August to Gen. Eugenio Martinez, in the state of Coahuila. There he might expect mercy; Amaro would have executed him.

HYDRAULIC HOIST FOR AUTOS REPLACES PIT

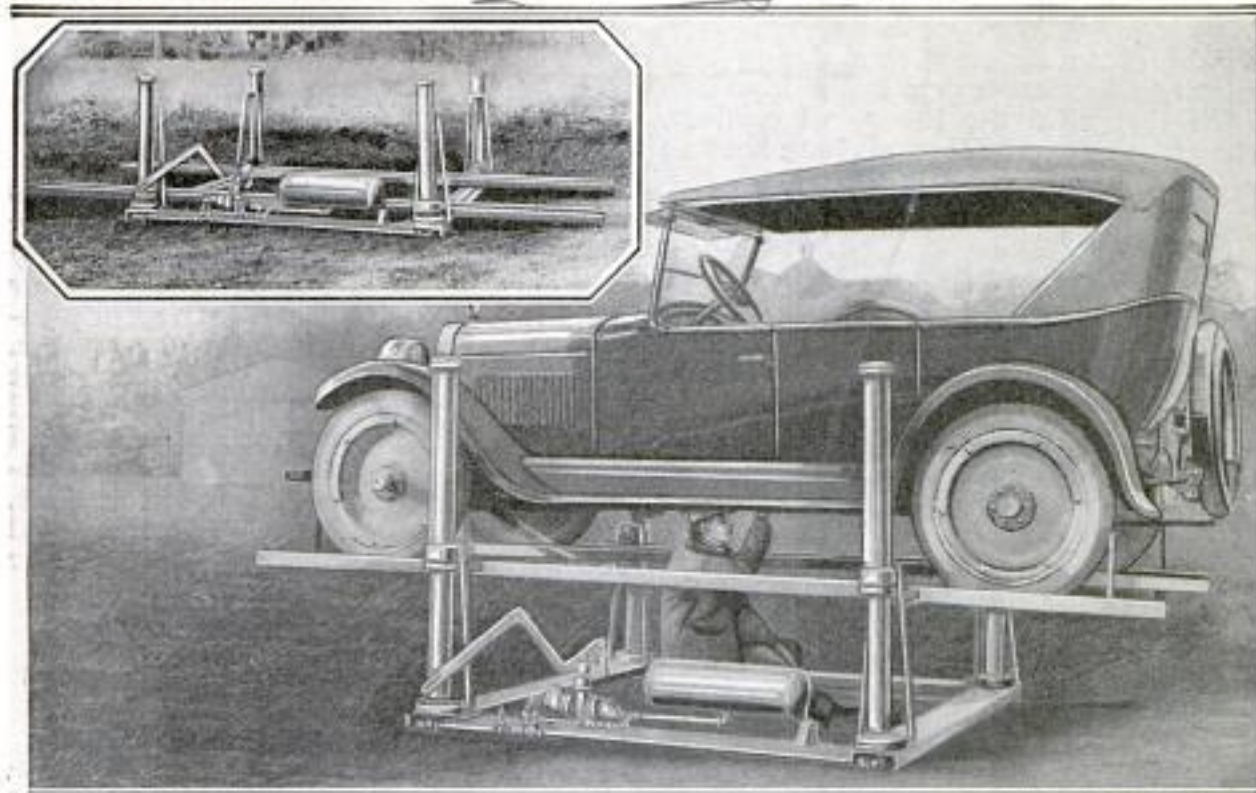

Hydraulic Hoist that Eliminates Pit in Repairing Automobiles and Lightens Mechanics' Labors. Below: Car Clamped to Runway and Raised

Reducing to one-half the labor required of mechanics working underneath an automobile, and doubling the working output, are said to be the advantages of a new hydraulic hoist on which patents are pending. Completely assembled, the device takes up little more floor space than a car.

The automobile is driven upon a runway of channel iron, suspended from four piston plungers, and a few strokes on a pump handle lift the car evenly, three feet, giving the mechanic a working space of four feet. By means of a valve, either end can be lowered, raising the other.

AIRCRAFT SKIMS ABOVE EARTH AFTER RAISING ITSELF

Ignoring the upper levels of the air, an inventor recently testing a new type of air-

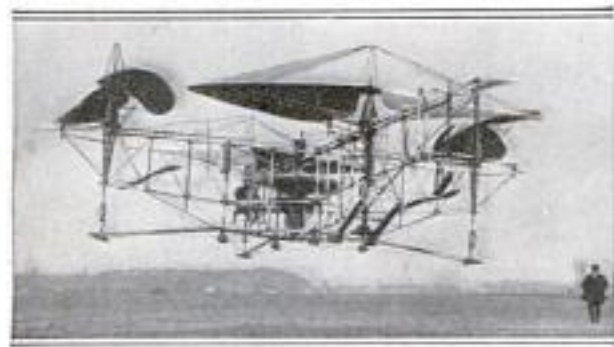

Helicopter which Made Flights at Altitudes of about 10 to 15 Feet from the Ground

plane in France, kept his machine within a short distance of the ground. The model, which was of the helicopter class, main-

tained its weight at a height of only 10 to 15 feet, flying a considerable distance before landing. This method is said to be favorable to the horizontal propeller with which such craft is generally equipped, since it serves to "pack" the air between the whirling blades and the earth, giving a better support for the flight.

USE OF GAS TO TRAP ANIMALS IS SUGGESTED BY EDISON

At the suggestion of Thomas A. Edison, the inventor, army experts are seeking to devise some means for using poison gas in connection with trapping so that wild animals will be instantly killed instead of lingering for hours in torture. The use of electricity in the traps was declared to be commercially impractical. Therefore, it was suggested that a chemical might be so placed as to be released when the trap was sprung.

Designed by
E. J. Lehnichers
France

New York Times
11/23/24

Cont. E. B. Schmidt

196

355

7 *St Charles Place*

POPULAR MECHANICS

Hyde Park, Cincinnati Ohio

ROSES CUT FROM SEA SHELLS
RIVAL NATURE'S EFFORTS

and tight sewing, are points that distinguish a well-made broom, and defects in their construction are detected easily.

4280

Faithful to nature's own design and color, flowers are being made from sea shells that rival the beauty of gardens. The artistically cut blossoms have become

Sold by - A. Burrod, 29 W. Austin, New York

made in Paris



Flowers Created from Carved Sea Shells that Appear so Lifelike They Rival Nature

a popular fad in France. Delicate petals of roses are imitated so faithfully that to the unpracticed eye they appear to grow. Models of roses, tulips, hyacinths, and hydrangeas are said to be cut with such skill that even the glint of the radiant colors deceives the observer.

Cont. Edwin Jarvis, Washington c/o The Harriott, 20 E. ...

USE OF BROOMS IS INCREASING DESPITE VACUUM CLEANING

Although the advent of vacuum sweepers has revolutionized house-cleaning methods, brooms are in greater demand than ever before and improved devices for their manufacture are being produced constantly. Government reports showing that approximately 50,000,000 brooms are consumed each year in the United States, and the slightly increasing acreage devoted to broom-corn culture, indicate that modern inventions have not entirely displaced the time-honored household implement. "Fancy" brooms for cleaning fine carpets and rugs have almost disappeared from the markets, but the "plain" article is in heavy demand. Unpainted handles, fine-fibered corn, regular and even shoulders,

ACTIVE VOLCANO "FOR RENT" AS POWER PLANT

Capable of furnishing enough steam to develop electrical energy approximating 400,000,000 kilowatt hours a year, a partly extinct volcano in Bolivia is "for sale or rent," according to a report recently received by the United States government. The value of the jets of vapor that shoot up from the volcano's sides was realized by an expert following the discovery of the crater a few years ago. Lack of capital prevented development of the project, after the first few experiments. Internal heat from the earth has been utilized for some time in Italy to generate power.

Chita Ledger 11/19/23

MASKS AND DUSTPROOF ROBES GUARD CHEMICAL WORKERS

Workers in the dark bleaching chambers of an eastern chemical factory go about their toil in masks, hoods, and respirators to shield them from dangerous fumes and dust that arise from the materials they handle. Their clothing becomes white with fine blanching powders. In addition to the face guards, a covering

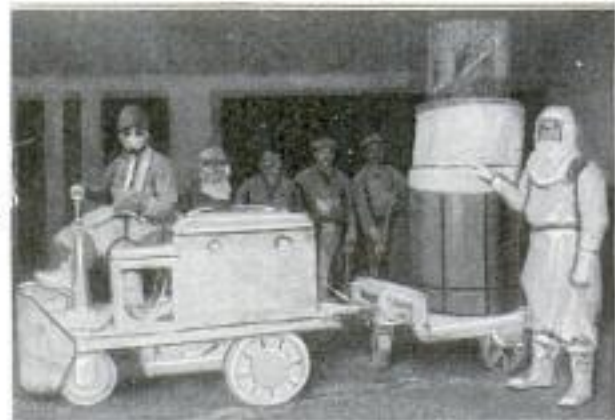

Masked Workers of a Chemical Factory Protected Against the Injurious Effects of Acid Fumes

which ties securely in the back and has a window for the eyes has been found effective. Another mask, called a "muzzle," is composed of flannel wound about the lower part of the head, covering the mouth. Leather mittens and hose made of wool are also worn to resist the effects of chlorinated lime.

Iron ore of excellent quality has been discovered in Cuba.

Hooker Electro-Chemical Co. Copyrighted material Niagara Falls, N.Y.

INDIANS BUILD HANGING BRIDGE WITHOUT NAILS

Ingenious bridges have been constructed by the more advanced American Indians without the use of nails or any other metal. The famous hanging bridges constructed by the Peruvians are often mentioned as marvels of primitive engineering. In the Sierra Nevada of Northern Columbia, the Arhuaco Indians, in the lower mountains, erect bridges that are held together entirely by vines

farthest inland being short and vertical, those close to the water, long and leaning out over the stream. Cross-ties are put over the uprights and lashed firmly with fiber cords. This done, the shore end of the structure is heavily weighted with stones, and the span is then thrown across and securely fastened. Thus safely erected, the guard rail is put in place, for even the Indians would find it difficult

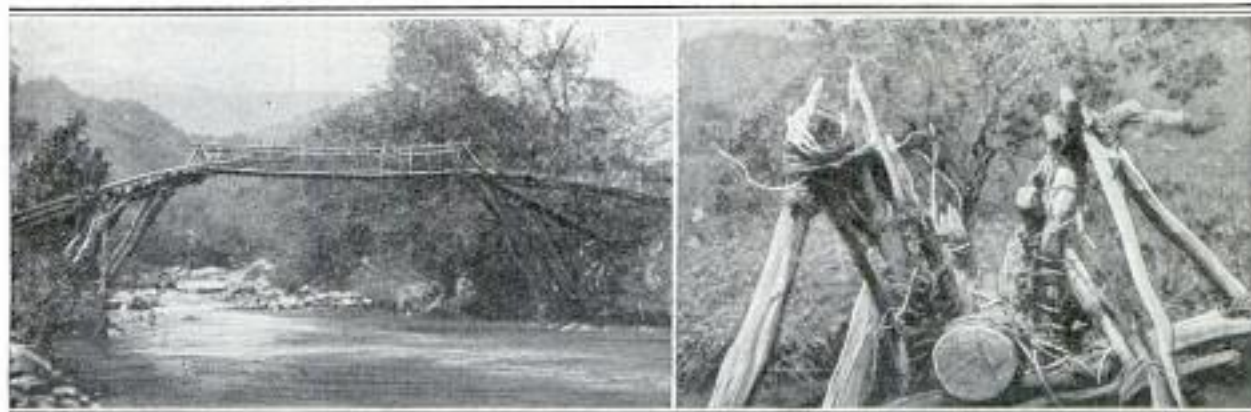

Left, Bridge Erected by Indians that Is Held Together only by Lashings of Vines, and Right, View of Passage-way. The Floor Is a Single Log with Guard Rails

and ropes made from fibrous plants. They first select a place where the stream to be spanned is narrow. A large number of long, thick poles with forks at the upper ends are stuck firmly in the ground near the water's edge and tied to the branches of trees. They are placed in several short rows parallel to the bank, those

to walk across the logs if they were burdened with heavy loads. Naturally, the bridges are not very strong, and never more than two people are permitted to venture on any of them at the same time. Domestic animals are made to wade or swim the stream when it is necessary for them to cross it.

ATOMS TOO SMALL TO BE SEEN ARE ANALYZED

Atoms 2,000 times too small to be seen under a microscope, and once thought to be the tiniest particles of matter, are described under a recently advanced theory as built like a solar system with electrons, or negative units, revolving about a positively charged center in much the same way as the planets revolve about the sun. Since the action of all matter is believed to be based upon electrons and protons, the positive form of electricity, the universe, under this theory, is regarded in somewhat the same light as a gigantic atom, the earth being one of the electrons.

Collecting of balata gum, derived from the milky juice of the balata tree and used in making rubber belting, is one of the principal industries of British Guiana.

TWINE CUTTER LIKE HOOK PROTECTS HANDS

To protect workers' hands from injury while snipping cord, a twine cutter has been invented by a Pacific Coast man to take the place of the ordinary knife. The end of the tool is turned up like a buttonhook, the inside of the curve is slotted, and a small blade is inserted in the opening.

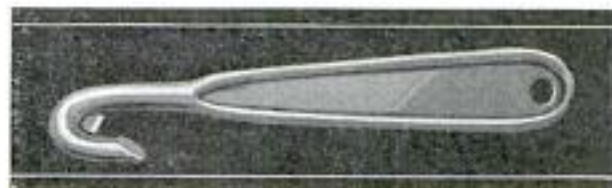

Cutter for Twine that Is Bent Like Buttonhook to Add to Efficiency of Worker

When the string is to be severed, a slight hooking motion with the utensil guides the strand against the sharp edge.

Hook Twine Cutter Mfg. Co. Seattle, Wash.
 608 - 24th Ave. North

4093

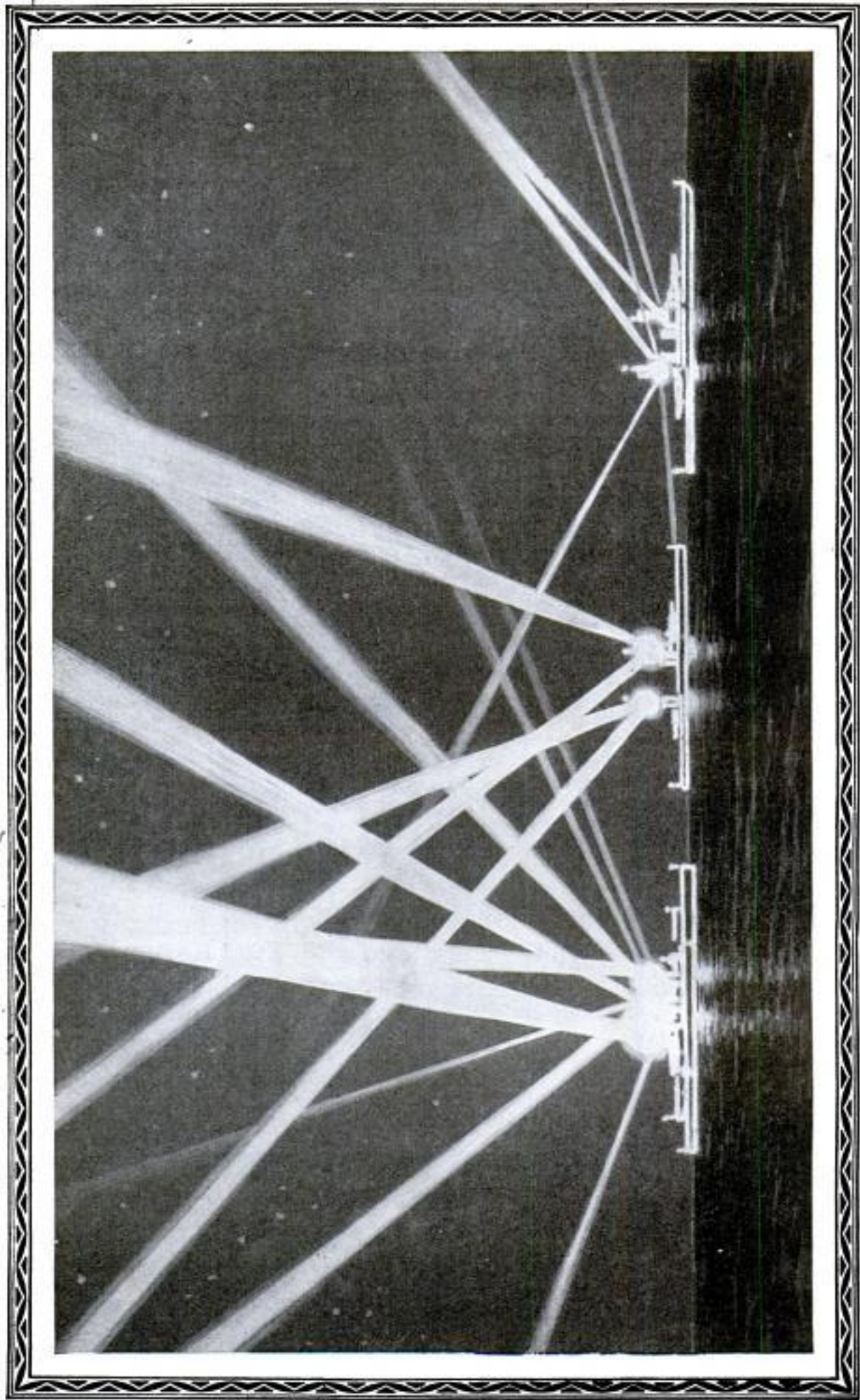

During an Electrical Display that Marked a Naval Pageant, Millions of Candlepower Radiated in Beams from Giant Searchlights that Illuminated the Sky for Miles Around with Ribbons of Opalescent Light

49
4093 Pacific & Atlantic Photo. Inc.
25 Park Place, New York

Monster Searchlights Are Eyes of Fleet

Naval Experts Develop Bigger Beacons to Meet the Needs of Faster Cruisers and Destroyers

WITH the building of warships like the U. S. cruiser "Concord," faster than any ocean liner and propelled by power enough to supply all the public utilities of a city like Baltimore, naval experts have directed their attention to designing more powerful searchlights for protection against submarine and torpedo-boat attack and to aid in signaling.

Visible at a distance of approximately 127 miles, the beam cast by the latest of these monster beacons is estimated at 500,000,000 candlepower. So concentrated are its rays that they will blister the skin and also cause sunburn. Known as the "eyes" of the navy, their work is largely defensive, as they are depended upon to reveal enemy craft during night attacks.

After a day spent in big-gun practice by the fleet in southern waters recently, the value of the searchlights was displayed dramatically during the progress of a war "game." Already stripped for action, the drab, gray, fighting monsters were swallowed up by sudden, tropical night that fell over them like a shroud. "General quarters" followed mess aboard the ships and, as the pole star wheeled into view overhead, every sailor and officer stood at his post, peering with anxious eyes into the darkness.

Away in the distance could be seen long fingers of light groping across the waves, beacons of hope from a protecting screen of destroyers and scout cruisers that surrounded the battleships and dreadnaughts as they rode quietly at their anchors. Somewhere in the encircling blackness, quivering under the suppressed power of their mighty engines, lurked a flotilla of "enemy" torpedo boats—assassins of the deep—waiting for an opportunity to drive home their attack.

After what seemed like hours of tense waiting, the beam of one of the searchlights near the horizon began to scrawl a code message across a distant cloud bank, rising and falling to indicate the dots and dashes. On the bridge of the flagship, a signal officer jotted down the words:

"Enemy—sighted—north—north—east—stop—am—starting—in—pursuit."

As the radio began to bring in reports on the progress of the chase, the searchlights

of the fleet were brought into action to prevent any surprise attack while the ships of the protective unit were seeking to close in on the quarry.

Restlessly searching the waves, one of the beams momentarily touched a dark object and passed on. Almost instantly the phone connecting the bridge with the fighting top rang.

"Destroyer on port quarter," was the report.

At the same time the strange craft which was racing along at express-train speed, was picked up again by other shafts of flame, but before its range could be relayed from the fire control to the bridge and secondary batteries, it vanished by suddenly turning sharply on its course and disappearing under the smoke screen it had been laying.

"Stand by!" the telegraph dials signaled frantically to the engine-room crews, as the ships hurriedly slipped their anchors in preparation for instant flight. Then, "Slow speed ahead," followed by "Full speed."

As they picked up way, the ships were swallowed up by the clinging smoke screen. Foglike in its density, it blotted out the stars and stopped the beams of the searchlights, turning their rays into mere glowing balls of orange-red flame. In response to orders from the flagship, the useless searchlights flickered out, and the ships, in column formation, steamed on, each being guided by a hooded light in the stern of the one ahead.

From the wireless room came the word that their signals were being "jammed," presumably by interfering radio waves sent out by the "enemy," and at the same time the submarine telephone gave warning of the presence of other ships, although indistinctly, because of the noise of the fleet's own engines and propellers.

To try to stay under the cover of the smoke screen, or to take a chance in the open? That was the problem faced by the fleet. It was decided in favor of the former course, as, without the protection of the fast destroyers that had been lured away on a futile chase, the only salvation for the comparatively slow battleships was in sighting and destroying the "enemy"

torpedo boats before they could approach close enough to discharge their deadly missiles. And there was always the hope that the distant cruisers might return in time to be of assistance.

But the plan was defeated by a vagrant gust of wind that rolled away the smoke shroud as though it were a great carpet, revealing a flotilla of torpedo boats steaming along in a parallel line so close that the big guns of the fleet could not be lowered sufficiently to be brought to bear.

Scarcely a word was spoken on any of the ships. In the secondary batteries of three-inch guns, pointers and sight-setters brought their pieces to bear as they received the range from the fire control through the telephone sets strapped about their heads.

"Fire on buzzer," came the order from the bridge of the flagship to the port battery in preparation for a ranging shot.

"Four thousand—," began the voice from the fire control in rectifying the range.

But the sentence was never finished, for the flotilla turned at right angles on its course and dashed toward its prey while a triumphant rocket tore across the heavens from the deck of the leader, bursting like a trench light above the fleet.

All was over, for, according to the rules of the "game," the fleet had been sunk, as the "enemy" had been able to approach within 4,000 yards without detection. "Secure," sounded the bugles, and, with all lights on, the ships slowly returned to their anchorage.

In signaling, the rays of the searchlights are interrupted by shutters so as to form the dots and dashes of the code. Carbons used in the electric arc that supplies their powerful rays have a core of a chemical composition. When this is fused, it forms an intensely bright ball of flaming gas, but cuts down the heat so that the lens can be placed closer without melting.

The result is an almost perfect concentration of the rays capable of carrying great distances except in a fog.

SPEED OF GOLF BALL DEPENDS ON WINDING

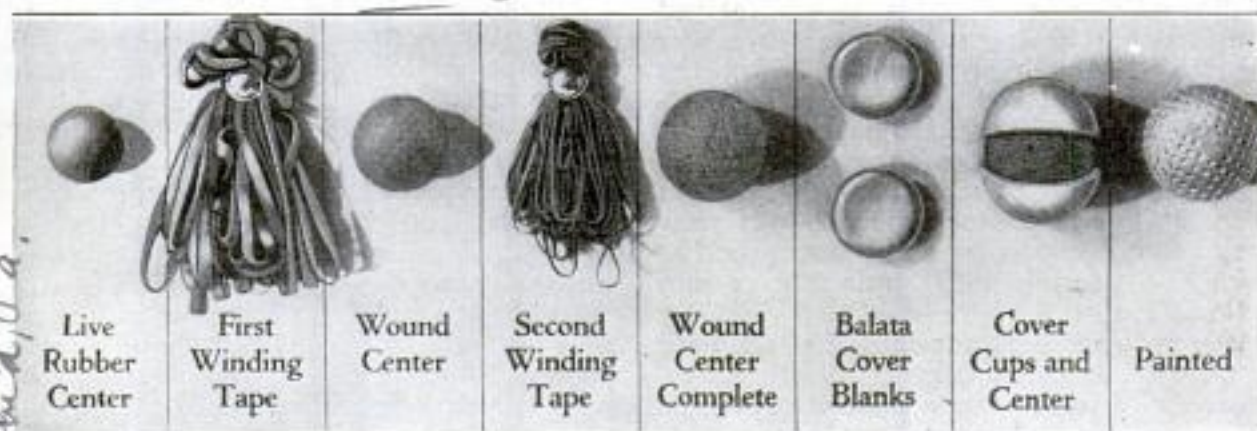

From a Center of Soft, Live Rubber, the Golf Ball Passes Through Various Stages, Acquires a Hard Rubber Shell, and Is Finally Ready for the Tee

Once fashioned of feathers stuffed into a leather cover, golf balls now are delicately constructed spheres, made with exacting care on complicated machines under the eyes of experts. Resiliency, durability, and perfect shape are the essential requirements. About a live core, yards of rubber tape are wound in machines which turn out thousands of the "pills" a day. The speed of the ball depends on the winding, according to tests. The hard covering is manufactured of balata, a product of trees grown in Venezuela. This is mixed with gums of various kinds to give it toughness. The cover is tightly joined to the tape-wound center by a special process and, after indentations have been made in the

surface to give the ball accuracy in flight, it is coated with a special kind of paint to resist blows of the clubs and to make it visible on the greens.

LIQUID SOAP IN BRUSH HANDLE MAKES SHAVING EASY

4316 To make shaving more convenient, a brush which lathers with liquid soap, supplied from the hollow handle of aluminum, has been made. The bristles are mounted in a detachable holder of the same metal, and can be removed easily for cleaning. The liquid is shaken, drop by drop, onto the brush, and the valve, through which it passes, is then automatically closed.

*The Huntington Mfg. Co., Bullitt
The Coldwell & DeLoria, Pa.*
Hawes Mfg. Co.,
Bridgeport, Conn.

Nothing like that
11-11

CONCRETE FREIGHT CAR SAVES LOSS BY WRECK OR RUST

After undergoing severe tests in collisions, the impact of which could be heard for miles, a 15-ton reinforced-concrete freight car recently built in Germany showed neither crack nor break. The weight of the car is greater than that of a steel carrier, but it is said that the former runs steadier, is immune to rust, and is less affected by wear. Traveling at a speed of about 13 miles an hour, it crashed into stop blocks placed on one rail, and also into steel cars.

4347

SMOKING MACHINE "BREAKS IN" AND TESTS NEW PIPES

Patrons of a tobacco store in London avoid the unpleasant experience of "breaking in" new pipes by having them tested

4192



Copyright, Keystone View Co. Automatic Smoker that "Breaks In" New Pipe While the Customer Waits

and seasoned in an automatic smoking machine which the proprietor has used for some time to demonstrate the qualities of his goods. The pipestem is inserted into a tube to which suction is supplied by a small air pump within the device. The bowl is filled with tobacco and lit and the machine smokes away while the purchaser is assured that the first drafts on the new pipe will not be attended by a bitter taste and a parched tongue. The qualities of tobaccos can also be tested by the invention in a short trial.

PAPIER-MACHE PACKAGE KEEPS FIGS FROM SPOILING

Packed in papier-mache containers, figs are now shipped by express without icing, from California to eastern markets. Only those 2½ inches in diameter are sent in this way, uniformity in size being necessary to fill a package that holds three dozen so that they do not touch or rub. The

4230

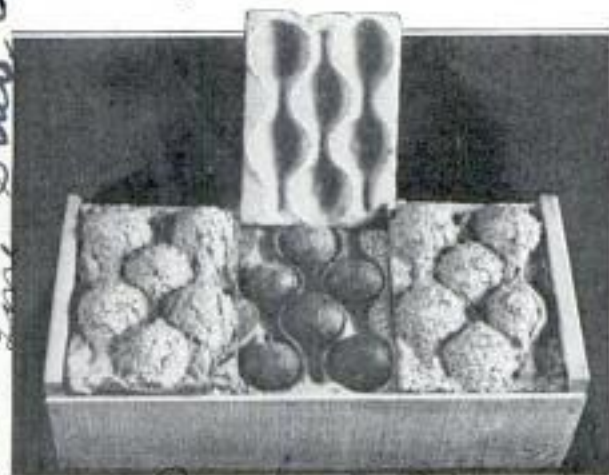

These Papier-Mache Containers Protect Figs from Bruises and Keep Them Cool

fruit is nested securely in the carrier and is said to be uninjured and kept cool and dry in transit.

BIT OF WIRE TO HUNT QUAKES AND FORECAST TREMORS

To chart movements of the earth's crust so that scientists will be able to forecast quakes, a tiny seismograph, weighing less than a portable typewriter, and no larger, has been put in use by the Carnegie Institute. It is claimed that this little machine records tremors undetected by the heavy types now used. The main part of the instrument consists of a length of wire of the same weight as the filament in an electric-light bulb. Perfected by Dr.

4330

J. Anderson, Mt. Wilson Observatory, California

PENCIL AND ERASER HOLDER FITS ON TYPEWRITER

4227

Eraser and pencil are kept conveniently near the stenographer's hand in a holder designed to be attached to the typewriter. The device is fastened under one of the rubber supports of the machine by sharp points on a bottom plate, or it is inserted between the foot and the frame by partly unscrewing one of the rubbers and affixing the holder, which has a slot for that purpose. The pocket can be adapted to any shape of eraser, and by bending the metal fastenings the tools are held securely when the typewriter tilts.



London, England
137 High Hill
New York City
74 Cortland St.
New York City
New York City

Letter read
6/4/24
see November 1923
P.O. Scott
inventor
Star

edit
ippi
y 22
is i

Capt. William Thompson,
 c/o E. H. Young, West Camp,
 3805 Webster Co., N.Y.

202

POPULAR MECHANICS



Wire-Mesh "Sand Shoes" that Make Desert Marching Easier by Lessening Strain

"SAND SHOES" OF WIRE END STRAIN OF TRAVEL

Made of stiff wire, and larger than the soles of the boots to which they are firmly strapped, "sand shoes" are used by the military forces in Syria, in making long marches over the shifting deserts. These meshed foot protectors distribute the weight over a greater area and give the wearer a better purchase in walking, thus doing away with much fatigue and strain. They operate on the principle of the snowshoe of the cold regions.

"HOT LANDS" RECLAIMED FOR COTTON IN MEXICO

Irrigation has been practiced on a small scale in Mexico, in the valley of the Rio Grande, to grow cotton, but the water supply is far too limited and uncertain to be of value in reclaiming more than a very

the water flowing between the rows of plants, and being discharged lower down in the rivers. In the few districts in which this is possible, excellent results are obtained, but these rivers are almost dry for

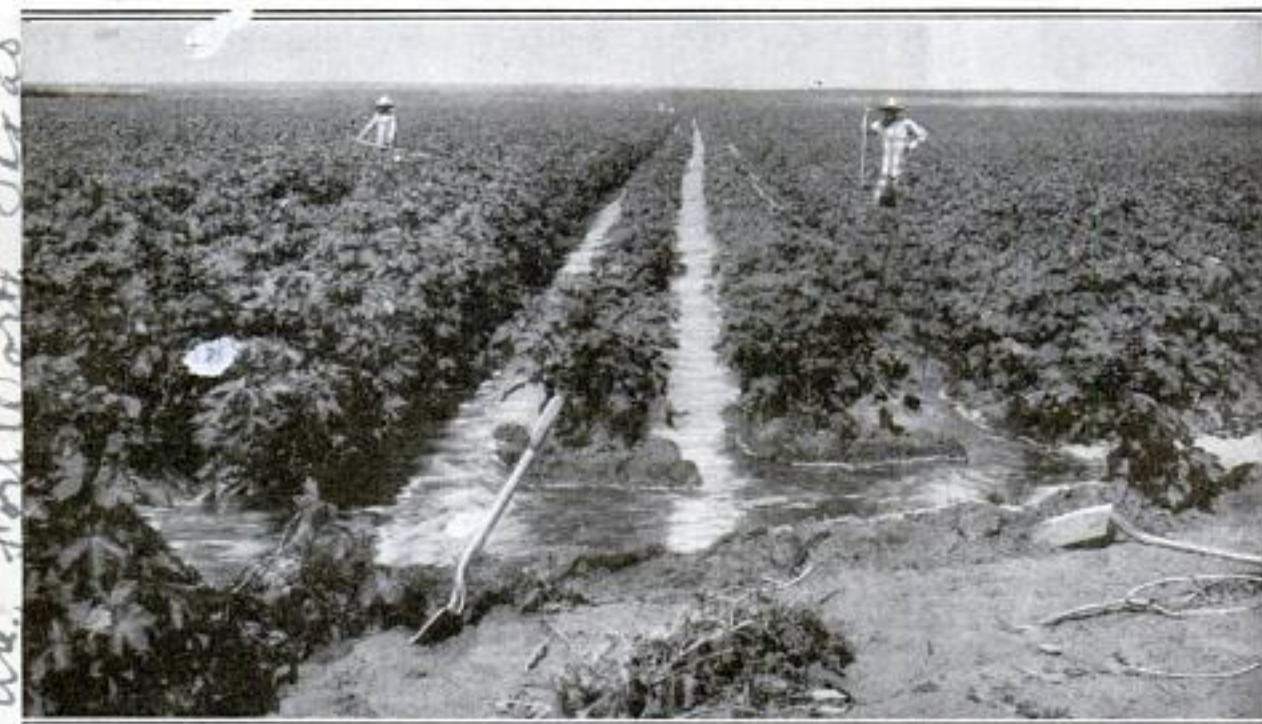

Cotton Grown by Irrigation in the Valley of the Rio Grande in the "Hot Lands" of Mexico

small proportion of the great tracts of arid lands. On the other hand, the problems that face the agriculturists operating on a large scale in the fertile valleys of the "hot lands," have to do with drainage, as the rainfall is heavy. Such irrigating projects as are carried on, are by means of the usual dam and trench system, with

several months each year, and sometimes the freshets do not flood them sufficiently for practical use.

☞ Oak timbers in the roof of a London building are as strong now as they were when put in five centuries ago, according to a recent test.

4094
 Capt. Byron C. Utecht, 2621 Gen. Mining
 Ave., Hot Water, Texas



"The Pit," of the Chicago Board of Trade, from which the Rise and Fall of Grain Prices Are Broadcast Daily to All Parts of the Country by Radio

Glimpse Behind Radio Broadcasting Scenes

Strange Mechanical Devices Used to Produce Realistic Effects for Unseen Millions of Listeners

WITH the constantly increasing popularity of radio, broadcasting stations have been forced to devise many ingenious contrivances to give realistic effects to their dramatic programs.

While theater audiences are familiar with the means employed for making stage thunder, rain, hail, hurricanes, pistol shots, and so on, entirely new methods have had to be resorted to for the wireless, because it must be done through the ears alone.

As a result, the average "fan" who listens in on the program would be sadly disillusioned if he could catch a glimpse behind the scenes, for it has been found that the voice alone often fails to give the proper illusion, and mechanical means have been used to help it out for the benefit of unseen hearers.

If an airplane is supposed to pass, the whir of its propellers must be reproduced. Should a house fall in, or a forest fire be supposed to menace the actors, there must be a corresponding sound. The noise of an aircraft, for instance, is produced in lifelike manner by placing an electric fan be-

fore the sending device and holding a piece of paper against the revolving blades. By moving the paper back and forth, the impression is given the listeners that the plane is approaching or receding.

When a house is supposed to fall with a crash, the impact is reproduced by some one jumping from a table onto several boxes, which are crushed beneath him. It was found impossible to give the illusion of a burning fire. Even when an actual blaze was started, the effect was not realistic. Finally, the problem was solved by holding a lighted gasoline torch near the microphone.

The sound of a falling tree is produced by bumping a chair about the floor. In

broadcasting a dinner scene, the actors do not need any table. It is important, however, that a number of dishes be rattled from time to time to suit the action. Also, it may come as a shock to those who have listened in on love scenes to learn that the sound of a kiss is not made in the conventional manner. The noise results from loudly kissing the back of

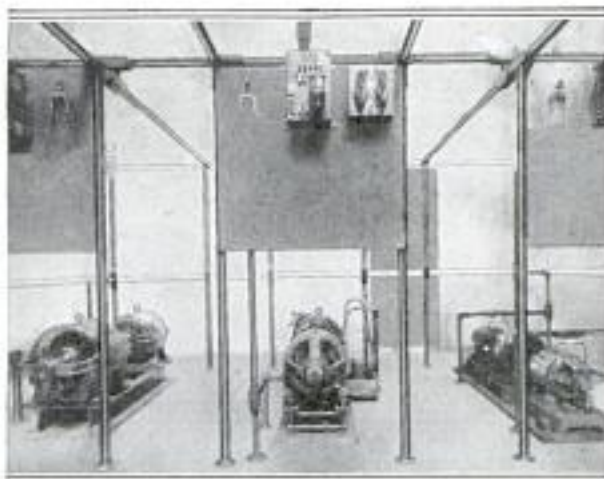

Electrical Generators that Supply Power for One of the Nation's Largest Broadcasting Stations

the hand held close to the transmitting device.

From the control desk, a broadcasting station presents an amazing view of complicated electrical meters and switches. At the far end of the room are the generators, and over it all extends an elaborate pipe framework that serves to inclose all of the power wires and support the apparatus.

A push on two buttons starts a pleasing purr from the generators, accompanied by a succession of clicks from the automatic starters attached to the machines as they "step up" the power and bring the speed to the maximum of over a thousand revolutions a minute.

Then an imposing array of tubes resembling huge electric lamps begin to glow. After a minute or so to allow them to become thoroughly warm, another button is touched and the soft drive of the generators changes, the indicator's needles jump ahead, and the station is ready to "go on the air."

Before the director, on the operating table, is a box of complicated switches which connect the transmitter with microphones, or "pickup" devices, strategically located near orchestras in any part of the city. One is marked "studio" and connects with a quiet room where singers, pianists, and other artists are waiting. By placing on his head a pair of telephone receivers connected to a regulation receiving set, the director is able to hear exactly the same sounds that float across the continent and the high seas within a range of thousands of miles.

The control cabinet houses a small amplifier, of the same sort used in a receiving

set, and this is switched on in order to amplify the voices and instruments which are waiting the signal to start. Finally the switch is closed, and a red light comes to life on the desk of the musical director in the studio. The announcer, seeing the signal, closes a switch on his table which cuts in a microphone, resembling nothing more than an overgrown and somewhat modified telephone transmitter, and in the head phones of listeners in all parts of the country comes the announcement, "This is W-D-A-P—."

The duty of the operator is to watch all of the meters for indications of trouble in the complicated network of apparatus and to carefully listen to everything coming over the microphone line in order that nothing shall be broadcast that does not come up to the requirements of the United States Department of Commerce, which regulates everything that goes on by way of the ether wave.

Occasionally the circuits are changed at the proper time to connect with an orchestra, giving the studio performers a chance to rest; and at last, about midnight, the announcer in the studio will say, "This is W-D-A-P, Chicago, signing off."

Then the generators are stopped, all of the switches turned off, and the lights put out.

But the next day approximately 400 letters will be received from radio fans commenting on the evening's performance.

These messages, sometimes in the form of telegrams, come from all parts of the country. Recently, a wire sent from Chicago to an Atlanta, Ga., station, was received there and read back to the sender in approximately 20 minutes.



Board from which Grain Prices Are Broadcast

3942



Studio of WDAP and the Microphones that Carry Music and the Announcements to the Transmitting Station

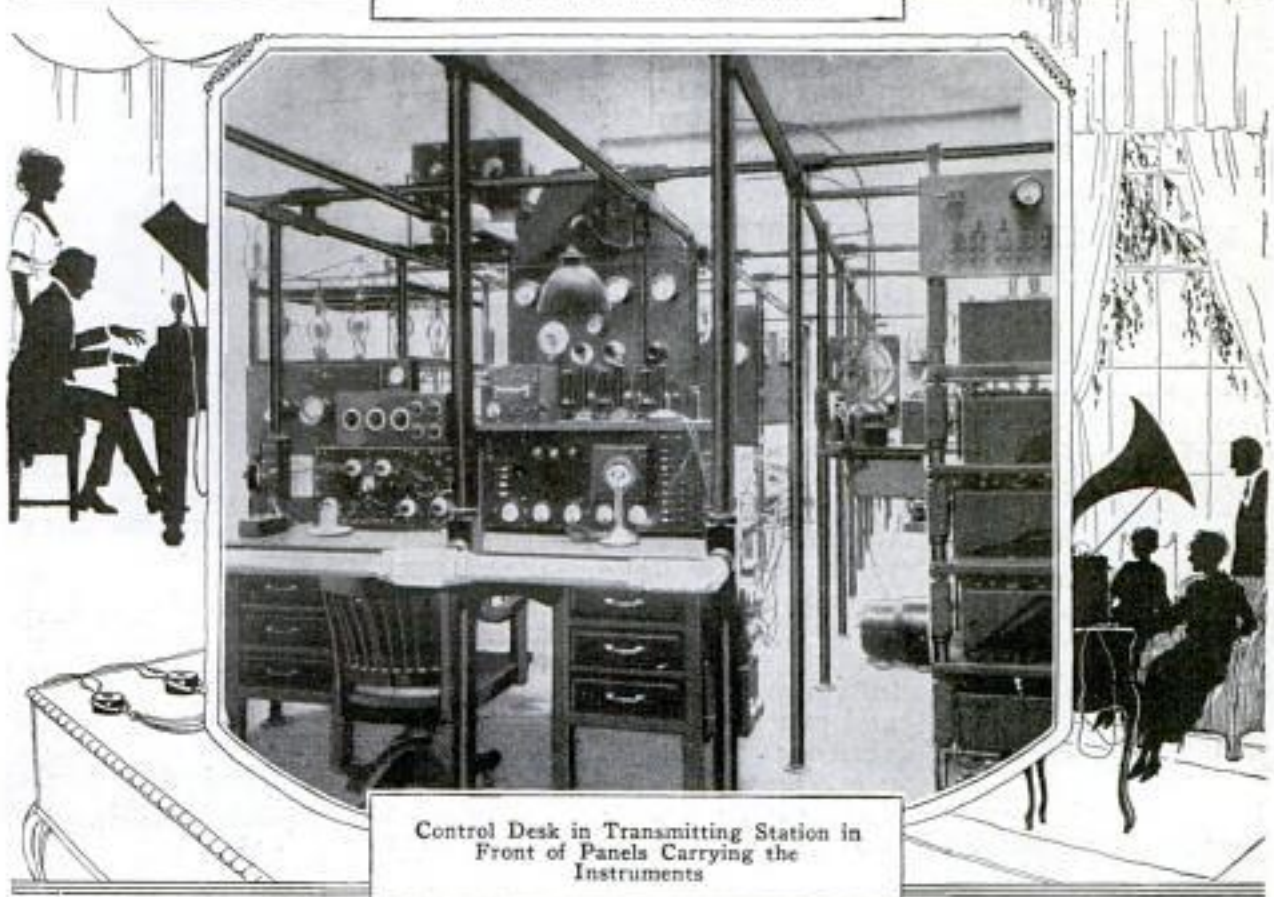

Control Desk in Transmitting Station in Front of Panels Carrying the Instruments

RADIO COMPASS ROBS THE SEA OF MANY OF ITS PERILS

431 To enable the navigating officer to ascertain the ship's position in even the densest fog, a radio compass has been installed



Radio Compass on "Leviathan" that Gives Position in Fogs and Diminishes Collision Risks

aboard the liner "Leviathan." By means of this latest aid to navigation, the dangers of running aground or collisions at sea, may be minimized. By means of radio direction finders, bearings are taken on stations of known position, and the ship's latitude and longitude can then be calculated with mathematical precision, whether the sun is visible or not.

RUBBER CAPS ON CORKS KEEP BOTTLES FREE FROM DUST

4300 To prevent accumulations of dirt on the necks or around the stoppers of bottles, thin rubber dust caps have been made.



They are perforated through the center to fit snugly around the cork, and are removed with it. A collar covers the mouth of the flask. They come in various sizes and can be converted to many uses. One of the

larger kind is convenient in keeping the shaving brush handle dry, and one of the smallest can be slipped over a medicine dropper, serving as cork and protector.

TEN FOREST FIRES EVERY DAY TOTAL MILLIONS LOSS

4587 Forest fires, which yearly destroy enormous quantities of timber and reforested areas, were recently made the basis of an inquiry which showed that in the past decade the total loss from this cause had been approximately 646,000,000 feet. For the past few years there has been an average of ten fires a day in the United States, according to government records. In 1921, in the 48 states, there were 38,400 blazes which burned over an area of 4,737,000 acres, whereas in 1922 the State of Washington lost 129,540,000 feet of timber on 68,902 acres, and Oregon 103,847,000 feet on 190,995 acres. The average loss caused by forest fires is about \$16,405,000 a year, but in 1921, Minnesota alone lost 30,895,868 dollars.

LOG HURLED OFF TRAIN SPLITS A LIVING TREE APART

4312 Splintering through like a wedge, a heavy log penetrated a massive tree trunk in a northwestern forest when it was hurled from a logging train rounding a sharp curve. Sent spinning as though from a catapult, it split the tree almost exactly in half. The train was derailed. Accidents frequently occur on the forest



Copyright, Underwood & Underwood
Like a Projectile from a Huge Gun, This Log Split the Tree Trunk

roads, due to the steep grades and unballasted track beds and the speed at which the heavy loads are rushed to the mills from the loading grounds.

☐ Made entirely of wood and having eighteen dials which show the time in as many cities, a clock upon which its maker is said to have worked twenty-three years, is being shown in Europe.

Ans. J. M. McLaurin
Shiloh, S. C.

PANAMA CANAL SHIPS TIED UP TO CLEAR "SLIDE"



South-Bound Ships Waiting for Dredges While North-Bound Steamers Proceed, After a Minor "Slide" in the Panama Canal Blocked Part of the Passage

Only south-bound ships were compelled to tie up recently after a minor slide in the Gaillard cut of the Panama Canal. Soundings showed that the other side of the passage was navigable, so north-bound boats proceeded as usual while the other steamers were tied up close to shore to

make room for dredges sent to excavate the channel. These small cave-ins happen occasionally as the earth settles in the steep cuts, but since the period, September, 1915, to April, 1916, when the canal was practically blocked, traffic has not been impaired seriously from this cause.

AID IN REMOVING SPLINTERS IS GIVEN BY LENS

4245

Aiding the eye in locating splinters in the flesh is the purpose of a household magnifying glass lately introduced. The article consists of

an optical lens set into a metallic hoop, the latter being mounted with a hinged joint upon an upright wire stand-ard having an ob-long loop at its lower end. A spool serves as a base, the loop being pushed into the hole in the center, and anchoring itself. The lens, which can be adjusted to any desired angle, is also of service in threading a small-eyed needle.



SECRETS OF MAN'S BEGINNINGS TO BE SOUGHT IN MONGOLIA

4/86

Before starting on their latest trip of exploration to the heart of the Orient, scientists attached to the expedition of the American Museum of Natural History, New York, declared that it already had been established that Central Asia was the original home of animal life and that it was the "mother of continents." They also expressed confidence that in Mongolia would be found formations that would reveal the secret of man's earliest existence. On a previous trip, thirty-six of the seventy-five camels in the caravan died from privations of the 400-mile march across the desert, where there was no forage. For twenty days men subsisted on scanty rations of antelope meat and tea.

More than \$14,000,000 worth of stock, in their own and in an affiliated telephone company, is owned by the employes of a large concern in Chicago.

Raid North & Co., Providence, R. I.

W. J. Samer 11/7/03

Crnk. B. Wailes 3118-14th St.
Washington, D.C.

POCKET CHART TESTS BLOOD BY COLOR MATCH

4166

Tests of the blood can be made by matching its color with those shown on a vest-pocket chart that has lately come into use among doctors. In making the experiments, the patient's finger is first pricked with a sterilized needle and a



Pocket Color Chart Used by Physicians to Determine Volume of Red Corpuscles in Blood

drop of the blood collected on a piece of white paper. The color is then compared with those on the scale of the instrument to determine the percentage of red corpuscles.

RADIO "DOT" SPANS OCEAN AT SPEED OF LIGHT

4114

Recent experiments show that radio messages can be acknowledged and checked almost simultaneously with the sending. The tests were conducted over the aerial loop between New York and Warsaw, Poland, a circuit of 8,500 miles. The operator at the control center in America instructed the European representative to "tie up" his receiving station with the transmitting station. A "dot" was then sent out and made the complete circuit from New York to Warsaw and return while the foreign operator was manipulating his key. The Polish operator was then instructed to leave his key and the "dot" raced twenty times around the circuit at a speed of 186,000 miles per second before dying away because of electrical disturbances.

Radio Corp., 233 Broadway, New York.

VESSEL KEPT IN SERVICE BY WELDER'S TORCH

4153

Welding on a gigantic scale was accomplished recently in repairing the sternpost of a great ocean steamship. The attention of engineers was first drawn to problems such as this when it became necessary to recondition the German boats left in American ports at the outbreak of the

World War. The results obtained from the method employed exceeded all expectations, and the speed in which the vessels were repaired and placed in commission is said to have astonished the mechanical world. In welding various breaks, it is said, the strength of the metal increases.

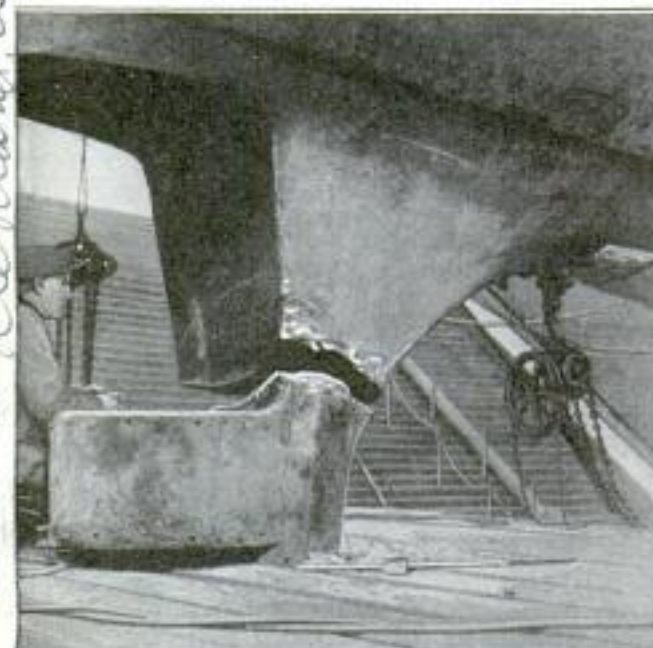

Broken Sternpost, Forced into Correct Position, Is Ready to Be Welded



Greatest Marine Weld on Record: Sternpost Stronger than Before the Break Occurred

Merck + Co.
45 Park Place
New York City

They Chesholm - Moore Mfg. Co.
Fairside Ave., Cleveland, Ohio

Camp Sans Souci, Bradford N. H.



Its White Slopes Gleaming in the Midst of a Desert Land, the "Mountain of Toothpowder" Has Become a Mine of Material Valuable to Important Industries

"Toothpowder Mountain" Built from Shells

Skeletons of Tiny Sea Urchins Piled Up on Bottom of Prehistoric Ocean Supply Industry with Valuable Rock

FEW materials possess a wider range of uses than is claimed for the white earth that forms a desert mountain in Nevada.

Believed to have been formed when that region was the bottom of a sea that dried up ages ago, the hill contains a deposit of soft snow-white rock which is easily reduced to powder so fine that the fingers can hardly feel its presence when rubbed between the hands. Such earth is generally said to be composed of the skeletons of minute sea creatures which multiply rapidly and die after short lives, leaving their little shells to pile up on the bed of the ocean.

Scientists say that they are everywhere that water is found on the surface of the land. Some attach themselves to foreign bodies while others float freely. Often they are found fastened to the stems and leaves of water plants. When the mite within the shell ceases to live the crustlike covering sinks to the bottom carrying within it the tiny skeleton and helps to form the sediment. This accumulation in time turns to almost solid rock.

The "mountain of toothpowder" is reported to have been discovered by a tired prospector who gave to it its name. While driving his burro to a place of shelter, he

passed the peculiar white mound. Struck with its dazzling shade he chipped off a bit of the substance and grinding it into fine particles he examined it and even attempted to scour his teeth with it. Then he polished the metal cooking utensils he carried about with him and traveled into the nearest town to proclaim his discovery.

It is an easily workable material, which may be lifted from the deposit in large blocks and readily reduced to powder form. The angular shapes of the minute particles make it a valuable ingredient for polishing and grinding mediums for glass and metals. Its absorbent quality fits it suitably for use in the manufacture of dynamite, while as a filtering material, it is claimed to be unsurpassed by anything else yet known. Inasmuch as it resists the conduction of heat, it has been employed in insulating steam pipes and boilers. In like manner, the white earth has been used with great success for filling in the walls of buildings to make them sound-proof.

Its almost pure condition and the fact that it does not contain harmful substances have won it a place as a base for various medications that are used as dusting powders for wounds. Cosmetic mak-

The Nature Products Co. Truckee, Nev. 2. N. Richardson, Nevada.

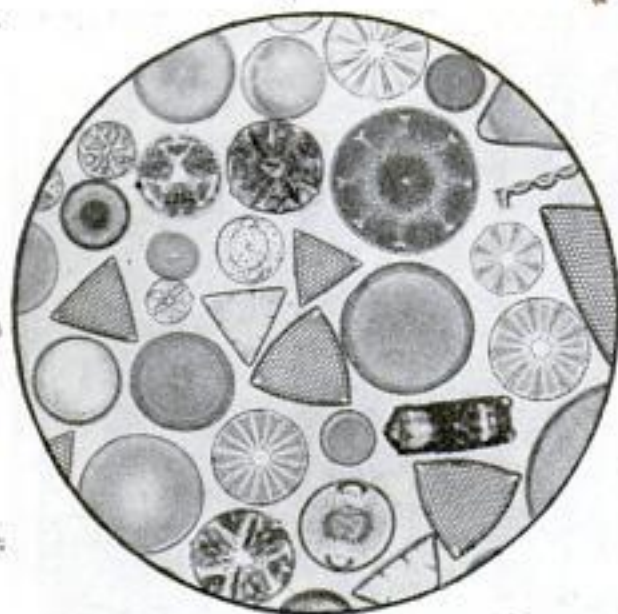

ers have also taken it up as part of preparations for nail polishes, and manufacturers of shoe dressings have made of it a cleanser for both white footgear and gloves. One of its prime uses is as a toothpowder, its absorbent features and freedom of acid making it a precious part of many dentifrices.

Each cell of the "diatom," the name given by science to the lively little plant animal which is credited with the creation of the valuable hill, is provided with a shell that has two halves. Inside these coverings the magnifying glass shows wonderful scrolls and natural sculpturings. The shells are in an almost endless variety of shapes. Some are circular and oval, and others are long, angular, and crescent-shaped, while still others resemble tiny boats and stars.

When alive, diatoms are found existing singly, but more often in colonies that are united in great branches, zigzag chains, and ribbonlike formations. Their average size is less than one two-hundredth of an inch. Seldom are they larger and the majority are much smaller.

Experts have not yet determined by just what method or at what time in the age of the earth this mountain of powder was cast up above the land. But probably no

purier material of this sort exists anywhere else.

To date, millions of pounds of the substance have been removed by the operators who are mining the mountain for its valuable earth. It is being quarried much like soft rock and is shipped in this state to the points of manufacture, where it is made into the various degrees of fineness that the different products require.

Just how far the mountain extends below the surface of the desert has not been definitely learned, but since it has stood for ages in the midst of wind-shifted sands, it is supposed that its actual base lies far beneath the ground. Scant vegetation surrounds the hill, and practically none at all takes root on its snow-white slopes.

Probably many years will pass before a material decrease in the size of the

toothpowder mound will be caused by withdrawals of the rock. While chemistry and industrial processes may find additional uses for the product in the course of time, there is always the chance that science will be able to discover other deposits of the kind ere the millions of tons lying in the mountain become entirely consumed. And the tiny organisms that caused it continue to grow.

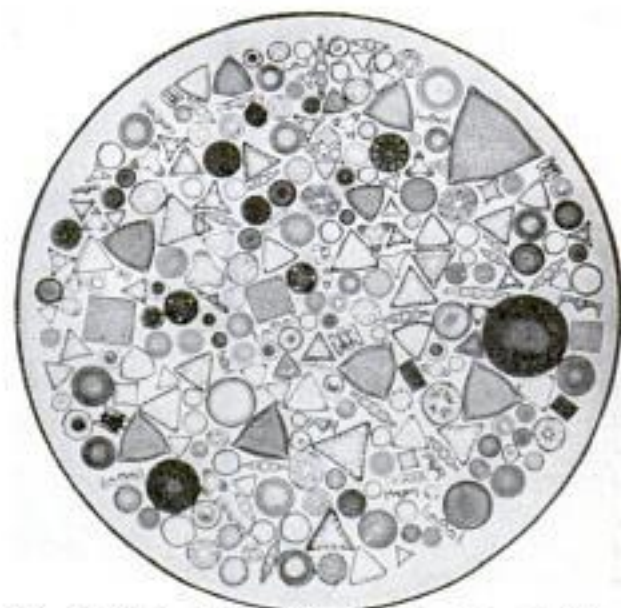

Tiny Shells that Form "Toothpowder Mountain" Are Found to Be in Almost Every Imaginable Shape

4311

*Lieut. Corley P. McHarmont,
Information Division Office,
Chief of Air Services, Munitions
Bldg., Washington, D.C.*

POPULAR MECHANICS

AIRCRAFT "HOOKED" TOGETHER IN TEST FLIGHT



While the "Silver Whale" Forged Majestically Along, a Tiny Messenger Plane Darted Under It, and Held Contact for a Full Minute by a Rod and Trapeze

That an airplane can be linked to a dirigible while both are in rapid flight has been proved by recent army tests. With both craft going at the rate of fifty-seven miles an hour, a rod was extended above the top wing of the plane and fastened at the lower end with elastic so that the pressure would not tear the framework.

At the same time, a trapeze arrangement was let down from the airship. While both flew along, contact was established and maintained for a full minute. Aviators declare the experiment indicates that large aircraft may be constructed to act as "mother-ships" for fueling and supplying ammunition to small planes.

4276

MINIATURE AERIALS IN CANDY DISPLAY HOTEL'S RADIO

Arrangement of the aerials on the broadcasting station of a Chicago hotel was effectively displayed at a recent radio exhibition from an exact model of the

structure fashioned entirely of candy on a cardboard frame. The relation of the main wires attached to a central pole, the distinguishing feature of the station, was clearly shown, the equipment being complete in every detail. At the same time, visitors were able to study the architecture of the hotel, which was faithfully reproduced by the chef's skill.

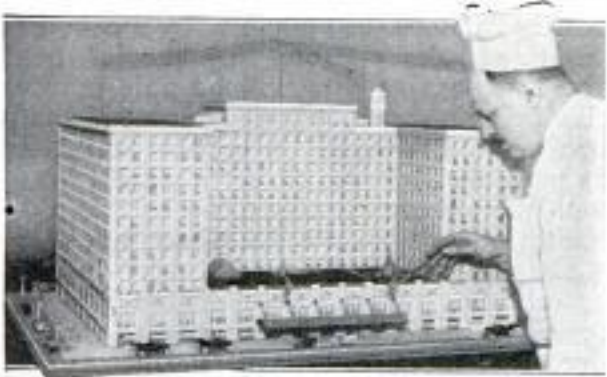

Putting the Finishing Touches on Candy Masterpiece Which Showed Arrangement of Hotel's Aerials

WHALE RAMMED BY SHIP'S BOW HALTS VESSEL'S VOYAGE 4271

When speed of the United States Navy transport "Argonne" was retarded suddenly without apparent reason, during a recent voyage, it was discovered that a whale had become impaled upon the bow of the vessel. According to one of the crew, the ship had rammed the monster and broken its back.

*Jacques Czerwinski
Chef, Grand Hotel,
Cass 210*

*True News
changed material*

Del. N.Y.
New York.

MILK BOTTLE AND CAN LOCK TO GUARD AGAINST THEFT

4190

Bottles of milk and canned goods are locked securely from the hands of thieves and breaking and spilling are avoided by



Copyright, Keystone View Co.

Until the Door Opens, the Bottle Cannot Be Pulled from the Spring Clip

the use of a clip which locks the containers to the house door. The device springs shut when a bottle or pail is inserted and cannot be loosened until the door, swinging open, releases the jaws of the clip. It is placed at a convenient height so that the owner does not have to stoop to pick up the articles.

GRIP NEAR HAIRPIN'S POINTS KEEPS IT IN POSITION

4237

Hairpins that hold their grip by compression have recently been placed upon the market. Made of wire or celluloid, the latter in three colors, these novelties are fashioned upon a principle which gives them a firm hold on the hair. The lower halves, in addition to the usual "waves," are bent inward until they touch just above the ends, and the points spread apart, which gives them a firm anchorage.

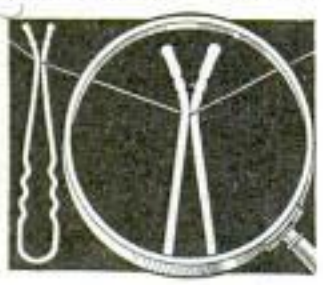

So that it may be moved from one room to another, a new dining table is built with a tilting top.

So that it may be moved from one room to another, a new dining table is built with a tilting top.

WIND DIRECTION PLAYS PART IN PLANNING OF CITY

4313

Prevailing directions of the winds largely determined the location of a proposed industrial district of a mid-western city recently. Records were consulted as far back as 1879, and it was found that the winds most of the year were from the south. Consequently, it was decided to build the factory district northeast of the city so that the winds would carry the smoke away from the residence areas the greater part of the time. Builders in other cities have seen the importance of gathering data as to the course of the winds before starting civic projects, and the information supplied by the weather bureau is of increasing value on account of the growing smoke nuisance.

Kansas City Star
11/28/23

SHIELD PROTECTS SPARK PLUG FROM OIL AND CARBON

4257

To make it carbonproof, a spark plug recently patented has a metal shield in its shell from which the oil drops off, thus protecting the core. It is claimed that the plug cannot foul, regardless of motor conditions, so that perfect firing and smooth operation are assured, and crank case dilution minimized.

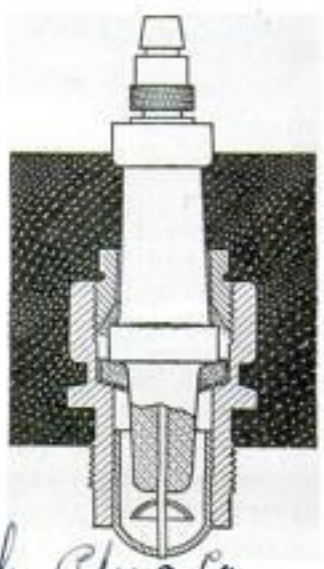

Toledo Spark Plug Co.
11/28/23

RELAY TOWERS TO BROADCAST RADIO TO FIFTY MILLIONS

4269

Broadcasting radio programs simultaneously to 50,000,000 persons by means of a chain of relay stations so powerful that even inexpensive sets will be able to receive the messages, is a development that soon may be realized, an eastern scientist has predicted. From three to six stations would be necessary, according to this authority, one on the Pacific Coast, another on the Atlantic Coast, and a third in the central Southwest. Others might be erected in foreign countries, and all would operate on the same wave length to prevent overlapping. Such a system would cost approximately \$5,000,000 a year.

Christian Science Monitor
11/20/23

English cannot locate maker

The Sta. Rite Hair Pin Co. Shelbyville, Ill.

Regulating all the clocks of the nation by wireless and with the aid of but a single station, is the aim of a German institution which has established two experimental structures. One of these is near Berlin and the other is located at a distance, on the summit of a high mountain. Twice every day the time signal is broadcast for the benefit of government offices, railroads, industries, individuals, and ships approaching the coast.

A special law prohibits any other radio station in the country from operating during the period of seven minutes required by the regulating broadcaster to complete its work. All other wireless traffic is interrupted and the paths of the air reserved for the time corrector. Five different signals are sent out, beginning at 12:55 o'clock, midday. Each of the first four occupies about a minute, being the same sign repeated for that length of time. When the 59th minute arrives the correcting code is released and lasts until the expiration of the hour.

During the passing of the preliminary signals, the receiving operator is supposed to prepare to adjust the clocks under his charge for the regulating message. For this purpose a special receiving device is necessary. It is made and leased by the sending organization to the subscriber. After the receiver has been installed, all that is needed is for its attendant to apply the phones to his ears when registering time is announced by the radio station. He then follows the message through, comparing the timepieces with the signals. Printed on the recording device is a copy of the code, so that the operator can read the signs as they are sounded.

Schools have been opened for watchmakers, wherein they can learn the meaning of the codes and the manner in which they are to be used in the adjustment of

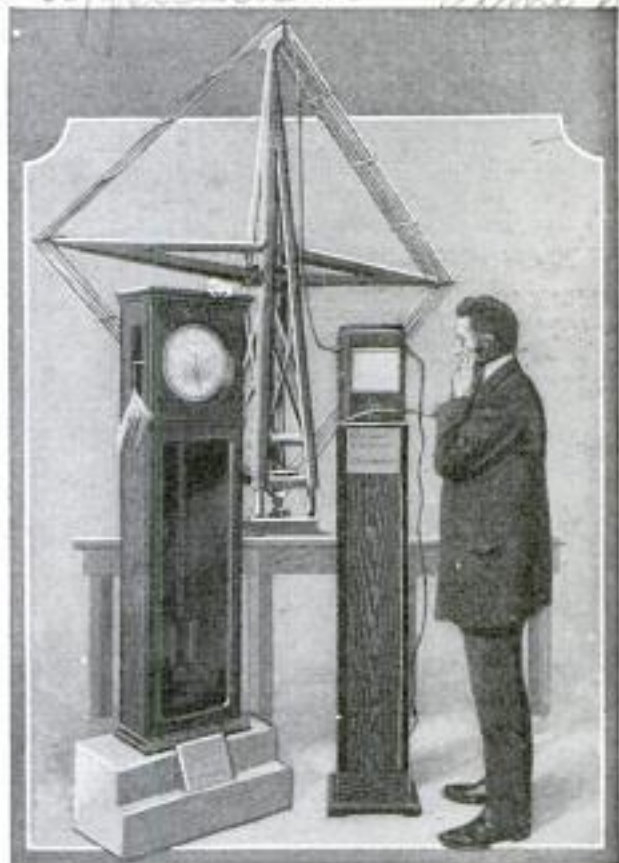

Aerial, Receiver, and Regulator that Compose Part of Wireless System for Setting Nation's Clocks

clocks and watches. They also receive training in the construction and upkeep of the radio apparatus employed to send and receive the messages.

Of the two wireless stations, one gives the first signal and the second, to which it is connected by cable, automatically begins the timing of the code and broadcasts it without further aid. The two hours of the day selected for the regulating signals are one o'clock a. m. and one o'clock p. m., corresponding to noon and midnight at the Greenwich observatory, according to the system used in Europe.

4125
BLOWTORCH HAS DETACHABLE IRONS FOR SOLDERING

Introduced to the hardware trade is a convenient combination of soldering iron



Combination Tool for Making and Mending Metal Articles

and blowtorch in which the flame is created by gas generated from wood alcohol. The handle, which is the fuel chamber, contains a wick to be saturated with the alcohol. A small pan is attached under the holes in the gas tube which is filled three-quarters full of the liquid, ignited, and permitted to burn out, thus generating the gas which issues from the holes.

Whenever you find that you wish to know more about any article in the magazine, write our Bureau of Information.

O. S. Bancroft & Co.,
 Incision. Copyrighted material

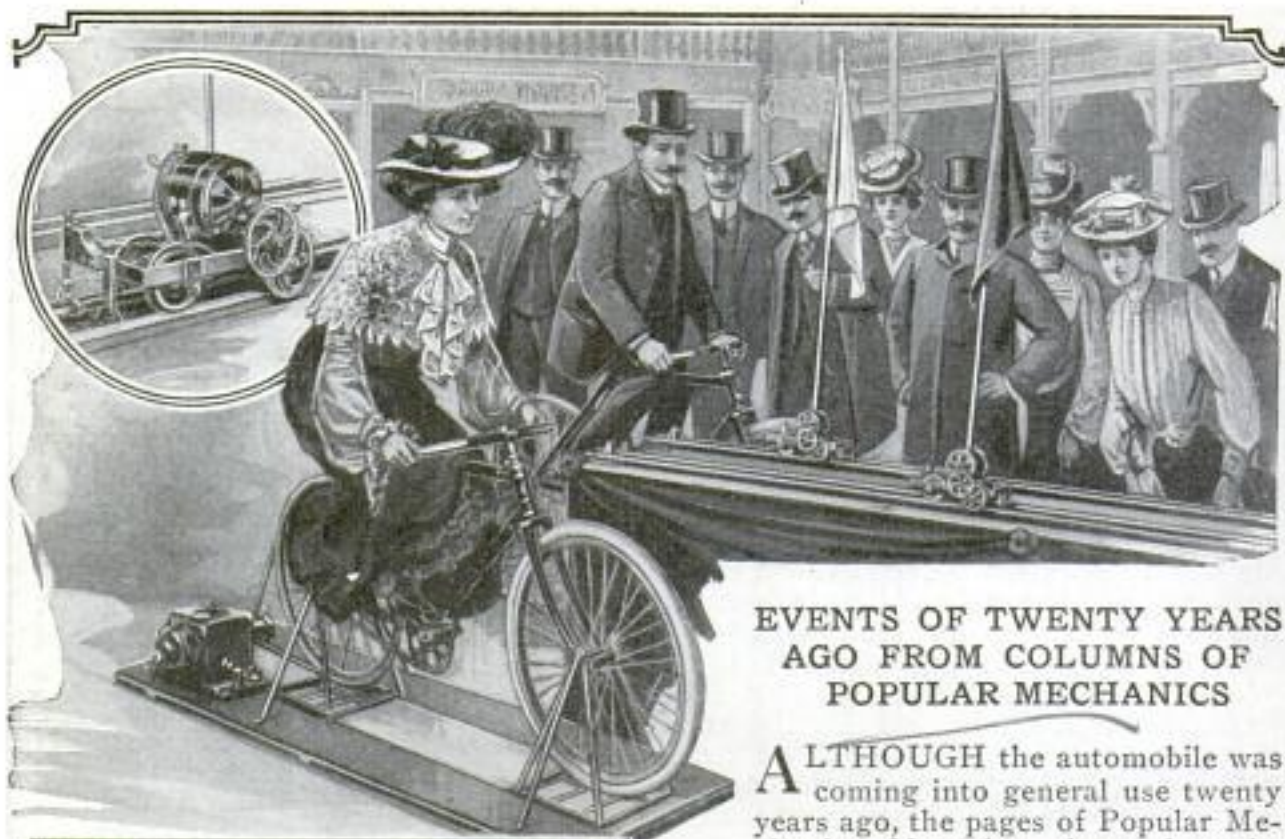

EVENTS OF TWENTY YEARS AGO FROM COLUMNS OF POPULAR MECHANICS

ALTHOUGH the automobile was coming into general use twenty years ago, the pages of Popular Mechanics Magazine show that the bicycle at that time still retained much of its popularity as a means of sport and transportation. This is indicated by the pictures at the top of the page. These were taken at a "race," where the wheels were held stationary in a frame while the "mileage" of the riders was recorded by an electrical device. In the same year Chicago built its first subway, shown in the center, which is still in use, but for freight only. The two bottom views are of a giant air bag, inside of which its inventor tried to make a trip across Lake Michigan but lost his life in the attempt.

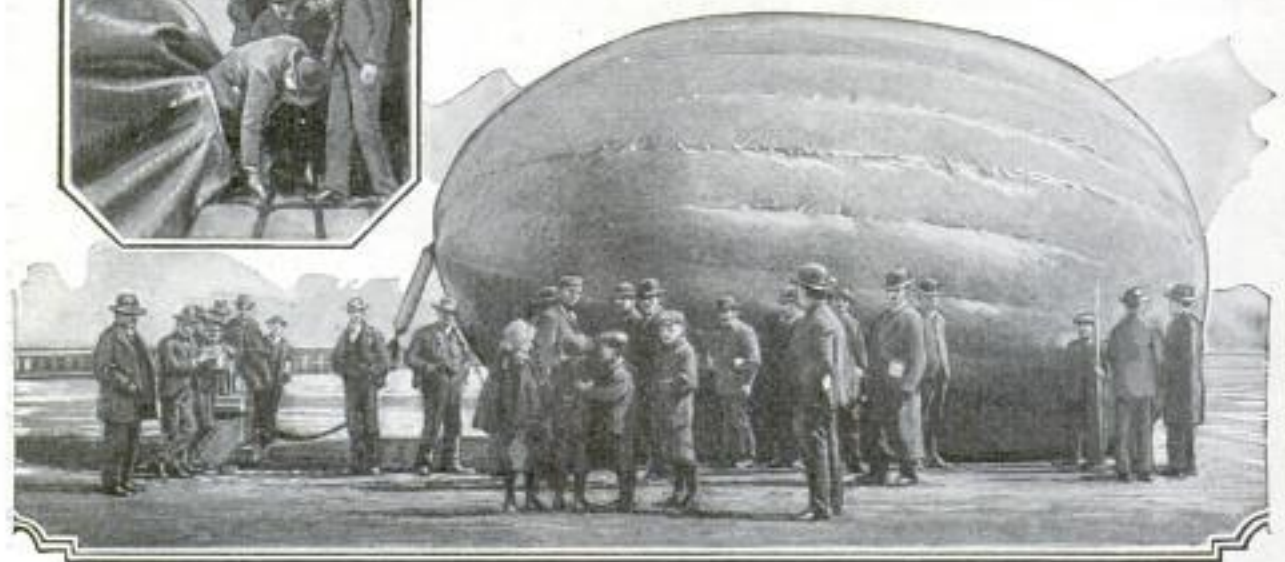

Floyd Clymer Corp. The H-N Co., Inc.
124 9th 14th Ave. 6609 North Western
Denver, Colo. Ill. Chicago

**OIL-LINE CLEANER FOR AUTOS
 PREVENTS ENGINE TROUBLE**

For use on small automobiles, an oil-line cleaner has been invented to insure a constant flow of oil through the engine and to make unnecessary the removal of the radiator, timer or other parts when the lubrication becomes clogged. The device consists of a pet cock attached to a bracket and fitted over a small hole bored in the crank case. A flexible cable, long enough to reach the oil line, is inserted and removes any obstruction.

4203
 Price - \$2.50.

**SECRET OF BANK-NOTE PAPER
 KEPT TWO HUNDRED YEARS**

Closely guarded, the secret of making the linen tissue for Bank of England notes has been kept for 200 years by the trusted employes of one firm. Of a peculiar whiteness, the paper is so tough that a folded note can sustain a weight of fifty pounds without tearing. The same bill is never paid out twice by the bank. If a customer receives the proceeds of a check in fresh notes, and immediately deposits them, they are canceled and retired. In the days before postal orders became common, it was customary, when sending money by mail, to cut a note in halves, inclose the first with the invoice, and await acknowledgment before parting with the second.

Edwin J. Parry of The Parry
Washington, D.C.
**EIGHT-HOUR CLOCK CUTS DAY
 INTO THREE EQUAL PARTS**

Changing conditions, as illustrated by the eight-hour law for railroad employes, have brought about the development of a new kind of timepiece that divides the day into three watches of eight hours each: "Morning Hours," denoted by the letter M, which appears in an opening in the dial, "Noon Hours," indicated by N, and "Evening Hours," designated by E. The first period begins at midnight, the second at eight a. m., and the third at four p. m. Heretofore, most timekeeping devices have had twelve divisions on their faces, although Southern Europe has long favored the twenty-four-hour clock.

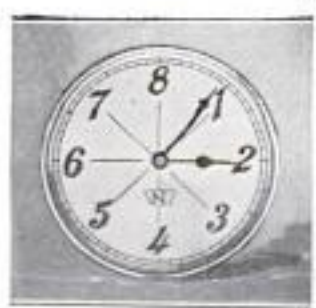

Copyright, Keystone View Co.

**"FILLING STATION" FOR PENS
 WORKED BY CENT-IN-SLOT**

For the convenience of fountain-pen users a penny-in-the-slot "filling station" which eliminates the waste and untidiness



Loading a Fountain Pen with Ink from a Penny-in-the-Slot "Filling Station"

of the open inkwell has been devised by a western inventor. It consists of a chamber and filling-cups inclosed in a case composed of metal and hard rubber which stands upon a writing desk or table. When a coin is inserted in the slot and a knob turned, ink sufficient to fill one pen runs into one of the cups. The pen is loaded from this, a dropper being provided for those not equipped with self-filling mechanism. A wiper attached to a spring reel is pulled out from a slit near the knob for cleaning the pen, and extra ink is poured into a refuse cup from which it runs into a waste chamber. The "station" holds sufficient ink to fill 600 pens, weighs only a few pounds, and has no complicated machinery to get out of order. It has been found especially convenient in hotels, schools, and public writing rooms.

Native to Mexico and Central America, the chayote, a vegetable having the qualities of the cucumber and squash, is now raised in the Gulf Coast regions of the United States, where it is winning popularity because of its delicate flavor and the beauty of the flowers of its vine.

Chas. J. P. Becker
San Francisco
Calif

**RADIO SET FOR POLICE ALARM
STRAPPED TO "COP'S" BACK**

Wireless sets are carried by policemen in parts of Germany by which they can receive alarms and orders sent out by radio



German Policeman Equipped with Wireless Set to Receive Alarms and Orders from Headquarters

from headquarters. The aerial is fastened to the officer's back by shoulder straps and the receivers are held close enough to his ears so that he can hear any message or signal broadcast. The box is suspended across the man's chest within easy reach of his hands. This arrangement permits a hasty mobilization of the guardians of peace in case of trouble.

**DOUGH POURED IN OVEN WHEEL
COMES OUT ICE-CREAM CONES**

Untouched by human hands, ice-cream cones are turned out at the rate of 2,000 an hour by a recently perfected machine shaped like a large paddle wheel, that forms and bakes them while it makes one complete turn. Released from a mixing tank, the batter flows into the cuplike spokes of the revolving oven, and in 95 seconds emerges as crisp cones which drop into carriers that convey them to where they are automatically deposited in racks. They are then stored in cartons by an operator. Thus, hand labor is reduced to a minimum and a uniform quality of product is maintained.

**SILENT SENTINELS OF THE SEA
GUARD TRAFFIC OF SHIPS**

Buoys signposts of the sea, mark the channel limits of harbors and guide ships to anchorage when entering ports. Like the crowded streets of big cities, the approaches to busy parts of the ocean highways are dotted with fixed caution signals that spell intelligent directions to the mariner. These floating guideposts vary in size and construction from a painted log of wood to steel gas buoys that carry lights which are never extinguished. Some operate whistles and bells that are sounded by the action of the waves. Most of these are found in dangerous spots guarding hidden rocks or reefs, or marking the position of sunken wrecks. Where buoys appear in the open seas, they usually indicate the points at which telegraph cables pass, and often signify the presence of mined or torpedoed grounds. In all there are more than twenty different kinds in use.

**METER FOR LOADING CHUTES
MEASURES COAL OR GRAIN**

Fine coal or other granular material can be measured while being fed through a vertical or sloping chute by a meter invented in England. The register has a counting dial on the outside of the feed pipe which shows the amount. Experiments, it is said, have demonstrated that the recorder can reach within 2 per cent of accuracy. The instrument is also suitable for tallying grain, cement, or crushed coke. Lubricating can be done while it is in operation and it may be removed for inspection or cleansing.



Radio loud speakers were successfully used in place of "barkers" and "ballyhoos" at a recent southwestern state fair. They were also used to direct large crowds to the various exhibits.

*W. C. I. Ltd.
199 High Holborn
W.C. 1, London, England.*

*Wafer Co.,
Shieldware,
Chicago*

3693

4064

4223

Nov. 3 1923

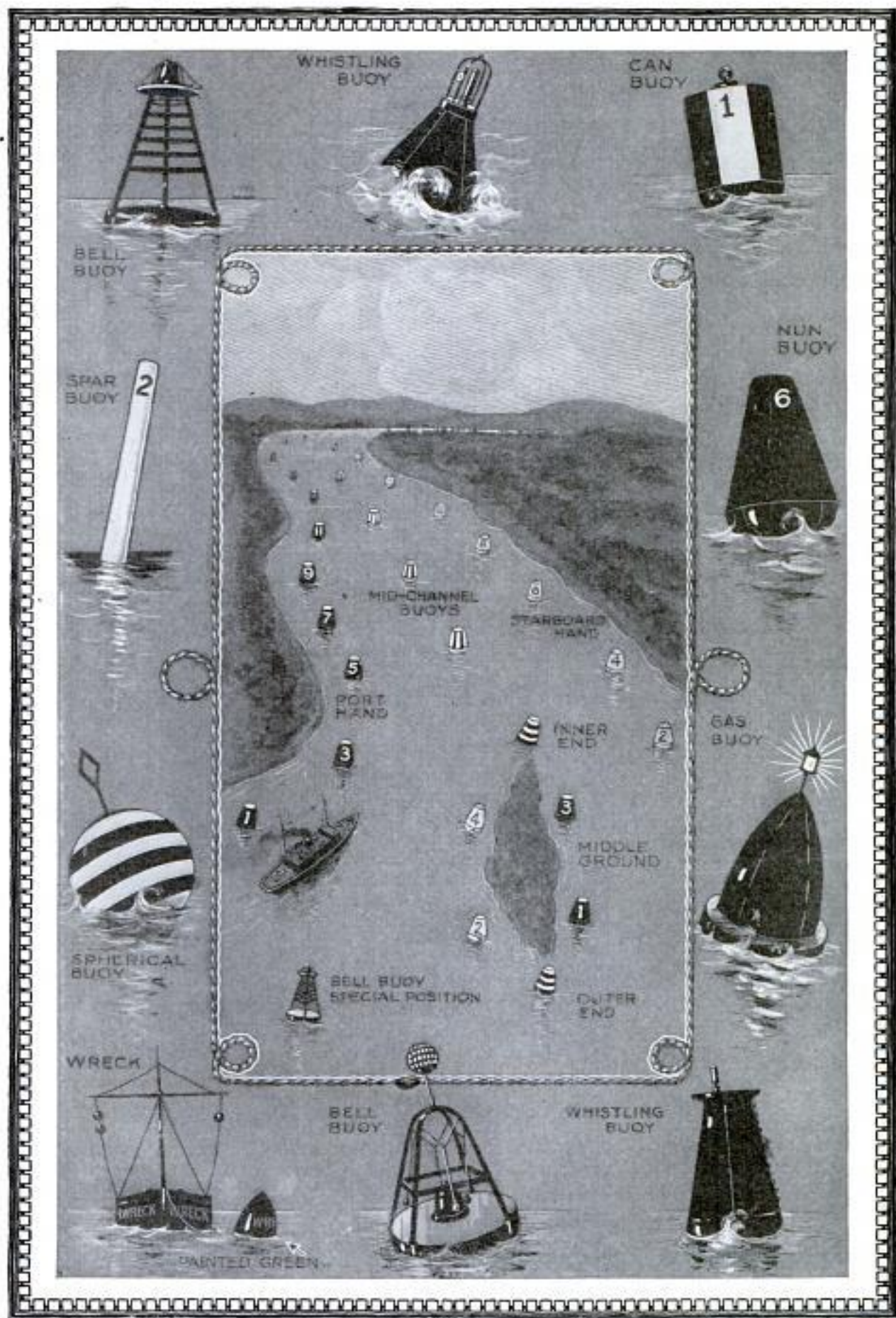

Signposts of the Seas that Serve Mariners as Guides and Warnings at Entrances to Harbors, Over Anchoring Grounds in Ports, and to Indicate Hidden Dangers Near Traffic Lanes

**RADIO SETS IN MINIATURE
 FIT IN POCKET**

4277 Midget-size radio sets, in various designs, were shown at an exhibition recently held at Chicago. A telephone receiver



Two of the Smallest Complete Amateur Radio "Hookups" that Have Ever Been Made

served as the cabinet of one, another was inclosed in a miniature keg, and a third was in the form of a coil which was carried on a lead pencil. Small as they are, these little "hookups" give excellent results, requiring no aerial other than a piece of wire which can be hung out of the window.

**AUTOS WORTH TEN BILLIONS
 COST BILLIONS TO RUN**

4144 Official estimates place the number of motor vehicles owned and operated in the United States at 14,000,000, the investment represented being about \$10,000,000,000 and the total cost of maintenance close to \$5,600,000,000 a year. This amount is said to equal more than half of all taxes. It is contended that payments made by owners of motor vehicles for highway service should be in proportion to the benefits received; that taxation should not be uniform but should correspond to the highway facilities of the different states.

**SLOT TAKES PLACE OF RINGS
 IN THINNER NOTEBOOK**

4266 Opening flat and weighing considerably less than similar notebooks, a loose-leaf holder for memoranda has been devised that is quickly filled with a "cartridge" of perforated pages. Into the one-piece cover is fastened a grooved metal slot for fastening the filler. This is inserted in one movement on a clip arrangement of metal slips. The pages are securely held, do not

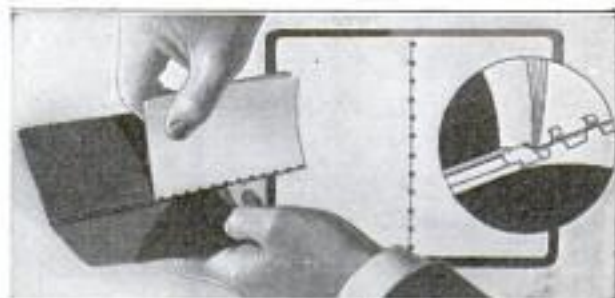

How Pages on a Metal Clip Are Inserted with One Movement into Notebook

**GRATER FITS DISH, SAVES
 FOOD PARTICLES**

4075 Intended for grating vegetables, chocolate, or similar substances without waste or spilling, a grater has been invented



which fits snugly on the rim of a cup or measuring bowl and causes the particles to fall directly into the dish. The device is held in place by a lip which curves over the edge of the vessel and the article may be

rubbed over its rasping surface. The utensil is made of tin and its openings are so arranged that they can be easily cleaned.

White arsenic is being produced in a Montana gold mine as a profitable by-product.

stick or become loosened while being turned, and the rings are so small that they add but little to the weight of the book.

**EGGS SCOURED WITH SAND
 TO CHEAT PUBLIC**

4702 Food inspectors in California are reported to have discovered that storage eggs whitened by a "sand-blast" process which made them look as though freshly laid were in the markets. Stains and discolorations had been removed and all evidences of handling so successfully eradicated that university experts, who attempted to select the freshest from a carefully chosen lot, picked those that had been scoured by the sand treatment. The effects last only a few days.

Conk H. H. Hump, 2722 Prince St., Berkeley, Calif.

Conk H. H. Hump, 2722 Prince St., Berkeley, Calif.

Mfr. Bahde Mfg. Co., 1219-30th St., Milwaukee, Wis. Attn - B. H. Helwig.

MILLION-YEAR-OLD MONSTERS IN THE MOVIES

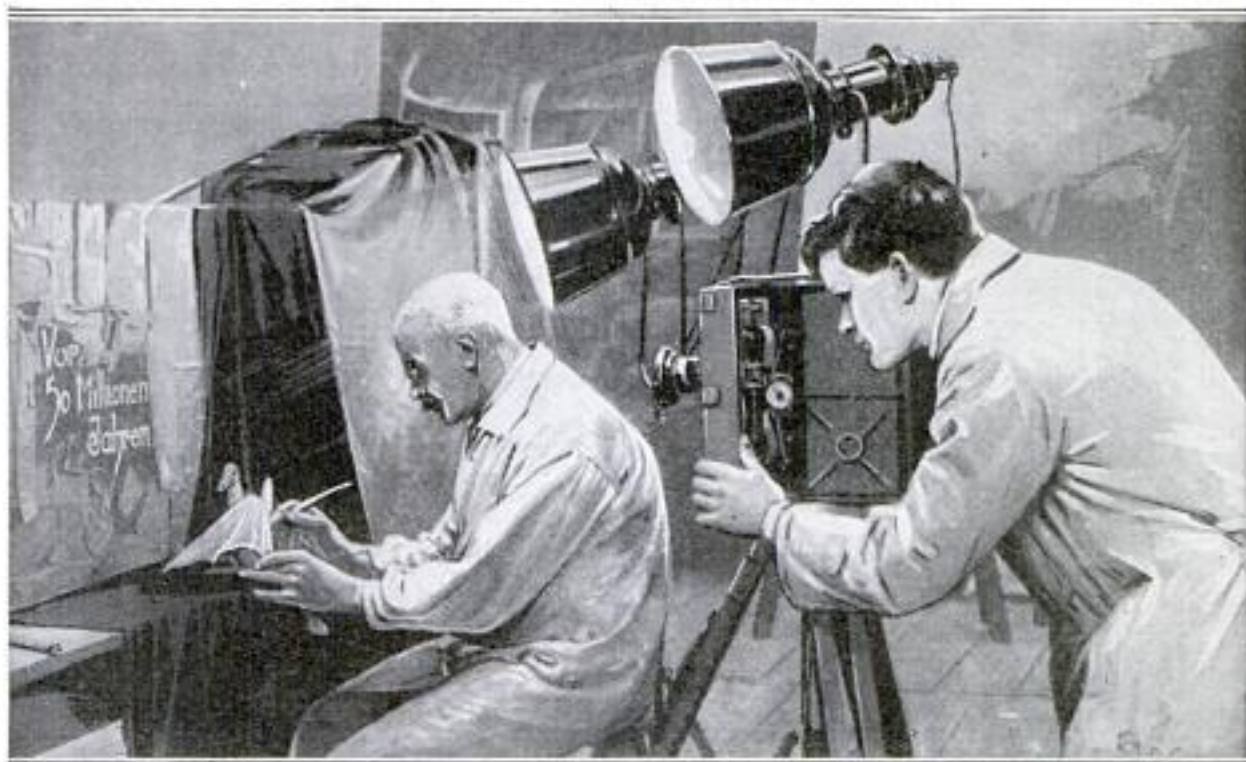

Posing Model of a Prehistoric Monster under Powerful Studio Lights for a Motion Picture. Realistic Backgrounds and Settings Are Chosen to Give the Film Scientific Value

So students may more clearly visualize the tremendous changes that have taken place since the world was young, papier-mache and plaster models of monsters that stalked the earth millions of years ago

are being made by a European scientist, who shows them in movies with specially designed backgrounds of the proper period. Lifelike figures of animals and vegetation during prehistoric ages are created.

HEAT OF ELECTRIC IRON HELD BY CORE OF SOAPSTONE

4244
Holding a working temperature for twelve to forty-five minutes after having

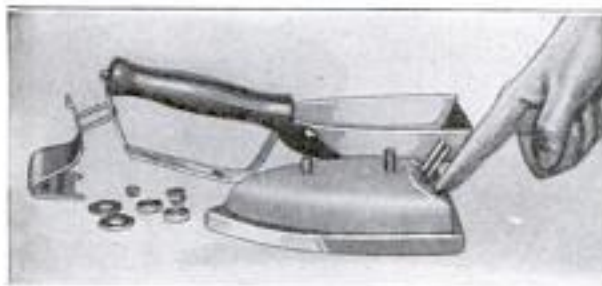

Electric Iron that Maintains a Working Heat Forty-Five Minutes After Current Is Shut Off

been disconnected, is the recommendation of an electric flatiron recently introduced to the hardware trade, and it is said to consume less current and costs less to operate than does the ordinary iron. It has a soapstone core which is held in close contact with the base of the implement by metal studs, and is heated by wires run-

ning through it in channels, which in seven minutes furnish heat sufficient for use. The steady application of current necessary when using the ordinary utensil results sooner or later in a short circuit, but, it is stated, this newer pattern can be heated continuously for 1,000 hours without detriment.

4113 EAST-BOUND SHIPS LIGHTER THAN THOSE GOING WEST

Scientific experiments to ascertain the possible effect of the direction in which a ship is going upon its weight-carrying capacity, recently made by a prominent scientist, resulted in his conclusion that a 2,000-ton vessel traveling east offers 400 pounds less resistance to the water current than it does when west-bound. This calculation, it is said, is based upon the influence of centrifugal force, which is greater when a body is riding with the tide in the direction in which the earth revolves, than when headed the other way.

Stahok Electric Corp.
Yorhtown Heights, New York

*Wincered in 1914...
comparing the air...
Wincered*

to force

3857

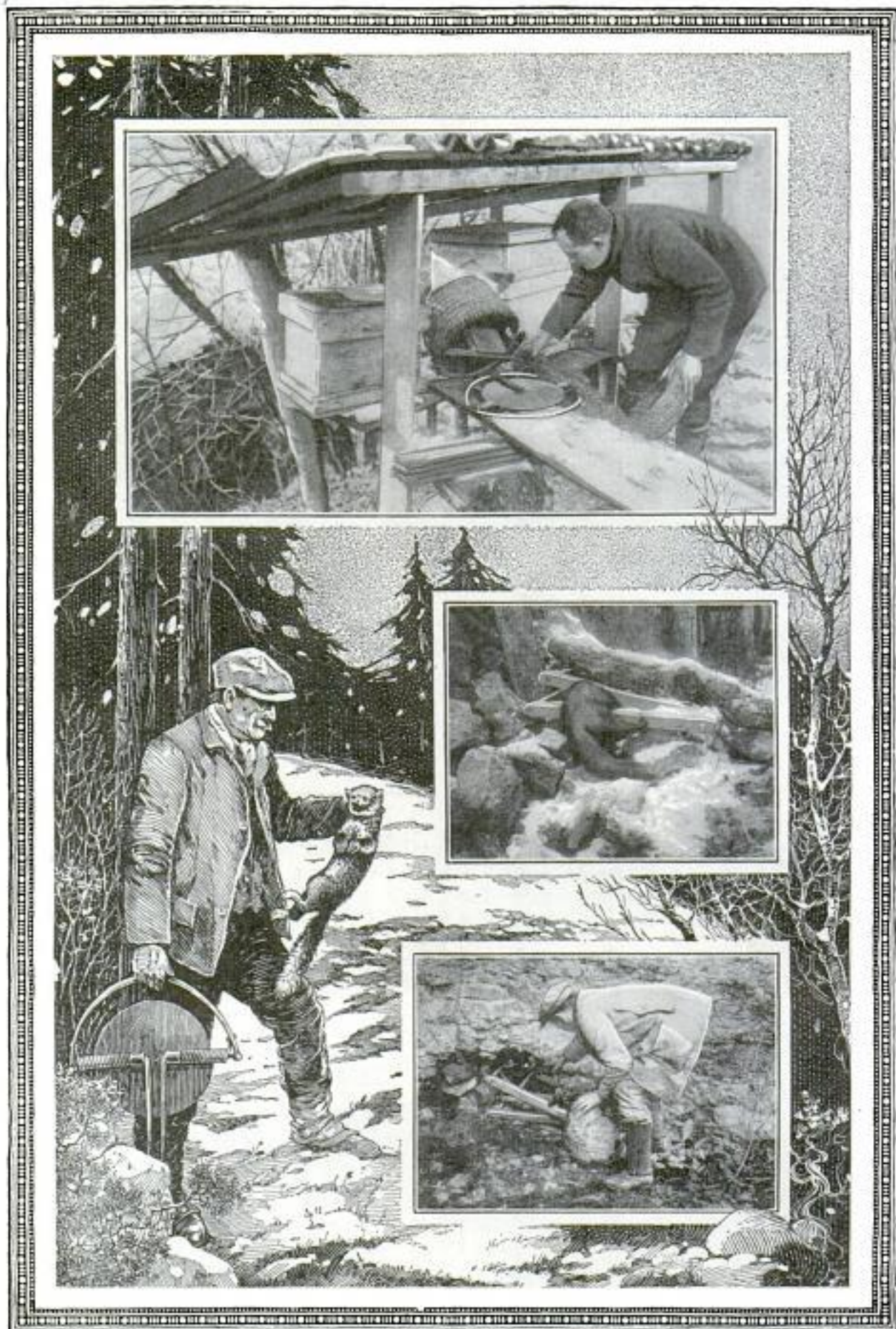

Above: Disguising a Trap from a Honey-Stealing Animal. Center: Beach Marten Caught on a Winter Prowl.
Below: Old Stone Wall Used to Hide a Snare for a Skunk

High Prices Urge Trapper in Quest of Fur

SO rapid has been the growth of the demand for fur garments that the manufacturers of such products have been forced to import a yearly supply of skins that is estimated at a value of more than one billion dollars.

Most of the pelts that form these shipments are taken from small animals trapped in the north of Europe and in Siberia. Even skins of animals formerly considered of little value, or entirely worthless, have been pressed into service and pass to market under various trade names that disguise them as completely as does the process employed to change their appearance.

The phenomenal rise in values of dressed skins has led to an enormous increase in the army of hunters and trappers who annually invade field and forest in search of the wary little fur bearers. During the trapping season more than 1,000,000 shipments of fresh hides arrive at the fur markets of St. Louis, the chief center for distribution in the United States. The estimated total value of this collection is placed between \$50,000,000 and \$60,000,000.

Contrasted with the catch that reached the same point in 1877, which numbered but 12,386 shipments, the figures are beyond comparison. At that time, too, there was possibly an animal population several times as plentiful as it is today. In 1810, skins that brought not more than \$30,000 represented the year's supply, and many of these probably went begging for buyers.

Now, not a single skin is ignored by the eager traders who purchase for the manufacturers of the eastern cities.

Fashion and the general popularity fur garments have attained in the past decade brought prices of the velvety hides, in many cases, from a few cents a skin to

almost an equal number of dollars. Rodent pests whose only claim to existence a short while ago seemed to be to pester the grain bins, chicken yards, and crops of the farmer, now have a fur value that causes them to be hunted in practically every neighborhood where they are known to live.

The market for furs is represented in every state of the Union, for it is a fact not generally known that with the exception of Florida, there is no commonwealth which has not experienced temperatures as

low at one time or another as zero.

With this nation-wide demand for fur, the animals that bear it are receiving more and more attention from sources heretofore little concerned with their commercial worth. The peak of prices for skins was reached about three years ago, and although several kinds and grades have dropped from 20 to 25 per cent, their values are still high. In four years the price of beaver skins advanced from \$17 to \$38.50 each, at the dressing centers. Otter hides went from \$14 to \$101, and the once-scorned muskrat that brought only 36½ cents before it became popular, reached the almost unbelievable figure of \$5.10.



Above: Setting Trap Under a Thick Hedge. Below: Camouflaging the Snare with Snow

Chas. Rev. F. A. Adams
222
Rec of Lion & Popular Mechanics
4194

POPULAR MECHANICS CANDLE SOCKET IN CYLINDER TO GIVE BETTER LIGHT

Equipped with a socket which can be raised or lowered in a cylinder, a "tel-



Copyright, Keystone View Co.
Candlesticks with Telescoping Cylinders that Permit the Wax to Be Consumed without Sputtering

escopic candlestick" has been patented recently. By using the device the entire candle may be consumed without sputtering.

PANAMA CANAL TOLL PROFITS FOR UNITED STATES GROW

Returns from Panama Canal tolls, according to United States government reports, are surpassing the profits of the postoffice. From May to October of 1923, the canal showed a margin of nearly \$12,000,000, with a high month's record of \$2,124,830 for July. During the first six months of last year 2,604 commercial vessels passed through the channel, an increase of 1,091 over a like period in 1922. Approximately \$375,000,000 was expended in building the waterway.

BUGS, NOT COLD, TAKE BIRDS TO SOUTHERN CLIMES

Scarcity of insects, owing to the approach of winter, and not cold weather, causes birds to start south when the frosts arrive, according to a western scientist. Seed or flesh-eating fowl, unaffected by the lack of bugs, survive all year as far north as the Arctic Circle. While migrations are largely determined by the food

supply, it is believed that habits inherited from the glacial ages partly influence some species. The tern makes a continuous 11,000-mile flight between the polar regions of the north and south, while the golden plover, which spends its summers in the Arctic and its winters in South America, goes first to Nova Scotia as it starts southward, then flies 2,400 miles to Brazil. Due to the mating instinct, experts believe, the spring flights of the birds are more regularly timed than are those of the fall.

SCOOP NET ON STEAMER'S BOW SWELLS CATCH OF FISH

Saving the labor of lowering and raising heavy seines, fish are caught and deposited on the deck of a steamer by scoop nets and belt conveyors attached to the bow of the boat. As the vessel passes through the water, the fish become imprisoned in the meshes of two traps suspended on steel frames and set about 12 feet below the surface of the water. An endless chain of



Copyright, Underwood & Underwood
Scoop Net on Steel Frame and Belt Conveyors Attached to a Fishing Steamer

conveyors, running to openings at the bottom of the cages, catch the struggling captives and carry them to the deck.

Finger prints are said to have been forged successfully.

Director of Hoddinghurst
Essex, England.

Herald. Es. America
Chicago Tribune
11/22/23

Sykes Ocean Harvester Co.
204 W. 88th St.
1452 Broadway

ROCKET LINE TO SAVE LIVES OF SHIPWRECKED



Rocket Being Used to Carry Life Saver's Line to Wrecked Ship: This Method Has Been Adopted to Do Away with the Cannon Formerly Employed for the Same Purpose

One of the recent developments in the life-saving service is the rocket line, an innovation having the following advantages over the older method: it is always ready for emergency, and there is no cannon to be loaded in a heavy storm.

A light line is attached to the powerful rocket which lies in a trough that has been carefully "sighted." The fuse is then ignited, and the rocket soars from its trough and crosses the hull of the ship with the line trailing.

No information available

CITY GIVES FIREMEN BROOMS TO FIGHT BRUSH BLAZES

Brush fires, caused by matches or hot cinders, have recently broken out in great numbers in the East End district of Pittsburgh. The firemen have found brooms

extremely useful in beating out these persistent ground blazes, and at present the broom forms part of the equipment of every fireman in the service of the city.



Fire Fighters Equipped with Brooms Ready to Extinguish Brush Fires that Menace City

MEN OUTNUMBERED BY WOMEN IN CENSUS OF WORLD

That there are more women than men in the world, is the conclusion drawn by a statistician after recent researches. Among the 475,000,000 inhabitants of the earth, there are 250,000,000 women, 25,000,000 more than the number of men, his figures show. In Germany there are 1,026 women to each 1,000 men; in Russia, 1,400 women to each 1,000 men, and in France and Belgium, respectively, 1,093 and 1,033 for each 1,000 men. The 1920 census reports for the United States show that there are 1,040 males to every 1,000 females in this country. The preponderance of women in foreign lands is believed to be partly explained by the death toll of numerous wars in the past few generations.

Pacific & Atlantic

4305
C. H. Bailey,
24, Rue de Valenciennes,
Paris, France
Copyrighted material

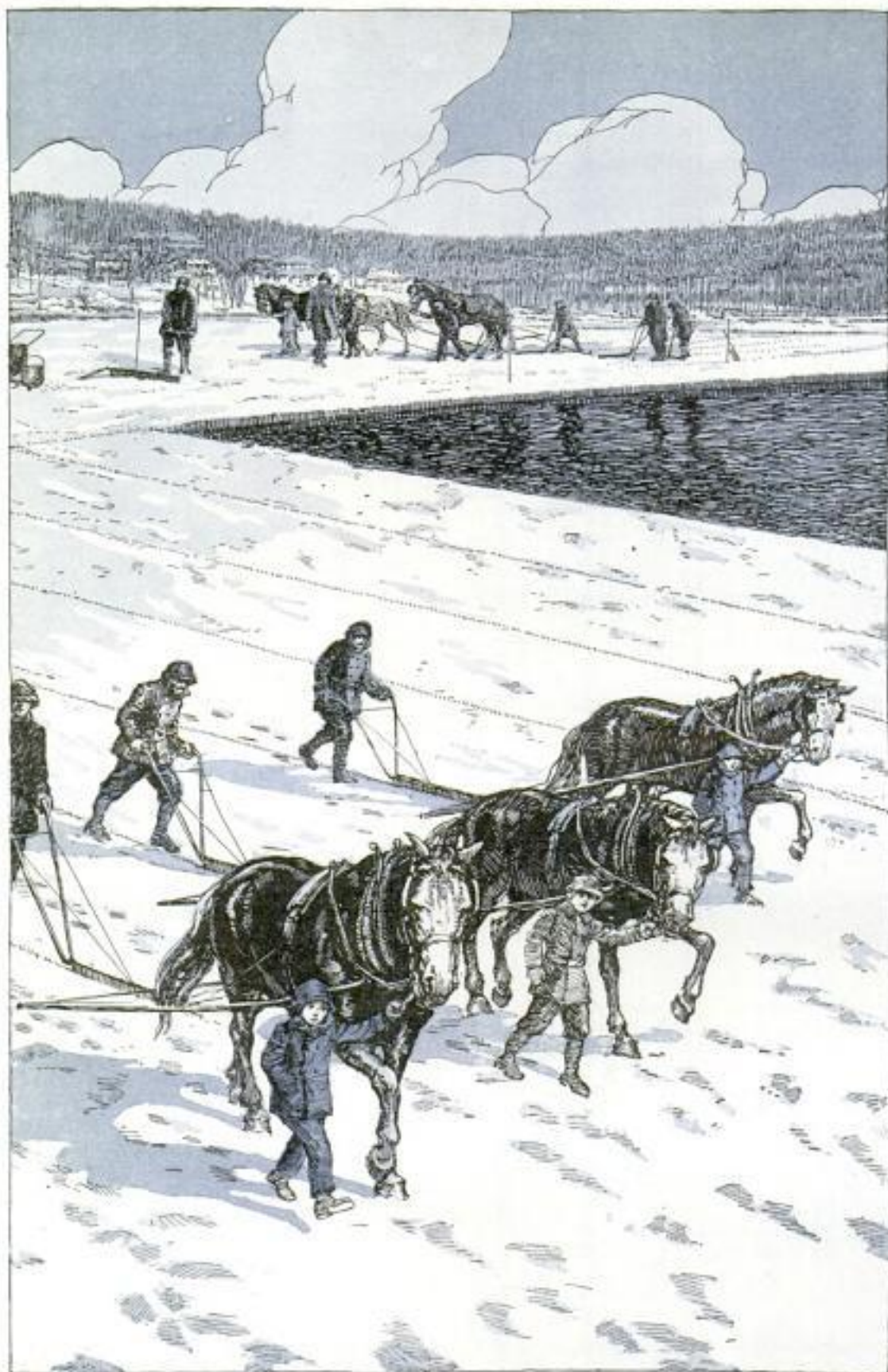

Long, Sharp-Toothed Saws Drawn by Horses or Propelled with Motors Cut the Ice into Narrow Strips after the Snow Has Been Scraped Away

3961

Ice Still "Grown" on Ponds Is Now Harvested by Machines



Showing How the Planer Cuts
Off Top or "Snow" Ice

HARVESTED with powerful motor or horse-drawn saws and packed by machinery in huge storehouses, some 24,000,000 tons of natural ice are cut each year in the United States for commercial purposes.

Little of this vast amount is seen in city delivery wagons, the clear, even cakes of the artificial product being preferred nearly everywhere, and it is estimated that more than 29,000,000 tons of manufactured ice were consumed last year, representing considerably more than half of the nation's ice bill of approximately two hundred and fifty million dollars.

But "putting up" ice from ponds, lakes, and rivers is still an important task to railroads that need thousands of tons in refrigerator cars, and to large wholesale companies. To take advantage of thick ice and to win out against the likelihood of sudden thaws, storms, and the shortage of the labor supply, machinery that saves time and work has been developed to a high degree.

It is estimated that more than 40 per cent of the total natural-ice harvest is done with power apparatus, practically every field that produces 600 tons or more having motor saws and power-driven elevators to hoist the cakes to the storehouses.

As soon as the ice is thick enough to support the weight of men and scrapers, snow that may have fallen is removed. The ice is kept cleared after every storm so that it will "grow"—a protecting blanket of snow preventing it from reaching a desirable thickness.

The clear-est, thickest, and best ice is near the center of the lake or pond where weeds have not accumulated and where the edges have not broken or rotted. A canal or sluiceway is cut out either with hand saws or with special machinery, the worthless ice being sunk or thrown aside. Then, with long, horse-drawn saws, or with rapidly moving motor-driven machines, the ice is cut into strips. In large fields, these are divided into 100-foot lengths and steered along the sluiceways by skilled men armed with pike poles who ride the "floats" in much the same way as loggers man huge saw logs in the forests.

A gang saw run on a shaft at the elevator cuts the floats into blocks of storage size. As the pieces are pulled out of the water and into the house on an endless-belt arrangement, a planer shaves off the surface or top ice and gives the cakes a corrugated top so they will not stick together and may be removed without breaking. This process also insures a level floor in the storerooms, an important factor in large houses.

Modern storage plants have insulated walls, floors, and ceilings and are designed on strict engineering principles. No sawdust is used between the cakes, as it has been found that this substance within eight or nine years, rots the walls of the house and makes it unfit for use. A light cover-



Armed with Sharp Pike Poles, Skilled Workers Guide the "Floats" Like Massive Logs to the Elevator Hoist where They Are Cut into Storage Blocks

ing of hay or a few layers of building paper are spread over the tops of the cakes and they are preserved perfectly. One huge storage house in New York holds more than 90,000 tons. It is so carefully built and packed each year that the loss from shrinkage of the cakes is negligible.

The enormous production of city manufacturing plants has driven the natural-ice harvest largely to rivers and lakes convenient only to railroads. Ice factories in New York City have a daily capacity of 16,000 tons, and those in Chicago manufacture 11,730 tons each day when operating to capacity. Largely due to the accessible artificial supply, the ice harvest on the Hudson River decreased from 4,606,800 tons in the winter of 1901-02 to only 190,823 tons in the winter of 1921-22.

That winter was not a good ice year, but each season for the period shows a marked decrease from the winter of 1901. In 1918 impetus was given temporarily to the natural-ice harvest throughout the country when the United States Fuel Administration urged consumers to store as much of the natural product as possible so as to save

Endless-Chain Elevator and "Floats" in the Sluiceway



coal in the manufacturing plants.

The scarcity and high cost of labor, the uncertainty of the season and the relative economy of the manufactured ice, are reasons given by officials of one large railroad company, that stored 230,000 tons last year, for the steady decline in the annual cut. But this line has found it profitable to install apparatus which will load a whole train at once near one of its lakes, and when the season is good, motor saws whirl and elevator machinery clanks busily to take full advantage of the crop, for if the ice is thick and the season is long enough, a supply can be taken that will show a considerable saving for the following summer.

Motor-driven apparatus is especially economical in large harvests. Twenty reports on the performance of power saws showed that they had effected a total saving of \$23,000 in a harvest of 400,000 tons, each of them cutting 1,250 tons a day. The expense of men and teams needed before was thus eliminated.

FISH ARE SENT IN CANS TO WAR ON MOSQUITOES

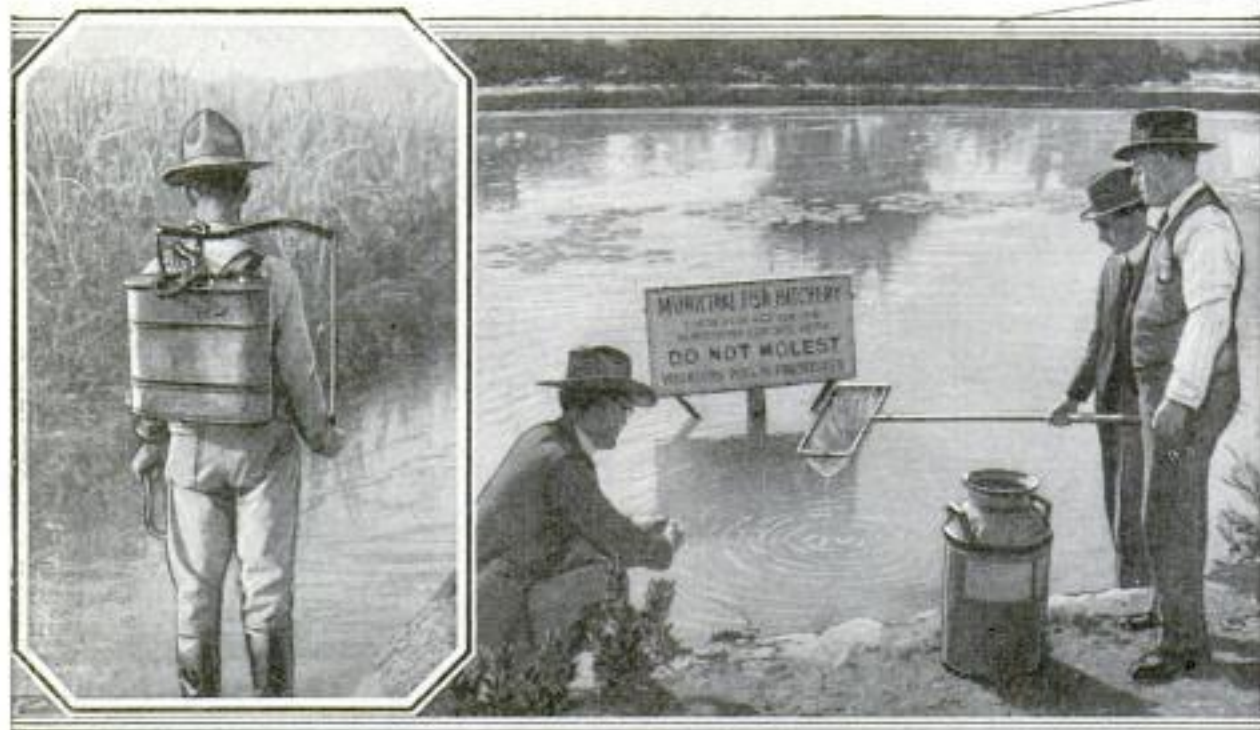

Copyright, Underwood & Underwood

Fish from Hatchery Being Placed in Cans Before Being Sent Out to Aid City's War on Mosquitoes; Oil from Portable Tanks also Was Sprayed Over Stagnant Waters

When mosquitoes recently menaced the health of a western city, the municipality started a hatchery where millions of small fish that feed on the pests' eggs were raised to combat them. As requests were received, cans of the fish were sent to residents who distributed them in ponds,

ditches, and other breeding places. The number of mosquitoes was noticeably decreased as the fry, multiplying in great numbers, continued to devour the developing insects. Crude oil sprayed from portable tanks equipped with hand pumps was also used to spread a smothering film.

4262

INVENTOR OF UMBRELLA RIBS REWARDED WITH FORTUNE

Although mystery shrouds the identity of the inventor of the umbrella, the man who devised the grooved rib and the paragon frame is known to have realized more than \$2,500,000 from his idea. Ancient ruins of Assyria and Egypt display parasols in the sculptured stories of the life that has departed from them. It was then a badge of royalty, the nobility, or the priesthood, but was used as a sunshade rather than as the preserver of a dry skin. When the first umbrella appeared on the streets in England, it is recorded that its bearer, the brother of Robert Southey, the poet, was mobbed, and thereafter for some time any one carrying the "contraption" was chased off the streets.

Iron and steel rust causes damage estimated at \$3,000,000,000 in the United States annually.

4074

RUBBER TIPS ON STEM OF DIAL MEASURE SPEED OF WHEELS

Speed of machinery wheels and gears can be measured regardless of their shapes, by a meter that is equipped with interchangeable rubber tips that revolve when placed against moving surfaces. A hand on a figured dial shows the number of revolutions a minute. The instrument can also be used to gauge the speed of work being cut on a lathe and to measure the movement of belts, rope drives, and pulleys. All parts of the device are nicked and it can be handled as easily as a watch.



The Universal Indicator Co.
3501 - Redzie Ave.
Chicago

Copyrighted material

New York Times 11/20/07

12000
to
practical
Station
Fla.

Chemical Age
Nov. 1923

TREE BEARING OIL FOR PAINTS TO GROW IN FLORIDA

4366 4341
Tung oil, a product of nuts that grow on a tree native to China, and an important ingredient in the manufacture of paints and varnish, may be produced in the United States according to tests recently completed in Florida. A few of the plants, placed in the ground eleven years ago, have flourished to such an extent that it is believed large groves of them can be cultivated successfully.

DEMAND FOR ELECTRIC POWER HELPED BY WATERFALLS

4367
Due to the rapid development of electricity for industrial and household service throughout the country, total sales of electrical energy in 1923 far surpassed those of any previous years, according to a bulletin recently issued. The report for the first six months of the year shows that 35 per cent of the output originated in plants operated by water, while steam furnished 65 per cent of the power.

AUTO SAFETY LIGHT RAYS GO TO FRONT, REAR, AND SIDE

4351
Acting as a warning signal to the front, rear, and side, and as a guide to oncoming and overtaking motorists, a three-colored running-board light has been made. The white rays thrown directly on the road beside the car serve as a warning to passing motorists and prevent side-swipes on dark roads. At the same time, it shows

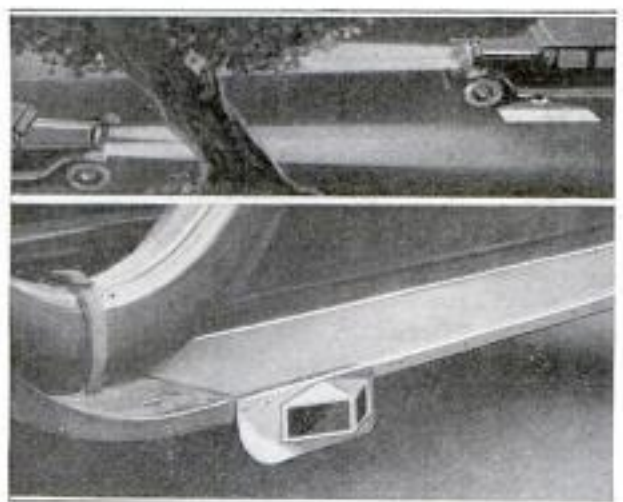

Automobile Running-Board Light that Gives Triple Warning to Passing Cars

green ahead and red to the rear, preventing crashes caused by failure of either of the head or tail lights.

Mc Kay
Mfg. Co., Chronicle Bldg.
San Francisco, Calif.

"SKYSCRAPER" IS "ABEL TOWER" WHEN TRIED IN EUROPE

Corresponding in many details to an American "skyscraper," a 16-story office building with a restaurant on the top floor



Sixteen-Story Office Building in Stockholm that Marks New Departure in European Construction

has been completed in Stockholm, Sweden. The edifice is said to be the highest modern business structure in Europe and may mark the beginning of a new construction era in cities where steel and other materials are available and where limited space makes this type of building practical. Residents of the Swedish city have nicknamed it the "Babel Tower."

WATER CURE IN FASHION TODAY KNOWN TO ROMANS OF OLD

4370
Ruins of luxurious Roman baths and temples found near fashionable French resorts celebrated for their healing waters, indicate that the value of the springs was known in early times. In the Auvergne region, famous for its mineral wells, are remains of an artistic ancient building, and near by are broken stones of a splendid temple surmounted by a statue. With the fall of the Latin empire, many habits of cleanliness were forgotten, but since that time, careful study has been given the springs which contain various chemicals suited to the treatment of diseases. The places are visited annually by thousands of persons who partake of the healing water and enjoy the beauty of the surroundings.

Copyrighted material
New York
1923

1414 S. Wabash
 Ja-Bed Co., ~~208 Lake~~ Chicago \$77.00.
 #120.00

BED THAT FOLDS INTO A TABLE SAVES SPACE

3924 Letter in general file

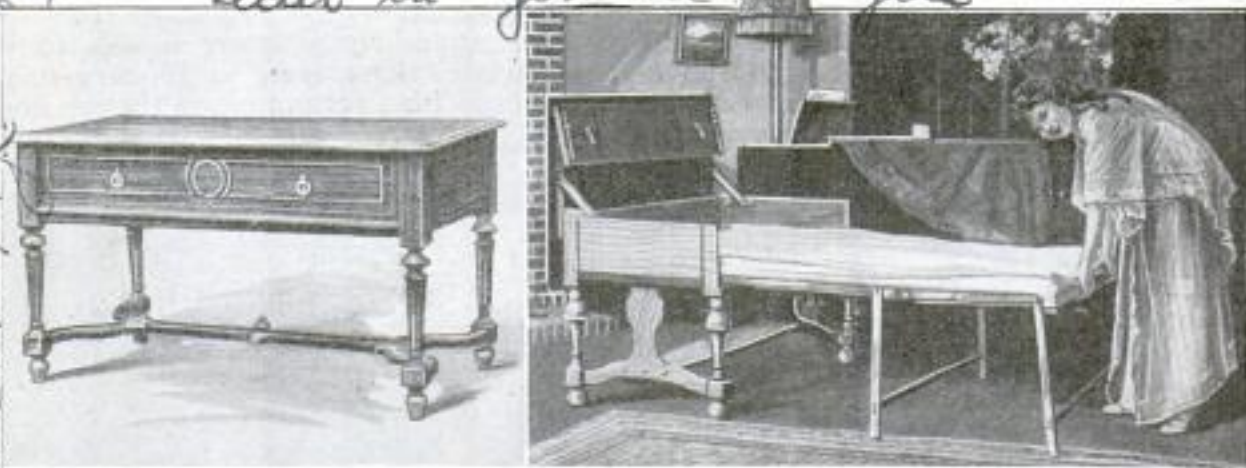

Mattress and Springs Concealed in the Drawer Space of Table when Bed Is Folded. The Top Tips Back to Form the Head of the Bed

Suited to small apartments, studios, and other rooms where space is limited, a combination bed and table is being made. Collapsible springs, a mattress and bedding fit into what is ordinarily the table-drawer space, and the top is lifted back to form the head of the bed. The springs, when ex-

tended, are four inches longer than the average, are comfortable, and are securely braced on stout steel legs. The article is manufactured in various finishes and styles to harmonize with other furniture. It requires no closet or wall space, costs little to install, and is quickly extended or folded.

4281 **AUTO TAIL LIGHT AND LICENSE COMBINED TO STOP THEFT**

Combining the tail light with the license plate, a box arrangement which cannot be removed from the automobile has been perfected by an eastern inventor to pre-

vent accidents and theft. The numbers serve as a door to the box which holds two strong lamps supplied with power from storage batteries. The numerals are visible for a block when the lights are lit behind them. The seal of the state and the make of the car are also carried so that theft of automobiles and shifting of plates are made increasingly difficult. The bright glow tends to lessen the likelihood of rear-end collisions at night.

4364

REFLECTOR FOR RADIO WAVES DIRECTS THEM LIKE LIGHT

By guiding radio waves with a screen reflector to prevent them from spreading in all directions, Sig. Marconi, inventor of wireless, hopes to confine messages to a limited zone, regardless of wave lengths, and thus reduce broadcasting costs. The Italian scientist is said to have developed an appliance to put back of the transmitter to keep the rays traveling within a narrow path. With this device, a message sent from London to New York might be heard only at stations near the receiving point, but would be kept from "listeners-in" in Spain or Sweden, for instance. The inventor believes that the reflector will decrease the amount of power now required for broadcasting. It also will prevent interference between different stations.



Illuminated License Plate that Forms Door to Tail Light, Opened (above) and Closed

no street address.

Detroit News
 12/14/23

Eastern Representative -
 Kitay Bros, Inc.,
 Paterson, N.J.
 Mrs. E. H. Spurlay,
 Brooklyn, N.Y.

*Cook H & Carter,
Bloemville, Box 41,
Elliott Cape Province
South Africa.*

**AMERICAN MACHINERY LEADS
IN SOUTH AFRICA** *4.35-3*

Writing from Elliot, South Africa, a correspondent declares that on his farm all the plows, harrows, corn planters, harvesting machines, "in fact everything but a cream separator" were made in the U. S. A., and the same can be said in the great majority of cases. In addition, he says 99 per cent of the tractors and automobiles throughout South Africa are imported from the United States. The reason is the low cost of the American product.

Merrill

**GREENBACKS DESIGNED TO FOIL
"BILL-RAISING" FRAUDS** *4.35-0*

To make it more difficult to counterfeit paper money and to aid in quickly distinguishing various bills, uniform designs for all bank notes of the same value have been prepared by the government. Each denomination will be so distinctive that less confusion is expected in handling currency, and it will be almost impossible to "raise" a \$1 bill to \$10, or a \$2 note to a "twenty," it is said. Old bills will be withdrawn as the new ones are distributed. At present there are 5 kinds of \$1 bills, 7 different \$5 notes, and 7 separate designs of the \$10 notes and certificates.

Wiley & Associates 12/1/23

**MORE HEAT WITH LESS FUEL
GIVEN BY OIL BURNER** *4.2-11*

Combining the fuel with an atomizer effect at the point of combustion, is the principle of a specially designed burner lately introduced. It is said to eliminate

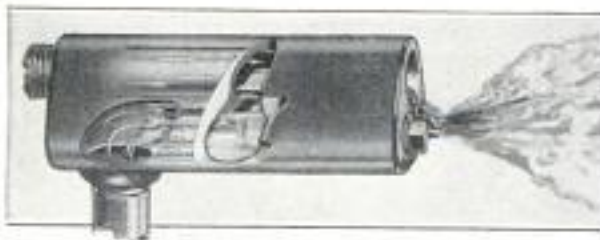

The Illustration Shows How Oil Is Mixed and Sprayed at the Combustion Point

smoke and obtain the maximum heating efficiency in boilers that use oil. As the liquid reaches the firing point, it mingles and forms a fine spray with air, gas, or steam, which is forced by pressure through a pipe below the feed chamber. Because the mixture occurs outside the burner, an unlimited supply of oxygen aids complete combustion. Adjustments are provided to produce a long jet or a spreading flame,

*Lacey Mfg. Co., 839 E. 3rd St.,
Los Angeles, Calif.*

**CHURCH SPIRE CHOPPED DOWN
—AFTER IT DEFIES FLAMES** *4.28-3*



Church Steeple Felled Like a Tree after It Had Survived a Fire

After flames had failed to destroy a 200-foot church spire in the West, recently, wreckers chopped into the corner supports on the inner side to topple the spectral structure to the ground. A smaller steeple on the same site was pulled over with the aid of an auto truck. Flames, which destroyed the edifice, started halfway up in the larger tower, making a picturesque spectacle for the crowds that gathered that night.



*Emb. L. R. Perry, 2165 Center St.,
Berkeley, Ca. Cal.*

Industries used 80 billion cubic feet of gas in 1922, or 25 per cent of the entire production of the United States. In 1910 less than 5 per cent of the yearly output was used for industrial heating.

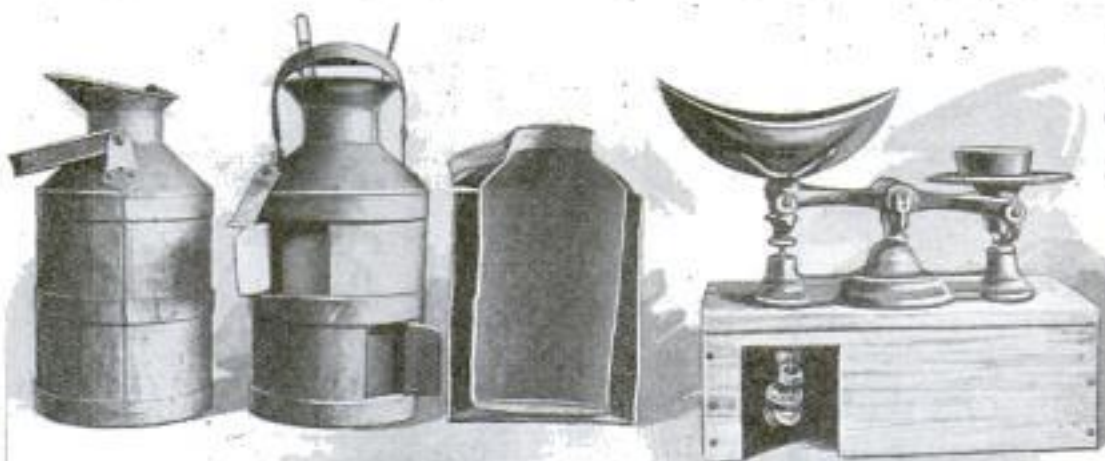

①

②



③



④

False weights and measures often are employed by dishonest dealers to defraud their customers, the devices used defying detection through a casual inspection. In the case of the milk cans, shown in 1, all of them are of the same external size, but the cutaway sections reveal double sides. Fraudulent weights have been attached to the scales (2). Dummy walls in the can (3) and buckets (4 and 5) were deliberately inserted to deceive the buyer. The bushel basket (5) also was arranged to cheat the unsuspecting public, the false sides and bottom cutting down its capacity at least a fourth. Although such devices are confiscated whenever found, and their users punished, nevertheless, the loss to the public is declared to run into the hundreds of thousands of dollars yearly.



⑤

⑥

Copyright, Keystone View Co.

To Protect Buyers from Short Weights and Measures, Such as Are Shown Above, Most Cities Maintain a Force of Inspectors Who Seize and Destroy Fraudulent Devices

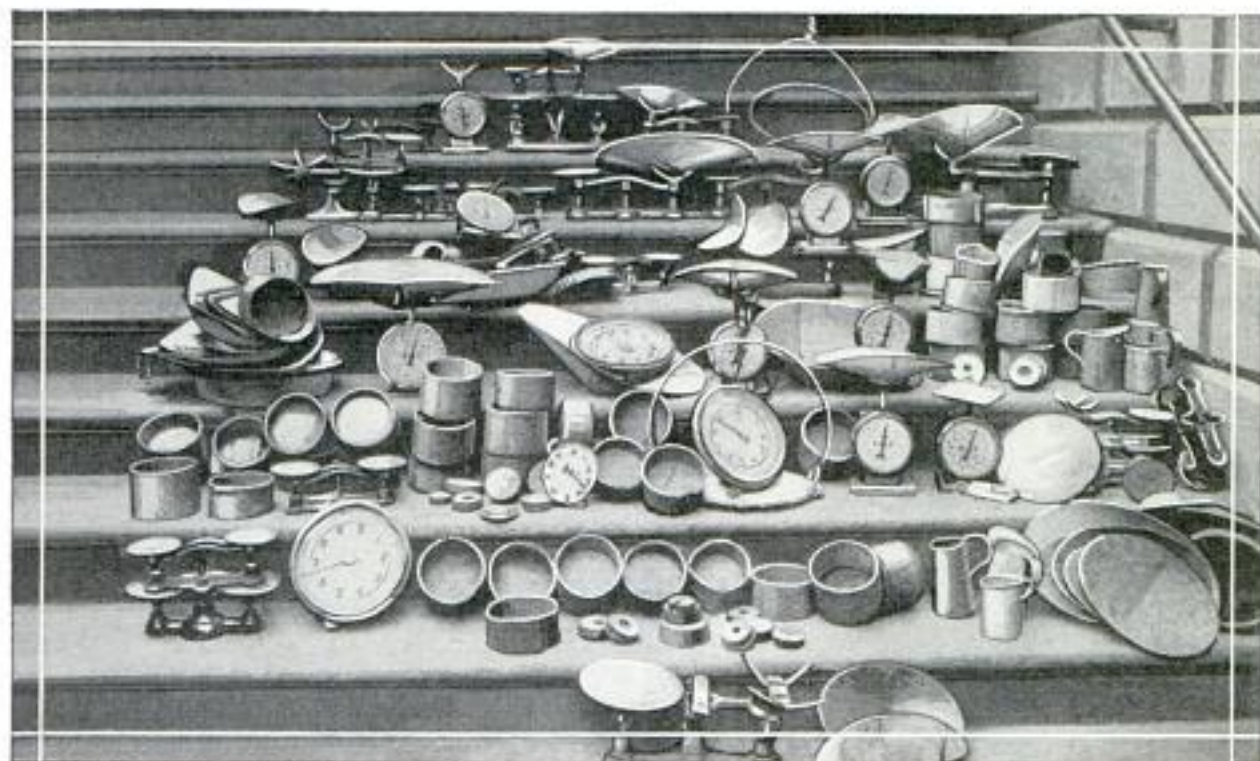

Confiscated Weights and Measures

Guarding the Nation from Weight Frauds

**Army of Inspectors Constantly at Work Checking Standards,
Save Public Untold Thousands of Dollars Every Day**

UNTOLD thousands of dollars are saved the public every day of the year through the activity of city, state, and government officials who check weights and measures to guard against mistakes and deliberate frauds.

By promptly discovering a faulty butter measure before it had been widely used in Chicago, it was estimated that purchasers had profited to the extent of at least \$750,000 a year. Detection of a false lard and meat scale was said to have kept approximately \$350,000 in the pockets of buyers.

In one city alone, coal bills are cut several hundred thousand dollars a year through the constant checking of weighing devices, according to officials. Every scale of less than three tons capacity is inspected once a year, and stamped with an official seal of approval if it is correct. Those of more than three tons are checked twice a year.

To guard householders against the wiles of unscrupulous dealers who rest too heavy a hand on the meat scales, or resort to other means of giving short weight or small measure, is the task of an army of inspectors throughout the country. Every

measuring machine, from a taxi meter to a candy scale, is checked. In many localities, the use of scoops and cups is prohibited and everything must be weighed.

Frequently, it is asserted, the trickiest storekeepers will have the most elaborate and reassuring weighing equipment known, but by clever movements or actual "doctoring" of the balances, they are able to cheat their customers. Dishonest dealers are haled into court, and, if convicted, fines are imposed and their weights confiscated. When a large assortment has collected, the false balances are destroyed.

As civilization advances, the task of insuring correct weights and measures has become harder. Measuring cups of some sort, and balances of design now considered obsolete, were employed ages ago, but the temptation was not so great then as values were not exact and had not been estimated with scientific precision.

In the Bureau of Standards, in Washington, a complete set of weights and measures is kept in sealed cases and under constant guard. These serve as models for the entire country. The weights are kept in air-tight cases to protect them from dust, and at a constant temperature.

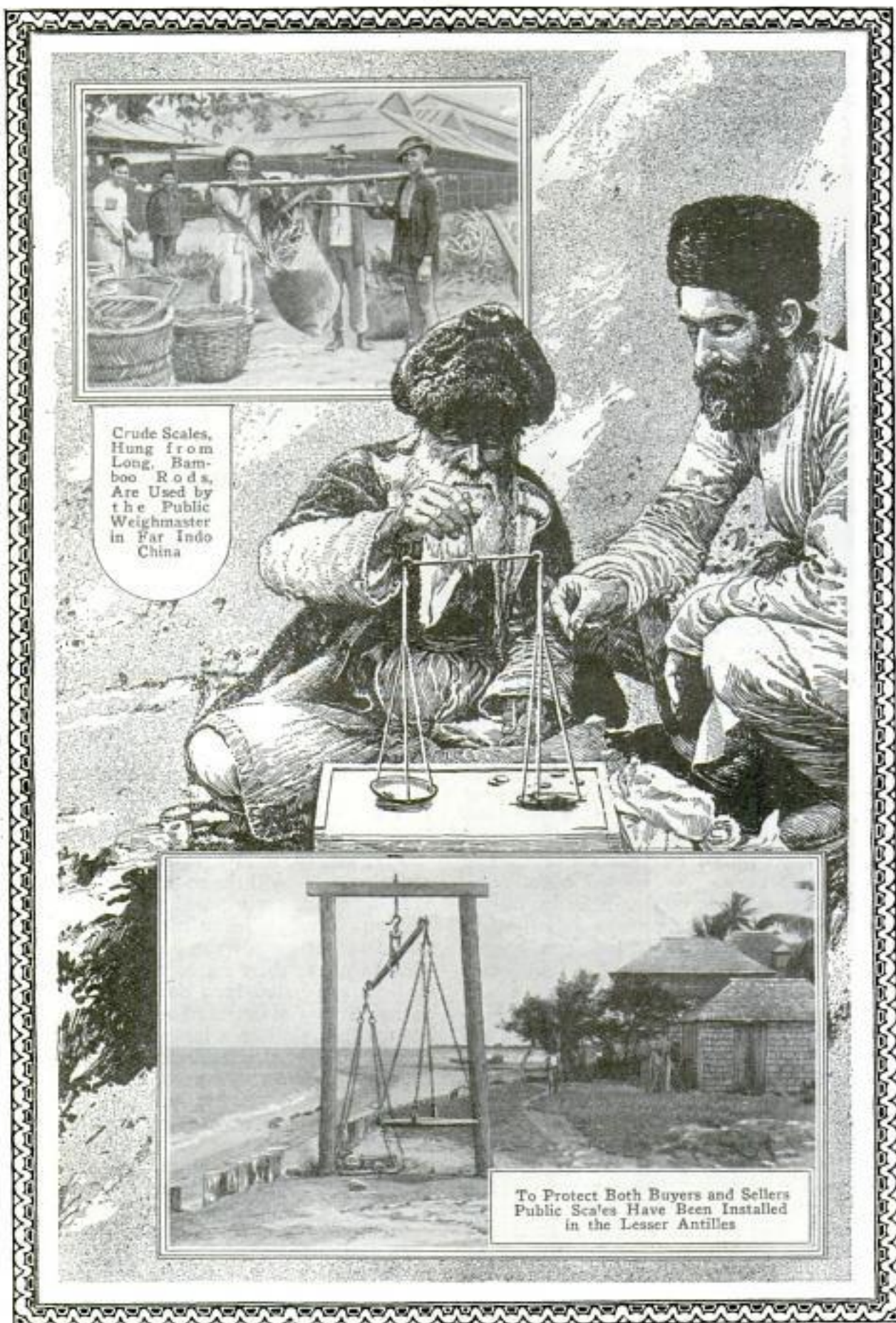

Copyright, Ewing Galloway.

Even at the Outposts of Civilization, Scales Are Used, Although, As in the Case of the Persian Spice Seller Shown in the Center, They Are Primitive in Form



Turkish Method of Weighing Wool, Showing the Scales of the Near East

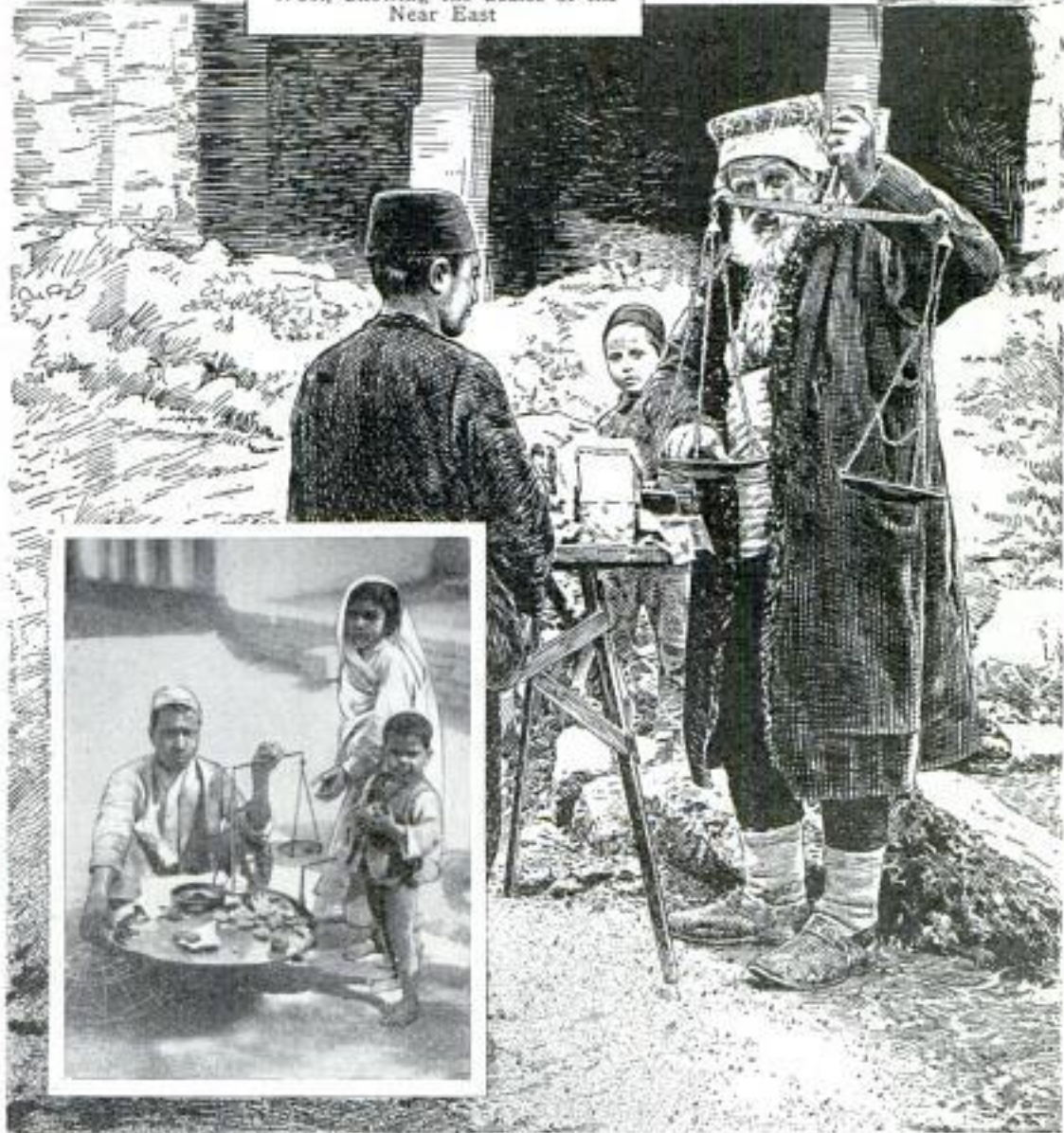

Turkish Candy Seller, with His Homemade Scales (Center), and, Below, an India Street Merchant Dealing Out Sweets by the Ounce with Round Pebbles as the Counterweights



Copyright, Ewing Galloway
Curious Scales, Set upon Long Tripods, that Are Used for Weighing Hay for Shipment by Boat Along One
of the Many Canals that Lower Transportation Costs in Holland

"UPSIDE-DOWN" BOILER SAVES HEAT AND FUEL

Heated at the top, where the smaller amount of water permits steam to be generated more quickly, a triangular-shaped boiler is now being used in plants where oil or gas is burned. Reversing the usual way of applying the heat from the bottom, it is unnecessary to bring all the water to the boiling point to get up steam, and so

jet strike the apex of the triangle, made up of cast-iron sections of pipe resembling radiators, at the level of the top of the water, so that steam is generated before the lower part has reached the boiling point. The working principle of the boiler is well illustrated with a test tube. In an upright position, it is necessary to heat all the

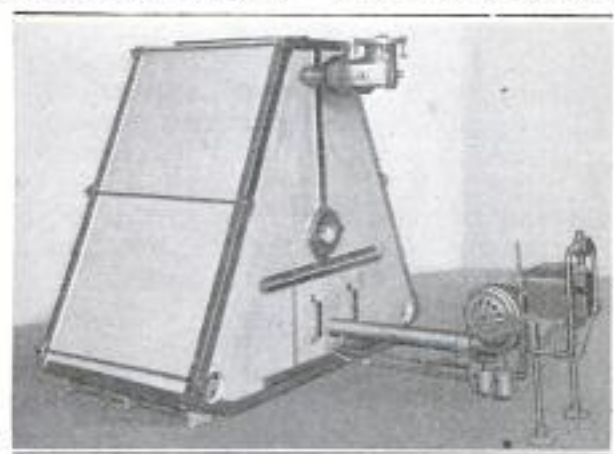

Striking the Sloping Side of this Triangular-Shaped Boiler at the Apex, Flames from the Burner Quickly Generate Steam. The Old and New Principles Are Illustrated by the Drawings

efficient has this method proved that in a recent test it was found that 85 per cent of the heat was applied directly to the water, 10 per cent went to warm the basement, and only 5 per cent was lost in the chimney and in useless radiation. The boiler, generally, is said to be more efficient than the ordinary type. Flames from the oil or gas

water in the tube before steam is made; with the tube tilted at an angle, the flame produces steam much more quickly, as only a small portion of the water has to be brought to the boiling point. As the boiler is heated, the cooler water flows back from the house pipes to the bottom, where it is warmed and rises to the surface.

BIRTHS OUTSTRIP DEATH RATE IN WORLD'S LARGE CITIES

Annual death rates in the ^{4,306} twenty-six largest cities of the world are only about three-fifths of the birth rate, according to figures compiled by a French statistician. His reports show that for every 10,000 inhabitants, an average of 250 births and 154 deaths occurred in the large metropolitan centers for the year ended July 1, 1923. Alexandria and Cairo, Egypt, stood high on the birth and mortality lists with 576 and 530 births, respectively, and 259 and 282 deaths per 10,000 inhabitants. Bombay had the highest death rate.

room wall where their contents may be squeezed upon the brushes without waste or smearing, by a key tape fastened to the end of the container. The arrangement is adapted to tubes of various sizes and is attractively polished and easily cleansed.

Ch. Bailey 4 Rue de
TOOTH PASTE KEPT IN CABINET SUPPLIED BY TURN OF KEY

Tubes of toothpaste or shaving cream are held neatly and conveniently in a metal cabinet, within easy reach on the bath-



As the Toothpaste Is Used, Tube Is Wound on Key in Cabinet

Joel E. Hawley Co., 310 Altman Bldg. Kansas City, Mo.

4101 Cont. John L. Von Blow.
Los Angeles Athletic Club,
Los Angeles, Calif.

Mystery Mansion Found in "Spook Palace"

House Unusual

Maze of Halls and Stairways Uniting Rooms Built in Steps and Ornate Trappings Compose Wonders of Freak House

CONTAINING 144 known rooms and representing an estimated total cost of close to \$5,000,000, "Spook Palace," a weird structure in California, is believed to be one of the largest, and probably the most complicated, private residences in the world.

Inspection of the marvelous house by experts after it had been thrown open for the benefit of the public recently, disclosed the fact that the builder sought to conceal as many rooms as possible from the eye of the ordinary observer. For instance, there are more than 2,000 doors in the building. About 10,000 windows requiring 150,000 panes of glass open out of the walls. Other materials used in its construction have been found to be the very best that could be procured.

According to reports, this sumptuous mansion was erected by a wealthy woman who gave little thought to expense in carrying out her ideas. She is said to have become possessed of the belief that when the building, which was her home, was completed, she would die. That was over 39 years ago. And until her death recently, the rasping of saws and the pounding of hammers had not ceased during that period of time.

Every working day for almost two score of years, a force of about a dozen artisans plied their trades in not only constructing new parts to the house, but in tearing out old sections as well, and rebuilding them in keeping with the wishes of the owner.

That the work might be delayed as much as possible,

conspicuous portions of the structure, both outside and in, were left glaringly incomplete for several years at a time. All during its erection, the home was occupied, but few persons were ever permitted to enter its forbidden grounds.

Of the great number of rooms in the four stories which constitute the spook palace, but four or five are on the same floor levels, the variations being from six inches to several feet. This arrangement necessitates ascending and descending queer little stairways when passing through the house. They are composed of steps not more than two and a half inches high with treads of about 18 inches and built in narrow casings that are often less than a foot and a half wide. To attain a rise of eight and a half feet in one of these stairways, 45 steps are used and there are nine sharp turns winding crazily back and forth. Eighteen steps and five turns are required to reach a room four feet below the floor of another chamber.

There are so many intricate, winding, and bewildering corridors that a stranger passing through the building is in danger of becoming lost in their maze. For the benefit of the guides, arrows are painted on the floors pointing the way out. The puzzle is furthered by hundreds of balconies, large and small, which invariably open out from the wriggly stairs. These landings are usually found in pairs, but sometimes in larger groups. They were built by expert cabinet makers who used the finest of woods. The majority of



Copyright, C. C. Pierce & Co.
Doors to Rooms of Mystery

Winchester Home.

Located at San Jose, Calif. 4101
in Winchester Park,

POPULAR MECHANICS

239

8 miles from the city.

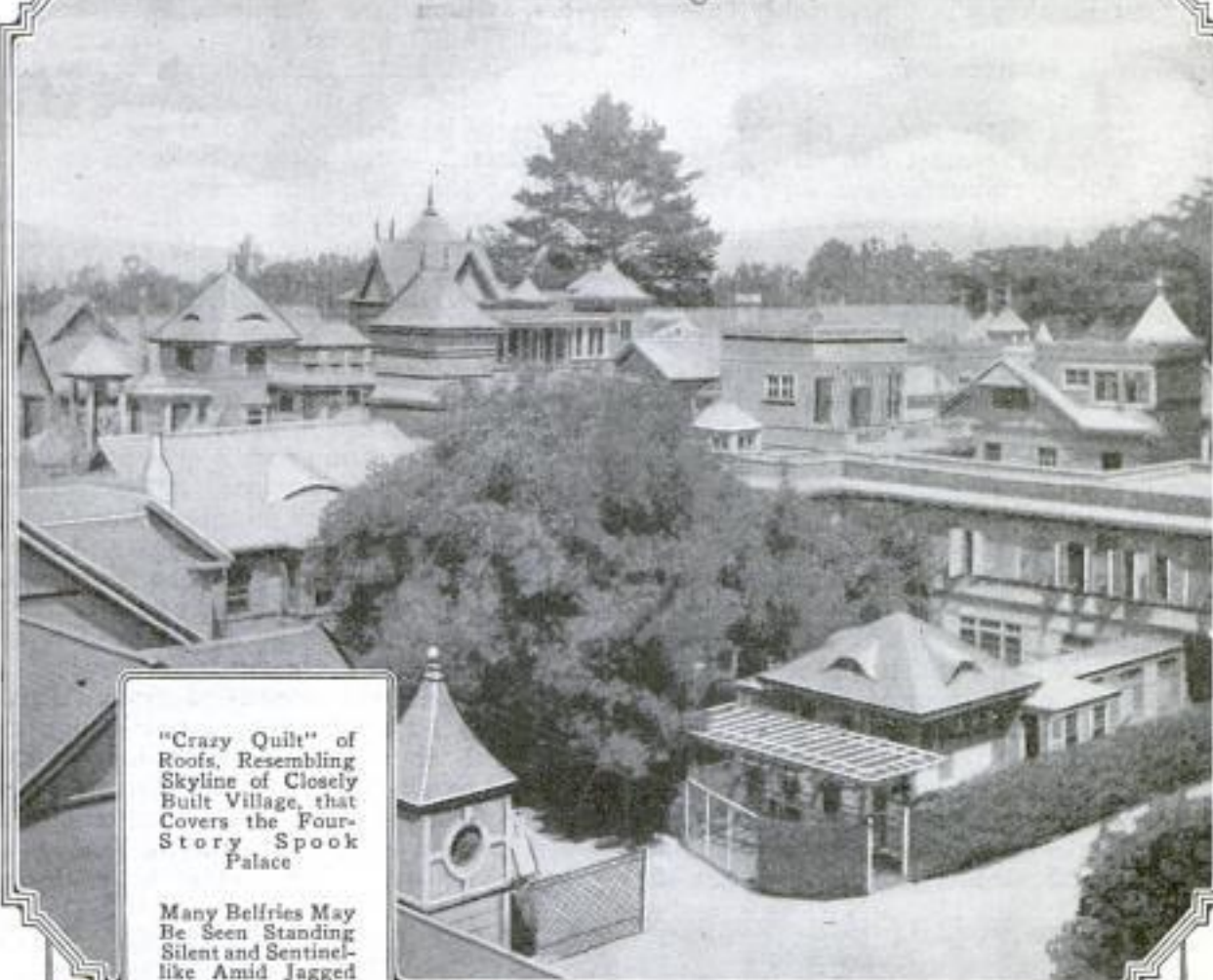

"Crazy Quilt" of
Roofs. Resembling
Skyline of Closely
Built Village, that
Covers the Four-
Story Spook
Palace

Many Belfries May
Be Seen Standing
Silent and Sentinel-
like Amid Jagged
Housetops of the
Mystery Mansion



them are in the centers of the rooms, on floor levels, in corners, and perched against blank walls. Invariably they are inclosed, so that climbing one of the crazy stairways is necessary to reach one of them.

Windows there are of all shapes and sizes and of the most exquisite glass. In walls, floors, chimneys, ceilings, and roofs they glisten by the thousands. And the same with the doors, which open inward and outward at the most unexpected places. Some cut in the upper stories open directly to the outside and mean a hard fall for the unwary visitor who should carelessly step through. Others lead to cupboards, closets, and innumerable nooks—sometimes so small that they will only admit a book. One door represents a gold-plated screen behind which is an elegant bird's-eye maple and art-glass panel. Back of that, is the wall, bare and unfinished, not even plastered.

Bathrooms number 25. In the center of one that is large and prominently located stands an old-fashioned zinc tub, but in the other 24 are modern fixtures, some silver-plated, and they have tiled floors and sides, decorated ceilings, and elaborate cut-glass windows. No attempt has evidently been made to connect any of the bathrooms with sleeping chambers, but they

are scattered at random throughout the house. So with countless chests of drawers, which are visible and concealed. Many kitchens exist, shiny with marble, porcelain, and nickel equipment, and hundreds of sinks with running water are peculiarly located in out-of-the-way places.

Electric wires form a network so confusing that its solution has almost been abandoned. Push buttons dot the whole interior. Behind doors are large gongs connected with a myriad of wires that have not yet been traced, but these bells do not seem to be either burglar or fire alarms.

All rooms are gorgeously furnished in a wild assortment of things both ugly and beautiful, and as found with the rest of the equipment are hung with gold and silver-plated fixtures. Fireproof vaults and burglar-proof safes are hidden about to accommodate valuable trappings and silver service plate. A magnificent pipe organ stands in the main dining and ball room which measures 20 by 40 feet and is finished in delicately carved woodwork.

The main entrance, known as "Prism Hall" is 40 by 10 feet. Its ceilings are set with thousands of glass prisms that glitter in all colors of the rainbow. The front door, which is said to be worth as much as an ordinary house, is believed to have been opened only three times during



Copyright, C. C. Pierce & Co.
Many Conspicuous Parts of the Weird Structure Were Purposely Left Unfinished on Their Exteriors. View of "Prism Hall," Main Entrance to the Once Forbidden House of Secrets

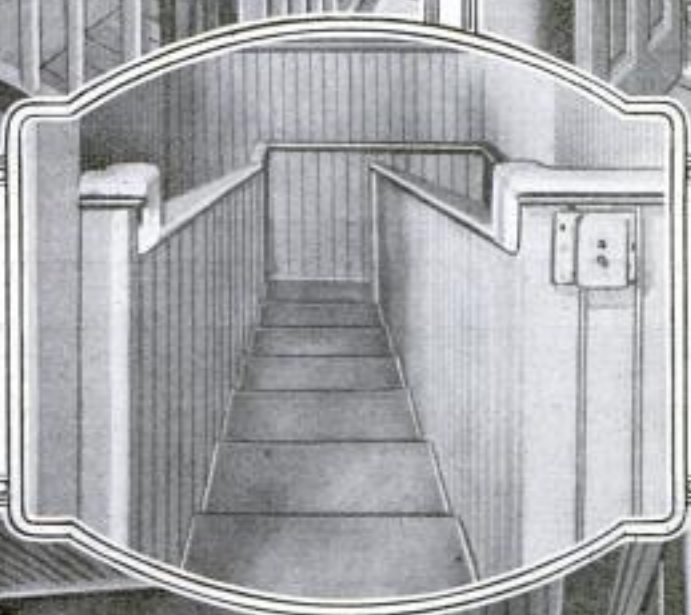
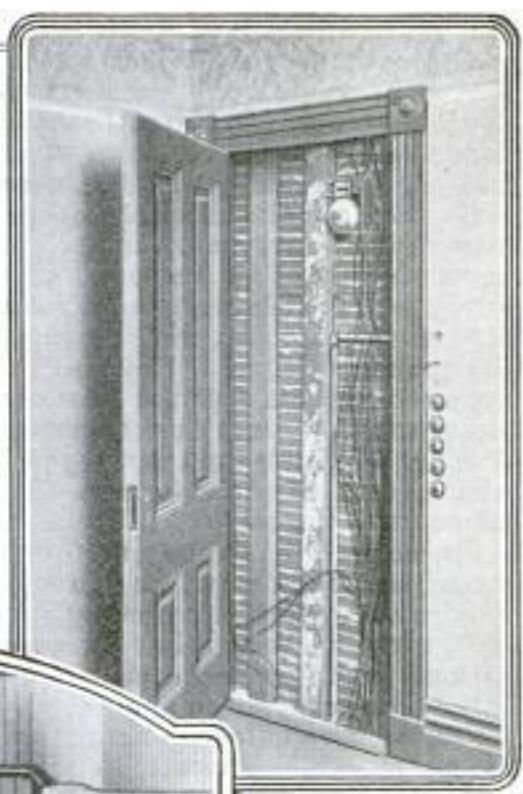
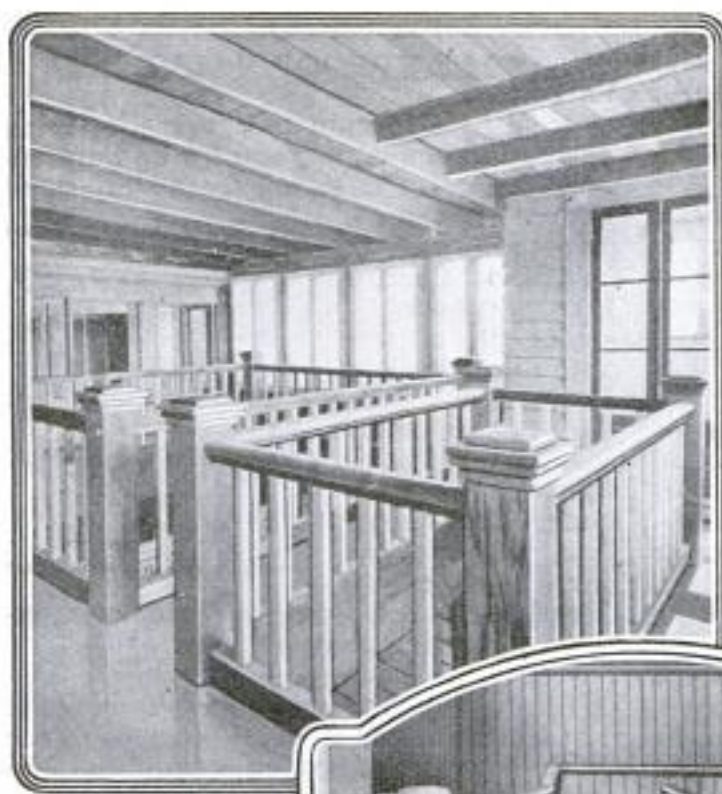

Above: Twin Balconies Built on Level of Floor at the Heads of Two Stairways. They Are Made from Finest Hand-Polished Wood and Scores of Them Are Scattered at Random Throughout the Interior

Above: Gong Concealed Behind Richly Finished Door. Left: Stairway that Makes Nine Turns in Rise of a Few Feet. Below: Four Hearths and Five Radiators in Small Space. Arrows Point to Locations

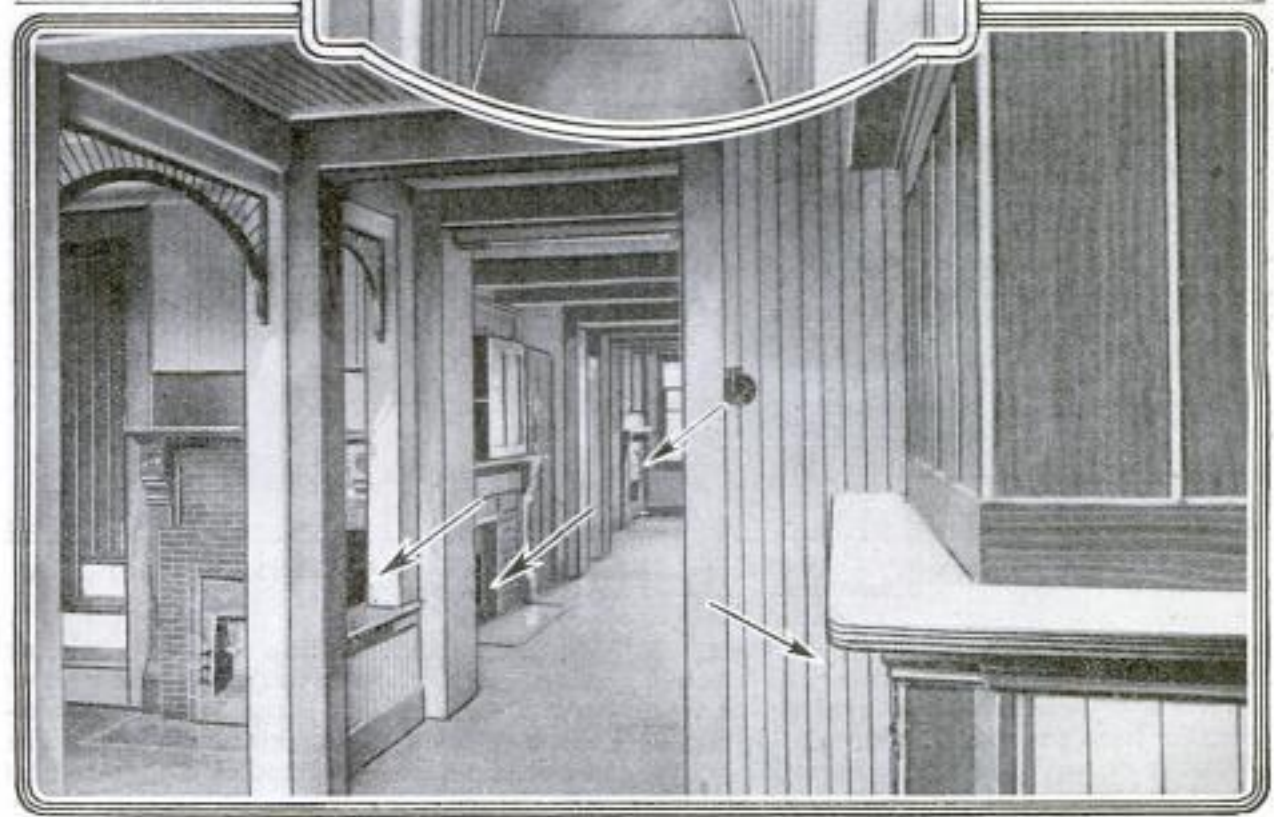

*Airlock Rubber Co.
2053 Jackson Blvd.
Chicago*

the owner's residence there. During all the years of occupancy with an extensive staff of servants and caretakers, none of these were ever permitted to enter more than five rooms of the mansion and, it is said, none ever saw more. The secret of the real reason for the existence of the house may never be learned, for the workmen knew nothing of its purpose. They were privileged to finish the exterior as they saw fit, just so long as it was in keeping with the general designs. They had to follow the one provision that the most conspicuous parts should not be completed on the outside. This resulted in rugged gaps in what were otherwise ornate walls surmounted by cupolas.

Formerly an eight-story bell tower reared above the labyrinth of roofs, but it toppled over shortly after being put up and was never replaced. After a generation of curious watching and speculation on the part of those living in the neighborhood, they have been allowed to enter the house of mystery and inspect its astounding interior.

AIR HELD PRISONER IN TIRE BY LEAKPROOF VALVE CAP

3867
Held by a locknut to prevent its being jarred loose, a double cap for an automobile tire valve stem has been devised to prevent any leakage of air. It is made in three pieces, one of which fits down into the end of the valve stem and is kept in position by packing. In addition, there is an outer and inner cap. When these are screwed up tightly, it is impossible for the air to escape, according to users.



As many incandescent lights are used in the United States as in all other countries of the world put together, according to recent estimates.

DRILL FOR SOWING GRAIN RUNS BETWEEN ROWS

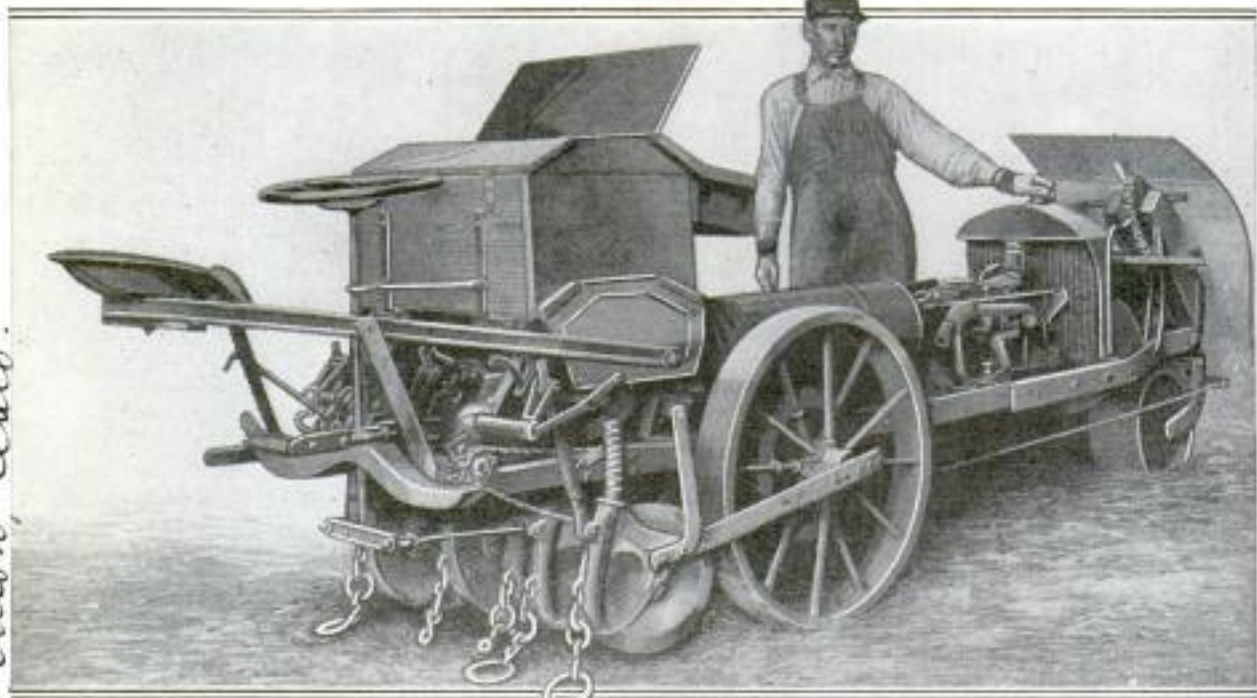

Tractor, Sower, and Cornstalk Turner Complete in One and Geared to an Automobile Motor for Planting Between Rows: Grain Is Carried in a Hopper

For sowing wheat between rows of standing corn, an Ohio farmer has invented a motor-driven tractor drill which will seed 25 per cent more acreage a day than a horse-drawn planter. Only 38 inches wide, the contrivance fits comfortably between the corn rows, which normally are

42 inches apart. While the grain is being sown, stalks that have been beaten down by rain or wind are lifted to vertical position again as the machine passes. The sower can be constructed at moderate cost and is a time and labor-saving addition to farm equipment.

*if m. J. Carl Van Cuedal,
Eaton, Ohio.*

near High Bridge
Ky

LOFTY DAM BETWEEN CLIFFS TO FORM INLAND SEA

4365

Rivaling nature's inland seas, a lake 36 miles long capable of developing 30,000 horsepower will be formed by a towering dam built between lofty cliffs of the Dix River gorge in Kentucky. Preliminary surveys for the water barrier were conducted for several years before the location was finally selected. When completed, the dam will be 270 feet high, and the estimated cost is 7,000,000 dollars.

DIVER IN CLUTCH OF OCTOPUS HAULED UP AND FREED

4380

Attacked by a huge octopus while working on the wreck of a battleship at the bottom of the sea off the French coast, a diver nearly lost his life before his comrades could haul him up to free him. After a terrific struggle on the floor of the ocean, he succeeded in getting one arm free and plunged his trident into the monster's body. While he was being pulled to the surface, the ferocious fish held to him. It would not relinquish its prey until cut to pieces by the knives of his assistants after he was drawn from the water.

Indianapolis News 12/1/23

DETACHABLE BLADES ON PEN-KNIFE FOLD IN HANDLE

4340

Having replaceable blades that fold compactly into the handle, when closed, a safety knife, which, it is said has many

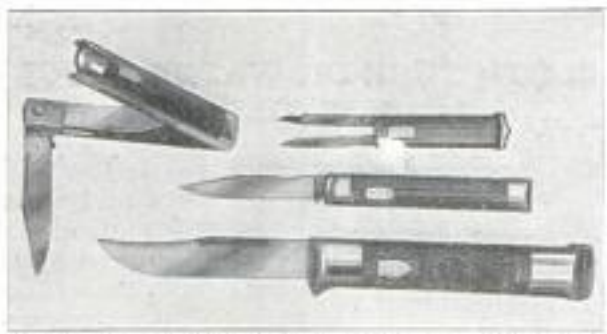

Various Sizes of All-Metal Safety Knives with Detachable Blades Folded and Open

advantages over other styles, has been patented. A lock catch on the side releases and opens the hinged handle. The blade is pulled out for use, and when it is in line with the body of the tool, the handle is closed down over it, holding it rigidly in place. The article is manufactured in various styles and sizes, and is of nickel silver to prevent rust. It reduces liability of injury to the fingers and there are no sharp edges to tear the pocket.

West Safety Knife Co. #1 Union Square New York

SAFE TAKES DEPOSITS, STAMPS RECEIPT ON BANK BOOK

4322

To collect industrial savings and do away with clerical work and bookkeeping, a recording safe has been constructed for use in business establishments. It accepts deposits

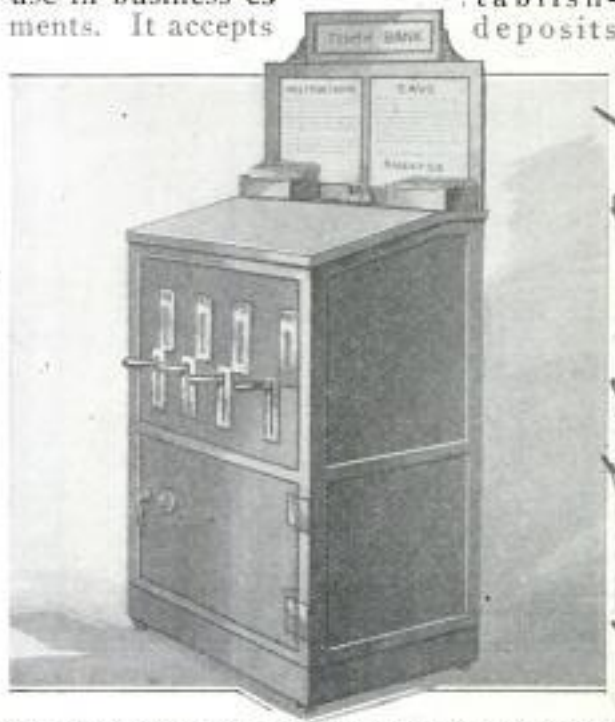

Automatic Teller that Identifies Savings Depositor, Accepts Money, and Issues a Stamped Receipt

of paper money, in denominations of from one to ten dollars, prints a receipt, and stamps the depositor's pass book. After the bank note is sealed in an envelope, it is inserted with the pass book into a folding metal frame, which is placed in the proper slot in the automatic teller. A lever is then pressed to carry the package into the vault. The device is said to encourage thrift among factory employes, because it conceals the state of their finances and eliminates the need of book work while paying in the installments.

HALF BILLION FEET OF SCREEN IN WAR AGAINST INSECTS

4368

To combat flies, mosquitoes, and other insect pests, about 550,000,000 square feet of wire screen cloth are consumed annually in the United States, according to recent estimates. Rust, it has been found, is the greatest enemy to the life of the mesh woven from metals that can not resist the action of moisture. It has also been pointed out that more than 100,000,000 square feet of such screens must be discarded at the end of each season. During winter months manufacturers of the netting produce almost the entire supply for the following summer.

new York Times 12/13/23

National Automatic Teller Corp. 215 North Ave. New York

no price.

Cml. Ernest A. Henchy, 395 2
 Commons Ave, Sheepshead Bay,
 POPULAR MECHANICS
 New York

244

4238

WAX MODELS SO REAL THEY DECEIVE THE EYE

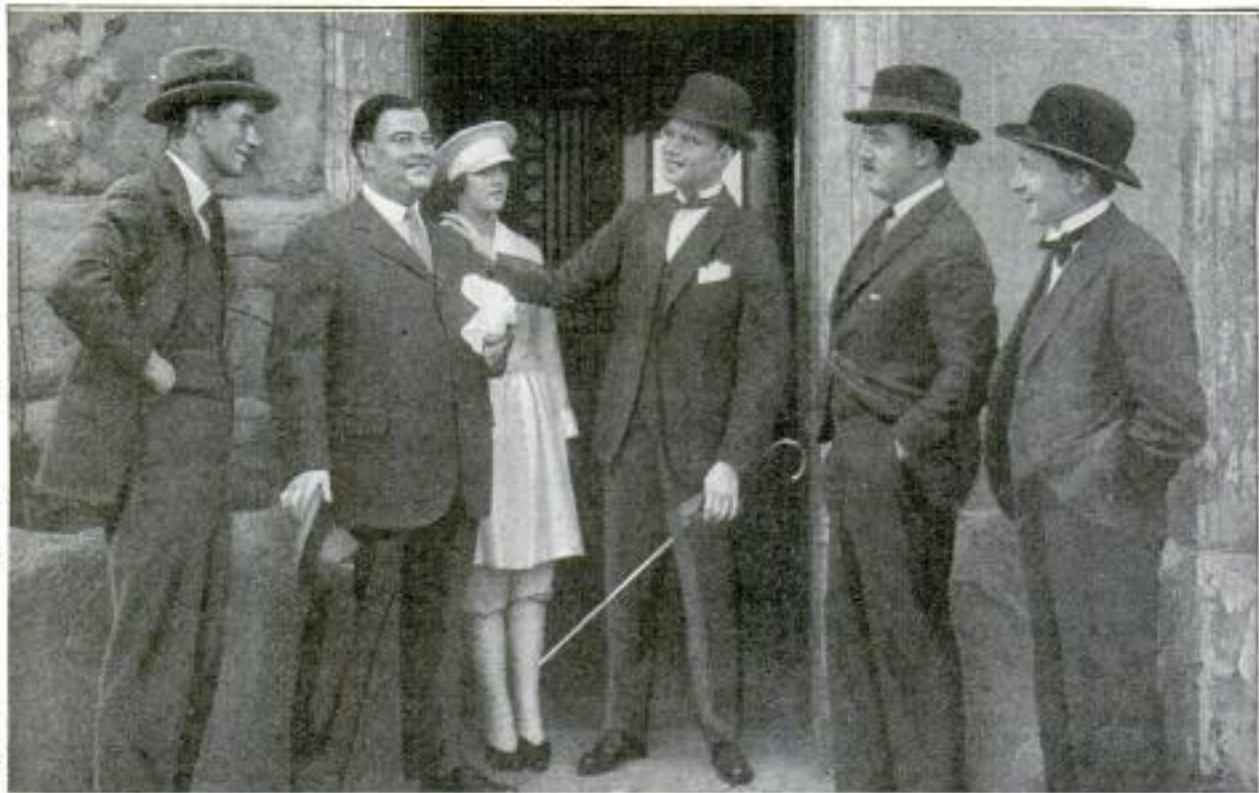

Wax Models So Artistically Molded that It Is Difficult to Tell Them from the Living Figures: The Two at the Right and the One at the Left Are the Only Real Ones in the Group

Working with wax, instead of with clay and marble, European artists have discovered a new industry in the making of models of men. These figures are said to be so realistic they deceive the eye and vie with the best product of the sculptor in naturalness of pose, fidelity to life, and correct-

ness of detail. They are being introduced to replace the foppish masculine figures so often seen in men's clothing stores. These new models are not the pretty-faced kind with staring glass eyes, for their features are sculptured, even the wrinkles and muscular contours being exactly reproduced.

ALUMINUM COATED WITH GOLD TO RIVAL COSTLY METALS

By a secret patented process, aluminum is being plated with gold, silver, and other costly metals in Germany. No special treatment of the material is required before applying the coating, it is said, and the finished article is as attractive as wares made from the more expensive minerals. Objects thus prepared are reported to be especially useful for purposes of decoration, such as wall and ceiling ornaments and illuminating fixtures, where lightness is of advantage. It has also been found that aluminum covered with copper or brass can be manufactured into various products at a much lower cost than when solid brass is used.

(San Domingo is the site chosen for the erection of an enormous lighthouse in memory of Christopher Columbus.)

CLOTH TUBE ON WATER FAUCET ACTS AS SILENCER



Householders and invalids need no longer be annoyed by the sound of running water. A device consisting of a rubber socket and a cloth filter tube does away with the disturbance. The socket grips the faucet firmly and

when the water is turned on it flows noiselessly into the basin or bathtub.

Used by Spelbridge's Department Store, London made in France.

Our Young People, 1923

Used by firm in Hanover, Germany. Marshall Field & Co. Chicago

Originated by - H. d. Lehman,

Electric POPULAR MECHANICS

Washington Power Co., Ephrata, Wash

FIVE THOUSAND FED AT ONCE AT ELECTRIC BARBECUE

Four steers weighing about 2,000 pounds each were roasted in an electrically heated pit in the West recently, the meat being served to 5,000 persons. With the temperature automatically controlled, it required 24 hours to cook the beef thoroughly. The improvised oven was 32 feet long, 4 feet wide and 6 feet deep.

H. d. Lehman

CAMERA TO DETECT FORGERY SNAPS FACE AND NAME

Simultaneously photographing the depositor and his signature, a double camera arrangement has been perfected by an eastern inventor for use in banks and business houses to detect forgeries. Upon a special plate the machine at one "snap" registers a picture of the person and of his handwriting, which is affixed to a blank and kept with the photograph for reference in case dispute later arises as to the depositor's identity or his signature.

And. O. C. Esch

GRAPES ARE SAVED BY SPRAY OF WET OR DRY SULPHUR

For spraying grapes to prevent mildew, a California vineyardist has invented a device which spreads a fine coating of wet or dry sulphur over the vines. Mounted on a wagon, the apparatus is driven between



This Sprayer Dusts the Vines with Wet or Dry Sulphur to Prevent Mildew

the rows. A blower run by a small gas engine distributes the powder from adjustable nozzles on each side. A rotating disk in the bottom of the hopper regulates the quantity of the material used per acre and mixes it thoroughly so that when moist it will not clog the pipes.

*Wm. Evans Trigg
Orinda, Calif.*

COIN-IN-THE-SLOT "BOOTBLACK" SHINES TAN OR BLACK SHOES

Only 40 seconds are required to polish a shoe by a recently patented machine that is set in operation by the insertion of a coin in a slot. The automatic "boot-



Coin-In-Slot Shoe-Shining Machine that Can Polish Either Tan or Black Footgear

black" applies dressing, brushes the footgear, and polishes with a cloth. One side of the device is for tan shoes and the other for black. A lever, which the patron pushes into labeled notches, adjusts the mechanism for the desired color. A cent must be inserted before each shoe is shined.

no price

TEST FOR OPTICAL ILLUSIONS PLANNED FOR STUDENTS

When two trains are standing at a platform and one starts, why is it difficult for those in the other to tell which is in motion without looking at some stationary object in the same line of vision? Why does the moon seem to race across the heavens on a partly cloudy night and the clouds stand still? Why is a person sitting in the dark unable to determine which of two lights is in motion and which is stationary? Exhaustive tests to determine the causes underlying optical illusions, such as those described above, are planned, more than three hundred students of psychology being used in the experiments which are expected to be of value because of the light they are expected to shed on human nature.

To make it fit the height of any-age child, an eastern man has designed a seesaw that can be raised or lowered.

*Automatic Shoe Shining Machine Co., 11/9/23
Front + Display Sta. 11/9/23*

Chicago Daily News 11/9/23

4030 ARCH SIDEWALK BARRICADE IS ORNAMENTAL

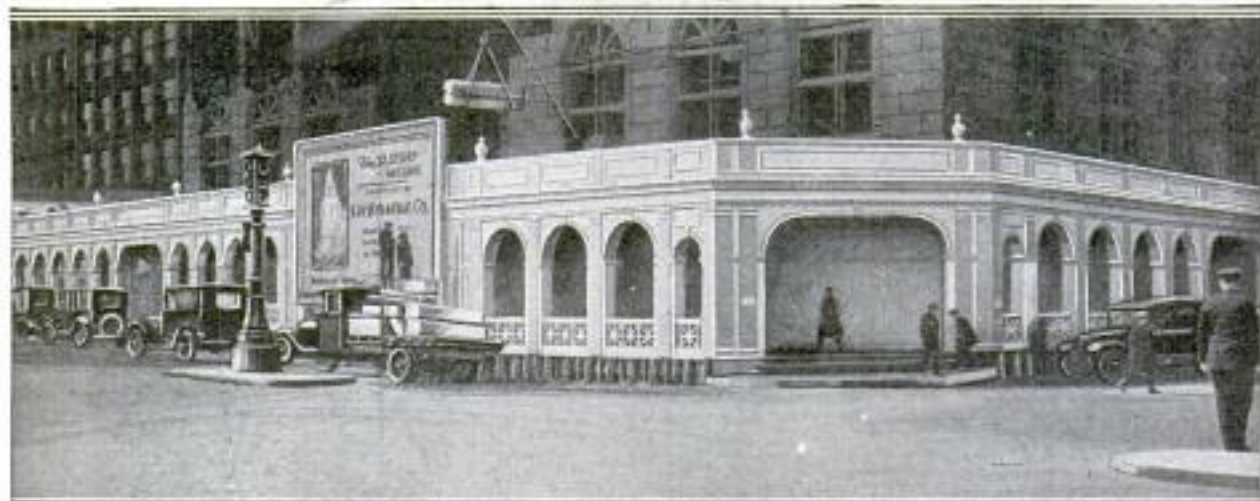

Beauty and Usefulness Combined in Protective Barricade Over Sidewalk to Provide a Covered Passageway while Chicago Skyscraper Was Being Erected

In place of the usual rough and unfinished barricade erected to protect pedestrians passing buildings in the course of construction, a firm of architects in a western city has designed a covered passage-

way that is attractive as well as serviceable. It surrounds one of the city's new skyscrapers. A series of graceful arches give it the appearance of a permanent structure.

421 ONE-MAN ORCHESTRA IN HOME USED FOR ACCOMPANIMENTS

Accompaniments to phonograph, piano, or radio selections may be supplied in the home on a set of drummer's traps rigged to an adjustable tripod stand. The outfit consists of a tambourine, wood drum, triangle, cymbal, two cow-bells and sticks and fits into a small case for carrying. The instruments are of a size especially designed for parlor use or in connection with dances in the home.



of the public and reading aloud the news, and the proclamations and orders of the authorities at Coblenz.

4034 SIGNAL LAMP AT GAS STATION SHOWS AMOUNT OF BILL

For convenience of motorists at filling stations, large signal lamps lighted at night and which can be seen from almost any angle, show the charge for a gallon of gasoline and the cost of the amount purchased. Connected to tops of the pumps, they have figures large enough to be read easily by persons seated below them in automobiles. Turning of a key changes the price for a gallon, and automatically adjusts a set of total amounts for various quantities printed on a vertical scale.



4115 "CRIERS" BELLS RING AGAIN IN THE RHINELAND

Town "criers" are again exercising their calling in the Rhineland. Newspapers rarely penetrate into the hamlets in the mountain districts along the Moselle, and the separatists have therefore pressed into service these survivals of feudalism. Once again they walk the streets, ringing their ancient bells to attract the attention

Eight thousand American buffalo were rounded up in Canada recently to make "atmosphere" for a moving picture.

Chicago Post
10/10/20

Lynn Healy Chicago

The Lawrence Deming Co., Delaware

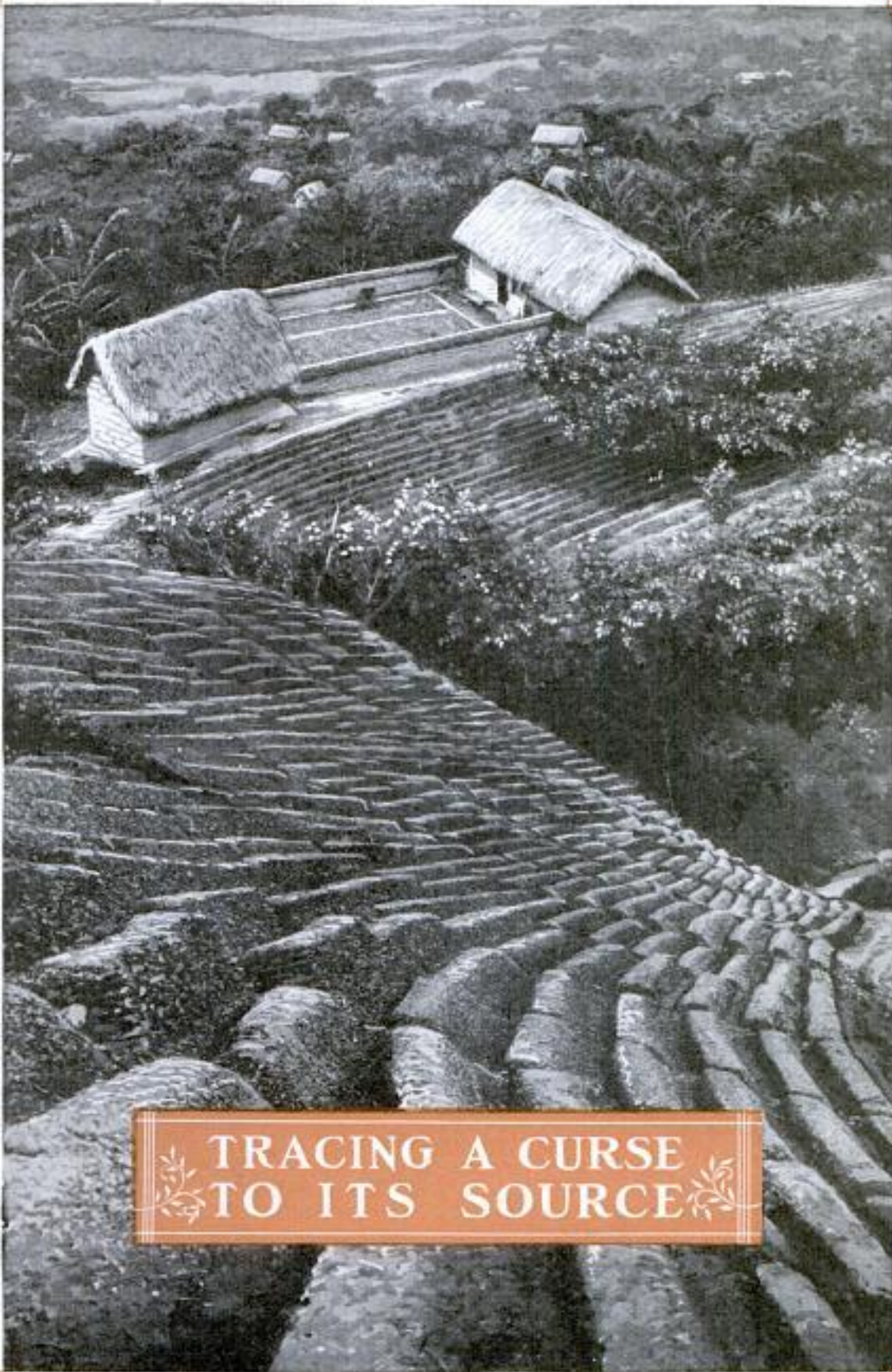

TRACING A CURSE
TO ITS SOURCE

Terraced Mountain Side where Coca-Plant Slips Are Grown During Their First Year



In the Coca Fields, Gathering the Drug Leaves which Are Packed to the Seacoast Cities for Export Abroad or Sent into Native Districts and Sold Among the Indians

Drug Curse Is Pall on Roof of World

Chewing Coca Leaf Is Almost Religiously Practiced by Andean Indians Who Live Under Its Spell

WITH the growing use of habit-forming drugs among the western nations, educational work is being directed toward the sources of supply of one of the most noxious of these—cocaine. Among its addicts it is better known as "snow," and some authorities hold it to be the curse of the Occident.

The principal sources of coca, from which cocaine is derived, are the Andean sections of Peru, Chile, Bolivia, and the Argentine. In the districts lying along the upper reaches of the Amazon River, the growing of coca leaves is as common as the cultivation of tobacco is in the United States. The province of Yunga, Bolivia, is the chief producing territory, the output aggregating more than 40,000,000 pounds annually. The production is constantly increasing, and it is believed that the total crop of the South American countries for the past year exceeds 75,000,000 pounds. More than three-fourths of this amount is consumed by the native Indian population.

An Andean Indian will bear up with stoic indifference while misfortune and disaster strip him of his most meager possessions, but never does he permit his supply of coca leaves to become exhausted. He will go to almost any length to prevent such a "calamity." The taking of their

coca with the rising of the sun has become an almost religiously followed practice among these people up on the roof of the world of the southern continent. The firmness with which the coca-chewing habit has practically an entire race in its grip is indicated by the ceremonial activities associated with its use. When the native laborer comes to his work in the morning, it is always at least a quarter of an hour before he is expected to begin his tasks. He picks out a spot upon which the rays of the sun will strike, and squatting on the ground, faces eastward. As the first bright gleams of light burst over the horizon, he extracts his coca pouch from beneath his belt and begins to stow the leaves, one at a time, into the recesses of his left cheek, crowding them in until the side of his face bulges.

About ten o'clock in the morning, the Indian worker generally finds that his supply of coca leaves is losing its strength. At this time he takes a respite from labor to replenish the quid. Then for a period of fifteen minutes the solemn ceremony of the early morning is repeated. Even the North American firms who employ the Indians throughout these regions find it necessary to grant them morning and afternoon recesses in order to renew their supplies of coca. Failure on the part of

the employer to permit this would furnish immediate cause for desertion by his laborers. The use of the drug is not confined entirely to the men. Wherever a number of women are gathered, in the harvest fields or gossiping in groups about their rude dwellings, they crowd together in a circle at regular intervals, and chatting all the while go through the strange ceremony of feeding the coca leaves into their mouths. Always it is done with the slow, monotonous, leaf-at-a-time motion. They never hurry in this performance.

The raising of coca plants is almost entirely limited to the eastern slopes of the mountains and has come to monopolize vast areas to such an extent that, although the soil and climate are admirably suited to the varied crops, even vegetables which are needed for the food supply are transported on muleback hundreds of miles over the rugged territory.

The coca plant is shrub-like and its small green leaves are stripped from the stalk three or four times a year. The seedlings are started in protected beds and when about one year old are transplanted to troughlike terraces for cultivation. The country everywhere is steep and rugged, so terraces must be constructed on the sidehills to hold back a part of the dashing mountain rain. About two years after being placed in the terraced fields, the first crop of leaves is gathered. These are dried on flagstones in the open air. After thorough curing they are baled in huge primitive presses, banana leaves and burlap being used for covering, and transported by muleback to the seacoast cities from which they are shipped to other parts of South America to be sold among the Indians or to the United States and Europe, where the drug, cocaine, is extracted.

Because of the bulky proportions of the

quid of coca leaves, the cheek of the Andean Indian given to the practice of chewing them assumes a permanent appearance of being swollen. But the effects of continued use of the drug are more deep-seated than this, say observers. While the chewing of the leaf is a habit far less harmful than the use of the refined drug, because of the slow assimilation, in the end the result is the same. The listless eyes and general appearance of stupor common to the natives who are accustomed to the narcotic, plainly mark them as a race of unhappy drug victims. Physical and mental destruction are the unavoidable re-



Among the Indian Laborers, the Continual Wadding of the Cheeks with Coca Leaves Causes Distortion of the Face

sults of years of addiction to the leaves, authorities agree. But all this the Indian ignores. The quid of coca leaves is his strength and his solace. Under its influence the rugged hills of the Andes are smoothed to his tired feet and the biting winds feel soft and pleasant to his sun-beaten cheek. His body-wracking tasks are lightened and his means of existence become bearable as long as he has access to

the leaf which gives him solace and rest.

Travelers who have penetrated to the mountainous fastness of the Andes, report having seen bands of workers, often numbering more than a score, squatting grotesquely on a wind-swept mountain side, solemnly stoking coca leaves into their cheeks and awaiting the reaction of the crude drug they contain. When the influence of the drug has taken effect they resume their tasks until its powers wear out.

With a system of education that will appeal to the worker, it is hoped by those interested in the movement to reduce production of the drug, not only to suppress the general sale of the leaves but to substitute other crops that are more needed by the thousands of languid, and often totally ignorant, natives, who live under the evil spell of the "snow" curse.

Build into ancient Spanish Catholic Church at La Pena Luzon, P.I.

POPULAR MECHANICS
CENTURY OF MUSIC SUPPLIED
BY BAMBOO ORGAN PIPES

4106

Constructed of 120 pipes of native bamboo, an organ in the Philippine Islands has furnished music for more than 100

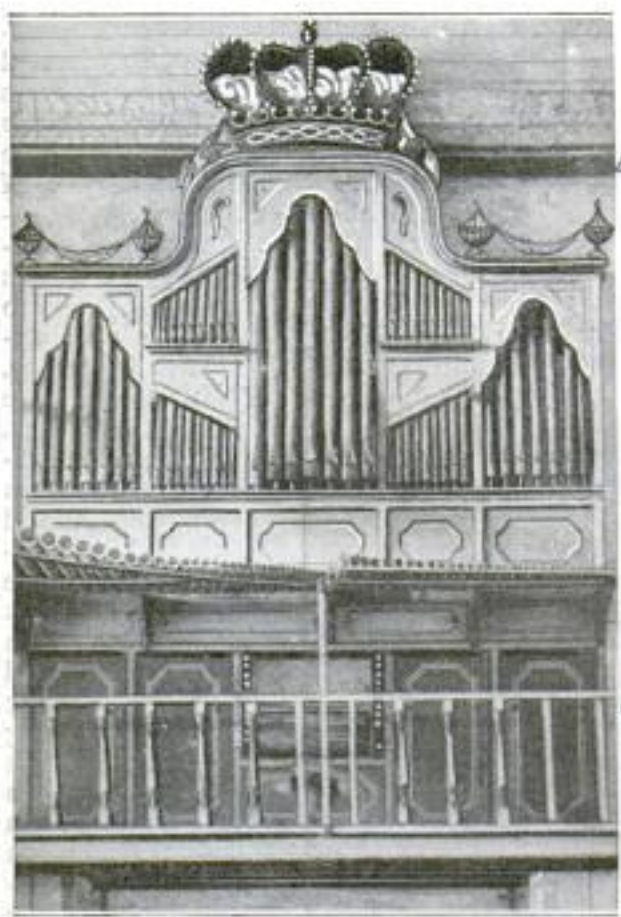

Bamboo Pipe Organ Played in Philippine Island Church for More than a Century

years. The hollow reeds, of various heights and diameters to produce the proper pitch, had been so thoroughly dried, polished and seasoned in the making of the instrument that they have not been damaged by the tropical climate and have resisted the ravages of wood-devouring insects. The organ is said to have a mellow tone of pleasing quality.

Indianaapolis News 11/3/23 4192

SOFT-COAL SMOKE COSTS CITY MILLIONS EVERY YEAR

Smoke clouds pouring from Chicago's locomotives, its 300,000 flats and large apartment buildings, and its 20,000 industrial chimneys, as the annual coal pile of 30,000,000 tons is consumed, has grown greater in recent years. It is estimated that the damage done by smoke to fabrics and the added cost of laundering amount approximately to \$8 per capita, and the loss in fuel, due to improper stoking and

poorly constructed furnaces, is placed at \$7,500,000 each year. More than 43 per cent of the smoke comes from the 1,800 locomotives in daily service within the city, according to official investigation, so that the contemplated electrification of the railway lines, when completed, will reduce the smoke nuisance nearly one-half.

AIR SPEED-RECORD LIMIT OFFICIALLY FIXED

4136

Believing that the maximum speed in the air which is possible without grave risk to human life has been attained, officials of the bureau of naval aeronautics have prohibited, for the time being, further official contests between fliers, it was announced recently. The action was taken after an aviator had two narrow escapes from death while shattering a world's record at an eastern field recently. An average of 266.6 miles an hour was maintained by one flier over a 3-kilometer course, and another reached the highest speed ever attained by man, doing part of the distance at the rate of 274.2 miles an hour.

Chicago Daily News 11/5/23

WHEEL ON SHEAR SHARPENER MOVES VISE, TURNS STONE

By the turning of a handwheel on a shear sharpener recently put on the market, scissors placed on the machine for dressing are passed over a revolving grindstone while held by a moving vise. Any bevel desired may be produced on the cutting edges by adjusting a set screw. The sharpener is strongly built and is of

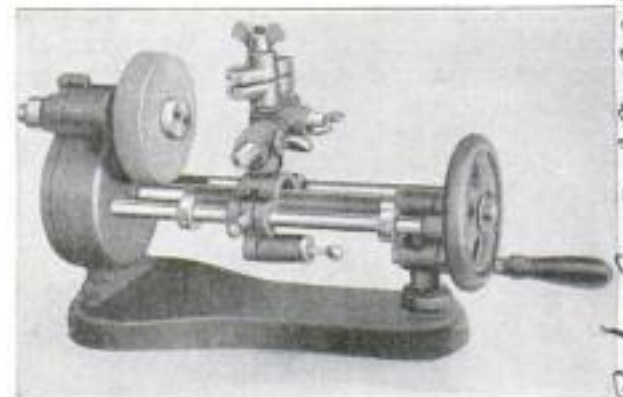

Scissor Sharpener with Vise and Handwheel that Moves Tool across Revolving Grindstone

special advantage to cloth cutters and barbers. It is said to give a perfectly even edge to the tool and to have no delicate parts.

Progressive Machine Co., 835 N. Clark, Chicago Price, \$25.00

Pat. Aug. 29, 1922. June 17, 1921. D.W.S.A. Hendell

BURGLAR INSURANCE RATE CUT BY DOG AS A WATCHMAN

Lower burglar insurance rates for persons keeping a dog, have been announced by one company. It does not matter whether it is a toy poodle, a ferocious English bull, or just a plain yellow cur. This is said to be the first recognition of the kind of the efficiency of animals as guardians of property.

AMOUNT OF LUMBER IN TREE IS MEASURED BEFORE FELLING

While a tree still stands in its forest home the number of board feet of lumber it contains can be measured with a fair degree of accuracy by an instrument recently



Accurate Tripod Scale for Measuring Board Feet of Lumber Before the Tree Is Felled

patented. A great saving of time results, as well as a reduction in the number of workers required to survey a timber tract since one man can rapidly and accurately perform work formerly requiring the services of twelve.

Werner, 3308 Loos St., Hartford, Wis.

SIX-FOOT WARSHIP HAS GUNS, RADIO AND ENGINES

Complete from wireless aerials to keel, a miniature battleship has been con-

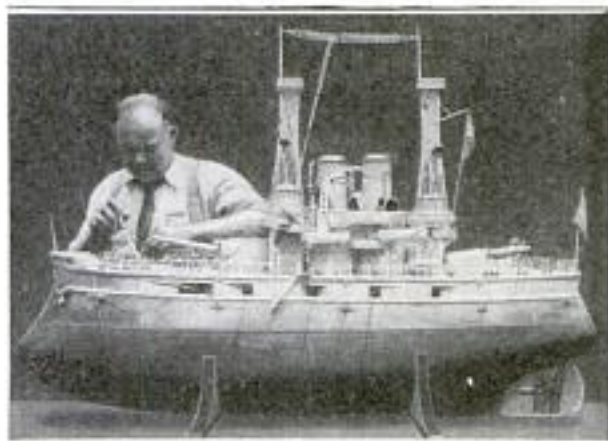

Model Battleship that Can Fire Broadside in Any Direction and Has Radio Equipment

structed by an inventor in New Jersey. The vessel weighs 500 pounds, is 5 feet 9 inches in length, and can float and fight. Operated by a series of levers, the craft can be set to start or stop at any time, and the guns can be adjusted to fire in any direction. The ordnance equipment consists of five pieces to each broadside, one machine gun and two anti-aircraft howitzers giving the ship a firing capacity of 120 shots per minute.

PASTE FOR MANY USES STICKS LIKE CEMENT OR GLUE

Adhesive qualities of the strongest glue, cement, or mucilage, are said to be combined in a transparent paste being manufactured by a western man. It will securely bind together a wide variety of materials such as glass or stone to wood, the maker asserts, but will not stick to the fingers. It is contained in a tube, and because of its transparency is especially adapted for pasting together torn book or newspaper pages. It will hold firmly to varnished woods or polished metals, leather, and various fabrics, it is claimed, and dries quickly. It is said also to contain medicinal ingredients beneficial to the skin.



Build. Equip.

Insurance Co. - including agents. Hosted by me & Dick

Build by George Novells, 654 Second Av., Elizabeth, N.J.

John J. Harris & Co., Mfg. Co. 4035 W. Chicago

4175

3888

4213

4127 Shaped to fit snugly into a theater chair, a raised seat for children has been constructed, enabling the child to look at the



From this Seat Placed in the Theater Chair Children Can See the Show

performance without standing up or climbing upon its mother's lap. The front side of the lower frame is extended so that it provides a foot rest, and the top is wide enough to allow the small occupant to curl up when reclining. The contrivance is easily adjusted or removed by an usher and does not mar the theater seat.

AUTO INVENTORS' TESTS KEEP GOVERNMENT EXPERTS BUSY

Hidden away from the owners of automobiles, there are thousands of men who are working for them—seeking to make their cars give more miles per gallon, to take the bumps out of the road, to make tires wear longer, and to improve the motors. The inventors' efforts keep a staff of government testers busy. First, probably, the device is tried out on a neighbor's car. Then a model is shipped to the staff of engineers in Washington, who read the careful instructions sent by the inventor and put it through its paces. "Gas savers," carbon removers, shock absorbers are received by the score. During the war, enemy aviators learned the trick of shooting holes in airplane gasoline tanks. An inventor got the idea that the

4255
 New York Times
 11/10/23

Laboratory, Automobile
 Power Plant Station,
 Bureau of Standards
 Washington, D.C.

fires and kindred disastrous results could be prevented by solidifying the fuel. His plan was to introduce albumin into the fuel and subject it to a whipping process, as the housewife whips cream. The fuel was prepared and the scheme tested. The engine ran for a few minutes, gasped, choked, and stalled. It refused to start again. Upon being dismantled, it was found to have foundered upon fried eggs. The heat of the motor had coagulated the albuminous substance which the inventor had brought with him and proved, without further chemical analysis, that it was indeed the white of eggs.

CANADA'S FOREST ACRES GROW HALF OF BRITISH TIMBER

4188 Representing approximately one-half of the timber resources of the British Empire, the Canadian forests supply lumber, wood pulp, news-print and other kinds of paper to all parts of the world. At a recent forestry conference in Canada, it was stated that there are about 500,000,000 acres of forest land in the Dominion, many parts of which have not yet been touched by commercial exploitation. The value of the annual timber production is placed at \$600,000,000.

DISH DRAINER IS REMOVABLE TO MAKE CLEANING EASY

4246 Equipped with a plate rack and a cutlery holder, both of which can be removed from the round frame of wire mesh, a newly invented dish drainer is recom-

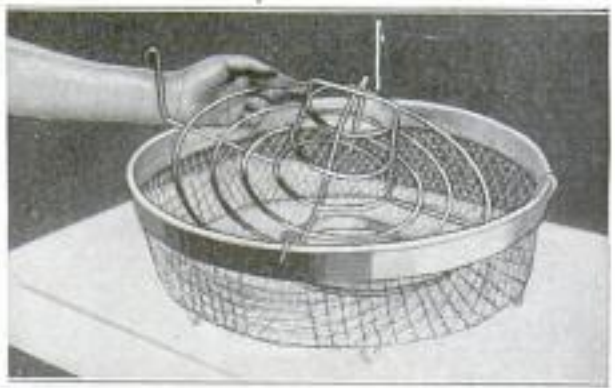

Dish Drainer that Can Be Easily Taken Apart After Using and Readily Cleansed

mended as being more easily cleansed than the older designs. It is made of aluminum, is light and compact, and has no rough wire ends to injure the hands.

Recent soundings place the greatest depth of the Mediterranean at 14,436 feet.

Utility Mfg. Co.
 Lancaster & Sherrill
 Baltimore, Md.

*Dr. Virgil Miller,
Cameras
Universal City*

POPULAR MECHANICS
NIGHT SCENES FOR MOVIES
TAKEN IN SUNLIGHT *4151*

Trick motion-picture photography has received an aid in a "panchromatic filter," recently perfected in California. The new invention consists of a series of glass filters which reverse the rays as they enter the camera and break up the light, similar to the action of a prism. When the screen is applied, strange effects take place. Sunshine is changed on the film into moonlight; red, which usually photographs black, comes out as white, and blue tends toward black. The sky takes on dark shadows without distortion of objects in the foreground, thus producing an appearance of moonlight.

MOTOR SCRUBBRUSH SAVES TIME AND LABOR *4133*

Designed for scrubbing the floors of large offices and halls, a self-propelled machine has been invented which is said to do the work of ten men. A row of brushes attached to a revolving frame whirls at high speed over the floor surface as the apparatus, running on two wheels geared to an inclosed electric motor, advances. Water and powdered soap, held in containers on the frame, are distributed in the path of the brushes as they rotate.

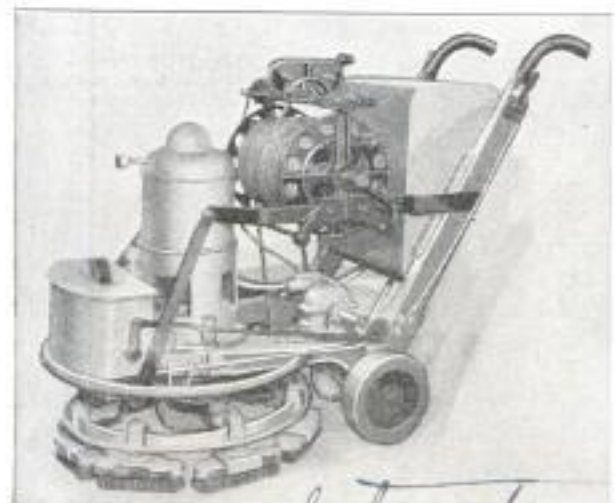

Electric Scrubbing Machine with Brushes, Soap, and Water Tanks for Scouring Floors

Power is supplied through a small cable which may be attached into a wall or lamp socket. It winds on a revolving drum as the machine moves. A path thirty inches wide is scoured at a speed of about 150 feet a minute. One man is required to operate it and another follows to mop up. The wheels have broad rubber tires to protect polished floors.

*Mr. S. K. Vail & Co.,
6582 Sheridan Road,
Chicago*

FOUR HANDS NEEDED TO GUIDE MONSTER FOUNTAIN PEN *4231*

Complete in every detail and carefully fashioned after one of ordinary size, an



Pacific & Atlantic
Writing Invitations with Fountain Pen so Large that It Took Four Hands to Guide It

enormous fountain pen was used to write public invitations to an eastern advertising show recently. Two young women were required to guide the utensil, which later was displayed as the central figure in one of the exhibits. The mechanism and the ornamental designs on the barrel were accurately modeled.

SHIP A DAY IS WRECK TOLL FOR THE PAST YEAR *4184*

Sea craft including 350 steamships and 144 sailing vessels were lost last year, not counting those under 100 tons burden, according to official information. Thirty-four were abandoned at sea; 105 foundered; 43 were posted as missing; 55 were burned; collisions accounted for 25; 214 were wrecked, and 18 were destroyed in various ways. This includes ships of all nations. In British shipping alone, more than 1,000 sailors and fishermen are lost every year, and several thousands are injured. In spite of all improvements in construction and navigation, seafaring remains one of the dangerous callings.

☐ Bubonic plague killed off one-fourth of the world's population in 1348.

*Com. F. Christie, 356
Union Station, Winnipeg, Canada*

Not in C.M. 1. 8. 8/13/35.

Boston Manufacturers Mutual

254

3970

POPULAR MECHANICS

Life Insurance Co.

185 Franklin St. Boston, Mass



Area of Land Ravaged Yearly by Forest Fires Could be Represented by a Strip of Ground One Mile Wide and Extending from Chicago to Atlanta, Georgia

Photo Courtesy American Lumberman

Pictorial Press Bureau.
145 W. 41 st N.Y.
255

POPULAR MECHANICS

3970

NATION'S MOUNTING FIRE LOSS CUT BY SAFETY MEASURES

With the nation's fire loss for 1921, as shown by insurance-company reports, placed at \$495,406,012—a sum equal to more than half the annual interest on the public debt of the United States, enough to run the navy and the legislative departments of the government for twelve months, or nearly twice the amount disbursed in pensions that year—the importance of safety measures and devices for putting out fires before they have gained a dangerous headway is growing. Insurance reports show in the last few years that of 28,814 fires recorded all over the country, 19,008 were extinguished by automatic means, with relatively slight damage, before fire-fighting apparatus arrived.

A single eastern insurance company states that losses paid by it have decreased from more than 25 cents on each \$100 of insurance, written during a period when practically no precautionary devices were installed in the plants of the insured, to about four cents on each \$100 since adequate protection has been obtained.

MOVIE TITLES GIVEN A VOICE WITH TALKING MACHINE

With the aid of an attachment for motion-picture projectors recently demonstrated in Europe, the "movies" may cease to be known as the "silent drama." The device consists of a talking machine that

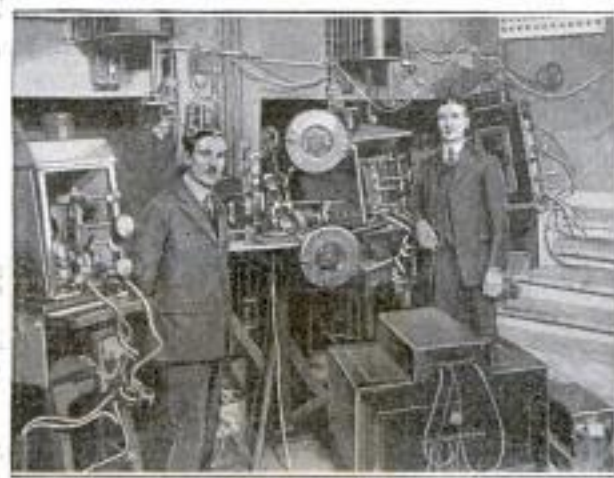

Motion-Picture Machine that Reproduces Voices of Characters as Film Is Run Off

can be timed to the movement of the film with such perfection, it is said, that the speeches appear to come from the characters on the screen. As the reels are run the lines of the play can be so reproduced as to do away with the titles and leads.

Inventors—two Danish engineers
Axel Petersen + Arnold Poulsen,
Copenhagen, Denmark.

GRAINS OF DUST ARE COUNTED BY GOVERNMENT EXPERT

To determine how much dust the average individual breathes, the government has detailed a weather-bureau expert to make an actual count of the particles in



Instrument Used by the Government to Determine Number of Grains of Dust in the Air

the air at the top of one of the buildings in Washington. Every day for the past year the test has continued. The grains are collected in a machine and then counted under a microscope, some being so small that they can scarcely be distinguished under the lens.

TRADE WINDS TO RID SAMOA OF MOSQUITOES

Experiments conducted by medical authorities in Panama and Cuba proved that the mosquito, unless blown by the wind, travels only a few hundred yards. Acting upon this knowledge, scientists purpose to clear Samoa of underbrush and give the trade winds a clear sweep, hoping that the insects will be blown out to sea. The infection which follows the bite of the pest in that archipelago lowers vitality and subjects the inhabitants to diseases which normally would be thrown off. It is believed that two years will be required to complete the undertaking.

Scholars estimate that at the end of the present century the population of the United States will be between 175,000,000 and 200,000,000.

Chicago Tribune 11/27/27
Copyrighted material

Danis
Chicago
COPY
une Re
speaki
for Ne
geles

Medical Supply Association
 256 **POPULAR MECHANICS**
London, England.
ELECTRIC DEVICE TO CLEAR FOG FROM SKIES IN LONDON

419 Seeking to eliminate the dense fogs which sometimes hang for days over London, English scientists are experimenting with an electric machine designed to attract the

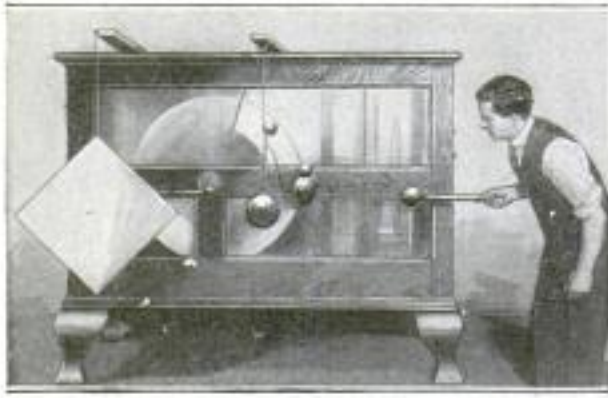

Copyright, Kerstone View Co.
Static Electricity Condenses Fog Particles When Plates in This Cabinet Revolve Rapidly

floating particles of moisture from the air and condense them into water. The invention consists of a cabinet in which sixteen glass plates, side by side, are made to revolve at high speed. Static electricity is generated in this manner and communicated to adjustable brass balls on the outside. A resulting discharge attracts the fog globules, and as they reach the cabinet they are condensed upon a metal plate and run off in small drops. It is thought that a large number of these machines operating throughout the city on misty days may clear the atmosphere in a short time and also be of use in the harbor.

MOUNTAIN OF BURNING COAL IS NATURE'S CRUCIBLE

Belching smoke and fire from the caverns and gorges that pierce its sides and summit, a huge mountain of burning coal, in Central Asia, has formed a natural laboratory which manufactures many chemicals. As early as the fifth century, Chinese travelers recorded their visits to the peak, the vapors of which can be seen for twenty-five miles. A peculiar mud, dark in color, oozes from the openings in the heights. People collecting the product are forced to wear shoes with wooden soles, as leather would be burned through. Po Shan, or, to give it its English name, White Mountain, so called from the deposits of alum on its sides, is not an active volcano. It is part of a great coal range which has been burning for hundreds of years.

CITY GIVES HOTEL FOR DUCKS AND SUPPLIES PROTECTION

4241 On the first of every October a western city of more than a quarter of a million inhabitants opens its doors to more than a million wild ducks and spreads a table for them, which is never empty until the last migrating duck has started northward at the beginning of March the following year. Oakland, Calif., is the city, and it has been able to establish and maintain this hotel for ducks because it has a salt-water pool of large size—Lake Merritt—in its midst, where the tides maintain a fresh supply of sea water in the lake at all times. As soon as the first ducks arrive, the gardeners spread for them all the wheat and cracked corn they can eat. This area has been fenced off with a tight woven-wire fence to keep the public out, and there, for the ensuing five or five and a half months, the birds are fed every day. Shooting is not allowed, and the fowl are guarded by a special patrol of policemen, who see to it that they are never disturbed. They become so accustomed to human beings that they walk among the spectators standing outside the feeding-ground fence. Hunters are as much interested in this municipal hotel for wild ducks as are students of ornithology, the tourists, and the humane society.

4206 **FELT PAD FIXED TO SQUEEGEE HOLDS CHEMICAL CLEANER**

Windows may be cleaned with less effort than is usually required by means of a squeegee that has a felt pad containing



Squeegee with Absorbent Felt Pad Containing Chemical that Loosens Dirt on Window Panes

a chemical, fastened close to the rubber scraper. As the tool passes over the glass pane, the pad, which absorbs water, moistens and loosens the dirt. The scraping strip easily clears it from the surface.

ⓄThe world spends \$200,000,000 a year for matches, seven for each person being the average daily consumption.

Emb. N. Tourneur, Thunderley, Strathely, Eng. 4063

International Squeegies Co. Seattle, Wash. 620 Polam Bldg.



Rising from the Water where They Rest, a Flock of Protected Wild Ducks Became Lively Background for an Outdoor Pageant



Feeding Time Brings Clouds of Migrating Fowls to Peaceful Neighborhoods where no Enemy Lurks to Rob Them of Life or Freedom

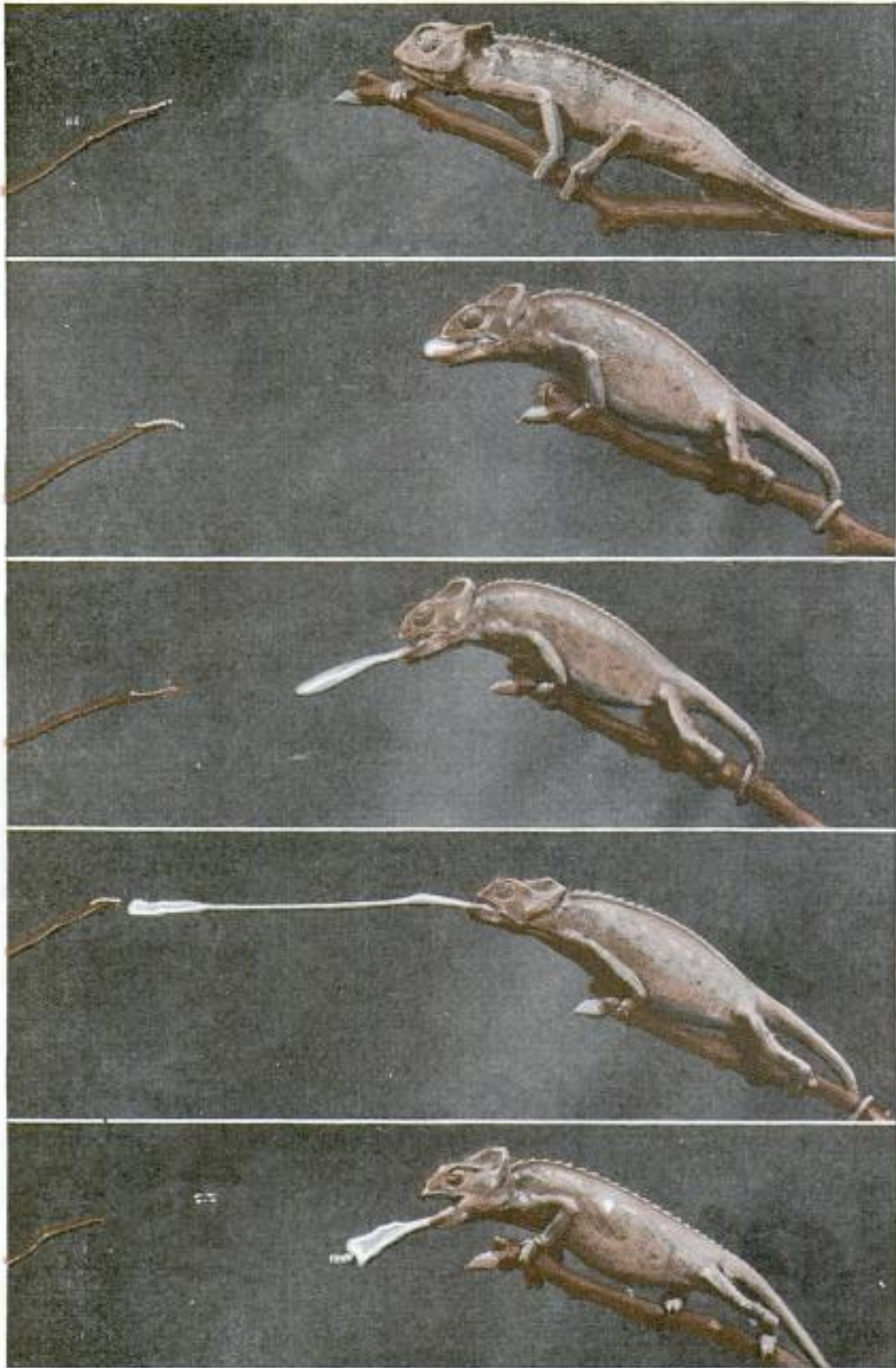

Slow-Speed-Camera Pictures of Chameleon Capturing a Worm with Its Long, Flexible Tongue, the Sticky Secretion Holding the Captive Until It Is Devoured by the Reptile

**REPTILE TOO QUICK FOR EYE
"SLOWED UP" BY CAMERA**

By attaining an extraordinary development, the tongue of the chameleon has become the only means of procuring the creature's food. This peculiar organ is long and club-shaped and is covered with a sticky secretion that holds to anything it touches. At rest, it telescopes and folds into the base, which is its narrowest part. In action it shoots out like a flash, often a distance of six inches, to seize upon insects, which make up the chameleon's diet. The ordinary-size lizard of this species can easily capture and devour a large moth within a fraction of a second. In most cases the reptile supports itself by wrapping its tail around a twig while it reaches out for the "shot" at its prey. So quickly does the movement take place that the unaided eye cannot follow it. However, a slow-speed camera was used to show the performance as one of the animals was foraging for food.

**GLASS PANELS REPLACE GLOBE
ON LAMPS FOR STREETS**

Modeled after the lanterns of Colonial days, street lamps, which are said to give 30 per cent more light at half the cost of



other similar types, are being installed in a large mid-western city. Only five of the new lights are needed to a block, it is claimed, whereas nine of some of the older varieties were required. Panels of glass replace the ordinary globes now used and are cheaper and easier to repair. Building fronts, it is said, can be lighted much better by the lantern-type lamps, which also save 10 per cent in wattage. Their simple shape makes them attractive, and they are easily cleaned. They are also adjustable to a hanging fixture as well as to posts.

More than one-third of the world's production of turpentine is consumed in this country.

**HOIST RAISES FIFTY TIMES
WEIGHT OF OPERATOR**

Interlocking cog teeth in the lifting block of a newly-invented hoisting device enable the operator to raise more than

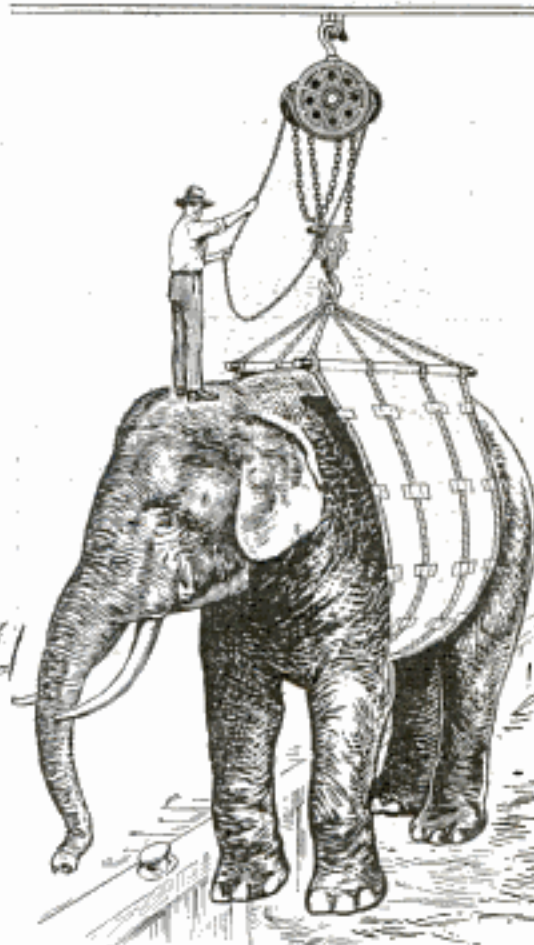

Aided by Cog-Wheel Hoisting Block, One Man Lifted an Elephant Aboard Ship

fifty times his own weight with ease. The mechanism is so constructed that there is no strain on the hands, the stress being absorbed by the parts of the apparatus engaged in the interlock.

**GAS POISONS ROOTS OF TREES,
ELECTRICITY NOT HARMFUL**

Illuminating gas from faulty pipes may poison the roots of trees, but ordinary electric currents never injure their vitality, according to a forester who recently made an investigation of the subject. He declared that the only test for gas was its odor. Boring a hole with a crowbar or an auger about two feet from the street and two or three feet deep, will disclose its presence. Power wires, if badly placed, cause only a cutting or local burning. If no other cause for decay is known, gas may be suspected.

*The Chisholm Moore Mfg. Co.,
Lakewood Av., Cleveland, Ohio.*

General Electric Co., Chicago

New York Times
Copyrighted material

Used by Iowa City Rapid
 4246 Transit Co. Minneapolis, Minn.
 NOISELESS TROLLEY CAR RIDES LIKE AUTOMOBILE

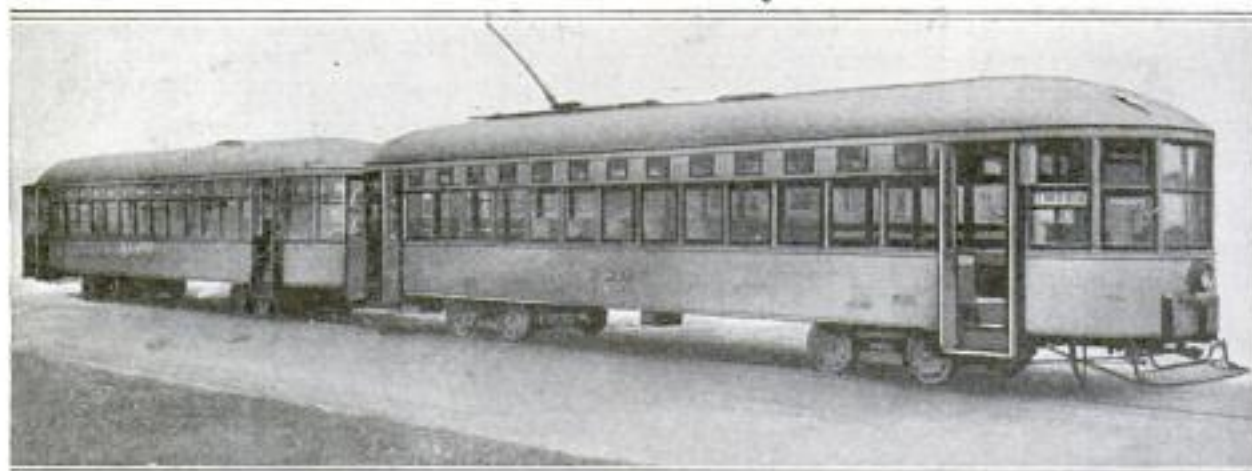

Trolley Cars in which the Usual Roar and Grind Has Been Eliminated by the Use of Automobile Brakes Instead of the Ordinary Iron Ones, and Roller Bearings

With band brakes of the automobile type, and roller bearings, and weighing several thousand pounds less than the average, a street car that is practically noiseless is now being used in a western city. Instead of the customary grinding and roaring sounds, the car is said to make only a musical whirring as it passes over the rails. Several innovations in construction have been used. Among these are wood-inclosed steel frames, double floors

insulated against sound, a special arrangement of the springs, and, particularly, the lightness of the car, which weighs only 25,000 pounds. The brakes are controlled with the usual air cylinders. There are four 24-horsepower motors to each car, and the doors are opened and closed by electricity. It may be operated by one or two men or run in trains of two with three men. It has seats for 50 passengers and a maximum capacity of 150.

SHELF ON HANDLE OF DRAWER IS AID IN FILING PAPERS

Attachable to the handle of a cabinet drawer, a light, portable shelf has been devised for holding within easy reach papers to be filed or removed. A wire bracket fits easily over the grip and the baseboard sets squarely against the drawer.



PHONE IN VALLEY OF KINGS LINKS TOMBS TO WORLD

Already disturbed by the diggings of scientists and trodden by the feet of thousands or inquisitive sightseers, the Valley of Kings, near Luxor, Egypt, is to be further modernized by the installation of a telephone. Connecting the city with the quarters established where explorations are in progress, a line is being built through the valley by the Egyptian government. At the time the late Carnarvon and his party made their important discoveries there, only the centuries-old paths led through that region.

SLICING BOARD IN BREAD BOX SAVES CRUMBS AND LABOR

Designed to eliminate waste by saving bread crumbs as well as labor, a cabinet with a slicing board that folds into it is on the market. The device consists of a box, which can hold several loaves, a rack, board, tray, and knife, all in one compact utensil. The lid opens downward, bring-



Labor-Saving Bread Box with Slicing Board and Crumb Receptacle in the Lid

ing the board into a position handy for cutting bread, and the crumbs can be brushed into a compartment provided to receive them.

4225
 Stationery Store

Order's

Foreign countries only
 in large wholesale orders

Indianapolis News
 11/7/23

The Republic Metalware
 Co., Republic + Alabama
 Buff. Ind. ref

**FOUR-POUND MOVIE CAMERA'S
FILMS ARE FIREPROOF**

4252

Suitable for taking short runs of film for home display, motion picture cameras and projectors of simple construction are now being manufactured which are said to produce the images with the steadiness and clearness of the larger apparatus. They are especially adapted to vacation trips, as lengths of film may be joined together forming an "album" of family scenes. The camera weighs only four pounds. Light for the projector is supplied from an ordinary lamp socket, and there is said to be no danger of fire. The film may be halted at any time for a "still" without damaging the reel. The mechanism is simply operated and shows the pictures without flickering.

**SPOTLIGHT IS TURNED BY ROD
AND HAS EXTENSION CORD**

4202

So that it can be adjusted easily from the inside of a closed car without opening doors or windows, a spotlight that can be raised or lowered by a turn of a brass knob has been designed for the convenience of motorists. Held firmly by a bracket, the light is turned by a small rod which ends near the driver's hand. Below the reflector is a chamber in which a 12-foot extension cord, attached to a spring reel, is carried so that the lamp may

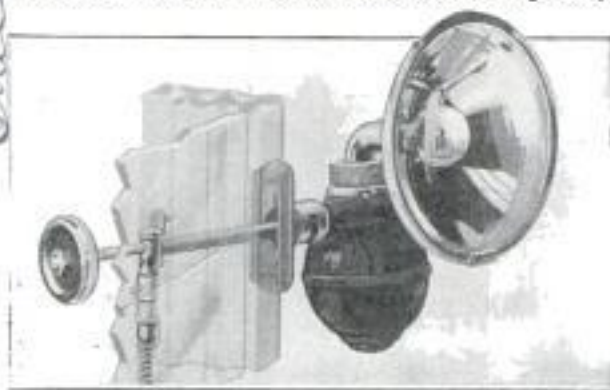

Spotlight Adjusted by Rod that Extends Inside Car Conveniently Close to Driver's Hand

be removed and taken about the car in making repairs. It also is adjustable to a tree or a table, to provide a convenient light for campers.

Decomposition caused by contact of the cream with metallic surfaces in the churn produces an iron lactate that causes the "fishy" taste frequently detected in butter, government experts have discovered.

**SHAPE OF LINER'S STERN WINS
CARGOES IN ORIENT**

4129

Believing that a certain ocean liner is more seaworthy than other ships because its straight, flat stern is like that of a



Triangular-Shaped Stern of Steamer that Is Favored by Superstitious Oriental Sailors

sampan, a form of skiff used for centuries on the coasts of China and Japan, some merchants of those countries endeavor to have their shipments carried on that steamer. The sturdiness of the small boats has become a tradition among the Orientals, and the likeness of the liner to the ancient-fashioned craft gives it preference over more modern boats and secures for it full cargoes. This odd belief is characteristic of the superstitions that sway the native sailors who believe that they are pursued by good and evil spirits all during their lives.

**GIANT TELESCOPE TO BE SET
ON TOP PEAK IN ALPS**

4139

Construction on what is expected to be the world's largest astronomical observatory, is soon to be started on top of Mount Saleve, in Savoy, between Mont Blanc and the Jura Alps, according to recent reports from France. The work is to cost more than \$6,000,000, and will require five years for completion. The station will have a telescope nearly four feet in diameter, considerably larger than the instrument at Mount Wilson, Cal., and a powerful radio apparatus will link the observers to the outside world. The location was chosen because of the clear atmosphere at the summit of the peak, which is 4,300 feet above sea level.

*Phila delphia
Public Ledger
2/22/23*
Copyrighted material

Appleton Electric Co., 1701 Wellington Ave
Chicago

3829

Cml. Earley W. Leage,
Asheville, N.C.

Sacking Grain Seeds which Were Carefully Selected and Graded as They Passed from the Thresher

World's Crops Seen in Tons of Seed

MORE than 7,000,000 tons of seed are produced each year on the farms of the world to supply the growers during the planting seasons. The greater portion of this is American grown. No account of the thousands of tons of potatoes, sugar cane, and other bulky stocks seeded annually, is taken in this compilation.

A few years ago the major part of the

seed required for farm and garden was grown in Europe, and only since recently have our gardeners been independent of foreign producers. At present, this arm of our agriculture is of vast proportions, encompassing every state in the union. Today the United States has the world's largest commercial seed-growing industry.

Climate and soil make the state of Cali-



Remarkable Crops of Clover Grown on Seed Farms where Stems often Attain Half the Height of a Man



Tons of Seed Are Harvested Each Year and Sent All Over the World to Await the Planting Seasons

fornia a leader in the modern seed world. Whereas, a decade ago there were but scattered and small areas devoted to experimental growing in that state, the present acreage is more than 20,000 acres given over to such seed crops as carrot, onion, lettuce, radish, spinach, tomato, and cabbage. These seeds are grown in a maximum of sunshine and matured without rain, and in the majority of cases without the aid of irrigation. The sunshine of the harvest season in that region permits natural drying in an atmosphere free from

dampness. Thus, seedsmen are saved the enormous expense of long curing sheds and miles of barns. There, nature performs the work out of doors.

Sweet-pea and mustard seeds are produced in tremendous quantities and the greater part of America's onion seed and sets are also grown in this section. Onions do well in the delta lands of the valleys, and lettuce and sweet peas thrive best on these deep soils, while radishes demand a lighter ground.

Great seed-cleaning machines have been



Gardeners Base Their Yearly Success or Failure on the Grades of Seeds Produced on Farms for Growers

developed, which handle each harvest season, tons of tiny tomato, pepper, cucumber, eggplant, lima bean, and other varieties of seeds. One ton of tomatoes produces only eight pounds of seed, so that it takes more than 9,000 tons of the fruit to give 75,000 pounds of clean seed. Approximately four billions of seeds are gathered every year on one farm alone, just to provide plants for the seed fields.

Tomatoes are picked into buckets which are emptied into water-tight wagons. Passing into the grinding machinery, sharp knives reduce the fruit to a pulp which is poured into barrels. Around the seed at this time is a "pulp sack" so slippery that one can scarcely hold the little globes between the fingers. In order to dissolve this coat, the pulp is allowed to remain in

the tanks for about 24 hours to ferment. Then the mass is put into long flumes of running water, which carries away the pulp, leaving the seed at the bottom. The dry seed is graded by passing over screens, and is then packed for market.

Celery seed is one of the most difficult of all to produce. France is the principal source of the choice varieties of this plant, yet seed growers of this country have made a specialty of that crop, which is exceedingly profitable. It takes months to complete the cycle of celery seed.

Of the large species of different flower seeds produced in commercial quantities, the sweet pea leads the list and is the most prolific of all. Due to an almost universal demand, the acreage yield is the highest of any seed crop.

4221

DRESS FORM OF PAPER MAKES AN EXACT MODEL



While the Model Waits, a Dress Form Giving Exactly Every Proportion Is Quickly Fashioned on Her Body. The Finished Form Is Shown at the Left

Dress forms which are exact reproductions of a woman's figure are fashioned from strips of gummed paper stuck to an undergarment on the body of the person for whom the dress or suit is to be made. When finished, the form is virtually a "paper cast" of the model, with proportions so accurately shown that garments fitted to it do not often have to be altered when they are tried on. After the strips have been pasted upon the model, the "cast" is cut down the front and back, taken off and sewed together again. A cardboard base is inserted and the armholes and neck finished. Bothersome trips to the dressmaker's are avoided with the use of this

form, or if a woman does her own sewing, she needs no assistance in fitting. The strips are also used in the same way in making children's clothing. The paper model is light, rigid, and is quickly constructed. It is not easily broken or torn and good quality glue on the strips holds them together for a long time.

Ten thousand young oysters produced from eggs artificially fertilized in an incubator were recently planted in Cold Spring Harbor. The lot is said to be the first successfully raised in this way and will be ready for consumption in five years.

Mrs. Liberty Paper Co., 203 Lafayette St. New York
 Chicago Lumber Paper Co., 171 N Dearborn, Chicago

WORLD-FLIGHT PLANES TO HAVE SPECIAL LANDING EQUIPMENT

Pontoon frames for alighting on water and special gears to enable them to land safely on the ground, are features of the United States army planes that will attempt a flight around the world. Routes for the journey have been mapped out. The trip is to be undertaken to test the possibility of international communication by air routes and to gain information on the operation of different types of machines in various climates. The line of travel has been laid out to avoid extreme rainy seasons in several countries and to reach the cold regions in the summer. Each plane will carry two men, and "hops" of nearly 1,000 miles will be made.

STREETS CLEANED BY VACUUM SWEEPER BUILT LIKE "TANK"

Capable of doing the work of twenty men, a "tank-like" motor-driven street-cleaning machine, has been adopted in a



Copyright, Underwood & Underwood
 Vacuum Motor-Driven Street Sweeper that Does the Work of a Score of Men

western city. The broom sweepers with which it is equipped loosen the dirt, which is then sucked up by vacuum and deposited in receptacles in the interior of the steel shell. The apparatus is said to be capable of cleaning 100 blocks of streets a day without stirring up clouds of dust.

HOME-BAKED BRICKS PROVING POPULAR IN ENGLAND

"Home-baked bricks" is the slogan of the tenants of an English peer of the realm. A huge kiln has been erected on his forested estate to serve two purposes; giving employment to the tenantry and furnishing them with an honest product at a reasonable price. The process of brick



Brick Kiln Erected on Peer's Estate to Aid Tenantry in Building Cheaply and Well

baking requires a heat so intense that twenty-four hours must elapse before the kiln can be entered.

TELEPHONE TESTS LIQUIDS

For testing the purity of liquids, French scientists are using a telephone device. Tubes containing samples of mixtures to be tested are linked with an electric circuit so that the current passes through them. As any adulterant changes the resistance, the variation of the sound in the receiver indicates its presence.

Survey H. Holden, Hill Crest Lodge, Tipton View Road, Chesterfield, England.

HANDY GASOLINE LANTERN HAS 4120 PUMP IN BASE

Something new in gasoline lanterns is one, lately introduced, that has a pump in its base which with a few strokes produces an illumination of 300 candlepower. Its handle is always ready for use, and it is claimed that the invention is safe, that it will burn upside down, will not spill oil when upset, and cannot be filled while lighted. The chimney is made of mica, and the fuel tank holds one quart of gasoline, sufficient to provide a light that will burn for sixteen hours.



price \$8.00

Knowledge of coming weather changes shown by birds is attributed to the atmospheric pressure on their nerves.

Read in New York

Send Street & weeping
 machine Co. St.
 141
 Southport and
 1906
 Justice Mfg. Co.
 Chicago
 Allen Mr. H. H. & Chicago

*d. no. James West, 51
Parkton Road
Jamaica Plain Mass.*

266

POPULAR

MECHANICS

4124

**ADJUSTABLE LINE-UP GAUGE
AN AID TO PRINTERS**

For lining up page forms of type to be used on cylinder or job presses, an eastern inventor has perfected a device which

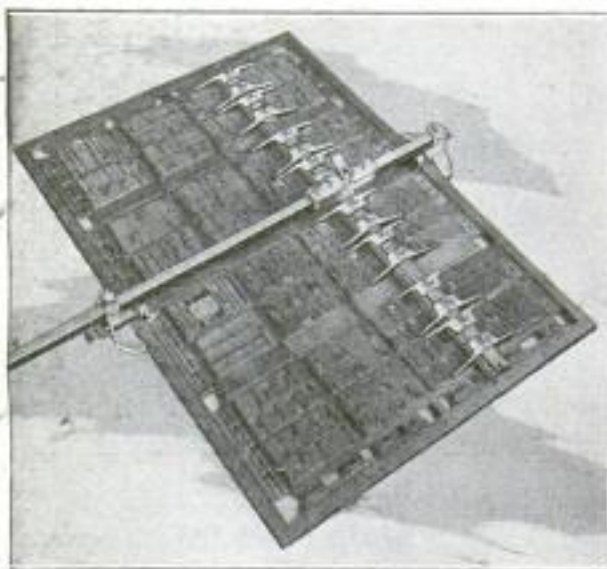

Quickly Adjusted to Any-Size Chase, this Lining Device Saves Printer's Time

may be attached quickly to any size or shape of printer's chase. It consists of a rod fitted by clamps to the exact center of the chase, and supports a ruled crossbar upon which a series of adjustable steel

measuring blades are set at right angles. A locking arrangement holds the crossarm a fraction of an inch above the type and when the instrument has been adjusted to the center, the forms are lined up by sliding the steel "fingers" to the proper spaces indicated on the rule and fastening them in place with set screws. The apparatus is easily detached and weighs only a few pounds.

**ALUMINUM TONGS FOR KITCHEN
HAVE FORKS FOR JAWS**

When taking hot meats from cook pans or picking vegetables from boiling water, housewives can be aided by aluminum tongs that have forks for jaws. Squeezing the handles brings the prongs close together, taking a firm grip on the article being lifted. A steel spring spreads the jaws apart when the pressure stops.



Scientists declare that of the 7,000 known varieties of bacteria, only about 100 kinds are believed to be harmful.

*Roll Patents Corp. Chicago
341 E. Ohio St.*

4155

BED MADE INTO A CHAIR BY ADJUSTABLE MATTRESS

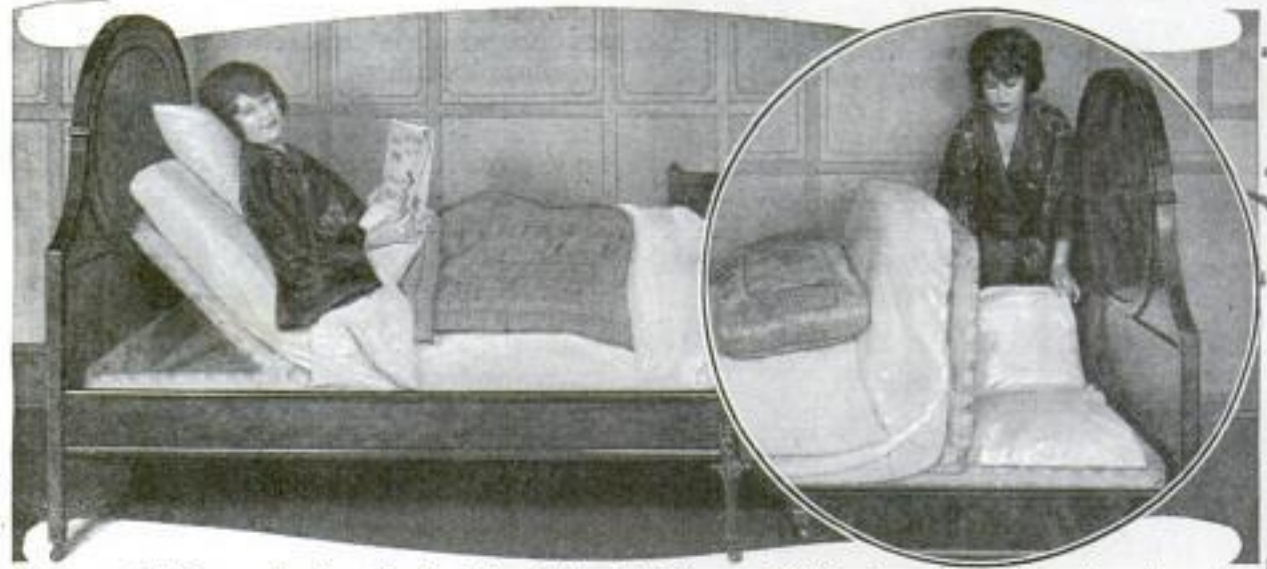

Turning a Bed Into a Comfortable Chair by Raising the Mattress Which, when Down, Conceals a Space for Pillows and Extra Bedding

Adjustable to various angles, so that a person may comfortably read or eat while lying in bed, a hinged section in a box-spring mattress can be raised or

lowered for a back support. Below the movable part, space has been left as a storage chest in which extra pillows or bedding are concealed by the mattress.

Not interested in foreign distribution.



Facing Death in the Wilds of Asia

Noted Explorer Tells of Adventures on Lakes and Rivers in Journey Through the Recesses of Little-Known Continent

By SVEN HEDIN

DURING the thirteen years I passed in the innermost recesses of Asia, I have had many notable adventures on the lakes and rivers of that continent. In the course of a journey in the years 1905 to 1908, and while crossing Tibet, I camped at the northern border of Lake Lighten. This is a very large lake, discovered and named by Captain Welby in 1896. Our situation was perilous. The country is uninhabited and there are few pasture grounds. Therefore the strength of our caravan animals had been declining rapidly, and one morning we found eight of our horses and mules dead on the shore.

I wanted to draw a map of the lake and

sound its depth. For this purpose I had taken along a collapsible boat with mast, sail, oars, and rudder. On the morning of Sept. 21, 1906, the boat was put together, and I went on board accompanied by one of my servants, Rehim Ali. The water level, smooth as a mirror, reflected clearly the well-defined outlines and the ocher-yellow and brick-red colors of the mountain chain, which rose on the southern shore and was crowned with eternal snow fields and blue shining glaciers.

The rest of the caravan, with 100 pack-animals and 25 men, had been ordered to advance along the north shore toward the eastern end, and there in the evening build

Sven Anders Hedin, noted authority on those little-known lands, Tibet, Turkestan, Mongolia, and central Asia in general, has spent a great part of his life—he is now 58 years of age—in exploring these strange lands. These journeys, performed at times amid extraordinary hardships and always at the immediate risk of lingering and terrible death at the hands of savages or by starvation, have won for him high honors and a world-wide reputation and fame. A noted scientist, a daring adventurer, a fluent writer—he is author of numerous valuable and weighty books—Doctor Hedin is an honorary or active member of nearly every scientific society in the world; is a member of the nobility of Sweden, to which he was raised in recognition of his work by the king; is the bearer of honorary degrees from most of the famous universities of the civilized world; is the personal friend of potentates and rulers, and is now on his way to Asia for another daring journey through the wild interior where he has found strange buried cities, grotesque and terrible customs, and where he has several times been forced to travel long distances on foot without water or food.—Editor's Note.



Battling for Life against Terrific Storm on Bottomless Lake in Asia where Wind and Waves Threaten to Send Frail Craft on the Rocks During Night

up a fire which was to guide us in case we did not finish our course before darkness had set in.

My plumbline was 213 feet long, but found no bottom when we reached the center of the lake. Rehim Ali was scared when he saw one knot on the line after the other plunge down and disappear.

"This lake has no bottom," he said, and kept on bestirring himself, so as to reach the southern shore as quickly as possible.

The lake looked like a plate of glass, but we found we had to traverse a greater distance than we had thought. When we finally reached the shore and sprang out to take our frugal meal, the best part of the day was already over. Therefore, we hastened our repast and then went back on board, rowing in an easterly direction, within a short distance from the south shore.

I was looking eastward and devoting all my attention to mapping the outlines of the southern shore. In the meantime Rehim Ali was busy rowing, his eyes turned toward the west. He kept scanning the westerly horizon, without saying a word. Gradually he became uneasy, and at last he whispered, in a voice almost smothered by fright: "There's a storm brewing in the west—it will break in a little while!"

I turned around. The sight was indeed alarming. From the western plain there rolled over the lake dense, yellow clouds, edged in below with dusky stripes. They looked like immense pillows and mattresses, and whirled along with them a deal of dust.

"Had we not better land?" asked my servant.

"No, we go on. You set the mast and

hoist the sail; we are getting fair wind!"

He obeyed and had hardly finished setting up his simple rigging when the first squalls, ushering in the storm, came whistling over the mirrorlike lake, bellied out the sail and whipped up the waters so that they rose in mighty billows within a few minutes, threatening to upset the craft.

The boat, sped on by the sail, flew over the lake like a wild duck. The waves sprayed madly around us; their crests, whitewith foam, parted and were carried hither and thither, gurgling and hissing. I had the ropes well tightened, but so they could be released by a pull of the hand. The sail was filled and expanded by the wind, and I was holding the tiller with a firm grip to keep the boat in the direction of the wind. With breathless speed we swept by one sand-

strewn neck of land after the other. They were surrounded by shallows, and if we had struck upon the bar the boat would have capsized, filled with water and gone down like a stone.

Frantically Rehim Ali ejaculated his prayer: "Jah Allah, jah Allah!" For a while he looked like a hedgehog that rolls itself up for defense, but finally, paralyzed with fright at the spectral billows, he sank down and lay like a corpse.

The storm had now grown to a hurricane; the danger was imminent that the mast might snap off and that I should lose all control over my frail craft. Impenetrable as the gloom was, I had to guard against our being flung on the east shore by the maddened gale, for the reefs would have dashed us to pieces. So I had to keep at the helm and I shouted to Rehim Ali: "Keep a good lookout!" but he heard nothing—he failed to move.

One dreary hour passed after another.

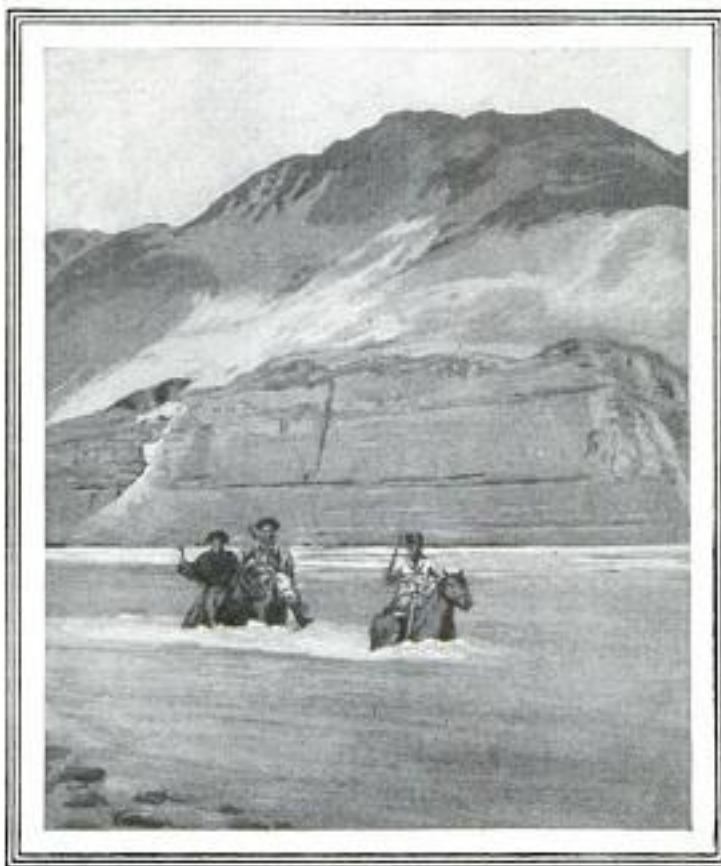

Where Brick-Red Mountains of Asia Are Crowned with Eternal Snow Fields and Glistening Glaciers

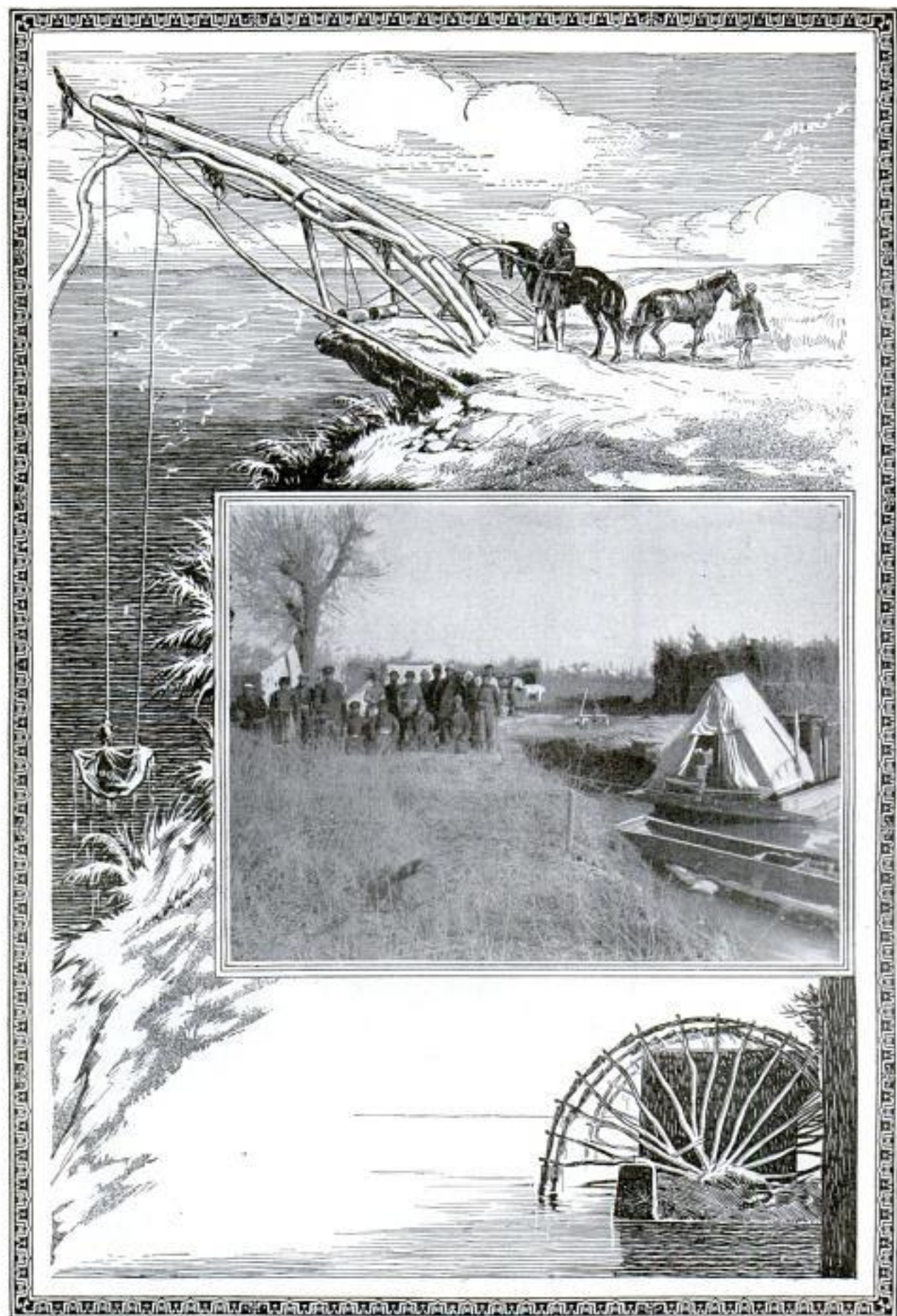

Primitive Devices for Hoisting Water from the Rivers for Irrigation with the Aid of Horses or Oxen that Are Still Used in Asia, and a Party of Explorers



Turkish Ferries
that Are Known
as "Schachtur" and Are Tied
Together to Give Greater Steadiness

What an endless night! But at last in the midst of all the turmoil a heavy sound of a peculiar kind reached my ear, and a few minutes later I discerned the white edges of the breakers beating against the shore.

"The next wave will hurl us on the shore! Jump out and take hold of the boat!" I called to my servant, but the stupor still bound him. So I let go the rope, threw him overboard and jumped out myself on the other side. Now the poor fellow came to his senses, and with united efforts we hauled the boat up at the same moment the returning wave was about to snatch it out again to the open lake.

We had been in the water from the waist down, and the water on our clothes turned to ice. However, we did what we could to overcome the effects of this nerve-racking bath.

Along in the night we saw a glimmer of light in the north. Some of our party, anxious about our long absence, had gone out to search for us, the man who rode ahead carrying a burning torch mounted on a pole. At last we were safe in our warm tent!

Now I come to a journey of quite another kind: six hundred miles down the River Euphrates, on a ferry driving with the current. This was in March, 1916, while the war was raging. I had been invited to Bagdad by my old friend von der Goltz Pasha, who, as the highest connecting link between the German and the Osmani army, had been placed in command of the Sixth Turkish army.

In Aleppo I was invited to accompany, in an automobile, two officers who had

been charged with carrying to Mosul three automobile trucks with benzine tanks, investigating at the same time the land-route over Nisibin to the last-named city.

The Bagdad road had been finished from Aleppo to Ras-el-Ain, and to this point the autos were transported in the train; from there on we made use of the motor cars themselves. The sky was overcast. We passed the nights in our tents in the desert. The farther east we came, the worse we found the road to be.

Outside the village of Bir-dava, south of Mardin, we ran fast in the sand-dunes on March 30 in such a way that there was no chance for us to extricate ourselves. The next night there were heavy downpours. We dug trenches around the tent to keep the water from submerging us. For a whole week, day and night, we lay on our artificial island, imprisoned by the deluge around us. I felt infinitely glad when, on the morning of April 9, I was back in Ras-el-Ain, having left behind me most of my baggage.

Near Jerablus, where the Bagdad road crosses the Euphrates, I alighted from the train and bought two Turkish ferries called "schachtur," which were tied together to give greater steadiness. On the ferry was laid a deck, on which a cabin was built containing my field-bed, a table, and a chair. From the bed-head I could, through a small window, look out on the port-side over the river and the bank. On the starboard side there was also a window, which afforded me a chance to have a sight of the right-hand river bank. The double ferry was 22 feet long and 16 feet wide, with two oarsmen at the front corner and a man at the helm in the stern. I had a crew of three men, Muhamed, Husein, and Kerit, and also a police-soldier.

"Bismillah! In God's name!" sounded the call in the afternoon of April 12, and the ferry was seized by waves of gigantic size and floated down stream. At night-fall we moored our vessel at the right-hand bank and passed our first night on board. The next day we resumed our voyage down the imperial river. I sat at my desk, with the compass and watch before me, and drew a map of the winding Euphrates.

Everything went well until on April 18 we had an adventure which came close to putting an abrupt stop to our advance. We had just passed by the large village of Raka, when the sky became gloomy. The flashes of lightning and the claps of thunder increased; at times we seemed to be wrapped in fire. I had directed the men to fasten an oil-cloth tent on the roof of the cabin with spikes, to make it water-proof. At a spot where the Arabs were busy hauling up the water, we saw them suddenly stop and retire to their primitive homes, driving before them their oxen and horses. They were right in surmising that the windows of heaven would open anon and bestow on them enough of the liquid element to render their efforts superfluous.

The rain, indeed, was brisk. The ferry made its course quietly along the right river-bank. Suddenly the rain stops, the thunder dies away, and for a moment everything is silent. But a moment later the storm breaks out in majestic rage. It was 5:25 p. m. and the 20 minutes which then followed I shall never forget. First

a few heavy drops; then a tropical down-pour, piercing, torrential! The hurricane came across the river with a stunning effect. The ferry stopped instantly in its course and swung aside. The cabin acted as a cave of the winds. Within a few minutes billows, crowned by foam, were rolling in over the rail. The ferry rapidly filled up with water and threatened to drag with itself to the bottom the other ferry whereon stood the cabin.

Because of the tremendous pressure of the storm against the cabin, the ferry on the starboard side was squeezed leeward so violently that the rail came to lay on the water. Even here the billows rushed in. The slightest increase in the pressure and down we should go! In the twinkling of an eye I snatched up maps, books, and instruments, rolled up everything in the rain-cloak, and threw myself in front, to support with all my strength the luff wall of the cabin—for this structure might at any moment be dashed to pieces. The tent cover was pulled loose from its spikes and tossed around in all directions.

But salvation was at hand! Some dark objects became discernible through the vapor. These are the tamarisk trees at the left bank! The ferry touches firm ground; we are rescued at the very moment when we thought all was over, the storm ceasing as rapidly as it had broken out, it having lasted but 21 minutes in all. But we had to stay there for a few days for repairs before continuing our journey.

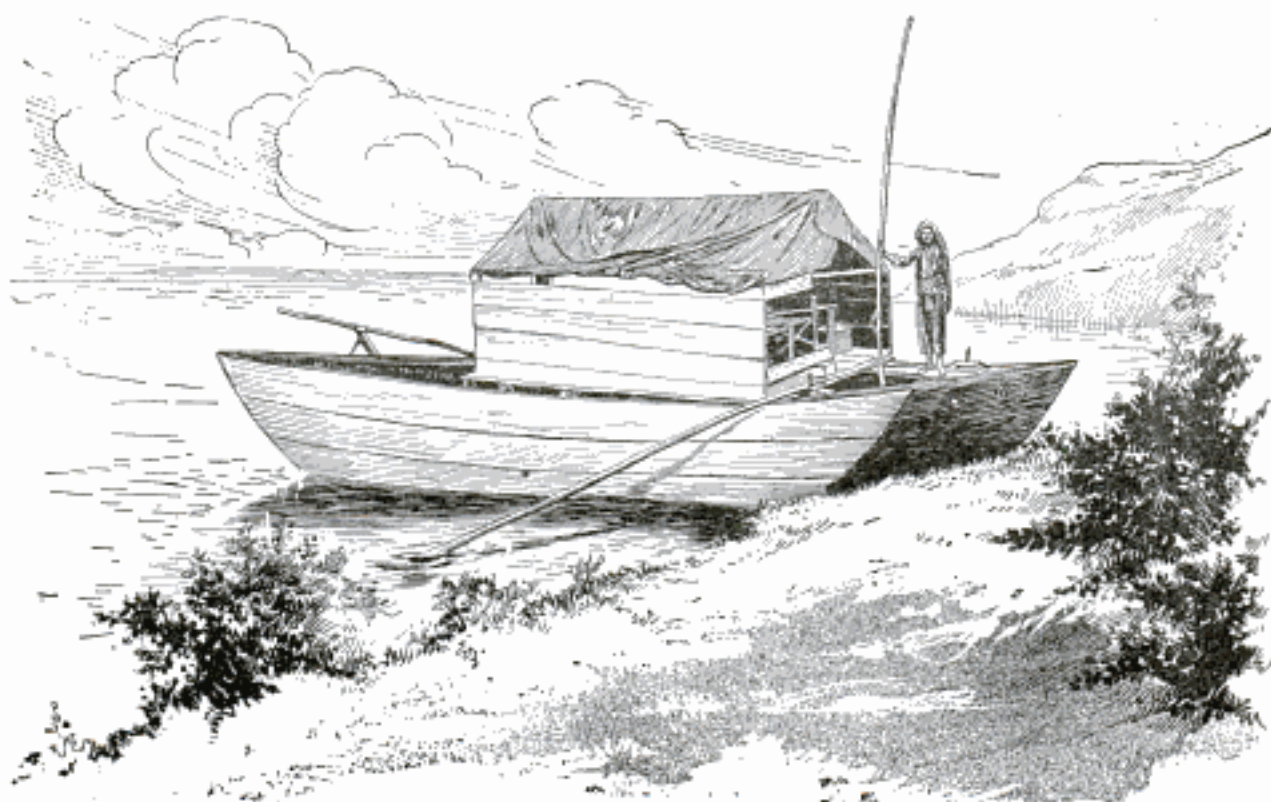

4171
**VESSEL OFF BALANCE
 DEFIES EFFORTS
 TO RIGHT IT**

After passing through rough seas in a severe storm on the Pacific Ocean, a vessel loaded with lumber and dynamite sailed into port recently with a heavy list. The tossing it received during the squall caused the cargo to shift, throwing the great hull off balance. Valiant work of thirty men for two days failed to right the craft, owing to the difficulty of handling the immense piles of timber. The explosive aboard also made the task extremely dangerous because of the cramped space.

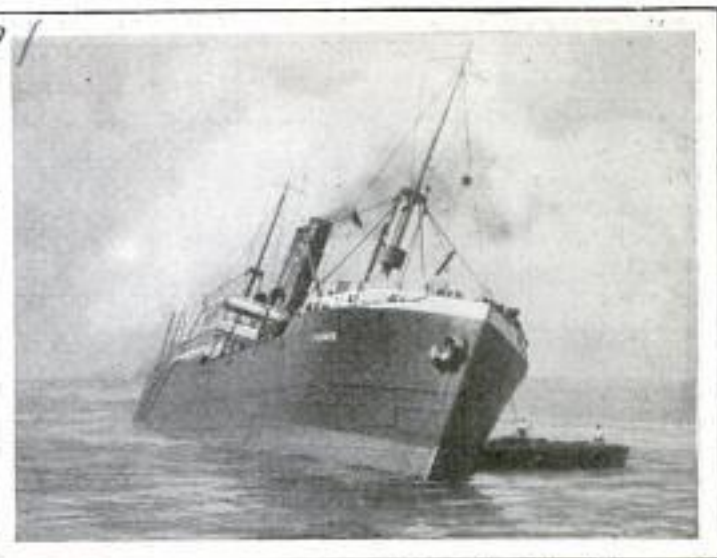

Vessel Loaded with Lumber and Dynamite Was Thrown Off Balance by Shifting Cargo

Pacific & Atlantic

4295
**LIGHT ON BIBLE TEXTS SOUGHT
 IN AN ANCIENT SCROLL**

What is believed to be the oldest book in the world, a copy of the Pentateuch, is the prized possession of a sect of Samaritans

with the text that little doubt is held as to the genuineness of the document. Photographic reproductions of the entire scroll are being taken for the first time and distributed among Hebrew scholars. They are expected to shed light on various scriptural controversies.

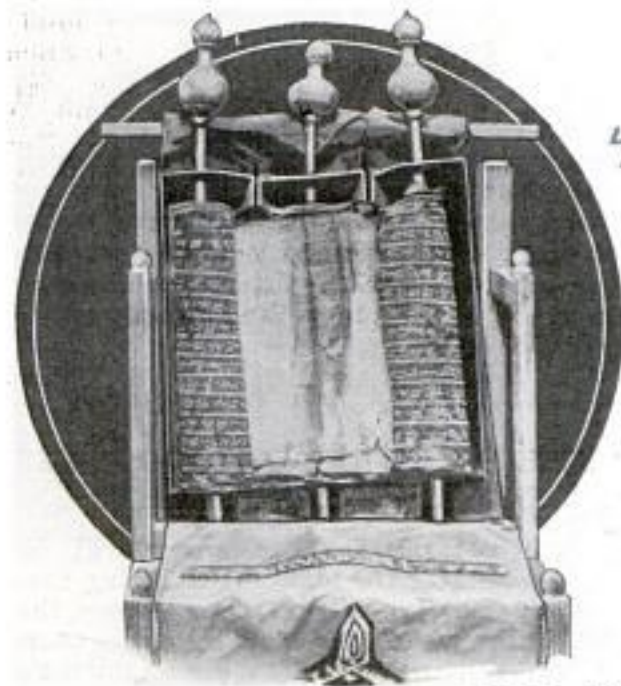

Wrapped in Silk, the Ancient Scroll Is Carefully Preserved in a Copper Case

who live in Palestine. Guarded with the utmost care in a case of copper, it is exhibited only at feast times, and is then uncovered from its silken wrappings only far enough to permit one column of the scroll to be seen. The parchment is 70 feet long, and scholars have found that toward the end of the manuscript the name of the writer and the date are so intermingled

4212
**DOUBLE JAWS ON CABLE GRIP
 TO DO AWAY WITH KNOTS**

Steel cables or wire ropes can be fastened to posts or ground anchors without the use of knots by a grip with two sets of jaws. The rope cannot slip, it is said, because as the pull upon the jaws increases, their grip tightens. A spring attached to the hinges prevents the hold from releasing too quickly when the strain is removed. The device is of especial aid in tying guy wires, and saves time formerly used in wrapping and twisting the strands.



Ray Mfg. Co. 839 E. 31st St. Los Angeles, Calif.

Coloring for electric-light globes is now put up in handy 2-ounce bottles and may be obtained in twelve different shades. The substance is easily removed with wood alcohol.

*Cont. Francis Dickie
 Heriot Bay, B. C.,
 Canada.*

*Greater Service
 Electric Co. St.
 329 Broad Street N.Y.*

PHOTOS TAKEN FROM AIR SHOW CROP ACREAGE

3730 - *valley aerial*

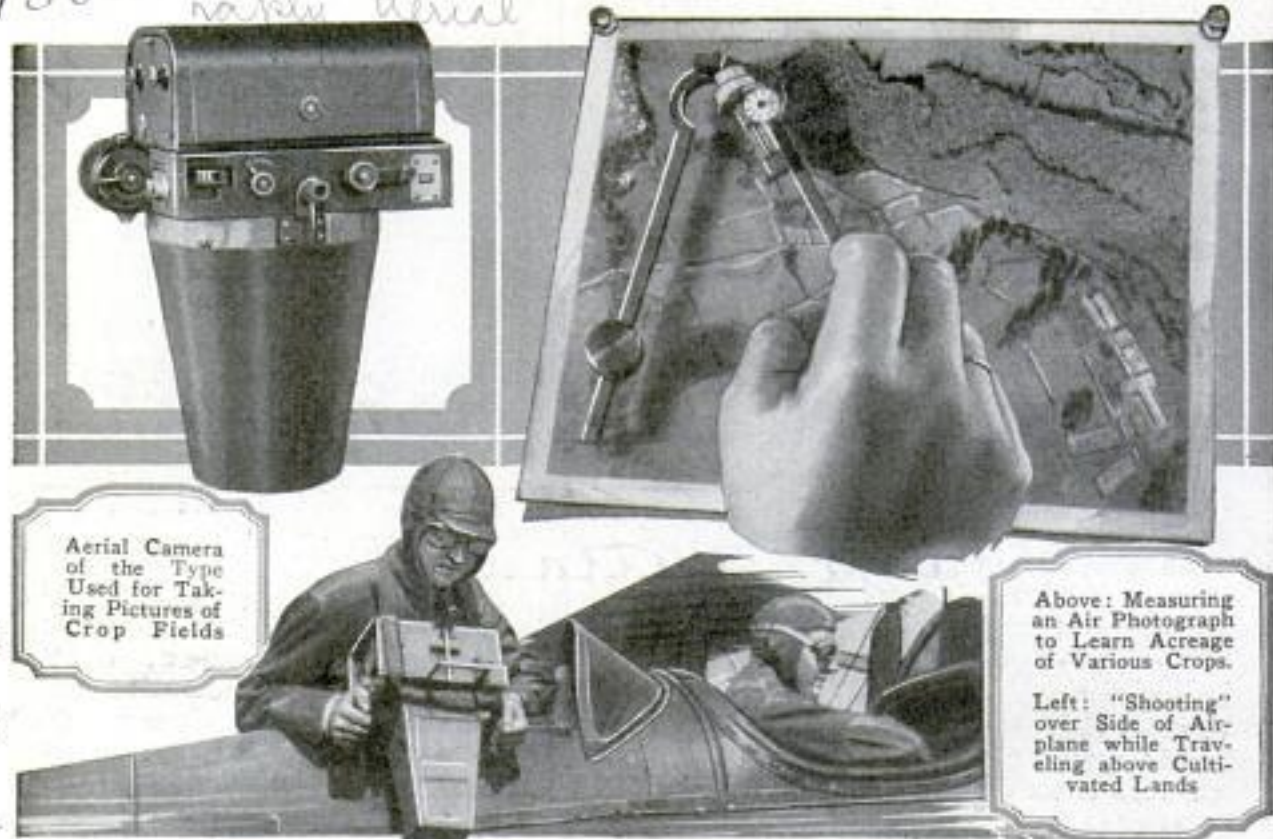

Aerial Camera of the Type Used for Taking Pictures of Crop Fields

Above: Measuring an Air Photograph to Learn Acreage of Various Crops.

Left: "Shooting" over Side of Airplane while Traveling above Cultivated Lands

By taking pictures of planted fields from an airplane, government estimators are able to obtain photographic evidence on which to base their reports of crop acreage. The camera used takes pictures at the rate of one a minute while the plane flies 80 to 90 miles an hour at heights of 2,500 to 7,000 feet. The actual sizes of the fields are calculated by measuring the distance in inches on the picture with a

"planimeter," and since the altitude of the plane had been recorded, the scale is worked out in acres. Different crops are easily recognized by this method, even when large areas are measured. In three hours, aerial pictures of 250 square miles of fields were obtained. Estimators also are enabled to gain valuable information as to the condition of the crops by flying at lower altitudes.

GERMS TO HELP RUN ENGINES BY PRODUCING GAS FUEL

4346

Methane, one of the gases used for motor fuel, is being produced in commercial quantities in India with the aid of germs that convert a mixture of sewer sludge and sawdust into various compounds of which the gas forms an important part. The tiny creatures are cultivated in air-tight tanks kept at a warm temperature. They multiply rapidly and by working on the mixture produce acetic acid and carbon gas as well as methane. Marsh gas, frequently found in stagnant pools, is largely the result of their presence and causes decay and fermentation of vegetable matter. Banana stems and skins have been found to yield as much as 81 per cent methane when acted upon by certain kinds of germs.

"WHITE POWER" OF TWO DAMS TO YIELD FARM RICHES

4257

Nearly 1,000,000 horsepower will be made available for making fertilizing material when the Wilson Dam across the Tennessee River at Muscle Shoals is completed. With another dam, fifteen miles up the stream, it is estimated that the water will supply more than 800,000 horsepower and electricity furnished to operate a chain of factories. The fertilizer is to be manufactured from a combination of nitrogen extracted from the air and phosphoric acid taken from native rock near the shoals. Thousands of tons of concrete are being used in building the huge dam and power house. A steam plant, developing about 100,000 horsepower, which has been built, will supplement the other units.

Kansas City Star 12/1/23

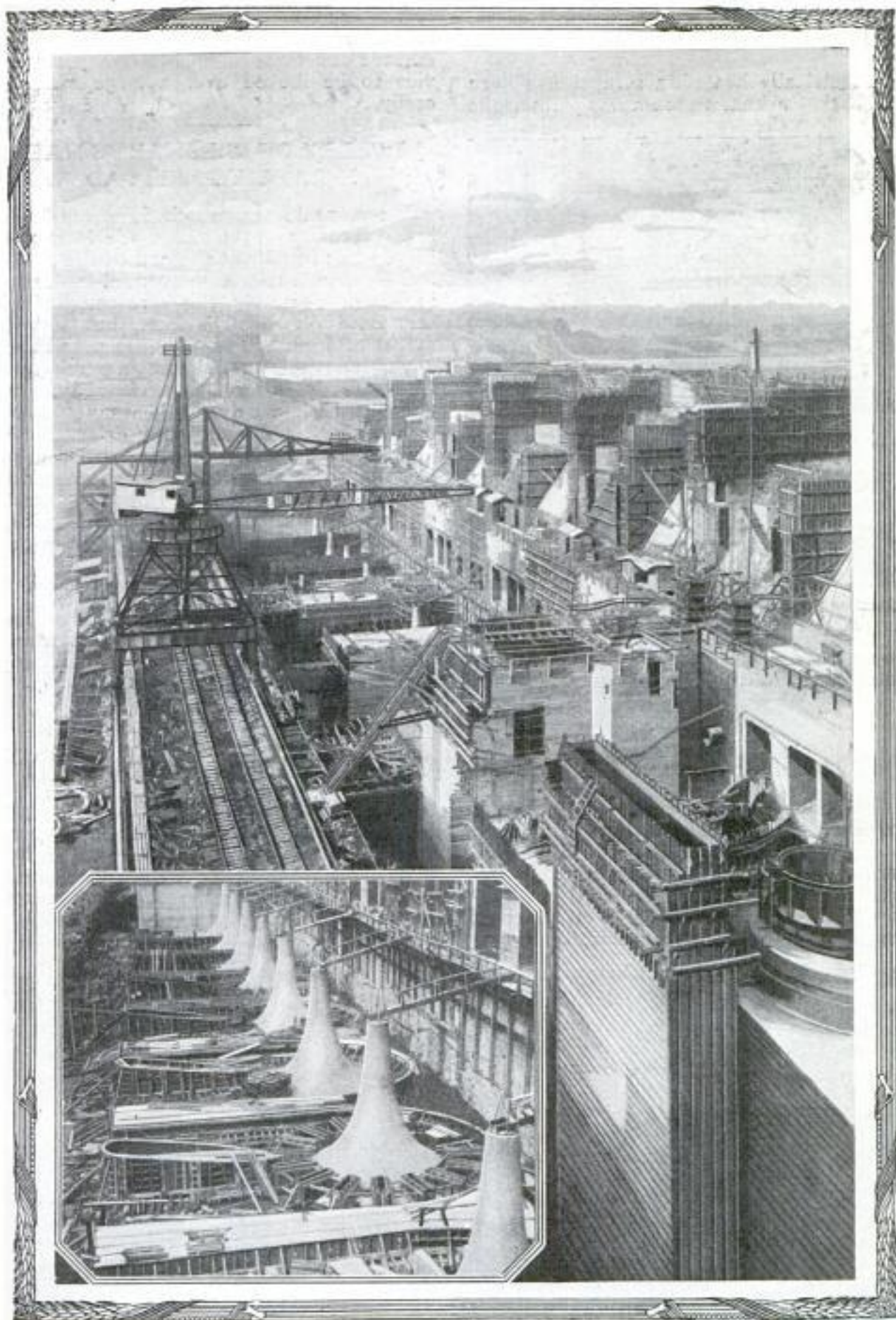

Harnessing Nearly 1,000,000 Horsepower with Monster Wilson Dam, a Part of the Muscle Shoals Project: Concrete Foundations for the Turbines Are Shown in the Lower Picture

William Stone St.
276 844 South St.
South Bend Ind.

POPULAR MECHANICS
ELECTRIC SCRAPER FOR PAINT
DOES WORK OF TWO TOOLS

4282

Electrically heated, a scraper has been made that softens and removes paint at the

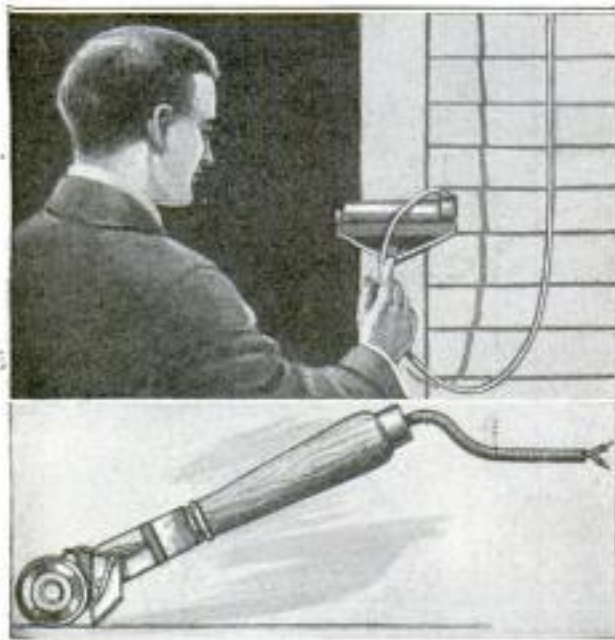

Electrically Heated Paint Scraper Melts and Removes the Surface at the Same Time

same time. The heated roller melts the surface, while the cleaning tool attached

Capt. George H. Holden,
Hill Crest Lodge,
Japton New Road,
Chesterfield, Eng.

to the same handle removes it. A cable suspended over a winding drum carries the current and makes it possible for the device to be moved over a large surface easily.

JEWELRY OF ELEPHANT'S HAIR
4323 IS LATEST PARIS FAD

Rings, necklaces, watch fobs, automobile mascots, and the like, made from the bristly tuft of hair at the end of the African elephant's tail, have aroused curiosity in Paris. Formerly, this rare commodity was used on milady's hats, but today, prices of from \$50 to \$100 are asked for any unique design required by a purchaser. The strands, after being cleaned in a chemical bath, are dyed in permanent colors, combed, and electrically dried. The plaiting and weaving of the bristles into rings occupies from half a day to several weeks, depending upon the pattern, and collectors are assured that jewelry made from elephant hair will outlast that made from the precious metals.

□ Fibrous material which is said to make good paper is obtained in Jamaica from the banana palm after the tree has been cut down and the fruit harvested.

3968

COBBLES USED TO BUILD NOVEL PRISON FOUNTAIN

To show the desired form of a circular cobblestone fountain, without making a mold, the superintendent of a western prison constructed a frame of wood and iron pipe, shaped like a cross-section outline of the completed work. This revolved on a wagon axle placed upright in the

ground. Inexperienced workmen formed the ornament guided by the moving frame. A miniature lighthouse was built of stones placed around a galvanized-iron form. A "run-around" near the top of the tower was made on a base of wire netting attached by several small steel rods.



Miniature Lighthouse and Fountain Built of Cobblestones by the Convicts in a Western Prison Who Used a Revolving Wooden Frame to Make a Perfect Circle

Capt. R. B. Shins, Supt. Arizona State Prison, Florence, Ariz.

New York Times
1/5/23

**SALMON FISHING RIVALS MINES
IN IMPORTANCE TO ALASKA**

Rivaling in importance the development of its mineral resources, Alaska's salmon fishing industry has become one of the major occupations of the territory. From a small beginning in 1878, when Chinese laborers caught and packed the fish in crude, handmade cans, the business has grown until it employs 25,000 men annually. Canneries equipped with the latest types of time-saving machinery, now dot the coasts and river banks and the value of the catch amounts to millions of dollars every year. In 1918, the peak of production was reached with a pack of nearly 7,000,000 cases. This was due to war orders and because many waters were nearly fished out at that time. Efforts have since been made to re-stock them and to bring the industry back to a stable basis.

4746
4097
4289
4530
4531
4532
4533
4534
4535
4536
4537
4538
4539
4540
4541
4542
4543
4544
4545
4546
4547
4548
4549
4550
4551
4552
4553
4554
4555
4556
4557
4558
4559
4560
4561
4562
4563
4564
4565
4566
4567
4568
4569
4570
4571
4572
4573
4574
4575
4576
4577
4578
4579
4580
4581
4582
4583
4584
4585
4586
4587
4588
4589
4590
4591
4592
4593
4594
4595
4596
4597
4598
4599
4600

**WRINGER ON BLACKING BOTTLE
SAVES FLUID**

Excess quantities of liquid shoe dressing in the dauber before it is applied are removed by an attachment, lately introduced, consisting of a notched upright clamped to the neck of the bottle. The swab is held in a groove and turned and squeezed before it is withdrawn. Economical and proper use of the dressing and increased durability of the leather of shoes are assured with the aid of this device, which also is more economical.



**LIBRARY "DOCTOR" GIVES FIRST
AID TO WORN BOOKS**

In a large public library of a mid-western city, the average life of a circulating volume is little more than three months. During its frequent handling, damage to



Book "Doctor" in Library Repair Room Stamping New Volume with Permanent Catalog Number

both the pages and the binding results, which necessitates repairs by the "hospital," where skilled workmen mend the slightest injuries. Torn leaves are repaired with transparent paper, and if a new cover is needed the book is sent to the bindery. More than 8,000,000 withdrawals were made through the institution's 45 branches last year. When new stocks are received they are sent to the repair room, where a permanent number is stamped on them and a catalog label is printed on the back.

PHONE WIRES HUNG TO BOTTLES

Broken insulators on the telephone poles have been replaced with the necks of bottles in a remote section of New Zealand. The wire is wound about the glass and is prevented from slipping off by the collar at the top.

4530
4531
4532
4533
4534
4535
4536
4537
4538
4539
4540
4541
4542
4543
4544
4545
4546
4547
4548
4549
4550
4551
4552
4553
4554
4555
4556
4557
4558
4559
4560
4561
4562
4563
4564
4565
4566
4567
4568
4569
4570
4571
4572
4573
4574
4575
4576
4577
4578
4579
4580
4581
4582
4583
4584
4585
4586
4587
4588
4589
4590
4591
4592
4593
4594
4595
4596
4597
4598
4599
4600

Answers to "Can You Name Them" Puzzle

THE correct names of the articles shown in the January issue under the heading: "Can You Name Them?" are as follows: No. 65, inkwell. No. 66, cuff link. No. 67, hair fastener. No. 68, stopper for ink bottle. No. 69, rotary toothbrush. No. 70, electric clock. No. 71, curry-comb. No. 72, liquid soap fixture. No. 73, dauber for liquid blacking. No. 74, electric push button. No. 75, toasting device. No. 76, comb cleaner. No. 77, egg beater. No. 78, lifter for hot dishes. No. 79, dish drainer. No. 80, artist's easel.

3861

SHELVES ON KITCHEN CABINET SAVE SPACE ^{no price}

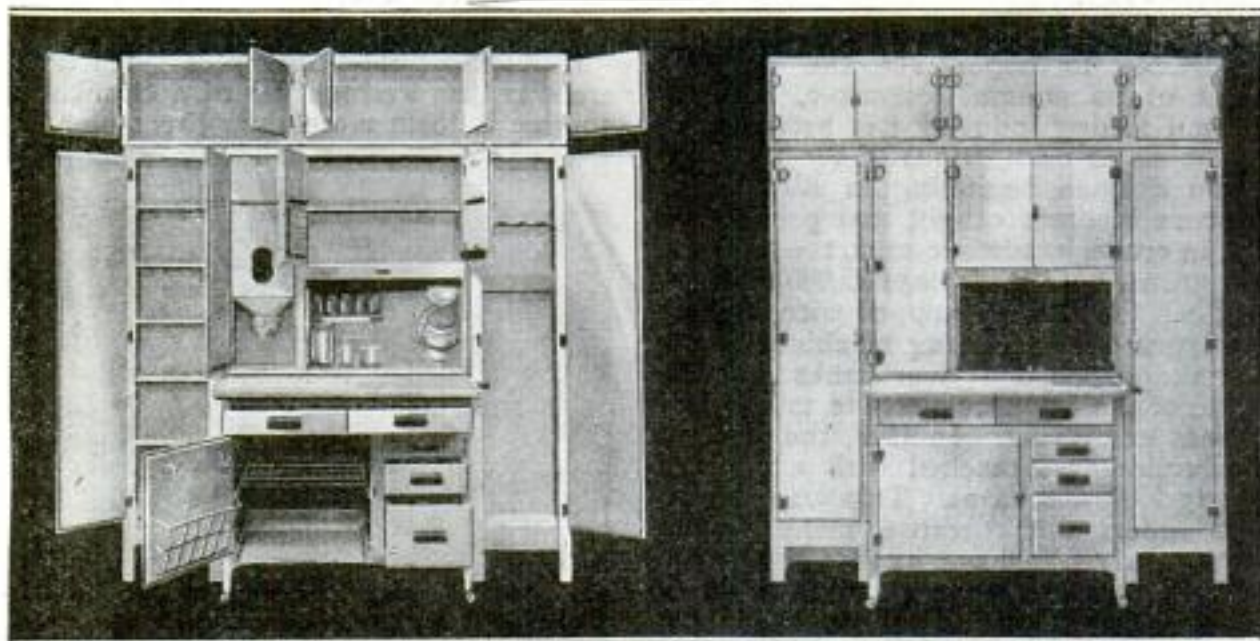

Cabinet Surrounded by Shelves and Closets that Save Housewife Time and Space in Kitchen

To save steps in the kitchen, shelves and cupboards for storing food, china, and cooking utensils are built around a cabinet recently marketed by a mid-western manufacturer. Particularly of value in apartments or homes which afford slight space, the cabinet is said to have enough

room to store practically every utensil used by the housewife. Things can be kept clean, for all compartments are closed. There are no nooks where dust can collect, as the doors have no panels and the inside corners are rounded to make them easy to wash.

WATERING TROUGH FOR HOGS CAN'T FREEZE IN WINTER

Insuring a constant supply of fresh water for hogs at all times, a fountain now being marketed is provided with a small kerosene heater for use during cold weather. In the warm season it requires no attention, for the flow is regulated by a control, and in the winter months the oil lamp needs refilling only two or three times a week. This heating system takes the chill off the water, making it more suitable for the animals. A swinging door over the

drinking basin keeps out dirt. The fountain may be attached to the side of a watering tank for other stock, or it may be connected with the well or pump by an underground pipe.



Fountain Water Trough for Hogs with Heating System for Use in Winter

JAPANESE SEE QUAKE RECORD WHILE FAR FROM HOME

While thousands of their countrymen were being killed and maimed and cities were laid in ruins, a party of Japanese delegates to a scientific congress witnessed the tracings of the disastrous tremors on a seismograph in Sydney, Australia, nearly 5,000 miles from the scene of the recent tragedy. As the visitors were examining the instrument at an observing station near the city, it began to tremble violently. Making calculations as the record proceeded, the officer in charge located the disturbance as arising near Tokyo. These highly sensitive seismographs are now capable of recording the slightest tremor caused by a disturbance of the earth's crust in any part of the globe. The instrument is usually placed upon a concrete

copy material
Mr. A. White, Norma Mount St., Strathfield, Sydney, New South Wales, Australia

4040
Cummings & Cummings
122 1/2 N. Main St. Roch. Mich. Ill.

pier resting on bed rock, through which the vibrations are carried to the recording apparatus, by which they are traced upon a photographic film by a beam of light. The direction and the distance of the disturbance from the instrument, and the character of the "waves," are determined from the readings. It is estimated that the average earthquake vibration travels at the rate of about 142 miles a minute.

**LIGHT FROM MOUNTAIN ROCKS
MAY BE RADIO RAYS** 4056

Rocks that shed a peculiar light, the rays of which are said to produce a painful rash on the skin and to rust metal, have been found on the crest of a mountain in the wilds of New Pomerania in the Bismarck Archipelago of Oceanica. Scientists believe that radium or a radioactive mineral may be found in them. Only three persons are said to have climbed the mountain and experienced the effect of the glow which can be seen for miles. Those who have stood where the queer light could strike them have been afflicted later with a rash that lasted for several days. An expedition is to be sent out by the Australian government, it is reported, to make borings into the mountain and to analyze the rocks.

**LIFT-TOP BUILDING VENTILATOR
HAS STORM-PROOF COLLAR** 41043

Among building utilities lately introduced is a device which provides any degree of ventilation necessary to remove

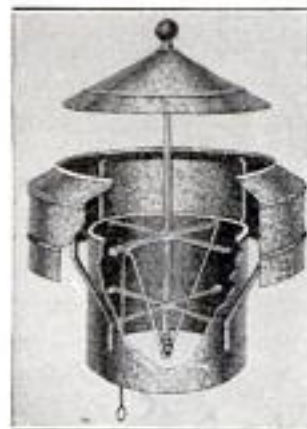

impure air. It has an encircling collar which keeps out rain, hail, sleet, snow, and wind, thus insuring operation even under adverse weather conditions. When closed, the cover serves as a damper. With a pulley and chain attachment, it is easily moved. This service is performed by a single shaft when a series of them are used in a structure. Another feature is a fusible link which melts in case of fire, dropping the lid and cutting off the draft which otherwise might fan the flames. The apparatus is also manufactured with a glass top.

**HUGE GRANARY HOLDS YEAR'S
GRAIN FOR SMALL NATION** 4096

Enough wheat to feed 500,000 persons for one year can be stored in a grain elevator recently built at a railroad terminal



Copyright, Underwood & Underwood
Huge Granary that Will Hold Enough Wheat to Feed Half Million Persons for a Year

on the eastern seaboard. The structure, said to be the largest of its kind in the world, will hold 2,500,000 bushels. Figuring the United States average per-capita consumption at about five bushels per year, the supply in this huge storehouse is sufficient to feed some of Europe's hungry nations for 12 months. The quantity that can be kept in this granary is estimated to be about one-fifth as much as the total crop of Iowa.

**HOLDER FOR EGGS GUARDS HAND
FROM STEAM** 4004

Lessening the risk of burning the hands or breaking a hard-boiled egg in removing it from hot water, a lifter that is made of

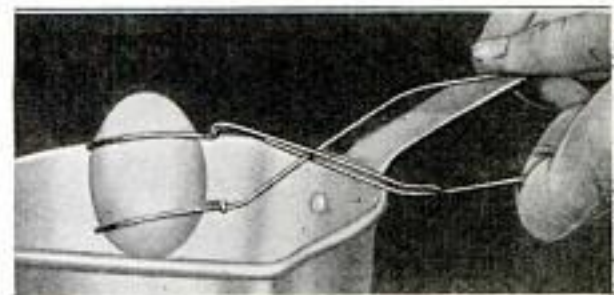

Holder that Lessens Risk of Burning the Hands or Dropping Boiled Eggs in Lifting from Water

strong silvered wire, has been devised in Europe. A spring on the holder grips two rings in place at the ends of the egg, which may be released by pressing the handle.

*Yorh State Canal Terminal Brooklyn, N.Y.
Eric Parson.*

*Messenger & Parks Mfg. Co., Toronto, O.
The Waterloo Tool Co., York Road, Waterloo, England.*

cont. James Medntyre Apartado 370 Mexico, D.F.

CORTES' GARDENS STILL WONDER OF MEXICO

AFTER four centuries, the gardens built by Cortes, the conqueror, are still one of the wonders of Mexico. Long lines of great trees, interspersed with stunted evergreens, border the drives and stretch away in wondrous vistas. Dwarfed firs have been trimmed by the landscape gardener, into geometrical designs, spheres, pyramids, cones, and the like, and the sight-seer gazes down a row of emerald globes which seem to grow smaller in the distance, but which are, in reality, all of a size.

The Spanish leader entered Mexico with only a handful of followers, overthrew the Aztecs, and destroyed their civilization. Later, he laid out the gardens, six miles

south of the capital, and they have remained untouched by the revolutions which have ravaged the country. The great soldier returned to Spain and fell into disfavor with his sovereign, who repaid the services of a lifetime by demanding to know who he was.

"I am a man who has given you more provinces than your ancestors left you cities," was the proud answer of the grandee, who, in disgust, retired to obscurity, and died in neglect.

The impression conveyed by this park is one of somberness and tragedy, well in keeping with the life of its creator, and the care with which it is tended should preserve it for many years to come.

"STEAM LAUNDRY" FOR HOME EASES WASHDAY LABOR

Operating without complicated attachments, a washing machine for home use has been devised to cleanse clothes by forcing boiling water through the gar-

steam rises, a partial vacuum is created which forcibly drives boiling water through perforated tubes in an inner jacket of the kettle down upon the clothes and through holes in a false bottom. Circulation is maintained at the rate of 162 gallons a minute and this action makes rubbing the clothes unnecessary. For articles which cannot be boiled, a geared rotating plunger is provided in the top.



"Steam Laundry" for Home Use May Be Placed upon a Stove and Runs without Machinery

ments under strong steam pressure. The apparatus consists of a copper and steel receptacle equipped with a dome-shaped cover, and may be placed upon an ordinary coal stove or over a gas burner. As

DUMB WAITERS IN STORE RUN FROM 6-INCH SWITCHBOARD

Fourteen electric package elevators of the dumb-waiter type are controlled by an operator and a switchboard in a department store of one of the large cities. Any number of the "lifts" can be moved to various floors by simply pressing buttons on the control panels. When an elevator is needed, the floor attendant signals "central" by a key at the side of the shaft. A light on the board notifies the operator, who then directs the proper carrier to that point. When it arrives, the signal light goes out. After it is loaded, other signals are used to indicate the floor to which delivery is to be made. Each lift has a corresponding panel allotted to it on the switchboard with rows of lights representing the floors.

STATUE CAST IN GLASS

Cast in glass, and over twenty-four feet high, a statue of William Shakespeare has been made for a London park. The model was first made in clay. No figure as large as this has before been made from glass.

Clad of business (2/2/26) washer vacuum laundry Co. (423 Clinton Bldg. Columbus, Ohio) adv. \$ - 1.00. 23.7 w. Both Madison Chicago.

suggested me in Dec 1924-956

Edwin James The Paragon Washington D.C. 4118 5 Statue cast in glass Cast in glass, and over twenty-four feet high, a statue of William Shakespeare has been made for a London park. The model was first made in clay. No figure as large as this has before been made from glass. Christie 356 Union Station, Washington Canada.

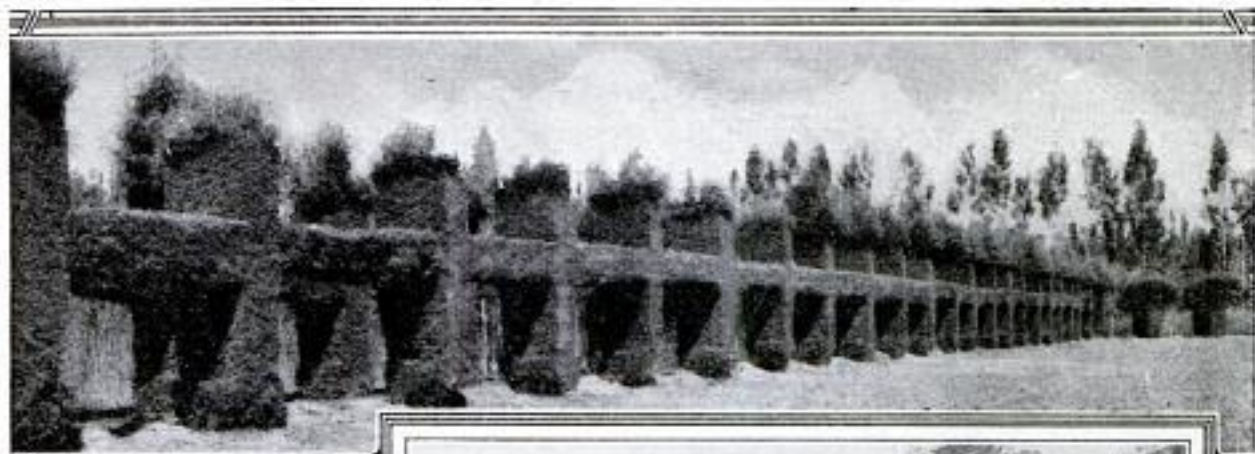

O-O-O

WITH pruning-hook and hedge shears, landscape gardeners have changed the dwarf firs planted by Cortes, the conqueror, near Mexico City, into carved figures, arcades, bridged pillars, and columns of foliage that rival the sculptured beauty of granite or marble. The dense covering of the evergreens has lent itself admirably to the purposes of the artist, and, with a precision almost mathematical, the interlacing branches of whole rows of trees have been transformed into veritable crossbeams of jade, that run the entire length of the park and seem to be supported by the tree trunks whose emerald tracery has also taken on the same form and dimensions, making them resemble giant green pillars. Farther along is a perfect line of arches forming a connected whole and resembling an old Roman aqueduct, in everything except height, and, in the near distance, stands a long file of inverted evergreen hearts reaching toward the sky.

O-O-O

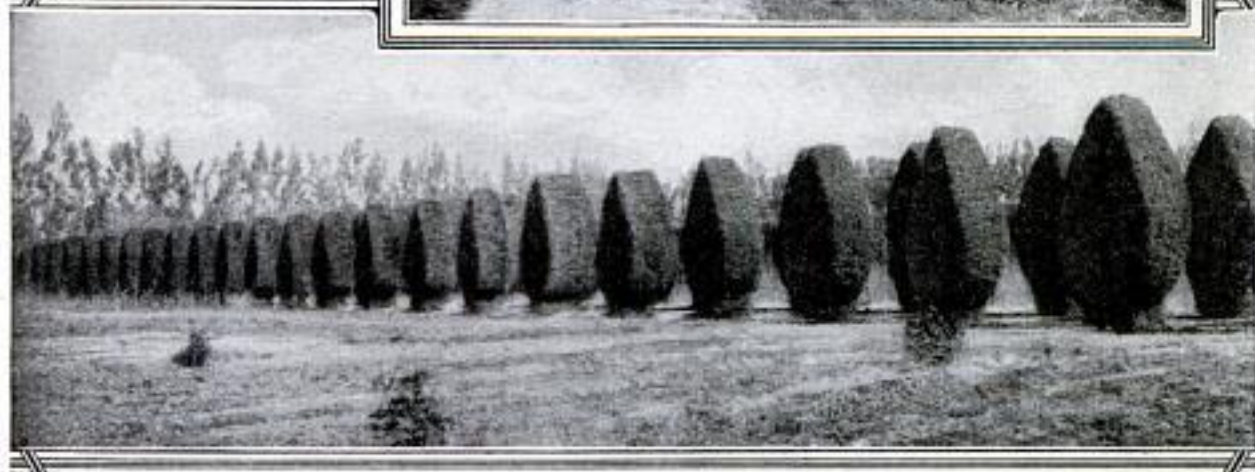
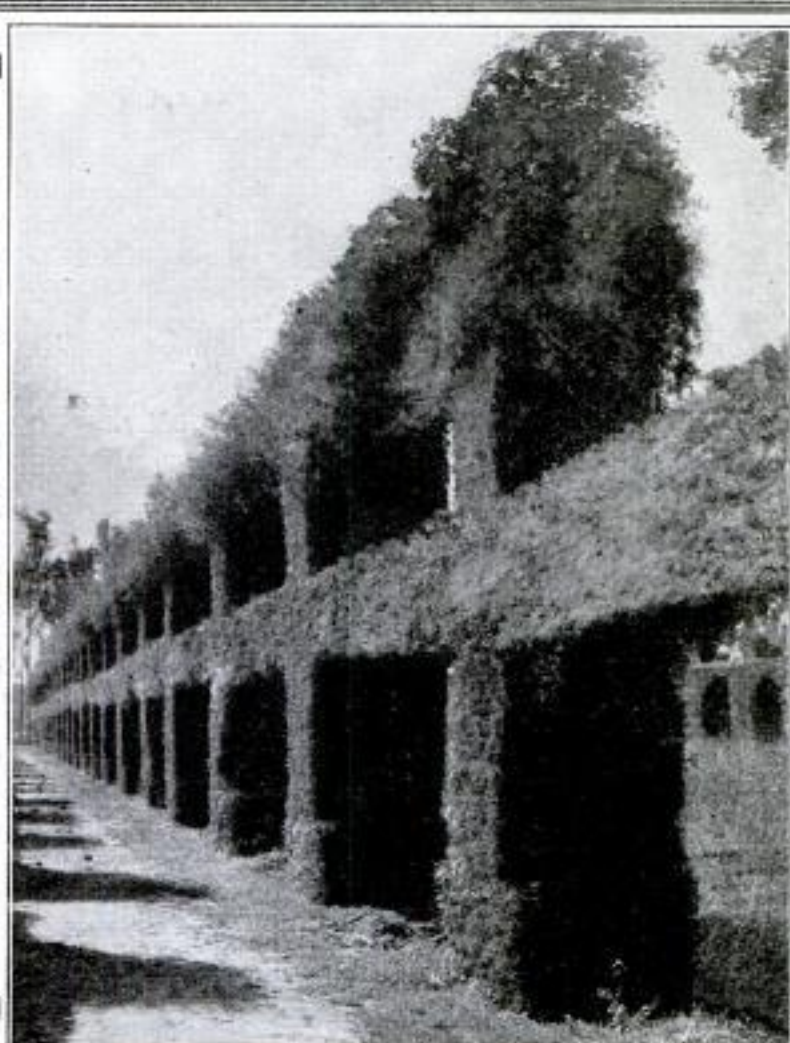

Clark, Williams Engineering Co., d no, 1710 Main St, Bridgeport, Conn
 282 POPULAR MECHANICS
 CONCRETE POLE BASE CUTS REPLACEMENT COSTS
 3998

In view of the fact that telegraph poles generally begin to rot at the ground line, a concrete base has been designed to

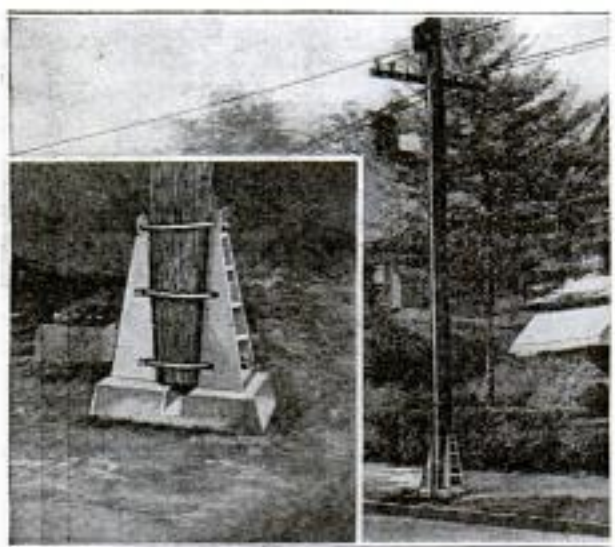

Pole Base of Concrete with Metal Grips that Are Tightened with Strap Bolts

lengthen the life of the wood and reduce the cost of replacement. Where this foundation is used, no allowance for extension of the pole into the earth need be made, as the "mount" rises above the surface of the ground. Two metal fixtures firmly bolted to the base, support the pole, which has been tapered to fit the socket made by three strap-bolts passing through these supports.

ANCIENT LIFE SHOWN BY BONES OF MAN AND MAMMAL

Fossil remains of what appears to be the skull of the first type of mammal that existed on the earth more than 4,000,000 years ago, are reported to have been discovered in Kansas. Three skeletons of persons thought to have lived in the quaternary epoch, were found in France, and a skull, believed to be that of one of the first Indians to arrive on the American continent, was lately exhumed by scientists in California. The three skeletons were those of two men and a woman believed to have lived 15,000 years ago, and the first human remains of that particular age in the epoch ever unearthed. Of fine physical development, they were evidently of a race of hunters and fighters. One of the men apparently had been killed in battle, as a piece of flint was imbedded in his skull. Rude slabs of stone above the bones indicated burial rites performed.

Chicago News 11/2/23

d w. John neverth, Jr.
 Blacksmith
 in Bridgeport, Conn.
 STREET SWEEPER HAS WING TO CLEAN GUTTERS
 4150

Leaves that collect in the gutters of paved streets are cleared away by an attachment at the side of a sweeper used in a mid-western city. Whether the debris is wet or dry, the device, which has weights to hold it close to the curb, throws the rubbish into the path of revolving brushes by which it is tossed into a box at the rear of the cart. The collection is then dropped in piles to be gathered up and hauled away.

CORK EXPANDS WITH AIR PRESSURE IN BOTTLE

Designed to prevent the evaporation of perfumes and other volatile liquids, a new form of cork has been patented by a French inventor. It has a cone-shaped hole extending inside about half way to the top, and is so fashioned that if pressure arises within the bottle, the stopper is expanded and held more firmly in place.

MOTOR OF ELECTRIC FAN RUNS PHONOGRAPH

Electric-fan motors may be utilized to operate phonographs. By removing the blades from the shaft of the fan, and fastening the base to the top of the talking machine, the motor may be tilted downward until the shaft touches the edge of

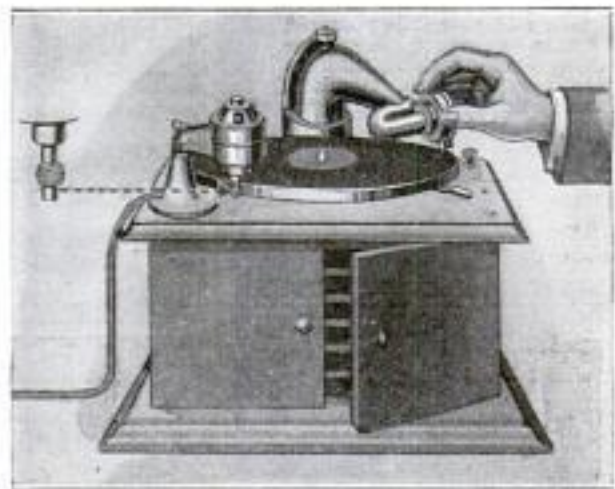

Electric Fan Motor Adjusted to Run Phonograph by Friction on Edge of Turntable

the turntable. The end can be transformed into a friction wheel by wrapping it with thread to give it a grip on the metal surface of the disk. The velocity of the phonograph may be regulated either by the thickness of cord or by the speed of the motor.

James A. Carroll, Charlotte, N.C.

France Paris Ill.

*Carl Edwin Tarzise
The Ferragut*

*Byrne, Kingston & Co,
Rokomo, Ind.*

POPULAR MECHANICS

283

Washington, D.C.

**PLATING OF ALUMINUM NOW
DONE WITH AID OF ZINC**

4090

Difficulties encountered in plating aluminum with copper, gold, silver, or other precious metals are believed to have been solved by a recently discovered process. The chief trouble had been that an invisible film forms on the aluminum when it is exposed to the air. By the new method, this is dissolved in a bath containing soluble fluorides, a little hydrofluoric acid appearing to act the best. A coating of zinc is added to the aluminum in the plating bath. To form a gold surface, the layer of zinc must be coated thinly with copper, otherwise the precious metal will sink into the zinc and almost entirely disappear.

**WHEN OIL FAILS, AUTO STOPS,
AS PUMP CONTROLS GAS**

3820

By combining an oil-circulating and vacuum fuel-feeding system for automobiles, the supply of gasoline is cut off



Vacuum Tank that Is Operated Directly from the Oil Pump Instead of the Intake Manifold

**PACIFIC LINER STRIKES SEA
OF JELLYFISH**

4139

Great masses of jellyfish, ranging in colors from black to white, were lately encountered off the California coast by an ocean liner. The steamer, according to the report given, plowed its way through this sea of jelly, which was visible near the surface of the water until the ship was well into harbor. It was surmised that the seismic disturbances in the western Pacific caused the creatures to migrate.

Image Pool 11/3/27

**COUNCIL OF EXPERTS BUILDS
MODEL SHIPPING CRATE**

4031

For shipping heavy pieces of machinery, government experts have designed an improved wooden crate, which is said to be much stronger than the ordinary type, although its construction requires less lumber. It weighs five per cent less than the old form, occupies smaller space, and needs but two-thirds as much banding. In

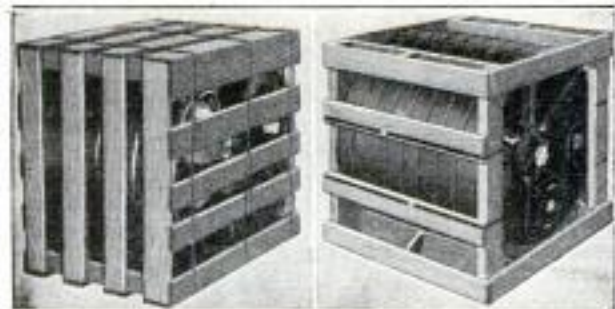

Shipping Crate Made by Experts to Save Lumber and Give Greater Strength

a laboratory trial the new pattern withstood 100 drops in a testing apparatus. The older one collapsed in the first fall.

*Forest Products Laboratory
U.S. Forest Service
Madison, Wis.*

and the car stops whenever the lubrication fails, thus warning the driver and preventing costly repair bills. The fuel is drawn from the rear tank to one on the dash by vacuum from the oil pump instead of the intake manifold. It follows, therefore, that a motor which is not getting oil will not get gasoline. It is claimed that the device results in less crankcase dilution and fewer repairs. Its single valve may be seated with a few turns from the fingers.

4079

**PEARLS FORMED IN OYSTERS
LEFT IN LIME SOLUTION**

Minute pearls, supposedly formed from larger ones which were inserted into oysters, were reported found by a Japanese scientist after he had immersed the oysters in a solution containing a high percentage of an organic lime compound and allowed them to remain there several weeks. Two or three pearls, in addition to the original gem, were discovered, though they were too small to be of any commercial value.

*R. White, Marine, Mount St. Bernard, New South
Wales, Australia*

4066 **TACKLE BLOCKS MADE BY HAND MOVE GIRDERS**

Handmade tackle blocks, each weighing about 800 pounds, for use in handling 68-ton steel girders and swinging them into place, were necessary in the erection of a 32-story office building in a mid-western city recently. So exacting were the re-

quirements of the task, that high skill was necessary in the construction of the devices needed to sustain the heavy loads while being raised and lowered into position. The edges of the plates on the big pulleys were ground to prevent injury to the cable.



Giant Tackle Blocks Made by Hand to Move Huge Steel Girders Used in the Construction of a Thirty-Two Story Office Building

MACHINE PACKS MATTRESSES, WRAPS THEM IN PAPER

3908

Hand labor is replaced and a saving in materials results through the use of a wrapping machine for mattresses, which rolls the bulky articles in a tight bundle and cuts the paper to cover them. As many as 500 a day can be finished by the appara-

tus, which requires the attention of only one man to operate it. The package produced is said to be dustproof, and so made that less space is required to accommodate it, thus reducing shipping and storing costs.

FOLDING CHAIRS FIND FAVOR 4147 IN ARAB MARKET

Sudden demand for folding chairs has arisen in Arabian markets, according to the report of an American consul, and has caused some surprise because the Bedouins are accustomed to sitting cross-legged on the ground or on cushions. Two thousand of these folding seats were lately imported from Austria, and local carpenters are reported to be manufacturing others to compete with the foreign product.

CLOTHING IS MADE FIREPROOF BY USE OF CHEMICAL

For the protection against burns and matches and bonfires, children's clothing can be made practically fireproof if it is soaked for a few moments in a solution of ammonium phosphate. The substance coats the fabric with a resisting film which is effective until the garments are washed again. Lace curtains and Christmas trees may be treated in like manner or dipped in a strong solution of alum water with equally good results.

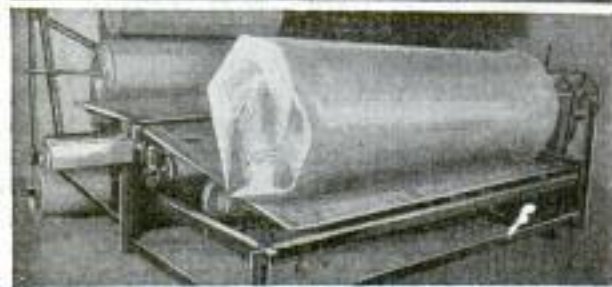
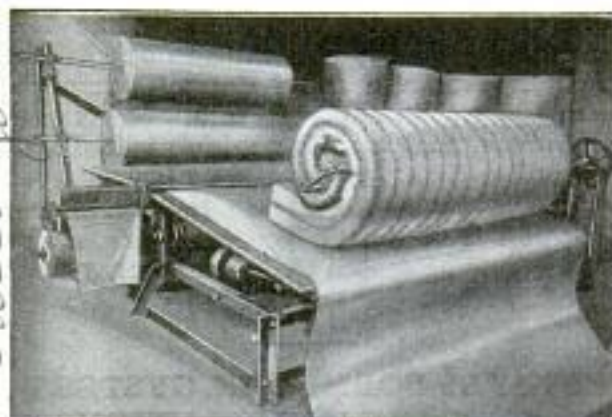

Machine that Replaces Hand Labor in the Packing and Wrapping of Mattresses

Roll Patents Corp. 341 E. Ohio
 Chicago

New York Times 8/15/23

4162

Jacoma Ledger
 8/26/23 Copyrighted material



All Shop Notes published in 1923, in book form—Fifty Cents—from our Book Department

Mounting the Grindstone

By J. V. ROMIG

GRINDSTONES of various diameters and widths may be purchased complete with the necessary bearings and spindle, ready to mount in a suitable frame, at a price much less than that of a mounted stone, and, as "store" mountings are not always satisfactory, many prefer to purchase only the stone and build a frame to suit it. For the farm or home workshop, a substantial wooden frame which provides a seat for the operator, is recommended.

A post or a wall upright in a convenient location is chosen upon which to mount the frame. Two long pieces of 3 by 4-in. stock are bolted to the upright, as shown in the illustration, using filler blocks as necessary,

to space the sills the proper distance apart for the grindstone bearings. A 2 by 10-in. upright is then fastened to the floor, between the ends of the sills, and jointed to the latter.

The treadles are made of flat iron, bent and drilled as shown in the detail drawing, and pivoted on a $\frac{5}{8}$ -in. rod run through the post. The end of each treadle is bent at right angles to serve as a foot rest, and the treadles are connected to the cranks by $\frac{3}{8}$ -in. iron rods with eyes at each end. The treadles, when down, should clear the floor by at least 1 inch.

The seat is made from a flat board, and may be padded and covered with burlap, if desired. A wooden tool rest is also made as shown; this

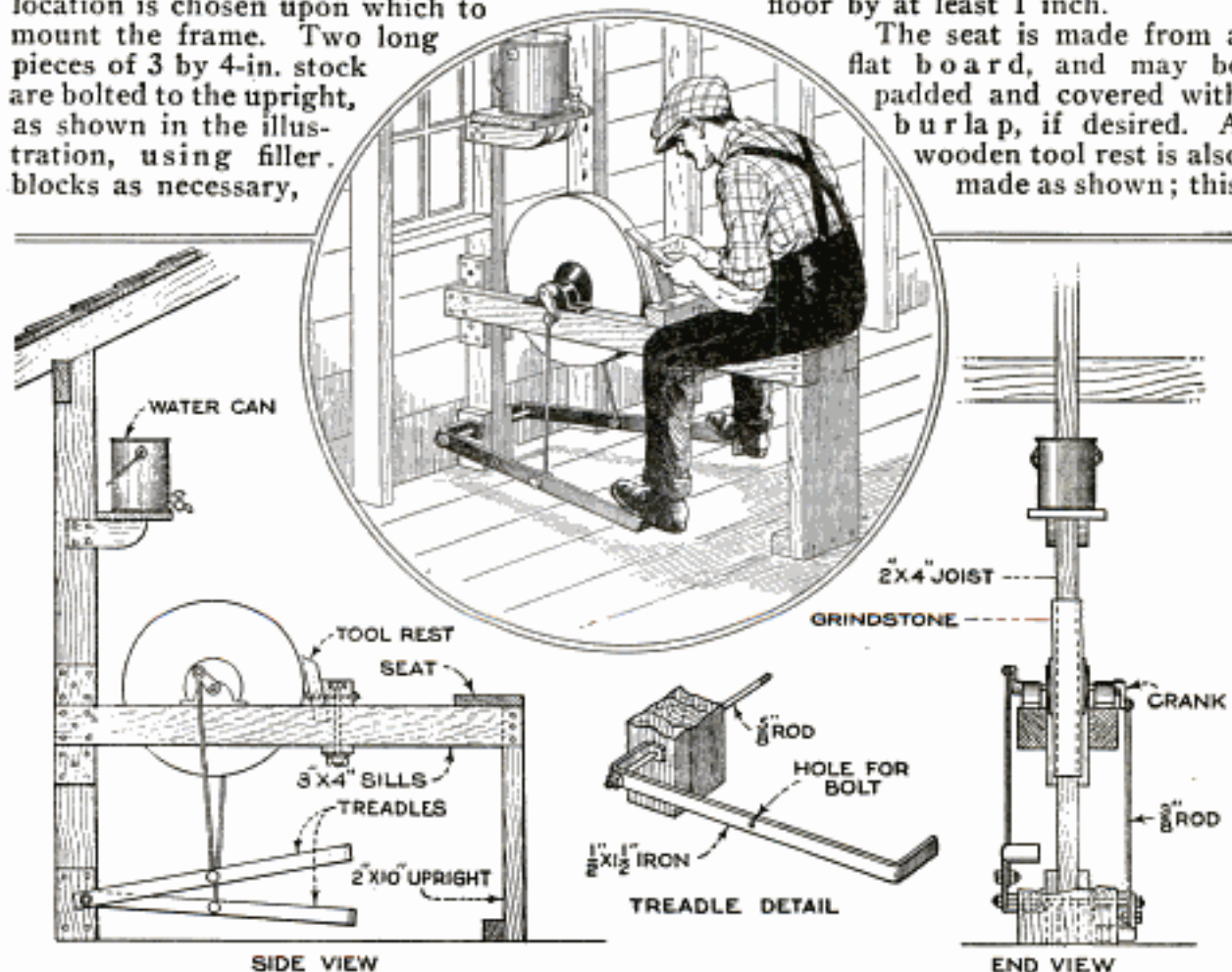

A Very Substantial and Satisfactory Frame for the Farm and Small-Workshop Grindstone, and One that Will Appeal to the Man Who Likes to Make His Own Equipment

is adjustable, to allow moving it in as the stone wears down.

Six inches above the center of the wheel a drip can is mounted on a small shelf. Just enough water should be allowed to drip to keep the wheel face wet. The wheel should be used over its whole face, so that it will wear evenly.

The stone, if worn unevenly, can be trued by means of a piece of pipe, resting one end of the pipe on the tool rest, and pressing against the wheel firmly. The pipe should be turned constantly, while moving it across the face of the stone, so as to present new cutting edges continually as it rolls along the rest.

Wrench for Welding Torches

Users of acetylene torches know how easily the torches can be damaged by rough usage. One of the most frequent

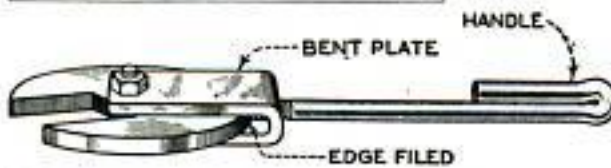

Insert, Loosening Torch-Tip Nut; Below, Details of Wrench Construction

causes of trouble is the nut used to hold the various tips. When tightening or loosening this nut, the wrench should be held at right angles to the torch tubes, otherwise it is difficult to hold the torch at all, as the effect is to push it to one side or the other. The torch should never be placed between heavy objects or in the vise to loosen the nut. A much better method is to use a tool specially made for the purpose. Such a tool is shown in the photo; it consists of a circular piece of steel plate, cut out to fit the nut. A strip of the same material is doubled and attached to the circular piece with a screw and nut, and a handle made of steel rod and threaded into the bent piece as shown. In use the wrench is placed on the nut with the handle loose so that no matter what position the flats of the nut happen to be in, the handle of the wrench can be brought to the right position and tightened. The screw hole is slightly off center, so that the harder the handle is pulled, the harder it presses against the cross-filed edge of the disk.

Hot-Weather Comfort for Autos

An automobile top, exposed to the sun's rays, absorbs an amount of heat that renders it rather uncomfortable for the occupants, especially during the summer time. Experience has shown that the application of a coat of aluminum paint to the under side reduces the absorption of heat to a great extent, and painting the outside with the same kind of paint helps still more. Practically one-half of the heat absorption can be prevented by applying aluminum paint to either inside or outside.

A Combined Drill and Reamer

When all the holes of a lathe turret are occupied by tools and still another tool is needed on the job, some combination is necessary, and the drawing shows how, in one instance, a drill and reamer were combined.

A toolholder was turned to fit the turret hole, and drilled at the front to take the combination drill and reamer, then slotted the width of the tool. The drill-reamer was made from square stock, left square at the center and slotted to take a clamping screw, which threads into the bottom part of the holder.

In using this combination tool the work was first drilled, the clamp loosened, and the tool pulled out a little way to allow the reamer to clear the locating hole in the holder. The reamer is swung around and the drill end pushed back into the holder, when the clamp screw is tightened and the next operation performed.

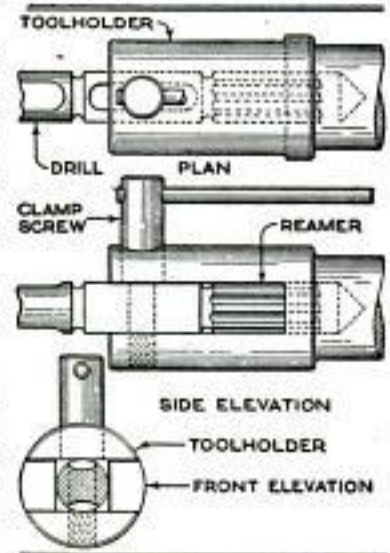

Tightening Barrel Spigots

Wooden spigots of the kind used on cider and vinegar barrels are apt to leak after being used for some time, due to the cork lining becoming compressed. It can be expanded to make the spigot tight again, by taking out the plug, and holding a burning match under the spigot body, so that the flame will char the cork slightly.

Roofing-Cement Holder

It is very inconvenient to be obliged to hold a cement can while working on a roof, and for this reason the holder shown



in the illustration should appeal to all who must do such work. It consists of a wooden block, with one side cut to correspond to the angle of the roof and three nails driven through it as shown, the pointed ends projecting just far enough to catch the roofing paper and prevent the block from

sliding. The upper ends of the nails keep the can from sliding off the block.—John A. Blaker, West Auburn, Mass.

Moving Tank on Runway

When moving a heavy iron tank up a wooden runway by means of a block and tackle, using lengths of iron pipe for rollers, it was found that the rollers were forced slightly into the wood, due to the weight on them, and this caused them to stop turning.

Increasing the pull on the tackle did not help, but merely caused the tank to slip over the rollers. One of the men obtained two pipe wrenches and applied them to the front and rear rollers in the same manner shown in the drawing. Turning the wrenches caused the rollers to turn while the load was being pulled up and also exerted an additional force in moving the load.

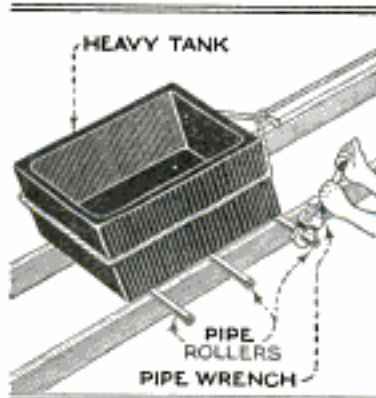

Motor-Driven Sieve for Foundry

In foundries and elsewhere a considerable saving of labor and time can be effected by using a motor-driven sieve of the

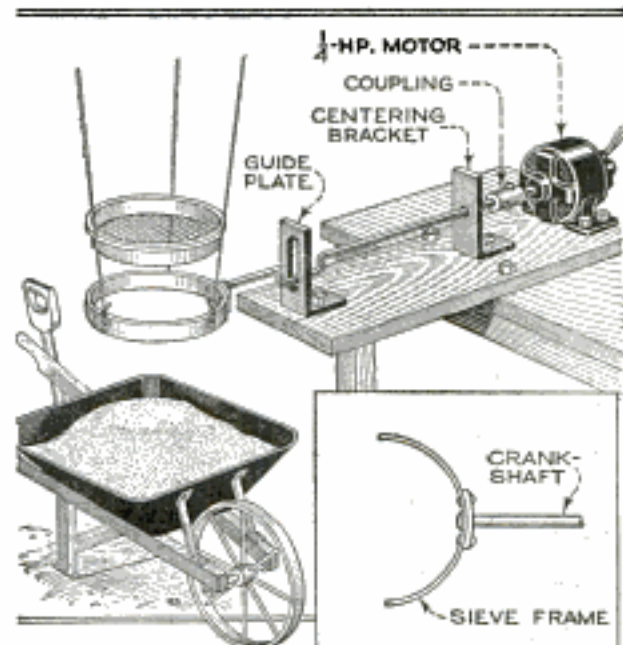

A Motor-Driven Sieve that Has Been Found a Time and Labor Saver

kind shown in the drawing. The sieve is held by a ring suspended from the ceiling on three cables, to prevent it from upsetting and to permit some lateral motion. The shaft that actuates the sieve fits loosely in the side of the ring, the hole being reinforced by a small piece of sheet metal, riveted on and drilled for the shaft to fit loosely. The other end of the shaft is coupled to the motor, as shown. Two brackets made of steel plate are used to support the shaft and to serve as bearings; the one nearest the sieve has a vertical slot a trifle wider than the diameter of the shaft cut through it so that the shaft, which is bent to form a crank at this point, will oscillate at this end when rotated. The other support is simply drilled to a neat fit for the shaft. The size of the motor to use for this purpose, of course, depends on the size of the sieve; for small sieves a 1/4-hp. motor has been found large enough. In use, the operator places a wheelbarrow or other container under the sieve and then shovels the sand into it. Besides being useful for sand, it can be used for sifting grain, ashes, and other materials.

☛ To keep milling cutters from slipping on the arbor, put writing-paper washers between the steel washers and the cutters. Very thin copper or brass washers can also be used.

A Substantial Lumber Rack

The lumber rack shown in the illustration has some excellent features, and

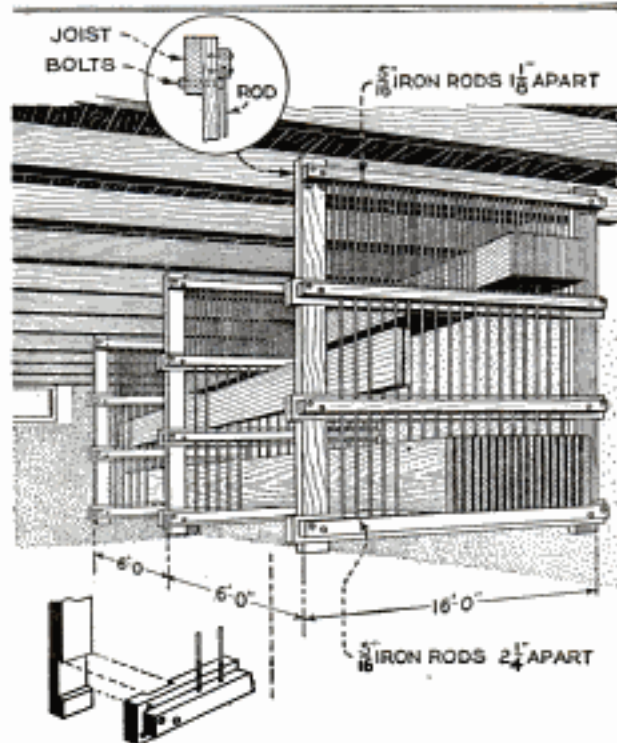

A Novel and Substantial Lumber-Drying Rack for the Woodworking Shop

should prove a valuable addition to any woodworking shop.

There are three frames, ends and center. Each frame consists of two upright pieces bolted to the floor joists, and four cross-pieces, half-checked and screwed to the uprights. The novel feature lies in the separators used in the frame. In building a lumber rack, it is common practice to use stock about $\frac{7}{8}$ in. thick by 1 or $1\frac{1}{4}$ in. wide; these not only waste valuable space, but are easily broken. In this rack, $\frac{1}{8}$ in. iron rods are used, held in strips screwed to the crosspieces of the frame. In the two center strips, $\frac{3}{8}$ -in. holes are bored right through, spaced $2\frac{1}{4}$ in. between the rods. In the bottom strip these holes are spaced the same, but are $\frac{3}{4}$ in. deep only. In the second strip from the top, $\frac{3}{4}$ -in. deep holes are bored between the through holes, and in the top strip the holes are spaced $1\frac{1}{8}$ in. apart, and bored through.

Thin stock, $\frac{1}{2}$, $\frac{3}{8}$, $\frac{3}{4}$ in. thick, etc., is stored in the upper rack, and the heavier stock in the lower ones. If it is necessary to remove one or more rods, to store very thick stock, or to replace bent rods, it is only necessary to raise the rod out of the bottom hole, draw it out enough to clear the strip, and pull it out. Putting in

new rods only means reversing the operations. The rods, of course, are cut to such a length that they can be raised enough to clear the bottom strips.—M. E. Duggan, Kenosha, Wis.

Replacing Wire-Wheel Rims

Repairmen who occasionally have to replace a bicycle rim, know how puzzling it is to put the spokes into the new rim correctly. This difficulty can easily be overcome by securely tying every pair of spokes together at the point where they cross, which will hold them in position until they have been attached to the new rim. A good method of doing this is to twist a short length of iron wire around them with a pair of pliers. If it is necessary to replace any of the spokes, this should be done after they are in place on the new rim, in order to avoid making mistakes.

Centering Round Work on Milling Machine

It is a slow and tedious task to find the center of a shaft when cutting a keyway or other groove in it. To eliminate this difficulty we made a center-finding tool of the kind shown in the drawing. It consists of an iron base, a vertical guide rod, with a keyway cut lengthwise as shown, and a centering block, which is drilled to fit the guide rod, and has a V-groove on each side. This block is provided with a pin, the end of which slides in the groove of the guide rod, and a setscrew to tighten the block on the rod at any point desired.

In use the block is raised and dropped onto the shaft, which automatically centers it, then the setscrew is tightened. The milling-machine table is then raised and moved until the cutter is in the center of the upper V-groove.—L. H. Moore, Toronto, Can.

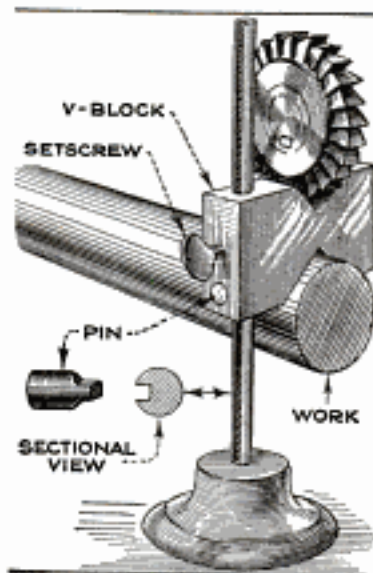

Building a Blower for the Forge

By RAY F. KUNS

Principal, Automobile Trade School, Cincinnati, O.

PRACTICALLY all machine shops and garages are equipped with some style of forge, often "knocked up" hastily from scrap material, but, while the making of the forge is quite simple, many mechanics are "stumped" when it comes to designing a blower.

The blower shown in the accompanying illustration was designed to supply a forge having four tuyere irons, and, when driven at a speed of 2,000 r.p.m., it provides

drums was chucked in the lathe, and the edge faced off until it was $\frac{1}{2}$ in. wide. The points at which the lugs were to be attached were then marked on both drums, and the lugs turned, drilled, and welded in place, leaving generous fillets of filler material on each lug, as indicated in the side elevation. The separate parts of the hous-

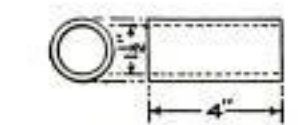
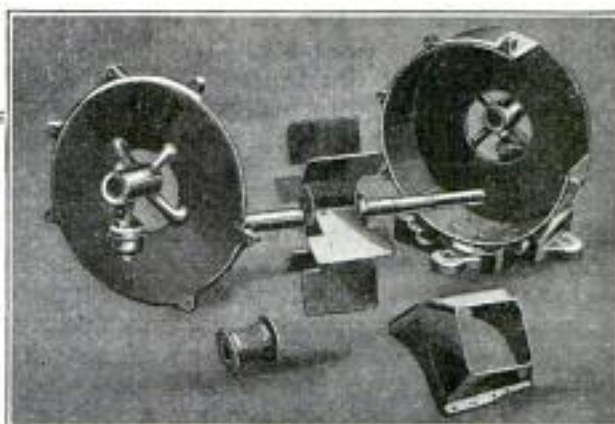
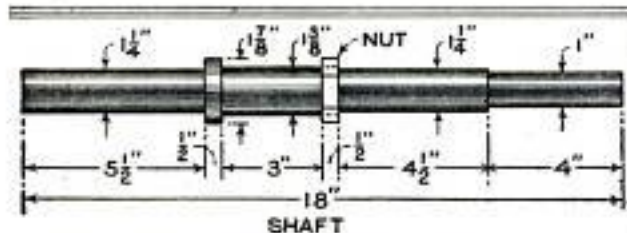

BEARINGS MADE OF GAS PIPE, 2 REQUIRED

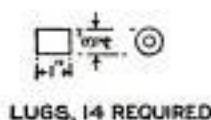

LUGS, 14 REQUIRED

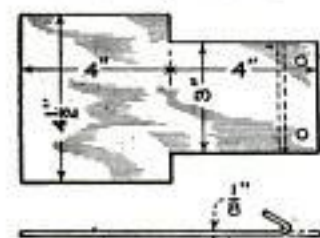

FAN BLADE, 6 REQUIRED

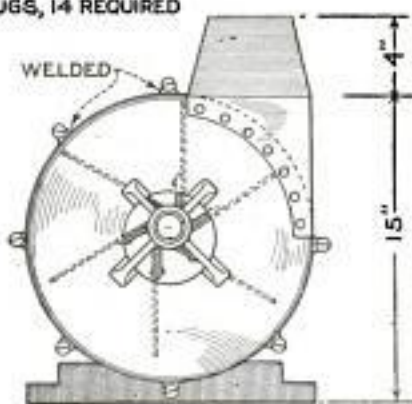

SIDE ELEVATION

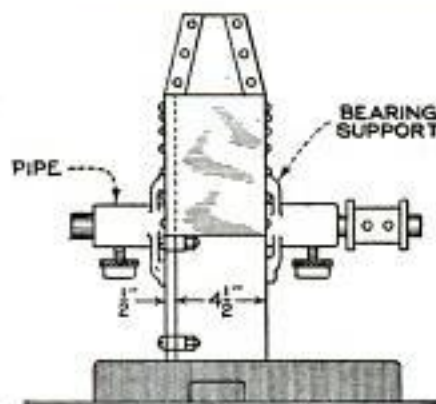

END ELEVATION

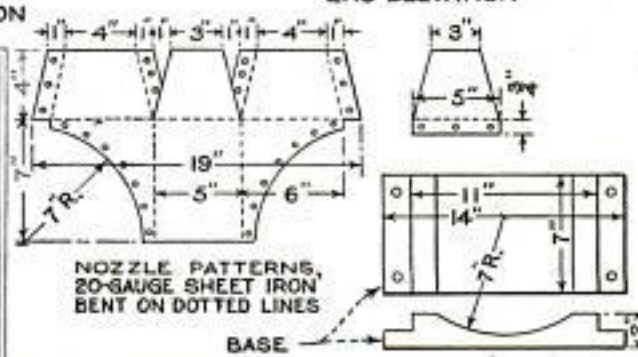
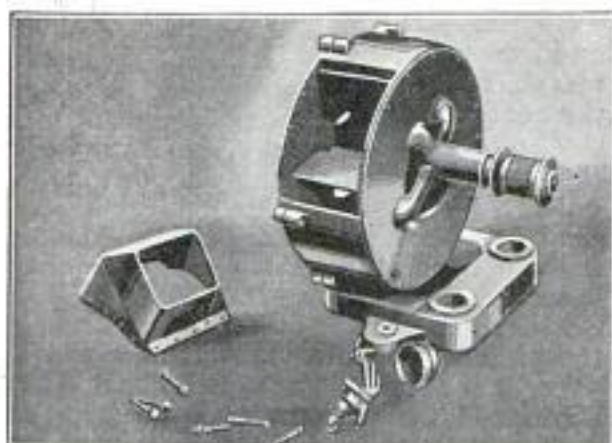

NOZZLE PATTERNS, 20-GAUGE SHEET IRON BENT ON DOTTED LINES

BASE

A Sturdy and Simple Blower for the Garage or Machine-Shop Forge Made from Scrap Material

enough pressure to operate all at the same time, when driven by a 1-hp. motor. The materials for its construction were found in the scrap heap.

Two 12 to 14-in. brake drums are required for the body or housing of the blower. In this case the drums were 14 in. in diameter by $4\frac{1}{2}$ in. wide. One of the

ing were then chucked and faced true in the lathe, after which the half-lap joint was turned.

The boxes for the bearings were made of $1\frac{1}{2}$ -in. pipe, 4 in. long. Short lengths of $\frac{1}{2}$ -in. iron rod were shaped to fit against housing and boxes, for supports, and the supports welded to the boxes as shown. The base was made from an old cast-iron

jig base; to provide a good seat for the housing the base was set up on the lathe carriage, and a fly cutter used to cut an arc of 7-in. radius in it. The housing was then hot-riveted to the base. A piece of hardwood may be used as a base if cast-iron is not available.

The shaft was made from an old automobile axle shaft, but, of course, machinery steel is quite as good. As may be noted, a collar was turned for the fan assembly to butt against, and threads chased for a nut to lock the fan assembly. The fan blades, six in number, were cut from $\frac{1}{8}$ -in. sheet steel, and welded to a built-up spider sleeve bored to fit the shaft. After mounting and locking the fan assembly on the shaft, the latter was placed between centers on the lathe, and the blades turned to insure that the lengths and widths were all equal. After all machine work was completed, the fan was balanced by placing a rivet or rivets in the blades requiring weight, testing for balance on a pair of

straightedges. The fan was made $\frac{3}{4}$ in. smaller in diameter than the housing.

The fan was then assembled with the bearings, and the latter placed so that the blade edges would just clear the point on the housing to which the upper edge of the nozzle is attached, the opening for the latter having previously been cut; the bearings were then welded to the housing, and babbitted, after all machine work was completed and the parts assembled. This insures the bearing being in alinement. The shaft should be heated and smoked before the babbitt is poured. Wick oilers, from attached oil cups, are used to lubricate the shaft.

The nozzle was made from 20-gauge sheet iron, cut to the pattern shown, in two sections, the sections riveted together, and the nozzle riveted to the housing. While the design shown was perfectly satisfactory, it may, of course, be changed to suit individual requirements, or if different materials are used.

Making and Using Cross Valves

A much neater and stronger pipe job can be done by using a cross valve than by using an ordinary angle valve, because

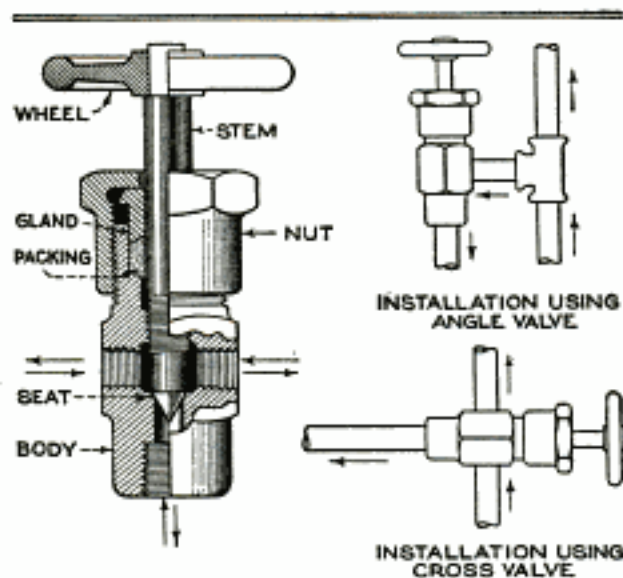

Left: An All-Steel Angle Valve for Use as a Cross Valve. Right: Comparative Installations

the tee and nipple, which must be used with the latter, are eliminated. A cross valve can readily be made by drilling and tapping the side of an all-steel needle-point angle valve, as indicated in the sectional view to the left in the illustration. The run of the valve is used in the main feed line, and when the valve is closed, the liquid flows in only one direction.—
J. V. Romig, Allentown, Pa.

Clamping a Grooved Pulley

The novel pulley clamps shown in the illustration were successfully adopted when it became necessary to place a grooved pulley on a shaft already in place. To enable the pulley to be placed without disturbing the shaft the following work was done: First, four small holes were drilled as shown and pins slightly tapered at both ends were driven in place; two holes for bolts were then drilled, and four clamping pieces drilled in the center to clear the bolts used for tightening, and at either side to suit the pins, the distance between the holes being a little

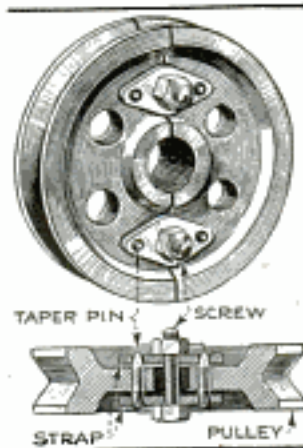

less than the center-to-center distance of the pins. The pulley was then sawed in two, on the line of the bolt holes. When assembled on the shaft the bolts were tightened, which drew the clamps together; the center distance of the holes being less than that of the pins, both sides of the pulley were drawn together, binding it securely on the shaft.

Oil the rocker arms on overhead-valve motors at least every two days. This takes only a moment and prevents wear.

Compressing Auto Springs

When installing snubbers on an automobile it is necessary to pull the strap as tight as possible, and this makes it necessary to compress the spring, which is impossible to do by hand or with a "C" clamp. The springs can be compressed without any difficulty by running the car in the garage doorway so that the middle of the spring is located directly under the door-frame header. The wheels are then blocked to make them stay in place and a length of 2 by 4-in. timber forced between the car frame and the header, directly over the axle, a piece of cloth being placed below the wood to prevent damage to the enamel. The wheel is then jacked up as far as necessary to attach the snubber snugly, making a nice tight job when the spring is released.—Rev. Philip Jonker, Peekskill, N.Y.

Locking Drill Chuck

The drawing shows an effective method of locking a drill chuck of the threaded-sleeve type. This chuck finds favor in many shops, as it is easily opened and closed by hand, but this very feature

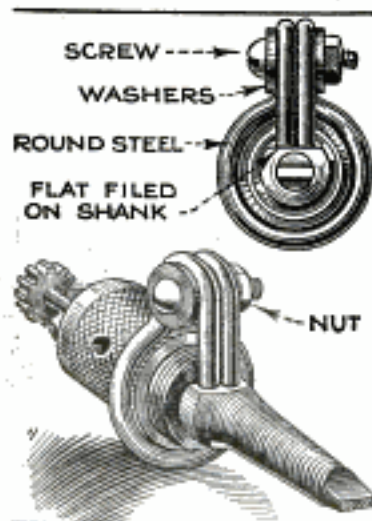

is a disadvantage if the chuck is run in the reverse direction. Small shops, which are compelled to utilize tools to the fullest capacity, often find it necessary to use a drill chuck in the milling machine for holding small shank end mills, etc., and

in such cases the lock shown is very useful. It can be made in a few moments to suit any size chuck by bending a piece of round steel around the chuck sleeve and forming the ends so as to bear on a flat spot filed on the shank. In use, the chuck is first tightened on the cutter in the usual way, and the ends of the lock are then squeezed together by a nut and screw, locking the chuck sleeve securely. Left-hand cutters can be held firmly in this manner, whereas if the sleeve is not locked the action of the teeth in cutting will loosen the chuck by unscrewing the sleeve, and perhaps spoil the job or break the cutter.

Preparing Castings for Welding

Welding on some work is very difficult, because the piece to be welded is of such a form or the break is at such a point that

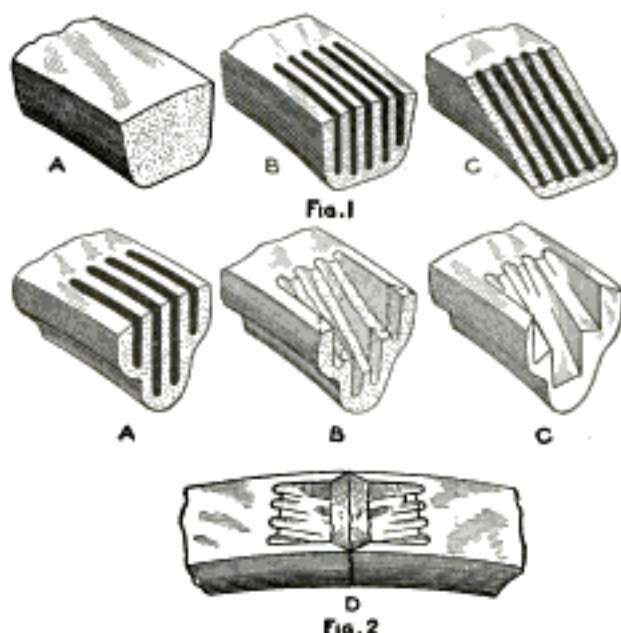

Improved Method of Doing a Good Job of Welding on Small, Irregularly Shaped Pieces

it is almost impossible to clamp it tightly in a vise for beveling, to provide a scarf for the weld, without danger of further breakage by pressure.

A good method of handling such a job, if the piece is of the general form shown at A in Fig. 1, is to clamp the work lightly in a vise and then make a series of parallel cuts with a hacksaw, as shown in B. The cuts are made almost to the bottom edge and at an angle which will make sufficient clearance for the welding operations to follow. The end is then beveled as shown in C, breaking off the sections by the wedging action of a thin-bladed cold chisel. In case the piece to be welded is of a more irregular contour, as shown in Fig. 2, the saw cuts are made of a depth proportional to the thickness of the material, as shown in A, and cut out as in B. The end is then beveled, as shown in C, by means of a file or emery wheel. When both sides of the break are prepared in this way, they are set together as indicated in D, and a good weld can easily be made.—C. R. Van Druff, McLouth, Kan.

☞ Grease or vaseline, rubbed on the hands before starting on a dirty job, will keep the dirt out of the pores, and enable the hands to be cleaned much more easily afterward.

Resurfacing Worn Street Pavements

Worn-out pavements with large "potholes" may be transformed into first-class boulevards by resurfacing with sheet asphalt. Recent developments in paving practice have shown that this can be done whenever the original base is in good condition, no matter how irregular the surface may be, or from what material it is constructed. The work of resurfacing can be accomplished in a few days without seriously inconveniencing traffic, as only half of the street need be surfaced at a time, leaving the other half open to traffic, whereas, when making a new pavement, traffic must be stopped until the concrete base has had time to set properly.

The area to be resurfaced is first thoroughly cleaned of all foreign matter by sweeping with rotary sweepers or hand brooms. The larger "potholes" are filled with concrete, defective gutters are rebuilt, and loose bricks are either relaid or replaced with concrete. The surface is then sprinkled with pure asphalt, heated to a temperature of about 300° F. This seems to produce a more effective bond between

the sheet asphalt and the original surface than can be obtained if the sheet is laid directly on the old pavement. The sheet asphalt is then brought from the plant, at a temperature a little higher than 300° F.,

dumped just ahead of the part already laid, shoveled into place with heated shovels, and raked to a uniform surface with heated iron rakes. It is then tamped, sprinkled with limestone dust, and thoroughly compressed by rolling with a 15-ton roller. After rolling, squares are cut out around valve boxes, manhole covers, etc., the castings raised to the new grade and reset in concrete, and a asphalt laid around them. The asphalt layer is allowed



Above, Dumping the Heated Sheet Asphalt; Below, Spreading Pure Asphalt over the Old Pavement

to thin out to a feather edge at the gutter, so as to avoid building a new gutter.

In Dayton, Ohio, some streets resurfaced in this way with layers averaging about $\frac{1}{2}$ in. in thickness, have given satisfactory service for two years, with no indication of the asphalt pulling loose from the surface. The resurfacing cost 49 cents per square yard.—Ivan E. Houk, City Engineer, Dayton, Ohio.

Wood Preservatives

During the last 10 years it has been proved by tests performed by the U. S. Bureau of Agriculture that coal-tar creosotes are more effective in protecting wood against boring insects such as "white ants," and Lyctus-powder post beetles, than any other wood preservative known. Wood, impregnated with the creosote under considerable pressure, has been found to last for at least 25 years. The open-tank method of creosoting

wood, if carefully done so that good penetration is obtained, will render the wood resistant for at least 15 years. On farms where it is impossible to use this method on the wood of buildings already erected, or on fence posts, the best method is to apply several coats of creosote with an ordinary paint brush or spray; this will add from 2 to 5 years to the life of the wood, providing it is not too old when the creosote is applied. By adding pigments to the oil a very neat and presentable appearance will be given to the wood.

Interior woodwork should be treated with zinc chloride, bichloride of mercury, sodium fluoride, or chlorinated naphthalene. Mercuric chloride is very poisonous, and, as it has a tendency to come off in small quantities, should not be used. Lumber, implement handles, wagons, etc., that cannot be treated with coal-tar creosote, for various reasons, should be stored in creosoted sheds.

Grinding Screw Ends

Sometimes screws of standard sizes are just a few threads too long for some particular job, and this makes it necessary to grind down the ends. If any number of screws of the same size must be ground down in this way, a simple holder of the type shown in the illustration will be found of considerable assistance, as, with it, the grinding can be accomplished without the necessity of frequent dipping in water to keep the screw cool.

The shank or body of the tool is a short length of $\frac{5}{8}$ -in. machine-steel rod, pointed at one end so that it can be driven into a wooden handle, and a piece of $\frac{3}{8}$ -in. flat steel about $\frac{5}{8}$ in. wide, bent as shown and drilled through the center to receive a

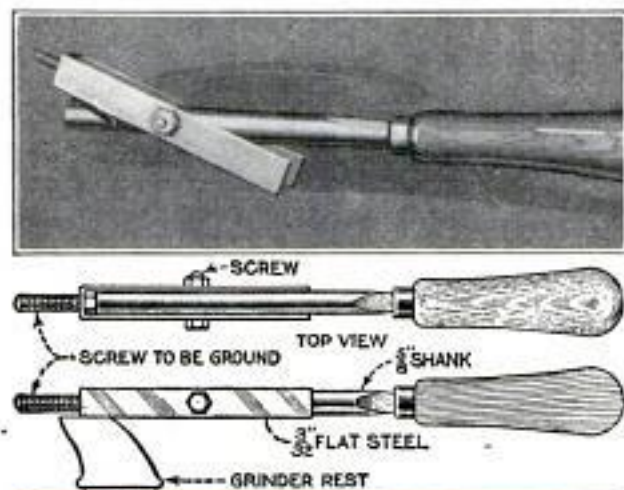

Simple but Effective Tool for Grinding Small Screws Rapidly

small screw, with which it is attached to the shank. The end of the flat piece is drilled to suit the diameter of the screw to be held, just enough space being allowed between the end of the shank and the screw heads to hold the screws securely. With this holder the operator need not touch the hot screws at all as they drop out themselves when the tool is opened. In use, both parts of the tool are held together and steadied on the toolrest, as shown in the lower detail.—Harry Moore, Montreal, Can.

Divider Attachment Marks Gears

The divider attachment is well worth including in a repairman's kit for its usefulness when "pegging" gears.

When several teeth of a gear have been

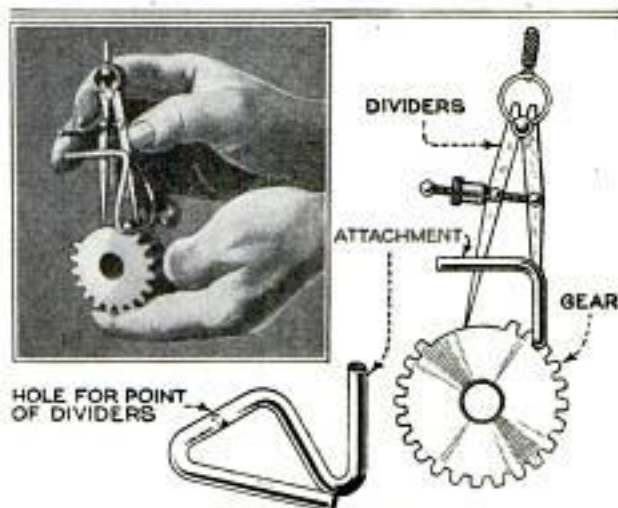

Simple Attachment that Enables the Repairman to Space Pegs Correctly When Repairing Gears

sheared off it is, of course, important to place the inserted pegs in the same position as the broken teeth, and it is for the purpose of marking the correct position that the attachment shown in the photo is used. It is made from a length of drill rod, bent to the shape indicated and drilled for the point of the dividers. The attachment and dividers are then assembled, the cross leg of the attachment set between two of the gear teeth, and the free point adjusted to the center of any convenient tooth. It is not necessary to open the dividers enough to span the complete gap in the gear teeth; about half the distance will do, as the dividers are used from each side of the gap. After filing or grinding off the remnants of the broken teeth, the surface is blued and the attachment moved across the tooth with the free point of the dividers touching the blued surface. The same process is repeated in the next tooth space and so on until the position of each missing tooth has been marked.

It will be seen that the dividers are held securely at right angles to the axis of the gear, so that the lines marked will run straight across, besides preserving the correct pitch. If the lines are followed closely in drilling, it will be found that no trouble will develop from "off-pitch" pegs.

Celluloid triangles may be written upon with anhydrous acetic acid. This may be colored to contrast with the celluloid.

Homemade Pipe Bender

In a Kansas shop, where it was necessary to turn out a number of short lengths of 1-in. pipe, bent at one end to a half cir-

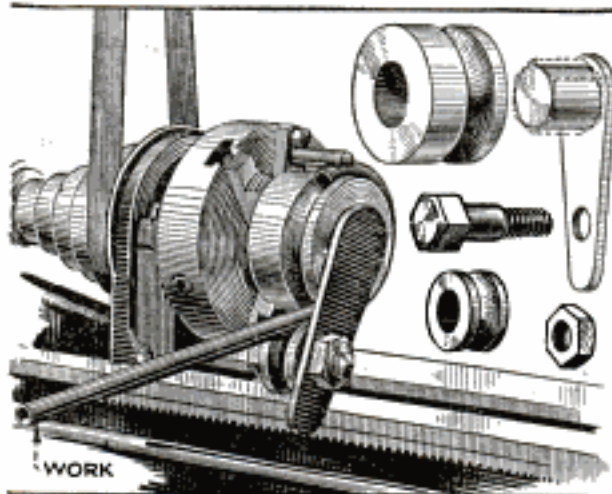

A Homemade Pipe Bender that Is Attached on the Lathe, Has Been Found Very Efficient

cle, having a radius of 6 in., all attempts to do this by heating the pipe, packing it with sand and then bending, and by numerous other methods, were entirely unsatisfactory.

One of the mechanics then decided to make a bender that would do the work. In looking for material to make it, he was fortunate to find a cylindrical casting of about the right diameter. This he chucked on the lathe, reduced it to the proper diameter and grooved it to fit the 1-in. pipe as shown in the drawing. It was then drilled out so that the side extension of an old discarded socket wrench would fit into it when the hexagon was turned as shown by the dotted lines. A small roller, also grooved to fit the pipe, was attached to the handle of the wrench extension with a shouldered bolt, and a stop was bolted to the chuck face. A length of pipe was run between the roller and the casting and between the stop and the casting, the stop being behind the roller when the handle rested on the ways of the lathe. The lathe was then revolved slightly more than a half revolution, so that the pipe would spring back to a half circle when the tension was removed. This bender made almost perfect bends without denting or flattening the pipe in the least.—Earl Pagett, Independence, Kan.

¶ The arc of contact of a grinding wheel on the work has a very important bearing on the grade of wheel required. The smaller the arc, the harder the wheel should be, and vice versa.

Removable Grip for Babbitt Ladle

When babbitt is melted in an ordinary gas furnace the ladle handle is almost sure to get too hot to be comfortable, and it is the customary practice to cover the handle with a bunch of waste to protect the hands. This is not satisfactory, because thick waste makes the handling of the ladle difficult and the waste often begins to smolder and burn. In one shop, a removable grip for the handle was made that proved very

satisfactory in use, and eliminated all trouble. A hole was drilled through the handle near the pot and a pin driven through, as shown in the drawing. The handle was then heated at the end and upset enough

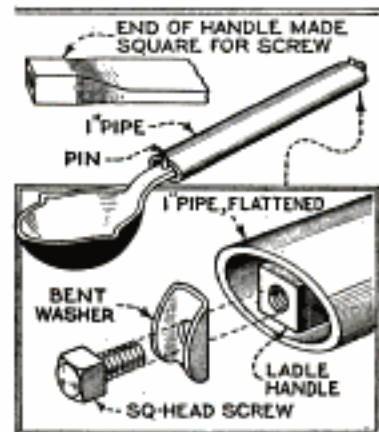

to enable it to be drilled and tapped for a capscrew. A length of iron pipe, slightly flattened, served as the grip, and was held on the handle by means of a screw and a round washer, both sides of the latter being turned up so that it would slip inside the pipe. The ladle is placed in the furnace with the grip off, and, when the metal is ready to pour, the grip is slipped on up to the pin, and the screw and washer in the end given a quarter turn.

Straightening Auto Rims

Dents in clincher rims can be removed very easily by means of the simple tool illustrated. It is merely half of a leaf spring

with the shackle eye at the end. A tapered punch is used to spread out the eye to $\frac{1}{2}$ in. in diameter, and the end is then cut off with a hacksaw to form a hook that can be placed under the bent edges of the rim. The dent is readily straightened by pulling the tool in the direction indicated by the arrow.—Fred Bar-

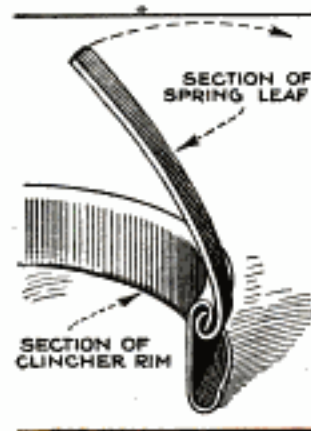

giband, Pittsburgh, Pa.

A Novel Ground-Feed Sifter

By DALE R. VAN HORN

A NEBRASKA poultry raiser has designed and built a novel ground-feed sifter and grader, with which he is able to separate any ground feed into four groups, graded according to the size of the particles, in one operation. Since all of the parts are such as may be picked up around the farm, making the cost negligible, a sifter of this kind will prove of value to every poultry raiser.

The frame of the sifter may be built of any available lumber, providing it is well jointed and braced; it is built to suit the size of the agitator, which may be made from any heavily built box. This particular agitator is 18 in. square by 14 in. deep. The bottom and top are knocked out, and four screens tacked in place as indicated by the dotted lines in the side view, the screen wire or cloth being first stretched on light frames as shown in the detail. The coarsest screen is arranged at the top, the next size just underneath, and so on, the finest being at the bottom. What falls through the lowest screen is practically flour, and falls into the bin at the bottom.

The agitator is hung in the frame at an angle, as shown, by means of four heavy sheet-metal supports, which are pivoted rather loosely on heavy screws at both ends. Hinged to the bottom edge of the back side of the agitator is a wooden connecting rod or pitman, which shakes the agitator back and forth. The connecting rod is split at the outer end to take a split bushing that rides on the crank. The

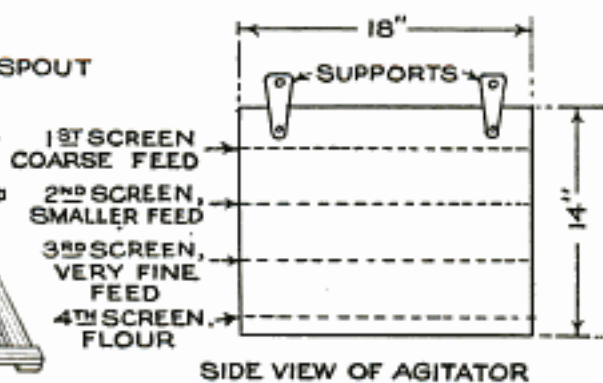
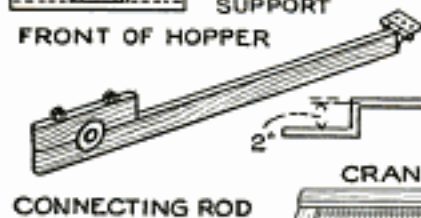
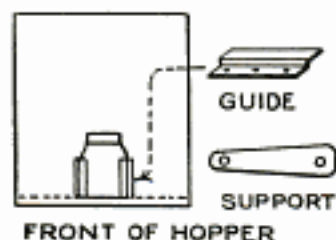
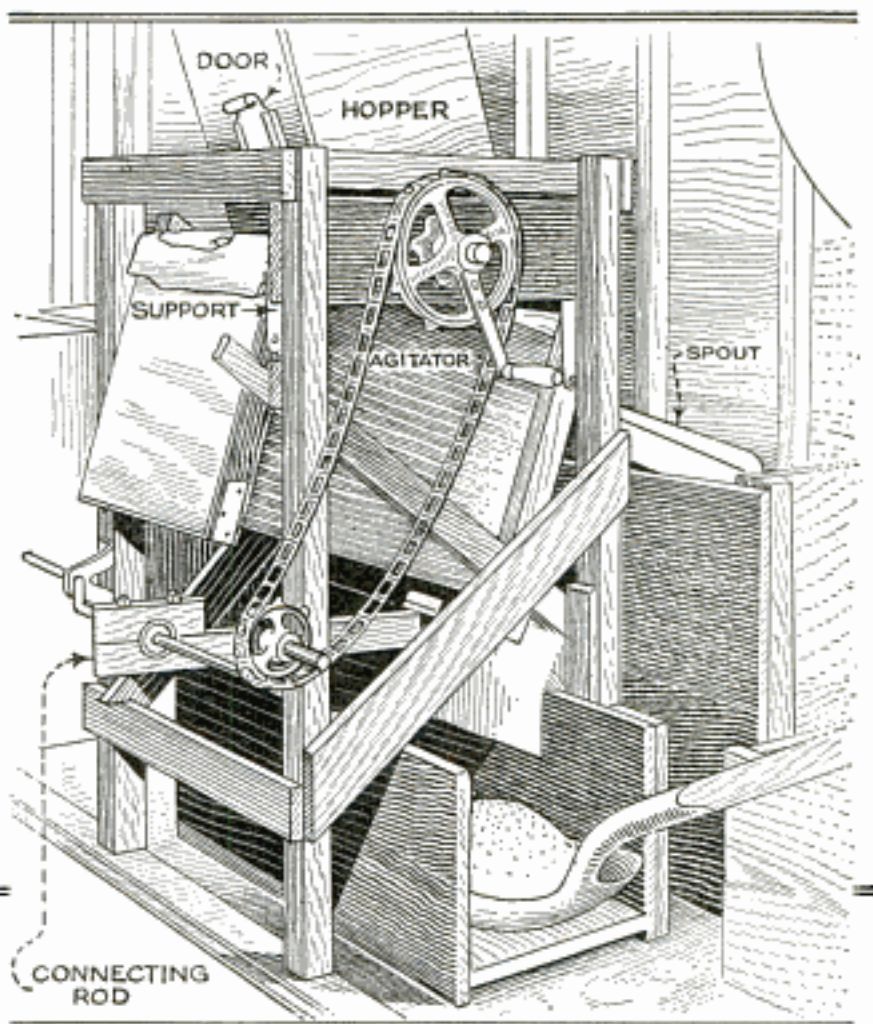

Above, Front View of Sifter, Showing Operating Mechanism; Below, Details of Construction of the Various Parts

crankshaft is made of $\frac{1}{2}$ -in. iron rod, as shown in the detail; it has a 3-in. sprocket keyed to one end, and runs in flat-iron bearings bolted to the frame. The crankshaft is driven by means of a chain, from a 7-in. hand-crank operated sprocket mounted on a stud attached to one of the upper frame members. The crank has a

2-in. offset, giving the agitator a motion of 4 inches.

A hopper, tilted in the opposite direction to the agitator, is firmly fastened to the top of the frame, to contain the unsifted feed. The flow to the agitator is controlled by a sheet-iron door, sliding in guides nailed at the sides of the opening.

Tightening Concrete Forms

Concrete forms for walls are usually tightened by means of lengths of wire, which are doubled, run through the sides of the forms at regular intervals, and twisted in the center by means of a stick. This method of tightening the wire necessitates working within the forms, which is very often difficult. A better method, which allows the wire to be tightened outside of the form, is shown in the illustration.

The chuck end of an old brace is flattened at one end, and two holes, slightly larger than an ordinary fence staple, are drilled as shown. The end is then slotted with a hacksaw as indicated and closed slightly to create a slight spring.

As the forms are erected the wires are passed through the holes drilled for them, a staple with a washer under it being hooked under the doubled end. The two free ends are twisted together and a nail inserted under them, a washer being provided under the nail to prevent the nail from being sunk into the form. To tighten the wires, the brace is slipped onto the staple and is then turned to twist the wire to the desired tension. The forms can later be removed by simply slipping the staple out of the wire and the washers will not be damaged. The holes in the staple side of the forms, of course, are large enough to take the doubled wire.

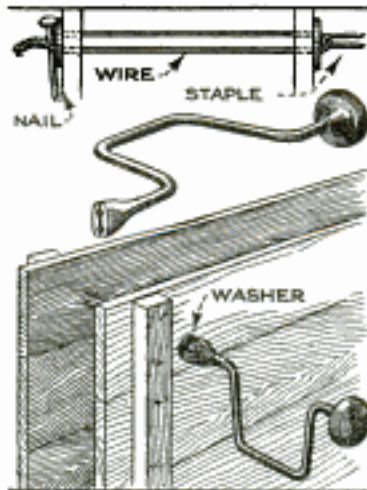

☛ Frequently a solid tire run out of line will develop lumps or an uneven tread. To remedy this, take the tire to any pneumatic-tire store and have the rubber buffed.

Turning Gasoline Car on Track

Turning a gasoline-propelled car around on railroad tracks can be accomplished easily and quickly by means of the device shown in the drawing.

It consists of a 12-in. jack and a piece of 1 by 4-in. iron bar, bent to the shape shown and fastened to the frame of the car, in the center, with U-bolts. A hole is drilled in the bottom of the attachment to fit the top of the jack. Screwing up the jack lifts the car, and as soon as it clears the tracks sufficiently it can be swung around. This can be done by one man in two or three minutes. The bar, of course, is permanently attached to the car frame and the jack is always carried on the car.—L. W. Brown, Braeman, Tenn.

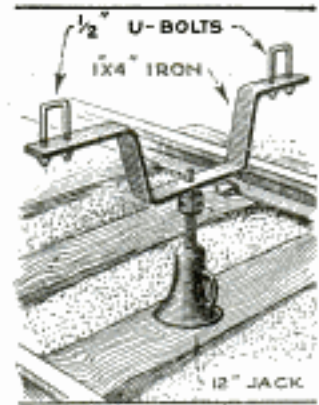

Facing Bosses to Gauge

In machining a large number of castings, the bosses of which had to be faced to an accurate dimension A, a simple gauge

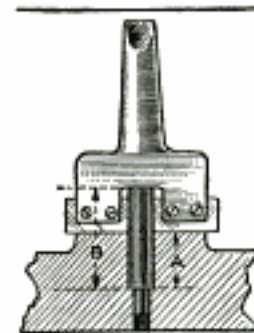

was made that greatly facilitated the operation, and prevented spoiled work. The facing tool used was of special form, as shown in the illustration, and a hardened-steel pin was used with it to serve as a gauge. The pin was of such a length that, with the tool seated on its top, the cutters had faced the boss to the correct height. Knowing that he could not spoil any work as long as the pin was in place, the operator made much better time than was possible by any other method.—J. H. Moore, Toronto, Can.

Curing Blowing Out of Gaskets

Some gasoline engines of the type having a detachable head are constantly blowing out gaskets. This usually occurs at the narrow points, as between the cylinder bores, or in the valve-chamber area, and is usually due to a slightly warped cylinder casting. A permanent remedy for this trouble is to cut two pieces of sheet copper, .005 in. thick, large enough to cover the place where the gasket blows out. One piece is placed below the gasket and the other above, and the head is then clamped down tightly. A new gasket must, of course, be used in making this repair.—G. C. Douglas, Raleigh, N. C.

Pan Catches Automatic Screw-Machine Work

Most automatic screw machines are so tooled that one operator can attend to several, but allowance must be made for a certain amount of spoiled work, as the operator's time must be divided between the machines. In a factory where small wire goods are made, the pan shown in the illustration is used to prevent spoiled pieces from entering the box containing work passed as correct. The pan is made of

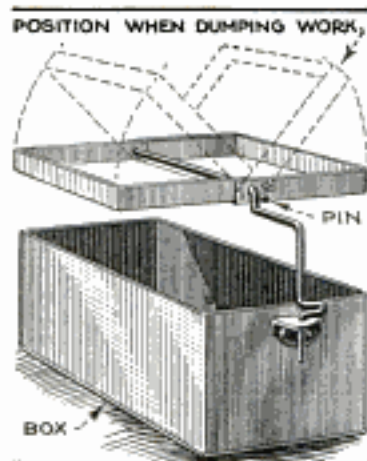

sheet metal and consists of two pieces, made in the shape of half trays. One piece fits over the other as shown and has its sides extending beyond the bottom of the other a short distance so that there will be space for the work to pass through when both sides of the pan are lifted to the position indicated by the dotted lines. Both sides pivot on a length of steel rod, bent to the shape shown, and passed through the hole in the box handle. A pin is riveted to the outside of the larger pan, and rests against the rod holding the pans, so that the weight of the work, which drops on this side, will not cause the pan to tip over. The operator inspects the work in the pan, and, if it contains no spoiled pieces, the sides are lifted and the work slides into the box below. If it contains spoiled pieces the work is emptied into another box.

Cutting Wire Safely

Above a certain diameter, steel wire cannot be cut conveniently with ordinary pliers, and therefore a chisel is often used

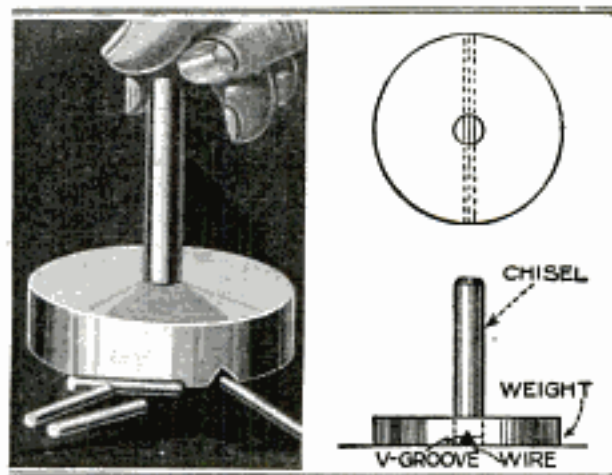

Left, Cutting Heavy Wire; Right, Details of Cutting Fixture

for the purpose. This method is rather dangerous, however, as the small pieces are likely to fly into the worker's face, and it is also somewhat inconvenient, as the pieces are apt to be lost. A better method of cutting the wire is to use a flat block of steel as shown, with a V-groove cut across the bottom, and a hole drilled through the center for a round-shank chisel. The wire is pushed along the groove and is cut off with the chisel.

To cut the wire in equal lengths, it is either nicked with a file at the points to be cut and the wire then pushed along until the nick comes directly in the center of the hole, or a weight is placed on the block and a stop is provided on one side so that the wire can be pushed up against this and then cut off. Spring wire can be cut safely in this way without any danger.

Adding to Usefulness of Micrometer

It is often necessary to take micrometer readings on work of the kind shown in the illustration. This is made possible by grinding down the head and part of the anvil about $\frac{1}{2}$ in. as shown, leaving a $\frac{1}{2}$ -in. lip projecting. This will not affect the accuracy of the micrometer and will add considerably to its usefulness.—F. J. Haas, Milwaukee, Wis.

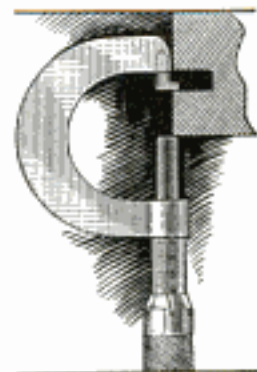

Bench Vise with Universal Base

Due to the limitations of the ordinary stationary vise, a workman must often stand in an uncomfortable posture in

order to apply the file or other tool to the work properly. To overcome this difficulty, the vise illustrated has been devised and found very successful; it has a spherical base that can be ad-

justed to any position within an arc of 90° ; this makes the vise especially adaptable for use in assembling small parts where individual fitting is necessary.

The constructional details and dimensions are clearly indicated in the drawing, but may be varied somewhat to suit individual tastes and requirements. The vise jaws slide in a T-guide that forms part of the body of the vise. A screw with right and left-hand threads, turned with a small socket wrench, moves the jaws. The jaws are, of course, made of steel, and are hardened and tempered.

The body, as well as the flange base and the plate underneath, is made of cast iron, although steel or brass will serve equally well. Machine bolts hold the flange base and the plate securely to the bench. A screw, provided with a ball-shaped head that seats in the body of the vise, and with a wingnut that can be loosened or tightened to permit adjustment, clamps the body when set. A setscrew in the side of the guide may be used to lock one jaw of the vise in position.

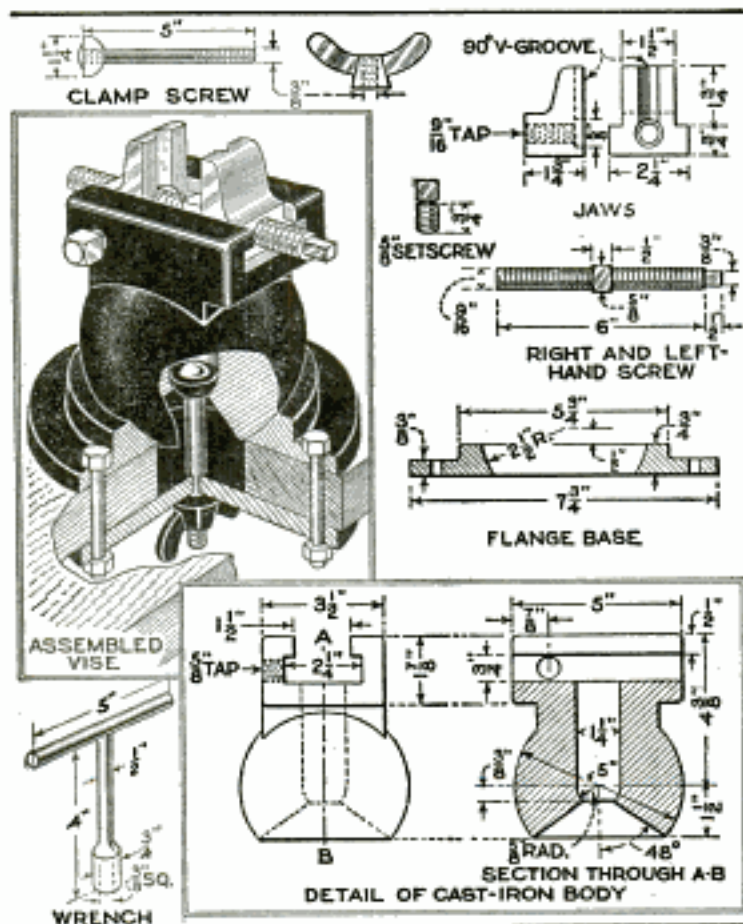

Bench Vise that Will Be Found Very Useful by Toolmakers and Machinists, as the Base Can Be Adjusted to Many Positions

Simple Lock for Hand Crank

On certain types of machinery, such as printing presses, some sort of hand crank is required to complete a certain cycle of operations or to bring a certain part of the machine to a position for adjustment or repairs. In case a gear-driven manual movement is used, the gears can be prevented from accidentally meshing by means of a simple catch of the type shown in the illustration. A semicircular

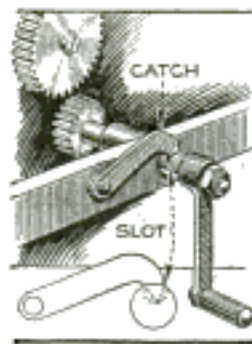

groove is milled in the shaft to receive a flat-steel dog, which is fastened to some convenient point on the machine frame. The groove should be cut in the top of the shaft as the weight of the crank handle will

cause this side to remain up at all times. When it is desired to engage the crank with the machine gear, it is only necessary to turn the crank to disengage the dog, and the gears can then be meshed.

Tearing Off Stamps

Generally the hardest and most disagreeable part of getting out a large lot of mail is the stamping of it, as the stamps soon become sticky if handled very much, and any attempt to tear up a number of sheets at once while flat, results in mutilating some of them. An easy method of tearing off a large number of stamps into strips is to roll several sheets into a tight roll about 1 in. in diameter. The successive rolls can then be broken off at the perforations without any danger of tearing the stamps. As many as ten sheets can be torn at one time in this way.—James Ellis, Memphis, Tenn.

Carpenters' Improved Tool Box

By EDWIN M. LOVE

THE ideal carpenters' tool box should be light and strong, simply built, with space enough for all tools used on the ordinary job, and have a special place for each tool, so that the owner can see at a glance what tools, if any, are missing.

The tool box shown in the accompanying illustration fulfills these requirements almost perfectly, being but $31\frac{1}{4}$ in. long, $8\frac{1}{4}$ in. wide, and $13\frac{3}{8}$ in. high when closed, yet it opens into a vertical rack displaying all tools to the sight, with the most frequently used tools removable instantly and independently of the rest.

Three-ply birch panel veneer, $\frac{3}{8}$ in. thick, is the material used, the main grain of the wood running lengthwise of the box on top, bottom and sides and vertically on the ends.



Make glued butt joints, nailing with three-penny common nails every 2 inches. Lay out the lid, bore the hinge holes in the top of the box, and then rip the lid loose; this insures a perfect fit without further work. Attach the hinges with machine screws and nuts. The handles, made of hardwood in two pieces, as shown in the drawing, enable both lid and box to serve in the carrying strain.

Make a bit rack, as shown, of two tapered blocks, A and B, and place in the lid, block A being bored and B slotted. This rack is for seven sizes, from $\frac{1}{8}$ to $1\frac{1}{8}$ in., and the bits are placed shank to lip, to save space. This rack is covered by the small-bit rack shown in the lower right-hand detail. Make this, on a $\frac{3}{8}$ by $6\frac{5}{8}$ by $9\frac{1}{2}$ -in. veneer back, with $\frac{3}{8}$ by $\frac{5}{8}$ -in. strips, and attach turnbuttons to hold the bits. This rack is held firmly by the large-bit rack end stop, two small stops glued to the bottom and side of the compartment, and a small hook and eye attached to the end stop. By means of light turnbuttons, a butt chisel, spoke-shave, bevel square, and gouge are held on the back of the smaller bit rack.

Nest the planes in the bottom, on their sides, as shown in the drawing, with the level behind; slip the take-down square behind the level and fill the spaces with butt gauge, greaser, oilcan, etc. The boxlike shelf at the right

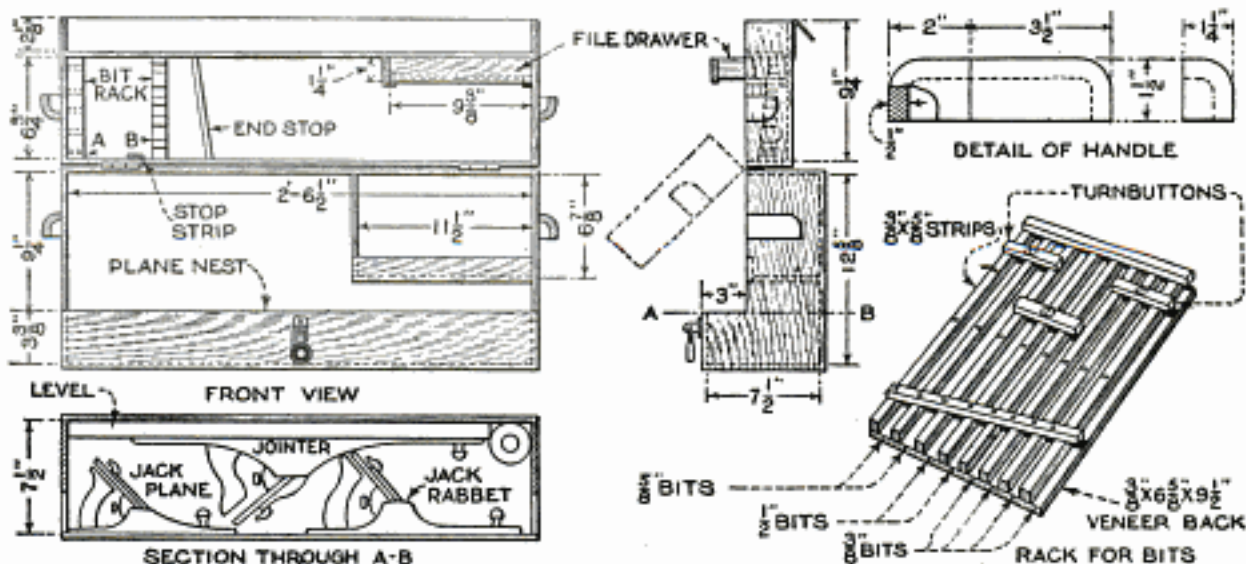

Above, Tool Box Open Ready for Work, with Saws on Shelf; Below, Full Details of Construction, and Method of Nesting Planes

contains a No. 45 universal plane, suspended upside down, with the boxes of cutters below in a vertical position, and the iron rabbet plane in front. The push drill lies behind the edging of the shelf, the block plane stands on end at the left side, and the hand drill is tucked in as well. The arrangement of the other small tools must be governed by the number and style, but turnbuttons seem to be the most practical means of keeping them in position. It is a good idea to silhouette all tools in black on the inside of the box, in position, so that any missing may be noticed immediately, when the box is packed.

Rip a hardwood strip 7 in. long to slip over the saws and keep them well nested as

they lie in the bottom of the box, on top of the planes. With this strip they can be lifted out bodily and set up on the upper shelf of the lid, as shown in the photo. Note that this shelf is exactly $2\frac{1}{8}$ in. below the edge, so that it will slip over the saws when the lid is down.

Make and attach the small file drawer shown in the upper right-hand corner of the lid. Reinforce the edges of the box with $\frac{3}{4}$ by 1-in. galvanized-iron window flashing, nailing with $\frac{5}{8}$ -in. brass escutcheon pins, well clinched. Put on a hasp and catch, and paint the box, and the job is done. If the box must stand out in the rain, carry a small strip of oilcloth to lay over the top.

Right-Angle Attachment for Straightedge

In building construction every part must be made plumb or square and the tools used to do this are a large steel square, a plumb line, a chalk line, and a spirit level.

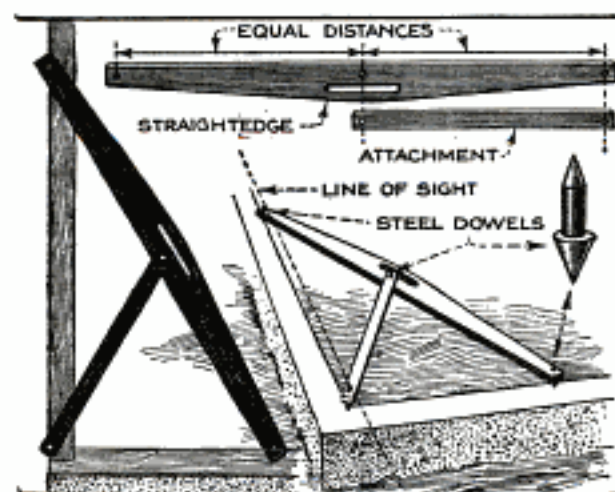

Accurate Method of Laying Off Right Angles by Means of a Simple Attachment for the Straightedge.

An easily improvised tool that will serve the purpose of these tools in many cases, with results that are just as accurate, is an ordinary 8-ft. straightedge fitted with the attachment shown in the illustration. Two pointed steel dowels are driven into the ends of the straightedge, and a similar dowel exactly halfway between. Pivoted loosely on the center dowel is a length of 1 by 3-in. piece of wood, also fitted with a dowel at the end. The distance between the center dowel and each of the other three dowels must be exactly equal, as the accuracy of the device depends on this.

In using this device for laying off the corners and other right angles of walls, the dowel on the attachment is carefully set on the corner as shown in the drawing,

and, with one end dowel on the straight-edge in line with it on the edge of the wall, the other dowel will lie on a line that is exactly at angles to the first. The correct position of a mark at the other end of the wall, or any other point in line with either side of the right angle, can be sighted over two dowels as indicated by the dotted lines. The three end dowels will always be located at the point of a right angle and its sides, regardless of the position of the attachment.—G. A. Luers, Washington, D. C.

Gravity Feed for Drill Press

Sensitive drill presses may be made self-feeding by means of the simple arrangement shown in the drawing. This works well for small holes through material of medium thickness. The regular feed handle is removed and a piece of round stock of the same diameter, doubled over at one end as shown, is substituted for it.

On this piece a weight made of heavy round stock drilled near one end is placed. The outer end of the bent handle is upset a little to prevent the weight from sliding off. In operation the weight is slid out to the long end of the handle, as indicated, to feed the drill through the work while the operator is engaged with other work. The drill head is raised automatically by slipping the weight to the back.

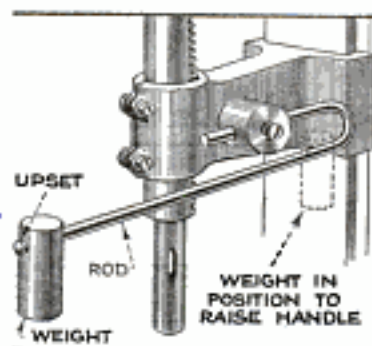

Jack Aids in Assembling Clutch

Considerable difficulty is usually experienced in removing and replacing the clutch spring while dismantling or assembling an automobile disk clutch. However, the special jack shown has been found to overcome the difficulty.

The illustration shows plainly how the jack is assembled and used. The base, which is made of cast iron, is drilled and tapped at the top for a $\frac{7}{8}$ -in. screw and at the bottom for a $1\frac{1}{4}$ -in. plug, which is counterbored to fit the drive shaft.

The head that holds the clutch spring is made of a suitable piece of steel or wrought-iron pipe. It is counterbored at one end, $\frac{1}{2}$ in. larger than the diameter of the spring washer, and has large slots cut in the sides to admit the thrust bearing and nut, when the spring is compressed. It is fitted with a standard pipe cap on the other end, the cap being drilled to fit over the small pivot turned on the end of the screw. The screw is made of a good grade of steel, and has a hexagon head.

In use, the clutch is first assembled;

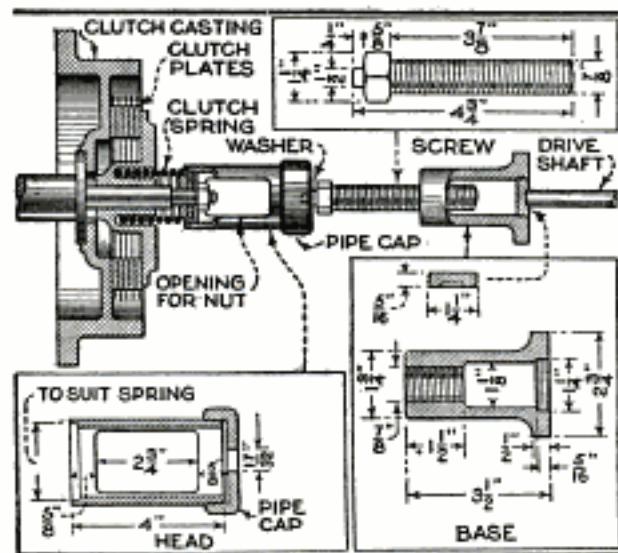

A Jack for Compressing an Automobile Multiple-Disk Clutch Spring that Has Been Found to Save Time

the head of the jack is then placed over the spring washer, and the base against the drive shaft; after the spring is compressed, the thrust bearing can be put in place on the clutch spindle. The jack can then be released.

Boring and Turning Attachment for Small Lathes

An attachment that will bore and turn short lengths with speed and accuracy, is very useful on small lathes, especially

those that are not equipped with a tool-rest or carriage.

The tool consists of a forged center

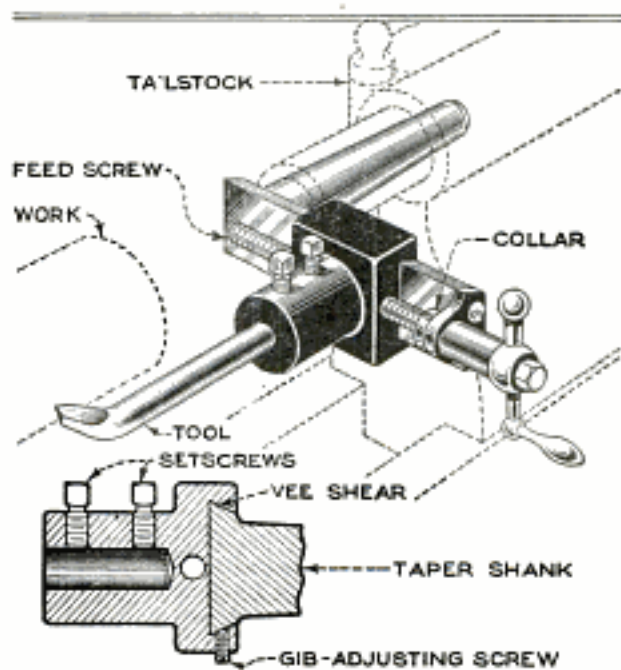

A Useful Attachment on Small Lathes for Boring and Turning Short Lengths Accurately

shank, which fits the taper in the tailstock spindle. On the front end a V-slide extends at right angles to the axis of the shank. On this V-slide is mounted a tool saddle, made from a steel block of suitable proportions, which can be made to slide in or out by the action of a feed screw. The tools are made of drill rod, the largest ones of $\frac{1}{2}$ -in. stock. When using smaller tools, bushings are used to take up the play in the tool slide, the bushings being split so as to allow the setscrews to hold the tools. To work to the best advantage and accuracy, the tail spindle should be clamped just snugly enough to prevent vibration under a cut. In making the shank of the tool it is advisable to turn up the taper shank and face the front of the slide between centers. Then the faced slide can be mounted on parallels on the shaper and the angular sides of the vee can be shaped. This method of making it will insure the squareness of the fixture. In order to have the tool-receiving hole in alignment with the headstock center, this hole should be drilled, after assembling, with a drill chucked in the head and with the attachment fitted in the tailstock. The operations possible with this attachment are drilling, boring, turning, facing, and cutting off. When used for cutting off, a support, such as a tee rest, should be placed below the tool.

An Acetylene-Torch Rest

Many jobbing welders have felt the need of a simple rest for holding the torch during the short time required to move the work to a new position, or to place a new

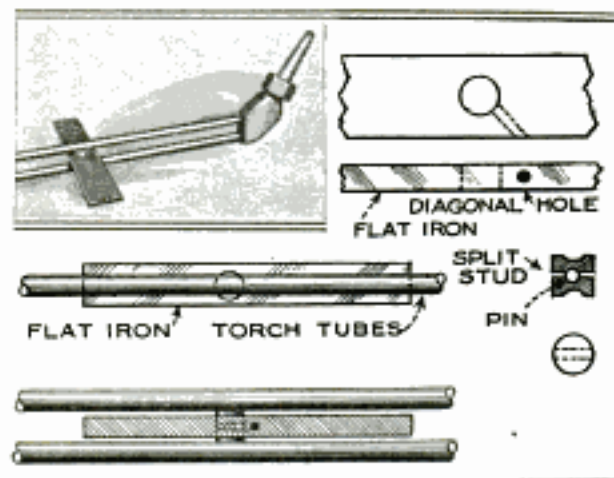

A Rest for the Acetylene Torch, of Utility when Laying Aside the Tool to Change Work

piece. A very convenient attachment for this purpose is shown in the illustration.

A short length of flat bar is drilled in the center for a pin, or stud, which fits between the torch tubes. The method of making this stud and assembling it is as follows: It is first drilled through the center crosswise and then sawed in two through the center of the hole. Both ends are then filed concave so that when a pin is inserted in the two halves of the hole, the split stud is a snug fit between the tubes. The last operation consists in drilling a diagonal hole the same size as the pin through the side of the bar as shown. In assembling, the stud is placed in the hole in the bar, and, the pin being out, it slips easily between the tubes. Then the bar is turned to the angular position neces-

sary to line up the diagonal hole with the hole in the stud and the pin driven in the latter, clear of the bar. This arrangement is necessary to prevent the pin from working out, for, as the bar is always held lengthwise except when the torch is to be set down, the two holes are never in line. With the bar attached to the torch in this manner the latter is supported so that the flame is directed upward and away from the operator.

A Solid Adjustable Wrench

On production work it is highly desirable to use special wrenches with as little adjustment as possible, to suit the nature of the work for which they are used. A wrench of this kind, which was designed to fit three sizes of nuts, is shown in the drawing.

The body of the wrench is made of flat stock and two small jaw pieces are bent and slotted as indicated to fit the jaws, and attached by means of small screws and nuts. When using the wrench on the largest size nuts, both jaw pieces are swung to the outside position as indicated by the dotted lines in the lower detail. When used for the next size, one jaw is swung to the inside, as at the left, and when used for the smallest size, both jaws are swung to the inside. This wrench was used on a milling fixture, where it was found much more convenient to have one wrench for this purpose than three separate wrenches.

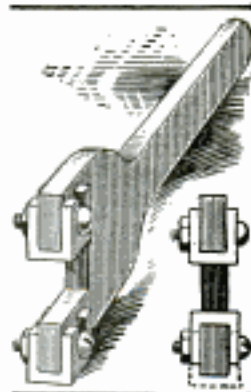

Substitute for Trailer

The demountable attachment shown in the photograph was made by a paper-hanger, and has proved to be an excellent substitute for a trailer. It is very

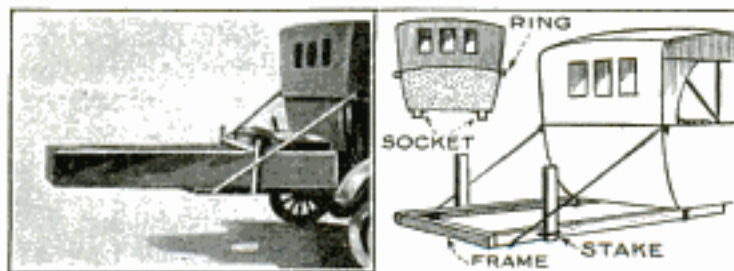

Attachment for Light Touring Car Permits Bulky Objects to Be Carried Easily

sturdy, and can be attached or detached in a few minutes.

The framework is made of 2 by 4-in. lumber, constructed as shown in the drawing. To the underside of the frame $\frac{3}{4}$ -in. boards are nailed to form the floor. A 2 by 4-in. stake is fastened on each side and the load is kept in place by lashings, tied around the stakes. The inner ends of the frame extend beyond the flooring, and fit into two U-shaped metal sockets, bolted to the chassis. Iron rods, attached to eyes or rings on the back of the body, as shown, support the rear of the carrier.

Replacing the Charging Indicator

Many older-model cars are fitted with a charging indicator, which merely indicates "charge," "off," and "discharge." It will be found a great convenience to replace this indicator with an ammeter, as this will not only show the rate at which the charging or discharging is taking place, but, by abnormal readings, will warn of any grounds in the circuits. The ammeter will also show when the generator is not charging at the correct rate. When connecting, care should be taken that the starting-motor current is not taken through the ammeter, as this will ruin it immediately; only the lighting, ignition, horn, and charging current should pass through either ammeter or indicator.

Handling Shock Covers

When curing alfalfa, it often occurs that wet weather sets in and much of the hay in the shocks is damaged. This damage can be prevented by using heavy canvas covers, which will save the fodder from being saturated by rain. A weight is, of course, tied at each corner to prevent the wind blowing the covers off.

An Illinois farmer found it practical to make a large number of small concrete



Weighted Canvas Shock Covers that Protect Alfalfa Crop from Rain, and Skid Used to Carry Them

weights for this purpose, and a simple skid for carrying the weighted covers around. The covers are neatly hung on the top rail of the inverted V-shaped skid, so that they can be instantly lifted off and placed over the shocks, one by one.

Painters, carpenters, and others, using ladders frequently, will find that if the center of the ladder, where it balances, is marked with a strip of bright-colored paint, the workman can grasp the ladder at this point immediately when preparing to carry it, thus saving energy and time.

Balancing Tool Divides Strips

In a factory where a quantity of brass-strip binding is used, a novel tool for

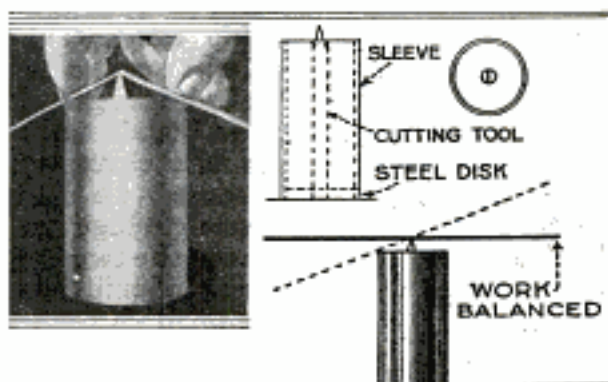

Tool for Dividing Brass Strips Equally: Insert, Bending Balanced Strip Before Cutting

cutting the material has recently been adopted.

Two strips of regular length are often cut in two to suit the smaller sizes, and because so many different lengths have thus to be divided equally, the balancing tool shown in the illustration has been found more efficient than the old method of marking the strips for center and then cutting them.

The tool consists of a piece of round steel, flattened at one end and shaped to a chisel point, and a sleeve, a trifle shorter, cut from iron pipe; both of these pieces are a drive fit on a steel disk. In use the brass strip is laid on the cutting tool and moved until it balances. It is then bent down on both sides, as shown in the photo, tapped with a hammer and broken in two.

Square for Filing Templates

When filing templates having several straight edges in the vise, considerable time can be saved and eye strain prevented by using a vise square of the type shown in the drawing. It should be made of tool steel, hardened and ground, and should be just as long as the width of the vise jaw. After the template has been roughly cut down to the desired size, about $\frac{1}{2}$ in. outside of the lines, it is ready for filing and is clamped in the vise as shown, matching the line with the edge of the square. The latter prevents the workman from filing the template down too far. —Chas. Homewood, Ontario, Calif.



Level Clamps for Carpenters' Straightedge

Plumbing and straightening door jambs by the usual method necessitates holding a straightedge against the jamb, and press-



ing the spirit level against the straightedge. A California carpenter clamps his level to the straightedge and uses the two as a single unit, thus simplifying the handling and leaving one hand free to shift the jamb into position. The draw-

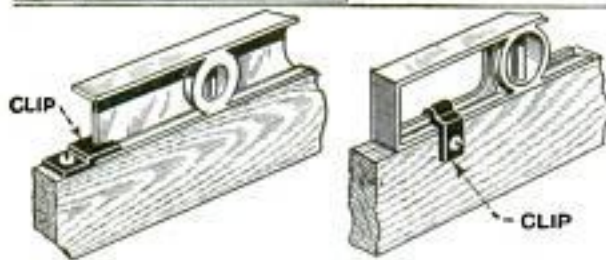

Above, Plumbing a Door Jamb; Below, Clips for Solid or Open-Frame Levels

ing shows two different kinds of clips, which can be made to hold the solid or open-frame type of level.

Quick-Acting Test Valve

The drawing shows how an ordinary valve, used to control the water pressure on a testing bench, was made quick acting. The testing operations made it necessary to open and close the valve every

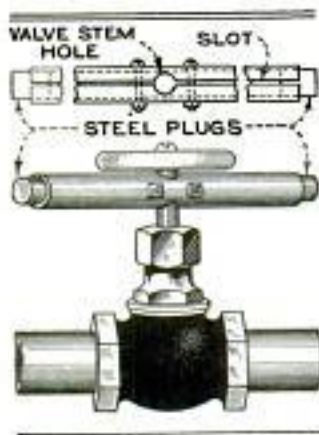

few minutes, and this consumed considerable time; whereas the device shown in the illustration enabled the operator to spin the valve wheel, opening and closing the valve in a fraction of the time otherwise consumed. The device consists of a short length of tube,

two round steel plugs, and a couple of nuts and screws. The tube is drilled in the center to fit the valve stem and at right

angles to this on each side to take the screws, and afterward slotted along its length as shown. The end plugs are a snug fit in the tube, and before the final tightening of the tube on the stem, the weights are moved in or out to attain correct balance. When correctly set, a slight spin of the wheel opens or closes the valve.

Brazing and Soldering Flux

Steel or copper brazing, and tin or copper soldering, can be greatly facilitated by using a flux of the following ingredients: Muriatic acid 4 oz., zinc, 1 oz., sal ammoniac 1 oz., English resin, 1 oz. Add the zinc to the acid, a little at a time, and then add the other ingredients. If one wishes to economize, 2 oz. of water may be added. The surface of the steel to be brazed is first swabbed with the flux and then wiped dry with a clean cloth; for soldering, however, it is not necessary to wipe the metal dry. Ordinary resin can be used if English resin is not obtainable.

Self-Closing Cover for Box

In shops doing a great deal of valve and plug grinding it is necessary to keep a cover on the box containing the grinding compound, as the smallest piece of foreign matter may cause a scratch that will take considerable extra grinding to remove. The box shown in the drawing is made of tin, and is fitted with a special cover, extending well beyond the front edge and bent to fit down over the sides as shown. Holes are punched in the top of the can and in the cover, and a wire pin is passed through the holes and bent down over the sides. The ends of the cover sides are bent out at right angles, as shown, and slotted to fit over the lower ends of the pin. After taking some compound out of the can, which is done with a stick, the cover will close itself as soon as it is released. The stick used for applying the compound should be thin enough to pass between the cover and the front end of the box, so that it can be placed in the position indicated when not used, to protect it from foreign matter also.

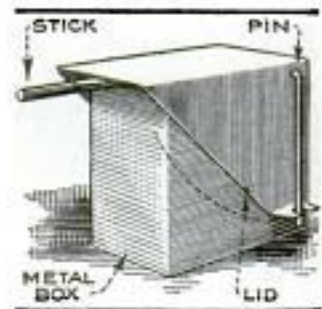



Cycling on Snow and Ice

By R. B. CUTLER

SEASONABLY shod with a tread such as that shown in the illustration, the "bike" can be depended upon for winter sport, or ordinary uses over ice and snow. With ordinary tires, cycling is not only hard work, in winter, but precarious; with the tread described here, however, good traction is assured, and the runner makes the machine easily handled.

The necessary materials are; twenty $1\frac{1}{8}$ by 3-in. back-flap hinges; seventeen $\frac{3}{8}$ -in. stove bolts, $2\frac{1}{2}$ in. long, and four 3 in. long; three strips of 26-gauge galvanized sheet steel, 2 by 30 in.; $\frac{1}{2}$ lb. rivets and washers; a pair of light 3-in. strap hinges; a 3-in. T-hinge; a pair of 3-in. butt hinges; a $\frac{3}{8}$ by $4\frac{1}{2}$ -in. machine bolt; six No. 14 screws, 3 in. long; one 1-in. awning pulley; 2 ft. of steel jack chain, No. 16, $\frac{5}{8}$ -in. link; one screen-door spring, and a skate. For a 26-in. wheel, one less back-flap hinge is used, nineteen $\frac{3}{8}$ by $2\frac{1}{2}$ -in. bolts, and one 3-in. bolt.

The twenty hinges are bent at each end at right angles, the lugs being $\frac{1}{2}$ in. long, and the countersunk sides opposite the lugs. Beginning $\frac{1}{2}$ in. from the end of

each galvanized strip, rivet the hinges to the strips, using four rivets to each hinge, and keeping them 2 in. apart. Equip two of the strips with seven hinges, and one with six, then connect each hinge to the next with the $2\frac{1}{2}$ -in. bolts. Cut the strips with $\frac{1}{2}$ -in. ends, center them over the rim of the wheel, and connect the end hinges with the 3-in. bolts. Tighten up all bolts, then, with pliers and hammer, shape the sides of the strips to grip the rim.

From 1-in. ash, cut a runner shoe, 3 in. wide and 25 in. long. Cut down 12 in. at one end to $\frac{1}{2}$ in. or $\frac{3}{8}$ in. thick and taper the sides down to $2\frac{1}{2}$ in. wide. Steam the toe, or soak it in hot water, then bend it to shape. The fork post fits

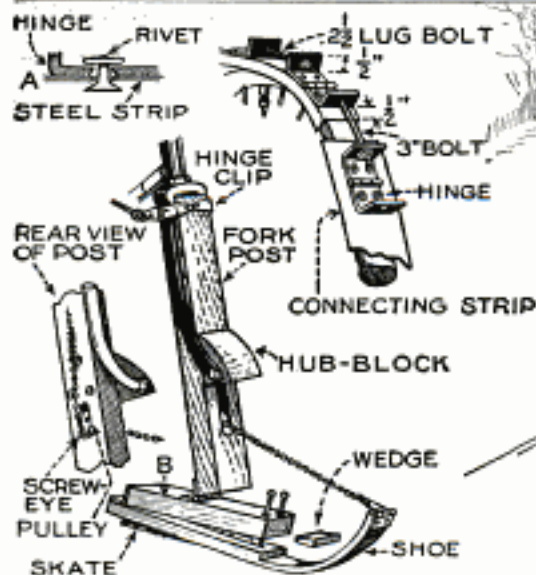

A Simple Tread and Steering Runner for the Bicycle that Will Enable It to Be Used in Winter as Safely as in Summer, and that Lessens the Hard Work of Pedaling in the Snow

below the head and is 2 in. wide and 24 in. long (22 in. for a 26-in. wheel); the hub block is 2 in. thick, 5 in. long, and $3\frac{1}{2}$ in. thick, and is bored to take the machine bolt with the post in place. To fasten the post below the head, shape the 3-in. strap hinges to form a clip, screw to the post, and bolt behind the head. With a bit and keyhole saw, cut a $\frac{3}{4}$ -in. slot, centered below the hub block, and extending down 4 in. at the front but only 2 in. at the back.

Cut the piece B of the runner, 2 by 3 in. long, and shape roughly a 3-in. side to fit the skate, placing the heel even with one end. If it is a clamp skate, remove the clamp and either drill screw holes or secure with three 3-in. mending plates as cleats. With the shoe shaped and dry, lay it over the skate with the toe end of B even with the shoulder of the shoe, and locate the skate toe. This point is the limit of the cutout in the shoe for the blade—a slit centered from the heel of the shoe.

Assemble the runner with the toe point of the skate set in about $\frac{1}{4}$ in. from the shoe bottom—so that there will be no possibility of “stubbing.” At this end there will be perhaps an inch space between B

and the shoe. Fit a wedge block here with the heel of the shoe brought up to block B, and secure it with two 3-in. screws driven through B, through the wedge, and into the shoe. These must be countersunk 1 in. and a washer or two used under each screw head. At the heel attach a 4-in. butt hinge, three screws into B and screw in each side of the shoe, then cut off any waste heel. At the toe, rivet the 3-in. T-hinge, as shown. Assemble the gear to the post with a 3-in. butt hinge centered on top of the B-block.

The 9-in. spring, pulley, and chain keep the runner “headed up” for easier steering, and safety when “jumping bumps.” Back of the post, secure the pulley with a screw eye set into the lower edge of the 2-in. opening. Cut the spring to length, and with another screw eye, fasten one end, then connect up the chain, around the pulley, through the opening to the hinge on the toe of the shoe. With the runner off the ground, if the spring is pulled down to within about 4 in. of the pulley, the tension should be right.

After trying out this tread for a few minutes, tighten up any hinges on the tread if necessary.

Detachable Bird Houses

It is becoming quite the fashion for country, suburban, and even city dwellers to provide small bird houses in yards and parks. They

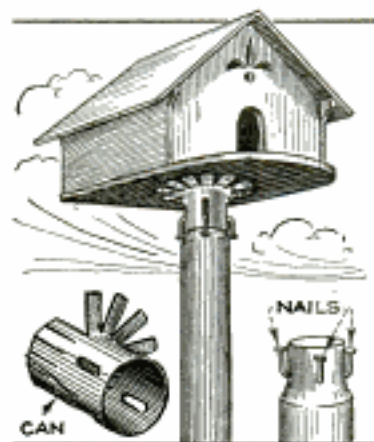

are usually mounted on poles or in trees, and as they are securely fastened, it is not an easy matter to remove them when it is desired to paint, repair, or clean them, which is occasionally necessary.

A method of mounting a bird house so that it can readily be detached is shown in the drawing. The top of the supporting post is trimmed down to fit loosely inside a No. 2 fruit can, which is cut and slotted as shown. The can is nailed to the underside of the bird house and slipped over the end of the pole. Nails are then driven into the slots and bent downward at right angles as shown, so that the can will not slip off. When removing the

bird house the nails are turned to the position shown in the lower detail, when the can may easily be released, by an upward pull.—G. E. Hendrickson, Argyle, Wis.

Emergency Ignition Repair

Ignition repairs made in emergencies on the road help to keep the car moving but are usually not very efficient, but a simple repair that was found entirely satisfactory is shown in the illustration. An ordinary high-tension coil of the kind used in a light car, which can be obtained anywhere, and a dry battery, were connected up with the distributor as indicated in the illustration. One of these coil units can be used with

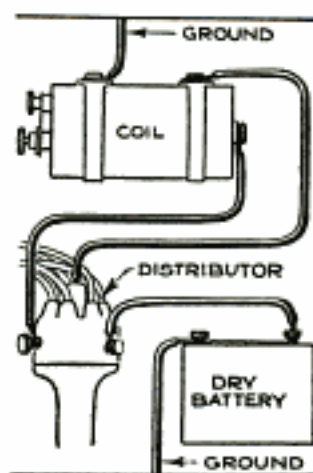

any breaker system. It may seem that the firing would be too early, but this arrangement has been tried and found to work perfectly.—R. M. Root, Anderson, Ind.

Bumpers for the Garage

Sand bags placed on the floor of the garage make excellent safety bumpers to prevent driving the car against the wall. They are easily dragged about wherever required and may be utilized as cushions upon which to sit or recline when making car repairs. Grain bags, or any heavy canvas bags will serve for this purpose, but they should contain only enough sand to make them about 6 or 7 in. thick.—G. E. Hendrickson, Argyle, Wis.

Simple Copy Holder

When using a typewriter under a fan or near an open window, some kind of holder is necessary to prevent the copy from being blown away. A simple holder can readily be improvised

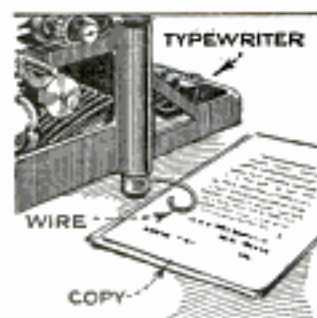

from an ordinary paper clip, the narrow end being left doubled and the wide end bent to the shape shown, so that it will press tightly against the surface of the table. The rubber foot of the left leg is partly unscrewed and the doubled end of the clip hooked around the screw, which is then turned tight to keep the clip in position. The copy is slipped under the spring clip and will be kept there securely.—L. H. Unglesby, Baton Rouge, La.

A Kink for Trappers

Every trapper has experienced the disappointment of finding that an animal had been caught in the trap, but got away. The most common cause of this is that the trap is fastened too securely to a stake or tree and this gives the animal a chance to pull itself loose. This trouble can be eliminated by attaching the chain to one or more small branches that will be dragged along when the animal attempts to escape. The work of dragging these tires the animal so much that it will not go very far with the load, and cannot free itself by sudden jerks.—H. H. Siegele, Emporia, Kan.



Snow Scraper Attached to Rake

A serviceable snow scraper can readily be made by attaching a piece of galvanized iron to an ordinary garden rake, as shown



Serviceable Snow Scraper Made from a Piece of Galvanized Iron Attached to the Teeth of a Rake

in the drawing. The metal should be at least $\frac{1}{8}$ in. thick and should be cut to the dimensions given in the upper detail. Short cuts are made at the points indicated and the strips between these cuts bent out as shown in the lower drawing. The loops thus formed should be made so that the tines of the rake must be forced into them, thus preventing the scraper from falling off the rake. A scraper of this kind costs much less than a manufactured one, and, if properly made, serves the purpose just as well.—Lorin A. Brown, Washington, District of Columbia.

Safeguarding the Aerial

Frequently a single-wire aerial is strung between the house and a near-by tree, and the swinging of the tree in a storm often breaks the wire or pulls it out of the support at the other end. A good method of overcoming this trouble is to place an ordinary screen-door spring between the end of the aerial and the house. This will keep the wire taut and at the same time prevent its being broken so easily. In some cases it may be desirable to have springs at both ends of the aerial.

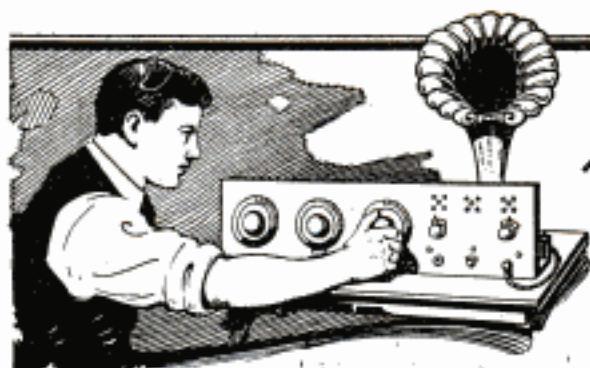

BUILDING A FIVE-TUBE NEUTRODYNE RECEIVER

BY F.L. BRITTIN

Part I—Assembling the Set

THE barriers to perfect long-distance reception have been removed by the design of the neutrodyne receiver, a result long desired, and heretofore regarded as almost impossible of achievement. Undesirable oscillation and regenerative effects are eliminated in this circuit; the tubes are prevented from oscillating by two condensers of very small capacity, called neutrodons, which are used to neutralize the grids of the radio-frequency amplifying tubes, thus preventing distortion. It is reported that radio messages from the Mac-Millan arctic expedition have been received with great clearness on a set of this type, although this is not surprising, in view of the fact that the same messages have been heard on a set of the type described in our March, 1923, issue, a set not especially adapted for long-distance reception.

The receiver is simple to construct, and consists of two steps of tuned radio-frequency amplification, the detector, and two steps of audio-frequency amplification. Three "neutroformers" are used, one as a tuning element, the others as tuned radio-frequency transformers. The neutroformer consists of two fixed windings, coupled to a 13-plate variable condenser and placed on the panel at an angle of 54.7° from the vertical. The builder need not trouble about the angle if the panel-template drawing is followed closely, as the holes are spaced to suit.

Bakelite, micarta, or hard rubber may be used for the panel, which is of standard size, $\frac{3}{8}$ by 7 by 26 in. Lay out the panel template, full size, on bristol board, pricking the centers of the holes with the point of the dividers. Clamp the template to the panel firmly, and with a sharp-pointed scribe, mark the position of each hole. This must be done carefully, especially the neutroformer-screw and shaft holes. The measurements should be

checked after removing the template, and the scribe marks made deep enough so that the drill will not slip, or they can be gone over with a prick punch. Use a No. 26 drill for all holes not marked otherwise, and countersink all holes marked with a double circle. Of course, holes for similar instruments must be drilled the same size; in some cases, hole sizes were omitted to avoid crowding the template drawing, as in the right-hand rheostat, for example, but the hole size is marked for the left-hand one, and the right is drilled to correspond with this.



Front View of Panel, Showing Location of Controls

After drilling the panel, mount the neutroformers; it is best to purchase these instruments, as well as the neutrodons, as accuracy is of first importance, and when

these instruments are made at home there is too much opportunity for error to creep in. This offsets the small additional cost of a standard tested instrument. The windings are placed on two bakelite tubes, the outer tube being 3 in. in diameter, and $2\frac{1}{2}$ in. long. It will be noted that all three secondary windings have a small loop tap at the 17th turn, near the top of the winding when the instrument is in place on the panel. No connection is made to the first or tuner-neutroformer tap, as may be seen in the circuit diagram; the leads from the taps on the second and third neutroformers are carried to one terminal of their respective neutrodons. The leads from the remaining terminals of the secondaries are led to the fixed and movable elements of the 13-plate variable condensers.

The primary of each instrument is wound on a separate bakelite tube, and the ends of the windings brought out to lugs fastened at the top and bottom of the tube. The primary is inside the secondary tube in the assembled instrument.

Two single panel-mounting sockets are used for the first and second radio-fre-

Simplified Wiring Diagram of Neutrodyne Circuit, with Instruments Spread Apart So as to Make the Connections Clear to the Novice

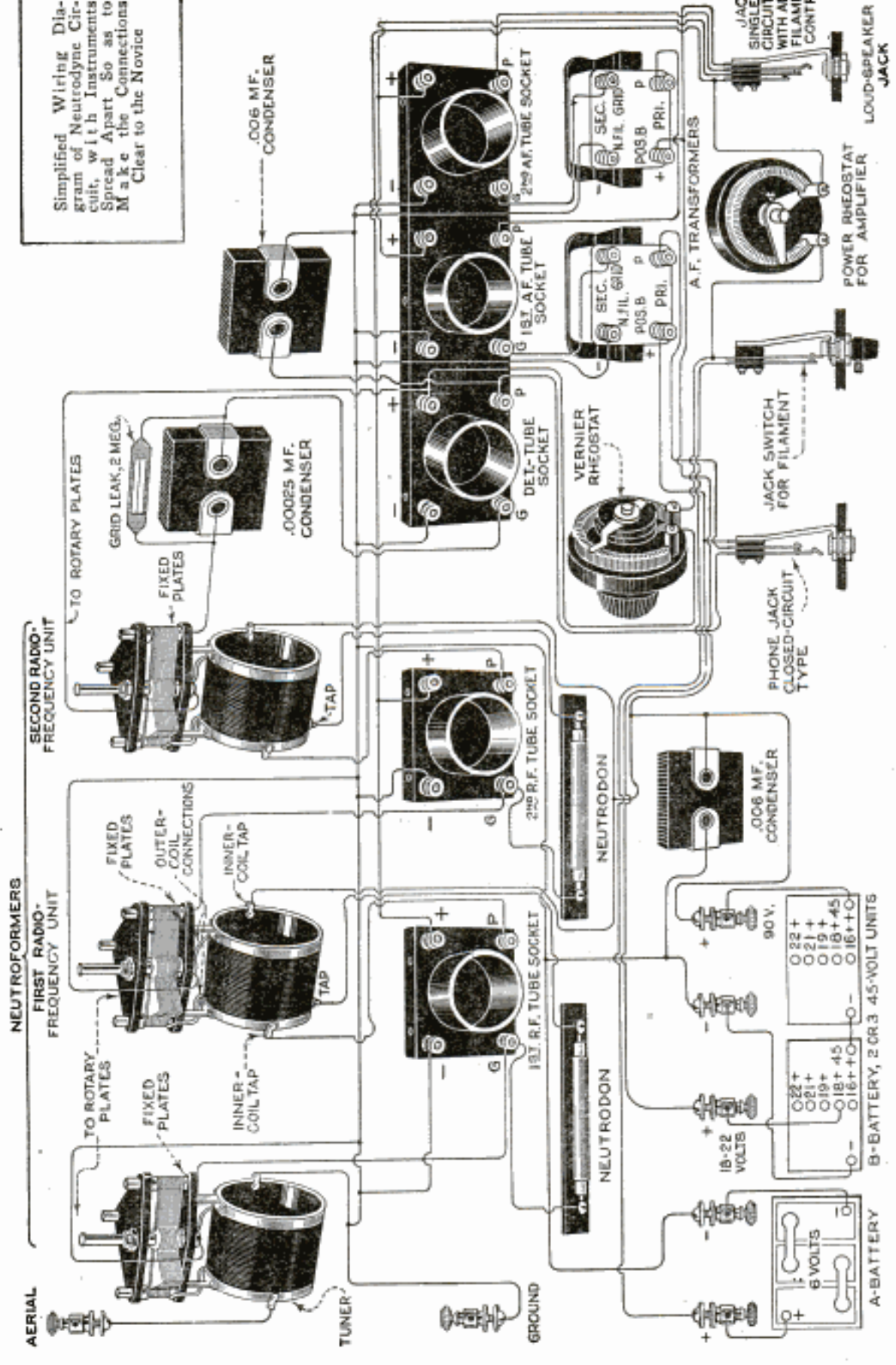

with the neutrotons. When wiring the circuit, bend the wire with the pliers so as to form the turns with a neat, small radius, and make each wire run at right angles to the others, as far as possible. Cut each wire to the proper length, as closely as possible, and slip on the "spaghetti" tubing before bending. Check the instrument against the wiring diagram.

The B-battery consists of two or three 45-volt units, connected in series. The detector-tube 18 to 22-volt positive binding post is connected to the corresponding terminal on the first B-battery unit. Some

tubes require more positive plate voltage than others, so experiment must be made from 18 to 22 volts to determine the correct voltage for any particular tube. The first negative B-battery connection is led to the center B-battery binding post on the panel, and the 90-volt lead to the remaining post. The amplifier positive voltage may be anything from 90 to 130, and the correct voltage must be ascertained by experiment.

Directions for neutralizing the tubes and tuning the circuit will be given in the March issue.

MATERIAL LIST

- | | |
|---|---|
| 1 panel, 3-16 by 7 by 26 in. | 1 pair phones. |
| 1 board, 1/2 by 6 by 26 in. | 4 UV 201A amplifier tubes. |
| 1 triple-tube socket. | 1 UV 200 detector tube. |
| 2 single-tube sockets. | 27 ft. No. 14 tinned-copper wire. |
| 3 neutroformers. | 27 ft. yellow varnished-cambric tubing. |
| 2 neutrotons. | 1 vernier rheostat. |
| 1 filament jack switch. | 2 .006-mf. fixed condensers. |
| 1 single-circuit jack, with automatic filament control. | 1 .00025-mf. fixed condenser. |
| 1 phone jack, closed-circuit type. | 1 2-meg. grid leak. |
| 3 4-in. dials. | 2 45-volt B-batteries. |
| 1 power rheostat. | 1 6-volt A-battery. |
| | 2 telephone plugs. |

Screws, lugs, etc.

Wheeled Camera Stand

When photographing small objects it is necessary to set the camera very accurately, especially in cases where the distance between the camera and the object is only a few inches. The work of focusing it is greatly facilitated by using the stand shown in the drawing. It consists of a wooden platform, made by cleating together several 1-in. boards, mounted on two axles fitted with

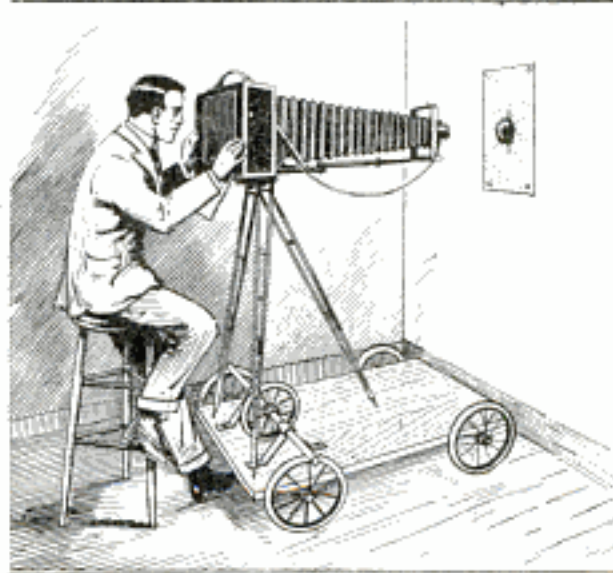

An Adjustable Camera Stand that Greatly Facilitates the Photographing of Small Objects

rubber-tired wheels taken from an old baby carriage, the axles being attached to the platform by means of small U-bolts. An iron or steel rod is mounted in two flat-iron bearings so that it presses against the rear-wheel tires as shown, and a small rubber-tired wheel is fastened to the center of the rod. With this arrangement the platform can be moved a fraction of an inch.

A REQUEST TO READERS

Our readers can do us a greatly appreciated service if they will answer this question: Have you made anything from a description published in this magazine, or restored something to usefulness by making repairs, in home or shop, as suggested in these columns? All we want is your name, and the name of the thing made or repaired.

We very seldom make requests of our readers, but compliance with this one will be a real help to us. Your name will not be included in the printed list if you object, but send us the information just the same.

Cold Cellar Dug in Bank

Many farmers have a concrete cold cellar for storing their vegetables and meat, but in most cases the entrance is very inconvenient, due to the steep and nar-

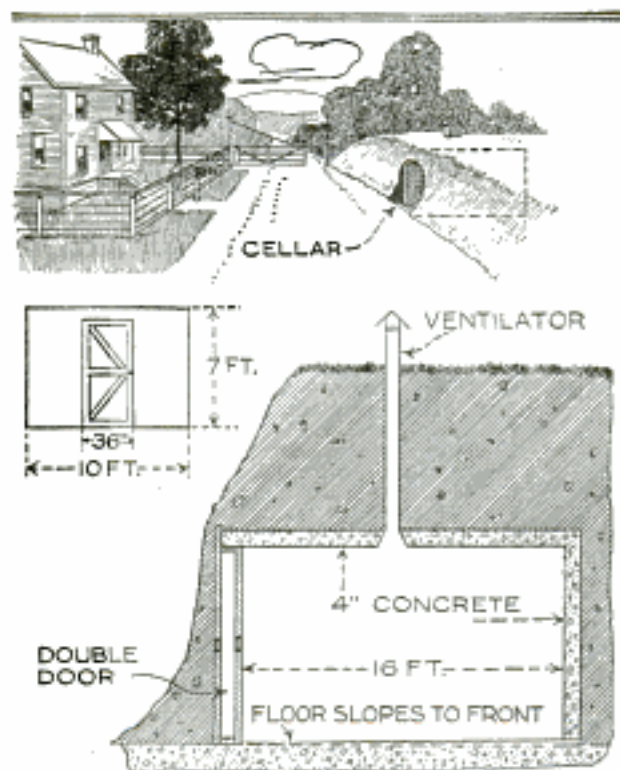

A Concrete Cold Cellar, Built in a Bank, that Has Many Advantages Over an Underground Cellar

row steps and the trapdoor above them. An additional disadvantage of the underground cellar is that it is difficult to clean out and that water readily accumulates in it. All these objections are eliminated by building the cellar in a bank near the house as shown in the drawing. This arrangement permits easy access to the cellar at all times. A suitable bank may be found close to a great number of farmhouses.

The cellar is made by excavating part of the bank, building the form from rough boards, and pouring the concrete into the form from the top of the bank. Iron rods, pieces of clean wire mesh and clean fence wire are used to reinforce the top. After the concrete has set, the ground is refilled over it to the level of the bank. The top of the cellar should be at least 3 ft. below the top of the bank. A wooden door, about 3 ft. wide, and having a dead-air space as shown, is set in the front end. The floor is laid to slope slightly toward the front so that water will readily drain out, and a 2-in. galvanized-iron pipe, fitted on top with a cap, is installed to provide proper ventilation.—J. V. Romig, Allentown, Pa.

Increasing Humidity of Air

The ordinary furnace water pan has a capacity of about 2 gal., only about half of which is vaporized in one day, under average firing conditions. This is usually not enough and therefore some method of increasing the evaporation must be resorted to. An excellent method, which has been found very effective, is to hang an old flannel or woolen shirt over the edge of the water pan, with one end dipping into the water. The shirt acts as a wick and greatly increases the moist surface in contact with the hot air, and consequently the rate of evaporation.—L. C. Prittie, Ottawa, Canada.

Auxiliary Tank Prevents Stalling on Grade

On automobiles having a gravity-feed gasoline system, the gasoline will not flow into the carburetor when climbing a very steep grade. This trouble can be eliminated by installing a small auxiliary tank in front of the carburetor, and connecting it to the main gasoline tank as shown in the drawing. On a level road the gasoline runs from the main tank into the auxiliary tank and from the latter into the carburetor, so that the auxiliary tank is always full. When climbing a steep grade, the small tank supplies the carburetor, as shown in the lower detail. The gas will not flow back into the main tank because the feed pipe extends almost to the top of the auxiliary tank. A length of $\frac{1}{8}$ -in. copper tubing connects to the top of both

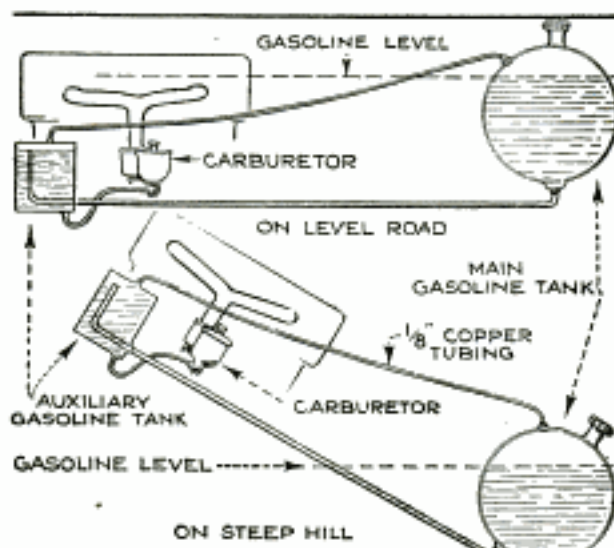

Auxiliary Gasoline Tank Supplies Carburetor with Gasoline When Climbing Steep Grades

tanks to allow gasoline to drain out of the main line without creating a vacuum in the auxiliary tank.—D. L. James, Wayland, New York.

Mechanics' Watch Charms

Any mechanic who likes to make things in his spare time, can turn his labor and ability into money by making and selling

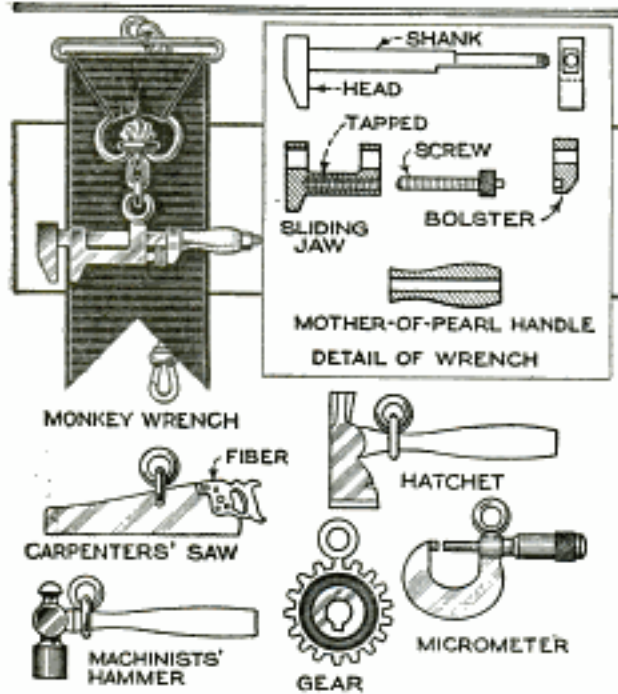

A Number of Gold-Plated Watch Charms in the Form of Tools Used by Various Trades

mechanics' watch charms. These charms are made in the shapes of the tools used by various trades. The material used is brass, which is easy to cut, quite strong enough for the purpose, and can readily be gold plated.

A little gold-plated monkey wrench always meets with admiration and interest. The frame is cut from one piece of brass, and the shank is turned or filed down and threaded at the end for a small nut. The handle is made from a piece of mother-of-pearl, cut down to the shape shown and drilled lengthwise to fit the shank. The sliding jaw is made by slitting a solid piece of brass, bending the lugs over the back of the frame, and soldering the ends together. The jaw is drilled and tapped for the adjusting screw, which is turned down and threaded to fit, a knurled head being formed on one end. The bolster slips over the shank to receive the tip of the screw. An eye for attaching the charm to the watch chain is soldered to the lower lug of the jaw. The parts are then gold plated, which will cover all traces of solder, and if well done, the plating will wear for many years.

A neat charm can also be made in the form of a carpenter's saw. The blade is nicked on its lower edge with a knurling

tool, making tiny teeth that can be seen and felt. The handle is made of black or red fiber, and attached to the blade by means of small brass rivets.

Hammers and hatchets of various kinds also make attractive charms. These tools should have wooden handles, made of ebony or hard redwood, and polished or waxed after they are cut to the proper size and shape. The attaching ring, in such cases, is made by twisting a length of gold wire into a groove cut around the handle.

A small gear and a micrometer have also been found very neat, especially the latter, when handsomely gold plated and engraved. The only tools necessary for this work, in addition to those already possessed by the machinist, are a jeweler's saw, a jeweler's screwplate, and a set of taps to fit.—J. V. Romig, Allentown, Pa.

Handy Container for Liquids

A handy container for oils, gasoline, or other liquids is shown in the illustration. It is especially useful in that the contents may be transferred from it without spilling a drop. The container is made from an old oil can, or other large tin can, a 2-in. length of $\frac{3}{8}$ or $\frac{1}{4}$ -in. copper tubing, and about 15 in. of rubber tubing. A hole, large enough to allow the copper tube to fit snugly, is made near the bottom of the can. The tube is then soldered in, and the rubber tubing slipped over it, bound on tightly, and taped to prevent the rubber from breaking. Near the other end of the rubber tubing is tied a small wire hook to catch on the handle or filler cap of the can. When assembled and filled, the can should be placed on a support so that, when the liquid is to be removed, the free end of the rubber tube will be lower than the bottom of the can.—Leslie J. Smith, Salem, Ore.



Removing Scratches from Showcases

Scratches on showcase tops can easily be removed by moistening some jeweler's rouge with water, and applying it to the surface of the glass with a soft chamois skin or piece of leather, rubbing hard until the scratches disappear.

Drying Clothes in Cold Weather

During cold weather clothes hung out on the line to dry become stiff, due to the frozen moisture in them, and in attempting to remove them they are frequently torn at the corners. This danger can be eliminated by hanging the clothes on wire coat-hangers of the kind used extensively by cleaners. The clothes are hung on the hangers, which are hung on the line. To keep them separated evenly, a number of old yardsticks or laths are used, holes being drilled in them about 3 in. apart, and the hooks of the hangers passed through the holes before they are hung on the line. The clothes are brought in on the hangers and allowed to thaw out before taken off. This method also obviates the usual discomfort of cold hands.—Elizabeth A. Ragan, Seward, Neb.

Projecting Microscopic Slides

Projecting microscopic slides on a screen has been found to be of considerable assistance in a class room, as it enables the whole class to see and discuss the subject at the same time, instead of the students looking through the microscope individually, which takes a great deal of time. The projecting lens of the lantern and the reflecting mirror of the microscope are first removed, and the microscope is then arranged about a foot in front of the lantern, as shown in the illustration. By carefully adjusting the distance between the lantern and the slide, the correct focus

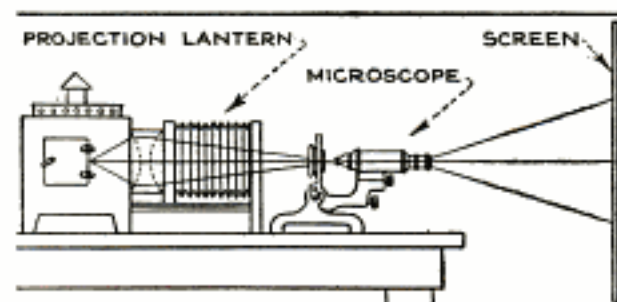

Simple Arrangement of Lantern and Microscope to Project Microscopic Slides in a Class Room

is obtained. The barrel of the microscope is then adjusted so that a clear image will be thrown on the screen, which is located about 15 ft. from the eyepiece of the microscope. The stronger the light in the lantern, the longer will be the distance that a clear image can be thrown. With some types of microscopes it may be found necessary to place a convex lens between the front of the lantern and the slide of the microscope.—W. A. Kimball, Keene, N. H.

Water Supply for Private Garage

Rain water is ideal for use in automobile radiators, as it is free from most of the scale-forming chemicals and salts present

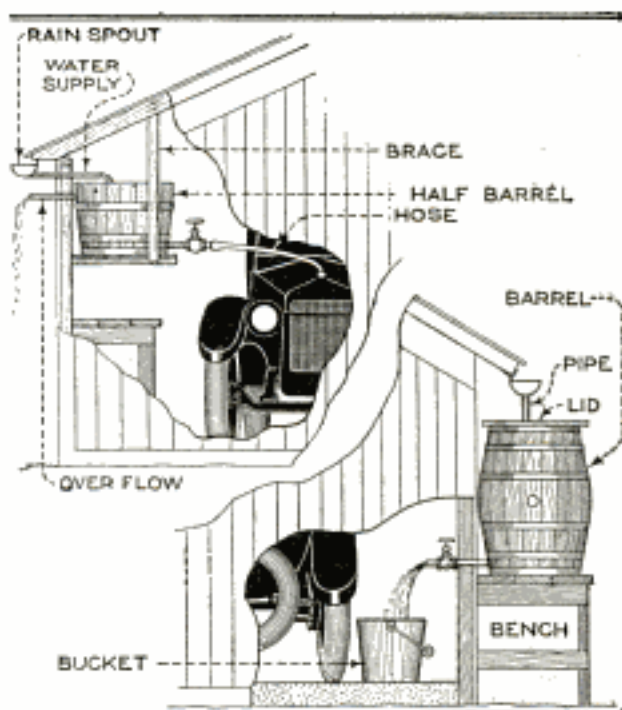

Easily Installed and Convenient Reservoirs for the Garage to Store Rain Water for the Radiator

in well and hydrant water. Two convenient methods of storing rain water in readiness for use are shown in the drawing. The upper figure shows how a half barrel may be arranged on a shelf inside the garage, at a height that will permit the water to flow into the radiator. A gutter is run along the edge of the roof and a small tap pipe from the gutter is brought through the wall as shown, so that the water will drain into the barrel. A short length of pipe, fitted with a valve, is fitted through the side near the bottom and a length of rubber hose is attached as shown. An overflow pipe is also provided. In garages where there is not enough space to permit the installation described above, a barrel may be mounted on a stand outside of the garage as shown in the lower figure. In both cases a fine sieve must be provided in the pipe leading from the gutter, to catch any foreign matter. The inside of the container should be washed out occasionally.

☛ When placing a tire chain on a wheel always fasten the inside first and hook it a little tighter than the outside. If this is done and the chain happens to come off, it will most likely come off on the inside, and will be retained by the axle until its dragging is noticed.

A Folding Kitchen Table

In a small kitchen, where space is at a premium, a folding table of the type shown in the drawing will be greatly appreciated.

The table top is 1 by 30 by 48 in. in dimensions, and is supported by two braces of 1 by 2-in. stock. Two 4-ft. lengths of 1 by 2-in. material are screwed to-

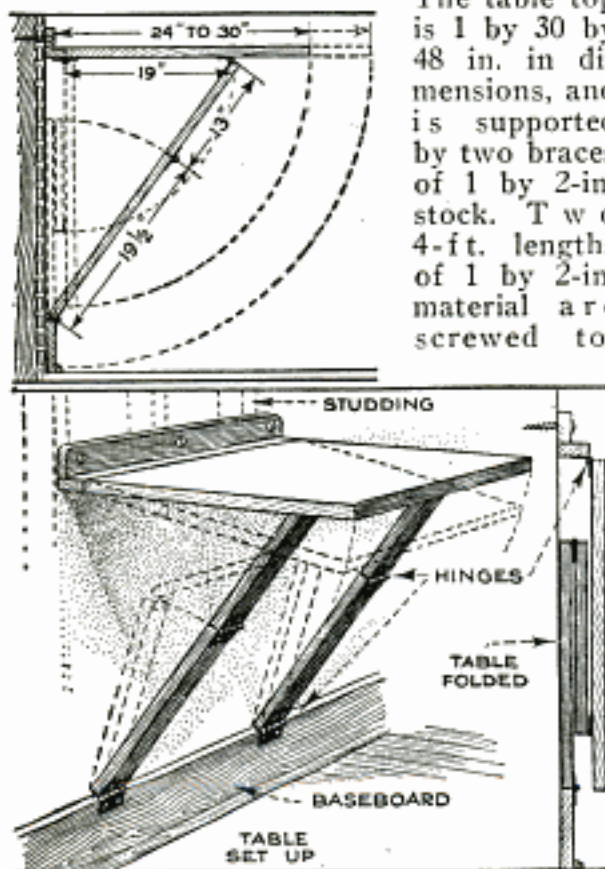

Folding Table for Small Kitchens that Can Be Set Up or Folded with One Hand

gether at right angles and fastened to the wall by long screws driven into the studs. The table top is then hinged to the lower member as shown. The braces are 32½ in. long, and are cut and hinged so that they will fall into place automatically when the table top is lifted. The dimensions given in the upper detail should be adhered to closely, or enlarged in proportion. To fold the table it is only necessary to strike the joints of the braces with the knee or hand, while holding the table top to prevent it from "slamming." There are no legs to sweep around with a table of this type, and the braces do not prevent a chair from being drawn up close to the table.—G. M. Beerbower, Tarrytown, N. Y.

Quick Camp-Fire Lighter

Camp boys in the Yellowstone National Park have a most ingenious mixture for lighting the hundreds of fires in tourists' camps. It consists of sawdust saturated with kerosene, carried in pails, a big spoonful being sufficient to light any fire.

Improving Water Circulation in Radiator

The water in automobile radiators often becomes hot very quickly, without any apparent cause. In such cases the rubber-hose connections should be removed, and it will often be found that the rubber is swollen on the inside, reducing the diameter considerably, which, of course, causes the water to circulate more slowly and makes it heat up more rapidly. To overcome this trouble, procure two new hose connections and also two short lengths of thin brass tubing, which will fit snugly inside the hose. The lengths of tubing must be shorter than the hose connections to allow the latter to be clamped to the radiator and engine in the usual way. The brass tubes will prevent the hose from becoming smaller in diameter and eliminate any future trouble.—William C. Fink, Springdale, Pa.

Increasing Utility of Small Motor

Small motors are very useful pieces of equipment for the workshop, but, in many cases, full advantage is not taken of their utility. The method by which one experimenter doubled the capacity of his motor is shown in the drawing.

Both ends of the armature shaft are utilized. On one end is fitted the small pulley used to drive the drill press. On the other end, a faceplate, interchangeable with a chuck, is fitted, and directly in line with this a tailstock is mounted on the bench, and a tool-rest, to enable light turning to be done. A long arbor, with an emery wheel mounted at one end, is also

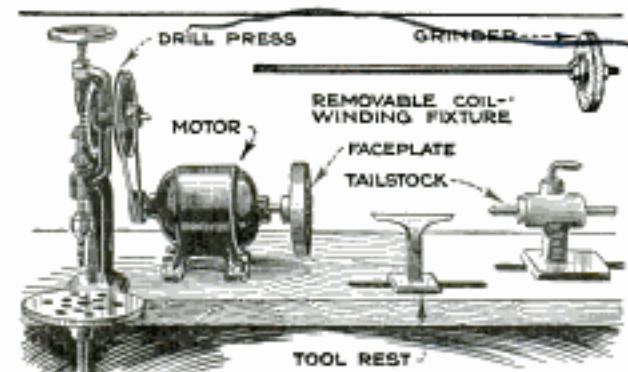

Doubling the Usefulness of the Bench Motor by Driving from Both Ends of the Shaft

provided, and may be used for winding coils in addition to grinding. The spools of wire are mounted on simple brackets screwed to the front edge of the bench.

The switch for controlling the motor may be screwed underneath the bench, at the front.

Goodell Pratt Co.

Aero-Propeller Shaft Installations

By J. V. ROMIG

DESIGNERS and builders of aero-propeller-driven craft, such as sleds and boats, are often handicapped by the lack of a suitable but cheap method of installing the propeller shaft. If advantage is taken of standard automobile parts, however, a very neat and close-coupled arrangement, which will give good service and operate efficiently, can be made at a minimum of cost and labor.

Front and rear-wheel hubs from a light car are used to form the main parts of the installation, together with a special shaft and a couple of sprockets. The shaft design is a combination of that of a front-axle spindle and the outer end of a rear-axle spindle or shaft. Between the two parts is a pad or shoulder for the seat of the driven sprocket.

The shaft must be carefully and accu-

flange, is then slipped on, the ball cones adjusted so as to allow the shaft to run freely without any shake, and the locknut tightened and fastened with a cotter pin. The regular hub cap is used, filled with good grease, just as in the car.

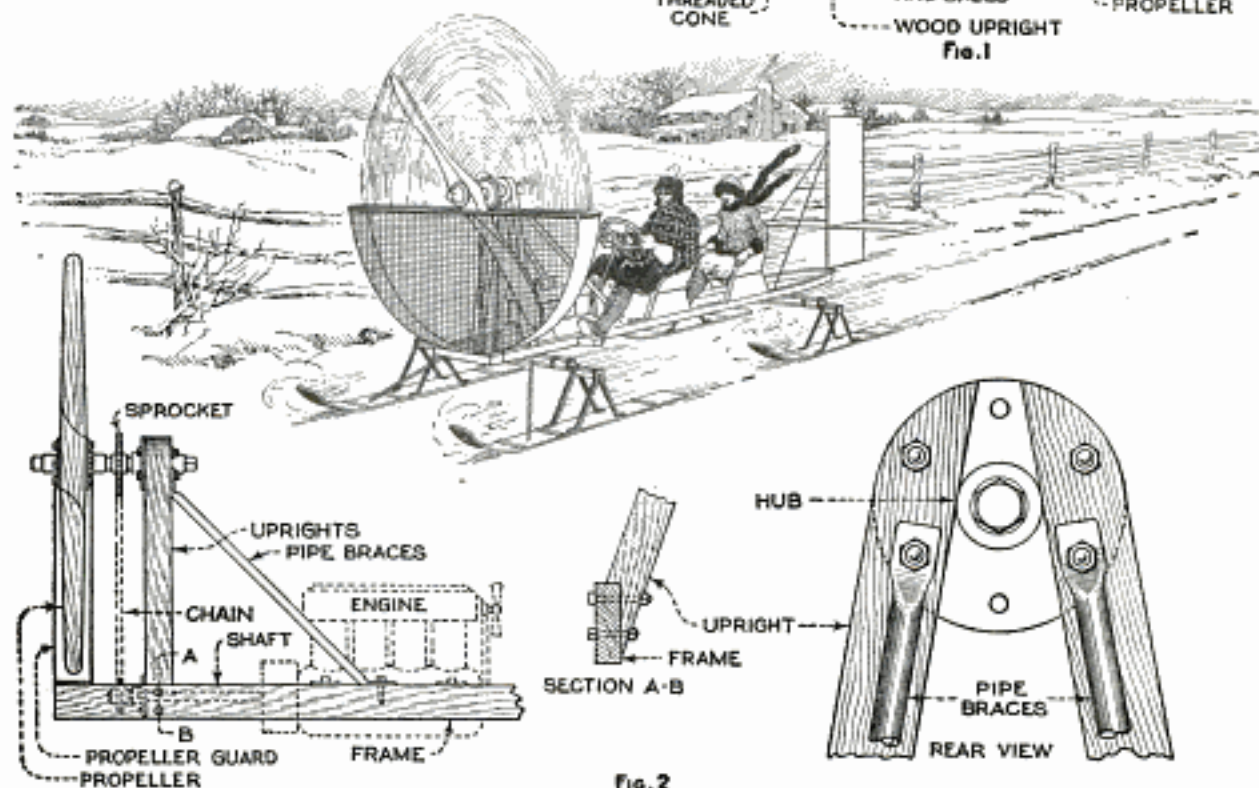
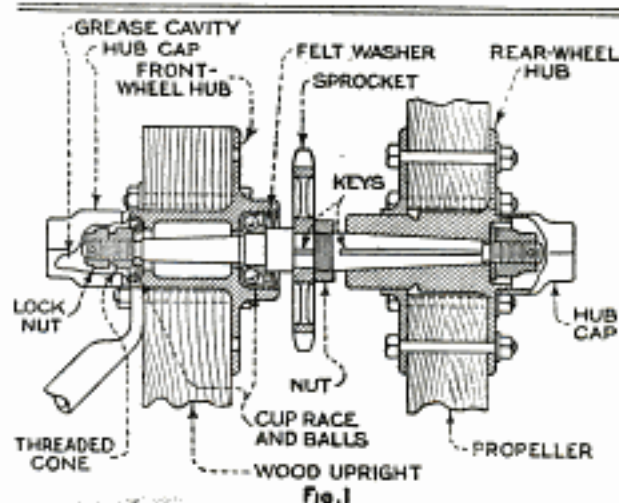

Fig. 2

An Exceptionally Neat Mounting for an Aero Propeller, Made from Standard Automobile Parts, Which Are Easily Obtained and Renewed

rately turned from a solid piece of good machinery steel; the rear end is turned and threaded to the same dimensions as the front-wheel spindle of the car from which the hub is taken, and the seats for the ball races must be held very carefully to size. The front end is turned to fit the rear-wheel hub, threaded for the nut, and keyseated. The seat for the sprocket may then be turned, keyseated, and the thread for the locknut cut.

The front wheel hub, minus the outer

The hub that carries the propeller is a rear-wheel hub, as stated above, and it is fitted with a second flange, made out of another hub, which is machined away until a flange is left that will pass over the turned portion of the hub proper.

The propeller hub is drawn up on the tapered portion of the shaft, as in the car, and locked by means of a nut, washer, and cotter pin. The propeller is clamped between the flanges by six through bolts of $\frac{3}{8}$ -in. diameter, the sliding flange allowing

for a wide variation in the thickness of propeller hubs. A hub cap is screwed on the forward side of the hub, to present a neat and finished appearance.

The key that holds the sprocket should be large and set deeply, as it carries all the motor torque.

Two heavy wooden uprights, meeting at the top to form an inverted vee, are bolted to the sills of the frame, and straddle the body of the front-wheel hub as shown. Four $\frac{3}{8}$ -in. bolts hold the tops of the uprights firmly to the hub. Angular braces, made of 2-in. pipe, are also fitted,

the ends being flattened and drilled for the bolts. The propeller should be balanced before installation, to insure vibrationless running.

An arrangement of this type not only presents a good appearance, but, as the bearings are standard, they are easily renewed when worn. Being of the cup-and-cone type, they will take a thrust in either direction, and so are suitable for either tractor or pusher types of propeller mountings. The hub cap should be filled with good grease, to insure perfect lubrication, and refilled at frequent intervals.

Simple Cut-Film Holder

Besides being non-breakable, nonhalation, and light in weight, it has been found that there is also a great economy in using

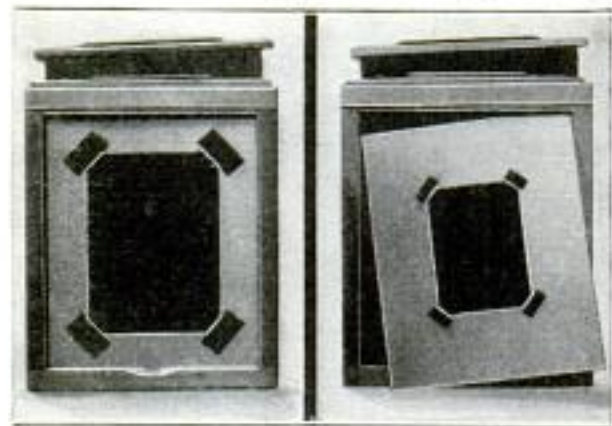

An Economical Method of Using Pieces of Cut Film of Various Sizes in a Plate Holder

cut films in making negatives. This is especially true if the photographer does much copying work.

Very often only a small piece of film is needed to make the desired copy. A piece of film is then cut from the regular size on hand, in the dark room. A piece of medium-weight cardboard is cut to the size of the plates for which the plate holder is intended, so that it can be used instead of a plate, and a piece of black paper, cut to the size of the film to be used, is pasted on the center of the cardboard. This is to prevent halation or reflection of light from the cardboard back through the film. Small triangular pieces of paper are cut to fit over the corners of the black paper and these pieces are stuck on the cardboard by means of adhesive tape as shown in the photograph. The film is then inserted under these corners and will be held in place securely. This method of using cut films is economical as the film is cut to the size needed and no margins are wasted. It is,

of course, necessary to mark on the ground glass lines corresponding to the different sizes and positions of films used.—Edward H. Flaharty, Denver, Colo.

Improving Radiator Stay Rods

Radiators of most automobiles are supported by a horizontal rod screwed into a bracket on the dash and a boss on the radiator. Due to the constant vibration the threads at the boss sometimes strip and allow the rod to pull out. To repair the boss is a difficult job, and, in any event, prevention is better than cure. If a nut of the proper size is screwed on the rod and locked tightly against the boss, there is very little danger that the threads will ever be stripped.—E. T. Gunderson, Jr., Humboldt, Iowa.

A Weather-Vane-Bearing Protector

Bearings on weather vanes should be protected in some way to prevent them from rusting. This can be done by slipping half of a hollow rubber ball over the bearing. A small hole is punched through the ball to make it grip the shaft securely so that it will not slip down on itself, but can be forced up or down.

The drawing shows a recording weather-vane protected in this way, the bearing consisting of a bicycle-wheel hub with one flange filed off, and set in the end of a length of pipe, which is split with a hacksaw at the other end, bent and bolted to the roof as shown. The lower end of the rod terminates just below the ceiling of one of the rooms and is fitted

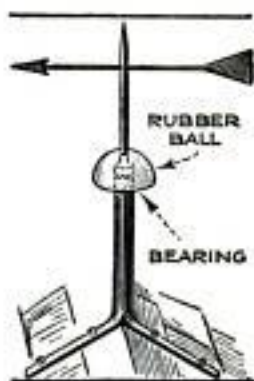

with a pointer. A compass face is provided under the pointer so that the exact direction of the wind can be seen inside the house at any time.

Silencing Overhead-Valve Assembly

In an overhead-valve engine, the wear in the joints of the push-rod and rocker-arm assembly allows considerable play and lost motion. Noise from this source can be partly stopped by careful adjustment of the tappets, but the wear in the rocker arms cannot be compensated in this way, and the engine will be more or less noisy.

This trouble can be avoided almost entirely with the coil-spring arrangement shown in the photograph. Two brackets of $\frac{1}{2}$ -in. round steel rod are shaped to fit the head of the engine, as shown, each of the brackets being bolted to the top of the engine and extending down along the push-rod side. A clip of heavy sheet metal is shaped and fitted to each rocker-arm head, above the upper end of the push rod, and short coil springs are stretched from holes in the clips to the brackets. The lower end of each spring

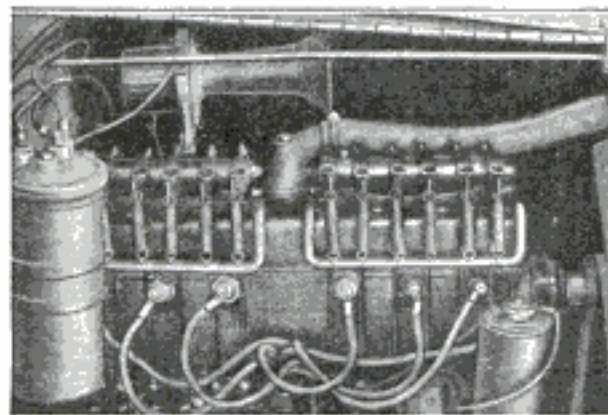

Effective Method of Eliminating the Noise of the Overhead-Valve Assembly on an Old Automobile

is fastened to the bracket by means of a cotter pin; the loop end of the pin is placed above the bracket and engages with the end of the spring, while the split end of the key is spread below the bracket.

The photograph shows a six-cylinder engine equipped with this silencing arrangement. The springs must be of approximately the same length, and arranged so that there is always a slight tension on the rocker arms. These are held tightly against the push rods at all times and thus much of the noise so common to old overhead-valve engines is eliminated.—Lowell R. Butcher, Des Moines, Ia.

Safe Hay-Fork Holder

In hauling hay or grain in the straw it is usually necessary to carry a pitchfork, but accidents often result from placing it

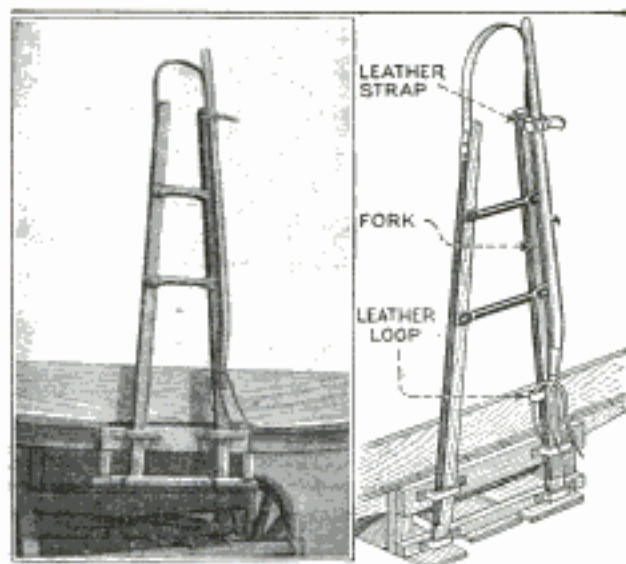

Accidents Are Prevented by Strapping the Pitchfork to the Front Standard of a Hay Wagon

carelessly on the load. A good place to attach the fork, where it will be held securely without any danger, is the front standard of the wagon. Two lengths of leather strap are nailed to one of the upright pieces as shown; the lower strap is simply looped around the handle securely.

With this arrangement the pitchfork cannot be lost, and it is in such a position that accidents are not likely to occur.

Marking Furnace Grates

When shaking the grates of a furnace it often occurs that a perfectly good fire is dumped into the ash pit because the position of the grates cannot be seen from the outside and are turned in the wrong direction. To avoid this, it is a good idea to mark the ends of the shaker bars that extend outside of the furnace, painting them half white and half black, as shown in the drawing, so that the position of the grate can be seen at a glance.



☛ Dipping the heads of clothespins in white paint makes them easy to find in case they are dropped in the grass.

One Lock Fastens Entire Cabinet

Locking five or more drawers in a cabinet by means of one lock can be done very easily by means of the arrangement shown

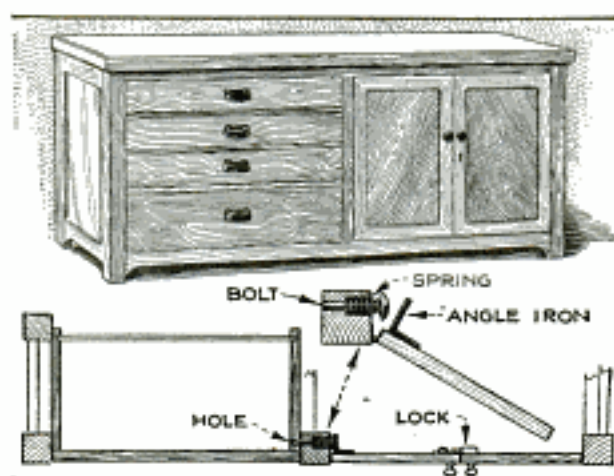

A Simple and Practical Arrangement for Making One Lock Do the Work of Five

in the illustration. The detail shows the method of construction; each drawer has a small hole drilled in the side to receive the end of a bolt, which locks it. A small spring, fitting on the bolt under the head, pushes it out of the hole as soon as pressure is released. A length of angle iron is screwed to the inside of the cabinet door, as shown, so that when the door is closed it presses the bolt in and locks all the drawers; one lock on the door will then keep the whole cabinet locked.

Priming the Auto Engine

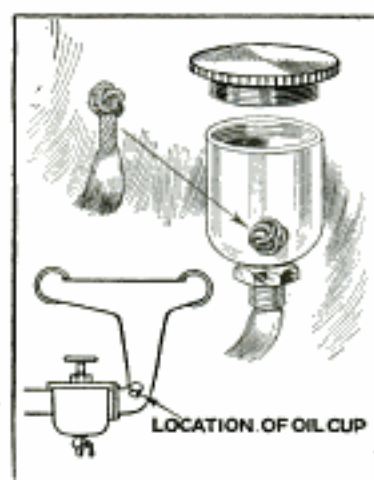

knotted at one end and inserted through the hole in the bottom of the cup.

The method of using such a priming device is to squirt some high-test fuel into the oil cup, the fuel being absorbed by the wick and vaporized inside the intake.—J. G. Brown, Evanston, Ill.

For quick starting in cold weather, a screw-cap oil cup, of the type shown, is tapped into the intake manifold of the automobile engine, as close to the carburetor as possible. A short piece of frayed-out twine is

A Simple Insecticide

While various kinds of insecticides on the market are effective, they are also rather expensive. A simple solution that is very effective in getting rid of bedbugs and similar vermin, consists of $\frac{1}{2}$ pt. each of kerosene, turpentine, and laundry ammonia. These ingredients are all poured into a quart bottle and shaken well, and the solution is then sprayed or brushed on the surfaces where the bugs have been noticed. It has been found that two applications are usually sufficient.—Tempest W. Fenton, Ashtabula, Ohio.

Raising Gas-Range Burners

The rapid decline of the natural-gas supply has compelled many gas companies during the past year to supply gas at a reduced pressure, and as a result the cook-stoves and ranges designed for high-pressure gas are rendered almost useless. This has resulted in the flooding of the market with so-called gas savers, many of them without any merit whatever. In high-

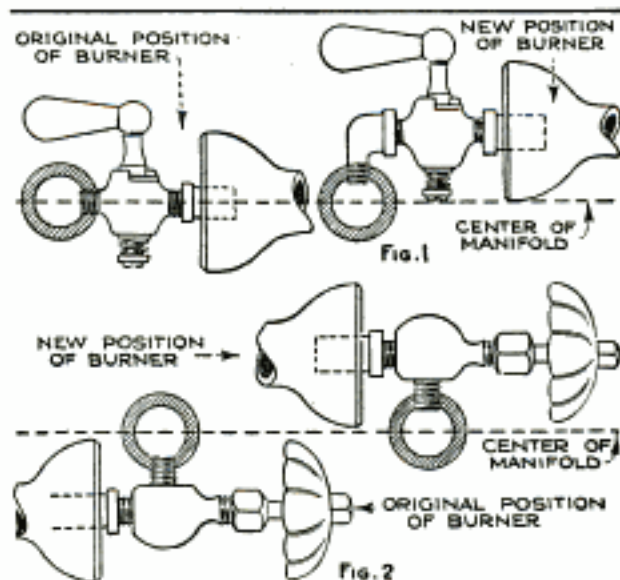

Changing Position of Natural-Gas Range Burners to Suit Lower Pressures

pressure gas ranges the burner is usually from 2 to $3\frac{1}{2}$ in. below the cooking top. These distances are entirely too great for the continually decreasing pressure, for satisfactory cooking operations.

The U. S. Bureau of Standards experts have made many exhaustive studies of burner positions, and the conclusion arrived at is that less gas will be used at low pressures if the burner is within 1 in. of the bottom of the cooking vessel than at the original high pressures with low burners.

Figure 1 illustrates a straight-cock connection. By turning the manifold through 90° and using a small service ell, the burner of the stove utilizing this type of connection will be raised to a more efficient height.

Figure 2 illustrates an angle-valve connection. By simply turning the manifold through 180° the valve will be above instead of below the manifold and in this way will also raise the burner to a more efficient height. Of course, the valve must be turned so as to face out.

It is a strange coincidence that, on the majority of ranges, this raises the burners to exactly the height recommended by the Bureau of Standards, and is probably the simplest, quickest, and cheapest method of raising burners that can be devised. All that is required in the way of tools are a couple of pipe wrenches.

Closing Furnace Damper Automatically

When opening the door of a furnace to put in coal, the ash pit damper is often left open, with the frequent result that a volume of smoke

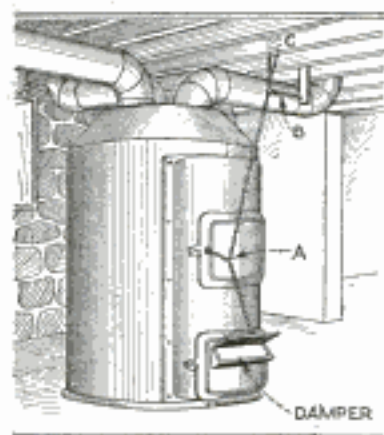

issues from the furnace door, fills the basement, and penetrates into the rooms above. This trouble can easily be prevented by the method shown in the drawing. The chain that operates the damper on the ash-pit door is made a little slack, and is connected to the handle of the furnace door by a short length of chain, as shown. This arrangement will not interfere with the function of the chain in raising or lowering the damper, and will always allow the damper to close when the furnace door is opened.

Increasing Life of Spare Tires

Motorists will find that the spare tire resists natural aging much better if it is put into service for a day every month. Whatever the cause of the deterioration, it is a fact that a spare carried month after month without being "exercised" does not retain its wearing qualities as well as one that gets an occasional day's use.

Coasting on Ice

Children who live in level regions, where coasting downhill is not possible, will appreciate the device shown in the drawing,

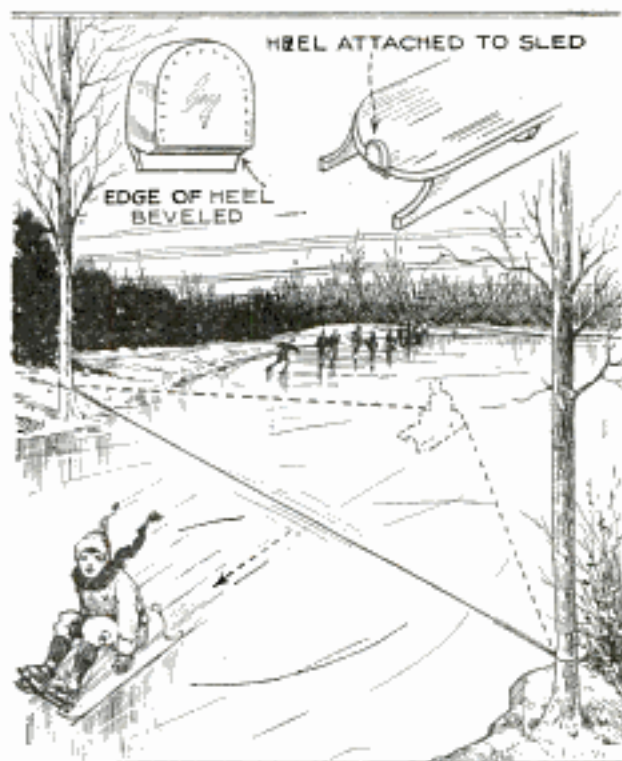

A Novel Method of Coasting on Ice by Means of a Stout Clothesline and Two Heavy Coil Springs

which will enable them to coast on the ice on a pond. A stout clothesline with a heavy coil spring at each end is stretched tightly across the pond, or a bay, between two trees. The sled is pushed backward against the center of the rope as indicated by the dotted lines, and will, as soon as it is released, coast a considerable distance over the ice, due to the action of the coil springs. An old leather heel is nailed to the back end of the sled to hold the rope. The rider pushes the sled backward against the rope by digging the sharp ends of his skates into the ice, or he may be pulled back by another boy.—Dale R. Van Horn, Walton, Neb.

Preventing Pump from Freezing

As an ordinary pitcher pump in good condition does not allow the water in the suction pipe to run down, the water is subject to freezing during winter. To prevent this, I tapped the vacuum chamber directly under the check valves, for a $\frac{1}{8}$ -in. drain cock, which, when opened, destroys the vacuum and releases the water. When the cock is closed the pump works as well as ever.—W. C. Robson, Cheboygan, Mich.

Carrier for Vacuum Bottle

Vacuum bottles are of great convenience for keeping liquids warm and are used extensively by farmers and workmen, but they are rather bulky to handle and this feature is somewhat objectionable as the bottle is easily broken or dented by drop-



An Inexpensive and Serviceable Canvas Bag for Carrying a Vacuum Bottle

ping it on the sidewalk or ground. Carrying cases are made, but they cost nearly as much as the bottles themselves, and therefore the homemade carrying bag shown in the photo will be appreciated.

For a 2-qt. bottle the bag is made from a piece of canvas or similar heavy cloth, 17 by 18 in. in dimensions. One 17-in. edge is turned over and hemmed on the sewing machine; this edge will later form the top of the bag. The 19-in. edges are then sewed together, and a disk fitting the lower end is sewed on in the same way. Turning the bag inside out will then bring all the seams on the inside. The shoulder straps, which are made from strips of cloth with the edges hemmed, are sewed to the bag as indicated. A bag of this kind is much better than a leather one because it can readily be washed when soiled.—J. R. Koontz, Bremen, Ind.

Stopping Radiator-Hose Leaks

Leakage of the hose connections on automobile radiators can usually be remedied by an application of shellac. The hose connection need not even be removed if the shellac can be run into the joint by gravity. After draining the water in the radiator to a point below the hose level, the clamp of the leaking connection is loosened and some shellac is run in. It is allowed to stand for a few minutes, until nearly dry, and the clamp is then tightened.

Preventing Damage from Battery Acid

Where a storage battery is to be used permanently as for radio, it is well to place it in a shallow wooden lead-lined box, filled with sand, in order to eliminate the danger of having the rug or varnished floor ruined by the acid, which sometimes seeps through. A plain wooden box can be used, but the lead-lined one, with soldered seams, affords absolute protection, while the plain box may allow acid to escape when the sand becomes saturated. Another help is to mix a slight proportion of powdered alkali such as wood ashes or soda in the sand.—George Davis, Oakland, Calif.

Simple Tube Adapter

It is often desirable to change a dry-cell radio outfit to a larger set using a storage battery for the filament circuit, or to change a larger set so that dry-cell tubes can be used. A simple adapter that permits the use of both kinds of tubes without changing the set in the least is shown

in the photograph. It consists of an old tube base that fits the sockets of the set. This is soldered in one end of a 4 or 5-in. length of 1/4-in. brass tubing as shown, and a socket of the proper type to carry the tubes to be used is fastened to the other end of the tube as



shown. Four lengths of lampcord are carefully soldered to the terminals of the old tube base, and after being brought through the tube, are connected to the corresponding terminals on the socket. Two ears are formed on the upper end of the tube, bent back at right angles, and drilled so that the socket can be fastened to them with small screws.—W. W. Brackenridge, Harrison, Ohio.

☐ A piece of coarse-mesh screen over the flower bowl permits the use of short-stemmed blossoms.

Inclosing the Porch for Winter

A large open porch on the northwest side of the house, has its advantages in the summer time but does not provide much shelter or comfort during the cold winter months, especially in the open country where the wind is unobstructed, and the porch lies in its full sweep. By providing an inclosure to keep the wind out, the porch can be made useful during the winter, and the room behind it kept much warmer. A simple inclosure that does not cost much, and can be made in a short time, is shown in the photographs.

The screen sections, which were hooked in the space between the frieze and the seat rail, and are of use during the summer months only, are removed and pieces of heavy wall board, nailed to 1 by

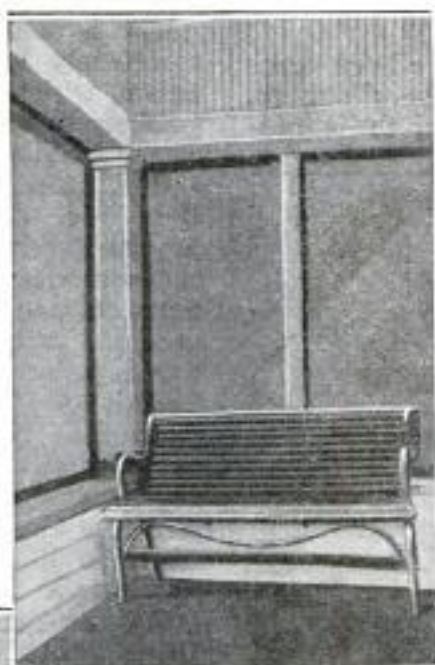

Above: Inside View of the Inclosed Porch. Below: Outside View Showing Arrangement of Storm Windows

2-in. wooden frames, of the same size as the screens, are substituted. However, as this does not admit any light on the porch, ordinary four-light storm windows are set in the frames in some sections. Three of these windows are sufficient in the case described, as they provide all the light necessary, but, if desired, all the sections can be made of storm windows, or windows can be specially made for this purpose. As soon as warm weather returns, the sections are removed and stored away for the summer, when the screen sections are again brought out and put in place. Extra-heavy hooks and screweyes should be used to fasten the storm section in place.—R. A. Franklin, Rochester, Minn.

Tanning Muskrat Skins

Formerly many muskrat skins were home-tanned and made into caps, collars, and other articles. The present home utilization of skins is much less extensive, but knowledge of a good method of dressing the fur is still desirable. Most of the methods employed by amateurs involve the use of alum to fix the hair; but satisfactory results, so far as pliability of the pelts is concerned, depend largely upon the labor spent on them. The directions here given, if followed, will give better results than processes using alum.

Prepare a tanning liquid composed of 1 qt. of salt and $\frac{1}{2}$ oz. of sulphuric acid to each gallon of water. This mixture should not be kept in a metal container. Muskrat skins are tanned in this mixture in a day, but they may remain in it longer without injury. When removed

from the liquid, wash several times in soapy water. Wring as dry as possible, and rub the flesh side with a cake of hard soap. Then fold them in the middle, lengthwise, over a line, hair side out, and leave to dry. When both surfaces are barely dry, and the interior is still moist, lay them over a smooth, rounded board and scrape on the flesh side with the edge of a worn flat file or similar blunt-edged tool. In this way the inner layer is removed and the skins become nearly white in color. They are then stretched, rubbed, and twisted until quite dry. If parts of a skin are still hard or stiff, the soaping, drying, and stretching process should be repeated until the entire skin is soft. Fresh butter, or other animal fat, worked into the skins while they are warm, and then worked out again in dry hardwood sawdust, or extracted by a quick bath in gasoline, increases their softness.—A. C. Cole, Chicago, Ill.

Simon & Schidmore Mfg Co,

324

110 E. 6th St.

POPULAR MECHANICS

83 **UNIVERSAL SQUARE LOCKS AUTOMATICALLY**

Five different functions have been combined in the latest woodworkers' square, while preserving the shape of the stand-

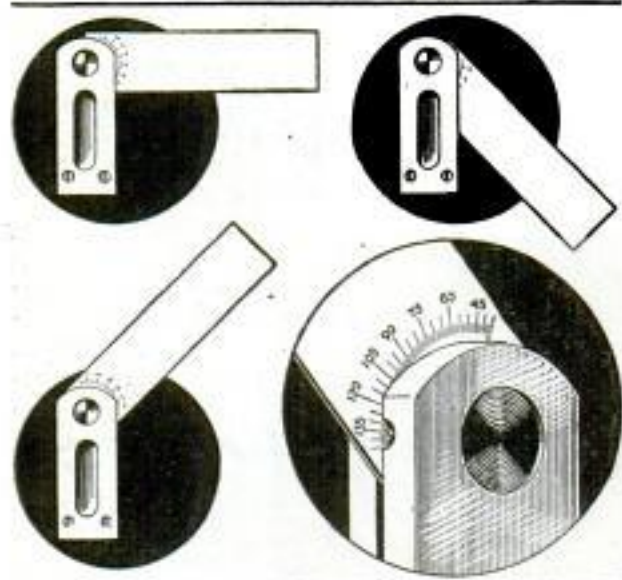

Universal Square for Woodworkers that Locks Automatically in Most-Used Positions

ard rosewood try-square, and keeping within the ideal weight for such a tool.

The handle is made of aluminum, and completely incloses the operating mechanism, which is simple, strong, and very unlikely to get out of order. On one side of the handle is a knurled thumb button; a slight pressure on this instantly unlocks the blade, which may then be moved to any of the five usual operating positions; the square, acute miter, obtuse miter, acute octagon, and obtuse octagon. The blade is rigidly locked as soon as the thumb button is released, and it is impossible to "break" the tool until the button is depressed. The bevel positions are all obtained with the blade swung to the left of the handle, and cover a range of 155°. There is also a semi-positive lock for the blade in line with the handle, for convenience in carrying the tool in tool box.

A fine protractor scale on the blade adds to the usefulness of the tool, as it makes it possible to measure or lay out any odd angle, and makes the tool a convenient angle divider. The blade is made of tempered steel, and all wear on the locking mechanism is automatically taken up.

SPRING TOOLPOST PREVENTS CHATTERING 61 m

It is the general practice to use heavy toolposts or boxes for carrying tools on automatic and turret-lathe cross slides. The tools are often used for comparatively heavy forming operations, and, although substantial toolholders help to a great extent, they do not always prevent chattering on heavy cuts. A new toolpost has been designed to overcome the tendency to chatter, and as it is effective when



used at the front of the slide, it leaves the rear toolpost free for parting tools, and enables the slide to take the pressure of heavy cuts on the horizontal face, and not on the narrow vees. The toolpost is made of mild steel, and carries flat forming tools in a slanting gap. The tool can be set by two hardened setscrews, and clamped by four similar screws. A hole and a saw cut through the lower portion of the box allow it to act like the familiar "gooseneck" tool, and, as the cutting edge of the tool is behind the center of the gooseneck, any movement of the tool under a heavy cut will be in a direction away from the work. At the same time,

the top-rake angle is increased, and the clearance angle reduced. In use, it is practically impossible to make the tool dig in when feeding by hand, and the effectiveness of the gooseneck as a spring is proved by the tool continuing to cut when the feed is stopped.

COMPACT BENCH SANDER FOR SMALL SHOP

Pattern shops, and woodworking factories that have not enough internal or irregular work

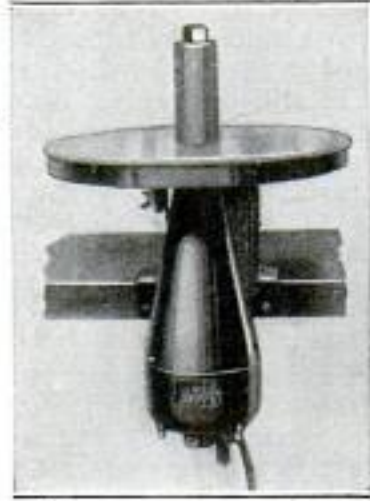

to justify the purchase of a large spindle sander will be interested in a small bench machine now on the market. The tool is equipped with a totally inclosed motor with a speed of 1,725 r.p.m. the motor is directly connected to

the spindle, which has a reciprocating movement of 1 in., is equipped with

*Potter-Cable Mach. Co.
1708 N. Salina St.
Syracuse, N.Y.*

*Pawson & Collins, Queen's Beate Works,
Kensington Square, S.W. 7, London,
England*

Holley Carburetor Co.
 Detroit Mich
 Vancouver Ave + P. M. R. R.

A. H. Petersen Mfg. Co
 1614 Fraternity St.
 Milwaukee Wis 825

POPULAR MECHANICS

6-in. roll. The 16-in. table of the machine is ground, and tilts 45° down and 15° up. The over-all dimensions are only 16 by 16 by 25 in., and the machine may be fitted with a pedestal, if desired.

ELECTRIC VALVE GRINDER HAS "HAND" MOTION

Oscillating and revolving movements combined, thus duplicating the motions made when grinding by hand, is the out-

LONG-LIFE MOLDS DEVELOPED IN IRON FOUNDRY

According to Dr. R. Moldenke, an authority on foundry practice, a prominent carburetor manufacturer has developed a mold for cast iron that can be used repeatedly; in fact, some of the molds have already had 10,000 castings made in them, and not one has yet been discarded. This has necessitated constant attention to the molds, of course, but is a great step forward in the molding of cast iron.

The molds are made of cast iron, lined with a highly refractory material, which is protected from abrasion and penetration of fine iron filaments, and which wears to a surface that need be repaired or patched only on rare occasions. While the castings so far made have been light, no great difficulty is anticipated in making heavier ones.

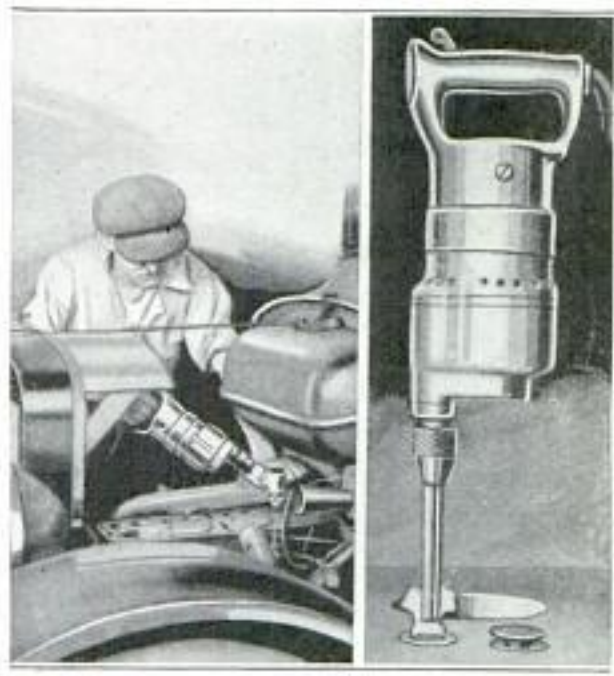

Left, Grinding Valves with the Offset Attachment; Right, Grinder, Showing 3-in-1 Driver Blade

UNIVERSAL VERNIER CALIPER OPERATED BY THUMB

Needing only one hand to adjust it to any size within its range, a new vernier caliper should find instant approval among mechanics.

Both inside and outside measurements may be made with the tool, and, in addition, an extension of the movable jaw serves as an accurate depth gauge. The jaw is moved by means of a small knurled

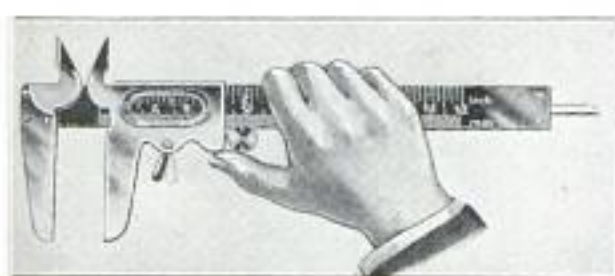

Method of Setting Movable Jaw of Caliper, Using Only the Thumb

wheel, operated by the thumb, permitting very accurate setting, and it may be locked by a small cam lever. The scale is graduated in sixteenths of an inch and millimeters, and, with the vernier, readings to 1-28 in. and 1-10 mm. may be taken. The tool is attractively finished, and will make a welcome addition to any tool kit.

standing feature of a new valve grinder of clever design.

The tool resembles an electric drill, and is provided with 3 and 6-in. grinding spindles, each of which will take any of the valve-driver blades, and which are gripped in the tool chuck. A special hook attachment is supplied for use in grinding valves held in cages, and, when grinding such valves, the body of the tool is held in a special vise. The tool may also be used for loosening stuck cage-type valves, without removing them from the cylinder block.

Some valves are located under the gas tank, or below the cowl, and are hard to reach with the ordinary grinder; with this tool, however, an offset attachment is supplied, which enables the mechanic to grind the valve quite easily. This attachment also enables the operator to grind all the valves from the side of the engine, instead of from the top, if he prefers to work that way.

The Popular Mechanics Bureau of Information offers its free service to all readers of our magazine. Names and addresses of manufacturers and dealers in articles described, and any other details in our possession, will be promptly furnished, by addressing the Bureau.

110 - volt - \$45.00
 220 - volt - \$48.00
 32 - volt

Brogan + Co, 80 N. 536
 Market
 Chicago

Wilkie Machine Works

Draw: A. L. Barrett
114 E. Grand Ave.
Chicago

326 POPULAR MECHANICS

Winona, Minn.
ATTACHMENT CONVERTS LATHE INTO GRINDER

87 m

Garages, service stations, and repair shops will welcome a new grinding attachment for the lathe. The tool will do all

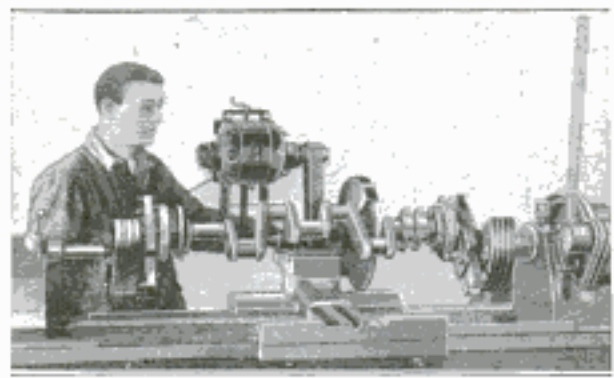

Grinding Crankshaft on Lathe, Using Ball-Bearing Throw Blocks

kinds of external grinding on any lathe, and may be used on lathes of 18-in. swing and over, for crankshaft grinding.

The unit consists of a sturdy, heavy-duty grinding stand with a base machined to fit the toolpost slot on the lathe carriage, and a rigid "whaleback" casting to carry the driving motor. The grinding wheels are carried on the spindle by locking collets, and hence may be removed from the spindle without the necessity of retuning when replaced; they may also be used at either end of the spindle. Collets

of the same type are used to carry the special wooden pulleys used on the motor spindle, so that the correct pulley for each size of grinding wheel may be quickly put in place. The motor is adjustable on the whaleback, to regulate the belt tension.

When used for crankshaft grinding, a set of patented throw blocks, counterbalances, jigs, and a steady rest are furnished.

98 m CANT CROSS THREAD ON NEW GREASE CUP

Users of grease cups—and their name is legion—will appreciate a novel form of cup recently patented. A spring-bayonet joint operates on a slight turn of the cap when removing or replacing the cap for filling.

When the cap is in position, the threads are, for all practical purposes, engaged, and it is impossible to start the cap crooked. While the cup is self-feeding, the grease can be forced by hand to clear the passages of hardened grease and dirt before automatic feeding begins, thus insuring perfect lubrication. The cup is designed to feed about one-third of its capacity at each adjustment, to prevent emptying it completely. The spring-snap bayonet joint holds the parts firmly together.

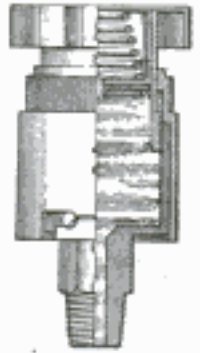

3 m COMPLETE MACHINE SHOP IN ONE TOOL

Work of immense variety may be done with a machine now in course of production by a French concern; it is really what its makers call it—

"The Complete Workshop"—as, with a few simple changes in the position of the head, it may be used as a radial drill, shaper, miller, grinder, gear-cutter, slotter, and saw, adapted for either hand or power. The speeds may be changed, by gearing, for different varieties of work, the head running at from 20 to 2,200 r.p.m. The tool feeds are all automatic, and the tool head not only swings around the column, but also swivels on the cross slides, so that the work may be machined at any angle. The heavy base is provided with T-slots to accommodate a swiveling graduated vise, and work-holding clamps and fixtures. The space occupied is only 15

by 30 by 32 in., making the machine ideal for model makers, and small workshops.

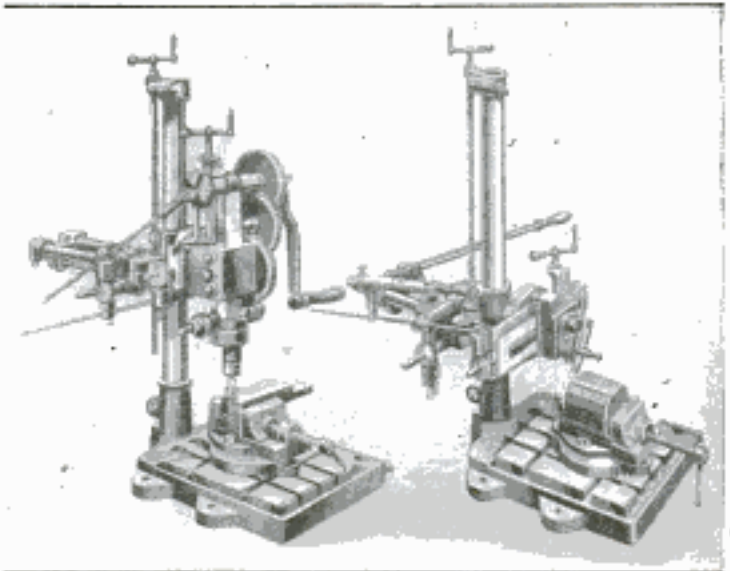

Left, "The Complete Workshop" Set Up for Milling; Right, in Use as a Shaper

Price \$650.00
Hand \$875.00
2 \$350.00
\$125.00

Compagnie Manufacturiere
66 Rue de la Paix
Paris, France

no U.S. agent.

Copyrighted material



Drilling out broken stud bolt in exhaust pipe bracket.

The "YANKEE" Ratchet Makes Every Tapping Job Simple

No. 250—Length $3\frac{1}{4}$ in. Diameter of chuck $\frac{3}{4}$ in. Holds up to $\frac{3}{16}$ in. taps.

No. 251—Length 5 in. Diameter of chuck $\frac{7}{8}$ in. Holds up to $\frac{5}{16}$ in. taps.

No. 1251—Length 13 in. For jobs needing long reach. Otherwise same as No. 251.

"YANKEE" Ratchet Tap Wrench

"It will take hours," says the mechanic who has no "Yankee" Tap Wrench. "I'll have it done in a jiffy," says the man who has one. That's the story on every difficult tapping job.

Here's why: You don't have to take the work apart to get at the hole when you use a "Yankee" Ratchet Tap Wrench. A fraction

of an inch to work in is enough. Slightest movement of cross bar keeps tap cutting.

A finger-touch gives you Left or Right-Hand Ratchet movement—or rigid adjustment. Cross bar slides easily to either end or center and STAYS PUT. Knurled thumb-piece is mighty handy for quickly starting taps or backing out.

Your Dealer Can Supply You
NORTH BROS. MFG. CO.
Philadelphia, U. S. A.

Free "Yankee" Tool Book pictures and describes many ingenious tools for boring, tapping, driving and drawing screws easier and quicker. Send postal for it today.



"YANKEE" TOOLS

Make Better mechanics



Priceless Service

Despite fire or storm or flood, a telephone operator sticks to her switchboard. A lineman risks life and limb that his wires may continue to vibrate with messages of business or social life. Other telephone employees forego comfort and even sacrifice health that the job may not be slighted.

True, the opportunity for these extremes of service has come to comparatively few; but they indicate the devotion to duty that prevails among the quarter-million telephone workers.

The mass of people called the public has come to take this type of service for granted and to use the tele-

phone in its daily business and in emergencies, seldom realizing what it receives in human devotion to duty and what vast resources are drawn upon to restore service.

It is right that the public should receive this type of telephone service, that it should expect the employment of every practical improvement in the art, and should insist upon progress that keeps ahead of demand. Telephone users realize that dollars can never measure the value of many of their telephone calls. The public wants the service and, if it stops to think, cheerfully pays the moderate cost.



**AMERICAN TELEPHONE AND TELEGRAPH COMPANY
AND ASSOCIATED COMPANIES**

BELL SYSTEM

One Policy, One System, Universal Service

for—

- Heat regulators
- Motor boat ignition
- Gas engine ignition
- Tractor ignition
- Starting Fords
- Door bells
- Buzzers
- Ringing burglar alarms
- Protecting bank vaults
- Calling Pullman porters
- Running toys
- Telephone and telegraph
- Lighting tents and out-buildings
- Firing blasts
- Electric clocks
- Radio "A"



Let Columbia batteries 'tend your heater

COSTLY coal makes reliable heat regulators worth more than ever. Reliability begins with energetic Columbia Dry Cells. Wonderful lasting power. All strength goes into work. They don't fret, corrode and weaken while waiting. In fact, there is a noticeable pick-up of new vigor. Packed with power. Fresh wherever bought because they sell so fast! The Columbia Hot Shot is right at home in damp basements—a water-tight metal case containing four, five or six Columbia Cells. Great for radio dry cell tubes.

Columbia Dry Batteries are sold by electrical, hardware and auto accessory shops, marine supply dealers, implement dealers, garages, general stores. Insist on Columbias. Fahnestock Spring Clip Binding Posts on Columbia Ignitor at no extra cost.

NATIONAL CARBON COMPANY, Inc., New York, San Francisco
Canadian National Carbon Co., Limited Factory and Offices: Toronto, Ont



The steel case battery defies water and weather

Columbia Dry Batteries

—they last longer

for Economical Transportation



Superior
Utility Coupé

\$640

f. o. b. Flint, Mich.



For the Small Family

The world's lowest priced high-grade closed car exactly meets the requirements of the small family.

Father uses it daily going back and forth to work. Evenings and Sundays it holds the young family comfortably, protects baby from winds, storms and cold in winter, yet has all the airiness of an open car in summer.

The plate glass windows are extra large. The wide doors make it easy for mother to enter or leave with baby in her arms.

Finally, and most important, its low price and low maintenance costs make it feasible for the family of modest income.

Chevrolet Motor Co., Detroit, Mich.

Division of General Motors Corporation

Five United States manufacturing plants, seven assembly plants and two Canadian plants give us the largest production capacity in the world for high-grade cars and make possible our low prices.

Prices f. o. b. Flint, Michigan

Superior Roadster . . .	\$490	Commercial Cars	
Superior Touring . . .	495	Superior Commercial Chassis . . .	\$395
Superior Utility Coupé . . .	640	Superior Light Delivery Utility Express Truck Chassis . . .	495
Superior Sedan . . .	795		550

Dealers and Service Stations everywhere. Applications will be considered from high-grade dealers only, for territory not adequately covered.

Thousands Now Find It **EASY** to Make Their Own **MUSIC**



with a

BUESCHER True-Tone Saxophone



TOM BROWN
Director
Six Brown Brothers
Saxophone Sextet
Victor Records



BEN SELVIN
Director
Selvin's Orchestra
Aeolian-Vocalion
Records



DAN RUSSO
Director
Orsino Orchestra
Brunswick Records



BENNIE KRUEGER
Director
Bennie Krueger and
His Orchestra
Brunswick Records

These Famous Saxophone Players

whose portraits are shown—use and recommend Buescher True-Tone Saxophones. Almost without exception, the great Professionals use Buescher Instruments exclusively. They are so flawless in scale, so perfect in tone and so accurate mechanically that more than 75 per cent of the popular Phonograph Records are played with them.



JASCHA GUREWIGH
Former Soloist
with Sousa's Band
Electric Records



CLYDE C. DOERR
Director
Clyde Doerr's Orchestra
Victor Records



NATHAN GLANTZ
Director Nathan Glantz
and His Orchestra
Edison and
Other Records



KEITH PITMAN
Musician
S.S. Leviathan Orchestra
Victor Records

Everyone has a perfectly normal desire to produce music, but the average person has not the time nor patience to spend months or years in learning to play. Heretofore, the making of music has been the privilege of the talented few. But now it is different. With this wonderful new saxophone, Buescher has made music a universal accomplishment, and has placed it within the possibility of practically everyone.

See How Easy It Is

With the aid of the first three lessons, which are sent free (upon request) with each new Saxophone, the scale can be mastered in an hour; in a few weeks you can be playing popular music. Practice is a pleasure because you learn so quickly. You could even take a place in a band or orchestra in 90 days, if you so desired.

Wins a Welcome Everywhere

You're always welcome with a sweet-toned Buescher Saxophone. Thousands of men and women, of all ages, have found it an infallible key to social popularity. For home entertainment, for church, school or lodge affairs, the Saxophone is the most popular and adaptable instrument. Saxophone players enjoy, also, many opportunities of earning money. They are always in demand for dance orchestras.

Free Trial Six days' Free Trial of any Buescher Grand Saxophone, Cornet, Trumpet, Trombone or other instrument. Easy terms of payment arranged. Mention instrument interested in and complete catalog will be mailed free.

A Remarkable Saxophone Book—Free!

We have prepared a very interesting book on the history and development of the Saxophone. It tells which saxophone takes violin, cello and bass parts, and many other things you would like to know. Also illustrates first lesson. It is sent free on request. Just send a postcard or clip and mail the coupon.

BUESCHER BAND INSTRUMENT CO.
Everything in Band and Orchestra Instruments
2599 Buescher Block, Elkhart, Ind.

Buescher Band Instrument Co.
2599 Buescher Block, Elkhart, Ind.

Gentlemen:

I am interested in the instrument checked below:

Saxophone..... Cornet..... Trombone..... Trumpet.....
(Mention any other instrument interested in)

Name

Street Address

Town.....

State

AMPLION

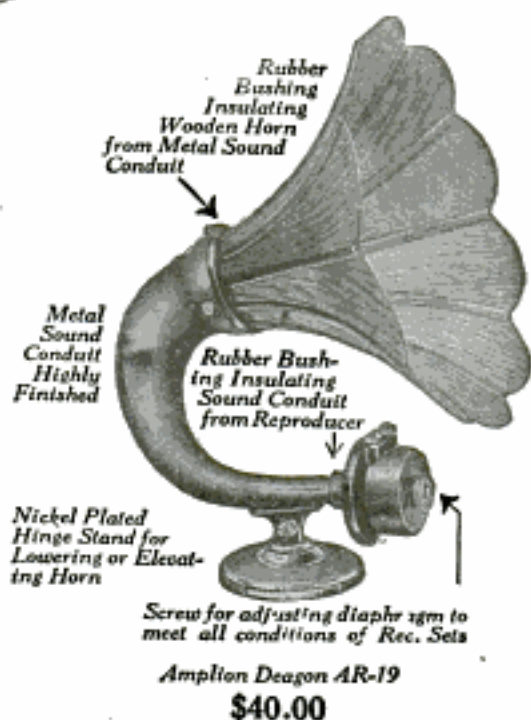

Amplion Dragon AR-19
\$40.00

Points of Amplion Supremacy

1. The "Amplion" requires no power amplifier. No battery necessary.
2. Connects up to regular head phone binding posts.
3. The diaphragm is made of a special alloy found to have no equal after years of experiment with all other materials.
4. The electro-acoustical device is insulated entirely from the Horn, eliminating distortion, ring or resonance.
5. Non-vibrating wooden horn surpasses all other materials.
6. Adjustable feature makes the "AMPLION" sound true with any make of receiving set, and ensures faithful reproduction.
7. The mechanism has not been hurriedly devised to meet the radio boom; it is not new; it is a development for radio purposes of a loud speaking device that has been used by leading navies of the world for years.
8. The finish and workmanship are supreme.

"That's the clearest reproduction I have ever heard"

This is what one of America's leading radio engineers said when he heard the Amplion at the New York Radio Show in October.

And added to this wonderful clearness is volume and tone quality as yet unequalled.

Simple to connect, no extra battery needed. Insist on an Amplion demonstration before you purchase a loud speaker.

Patentees: ALFRED GRAHAM & CO.
SIGNAL ELECTRIC MFG. CO.
Sole United States Distributors
Menominee, Michigan
BURNDEPT OF CANADA, LTD.
Canadian Distributors - 172 King St. W., Toronto

AMPLION

The World's Standard Loud Speaker

"Buy a Studebaker Direct from the Maker"



Only \$1 Down!

Just \$1.00! The balance in easy monthly payments. You get the famous Studebaker, 21 Jewel Watch—Insured for a lifetime—direct from the maker at lowest prices ever named on equal quality. Send at once for FREE Book of advance Watch Styles.

21 Jewel STUDEBAKER -the Insured Watch

Choice of 54 latest, thin model, Art Beauty Cases in yellow gold, green gold or white gold; 8 adjustments, including heat, cold, isochronism and 5 positions. Direct to you from the factory—the greatest watch value in America today.

Write for Style Book! Send at once and get a copy of this book—FREE! See the newest, beautiful, advance styles in Studebaker Art Beauty Cases and Dials. Read how you can buy a 21 Jewel Studebaker Insured Watch *direct from the maker*—save big money—and pay for it while you are using it. Write for our Free Book. It will post you on watch styles and watch values. Send coupon at once. Get Free Chain offer today while it lasts.

STUDEBAKER WATCH CO.

Dept. 222

South Bend, Indiana

Mail Coupon for FREE Book

**FREE!
Watch Chain**

For a limited time we are giving away free with every Studebaker Watch a beautiful Watch Chain. Write now while offer lasts.

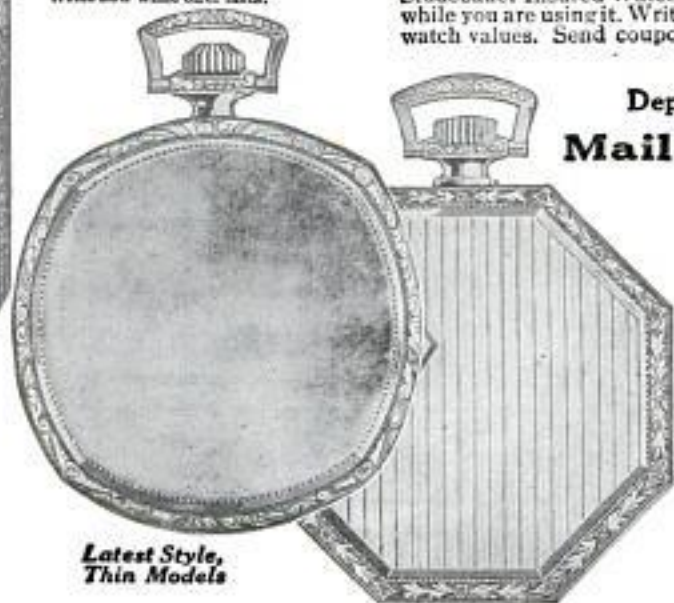

Latest Style,
Thin Models

Studebaker Watch Co.
Dept. 222 South Bend, Indiana

Please send me your Free Book of Advance Watch Styles and particulars of your \$1.00 down offer.

Name.....

Address.....

City..... State.....

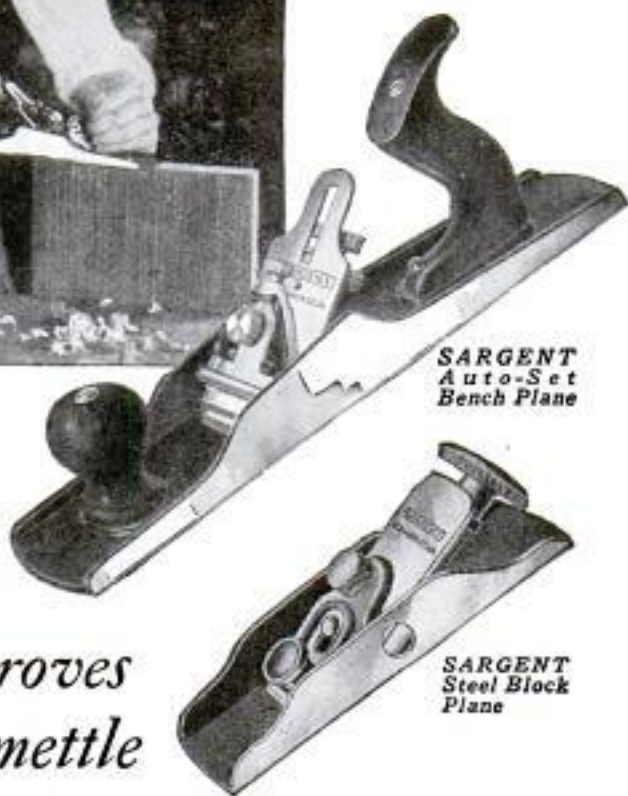

*The cross-grain cut
is the test that proves
this plane's mettle*

THE Sargent Auto-Set Bench Plane has a reputation for coming through the thousand-odd jobs that develop at a busy work bench, without a murmur or a moment's hesitation.

Its unusual cutting keenness—across or against as well as with the grain—will surprise you. Its all around dependability and simplicity of adjustment have gained for it, everywhere, that real affection which craftsmen feel toward tools which never fail them.

The auto-set feature permits the removal, whetting and replacement of the chromium steel cutter in the shortest possible time. Furthermore, in doing this it is not necessary to change the original adjustments.

Ask your hardware dealer to show you the Sargent Auto-Set and the Sargent Steel Block Plane for smaller jobs. You'll find they are made of lasting materials, perfectly fashioned and finely finished. Both are worth having.

*Drop us a post card for the Sargent Book of Planes,
which contains detailed information concerning them.*

SARGENT & COMPANY, Hardware Manufacturers
49 Water Street, New Haven, Conn.

SARGENT
Tools & Hardware

Be Sure of Your Work—



*Then and
there
he was
convinced*

There was a mechanic who said he could get other tools than "Brown & Sharpe."

He could

He said, "I'll try a new Micrometer of another make."

He did

He thought that this other tool would be just as reliable as a Brown & Sharpe.

It wasn't

His work was not as good—and the tool was to blame.

*He was
dissatisfied*

Finally he made up his mind to buy a Micrometer that he *knew* he could rely on—and it was a Brown & Sharpe.

*He has used it
ever since*

BROWN & SHARPE TOOLS

are made in the largest factory of its kind — their accuracy, improved design, long life and quality have made them the "Standard of the Mechanical World."

Catalog listing over 2000 different tools, with discount sheet, sent on request. Send for it today.

BROWN & SHARPE MFG. CO.
PROVIDENCE, R. I., U. S. A.

Trade Mark Registered

WURLITZER

THE WORLD'S LARGEST MUSIC HOUSE

200 Years Ago in the little Saxon town of Schoeneck lived Hans Adam Wurlitzer, Master Violin Maker. His shop was a gathering place for musicians of the time, for he was a true craftsman—the artisan upon whose work the genius of the artist must depend.

When he died his shop passed into the hands of his eldest son, and for seven generations, down to the present day, the descendants of Hans Adam Wurlitzer have carried on his work. Each succeeding generation has added a wider experience as new instruments have been developed, and a greater technical skill as methods of instrument building have been improved.

In every Wurlitzer instrument you will find a quality, a character, that could not come from mere excellence of manufacture. It is the heritage of these seven generations of music-craftsmanship.



Try Any Wurlitzer Instrument in Your Own Home

YOU may now have any Wurlitzer instrument for a week's free trial in your own home. Examine the instrument, show it to your friends, play it as much as you wish. No obligation to buy—no expense for the trial. We make this liberal offer because we want you to see for yourself the superior quality of Wurlitzer instruments, the result of 200 years' experience in musical instrument building.

Leading professionals everywhere recognize the artistic quality of Wurlitzer instruments. Ysaye, the great virtuoso; Salvi, internationally famous as a harpist; Carl Preble of Sousa's band; Justin Huber, leader of the well-known syncopated orchestra of that name—artists of the highest standing in every sphere of music use Wurlitzer instruments and recommend them to others. They speak especially of the ease of playing, a feature that is of importance to the amateur as well as the professional.

Easy Payments

If you decide to buy after the week's free trial, payments are arranged in small monthly sums. A few cents a day will pay for your instrument. By buying direct you obtain genuine Wurlitzer quality at moderate prices. Special offers on complete outfits—velvet lined case, all accessories, self-instructor, etc.—all you need at practically the cost of the instrument alone.

Send for New Catalog!

The greatest musical catalog ever published! Over 3,000 articles—every known instrument described and illustrated; many of them shown in full colors. Gives you lowest prices and all details of Free Trial, Easy Payment plan. All sent FREE—no obligation. Send the coupon today.

Fill out this coupon and mail to address nearest you



THE RUDOLPH WURLITZER CO., Dept. 1772
120 W. 42nd St., New York 117 E. 4th St., Cincinnati
329 S. Wabash Ave., Chicago 250 Stockton St., San Francisco

Send me, absolutely free, your new illustrated catalog, with prices and description of every known musical instrument. Also tell me how I may try any instrument in my own home and pay for it in small monthly sums. No obligation.

Name _____

Address _____

City _____ State _____

Instrument _____
(State instrument in which you are interested)

Copyright, 1924, The Rudolph Wurlitzer Co.



Super-service

Wide-awake radio fans refuse to miss a good program because of storage battery weakness. For super-service they keep the battery fully charged from the house current with a Tungar. Likewise they use Tungar to charge the auto battery at home. The result is longer battery life and more "pep" — plus convenience.

In homes with electricity Tungar recharges the run-down radio or auto battery over night at a saving. Sold by Electrical, Auto-accessory and Radio dealers.



The home completely wired is ready for every convenience and comfort that Electricity can furnish.

The book — "The Home of a Hundred Comforts" tells how to plan for a completely wired home. Thousands have sent for it. Write for your free copy.

Address Section PM 2
Merchandise Department
General Electric Company
Bridgeport, Conn.



Tungar

BATTERY CHARGER

Tungar operates on alternating current. Two sizes, \$18.00 and \$28.00 (60 cycles) Prices east of the Rockies.

GENERAL ELECTRIC

"What a whale of a difference
just a few cents make!"

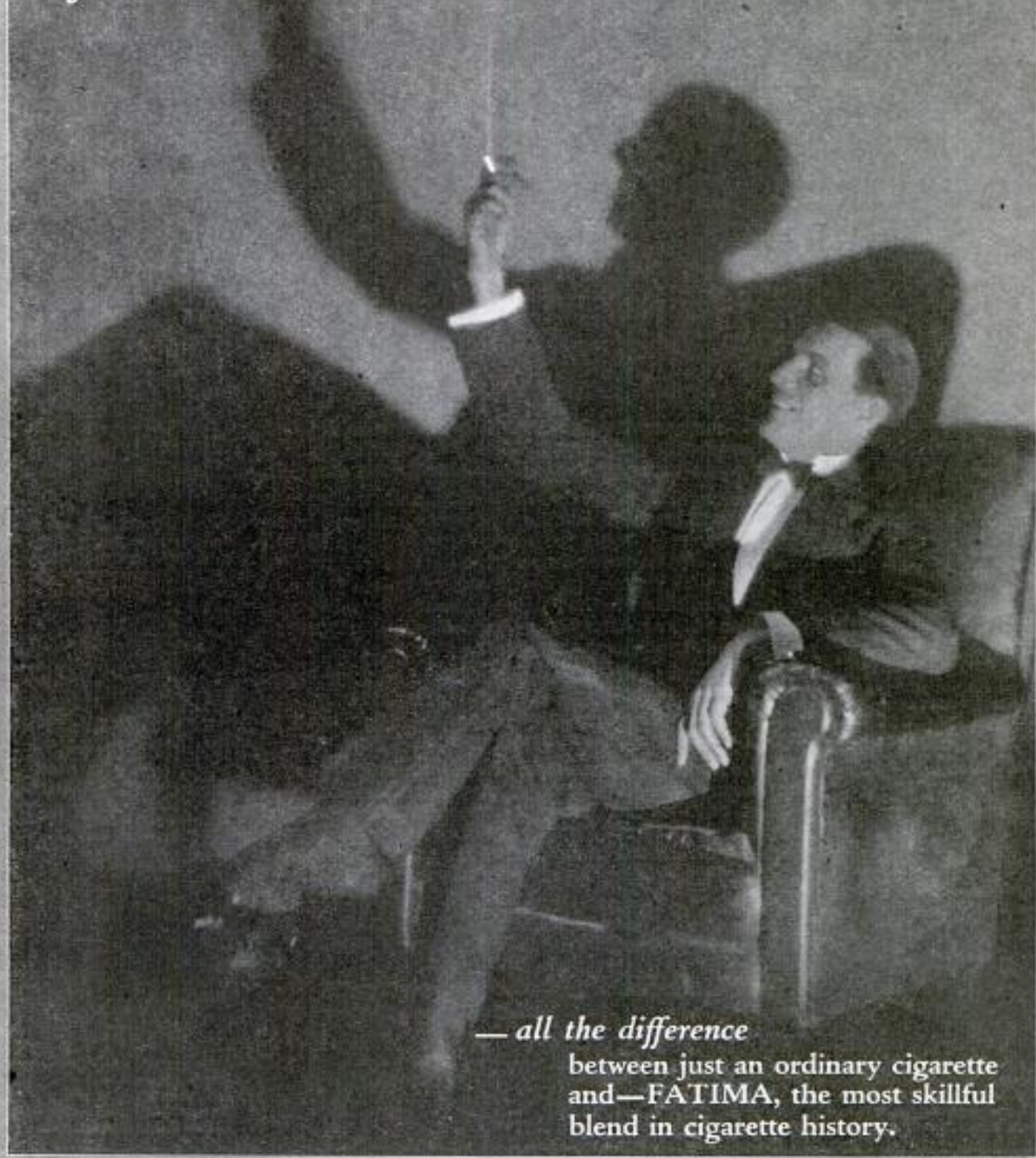

— all the difference

between just an ordinary cigarette
and—FATIMA, the most skillful
blend in cigarette history.

POPULAR MECHANICS Shop Notes Book FOR 1924 IS READY

Send for your copy today. Like its predecessors, this volume is packed full of **Easy Ways to Do Hard Things** that are of daily use to every mechanic. The entire collection of 550 Shop Notes articles that appeared in Popular Mechanics Magazine during the past year is now offered to you in this one handy volume, conveniently indexed. **50c Postpaid**
Bigger and Better than Ever 248 Pages—455 Illustrations. If you have at hand for quick reference a set of Shop Notes consisting of 15 volumes previously issued, you will seldom, if ever, **GET STUCK ON A JOB.** You cannot afford to be without these helpful books any longer. The several thousand time and labor-saving kinks will save you the price of 50 cents a volume many times over. Make this a red-letter day of preparation for increased efficiency by mailing us your order for a set of the books.

POPULAR MECHANICS BOOK DEPARTMENT, 200 East Ontario Street, CHICAGO

Reduce Tubes by Half With Erla Synchronizing Transformers

Vacuum Tubes
in ERLA Duo
Reflex Circuits

1 = 3
2 = 4
3 = 5

Vacuum Tubes
as Ordinarily
Employed —



Increased amplification and elimination of distortion inevitably follow installation of Erla transformers. Reflex and cascade types. \$5



Crystal troubles vanish on installing an Erla rectifier. No adjustment required. Proof against jolt and jar. Lasts indefinitely. List \$1



Look for the words "tested capacity," found exclusively on the labels of Erla fixed condensers. Made in eleven sizes, 35c to 75c ea.

Nation Wide Loud Speaker Reception With Only Three Tubes

Greater range and volume with fewer tubes than ever before are attained through Erla Duo-Reflex circuits, using Erla synchronizing radio and audio transformers.

In Erla circuits, tubes do triple duty, as simultaneous amplifiers of received radio frequency, reflexed radio frequency, and reflexed audio frequency currents. Through accurate superimposition of currents identical in phase and frequency, by means of Erla synchronizing transformers, this triple function is flawlessly performed, resulting in tremendously magnified amplification without distortion.

Even one tube provides excellent loud speaker reception over a wide range; two tubes blanket the zone ordinarily covered by four, while three tubes bring in stations on the loud speaker from coast to coast.

Other notable improvements, contributing vitally to the superiority of Duo-Reflex circuits, are the Erla fixed crystal rectifier and Erla tested capacity condensers. Combining advanced characteristics for reflex work with unduplicated uniformity, they are indispensable to complete stability and purity of reproduction.

Detailed diagrams and descriptions of Erla Duo-Reflex circuits are presented in Erla Bulletin No. 16. Ask your dealer, or write, giving your dealer's name.

Electrical Research Laboratories
Dept. J 2515 Michigan Avenue, Chicago

ERLA



Erla audio transformers add tremendously to the purity and volume of any receiving unit in which they are used. Ratios 3½ and 6 to 1. \$5



Screen unsightly openings for tube ventilation with Erla bezels, made in 1" and 1½" sizes, in bright nickel or dull enamel. List, 20c



Erla sockets combine maximum beauty and strength, with heavy, nickelled shell cast into moulded Bakelite base. Many other advantages. 75c

Hand
Forged
Razor Steel
Blades, No. 57



Direct at Factory Prices

This \$2 KNIFE \$1.18 Postpaid
Hand Forged Razor Steel Blades
Handy shaped Blade makes this knife best for mechanics, sportsmen and farmers; light but strong; re-sharpened easily. Stag handle. German silver finish; blades file tested, hand forged from razor steel and warranted.

Sample \$1.18 3 for \$3.00 Postpaid.

Send for our 100-page List and "HOW TO USE A RAZOR" FREE

MAHER & GROSH CO., 106 A St., Toledo, Ohio

60% of Market Price

will buy

Diamonds here

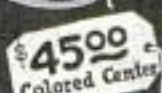

Why Pay Full Prices Costs Nothing to See

This famous 75-year old firm — the Largest and Oldest Diamond Banking Institution of its kind in the world — must sell the diamonds on which we loan money. This firm rated highest, at over \$1,000,000.00 capital, having made loans on diamonds, watches, other jewels in unpaid loans and other special advantage bargains that we must sell to get back our cash. Buy here where loan values the price basis, not market values. Send now for bargain list.

FREE—On Approval! The Buys of a Lifetime!

The diamond bargains pictured here are merely a few of the many unusual offers on our lists, all with full and complete descriptions. At our risk—we send you any bargain you wish for Absolutely FREE Examination. No obligation. Compare it carefully, have it valued any way you wish. If you decide not to buy, you are not out one penny.

As Low As \$60 Per Carat

Not all, but some. Yes, some even lower priced, but also diamonds of finest qualities at higher per carat charges. Get a diamond now around half its market price.

Send for Latest List of Diamond Loans

Unlike the ordinary catalog. Hundreds of Diamond Bargains described in full detail with exact weight, color, quality, etc. You know what you're buying before you buy. Besides it tells of Guaranteed Loan Value, unlimited exchange privilege at full price paid, and complete details of free examination offer.

Use Coupon NOW!

We'll send our latest Bargain list. It's free. No obligation. No expense to you. Write Now!

Jos. De Roy & Sons
1917 De Roy Building
Only Opposite Post Office,
Pittsburgh, Pa.

References by permission:—
Bank of Pittsburgh—N.
A. Marine Nat'l Bank
—Union Trust Co.,
Pittsburgh, Pa.
Your bank can
look us up in mer-
cantile agencies.

Jos. De Roy & Sons
1917 De Roy Building
Only Opposite Post Office,
Pittsburgh, Pa.

Gentlemen: Please send me free and prepaid, your latest bargain list of diamonds, watches and other jewelry. It is understood I assume no obligation of any kind.

Name _____

Address _____

Guaranteed Cash Loan!

Diamonds bought here are like insurance policies. You know what you can borrow before you decide to buy—SEE OUR CASH BACK GUARANTEE!





Save $\frac{1}{3}$ on Guaranteed Radio Equipment

**Write us a post card—
Address Dept. 6-R**

and we will send you free this 52 page catalogue of radio sets and parts. It also contains explanation of radio terms, map and list of broadcasting stations and much radio information, including an explanation of successful hook-ups and circuits.

You will be amazed at the low prices Ward's quote. A complete tube set having a range of 500 miles and more, including tube, head set, batteries, and antenna equipment, as low as \$23.50.

This catalogue contains everything for the expert and amateur. Complete sets and every improved part for building sets, all the most up-to-date devices—at the lowest possible prices.

Headquarters for Radio

Montgomery Ward & Co. is headquarters for Radio, selling everything direct by mail without the usual "Radio-profits." Why pay higher prices? Ward quality is the best and the prices will often save you one-third. Everything sold under our Fifty Year Old Guarantee—Your Money Back if You Are Not Satisfied. Write today for your copy of this complete 52-page Radio Book.

**Write to our house nearest you
Address Dept. 6-R**

Chicago Kansas City St. Paul Portland, Ore.
Ft. Worth Oakland, Cal.

**This Radio
Catalogue
FREE**

Established 1872
Montgomery Ward & Co.

The Oldest Mail Order House is Today the Most Progressive



“What’s the print allow you, Bill?”

“Two thousandths under — nothing over.”

“*With* no chance to fit and try *and* a fine chance of getting fired if you spoil it. All I got to say is it’s a good thing you own a set of Starrett ‘Mikes’.”

THE L. S. STARRETT CO.

The World’s Greatest Toolmakers—Manufacturers of Hacksaws Unexcelled
ATHOL, MASS.

The Micrometer Head illustrated at the right is part of the Starrett Inside Micrometer Set No. 124. A wonderfully accurate tool beautifully finished and built to give a lifetime’s service. Furnished in four size combinations ranging from 2 to 8 inches to 2 to 32 inches. See pages 180 to 186 in the Starrett Catalog for complete description of these fine Micrometers. Free. Write for Catalog No. 22 AP.

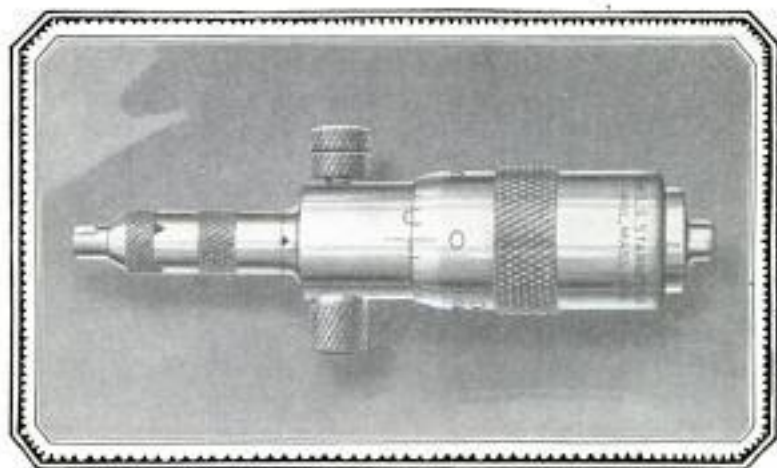

Use Starrett Tools



21 Jewels **Santa Fe** **Special** **Sold Direct**

III

SAVE YOU MONEY

My sole aim during the year 1924 is to place as many standard, dependable watches, as I can, in the hands of men throughout the land, REGARDLESS OF PRICE OR PROFITS. To do this, I have cut the prices to ABSOLUTELY ROCK BOTTOM. I know that if I can distribute 5,000 "Santa Fe Specials" this year on this CUT-PROFIT PLAN, that every watch will sell another. I am making this STARTLING OFFER to those who will tell their friends of this remarkable watch value, if they find the watches all and more than I claim for them.

Alvino Thomas
Pres. Santa Fe Watch Co.

LOOK!

21 Perfect Ruby and Sapphire Jewels. Adjusted to Positions. Adjusted to Temperature. Adjusted to Isochronism. Adjusted to the Second. 25 Year Gold Strata Case. Your Choice of Dials (including Montgomery R. R. Dial). New Thin Models. All Sizes. Guaranteed to last a lifetime and give satisfactory service.

No Money Down—Sent on Approval

In addition to our Cut-Profit Special Offer, we will send this famous watch, express prepaid, for you to examine, to inspect, to admire, to approve without one penny advance payment. Examine the watch and be convinced it's the best watch you ever saw, just a small payment down, the balance in easy MONTHLY payments. You use the watch while paying for it.

Save 1/3 to 1/2 of Your Money

By purchasing this Famous Santa Fe Special Watch. Not only are you saving money from the present day prices of watches, but you can still secure the "Santa Fe Special" Watch at the same low prices and terms that have made our watches famous.

Ladies' Wrist Watches—The "New Elite"

This Artistic dependable Ladies' Wrist Watch, fitted with genuine Illinois Springfield movement. A perfect timepiece. Beautiful 14 Karat white or green solid gold cases. Ask for New Watch Book showing New Cases in all the new shapes and designs. Watch sent on approval and sold on payments.

Send for Free Watch Book

Clip the coupon, fill out and receive the FREE WATCH BOOK. All the newest watch case designs in white or green gold, fancy shapes and thin models are shown. Read our easy payment offer. Wear the watch 30 days FREE. Watch sent for your examination and approval without a penny down. Nothing to risk. See the watch before you buy. Write for FREE Book Today and Select Your Watch—Mail Coupon.

SANTA FE WATCH COMPANY
26 Thomas Building TOPEKA, KANS.
The Home of the Great Santa Fe Railway

SANTA FE WATCH CO.
26 Thomas Bldg.
Topeka, Kans.

Please send prepaid and without obligation your Watch Book Free, explaining your "No Money Down" Offer on the Santa Fe Special Watch.

Name.....

Address.....

State.....



\$3
DOWN

and it's YOURS

The Greatest Typewriter Bargain Ever Offered

Right now we are making you the greatest typewriter offer you ever dreamed of—an eye opener. This wonderful standard Shipman-Ward Rebuilt Underwood only \$3.00 down. Ten days' free trial and the easiest monthly payments, shipped direct to you from our big factory.

10 Days' Free Trial From Factory to You

Yes, only \$3.00 down puts this genuine late model Shipman-Ward Rebuilt Underwood in your home. You can try it, test it, and then decide. See for yourself how new it is, how it writes. You must be satisfied. Your \$3.00 unconditionally returned if at the end of ten days you are not satisfied. The entire transaction will not cost you one cent.

EASY Monthly Payments

Little more than rental. Balance of payments so small you will hardly notice them, while you enjoy the use of this wonderful machine. You don't have to scrimp and save to pay cash. All at a big saving to you.

5 Year Guarantee

With every typewriter we give a written guarantee. These machines are rebuilt like new by the famous SHIPMAN-WARD PROCESS. Equipped with late improvements. You can't tell them from a new machine. The world's standard typewriter, the same models as sold by the Underwood Typewriter Company today, at a big saving to you. Act now! Get this splendid offer and save money.

SHIPMAN-WARD MFG. CO.

2122 Shipman Bldg., Montrose and Ravenswood Aves., Chicago

These machines are shipped direct from our factory—the largest typewriter rebuilding plant in the world. They are rebuilt by the famous SHIPMAN-WARD PROCESS. Developed through 30 years in the typewriter business. Through our money saving methods of rebuilding and elimination of a large expensive sales force we are able to make this wonderful money saving offer to you. ACT TODAY, take advantage of it and you will SAVE MONEY. ACT NOW! Mail this coupon today.

Free Book of Facts

Write for this free book of facts explaining Shipman-Ward's wonderful system of rebuilding typewriters. We show you exactly how it's done. How you are able to buy them. Complete and valuable information about the typewriter industry, both instructive and educational.

FREE with Every Typewriter

A complete course in touch typewriting. You don't have to know how to operate a typewriter. You can learn to operate this machine in one day. We also give free a waterproof cover and all tools that come with a typewriter.



All Shipments made direct to you from our modern factory—the largest typewriter rebuilding plant in the world.

FREE BOOK COUPON

SHIPMAN-WARD MFG. CO.
2122 Shipman Bldg.
Montrose and Ravenswood Aves.
CHICAGO

Send by return mail your wonderful offer of Shipman-Ward Standard Rebuilt Underwood, also your book of facts. (This is not an order and does not obligate me in any way.)

NAME.....

STREET.....

POST OFFICE.....STATE.....

WINDOW SIGNS



AGENTS 500% PROFIT

Genuine Gold Leaf Letters

GUARANTEED TO NEVER TARNISH



For store fronts, office windows, Bank windows, Office Doors, Panels, Board Signs, Trucks, Automobiles and Glass Signs of all kinds. Anyone can put them on and make money right from the start without previous experience. All you have to do is to show your samples; the letters are very attractive and easy to sell. Letters costing 3½¢ sell for 25¢. One agent says: "Your Letters are the best thing I have seen in years; I have made \$125.00 the first week and still going strong." Paul Clark says: "Smallest day \$28.70." H. Gilder made \$835.00 in six weeks.

\$60 TO \$200 A WEEK

GENERAL AGENTS—It is easy to appoint sub-agents for this line. We pay you 20% cash commission on all orders we receive from local agents appointed by you anywhere. We allow you 50% discount on your own orders. You can sell to nearby trade or travel all over the country, as you please. Large demand for window lettering everywhere. Write today for free sample, full particulars and liberal offer to general agents.

Metallic Letter Co., 433-B N. Clark St., Chicago

SEND for the INTERNATIONAL CATALOG

FOR FORD PRICES FROM \$17.95 UP.



Our net price list. Full line of auto bodies and accessories for Fords at Wholesale Prices. Save big money on bodies by buying direct from factory.

Factory to Consumer direct—Pay only one profit.

INTERNATIONAL BODY WORKS, Dept. 7, 914 W. Ohio Street, CHICAGO, ILL.

FORDS run 34 Miles

on Gallon of Gasoline

Low Gear Seldom Used with Air Friction Carburetor



We guarantee all other cars nearly double present mileage, power and flexibility, make hills on high formerly difficult on low. Models for any car, truck, or tractor. See wonderful mileage guarantees for other cars.

Ford.....34mi.	Reo.....24mi.	Chevrolet.....32mi.
Buick 4.....30mi.	Chalmers.....23mi.	Maxwell (25).....30mi.
Buick 6.....24mi.	Olds 6.....23mi.	Nash 6.....23mi.
Hudson.....20mi.	Paige 6.....20mi.	Lincoln 8.....17mi.
Hupp.....25mi.	Oakland 6.....24mi.	Stbkr Lt. 6.....23mi.
Dodge.....28mi.	Overland 4.....32mi.	Cole 8.....17mi.

If your car is not mentioned here send name and model for particulars and our guarantee on it. **AGENTS WANTED.**

SENT ON 30 DAY'S FREE TRIAL

You can drive any car in heaviest traffic without shifting gears. Starts off on high in any weather without priming or heating—no jerking or choking. No more foul spark plugs or carbon in cylinders. No leaking of gas into crank case. Try it 30 days on our guarantee of money back if not entirely satisfied. No strings to our guarantee. **YOU ARE THE JUDGE.** Anyone who can handle a wrench can attach it. No boring of new holes or changing of operating mechanism. Write today.

AIR-FRICTION CARBURETOR CO.
592 Raymond Bldg. Dayton, Ohio, U. S. A.

Roofing Book FREE



World's Best Roofing at Factory Price

Don't buy Roofing of any kind until you get our big Free Roofing Book, describing full line of Edwards Famous "Tightcoats" Galvanized Roofings, Sidings and Ceilings, and our lowest factory prices. Then see for yourself how much we save you by selling direct and saving you all in-between-dealers' profits.

EDWARDS "REO" Metal Shingles

Absolutely rust proof. By our patented "Tightcoats" process, edges as well as sides of metal sheets are heavily coated with zinc—not a space the size of a pin point exposed to weather. Fire and lightning proof. Outlasts three ordinary roofs. Forever wind and weather proof. Need no repairs—and all roofing expense. Patent **INTERLOCKING DEVICE** makes water tight seams—all nail heads covered—no chance for rust or leaks.

EDWARDS Galvanizing Test

Edwards "Tightcoats" Galvanized Roofing can be bent, twisted or struck by lightning, and the galvanizing will not crack or flake. Bend it or hammer it—you can't loosen or scale the galvanizing. No other galvanized roofing can withstand this test.

Low Priced Garages

Wide variety of styles, all sizes of Portable Fireproof, Metal Garages. Lowest prices ever made. Postal brings Big Garage Catalog free.

Write Today for free samples and proof that we can save you a lot of money on any kind of roofing, siding or ceiling you may need. Ask for Roofing Book No. 140.

THE EDWARDS MFG. CO.,
200-250 Pike St., Cincinnati, O.



FREE
Samples &
Roofing Book

You Can Save \$35.00



Recover your old auto top frame yourself. Custom tailor made to fit all makes and models of cars. Any person that can drive a car can put it on. Roof and quarters sewed together, with rear curtain, fasteners, welts and tacks complete. Give name, year and model number of your car and we will send you catalog with samples.

LIBERTY TOP & TIRE CO., Dept. E-7, Cincinnati, O.

Steady Work

in a fast growing business with Vanderpool Latest Improved Vulcanizer. Made in America.

Ask for Catalog

Vanderpool Co., Dept. 2P, Springfield, Ohio

F. H. DIBB, Agent for British Isles
26 Fairfield Rd. Winchester, England



MOTORCYCLE BARGAINS

Save 25% to 65%

on Slightly used and Rebuilt Motorcycles, Side Cars, Johnson Motor Wheels, Evans Power Cycles, Bicycles. Send for Free Bargain Bulletin and Money Saving Message, listing hundreds of Bargains in used, rebuilt and new machines, supplies, accessories, etc.

AMERICAN MOTOR CYCLE CO. CHICAGO
Dept. 222, 2047 W. Chicago Avenue.



MOTORCYCLES



RELIABLE STANDARD MAKES that you can **DEPEND** on. Enjoy the glorious experience of going wherever you like—whenver you like. The price is within your means—35% to 50% less than others. These machines are sturdily used, thoroughly overhauled or rebuilt. Send for catalogue.

MYEROW BROS.,
258 Columbus Ave., Boston, Mass.

LESS PERSPIRATION MORE RESULTS

Don't do any more tugging on a die-stock handle than you have to. Use a tool that cuts a perfect thread the first time and does it easily. That means use an

OSTER

BULL-DOG DIE-STOCK

THE OSTER MFG. CO.

2100 East 61st Place
CLEVELAND, OHIO



ATKINS METAL CUTTING SAWS



Use
Atkins
"Non-Breakable"
Hack Saw
Blades

"Best I Ever Used"

That's what you'll say if you'll try an Atkins "Non-Breakable" Blade in your hack saw frame—you can cut faster and easier, and avoid blade breakage.

These blades are made of specially selected steel and tempered by an exclusive gas and oil process which gives them a harder, keener cutting edge and a tougher, more flexible back. That's why they have greater cutting capacity, hold their edge longer, and do not break. Prove it for yourself. Tell us what metal you cut, enclose ten cents and we'll send you a sample blade.

Saws of All Kinds

When you need a hand saw, circular saw, band saw, pruning saw, or any saw for cutting wood or metal—there's an Atkins saw that will save time, money and labor. Write for our free booklets.



Send for This FREE Book

Here's a 32 page book that's full of practical suggestions on metal-cutting, and general shop information. Every man who buys or uses saws will find it helpful. Send for it NOW. Just write your name and address on the margin of this page and mail it to us.

E. C. ATKINS & CO., Inc.,
Dept. P, INDIANAPOLIS, IND.
Makers of "Silver Steel" Saws and Tools

PILLIOD Tool Cases Excel

Machinists, Tool Makers and Carpenters find them most satisfactory in construction, appearance, service and price. Immediate shipment.

Booklet describing 20 styles on request.

THE PILLIOD LUMBER CO.
Dept. 1 Swanton, Ohio



Accurate Measurements

Interlox

MASTER SLIDE RULE

Inside or outside, made instantly. Rule slides in and out; no slow folding. Strong; brass-trimmed. Any length, 2 to 8 feet, 20c per lineal foot. If not at dealer's, sent postpaid.

MASTER RULE MFG. CO., Inc., 841-43 East 136th Street, New York City



Dealers and Agents request
attractive proposition.

My Engine Will Do the Work of 6



Write now for the facts about this wonderful farm engine. Same engine gives 1 1/2 to 6 H. P. Uses kerosene or gasoline. Portable, light, free from vibration, requires no anchorage. Easy starting—no cranking. Operates pump, 30-inch saw, 8-inch grinder, runs small silo filler,

concrete mixer, spray rig, washer, churn, separator. Does all chores. All moving parts enclosed. Easy to operate.

Low Price—Free Trial Offer

Low factory price. Tremendous value. Thousands of satisfied users. Write at once for complete information and special free trial offer on this amazing engine.

EDWARDS MOTOR CO.
518 Main St., SPRINGFIELD, OHIO



Only \$14²⁴ DOWN



(WICO Magneto Equipped)

This WITTE Throttling Governor ENGINE

Is sold DIRECT from FACTORY to YOU on 90 Days FREE Trial

Here's the engine that has revolutionized power on the farm—makes every job easy and cheap. Low priced—in all sizes, 2 to 25 H-P. Simple to operate and free from usual engine troubles. Over 100,000 WITTE Engines in use today.

Burns **KEROSENE, GASOLINE, DISTILLATE or GAS**

Delivers power far in excess of rating on the cheapest fuels. Built to burn any fuel—no attachments necessary. Practically no carbon and equipped with the famous WICO Magneto.

Write Today for my FREE BOOK Investigate this engine now. Write for my Big, Free, Illustrated Engine Book and details of amazing 90-Day FREE TRIAL Offer. No obligation. ED. H. WITTE, Pres.

WITTE ENGINE WORKS

1748 Oakland Avenue
KANSAS CITY, MO.

1748 Empire Building
PITTSBURGH, PA.



Garage and Repair Shop
LATHE SPECIAL

18" - 25" x 6' Gap
Other Sizes and Types **\$500**

Write for Catalog

THE SEBASTIAN LATHE COMPANY
107 Culvert Street, CINCINNATI, OHIO, U. S. A.

MAKE MORE MONEY TORIT ACETYLENE TORCH NO. 13

For soldering, heating, melting, tempering, auto radiator repairing, battery repair work, and for all kinds of small jobs requiring a hot flame instantly. Usually pays for itself in a single day.

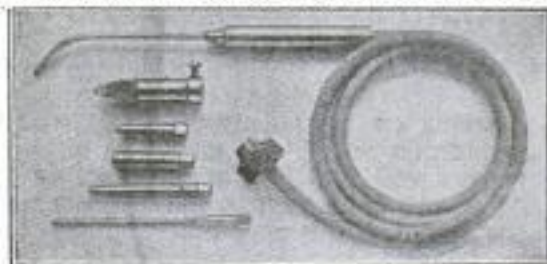

USES ACETYLENE GAS ONLY

Teach with 4 tips for different kinds of work, soldering copper, 5 ft. tubing and connection for auto-acetylene tank..... **\$7.50**
Order from your jobber. If he cannot supply you send your order to us.
St. Paul Welding & Mfg. Co., 177 W. 3rd St., St. Paul, Minn.

Put this Parks in your shop

Parks
"4-in-1"
Price
\$240

Why spend time on hand work? Why not do every job on this husky, convenient, fast-working Parks machine? Make your shop up-to-date and a money-maker. The Parks "Four-in-One" is a circular rip and cross-cut saw, band saw, jointer and borer, all in one. Angle-steel frame, channel-steel top, fully equipped and guaranteed 10 years.



Send for circular and Parks catalog showing lathes, saw-rips, band saws and combination woodworkers for any shop requirements.

THE PARKS BALL BEARING MACHINE CO.
1500-1540 Knowlton St. Cincinnati, Ohio

Canadian Factory:
200 Notre Dame East, Montreal, Canada

PARKS

WOODWORKING MACHINES

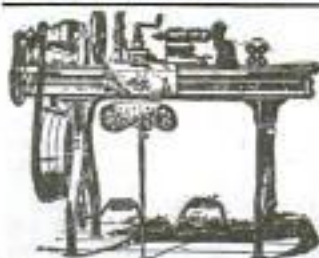

LATHES

9 to 18-inch Swing

List price \$165 and up according to size. When ready to buy send for Lathe Catalog and prices.

W. F. & John Barnes Co.
100 Ruby Street, ROCKFORD, ILL.

New 1/4 H. P. 110 Volt Guaranteed Motors

Complete with Cord, Plug and Pulley



60 cycle A. C. 1740 speed . . . \$13.00
60 cycle A. C. 1160 speed . . . 16.50
25 cycle A. C. 1450 speed . . . 16.50
Direct current 1740 speed . . . 17.25
Direct current 1160 speed . . . 19.75

HYRE ELECTRIC CO.
615M S. Dearborn St., Chicago, Ill.

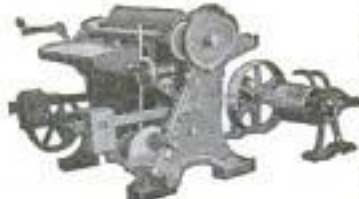

It is the well known quality of **CRESCENT** machines that justifies you in selecting one of them each time you have need for wood working machinery. The **CRESCENT** line is better than ever and will always give you satisfaction in every particular. Ask today for catalog of hand saws, saw tables, jointers, shapers, planers, borers, routers and routers, swing saws, disk grinder, cut off table, hollow chisel mortiser, variety wood worker, Universal wood workers.

THE CRESCENT MACHINE CO., 93 Columbia Street, Leetonia, Ohio

CLASS PINS

FREE CATALOG GIVE NAME OF SCHOOL OR CLUB AND NUMBER IN CLASS



Either pin illustrated made with any 3 letters and 2 figures, 1 or 2 colors enamel Silver plate, 25¢ ea., \$2.50 doz., Sterling silver, 40¢ ea., \$4.00 doz. Write for catalog of sterling and acid gold pins and rings.



Beston Bros. Co. 548 Beston Bldg., Rochester, N. Y.

LOFTIS

BROS. & CO. EST'D 1858

DIAMONDS WATCHES



"Virginia" Diamond Ring
Blue White, perfect cut Diamond. The ring is 18-K Solid White Gold, carved and pierced. Special at \$75. Only \$10 with order or on delivery, then **\$1.75 A WEEK**

GENUINE DIAMONDS Guaranteed

Cash or Credit



"Sylvia" Diamond Ring
Blue White, radiant, perfect cut Diamond. The ring is 18-K solid White Gold, carved and pierced. Special at \$100. Only \$7.50 down, then **\$2.50 A WEEK**
Also Bargains at \$100 to \$800



Rectangular Wrist Watch Ribbon Bracelet
18-k White Gold 17 Jewels, \$29.75;
14-k White Gold, 15 Jewels, \$24.85.
Yours for \$3.00 down, then \$1.00 a week.



Loftis Carved "Perfection" Diamond Ring
Blue White, perfect cut Diamond, set in White Gold prongs. Ring is 14-k Solid Green Gold. Bridal Blossom design.
\$50



17 Jewel ELGIN
No. 15—Green Gold, engraved, assorted patterns, guaranteed 25 years, 12 Size, gilt dial - **\$32**
Terms: \$3.25 down, then \$1.00 a week until paid.

DIAMONDS, WATCHES, JEWELRY
SEND FOR CATALOG

Our new Catalog is your shopping guide to unusual bargains. Over 2,000 illustrations of Diamond-set Jewelry, Watches, Wrist Watches, Pearls, Mesh Bags, Silverware, etc. There is something appropriate for everyone. Select as many articles as you wish and have all charged in one account. Sent prepaid for your Free Examination.

LOFTIS NATIONAL CREDIT JEWELERS
108 N. State St. Chicago, Ill.
Stores in Leading Cities

TERMS: \$5.00 with order or on delivery, then \$1.25 a week until \$50 is paid. Also any price to \$2,500.

SPECIAL VALUES

Diamond Rings	\$25.00
Diamond Bar Pins	25.00
Diamond Scarf Pins	15.00
Diamond-set Onyx Rings	15.00
Men's Watches	15.00
Pearl Necklaces	10.00
Mesh Bags, fine mesh	15.00
Wedding Rings	5.00
Diamond Cuff Links	25.00

WE IMPORT DIAMONDS direct from Europe and sell direct by mail—a great saving to you.
Satisfaction Guaranteed or Money Refunded
Our Diamonds are distinctive in beauty, blue white, perfect cut, of great brilliancy, set in the latest engraved and pierced Solid White, Green or Natural Gold mountings; also Platinum.

Send for Catalog

BURN YOUR NAME ON TOOLS WITH ARKOGRAF

Protect your tools from theft. Write any name, engrave any design on metal with electricity like writing on paper with pen or pencil. Complete outfit \$3.50, prepaid any where. Interesting descriptive circular free. Write today. Agents Wanted. Arkograf Pen Company 481 East Couch St. Portland, Oregon



Toolmakers and Machinists FIND GERSTNER Tool Cases

valuable because of the time they save. No tools mislaid—every tool has its place. Use one and you will wonder how you got along without it. Catalog free.

J. Gerstner & Sons
402 Columbia St., Dayton, Ohio



Print Your Own Stationery

Cards, circulars, labels, tags, book, menus, paper Press, \$12. Larger \$35. Job Press \$150 up. Save money. Print for others, BIG PROFITS. All easy, rules sent. Write factory TODAY for press catalog, TYPE, cards, paper. **THE PRESS CO. D-37, MERIDEN, CONN.**



MATHEMATICS

can be easily mastered with the Midget 5 in 1 Slide Rule. With this calculator you can instantly add, subtract, multiply and divide any combination of decimals, fractions, whole and mixed numbers. Also obtain all roots, powers, Logs, and Trig. Functions.

It is used at all colleges, 200 at Harvard, 300 at Cornell, etc. The Engraved-Divided Scales are on white celluloid, mounted on aluminum and are gresse and waterproof. Diameter 4 inches. Price with Instruction Book. **\$1.50**
Leather Case 50c extra. Catalogue Free. Your money back if you are not satisfied.
GILSON SLIDE RULE CO., Niles, Mich.



New Easy Way FREE TRIAL WILL CONVINCEN YOU!

to wind coils of any kind. Clamp "Lock-Grip" on the Wire

Ordinary pliers won't stay clamped. "Lock-Grip" grips tight and locks—the easy way to do your winding. Tool steel, nickel plated. Sent postpaid for \$1.00 or c.o.d. An extra hand for you. Satisfaction or money back. Order today!

C. E. CARSON
Dept. 11 1001 Washington Blvd., Chicago, Ill.



5 SIZE TAP AND DIE SET, ONLY \$3.00 FOR THE HOME—THE FARM—THE WORKSHOP DIRECT FROM THE FACTORY TO YOU!

Our No. 12 Automobile Set furnished in our highly finished chestnut box contains 5 each taps and dies (1-4, 5-16, 3-8, 7-16 and 1-2"). In the S. A. E. thread, 1 die stock, and one tap and resizer wrench.

Our No. 11 Set is the same as No. 12 except that the thread is U. S. S. instead of S. A. E. You are purchasing a splendid set at a very low figure.

Send us your order at once and be one of our many satisfied customers. Let us also send you one of our circulars illustrating our full line of Handy Tools.

WORCESTER STEEL PRODUCTS CO. Dept. 24, 25 Union Street, Worcester, Mass., U. S. A.



SAVE MONEY
Get This Book

HANDY MAN BOOK

Install Your Own
PLUMBING & HEATING
NEW EASY WAY - SAVE HALF

25c

Reg. Price 50c

Brings you this big Plumbing and Heating Encyclopedia-Catalog. Write for your copy today without fail.



Hot Water Boiler

Guaranteed Heating Plants

Our Handy-Man Book shows how. Big 256-page well-bound encyclopedia of Plumbing and Heating Encyclopaedia, Systems, Supplies, Fixtures and Accessories—10,000 items—illustrated. Hundreds of floor plans, elevations, diagrams, trade secrets, money and trouble-saving kinks, etc. "How to save coal in heating," "Easy repair methods." Every householder, contractor, farmer, mechanic, institution needs this book. Shows how to save wages, work and materials.



Pipeless Furnace

BIG HANDY MAN BOOK

Tells how we help you plan and install. From rough sketch or description we supply working plans and clear instructions. We loan the tools needed. Any handy man can install. This is the place to buy on money-back guaranty. Plumbing Outfits and Supplies; Water Systems; Hot-Air, Water or Steam Heating Plants; Radiators, Pipes, Boilers or Septic Disposal Tanks.

Send 25c for Yours Today

We have spared no effort or expense to complete this remarkable and instructive book. To keep from sending it broadcast to disinterested persons, we request a deposit of 25c, which will be refunded on your first order—or send for our FREE Bulletin. Write today and save half.



Bathroom Outfit

HARDIN-LAVIN CO.

50 Years
at 4547-57
Cottage Grove Ave.,
CHICAGO

\$2 Brings This Genuine **DIAMOND RING**

Simply send \$2.00 for the Most Sensational Price Smashing Diamond Ring Offer Ever Made. A perfect cut, blue white, fancy Diamond in newest hand pierced model of 18 Karat White Gold. Both sides of Diamond set with a genuine French Rose Sapphire. Send Only \$2.00 and ring comes to you charges paid. Guarantee Bond accompanies each ring. 10 Days' Free Trial—You take no chance. If you are not satisfied at the end of ten days, your deposit will be refunded to you. No Red Tape, No Delay—After trial, pay \$5.55 a month for ten months. Price only \$57.55. Ring furnished in gentleman's mounting without extra charge. Free Book of Gems—Complete Diamond, Watch and Jewelry Catalog, 10 months to pay on everything from our TWO MILLION DOLLAR STOCK. Address Dept. 989 for your copy today.

ROYAL DIAMOND & WATCH CO.
170 Broadway-New York

CAMERAS

Over a Hundred Styles and Sizes

Send for new illustrated catalog showing latest reduced prices. It's Free.

10 days' trial given

SENECA CAMERA MFG. COMPANY
300 Central Avenue Rochester, N. Y.



DIVINE RED DEVIL Water Motors

Simple—strong—durable. Wonderful little workers for all sorts of household and shop uses. Thousands in use. For all light power purposes. Attaches to faucet.

Two sizes: 4"—\$4.25
6"—\$6.75

The higher the water pressure the more work they do.

Send today for catalogue.
Divine Water Motor Company
Utica, N. Y.



FREE

Fine Tone Musical Instruments \$20



We have a wonderful new copyrighted system of teaching note music by mail! To first pupils in each locality we will give free a \$20 superb Violin, Tenor Banjo, Ukulele, Hawaiian-Guitar, Banjo, Mandolin, Banjo-Ukulele, Banjo-Mandolin, Cornet or Banjo-Guitar absolutely free. Also teach Piano and Organ. Very small charge for lessons only. Four lessons will teach you several pieces. Over 100,000 successful players. We guarantee success or no charge. Complete outfit free. Write today, Dept. 167. No obligation. SLINGERLAND SCHOOL OF MUSIC, 1815 Orchard Street, CHICAGO, ILLINOIS

SELLS for \$1.25 AGENT'S SAMPLE 65c.!

New Self-Filling Bamboo Fountain Pen with Stylo Point



Imported from Japan

"It makes Carbon Copies"

Guaranteed for 1 year

Hustlers Making \$20 Daily! Money refunded if you don't think it's the best pen you ever wrote with. Just out! Up to 150 per cent Profit. Send for quantity price list and distributing plans.

F. SPORS & CO., 331 Main Street, Lesueur Center, Minnesota



Bunte 5¢
ESTABLISHED CHICAGO 1870

**MENTHOL HOREHOUND
COUGH DROPS**

refresh and clear the throat and stop the annoying tickle. Made of pure cane sugar, menthol and horehound. The menthol heals—the horehound soothes.

BUNTE BROTHERS · CHICAGO



\$6.50

LITES-IT
AUTOMATIC POCKET LAMP

NO BATTERIES
Current is Generated by Movement of Lever

The most practical Electrical Pocket Lamp ever invented. Think of it—no batteries. A simple movement of the hand generates a current that throws a powerful light. Has beautiful aluminum case—nothing to wear out—lasts a lifetime. Ideal for Sportsmen, Motorists, Miners, Watchmen, Camping Parties and should be in every home.

ORDER NOW!

—while our supply is big—the enormous demand will soon be ahead of our large production facilities. Don't wait—send \$6.50 by Postal or Express money order. We ship postpaid. Price in Canada \$6.75. Dealers write us on your letterheads for attractive sales proposition.

Agents: Ask us to write you how to make UP-TO-DATE MACHINE WORKS
2913-15 So. Wabash Ave. Dept. 218 Chicago, Ill.

MAKE THAT LUGER INTO A RIFLE!



LUGER CARTRIDGE .16" barrel Model de Luxe.

Mail us your Luger for equipment—ing it with any of the above interchangeable Long Barrels with 850 yard sight. Free labor. Shoot 200 accurate shots per minute with our 32-shot magazine and holster-stocks, equalling 3 riflemen. World famous V. Chr. Schilling super-accurate Mausers; Mannlicher sporters and other ultra-modern arms.

Catalog L Ten Cents Pacific Arms Corporation, Liberty Bank Bldg., San Francisco, U.S.A.

TAILORING SALESMEN

We Pay You Salary and Commissions

Greatest money-making line in America. Made to measure suits, overcoats, one price, \$33.65, express prepaid, all wool, all wool linings, hand tailored, finest workmanship. No extra charges for style or oversize. Blazer advance commissions, weekly salary besides. Protected territory. Apply at once.

GREAT WESTERN TAILORING CO.
Dept. P, 837-841 W. Jackson Blvd. CHICAGO, ILL.

NEW LAMP BURNS 94% AIR

Beats Electric or Gas

A new oil lamp that gives an amazingly brilliant, soft, white light, even better than gas or electricity, has been tested by the U. S. Government and 35 leading universities and found to be superior to 10 ordinary oil lamps. It burns without odor, smoke or noise—no pumping up, is simple, clean, safe. Burns 94% air and 6% common kerosene (coal oil).

The inventor, H. E. Johnson, 609 W. Lake St., Chicago, Ill., is offering to send a lamp on 10 days' FREE trial, or even to give one FREE to the first user in each locality who will help him introduce it. Write him to-day for full particulars. Also ask him to explain how you can get the agency, and without experience or money make \$250 to \$500 per month.

Going to Build Remodel or Repair?

DON'T think of planning a new home or repairing an old one without copies of our two free books.

Our Building Material Catalog shows latest ideas and most advanced styles for everything in building. We ship everywhere everything in the way of high grade lumber, roofing, doors,

windows, porchwork, screens, builder's hardware, paints, wallboard, interior woodwork, plumbing, heating and water supply outfits—all at money saving prices direct to you. Plan Book shows skillfully planned homes of all kinds, bungalows, city homes, suburban residences, country homes, farms. Tells you how to get building plans FREE. Write today. No obligation.

Catalog of 8000 Price Bargains

Beautifully Illustrated PLAN BOOK

CHICAGO MILLWORK SUPPLY CO., 1144 W. 37th St., Chicago, Ill.
PLEASE SEND ME YOUR FREE BOOKS

Name _____
Town _____
State _____
Occupation _____

St. No. _____

Books Are Free

Get this Wonderful Ring
 IF YOU CAN TELL IT FROM A GENUINE DIAMOND SEND IT BACK
 These Amazingly Beautiful CORODITE GEMS are the nearest approach to GENUINE DIAMONDS that the ingenuity of man, aided by years of scientific and chemical research can produce. They have the same gorgeous, blazing flash and dazzling play of living rainbow fire. Standing the terrific acid test of direct comparison. Even lifetime experts need all their experience to see any difference. Prove this yourself.

Send No Money
 You risk nothing. Wear a Genuine CORODITE and a Diamond side by side on the same finger, and if you and your friends can tell the difference, send it back. You won't be out a single penny. That's fair enough. If you keep the ring, price printed here is all you pay. Remember only CORODITE GEMS have the same facet cutting as genuine stones. Beautiful hand made, hand carved mountings created in latest and most fashionable designs.

Make this Test
 You can tell the difference, send it back. You won't be out a single penny. That's fair enough. If you keep the ring, price printed here is all you pay. Remember only CORODITE GEMS have the same facet cutting as genuine stones. Beautiful hand made, hand carved mountings created in latest and most fashionable designs.

Money Back Guarantee
 You do not risk a penny. Our signed binding legal guarantee to refund your money in full is attached to every ring we sell. You must be satisfied. Sole Importers Genuine Corodite Gems

No. 1	\$2.84
No. 2	\$4.19
No. 3	\$3.96
No. 4	\$3.54
No. 5	\$4.90
No. 6	\$4.26
No. 7	\$3.68
No. 8	\$4.26
No. 9	\$4.26

NO MONEY, just send name, address and number of ring wanted and size as shown by slip of paper fitting tightly end to end around finger. Your ring will come by return mail. When it arrives pay postman amount shown. **OUR MONEY BACK GUARANTEE PROTECTS YOU. SEND TODAY.**
E. RICHWINE CO., 19 W. Jackson Blvd., Dept. 906, CHICAGO, ILL.

Planning a NEW HOME?
 Let these books be your guide. Beautiful California Styles, with Pictures and plans for all-climate homes.

"South-West Stucco Homes"
 Spanish, English, some 2-family—\$1

"All-American Homes"
 50 Houses—7 to 10 Rooms—\$1

"The New Colonials"
 60 Houses—6 to 10 Rooms—\$1

"West Coast Bungalows"
 50 Houses—6 and 7 Rooms—\$1

"Little Bungalows"
 75 Houses—3-4-5 Rooms—\$1

SPECIAL OFFER:
 Send \$2.50 for any three of these books and get Garage Folder FREE.
 Money back if not satisfied.
E. W. STILLWELL & COMPANY, Architects, 122 California Building, LOS ANGELES

WHITE FLAME BURNERS make your old kerosene lamps and lanterns give a brilliant white light better than electricity or gas. Doubles your light. Saves oil. **NO MANTLE TO BREAK.** Guaranteed Safe and Reliable. Delights every user. Send now for complete sample postpaid 91 cents, stamp or coin. 5 for \$1.25. **Money Back if Not Satisfactory.** Live Representatives Wanted. Exclusive Territory.
WHITE FLAME LIGHT CO., 68 Clark Bldg., Grand Rapids, Mich.

BURN Home Made GAS COAL STOVES
 In Your Old Wood or

Change your coal or wood stove into a gas stove in 3 minutes. A Child can do it. Burn kerosene Vapor Gas—hotter than coal or wood and costs less. Safe and simple.

FREE TRIAL
 Just turn a valve and get even heat instantly. No ashes, no dirt, no smoke, no wood to chop or carry. No fires to build and feed. No fuel wasted. Cooks and bakes better. No damage to stoves. Makes its own gas from common coal oil, cheapest, cleanest fuel. Guaranteed five years. Money back if not satisfied after 10 days' trial. Write for FREE folder with proof and SPECIAL OFFER.

SIMPLEX UTILITIES MFG. CO.
 210 Simplex Bldg. 1426 No. Wells St., Chicago

Please Mention Popular Mechanics

1000 SHOT ALL STEEL MAGAZINE AIR RIFLE WE GIVE TO BOYS WITHOUT COST
HAMILTON 22 CAL. HUNTING RIFLE

Choice of six guns (on four easy plans) for selling our Magic Healing Wave-o-lens at 25c box. We Trust You! Order Seven Boxes Today On Postal Card—we send promptly, prepaid. Easy to sell—used in every home. Return money as instructed, choosing your gun according to one of the plans shown in our Big Premium List. Also 200 other Gifts or Big Cash Commission if you prefer. If you are prompt, a special Free Gift.
Waverly Co., 218 Towner Bldg, Monongahela, Pa.

Beautiful HOUSES \$900 and BUNGALOWS
 CAN BE BUILT FOR AND UP
 This and many others in my new book, Building Plans for Modern Homes, will save you hundreds of dollars. One of the most complete and comprehensive books of plans ever published by any architect. New edition just off the press. Nearly 500 floor plans and photographs of bungalows, Colonial houses, etc., costing from \$200 up; given sizes and cost to build.
Frederick H. Gowing ARCHITECT
 Sent postpaid for \$2.00 161 Tremont St., BOSTON, MASS.

SELF-FILLING INK PENCIL "INDEPENDENT"
 Guaranteed Improved Fountain Pen. Eliminates fatigue. Promotes efficiency. Writes uniformly. A business necessity.
\$2.00 Mail

Meets all requirements. Self-filling, non-leakable, safety cap. Attached clip. Smooth writing gold style point.
 Your Name in Gold—25 Cents Extra
AGENTS WANTED
J. C. ULLRICH & CO., 161 Washington St., New York

Build This Phonograph Yourself
TREMENDOUS SAVING IN COST
 Easy, fascinating work with our SIMPLIFIED PLANS. We furnish blue prints, diagrams, motor, cabinet pieces, ready-built horn, etc. You don't need to be a cabinet maker. A few hours assembling and you will have a fine instrument at one-quarter the regular retail price. **AGENTS MAKE MONEY** making and selling these instruments. Write today for full details and our FREE OFFER. Address
LUPERL PHONO PARTS CO.
 2648 W. Chicago Ave. Dept. 10 CHICAGO, ILLINOIS

Different from all others—the NEW BENJAMIN

AIR RIFLE

Made on a different principle from all other Air-Rifles. The Benjamin is really a strong air-pump used to compress the air in the air chamber to any degree of power desired. From one to six strokes of the pump give all the force necessary. Each additional stroke gives increased power. The Benjamin works on the same principle as all air-drills and air-hammers—with this difference:

You control the shooting force as you desire. Look at this block of hardwood. It shows how Benjamin power is regulated as you wish.

You can't have accidents with a Benjamin. It's safe, always, because you control the power. The Benjamin never loses shooting force, and has no springs to get out of order or shake your aim. Write us for an interesting folder about this wonderful air-gun.

If your dealer does not handle yours, send direct to factory—
(PRICE \$5)
POSTPAID
BENJAMIN AIR-RIFLE & MFG.
CO., 615 N. Broadway, St. Louis, Mo.

Ask your dealer for demonstration.

Pacific-Coast
Representatives
TRAYNER &
BOWER
Los Angeles
Calif., and
San Francisco
Calif.



"HOME COMFORT" Insulated WEATHERSTRIP

Stops icy blasts and saves 20 to 40%
fuel—plus the "comfort"

You can install it yourself. "Simply tack on—turn the corners." It is waterproof, Airtite, Flexible, Noise-absorptive, Dustproofing, Non-conductive; Woodless; Metal-less and Rustless. Enjoy winter in Home Comfort.

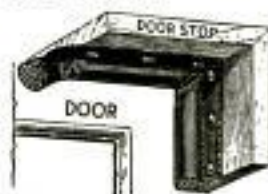

Ask your Dealer, or Mail Coupon
for Free Sample and Prices—Today!

Name _____

Street _____

Town _____

State _____

Dealer's Name _____

P.M.

E. J. WIRFS MANUFACTURER
103 S. 17TH ST. ST. LOUIS, MO.

\$\$\$\$ MAKERS!

Salesmen—the beautiful and artistic Standard Art Boudoir Lamps are in demand everywhere—they're pleasant and easy to sell—real dollar makers. Special FREE offer to every prospect. 30 day FREE trial offer now open. Write today.

STANDARD ART PRODUCTS CO.

Desk 102

FORT WAYNE, IND.

Are You Old at 40?



A very common cause of early old age is the disturbed condition of an important gland. Even big, strong men are not exempt from this common and serious irregularity which our plainly written, interesting and educational pamphlet explains in detail.

FREE BOOK

"Why Many Men Are Old at 40"

This amazing book may bring a priceless message to you. It tells of a simple, sensible way by which thousands have corrected this prostate gland condition. It tells how setatic, backaches, foot pains, interrupted sleep, mental depression, etc., are so often due to this gland. Sold for over five years upon a money-back-if-not-satisfied plan. Do not confuse it with massage, medication, violet rays, etc. No obligation. Write for your copy of the FREE BOOK today.

The Electro
Thermal Co.



2130 Main St.
Steubenville
Ohio

REMINGTON PORTABLE TYPEWRITER Dealers and Branches Everywhere

GOLD FISH

Only \$2.00

brings by express a two-gallon bowl and three Gold Fish. Orders filled immediately from producer. Send now and you will have your GOLD FISH in a few days.

FALLS FISHERIES, 1533 B. F. Keith Bldg., Cleveland, O.

WANTED RAILWAY MAIL CLERKS



\$1600 FIRST YEAR

Raise to \$2300
Travel—See the Country
MEN, BOYS—18 UP
LIFE JOB
Mail Coupon Today Sure

FRANKLIN INSTITUTE
Dept. F200, Rochester, N. Y.

Send me at once, free of charge, Sample Railway Mail Examination questions, list of other U. S. Government positions now obtainable and free book describing them.

Name _____

Address _____

Please Mention Popular Mechanics

SEND AND WE'LL SEND
\$2 THIS 21 JEWEL
BUNN SPECIAL
 DOWN ILLINOIS R.R. WATCH



FREE TRIAL

Test this watch any way you please. If it fails to keep time, we will return your deposit—every cent.

\$5.50 A MONTH

If satisfied, pay only \$5.50 a month for ten months. Total price \$57.50. Montgomey dial same price.

NO RED TAPE NO DELAY

Just send the deposit and we will send the watch. The dust proof gold filled case is guaranteed to wear like solid gold for 20 years.

GUARANTEED TO PASS INSPECTION ON ALL R.R.'S

This fact proves the high quality of this watch. A complete technical description will be supplied to you if desired. Better still, order it on free trial.

A full technical description will be given to anyone who asks. Just ask any watch inspector what he thinks of this watch. Test it at our invitation.

SIX ADJUSTMENTS BEST

Watches adjusted to only five positions have been known to run inaccurately when in the sixth position. This watch will run accurately in all six positions.

WRITE FOR CATALOG

Thousands of diamond, watch and jewelry selections are listed at money saving prices. Compare our values.

STERLING DIAMOND & WATCH CO.

The Great R.R. Watch House Since 1879
 63 Park Row Dept. 1391 New York

INFANTILE PARALYSIS

Caused Club Foot

For 16 of his 17 years, Edward Bolian's foot was badly deformed as a result of Infantile Paralysis. His letter and photos show what was done for him at McLain Sanitarium in 5 months.



I wish to express my thanks for the great benefit that I received at your Sanitarium. I walked on the side of my foot for 16 years, and after 5 months' treatment, I am now walking flat on my foot and as good as anyone.
 EDWARD BOLIAN,
 Slidell, Louisiana.

Parents of Crippled Children

and young adults should know about McLain Sanitarium, a thoroughly equipped private institution devoted exclusively to the treatment of Club Feet, Infantile Paralysis, Spinal Disease and Deformities, Wry Neck, Hip Disease, Diseases of the Joints, especially as found in children and young adults. Our book, "Deformities and Paralysis," and "Book of References" sent free.

McLAIN ORTHOPEDIC SANITARIUM
 902 Aubert Ave. St. Louis, Mo.
 GR536

I Offer You
\$8.00 a Day
 and a

Buick
 TOURING CAR

Write today for offer. \$8.00 a day to start and a Buick touring car if you make good. Demonstrate and take orders for Comer All-Weather Raincoats. Permanent, high-grade business. Largest company of its kind in the world. No experience required. We furnish complete outfit and instructions. Write now.

Comer Mfg. Co., Dept. BW-591, Dayton, O.



LEATHER JERKIN

WOOL LINED \$3.75

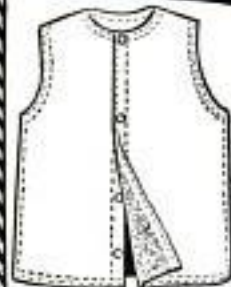

Standard U. S. Army First Quality, Blanket Wool Lined Leather Jerkins

\$8 VALUE for \$3.75

Postage extra. Shipping weight 3 1/2 lbs. What the Government lost you gain. Good for hunters, skaters, drivers, farmers, laborers, mechanics, railroad men, golfers or others who work or play outdoors. Sizes 38 to 46. Bargain Circular No. 58 with big values on hats, coats, clothing, and guns, sent upon request.

Free

RUSSELL'S INC. 245 W. 42ND ST. NEW YORK

Clear-Tone FOR PIMPLES

Your skin can be quickly cleared of Pimples, Blackheads, Acne Eruptions on the face or body, Enlarged Pores, Oily or Shiny Skin. \$1,090.00 Cold Cash says I can clear your skin of the above blemishes.

FREE WRITE TODAY for my FREE Booklet—"A Clear-Tone Skin"—telling how I cured myself after being afflicted for fifteen years.

E.S. GIVENS, 129 Chemical Bldg., Kansas City, Mo.



The Beginning—(1892)

"If I hadn't been all through it myself, I would n't have the assurance to tell you to 'cheer up.'"

ERICKSON.

Those who wear them say:
ERICKSON LEGS are Wonderful
 because they do not chafe, overheat or draw end of stump.



If you have had a recent amputation send for new booklet on TEST LEGS for beginners.
 E. H. ERICKSON CO.
 38-A Washington Av. N.
 MINNEAPOLIS MINN.

Hart Heat

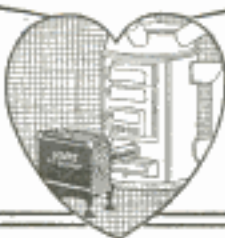

IT IS HERE! The most wonderful heating appliance of the age. Burns a low test oil for fuel. Cheaper than coal. Eliminates dirt, soot, ashes, and work required in coal burning furnaces and boilers. Can be installed in any type of furnace now in the home.

We Want a Representative in This City

to supervise the demonstration, sales and installations of **HART OIL BURNERS**. No experience necessary. We teach you. Very little capital required. An established dealer preferred. Every Hart Oil Burner backed by manufacturers' guarantee. Thirty-four years in business. Wonderful money-making opportunity.

Write Immediately for Full Particulars

HART OIL BURNER Co.

PEORIA — ILLINOIS



STEAM PLANT

\$3 Cash Buys Typewriter



Balance Only \$5 Monthly
Save 35 to 60% on all standard makes—Underwood, Royal, Remington, etc. Every machine thoroughly rebuilt and **GUARANTEED**. Try five days at our expense before you buy.

WRITE at once for Free Descriptive Circular and Special Low Prices.

5 DAYS FREE TRIAL

WYNN TYPEWRITER EXCHANGE 13 Reliance Bldg. Kansas City, Mo.



MCCORMICK & CO., Baltimore

AGENTS: \$14 a Day



New plan for selling non-alcoholic food flavors. Sure winners. Flavors in tubes instead of bottles. Ten times as strong. Guaranteed under U. S. laws. All flavors. Favorites in every home. We have a sure-fire way to build up repeat business.

Spare Time or Full Time

Our wonderful new plan will put you in a \$5,000 class. 350 Products—all fast sellers in every home. Low prices. Supreme quality. Complete outfit free. We furnish automobile. Write quick for territory.

AMERICAN PRODUCTS CO., 233 American Bldg., CINCINNATI, O.

FASTEN IT WITH AN AJAX EYELET FASTENER

Binds Paper, Cardboard, Leather, Cloth
It Saves Time by Punching the hole, feeding the eyelet and clinching it in one operation. Order from your Stationer

Machine Appliance Corp.
Dept. P. M. BROOKLYN, N. Y.

SHOTGUN or RIFLE

There's remarkable gun value in a Stevens. Write for the interesting catalog describing our line.

J. STEVENS ARMS COMPANY
Dept. 550 Chicopee Falls, Mass.
Owned and Operated by the Savage Arms Corporation

MAKE YOUR FORD INTO THIS SPORT CAR—SAVE \$50 to \$150 WITH Red-i-Kut Life-Size Patterns \$6.40 COMPLETE

Famous **Red-i-Kut** life-size patterns and pleasure-fit instructions show you how you can easily convert your Ford into this Fast, Sexy, Sport Car as thousands have done with easily obtained materials. No need to lay up the car. **LOOK AT WILFRED ENO'S PAL**—Eno says, "Total material cost with steel and paint for my Pal only \$11.51. It took me just 3 Sundays to build it and I sure am proud to hear them say, 'He built that speedy sport car.' I never cut any steel or did any welding before but now can't go wrong with Red-i-Kut patterns." Overland City, Mo. Look, Mo. The "Pal" with pressed metal streamline rear,

life-size patterns for each part of the body so you can't go wrong, picture instructions and **CONICAL DISK WHEEL PATTERNS** Only \$5.00 delivered. Order now while we can make good delivery, and really enjoy these wonderful days in your "Pal." Keen, Classy, Up-to-the-minute. You can build it. Over 11,000 in use. Don't hesitate. "Swing Lo" Underlashing Irons, no frame cuttingblad, only \$7.85. Send 5c coin for new manual of other distinctive sport body patterns from \$2.50 up — "Red-i-Kut" Speed "Swing Lo" Irons, "J.P." Taps and "Gunner" Windshields. Order Right Now, Kuempel Co., 45 Kuempel Bldg., Guttenberg, Iowa



30-inch, Easy-riding seat

GLASS GRAB BAR



Pioneer
Autoplex
Variometers

The One Tube Set that Operates a Loudspeaker

Pioneer Autoplex Variometers are built especially for this one tube circuit. All the advantages of super regeneration with none of the disadvantages.

Variometers must be specially built. Three features are essential.

High Ratio of inductance. Stator and Rotor coils close together.

Stator coil wound on inside of coil.

Don't spoil a good circuit by buying any old variometer. Insist on Pioneer Autoplex and get results.

Complete wiring diagram free on request.

Pioneer Variometer
\$6.50

PIONEER RADIO CORPORATION
104 Pioneer Ave., Galesburg, Illinois



MIRACO
GETS 'EM FROM COAST TO COAST

PRICE ONLY \$29.50

At rock-bottom prices you get the efficiency of sets costing three times as much. Users tell us that Miraco Radio frequency receivers pick up stations from coast to coast. Operate either on dry cells or storage battery. Solid mahogany cabinets — finest workmanship throughout. Order direct or send for bulletin.

Two tube outfit \$29.50
Four tube outfit \$4.50

DEALERS—AGENTS—Write for proposition quickly—If no winner
THE MIDWEST RADIO COMPANY
807 Main Street, Cincinnati, Ohio



Rings Bells Without Batteries

Avoid the annoyance of having bells out of order. At a nominal cost you can install this little device which will ring electric bells, buzzers, annunciators, electric heat regulators, door-openers, etc., from the same current that lights your home.

ONLY \$2.00
Canada \$3.00

Air-Way
Bell Ringer Transformer

Connects direct to lighting-current, and eliminates forever the use of troublesome dry batteries. Does not use enough current to register on meter. Buy it from any electrical dealer, or we will send it anywhere postpaid upon receipt of price. Your money back if you are not satisfied.

JOBBERS, DEALERS, AGENTS—Write for selling proposition.
AIR-WAY ELECTRIC APPLIANCE CORPORATION
Toledo, Ohio



WEIGHS ONLY 8 OZ.

The Scientific

THE PHONE IT TOOK A SOLID YEAR TO DESIGN

A \$200,000.00 COMPANY stands squarely back of the guarantee on every Scientific headset.

SEND NO MONEY!
10,000 TURNS EQUIVALENT TO 3,000 OHMS

Order TODAY by Postcard and Pay Postman on arrival

2.95
POST-PAID
LOUD SPEAKER UNIT 'E'PS

We Guarantee The Scientific Headset to be the greatest value on the market. Try it for five days. If not satisfactory send it back and your "money" will be refunded immediately. Circular on request. Dealers wanted.

THE SCIENTIFIC ELECTRIC WORKS
99 Brookline Ave. apt. C BOSTON, MASS.

NEW HOOK-UPS ARE EASY NOW

Save hours of labor—get connections solid as soldering with Stevens SPINTITE Wrenches. Hollow stem goes over projecting screws—socket secures firm grip—comfortable handle, strong levers, easy to reach difficult places.



SEND \$1.00 for set of 3 raffle and household sizes.

STEVENS & CO., Toolsmiths since 1859
375 Broadway NEW YORK

Vacuum Tubes Repaired

SAVE AT LEAST 1/2 THE COST OF NEW

UV200 and UV201 \$2.75 each
UV201-A, WD-11 and WD-12 3.50 each

GUARANTEED EQUAL TO NEW

Opportunity for boys to make big money by collecting tubes in quantities.

All tubes received and returned parcel post, C. O. D.

HARVARD RADIO LABORATORIES
200 & 204 Old Colony Ave., So. Boston, Mass.



Branston D. L. Honeycomb Coils
and Geared Back and Front Panel Mountings

BEST for SELECTIVE TUNING

Superior construction and vernier adjustment give better results in your set. Licensed under DeForest Patents. Send 2c for new Radio Manual with 3 Honeycomb Coil "Hook-ups."

CHAS. A. BRANSTON, Inc.
819 Main St. Buffalo, N. Y.
In Canada—Chas. A. Branston, Ltd., Toronto



CATALOG E19-100 PAGES FREE

LATEST REFLEX AND NEUTRO DYNE CIRCUITS
One of the largest complete stocks in the world.

DEALERS ALL OVER THE U.S.

Making big profits handling our supplies. 24-hour service. Goods shipped same day order received.

QUALITY AMERICAN RADIO MFG. CO. SERVICE
WHOLESALE DISTRIBUTORS
Dept. 0, 6 W. 14th St. KANSAS CITY, MO.

Reliable
RADIO
Goods

Results are sure with RELIABLE goods

And it's easy to get such goods—anything you want in radio equipment. Big, complete stock—everything guaranteed; quick service; right prices. And you're sure it's reliable when it comes from Andrae. Get our complete catalog—free.

JULIUS ANDRAE & SONS CO., 116 Michigan St., Milwaukee, Wis

ANDRAE In Business Since 1860



FANSTEEL Balkite

PATENTS
APPLIED FOR *Battery Charger*

Noiseless and Indestructible

A new battery charger for Radio "A" (6 volt) batteries. Entirely noiseless. Has no moving parts, requires no attention or adjustment, and cannot get out of order. No bulbs to break. Simple and unflinching in action. Can be used while the radio set is in operation. A positive economical charger for home use. Can also be used to charge automobile batteries. If your dealer can't supply you, sent direct on receipt of price. Money back guarantee.

Price \$18 (\$18.50 West
of Rockies)

Dept. P5 Fansteel Products Co., Inc.
North Chicago, Illinois



ALL-AMERICAN

AMPLIFYING TRANSFORMERS

Largest Selling Transformers in the World

SPECIAL OFFER!

All-American diagram and circular describing Power Amplification; also Book of Hook-ups containing 22 tested circuits. Send 4c in stamps.

RAULAND MFG. CO., 200 N. Jefferson St., CHICAGO

Pioneers in the Industry

TURNER BLOTORCH

Safe as a Candle

A tool of surpassing ability. Embodies the greatest and most important improvements ever made in a blow torch. Easy to use, handle and operate. *Absolutely safe!* 11 exclusive features. Uses any grade gasoline or kerosene. A necessity in every home; indispensable to workshops, garages. At your hardware store—or direct, at this unbelievably low price... **\$8.25** Postpaid

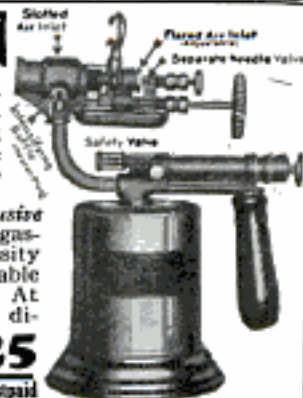

THE TURNER BRASS WORKS
Industry Ave., SYCAMORE, ILL.

The World's Largest Exclusive Manufacturers of Blow Torches, Fire Poles and Brazers

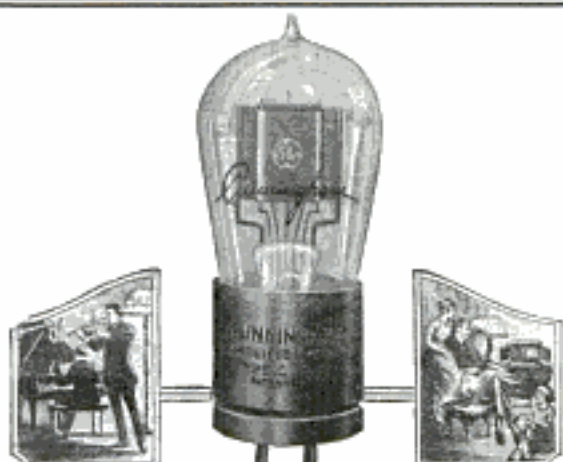

Type C-301A gives greater Power Amplification with only $\frac{1}{4}$ Amp. Filament Current.

Cunningham

RADIO TUBES

*for Every Make
of Receiving Set*

THROUGHOUT the entire country today Cunningham Radio Tubes are recognized as the ideal tube for use in all makes of Radio Receiving Sets.

The famous Cunningham C-301A Amplifier shown above is a high vacuum tube designed for use as an amplifier and detector containing a new Tungsten Filament, the characteristics of which are long life, low power consumption, low operating temperature and greater power amplification than any previous amplifier tube. This tube has a standard four prong base, and the glass bulb has the same dimensions as C-300 and C-301. The filament current is only one-fourth of the filament current of the previous type of Amplifier tube and it is, therefore, possible to use four of these tubes in a set without exhausting the storage battery any faster than when using only one of the previous types of tubes.

The care and operation of each model of Receiving Tube is fully explained in our new 40-page "Radio Tube Data Book." Copies may be obtained by sending ten cents in stamps to our San Francisco office

Patent Notice: Cunningham tubes are covered by patents dated 11-7-05, 1-15-07, 2-18-08, and others issued and pending. Licensed for amateur, experimental and entertainment use in radio communication. Any other use will be an infringement.

Cunningham Radio Tubes

C-301A	—5 Volts $\frac{1}{4}$ Ampere Filament.....	\$6.50
C-299	—3 Volts .06 amp. Dry Battery Det. & Amp.	6.50
C-300	—5 Volts Gas Content Detector.....	5.00
C-11	—1.1 Volt .25 amp. Dry Battery Det. & Amp. Special Base.....	6.50
C-12	—Similar to C-11 with standard base....	6.50

E. J. Cunningham Inc.

Home Office: 132 Second Street, San Francisco
154 West Lake Street Chicago 30 Church Street New York

CLEAR RECEPTION ASSURED

Crosley Model X-L

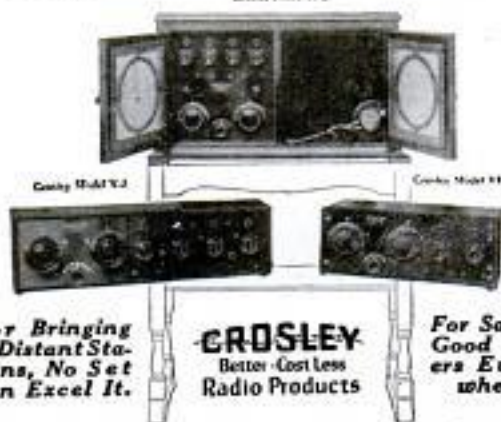

For Bringing
in Distant Sta-
tions, No Set
Can Excel It.

CROSLEY
Better—Cost Less
Radio Products

For Sale by
Good Deal-
ers Every-
where.

MODEL VI—\$30. A wonderfully efficient two-tube set, one stage of Tuned Radio Frequency Amplification and Detector.

MODEL X-J—\$65. A four-tube radio frequency set combining one stage of Tuned Radio Frequency Amplification, a Detector and two stages of Audio Frequency Amplification. A jack to plug in on three tubes for head phones, the four tubes coupled up for loud speaker.

MODEL X-L—\$140. A duplicate of Model X-J, except the arrangement and mounting into a beautiful cabinet provided for housing the necessary batteries. Special mahogany stand for Model X-L \$25 extra.

Cost of necessary accessories \$40 up.

MAIL THIS COUPON TODAY

CROSLEY MANUFACTURING COMPANY

POWEL CROSLEY, Jr., President

215 Alfred Street Cincinnati, Ohio

Gentlemen: Please mail me free of charge complete catalog of Crosley Instruments and parts, together with booklet entitled "The Simplicity of Radio."

Name.....

Address.....

An Easy Way
to Cut Out
Interference



The Ferbend "Wave Trap" Makes Every Night Silent Night

Get the station you want quickly. Listen in on the distant stations without annoying squawk-k-k-s or irritating whistles. Listen like this St. Louis user—"Heard Havana clearly with three St. Louis stations broadcasting. My receiver works like a new set. The 'Ferbend' is certainly a wonder!"

YOU Can Obtain These Remarkable Results

You can obtain results as satisfactory as this St. Louis user. If you don't, it doesn't cost you a penny, for the "Wave Trap" is sold with a positive guarantee that it will tune out interfering stations. Don't wait. Order now at our risk.

Send No Money You need not send a penny. Pay you prefer, send \$6.00 with order and "Wave Trap" is mailed postpaid. Money back guarantee either way. You see you take no risk, so order **TODAY.**

Ferbend "Wave Trap" can also be supplied complete for use mounted on formica panel in mahogany finished cabinet 6x5x5 at \$8.50. Complete circular on request.

Water St., Chicago

Send me a Ferbend "Wave Trap". I will pay Postman \$6.00, plus postage. I understand you guarantee "Wave Trap" to tune out interfering stations or refund money.

Name.....

Address.....

FERBEND ELECTRIC CO.

15 E. South Water Street, CHICAGO

FERBEND

Wave Trap



Charge Your Radio or Auto Battery
at Home for a Nickel with the

GOLD SEAL HOMCHARGER

Simple, dependable, practically silent and absolutely safe. Charges in one-half the time and at one-third the cost of most other chargers. Beautifully finished in mahogany and gold. Sold by all good dealers, complete with ammeter, charging cable, clips, etc. \$18.50. (\$25.00 in Canada.)

FREE Ask your dealer or send direct for free HOMCHARGER list of broadcasting stations and GOLD SEAL bulletin.

Insist on the GOLD SEAL

It's your guarantee against substitution and appears on name-plate and package. No other charger is just as good.

Automatic Electrical Devices Co. 129 West Third St. Cincinnati, O.

Largest Manufacturers of Vibrating Rectifiers in the World

FREE Radio Text Book and Catalog

A Post Card Brings It

**CONTAINS 75 VACUUM TUBE
HOOK-UPS
300 ILLUS. 500 RADIO ARTICLES**

All Armstrong Circuits: These important circuits are explained clearly, all values being given, leaving nothing to puzzle you.

Also 75 full, clear diagrams, explanations and instructions for all important vacuum tube circuits, from the simplest to the most advanced. How to make a wave-trap—how to increase wave length of set—aerial data—tube data—battery data—reflex—regeneration—radio amplifiers—audio amplifiers—loud speakers—tables of component parts, and endless other radio subjects covered in simple, understandable way.

The 75 diagrams in book form alone would cost you \$3 to \$5. Get this all FREE. Send for it right away. Offer limited.

RADIO SPECIALTY COMPANY, 98 E. Park Place, N. Y. City



The Real Metal Solder in Paste Form

SOLDERALL

Introducing Our New
SOLDERALL BLOW TORCH
of Heavy Solid Brass

Indispensable in the Home, Garage and to the Electrician. For soldering Radio, House Wiring, Jewelry, Ignition, Kitchen Utensils, etc.



SOLDERALL CO. Dept. P Newark, N.J.

YOU DON'T NEED TUBES

to receive concerts from Distant Stations.
You can hear them on
YOUR CRYSTAL SET

If you fix it up the right way. You may already have everything you need and just have it connected up wrong. People using my methods hear programs clearly from stations

400 TO 1000 MILES AWAY

No Tubes, Batteries or Amplifying apparatus required. No Special Crystal Necessary. Changes often cost less than a dollar. Picture of my set and further information free. Write today.

LEON LAMBERT, 539 So. Volusia St., WICHITA, KANSAS

THE NEW WAY TO MEND AND DARN Hosiery and All Fabrics

Mrs. Cross' Takes 1/10th as much time as needle and thread.
NO-WAY Guaranteed to stand washing, boiling and ironing. Saves trouble, work, expense and time.
Mending Fluid Send 50c for Large Tube.
Write for Free literature **AGENTS WANTED**
The New Way Laboratories, Inc., C. M. Healy, Cincinnati, O.



Saws Logs—Falls Trees—
Buzzes Branches
—Does Belt Work
10-Year Guarantee—Cash or Easy Terms.
TRY 30 DAYS

One Man Saws 15 Cords a Day!

—Easy with the OTTAWA Log Saw! Wood selling for \$3 a cord brings owner \$45 a day. Use 4 H. P. Engine for other work. Wheel mounted—easy to move. Saws faster than 10 men. Shipped from factory or nearest of 10 Branchhouses. Write for FREE Book—"Wood Encyclopedia"—today.

OTTAWA MANUFACTURING CO.
1741-T Wood Street, Ottawa, Kansas
Room 1741-T Magee Bldg., Pittsburgh, Pa.

Make \$60 to \$100 A WEEK

New 300 Candle Power Lamp—Burns 96% Air

Introduce wonderful patented invention. Burns only 4% fuel—cheap kerosene or gasoline. Uses less than wick lamps. Greatest advancement in lighting of the age. Table lamps, wall lamps, hanging lamps, lanterns. Powerful, brilliant, soft, restful white light—like daylight. Brighter than a score of wick lamps. No Smoke—No Soot—No Odor.

FREE Outfit Offer Easy to earn big money. No experience—no capital required. Work all or spare time. Simply take orders. We deliver and collect—pay you big commission same day. Vivian of Minn. made \$400 in 39 days. Green of N. Y. made \$33 in one day. Hundreds making \$10 to \$40 a day. Get territory quick. Big season now on. Write today for Free catalog and special agents offer.

The Akron Lamp Co., 102 Lasp Bldg., Akron, O.

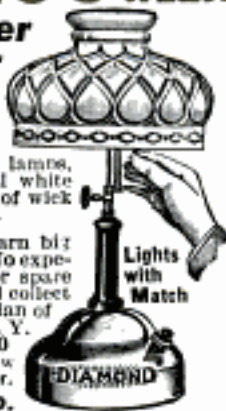

Morrison



Loud Speaker Enthusiastic

—is the only word that describes those radio critics who have chosen Morrison Loud Speaker. For them Radio has taken on new delights. Bright stars of the musical comedy stage, famous lecturers and singers, all are theirs no matter where they live—every night as long as they care to stay awake. Real reproduction without annoying vibrations as soft or loud as you please—that describes Morrison attached to your phonograph tone arm or used with a horn.

\$10.00

That's all Morrison costs complete with 5 foot cord.

Nickel Plated Model

This perfect little loud speaker has no rivals. We assure you your money back if you don't like it. Ask for descriptive 2 color catalogue.

Dealers Thousands of new radio fans have receiving sets—Christmas presents. Every one needs a Morrison Loud Speaker. We will show you how to merchandise Morrison. Ask us for our plan—at once.

MORRISON LABORATORIES, Inc.
337 Jefferson Ave., East DETROIT, MICH.



Armored MOCCASIN SHOE FOR WORK OR OUTDOOR WEAR

By Mail, Prepaid
\$4.85

DIRECT TO YOU

Choc. elk uppers; two full soles; Armored sole; full rubber heel; full vamps (nothing to rip). A sturdy shoe for real wear and comfort.

CHARLES KELLERT CO.
116 Bedford St., Dept. 501, Boston, Mass.
(Exclusive territory open to agents)

THEY WEAR!

HEMSTITCHING AND PICOTING MADE EASY

This attachment does very beautiful work on ALL Machines. Made of finest materials; fully GUARANTEED. Price with full instructions and sample of work..... **\$2.50**

ORIENTAL NOVELTY COMPANY, Drawer 11, WACO, TEXAS

THE TRINITY LOUD SPEAKER

The only device of its kind in the radio field.

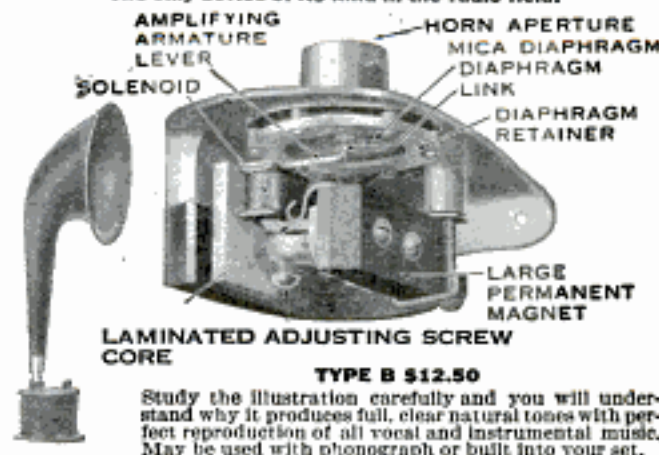

LAMINATED ADJUSTING SCREW CORE

TYPE B \$12.50

Study the illustration carefully and you will understand why it produces full, clear natural tones with perfect reproduction of all vocal and instrumental music. May be used with phonograph or built into your set.

TRINITY RADIO CORPORATION
Type A1, \$25.00 21" Fibre Horn 446 TREMONT ST., BOSTON, MASS.

I want to Pay You \$85 a week

Man or Woman

Send for my proposition, I pay men and women \$85.00 weekly to as high as \$36.00 per day for either all or spare time help. No experience necessary.

Sell PRINCESS RADIUM LINGERIE

Charming ladies lingerie and hosiery, pretty, low priced, sells on sight, actually. Miss Grace James averaged \$36 a day, spare time; R. G. Thompson earned \$33 in one day. You can do as well, we tell you how.

Profits in Advance

Your profits in advance, we ship and collect. You show goods and mail us the orders. Nothing in any store compares in beauty and value to "Princess Radium" lingerie and hosiery.

High Grade-Steady

Unusual opportunity for big cash quick, write for plan and exclusive territory, build a steady income for life. District managers wanted. Territorial rights going fast, don't delay, write now.

Free

Handsome photos from actual models and samples of genuine "Princess Radium" silk, free.

ROBERTS-FRANK CO.
Dept E-12
127 No. Dearborn Chicago

Tailoring Agents \$5⁰⁰ to \$25⁰⁰ Daily And FREE SUIT

Full or spare time men with or without experience can earn \$5 to \$25 daily taking orders for world's greatest values in made-to-measure suits at \$18 and up. All delivery charges prepaid. Handsome assortment of woollens and a brand new sample outfit that is a wonder. **One man in each community can earn a suit** on easiest, most liberal offer ever made. No experience needed. We furnish full information about styles, prices, agents' outfit, etc.—simple, clear, interesting and profitable. Write us—No obligation—A postcard will bring prompt reply.

American Woolen Mills Co., Dept. 2013, Chicago, Ill.

Coleman Camp Stove

It's the all-complete stove for auto-tourists, campers, hunters, fishermen. Everything built in—pump, funnel, swinging tank, wind-baffle, drum-beater, warming-cabinet and baking oven—all attached to stove. Folds up like a suit case. Write for descriptive literature and prices. **Addr. Camp, Dept. P M 13**

THE COLEMAN LAMP CO.
Factory and General Offices: WICHITA, KANSAS

BUSH AUTOMOBILE WITHOUT MONEY

Get the Bush Agency in your territory and take orders for Bush Cars. Wonderful opportunity. Write today. Bush Closed and Open Cars Guaranteed. Big Free Car Offer. Address

BUSH MOTOR CO., Dept. 352, Bush Temple, Chicago, Ill.



Turn Your Ideas Into Profits

On Whether you are interested in light manufacturing, repairing or experimental work; whether you are a mechanic, engineer, amateur or student; whether you work in wood or metal, your ideas can be turned into profits with accuracy, speed and economy on

The Baby Grand Lathe

A sturdy, simple lathe of high quality at low price. Operation same as large lathes. Made of selected materials by skilled machinists who specialize on lathe building. Quantity production explains the low price. Not a toy but a practical machine for all small work. Sold direct from factory to you on positive money-back guarantee.

Write today for illustrated folder giving complete description and prices.



The Watson Mfg. Co.
2470 Albion St., Toledo, Ohio, U. S. A.

SPORT BODIES for FORD and CHEV. 490 at \$34.50 UP

Life-size paper patterns—You can build your own body at small cost. We are manufacturers and our quantity production enables us to quote exceptional low prices. Our unique shipping methods save you 73% in FREIGHT CHARGES. Send at once for free particulars on Central Bodies. Our Book: "HOW TO BUILD A FORD RACER" sent anywhere on receipt of 25c in cash or stamps. **WRITE TODAY!**

Central Auto Supply Co. Dept. 120, Louisville, Ky.



UNDER SLUNG PARTS Per Set \$6.75

THIS WONDERFUL INVENTION

converts any ordinary cook stove into a gas stove. OXO-GAS is made from kerosene and air. Cheaper, cleaner and more efficient than coal. Responsible distributors wanted.

GLORIA LIGHT CO.
114 N. May St. Chicago, Ill.



We Pay \$6 a Day

taking orders for Insyde Tyres—inner armor for automobile tires. Positively prevents punctures and blowouts. Guaranteed to give double tire mileage. **Work Spare Time or Full Time.** Every auto owner buys on account of low price. Enormous demand. Write quick for territory and special terms to County Representatives.

AMERICAN ACCESSORIES CO., B 1476, Cincinnati, Ohio



AGENTS! If you are making less than \$150 a week, better write for information about selling SAAL HEAVY OIL SYSTEMS.

H. G. SAAL CO., Dept. 1101, 1390 Montrose Ave., CHICAGO

Drive 100 Tacks and Save \$25

on your next Top or Best receiving: Fords \$5.20 to \$10. Chevrolets \$7.95 to \$15. All other cars \$9.95 to \$22. Our Plate Glass Lights enhance the value of your car. Side Curtains \$5.95 up. Seat Covers \$2.50 to \$32. Quality and fit the best. Our instructions make it easy to apply. Send for samples. Our prices include delivery at your door. Eastern orders shipped from Ohio.

Auto Equipment Co., 1055 So. Broadway, Los Angeles, Calif.

\$5.20 up Delivered



When men like these

Write words like these



F. E. Mendenhall

Mendenhall says, "I average \$100 every half-week — made \$140 my first day"

"I have been interested in many selling propositions, but never yet have I found an article that sells as readily as Fyr-Fyter Extinguishers. I have averaged better than \$100 a week for the last three months, working only three days a week. Now, on full time, I look forward to an earning power of at least \$250 weekly."



James Ryan

Ryan says, "Thanks to your splendid co-operation, I made \$130 my first week"

"For an ambitious man success is certain from the start, even though, like myself, he has not had any previous selling experience. A Fyr-Fyter man has a superior product to sell, a fine Company to work for, and your special Sales Plan makes it easy to get the orders. Thanks to your splendid co-operation, I made \$130 my first week."



Glenn Howard

Howard says, "My earnings have grown every month — I made \$100 in one day"

"When I first wrote you over a year ago I was skeptical as to how Fyr-Fyters would sell—but after 14 months' experience with you I believe my record of earnings speaks for itself. The people I have sold in the past are all well pleased, and they are a great help to me in getting more orders. Earnings are increasing every month—I've made over \$100 in a single day."

WE NEED MORE AMBITIOUS MEN LIKE THESE

There is a tremendous market for Fyr-Fyter Extinguishers in every section of the United States. They are Approved and Labeled by the National Board of Fire Underwriters. Everyone who owns anything that will burn is a real live prospect, so you can devote your time to getting orders and not to just

hunting for prospects. We need more men who are really ambitious and who want to get out of a rut—we offer a *real opportunity* not only to individual salesmen but also to distributors and we give exclusive territory. If you're looking for something *real*, get in on this at once.

You can make big money

With us regardless of whether you have had previous selling experience or not. We show you just how to do it.

Write today for our Plan

There's no obligation to you and it may show you how to double or treble your present earnings.

Can you afford to hesitate

THE FYR-FYTER COMPANY

4030 Fyr-Fyter Bldg., Dayton, Ohio

Orlando is Calling You

Do you want to get away
From the grind of every day—
From the drudgery of things you have to do?
Do you want to settle down
Near a lively, busy town,
Where the joy of living will appeal to you?

Do you want to scent the breeze
Coming through the orange trees?
Do you want to hear the birds call—loud
and clear?

Are you seeking perfect health
That's combined with certain wealth
And an income from an orange grove each
year?

Do you want a piece of land
That will grow to beat the band
All the different garden crops that you
enjoy?

Do you want to make a "Nest,"
And a permanent bequest
For the future welfare of each girl and boy?

Do you want a sunny clime
Where there's fishing all the time?
Where there's ducks and deer and quail
and other game?

Where the summer climate's cool,
And within each lake and pool,
You can swim in January—just the same?

Do you want to buy this land
On an easy-payment plan,
With about your monthly outlay for cigars?
Do you want to read a book
That will make you want to look
On the finest land that lies beneath the stars?

Send a letter right away;
Put it in the mail to-day,
We will send this Booklet absolutely FREE.
After you have read it through,
If a thought occurs to you—
Just address another letter here to me.

We will answer, straight and true,
Questions that occur to you.
We have nothing to evade or to conceal.
On an Orange County Farm
Life will take on added charm,
And you'll never lack a dollar — nor a meal.

Send for our Big, FREE Illustrated Book—
"TWENTY ACRES AND PLENTY." It
tells of almost unbelievable profits made
from trucking and fruit-growing in our part
of FLORIDA. Also about sick-and-out-of-
work Clauses, and other protective features
of our contract. Address Sylvester E.
Wilson, Dept. I-14, Orlando, Florida.

FREE 1000
illus-
trations **ELECTRIC
FIXTURE CATALOG!**

Write today for your copy. Save
50% direct from Manufacturer.
No Middleman's Profit. OUR
SPECIAL: 8 Room Electric Set,
ready to hang, \$24.50—Other bargains.

UNITED LIGHTING FIXTURE CO.
280 Bowery Dept. 120 New York



Learn to Play **SAXOPHONE**
EASY PAYMENTS

"C Melody"
Artists' Model Saxophone

Boy, it's a WOW! As easy to play
as one-finger tunes on a piano—easi-
est fingering, easiest blowing, richest
TONE! "Sax" ever! The choice of teachers
and professionals all over the world. Now
offered direct from factory at wholesale
price, on small payments!

10 MONTHS to PAY!
Thousands of snappy young
fellows have made their AR-
TISTS' MODEL SAXO-
PHONE pay for itself in
spare time earnings. Now at
last you can be Everybody's
Favorite—you can turn your
saxophone playing into pleasure and profit!

\$1 DOWN

FREE TRIAL! Seasonal offer right now! Big complete outfit on 6
DAYS FREE TRIAL! Consists of \$10 case, self-in-
struction book, sheet music, reeds, strap, pearl keys,
etc. \$1 reserves your Saxophone. Small first pay-
ment, then only \$5 a month!
Highest quality PROFESSIONAL Saxophone
now within your reach. Write for catalog today!
Standard Music Co., Dept. 1822, P. O.
Box 803, Chicago

Complete Professional
Outfit

**CATALOG
FREE!**

Two Models of the New Simore Tool "Lightning-Change"

Three blades in the handle—blades selected
and produced by gravity instantly—change
blades in two seconds.

Model No. 12 has a keen steel knife
blade as shown and two screwdriver
blades. Handle blued to prevent rust,
blades best grade steel, a beautiful
tool. Sent postpaid for only \$2.25.

Model No. 11 same as No. 12 except
has three screwdriver blades. Sent
postpaid for only \$1.80. We ac-
cept money order or your check.
Ask your dealer or write direct.

Dealers and others invited to write
for information on Simore tools.

THE SIMON & SKIDMORE MFG. CO.
Dept. 5-2 SANTA ANA, CALIFORNIA

AGENTS: \$8.00 A DAY

Newest Invention
Coal-Oil Burner
Cheapest Fuel Known

Most perfect burner ever
invented for heating, cook-
ing, baking. Fits any stove.
Heats oven to baking point
in 10 minutes. Low priced.

Make \$5 to \$12 a day. You take orders. We deliver and
collect. Pay you daily. Write for terms and sample.

PARKER MFG. CO., Burner 978, Dayton, Ohio

100 Genuine 10c Cigars \$6⁹⁵

Regular Retail 10c Cigar, Havana Filler.
Wisconsin Binder and Sumatra Wrapper. These cigars are nationally known for
their wonderful quality. Satisfaction guaranteed or money refunded. Order Today,
OWENSBORO TOBACCO CO., Dept. 130, OWENSBORO, KY.

**21 Jewel
Burlington**

\$1 DOWN

Adjusted to the Second—Temperatures
— Isochronism — Positions — 21 Ruby
and Sapphire Jewels — Cased in a 25
year Gold Strata Case. Only \$1 down
will bring you this masterpiece.
Write today for free book to

Burlington Watch Company
19th Street & Marshall Boulevard
Dept. 13-52 Chicago, Ill.



SENSATIONAL SALE

GUARANTEED TYPEWRITERS



\$1 DOWN
Balance on
Easy Terms

This is the famous L. C. Smith typewriter which has set the world's standard for quality and service for over twenty years. Perfect machines, Standard size, Keyboard of Standard Universal arrangement, 42 Keys, writing 84 characters—universally used in teaching the touch system. The entire line of writing completely visible at all times; has the tabulator, the two color ribbon, with automatic reverse, the back spacer, ball bearing type bars, ball bearing carriage action, ball bearing shift action. This ball bearing construction makes it much easier to learn operating on the L. C. Smith than any other typewriter. Also it gives unlimited speed—beyond the limits of human possibilities. Every late style feature and modern operating convenience. Comes to you with everything complete: tools, cover, operating book and instructions—nothing extra to buy. You cannot imagine the perfection of this beautiful typewriter until you have seen it. We do the most perfect and highest class job of rebuilding known to the typewriter industry. We have sold thousands of these perfect late style machines at this bargain price and every one of these satisfied customers had this splendid, strictly up-to-date machine on five days' free trial before deciding to buy it. We will send it to you F. O. B. Chicago for five days' free trial. It will sell itself, but if you are not satisfied that this is the greatest typewriter you ever saw, you can return it at our expense. You won't want to return it after you try it, for you cannot equal this wonderful value anywhere.

FREE BOOKLET giving description of this machine and other models, also Valuable Typewriter Information, sent on request.

Only \$1.00 down, then a few dollars a month and the machine is yours. This is absolutely the most generous typewriter offer we ever made. Why rent a machine when your rent money will buy one? Think of it—buying a perfect, late model highest grade \$102.50 Typewriter at a bargain price.

The Famous L.C. Smith Model No. 5

Just send \$1.00 with the coupon and the machine will be shipped at once. Then after 5 days if you are convinced that it is the best typewriter you ever saw, keep it, send us \$4.15 and then send us \$4.00 a month until our bargain price of \$57.15 is paid. All cash, \$53.05, just a little more than half its original price.

FREE TRIAL

If you don't want it, return it and receive your \$1.00 back. We will pay the return express charges. This machine is guaranteed just as if you paid \$102.50 for it. It is standard. Over a half-million people own and use these typewriters and think them the best ever manufactured. The supply at this price is limited; the price will probably be raised when the next advertisement appears, so don't delay. Fill in the coupon today—the typewriter will be shipped promptly. There is no red tape. We employ no solicitors—no collectors—no chattel mortgage. It is simply understood that we retain title to the machine until full \$57.15 is paid. You cannot lose. It is the greatest typewriter opportunity we have ever offered. Get the coupon in the mails today—SURE.

SEND NOW—BEFORE THEY'RE GONE

SMITH TYPEWRITER SALES CO.
300-360 E. Grand Ave., Chicago, Ill.

Send This Free Trial Coupon NOW

SMITH TYPEWRITER SALES CO.,
300-360 E. Grand Ave., Chicago, Ill.

I enclose \$1.00 as evidence of my good faith. Ship me the L. C. Smith Model No. 5, F. O. B. Chicago. After five days' trial I will send you \$4.15 and then \$4.00 per month thereafter as rent until the \$52.00 balance of the Special \$57.15 sale price is paid. The title to remain in you until fully paid for. It is understood that I have five days in which to examine and try the typewriter. If I choose not to keep it, I will carefully repack it and ship it back to you and you will return my \$1.00 deposit. It is understood that you give the standard guarantee.

Name..... Street.....
City..... State..... Business or
Two..... Employer.....
References.....

NEW INVENTION BURNS AIR IN ANY RANGE OR HEATER

Heats, Cooks and Bakes Better Than Coal or Wood. Cuts Housework in Half. Avoids Expensive Heat Waste. Proved by Many Severe Tests to Be Best Kind of Heat. Then Recommended to Housekeepers.

MANY modern homes are being built without coal bins or wood sheds simply because it is so much easier and cleaner to burn free air. Science has shown that one part of coal oil (kerosene), the cheapest of fuels, can be mixed with twenty parts of air (by a remarkable burner) and the result is a gas that is simply wonderful for heating, cooking and baking.

The Simplest Device of All

Following the original discovery of this new, easy way to make every stove a gas stove—a method which is used extensively in our Navy—devices were made which could be used in any kind of range, or heater, and those housekeepers who were abreast of the times began to install them as fast as they could be secured.

Heat at Twist of Wrist



Don't freeze while building Winter fires. A twist of the wrist brings cheerful heat in few seconds.

Then, recently, later discoveries showed how to cut out certain parts and yet get even better results. The device which embodies these latest discoveries is called NU-HEAT. It is installed in any range or heater in a jiffy. It does away with all worry as to coal or wood prices or scarcity. It cuts half your housework and the dirtiest and most disagreeable half, at that. Not necessary to BUILD a fire. Just a twist of the wrist and in a few seconds there is an intense cheerful glow that warms the largest rooms on the coldest mornings in a few minutes. NU-HEAT gas is much cheaper than city gas. Gives three times the heat of coal—and it burns at a steady, even temperature that gives far better baking results than coal.

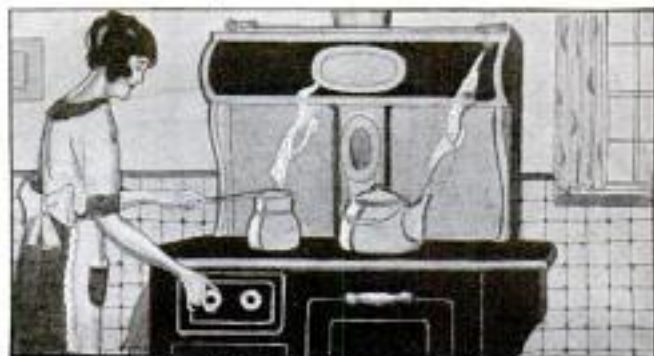

A twist of the wrist brings a fire in a few seconds. Good steady oven heat for better baking.

30 Days Free Trial

Absolutely safe. Nothing to get out of order. Sold under an iron clad guarantee. Sent on 30 days' free trial.

Send for Free Book

Write for complete information FREE. Learn how to cut housework in half. Learn how to economize by having all the heat you want but only when you need it. Learn how to have the warmest, cleanest, coziest home in town. Learn how to get better cooking and baking results than ever before. Just say "Send NU-HEAT information." Mention if you have heater, range or furnace. Write at once to

WADE HILL MANUFACTURING CO.
Dept. B39 ST. LOUIS, MO.

Agents make \$50 to \$200 a week selling what every up-to-date woman wants. Here's a better burner at a low price—every home can easily afford. Personal co-operation. Free Sample Case offer. Write quick for exclusive territory.



TANK

Safety Blade Stropper

(FOR GILLETTE BLADES)

Send \$2.75 Strop your own blades! We pay postage Imported Safety Razor Blade Stropper.

REVERSES BLADE AUTOMATICALLY
Rollers move laterally from right to left. Perfect action! Perfect stropping! Keeps blades always sharp. GUARANTEED.

CHARLES KELLERT CO.

116 Bedford St., Dept. 501, Boston, Mass.
Territory open to agents. Dealers write for quantity prices.

RANGER \$5 a Month

Finest bicycle built—44 styles, colors and sizes. Factory to Rider prices FREE delivery, express prepaid on 30 days Free Trial. Cash or easy pay'ns.

TIRES lamps, wheels and equipment at half usual prices. Send no money. Write today for big catalog, special Factory Prices, free trial plan and marvelous offers.

MEAD CYCLE CO. Dept. G-108 CHICAGO



Start Little Mail Order Business Home Evenings

Instructive Booklet Free

PIER CO., 556 Cortland St., N.Y.

DIAMONDS

FOR A FEW CENTS A DAY

Don't send a single penny. Ten days' Free Trial. When the ring comes, examine it—if you are not convinced it is the Greatest Bargain in America, send it back at our expense. Only if pleased, send \$1.50 weekly—at the rate of a few cents a day. This Bargain Cluster Ring with 7 Blue-White Perfect Cut Diamonds can be yours. No Red Tape. No Risk.

Send for it today. It pictures thousands of Bargains. Address Dept. 1722

FREE

Million Dollar Bargain Book

J.M. LYON & CO.
2-4 Maiden Lane N.Y.

\$1.50 a Week

SEND NO MONEY

Looks like \$350 Solitaire No. 61 only \$59.50

We Trust You

MONEY BACK GUARANTEE

MILLION DOLLAR BARGAIN BOOK

HANDS ALL PAINT?
You can remove it quickly with

GIT HAND PASTE

18 OUNCES

10¢ at F. W. Woolworth Co. McCrory and other stores



PAY NOTHING DOWN

5 DAYS FREE TRIAL

"INVINCIBLE" REBUILT GUARANTEED

REMINGTON MONARCH No. 3

Prices greatly reduced. A real bargain. Lightest touch, entirely visible. Writes small cards better than any other machine. Full 84-character keyboard, back spacer, two-color ribbon, etc. Deliveries from nearest of our 28 stores. Take advantage of low price NOW. Circular on request. Many other standard makes. Time payments if desired. Resident salesmen wanted.

AMERICAN WRITING MACHINE CO.
Estab. 1860
Factory: 452-M Central Ave., Newark, N. J.





Pleasure and Profit With a "KING" Saxophone

IT'S so easy to learn to play the famous KING saxophone! A few weeks' practice and you can play popular music—then join a band or orchestra and make good money playing for dances and other entertainments.

"KING" Band Instruments and Saxophones are easiest to play because they are built acoustically correct. Scientific design, finest skilled workmanship, careful supervision at each phase of construction make "KINGS" the most perfect instruments in the world. The tone quality is impossible to duplicate. Leading bands and orchestras insist upon "KINGS." Let us send you one for 10 days free trial.

Free Trial—Easy Payments
"KING" Band instruments and Saxophones are fully described in beautifully illustrated circulars. Write today for complete information about our ten days free trial and our easy payment plan on any instrument. Ask for bargains in rebuilt instruments—old ones taken in trade.

THE H. N. WHITE COMPANY
5211-48 Superior Avenue, Cleveland, O.

Great New Invention for seekers of Health Power Beauty



Elco Health Generators at last are ready for you! If you want more health—greater power to enjoy the pleasures and delights about you, or if more beauty is your desire—write! Ask for the book on these inventions which has just been prepared. It will be sent to you without cost. It tells you how Elco Health Generators aid you in leaving the lethargy and hopelessness of bad health and weakness behind forever. Re-vitalize yourself. Bring back energy. Be wholly alive. Write today!

10 Days Free Trial—Write for FREE BOOK



These great new inventions generate *High Frequency Violet Ray, Mechanical Vibration, Medical Electricity and Ozone.* Combined or separate.

They operate on the electric light in your home or on their own motive power at less than 60 cents per year. Elco Health Generators are positively the only instruments which can give you in one outfit Electricity, Violet Ray—Vibration and Ozone—the four greatest curative agents. Send coupon below. Get the Free Book NOW!



For All These:

Rheumatism	Asthma
Gout	Hay Fever
Lumbago	Sore Throat
Neuralgia	Catarrh
Sciatica	Deafness
Headache	Insomnia
Neuritis	Pain
Nervousness	Development
Circulation	Skin Disease
Weakness	Pimples
Paralysis	Scalp Disorders
Eye Trouble	Obesity

MAIL the COUPON for FREE Book!

Do not put this paper down without sending the coupon. Don't go on as you are with pains and with almost no life and energy. You owe it to yourself to be a better man or woman. You were put here to enjoy life—not just to drag through it. So do not rest another day until you have put your name on the coupon here. That will bring the whole story of these great new inventions. Do it today—now.

Health
Power
Beauty

Lindstrom & Company

442-448 North Wells Street, Dept. 13-52, Chicago, Ill.
Please send me your free book, "Health—Power—Beauty" and full information on your 10-day Free Trial Offer.

Name.....

Address.....

State your ailment and receive our expert advice
REPRESENTATIVES WANTED

Sell Shirts



Sell Madison "Better-Made" Shirts, Pajamas, and Nightshirts direct from our factory to wearer. Nationally advertised. Easy to sell. Exclusive patterns. Exceptional values. No experience or capital required. Large steady income assured. Entirely new proposition. WRITE FOR FREE SAMPLES.
MADISON SHIRT CO., 503 B'way, N. Y. City

DEAFNESS IS MISERY



I know because I was Deaf and had **Head Noises** for over 30 years. My invisible Antiseptic Ear Drums restored my hearing and stopped Head Noises, and will do it for you. They are Tiny Megaphones. Cannot be seen when worn. Effective when Deafness is caused by Catarrh or by Perforated, Partially or Wholly Destroyed Natural Drums. Easy to put in, easy to take out. Are "Unseen comforts." Inexpensive. Write for Booklet and my sworn statement of how I recovered my hearing.

A. O. LEONARD, Suite 226, 70 5th Avenue, New York City

Write FOR BOOK ABOUT Elto

3 H.P.—The Fastest "Light Twin"



Designed and Built by Ole Evinrude Weighs less than 17 lbs. per h. p. Gives half more power, much more speed, yet easy to carry. Instant starting without spinning. Safe rudder steering. Trouble proof carburetor. Push button reverse, without danger of tipping boat. The ideal family motor. Fits carrying case without taking apart. Write for catalog.
ELTO OUTBOARD MOTOR COMPANY
Manufacturers' Home Bldg., Dept. A A Milwaukee, Wis.

(C)



You Can Make Big Profits with These Improved Torches

Our Representatives are making big money selling our new and wonderfully improved Welding and Cutting Torches. The Welding Torch with five tips sells on sight for \$40.00. Costs you only \$16.50. The Cutting Torch with two tips outsells others for \$60.00 and costs you only \$23.75. One of our men—O'Donnell—makes a profit of \$62.00 a day. No Real Competition. These Torches equal those costing double. Used in the largest industries everywhere. Easily and quickly demonstrated and sold. Get Into the Big Money Class. Order one or both torches today at above prices. If you do not sell them the first day, return them and get your money back.

MACKAY & HARRIS, Inc., 308 W. 10th St., Los Angeles, Calif.



Ten years, and
no breakdowns

That's the record which James Bishop's Auto-Wheel Coaster has made. He says: "I have had an Auto-Wheel Coaster for ten years. Have hauled heavy loads most every day on rough ground, but the wagon went through it all without a breakdown."

Auto-Wheel Coasters and Auto-Carts

Superior construction makes Auto-Wheel Coasters sturdy. Bolsters of hard maple; mortised joints; self-contained roller bearings; hound brace; hand brake, special hub cap and locking pin; rubber-tired disc wheels (oversize tires on three largest), or steel-tired disc or wood spoke wheels.

Write for catalog of all models of the Auto-Wheel and the Auto-Cart (for little brother or sister). If you send names and addresses of three coaster wagon dealers in your town, telling which sell Auto-Wheel, we give you a year's subscription FREE to the "Auto-Wheel Spokes-man," our magazine.

AUTO-WHEEL COASTER CO., Inc.
NORTH TONAWANDA, N. Y.

SWEATERS SAVE 20%-30%



Any Style or Design
for Men, Women, Boys,
Schools, Clubs, Teams

Order direct from mill. Save from 20% -30%. Pick any style, any color, size or design from our regular stock or special to order. Finest virgin wool and pure worsted only. Custom tailored workmanship of highest grade. Closely knit. Warm, soft, snug. Real beauties you will be proud to wear.

FINEST QUALITY AT BARGAIN PRICES

FREE Always holds shape. Most customers get from 3 to 5 years wear easily. Can endure severe wear and retain bright, fresh appearance. Biggest values in history. Workmanship guaranteed. Prices slashed. Unusual chance to save. Special offers to schools, clubs, teams. Write for free illustrated catalog.

AMERICAN KNITTING MILLS 1538 Clybourn Avenue
Dept. 20 CHICAGO



MADE TO YOUR MEASURE \$
Suit 14.95
NO EXTRA CHARGES Postage Prepaid



SEND NO MONEY We make this special offer to prove the wonderful value, style and fit of Progress tailoring. We will tailor to your special order one of these fine suits, send it to you postage prepaid and guarantee absolute satisfaction for only \$14.95. We have other equally striking bargains in the finest made-to-order suits at from \$14.95 up to \$39.50.

—AGENTS WANTED— Earn \$20 to \$55 extra every week, taking orders from your friends and neighbors for our high-class tailoring. NO EXPERIENCE NECESSARY.

Big Sample Outfit FREE

Drop us a line today and we will send you absolutely free, our big assortment of woolen samples, style book and special wholesale prices, on our made-to-measure suits.

THE PROGRESS TAILORING CO., Dept. B-145, CHICAGO



EVINRUDE WILL

To insure delivery of a new SPORT TWIN, order from your dealer at once. Send for catalog.

EVINRUDE MOTOR CO., 227 Broadway Block, Milwaukee, Wis.

BE OVERSOLD

Swing 4 in.; 11 in. between centers, 17 in. total length. Shipping weight 13 lbs. Bed of lathe is machined. Workmanship first-class. Equipped with wood turning chuck. Can be fitted with 3 in. face plate and drill chuck as special equipment. Order one today.



Price \$6.00 cash with order
Made also in larger sizes.

SYPHER MFG. CO.
Dept. D TOLEDO, OHIO

Build Your Own PHONOGRAPH

IT'S EASY WITH OUR HELP

A few hours' interesting work saves over half and gives you a machine to suit your ideas. We furnish motors, tone arms, case material, blue prints and full instructions. Plays any record. Make fine profit building phonographs for your friends.

Write today for our **FREE** Blue print offer.

GET YOUR **RADIO SUPPLIES** FROM US

Choraleon Phonograph & Radio Co.
224 1st St., Elkhart, Ind.



SAVE OVER HALF

\$1662⁰⁰ Earned IN ONE SEASON

A NEW BUSINESS—BIG BUSINESS

A Business to Enthuse Over—The "Ideal" Lawn Mower Sharpener

W. F. Kendt,
1476 Main St., Buffalo
writes:

I sharpened 934 lawnmowers last season, and the receipts were \$1662.00 which is not bad for a side line."

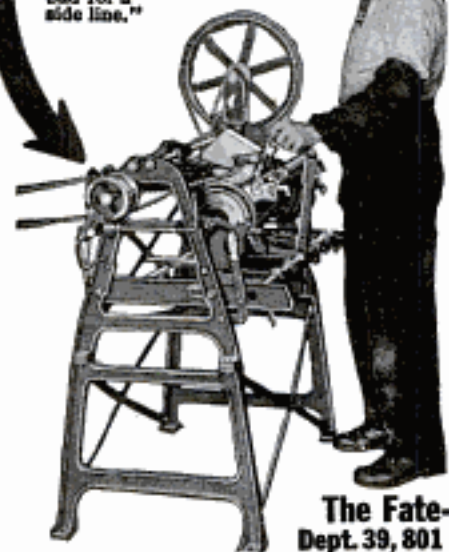

A wonderful invention that sharpens lawn mowers scientifically—quickly—perfectly; does the work as nothing else can.

Fred C. Milkert of Melrose Park, Ill., writes:

"The Ideal Lawnmower Grinder put me in business, starting in the basement of my home and forcing me now for the third time to move into bigger quarters. Today the dream of my life—a shop of my own—is realized. With a machine like yours and a little hustle any man can have a business of his own and be independent."

You Start Now No town too small. Lawn mowers are dull—owner doesn't know where to get them sharpened. Mowing the lawn dreaded because of dull or improperly sharpened mower. Lawn mowing healthful, invigorating and pleasant when Mower is "Ideally" sharpened. You do the work scientifically—you are in big demand.

Lawn Mowers Sharpened to Razor Edge—

People glad—owners delight in mowing lawn with mower sharpened on an "Ideal." Mower runs light—click-click-click and the grass is cut. Build permanent business for yourself. Start now!

Write Today Get our proposition Free—We have detailed illustrated book to send you. Write today for our proposition.

The Fate-Root-Heath-Company
Dept. 39, 801 Bell St., Plymouth, Ohio

USE THIS—Mail it Today

The Fate-Root-Heath-Company
801 Bell Street, Dept. 39, Plymouth, Ohio
Please mail at once details of your complete proposition.

Name _____

Address _____

THE SCREWDRIVER THAT HOLDS THE SCREW

As Good as a Third Hand in Assembling anything from a Watch to an Automobile



Appeals

Especially to Radio

amateurs and professionals. A wonderful (patented) Improvement.

Jobbers, Dealers and Agents. Favorable discounts

\$1.00 Postpaid **THE COBURN TOOL CO., 114 Bedford St., Boston**

Taxidermy Book FREE!



Write today.

Stuff Beautiful Birds

Learn by mail to stuff and mount all kinds of birds, animals, fish and game heads, make rugs, tax skins. Mount your own specimens and make money preserving for others.

Men, women and boys learn easily and quickly. Success guaranteed or no tuition. Write today for our wonderful FREE book, "How to Learn to Mount Birds and Animals." N. W. School of Taxidermy, 9772 Elwood Bldg., Omaha, Neb.

Men's Shirts



From factory to wearer. Easy to sell. Big demand everywhere. Make \$16 daily. Under-sell stores complete line. Exclusive patterns. No experience necessary. Free samples.

Chicago Shirt Manufacturers, 241 W. Van Buren St., Chicago, Factory 228

"Lighting Fixtures"

READY TO HANG

(Direct from Manufacturers)

Completely wired, including glassware. New designs. Send for catalogue No. 24. Send for DEALERS' proposition.

ERIE FIXTURE SUPPLY CO.
STA. A ERIE, PA.



"Been on a vacation Bill?"

"No, Jim—I've stopped smoking.

Gained six pounds in a week. You know how I used to smoke—a package of cigarettes and a cigar or two a day—it sure had some hold on me. But I'm cured—

took a scientific home to bacco treatment—fixed me up in two weeks.

"Wasn't hard on me at all—noticed improvement the first day—I feel like a new man. It didn't interfere with my work—didn't leave any druggish after-effects—the money I saved in the last two weeks has paid for the treatment alone.

"Why don't you take it! It has cured men like you and me for over forty years—it is a doctor's individual prescription that sure fixes you up. Just send the coupon for full information NOW. No obligation. All correspondence is strictly confidential."



A Doctor's Prescription

The Keeley Institute, Dwight, Ill.

Please send me, without any obligation on my part, your free booklet which will tell me how to rid myself of the tobacco habit.

Name.....

Town.....

Street..... State..... P.M.-2

PATENT TRADE MARKS PROTECT

ANY NEW article, machine, design or improvement thereof, or any combination of parts or improvements in any known article which increases its efficiency or usefulness, may be patented, if it involves invention.

IF YOU HAVE ANY NEW IDEAS

which you feel are useful, practical and novel, take prompt action to protect your rights. If you have invented any new machine, or new combination of parts or improvement, or any new design or process, SEND DRAWING, MODEL OR DESCRIPTION of it for information as to procedure to secure protection.



DRAFTING and SPECIFICATION ROOM of CLARENCE A. O'BRIEN, Registered Patent Attorney, Washington, D. C.

All Communications are held in strict confidence. My personal, careful and thorough attention is given to each case. I offer you efficient, reliable and prompt service—based upon practical experience. **Highest references.**

NO CHARGE FOR ABOVE INFORMATION

Clarence A. O'Brien

REGISTERED PATENT ATTORNEY

Member of } Court of Appeals, District of Columbia, United States Court of Claims;
Bar of } Supreme Court of United States, Supreme Court, District of Columbia

Practice Confined to Patents, Trade Marks and Copyrights

NTS

COPYRIGHTS YOUR IDEAS

WRITE TODAY FOR FREE BOOK,

“How to Obtain a Patent”

This book will give you valuable information, and it may save you much time and effort. Send for it, NOW. My practice is devoted exclusively to United States and Foreign Patents and Trade Marks. Write me freely, frankly and with full confidence; it is very probable that I can help you.



United States Patent Office as Viewed from My Office, Directly ACROSS THE STREET

WRITE TODAY FOR BLANK FORM “RECORD OF INVENTION”

USE THE COUPON attached, and immediately upon its receipt I shall send you this form to be returned to me with drawing, description or model of your idea; promptly upon receiving your idea I shall write you as to procedure and costs.

**CLARENCE A. O'BRIEN, Patent Attorney, 70B Security Savings & Com'l Bank Bldg.
Directly Across Street from Patent Office WASHINGTON, D. C.**

Please send me your free booklet, “How to Obtain a Patent,” and blank form, “Record of Invention,” without any obligation on my part.

Name.....

Address.....

(WRITE OR PRINT PLAINLY)



PATENTS

*Seventy-seven
Years of Practice*

THE firm of Munn & Company filed its first application for a patent in 1846, and for seventy-six years has endeavored to keep pace with the inventive genius of the United States.

An experience of many years is at your disposal. If you have an invention which you wish to patent, send your sketches or model together with a description of your device, explaining its operation, and you will receive prompt, courteous attention.

Write for our Handbook on
PATENTS

A full and complete booklet on Patents, Designs, Trade-Marks, Foreign Patents, Copyrights, Labels and Patent Office Practice with an explanation about our methods, terms, etc.

All communications strictly confidential.



Keep in touch with the inventions of the world by reading

SCIENTIFIC AMERICAN

The MONTHLY MAGAZINE with a special appeal to every man of inventive genius. Recent rulings of the Patent Office, descriptions of the latest patented inventions, legislation and court decisions affecting patents, are noted in this authoritative publication.

MUNN & COMPANY

Patent Attorneys

672 Woolworth Building, New York City

Scientific American Building, Room 2
625 F Street, Washington, D. C.

Suite 801, Tower Building, Chicago, Ill.
601 Hobart Building, San Francisco, Cal.

U.S. PATENTS



**SEND FOR
THIS FORM**

**DON'T LOSE YOUR RIGHTS
TO PATENT PROTECTION**

Before disclosing your invention to anyone send for blank form "EVIDENCE OF CONCEPTION" to be signed and witnessed. A sample form together with printed instructions will show you just how to work up your evidence and establish the same before filing application for patent. As registered patent attorneys we represent hundreds of inventors all over the United States and Canada in the advancement of inventions. Our schedule of fees will be found reasonable. The form "Evidence of Conception," sample, instructions relating to obtaining of patents and schedule of fees sent upon request. Ask for them—a post card will do.

PATENTS AND TRADE MARKS

LANCASTER & ALLWINE

480 Ouray Bldg. Washington, D. C.
Originators of forms "Evidence of Conception."

Have You An Invention?

If so the WORLD PROGRESS will show you how to **PROTECT AND PROFIT FROM YOUR IDEAS**
Sample copy free. One year's subscription \$1.00.
Send for free book,

"WHAT TO INVENT"

containing SUGGESTIONS TO INVENTORS as to Inventions Needed. We invite manufacturers to address us regarding inventions they want.

WORLD PROGRESS PUB. CO., Inc.
Room 203 Victor Bldg. WASHINGTON, D. C.

PATENTS

C. L. PARKER
Formerly Member Examining
Corps, U. S. Patent Office
PATENT LAWYER
MCGILL BLDG.
WASHINGTON, D. C.

Patents, Trade Marks, Copyrights, Patent Litigation

Handbook for Inventors, "Protecting, Exploiting and Selling Inventions," sent free upon request.

PATENTS

As one of the oldest patent firms in America we give inventors at lowest consistent charge, a service noted for results, evidenced by many well known Patents of extraordinary value. Book, Patent-Sense, free. Lacey & Lacey, 646 F St., Wash., D.C. Estab. 1869.

PATENTS

REGISTERED PATENT ATTORNEY SINCE 1905
CHARLES W. LOVETT SECURITY BLDG LYNN MASS.

SEND FOR FREE BOOKLET

PATENTS

TRADE-MARKS and COPYRIGHTS

OUR OFFER: No Charge for Examination and Instructions

Have You Any New Ideas?

Your First Step: Before disclosing an invention the inventor should write for our blank form "Record of Invention." This should be signed and witnessed and returned to us together with model or sketch and description of the invention for examination and instructions.

No Charge for the Above Information



Our Three Books Mailed FREE to Inventors

Our Illustrated Guide Book

How to Obtain a Patent

Contains full instructions regarding Patents. Our Methods, Terms, and 100 Mechanical Movements illustrated and described; Articles on Patent Practice and Procedure, and Law Points for inventors.

Our Trade-Mark Book

Shows the value and necessity of trade-mark protection and gives information regarding Trade-Marks and unfair competition in trade.

Our Foreign Patent Book

We have direct agencies in all foreign countries and secure foreign patents in the shortest possible time and at the lowest cost.

Prompt Attention Reasonable Terms
Highest References

*All Communications and Data Strictly Confidential.
Interference and Infringement Suits Prosecuted.*

FREE COUPON

Victor J. Evans & Co.

Patent Attorneys

Main Offices: 722-724 9th Street, N. W.,
WASHINGTON, D. C.

Write Today.—Just fill in your name and address below and send to nearest office and we will send you Free of charge our Patent Books.

Name.....

Address.....



Our New York Office
Suite 1007 Woolworth Bldg.



Our Philadelphia Office
Suite 714-15 Liberty Bldg.



Our Washington Office
Victor Building



Our Chicago Office
Suite 1114 Tacoma Building



Our Pittsburgh Office
Suite 514 Empire Building



Our San Francisco Office
Suite 1010 Hobart Building

PATENTS

Booklet Free

Highest References

Promptness Assured

Best Results

Send drawing or model for preliminary examination

ALL BUSINESS GIVEN PROMPT AND PROPER ATTENTION

WATSON E. COLEMAN, Patent Lawyer, 644 G St., Washington, D. C.

PATENTS

To the Man with an Idea

I offer a comprehensive, experienced, efficient service for his prompt, legal protection and the development of his proposition.

Send sketch, or model and description, for advice as to cost, search through prior United States patents, etc. Preliminary advice gladly furnished without charge.

My experience and familiarity with various arts frequently enable me to accurately advise clients as to probable patentability before they go to any expense.

Booklet of valuable information and form for properly disclosing your idea free on request. Write today.

Richard B. Owen, Patent Lawyer
9-303 Owen Building, Washington, D. C.
2276-E Woolworth Bldg., New York City



PATENTS

Send us sketch or model for patentability opinion and exact cost of patent. Our book "How to Obtain a Patent." Sent Free on request. It tells how to apply for Patents, Trade Marks, Foreign Patents, Copyrights, etc.; gives information on Patent Procedure; tells what every inventor should know. Thousands of inventors, who are our clients, are our references.

Chandlee & Chandlee, 25 Years' Experience.
455 7th St. Washington, D. C.

PATENTS

Trade-Marks, Copyrights and Patent Litigation

Write for advice and instructions how to proceed, costs, etc. Hand Book with illustrations of 100 Mechanical Movements sent free on request.

ALBERT E. DIETERICH

Patent Lawyer and Solicitor

Successor to Fred G. Dieterich & Co. 621 Ouray Bldg., Washington, D. C.

BLUE BOOK ON PATENTS

gives instructive information and candid advice.

MONROE E. MILLER, PATENT LAWYER
411-2 Ouray Building WASHINGTON, D. C.
ELECTRICAL AND MECHANICAL EXPERT



GEARS ALL KINDS SMALL

The most accurate made and prices reasonable. We carry a complete line of gears in stock for immediate shipment. Can also quote on special gears of all kinds. Send us your inquiries.

WRITE FOR CATALOGUE.

CHICAGO STOCK GEAR WORKS
105-109 S. Jefferson St., CHICAGO

Fibre-Lite Limbs



Easy Payments—Do Nature's Work.
AGENTS WANTED who use Artificial Leg. GOOD PAY.
FREE Fibre Sample. DESCRIBE STUMP TO **WORMAN CO.** 252-P HENNEPIN AVE. MINNEAPOLIS, MINN.

INVENTORS PROTECT YOUR IDEAS

Send for our Guide Book, **HOW TO GET A PATENT**, and Evidence of Invention Blank, sent Free on request. Tells our terms, methods, etc. Send model or sketch and description of your invention and we will give our opinion as to its patentable nature.

RANDOLPH & CO.
600 F St., N. W., WASHINGTON, D. C.

NAME.....

STREET.....

CITY.....STATE.....

Great Inventors now teach you secrets of practical invention



RAYMOND F. YATES

EVERYONE knows that one single idea can make a person independently wealthy in a short time. Little things—like the crimped hairpin, the paper safety-match, the metal-tip shoelace—brought their inventors hundreds of thousands of dollars.

And yet, invention is nothing more than the science of "fixing things." A leaky faucet, a rattling window, a broken strap—you fix hundreds of things just like these almost every day—actually using the laws and principles upon which every invention is made.

This proves that invention is not guesswork or blind luck—that it is not a God-given faculty possessed by a few favored mortals. The truth is that invention is based upon exact laws which anybody can learn. It is merely a matter of first seeing a problem to be fixed and then of *thinking* of some principle which will solve the problem.

Surely you have at least one idea which can be harnessed to a natural law for the solution of some problem. It doesn't need to be anything as great as the steam-engine or the electric light. It can be a new kind of mechanical toy or some device which will make your wife's housework easier. It can even be something as simple as the common nutcracker. The man who invented the Kiddie-Kar, it is reported, made over \$5,000,000!

No matter what it is—no matter how great or how small—if the world needs it the world will pay well for your invention. Every day you see things which can be improved or which must be "fixed." Every day you can get ideas for new inventions. You have the ability to invent—NOW! All you need is the training to show you how to develop your ideas methodically, the training to show you how to harness your ideas to some physical or natural law, which you know, to be used to "fix" some problem.

WHAT EDISON SAYS

Learn Invention by Actual Practice at Home

Hitherto every inventor had to work out the principles of invention for himself. But at what a terrific price in long years of discouragement, lost time, wasted money!

And now, for the first time, you can actually learn invention as a profession—exactly as other people are learning electricity, automobile mechanics, law, medicine, as a profession. Never before were the easy-to-learn principles of Inventive

Science written down so everybody could read them, and learn to use them. But now the Bureau of Inventive Science offers you the first course in practical invention ever devised.

Fifteen famous inventors now tell you **WHAT TO INVENT** and **HOW TO INVENT**. They tell you the secrets of invention which every successful inventor must know. They explain how to originate ideas, how to develop and perfect them, how to patent your inventions. But this course tells you more than how to invent. Thousands of inexperienced inventors have been defrauded out of their rewards because they did not know how to protect their patent rights, or how to sell their inventions. This great course tells you everything you want to know—how to sell your invention, how to get royalties, how to organize a company, how to get the most money for your ideas.

The most fascinating part of this great new course is that it teaches you by actual practice, right in your own home. Each lesson reveals to you a new chapter in Inventive Science, takes you into the laboratories of famous inventors and shows you just how they work. And then with each lesson you are sent some problem in invention—just like the one shown here.

Can You Solve This Problem?

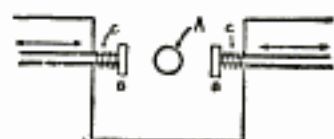

"A" is the end of a shaft. The two members "B B" are free to move in either direction indicated by the arrows. If they are pushed back, the springs "C C" will immediately pull them forward again. Our problem is to put some kind of an attachment on the revolving shaft "A" so that the members "B B" will be pushed back both at the same instant every time the shaft "A" makes a single revolution. The device on shaft "A" must also allow the two members "B B" to come forward once in every revolution. What would you suggest putting on the shaft "A"?

This fascinating exercise in solving actual problems in invention, sharpens your instinct to fix things. Better than anything else, it teaches you to apply your inventive ability to the development of any idea which you may think of. It gives you an unforgettable, instinctive habit of thinking inventively which is worth more than you realize. In fact, the lessons and exercises are so simple, so easy to understand, so interesting, that they seem more like a pleasant game than like instruction which can make you a successful inventor.

Everything Explained in New FREE Book

A wonderful new book, just printed, tells you more about the Bureau of Inventive Science and its simple new course in invention. It explains in detail just how this course develops your ability to invent.

It tells how this Course teaches you to develop your ideas, how to get a patent, how to protect your invention, the best way to sell your invention, either outright through your own company, or on royalties, so a simple little idea is converted into big money. It costs you nothing, so if you are genuinely interested send the coupon at once. This Bureau is not connected with patent attorneys or manufacturers. Its only purpose is to teach you the secrets of practical invention used by every successful inventor. Write for the FREE BOOK now.

BUREAU OF INVENTIVE SCIENCE

Dept. 32 Wisner Building Rochester, New York

BUREAU OF INVENTIVE SCIENCE,
Dept. 32, Wisner Building, Rochester, N. Y.

Please send me your free book, "The Science of Invention."

Name.....Age.....

Address.....

City.....State.....

GENUINE RALITE Diamonds

Amazing offer to introduce imp. Ralite Diamonds. They have all the dazzling sparkle and sheer brilliance of genuine diamonds. Only an expert can guess your imp. Ralite is not a \$250.00 diamond—your friends will believe it genuine. Ralites alone match genuine diamonds in perfect cut—set in latest exclusive design gold and white platinum finish mountings. Full carat-size gems. Unequaled bargains in genuine quality rings.

Send No Money! Wear a RALITE Diamond a Week on trial. Order ring by number and send strip of paper that meets end to end around finger. On arrival deposit amount listed with postman—not a cent more. We pay postage. If not delighted with your beautiful ring, and if your friends don't think it is a real diamond, send it back! Satisfaction positively guaranteed or money returned. You don't risk a penny. **BE SURE TO SEND SIZE.** **FREE** with each ring your choice of Ladies' Bar Pin, Sterling Silver platinum finish, set with seven exquisite Ralite Diamonds, or Men's Ralite Diamond Scarf Pin. State which desired. **Send today.**



- | | |
|---|--------|
| 1—Men's Heavy Belcher, 14k gold S., genuine Ralite | \$3.25 |
| 2—Lady's Solitaire, 14k gold S., Floral Blossom engraved | 2.95 |
| 3—Lady's Oxy Top, platinum finish, 3 carat Ralite | 3.45 |
| 4—Wedding Ring, white platinum finish, 27 genuine Ralites | 4.44 |
| 5—Lady's Hand-Carved, basket-setting, platinum finish | 3.87 |
| 6—Lady's Solitaire, 14k gold S., 1-carat genuine Ralite | 2.49 |
| 7—Man's Massive Hexagon, 2-carat stone (very special) | 3.98 |



FERRY & CO., 75 WEST VAN BUREN STREET

DEPT. 1772, CHICAGO, ILLINOIS

Can You

think of a simple, practical idea that will fill one of the many requests we have on file for new inventions? It may mean a fortune for you. Thousands of things are needed **right now**. Your brains can help. Send today for our great new book—

"Inventions and Trade-Marks, Their Protection and Exploitation" and learn more about making money from ideas than you ever knew before. It tells many things that are wanted, too.

A postal will do—
It is free

We Help Our Clients

without charge, to get the dollars out of their ideas—having facilities none others possess. Advice free. Don't delay—get the book at once.

American Industries, Inc.
200 Patent Dept.
WASHINGTON, D. C.

Patents
Advertised
For Sale Free
in Invention and
Manufacturing Supplement

Published for the
man with an idea.
Send for free sample
copy. One year's
subscription, 50c

16¢ a rod WIRE FENCE

Hog, Field, Poultry, Lawn
Need for sensational fence
bargains. Save money on every rod. Sold
Direct from our factories to you at
prices that will amaze you. Satisfaction
Guaranteed or your money back.
Many styles of fence, gates and posts.
Write today for FREE Fence Book.
OTTAWA MANUFACTURING CO.
Free Makers for over 30 Years
Box 811-G OTTAWA, KANSAS
Box 811-G CHICAGO HEIGHTS, ILL.

FREE
Fence
Book

Live Interest—Serious, Efficient, Personal Service Patents, Designs, Trade Marks, Copyrights Validity Reports. Title Investigations

Send sketches for advice, new book, Evidence
form and references including manufacturers
and technical experts served by me many years.

HORACE L. WOODWARD, Registered Patent Attorney Since 1905
704 Ninth Street WASHINGTON, D. C.

FORDSPEED

SPECIAL
MONEY
SAVING
OFFER

For Speed
For Beauty
For
Comfort



SPORT BODIES \$29⁰⁰ UP

4, 8 and 16 Overhead
Valve Heads
Sport Fenders for Under-
slung and Standard Fords

NOW is the time to build your Fordspeed sport car. SAVE MONEY and avoid the SPRING RUSH. FORDSPEED bodies are well known for their beauty—quality and workmanship, and they produce cars that afford pride and pleasure to the owner. WRITE NOW for our catalog and Special Reductions for this month only.

A FEW OF OUR SPECIALS
Undercar Fitters... \$12.50 8.95 Speed & Power Camshafts \$19.00 \$ 9.95
24" 1 and 3/4 1 Gears... 12.50 8.95 Worm Steering Gear... 30.00 16.95
SATISFACTION OR MONEY BACK GUARANTEE
30% with order, balance on delivery

V. S. FORD SPEED & POWER EQUIP. MFRS., 250 W. 54th St., New York, 2nd Floor

"MOORE-MADE" MERRY-GO-ROUNDS MEN MAKE MONEY AND GET RICH

furnished at \$575; up to \$2,000. Get full particulars
Beautiful Outfits
about MERRY-GO-ROUND Business.

"MOORE-MADE" AMUSEMENTS, LAPEER, MICHIGAN

CASH FOR PRACTICAL IDEAS

of some new and useful WAY to utilize Pressed Metal in place of other
materials. The undersigned pays cash for every acceptable suggestion
approved by our Engineering Advisory Board. Free book gives you the facts.
PRESSED METAL TRADE COUNCIL
EXTENSION
27 QUINCY STREET, SUITE 1705, CHICAGO

"Old Town Canoes"

are wonderfully light in construction. They
are strong, steady and remarkably low in
price. New illustrated catalog free on request.
OLD TOWN CANOE CO., 1462 Middle St., OLD TOWN, Maine, U.S.A.

AGENTS WANTED

Here is the most popular and fastest selling Chevrolet accessory
ever offered to the public. And there are more than 1,500,000
Chevrolets in use. Gives absolute silent operation to Chevrolet
engine. Smothers all tappit noises. Protects all surface working
parts from dust and water. Constant lubrication. Eliminates daily oil can routine. Prevents
valves from freezing. The only silencer that lubricates the motor head without necessity of re-
moval. Agents' sample \$2.49. Prepa'd if cash is with order; or C.O.D. Act quick on this for ex-
clusive territory. It is a clean-up for fast workers. Write Dept. 52.

FOR THE FAST SELLING HAYES SILENCER AND OILER FOR CHEVROLETS

SAMPLE PRICE
\$2.49
HAYES-IONIA SERVICE CO., Grand Rapids, Mich.

LUMINOUS PAINT

Make Your Watches, Clocks, Etc., Visible by Night

The very latest discovery in the scientific world, hitherto, practically unobtainable except at an exorbitant price, we have at last succeeded in producing this remarkable LUMINOUS PAINT, which, applied to the surface of any article, emits rays of white light, rendering it perfectly visible in the dark. **THE DARKER THE NIGHT, THE MORE BRILLIANT IT SHINES.** Quite simple to use. Anyone—*you* can do it. A little applied to the dial of your watch or clock will enable you to tell the time by night. You can read the push buttons or switch plates of your electric lights, switch boxes, and innumerable other articles; make your own Luminous Crucifixes, Luminous Rosaries, etc. Small bottle, price 25c. Larger sizes, 50c and \$1 postpaid.

Serpent's Eggs

Box contains 12 eggs. When lit with a match, each egg gradually takes itself into a snake's form, which curls and twists about in a most life-like manner. Price per box, 10c postpaid, 3 for 25c.

Potmend

Mends Ironware, Agate-ware, articles, pots, pans, boilers, brass, copper, aluminum, iron, boxes, iron pipes, cracks in stoves, broken china, porcelain, teacups, crockery, woodware, marble, etc. Comes in powdered form. Just mix with water and apply. **HALENS LIKE IRON.** Needs a big hole or a small crack. PRICE 15c, 3 for 40c, postpaid.

Midget Bible

GREAT CURIOSITY Smallest Bible in the World. Size of a postage stamp. 500 Pages. Said to bring good luck to the owner. A genuine work of art. Must be seen to be appreciated. Make good money selling them to friends, school organizations, etc. PRICE 15c each, 3 for 40c, 12 for \$1.35, 100 for \$7.50.

STAGE MONEY

With a bunch of these bills, it is easy for each person of limited means to appear prosperous by flashing a roll of these bills at the proper time and peeling off a genuine bill or two from the outside of the roll. The effect created will be found to be all that can be desired. Prices, postpaid: 15 Bills 10c, 50 Bills 25c, 125 for 50c, or \$3.50 thousand.

Wonderful X-Ray Tube

A wonderful little instrument producing optical illusions both surprising and startling. With it you can see what is apparently the bones of your fingers, the lead in a lead pencil, the interior opening in a pipe stem, and many other similar illusions. A mystery that no one has been able to satisfactorily explain. Price 10c, 3 for 25c, 1 dozen 75c. Johnson Smith & Co.

Good Luck Ring

A VERY striking and uncommon ring. Silver finish, skull and crossbones design, with two brilliant, flashing gems sparkling out of the eyes. Said by many to bring Good Luck to the wearer, hence its name, Good Luck Ring. Very unique ring that you will take a pride in wearing. **ONLY 25 CENTS.**

Address orders for all goods on this page to
JOHNSON SMITH & CO.
 Dept. '65 RACINE, WIS.
 Our large catalog (356 Pages) of all the newest and best novelties, unobtainable elsewhere, free with every order.

The Dying Pig



The most laughable novelty yet produced. Made of rubber, and you have only to blow it up and stand the pig on his feet, when he begins to squeal as he slowly collapses and finally lies down and dies in the most natural manner. You can blow him up as often as desired, and each time he will go through the same performance to the great amusement and delight of your friends. Price 15 cents; 3 for 40 cents; one dozen \$1.35, mailed.

Popular Watch Charms

15c
 ONLY 3 for 40c; \$1.35 doz.

Very pretty little curiosities and decidedly novel. Fitted with Magnifying Lenses that enlarge the pictures to a very surprising degree; in fact, it seems almost incredible that a clear picture could be possible in such a small compass, and how sharp and distinct they show up when you look through it. Comes in assorted colors—Arcturians, views of Panama Canal, Lord's Prayer in type, etc.

Mystic Skeleton

A jointed figure of a skeleton 14 in. in height, will dance to music and perform various gyrations and movements while the operator may be some distance from it. **10c + pd.**

NEW BOOK ON ROPE SPLICING

Useful Knots, Hitches, Splices, etc. A most practical handbook giving complete and simple directions for making all the most useful knots, hitches, rigging, splices, etc. Over 100 illustrations. All about wire rope attachments, lashing, blocks, tackles, etc. 37 Herold's Knots, Blue Book. Of great value to mechanics, riggers, carpenters, boatmen. Price 20c ppd.

MAGIC FLUTE

Wonderfully Sweet Toned and Musical The Magic Flute, or Harmonstone, is a unique and novel musical instrument that is played with your hand and mouth combined. There is just a little knack in playing it which, when once acquired after a little practice will enable you to produce very sweet tones that somewhat resembles a flute. There is no fingering, and once you have mastered it you can play all kinds of music with facility and ease. When played as an accompaniment to a piano or any other musical instrument, the effect is as startling as it is surprising.

BLANK CARTRIDGE PISTOL

Protection against Burglars, Tramps & Dogs
Prices 50c \$1.00
 Post-paid

Well made and effective; loaded on latest type of Revolver; appearance shows it enough to scare a burglar. When loaded it may be as effective as a real revolver without danger to life. It takes standard 22 Cal. Blank Cartridges obtainable everywhere. Price 50c, superior quality, \$1.00 postpaid. Blank Cartridges, by express, 50c per 100. Johnson Smith & Co., Dept. 65, Racine, Wis.

DANCING BEAUTIES

BEST EVER
 Get a Kinemograph and see the picture move. France's latest sensation. A great surprise. Is worth twice what they cost. Are made of solid brass, highly nickel and very durable. Satisfactory of your money back. **50c**

BOYS! BOYS! BOYS! THROW YOUR VOICE

Into a trunk, under the bed or anywhere. Lots of fun fooling the teacher, policeman or friends. **THE VENTRILO** a little instrument, fits in the mouth out of sight, used with above for Bird Calls, etc. Anyone can use it. **Never Fails. A 32 page book on ventriloquism, the Ventrilo, ALL FOR 10 CENTS**

1000 Silk Remnants

For patching Crazy Quilts, Sofa Cushions, Head Rests, Pin Pads etc. Large pieces, all colors and shades. Sure to delight you. **For 10 Cents** stamps, we send a large package and Book of quilt designs. 3 packages, 25c. 1 pound makes a lovely large quilt. Price 75c postpaid. Our silk is the best. JOHNSON SMITH & CO., Dept. 65, RACINE, WIS.

LOOK 35c LOOK

Wonderful instrument. Greatest thing yet. Nine separate articles in one. Everybody delighted with it. Odd, curious and interesting. Lots of pleasure as well as very useful. It is a double Microscope for examining the wonders of nature. It is also an Opera Glass, a Stereoscope, a Burning Lens, a Reading Glass, a Telescope, a Compass, a Pocket Mirror, and a Laryngoscope—for examining eye, ear, nose and throat. It is worth all the cost to locate even one painful cinder in the eye. Folds flat and fits the pocket. Something great—you need one. Don't miss it. Sent by mail, with 356 page Novelty Catalog. **Only 35c or 3 for \$1.00**

Resurrection Plant

One of the most wonderful plants known. Possesses the strange power of turning in a few minutes from an apparently lifeless, dry herb to a beautiful living fernlike plant of a dark green color. Simply place the plant in saucer of water, it will open up and start to grow in 20 minutes. When taken out it will dry up and go to sleep until placed in water again. Fine house plant—summer or winter. 10 cents each or 3 for 25c. **AGENTS WANTED** JOHNSON SMITH & CO., Dept. 65, RACINE, WIS.

Buy Today 10 Months to Pay \$ 200 Down

Makes Any Article YOURS

Any article you select sent for your thorough examination and approval—you need send only \$2 as deposit. After you convince yourself that the article you have selected is an exceptional value, keep it. You can pay the balance in 10 easy, monthly remittances. Unless you are thoroughly satisfied, deposit will be returned immediately. **GUARANTEE VALUE BOND** with every diamond. 7½% yearly increase in value. **GUARANTEED!** Transactions strictly confidential. **NO RED TAPE—NO DELAY!**

SWEET Diamonds possess a rare blue white color, and are scientifically cut for maximum brilliancy, fire, snap and animation.

FREE

Our new Diamond Book 'Gifts for every occasion': Diamonds and Watches, Jewelry, Novelties, Silver and Toiletware. 3000 exceptional values—10 months to pay. Write to



P.M.1

7 perfectly cut and matched diamonds, PLATINUM set. White gold top. 14K. shank. \$48.50.



P.M.2

Radiant diamond of superior quality, perfect cut. Engraved 18K. W.G. ring. \$50.00.



P.M.3

Men's ring, with sparkling, perfect cut diamond, 14K. shank. Engraved white gold ornaments. \$60.00.



P.M.4

Fine quality, blue white diamond set in 14K. gold Engagement ring. White gold prongs. \$60.00.



P.M.5

Dainty, 15 jewel wrist watch. Engraved, 14K. white gold case. Sapphire set crown, silk grosgrain ribbon, white gold fittings. Guaranteed against repairs for a year. \$18.50.



Dept. 64G

"THE HOUSE OF QUALITY"
CAPITAL \$1,000,000.

L.W. SWEET INC.

1650-1660 BROADWAY, NEW YORK

YOU can succeed!

When this famous clothing house announced the \$23.50 price for the finest all-wool, made-to-measure Suits and Topcoats, hundred of new salesmen flocked to the Style-Center banner. They are cleaning up! Orders and congratulatory letters are pouring in by the thousand! Style-Center quality literally sells itself at this price!

You can succeed! Here is opportunity to earn \$75 to \$150 a week at the start, with unlimited advancement! *The Spring-Summer lines are ready!* Suits! Topcoats! Up to the minute, for the regular or snappy dresser!

You have 250 big, attractive samples and a superb style book to work with. *You are paid when you make a sale.* We deliver, collect, take care of alterations—and do it right! Begin now! Send the coupon *this minute.* This is your opportunity for immediate success!

The Style-Center Tailoring Company
101 Anderson Building, Sixth and Broadway
Cincinnati, Ohio

Please tell me how I can obtain the agency for Style-Center Suits and Topcoats.

Name

Street Address

City..... State.....

Don't forget your pliers*



Particularly if you handle packing cases with wire or metal strapping. Bernards (No. 102) enable you to grip the binding anywhere without a slip, and to cut cleanly and closely without prying. You will find a score of uses for

* BERNARD

Standard High-Power Cutting
PLIERS



**No. 165—Bernard
End Cutting Nippers**

Catalog "P" free on request from

WM. SCHOLLHORN CO., New Haven, Conn.

STOP LEAKS! REPAIR BREAKS! MAKE LOOSE PARTS STAY TIGHT!

Smooth-On No. 1

STOPS leaks and repairs breaks in pipes, furnaces, radiators, tanks, bursted water jackets, etc., with one simple application.



Keeps bolts, nuts, grease cups, etc., from loosening and dropping off — makes loose handles tight—joins wood, metal or glass to each other tightly—holds on iron, brass, lead, aluminum, etc.

For quick, cheap, lasting joints and repairs and stopping many nuisances in every home, automobile and workshop, Smooth-On is in a class by itself.

Get Smooth-On No. 1 in 6-oz., 1-lb. or 5-lb. tin at any hardware store.

SMOOTH-ON MFG. CO.
574 Communipaw Ave., Dept. 37
JERSEY CITY, N. J.

144 pages
**This Book
FREE**

**SMOOTH-ON
REPAIR
BOOK**

MOVIE FILMS For Use With the KEYSTONE MOVIEGRAPH

Brings happiness, fun and pleasure into the home for the long winter evenings. Large list of subjects.
SEND FOR CATALOG TODAY.

LIBBEY & NICHOLS, Dept. P, 230 State Street, BOSTON, U. S. A.

Write Us At Once—

if you want to make \$10 to \$25 a day selling Toilet Articles and Household Necessities that have the backing and reputation of a manufacturer 30 years old. Simple plan. No red tape. Quick returns for your time.

T. H. SNYDER CO.

810B Broadway Cincinnati, O.

SAW FILING PAYS

Buy a Foley Saw Filer and Setter and establish an independent, profitable business. Prices and catalog on request. Territory open to interested parties.

FOLEY SAW TOOL CO.
3613 Portland Ave., Minneapolis, Minn.



EVERY BOY'S ROOM

To be attractive is filled with pictures and pennants he likes fastened up with

Moore Push-Pins

Glass Heads—Steel Points

Moore Push-less Hangers

"The Hanger with the Twist"

Will not injure wall paper or plaster

10c pkts.

Sold everywhere
In Canada 15c

MOORE PUSH-PIN CO., Philadelphia, Pa.



"I'll say you can learn to play a York"



Yes, it's a fact! A York Saxophone is the easiest real instrument to play. You'll be surprised at the superb tone, the fine workmanship, the ease of blowing. And you can have this world famous instrument sent to you on

6 Days' Free Trial

Send for the York Saxophone for 6 days' free trial. Play on it in your own home. Compare the values. If you are not completely satisfied in every way all you have to do is ship the instrument back to us and it won't cost you a cent. Send the coupon with your name, address and instrument of your choice for our beautifully illustrated literature and details of our free trial offer. This obligates you in no way. If you don't prefer a Saxophone simply

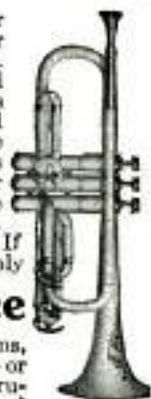

Take Your Choice

of Cornets, Trombones, Clarinets, Drums, Basses, Altos, Baritones, Trumpets—or any other House of York Band Instrument. Any instrument sent on 6 days' free trial and sold on easy payments if you wish.

Easy Payments If You Buy

If you decide that the York Saxophone is the instrument for you, simply make small monthly remittances on the balance and pay while learning to play.

J. W. YORK & SONS
GRAND RAPIDS, MICH.

Dept. 221-B

MAIL THIS COUPON

**J. W. YORK
& SONS**

Dept. 221-B

GRAND RAPIDS, MICH.

Gentlemen: Kindly mail, without cost to me, your beautifully illustrated literature and details of your Free Trial and Easy Payment Offer.

Name

Address

Instrument
(Mention above the instrument most interested in)



AGENTS WANTED



GAS MADE FROM OIL AND AIR

FIRE FOR ALL PURPOSES

OIL BURNERS

FURNACES

COOK STOVES

HEATERS

AGENTS MAKE 100 to 200 PER WEEK

SEND FOR FULL PARTICULARS NOW

HEAT APPLIANCE CORP.

86 N. MAY ST., CHICAGO, ILL.

Prices Reduced



On All Standard Make Typewriters

Lowest Prices in Years

We will ship any make you choose for one week's trial, Underwood, Royal, L. C. Smith, Remington, Oliver, etc.

Easy Terms Pay less than rent each month and own a typewriter. Guaranteed good as new. Perfectly rebuilt by experts—the famous "Young Process."

Send for our free trial offer and new low price list now. Write today.

Young Typewriter Co.

World's Largest Dealers in Standard Typewriters
654 W. Randolph St., Dept. 1102, CHICAGO, ILL.

BUILD THAT HOME



KEITH Will Help YOU See Offer

No better time to build — no better way than this! Ideal house designs; tested, built-from plans. No disappointments, no costly "extras" with Keith's plans.

7 PLAN BOOKS — 225 PLANS

with a year's subscription, twelve house planning numbers of Keith's Magazine (25 years a leading authority) — all for \$3.50.

Trial subscription 8 mos. and 3 books, \$2 Please state style house wanted.

—KEITH CORPORATION, 23 N. 7th St., Minneapolis

10 DAYS TRIAL



Home Barber Outfit \$1.98

If you order at once Each set consists of 1 close cutting barber's hair clippers, one 7-inch barber comb, 1 barber hair shears of razor like steel This is our regular high grade \$4.00 set, guaranteed to give perfect satisfaction. Special offer complete outfit only \$1.98 if you decide to keep the set—less than price of clippers alone.

Mother will cut the children's hair.

The bobbed haired girl needs it every day.

THE WHOLE FAMILY will use this set and save barber bills. Four hair cuts pays for it if you get in on this special offer.

Send only \$1.98 for this splendid outfit! Use it for 10 days and if you are not perfectly satisfied return it and your money will be promptly refunded. Or if you prefer, send no money. Just your name and address. Pay postman \$1.98 plus postage on arrival and have the same 10 day trial privilege. But order at once as we can sell only a limited number, at this special price.

Home Supply Co., Dept. A, Madison Wis.

Bargains in Blue Ribbon White Collies



Write for special lists of famous Shomont White Collies. We are World's largest breeders. Our White Collies bring beauty, watchfulness, and devotion into your home, joy to your children, safety to your herds. Gentle, intelligent, fearless. Satisfaction guaranteed. Write quick for low offers.

SHOMONT KENNELS
Box 143 Monticello, Iowa

64 BREEDS

Most profitable chickens, ducks, turkeys and geese. Choice, pure-bred northern raised. Fowls, eggs and incubators at low prices. America's great poultry farm. At it 31 years. Valuable 100-page book and catalog free.

R.F. NEUBERT Co., Rt. 908, Mankato, Minn.

POULTRY

Big money. Mrs. Berry tells how in 144-page book, 215 pictures, years of experience. I START you with Poultry, Eggs, incubators, BABY CHICKS, etc. Wonderful book mailed for only a nickel.

Berry's Poultry Farm, Box 78 Clarinda, Iowa

PLANS for Poultry Houses!

All styles. 150 illustrations; secret of getting winter eggs, and copy of "The Full Egg Basket." Send 25 cents.

INLAND POULTRY JOURNAL, Dept. 74, Indianapolis, Ind.

WEBER'S BEST

laying, BEST paying chickens, ducks, geese & turkeys. Fine pure-bred quality. Fowls, Eggs, incubators at new low prices. 42 years poultry experience, and my 100 page Catalog and Breeders' Guide Free.

W.A. Weber, Box 82, Mankato, Minn.

RUSSIAN GERMAN AUSTRIAN SOVIET MONEY

Buy and sell currencies of the world! Everybody here. Cheap, popular give away advertising for Agents, Developers, etc. Will boost your sales tremendously. Largest Dealers. "Right at the market". See you MONEY on anything. Write

Many bargains and ideas for you in our big FREE circular

HIRSCH EXCHANGE, 70 Wall St., N.Y.

AGENTS



200% PROFIT

Make \$10 to \$20 daily selling Premier Knife and Scissors Sharpeners.

or more. 9 out of 10 women buy. Produces keen edge quickly. Sells for 50c.

PREMIER MFG. CO.
Dept. 29, DETROIT, MICH.

Custom-Made Tops Less Than Half Price



EASILY ATTACHED

Full instructions sent. Complete tops with beveled plate glass, tacks, fasteners and wets. Free delivery 1,000 miles. For all cars; special prices on St. Mrs. Overland Fours, Dodges and Chevrolets. Describe your car. Samples and money-saving Bulletins free.

Automobile Trunks for Running Board or Rear Platform.

S-C PRODUCTS CO., 767 Nicholas Bldg., Toledo, O.

Make \$200 a month with this incubator in your spare time

Millions and millions of baby chicks are sold yearly by chick hatcheries all over the country — thousands doubtless sold right in your neighborhood. Why don't you get into the hatchery business for yourself and get these profits? We start you with complete information on chick hatchery operation, management, how to sell, etc. This 2640-egg Buckeye Mammoth Incubator is the machine that has started 1600 successful hatcheries in the most profitable business in the world. Let us tell you how to start small and grow big with a small investment. Write to



The Buckeye Incubator Co., Dept. 782 Springfield, O.

160 Hens Make \$1,329.67 With Big Saving In Feed!

FARMERS and back-yard poultry raisers are making big poultry profits the "Quisenberry Way". All the secrets of bigger egg production, raising chicks without loss and hundreds of other phases of poultry raising are outlined in Prof. Quisenberry's New 96-Page Book, "Dollars and Sense in the Poultry Business", offered FREE to all readers of this paper. If you are anxious to have new, advanced knowledge that makes poultry raising more profitable

Send Now!



WRITE AT ONCE to
AMERICAN POULTRY SCHOOL,
Dept. 181, Kansas City, Mo.

LET THE "SUCCESSFUL" RELIEVE YOU OF HATCHING WORRIES



31 Years
of Big Success

Des Moines Incubator Co., 689 Second St., Des Moines, Ia.

Mail a postal—get our offer. Poultry lessons free to every buyer. Booklet, "How to Raise 48 out of 50 Chicks," sent free on request. Catalog FREE. Make green, egg-making feed in "SUCCESSFUL" Grain Sprouters.



GREIDER'S FINE CATALOG

of fine breed poultry and incubators and brooders for 1924; choicest breeds illustrated and described; how to make hens lay, grow chicks—all facts. Low price on breeding stock and hatching eggs. 31 years in business. This book only 10c. B. H. GREIDER, Box 19, Rheems, Pa.

POULTRY MILLER'S GUIDE

tells all about chickens—care, feeding and raising for profit. Also describes IDEAL INCUBATORS, Hot Water and Electric IDEAL BROODERS—Good and Old Burning—Baby Chicks, Eggs for Hatching, Special Low Prices. **FREE**

J. W. MILLER CO., Box 12, ROCKFORD, ILL.



RAISE BELGIAN HARES

New Zealand Reds—Flemish Giants—Americas Blues
FOR US—BIG PROFITS—WE SUPPLY STOCK AND PAY \$2 TO \$8 EACH. Also other fur bearing animals, easily raised anywhere. Large Catalog and Contract **FREE!** Big Illustrated Rabbit Book, and copy of our large small stock magazine free.
OUTDOOR ENTERPRISE CO., 100 E. 8th St., Kansas City, Mo.

SQUAB BOOK FREE!

Squabs are selling at highest prices ever known. Greatest market for 20 years. Make money breeding them. No mixing feed, no night labor, no young to attend. Start small, grow big. Start now. Head how our customers sell squabs for \$12 a dozen. We have been established for 25 years. Better look into this. Let us send you, at no cost to you, our big, illustrated free book telling how to make money breeding squabs. Address

Plymouth Rock Squab Co., 634 H St., Melrose Highlands, Mass.

A Home and Income For You in Sunny Florida



Be Independent—Own a Grapefruit and Orange Grove—A Truck or Poultry Farm. Increase Your Income

You Can Start a Grove Today Under Our New Plan

Develop a profit-earning fruit farm without leaving your present position—provide for your future. A small payment now and a few dollars invested each month.

A profit-producing fruit grove is a permanent investment and provides protection against old age.

THE RIGHT LAND IN THE RIGHT LOCATION AT THE RIGHT PRICE

We Have It—Any Size Farm

These splendid lands are suburban to Tampa, the metropolis of South Florida. Here you find the most healthful, the most delightful climate in North America. For ten years we have been right here helping develop Hillsboro—the banner agricultural County of Florida, and we are still here to serve you and to help you obtain the farm you want, on very easy payments extending over 2 or 3 years' time to suit.

Groves Developed for Non-Residents

If you want to remain in your present position for a few years we can develop a grapefruit and orange grove for you. When you are ready we will clear your land, furnish fruit trees, plant and care for your grove until you are ready to look after it.

We Raise Our Own Guaranteed Citrus Trees in Our Own Nurseries

This insures every purchaser the best fruit trees that can be grown. This also insures a successful grove. We can save you money on planting and caring for your grove.

\$300.00 to \$500.00 Per Acre Profit

This is not an unusual return for truck farmers in the Famous Tampa district. All kinds of vegetables can be grown. Big prices are paid for early potatoes, Winter cabbage, Bermuda onions, tomatoes, celery and dozens of other vegetables during the Winter and early Spring, when the north is covered with ice and snow. Strawberries, Melons and other small fruits, also yield large profits.

Write for Facts About Sunny Florida

IT COSTS YOU NOTHING TO LET US PROVE TO YOU that we have the land you want—in the location you want—at a price you can afford to pay and on the easiest terms you can imagine. Let us show you.

Fill out and mail us the coupon today and receive our large descriptive book FREE!

NORTH TAMPA LAND CO.

404 Zack Street

TAMPA, FLA.

Coupon for FREE Book on Florida

NORTH TAMPA LAND CO.

404 Zack St., TAMPA, FLA.

Please send me your large illustrated book, "The Call of the Southland," on choice Citrus Fruit and Truck Farms suburban to Tampa, Florida, and information on how I can have a grove developed on the monthly payment plan. P.M. 2-24.

Name.....

St. No.....

City.....

State.....



Super Transformer Audio Frequency

Does your receiving set refuse to amplify the bass notes of the piano? Does it make organ music sound like that of an accordion? If so, you are not getting the maximum enjoyment from radio.

Recent experiments in the Thordarson Laboratory have proven that the low notes of the heavy instruments can be amplified as readily as the high C of the soprano.

The Thordarson Super Transformer reaches its amplification constant at approximately 600 cycles and continues at even amplification well past the highest frequency of audibility.

Such manufacturers as the Colin B. Kennedy Co. and the Zenith Radio Corporation, convinced of the perfect reproduction of the Super Transformers, are incorporating them in all their sets.

Install a pair of Thordarson Super Transformers in your set and you will hear a radio concert as you have always wanted to hear it.

FREE BOOKLET

Write for our free Booklet No. 2, which contains many helpful suggestions regarding radio receiving.

PRICE (MOUNTED ONLY)

High Ratio 6 to 1 \$4.50
Low Ratio 3½ to 1 4.00

Sold by good dealers everywhere

THORDARSON

ELECTRIC MFG. CO.

Huron and Kingsbury Streets, CHICAGO



National Audio Frequency Transformers

The New 6 to 1 Ratio National Transformer is for use on the first stage of amplification. Its greater ratio means increased volume, but the tone qualities that characterize the 3½ to 1 ratio have been fully retained. Price of 6 to 1 ratio \$4.50 postpaid; of the 3½ to 1 ratio, \$4.00 postpaid. Dealers: Write for interesting sales proposition.

National Transformer Mfg. Co.
154 Whiting Street
Dept. 210 Chicago, Ill.

YOU, TOO Can Easily Make Big Money Building and Selling Long Distance Radio Instruments



Radio offers the biggest money-making opportunity on earth today. And the Ozarka Plan opens the door to this big opportunity. Look at the picture of this beautiful Radio Receiver. This picture was made from an actual photograph. By the Ozarka Plan that Radio Instrument can be the product of your own making—easily, simply and surely. It will be yours to make, to sell and to reap a rich reward in cash profits.

No experience necessary. You need not have much cash. All you need is spare time, determination and action. If you're that kind of a chap, the Ozarka Plan will start you on a straight line toward a real money-making business of your own. It can be as big and as profitable as you are ambitious to make it. We want good men in every county. Exclusive territory is going fast. Be sure and give us the name of your county. Write today for the Ozarka Plan. A wonderfully interesting book, of facts, particulars and proofs. It is FREE. Act now.

OZARKA, INC.

851 Washington Blvd. CHICAGO



ELECTRAD VARIOMM

Each movement adds definite new resistance. Positively does the work where others fail. Gradual resistance over entire range of ¼ to 10 megohms. Eliminates circuit noises, moisture proof, non-microphonic. At your dealers', or order direct. ELECTRAD, Inc. 428 Broadway, New York

Sept. 20

No Joke To Be Deaf



—Every Deaf Person Knows That

I make myself hear, after being deaf for 25 years, with my Artificial Ear Drums. I wear them day and night. They are perfectly comfortable. No one sees them. They stop head-noises. Write me and I will tell you a true story, how I became deaf and how I make you hear. Address

GEO. P. WAY, Artificial Ear Drum Co. (Inc.)
80 McKeeney Bldg., 2631 Woodward Ave., Detroit, Mich.



 \$1.75

"And it's real
bakelite!"



**FROST-
RADIO**

TUBE CONTROL UNIT

At last! The perfect tube control unit. Of course it is **FROST-RADIO**—that goes without saying. Genuine maroon moulded **BAKELITE** frame. Fluted knobs of black **BAKELITE**. Single hole mounting. 6 or 35 ohm rheostat, with vernier—400 ohm potentiometer. A quality product clear through.

Your local dealer can show you this and other **FROST-RADIO** products. See him today.

HERBERT H. FROST, Inc.
New York CHICAGO Kansas City



The Ace Type 3B Radio Set Should Be in Every Home

This marvelous set is giving perfect satisfaction in thousands of homes. You can't buy a set that will give better results. Like the Ace Type V it is manufactured under Armstrong U. S. Patent No. 1,113,149. This set is new, but months of research work have brought it to a high degree of perfection. Out-performs receiving sets costing great deal more. A filament switch eliminates necessity of tuning out rheostats when set is not in use. A person hearing a broadcasting station may turn off the set by throwing switch and come back later without retuning. A telephone jack is between first and second stage of amplification. This is for use of persons who desire to use head phones instead of loud speaker. Crosley Multistats. Universal filament control rheostats for all makes of tubes. Are used in the Type 3B.

Price \$50.00

Without Tubes or Batteries

PRECISION EQUIPMENT CO.

POWEL CROSLY, Jr.

215 Vandalia Ave.

Cincinnati, Ohio

A Wonderful NEW Way to PAINT YOUR OWN CAR

CAR OWNERS, at last your refinishing problem is scientifically solved. The **AALOFF** Process makes it possible for you to get an *absolutely* NEW finish without paying a fancy price. In just a few hours of your leisure time you can remove all the old paint and put on a beautiful, durable finish equal in every way to a good professional paint-shop job. The complete cost (if you act now) will be only \$8.50.

HERE IS THE SECRET

AALOFF Process does exactly what professional painters do—removes ALL the old paint first. It does this with lightning-like speed and no hard labor. You simply apply **AALOFF**, let it stand a short time, turn hose on it and ALL old paint washes off like mud. Absolutely NO Scraping, NO Sanding, NO Burning. Refinishing is equally easy, speedy and satisfactory; **AALOFF** finish defies weather, remains bright and glossy many months, **GUARANTEED** to be exactly as represented.

48 hours after you start work
your car is ready to drive.

**AALOFF
PROCESS**

**SPECIAL
INTRODUCTORY
OFFER**

The
Complete Kit

\$8.50



For a short time only we are making this special introductory offer. Send for your **AALOFF** Kit at once. Simply attach \$1.00 to coupon and mail. You need not pay the balance until the postman delivers the kit, *subject to your inspection.*

Complete Kit Includes everything you need: **AALOFF** for removing old paint, Priming Coat, Finishing Enamel, Top Dressing, Set of Brushes, Rubber Gloves, Sponge, etc. **COMPLETE INSTRUCTIONS.**

***** USE THIS COUPON NOW *****

Auto Paint & Varnish Co.,
Murray Building, Grand Rapids, Mich.

Send me at once Complete **AALOFF** Kit. I enclose
\$1.00 { Money Order } and will pay the postman \$7.50, plus
 { Currency } postage, on delivery.
 { Check }

Name

St. Address

City.....State.....

WRITE PLAINLY



"Red Devil" Rapid Boring Auger Bits are 33 1/4% easier boring, have 10% greater clearance, and bore with or against the grain of any wood. Style 2400—10/16 in., shown here, 75c.

Red Devil Pliers

REG. U.S. PAT. OFF.

Make Your Everyday Repair Jobs Easy



They reduce difficult problems in the home, the office, the workshop, around the car, to surprisingly easy tasks. There is no end to the number of things you can make and mend with them. Forged of steel for strength. Tempered and tested—beautifully finished.

"Red Devil" Pliers help you keep things in order, help you save. The following are a few suggested uses;

Repair:

Radio Sets
Sewing Machines
Vacuum Cleaners
Carpet Sweepers
Typewriters
Automobiles
Trucks
Tractors
Gas Engines
Motorcycles
Toys
Guns

Turn:

Tight Valves
Nuts and Bolt
Sticking Key

Hang:

Pictures
Mirrors
Bells
Window Shades

Make:

Lamp Shades
Hat Frames

"Red Devil" Slip Joint Plier, No. 1024—6 1/2 inch shown above, at all hardware dealers, \$1.00. If not in stock, send dealer's name and order direct.

Send for the "Red Devil" Mechanic's Tool Booklet.

SMITH & HEMENWAY CO., Inc.

Manufacturers of "Red Devil" Tools

260 Broadway

New York, N. Y.

"Red Devil" Glass Cutters—the glassiers' standard tools of the world. "It's all in the wheel." Made in 40 styles. No. 024 shown here, 20c



Biggest Money I Ever Made



—says one of our prosperous agents. A hundred dollars a week—says another. Still another made \$232 in a week. One spare-time salesman adds \$2,500 to his income this year. Easy work—liberal profits. This is what we read in letters our agents write to us. There's nothing else like it. Absolutely new, different, better.

Write Today for Agent's Plan

Everybody Wants a

Security

CHECK-PROTECTOR
FOUNTAIN PEN

the minute he sees it. Besides a beautiful fountain pen—all sizes—14-K gold pen with native iridium point—special ink bag—exclusive clip design—and other features covered by our own patents; besides a pen that always works and doesn't blot—there is the marvelous check protector. Guaranteed 5 years. All for the price of the pen.

You owe it to yourself to investigate this. Order sample pen: \$3.50, \$4, \$5 or \$7. All pens same high quality. Only difference is in ink capacity. State whether you want fine, coarse, stub or medium point. You get FREE a cut-out pen for demonstration. Write quick for Agent's plan in your locality.

Security Pen Corporation

Dept. PM-908 West Jackson Blvd., Chicago, Ill.

WARNING TO INVENTORS

Years of experience as an inventor taught me what to avoid in selecting a Patent Lawyer and in dealing with Financiers, Patent Buyers, Manufacturers and others. I have compiled my experiences in a book that will save Thousands of Dollars to Inventors. Price \$1.50. Satisfaction or money refunded. A. W. OLSOHN, 1106 Chestnut Ave., MINNEAPOLIS, MINN.



BUILD SHIP MODELS

Easy to build and sell. Pirate Ship—Santa Maria—Clipper. Complete plans, 35c each—3 for \$1.00.

MAAS & RICHTER
422 Brumder Bldg., Milwaukee, Wis.

\$47²⁵ Profit in 4 Hours

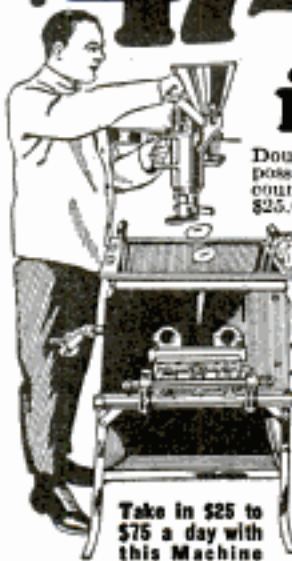

Doughnut Making business has wonderful possibilities. Doughnuts have taken the country by storm. Enormous demand. \$25.00 to \$75.00 a day. Capacity 800 doz. a day. Doughnuts sell fast at 30c to 40c a doz. 200% profit. No experience needed. Flour ready prepared—add water—put dough in hopper—turn crank—out drop sweet, savory, golden doughnuts.

AMAZING PROOF FREE

Money-making possibilities unlimited. Put this Automatic Doughnut Machine in display window. Attract crowds. Enticing odor whets appetite. You take in money fast. Pay for the machine the first week. Jos. F. Demme, Pa., says: "Made \$47.25 profit in four hours." Others report earnings equal or better. Big money wholesaling.

WRITE NOW Get in on the ground floor—act quickly before others start. These machines pay big anywhere—no town too small. Get full details of this new profitable business—costs nothing to investigate. Write today.

Take in \$25 to \$75 a day with this Machine

BUTLER & BUTLER, Dept. 31, 5650 Lake St., Chicago

Sears, Roebuck and Co.

The World's Biggest Mail Order House

Radio Fans

Here Is a Winner
Armstrong
Regenerative Set
Receiving
Radius
600 Miles
\$23.25

Order Direct From
This Advertisement.

HERE is a money saving Radio Outfit that will bring the news of the world—concerts, lectures and stock reports—into your home. Sold complete with head set, tube, batteries, aerial and ground wires, for only \$23.25! Connections simple and plainly marked. Easy to tune. Order NOW! Shipping weight, 12 pounds. Shipped from CHICAGO or PHILADELPHIA store.

57 P. M. 9366 \$23.25

Save on All Radio Supplies.

Save money on your radio supplies, and get guaranteed quality! Our big FREE Book shows hundreds of bargains in complete sets and parts. Many new hookups, complete list of broadcasting stations. Contains "How to Build an Aerial." Mail coupon!

**FREE
Radio
Catalog!**



Licensed under the Armstrong Patent No. 1113149 for amateur experimental and scientific uses only.

Sears, Roebuck and Co.
Chicago - Philadelphia

Mail coupon today to
store nearest you for Free
Radio Catalog.

Send me FREE Radio Catalog No. 80 P 68

Name

P. O. State

Rural Route

Street and No.

MECHANICS FOR YOUNG AMERICA

Plain and complete directions for building boats, water motors, wind mills, searchlight, burglar alarm, ice boat, water bicycle, cabins, camps, kites, etc. 6x9 in. Illustrated. 25c, postpaid. Popular Mechanics Book Dept., 200 E. Ontario St., Chicago.

PAPER MAGIC

A new book by Houdini in which are described not only a large number of tricks with paper, but also the amazing and puzzling articles which may be made of folded paper and tearing of paper. Paper Puzzles are also included. 206 pages, 111ms. Price \$2.50, postpaid. Popular Mechanics Book Dept., 200 E. Ontario St., Chicago



Send
Birth Date

You Should Know the Truth!
I will tell
FREE

What are your chances in life, your future prospects, happiness in marriage, friends, enemies, success—under which zodiac sign were you born?

ASTROLOGY the most ancient science of history indicates all.

SOLAR will tell you FREE whether you were born under a lucky star and will give you the most accurate astrological interpretation of your zodiac sign. Send immediately your name and birth date in YOUR OWN HAND-WRITING, and to cover the cost of this notice and postage ENCLOSE TEN CENTS (stamps or coin) also exact name and address. There will then be sent you securely sealed and postpaid your astrological interpretation, plainly written and understood. A great surprise awaits you! Do not fail to send birth date and ten cents. Print name and address to avoid delay. WRITE TO-DAY-DON'T DELAY.

SOLAR STUDIO, 489 Fifth Avenue

Dept. 113

NEW YORK



Enjoy Washington's Birthday as Our Guest

That's a real date—mark it on your calendar. Your nearest Indian Dealer has a glorious surprise for you—at his wigwam! Bring her along too, and join in our big annual celebration. Valuable souvenirs given away.

Indian Day February 22nd.

You're bound to enjoy this get-acquainted reception. You'll appreciate the useful souvenir. You'll be interested in the latest improvements in the 1924 Indian Motorcycles. And you'll be delighted with the entertainment that every Indian dealer will provide. Don't forget the date—it's important!

Indian Motorcycles

INDIAN MOTORCYCLE CO.

Dept. P2

Springfield, Mass. U. S. A.



MOTOR BARGAINS

Every Motor
Guaranteed

1/4 H. P. A. C.

\$10.50
and
\$13.50



return charges) will be refunded.

Every motor guaranteed O.K. If not satisfactory, you can return and your money (less Send cash with order.

	Rebuilt	New
A. C. 110 Volt, 60 cycles	\$10.50	\$13.50
D. C. 110 Volt, 60 cycles	\$12.50	\$16.00



New 1/4 H. P.
110 Volt, 60 Cycles

Buffer and Grinder with base and switch **\$25.00**

Without base or switch **\$20.00**

NORTHWESTERN ELECTRIC CO. 408 S. Hoyne Av. CHICAGO, ILL.

NEW VEST POCKET ADDING MACHINE

Adds as rapidly and accurately as a \$300 machine, yet fits the vest pocket. Mechanically perfect. Easy to operate. Everyone who uses figures should own one.

COUNTS UP TO 999,999,999

\$2.95



Total visible at all times. A pull of the finger clears it. Don't carry a pocket full of pencil stubs and scrap paper to do your figuring. Carry a Ve-Po-Ad.

10 DAYS TRIAL SEND NO MONEY. Just name and address and we will send machine postpaid. Pay postman on delivery \$2.95. Use it for 10 days to prove it does all we claim. If not perfectly satisfied we will refund your money. Limited supply. Order today.

RELIABLE ADDING MACHINE CORP.
170 C West Washington Street CHICAGO, ILL.

AGENTS Here's a money maker for you. Everybody wants one. Splendid profit. Write for special offer. DO IT NOW.

8 Tests of Bond Safety

From our 39 years of financial experience we have devised Eight Tests that insure absolute safety for the money you invest. These eight tests will show you the safe way to increase your income—through a higher yield.

"How to Select Safe Bonds"

A postcard or letter will bring you a copy of our book, "How to Select Safe Bonds," with the "Eight Tests of an Investment." For 39 years no investor has ever lost a penny on an investment purchased from George M. Forman & Company—a record that is unsurpassed. Send today for your copy of our interesting book.

GEORGE M. FORMAN & COMPANY, Dept. 442
105 West Monroe Street, Chicago, Illinois

"39 Years Without Loss of a Customer."



No. **677**
RATCHET
BREAST
DRILL



Try this light-weight breast drill

See how easily the two-speed ratchet mechanism works. Changes of speed and changes of motion are made by a turn of the dial on the back of the frame. Frame of aluminum alloy. Steel spindle runs on ball bearings which take up end thrust. The all-steel chuck has three hardened jaws for holding round-shank drills 0 to $\frac{1}{2}$ ".

Just one of 1500 Good Tools

The Goodell-Pratt Catalog—a 448-page book that illustrates and describes each of the 1500 Good Tools—is free. Write for it.

GOODELL-PRATT COMPANY
 GREENFIELD, MASS., U. S. A.

Toolsmiths

Makers of Mr. Punch

GOODELL- PRATT

1500 GOOD TOOLS

GENUINE ONLY
BLUE WHITE
DIAMONDS \$ **2**
DOWN
\$48 **\$4.60**
A MONTH



IF YOU CAN DUPLICATE IT FOR LESS THAN \$75.00 WE WILL RETURN YOUR MONEY

10 DAYS TRIAL **18K** **NO RED TAPE**

Just send \$2.00 deposit to show your good faith (or pay postman \$2.00 on delivery) and we will send this beautiful, latest style diamond ring. If satisfied after trial, pay only \$4.60 a month for only ten months. Total price \$48.00.

SET WITH BLUE SAPPHIRES

The sparkling, blue white, perfectly cut, genuine diamond in the center is set off attractively by the two deep blue sapphires set on either side in the shanks of mounting. The ring is 18 karat solid white gold, hand engraved and pierced, and looks like solid platinum. SEND FOR IT.

ORDER IT ON FREE TRIAL

Compare it with any \$75.00 diamond. We will give you a written guarantee that every penny you paid will be returned, if you are not satisfied and return the ring within the ten days' trial. Can not be equaled as a bargain.

Write for BARGAIN CATALOG

It brings our large jewelry store right into your home. Compare our prices! \$1,000,000 Stock. EASY TERMS.

STERLING DIAMOND & WATCH CO.

(Diamond Importers—Established 1879)

63 PARK ROW, Dept. 1482, NEW YORK, N. Y.



ARLINGTON Receiving Set

Brings in local stations clear and loud. The tuner is the Army type loose coupler. There is nothing better on the market. This receiving set is priced so everybody can own a set, and listen in to the good things his local station is sending out. Radio offers big opportunities, begin to learn about it by buying one of these sets. You can soon learn the code and with this set receive messages up to 2,000 meters, which covers the mostly used range. Send money order today, begin to enjoy radio at once.

HECCO ELECTRIC COMPANY

911 Sheridan Road

Menominee, Michigan



Those Saxophone Blues!

Drive away the blue devils, give your musical longing free expression, win new popularity with an "Inspiration" Saxophone!

Inspiration Leads the World!

Easiest to learn! Acknowledged the finest, sweetest, easiest playing Saxophone made! Absolutely pure tone! No buzz or rasp! Easy action! Always in perfect tune! Guaranteed quality! Exceptionally beautiful finish!

Free Trial—Easy Terms!

Write for FREE Catalog describing "Inspiration" Saxophones—Cornets—Trombones—Trumpets—Mellophones, etc., etc. All equally supreme in tone and quality! Try your choice for week's FREE TRIAL in your own home. Easy monthly payments. Write TODAY!

Dealers—Some choice territory still open—Write

LYON & HEALY 64-82 Jackson Blvd. CHICAGO INC.

World's Greatest BATTERY BARGAIN

FREE

Written 2-Year Guarantee
 Your Proof of Performance
START NEW YEAR RIGHT

Thousands of Popular Mechanics Readers will profit by this amazing offer. They will buy the famous 2-year guaranteed World Battery at the lowest price ever quoted. They will get their choice of a hydrometer and a "B" Battery or a nicked Auto Spotlight FREE. And they get the best battery built, with 2-year ironclad guarantee.

Compare These Prices

Five Per Cent Discount for Cash with Order

Automobile Prices		Radio Prices	
6 Volt, 11 Plate	\$12.25	Special 2 Volt Storage Battery	\$5.00
Ford, Chev., Mitchell, Hup.,		For W. D. 11 and W. D. 12 Tubes.	
Grant, Elgin, Vette, Saxon.		Will run 200 hours on one charge.	
6 Volt, 13 Plate	\$14.00	Rechargeable, Special 4 Volt	\$8.00
Overland, Buick, Reo, Paige,		Storage Battery	
Hudson, Nash, Stude., Dort.		For U. V. 109 Tubes. Same	
12 Volt, 7 Plate	\$17.00	features as 2 Volt.	
Maxwell, Dodge, Regal, Frank.,		6 Volt, 60 Amps.	\$8.50
Priscoe and Crow-Elkhart.		6 Volt, 30 Amps.	10.00
Give year and model of car.		6 Volt, 150 Amps.	12.50
		6 Volt, 130 Amps.	14.50
		6 Volt, 140 Amps.	16.00

SEND NO MONEY

You need not send a penny. Just clip this ad, and mail with your name and address. The battery you specify will be shipped to you the day your order is received. When the battery arrives, inspect it—read our 2-year guarantee before you pay one penny. Convince yourself you are protected from every angle—that the World Battery saves you 50 per cent. Get the "B" Battery and hydrometer, or Auto-Spotlight FREE. Clip the ad, and send your order today.

WORLD BATTERY CO.

Dept. 6, 1219 So. Wabash Ave., Chicago, Ill.

Your Choice NICKED AUTO SPOTLIGHT

"B" Battery and Hydrometer

FREE



A Perfect Glareless Headlight At Last

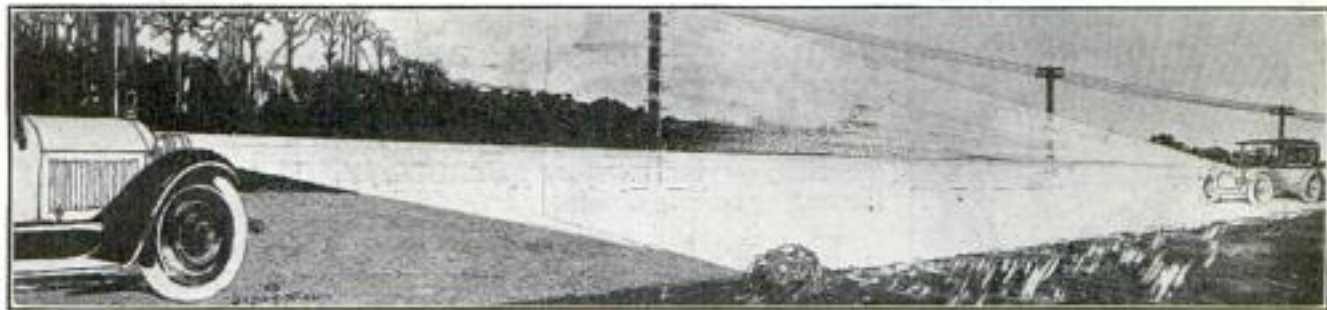

Distributors—Agents and Dealers—Can Make \$3,000 to \$15,000 or More A Year

The Detroit Safety Headlight Devices absolutely solve the greatest menace to automobiling—the headlight glare. This

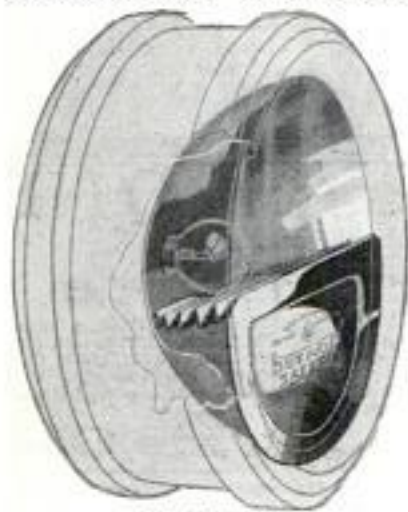

PATENTED

is a new, simple device and fits any model of any car. Installed easily and quickly by anyone.

Used with low priced plain glass lens. It adds style and dignity to any car. It absolutely concentrates the light down on the road, not up in others' eyes. Drive with all the courtesy of the road with bright lights on. The glare is positively eliminated. Will last a lifetime. Will not rust, corrode or deteriorate. Meets every legal requirement. They are the best headlight devices made and stand any test.

Detroit Safety Headlight Devices **Sell On Sight**

They sell on sight—a demonstration sells anyone. Easily demonstrated in store, home or on car. Sold on 30 day trial—never taken out. Appeals to fairness—no one wants to drive others to death in ditch. Owners urge others to buy. Gives longest light on road—lights full width of road. See illustrations as to installation and effect.

Exclusive Territory—Newspaper Advertising—Installed Free

Exclusive territory granted to right men—we run newspaper advertising and arrange for **Free** installation by competent garages. Printed matter and cards also furnished. We want men in every county who can handle men and sales and

make from \$3,000 to \$15,000 or more according to territory.

Hundreds of live wide-awake men have made application for territory—there is still plenty of excellent territory left. Better act NOW.

FREE—One Set. Free Introductory Advertising Offer

One set of Detroit Safety Headlight Devices in a neighborhood makes everyone want them. It's the best kind of advertising for our representatives. Therefore, for a short time we will sell two sets for the price of one (\$2.00) or one set at wholesale price of \$1.00, postage paid. Buy two sets, sell one easily at \$2.00—yours will be free. This offer is open to everyone to advertise the devices. When territory Representatives are appointed offer ceases—so act now. Easily installed by anyone. Get literature—clip **FREE** coupon, fill in, pin \$1 or \$2 bills to coupon—act quickly NOW.

FREE—One Set Free Coupon

Motor City Syndicate,
Office: 1217 Book Bldg., Dept. 22,
Detroit, Mich.

Gentlemen: Without obligations, please send literature on Detroit Safety Headlight Devices. Send such offer as I have marked below.

Do you want to sell?.....

What territory?.....

Make of your car..... Model..... Year.....

Make of other car..... Model..... Year.....

Fill in both for \$2.00 offer.

Are you interested in Bonus Offer?.....

Just use Dollar Bills if sending money.

Enclosed \$..... for offer as marked above. These to be mailed postage paid.

Name.....

Address.....

City.....State.....

Motor City Syndicate

Sole Manufacturers

Offices: 1217 Book Bldg., Dept. 22

Detroit, Mich., U. S. A.



Are You Reaching for the Truth?

I will tell you
FREE

Under which Zodiac Sign were you born? What are your opportunities in life, your future prospects, happiness in marriage, friends, enemies, success in all undertakings and many other vital questions as indicated by **ASTROLOGY**, the most ancient and interesting science of history?

Were you born under a lucky star? I will tell you free, the most interesting astrological interpretation of the Zodiac Sign you were born under.

Simply send me the exact date of your birth in your own handwriting. To cover cost of this notice and postage, **enclose twelve cents** in any form and your exact name and address. Your astrological interpretation will be written in plain language and sent to you securely sealed and postpaid. A great surprise awaits you!

Do not fail to send Birthdate and to enclose 12c. Print name and address to avoid delay in mailing.

Write now — **TODAY** — to the

ASTA STUDIO, 309 Fifth Ave., Dept. 138, New York



Write today for descriptive literature on this and other **BOICE-BUILT** Bench Machines and Motors.

SIX Machines in ONE

Saw, Sander, Drill, Grinder, Polisher and Buffer

Boice Pony Bench Machine

A decidedly practical, extremely compact, precision machine. Height 10". Handles 4" and 5" grinding wheels; 6" saws; 6" and 8" sand discs; 3/4" chuck. Top, 10"x12", easily removable. Saws up to 1 1/2" stock. Easily driven by 1/4 or 3/8 h. p. motor.

BOICE-BUILT Machines are in daily use in hundreds of shops. Their size, absolute accuracy and low cost provide a means for producing a better job for less money. Boice saws are made in six models—are portable and attach to any light socket.

W. B. & J. E. Boice, Dept. P. M. 2, Toledo, Ohio
1730 Norwood Ave.

Radio Experts Earn Thousands!

YOU can earn from \$4,000 to \$15,000 a year by becoming a Radio Expert at home in spare time. New easy method. World's Largest Radio School. Write for **FREE BOOK**. Explains amazing opportunities.

NATIONAL RADIO INSTITUTE, Dept. 158A, Washington, D. C.

AMATEUR MECHANICS

A book for those who like to make things. 132 separate articles tell how to build electrical and mechanical devices, reed furniture, fishing tackle, hammocks, etc. 128 pp., illustrated. 25 cents postpaid.

Popular Mechanics Book Dept., 200 E. Ontario St., Chicago

HOW TO MAKE DEVICES FOR OUTDOOR WINTER SPORTS

Motor-Driven Sleds—Ice Yachts—Coasting Bobsleds and Toboggans—Snow Speedsters—Skis and Ski Running—Air-Propelled Sleds and Ice Boats—Airplane Ski Gliders, etc.

64 Pages. Price 25 cents, postpaid.

Popular Mechanics Book Dept., 200 E. Ontario St., Chicago.



This Palatial

Florida Home

can be purchased at a very reasonable price. It is the finest estate in a community of 30,000 situated amid 5 acres of orange, grape fruit, sweet bay, palmetto and a large variety of semi-tropical trees and foliage. A water front of 400 feet, with entrance from a Boulevard, affording every modern convenience. House recently completed and never occupied. Has every modern improvement, large sun parlors, sleeping porches and 8 bath rooms. Inexhaustible supply of soft water, steam heat, high, light basement under entire house. Surf bathing all winter within 5 minutes' walk.

For full details, photographs and price address

OWNER,

200 E. Ontario St. CHICAGO, ILL.

Build This Speedster Yourself!



Anybody who can use a hammer, screw driver and other ordinary tools can build the SHAW Speedster pictured here. Just follow the easy instructions we send you. Not a toy, but a real auto with a famous 2½ H.P. SHAW Motor. Makes 4 to 25

miles an hour. Gives you 60 to 90 miles per gallon of "gas". Whizzes you wherever you want to go for about one-third of a cent a mile! A keen looking little car that will give you years of pleasure.

You can build it yourself at low cost, or, if you prefer, all complete, ready to run.



Complete Book of Plans Tells How

Make Your Bike a MOTORCYCLE!

The Shaw Attachment Fits Any Bicycle

Makes your bike a dependable, easy-running, light weight power machine. Battery or Magneto Ignition. Compact. Easy to attach. No special tools or knowledge necessary. Thousands in use in U. S. and foreign countries. Wonderful hill climber. Send the coupon below for prices, terms, etc., also about SHAW Motorbicycle, a completely equipped power bike at a big saving.



Send
Coupon
for
Full
Information

Get a SHAW GARDEN TRACTOR

Now you can get a better power Garden Tractor at less cost. Amazingly low price on the SHAW. Just the thing for Truck Gardeners, Small Farms, Estates, etc.: Low Cost; Simple to operate.

Send the attached coupon for full information, prices and Big Special Offer. Write today!



2½
H-P

Get this big, new book, "How to Build Your Own Speedster"—a regular text book. Valuable, interesting and educational. Tells all about building your own car. Tells what parts you need. Describes every move in detail. Gives pictures, diagrams and plans. Tells how to drive and control the car, how to care for it, etc. Contains everything you need to know to build and run your own speedster. Sent postpaid, anywhere, on receipt of 25c. Send for your copy today.

Write Today Fill in the coupon below, mail it with 2 cents and we will send you full details about the SHAW Speedster, illustrated literature, etc. Or send the coupon and 25 cents and receive the book, "How to Build Your Own Speedster."

THE SHAW MFG. CO.

Dept. 2.P4

GALESBURG, KANSAS



SHAW MFG. CO., Dept. 2.P4, Galesburg, Kansas

I enclose 25c for the Book, "How to Build Your Own Speedster." Please send me circular and price on article I have checked below, for which I enclose 2c to cover mailing cost.

- | | |
|---|--|
| <input type="checkbox"/> SHAW MOTOR FOR BICYCLE | <input type="checkbox"/> SHAW SPEEDSTER |
| <input type="checkbox"/> COMPLETE SHAW MOTORBICYCLE | <input type="checkbox"/> SHAW GARDEN TRACTOR |

Name

Address

R. F. D. State

3 the

a pair of
MURDOCK
HEAD PHONES
\$4.00 or \$4.50

the new
MURDOCK
PLUG-JACK
for \$1.00

the complete
MURDOCK
LOUDSPEAKER
for \$5.00

best in radio

AT ALL RADIO DEALERS

If your dealer cannot supply you, send money direct and your order will be promptly filled.

WM. J. MURDOCK COMPANY
349 Washington Avenue, Chelsea, Mass.

FREE VACUUM TUBE RADIO SET

Can receive 100 miles and more.

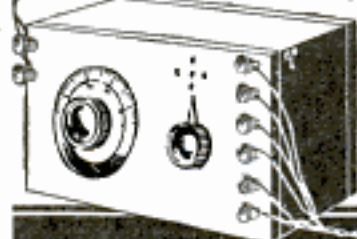

RUSH your name to learn how you can get a Vacuum Tube Radio Set **ABSOLUTELY FREE**. Don't delay; write today for FREE RADIO PLAN.

HOME SUPPLY CO.
Dept. 27
131 Duane St., N. Y. C.

Be a Radio Owner-Agent!

BIG Profits for Agents—Dealers.
Savings for Buyers

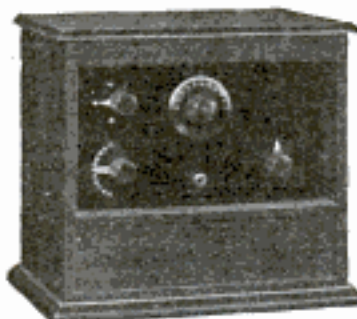

CHERINGTON OUTFITS

Are the latest—the slickest on the market. You can own a Cherington, at a rock bottom price—and arrange to represent us in your community. Cherington owner-agents are making big money every day—every week. A complete line—the newest—and the best in the world of radio at the price—and we have mighty interesting information for agents and dealers everywhere.

Write Quick for Details

CHERINGTON MFG. CO., Dept. 101, Waukegan, Ill.

Make Big Money

SELL
from our New
Outfit

Tailoring Agents

Earn big cash profits in advance taking orders for our fine tailoring from friends and neighbors. \$65 to \$95 a week, all or spare time. We deliver orders and collect.

Profits in Advance

Our plan gives you quick, ready money, profits paid daily, work where and when you like, get your money as you go along. Orders come easy with our fine samples. No dinky outfit like every Tom, Dick and Harry carries.

Tailored to Order

Folks like our swell clothes, tailored to measure, perfect fit and style. Get your own clothes at special wholesale price. You'll be delighted with our low prices and fine big, all wool samples, beautiful fashions all in classy

FREE Buckram cover, snap fastener; also booklet, tells how to make Big Money, all Free, write at once.

**WASHINGTON
TAILORING CO., CHICAGO**
159 W. HARRISON ST. Dept. B-345



HOWARD



Howard Adjustment Rheostats

Instant adjustment. Made from special heat resisting materials; operates with single knob; positive smooth contact. Micrometer adjustment.

Rheostats, 6 1/2" — 25 or 40 Ohm, Plain, \$1.10; Micrometer, \$1.50
Power Rheostats, \$1.50
Potentiometers, 200 Ohm, \$1.50; 400 Ohm, \$2.00

Ask your dealer or write us. Complete catalog of Howard radio parts and look-ups free on receipt of 2c for postage. Jobbers write for discounts.

HOWARD RADIO COMPANY 4244 N. Western Avenue
CHICAGO

OUR BUREAU OF INFORMATION will answer all questions regarding articles appearing in this magazine. Address Bureau of Information, Popular Mechanics Magazine, Chicago.

F-F BATTERY CHARGER CHARGES AT HOME

\$15 RADIO "A" & "B" & AUTO STORAGE BATTERIES Overnight For Few Cents From Any 110 Volta. C. Lamp Socket. COMPLETE, PORTABLE, AUTOMATIC. No Skill Required. Sorensen Plug in Lamp Socket. Snap Clips On Battery Terminals. Turn Switch & Battery is Charged in Morning. Batteries Last Longer. Charge in 1/2 hour. Lifetime. 5 Types. POPULAR PRICES.

TYPE 6 CHARGES 6 VOLT BATTERY AT 6 AMPERES \$ 15
TYPE A-B CHARGES 6 VOLT A & up to 120 Volts Of B Bats. \$20
TYPE 166 CHARGES 6 VOLT Battery At 12 AMPERES \$20
TYPE 1612 CHARGES 12 VOLT Battery At 7 AMPERES \$30
TYPE 1626 is a COMBINATION of TYPES 166 & 1612 \$25
SHIPPING WEIGHTS COMPLETE 9, 12 & 16 lbs.
PURCHASE FROM DEALER, or Write Us To Ship C. O. D.
ORDER now, or WRITE for FREE CHARGER Bulletin 24
10424 Berea Road
FRANCE MFG. CO., CLEVELAND, OHIO

Send for DEALERS Catalog

HARRY ALTER'S
"POCKETBOOK"
is a monthly net price catalog of Radio, Electrical and Lighting supplies. All good dealers should have a copy—get on our mailing list now. No obligation. Use your letterhead.



HARRY ALTER & CO.
WE SELL WHOLESALE ONLY
OGDEN BOUL. & CARROLL AV. CHICAGO

Complete RADIO Outfit



\$5

Down Puts This Famous
TUSKA

Armstrong Regenerative 3-Tube Outfit
in Your Home
Balance in Easy Monthly Payments

NOW everyone can have the finest radio receiver and amplifier that is made. No need to put up with inferior equipment. For here we are offering you the set designed and built complete by Mr. C. D. Tuska, the famous Radio Engineer. It comes to you complete with all the accessories you need, for just a five-dollar payment. Take advantage of this new way of selling radio. Get an outfit that will give you permanent satisfaction. Send the coupon below for our Great Special Offer, made for a limited time only.

The Perfected Radio At Last!

So simple to tune that it is just the thing for the beginner. Yet so perfect that it will delight the most hardened "radio fan" who has long been searching for the ideal circuit. Its long range will bring in stations never heard before, so loud and clear that a loud speaker will delight the whole family. Wonderfully selective. With it interference, internal noises and annoying body capacity are forgotten.

Send Coupon for Great Special Offer

Just mail this coupon. Get all the details without any obligation. Don't think of buying a radio set without finding all about this new and better way. Very easy terms. Free Trial. The highest quality of radio equipment possible to own. Send coupon NOW.

BABSON BROS. 2843 West 19th Street
Dept. 13-52 CHICAGO, ILL.

No Accessories to Buy

The radio outfits we sell are absolutely complete. Most others make an offer on the bare set and leave you to buy all the extras like tubes, phones, etc. in addition. The outfit we offer you now includes, the Regenerative Receiver and 2 step Amplifier all enclosed in a solid mahogany case. Also the batteries, head-phones, tubes, aerial, lightning arrestor, and full wiring installation equipment. You start operating without investing another single penny. Your \$5 payment brings it all.

UV 199 Tubes and Dry Cells Reduce Upkeep to Almost Nothing

Equipped with 3 of the latest type of dry battery tubes, which use only .06 ampere current. Most perfect tube, both for detecting and amplifying. Battery expense reduced to the absolute minimum.

BABSON BROS., Dept. 13-52
2843 West 19th Street, Chicago, Ill.

Please send me your special offer on a Complete Tuska Radio Outfit on terms of \$5 down and monthly payments.

Name _____

Address _____

I PAY \$75⁰⁰ a Week and up MEN

I pay men \$75.00 a week and up by my plan which I want to send you at once. Be your own boss, work where and when you like. You can do fine even without previous experience. **Biggest values—positively sell on sight.**

Profits in Advance

My plan pays biggest profits and commissions in this line, paid in advance, we attend to delivering orders and collections.

Sell *fine* Tailoring



Astonishing values get orders easy when you show samples of our tailored to order, all wool, suits and o'coats, all one price \$31.50. Our advertising helps you take orders quick.

FREE

This big, fine sample outfit furnished free, contains 100 all wool big samples, all one price \$31.50, fine colored, fashions, stationery, supplies, tape, etc. All in classy fine carrying case. Also complete sales manual, we place you in Big Money class.

\$31⁵⁰
ONE PRICE
W.Z. Gibson

W. Z. GIBSON, Inc., CHICAGO, ILLINOIS
161 West Harrison Street, Dept. B-11

Please send me your plan for \$75 a week and up, also FREE outfit and sales manual.

Name _____

Address _____

City _____

State _____

The MONARCH Jr. Lathe Is Priced Within Your Means

Most efficient machine tool you can have in home workshop, repair shop or garage too. Turns out, with 1000th-inch accuracy, all small wood and metal parts that other lathes will. *Experimenters, inventors, mechanics* enthusiastic over it. Completely equipped; auto. safety device; semi-quick change gear.



\$245 9-in. Lathe—
2½-ft. bed—
with bench legs
SEND for Free Catalog

Also built with bed lengths up to 5 feet.
Made in 11-inch swing size, too, at slightly higher price.

THE MONARCH MACHINE TOOL CO.
400 Oak Street
SIDNEY, OHIO

FREE TRIAL

Whether you have one belt or a hundred we want you to try **DETROIT Wire Hook BELT LACING**



at our expense. We will send postage paid, this complete outfit including large box of belt hooks to lace every kind and thickness of belt together with a (Vise Tool) belt lacing machine.



If you want the outfit after trying it, send us your check for \$5, if not return it at our expense. Laces belts for one cent an inch. Used by International Harvester Co., Advance Sundry Co., and thousands of others.
Outfit \$5.00. Assorted laces \$1.50 per box. Tool \$3.50.

Detroit Belt Lacer Co., Detroit, Mich.

\$32⁵⁰

U.S. Government HARNESS



Slightly used U.S. Gov't. All Leather Harness purchased for spot cash in enormous lots enables us to smash all prices and give you the saving.

Double Ambulance Harness with NEW BRUSHES, Per Set **\$32.50**

65,000 SATISFIED FARMER CUSTOMERS

New FREE Bargain Book now ready. Send today
—save half or more—NOW!

U. S. FARM SALES CO.
769 N. 5th St., Salina, Kans.

FREE Bargain List



O. D. Wool Coats \$1²⁵

Like Cut New. Sizes 33 to 38.

The coat for lounging, hunting or working. Postage Prepaid.

Overcoats \$4.00. New. All Sizes

Weight 5 to 7 lbs. Purest Post extra. Coat for dress or work. Arms and other goods in catalog. It's Free.

W. STOKES KIRK 1627-PM No. 10th Street
PHILADELPHIA, PA.

Send for 48-Page Catalog

Showing Lionel Electric Trains and Accessories in full colors. **WRITE TODAY.** Address Department 14.
THE LIONEL CORPORATION, 48-52 E. 21st St., N. Y. C.

MOVIES In Your Home



Our marvellous, practical **Movie Machines** sell as low as \$3.00—and what's more, we have wonderful films at lowest prices—with a new film rental service. **DON'T MISS THIS!**

Write NOW for Free Catalogue
PARAMOUNT MFG. COMPANY
Box 1371, Dept. M2, Boston, Mass., U.S.A.



HEAT!

THE NEW WAY

Amazing Invention Does Away With Coal and Wood

NOTE SCIENTIFIC APPLICATION OF AIR TO FLAME

No Wood no Coal

Fits Any Stove

Twice the Heat at Half the Cost—On or Off with the Turn of a Valve.

Think of having instantly all the heat you want IN ANY STOVE without building fires; without kindling, ashes, dirt, or odors. Think of having—at the touch of a finger—a fire that is three times hotter than coal—or just enough to simmer a kettle. A fire that stays where you want it—high or low.

THREE TIMES HOTTER THAN COAL.

Think of the wonderful cooking and baking you can do with such a fire, think of the better health and comfort the family will enjoy when you can keep every room in your home at just the heat you want, warm and cozy, day and night, in any weather. These are but a few of the advantages enjoyed by users of a remarkable new invention—

INSTANT-GAS—CHEAPER THAN COAL

A scientific combination of 96% superheated air and 4% kerosene (common coal oil)—the cheapest and safest fuel known. It is produced by an amazing invention which, in one minute, can be slipped into the fire box of any coal or wood stove. All the convenience of gas at half the cost.

Start with the Turn of the Valve

Turn high or low to suit, heat your home, do your cooking and baking, and then stop with another turn of the valve. A child can operate it. Instant-Gas gives a clean, steady, dependable fire. No ups and downs to give the family influenza and pneumonia, no running out into the cold to fetch coal or wood, no fallen cakes or sodden biscuits from an unsteady oven. Saves cleaning bills, doctor bills, wall paper and curtains.

Works in Any Stove—Old or New

No holes to drill, no injury to stove, installed in a few minutes, makes old stove work like new, and makes a new stove last twice as long. Lasts a lifetime. For many years the markets have been



The Leviathan Furnace Oil Burner fits in steam, hot water and hot air furnaces. Burns cheap oil instead of coal. Write for Folder No. 17. Great opportunity for distributors.

Booded with oil burning devices—but a scientific improvement in the application of oil burning principles makes the Instant-Gas Oil Burner the one great, outstanding success of its kind. Yet it costs no more than inferior out of date makes. Money-back-guarantee gives you absolute protection.

TRY IT IN YOUR HOME FOR 30 DAYS FREE

Test the Instant-Gas for yourself, try it in your own stove at our risk for 30 days, see for yourself how much superior Instant-Gas is to any other fuel, how much money it saves, how easy it is to turn on and off, how much cleaning and scrubbing it saves, how much warmer you can keep your home, and how much better cooking and baking you can do. Join the hundred of thousands of Instant-Gas users who have gained health and strength by cutting their work in half and doing away with the heavy, dirty, back-breaking coal and wood. Mail coupon today for 30 day trial offer and amazing new book "Scientific Oil Burning." No obligation. Special low introductory price to those who mail coupon at once. Mail yours today.

AGENTS Oil burning is the rage. People everywhere are turning to this remarkable new method of heating and cooking. \$50.00 a week sales plan for beginners and spare time workers. \$5,000.00 to \$10,000.00 a year easy for real producers, who can handle big territory. Write at once for details and be ready for big Fall and Winter sales.

INTERNATIONAL HEATING CO.

119 South 14th Street, Dept. 392, St. Louis, Mo.

Manufacturers of scientific heating equipment.

Mail this Coupon for Amazing Free Book

International Heating Co.,

119 South 14th Street, Dept. 392, St. Louis, Mo.

Without any obligation whatever to me, mail me, post paid, your Free Book entitled "Scientific Oil Burning," together with your special introductory price and 30 day trial offer to those who act at once.

Name.....

Address.....

City and State.....

If interested in making from \$50.00 to \$200.00 a week as agent, like Lacey of Mass., mark X in this square.

Agents \$12.00 a day

NEW Self-Heating IRON

New invention now makes ironing easy in every home. Ends hot stove drudgery. Cuts ironing time in half. Saves steps. Costs one cent for 3 hours use. No attachments. No cords. No tubes. Gives quick regulated heat. Guaranteed. Sells fast. Mrs. Wagner, Ohio, sold 24 in few hours spare time. Moyer, Pennsylvania, made \$164 in one week. You can do as well. Work all or spare time. No experience needed. No capital. New plan. Simply take orders. We deliver and collect. Commissions paid same day you take orders. Send for exclusive territory and FREE OUTFIT OFFER. Write today. THE AKRON LAMP CO., 32 Iron St., AKRON, OHIO



LYON BODIES

Send For Our 1924 BOOK OF BARGAINS

Containing a full line of bodies and accessories at exceptionally low prices. Buy direct from the factory.



\$27.50 AND UP

AUTO TIRE SALES CO.

Body Division Dept. P17
1346 S. Michigan Ave., Chicago

FREE Book of Newest Styles just out. Women's, men's, children's clothing on credit and at bargain prices, less than cash prices everywhere. Very latest fashions; best materials. Open a charge account with us. Buy on credit and save money! Dress in newest styles. Send for Style Book absolutely FREE today! Elmer R'char's Co., Dept. 1772, W. 35th Street, Chicago

ALL MAKES BAND INSTRUMENTS AT 1/3 to 1/2 PRICE!

All famous American and imported instruments for band, orchestra or solo offered at astonishingly low prices. Hundreds of bargains in new list. New Guarantee. 5 Days' Free Trial and money back guaranteed.

CONN

"C Melody" silver plated Saxophone, gold bell, latest model, new pads, factory rebuilt, guaranteed same as new. Case, reeds, straps. Buy price.....\$89.75

HOLTON

Silver plated gold bell Cornet, in case, pearl keys. Slightly used, completely rebuilt, guaranteed new condition, perfect. \$90 list. Our price \$35.45

BARGAIN LIST FREE

DEAGAN XYLOPHONE
\$15 list, 2 1/4 octaves, slightly used, rebuilt guaranteed like new. Our price.....\$8.55

SPECIAL!
Brand new Brass Cornet made by most famous factory in U. S. Low pitch, pearl keys. List \$50. \$12.25

WRITE TODAY! Don't waste time and money. Dixie known for 21 years as bargain headquarters. Send for latest bargain list TODAY. Dixie Music House, Dept. 161, 320 S. Wabash Ave., Chicago

Use a Spencerian and experience new writing sensations: effortless speed, unusual flexibility, greater legibility. Seven hand-processes fashion Spencerian Personal Steel Pens. That's why they write so well, outwear two ordinary pens, and have been acknowledged "best" for more than half a century. There is a style for your handwriting.

SPENCERIAN
PEN CO.

349 Broadway, New York

A sample card of one dozen assorted pens for a dime and our handwriting booklet, free.



No. 1—
College,
fine point,
double
elastic.



No. 28—
Congressional,
square and
flexible.



No. 40—
Medium
point, all
round
ability.



No. 42—
Gold and
some
colored;
smooth
action.

Spencerian Personal Steel Pens

Send No Money

Limited supply. Wonder Telescope. Opens over 3 ft., long in 6 sections. Brass bound. "Can see children playing in school yard 6 mi. away."—P. H. Henzington, McDade, Tex. See persons and objects miles away as never before. Great fun! **SPECIAL OFFER**—send your name. On arrival deposit \$1.55 with postman plus a few pennies postage. Satisfaction guaranteed or money back. Ferry & Co., 75 W. Van Buren, Dept 9772, Chicago

Big 3-foot Telescope

"Read the numbers on Ferry & Co. P. H. Henzington, McDade, Tex. I have been watching submarines & miles off the coast." P. Green.



FREE To You

Book of Factory Bargains in Stoves, Ranges, Furnaces, Furniture, Refrigerators, Farm and Home Needs

Let me send you my new free catalog and show you how to make great savings at wholesale—direct from factory, at money saving prices. Everything guaranteed—set in your home on

30 DAYS' TRIAL—DON'T RISK A PENNY

Your money back without question or quibble. More than 500,000 satisfied customers.

Easy Terms—Write at Once Just send name and address. A postal will do. **W. S. DEWING,** "The Stove Man."

Kalamazoo Stove Company
391 Rochester Ave., Kalamazoo, Mich.

A Kalamazoo Direct to You





17c

a Day
Pays for
this
Beautiful
Rocker

Tapestry or Velour

Over 1000 other Cozy Home Furnishings. Latest styles. Just what you need now. **Save big money** at our low Factory-to-Family prices. Pay as little as \$3 down; up to a year and a half to pay balance. Get all your Furnishings at once—pay as you use. Thousands buying this new way.



Big Catalog FREE

New Spring "Larkin Book of Better Homes." Shows everything for parlor, porch, dining-room, bedroom, kitchen. **Bargain Prices** on famous Symphonola Phonographs. Also Symphonola Pianos, Player-Pianos in genuine Mahogany, Walnut, Fumed Oak. Free trial. Up to 4 years to pay. Satisfaction or money back. Check below article interested in.

- Home Furnishings
- Pianos or Players
- Phonographs

Cut out this adv.—write TODAY for FREE Book.

Larkin Co Inc.
Dept. 239 BUFFALO, N. Y.
Peoria, Ill. Chicago, Ill.



Sore throat



Combat it both inside and outside. Use Absorbine, Jr. as the soothing, healing, germ destroying, antiseptic gargle. Apply it outside to break up congestion, draw inflammation and reduce swelling.

All druggists', \$1.25 or postpaid.
Liberal trial bottle 10c., postpaid.
W. F. YOUNG, INC.
347 Lyman St. Springfield, Mass.

Absorbine, Jr.

THE ANTISEPTIC LINIMENT

for Cuts Strains Bruises Sprains Chapped hands Sore throat Rheumatic aches

Pants Always Pressed



STAYPREST TROUSER PRESSER puts a real master-tailor crease in pants. Takes the bag out of knees and removes wrinkles. Easy to use—takes only a few seconds. Always a like-new press without delay or trouble. A real convenience. Saves many dollars in pressing bills, and trousers always look like just from the tailor. Makes them last longer. Saves nap of cloth, which ironing ruins. Every man should have at least one or two.

Stay Prest

Made of selected hardwood, fabric covered, canvas lined. All metal parts heavily nickel plated. Fits any size trousers. Folds into small pack to fit handbag. Strong but light. Has collapsible coat hanger. Lasts a lifetime. Thousands in use. Well dressed men have several to keep all trousers well pressed. Sold through dealers, agents or direct by mail. **Wish postpaid on receipt of \$2.50. C.O.D. if desired.** Satisfaction or money back. Order today. Book free.

THE GETCOY-JUNG COMPANY
212 G. & J. Bldg. Cincinnati, Ohio





Harris Homes Beautiful

Permanent Built! —Now Within Your Reach

The combined efforts of thirty great departments in experimenting and testing materials and methods of construction have produced for you a GUARANTEED home, expert machine cut, bundled and marked—the last word in building economy.

Not One Penny in Advance

So sure are we of the super-excellence of our material and our GUARANTEED Ready-Cut System that we will ship you any HARRIS HOME without the payment of one cent down. Our plan Book explains our liberal terms fully.

BUILDING MATERIAL!

For over a quarter of a century, thrifty wise buyers have realized that here is the open door to real economy, whether it be a brand new home or material for improvements or repairs.

FREE BOOK OF PLANS!

The latest edition is waiting for you, contains our FREE PLAN OFFER and photographic reproductions, with floor plans and specifications of 100 beautiful homes. Mail coupon today.

Plumbing and Heating!!

Hot water and heating systems, warm air heating plants, pipeless furnaces and plumbing material of every kind—the product of America's leading makers. Our mammoth plumbing stock offers unlimited possibilities for you to save money. Our heating plants are guaranteed to heat your home in any weather with big fuel economy.



Bathroom Outfit Complete!

Consists of white porcelain enameled bathtub, 5 ft. long, complete with fittings, washdown closet outfit with white vitreous china earthenware bowl and tank fitted with mahogany seat and cover. Lavatory complete with indexed faucets, trap and supply pipes. *This is but one of Many Wonderful Values in guaranteed Plumbing in Our Big Complete Stocks. Mail the Coupon!*

MAIL THIS COUPON

HARRIS BROTHERS CO.,
Dept. PG-7, Chicago
These books are FREE and sent postpaid. Mark an "X" in the squares to indicate which ones you wish.

<input type="checkbox"/> Harris Home	<input type="checkbox"/> Book of "Presto-up"
<input type="checkbox"/> Book of Plans	<input type="checkbox"/> Houses and Garages
<input type="checkbox"/> Building Material	<input type="checkbox"/> Plumbing and
<input type="checkbox"/> Catalog	<input type="checkbox"/> Heating Book

Name.....
Address.....

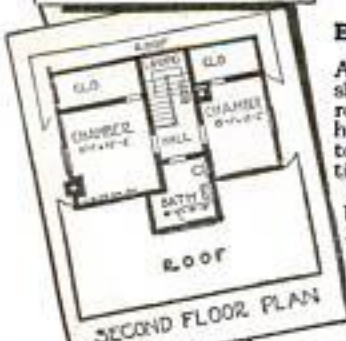

Expert Engineers Waiting to Help You

A rough sketch of your building showing number and size of rooms, doors, windows and height of ceiling is all we need to give you complete information and low prices.

Dept. PG-7
HARRIS BROTHERS CO.
35th and Iron Sts., Chicago



Free Book of Plans



WANTED! AGENTS AT \$50 to \$90 a Week

New Invention—Just Out!

Needed in every home every day. Patent just applied for. Nothing else like it. Supplies what every housewife has wished for, for years. Perfected after long experimental work by mechanical experts. Low priced—anyone can use it—**sells on sight**. We want three hundred representatives at once—men or women hustlers—to advertise, accept orders and manage deliveries for our new **Quickedge Knife and Shear Sharpener**. Sharpens any kitchen knife, paring knife, carving knife, bread knife or shears and scissors in **ten seconds**. Agents are taking orders at every house—wiring for rush shipments. Write today for this opportunity to make \$10 to \$20 every day.

Make \$400⁰⁰ Next Month

This little machine is a mechanical masterpiece. A child can use it. Just put knife in slot—turn crank—**grinds automatically**—draws blade to keen, sharp, perfect, lasting edge at **absolutely correct bevel for daily use**. Nothing to adjust—nothing to change—nothing to get out of order—**absolutely guaranteed**—will last for years. Once they see it and use it, women will not do without it for several times its cost. **Easy to make big money** if you will just follow instructions and work faithfully. **No charge for territory—200% profit for agents**. Business supplies capital. Exclusive protection, co-operation and assistance. Failure impossible. Nothing to risk. Success assured.

No Experience Required

Just take one of the machines to any house and show it—give a ten-second demonstration upon the dulllest knife in the house; **the order is yours right on the spot; instantly**. No talking necessary. No argument. The machine simply sells itself, and stays sold. Every customer becomes your friend. They tell others, your profits double and multiply. Leave one hundred on trial over night. Collect the cash for every one of them next day. **The machine will do its own talking**, it is so easy to operate, no explanations or instructions are necessary. Secure your county now; **FREE**. Get started right now and—

Make As Much Money Next Week As These Men Are Making Now

J. C. Lewis, of Kansas, says: "I have sold one hundred Sharpeners in four days." Kerr, of Md., writes: "The women can hardly wait until they get them." Herbert Cain, of Ky., sold nine after supper. At the end of his first day, J. W. Gordon, of Pa., writes: "I sold two dozen, and I sold to every one I saw." Wm. G. Hall, of N. J., says: "I think it is great. I sold six in about one-half hour. The machine is a mighty fine proposition. I am a mechanic and I know what I am talking about." Peter Courtland, of Mich., writes: "I received your Sharpener and opened it in a barber shop. I ground his shears and I got an order for one right on the spot." H. A. Henkel, of Va., says: "I have examined it and find it a wonderful little machine. The workmanship is simply perfect." Frank King, Colo., says: "Sample received Saturday, sold ten today. Sell to most every house." Forest Webb, of Pa., says: "Went out Monday afternoon and about three hours and received one dozen orders." H. Tillery, of Tenn., wrote: "I took three orders first hour. When you sharpen an old, dull knife, dull as a hoe, in less than a minute, they sit up and look." Ray Carter, of Mass., writes: "I went out two days and have orders for thirty sharpeners." John Durr, of Wis., also says: "I have sold thirty in two days."

You can make this money. SEND NOW. Territory Free. GET BUSY, WRITE TODAY.

The Quickedge Sharpener Co.
102 Sharpener Building, JACKSON, MICHIGAN

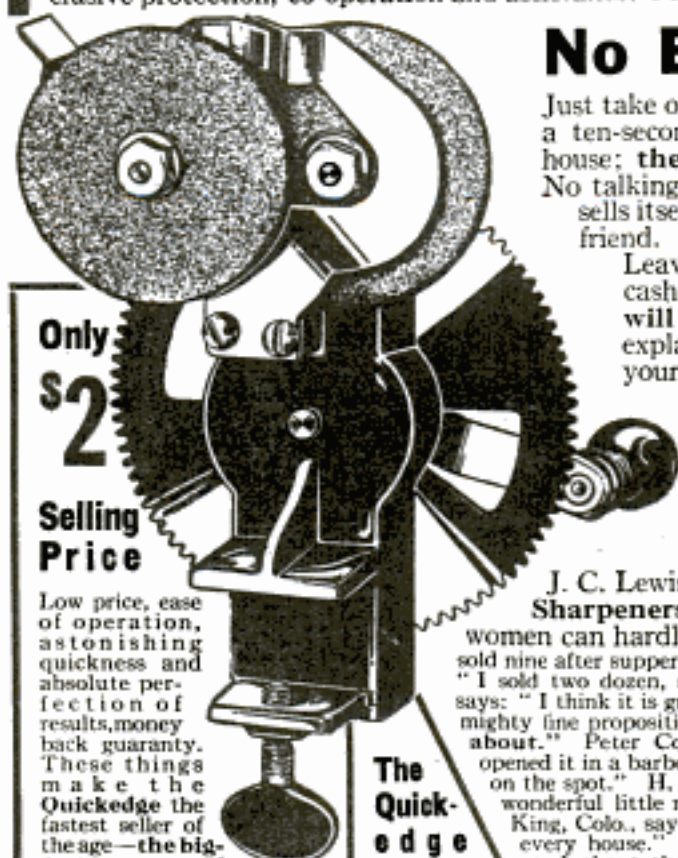

Only
\$2
Selling
Price

Low price, ease of operation, astonishing quickness and absolute perfection of results, money back guaranty. These things make the Quickedge the fastest seller of the age—the biggest money-maker for agents, general agents and managers ever invented.

Write Today

Send for application blank and complete information today—free. Investigate. Get the proof. Don't delay. Write a postal card or letter right now. Territory is being assigned very fast. Get your county now—free. Write today.

The Quick-edge Knife and Shear Sharpener Grinds Any Kitchen Knife or Shears in 10 Seconds ABSOLUTELY GUARANTEED



Amazing *new* farm offer!

PAYMENTS SO SMALL YOU WILL HAVE A SURPLUS FOR COMFORTABLE LIVING

The Canadian Pacific Railway now offers you a Farm Home in Western Canada on a New Long-Term Plan of Easy Payments that is Extraordinary. The plan makes it possible to own a farm home without taking all profits to meet land payments and leaves a surplus for the comforts and enjoyments of life.

PAYMENTS EXTENDED OVER 35 YEARS —FIRST YEAR FREE USE OF LAND

Under this plan all the settler pays down is 7% of the purchase price—One year's free use of the land without any interest chargeable whatsoever. The balance of principal and interest will be amortized on an easy payment plan of 34 equal annual payments which makes the second payment fall due two years after the purchase of the land, which is figured on the basis of 7% (including principal and interest) of the balance of the cost of the land. For example, on a purchase of 160 acres costing say, \$3,000, the down payment will be \$210 and the annual payments, commencing at the end of the second year, will be \$195.30. After 35 years the settler will get clear title to the land—unless, of course, he wishes to pay sooner, which is his privilege.

CANADA'S 1923 CROPS BEAT ALL RECORDS

In 1923 the wheat crop of Canada exceeded the 1922 crop by almost 100,000,000 bushels. In Alberta, the average yield was 26.5 bushels per acre and there were many individual cases where yields of 50, 60, 75 and 80 bushels were returned. Other crops showed a corresponding increase over previous years with equally high yields. These enormous yields on moderate priced land even at average prices for farm products have placed many farmers on the road to success.

NO TAXES ON IMPROVEMENTS

Taxes are moderate and there are no taxes on livestock, buildings, improvements, implements or personal effects. Good markets, modern schools, roads, churches, amusements make farm life in Western Canada desirable and attractive.

IRRIGATED FARM LANDS

In sunny Alberta—a district that is especially adapted to mixed farming and where irrigation has been proved beneficial—a vast irrigation system with an unfailing supply of water administered under the direction of the Government, has been constructed.

Irrigation in Southern Alberta—insures you a crop every year—increases your crops each year—makes you independent of weather conditions—produces great quantities of coarse grains, pastures, alfalfa, roots, etc., thus developing the livestock industry which is safer and ultimately more profitable than wheat farming—tends toward closer development, well-cultivated farms, good neighbors.

These lands are also for sale upon the same amortization terms as our other farm lands. Full details on application.

YOU CANNOT BUY UNTIL YOU INVESTIGATE

You must inspect the land before buying in order to judge of its fertility. Special inspection trips from points

Chicago and West will leave on the first and third Tuesdays each month. Single fare plus \$2.00 for the round trip. Let us arrange details. Send this coupon now. It will give you without obligation complete information on the new and amazing plan. These terms are so easy that you can own your own farm home—instead of renting.

M. E. THORNTON, Supt. of Colonization
Room 432, Canadian Pacific Ry. Bldg.
Calgary, Alberta

M. E. THORNTON

Supt. of Colonization, Room 432
Canadian Pacific Railway Bldg.
Calgary, Alberta, Canada

I am interested in learning more about
Prairie Provinces of Canada
Irrigation Farming in Sunny Alberta
Business and Industrial Opportunities in Western
Canada
Lloydminster and Battleford Districts

My Name.....

Address.....

Town.....State.....

Fired!

Do you work for day wages? Are you working for someone else? If you are, you can more easily appreciate this fellow's misfortune—and you will understand more fully why, at the age when he should be well fixed and in a position to spend the rest of his life in comfort, dependent on no one for support, he is practically penniless—and out of a job, fired because he is too old to work.

Some Facts Straight From the Shoulder

Nearly everyone who works for others tries to save—tries to get enough money together to take care of him and his family when old age overtakes him—but how many are successful in their efforts to accumulate a fair sized savings account?

Government Figures Show

That 82% of the Country's Men, at the Age of 65, Are Dependent on Relatives or Friends for Support! The other 18%, who have money and are independent, are Business Men, Not Fellows Who Have Worked For Others All Their Lives! The workingman can't save. There are too many bills to pay. His pay check comes every so often, but so does the grocery bill, meat bill, light bill, doctor bill, dentist bill, and a hundred and one other incidental expenses. Then sickness often robs him of a couple of weeks pay. No Matter How Hard You Try, It's Practically Impossible to Save Enough Money From Day Wages or a Monthly Salary to Make You Independent in Your Old Age!

Did You Ever Hear of a Retired Workingman?

No, you never did—and what's more—you never will! You hear of retired Business Men. Business men can afford to retire! The fellow who works for someone else (whether he wears a white collar or not) never leaves the job until he is forced to—until fired—replaced by someone younger.



What Are You Going to Be?

A Retired Business Man—or a Fired Workingman? It's up to you. Do your deciding right now! The floor surfacing business will make you and your family independent. The "American Universal," electrically driven, replaces six hand scrapers—and turns out much better work. There's \$25.00 to \$40.00 a day, and more, in it for you as a floor surfacing contractor. Requires a surprisingly small investment—no special training necessary. Beautiful work creates big demand—every floor (old or new) a prospect. Pleasant work—profits unlimited.

Write for Full Particulars at Once

Act Now—don't turn this page until you have written to us for full particulars and testimonials from "American Universal" floor surfacing contractors who are making big money, who are actually enjoying life—and who will continue to enjoy life as long as they live. Don't Wait Until Tomorrow. Write Today—Now!

American Floor Surfacing Machine Co.
523 South St. Clair St. Toledo, Ohio



How to do 52 LATHE JOBS Write for it!

"Lathe Work" illustrates and describes 52 practical lathe jobs in the machine shop, showing the proper method of machining each job. A similar bulletin just issued, illustrates the lathe's use in the auto repair shop. Either or both bulletins will be sent free on request. Enclose this ad with your name and address or use postcard. We will also send you catalog No. 83 if you desire facts about SOUTH BEND LATHES.

SOUTH BEND LATHE WORKS
555 E. MADISON ST. SOUTH BEND, IND.

SOUTH BEND LATHES

**AUTO SUPPLIES
WHOLE SALE
3000 BARGAINS**

SEND FOR THIS CATALOG -
it's FREE!

Everything you need
in Auto Supplies at
Amazingly LOW PRICES.

NEMCO BARGAIN SUPPLY HOUSE
33 to 49 No. Peoria St. Dept. P. CHICAGO, ILL.

THIS WONDERFUL INVENTION



converts any ordinary cook stove into a gas stove. OXO-GAS is made from kerosene and air. Cheaper, cleaner and more efficient than coal. Responsible distributors wanted.

GLORIA LIGHT CO.
114 N. May St. Chicago, Ill.

FREE

**300 Candle
Power
FARM
LANTERN**

The world's greatest contribution to light is the New Improved Wizard Gasoline or Kerosene Table Lamp, equipped with automatic cleaning needle. The discovery of "Thena" metal, used exclusively in Wizard Lamps and Lanterns, has revolutionized this industry. Now 10¢ worth of kerosene or gasoline will give 30 hours' pure white, soft yet intensely brilliant light. To introduce this remarkable lamp, we give absolutely FREE a genuine \$8.50 Wizard Gasoline or Kerosene Lantern with the purchase of one lamp. But you must act quick. Offer limited to 5000 Free Lanterns. Write at once for Free book showing style of lamp you like and details of Free Offer. No obligation. Write now. Agents send for unusual offer and exclusive proposition.



THE NAGEL-CHASE MFG. CO., 290 E. Erie St., CHICAGO

New Selling Plan

Better Than Owning a Store

William B. Garden



WM. B. GARDEN

During my 30 years in the retail business I owned and successfully operated 3 different stores—a store for men in Joliet, a tailoring store in Cedar Rapids, also in Rockford.

In good years my investment and service would earn me \$7,000 or \$8,000. In poor years I made less, of course. Some years I lost money. In 1893, 1903, 1907, 1914 and especially

1920, I lost a good deal of money.

Retailing at best is a hard and risky business. My gross profit was the usual liberal percentage of 25% on small articles, and 50% on slow moving goods like men's tailoring, but when I got through paying rent, clerk hire, insurance, light, heat, depreciation, taxes, credit losses, etc., I was fortunate to have 5% to 7% net in payment for my time, investment, risk and worry.

During these 30 years in the retail store, I noticed the cost of selling and serving the customer was constantly increasing and the risk and worry on the part of the merchant seemed constantly growing greater, while the net returns grew smaller. My customers seemed to have the impression that every retailer was a highway robber, while the truth of the matter was that it was getting more and more difficult to earn a living. So, in 1920, I sold out and put my money into sound investments.

In January, 1921, having heard of J. B. Simpson, Inc., and their wonderful virgin wool suits at \$31.50, I went to Chicago to investigate. I was immediately impressed by the size of their plant, it being the largest tailoring institution with the biggest, busiest shops I had ever seen. I found them retailing their suits at about the same price equal quality would sell for at wholesale. In other words, they were selling direct to the user at wholesale prices.

Their fabrics were fine, their assortment splendid. Their finished garments very satisfactory in style, fit and workmanship, but the commissions appeared to me as being so small that I could not understand how any man could possibly sell enough suits to make big money. I had yet to learn that real success comes only when the saving you make by improved selling methods or increased efficiency, is passed on to the customer. That's what Simpson was doing. The retail price was printed on the label. The garments were sold at the same price everywhere and I found that it was a wonderful appeal to show a prospect 150 patterns all at the same price—take your choice. No man could raise

or lower the price. Every salesman was arbitrarily limited to a small commission, and had to depend on a large number of sales.

I met several of their salesmen who were making big money and I determined the Simpson plan was worth a trial.

I went out among my old customers and I was successful right from the start. After the first few weeks, I began getting business galore. For the first time in my life, I had people coming to me. One of my old Joliet customers sent me to his Brother-in-law to whom I sold 2 suits. Three weeks later he called me up saying he had 2 customers and I got 7 orders in that office—one of these sent me to another office where I got 10 orders—all new customers all in one day.

This new way of selling clothes is so much more economical, so much more satisfactory, that I feel sure that very soon at least half of the clothes made will be sold in this manner. People will not pay \$45.00 or \$50.00 or more when they find out the same article can be bought direct from the manufacturer at \$31.50. I sell to the best trade in Joliet. Men who used to pay \$60, \$75 or \$90 for a suit of clothes, now pay me \$31.50 and they often buy 2 instead of one, and have lots of clothes at a less cost per year. I sell all my old trade and I sell new trade that never would buy from me before. I never had so many customers—so many thoroughly satisfied, enthusiastic customers.

In my many years of experience I never knew a firm who will go so far to satisfy a customer. Their policy is absolutely 100% fair. In the two years I have been representing them, their quality and service has been steadily improving. Every season they grow better and every season my business has shown an increase.

I believe there are hundreds, yes thousands of men in business who would earn more without risk or investment, with less worry to themselves and far greater satisfaction to their customers by representing J. B. Simpson, Inc.

(SIGNED) WM. B. GARDEN.

We make and sell direct to the wearer, through our own sales force, a suit or overcoat tailored to order of all virgin wool fabrics, guaranteed to satisfy the customer in every way for the remarkably low price of \$31.50—a price that meets the tremendous demand for dependable quality at a cost within the reach of all. We also make beautiful all wool worsted two-piece summer suits for \$21.50.

We offer ambitious men anywhere in the United States, where we are not fully represented at present, the opportunity to earn \$50.00 to \$200.00 a week.

If you want this chance, mail coupon below, or if living in any of the following cities, please call in person.

Chicago 843 West Adams Street
New York 19 West 34th Street
Detroit 1550 Broadway
Milwaukee 114 Grand Avenue
Minneapolis 1108 Nicollet Avenue

FREE INFORMATION COUPON

J. B. Simpson, Inc., Dept. 760,

843 West Adams Street, Chicago, Illinois.

Gentlemen: Please send me application blank and full information about the wonderful opportunity you offer.

Name.....

Address.....

City..... State.....

Territory Preferred.....

If you are not interested in becoming a salesman, but would like to see samples of our fabrics, kindly check here and we will have a representative call.

The Best Seller in the Ford Field



Clamps into tank opening



Fills Tanks without removing cushion



Gas Gauge as seen from driver's seat

Dealers! Salesmen! Write or Wire Today!

Salesmen find Fil-O-Meter increases their earnings over 100%. Manguson made \$48.00 in one day; Laux, as a side line, cleared \$56.00. Already territory is completely closed in some states. Line up quick with this big money-maker.

Kirstin

FOR FORDS

FITS ALL MODELS

Fil-O-Meter

A Gasoline Gauge and Filler Combined fills Ford gas tanks without raising cushion. Gas Gauge always within driver's sight. Basic patents prevent all competition. Weighs 2 pounds. Attaches to any Ford in ten minutes.

\$5 Retail—Big Profits

This handsome instrument retails at \$5.00 (open cars), \$6.00 closed models. (Add 50 cents in West.) You make a liberal commission and are given sales help such as local advertising, circularizing, printed matter, etc.

Territory Closing Fast

Now is the time to get lined up. Write today for complete plans, sales help, etc. On receipt of \$1.00 deposit, will ship sample C O D for balance of Distributor's Price.

A. J. KIRSTIN CO.

15 First Street, Escanaba, Mich.

MOTOR KIT COMBINATION PLIERS

A handy, popular-priced, all-round tool for the car owner, electrician, plumber, mechanic or farmer. Great in the family tool chest. Hand finished. Handles drop-forged, hardened, oil drawn. Bolt and nut turned from solid steel bar and case hardened. Will not slip or shear. Wire cutter and screw driver. Price, nickel finish, 5 or 6 in. size — 50c.

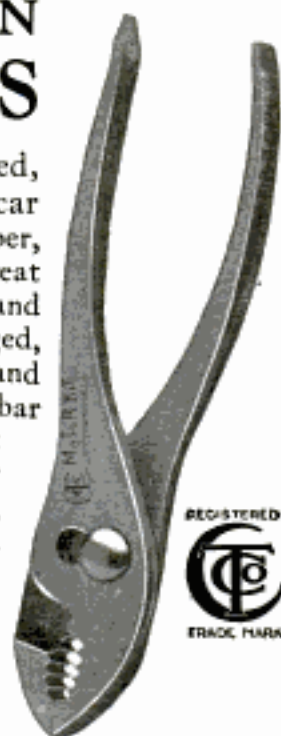

REGISTERED
TRADE MARK

CRESCENT TOOL CO.

Jamestown, N. Y.

Originators of the

CRESCENT WRENCH

CRESCENT TOOLS

TYPEWRITERS



\$50 buys a brand new Corona, the Personal Writing Machine. Latest model with many improved features. Write for free booklet No. 8.

Corona Typewriter Co., Inc.
GROTON, N. Y.

VITALIC Bicycle Tires

TRADE MARK REGISTERED
Tougher Than Elephant Hide

Superior Automobile Trouble Light
Only \$1 postpaid, or C. O. D. if you wish

Made of highest grade materials, furnished in either single or double contact, complete with 10 ft. cord, 2 c. p. bulb, guard and socket. Order yours today.

INSTITUTE MFG. CO.

Dept. 202, 311 Main St., WORCESTER, MASS.



Pepsodent PAT. OFF. REG. U.S.

The New-Day Dentifrice

Heat Your House or Store

WITH THE

Victor Furnace Oil Burner

E. R. KNOTT MACHINE CO.

1 Ellery Street

S. BOSTON, MASS.



\$11⁵⁰

COMPLETE
\$12.00 East of Buffalo

Alfred's Ice King
The Skate for Pleasure

The Finest Tubular Skate and Shoe Made

Used by the World's Greatest Amateur and Professional Skaters. For Sale by All Good Dealers or Direct from Factory.

Factory and Salesroom

Dept. PM, 2846 W. North Ave., Chicago, Ill.

WE WANT AGENTS

TO introduce the Milburn Puncture Proof Inner Tube. Mr. L. A. Milburn, of the Milburn Puncture Proof Tube Company, Chicago, after many years of practical and theoretical experiments, has perfected an inner tube which in actual test suffered the loss of NO AIR after being punctured as many as 500 times. Many users have run over 20,000 miles without removing a tire from the wheel. Milburn Puncture Proof Inner Tubes are made of the best quality live red gum rubber—especially built and air inflated. Milburn Puncture Proof Tubes cost no more than other ordinary tubes.



CAR OWNERS WANTED

To sell and demonstrate this wonder tube. Interests everyone immediately. Automobile owners buy on sight. It makes no difference what car they drive or what tires they use. Our salesmen are coining money on our "DIRECT FROM FACTORY" scheme of selling. Absolutely no competition. We control all basic patents. Previous selling experience not necessary.

Earn from \$5000 to \$10,000 a Year



Earn \$5,000 to \$10,000 yearly or more. Get into business for yourself. Sell Milburn Puncture Proof Inner Tubes. Every car owner is a prospect. Your field is unlimited. Get in while it is good. Be independent.

Find out all about it now and get started at once. Then you will be ready to make big money when the heavy spring selling season starts.

FREE TUBE SPECIAL FREE TUBE OFFER

Send coupon or write today for special free tube offer and further details. References, Industrial State Bank of Chicago, National Bank of the Republic, Chicago, Baker State Bank of Chicago. Don't hesitate. Fill out the coupon and send it in or write and send name and we will send you all details. This is your opportunity so don't delay. Address

L. A. MILBURN, Pres.
Milburn Puncture Proof Tube Co.
 333 West 47th Street
 CHICAGO, ILL.

TESTIMONIALS

Convincing Statements from a Few of Our Agents

J. D. Cooper—"I have made 30,000 miles with my Milburn Puncture Proof Tubes and have not as yet removed a rim or casing and my casings are still in excellent condition."

J. C. Jerves—"I sold 50 Milburn Tubes in the first three days."

Chas. Cayton—"I sold twelve tubes yesterday in ten minutes."

L. S. Knapp—"My first few hours out I sold eight tubes, no trouble at all to sell them. The most wonderful tube on the market today, I think. I am hoping you will give me the agency for a big territory."

D. Edelere—"I have driven seventy-five miles in one of the 30x3 tubes and twenty were spike nails. It has gone above the test that you recommended to me it would do."

MILBURN PUNCTURE PROOF TUBE COMPANY
 333 West 47th Street, Chicago, Illinois
 Gentlemen: If the money-making opportunity is so big as you claim, I am interested in getting the tube that I can sell for a share of the profits without a heavy commission and FREE OFFER TO AGENTS.
 Name.....
 Address.....
 City.....
 State.....

New Cheap Fuel!

Gives 3 Times the Heat of Coal

in Any Stove or Furnace



The discovery of an amazing heating secret—by Mr. B. M. Oliver, St. Louis heating expert—at last frees housewives from the dirt and drudgery of coal and wood—and all of us from the worry of strikes and enormous fuel bills. Mr. Oliver's discovery is a simple device that sets right in any cook stove, heater or furnace—without change. And it combines 95% air, the cheapest fuel there is, with 5% oil—producing an intense, clean flame that actually gives three times the heat of coal.

Cuts Housework 80%

This modern invention turns any coal or wood burner into a real up-to-date gas stove. Think what it means to the housewife—no more dirty, heavy coal to carry and lift—no more clouds of ashes to breathe—no more fires to build, bank and watch—no more cold rooms in winter—or more burned, under-cooked food on account of an uncertain fire. The house doesn't get dirty half so quick; an authority says that this convenience actually eliminates 80% of all housework.



150,000 Already in Use

But this is no untried experiment. Over 150,000 Oliver burners are already being used. In Northern Canada, even in cold Alaska, the Oliver is being used to heat rooms through Arctic Winters. Yet this wonderful heat can be regulated to any degree, high or low, by simply turning a valve. It is just the thing for uncertain Fall weather. Physicians recommend the Oliver as a sure safeguard against colds, influenza, etc. It is absolutely safe—will last a lifetime. Perfect heating guaranteed.

FREE Book!

A special Low Introductory Price is now being made by Mr. Oliver, because he wants every American housewife to see how this invention works, in her own stove. Now—once and for all you can do away with household dirt and drudgery—you can protect your family's health during coldest Winter. Write immediately to the Oliver Oil-Gas Burner Co., B-57 Oliver Bldg., St. Louis, Mo., and you will get full details of this offer and an attractive Free Booklet. There is no obligation. Specify whether you are interested in a heating stove, cook stove or furnace burner. And you should write at once to get the advantage of this Special Low Price Introductory Offer. Agents, sparetime workers and distributors should address Mr. B. M. Oliver, President, for complete details of how Oliver representatives are making from \$75 to \$200 a week and more.



5-Room \$548
ALADDIN

We Pay the Freight

You can buy all the materials for a complete home direct from the manufacturer and save four profits on the lumber, millwork, hardware, labor.

6-Room \$695
ALADDIN

Living room, dining room, 2 bedrooms, kitchen, bath, 4 other plans, some with pantries, dining alcoves, grade and inside cellar entrances. Get free Aladdin Catalog.

7-Room \$975
ALADDIN

Aladdin catalog contains seven different plans of this house; some with inset porches, grade and inside cellar entrances, two and three bedrooms.

Price includes all lumber cut to fit; highest grade interior woodwork, siding, flooring, windows, doors, glass, paints, hardware, nails, lath, roofing, with complete instructions and drawings. Freight paid to your station. Permanent Homes—NOT PORTABLE. Many styles to choose from. Write nearest mill today for FREE Money-Saving Aladdin Catalog No. 933.

The ALADDIN Co., BAY CITY, MICHIGAN
Wilmington, North Carolina; Portland, Ore.; Toronto, Ont.

\$33 UP **FARM ENGINES**

Saved \$21 ordering direct from your factory says W. Price, Ind. You will save on our reliable engine—built to do hard, heavy work. Kerosene, gasoline. Easy to start—no cranking. Sizes 1-4 to 25 H.P. 3 Months Trial. Cash. Easy Terms. 10-Year Guarantee. Free Book—"How to Know Better Engines." Write today. **THE OTTAWA MFG. CO.** 521-2 King Street, Desk 531-2, Magee Bldg., OTTAWA, KANSAS PITTSBURGH, PA.

Factory to Rider

Saves \$10 to \$25 on the Ranger Bicycle you select. You can have your choice of 44 Styles, colors and sizes. Delivered free on approval, express prepaid, for 30 DAYS' FREE TRIAL.

12 Months to Pay if desired. Possession and use at once on our liberal year to pay plan. Parents often advance first payment.

Tires best quality, at factory prices, express prepaid. Lamps, wheels and equipment, low prices. Send no money, do business direct with makers.

Mead Cycle Company Dept G108 Chicago

Write today for free Ranger Catalog, factory prices and installment easy payment terms.



Big Money for Spare Time Workers

This notice is written to interest the man who wants to earn some money and in return for very liberal pay would be willing to introduce to friends and neighbors the finest C. T. A. clothes selling for \$19.00, \$24.00, \$31.50, \$33.50 per suit. One man in each community can earn one of our best suits and in addition \$3 to \$12 for each order, besides extra cash bonuses, and many beautiful presents, including \$1000 in cash, Ford Sedan, Elgin Watch, Diamond Ring, etc. If you would like a fine suit and will be willing to show samples to at least a few men each week, send me your name and address and I will be glad to send you full details. C. A. Milligan, Manager.

Chicago Tailors Association, Dept. 551, 24 C. Chicago

You! can be a \$5000 Auto Expert!



Garage Owner or Manager



Automotive Expert



Automotive Electrician



Salesman, Demonstrator

"What Big-Pay Work Can I Learn Quickest?"



J. R. Bayston, M.S.A.E., Pres.
CHICAGO AUTOMOTIVE
INSTITUTE

Originator of the "Job-Way" System of Training
I give you this Tool Kit FREE
and train you to use it



18 Piece Master Mechanics' Tool Kit FREE!

This Complete \$15.00 outfit doesn't cost you one penny! Full size, everything you need to do the "Jobs." 75 lessons, 150 Jobs, 12 lectures and many Free features in the C. A. I. course. And "Cigarette Money" pays for it!

"THE C. A. I. JOB-WAY
TO BIGGER PAY!"

LOAN me an hour of your spare time a day! I'll guarantee to put you in the \$100.00 a week class quicker than you can learn any other big-pay work! **Don't quit your job! Stay home!** Thousands of men **no better than you** are making big salaries, holding down important jobs, earning enormous profits in their own business. I know how you can do the same, and I'll tell you how!

Learn Auto Repairing! Learn Automotive Electricity! Learn Vulcanizing, Welding, Battery!

My copyrighted "Job-Way" system teaches you in an hour what ordinarily takes a month to learn! The speed with which C. A. I. students get ALL the work of the complete course has astonished educators everywhere! So simple a school-boy can understand it. Think of it! 13,000,000 autos to repair each year—13,000,000 batteries to service—65,000,000 tires to sell and repair—3,000,000 trucks to overhaul. Do you realize how hungry employers are for competent men? Do you know what they're willing to pay for Automotive Experts? Can you imagine the opportunities today to make big money in a business of your own?

Coupon Brings FREE BOOK and FREE LESSON!

I don't ask you to risk a penny. I know you can learn to earn \$3,000 to \$8,000 a year as an Automotive Expert. So I guarantee in writing to return every cent of your money if you don't think it's the most profitable investment you ever made. I want you to send for my free book, read the free lesson, find out about my wonderful "Job-Way" method. See why I offer the most complete Automotive course for the least money, and on easiest payments. Mail Coupon or postal today!

MEN WANTED!

Thousands of big-pay jobs open right now, all over the U. S. Our Employment Service FREE to both students and graduates, teaches employers in every part of the Country. Look at this:

Master Mechanics	\$3,000 to \$8,000
Electrical Experts	\$3,600 up
Garage Manager	3,600 up
Battery Expert	2,400 up
Expert Welder	2,400 up
Salesman	3,000 up
Tractor Engineer	2,400 up

My graduates earn money fast enough to go into business. Own your own Garage, Battery Station, Ignition Service, Repair or Welding plant.



Mail Coupon for
FREE BOOK!

Bigger-Pay Coupon!

J. R. Bayston, M.S.A.E., Pres.
Chicago Automotive Institute
Dept. 702, 536 So. Clark St., Chicago

Without a penny of expense or the slightest obligation, please send me Free Book about your rapid course in Automotive Master Mechanics, and Free Tool Kit offer. Explain your money back guarantee. I want to see a Free Lesson, too.

Name.....

Address.....

CHICAGO AUTOMOTIVE INSTITUTE
J. R. Bayston, Pres., Dept. 702, 536 So. Clark St., CHICAGO

LEARN AT HOME THE C.A.I. JOB-WAY

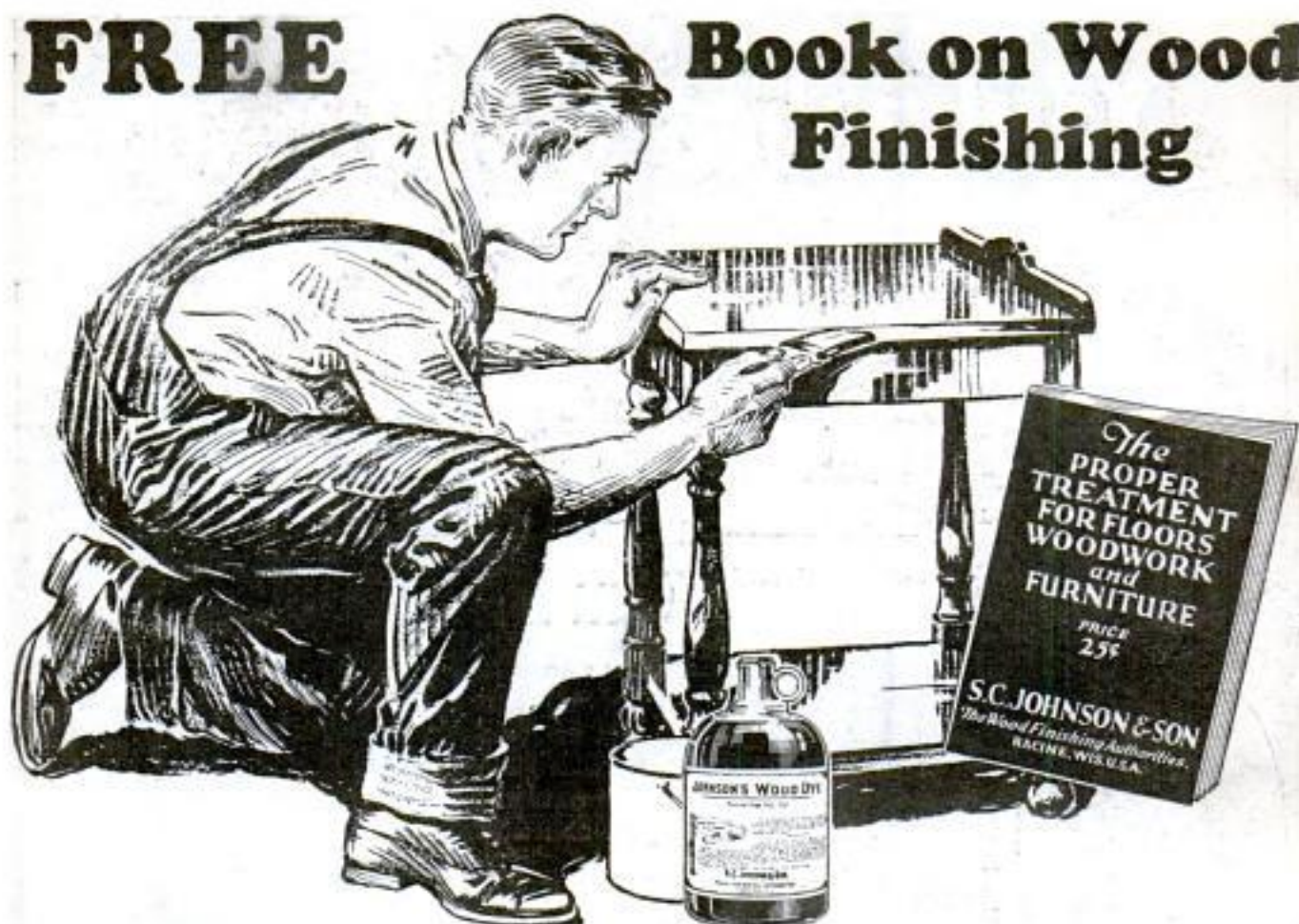
FREE**Book on Wood Finishing**

OUR book gives complete instructions for finishing all wood—hard or soft—old or new. Tells how inexpensive soft woods may be finished so they are as beautiful and artistic as hard wood. Explains just what materials to use and how to apply them. This book is the work of experts—beautifully illustrated in color—gives covering capacities—includes color charts, etc. Fill out and mail coupon below for a FREE copy.

JOHNSON'S WOOD DYE

Johnson's Wood Dye is very easy to apply—it dries in four hours and will not rub off or smudge—penetrates deeply—bringing out the beauty of the grain. Made in fourteen popular shades all of which may be easily lightened, darkened or intermixed. Full directions on every label.

Johnson's Wood Dye has many uses, for both the artisan and amateur. **Architects** and **contractors** specify it for coloring woodwork and flooring in new buildings. **Painters** and **decorators** use it with equal satisfaction on new and old woodwork of all kinds. **Housewives** delight in it for doing over old furniture and for coloring reed and wicker baskets, etc. **Manual training teachers** and **pupils** use it for finishing their models. **Upholsterers, furniture repairers** and **cabinet makers** find it "just the thing" for their work—old and new.

S. C. JOHNSON & SON, Dept. P.A. 2, Racine, Wis.
 "The Wood Finishing Authorities"

Please send me free and postpaid your Instruction Book on Wood Finishing and Home Beautifying.

My dealer is

My Name

Address

City and State

S. C. JOHNSON & SON

RACINE, WISCONSIN

(Canadian Factory—Brantford)

"The Wood Finishing Authorities"

HERE'S YOUR CHANCE To Get In Business for Yourself



Seven Floors of Auto Shops

The Greer Shops are located in this magnificent building. Seven huge floors—over 3 acres of space—filled with autos, tools, machines and up-to-date equipment. Learn by *doing*—in the big Greer Shops. Here's the short cut to getting in business for yourself.

Come to Chicago

We Pay Railroad Fare

Within 20 minutes' walk of the Greer Shops are at least 40 large Automobile Sales Agencies. Hundreds more are scattered throughout the city. There are, in addition, approximately 5000 Garages and Repair Shops. All want trained men. Here you are surrounded by business opportunities.

To fill openings that now exist, we will pay your railroad fare to Chicago, and find you a home. Coupon brings full offer.

Mail the Coupon

Chicago is the place to train for the Auto Business. Free Book tells why. Mail coupon for it at once.

GREER COLLEGE

of Automotive Engineering

2052 S. Wabash Avenue, CHICAGO, ILL.

Greer Offers You the Short Way

It takes years to learn the Auto business working for someone else. That is the *long* way to independence. Greer offers you the **Short** way. Here in the big Greer Shops you get practical training in every Auto subject in **Eight Weeks**. Then you are equipped to go in business for yourself—or we will **Guarantee** to get you a high paid job.

Little Capital Required

Providing you have proper training, as little as \$25 to \$50 invested in working equipment will start you in an Auto Shop of your own. Thousands of big shop and garage owners have started in this way. **You can do it too.** Let us show you how. The Coupon below brings full information.

Earn While You Learn. Easiest possible terms are given those who cannot afford full payment at the start. The coupon below brings full information.

Training by Actual Shop Practice

In the big Greer Shops you get actual work on 4, 6, 8 and 12 cylinder engines. Electricity thoroughly covered. All known Lighting, Starting and Ignition units used. Special Courses in Machine Shop, Batteries, Welding and Vulcanizing. Individual Road Lessons given. Complete Greer Master Training Course includes Machine Shop—Shop Management—Selling—Truck, Tractor and Automobile Repairing—Lighting—Starting—Vulcanizing—Storage Batteries—Driving—Every subject you need to run an Auto Business or get highest salaries anywhere.

How to Get the Training

Here in the heart of "Automobile Row" in Chicago are the big Greer Automotive Shops. Hundreds more Greer-trained men are needed for present and future opportunities. We **Guarantee** automotive employment to every Greer Graduate. If you are in need of assistance while training, our Free Employment Bureau helps you to

**FROM
HERE**

**IN
ONLY 8
SHORT
WEEKS**

**TO
HERE**

Mail the Coupon for FREE Book

Get this Free Book. It contains 107 Photographs, many Drawings, and is packed with information about the Auto Business. Getting this book has started thousands of men to independence. Mail the Coupon now. It will bring book and Special Training Offer.

"How to Succeed in the Automobile Business"

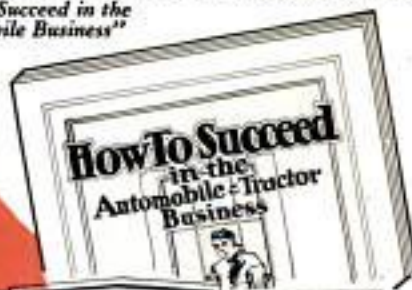

ERWIN GREER, President
2052 S. Wabash Ave., CHICAGO, ILL.

Please send me at once your Free Automobile Book and Special Training Offer.

Name

Address

Your Initial in two places on every piece

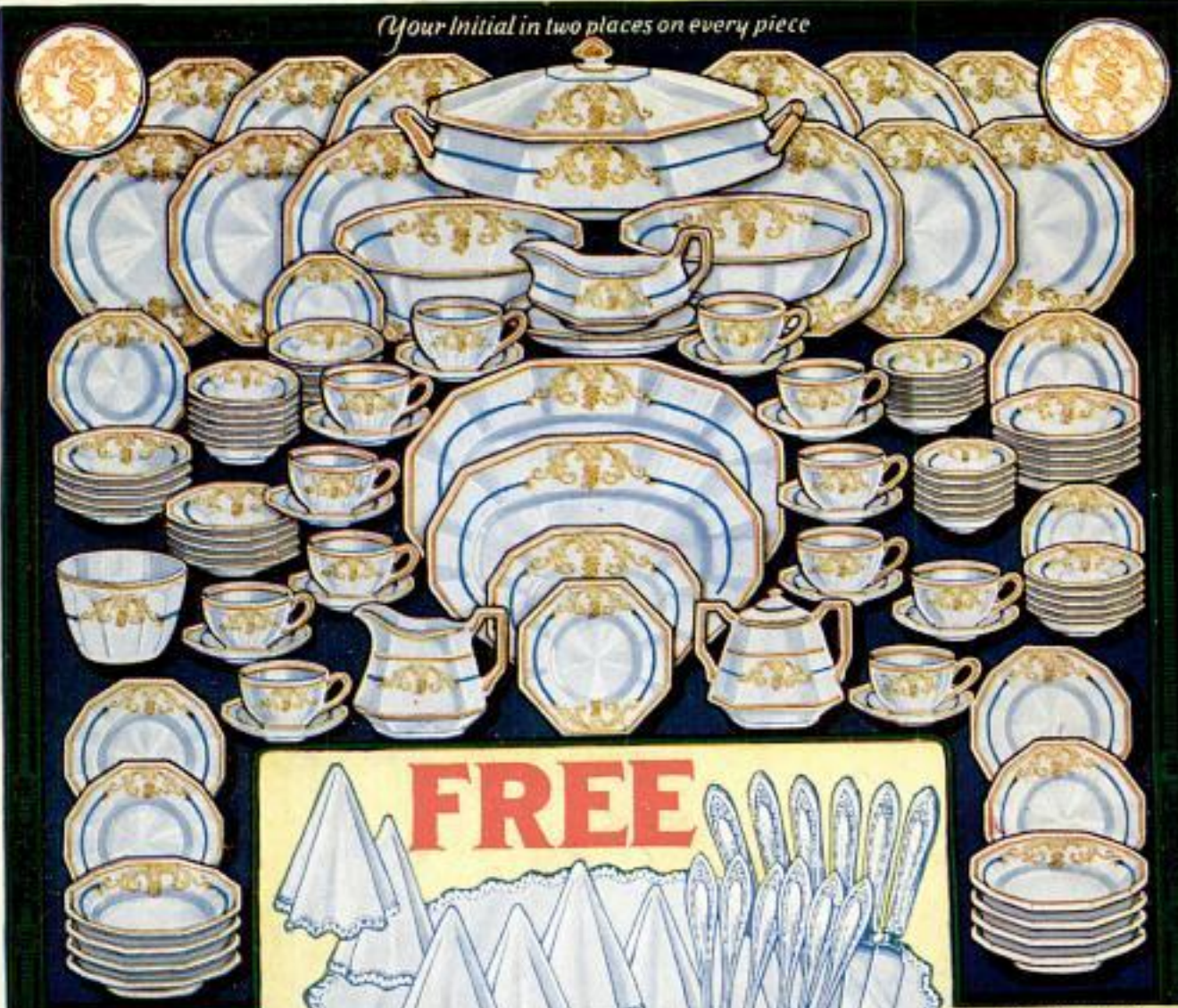

This superb 110-piece Set, consists of:
 12 Dinner Plates, 9 inches
 12 Breakfast Plates, 7 in.
 12 Soup Plates, 7 1/2 inches
 12 Fruit Dishes, 6 1/2 inches
 12 Cereal Dishes, 5 1/2 inches
 12 Individual Bread and Butter Plates, 6 1/4 inches
 1 Platter, 12 1/4 inches

12 Cups
 12 Saucers
 1 Platter, 11 1/2 in.
 1 Celery Dish, 8 1/2 in.

1 Sauce Boat Tray, 7 1/2 in.
 1 Butter Plate, 6 inches
 1 Deep Bowl, 8 1/2 inches
 1 Oval Baker, 9 inches
 1 Small Deep Bowl, 5 inches
 1 Gravy Boat, 7 1/4 inches
 1 Creamer
 1 Sugar Bowl with cover (2 pieces)
 1 Vegetable Dish, 10 1/2 in., with lid (2 pieces)



1 Brings 110-Pc. Martha Washington Blue and Gold Decorated Dinner Set
 Send only \$1 and Hartman will ship the complete set. Use it for 30 days on Free Trial. Then if not satisfied, send it back and Hartman will return your \$1 and pay transportation charges both ways. If you keep it, TAKE NEARLY A YEAR TO PAY—a little every month.



Your Initial in Gold, Surrounded by Wreath of Gold, in 2 Places on Every Piece (Gold Covered Handles)

Beautiful Colonial Martha Washington shape. All handles are of solid design and are covered with gold. Every piece decorated with a rich gold band edge, a mazarine blue follow band and 2 pure gold initials in Old English design with gold wreaths. Guaranteed firsts; no "seconds."

FREE Beautiful Centerpiece, Six Dainty Doilies to Match and 6 Silver Plate Knives and Forks

With every dinner set, we send FREE a 35-inch "Indian Head" linene centerpiece, 6 doilies, 12 inches in diameter to match, 6 extra silver plated knives and 6 extra silver plated forks, fleur-de-lis pattern. Only \$9.000 will be given Free with the Dinner Sets—so act quick. Send the coupon—NOW!

Order by No. 320FMA21. Bargain Price, \$32.85
 Pay \$1.00 Now. Balance, \$3.75 Monthly

The Centerpiece, 6 Dainty Doilies to Match, 6 Silver Plate Knives and 6 Forks are FREE
HARTMAN Furniture & Carpet Co.
 Dept. 5941 CHICAGO, ILL.

FREE BARGAIN CATALOG FREE GIFTS

316 pages of astounding bargains farm machinery, etc.; all on our easy in home furnishings, monthly payment terms—30 days' free trial. Also explains Hartman's FREE gift plan. Send postal for this big free bargain catalog today.

"Let Hartman Feather YOUR Nest"



HARTMAN Furniture & Carpet Co. Dept. 5941 CHICAGO, ILL.

Enclosed find \$1. Send me the 110-Piece Dinner Set No. 320FMA21. Price \$32.85, as described, and with it the centerpiece and 6 doilies, also 6 silver plate knives and 6 forks absolutely FREE. It is understood that if I am satisfied, I will send you \$1.75 monthly, until full price of Dinner Set, \$32.85, is paid. Title remains with you until paid in full. If not satisfied, after 30 days' free trial, I will ship all goods back and you will refund my \$1 and pay transportation charges both ways.

Name..... Occupation.....
 R. F. D., Box No., or Street and No.,.....
 Post Office..... State.....
 (If your shipping point is different from your post office, fill in line below.)
 Send shipment to.....