

JANUARY

N.S.E.

25 CENTS

POPULAR MECHANICS MAGAZINE

WRITTEN SO YOU CAN UNDERSTAND IT

REG'D. TRADE MARK. GREAT BRITAIN. No. 410426

REG. U. S. PAT. OFF.

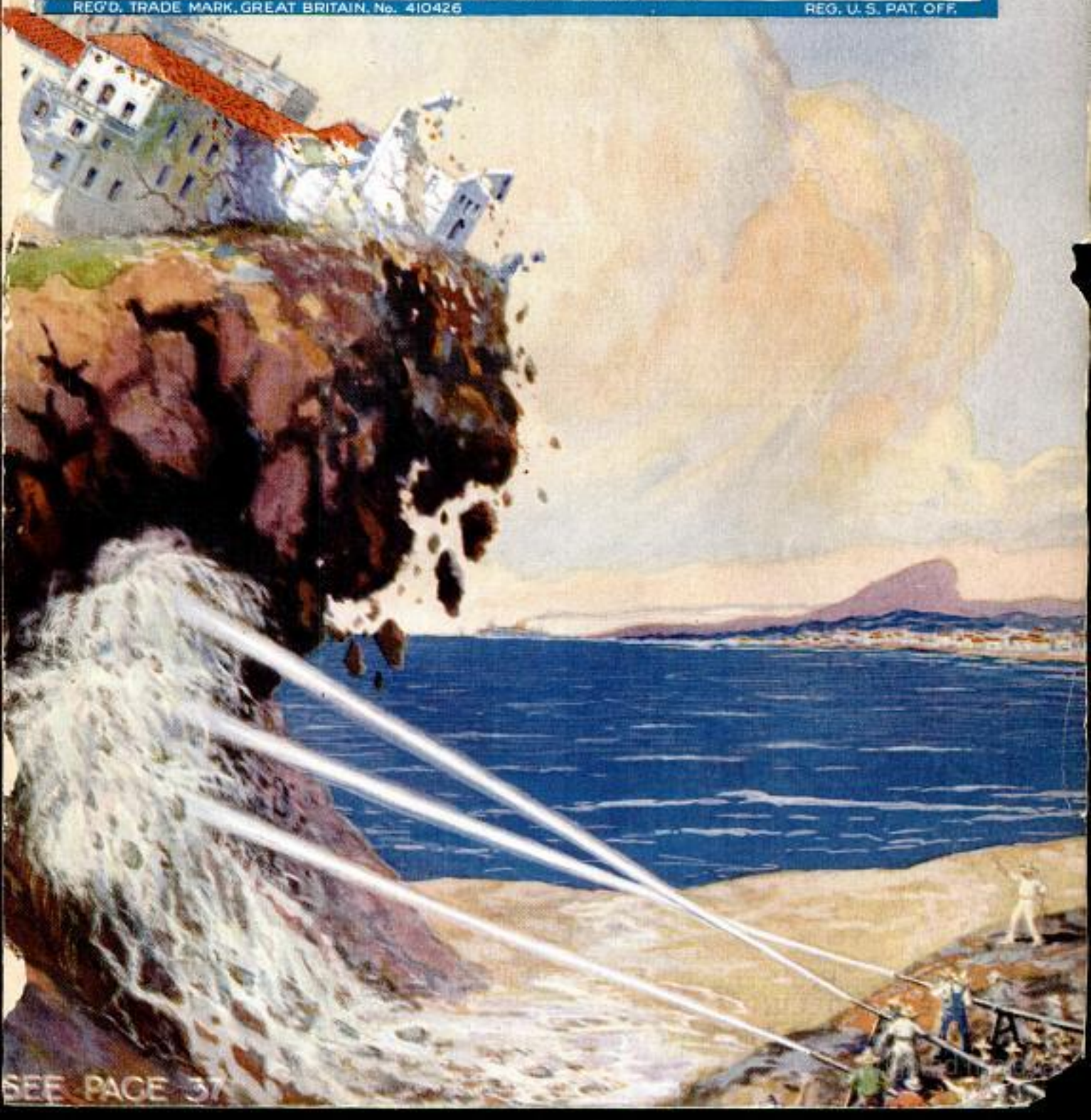

SEE PAGE 37

Takes Only 60 Days to Get a Big Job

Automobile Tractor & Electrical Catalog

FREE



My Cincinnati School



I'll pay your railroad fare both ways, and pay your board and room; no extras; no incidentals—in 10 weeks you can get a real job at real pay.

My Chicago School



No Experience, no Education Necessary. You Learn with your Hands under Experts in a Wonderful Shop. No Books. Success Sure.

RAHE-TRAINED MEN IN DEMAND

Rahe-Trained men earn \$200 to \$600 per month—no lay-offs or strikes. You Can Do It, Too. Own Your Own Garage. Send the coupon NOW for my Big Free Catalog.

YOU CAN DO WHAT THESE RAHE MEN DID

"My garage is a big success. I owe it to Rahe training."

—G. Smith, W. Alexandria, O.

"I got a fine job the day after I left school."

—W. C. Wyatt, Mt. Sterling, Ky.

"I thank Rahe training for a great job in the best garage in Lima."

—Howard Metzger, Lima, Ohio.

"Rahe Training was the best investment I ever made."

—Colby Lord, Oakland, Maine.

BE AN EXPERT IN—

Auto and Tractor Mechanics, Ignition, Starting, Lighting, Vulcanizing and Machine Shop Work. Takes only 60 Days.

ELECTRICAL COURSE INCLUDED

All kinds of wiring and generator work. All this in addition to the famous RAHE Life Scholarship, which permits you to return to the school AT ANY TIME for further work WITHOUT COST.

SPECIAL TUITION OFFER—Short Time Only

Send to My Nearest School for Free Catalog

Rahe Auto, Tractor & Electrical School

4445 Grand Boulevard
CHICAGO, ILLINOIS

Ninth and Walnut Sts.
CINCINNATI, OHIO

Desk 140
SEND ME YOUR BIG FREE CATALOG

Name _____

Address _____

City or R.R. _____

(No facilities for colored students)

Radiotron

REG. U. S. PAT. OFF.

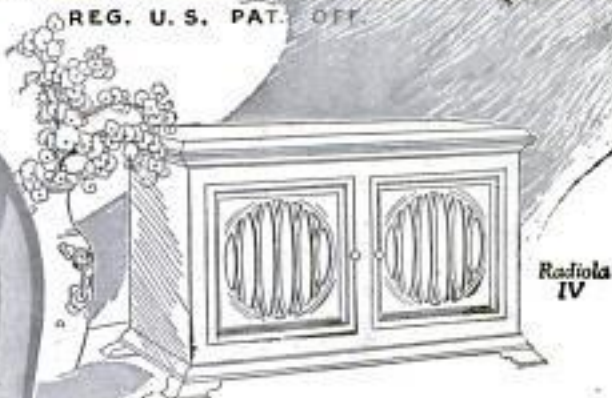

Radiola IV

In high quality receiving sets, vacuum tubes — the heart of their fine performance — carry the name **Radiotron** and the RCA mark. Be sure to look for this identification when you replace your tubes.



This symbol of quality is your protection



Radiola Grand

Radiotron WD-11 Radiotron WD-12
 Radiotron UV-199 Radiotron UV-200
 Radiotron UV-201-A

Radio Corporation of America

Sales Offices:

233 Broadway, New York

10 So. La Salle Street, Chicago, Ill.

433 California Street, San Francisco, Cal.

Radiola

REG. U. S. PAT. OFF.

Send for the free booklet that describes all Radiotrons and Radiolas.

RADIO CORPORATION OF AMERICA
 Dept. 511 (Address office nearest you.)
 Please send me your free Radio Booklet.

Name Street Address City R.F.D. State

"PUT A STOP TO DEPRECIATION—BUILD WITH CYPRESS AT FIRST!"



CYPRESS is SO MUCH *the best wood*—for SO MANY KINDS of uses—that only its more conspicuous merits can be covered in any single advertisement. CYPRESS advertising will therefore continue upon the broadest lines—with an educational purpose as *permanent and safe* as your investment in CYPRESS itself.

For the moment, (and as a guide of *real value* in your *Winter Plans* for *Spring Building*, or *Spring Improvements*, or the Repairs due to your not having known CYPRESS before) the vital CYPRESS *FACTS* may be condensed into 9 words:—

**"CUT OUT REPAIR BILLS—
BUILD OF CYPRESS AT FIRST!"**

If "it" (whether palace, bungalow, "back-steps" or *pasture fence*) is *already built*—

**MAKE YOUR NEXT REPAIRS WITH CYPRESS
and PUT A STOP TO DEPRECIATION**

SOME DIFFERENCE BETWEEN THESE HOUSES—(BOTH CYPRESS):

150 years ago a wise man built this substantial home of "The Wood Eternal."



In this house (of solid CYPRESS) in Sinepuxent, Md., the heroic Commodore Decatur was born, January 5, 1779. In 1884 a cyclone left it as photographed above—wrenched and half-denuded, BUT NOT DECAYED. CYPRESS is equal to an insurance policy against Ordinary Depreciation and Repairs.

Today the home-builder with equal wisdom, and more art, secures permanency, by using "The Wood Eternal."



This modern Colonial residence, in a fashionable Chicago suburb, is sided and trimmed with CYPRESS throughout. A good architect enabled the foresighted owner to achieve beauty and likewise practical insurance against repair bills not only for his lifetime, but for many generations to come. "Cut Out Repair Bills."



*CYPRESS is indeed "the wood eternal."
He who uses Cypress builds but once.*

Why not FIND OUT what CYPRESS can do for YOU, NOW?

INSIST ON TRADE-MARKED CYPRESS AT YOUR LOCAL LUMBER DEALER'S. IF HE HASN'T IT, LET US KNOW IMMEDIATELY.



SOUTHERN CYPRESS MANUFACTURERS' ASSOCIATION

1219 POYDRAS BUILDING, NEW ORLEANS, LA., or, 1219 GRAHAM BUILDING, JACKSONVILLE, FLA.

Files of Great Volcano. Ideal city - 4
mouse Short circuits Power Plant. 16
Executed for Burning Coal. - 17
Ready cut model houses sent to Europe

Popular Mechanics Magazine

200 E. Ontario Street, Chicago, U. S. A. Volume 22

H. H. WINDSOR, Editor

London: Hachette & Co.,
 16-17 King William Street, Charing Cross, W. C. 2

Paris: Hachette & Co.,
 111 Rue Reaumur

Melbourne, Australia
 The Australasian News Co.

ISSUED MONTHLY

SUBSCRIPTION:

SINGLE COPY, 25 CENTS

In United States and its possessions, also Canada, Cuba, and Mexico, per year, postpaid - \$3.00

To all other countries in the Postal Union - - - - - 3.50

All subscriptions are discontinued at expiration. Please examine the date printed on your wrapper.

Entered as Second Class Matter Sept. 15, 1903, at the Post Office at Chicago, Illinois, under Act of March 3rd, 1879.

Entered as Second Class Matter at the Post Office Department, Canada.

Published monthly by POPULAR MECHANICS CO.

Copyright, 1923, by H. H. Windsor. Copyright in Australia

Vol. 41

Alarm Siren auto sounds of
Chief starts motor 9/7
 Contents for January, 1924

No. 1

Accidents, Majority of, Occur on Crowded Streets	44	Drawings, Queer, Guard Babes from Evil Spirits	119
Agriculture—Wild Tribes Irrigate Barren Hills	121	Drill on Wheels, Electric, Cuts Construction Cost	79
Air Blower on Diesel Motor Increases Power	53	Eagles, Extinction Threatens	3
Airplane with Wings to Rise from Housetop	26	Earthquake, Native Japanese Tells of, by M. Sakata	69
Airplane, "Eyes" for, Aid Fliers	39	Egg, Beater, Odd Shaped	77
Airship Has Flapping Wings	88	Einstein Theory, Pipe Block Long Tests	61
America's Name, Hunt for, Leads to Dark Ages	77	Engine, Gasoline, Started by Exploding Cartridge	119
Animals, Wild, Automobile and Gun Eliminate	65	Eraser, Motor Driven	103
Apple Tree, Rare, Burglar Alarm Cage Guards	115	Eye, Cinder in, Extracted by Magnetic Loop	50
Art Glass Windows, Glories of Mankind Told in	54	Fertilizer, Sewage Plant of City Factory for	32
Ash Sifter, Dustless	63	Films, Tubular, Bring Motion Pictures to Home	52
Automobile Engine, Heat of, Governs Gas Supply	116	Fire, Fighting Seas of, in Timber Lands	18
Automobile Dash Light Has Adjustable Shade	103	Fire, River Made Ribbon of, by Wrecked Oil Train	86
Automobile Gets Heat from Hot Water of Radiator	111	Fish, Ice Preserves Shipped	80
Automobile Lock, Keyless	97	Fish, "Stone" of Tropics, Has Deadly Sting	7
Automobile, Porous Bearings Prolong Life of	64	Fishes, Trapping Strange, in South Sea	106
Automobile, Tag on, Marks as Guest	93	Fishing Bill, Testing Cords of Nets Cuts Nation's	77
Automobile, Two-Seater, Proposed as Taxicab	39	Flag Factory, Uncle Sam Maintains	83
Bank Accommodations, Ocean Liner Has	29	Flower Box, Reservoir in	81
Bank, Soil of Orient Becomes, for Natives	68	Footprints in Stone May Mark Early Race	74
Baseball, Father of, Honored by Memorial Picture	86	Forests Burned to Increase Growth of Trees	78
Bears, Polar, Fight in Zoo Tank	29	Fossils, Missing Link of, Found in Mongolia	80
Bee Travels 40,000 Miles for Pound of Honey	63	Fountain Pen Has Transparent Barrel	37
Bell's, World's Fair, Fate Shrouded in Mystery	115	Fracture, Metal Sprints for, Easily Adjusted	73
Bench, Folding, for Washtubs	118	Fruit Displayed on Motor Truck	38
Bicycle Is Boon to Victims of Japanese Earthquake	104	Gas, Bakery Generates Own, to Heat Ovens	97
Bills, Checker Saves Error in <i>Lunchroom</i>	5	Gas, Mask and Rubber Gloves Protect Painters	27
Block, Concrete Wheel, Locks Automobile to Floor	35	Gas Tank, Floating Roof of, to Stop Losses	76
Boat, Canal, Runs by Trolley	3	Gauge, Turbine Oil Pressure, Detects Air	124
Boat, Ice, Resembles Airplane	112	Geyser of Boiling Mud Seen in Alaskan Volcano	118
Boat, pontoons on, Prevent Rocking	17	Gold, Chemists Try to Make	44
Bolt Weevil, Trapping, in Fight on Pest	75	Gold Lures Americans to Siberia	92
Bookkeeping, First Text Book on	49	Golf Course, Entire, Laid Out in City Block	80
Bookmaking, Ancient Volumes Show Progress in	15	Golf Tee, Indoor, to Help in Perfecting Stroke	50
Bones of Men Buried 80,000 Years Ago Found	114	Guide, Columns, for Ledgers	111
Bridge, Fallen Weight Halts Traffic on Canal	2	Hat, Hard, Protects Workers from Head Injuries	111
Bridge, Foot, Made of Chicken Wire	98	Hinge, Adjustable, for Doors	53
Brush, Hand, and Pumice Combined	110	Homes, Workmen's, Built in New York	3
Bugs Aid in Studying Changes of Earth	27	Horn, Huge, Played by Six Midgets	43
Building, Nine Story, Moved by Twelve Horses	116	Horns, Musical Plug for	22
Bungalow Built in Tree Top	68	Horse Takes Ten-Foot Fall, Rescued	22
Cabinet, Heater, Controlled by Push Button	31	Hydroglider with Raised Motor Travels on Water	35
Cable, Thrills in Laying Deep Sea	94	Ideas, When Pioneer, Were Jest	40
Cactus Plant Like Mass of Serpents	64	Insects, Red Lights Lure to Deadly Fumes	15
Calculator, Toy, Helps Pupils	119	Instrument, Jazz, "Played" by Humming	39
Camera Catches Speed of Machine and Man	14	Iron, Electric, in Vanity Set for Travelers	74
Camera "Sees" Sun's Course in Polar Day	107	Iron, Cast, Fluids Harden	124
Can Opener Puts Rounded Edge on Tin	119	Keys, Name Plates on	33
Cap for "Squeeze" Container Prevents Leakage	79	Knife, Notched-Edge Bread	39
Capitol, Nation's, in Miniature Is Prized Model	82	Lamp, Oil Vapor, to Mark Hidden Sea Dangers	102
Chair, Motor, for the Aged	7	Lathe Turns Both Ends of Shaft at Once	122
Chalk, Dustless, Protects Health	121	Leadizing Process Protects Piping and Plates	122
Chandelier Serves as Banquet Hall	93	Leprosy, Coal Tar May Hold Remedy for	93
Checkers Played on Mammoth Board	98	Light Without Heat Sought in Electrified Vacuum	86
Cities Half Centuries Hence to Be "Built in Air"	77	Lion Has Cageless Den in Zoo	104
Clocks in Odd Figures	4	Lock, Trunk, A New	112
Coffee Mill Combines Grinder and Pot	86	Logs' Plunge Rivals Geysers	114
Comb, Paper, Promotes Sanitation	45	"Lumber," Sugar Cane, Resists Heat and Cold	26
Cow Modeled from Block of Butter	110	Magic Lanterns, Hidden World's Life Shown with	57
Cow, Skull of Stone Age, Found	78	Map of United States on Acre of Paper	59
Crops, Novel Booster for, in Nebraska Exhibit	4	Metal, Sheets of, to Replace Plaster and Wall Paper	72
Cutter Grinder, Variety of Tools Handled by	123	Milking Machine Works Like Hand	81
Dater, Pocket, Changed by Turn of Hand	45	Mine Blasting, Danger of Reduced <i>(Telephone)</i>	52
Detectives, Chemical, on the Case	46	Miners Rescued from Entrapped Mine	1
Dishes Broken to Test Hardness of China	35	Model, Tiny, Guides Sculptor in Fifteen Year Task	112
Diving Bell, Magnates Hold, to Ship	22	Music—Artillery and Sirens Play Soviet "Jazz"	2

[Continued on Page 4]



BU17-8Y7-OLSL

[Contents—Continued]

Money, Millions in Bad, Devoured by Machine	118
Money, Paper, Becomes Fad of Collectors	27
Motion Picture, Lifelike, Taken by Super Camera	73
Motion Pictures, Daylight, Showing of	121
Mountain Washed into the Sea	37
Mower Hitched to Trolley Car	103
Musical Instruments, Rubber Replaces Reed for	75
Needleworker's Art Demands High Price, Piece of	65
Opera's Glitter, Hidden Stars Make	8
Paint Can, Brush "Screws" in, to Close Top	116
Pantagraph Aids Instructors in Drawing	29
Penknife Made with a Safety Razor Blade	29
Periscope Aids Golf Players to See Hidden Green	68
Phonograph, Receiver on, Aids in Selecting Records	14
Photograph Test for Efficiency Reveals Lost Motion	88
Photographs, Mercury Burned Under Sea for	115
Photographs of Wind's Path Aid Pilot	114
Pianist, Exact Touch of, Put on Player Rolls	7
Piano Has Double Keyboard	86
Pins, Paper Roll Holder for	20
Plume Combines Beauty of Ten Thousand Feathers	82
Plymouth Rock Transplanted from Canada by Glacier	33
Pop Corn Bursts Open in Heat of Sun	76
Popular Mechanic's Records of Twenty Years Ago	34
Pump, Motor Driven Centrifugal	124
Quicksilver "Roasted" from Soil	119
Quinine Bearing Bark Found on Tree	14
Radiophone on Liner Works Like Wire Instrument	81
Rail Couplings, Blows from Hammer Tests	88
Raquet, Spring Clip on, Holds Tennis Ball	74
Ring, Notched Wedding, Worn to Denote Divorce	73
River Cutting New Course Undermines Shore	30
Roof of Building Held Up While Story Is Added	81
Rugs, Pictures Woven in, Show Race's Glory	82
Salt Crop, Harvesting, from Natural Beds	100
Sandals, Open, Recommended by Surgeons	103
Scissors Get Sharp Edges Cutting Metal Strips	68
Screen of Melted Gold Coins, Relics	17
Screws, Tool for Retreading	102
Seaphones Track "Footsteps" of Unseen Craft	38
Seaplanes, Tracking Fish in the Deep with	66
Shaft Hanger Made of Pressed Steel	122
Shields Protect Automobile While Men Work	79
Ship, Gas Formed in Grain Cargo Raises Sunken	73
Ship, Push Buttons Assist Wheel for Steering	63
Ship Rocked by Earthquake in Mid-Ocean	50
Ships Pass Above Lofty Hills in Journey Over Hills	72
Ship's Teeth, Pulling, Takes Crane and Forceps	33
Sidewalk of Seats, Moving, for New Yorkers	16
Skulls of Africans Reveal New Race	111
Skunk Is Friend of Farmer	50
Skyscraper Best Refuge in Storm	17
Slippers, Paper Bath	16
Smoke Curtain, Airplane, Hides Navy Forces	7
Snowfalls as Heavy as in Grandfather's Days	32
Sound, Study, by Recording Reversed Speech	112
Speed Motion, High, Becomes Slow for Critic's Eye	45
Spoons, Holder for Serving	72
Spraying and Cultivating Crops at Once	124
Statue Sealed in Bottle Made to "Bleed"	15
Steam Cleaner for Pipe Stem	65
Steamships on Night Trips Carry Illuminated Ads	74
Stepladder Permits User to Move it as He Works	104
Stones Sorted into Five Sizes by Machine	103
Stove, Electric, Controlled by Alarm Clock	27
Studios, Backyard, in Japan	116
Sulky, Baby, Has Locked Seat	115
Surgeon Operates on Conscious Patient	53
Sweeper, Street, Is Motor Driven	123
Tank Tread Builds Own Road for Oxcart	23
Telephone Receiver Held to Ear by Bracket	107
Telephone Talk Received on Wax Roll	65
Tire, Puncture Proof	23
Tires, Automobiles, from Jungle to Factory	108
Tombs of Mystery, Picks and Shovels to Rifle Old	73
Tooth Brush and Paste Combined	100
Tractor, Mammoth, Built for Logging Operations	49
Trees Dyed Any Color with Chemicals	33
Trees, Sheet Tin Around Limbs Protects	104
Trousers, Pressing, Electric Valet for	72
Tunnel Bored into Sierras Gets Water for Power	31
Viol, Bass, Measures Fourteen Feet	88
Walls, Bright Colored, Cut Cost of Lighting	82
Warship, Insulators on, Like Strings of Beads	4
Warships Now Chained to Docks	44
Warships, United States, on the Auction Block	24
Washer, Tiny Electric Clothes	88
Wealth of Pirates, Government Asked to Return	49
Windmills of Holland Give Way to Oil Engines	99
Window, Hinged, in Automobile Door	15
Wires, Street Car, Disturb Telegraph Cable	110
World's Dark Corners, Strange Scenes in	89
X-Ray Movies Show Machinery in Operation	92

SHOP NOTES

Automobile Clutch Shaft, Repairing	131
Bridge Abutments, Preventing Scouring of	143
Can Opener, Quick Action	143
Casters Facilitate Tinsmith's Work	128
Chute Distributor, A Work	126
Circle Making Tool	131
Clamp for Woodworker's Bench	141
Coil Spring, Flattening the Ends of	134
Corn Shock Tightener	130
Cup, Removing the Roller or Ball Bearing	144
Drawing an Ellipse by Projection	142
Envelopes, Avoiding Waste of	134
Floor Boards, Raising Sunken	135
Glucose for Antifreezing Solution	142
Hacksaw, Power, Made from Automobile Engine	129
Hoist Tackle, Adjustable Cable Hook for	141
Hole Centers, Transferring	126
Lamp, A Simple Spirit	131
Lathe Centers, Lubricating	128
Lathe Cuttings, Breaking Off	144
Mats, Cocoa, for Workers	129
Metal, Sheet, Method of Straightening	141
Micrometer, Holder for Inside	127
Paint, Method of Mixing	143
Pipe, Acid Clears Clogged	143
Piston Head on Pump, Packing	135
Plugs, Unscrewing Separable	127
Polishing Wheel, Improvised	127
Pulley, Making a Leather	129
Pulleys, Machining Two Cone, on One Mandrel	136
Pump, A Simple Acid	144
Pump, Driving the Farm, Electrically	125
Riveter, A Hand Operated	137
Sander, A Vertical Spindle Bench	132
Shaft Centering and Caliper Tool	137
Shovel, Auxiliary Handle for	136
Sprayer, Homemade	136
Tank, A Septic, for the Farm	138
Tanks, Lowering Storage	127
Thin Pieces, Soldering	142
Vat for Scalding Hogs	135
Vise, Pipe, Homemade	130
Wedge Jack for Planer	128
Wheelbarrow for Soft Soil	129
Wood, Moisture Resisting Coats for	140
Wrench, Adjustable Spanner	135

AMATEUR MECHANICS

Automobile Engine, Vacuum Bottle Aids in Starting	159
Automobile Hood, Fender for	147
Automobile, Locking the Closed	154
Automobiles, Easy Starting Fluid for	155
Baby Carriage, Detachable Runners for	159
Baseball Game, A Homemade	145
Battery Polarity, Testing	155
Binding Posts, Improving	160
Boats, Motor, Mooring Small	149
Brush for Washing Automobiles	148
Clarinet Reeds, Trimming	158
Clothespins Handy, Keeping the	156
Coal Cabinet, Homemade	159
Cork Extractor	154
Cotter Pins, Emergency	159
Cover for Egg Crock	147
Drain, Cellar, Converted into Trap	148
Fireplace Dampers, Regulating	154
Floor Cracks, Putty for	149
Floors, Shellacs for	155
Furniture, Turned Posts for Homemade	149
Garage Heater, Emergency	158
Guard for Ax Handles	161
Holder, Dry Plate	156
Humidifier, A Furnace System	156
Leaves, Method of Carrying Large Quantities of	161
Mechanics, Amateur, Hints for	162
Multiple-Phone Connector	161
Photographic Plateholders, Fit, Making	147
Poultry Waterer Made from Carburetor	160
Pump Repair Bills, Buggy Spring Saves	155
Radio—Making an Inexpensive Crystal Receiver	157
Sardine Tins, Method of Opening	154
Screen, Catch for Sliding	148
Sewing Machine, Remodeling an Old	160
Still, Radiator Used as	161
Toboggan, A Ski	149
Trick, An Amusing	155
Vacuum Tanks	150
Wreath, Christmas, Illuminating	147

DRAKE'S PRACTICAL MECHANICAL BOOKS

THEY WILL RAISE YOUR PAY—

ORDER ON 5-DAY TRIAL

The books listed below will perfect you in your chosen trade — pave the way to the big positions. Written in non-technical language—easy to read and understand. *Every book covers its subject completely. An entire course of instruction condensed into one volume.* Your choice sent postpaid — you benefit 5 days — money refunded in full if not entirely satisfactory. Order direct from this page.



Automobile Books

Automobile Ignition, by Manly	Leatherette	\$2.00
Automobile Starting and Lighting, by Manly	Leatherette	\$2.00
Brookes' Automobile Handbook	Leatherette	\$2.00
Ford Motor Car, Truck and Tractor, by Manly	Cloth	\$1.50
Starting and Lighting Troubles, Remedies and Repairs, by Manly	Leatherette	\$3.00
Automobile Battery, Care and Repair, by Manly	Leatherette	\$2.00
Automobile Catechism and Repair Manual	Leatherette	\$1.50
Tires and Vulcanizing, by Tufford	Cloth	\$2.00
Gas and Oil Engine Handbook	Cloth	\$1.50
Automobile Upkeep and Care, by Manly	Cloth	\$1.50
Motorcycle Handbook, by Manly	Cloth	\$1.50

Shop Practice Books

Sheet Metal Workers' Manual	Leatherette	\$2.00
Oxy-Acetylene Welding and Cutting	Cloth	\$1.25
Slide Rule and Logarithmic Tables	Leatherette	\$2.00
Handbook for Millwrights	Cloth	\$2.00
Modern Blacksmithing	Cloth	\$1.25
Machine Shop Practice	Cloth	\$2.00

Mechanical Drawing and Machine Design	Cloth	\$2.00
Pattern Making	Cloth	\$1.50

Carpentry Books

Cloth Binding	
Modern Carpentry, 2 vols.	\$3.00
The Steel Square, 2 vols.	\$3.00
Wooden Boat and Shipbuilding	\$1.50
Modern Estimator	\$1.50
Timber Framing	\$2.00
Builder's Architectural Drawing	\$2.00
Concrete	\$1.50
Practical Bungalows	\$1.00
Low Cost Homes	\$1.00
Roof Framing, by Van Gasbeek	\$1.50
Stair Building and Hand Railing	\$1.50

Electrical Books

Practical Applied Electricity	\$2.00
Alternating Current	\$1.50
Electric Motor Control Systems	\$1.50
Wiring Diagrams and Descriptions	\$1.50
Electrical Tables and Data	\$1.50
Armature and Magnet Winding	\$1.50
Modern Electrical Construction	\$1.50
Modern Electric Illumination	\$1.50
Electricians' Operating and Testing	\$1.50
Motion Picture Operation	\$1.50
Drake's Electrical Dictionary	\$1.50
Electric Motors, D. & A.	\$1.50
Electrical Measurements and Meter Testing	\$1.50
Drake's Telephone Handbook	\$1.50
Easy Experiments	Cloth \$1.25
Wireless Telegraph and Telephone Handbook	Cloth \$1.25
Telegraphy Self-Taught	Cloth \$1.25

Steam Engineering

Swingle's Handbook for Steam Engineers and Electricians	Leatherette	\$4.00
Examination Questions and Answers for Marine and Stationary Engineers	Leatherette	\$2.00
Steam Boilers	Leatherette	\$2.00
Swingle's Catechism of Steam, Gas and Electrical Engineering	Leatherette	\$1.50

Painting Books

Scene Painting and Bulletin Art	Cloth	\$4.00
A Show at Sho' Cards	Cloth	\$4.00
Sign Painting	Cloth	\$4.00
Strong's Book of Designs	Leatherette	\$4.00
Strong's Art of Show Card Writing	Cloth	\$4.00
Signalist's Alphabets	Cloth	\$1.50
Modern Painter's Cyclopedia	Cloth	\$2.00
Automobile Painting	Cloth	\$1.50
Estimates, Costs and Profits, Painting and Decorating	Cloth	\$1.50
New Hardwood Finishing	Cloth	\$1.50
The Amateur Artist	Cloth	\$1.50
New Stencils	Cloth	\$1.25
Chalk Talk and Crayon Presentation	Cloth	\$1.25

Farm Books

Farm Mechanics	Cloth	\$1.25
Farm Buildings	Cloth	\$1.25
Farm Engines	Cloth	\$1.25
Traction Farming	Cloth	\$1.50

Business and Reference Books

Better Business Letters	Cloth	\$1.00
Better Business English	Cloth	\$1.00
Better Advertising	Cloth	\$1.00
Finger Prints Simplified	Cloth	\$1.25
Practical Bricklaying	Cloth	\$1.25
Practical Instruction for Detectives	Cloth	\$1.00
Practical Plumbing	Cloth	\$1.50
Hot Water Heating	Cloth	\$1.50
Elementary Chemistry	Cloth	\$1.50
Courses in Civil Service	Cloth	\$1.50
Cyclopedia of Recipes	Cloth	\$1.50
American Star Speaker	Cloth	\$1.50

Modern Languages

By Prof. F. S. Allen, U. of Chicago	
French without a Teacher	Cloth \$1.25
Spanish without a Teacher	Cloth \$1.25
German without a Teacher	Cloth \$1.25
Everyday French	\$1.25
Everyday Spanish	\$1.25

ORDER DIRECT FROM THIS PAGE—ON OUR MONEY-BACK PLAN

The books listed above are only a few of the many in our catalogue, which you will receive promptly after filling out and mailing us the attached coupon. For quick action order direct from this page—cross name of each book wanted and send in with price quoted. We prepay postage and send the books on our money-back plan.

FREDERICK J. DRAKE & CO.

PUBLISHERS

1008 Michigan Ave., Chicago

Drake Books Are For Sale at All Book Stores

FREDERICK J. DRAKE & CO.
1008 Michigan Avenue
Chicago, Ill.

GENTLEMEN:—Please send me free, postage paid, your illustrated catalogue which lists and describes over 100 Practical Mechanical Books for Home Study.

My name is

and my address

Mail Coupon For Free Catalogue
Your Guide to Home Study

Discovers New Heating Device Which Burns 95% Air



B. M. OLIVER

Did you ever think of burning air in order to heat your home or do your cooking? I have a new invention, gives two times the heat of coal or wood—yet burns 95 per cent air, and only 5 per cent oil.

Thousands of housewives, happy to be free from the drudgery of coal and wood, are enthusiastic about my amazing new invention—the Oliver Oil-Gas Burner. It frees them from the dirt and muss of heating and cooking the old way and, also, it saves them expense and worry of coal and wood.

The device sets right in the fire box of any stove or furnace. It is entirely safe and requires no adjustment. Just a turn of a little valve and the housewife instantly has as much or as little heat as she wants—two times the heat of coal or wood—when she needs it in the coldest weather. I want every woman to have the use of my invention.

If you will write to me, you will receive an attractive booklet FREE that tells all about it. I am now making a special Low Price Introductory Offer, and am also looking for good live distributors. If you are interested I will tell you how to earn \$500 per month, or, in only your spare time, how you can make \$100 per month. Write to me today for Free Sample Case Offer. Address Mr. B. M. Oliver, A-57 Oliver Building, St. Louis, Mo.

You can easily learn to play any music on the **TENOR BANJO**

You Play a Piece of Real Music Your First Lesson

Imagine the joy that will be yours when you surprise your friends with your wonderful playing of the TENOR BANJO. You will find it so amazingly easy to learn that you will thank your stars that you wrote us.

TENOR BANJO is the Most Popular Instrument of the Age

—and Prof. Barker's method of teaching is so simple and easy that you will quickly learn to play any and all of the popular dance hits just as you have heard them played by expert musicians—in dance orchestras, on the stage—everywhere.

No Previous Musical Knowledge Necessary -- Quick -- Easy -- Positive

Only 5 motions to acquire, and you learn them quickly; after that a short period of easy practice and long before you can play our Conservatory Course, you will be playing "Stumbling" "Three O'Clock in the Morning" "Hot Lips" and other popular hits. We furnish free a handsomely finished \$15.00 Banjo, and all necessary equipment -- THERE ARE NO EXTRAS!

Be the Center of Interest Among Your Friends Don't hesitate because you may not be able to read music -- simply write us on a post card -- "I am interested in your FREE TENOR BANJO Offer and course of 12 lessons." When you get our amazing offer, we know you will enroll at once. Rush Post Card to us today.

Special courses under famous teachers:
Hawaiian Guitar
Viola - Ukulele
Instrument - Frog

First Hawaiian Conservatory of Music, Inc.
Desk 60
233 Broadway, (Woolworth Bldg.)
New York City

THIS \$15.00 TENOR BANJO FREE



STAMMER

If you stammer attend no stammering school till you get my large FREE book entitled "STAMMERING, Its Origin and the Advanced Natural Method of Cure," bound in cloth and stamped in pure gold. Ask for special tuition rate and a FREE copy of "The Natural Speech Magazine." Largest, best equipped and most successful school in the world for the cure of stammering; stammering, etc. No sing-song or time beat. Write today. The North-Western School, 2317 Grand Ave., Milwaukee, Wis.

LEARN WATCHMAKING

and become independent. Good-paying positions secured. Easy to learn. Send for FREE CATALOG.

ST. LOUIS WATCHMAKING SCHOOL, Dept. 5, ST. LOUIS, MO.

LAW

STUDY AT HOME
Become a lawyer. Legally trained men win high positions and big money in business and public life. Greater opportunities now than ever before. Lawyers earn \$3,000 to \$10,000 Annually. We guide you step by step. You can train at home during spare time. Let us send you records and letters from LaSalle students admitted to the bar in various states. Degree of LL.B. conferred. Thousands of successful students enrolled. Low cost, easy terms. We furnish all text material, including fourteen-volume Law Library. Get our valuable 120-page "Law Guide" and "Evidence" books FREE. Send for them—NOW.
LaSalle Extension University, Dept. 164-L, Chicago, Ill.

BE A TRAFFIC MAN

Earn \$50 to \$150 Weekly

With the energetic revival of business activities, the demand for men trained to handle transportation problems is greater than ever before. Our highly specialized course prepares you for this high salaried profession. Personal attention and practical experience—with successful Traffic Men. Special plan to help pay your tuition. Post graduate course FREE. Write today for full information.

INTERSTATE TRAFFIC SCHOOL
101 Traffic Bldg. FORT WAYNE, IND.

Whatever Your Question;—be it the pronunciation of Fascista, the spelling of a puzzling word, the location of Esthonia the meaning of soviet, realtor, vitamin, etc., this Supreme Authority—

WEBSTER'S NEW INTERNATIONAL DICTIONARY

contains an accurate, final answer. 407,000 Words. 2700 Pages. 6000 Illustrations. Regular and India-Paper Editions. G. & C. MERRIAM CO., Springfield, Mass. Write for specimen pages, prices, etc. and FREE Pocket Maps per POPULAR MECHANICS



WANTED! Get \$1600 to \$2300 a Year

U.S. RAILWAY MAIL CLERKS

MEN—BOYS 18 OR OVER

MAIL COUPON IMMEDIATELY

Steady Work—No Layoffs—Paid Vacations
Travel—See Your Country
Common Education Sufficient—Send Coupon Today—SURE

Franklin Institute, Dept. E179, Rochester, N. Y.
Sirs: Send me, without charge, (1) sample Railway Mail Clerk Examination questions; (2) tell me how to get a U.S. Government job; (3) send list of places at which examinations will be held; (4) send copy of illustrated book, "How to Get Government Jobs."

Name.....
Address.....

PRACTICAL ELECTRICITY SELF TAUGHT COMPLETE COURSE IN ELECTRICITY FOR FREE EXAMINATION



HAWKINS ELECTRICAL GUIDES

3500 PAGES—4700 PICTURES—\$1 A VOLUME—\$1 A MONTH—10 VOLUMES

OVER 5000
READERS
HAVE
OWNED
THIS
SET

Know the facts in Electricity. They mean more money and better position for you. Hawkins Guides tell you all you need to know about Electricity. Every important electrical subject covered so you can understand it. Easy to study and apply. A complete, practical working course, in 10 volumes. Books are pocket size; flexible covers. Order a set today to look over.

LEARN ALL ABOUT THESE IMPORTANT POINTS

Magnetism—Induction—Experiments—Dynamamos—Electric Machinery—Motors—Armatures—Armature Windings—Installing of Dynamamos—Electrical Instrument Testing—Practical Management of Dynamamos and Motors—Distribution Systems—Wiring—Wiring Diagrams—Sign Flashers—Storage Batteries—Principles of Alternating Currents and Alter-

nators—Alternating Current Motors—Transformers—Converters—Rectifiers—Alternating Current Systems—Circuit Breakers—Measuring Instruments—Switchboards—Wiring—Power Stations—Installing—Telephone—Telegraph—Wireless—Belts—Lighting—Railways. Also many Modern Practical Applications of Electricity and Ready Reference Index of the ten numbers.

FREE Not a cent to pay until you see the books. No obligation to buy unless you are satisfied. Send Coupon now—today—and get this great help library and see if it is not worth \$100 to you—you pay \$1 a month for ten months or return it.

THEO. AUDEL & CO., 72 Fifth Ave., New York City

Please submit me for free examination, HAWKINS ELECTRICAL GUIDE. (Price \$1 a number). Ship at once prepaid, the 10 numbers. If satisfactory, I agree to send you \$1 within seven days and to further mail you \$1.00 each month until paid.

Name.....

Occupation.....

Employed by.....

Home Address.....

Reference.....

PM Jan. 24



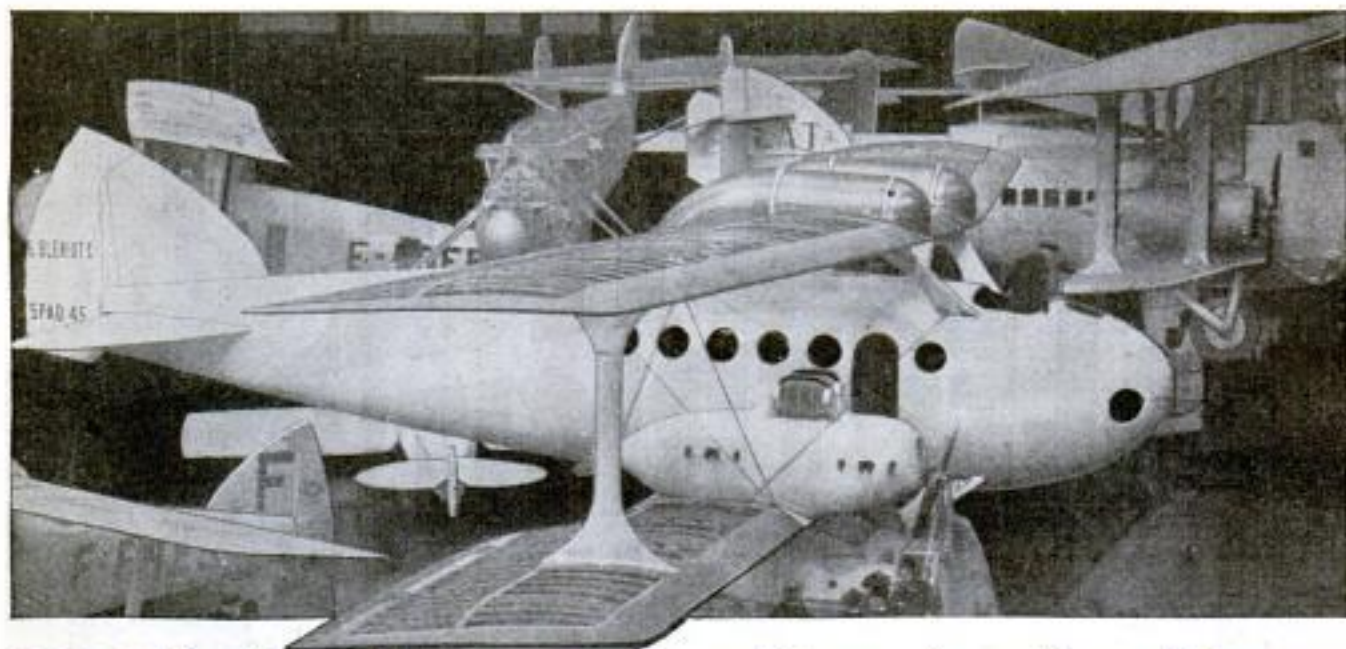

Quick Success in Aviation Fascinating—Daring—Big Paying

To young men of daring, no other field of work offers such a fascination, such high pay, nor such opportunities for quick success as the field of Aviation. As yet, aviation is practically in its infancy. NOW is the time to get in.

Amazing Opportunities in Airplane Industries

In the automobile industry and in the moving picture business hundreds of men got rich by getting in at the start. They made their success before others woke up. Today, these lines offer no greater opportunities than a hundred and one others. BUT AVIATION IS NEW. Get in while the opportunity and pay are big. All over the country there is a clamor for trained men. It is not a question of pay, but of getting capable men.

**HERE ARE REAL
POSITIONS, \$50 TO
\$150 PER WEEK**



View in an Airplane Factory

Aeronautical Instructor, Aeronautical Engineer, Aeronautical Contractor, Airplane Repairman, Airplane Mechanician, Airplane Inspector, Airplane Salesman, Airplane Assembler, Airplane Builder.

AMERICAN SCHOOL OF AVIATION
3601 Michigan Ave., Dept. 1191, Chicago, Ill.

Without any obligation, send me your Free Book, "Opportunities in the Airplane Industry," also information about your Course in Practical Aeronautics.

Name.....

Street.....

City..... State.....

A Sure and Easy Way to Learn Aviation—at Home



A New Job—The Aerial Postman

The study of aviation is almost as fascinating as the actual work. Every lesson is full of interest. That is why it is easy to learn aviation. You do not have to make yourself study—it is like reading an interesting book that tells you things you have always wanted to know. Only one hour each evening will give you the basic training in a surprisingly short time. You need only a common school education.

One of my students, James Powers, Pa., says, "I am indeed surprised that such a valuable Course can be had from such practical men for so little cost."



A New Seven-Passenger Airplane

Personal Instruction by Experienced Men

Men who have had actual experience give you personal attention. They select the lessons, lectures, blueprints and bulletins. They tell you things that are essential in everyday practice. Each lesson is easy to read and understand.

Big Book of Opportunities FREE

Send coupon at left for New Book, just out, "Opportunities in the Airplane Industry." It is interesting and instructive. It will show you many things you never knew before about aviation. Due to shortage of paper we could get only a limited supply of these books—send the coupon before they are all gone.

AMERICAN SCHOOL OF AVIATION
3601 Michigan Ave., Dept. 1191 Chicago, Ill.

How I Increased My Salary More Than 300%

By JOSEPH ANDERSON

I AM just the average man—twenty-eight years old, with a wife and a three-year-old youngster. I left school when I was fourteen. My parents didn't want me to do it, but I thought I knew more than they did.

I can see my father now, standing before me, pleading, threatening, coaxing me to keep on with my schooling. With tears in his eyes he told me how he had been a failure all his life because of lack of education—how the untrained man is always forced to work for a small salary—how he had hoped, yes, and prayed, that I would be a more successful man than he was.

But no! My mind was made up. I had been offered a job at \$9 a week and I was going to take it.

That nine dollars looked awfully big to me. I didn't realize then, nor for years afterward, that I was being paid only for the work of my hands. My brain didn't count.

THEN one day, glancing through a magazine, I came across the story of a man just like myself. He, too, had left school when he was fourteen years of age, and had worked for years at a small salary. But he was ambitious. He decided that he would get out of the rut by training himself to become expert in some line of work.

So he got in touch with the International Correspondence Schools at Scranton and started to study in his spare time at home. It was the turn in the road for him—the beginning of his success.

Most stories like that tell of the presidents of great institutions who are earning \$25,000 and \$50,000 a year. Those stories frighten me. I don't think I could ever earn that much. But this story told of a man who, through spare-time study, lifted himself from \$25 to \$75 a week. It made an impression on me because it talked in terms I could understand. It seemed reasonable to suppose that I could do as well.

I tell you it didn't take me long that time to mark and send in that familiar coupon. Information regarding the Course I had marked came back by return mail. I found it wasn't too late to make up the education I had denied myself as a boy.

I was surprised to find out how fascinating a home-study course could be. The I. C. S. worked with me every hour I had to spare. I felt myself growing. I knew there was a bigger job waiting for me somewhere.

Four months after I enrolled my employer came to me and told me that he always gave preference to men who studied their jobs—and that my next salary envelope would show how much he thought of the improvement in my work.

Today, my salary is more than 300% greater than it was when I began my studies. That increase has meant a better home and all the luxuries that make life worth while.



What I have done, you can do. For I am just an average man. I had no more education to begin with than you have—perhaps not as much. The only difference is a matter of training and a resolve to be like Lincoln, who said—"I will study and get ready and some time my chance will come."

TO every man who is earning less than \$75 a week, I say simply this:—*Find out what the I. C. S. can do for you!*

It will take only a minute of your time to mark and mail the coupon. But that one simple act may change your whole life.

If I hadn't taken that first step four years ago I wouldn't be writing this message to you today! No, and I wouldn't be earning anywhere near \$75 a week, either!

INTERNATIONAL CORRESPONDENCE SCHOOLS Box 5569-D, Scranton, Penna.

Without cost or obligation, please tell me how I can qualify for the position or in the subject before which I have marked an X:

BUSINESS TRAINING COURSES

- | | |
|------------------------------------------------------------------|---------------------------------------------------------------------------|
| <input type="checkbox"/> Business Management | <input type="checkbox"/> Salesmanship |
| <input type="checkbox"/> Industrial Management | <input type="checkbox"/> Advertising |
| <input type="checkbox"/> Personnel Organization | <input type="checkbox"/> Better Letters |
| <input type="checkbox"/> Traffic Management | <input type="checkbox"/> Show Card Lettering |
| <input type="checkbox"/> Business Law | <input type="checkbox"/> Stenography and Typing |
| <input type="checkbox"/> Banking and Banking Law | <input type="checkbox"/> Business English |
| <input type="checkbox"/> Accountancy (including C.P.A.) | <input type="checkbox"/> Civil Service |
| <input type="checkbox"/> Cost Accounting | <input type="checkbox"/> Railway Mail Clerk |
| <input type="checkbox"/> Bookkeeping | <input type="checkbox"/> Common School Subjects |
| <input type="checkbox"/> Private Secretary | <input type="checkbox"/> High School Subjects |
| <input type="checkbox"/> Spanish <input type="checkbox"/> French | <input type="checkbox"/> Illustrating <input type="checkbox"/> Cartooning |

TECHNICAL AND INDUSTRIAL COURSES

- | | |
|-------------------------------------------------|----------------------------------------------------------------------|
| <input type="checkbox"/> Electrical Engineering | <input type="checkbox"/> Architect |
| <input type="checkbox"/> Electric Lighting | <input type="checkbox"/> Blue Print Reading |
| <input type="checkbox"/> Mechanical Engineer | <input type="checkbox"/> Contractor and Builder |
| <input type="checkbox"/> Mechanical Draftsman | <input type="checkbox"/> Architectural Draftsman |
| <input type="checkbox"/> Machine Shop Practice | <input type="checkbox"/> Concrete Builder |
| <input type="checkbox"/> Railroad Positions | <input type="checkbox"/> Structural Engineer |
| <input type="checkbox"/> Gas Engine Operating | <input type="checkbox"/> Chemistry <input type="checkbox"/> Pharmacy |
| <input type="checkbox"/> Civil Engineer | <input type="checkbox"/> Automobile Work |
| <input type="checkbox"/> Surveying and Mapping | <input type="checkbox"/> Airplane Engines |
| <input type="checkbox"/> Metallurgy | <input type="checkbox"/> Navigation |
| <input type="checkbox"/> Steam Engineering | <input type="checkbox"/> Agriculture and Poultry |
| <input type="checkbox"/> Radio | <input type="checkbox"/> Mathematics |

Name.....
Street.....
Address..... 6-3-23
City..... State.....

Occupation.....
Persons residing in Canada should send this coupon to the International Correspondence Schools Canadian, Limited, Montreal, Canada.

Men Wanted for Big Money Jobs

TO YOU MEN who have ambition we say "Come." Come to Chicago, the electrical center of the world. Come to the World's Greatest Electrical School.

Come and master electricity. Be an Electrical Expert. Get the actual experience in doing the things you must do in actual electrical work. You work on \$200,000 worth of electrical apparatus.

The Great Shops of **COYNE**

Endorsed by Electrical Industry

Established 1899

You actually work on motors, generators, autos, batteries, radios, switchboards, power plants and hundreds of other electrical devices, the same as you will find "out in the field". When you finish Coyne after a course of only 3½ months you are a **Master Electrical Expert** ready to take a big paying electrical position or to go into business for yourself.

LEARN

THE

Only 3 1/2 Months

Students even with no previous knowledge of electricity complete this course in 3 1/2 months (study longer if you wish.) Students step from Coyne to big paying positions because Coyne training is so practical and thorough that big employers welcome the Coyne Trained Electrical Expert. No books or useless theory. You work on Circuits, Housewiring, D. C., A. C., Armature and Stator Winding, Drafting, Auto, Truck and Tractor Electricity, Battery Building and Repairing and Radio — everything to make you an expert ready to step right into a position paying from \$65 to \$150 a week.

Free Radio

To every student who enrolls now we will give FREE a complete course in radio.

Coyne Electrical School, Dept. 13-51
1300-1310 W. Harrison St., Chicago

Gentlemen: Please send me free your big catalog and full information about your practical training and special offer.

Name.....

Address.....

FREE

\$200 to \$600 a Month

The whole world of electricity is open to the Coyne trained Electrical Expert. Coyne trains you in all branches of electricity. We do not offer a number of individual courses — we give you just one **Complete** course so that you will be an **Electrical Expert** capable of commanding big pay. Let ordinary electricians do the small jobs. You can become an **Expert** and get the big money in any branch of electricity or you can go in business for yourself and make from \$3,000 to \$20,000 a year as other Coyne graduates are now doing.

Earn While You Learn — We help students to secure part time jobs while studying and assist you to a position after graduation. We also furnish every student with a life scholarship which permits you to study as long as you like.

Write!

Send this coupon now. Determine today that you are going to become a part of the world's greatest force — electricity. Assure your future by sending this coupon now. It brings you full information. Think of it — if you send the coupon today, you can be fully equipped for a fine paying electrical job in a few months. Send the coupon now before the special offer we are making is withdrawn.



Student Winding a Stator

COYNE
Electrical School

Endorsed by Electrical Industry

1300-1301 W. Harrison St., Dept. 13-51, Chicago, Ill.

CARPENTERS

LET THIS NEW AUDEL SET SOLVE YOUR PROBLEMS

POCKET SIZE—
FLEXIBLE
COVERS—
3100 ILLUS-
TRATIONS
— 1000
PAGES

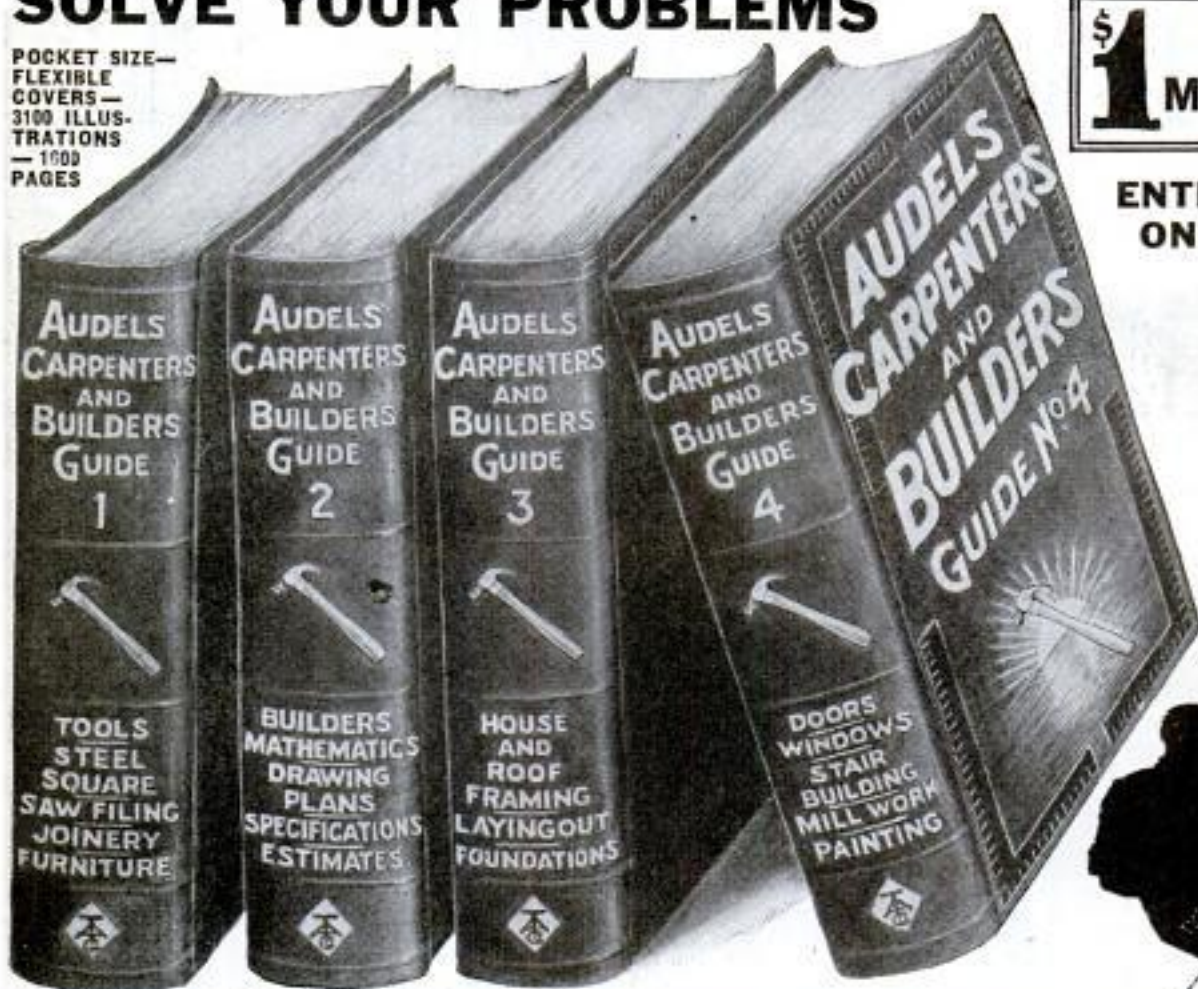

\$1 PER MONTH

ENTIRE SET ONLY \$6

JUST OUT!

Audel's Newest Set, Concise and up-to-date **FOUR** Handy Volumes



QUESTIONS AND ANSWERS—CLEAR ILLUSTRATIONS—SHORT CUTS THAT MAKE YOU A BETTER WORKMAN AND INCREASE YOUR PAY

Just available—Audel's Carpenters and Builders Guides—the short cut, professional information you want. A Guide that keeps you in close touch with your work and shows you how you may increase your earning power. No need to guess or take chances. Every day you have before you in this set, exact, practical, useful information to help you with your daily work.

HOW To Handle the Job That Puzzles YOU

There are thousands of examples of modern construction and building work—new methods, new ideas, proved efficiency plans, short cuts, time saving suggestions, new ways that cover the entire theory and practice of modern carpentry. Every point is easy to read and understand and clearly illustrated with sketches and forms. Inside Trade Informa-

tion for Carpenters, Builders, Joiners, Building Mechanics and all Woodworkers on—Care and Use of Tools—How to Use the Steel Square—File Saws—Make All Kinds of Joints—Draw and Read Plans—Write Specifications—Make Estimates—How to Frame Roofs and Houses—Lay Out Work—Put in Foundations—Full Instruction on In and Outside Building Work—Stair Building—Saw Mill Work—Practical Painting—Thousands of Short-Cuts that save time and money—Information usually obtained only by hard experience.

NO MONEY!

MERELY SEND COUPON AND LOOK THE SET OVER AT THEO. AUDEL'S RISK

THEO. AUDEL & CO., 72 5th Avenue, NEW YORK CITY
 Send me for free examination of Audel's Carpenters and Builders Guides. I will send you \$1 within 8 days and mail \$1 monthly until you are satisfied. If satisfactory I will send you \$1 within 8 days and mail \$1 monthly until you are satisfied.

Name.....
 Address.....
 Occupation.....
 Employed by.....
 References.....
 P. M. Jan '24

FREE

EXAMINATION

Not a cent to pay until you see the books. No obligation to buy unless you are satisfied. Fill in coupon in pencil. Send now—today—get this great help library for carpenters and builders.

Tighten Your Grip on a Trade

Be An Electrical Expert

At \$75 to \$200 a Week

Every up-to-date fellow knows what a future there is in electricity.

Big pay—fascinating work on land or sea—rapid advancement in a field where jobs are ten times more numerous than trained men to fill them, where \$75.00 a week is just a fair starter, where top notchers pull down ten thousand dollars or more a year—in a field, where any man if he wishes, can easily have a business of his own, have men working for him, be his own boss!

But what the average young man does NOT know, is what a simple, easy, A-B-C sort of a job it is to get started.

You Can Start Right Now!

Yes, you. You don't need a thing you don't already have! You can read. You can write. You can figure. You can think. And in your breast is the fire of ambition—the desire to get ahead! All right, that's all you need—we can help you just as you are—just as we have helped scores, yes, thousands of other two-fisted young fellows determined to get out of the rut and into the electric field—into work that will be pleasant—easy—and all in your home, during spare time.

Fascinating Home Study As You Hold Your Old Job

With the help we will give you, you can slip right into one of these big pay—be-man jobs and never lose a day's work. After a few weeks' start, you can earn enough in installation and electric repair jobs alone to more than pay for the Course and lay a foundation for an Electrical Contracting or Repair Shop Business of your own. When the proper time comes, we will tell you the easy way to go about doing it.

The Most Practical, Thorough and Condensed Electrical Course Ever Written

This is the only home study electrical course that gives you the combined practical and theoretical training you must have before you can be a successful electrician without which you cannot succeed—with which you cannot fail.

Written not by ONE man, with the narrow one-man viewpoint, but by 22 of the best, most successful, electrical experts ever drawn from the field of practice and theory. Gives you the complete mastery of the subject—qualifies you as electrical expert to boss jobs—fits you right into the kind of a job you want—and does it in shortest time—at lowest cost—with the

Most Binding Guarantee of Results Ever Offered!

Satisfaction guaranteed or no sale! We not only SAY we can make you an electrical expert, we Guarantee it! If you are not absolutely satisfied when you have finished our Practical Electrical Course, we will refund every nickel you sent us.

FREE! Experimental Outfit Worth \$30 Find out all about our
 Drafting Course Worth Another \$30 offer. Find out about the
 Big Electrical Library Worth \$25 thousands who have taken
 this course in preference to
 all others and MADE GOOD. Find out about the Electric Library—four elegant volumes—worth \$25,
 but free. About the free Drafting Course worth another \$30. The free Experimental and Demon-
 stration Outfit, including a real, not a make-shift Electric Motor, Wheatstone Bridge, etc.—the most
 scientific, high-grade and complete Experimental Outfit ever supplied with a Course in Electricity.
 Get all the facts without obligation, without expense! Just send the coupon!

American School

Dept. E-174

Drexel Ave. and 58th Street, Chicago

FREE Electrical Coupon

American School
 Dept. E-174, Chicago

Please rush all information relative to your Course in Electricity. This obligates me in no way whatever.

Name.....

Address.....

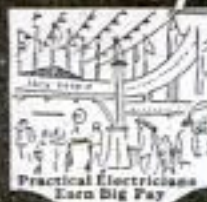

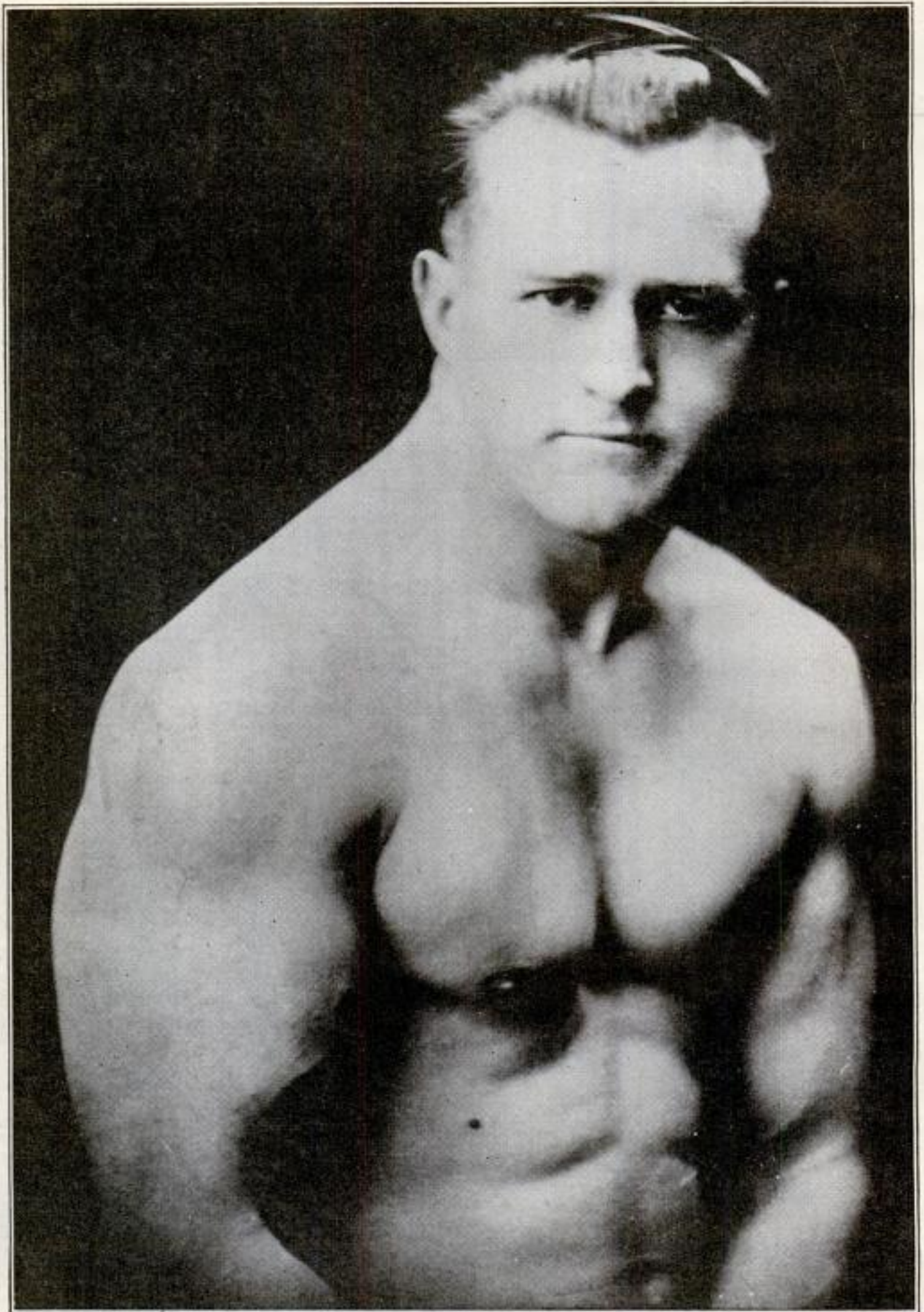

EARLE E. LIEDERMAN, *America's Leading Director of Physical Education*

Start the New Year Right

Will 1924 Bring Success or Failure?

Right now is the time to decide. If you had started right one year ago you would be on the high road to success this very minute. Don't let another year pass you by. It is within your power to make yourself just what you will. Make this day the beginning of a new life and a better one.

I will give you Wealth, Health and Happiness

I will transform that body of yours and make you physically perfect. I will make a real HE man out of you. I will build out your chest so that every breath means increased life, purifying your blood and sending vim and vitality throughout your entire system. I will broaden your shoulders and give you the huge muscular arms and legs of an athlete. I will put pep in your old backbone and strengthen every vital organ within you. You will be just bubbling over with life, having the keen, alert brain, the bright flashing eyes and the spring and step of youth. You will be admired and sought after in both the social and business world. You will be a leader of men, and the good things of life will naturally come your way.

I Challenge the World

If a man stood on the housetops and shouted to the people that he was the strongest man on earth, it would avail him nothing. Someone would make him come down and prove it. But records speak for themselves. I will gladly show anyone personal letters from the leading strong men in the world today that my course is absolutely the best and the quickest to acquire physical perfection. Come on then and make me prove it—I like it. I have the means of making you a perfect physical specimen of manhood, of making you a successful leader of men. You will be a credit to your community. I have done this for thousands of others. What I have done for them I will do for you. I don't care what your present condition is. The weaker you are, the more noticeable the results. Come on then, start the New Year right.



Send For My New
64 Page Book—

"Muscular Development"

IT IS FREE

It contains forty-three full-page photographs of myself and some of the many prize-winning pupils I have trained. Some of these came to me as pitiful weaklings, imploring me to help them. Look them over now and you will marvel at their present physiques. This book will prove an impetus and a real inspiration to you. It will thrill you through and through. All I ask is ten cents to cover the cost of wrapping and mailing and it is yours to keep. This will not obligate you at all, but for the sake of your future health and happiness, do not put it off. Send today—right now, before you turn this page.

EARLE E. LIEDERMAN
Dept. 2001, 305 Broadway, New York City

EARLE E. LIEDERMAN

Dept. 2001, 305 Broadway, New York City

Dear Sir:—I enclose herewith 10 cents for which you are to send me, without any obligation on my part whatever, a copy of your latest book, "Muscular Development." (Please write or print plainly.)

Name.....

Street.....

City..... State.....

JUST OFF

The Science of Wrestling

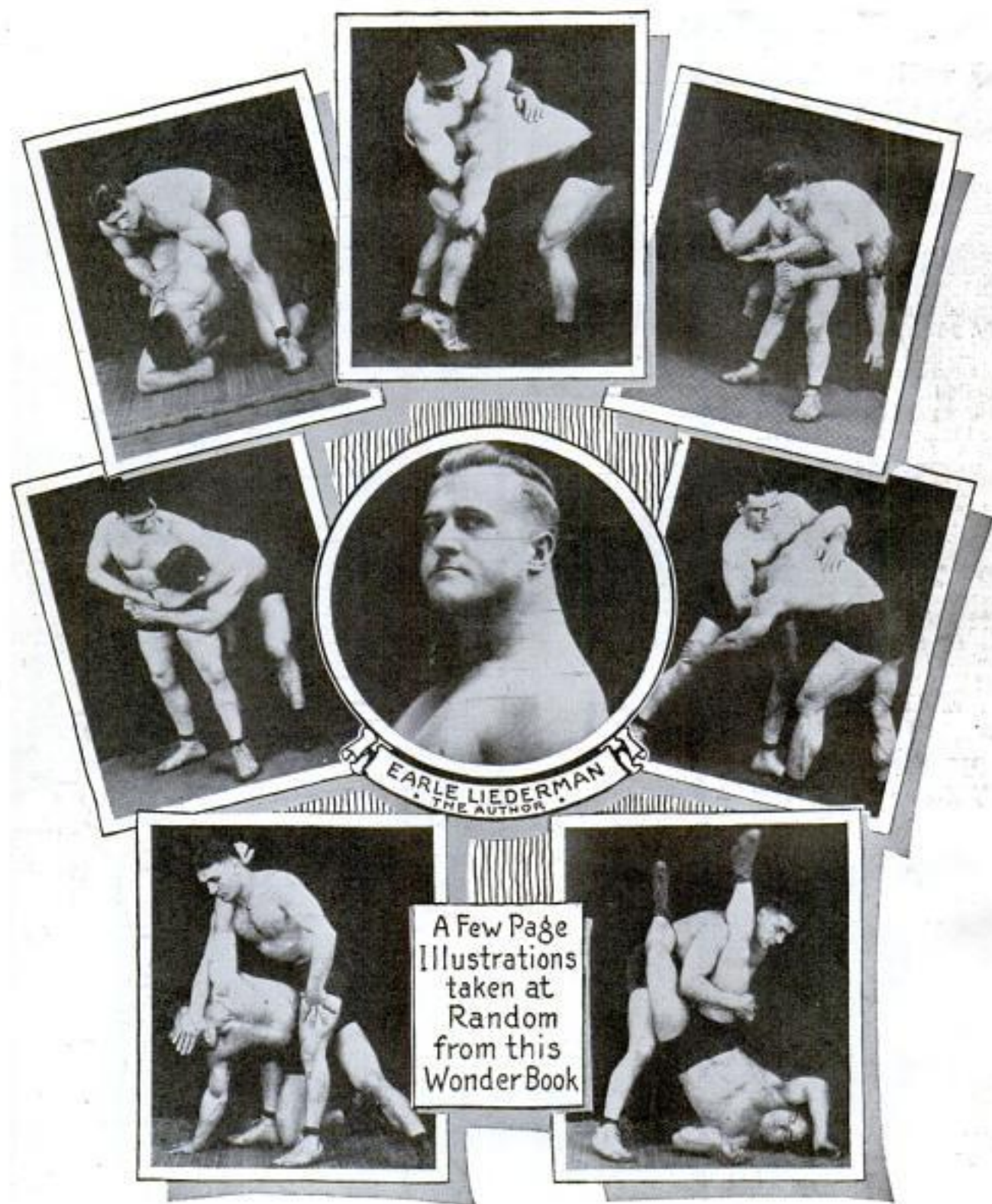

THE PRESS

and the Art of Jiu Jitsu

THIS book is going to startle the athletic world. It is going to open your eyes. It will surprise you with its revelations. You will wonder at its contents. The most elaborate instructions in wrestling ever produced; highly illustrated from life together with a most detailed course in Jiu Jitsu—the most dangerous art of self-defense ever practiced by mankind. Each and every hold, if fully executed, means a broken bone or fatal results. This information is invaluable. With such knowledge in your possession you need never fear attack, whether your opponent be armed or unarmed. The Jiu Jitsu education is so complete and so simply described that this alone is worth far more than the price asked for the entire book.

The course in wrestling is complete to the minutest detail. It is also a startling revelation. I am exposing secrets heretofore known only by professionals. No doubt you have frequently wondered how a professional wrestler has thrown a man twice his size, or how some of our former lightweight champions have succeeded in throwing practically any man, no matter what his size or weight might be. There are numerous tricks and holds known only to the American professional wrestlers, and which they have held as their prize possessions. These trick holds are simple enough if you could only learn them, but few know them and the professionals do not care to disclose them to the public.

The Secret Told

I have been severely criticized by numerous wrestlers for revealing these secrets, but I ignore unjust criticism. I am determined to present the facts as I know them.

Possibly you have already had considerable experience in the science of wrestling; even so, I doubt very much if you have been intimate enough with the men higher up to learn these secret tricks of the game. Suppose this very night some thug should attack you? Suppose a man many pounds heavier than you and well armed should attempt to hold you up, what would you not give to know how to immediately place him at your mercy? You will find just such information as this in "The Science of Wrestling."

To My Pupils

Do not confuse or compare this volume with any other wrestling book or wrestling course now on the market, for it makes all previous works on wrestling look amateurish. It is a classic and I am most proud to be its author. The regular price of this book is \$5, but as a special introductory offer I am putting it before my pupils and prospective pupils at the special price of \$3. If you will send for your copy now and use the coupon below, you will save \$2. Remember, the edition is limited; first come, first served. Should the demand for this book

exceed the output, it will simply mean a delay until another edition is printed; so use the coupon below, save \$2—and get your book immediately. I pre-pay all packing and mailing expenses.

This book is not for sale at book stores or newsstands. It cannot be bought anywhere in the world except from me, for it is a private edition.

Positively no more than one to each person. The edition is limited, and I want as many pupils as possible to get a copy of this book. Do not send more than \$3, as I will be obliged to return any excess amount.

This book will prove a revelation to you. You will marvel at it. It contains nearly two hundred full-page photographs, the size of each page being 6x9 inches. It is handsomely bound in leatheroid cover, embossed in blue and gold, and is worthy of a prominent place in anyone's library collection.

Is Your Life Worth \$3.00?

Think of it. Two hundred and twenty-four intensely interesting pages containing secret information never before revealed to the public. The phenomenal and marvelous holds to offset attack by a gunman make it impossible to set its value in money, for surely you would not place a value of \$3 on your life.

Cut Out Coupon \$2.00 and Save

It is new—just off the press; everyone who gets this book will be the first to know of these mysterious holds. I have spent many months in the preparation of this book, and all the knowledge I possess in wrestling and Jiu Jitsu is revealed within its pages.

EARLE E. LIEDERMAN

Dept. C

305 Broadway NEW YORK

EARLE E. LIEDERMAN, Dept. C
305 Broadway, New York, N. Y.

Dear Sir:

Enclosed herewith please find \$3.00 for which you are to send me immediately "THE SCIENCE OF WRESTLING AND THE ART OF JIU JITSU."

Name.....

Address.....



Be An **AUTO EXPERT**
 Make \$75 to \$200
 A WEEK

Learn
 at Home
 to **BOSS**
THE JOB!



B. W. COOKE, Directing Engineer

CHICAGO AUTO SHOPS

I GUARANTEE

Keep your job, stay home—just loan me a part of your spare time. As Directing Engineer of the big CHICAGO AUTO SHOPS, I train you the "JOB-WAY"—not with books. Go into the best-paying business on earth—get your share of the thousand million dollars spent every year to keep Autos, Trucks and Tractors running!

I TRAIN YOU

AT HOME!

My home-training makes Auto EXPERTS! I prepare you to BOSS THE JOB! My "JOB-WAY" instruction makes you MASTER of every branch of Automobile work—Mechanical, Electrical, Battery, Ignition, Farm Power plants, Welding, Brazing, Vulcanizing, etc. My training is COMPLETE!

Start Now! I'll help you start and stay with you until you're a success, actually placed in EXPERT'S job at top-pay. Inducements you cannot resist right now to ambitious men. Easy terms, within reach of everybody. Many Free features. Coupon brings your greatest opportunity—mail it to me right away!

B. W. Cooke, Directing Engineer
CHICAGO AUTO SHOPS
 Dept. 116, 1553 W. Madison St., CHICAGO

B. W. COOKE, Directing Engineer
 Dept. 116, 1553 W. Madison Street, CHICAGO

Please send me Free Book and complete information about your "Job-Way" training at home. Tell me about the opportunities for Auto Experts. I am mailing this promptly to secure FREE REPAIR OUTFIT and the reduced prices and special terms you offer now.

..... NAME
 ADDRESS
 CITY STATE
 OCCUPATION

MAIL COUPON TO-DAY!

AUTO BOOK FREE!

EXPERTS WANTED!
\$3,000 to \$10,000 a year!

The "best-paying business on earth" is hungry for EXPERTS! Where else can you find such opportunities as in the AUTO business? 15 million Autos, Trucks and Tractors to keep going, 50 million tires to repair, 15 million starting, lighting and electric systems to maintain, 15 million batteries to service and replace. *Man alive!* Wake up to this rich money-making opportunity!

GO INTO BUSINESS!
Make \$5,000 to \$15,000 a year!

There are thousands of opportunities to go into business for yourself, with small capital. Hundreds of my graduates are now running big service stations, making up to \$15,000 a year! The same wonderful opportunity is waiting for you. My "Job-Way" instruction prepares you for it.

My "Job-Way" training makes successful high-price AUTO EXPERTS!

FREE OUTFIT
 \$18.50 repair and testing outfit free! Mail coupon for my remarkable offer. Use it to do my JOBS, use it to make money, use it to make this training pay for itself!

FREE JOBS
 My big Employment Department helps you get big pay jobs without one penny of cost.

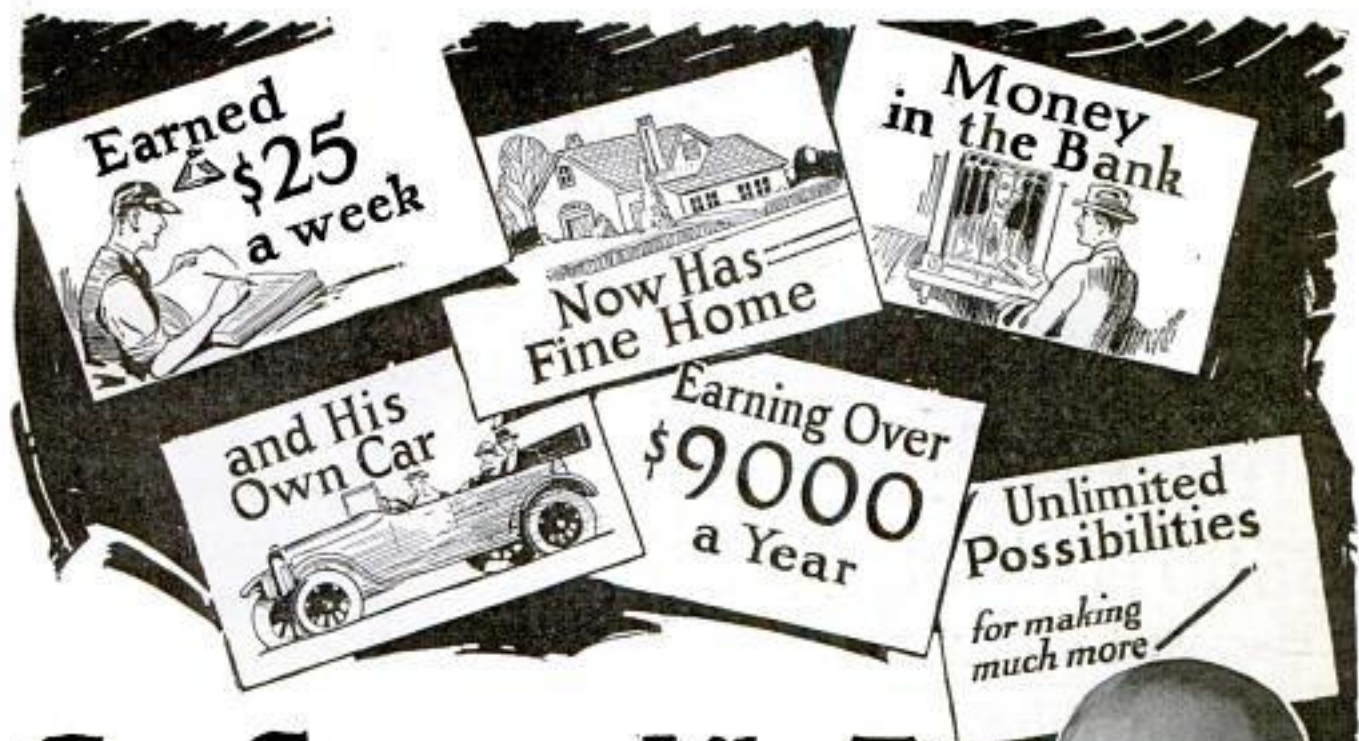

Can Success Like This Be An Accident?

"THE fellows who used to work with me while I was plugging along at \$25 a week are convinced that I either had a pull or just fell into a good thing—that my \$9,000 a year position is a sheer accident.

"When I told them I had found an easy way to earn big money as a salesman, they laughed at me and called it a hare-brained idea. They told me 'salesmen are born, not made.' But I decided to see my harebrained idea through. I was sick of slaving for a pittance.

"I started studying the secrets of master salesmanship as taught by the National Salesmen's Training Association—and almost before I knew it I had confidence to tackle my first selling position. And why not? I had mastered the very secrets of selling used by the most successful salesmen.

"My earnings during the past month were \$750. I now have better than a \$9,000 a year position—with lots more room to grow. I can state positively that my sudden success was not an accident. It came because I knew how to sell scientifically. And how simple it is to sell when you know how. My regret is that I did not know these secrets ten years ago."—*Ellis Sumner Cook, Manufacturers' Agent, 20 E. Jackson Blvd., Chicago, Ill.*

Why Not Make More Money?

If you want to get out of the wage-earning class, if you want to make good money without loss of time—then do as Mr. Cook and thousands of others have done.

The secrets of salesmanship which Mr. Cook learned are available to you. There are certain ways to approach prospects, to stimulate interest, to overcome objections, and to close sales. Every move in selling is governed by certain rules. Once you know these, success is yours.

Success Like This Yours

Adam Horneber, Bay City, Mich., writes: "I have increased my earning power 500% since I secured your training in the Science of Selling."

Lewis A. Tinnes, Minneapolis, Minn., writes: "When I finished your training I left my job at \$160 a month and took a job as salesman. The first month I made over \$600 and I expect to go higher yet."

F. K. Kramer, Pine Bluff, Ark., writes: "Since studying the N. S. T. A. Course I have increased my earning capacity from \$2,200 to over \$6,000 a year."

N. D. Miller, 1705 S. Clark Street, Chicago, says: "I place the credit for my success

where it rightfully belongs. I owe my present position wholly to the N. S. T. A. In July, 1919, I studied your selling secrets and in September you secured me the position which I now hold. I am earning in excess of \$100 a week."

Bear in mind that these stories of real success—the kind that is awaiting you in this field of unlimited money-making opportunities—are but a few of thousands on file. You will find scores of them in our literature.

Valuable Book Free

No matter what you may now think, it is only a thought. Get the facts! See for yourself how you can easily duplicate any of these stories of success. NOW and no other time is the minute to mail the coupon below. Our big free book, "Modern Salesmanship," will be mailed promptly. And there's no obligation.

NATIONAL SALESMEN'S TRAINING ASSOCIATION
Dept. 12-A, 53 W. Jackson Blvd., Chicago, Ill.

National Salesmen's Training Association,
Dept. 12-A, 53 W. Jackson Blvd., Chicago, Ill.

Send me FREE your book, "Modern Salesmanship," and proof that I can become a Master Salesman.

Name.....
Address.....
City..... State.....
Age..... Occupation.....

EMPLOYERS

are invited to write to the Employment Dept. of the N. S. T. A. We can put you in touch with just the men you need. No charge for this service to you or our members. Employers are also cordially invited to request details about the N. S. T. A. Group Plan of instruction for entire sales forces. Synopsis and charts sent without obligation.



This Man Earns \$3500 to \$5000 a Year

—WORKING WITH A DENTIST—
THREE MONTHS' TRAINING
QUALIFIED HIM TO DO IT

There are thousands of these positions awaiting trained men in this profitable profession. After just a few months of specialized training hundreds of men will have become full-fledged members of the dignified profession of

MECHANICAL DENTISTRY

They will have the technical knowledge and skill to enable them to earn several thousand per year. You can be among them. The Dental Profession needs 2500 more Dental Mechanics right now and is constantly calling for graduates of the four great schools of this institution; salaries from \$35 to \$45 a week to start, with advancement up to \$125 a week.

FREE PARTIAL SCHOLARSHIPS

In order to meet this urgent demand for the men we train, we are offering for a limited time Free Partial Scholarships. You will want to get in on this exceptional offer—so don't delay. NOW is the time!

JUST COMPARE

Compare the unusual opportunities this profitable professional trade offers with what you are now doing—the earnings, the pleasant, dignified occupation. Compare also our ability to train you and put you in touch with the right opportunity—our four large, well-equipped schools, over 30 years of experience in this one line, our wide acquaintance with the Dental Profession throughout the nation!

SEND FOR CATALOG AND SCHOLARSHIP OFFER

Describes the field and why the demand. Shows how students "Learn by Doing" actual work through practical, individual instruction, day or evening sessions. Shows how you can "Earn while Learning."

BODEE DENTAL INSTITUTE

136 West 52d Street, NEW YORK

PHILADELPHIA BUFFALO BROOKLYN
1305 No. Broad St. 1226 Main St. 15 Flatbush Ave.

BODEE DENTAL INSTITUTE: Without obligation to me send me a Free Copy of your catalog and complete details of the Free Partial Scholarship Plan No. 2.

Name

Address



Let A Master Teach You Music

Learn to play for Pleasure or Profit without leaving home. Our simplified and complete courses are specially prepared for home study.

**Celebrating 20th Anniversary
with Special Tuition Rates**

Be one of the first to receive the Anniversary Offer. Not a new method but one tried and endorsed by Paderewski and other great authorities as well as by thousands of students.

**PIANO—CORNET—VIOLIN—HARMONY—GUITAR
BANJO—MANDOLIN—VOICE—PUBLIC SCHOOL MUSIC**
Send today for Illustrated Catalog. Every person who loves music should read this free book. Write which instrument you have. Get details of the lessons and our Anniversary Offer—one which means a cash credit on your tuition. Careful training by Faculty in grading examinations makes the instruction personal for each individual pupil. See for yourself what others have done. You can be sure of the same results.

UNIVERSITY EXTENSION CONSERVATORY
865 Siegel-Myers Bldg., Chicago, Ill.

WRITE JOKES

EARN FROM \$50 TO \$150 PER WEEK

writing jokes, epigrams and humorous stories for publications. Tremendous demand for material. Our short course in Humor Writing teaches you to write humorous material that sells. Learn in your spare time—earn in your spare time. Complete marketing plan and markets furnished.

Write for full particulars

AMERICAN INSTITUTE OF HUMOR
Office J, 414 Park Bldg., Cleveland, Ohio



Learn Expert Auto Painting



Painting

There is **Big Money** in auto painting and refinishing. Our **Home Study Course in Practical Auto Painting** will enable you to do the finest work and earn big wages. Wonderful opportunity for new money-making business of your own.

FREE circular tells all about this big new business. Be first. Write quick.

CHICAGO COLLEGE OF AUTO PAINTING
Dept. 14, 140 S. Dearborn St., CHICAGO, U.S.A.



WANTED! U.S. RAILWAY MAIL CLERKS

**\$1600 First Year
Raise to \$2300
Travel—See Your
Country**

Min.—Evs. 18 22
—Mail coupons
at once.

Name

Address

FRANKLIN INSTITUTE
Dept. E-181
Rochester, N. Y.

Sirs: Send me, without charge (1) sample Railway Mail Clerk Examination questions; (2) list of government jobs now obtainable; (3) tell me how I can get a government position.

TRAIN IN SPARE TIME TO DOUBLE YOUR INCOME

Everywhere there is an insistent call for men with technical training. The boom in building and the speeding up of manufacturing and construction work has brought a pressing need for more men who know how to use their heads. Skilled draftsmen and men who can estimate, plan and direct building operations are drawing the highest salaries ever paid in these occupations—and the demand for able men far exceeds the supply. Never before has the ambitious man had such an opportunity to compel a betterment in his income. A big job and a fat pay check are ready now for every man who can make good. If you are in a position where the pay is small and the outlook doubtful—pull yourself out of the rut and *train* for the opportunities that are waiting.

Become An Expert In

DRAFTING

In Your Spare Time



Right in your own home you can become a proficient practical Draftsman. The Chicago Tech. experts will train you by mail, giving you the same thorough instruction you would get if you came to the college. Hold your present job and master Drafting in your spare time—just a few hours a week. No interference with your present work—and you advance yourself by years.

Get Practical Men Back of You

Chicago Tech. experts will teach you the practical methods which enable you to take a job knowing just what to do and how to do it. No time put in on unusable theories. Every lesson deals with actual problems and you have the direct, personal instruction of these experts at every step. All this you get by mail in your spare time or by attending the day or evening classes at the College in Chicago.

FREE Send for This Trial Lesson



If interested in Drafting ask for Catalog "D"

While other schools ask you to enroll and pay a fee before you receive instruction, we send you this free lesson first. Before you pay—before you even decide about enrolling—you can test your ability and also learn about the Chicago Tech. method of teaching Drafting by mail. Send for it today.

Write!

Send letter or postcard today and the Free Lesson—also Catalog and information about the opportunities in Draftsmanship will be sent by return mail.

Pay Raising Training In

BUILDING

(For Men in Building Trades)

If you are now "at the bench," you can easily master the higher branches of building without taking a single hour from your work. Chicago Tech., America's oldest school for builders, will train you *by mail*—give you the practical instruction in your spare time at home that will enable you to hold a boss' job or to become a contractor.



The Subjects We Teach

Our experts will train you thoroughly in *Plan Reading, Estimating, Construction and Superintending*—show you how to read every detail of a blue print. Also how to estimate cost of material and labor for carpenter work, brick work, stone work, concrete and excavating. They will explain methods of handling material and labor, etc.—giving you just the knowledge you need as foreman, superintendent or contractor.

FREE 2 Books and Blue Prints

Our new book "How to Read Blue Prints," just off the press. Full of valuable information for men in the building trades. Sent Free with Blue Prints, Drawings, etc. Also a book which explains how you can master the higher branches of building—to men in the building trades.

Write!

Send no money—the books and blue prints are free. State what trade you are in. No matter whether you are a journeyman or an apprentice, you should write for these free books.

Ask for Special Catalog "B"



CHICAGO TECHNICAL COLLEGE DEPT. 130, CHICAGO TECH. BLDG. 118 E. 26th ST., CHICAGO, ILL.



“\$1,000 Saved!”

“Last night I came home with great news. Our savings account had passed the thousand dollar mark!

“A few years ago I was making \$25 a week and it took every cent to keep us going. Then one day I realized why I wasn't being advanced—I couldn't do anything in particular. I decided right then to invest an hour after supper each night in my own future. So I wrote to Scranton and arranged for a course of special training.

“Why, in a few months I had a whole new vision of my work! An opening came and I was promoted—with an increase. A little later another raise came—I could save \$25 a month. Then another—I could save \$50 each pay day. So it went.

“Today I am manager of my department. We have a thousand dollars saved—and there is a real future ahead!”

For 32 years the International Correspondence Schools have been helping men and women everywhere to win promotion, to earn more money, to have happy prosperous homes, to know the joy of getting ahead in business and in life.

You, too, can prepare right at home in spare time for the position you want in the work you like best. Just choose your career from this coupon and mark and mail it now.

INTERNATIONAL CORRESPONDENCE SCHOOLS Box 5572-D, Scranton, Penna.

Without cost or obligation, please tell me how I can qualify for the position or in the subject before which I have marked an X:

BUSINESS TRAINING COURSES

- | | |
|------------------------------------------------------------------|---------------------------------------------------------------------------|
| <input type="checkbox"/> Business Management | <input type="checkbox"/> Salesmanship |
| <input type="checkbox"/> Industrial Management | <input type="checkbox"/> Advertising |
| <input type="checkbox"/> Personnel Organization | <input type="checkbox"/> Better Letters |
| <input type="checkbox"/> Traffic Management | <input type="checkbox"/> Show Card Lettering |
| <input type="checkbox"/> Business Law | <input type="checkbox"/> Stenography and Typing |
| <input type="checkbox"/> Banking and Banking Law | <input type="checkbox"/> Business English |
| <input type="checkbox"/> Accountancy (including C.P.A.) | <input type="checkbox"/> Civil Service |
| <input type="checkbox"/> Cost Accounting | <input type="checkbox"/> Railway Mail Clerk |
| <input type="checkbox"/> Bookkeeping | <input type="checkbox"/> Common School Subjects |
| <input type="checkbox"/> Private Secretary | <input type="checkbox"/> High School Subjects |
| <input type="checkbox"/> Spanish <input type="checkbox"/> French | <input type="checkbox"/> Illustrating <input type="checkbox"/> Cartooning |

TECHNICAL AND INDUSTRIAL COURSES

- | | |
|-------------------------------------------------|----------------------------------------------------------------------|
| <input type="checkbox"/> Electrical Engineering | <input type="checkbox"/> Architect |
| <input type="checkbox"/> Electric Lighting | <input type="checkbox"/> Blue Print Reading |
| <input type="checkbox"/> Mechanical Engineer | <input type="checkbox"/> Contractor and Builder |
| <input type="checkbox"/> Mechanical Draftsman | <input type="checkbox"/> Architectural Draftsman |
| <input type="checkbox"/> Machine Shop Practice | <input type="checkbox"/> Concrete Builder |
| <input type="checkbox"/> Railroad Positions | <input type="checkbox"/> Structural Engineer |
| <input type="checkbox"/> Gas Engine Operating | <input type="checkbox"/> Chemistry <input type="checkbox"/> Pharmacy |
| <input type="checkbox"/> Civil Engineer | <input type="checkbox"/> Automobile Work |
| <input type="checkbox"/> Surveying and Mapping | <input type="checkbox"/> Airplane Engines |
| <input type="checkbox"/> Metallurgy | <input type="checkbox"/> Navigation |
| <input type="checkbox"/> Steam Engineering | <input type="checkbox"/> Agriculture and Poultry |
| <input type="checkbox"/> Radio | <input type="checkbox"/> Mathematics |

Name.....
Street.....
Address..... 8-3-23

City..... State.....

Occupation.....
Persons residing in Canada should send this coupon to the International Correspondence Schools Canadian, Limited, Montreal, Canada.

Please Mention Popular Mechanics

DANCE And be Popular

Learn In ONE HOUR at Home

There's now no need of being a wall-flower. In one hour—at home—by mail—I can make you an easy confident dancer—popular in any ballroom.

New Easy Method

No Partner Needed—No Embarrassment

Over 60,000 men and women have become popular dancers of Fox Trot, One-Step, Waltz and all latest up-to-the-minute society dance steps through my new **Foto-tell** and **Fono-tell** Method set to music. Amazingly easy—fascinating. No other course like it. I teach you perfect time and rhythm—the secret of good dancing. Your success guaranteed.

SENT FREE ON TRIAL—NO DEPOSIT

Convince yourself at my expense how amazingly easy it is to learn modern dancing with my new method. For a short time only, I'll send the first six lessons of my course (in plain wrapper), including 10 inch dance instruction record, free and prepaid for five days trial. See, test and prove this remarkable new method in your own home. Then, if not delighted at your success, simply return record and lessons within five days and you'll owe me nothing. Write quick before this unusual offer expires. Please mention make of phonograph you have.



WILLIAM CHANDLER PEAK, M. B.
Studio 25. 4601-4611 Broadway, Chicago, Illinois



LEARN PIANO TUNING

MAKING TRIALS OF TRUE TONE

By
TUNE-A-PHONE



We furnish our accurate teaching device with tools, action model and lessons. Diploma given graduates. 25th year teaching this art by correspondence. Write today for free booklet and guarantee plan.

NILES BRYANT SCHOOL 30 BRYANT BLDG. AUGUSTA, MICH.

LEARN ENGINEERING

Great Demand for Practical-Technical Men. Big Salaries. Wonderful Opportunities. Beautiful New Building. Extensive Laboratory and Shop Equipment. Not a trade school but a Practical-Technical College. Faculty of Trained Experts. 3 mo. courses in Practical Electricity and Steam. 1 and 2 year courses in Mechanical and Electrical Engineering. Architectural, Structural, Mechanical Drafting. Day and night. Degrees awarded. 22nd year. Write for catalog D.

FINLAY ENGINEERING COLLEGE, Kansas City, Mo.

BE AN ARTIST

Comics, Cartoons, Commercial, Newspaper and Magazine Illustrations, Fashion Croquis, Portraits and Pastels. Our simple method quickly develops your talent. It costs less. B- Mail or Local Classes. Write for terms and list of successful Students. ASSOCIATED ART STUDIOS 87-B Flatiron Building, NEW YORK



MEN WANTED

Prepare as Firemen, Brakemen, Electric Motormen, and colored Train Porters. Hundreds put to work. No experience necessary. 500 more wanted. Name position you want.
RAILWAY INSTITUTE Dept. 35 Indianapolis, Ind.



Gov't Help Needed

All men, women, boys, girls, 17 to 65, willing to accept Government Positions, \$117-\$250, traveling or stationary, sign name and address below and mail this ad to Mr. Ozment, 111 St. Louis, Mo. immediately.

NAME.....

ADDRESS.....

AUDEL'S GUIDES
ANSWER YOUR
QUESTIONS IN A
PRACTICAL WAY

YOUR FOREMAN
WILL QUICKLY
NOTICE THE SUPERIOR
QUALITY OF YOUR WORK

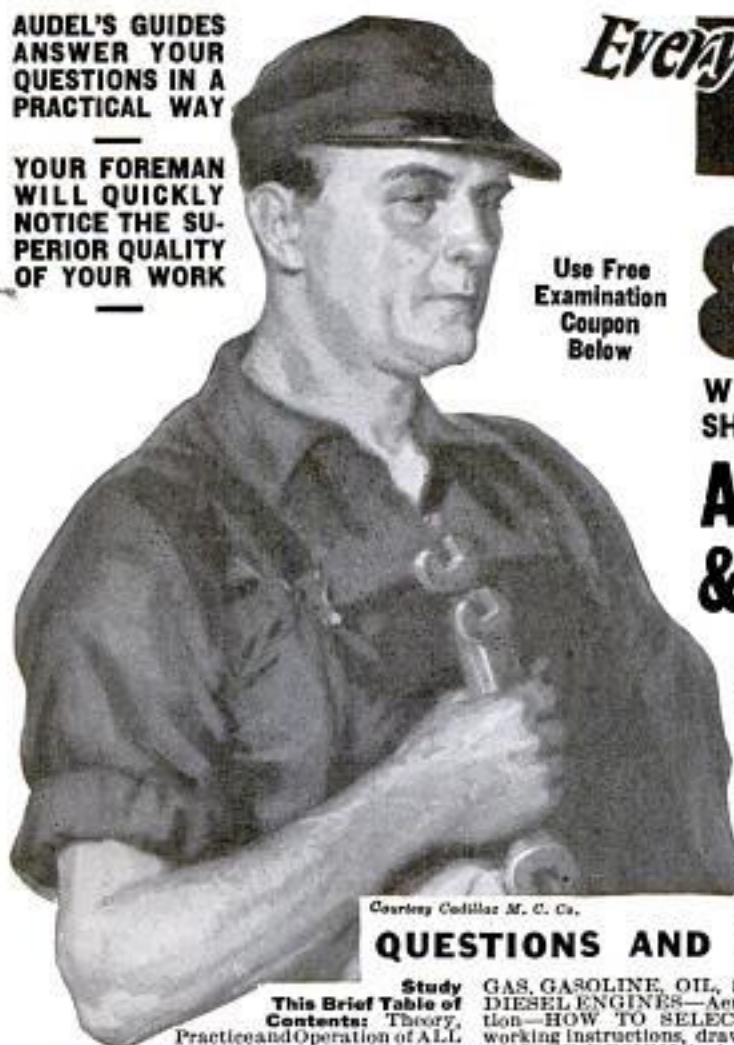

Courtesy Cadillac M. C. Co.

Use Free
Examination
Coupon
Below

Every ENGINEER & MECHANIC

WILL FIND PRACTICAL INFORMATION ON
SHORT CUTS AND MODERN METHODS IN
**AUDEL'S ENGINEERS
& MECHANICS GUIDES**

Every Engineer, Mechanic and Electrical Worker will welcome this new master set. It will answer your problems.

It will help you with your daily work.—A sure source of advancement and higher pay. Complete up-to-date information that is thoroughly and easily explained on every branch of modern engineering and electrical practice. The entire set costs you only twelve dollars—knowledge and instruction that has cost thousands of dollars and years of time—yours for \$12.00—\$1.00 a month.

QUESTIONS AND ANSWERS TEACH YOU QUICKLY

Study
This Brief Table of
Contents:

Theory, Practice and Operation of ALL Steam Engines, Valve Motions—VALVE SETTING: complete information on All engines and pumps—CORLISS ENGINES and the Theory, Construction and Operation of all Steam Engines, including UNIFLOW and POPPET VALVE ENGINES, and LOCOMOBILES—Locomotive-Marine Engines; Turbines; Rotary Engines—the Indicator—Lubrications—PRACTICAL MANAGEMENT. How to use Indicator—

GAS, GASOLINE, OIL, SEMI- and FULL DIESEL ENGINES—Aeroplanes and Aviation—HOW TO SELECT AN ENGINE, working instructions, drawings on STEAM ENGINE DESIGN, including rules and formulae, Theory and Construction of ALL Steam Boilers; Heat-Combustion; Fuel and Flue Gas Analysis—CO₂ recorders—Characteristics of Boilers—Materials—Construction of all types of Boilers. (THE LATEST PRACTICE.)—Boiler Construction—Mechanical Stokers—Oil Burners—Setting—Chimneys—Mechanical Draught—HOW TO SELECT A BOILER—Complete instructions and draw-

ings on BOILER DESIGN based on A. S. M. E. BOILER CODE—OPERATION, including installation, FIRING; care and repair of Steam Boilers—Pipes, Fittings and Pipe Fitting—Heating and Ventilation—Refrigeration—Cooling Towers—Condensers—Distilling Apparatus—Elevators—Cranes and Hoisting Machinery—Ropes and Cables—Splicing—electric wiring in ALL branches; compendium of practical electrical engineering as an aid for engineers and electricians in obtaining a license—57 chapters—ready reference index, covering entire field of Modern Electricity.

**AUDEL'S MASTER SET 8754 ILLUSTRATIONS
4750 PAGES**

POCKET SIZE—FLEXIBLE COVERS

**TURN SPARE TIME INTO CASH
BY STUDYING THE GUIDES**

Take a volume with you where ever you go. They can be easily slipped in and out of your coat pocket without damage. Study the questions and answers. Fifteen minutes a day study will increase your pay.

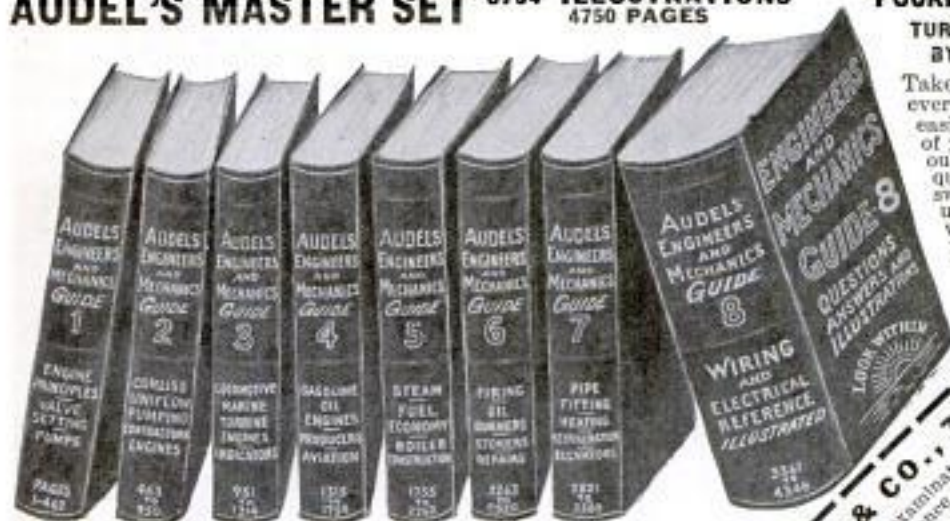

FREE EXAMINATION
Not a cent to pay until you see the books. No obligation to pay unless you are satisfied. Send coupon now—today and get this new master set for engineers.
Pay only \$1 a month.

THEO. AUDEL & CO., 72 Fifth Avenue, NEW YORK CITY
Please submit me for free examination. AUDEL'S MASTER SET FOR ENGINEERS AND MECHANICS, ship at once prepaid, the 8 numbers, total cost \$12.00. If satisfactory, I agree to send you \$1 within seven days and to further mail you \$1 each month until paid.

Name.....
Occupation.....
Employed by.....
Home Address.....
Reference.....

• P.M. Jan. 24

\$100 a Week

in this

Fascinating Business



EARN big money as a cartoonist! Millions of dollars were spent last year on comic strips, political and sport cartoons, animated cartoons, etc. Thousands of new cartoonists are needed now to meet the ever-increasing demand for this work. Never before have the opportunities in this fast-

growing field been so many, so varied or so high-paying.

Easy to Learn CARTOONING at Home in Spare Time

Regardless of how little you know about cartooning now, you can easily qualify for a position in this attractive, high-salaried business. This home-study method starts you at the simplest fundamental principles of cartoon-making and takes you through every branch of humorous and serious cartooning. You will be amazed at how quickly it teaches you to draw salable work. Many students of this method began to sell their drawings before they were half through their courses. The training paid for itself long before they finished it.

Learn cartooning this easy way. Enjoy the fascinating life of a successful cartoonist—easy hours, freedom from routine, your own boss, and \$3,000 to \$15,000 a year for this work that is play!

Send for FREE BOOK

Learn more about the wonderful opportunities in Cartooning, and details about this remarkable home-study method. A handsomely illustrated booklet has just been prepared which, upon request, will be sent to you without the slightest obligation. This booklet gives a thorough outline of the cartooning field, and explains in detail this wonderful new method of teaching Cartooning. Send for it today. Washington School of Cartooning, Room 301, 1113-15th St. N. W., Washington, D. C.



WASHINGTON SCHOOL OF CARTOONING
Room 301, 1113-15th St. N.W., Washington, D. C.

Please send me, without obligation, your Free Booklet on Cartooning and full details of your home-study method of teaching Cartooning.

Name.....
(Print Name Plainly.)

Address.....

City..... State.....
(If under 16 please, give age.....)



Ever Get Stuck On a Job?

SHOP NOTES FOR 1923

The latest volume of Popular Mechanics series of year books tells

544 Easy Ways to Do Hard Things

of daily use to every mechanic. Among the many useful articles are Shop Crane—Testing Motors—Power Hammer—Arbor Press—Air Compressor—Turret Lathe—Bench Punch—Concrete Mixer—Bench Grinder—Drag Saw—Concrete Tile.

224 Pages—436 Illustrations

Price 50 Cents, Postpaid

SHOP NOTES SET—comprising 14 of the volumes previously issued and including the latest or 1923 number—\$7.50 Prepaid.

Popular Mechanics Book Dept.
200 E. Ontario St. CHICAGO

If Every Boy

who Loves to Fish and Camp, or is fond of the Water, will write to the

Izaak Walton League

537 Lake Shore Drive
CHICAGO

He will receive something which cannot fail to interest him. A postal card will do.

These Books FREE For One Week

Send no money—just fill out the coupon. After you receive the full set of books, express collect, read them over and test them out for seven days. If you don't want them, send them back at our expense. If you decide they will do for you what they have done for more than 100,000 others, pay \$2.80 within one week and \$3 each month thereafter until the special price of \$21.80 is paid. This amounts to only ten cents a day. Mail coupon NOW if you want a bigger, better job at higher wages.



All Automobile Engineering Facts at Your Fingers' Tips

Six Complete New Books for Study or Reference
Also Year's Consulting Membership in
American Technical Society—FREE

Here's the most practical set of books ever written on automobile engineering. Each book is brimful of information about the various phases of this work. 2,600 pages, 2,300 pictures and diagrams, 125 blue prints on every subject. Practical problems are solved in everyday language. They make automobile engineering as plain as day. Completely cross indexed for ready reference.

Know All About Automobiles and Earn Big Pay

These are just the books for the man who wants to know all about automobiles and fit himself for a big-paying job. They are interesting from start to finish and crammed with information. A little regular reading in them during spare hours will soon equip you for

the automobile business. Then after you get into the auto game, you'll still have them for reference.

Let These Books Solve Your Daily Problems

To the man now engaged as a mechanic or shop foreman, these books will give a world of help. They dig deep into the technical angles and theories and explain them in everyday words. If you have trouble on any point, you'll find the answer in these books. They are the work of fifteen auto experts who know from experience, the problems and difficulties of the shopman.

Repair Your Own Car

The car-owner will find these books extremely valuable as an aid in repairing his own car. Think of the heavy repair bills this will eliminate. Think of the money you can save.

© A.T.S. 1923

FREE Consulting Membership

A resident consulting staff of 18 practical experts is waiting to solve for you any auto, tractor or motorcycle troubles that you may have. A letter or a wire to the American Technical Society will bring you an immediate answer and the solution to your problems. This advisory staff of practical automobile men plus your library of Automobile Engineering will enable you to handle successfully any auto job. These men know all the latest methods and the newest and best ways of doing things. Let this pay-raising consulting staff be YOUR SILENT PARTNER. Use this service daily if necessary.

This free consulting membership offer is good for a limited time only and can be withdrawn without notice.

American Technical Society
Dept. A-119 Chicago, U. S. A.

AMERICAN TECHNICAL SOCIETY, Dept. A-119
Chicago, U. S. A.

Please send me a set of Automobile Engineering, for seven days' FREE EXAMINATION, shipping charges collect. I will examine these books thoroughly, and if satisfied, will send \$2.80 within seven days and \$3 a month until I have paid the special price of \$21.80. If I decide not to keep the books, I will return them within one week at your expense. It is understood that if I keep the books I am entitled to a FREE Consulting Membership in the Automotive Division of the Society.

Name.....

Address.....

Reference.....

(Please fill out all lines, give local merchant, banker or employer as reference.)



LEARN BY DOING

Every phase of all branches of

ELECTRICITY

TAUGHT BY ACTUAL PRACTICE

In America's foremost institution for trade training.

NO BOOKS USED
Individual Instruction Start Any Day

A SPECIAL and SEPARATE Course in Ignition, Auto Lighting and STARTER Systems.

Write for FREE 64-Page Catalog

THE NEW YORK ELECTRICAL SCHOOL
44 West 17th Street NEW YORK CITY



Learn to Write

I Teach by Mail

I can make a good penman of you at your home during spare time, no matter where you live or how poorly you now write. My simplified system has shown thousands the way to good penmanship during the past twenty-five years — it CAN and WILL do the same for YOU.

My beautifully illustrated 32-page Book

"How to Become a Good Penman" FREE!!

It contains many beautiful specimens of penmanship showing what others have accomplished by the Tamblin System, with testimonials and general information about our courses. (Your name elegantly written on a card if you enclose stamp for postage.) Ladies taught as successfully as men. Write Today. Address

F. W. TAMBLIN
418 Ridge Bldg. Kansas City, Mo., U. S. A.

F. W. Tamblin

PIANO JAZZ

By Note or Ear. With or without music. Short Course. Adult beginners taught by mail. No teacher required. Self-Instruction Course for Advanced Pianists. Learn 67 styles of Bass, 180 Syncopated Effects, Blue Harmony, Oriental, Chime, Movie and Cafe Jazz, Trick Endings, Clever Breaks, Space Fillers, Sax Stuns, Triple Bass, Wicked Harmony, Blue Obligato, and 247 other subjects, including Ear Playing and Musical Invention. 110 pages of REAL Jazz, 25,000 words. A Postal brings our FREE Special Offer.

Waterman Piano School, 259 Superb Theatre Bldg., Los Angeles, Cal.

LEARN WATCH REPAIRING

Be a watchmaker—you can learn this profitable trade by correspondence in a few weeks in your own home by the DeSelms Chart System. After you complete the course you will know a watch from A to Z. You will know just what the matter is and how to repair one. When you graduate you will be a practical watchmaker and repairer and competent to fill any position. Positions for our graduates. Ask for our Free Book. It explains our system and terms.

THE DeSELMS WATCH SCHOOL
23 Perry Street ATTICA, INDIANA



"STAMMERING

Its Cause and Cure"

You can be quickly cured if you stammer. Send 10 cents, coin or stamps, for 288 page cloth bound book on Stammering and Stuttering. It tells how I cured myself after Stammering and Stuttering for 20 years. **BENJAMIN N. BOGUE**
6905 Bogue Building, 1147 N. Ill. St. Indianapolis

WORK FOR UNCLE SAM

"The best employer in the world"

Wonderful opportunity for men and women. Thousands of appointments yearly. Good salaries, short hours, liberal vacations. Positions open now in every city of the country and in Alaska, Porto Rico, Hawaii and the Philippines. Write for FREE CIVIL SERVICE BOOKLET, which tells how to get a position with the U. S. Government.

INTERNATIONAL CORRESPONDENCE SCHOOLS

Box 5576-D, Scranton, Penna.



Copyrighted material

YOU CAN PLAY THE HAWAIIAN GUITAR

Just Like the Hawaiians!

Because Our Native Hawaiian Instructors Will Show You How!

Be the Most Popular Member of Your Set, Play "When You Walked Out," "Ten Ten Tennessee," "Stella," "Louisville Lou." All the Late Song and Dance Hits. You can play First Selection in Half an Hour and Harmonious Chords AT ONCE.

Here is your chance to get in the swim—to learn to play the most fascinating of all instruments, the Hawaiian Guitar, just as the Hawaiians do, and in an amazingly short time. Our method is so simple, plain and easy that you begin a piece your first lesson. In half an hour you can play it! Thousands of successful students prove this to be true. It is quite astonishing to find the ease with which you can master the Hawaiian Guitar—no matter how little your knowledge of music may be you can positively learn to play by our plain and easy method.

Expert Hawaiians Teach You to Quickly Master Their Secrets of This Fascinating Music

The instructions you receive from such world famous experts as Lawrence Kalaniki, Walter Kolesmoku, Frank Ferrer, Carl Seville and others are invaluable. No other Conservatory can even begin to give you the expert teaching and knowledge you gain through us. And remember, while it is conceded that the Hawaiian Guitar produces the sweetest music, yet its mastery by you will be simple and quick, since there are

ONLY 4 EASY MOTIONS

to learn to be able to play any music—popular, dance, classical, native Hawaiian airs, or old time melodies and hymns. Just think of it! You need never have read a musical note in your life! For that matter, even though you haven't the slightest knowledge of any musical instrument we guarantee to teach you how to play just like the Hawaiians!

A Complete Conservatory Course!

Never before has such a complete and easily understood Conservatory Course in Hawaiian Guitar been offered. We are able to grant you this opportunity of quickly learning how to play the Hawaiian Guitar through acquiring the services of real Hawaiians to teach you.

How well this has been accomplished is proved by the fact that this is the only Conservatory teaching Hawaiian Guitar exactly as played by the Hawaiians. It is your good fortune as well as ours, that these Native Masters of Hawaiian Guitar came to this Conservatory to teach—and best of all

We Furnish Everything

When you enroll as a student in this Conservatory you receive FREE a handsome, sweet toned Genuine Hawaiian Guitar—valued at \$15.00—52 especially arranged lessons and 52 carefully selected pieces of music, as well as all necessary picks, Steel Playing Bar, etc. There is nothing extra to buy, everything is furnished.

SEND FOR DETAILS TODAY

of this remarkable course—simply fill in the coupon, mail to us and we'll gladly send you full details of our complete Conservatory Course and FREE Hawaiian Guitar Offer! We know you will not let another day go by without enrolling as a student in this Conservatory, once you learn how quickly and easily you can master this most popular of all instruments—the Hawaiian Guitar—So mail the Coupon NOW.

First Hawaiian Conservatory of Music, Inc.
Dept. 48, 233 Broadway (Woolworth Bldg.) N. Y.

Special Courses Under Famous Teachers: TENOR-BANJO
VIOLIN, BANJO-UKULELE and UKULELE

This Makes a Splendid Christmas Gift



FREE

This Genuine
HAWAIIAN
Guitar—

A Real
\$15.00
Value



MAIL THIS COUPON NOW!

First Hawaiian Conservatory of Music, Inc.,
Dept. 48 233 Broadway, (Woolworth Bldg.), New York
Please mail at once full details of your 52 easy lessons and
FREE Hawaiian Guitar offer. This, of course, does not oblige
me in the least.

Name _____

Address _____

City _____ State _____

(Please PRINT name and address clearly)

Smashing Reduction!

**BOXING,
Jiu-Jitsu,
Wrestling**

**Now
\$1.97**

"Had I studied this course before I took up boxing I would have saved myself a few hard knocks. Have knocked out two local boys—best scrappers in town."
Charles F. Ball
Pocatello, Idaho

"It is as complete as it could possibly be for scientific boxing, Jiu Jitsu or wrestling."
Lewis E. Davidson
Berkshire, O.

Down goes price again. Now you can get the complete Marshall Stillman Course for \$1.97. It teaches you how to feint, duck, block and hit like a professional. It contains all the secrets of the ring.

**Marshall Stillman Association,
Dept. 1224-A, 42nd St. and Madison Ave., New York**

You may send me on approval the Marshall Stillman course. I will deposit 97 cents (plus actual postage) with the postman, with the understanding that if, after 10 days, I wish to return the course, I may do so and my money will be instantly refunded. If I keep the course I am simply to send you \$1 in final payment.

Name.....

Address.....

Canadian and foreign orders must be accompanied by cash (\$1.97 U. S. funds) subject to money back guarantee if not entirely satisfactory.

A pugilist says: "Your course is a most valuable assistant to any one who wishes to become either a real prize fighter or an amateur boxer."

All that is needed to master the Marshall Stillman Course is persistence. Every movement is described so clearly you have no difficulty in understanding it. You are taught expert blows such as Corbett's Left Hook; Fitzsimmon's Shift; the McCoy Corkscrew; the Dempsey Triple.

Jiu Jitsu and Wrestling are also included. You are taught bone-breaking holds, how to take a gun, club or dagger from a ruffian and break his arm, how to render an opponent helpless, break a grip on your throat, or baffle a man who tries to kick you.

A 96-page book containing the lives of famous pugilists with many little known stories is included FREE.

SEND NO MONEY

Fill out coupon and we will send you course. Hand the postman a temporary deposit of \$0.97 and send us the remaining \$1.00 in 10 days if satisfied. Otherwise return the course and we will return your deposit.



Do Your PRINTING

Cards, circulars, labels, tags, book, menus, paper, Press, \$12. Larger \$35. Job Press \$150 up. Save money. Print for others. BIG PROFITS. All easy, rules sent. Write factory TODAY for press catalog, TYPE, cards, paper. THE PRESS CO. D-78, MERIDEN, CONN.



LEARN WATCHMAKING AND ENGRAVING

Earn while learning. Most practical watch school. Individual instructions. Graduates in great demand. Book free. Chicago School of Watchmaking, Dept. 20, 6840 Lincoln Ave., Chicago

"THERE'S MONEY IN IT"

AT HOME LEARN TELEGRAPHY AT HOME

MORSE AND WIRELESS

TEACH YOURSELF in half usual time, at trifling cost, with the wonderful Automatic Transmitter, **THE OMNIGRAPH**. Sends unlimited Morse or Continental messages, at any speed, just as an expert operator would. Adopted by U. S. Government, and leading Universities, Colleges and Telegraph Schools. 3 Styles. Catalog free. **OMNIGRAPH MFG. CO., 16-22 Hudson St., NEW YORK**

If you own a Radio Phone Set—and don't know the code—you are missing most of the fun.

LEARN CARTOONING

Successful cartoonists earn big salaries. Many of the most popular cartoonists of to-day learned to draw in their spare time, at home, through the Landon Course of Cartooning and now earn \$75 to \$200 a week.



The Landon Picture Chart Method of teaching ORIGINAL drawing makes cartooning easy to learn. Hundreds of sketches like the above explain every step in creating ORIGINAL heads, figures, animals, etc.

Write today for Sample Landon Picture Chart, long list of successful Landon students and full information showing possibilities for you. *Please state your age.*
The LANDON SCHOOL, 738 National Building, CLEVELAND, OHIO

Results Prove Merit

In the leading publications and reviews which monthly reproduce the work of America's best cartoonists, you will constantly find the work of Landon students, including:

1. Dorman Smith of the N. E. A. Service.

2. Craig Fox of the Rochester Democrat and Chronicle.

3. Leo Thiele of the Sioux City Tribune.

4. Fred O. Seibel of the Knickerbocker Press of Albany.

5. Cartoonist Kuhn of the Indianapolis News—and others.

A constantly increasing number of Landon students are becoming nationally known as America's leading cartoonists.

Look Here!

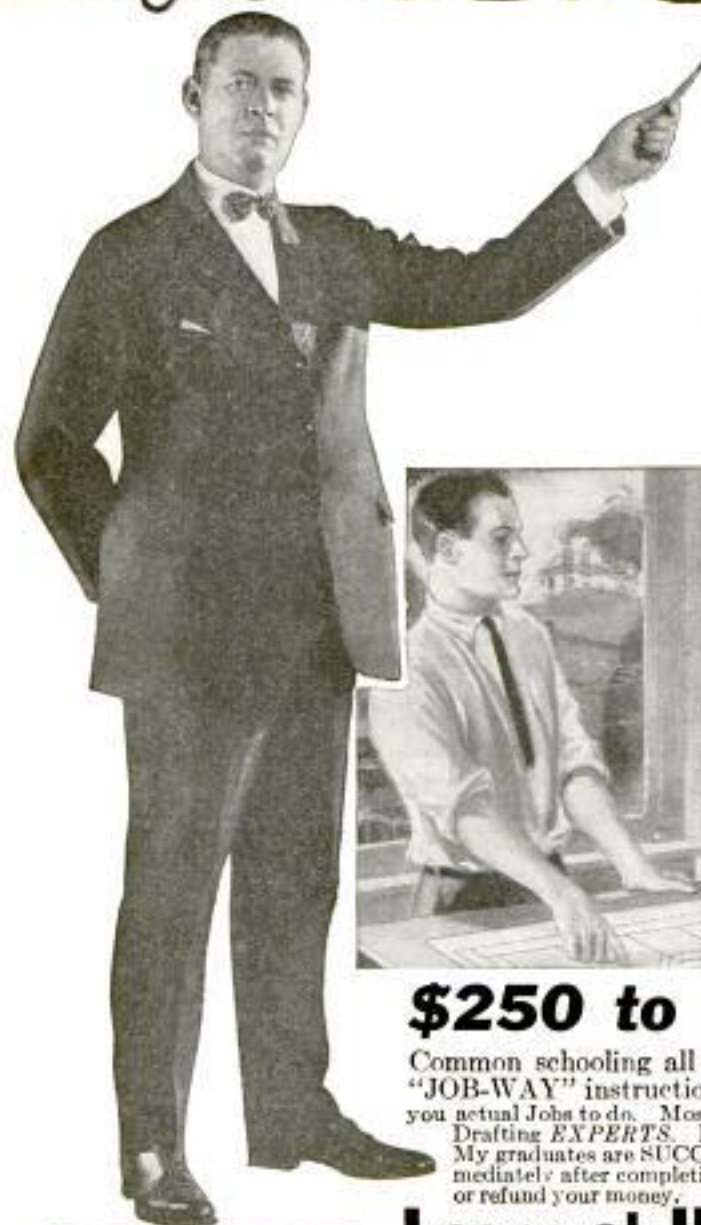

I GUARANTEE
to make you a
DRAFTING
EXPERT



If you're earning less than \$100 a week GO INTO DRAFTING. I guarantee to train you AT HOME, to make you a high-price DRAFTING EXPERT quick! Send for my 2 free books, find out about the wonderful opportunities to earn big money in this easy, fascinating business. Get my astonishing offer to train you until you're actually placed in position paying

\$250 to \$400 a MONTH!

Common schooling all you need. I train you by my copyrighted "JOB-WAY" instruction. I cover every branch of Drafting by giving you actual jobs to do. Most complete training on earth, only instruction that makes Drafting EXPERTS. No books or lessons or useless theory to waste your time. My graduates are SUCCESSFUL—they step into big-pay EXPERTS' jobs immediately after completing my course. So I guarantee to make YOU an EXPERT or refund your money.

Learn at Home!

Thousands of big-salaried jobs, all over the country, looking for DRAFTING EXPERTS! Railroads, factories, builders, architects, ship-yards, auto plants, Cities, Countries, States, the U. S. Government—all hungry for Drafting Experts. Man alive, wake up to your biggest opportunity!

Experts' Outfit FREE!

"JOB-WAY" training makes you a DRAFTING EXPERT quick because you learn to do actual jobs with the same professional instruments you will use when employed at a big salary. To encourage you to START RIGHT NOW, I will give you this costly outfit without one penny of cost! Coupon brings complete information.

2 Books Free! Mail Coupon Today!

Address **CHIEF DRAFTSMAN**
COYNE SCHOOL OF DRAFTING
1-9 S. Ashland Ave., Dept. 119
CHICAGO, ILL.

Chief Draftsman
COYNE SCHOOL OF DRAFTING
1-9 S. Ashland Ave., Dept. 119, Chicago, Ill.

Without obligating me in any way, please send me your two books, "Drafting, the Foundation of Industry" and "Learn Drafting by the Job-Method"—all absolutely free. Also complete information of your rapid home-study Drafting course, free instruments and other features.

Name.....

St. No.....

City..... State.....

FREE!



MAIL COUPON TO-DAY!

Are You the Boss? —or Are You Riley?

THE BOSS gives the orders—Riley takes them and does what he is told. Both started the same, had equal ability to begin with. Riley works harder than the BOSS and gets less money. What is the answer?

Training did it. Your brain is an engine that needs fuel. Study and training supply the fuel that makes it go. And when you mix brains with your work you **SIMPLY CANNOT HELP BUT GET AHEAD.**

Be a Contractor or Builder

Fit yourself for a big job in the Contracting or Building business. Train for it right at home. The Course is easy to learn, is simple but thorough, is taught by experts who have made it their life study. We teach you Estimating, Blue Print Reading, Building Regulation, Use of Steel Square, Water Supply and Drainage, Heating and Ventilating, etc.

The cost is low, terms easy, results quick and sure. Our money-back guarantee insures satisfaction. Thousands are earning **BIG MONEY** in this business today. Get ready to get yours. Fill out the coupon now. Check the Course you are interested in. It costs you nothing but a 2c stamp for full information. It will mean much for your future.

American School

Dept. G-174 © A. S. 1923

Drexel Ave. & 58th St. CHICAGO



"Riley—Take up These Bricks"

"All Right Boss"

AMERICAN SCHOOL,
Dept. G-174, Drexel Ave. & 58th St., Chicago
Send me full information on the subject checked.

- | | |
|-------------------------------------|--------------------------|
| .. Architect | .. Business Law |
| .. Building Contractor or Carpenter | .. Lawyer |
| .. Automobile Engineer | .. Machine Shop Practice |
| .. Automobile Repairman | .. Photoplay Writer |
| .. Civil Engineer | .. Mechanical Engineer |
| .. Advertising Manager | .. Shop Superintendent |
| .. Business Manager | .. Employment Manager |
| .. Financial Manager | .. Steam Engineer |
| .. Sales Manager | .. Foremanship |
| .. Cert. Pub. Accountant | .. Sanitary Engineer |
| .. Accountant & Auditor | .. Surveyor (& Mapping) |
| .. Bookkeeper | .. Telephone Engineer |
| .. Draftsman & Designer | .. Telegraph Engineer |
| .. Electrical Engineer | .. High School |
| .. General Education | .. Fire Insurance Expert |
| .. Personal Analysis | .. Wireless-Radio |
| | .. Undecided |

Name

Address

Occupation

Please Mention Popular Mechanics

We Teach COMMERCIAL ART

Meyer Both Company, the largest Commercial Art Organization in the World offers you an unusual opportunity for practical training, based upon twenty-three years of success.

This nationally known organization each year produces and sells to advertisers over 15,000 commercial drawings. Meyer Both instruction is the difference between successful fact and experimental theory. This well paid profession equally open to men and women. Home study instruction.

Get Facts Before You Enroll in Any School

Ask the Advertising Manager of the leading newspapers in your city, anywhere in the United States, Canada, England or Australia about the Meyer Both Company—let them tell you about us. Write for our illustrated book telling about the success of our students—for one-half the cost of mailing—four cents in stamps.

MEYER BOTH COMPANY

Department of Art Instruction

Michigan Ave. at 20th St., Dept. 16 CHICAGO, ILL.

Note—To Art and Engraving Firms: Secure practical artists among our graduates. Write us.

MUSIC LESSONS FREE

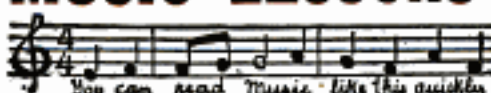
 **IN YOUR OWN HOME**

You can read Music like this quickly
Piano, Organ, Violin, Mandolin, Guitar, Banjo, etc.
Beginners or advanced players. One lesson weekly. Illustrations make everything plain. Only expense about 2¢ per day to cover cost of postage and music used. Write for **FREE** booklet which explains everything in full.

AMERICAN SCHOOL OF MUSIC, 51 Lakeside Building, CHICAGO

STUDY AT HOME

Directed by

The University of Chicago

Courses in English, History, Chemistry, Business, Education, Mathematics, Psychology, and 35 other subjects command credit toward a Bachelor degree. Begin any time. Address 15 Ellis Hall, University of Chicago, Ill.

STAMMER NO MORE

Kill the fear of stammering. Re-education the key. The widely famed Hatfield Method fully outlined in an accurate, dependable, worthwhile book—"HOW TO STOP STAMMERING." It has inspired thousands. Free copy today.

THE HATFIELD INSTITUTE, 109 N. Dearborn, Chicago, Ill.

MINSTRELS

Musical Comedies and Revues, with full instructions for staging. You can stage your own show with our books. Full line of plays, music, crossfire, monologues, afterpieces, vaudeville acts and makeup. Catalogue free.

T. S. DENISON & CO., 623 So. Wabash, Dept. 19, CHICAGO

LEARN WATCH REPAIRING



You can learn by our modern and original system of instruction every part of the **Watch Repairing Trade** at home as good or better than at a shop. You can earn money while learning and secure a well paying position or start in business after completing our course of instruction. Good watch repairers are always in demand and earn from \$30 to \$70 per week. For particulars apply to the **Wisconsin School of Watch Repairing** 166 Mason St., MILWAUKEE, WIS.

Learn to Mount Specimens like These

Write for
FREE
Taxidermy
Book!

Mount Birds, Animals and Fish Be a Taxidermist. Learn by Mail

You can now learn quickly, easily and thoroughly right in your own home by mail. Mount all kinds of game—birds, animals, game heads, fish, also taxskins and furs and make fine robes and rugs. Our wonderful course of 40 lessons teaches you all about taxidermy. The most interesting art you ever studied or can study. Here is the opportunity you have long wanted. Write for free book today. Men, women and boys—all love this wonderful art and all learn quickly. Of untold value to hunters and trappers. Business men, farmers and clerks, all take our lessons and are completely fascinated with this beautiful and easily learned art. If you do nothing else today, send for the free book and investigate.

Make Big Money!

Sell your mounted specimens (if you wish). Big demand and big prices. Mount for your sportsmen friends. The news soon travels that you are a taxidermist and the work pours in. Our students earn big extra money in spare time for guns, traps, books, radio, vacations, etc. One writes "have made over \$200.00 from taxidermy, in spare time, since I joined the school". The most profitable "side line" business in the world.

Learn Field Taxidermy Sportsmen and fishermen, you must know "field taxidermy" to properly care for specimens when you take them, if they are to be correctly mounted later. This is of great importance to all who take hunting and fishing trips. Completely taught in our lessons.

Be a Taxidermy Artist

We now reveal all secrets of taxidermy. We teach latest methods. You become a true artist. You can decorate your home, office or den with nature's finest art—actual game specimens, preserved exactly like life—not mere pictures, but the beautiful game itself. You can become a true taxidermy artist, using spare time only.

Sportsmen—Fishermen if you do not save your finest trophies you miss and lose more than half the pleasure and all the profit. Save your hard-earned game and make fine robes and rugs. Our wonderful course of 40 lessons teaches you all about taxidermy. The most interesting art you ever studied or can study. Here is the opportunity you have long wanted. Write for free book today. Men, women and boys—all love this wonderful art and all learn quickly. Of untold value to hunters and trappers. Business men, farmers and clerks, all take our lessons and are completely fascinated with this beautiful and easily learned art. If you do nothing else today, send for the free book and investigate.

Write for FREE Book

Our beautifully illustrated Taxidermy Book tells you how to learn the art. Send the coupon at once and receive copy by return mail extremely interesting, and shows dozens of photos of mounted game specimens.

FREE This book is absolutely free. No obligation on your part whatever. If you hunt, fish or trap, you need this book. You cannot imagine how interesting and valuable it will be to you, so send right now. Don't delay or you may forget it. Clip the coupon this minute.

Free Book Coupon

Northwestern School of Taxidermy
1771 Elwood Bldg., Omaha, Neb.
Send me absolutely free your illustrated book, "How to Learn Taxidermy." No obligation.

Name

Address



"Be Wise"

Get a Job Like These

Earn \$3500 to \$10,000 a Year

in the Big Pay Field of ELECTRICITY



20 Years Old— Makes Almost \$500 a Month

Harold Hastings of Sonoma, Calif., says: "The profit on my electrical business amounts to \$475 a month. My success is due entirely to your instruction. You make your men just what you say. Electrical Experts. No man will ever make a mistake enrolling for your course."



Dickerson Gets \$7,500 a Year

"I earned \$30 a week when I started with you—\$50 a week when half through your course. Now I clean up at the rate of \$7,500 a year. Thank you a thousand times for what you did for me. Electricity pays big on the farm." Herbert M. Dickerson, Warrentown, Virginia.



\$20.00 a Day for Schreck

"Use my name as a reference and depend on me as a booster. The biggest thing I ever did was answer your advertisement. I am averaging better than \$200 a month from my own business now. I need to make \$18.00 a week."

A. Schreck,
Phoenix, Ariz.



Pence Earns \$9,000 a Year

W. R. Pence, Chesham, Wash., says: "Your course put me where I am today. Mr. Cooke—making \$150 a month doing automobile electrical work—think of it—\$9,000 a year. Besides that I am my own boss. My wife joins me in thanking you for what you did for us."



\$30 to \$50 a Day for J. R. Morgan

"When I started on your course I was a carpenter's helper, earning around \$5.00 a day. Now I make from \$30 to \$50 a day and am busy all the time. Use this letter if you want to—I stand behind it."

J. R. Morgan,
Delaware, Ohio.

in the Big Pay Field of ELECTRICITY

It's your own fault if you don't earn more. Blame yourself if you stick to your small pay job when I have made it so easy for you to earn \$3500 to \$10,000 a year as an electrical expert. Electrical Experts are badly needed. Thousands of men must be trained at once. One billion dollars a year is being spent for electrical expansion and everything is ready but the men. Will you answer the call of this big pay field? Will you get ready now for the big job I will help you get? The biggest money of your life is waiting for you.

I Will Train You at Home

I will train you just like I trained the five men whose pictures you see here. Just like I have trained thousands of other men—ordinary, everyday sort of fellows—pulling them out of the depths of starvation wages into jobs that pay \$12.00 to \$30.00 a day. Electricity offers you more opportunities—bigger opportunities—than any other line and with my easily learned, spare time course, I can fit you for one of the biggest jobs in a few short months' time.

Quick and Easy to Learn

Don't let any doubt about your being able to do what these other men have done rob you of your just success. Pence and Morgan and these other fellows didn't have a thing on you when they started. You can easily duplicate their success. Age, lack of experience or lack of education makes no difference. Start just as you are and I will guarantee the result with a signed money back guarantee bond. If you are not 100% satisfied with my course it won't cost you a cent.

FREE—Electrical Working Outfit and Tools

In addition to giving my students free employment service and free consultation service, I give them also a complete working outfit. This includes tools, measuring instruments, material and a real electric motor—the finest beginners' outfit ever gotten together. You do practical work right from the start. After the first few lessons it enables you to make extra money every week doing odd electrical jobs in your spare time. Some students make as high as \$25 to \$35 a week in spare time work while learning. This outfit is all FREE.

Mail Coupon for FREE BOOK

—the Vital Facts of the Electrical Industry

The coupon below will bring you my big free electrical book—over 100 interesting pictures. The real dope about your opportunities in electricity—positive proof that you, too, can earn \$3500 to \$10,000 a year. Send for it now. Along with the book I will send you a sample lesson, a credit check allowing you a \$45.50 reduction, my guarantee bond and particulars of the most wonderful pay-raising course in the world. Send the coupon now—this very second may be the turning point in your life. Send it while the desire for a better job and more money is upon you, to

L. L. COOKE, Chief Engineer

Chicago Engineering Works

Dept. 11 2150 Lawrence Ave., Chicago

The Cooke
Trained Man
is the Big
Pay Man

L. L. COOKE, Chief Engineer, Chicago Engineering Works,
Dept. 11, 2150 Lawrence Ave., Chicago, Ill.

Without obligating me in any way send me the "Vital Facts," your Free Book, Sample Lessons and particulars of your Free Outfit Offer, Free Employment Service, and proof that you can fit me for a big-pay electrical job.

Name

Address

Occupation.....Age

Classified Advertisements

WORLD'S BEST WANT AD MEDIUM

Advertisements in this section, 25 cents per word, each insertion, minimum 10 words, payable in advance. To be inserted under proper classification in February issue, copy should be in our office December 18th.

ADVERTISING AGENCIES

TO secure agents or salesmen or for selling farms and reaching investors, use classified (want) ads in largest newspapers and magazines. Price list No. 30 sent free. Ankrum Advertising Agency, 20 W. Jackson Blvd., Chicago, Ill. The largest classified advertising agency in the U. S.

25 WORDS—355 Rural Weeklies \$14.20. Ad-Meyer Agency, 4112-M Hartford, St. Louis.

A SERVICE agency for magazine and newspaper classified advertisers. Complete advertising service free of charge. We edit and place your copy. Send for our free list and explanation. Sweet & Phelps Advertising Agency, 212 E. Ohio St., Chicago.

FOR ADVERTISERS

ADVERTISE in 24 Big Sunday Newspapers, 24 words \$15.00. Catalog listing 1,000 leading Dailies, Weeklies, Magazines, 4c stamps. Union Advertising, Baltimore Bldg., Chicago.

ADVERTISERS—20 words in 30 magazines \$1.00. Auto-City Agency, 2747 Gladstone, Detroit.

I WRITE letters, folders, booklets, complete follow-up for manufacturers, mail-order dealers. Long experience. Write for details. L. Taylor, Box 44M, Freeport, Ill.

PAGE—65 Magazines—\$15. Copy 15c. Arthur Machemer, Sinking-Spring, Pa.

INTERNATIONALIZE Your Business!!! Buy!—Sell!—Trade! Everything!!!—Everywhere!!! 1c word; \$1.00 inch. International circulation! Trial Year—35c. International-Opportunity, Brookings, S. Dak.

INCH display, hundred magazines \$4.00, three issues \$8.00. Pennell Company, Covington, Ky.

INCH Display 100 magazine thrice \$8. Beck, 5406 Alaska, St. Louis.

SALES PROMOTION

25 YEARS' Experience Developing daily sales, \$50 to \$50,000. Magazine, newspaper, mail campaigns planned. Letters, circulars, booklets written. One client's annual sales after 25 years totaled only \$150,000; following four years of my plans and copy exceeded \$1,000,000 annually. Another's \$25,000 yearly sales increased ten times first year by my plans and copy. From zero, another's direct mail sales reached \$3,000,000 annually in six years through my plans and copy. Submit in detail your problems for free preliminary diagnosis. Ten years Sales Promotion Manager, Larkin Co., a thirty-million-dollar corporation. James C. Johnson, 118A Woodbridge Ave., Buffalo.

OUR Letters Are Business Getters! \$5 each (prepaid). Alpha Adservice, One Hudson, New York.

AUTOMOBILE SUPPLIES

AUTO and Truck Parts. Save 25-50%. New and used motors, gears, axles, bearings, springs, generators, \$10 up. New Zenith, Johnson, Rayfield, Stromberg carburetors, \$7.50 up; new waterproof Slims and Berling magnets, \$15; Ford retopping, \$4-65; other cars, \$12 up. Brightman Auto Exchange, 321 Windsor Ave., Hartford, Conn.

PEP Water-mixed Valve Grinding Compound gives twice the speed of grease-mixed compounds and a better job. Would you put grease on a grindstone to grind an axe? Repeat orders from the Navy, Standard Oil and others who cannot be fooled twice. Write for free sample. Pep Mfg. Co., Aeolian Building, New York.

E. Z. BRAKE Silencers insure safety and comfort. No squeaking, chattering or grabbing, 50c set. E. Z. Bushings eliminate rattle and hammer of steering post. State make of car. Sample 50c. Money-makers for distributors or salesmen. Keystone Sales Co., Pacific Bldg., San Francisco, Cal.

LIBERTY Air Compressors, for garages, tire-shops, filling stations, also paint spraying equipment. Air Compressor Equipment Co., 1437 Carroll Avenue, Chicago, Ill. Distributors wanted.

RECHARGERS for all magnets, \$5.00. Benner Manufacturing Company, Webb City, Mo.

AUTO Parts at cut prices! All kinds of new and used, for all cars. Engines, Clutches, Transmissions, Axles, Radiators, Magnets, Generators, Batteries, Shafts, Gears, Bearings, Springs, etc., etc. If you have never known the House of Warsawsky, you had better write us and get acquainted. Think of buying the Osgood lens for 35c per pair, and rims for any car at \$2.00 each. Windshields from \$8.00 to \$10.00. Spotlights \$1.75. Welding outfits at a low price. Specify make and model of car when writing. "Ask for Bargain List." Warsawsky & Co., 1935 S. State St., Chicago, Ill.

AUTOMOBILE owners, garagemen, mechanics, send for free copy America's popular motor magazine. Contains helpful, money-saving articles on repairing, overhauling, ignition, carburetors, batteries, etc. Automobile Digest, 507 Butler Bldg., Cincinnati.

AUTOMOBILE Parts—Used parts for most any car at half factory list prices. Allen, Briscoe, Buick, Cadillac, Chalmers, Chevrolet, Dodge, Dort, Grant, Hudson, Hupmobile, Oakland, Overland, Oldsmobile, Reo, Studebaker and many others. Send list of parts wanted. Maxwell Bros., 4106 Olive St., St. Louis, Mo.

REPAIRING Ford Cars, Trucks and Tractors in the most proper and efficient way is explained in a new 229-page book by the former director of the Ford Motor Co. Service School. This information is otherwise unavailable outside of the Ford plant. Written more especially for the mechanic and repairman. Price \$2 postpaid. Popular Mechanics Book Dept., 206 E. Ontario St., Chicago.

\$250 MONTHLY earned by W-B Battery Co. (Montgomery); HB 8-Hour Battery Charging pays Diamond Grid Shop, (Asheville) \$500 monthly. Hundreds more making big profits—you can, too. HB Outfit easy payments. Write Hobrocco, Troy, Ohio.

TOWLINES: Guaranteed; \$2.50 each, \$18 doz. Agent's sample \$1 prepaid; C. O. D. \$1.10. Superior Mfg. Co., 211 High Ave., Cleveland, O.

REMANUFACTURE Fords—most profitable business on earth—\$14,355.00 Made on 200 complete jobs, \$850.00 completely equips shop with tools recommended by Ford Motor Company. Circular. K. R. Wilson, Buffalo.

FROZEN Radiators Prevented in Coldest Weather by using No-Freeze. Ace Auto Polish. Make old cars look like new; either formula \$1.00, or both \$1.50. Ace Laboratory, Dept. P-712, 3421 Wabash, Chicago.

JIFFYCHAIN, New-antiskid chain. On or off in a jiffy without jacking. Dealers and distributors wanted. Holco, Annawan, Ill.

AUTOMOBILES

MAKE Your Own Auto Side Curtains. I did, you can. New Invention. Particulars, Hallock, Pittsburgh Building, St. Paul, Minn.

MAGNETO Recharger, Alternating \$55. Magneto Speed tester \$6. Magneto Bench tester \$3. Adjustable Gasoline sign \$5. Adjustable Intensifiers 8c. Glass Intensifiers 10c. Reliable, 330 Jay, Utica, N. Y.

AUTOMOBILE owners, garagemen, mechanics, send for free copy America's popular motor magazine. Contains helpful, money-saving articles on repairing, overhauling, ignition, carburetors, batteries, etc. Automobile Digest, 507 Butler Bldg., Cincinnati.

PATENTS—Write for our Guide Books. List of Patent Buyers and "Record of Invention Blank" before disclosing inventions. Send model, or sketch and description of your invention for our free opinion of its patentable nature. Highest references. Reasonable terms. Victor J. Evans & Co., 185 Ninth, Washington, D. C.

DYKE'S Automobile Encyclopedia, 13th edition, new, greater than ever, entirely rewritten and rearranged. Contains greatest array of automobile facts ever published in one volume. Separate books containing same information cost \$21. Over 1,200 pages and 4,100 illus. Cloth \$6. Flex. Amer. Morocco \$7.50 postpaid. Popular Mechanics Book Dept., 206 E. Ontario St., Chicago.

LEATHER Coats, U. S. Aviators, \$10 to \$15. Wonderfully warm. 28 H. P. airplane motors, new, \$100. Smith, 403 Goggan Bldg., Houston, Texas.

PATENTS Procured. Send sketch or model today for examination, prompt report and advice. No charge for preliminary advice. Write for free Booklet and blank form on which to disclose your idea. Highest references. Promptness assured. Clarence A. O'Brien, Registered Patent Lawyer, 53-A Security Bank Building, Directly across the street from Patent office, Washington, D. C.

RACING Bodies for Fords and Chevrolet 490. Send for free particulars. Our book "How to Build a Ford Racer" sent on receipt of 25c. Central Auto Supply Company, Dept. 120-C, Louisville, Ky.

M. P. LAUGHLIN—Patents—Engineer—Attorney—Specializing Power-Automotive Inventions. 48 East 41st St., New York.

FOR FORD OWNERS

FORD Repair Book Free: A very complete and well illustrated book explaining how to make repairs on most every part of your Ford. We offer this book free with a nine months' subscription to Ford Owner and Dealer Magazine—at only \$1.00. Everyone interested in the Ford car should read this big magazine of about 200 pages monthly. It clearly explains the things you want to know about cutting down the cost of operation, the engine, ignition, transmission, carburetor, etc. Send Today and get the valuable Repair Book Free. Ford Owner and Dealer Magazine, 537 Montgomery Bldg., Milwaukee, Wis.

FORDS Get 25-45 Miles with Reid's Automatic Air-Friction Vaporizer. Something new. Guaranteed. Send today. Price \$3.00. Agents wanted. R. A. Reid, 19 Barget Ave., Medford, Mass.

AUTOMOBILE owners, garagemen, mechanics, send for free copy America's popular motor magazine. Contains helpful, money-saving articles on repairing, overhauling, ignition, carburetors, batteries, etc. Automobile Digest, 507 Butler Bldg., Cincinnati.

UNDERSLING with "RKO" Swing Lo Irons. See "Red-I-Kut" ad, page 143.

MOTORCYCLES, BICYCLES AND SUPPLIES

USED parts for all motorcycles, cheap. State wants. Schuck Cycle Co., 1922 Westlake, Seattle, Wash.

WONDERFUL bargains in reconditioned motorcycles. Priced at low as \$35. Sidecars from \$25 up. Everyone expertly rebuilt and guaranteed in absolutely first-class condition. Don't delay. Send 2c for new big catalog showing 1923 bargains. Western Supplies Co., 359 Hayutin Bldg., Denver, Colo.

1922 HARLEY-DAVIDSONS, \$125; 1921, \$115; 1920, \$85; 1919, \$65; 1917, \$50; 1914, \$45; 1915, \$40; 1914, \$35. Guaranteed. Money refunded if not satisfied. Circular free. Wisconsin Cycle Sales Co., 726 National Ave., Milwaukee, Wis.

USED Motorcycle Bargains: Indians, Harleys, Excelsiors at big reductions, \$50.00 up. Guaranteed and shipped on approval. Easy payments. Big fall sale now on. Send stamp for free catalog "A." Clymer, the Motorcycle Man, Denver, Colo.

'19 INDIAN 3 Speed \$75.00. '20 Indian 3 Speed \$95.00. '21 Indian 3 Speed \$125.00. Howard A. French Company, Baltimore, Md., Washington, D. C.

OVERSTOCKED—200 Used Motorcycles. Must be sold at once. We have Harley-Davidsons, Indians, Hendersons, Excelsiors, Clevelands, Prices \$25.00 Up. Write for our Bargain List. Myerow Brothers, Dept. B. 15, Berkeley St., Boston, Mass.

HARLEY-DAVIDSON—\$20-J—\$100. Good Condition. Joe Ries, Carroll, Iowa.

MOTORCYCLE spark plugs, genuine Champion, brand new, \$3.50 for 10. Air Transport, L. I. City, N. Y.

SEND for our Bargain Bulletin and Money Saving Message. It will save you money on Motorcycles, Side Cars, Motor wheels, Repair Parts and Accessories. Some used parts at less than half. Cleveland and Ace Motorcycles our specialty. See our ad on page 133. American Motor Cycle Co., 2043-5-7 W. Chicago Ave., Chicago.

AVIATION

THE American School of Aviation announces a new correspondence course in Mechanics of Aviation. A thorough training in Practical Aeronautics. American School of Aviation, Dept. 1868, 3601 Michigan Ave., Chicago, Ill.

TEN lessons in the air, of twenty minutes each, will make you a pilot, by our advanced method of training. This together with our five week shop course at \$100.00 makes America's oldest aircraft factory the most popular flying school. Work after class hours guaranteed. Heath Airplane Co., Inc., Chicago, Ill.

SEND one dollar for beautiful pair of sterling silver wings mounted on stick or bar pin with safety catch. Wear one to boost aviation. Money refunded if not absolutely satisfactory. Wallace Aero Company, Davenport, Iowa.

THREE foot model aeroplane. Small cost. Circulars free. Aero Shop, 3050 Huribut Ave., Detroit, Mich.

BIGGEST, best catalogue Model Aeroplanes, Parts and Supplies; 3c Postpaid. Ideal Aeroplanes Co., 72½ Green St., New York.

HEATH propellers represent the most efficient method of aerial drive. Each propeller individually designed for the particular work to be done, as laid out by America's oldest aeronautical engineers. Propeller catalog, 4c. Heath Airplane Co., Chicago, Ill.

LEARN to fly this winter a special course; a special price. Varney Aircraft Co., Peoria, Ill.

AIRPLANES, Cheap, Complete, 1 to 5 Passenger. First-class condition. Flying instruction \$35.00 per hour. Rowe Fliers, Binghamton, N. Y.

"GENUINE photograph, 17 in. x 13 in." Harding World's largest Airplane, beautifully mounted, artistic frame, \$2.95 prepaid. Air Transport, L. I. City, N. Y.

SEND 10c for our latest aeronautical catalogue, listing a complete line of airplane goods at reduced prices. Ford or Motorcycle motor airplane catalog, 4c each. Heath Airplane Co., Chicago, Ill.

AIRPLANES, new or slightly used, \$300 to \$1,250. Motors, wings and propellers—Bargains. Leather Coats, \$10 up. Smith Machinery Co., 403 Goggan Bldg., Houston, Texas.

"BUILD an Airplane." Motorcycles Engine Monoplane Plans, \$1. Sportford Biplane Plans, \$2.50. "Knockdown Planes," \$100 up. Illustrated Circular Free. Aviation Engineering Co., Lawrence, Kansas.

CURTISS 8-cylinder air-cooled motor, 50 H.P., weight 160 lbs. Price \$85. Eugene Shank, "Y," St. Paul, Minn.

PATENTS Procured. Send sketch or model today for examination, prompt report and advice. No charge for preliminary advice. Write for free Booklet and blank form on which to disclose your idea. Highest references. Promptness assured. Clarence A. O'Brien, Registered Patent Lawyer, 58-A Security Bank Building, Directly across the street from Patent office, Washington, D. C.

Indian power-plus motors complete with air propellers, high tension magnetos and carburetors. Ready for sled mounting, \$75.00 each. Sled blue-prints, \$1.75. Heath Airplane Co., Chicago, Ill.

MANUFACTURERS' Representative Aeronautical People. Write Confidentially Johnston B. Blakely, 22 West Quincy Street, Chicago, Ill.

BOOKS AND PERIODICALS

INDUSTRIAL Alcohol. Wright's book everybody wants. Full directions for making with drawings of necessary apparatus. \$2.50 postpaid. Spon & Chamberlain, 120 P. M. Liberty Street, New York, N. Y.

TRADE, class, technical magazines. List free! Local agents wanted everywhere. Toepf Magazine Agency, Middletown, N. Y.

AMERICA'S greatest employment magazine wants co-publishers everywhere. Rare money-making opportunity. Particulars and copy of magazine, 10c. Employment News, Hyannis, Mass.

FOR Success Read "Master Key," \$2.50. Phipps, 1014 Belmont, Chicago.

WONDERFUL Reference Album Lays and Stays flat when opened. Will bind large quantity clippings, papers, etc., on gummed hinges. 3 sizes, fabricoid cover, 16 in. x 11½ in.—\$3.50; 11½ in. x 10½ in.—\$3.35; pressboard cover 11½ in. x 10½ in.—\$1.25. Write for particulars of other up-to-date filing devices. Zeta-Be Company, 30 East 42nd Street, New York City.

GET our Chalk-Talk Book Full of Trick Drawings and instructions for \$1.00. Postfolio of 7 drawings for 50c; 3 for 25c. 1 for 10c. The Lewis-Hart Art Service, 881 Francis Ave., Portland, Ore.

SHORTHAND Revolutionized scientifically, shorter, speedier, 100% readable. Learn 2 weeks. Complete instruction Manual \$1. Nuhand, B102, Oberlin, Ohio.

OUR valuable catalog of over 500 practical books arranged for easy reference under 80 different subject headings will be sent free on request. Popular Mechanics Book Dept., 206 E. Ontario St., Chicago.

BOOKS on love, human nature, dreams, letter writing, poetry, health, etc. Catalogue and two intensely interesting books, 25c. E. Smetana Co., Owosso, Mich.

"VENTRILQUIISM"—Complete instruction book, 10c. G. Elsen, Bowling Green, Ohio.

FRENCH, language of 50,000,000 people; Primer, \$1.94 postpaid. French-English dictionary, \$1.98. French sound-chart, World-Romic system, 37c. French pronunciation-table, 30c. French phonic text, 13c. Speech-organs chart, 37c. Languages Publishing Company, 8 West 40th Street, New York.

ELECTRICIANS' Examination book of questions and answers, with diagrams, symbols, tables, notes and formulas, for preparation for license, \$1.25. Address Reade Pub. Co., 296 Broadway, New York.

AUTHORS!! Publish your work! Cost low! Particulars 35c. Hansen Company, One, Brookings, S. Dak.

BRYANT'S book "Theology and Creation vs. Evolution and Darwinism," now on sale at Manschreck's Book Store, 113 North Seventh St., Joseph Mo. Price postpaid \$1.10.

FREE—Send for my Newthought, Self-culture, Occult, Mystic and Scientific book literature. A. W. Martens, M. D. Burlington, Iowa.

USED Books, Bargains, Lists, Higene's, 2441 Post Street, San Francisco.

SPANISH, language of 40,000,000 people; Primer, \$1.94. Dictionary, \$1.98. Sound-chart, 37c. Pronunciation-table, 30c. Languages Publishing Company, 8 West 40th Street, N. Y.

25 DIFFERENT Mailorder Publications 50c. Hansen Company One, Brookings, S. Dak.

LEFAX—"Facts on Leaves." You make your own handbook, loose-leaf. From our complete list of Lefax data sheets you select only those that you actually need, then fill in your own notes or diagrams on extra blank sheets which come in 100 different styles. These in loose-leaf binder make up a book covering your individual needs. Send for complete information and price list to Popular Mechanics Book Dept., 206 E. Ontario St., Chicago.

PICTURES AND POSTCARDS

PHOTO post pictures in colors, California, Los Angeles, Hollywood, Ranches, Ocean, Mountains, Assorted, dozen 25c. 100, \$1.50 postpaid. Carrigan Photo Co., 956 Ridgewood, Los Angeles, Calif.

JOIN Live Postcard club; Membership list, including Catalog, 10c. Harvey Teeple, Decatur, Ind.

JOIN the Old Reliable Card Club. Membership, 10c. Riverside Club, Frederick, Md.

NOVELTIES, CURIOS, ETC.

IMPORTED Japanese Wonders, dropped into water, expand five times original size, turning into fish, flowers, animals, babies. Pretty package twelve assorted, 15c. Six 50c. Thirteen \$1.00. Prepaid. Hootch Insurance Policy, latest Prohibition joke, free, each order. Heinemann, 7242 Pingree, Chicago.

MAGIC Goods, cards, books, novelties. Catalogue free. C. Fenner, 2401 Jefferson, Louisville, Ky.

ARMADILLO Baskets for Christmas gift. P. P. paid; Plain basket \$2.75; silk trimmed \$3.75 each. Satisfaction guaranteed or money back. Address: Charles Apelt, Comfort, Texas.

MOON-O-LIGHT Radium Paint shines in darkness, 25c per bottle. Gray & Breter Co., Dept. 10, 1448 St. Lawrence Ave., Bronx, N. Y.

ITS New Aeroplane flies 300 ft. Sample 25c. Koehlers Novelties, 6925 Dorchester Ave., Chicago, Ill.

"SPICEBOX" Imported Novelty, Thrills, Pleases, Amuses, Amazes, 50c. Aircraft, Box 53, Omaha.

GAMES, ENTERTAINMENTS AND PLAYS

VENTRILQUIISM taught almost anyone at home. Small cost. Send 2c stamp today for particulars and proof. George W. Smith, Room M-824, 125 N. Jefferson Ave., Peoria, Ill.

200 KINDS Iron, wood and wire puzzles. Leader and Illustrated list 10c. Western Puzzle Works, St. Paul, Minn.

PLAYS, musical comedies and revues, minstrel music, blackface skits, vaudeville acts, monologs, dialog, recitations, entertainments, musical readings, stage handbooks make-up goods. Big catalog free. T. S. Denton & Co., 623 So. Wabash, Dept. 11, Chicago.

FREE—Free—Free—Large illustrated catalog Magic, Sensational Escapes—Mind Reading. Write us and get started. Heaney Magic Company, Berlin, Wis.

EASY ways to play mouth organ, 25c. Mercatus, Box 1422, Indianapolis.

MAGIC TRICKS, BOOKS, AND JOKERS' NOVELTIES

HYPNOTISM easily learned. Lessons guaranteed. Postpaid \$1.10. Smith Publishing Co., Springfield, Mass.

NEW and Original Magic, Massey, 205 pages, 28 page plates, \$3.15 postpaid. Spon & Chamberlain, 122 P. M. Liberty Street, New York.

MAGIC—Tricks, Books and Supplies. For Amateurs as well as the great professionals. Anyone can learn through our instructions. Feature Acts in Mind Reading, Spiritualism, Rope Ties, etc. Large Illustrated Professional Catalog, 10c. Chicago Magic Co., 140 S. Dearborn St., Dept. B, Chicago, Ill.

EVERYTHING in Magic, Four Catalogs 15c. Gilmaglio, Morgan Park, Ill.

MAGIC-Ink, invisible writing, a barrel of fun, 25c a bottle. Fred Orso Co., 432 East 136 St., New York.

FREE—Our puzzle, trick, game, joke, Novelty Catalog. Wright & Sons, 601-G Ind. Ave., Peoria, Ill.

2,388 MAGIC Tricks, Problems, Experiments, Money-making Secrets, etc., \$1.00; Ancient Golden Wonderhorn of Secrets, 25c; Peg Solitaire, Perplexing, Interesting; Everlasting Game of Checkers, \$1.00; 200-page Catalogue, 25c. Money Refund. Chelsea Department 16, Station R, Box 24, New York.

"VENTRILQUIISM"—Complete instruction book, 10c. G. Elsen, Bowling Green, Ohio.

TRICKS, puzzles, jokes, magical apparatus, plays, stage supplies, mind-reading, sensational escapes, 160-page illustrated professional catalog, 10c. Oaks Magical Co., Dept. 548, Oshkosh, Wis.

YOU can entertain, mystify, and make money. Large illustrated catalog Magical effects, Crystalgazing Acts, Mindreading, Sensational Escapes, also card tricks, Jokes, Puzzles, novelties. Mailed free to your address. Write today. Heaney Magic Company, Berlin, Wis.

HYPNOTISM astounds, controls others. Wants gratified. 25 easy lessons, \$2.75. "Mindreading" (any distance), Wonderful, \$2.75. Both \$5.00. Popular Institute, 2N1014 Belmont, Chicago.

500 LATEST listed tricks, novelties, 10c. Catalogue. "Novelco," 68 Houghton, Worcester, Mass.

STAMP COLLECTING

FREE—"Leader" Pkt. to approval applicants sending 2c stamp. Earl Stamp Co., 1811 26th Ave., North, Minneapolis, Minn.

1,000 DIFFERENT Stamps, \$1.50; 500, 50c; 300, 25c. Fred Onken, 639 79th Street, Brooklyn.

FREE—50 varieties to approval applicants sending 2c. Richard P. Lamprecht, Valparaiso, Ind.

GERMAN Air Mail Set Free to applicants for my 1 cent to 15 cent net approvals; also high priced stamps at 50% discount. Reference Required. Chas. W. Schmidt, 3227 Benner St., Wissinoming, Philadelphia, Pa.

\$2.00 FOR 12c!! 100 different Neurope, catalogued \$2.10; triangle stamp, Red Cross set, airplane set, perforation gauge, millimetre scale, fine wallet, 5 approval sheets, 250 hinges, scarce packet from Nyassa, Abyssinia, etc., price lists and approvals—all for 12c!! Atlanta Stamp Co., Box 532, Atlanta, Ga.

SET German Air Post. Eight different China Ships, and 50 different unused Hungary, cataloging over \$1.50. Millimeter scale, ruler, and perforation gauge. To those requesting our new Sudden Service approvals—2c. Fennell Stamp Co., Dept. P2, Fullerton Bldg., St. Louis.

TO Applicants for Cleveland Approvals we offer Hinges, Pocket Album, perf. Gauge and 40 var. Stamps from Asia, Africa, including Johore, Malay Sts., etc. Price only 16c. Mekeel's Weekly Stamp News 3 mos. for 25c, and 200 var. foreign stamps free. The Cleveland Stamp Co., Dept. P, 323 Caxton Bldg., Cleveland, Ohio.

FREE—25 different U. S. Stamps with 60% approvals to reliable parties. 75 different U. S. stamps 25c. C. Seidenberg, Merion, Wis.

ZAMBESIA, Zanzibar, Abyssinia, Herzegovina, Allenstein stamps, managerie collection, hinges, 10c. Liberty, 3974 Arsenal, St. Louis, Mo.

250 MIXED stamps and souvenir photo, 10c. Phil Lunsted, Cape Cottage, Maine.

FRENCH Souvenirs. High class novelties, curios, war relics, stamps. Price list free. L. Nicolas, 3 Rue Primatice, Paris-13, France.

BEST one-cent approvals in America. F. P. Hand, 1117 So. 60th St., Philadelphia, Pa.

LOWEST Prices! Send for my approvals priced at 1/2, 1/4, 1/8, 1c, and up. Please mention size of collection and give references. L. J. Newberry, San Lorenzo, Calif.

GENUINE Mexican \$5 bill and 150 foreign stamps for a dime. 1,000 unpicked mission stamps 35c. B. Nagle, 1101 Marion, Reading, Pa.

500 DIFFERENT Stamps 32c. 1,000, \$1.20, to approval applicants. Stadler, 437 Beach Ave., Bronx, N. Y.

FREE—Valuable Christmas present to approval applicants sending 2c postage. N. Cousins, 777 Tenth St., Oakland, Calif.

STAMPS sent on approval at 70% discount. Reference required. Emory, Renoll, Hancock, Pa.

FREE—Stamp magnifier to applicants of our lists. Iiter & Shore, 1197 16th Ave., W., Vancouver, B. C.

NEW United States 16c Blue Unused Airplane Stamp; also 100 different stamps for 2c. Jacob Fischer, 4230 Crystal St., Chicago.

FREE, 100 stamps, all different, with each request for my 1c and 2c approvals. John P. Miller, Box 858, New Haven, Conn.

1,000 MIXED Newfoundland, etc., 25c. Izen, 3808 12th Avenue, Brooklyn, N. Y.

LOOK! 500 variety packet, exceptional quality, sent postpaid for forty cents. Desirable premium, free to applicants for my high-class approvals. References positively required. Hugh Argenbright, Staunton, Va.

FREE! World's Smallest stamp. Approvals. Postage 2c. Cannon, 1420 Carey, Davenport, Iowa.

FREE: Cuban cataloging 50c to approval applicants. Send references. Gateway Stamp Co., Box 165, Stockton, Calif.

25 BRITISH Colonials, all different, free to approval applicants sending 2c postage. Nickles, 122 Florida, Washington, D. C.

UNIVERSAL Packet, 100 varieties, all over the world, 10 cents. Covert Stamp, 39 State, Rochester, N. Y.

FREE: sets North Borneo, Jamaica Pictorials by asking. 50% approvals. Reference. Elliot B. Southward, 260 Pleasant St., Wiltimantle, Conn.

PACKET of 23 stamps, no two countries alike. Packet hinges. Set of \$1 and \$2 U. S. Rev., all for 5c. Mention paper. Miami Stamp Co., Toledo, Ohio.

STAMPS. 20 unused, all different, free. Postage 2c. Mention paper. Quaker Stamp Co., Toledo, O.

SNAPS—200 different stamps, 10c; 40 different United States Stamps, 12c. With each order we give free our price list of sets, packets, albums, etc., and our pamphlet which tells "how to make a collection properly." Queen City Stamp Company, Room 38, 604 Race, Cincinnati, Ohio.

PACKET Free to Approval Applicants. Dan Reid, 639 Rhodes Ave., Toronto.

STAMPS, 50 varieties, Africa, Brazil, Peru, Cuba, Mexico, etc., 10c. 50 different U. S., 25c; 1,000 mixed, 40c; 1,000 hinges, 10c. List free. C. Stegman, 5948 Cote Brillante, St. Louis, Mo.

FREE! Loose Leaf Postage Stamp Album at rate of 8 pages each month given with subscription to monthly Journal. Send 2c stamp for prospectus. United Stamp Co., Marquette Bldg., Chicago, Ill.

24 VARIETIES Cuban stamps, 10 cents. List of 6,000 low-priced stamps free. Address Chambers Stamp Co., 111P, Nassau St., New York City, N. Y.

20 UNUSED stamps free. All different. Postage, 2c. Flak Stamps, Toledo, Ohio.

158 GENUINE Foreign Stamps. Mexico War Issues, Venezuela, Salvador and India Service, Guatemala, China, etc., only 10c. Finest approval sheets 50 to 60%. Agents Wanted. Big 72-p. Lists Free. We Buy Stamps. Estab. 29 years. Hussman Stamp Co., Dept. 54, St. Louis, Mo.

FREE—Two sets Nyassa, 20 Diff. British Colonies Barbados and Jamaica pictorials and a packet of hinges—all for a request for my 1, 2 and 3c net approvals, none better. Chas. T. Egner, 4821 Frankford Ave., Frankford, Phila., Pa.

FREE—10 unused stamps sent to approval applicants on approval at 60% discount from standard catalogue prices. J. De Jong, 516 West 162d Street, New York, N. Y.

FOUR unused sets, hinges, gauge, 55 different, 15c. Deering, Newton St., Marlborough, Mass.

30 DIFFERENT Sweden 10c; 50 different U. S. 10c; 10 different Ukraine, 10c; 25 different Poland 10c. R. H. Carlton, 200 W. So. Temple, Salt Lake City, Utah.

FREE—8 Portuguese Colonials, to (50%) approval applicants only. Lampe, 423 West 42nd, New York.

105 CHINA, etc., stamp dictionary, list, 2c. Album (500 illustrations), 3c. Bullard, Sta. A, Boston.

FOREIGN Stamp Collection Sent Free. Cornish Company, Schenectady, N. Y.

"MEKEEL'S News and Trade Circular" sent free to stamp collectors. The name "Mekeel" and Stamp collecting have become synonymous, representing the stamp field for over 45 years. "A Stamp Collector's Souvenir," handsomely bound, published in 1892—50c. Mekeel Stamp Co., Bethlehem, Penn.

15 MINT German mark values 10c. Royal James, Ulrichsville, Ohio.

100 RARE and valuable foreign stamps, all different, bargain list, and Stanton's Stamp News 3 mos., all for 10c. Stanton, Niantic, Conn.

100 VARIETIES Europe, Cat. over \$2.00, for only 12 cents to new approval applicants sending A-1 reference. Perforation gauge and mime. scale free. Pathe Stamp Co., 521 Woodward Ave., Atlanta, Ga. Member: Stamp Trade Protective Association.

250 DIFFERENT British Colonials 95c. Guatemala No. 14 free to approval applicants. Rae, Storm Lake, Iowa.

STAMPS on approval 1/2c up. Free Premiums. Herbert A. Keigwin, Middletown, N. Y.

NYASSA Giraffes and packet of 52 different scarce stamps. Flame Triangle, large \$1.00 U. S. Rev., millimeter scale, perforation gauge and ruler for only 2c. To introduce our Sudden Service approvals. Fennell Stamp Company, Dept. P, Fullerton Bldg., St. Louis, Mo.

FREE! Set 19 Beautiful German Mourning stamps to approval applicants. Penna. Stamp Co., Manor, Pa.

100 DIFFERENT New Europe Free to approval applicants sending return postage. Amvelink Co., 2410 Prairie, Milwaukee, Wis.

APPROVALS for more advanced senior collectors. Discounts to 80% of catalogue. Reference. International, 2117 Regent Pl., Brooklyn, N. Y.

FREE—10 Central American stamps to approval applicants. References essential. Southwestern Stamps, Slaughter Bldg., Dallas, Texas.

25 DIFF. Bulgaria 8c approvals. Fryear, 1411 4th Ave., Cedar Rapids, Iowa.

150 DIFFERENT varieties—10 cents—Every continent represented—no cheap unused. A Black, 1300 Fillmore St., Philadelphia, Pa.

100 DIFFERENT foreign—No English, French, German, Canadian, cheap unused European, ten cents. R. Lehr, 1500 Foulkrod St., Philadelphia, Pa.

1000 HINGES and 100 different stamps 15c; Free packet postage 2c, 50% approvals. Premiums with every purchase. Whelan, Box 174, Jersey City, N. J.

100 DIFFERENT stamps free to applicants for our Popular Approvals. Postage 2 cents. Christensen, Sycamore Bldg., Milwaukee, Wis.

BIG \$4.00 Outfit 10c to Approval Applicants. Buckey, 712 Bowen, Dayton, Ohio.

ODD Moments—Odd Stamps—Approvals—reference appreciated. Odd Stamp Co., Sunset Heights, Asheville, N. C.

FREE Unused Set—14 varieties, to applicants, 1c approvals—Postage, 2c. Elmer, 39 Court St. Boston.

FREE, 25 U. S. with Approvals. 2c postage. St. Elmo Stamp Co., 2311 Gladding St., Chicago.

A DOVER Bargain Stamp Outfit! 250 Peelable Hinges, 50 all diff. stamps, Plume (triangle), Nyassa, French Coins (Pictorials), Malay (Tiger), etc.; 20 Vars. War and New Europe. 5 Blank Approval sheets, 36-page list and Bargain list, all for only 10c to those asking to see my choice 50% approvals. L. B. Dover (Dept. C), St. Louis, Mo.

FREE! 100 different world-wide, many unused, to approval applicants enclosing 4c postage. Walter Medding, Rolla, Mo.

MYSTIC'S "Mysterious" Packet! Contains stamps from the lands of cannibals, heathens, sun worshippers, and wild savages. Included are Travancore, Malay, Dutch Indies, Liberia, Siam, Africa, Abyssinia, North Borneo, Nyassaland, Zanzibar, etc. This wonderful packet containing 110 all different (mostly unused) for only 8 cents to approval applicants. Mystic Stamp Co., Dept. 8, Camden, New York.

FREE, Dollar Stamp Free to applicants for my 60% approvals. Norman Shultz, Colorado Springs, Colo.

FREE—200 different stamps to approval applicants sending 4 cents postage. H. W. Myers & Co., 1018 Florida St., Richmond, Calif.

FREE—Set Russian Occupation gauge, \$1. U. S. Stamp lists, etc., for 2c stamp and reference for approvals, 100 diff. U. S. 22c; 25 diff. Bulgaria 2c. Hawksey Stamp Co., Cedar Rapids, 39, Iowa.

1000 DIFFERENT stamps \$2.00. Address: Luther Matheson, Newton, N. C.

DANZIG Free—Nice Set Danzig Stamps with Biggest Lists Issued, 2c postage. Midland Stamp Co., Station E2, Toronto, Canada.

FRENCH Colonies Free—Pretty Picture Set, Native Chiefs, Tigers, 2c Postage. Empire Stamp Company, 342 Lippincott, Toronto, Canada.

BIG Variety Packet Foreign Stamps Free for 2c postage. Gray Stamp Company, Station E10, Toronto, Canada.

2000 DIFFERENT stamps \$5.65; 1000 \$1.55; 500 55c; 200 15c. Michael, 5353 Calumet, Chicago.

STAMPS, catalogue over dollar, with approvals, dime. Goodman, Six-Twenty South Spring Street, Los Angeles, Calif.

1000 DIFFERENT Stamps, \$1.00; 500 40c. Martel, 306 Station "C," Montreal, Canada.

\$2,500 WORTH, pre-war value, of German stamps given free during December to purchasers of our 15c packet of scarce stamps from South and Central America having catalog value of over \$7. Fenway Stamp Co., Box 84, Fenway Station, Boston, Mass.

RARE COINS

\$2 TO \$500 each paid for hundreds of Old Coins. Keep all Odd or Old Money. It may be very valuable. Send 10c for New Illustrated Coin Value Book, 4x8. Get posted. We pay cash. Address Clarke Coin Co., Ave. 2, Le Roy, N. Y.

OLD Coins. Large Spring selling catalogue of coins for sale, free. Catalogue quoting prices paid for coins, 10c. William Hesslein, 101 A Tremont St., Boston, Mass.

OLD Coins Wanted. Do you know that Coin Collectors pay up to \$100.00 for certain U. S. Coins? And high premiums for all rare coins? We buy all kinds. Send 4c for large Coin Circular. May mean much profit to you. Numismatic Bank, Dept. H, Fort Worth, Texas.

CALIFORNIA gold, 3/4 size, 27c; 3/8 size, 55c; three-cent-piece and catalogue, 10c. Norman Shultz, Colorado Springs, Colo.

1,000,000 GERMAN Marks 50 cents, 1,000,000 Russian Rubles \$1.00. Price list on request. Craig Dare, 440-55th, Brooklyn, N. Y.

U. S. CENT over 100 years old, 25c with Bargain list. Fred Greenclay, 335 16th St., Denver, Colo.

SCARCE Morocco Solomon's seal coin, 20c. Duro, 25 Malberry, N. Y. City.

44 DIFFERENT Foreign Coins, Postpaid, \$1.00. Otto Oddehon, Independence, Mo.

SEND for This Now—Civil War Cent—historically interesting, and large 50-page illustrated Coin Catalog for only ten cents. This offer is just to get acquainted. You'll be surprised how pleasant and profitable you'll find Coin Collecting. Start now. B. Max Mehl, Numismatist, Mehl Bldg., Dept. P, Fort Worth, Texas. Largest Rare Coin Establishment in the United States.

FOR BOYS

BOOKS — "Ventriloquism," "Toymaker Book," "Boy Electrician," 10c each, all for 25c. G. Elsea, Bowling Green, Ohio.

MOUTH-ORGAN Instructor, 25c. Learn in one hour. G. Elsea, Bowling Green, Ohio.

CAMERAS AND PHOTO SUPPLIES

MODERN Photography in all its branches now taught by mail. **New Successful Method.** Students earning \$300.00 while learning. **Big Opportunity.** Write for particulars and unusual offer open for short time. Dept. 3431, International Studios, Inc., 3601 Michigan Ave., Chicago.

KODAK Films—Special trial offer: your next kodak film developed, 5c—prints, 2c each. Moser & Son, 1917 St. James Ave., Cincinnati.

HAVE You a Camera? Write for Free sample of our big magazine, showing how to make better pictures and earn money. **American Photography, 116 Camera House, Boston, 17, Mass.**

AT Last! A Reflex Camera with an F-3.5 German Anastigmat Lens and a roll of Kodak Film at \$10.00. A marvelous value. Extra film 20c per roll. Order Quick! Shipped for examination for \$1.00 deposit. DeFrance, Importers, 199 North Dearborn St., Chicago, Ill.

JUST Published—Our new complete 128-page catalog and bargain book of new and used cameras and supplies. Our goods are guaranteed finest quality obtainable. We have thousands of satisfied customers. Write at once for this bargain bulletin, just hot from the press. **Address Central Camera Co., 124 S. Wabash Ave., Dept. E77, Chicago, Ill.**

FILMS Developed. Special Trial Offer. Any Size Kodak film developed 5c, prints 3c each. Trial 6x10 Enlargement in handsome folder 40c. **Overnight Service.** Roanoke Photo Finishing Co., 269 Bell Ave., Roanoke, Va.

THE Artograph Diffusing Screen Makes Any Lens Soft Focus at Small Cost. Artograph Screen Co., 500 Fifth Ave., New York.

FILMS developed, prints made. Write for Price List. Z. Koscielniak, 17214 Lamont, Detroit, Mich.

SEND \$2.97 and film, kodak picture or photo. I'll make a 11x14 in. Hand Oil-painted portrait from it. State color of hair, eyes, clothes, etc. Block-out \$1.00 extra. Original returned without damage. Otto Hesser, 4356 No. Lincoln St., Chicago, Ill.

FOR best pictures try our hand printing and developing service. Write for reasonable rates. **Doris Chemical Laboratories, East Cleveland, Box 59, Cleveland, Ohio.**

FILMS developed and printed, 6 exposures, 45c; 12 exposures, 75c; copying, 60c; enlargements 5x7, 60c; 8x10, 90c. Send money with work. Satisfaction guaranteed. **Dearing Photo Service Co., 41 Broad Street, Bloomfield, N. J.**

FILM Developed 5c. Prints, Velvet, 2c. Glossy 3c, or roll developed and printed 25c. 8x10 enlargement, any negative, 30c. **Reliable Photo Finishing, Box 151, South Bend, Ind.**

BIG Money Saved on Photographic Lenses and Apparatus—goods exchanged; repairing done. **Ralph J. Golsen, 1128 Arzyle St., Chicago, Dept. P.**

MOTION PICTURES

ONLY \$98.00 starts you in this business. Wonderful opportunities for making Fortunes. Details Free. **Monarch Theatre Supply Co., Dept. 46, Memphis, Tenn.**

REMARKABLE value: Light Weight Professional Motion Picture Projector, Mazda Illuminated, with 1,000 feet of film, \$37.50. Send for photograph. **DeFrance, Importers, 109 No. Dearborn St., Chicago, Ill.**

MOVIES in the Home. Toy machines \$5 up. Films 40c up. Send for illustrated folder and film catalogue. **Independent Film Exchange, Dept. P, 177 Golden Gate Ave., San Francisco, Calif.**

AMERICA'S Greatest Fortunes made in the Motion Picture Business. We furnish Complete Theatre Equipment on easy payments. Openings everywhere. **Catalog Free.** **Monarch Theatre Supply Co., Dept. P—724 South Wabash Ave., Chicago.**

MAKE money writing photoplays; details free to beginners. No correspondence course. **Producers League, 230 Wainwright, St. Louis.**

FILMS: Special Features—Comedies—Cartoons—Dramas and Serials. Lowest Prices. Bargain List Free. **Monarch Theatre Supply Co., Dept. 81, Memphis, Tenn.**

PATHESCOPE Premier Projectors, 3 lenses—case—powerful light \$185—100,000 feet Pathescop film 1 1/2 cents foot. Home Projector, standard film \$25—1,000 feet \$37.50. Motor-Driven suit case \$75—3,000 Film \$3 up—Silver and White screens—Sateem folding screens. 8x10 white canvas screen \$15. Ray, 324 5th Ave., New York.

BIG Money Nightly—Good assortment. Complete Outfit, installment plan. Splendid Home Outfit, \$25.00. **Ralph J. Golsen, Dept. M, 1128 Arzyle St., Chicago.**

\$\$\$ FOR Ideas. Photoplay plots accepted any form; revised, criticized, copyrighted, marketed. **Advice free.** **Universal Scenario Corporation, 206 Security Bldg., Santa Monica and Western, Hollywood, Calif.**

ONE and two reel western film, \$5.00 per reel. One reel Broncho Billy western film \$10.00 per reel. Mutt and Jeff cartoons \$10 per reel. **Monarch Theatre Supply Co., Dept. 8 W. 724 South Wabash Ave., Chicago.**

\$35.00 PROFIT nightly. Small capital starts you. No experience needed. Our machines are used and endorsed by government institutions. **Catalog free.** **Atlas Moving Picture Company, 482 Morton Bldg., Chicago.**

FREE to Writers—A wonderful little book of money-making hints, suggestions, ideas; the A B C of successful story and play writing. Absolutely Free. **Just address Authors Press, Dept. 12, Auburn, New York.**

JUST in time to get in on the big money to be made! **Bass will start you in the Motion Picture Making Business, enormous profits making Industrial Films, News Weeklies, etc. Catalogue and full information Free!** **The Cinema Handbook, 575 pages for \$3.00 postpaid.** **Bass Camera Company, 105 No. Dearborn St., Chicago, Ill.**

SCENERY TO RENT

SETTINGS for Opera, Plays, Minstrels. Flash drops. **Address Amelia Grain, Philadelphia.**

EDUCATIONAL AND INSTRUCTION

USED educational matter, books, etc., sold, rented and exchanged. **Big list free.** **Lee Mountain, Pisgah, Ala.**

PENMANSHIP by Mail. Written Cards. Dozen and case 40c. **Jackson, 22 W. 36th St., Wilmington, Del.**

FEAR, timidity and bashfulness banished. Self-confidence achieved in ten nights of subconscious reconstruction; in ten days of directed activity or your money promptly refunded. **Complete course \$1.00.** **Address, H. Lawrence Juhnke, Box 851, Sacramento, Calif.**

BOOKKEEPING, Accounting, High School, Story Writing, Public Speaking, Salesmanship, Poetry, 4-year College, Success Guaranteed. Payment Plan. **Peoples College, Kansas City, Mo.**

FREE. Instruction in Shorthand, Secretary. **1552 Broadway Avenue, Grand Rapids, Mich.**

WRITE articles, stories, news, in spare time for newspapers and magazines. Big pay. Copyright book free. **Press Syndicate, 552, St. Louis, Mo.**

YOU can have a business profession of your own and earn big income in service fees. A new system of foot correction; readily learned by anyone at home in a few weeks. Easy terms for training; openings everywhere with all the trade you can attend to. No capital required or goods to buy. no agency or soliciting. **Address Stephenson Laboratory, 1 Back Bar, Boston, Mass.**

BE a Laboratory Expert. Earn \$300.00 to \$500.00 a month. **Study Microbiology, Bacteriology, Laboratory Technology, Sanitation. Interesting Extension and Residential Courses. Diplomas and Degrees granted. 71-piece Urinalysis Outfit Free to students.** **Write for Free 48-page Prospectus Today.** **Int'l Physicians and Surgeons College of Microbiology, Room 955, 550 Garfield Ave., Chicago, Ill.**

DOUBLE Entry Bookkeeping mastered in 60 hours with 8 keys; guaranteed; diplomas. **Our graduates lead in bookkeeping, auditing, accountancy, balance sheets, and financial statements.** **International Bookkeeping Institute, Dept. 8, Springfield, Mo.**

ARTIFICIAL Marble, sanitary flooring instructions, ornamental casting, concrete plaster, papier-mache decorations, garden furniture, statuary, Rubber-moulds, Electrometallurgy, particulars and 200 illustrations free. **Chris Mahler, Box 122, Huntington, N. Y.**

BOOKKEEPING in a Week, \$1 Postpaid. **Dukes, 1877 Walton Ave., New York.**

CARTOONISTS—Improve your style by following the work of the greatest cartoonists found in the bound volumes of Cartoons Magazine. Three volumes, each covering six months, Jan.-June, 1919 to Jan.-June, 1920, inclusive. 1,200 cartoons, 900 pages to a volume, 7 by 9 1/2 in., 3 in. thick. New books, durable and attractive binding. Sold separately at \$2 per vol. postpaid. Supply limited. Send at once. **Popular Mechanics Book Dept., 206 E. Ontario St., Chicago.**

EARN \$4,000 to \$10,000 per year. Men and Women we will train you in twenty weeks at home to be expert salesmen. We guarantee graduates position in City or Traveling, Particulars free. **Address Dept. P. M., Chicago Salesmen's Training Institute, 2709-11 Bosworth Ave., Chicago, Ill.**

STUDY Structural Engineering (by mail). Strictly A1 proposition; established 1912. Courses give actual experience. Tech. grads. High School grads, qualified enroll. New Prep. course in Arithmetic, Geometry, Algebra enables others to enter above Higher Courses. Lit. Free, no agents. Write Now. **Wilson Engr. Corp., Hanover, Mass., U. S. A.**

WORLD-ROMIC System, Masterkey to All Languages. Primers, 23 languages, \$1.94 each language; Cantonese, English, French, German, Italian, Portuguese, Russian, Spanish, Swedish. Pronunciation-Tables, 30c each language. Dictionaries, grammars, 4,000 languages, of 1,700,000,000 people: Afro-Asiatic, Amerindic, Eurindic, Indopacific, Siberia, Sinindic. Languages Publishing Company, 8 West 46th Street, New York.

USED books and educational matter bought, sold, exchanged. Bulletin free. Instruction Correspondence Exchange, 1949 Broadway, New York.

"WHAT to Invent for Profit" free. **Patent News-N, Washington, D. C.**

LEARN How to wind D. C. Armatures. Engineering students will find in this book by W. E. Henning a simplification of a difficult yet important subject. Mathematical and technical discussions have been avoided as far as possible. Contains all diagrams heretofore scattered in many books. 205 pp. Illus. in colors. Cloth binding. Price \$3.50 postpaid. **Popular Mechanics Book Dept., 206 E. Ontario St., Chicago.**

LEARN Photographic Journalism; paying profession. **Taytex, 28 School, Boston.**

SPANISH. Spontaneous method. You and I correspond in Spanish. Particulars free. **Guillermo Hedin, 3569 Franklin, St. Louis.**

PERSPECTIVE drawing made easy. Fuller Simplified System makes beginners and junior draftsmen expert overnight. **Send stamp for particulars.** **Earl Fuller, 162 Gumble Bldg., Kansas City, Mo.**

WHAT'S Your Future? Develop Winning personality, be popular. Personality makes success. Free literature. Write today. **P. S. Bureau, Box 349, West Palm Beach, Fla.**

COMPLETE Course in photoplay writing for \$1 money order. **Henry Gardner, Box 381, Little Rock, Ark.**

SHOW Card Writing, a pleasant, profitable profession. Quickly and easily learned through our new, simple method. No canvassing or soliciting. We show you how, no matter where you live. Full particulars and booklet free. **American Show Card System Limited, 203 Adams Building, Toronto, Canada.**

JOURNALISM—Photoplays—Short Stories. Plot Chart and Copyright Book free to those wishing to enter above professions or to dispose of manuscripts on Commission. (The Service offered is given by Professional Authors and Editors of high standing.) **Harvard Company, 431, San Francisco, Calif.**

USED books and educational matter bought, sold, exchanged. List 1,000 items free. **Students' Exchange, 47-A West Forty-second Street, New York, N. Y.**

VEST-POCKET Bookkeeper—Complete instructions for the correct keeping of books of accounts. Shows an entire set of books based upon actual transactions. 160 pp. Leatherette. \$1 postpaid. **Popular Mechanics Book Dept., 206 E. Ontario St., Chicago.**

PENMANSHIP. Trial lesson 25c (silver). **Prince, 130 W. 164th, New York.**

"VENTRILLOQUISM"—Complete instruction book. **G. Elsea, Bowling Green, Ohio.**

CIVIL Engineer, Expert Mathematician, teaches Arithmetic, Algebra, Geometry, Trigonometry. **Mondell, 50 E. 42nd, New York.**

MEN Wanted—For big paying electrical jobs. 2½ months at Coyne puts you in the field as an Electrical Expert. No previous training or education necessary. Practical work. Write for big Free Book. Coyne Electrical School, Dept. 93-51, 1390 W. Harrison St., Chicago, Ill.

ROPP'S Calculator and Short-Cut Arithmetic shows the answer as quickly as a watch shows the time to all problems likely to occur in office, store, shop, bank, farm or factory. Price, pocket size, paper 35 cents; cloth 50 cents; leatherette \$1. Desk size, cloth, \$1.50 postpaid. Popular Mechanics Book Dept., 206 E. Ontario St., Chicago.

SHOW-CARD writing a pleasant, profitable profession easily and quickly learnt by our new, simple, graphic block system. Artistic ability not necessary. We teach you how. Distance no object. Full particulars and booklet free. Wilson Methods, Limited, Dept. 53 A, East Richmond, Toronto, Canada.

BACTERIOLOGY instruction, urinalysis outfit, books, etc., \$20. Send for prospectus. Peerless College of Bacteriology, Petries Corners, N. Y.

STUDY a Profession at the Distinctive University. We will make you an expert Bacteriologist, Chiropactor, Osteopath, Chiropodist, quickly. National University, 2925 Michigan, Chicago.

RADIO OUTFITS AND SUPPLIES

YOU Don't Need Tubes to get out of town. If you want new stations on your crystal set Write Me Today. Mine works 400 to 1,000 miles without tubes or batteries! Thousands have bought my plans and now get results like mine. Changes often cost less than a dollar. Send self-addressed envelope for further information. Leon Lambert, 539A So. Volusia St., Wichita, Kansas.

ONE "Hunt's" Universal Hair-Line Radio Tuning Device gives micrometric adjustment of any number of any size dials outside the field of inductivity, thereby eliminating Body Capacity. Simple of application and use. Best device on the market for Sharp Tuning. Results obtained worth many times price. Satisfaction guaranteed. Ask your dealer or send \$1.00 to Hunt Co., 492 Shrine Bldg., Memphis, Tenn.

RADIO Map of the U. S.—Government Radio Stations, Broadcasting Stations, Commercial Stations, Call Letters, Wave Lengths, etc. 35c postpaid. Popular Mechanics Book Dept., 206 E. Ontario St., Chicago.

RADIO Record Book; New, Unique, Complete, Handy, Simple. Station Records Easily Kept for Reference. Widespread Demand. Selling Fast. Only Fifty Cents. Order immediately. Radio Progress Press, Union, S. C.

DICTIONARY of Radio words and terms, electrical symbols, wiring diagrams, radio diagrams and complete electrical dictionary, new, up-to-the-minute, just published. 188 pages, cloth cover, vest-pocket size. 35c postpaid. Popular Mechanics Book Dept., 206 E. Ontario St., Chicago.

F. L. BRITTIN'S Simplified Radio Diagrams and Tested Standard Parts, for building Neutrodyne, Reinaris Spider Coil, or Standard Regenerative Receivers. Blue prints \$2.50 set of all types, \$1.00 single. Quality Radio Parts by Mail. Rosemont Radio Supply Co., 1469 Rosemont Ave., Chicago, Ill. Sole distributors of F. L. Brittin's Simplified Radio Blue Prints.

RADIO Generators, 500 Volt, 100 Watt, \$28.50 each. Battery Chargers \$12.50. High Speed Motors, Motor-Generator Sets, all sizes. Motor Specialties Co., Crafton, Pa.

RADIO Call Cards printed to order. Red call, black printing. 100, \$1.75; 200, \$2.75, prepaid. Color changes 35c extra. Government postals 1c extra each card. Letterheads 8½x5½ and Envelopes, 100 each, \$2.25; 200 each \$3.50. ARRL emblem used on cards or stationery if requested. Send Today. Department 31C, Radio Printers, Mendota, Ill.

FEDERAL Junior Receiving Sets. Price list, free. King, 644 McMahon, Monessen, Penna.

O-50 VOLTMETER \$2.00. Loop Aerial \$1.00 Call Book free with order. Wm. Wambach, 159 Franklin St., Paterson, N. J.

BUILD your own set. Many making big money. We supply all parts and directions. Lowest prices on nationally advertised merchandise. Send for free list. North Shore Radio Works, Dept. 20, 813 Mulford St., Evanston, Ill.

RADIO Parts Manufacturing Company—1249 Mariboro, Detroit, Michigan, have many genuine bargains. Send card today for list. New detector tubes \$2.95 and \$3.00. 23 plate condensers for \$1.75 just sample of savings.

COAST to Coast on 1 tube—Royal portable broadcast receiver completely assembled in beautiful cabinet \$10. Phones, tube, aerial for Royal set \$9.75—Royaltron 1½ Volt Tube-detector and amplifier, guaranteed; \$3.95. Dietzen phones list \$5, special \$3.65—Complete parts Cockaday or Rehnartz circuit \$13.47—Tube free. Many other radio bargains. Send Bank draft or Money Order. Royal Mfg. Co., 501 World Building, New York.

COMPLETE Radio set for receiving broadcasting, postpaid \$3. Includes receiver, head-phone, aerial, and insulators. Specialty Sales Bureau, 1429B Milton St., Grand Rapids, Mich.

SKYOLA Receivers, Phones, Speakers, Batteries, Chargers. Wholesale prices to consumers. National Reserve Radio Company, 2 Stone Street, New York.

1 TUBE long range radio set \$15.00, worth \$25.00. Coast to coast reception. Guaranteed. Works loud speaker fine. While 50 sets last at this low price. State Radio Co., 6548 State St., Chicago, Ill.

VACUUM Tubes, 1½, 3 and 6 volt Standard Base \$3.50 each. Federal phones \$5.25 pair. William Gibbons, 535 Palace Building, Minneapolis, Minn.

FREE—Complete price list Aitken Radio Co., 594 Superior St., Toledo, Ohio.

PURE Sheet Aluminum and Lead 80c square foot prepaid. Electrical Specialty Company, Valparaiso, Ind.

JUST out, Brandes Loud Speaker \$10.00. Voltmeter Free with each Speaker. Wm. Wambach, 159 Franklin St., Paterson, N. J.

1700-MILE Guaranteed Receiver, complete with antenna equipment, tube, head-set, batteries, etc., \$38.00. Complete with Storage Battery \$48.00. Receivers, with loud talkers, prices on application. Quality Radio Company, 833 West 16th, Chicago.

LOUD Speaking Crystal Set. Broadcastings heard throughout house. Easily constructed. Instructions complete 25c. Catalog free. Steinmetz Wireless Mfg. Co., Eastend, Pittsburgh, Pa.

ARMSTRONG Regenerative Receivers (Licensed) 500 to 1000 mile distance, complete with tube, phones, batteries, aerial, \$26.75. Cash with order. William Gibbons, 535 Palace Building, Minneapolis, Minn.

TELEGRAPHY

TELEGRAPHY—Both Morse and Wireless—taught thoroughly and quickly. Tremendous demand. Big salaries. Wonderful opportunities. Expenses low; chance to earn part. School established fifty years. Catalog free. Dodge's Institute, H St., Valparaiso, Ind.

TRADE SCHOOLS

LET us place you in a position to earn from \$10 to \$25.00 per day. That's what our Students are doing all over the country. You can learn in a few weeks at low cost to be a Sign, Auto and Pictorial Painter-Decorator, Paperhanger, Showcard Writer, Grainer and Marble. No books used, all practical work. Send for Free Catalog. Chicago Painting School, 148 West Austin Ave., Chicago.

BE a Bricklayer; Good pay, outdoor work that is always interesting. Course is eight hours a day, five days a week, for six months. Tuition is \$100.00, one-half payable on entrance and one-half in three months. We have openings for a limited number of day students. Send for circular and give your age, and previous work. Associated Building Employers, Grand Rapids, Mich.

BE An Electrical Expert—Big Pay—no layoffs—advancement rapid—interesting work. Get your training in Great Shops of Coyne. No previous experience or education. Earn \$45 to \$125 per week. Write for Free Book. Coyne Electrical School, Dept. 83-51, 1390 W. Harrison St., Chicago, Ill.

BUSINESS OPPORTUNITIES

LEARN Candy Making. Make big profits at home or in shop. Big demand for good candy. Easily, quickly learned through our correspondence course. Write today for booklet 1-1. The Candy Institute, Sixty West Fifth Street, New York.

INCH Display Advertisement 166 Magazines Thrice \$15. Year \$50. Page \$100. Wood's Popular Services, Atlantic City, N. J.

SILVERING Mirrors! My exclusive French Tartare method opens enormously profitable business. Booklet free. H. Barstow, 514 23d Street, Oakland, Calif.

MAIL Order Business is your opportunity. Brenner's Famous Handbooks teach how to start small, grow big. Sell merchandise, service, ideas; enormous profits. Spare time to begin. Get complete set, 11 books, \$3.00, and be posted. Brenner, 335 Walnut, Philadelphia. Descriptive Catalog and big batch interesting mail order information, 25c. None free.

MANUFACTURE Extracts and other necessities, 200% profit; we tell you how. Write White Manufacturing Drug Co., 1429 Laidlaw Ave., Cincinnati, O.

SPARE time; turn it into money. Cal System, Bangor, N. Y.

EARN \$15.00 Daily. Repaint, Refinish, Retrim, Enamel, Regloss—Renew Old Cars—Make automobile specialties—New Tops—start shop—Steady work. Autoremco, Sheboygan, Wis.

"HOW to Sell Patents" free. Patent News-H, Washington, D. C.

EARN big money, making and selling signs and house numbers. Easy to make. They sell at sight. Full instructions, \$2.00. F. O. Armstrong, 149 N. Essex Ave., Orange, N. J.

\$50 WEEK evenings—I made it. Mail Order business; booklet for stamp tells how. Sample and plan, 25c. Free 12 articles worth \$3. Alphonse Scott, Cohoes, N. Y.

MOVIES for Home—Pickford, Fairbanks, Chaplin, Mix, Hart, other stars. Complete short and long subjects. Standard and Non-Inflammable. Dealers supplied. Agents wanted. Cosmos, 729 Seventh Ave., New York.

MEN Wanted—To sell our goods in country or city; be independent, have steady income; we sell on time if you wish; team or auto needed for country; no outfit for city; we train you; no selling experience needed. McCannon & Co., Winona, Minn. Mention this paper.

UNUSUAL business opportunity, local or mail order. Unlimited money-making possibilities on small investment at home. Write, Stanley, Box 626, San Francisco, Calif.

LUCRATIVE business opportunity, little capital, no credits, no mdse. Dept. M, Paul Kaye, 149 Broadway, New York.

ASK for free Patentbook, 139 mechanical movements and illustrations. Labiner, Three Parkrow, New York.

A FEW Dollars invested now in our great borax-potash enterprise should quickly return immense profits. Our vast deposits near Death Valley, California, leased direct from U. S. Government, estimated greatest in world, totaling hundreds of millions in value. Plant construction under way. Our proved recovery processes covered by eight basic patents. Planning commercial production on a startling scale. Our amazing book, "The Romance of Borax," mailed free. Burnham Chemical Company, 138-C, North Center St., Reno, Nev.

FREE Book—Start little mail order business anywhere; home employment evenings; beginner's working outfit furnished; 500 circulars, samples, things to sell; you deal direct with manufacturers; no stock to carry; instructive booklet free. Pier, 517 Cortland St., New York.

BIG money writing photoplays, stories, poems, songs. Send for free copy America's greatest magazine for writers. Tells you how to write and sell. Writer's Digest, 603 Butler Bldg., Cincinnati, Ohio.

PUBLISH small magazine of your own and start mail order business. Plan and sample magazine, 10c. Harvey Teeple, Decatur, Ind.

MAKE toys and novelties at home. Big profits. Instructions and 200 illustrations, 25c. Astrolite Company, Sharpsburg, Pa.

EXCEPTIONAL Opportunity for Sales Manager capable of handling state distribution. Marvelous new Adding Machine. Retalls \$15. Work equals \$350 machine. Tremendous possibilities. Unlimited profits. Write quick for details. Lightning Calculator Co., Dept. B., Grand Rapids, Mich.

"GET into the Specialty Manufacturing Business" or "Why Work for Others?" may sound good to you, but you won't succeed in that business unless you possess Formulas that are absolutely reliable, the same required by leading manufacturers supplying the Best. Don't be Bunked into buying a Collection of cheap "Formulas" and expect to succeed. Send today for my valuable literature and Formula Lists and Real Money-Makers in the Specialty Manufacturing Business. 26 years supplying the Best. Miller, Chemist, 805 De Leon St., Tampa, Fla.

GOOD money easily earned at home spare time silvering mirrors; no capital. Free instructive book tells how. Patterson & Co., Brookville, Ky.

WE Start You in Business, furnishing everything; men and women, \$30.00 to \$100.00 weekly operating our "New System Specialty Candy Factories" anywhere. Opportunity lifetime; booklet free. W. Hillyer Ragsdale, Drawer 4, East Orange, N. J.

ENTER a new business. Earn \$3,000 to \$5,000 yearly in professional fees making and fitting a foot specialty, openings everywhere, with all the trade you can attend to; easily learned by anyone at home in a few weeks, at small expense; no further capital required, no goods to buy, job hunting, soliciting or agency. Address Stephenson Laboratory, (1) Back Bay, Boston, Mass.

RAISE guinea pigs. Pay better than poultry or rabbits; easy to raise; little space required. We guarantee market. Particulars and booklet how to raise free. Cavies Distributing Co., 3102 Grand Ave., Kansas City, Mo.

GO into the Crispette business. Everybody likes Crispettes. You can make a lot of money. We start you. Write for facts. Long Eakins, 1959 High St., Springfield, Ohio.

PATENTS—Write for our Guide Books. List of Patent Buyers and "Record of Invention Blank" before disclosing inventions. Send model or sketch and description of invention for examination and instructions. No charge for the above information. Victor J. Evans & Co., 192 Ninth, Washington, D. C.

STOP Plodding! Be Successful. Operate a Tire Repair Shop. Make big profits in any locality. We teach you and furnish complete equipments \$100.00 up. Book of Opportunity free. Haywood's, 1305 South Oakley Avenue, Chicago.

STOP making others rich. Hire yourself as boss. Start your own business. Small capital. Spare time. Get startling facts that helped several to wealth. Knights, 1188 West Ave., Buffalo, N. Y.

DOLLARS Yearly in your Backyard No mushroom dope. Particulars free. Metz, 313 East 89th, New York.

START a Real Estate Office of your own. Earn from \$3,500 upwards. Our course of 21 lessons tells you how. Booklet M, on application. Frederick Jenkins, Corlaer Heights, Schenectady, N. Y.

"SCHEMER Magazine." Alliance, Ohio, prints big profit schemes; one subscriber making \$25,000 from three; another \$10,000 from one. Try your luck. Year, only \$1.00; three months, 25c.

MARBLE mixing instructions, covering wood or cement flooring 3/4 inch thick, fireproof, waterproof, low cost, sanitary, all colors. Particulars, 200 illustrations free. Chris Mahler, Box 122, Huntington, N. Y.

EARN \$10 daily silvering mirrors, plating and refinishing metalware, autos, chandeliers, bedsteads, headlights. Outfits furnished. E. Deele Laboratories, 1133 Broadway, New York.

START clean business manufacturing our Acme Doughnut Flour. Makes pure, wholesome, delicious doughnuts. Ready Sales. Full directions Two Dollars. American Cereal Company, Everett, Wash.

HUNDRED stores paying \$5 monthly. You can do the same in your City. Few weeks qualifies. Cincinnati, Chicago, Detroit, York, Minneapolis, Newark closed. Only one person in each City chosen. Midnight Alarm System, 2965 Algonquin, Detroit.

LEARN the collection business. Good income, quick results. Interesting booklet, "Skillful Collecting" free. National Collectors Assn., Long St., Newark, O.

\$3,000 TO \$6,000 Yearly. Want it? Others are making it. Send check or money order today for our invaluable books "How to Sell Real Estate," \$3.00—and "How to Conduct Real Estate and Insurance Business," \$1.50. Absolute satisfaction guaranteed. Free catalogs. Realty Book Co., Dept. 52, Cleveland, Ohio.

CORPORATIONS organized, security issues formulated, prospectuses prepared—moderate fee. Blanchet & Co., 347 5th Ave., New York City.

WONDERFULLY Successful. Money Making Opportunity. Earn \$10.00 to \$200.00 Daily Manufacturing at Home, Whole or Spare Time. Experience Unnecessary. No Canvassing. Marvelous Results Obtained. Profits Exceed 2,000%; Unlimited Demand. Fortunes Being Made. \$15.00 Capital Starts You. Honest, Legitimate Proposition. Particulars Free. Investigate. Robinson, 2926 Inglewood St., Los Angeles, Calif.

MONEY in Cash Grocery Business. 31 years' test. Practical and complete. Course by a most successful retired Grocer. \$5.00 postpaid. John F. MacDonald, Box 15, Detroit, Mich.

HERE Is a Real Opportunity. Successful business man and inventor offers Free interest in new Patent. Poor men of two years ago now making fortunes. Free interest includes right to manufacture or put out on Royalty for a period of five years Patent No. 1,319,263 covering a one cut Wrapping Box. Cut in 16 sizes. Every Department Store and Clothier can now buy at a lower price. A truly wonderful invention. You can use the top for the bottom or the bottom for the top. Inclose \$1.00 to cover cost of legal papers giving you free interest in my Patent together with Model pattern. Here is your chance to make yourself a rich man without any capital invested. Address: Edward Baker, care Baker's Garment Shop, Oneonta, N. Y.

"WHAT to Invent for Profit" free. Patent News-C, Washington, D. C.

CHEMICAL Expert furnishes manufacturing formulas with complete working directions, resulting products possessing distinct individuality and merit. Processes perfected. All lines. No lists of worthless stock formulas but reliable individual service. Charges reasonable, correspondence invited. Dr. Arthur VanHeeden, 508 South Oakley Boulevard, Chicago.

MANUFACTURE Ready-Made Gold Window Sign Letters. Unlimited Profits! We furnish complete instructions, accurate patterns. Absolutely no experience required. Wonderful Business Opportunity! Particulars, Wiltedling, 3161 Abbott Court, Chicago.

LEARN Mail Order Business. New system raise money. Taytexco, 28 School, Boston.

MONEY-MAKING Opportunity; learn how; valuable information; send stamp. Skarm, 2926 Lorina, Berkeley, Calif.

NICKEL plate automobile accessories, hardware, electrical parts. Big profits. Requires no capital. Simple battery process. Write today. Webster Engineering Co., Webster Groves, Mo.

LEARN destroying superfluous hair permanently without scar. Complete instructions \$1. Benj. Zitka, Fairview, Mass.

OPEN a rental bureau in your city under unique "Personal Inspection" plan. No capital required. Ask for details. Washington Service Bureau, District National Bank Bldg., Washington, D. C.

PATENTS Procured; Trade Marks Registered—A comprehensive, experienced, prompt service for the protection and development of your ideas. Preliminary advice gladly furnished without charge. Booklet of information and form for disclosing idea free on request. Richard B. Owen, 30 Owen Bldg., Washington, D. C., or 2276-R Woolworth Bldg., New York.

FORMULAS, Processes, Trade Secrets—Different, dependable, profitable. Catalog free. B. Thaxly Co., Washington, D. C.

608 WAYS to Make Money—2,716 Formulas "Encyclopedia Business Opportunities," 3 volumes, \$1. Ideal Book Shop, 5501-PV, North Robey, Chicago.

PATENTS Procured. Send sketch or model today for examination, prompt report and advice. No charge for preliminary advice. Write for free Booklet and blank form on which to disclose your idea. Highest references. Promptness assured. Clarence A. O'Brien, Registered Patent Lawyer, 58-A Security Bank Building, Directly across the street from Patent office, Washington, D. C.

START and Operate Your Own Business. Our System proprietary specialty manufacturing offers wonderful opportunity to make \$100 to \$500 weekly. Openings everywhere. Either men or women. We furnish everything and show you how. Big explanatory book, "The Open Door to Fortune" free. Write for it now. National Scientific Laboratories, 208 Monroe, Richmond, Va.

SLOT Machines; Headquarters for Premium Machines, 1016 Germantown Ave., Philadelphia.

WANTED—Ambitious men to start light, novel business at home; whole or spare time. Small investment. No previous experience required. Profits big. Write immediately. Kraft, Box 886-Pm, San Francisco, Calif.

FREE Advice: How to be successful in real estate. Particulars, MacDonald Co-operative Realty Co., San Diego, Calif.

EARN \$3,000 to \$20,000 yearly. You can be a Professional man in Bacteriology, Pharmacy, Osteopathy, Chiroprody, Resident and Home courses. Begin now. National University of Sciences, 2923 Michigan, Chicago.

53 GREAT Money-Making Plans Free. Universal Bureau-M, Boston, Mass.

CHEMISTRY

YOUR chemical problem solved and working process furnished Five Dollars. Write me. W. Stedman Richards, Consulting Chemist, address, Box 2402, Boston, Mass.

CHEMICAL Service. Formulas, analysis, methods, experiments. Jacob Sluyter, Chemist, 2535 East St., Davenport, Iowa.

PRODUCTS: formulas; duplicated. Improved, cheapened. Ethical. Reasonable. Xmas Special, Season's three best rouges, \$2.00. Others, Harding Laboratories, Box 1029, Chicago.

TRY our laboratory service, write for reasonable rates. Doris Chemical Laboratories, East Cleveland, Box 59, Cleveland, Ohio.

CHEMICALS—for all purposes. Chemists Supply Co., 61 East Lake St., Chicago.

EXPERIMENTERS—Complete supplies for the chemical laboratory. Catalogue Se. National Scientific Supply Co., 241 Pa. Ave., Washington, D. C.

CHEMICAL Processes, Analysis, Research, Technical Information. Consulting Chemist, Madison, Maine.

FORMULAS AND TRADE SECRETS

BIG, Interesting formula catalog free. National Scientific Laboratories, 208 Monroe Street, Richmond, Va.

500 FORMULAS, including Luminous Paint—Renewing Dry Batteries—Mechanics Soap—Gas Tonic—25c. Catalog Free. Ideal Book Shop, 5501-PK, North Robey, Chicago.

10,000 Selected chemical, technological and practical recipes and processes, including hundreds of so-called trade secrets for every business, alphabetically arranged in one large volume of 800 pages. Price \$4 postpaid. Popular Mechanics Book Dept., 206 E. Ontario St., Chicago.

500 FORMULAS; resilvering mirrors, valuable collection, 20c. Universal, 4047-PL, North Whipple, Chicago.

FORMULAS—Best that Chemical Science can devise. Not "Better Sort" Formulas, but Guaranteed Reliable processes in all lines. Stamp brings Valuable Literature and Latest Summer Sellers from an Analytical Chemist. Miller, Chemist, 807 De Leon, Tampa, Fla.

COLD Cream—Never Turns Rancid. Formula Dollar Bill Guaranteed. Alchemist, 57 Saratoga, Yonkers, N. Y.

FORMULAS—Guaranteed. Catalog Free. Restoral Laboratories, 4047-PL, North Whipple, Chicago.

5,000 RECIPES, \$1.25. Best formulas and processes for every business, trade or occupation are in "Youman's Guide." Many never before published. Worth \$1.25 each. 500 pages. Paper cover \$1.25. Cloth \$2.00 postpaid. Book catalog free. Wells and Edwards, X832 George, Chicago.

20,000 FORMULAS, 557-page volume, \$1.20. Universal, 4047-PL, North Whipple, Chicago.

500 VALUABLE Formulas 25c. Circular free. Harvey Teeple, Decatur, Ind.

FORMULAS; every description select lists with privilege card free. Byron, X 27, Sta. I, New York.

1,000,000 FORMULAS, 1,016 pages, \$2. 500 Formulas Free if you order quick. Ideal Book Shop, 5501-PM, North Robey, Chicago.

AGENTS WANTED

SUCCESS in Business and Personal Affairs! Head character by handwriting and features. Conlin System. Low price for entire course. Write, H. E. Conlin, Dept. B, 21 St. John's Place, Buffalo, N. Y.

AGENTS—If you have formerly sold felt rugs, write for our new proposition concerning new goods. It's a winner. Newark Felt Rug Company, 27-C 16th Ave., Newark, N. J.

BIG Money and Fast Sales. Every owner buys Gold Initials for his auto. You charge \$1.50; make \$1.35. Ten orders a day easy. Write for particulars and free samples. American Monogram Co., Dept. 40, East Orange, N. J.

AGENTS—Best seller: Jem Rubber Repair for tires and tubes; supercedes vulcanization at saving of over 80% per cent; put it on cold, vulcanizes itself in two minutes, and is guaranteed to last the life of the tire or tube. Sells to every auto owner and accessory dealer. For particulars how to make big money and free sample, address Amazon Rubber Co., Amazon Bldg., Philadelphia, Pa., Dept. 503.

AGENTS—The Big Seller of the year is the Universal Jar Opener. Has many uses. Sells for 50c. Costs \$2.00 dozen prepaid. Sample 25c. We offer agents the largest line of steel and wire specialties on the market. General Products Company, 7 Oliver Street, Newark, N. J.

NO Dull Times Selling Food. The greatest, surest and safest business in the world today is selling Federal Pure Food Products, and here is your opportunity to get into this business. You can make \$3,000, \$5,000, \$10,000 or more per year—the only limit is your ability to take care of the business. People Must Eat, and our food products are the fastest selling, surest and quickest repeat order getters in the world. Sell on sight in every home where food is used. Repeat orders immediate and every week thereafter. We supply you with effective Free Advertising Matter, Free Samples and a Free Course in Salesmanship. We also have over 100 high-grade beautifully packaged Toilet Preparations. Your future will be a financial success. A Real Big Business All Year Own. Every New Customer adds a great deal to your weekly income. Your business once established has a market value just like a store and can be easily sold. The greatest money-making opportunity of your lifetime, because you risk absolutely nothing, as we guarantee your sales, and we will not let you fail. Remember! Guaranteed! Best products, biggest sellers, surest repeat orders. No capital or experience is required. We furnish capital and everything necessary for you to become a Federal Distributor. Exclusive territory will be given honest men or women who will write at once asking us to send our "Success Guaranteed" proposition. Address, Federal Pure Food Company, Dept. A, Chicago, Ill. Largest inventors of and packers of Pure Food specialties in the world. Reference, any bank, Dun or Bradstreet rating agency, Express or Railway Company in America.

AGENTS—Steady Income. Large manufacturer of handkerchiefs and dress goods, etc., wishes representative in each locality. Factory to consumer. Big profits, honest prices. Credit given. Send for particulars. Freepost Mfg. Co., 59 Main St., Brooklyn, N. Y.

AGENTS Wanted—Something New—Fire Fighter sells easily. Makes a spectacular demonstration; car owners, homes, factories, stores, practically buy on sight. Our men make \$10.00 to \$50.00 a day; exclusive territories. If you wish to establish a business of your own with unlimited possibilities for making big money, write us today. Fry-Fyter Co., 143 Fry-Fyter Bldg., Dayton, Ohio.

LARGE Corporation wants a Service Man in every town to paste up its signs on store-keepers' windows. Excellent opportunity for reliable party. Steady work. No experience necessary. We also have attractive proposition for agents and salesmen. Guarantee Sign Service, 363 West Superior, Chicago.

AGENTS—Stamping names on Pocket Key Protectors; sample Check with your name and address, 25c. Stamping Outfits, Emblem Checks, Check Fobs, Name Plates, Hart Mfg. Co., Desk 2, 303 Degraw St., Brooklyn, N. Y.

AGENTS make 500% profit handling Auto Monograms, New Pictures, Window Letters, Transfer Flags; Novelty Signs. Catalog Free. Write Hinton Co., Star City, Ind.

RUSSIAN, German, Austrian, Soviet money. Sensational sellers. Cheap, attractive, giveaway advertising for Agents, Merchants. Big Circular Free. 100 banknotes \$2.00, splendid assortment. Hirsch Importing, 70 Wall St., New York.

VALUABLE Information I supply sells readily. 1000% profit. K. Home, 1937 Warren, Chicago.

AGENTS—Our soap and toilet article plan is a wonder; get our free sample case offer. Ho-Bo-Co., 2725 Dodier, St. Louis.

AGENTS "Cleaning Up." Housewives everywhere talking about wonderful new invention—Perfection Pressure Cooker. Saves money, time, labor. Easy to sell. Write quick. Jubilee Mfg. Co., 23 Station C, Omaha, Nebr.

MAKE money silvering mirrors, all kinds plating, knives, spoons, auto headlights. Outfits furnished. Free booklet. International Laboratories, Dept. 25, 311 Fifth Ave., New York.

INSTANT Weld. Repairs largest punctures without cement or heat. Lenn's profit one day, \$56. Write quick. Free sample; territory going fast. Tourists' Pride Mfg. Co., Desk T, Minneapolis, Minn.

PORTRAIT and Medallion Agents—Our Goods Will Make You Big Profits; delivery guaranteed; prompt shipments; low prices; send for latest catalog. Adam J. Kroll & Co., 602 Blue Island Ave., Chicago.

SELF-THREADING Needles find sales in every home. Fine sideline, easy to carry. Big profits. Sample free. Prentice-Lee, 145 East 23rd St., New York.

MAKE \$31.00 Profit—Cost you \$1.50. Complete Gold Monogramming Outfit. Transferred Instantly on Automobiles, Trunks, Bags, Windows. Experience Unnecessary. Free Samples. NuLife Monogram, Hartford, Conn.

KAPFORM holds soft caps in shape. Neat, Dressed. Will not sag in front. 25c, 81x \$1.00. Kapform Agency, 3518 Ellis Av., Chicago.

AGENTS: Can start you in Mail Order Business Immediately. Been at it 17 years. Small capital needed. Particulars stamp. Home Business Expert, Valdosta, Ga.

\$80-\$200 A WEEK. Genuine Gold Letters for store windows. Easily applied. Free samples. Liberal offer to general agents. Metallic Letter Co., 438-D, North Clark, Chicago.

AUTO owner tire agent wanted each locality to use and take orders for handmade Mellinger fabric and cord tires; guaranteed bond 3,000 and 12,000 miles (no seconds); shipped prepaid on approval; get your tires free; no capital or experience required; make \$100 to \$200 weekly. Write for wholesale prices and sample kit. Address, Mellinger Tire Co., Dept. 100, Kansas City, Mo.

CALIFORNIA Rosebuds selling like hot cakes. Agents coinng money; new stuff. Big profits. Catalog free. Mission Factory PM, 519 No. Halsted, Chicago, Ill.

AGENTS—Send for sample "Fretnot"—the washday wonder. Be convinced you can do a whirlwind business. You can clear at least \$20 to \$100 weekly, according to spare or whole time. You don't have to talk; if she doesn't buy at sight, leave sample; she will be looking for you long before you are able to make the rounds again. Samples furnished free. Premiums for your customers. Exclusive territory guaranteed to agents who can produce. Credits given. Don't call. P. M. Motter & Sons, 29 E. Jackson Blvd., Chicago.

START your own business as our sole agent, selling 100 famous home products. All or spare time. Dr. Blair Laboratories, Dept. 524, Lynchburg, Va.

\$2 AN Hour in your Spare Time doing work among families of your city. No Experience or Capital Required. Write Today for particulars while your Territory is open. American Products Co., 1531 American Bldg., Cincinnati, Ohio.

PORTRAITS, photo pillow tops, frames, sheet pictures, medallions, merchant's signs, water-proof and tea aprons, guaranteed hose, toilet requisites, luminous crucifixes; catalog, 50 specialties free. 30 days' credit. Jas. C. Bailey Co., Desk A-1, Chicago.

WE Pay \$50 a Week and expenses and give a Ford Auto to men to introduce poultry and stock compounds. Imperial Co., D-23, Parsons, Kan.

\$5 TO \$15 daily easy—Introducing New Style Guaranteed Hosiery. Must wear or replaced free. No capital or experience required. Just show samples, write orders. Your pay in advance. We deliver and collect. Elegant outfit furnished, all colors, grades including silks, wool, heathers. Mac-O-Chee Mills Company, Room 2561, Cincinnati, Ohio.

AGENTS—Good salary and commission selling "Ratskyl," new rat and mouse exterminator; ready for use; no bait required; non-poisonous; rodents die outside premises; no odor. Empire Specialties Co., 1549 N. Wells, Dept. 391, Chicago, Ill.

WONDERFUL Invention—Eliminates all needles for phonographs. Saves time and annoyance. Preserves records. Lasts for years. 12,000,000 prospects. \$15.00 daily. Free sample to workers. Everplay, Desk 123, McClurg Bldg., Chicago.

AGENTS sell Wolverine Laundry Soap. Wonderful repeater and good profit maker. Free auto to hustlers. Wolverine Soap Co., Dept. B37, Grand Rapids, Mich.

EARN \$5,000 annually, selling well known washing compound and soap. Washes without rubbing. Greatest repeater on market. Credit given. Ford furnished agents. Premium to customers. Write today for sample and terms. Sale of every package guaranteed. Buss-Beach Company, Dept. 27, Chippewa Falls, Wis.

\$100 TO \$300 Weekly—Men with slight knowledge of motors who can reach car owners can earn \$300 weekly without making single sale. If they can also make sales profits may reach \$25,000 yearly. Only proposition of its kind ever offered. A. E. Phillips, 1904 Broadway, New York.

NEW Wonderful Seller. Over 100% profit on every sale of Harper's Ten-use Set. Needed in every home. Washes and dries windows, sweeps, scrubs, mops, etc. Greatest year 'round seller. Write Harper Brush Works, 132 2nd St., Fairfield, Iowa.

THESE Advertisements of mine have appeared in Popular Mechanics for sixteen years. Hundreds of Successful Manufacturers today owe their success to my formulas and valuable information. Majority started with practically nothing. You can do the same—write today for my valuable literature relative to my Guaranteed Manufacturer's Formulas for making Non-Thermic Ice-Saving Cloths, Delicious Beverages for Home, Bottlers and Fountain sale. Pure Food Products, Non-Alcoholic Flavors, Launderite Washing Marvel, Zebest, greatest stain remover, Sta-Combed, Marcel Hair Curler, and latest Toilet specialties. Mexican Yucca Soap, Laundry Soaps, Firmox, Sensol, and all latest disinfectants. Amazon Tire Repair, Toy Rubber Balloons and all latest selling goods in all lines. Don't compare these with "junk" commonly offered. Analytical work carefully done. Highest references. Miller, Chemist, Tampa, Fla.

FIREARMS, Ammunition, Hunter's Supplies. Salesmen in every county; good commission. A. F. Stoeger, Dept. A, 242 East 42nd Street, New York.

CARD Signs for every business. Big profits for agents. Sample, 10c. Signs, 819 St. Louis, New Orleans.

AGENTS. Write for free catalog 200 sure sellers. Blankets, Flannels, Hosiery, slippers, House Dresses, Novelties, etc. Economy Sales Co., Dept. 293, Boston, Mass.

ATTENTION! 10,000 Ties and Collars given away free. Earn one of our ties and collars by distributing six of our coupons among your friends. Address Rex-Ola Shirt Co., 44 Lispenard St., New York City.

GET Our Free Sample Case—Toilet articles, perfumes and specialties. Wonderfully profitable. La Derma Co., Dept. A, St. Louis, Mo.

AT Last—World's Greatest Adding Machine. Almost human. Retail \$15; work equals \$300 machine. \$500 monthly easily made, demonstrating to stores, offices, garages, factories. Simple, easy; adds, subtracts, multiplies, divides automatically. Speedy, accurate, durable, handsome. Five year guarantee. Tremendous demand, amazing profits. Liberal trial offer. Protected territory. Write quick. Lightning Calculator Corp., Dept. F, Grand Rapids, Mich.

AGENTS—Clever Invention! Inkspoon makes every pen a fountain pen. Fast office seller; big profit, demand increasing everywhere. Exclusive territory offered. Sample free. H. Marul Company, Tribune Bldg., New York, N. Y.

SELL Madison "Better Made" Shirts direct from our factory to wearer. No capital or experience required. Easily sold. Big profits. Write for Free Samples. Madison Mills, 503 Broadway, New York.

MOST Wonderful Seller. 96c profit every dollar. No stock to carry. License unnecessary. Sample free. Mission Factory PM, 519 No. Halsted, Chicago, Ill.

BUILD a lasting business in your own community, with the Waterizer—big profits—cumulative—clean cut. James B. Lund, Manufacturer, 19 S. LaSalle, Chicago.

GENUINE Gold Leaf Letters anyone can put on store windows. Guaranteed to never tarnish. Large profits. Enormous demand. Free samples. Write today. Metallic Letter Co., 438-A North Clark, Chicago.

YOU can be your own boss with our Key-Check outfit. Good for \$5 a day stamping names on pocket key checks, fobs, etc. Sample check with your name and address, 20 cents. Pease Die Works, Dept. M, Winchester, N. H.

AGENTS—100% profits. Fast-selling novelty for Lodge members. Emblematic Belt Co., Ashland, Ohio.

AGENTS—\$9.75 a day and Cash Bonus Paid Weekly, handling samples and writing orders near home. Easy, pleasant work, all or part time. No capital required. Write quick for free samples. 130 Harley Building, Dayton, Ohio.

10,000 TEGO Brushes sold in Rochester. They automatically clean all phonograph records. Exclusive territory. 150% profit. Sample 50c. State make machine. Peck Co., 10 Medina, N. Y.

AGENTS, \$10 to \$25 a day. No investment. Free outfit. Best values. Largest commissions. World Raincoat Co., 659-B Morris Park Ave., New York.

MAKE 10,000 miles without a puncture. Inlay Tyres positively prevent punctures and blowouts. Double tire mileage, any tire, old or new. Use over and over again. Low priced. Agents wanted. Write for terms. American Accessories Co., B 978, Cincinnati, Ohio.

AGENTS—Men and Women. Stop! Look! Wonderful opportunity! Make \$3.00 per hour easy. Fancy Hemstitched stamped Buffet sets 50c. Center Pieces 60c. Iron Board Covers, Rubber Aprons, Sanitary Aprons, Fancy embroidery dainty, Linen and Saten Aprons, Austrian Cloth Bed Spreads, Free working sample! Write us quick. Dept. P. American Braiding Co., 329 Monroe, Chicago.

START and Operate Your Own Business. Our System proprietary specialty business offers wonderful opportunity to make \$100 to \$500 weekly. Openings everywhere. Either men or women. We furnish everything and show you how. Big explanatory book, "The Open Door to Fortune." Free. Write for it now. Nat'l Scientific Labs., 208 Monroe, Richmond, Va.

\$8 To \$16 daily easy. New Patented Cutlery and Carving Set. You take orders, we deliver and collect. Your pay daily. No experience necessary. Not for sale in stores. Full or spare time. Mac-O-Chee Company, Stand 1101, Cincinnati, Ohio.

AGENTS—\$2.00 an hour. Magic Pomade keeps hair combed. I teach newest leads in selling. Blackburn Co., 3288 Beresford, Cincinnati, Ohio.

POLMET—The Wonderful Polishing Cloth that cleans all metals without liquid, paste or powder. Approved by "Good Housekeeping" and "Modern Priscilla"—sells fast at 25c. Sample free. Gale & Co., Inc., 15 Edinboro St., Boston.

OIL or Coal "The Burning Question." Interesting booklet discusses high efficiency low-priced residence oil burners. Copy free. Write E. L. Miller, Manufacturer Climax Burners, 33 Climax Bldg., Kansas City, Mo.

AGENTS—Mosco Corn and Callous Remover will build you a steady repeat business. Send today for pocket size trial outfit. The Moss Company, 175 Searle Bldg., Rochester, N. Y.

AGENTS: Sell Jack Frost Winter Coats; Adults, Children, \$7.50 up; Big profits. Temple Raincoat Co., 212, Gardner, Mass.

YOUR Pay in Advance. \$10-\$15 daily selling High Grade Hosiery direct to wearer, 26 numbers, Full Fashioned Silks, Chiffons, Lace Clox, Glove Silk Pancies, Silk and Wool, All Wool; also Pure Silk—4 pair \$5.50. Some territory open for State and District Managers. Donde Hosiery Co., 407 Standard Trust Bldg., Chicago.

PORTRAIT Agents—for better quality enlargements, quicker service and lowest prices, try us. Quality Service Portrait Co., 2014 Rice St., Chicago.

DISTRICT Managers wanted every city and county in U. S. to manage branch offices. No experience required; we teach you how to earn \$100-\$200 weekly. Must appoint sub-agents, salesmen. Fireite sells to every home, store, factory, office, garage, hotel/public building, etc. Lifetime opportunity for men with few dollars capital. Your territory open. Write Fireite Co., Masontown, Pa.

MONEY comes Fast—\$50 to \$75 weekly for agents, energetic men and women everywhere; every home buys our food products; cash sales come fast; repeat orders double your income; live proposition; lifetime opportunity; get exclusive rights; free folder explains. Stoner Products Co., 874, Atlanta, Ga.

DARN E-Z selling system will double agent's income, regardless of what you sell. Every agent or district manager needs this plan—Details free. Address Darn E-Z Laboratories, Department P. M. 2, Mutual Home Bldg., Dayton, Ohio.

AGENTS, Salesmen—Sell New Thermostatic Automatic Carburetor Control Attachment for Fords. Big Profits, full or part time. Burns 95% air. Doubles Mileage. Attached in two minutes. No drilling. Does automatically exactly what Ford Manual says to do by hand. Cadillac now using Thermostatic Carburetor Control under Blanche license. Write today. A. C. Blanche & Co., Dept. 10, 602 Lake St., Chicago.

\$2.50 FOB ten names and addresses. Particulars free. Central Press, Box 41, Somerville, N. J.

FLORIST'S Plant Food Big Profit. 25 cents prepaid. DeMuth, Camden, Mich.

AGENTS: W. F. Omels, just an ordinary fellow, made over \$5,000 during 1922 selling our \$1.50 kitchen specialty. He is now a district manager. We are offering you the same proposition—an opportunity as big as you want to make it. You can do what Omels did. Write today. M. H. Tyler Mfg. Co., Dept. M-1, Muncie, Ind.

\$10-\$25 DAILY selling men's and women's shoes direct to wearer; exclusive territory; sales come easy. Economy Shoe Company, 202 Palace Bldg., Kansas City, Mo.

SELL this high-grade automobile necessity. Combination spring leaf spreader and lubricator. No competition. Attractive price. You double your money. Every car owner a prospect. Spread spring leaves apart and forces grease between them in one simple operation—a slight turn of a thumb screw. No other tool necessary. Sells on sight. Removes rattles and squeaks, makes car ride much easier, saves spring breakage, greatly lengthens tire mileage and the life of any car. Not a makeshift. Real quality article built throughout of tool steel and drop forgings. Send \$1.00 today for sample (this is practically manufacturer's cost). Complete selling information free with sample. Turner Manufacturing Co., Dept. P., Kokomo, Ind.

AGENTS: Sell full line of guaranteed hosiery for men, women and children. Must wear 12 months or replaced free. All styles, colors and finest line of silk hose. Often take orders for dozen pairs in one family; permanent customers and repeat orders make you steady income. Write for sample outfit. Thomas Mfg. Co., Class 462, Dayton, Ohio.

\$3 EASILY earned during lunch hour. Write Central Press, Box 41, Somerville, N. J.

AGENTS: Men or women. Year round position. No layoffs. Take orders for Jennings New Guaranteed Hosiery. Must wear and give satisfaction or replaced free. Write for outfit. Jennings Mfg. Co., Dept. 108, Dayton, Ohio.

WRINGER Mop—We have the best wringer mop made and can offer high-grade mop and brush salesmen exclusive territory and liberal profit. M. C. Newton, 1338 West 104th, Cleveland, Ohio.

AGENTS—\$5 to \$12 a day. Sell Interlock guaranteed hosiery for men, women, children. Full line. All styles, colors. No experience needed. Full or spare time. Repeat orders run 90%. Prompt deliveries. Samples to start you. Parker Mfg. Co., Sample 478, Dayton, Ohio.

Agents: Where to buy 12,000 articles. Wholesale. Actually worth \$50. Enclose stamp. Wholesale Supply Co., Valdosta, Ga.

DUSTLESS Sponge Cloth. New Invention. Retail (50c)—costs (16c). (1) Rub Cleans, Polishes Automobiles, Pianos, Furniture, NuLife Sponge, Hartford, Conn.

GOLD Leaf Sign Letters; make and sell; profits exceed 1,500%; immense demand; particulars free. Johnston Co., Quincy, Ill.

MAGICAL Necklars. "Shines in the Dark." Absolutely new. Be the first to sell this charming and captivating necklars. 100% to 400% profit. Send \$1.00 for sample and territory protection. W. G. Hannan Co., Dept. E, 57 E. 18th St., Chicago.

AGENTS, both sexes, we manufacture and control new household article. Fast seller. Big profits. Exclusive territory. Write now. Connolly, 123 Liberty St., New York.

OFFICE Specialty—300% profit. Big repeater. Manufacturer, 3240 North 13th, Philadelphia.

SELLS like Hot Cakes; Big Profits. New Ironing Wax Pad and Asbestos rest, Clamps Board, perfumes clothes. Outfit 10c. Yankee Mfg. Co., 380 Atlantic Ave., Brooklyn, N. Y.

TWO More Wise Men Make Good. One goes East another West, with the very same results. The checks that we have already sent them prove that they had been wasting years in the wrong field. Selling motion picture publicity is a big man's game, but it pays Big Men what they are worth. You are invited to inquire for the "low down" on your opportunity with us. Alexander Film Co., Studio 3389 So. Broadway, Denver, Colo.

YOU'LL Want this thrilling baseball card game. Deck of beautiful regular size cards, clear rules, team players, only \$2.00. Played exactly like diamond. Baseball fans wild about it. Gold mine for Agents. Sells on sight. Big steady income. Don't wait—send today. National Card Baseball Co., F-225 W. Pleasant, Springfield, Ohio.

AN agent wanted in every town to sell double-suction cups. For sample and full details send ten cents. Hawaiian Rolling Bar Co., Sayville, N. Y.

AGENTS wanted to distribute The Hercules Lift and Force Pump of many uses. Every building owner buys on sight. Exclusive Territory—Big Profits. Write today. 1023 Widener Bldg., Philadelphia, Pa.

53 SUCCESSFUL Money-Making Enterprises Free. Stearltins Company, Waltham, Mass.

27,000 RECORDS guaranteed with one Everplay Phonograph Needle; new—different; cannot injure records; \$15.00 daily easy. Free sample to workers. Everplay, McClurg Bldg., Desk 16, Chicago.

BIG Profits Selling New \$3.50 Automatic Adding Machine. Absolutely accurate. Fully guaranteed. Quick sales. Ten daily easy. No competition. Pocket size. Business people everywhere positive customers. Thousands being sold. Tremendous demand. Here's high-grade money-maker. Bassett Co., 1458-A Hollywood Ave., Chicago.

WE start You Without a Dollar. Soaps, Extracts, Perfumes, Toilet Goods. Experience unnecessary. Carnation Co., Dept. 201, St. Louis.

MAIL-ORDER houses and distributors; we pack big profit beauty creams, face powders, perfumes, toilet preparations with your label. Chemist, 944A No. Clark, Chicago.

AGENTS clear \$50.00 weekly selling Opaline Portraits. Expense money advanced. Credit given. Big line now ready. Samples and Catalog free. Consolidated Portrait Co., Desk 2, Chicago.

\$8.00 To \$20.00 per day. A wonderful seller. Any man, woman, boy or girl can make big wages Selling Crimp Grip Clothes Line Fasteners. It is a perfect rope holder and can be used for many purposes. Crimp Grips are a simple, time-saving device. They last a life time and will not rust; it holds the line tight, and saves time on wash days. Every buyer is a booster. Send 50c for Mounted Sample and one pair of Crimp Grip Clothes Line Fasteners. Write for particulars. Crimp Grip Company, Belvidere, Ill.

PATENTED Cigar Lighters with Glass Advertising Front. Also Electric Cigar Moisteners. Wonderful Sellers. No Competition. Big Steady Profits. Proof, Cuts, Sales Plan Free. Drake Mfg. Co., Dept. M, Milwaukee, Wis.

EVERYBODY uses extracts. Sell Duo Double Strength Extracts. Complete line household necessities. Big repeaters. Write today. Duo Co., Dept. El, Attica, N. Y.

WE have the finest needle case. \$50.00 to \$200.00 weekly. Send 10c for sample; sells 25c. Empire Specialties Co., 1540 N. Wells, Dept. 301, Chicago.

AGENTS, \$100.00 weekly easy selling Oriental Perfumes and Cosmetics. Every woman buys on sight. Highest profits. Rosalva Parfumerie, Inc., 6346 Cottage Grove Ave., Chicago.

AGENTS—\$100 weekly easy quick selling items. Responsible company—Exclusive territory—Mosedale, 25 N. Dearborn, Chicago.

PORTRAIT Agents, Dealers, get your Portraits and Bromide Prints direct from Manufacturer, lowest prices, prompt service. Lincoln Portrait Co., 1923 Hudson Ave., Chicago, Ill.

AGENTS, Sell Anti-Mist Compound, Keeps rain, steam and snow off of windshields and eye glasses for 24 hrs. Send 25c for sample and particulars. A. W. Brust, 210 S. Seelye Ave., Chicago, Ill.

GET out of low wage rut. Make \$12-\$30 day. Positions everywhere. Demand greater than supply for qualified automobile painters. We teach you in 8-10 weeks. Get facts. Have eyes open to wonderful new opportunity. Investigate. Write. Detroit Auto Painting School, 1486 Van Dyke, Detroit, Mich.

CLARKE Earned \$716.00 Selling Pullerup Kuff Buttons. Fifty other meritorious jewelry specialties that sell like wildfire. Master Jeweler, Sheboygan, Wis.

AGENTS and salesmen wanted to sell high grade shoe dressings. Write for territory to G. Colborn, 116 N. Paulina St., Chicago.

MAKE \$8 a day selling Imported Bamboo Fountain Pen. Whirlwind seller. Free sample. Mohler, Dept. 5, 416 S. Dearborn, Chicago.

AGENTS Wanted to Sell Men's Hats Direct from Factory. Send for Catalog. Model Hat Company, East Orange, N. J.

AGENTS sell made to measure gaberdines, whipcords, \$14.50; reversible raincoats; \$75-100 weekly. Outfit free. Standard Raincoat, Dept. 5, 129 W. 17 St., New York.

"HOW to Sell Patents" free. Patent News-O, Washington, D. C.

CLARKE made \$18 an hour selling vest-pocket windshield cleaner needed by every autoist, motorman, engineer; one rub keeps glass clear 24 hours; 60,000 sold; amazing proposition free. Security Mfg. Co., Dept. 720, Toledo, Ohio.

GENERAL Distributors—Make \$100 to \$150 weekly as Distributor for World's Greatest Automobile Polish. Easily demonstrated, wonderful results, sure repeater. Sell to consumers, sub-agents, dealers. Big money-making proposition to hustlers. Write quickly for exclusive territory. The Armo Mfg. Co., N-130 Goodale, Columbus, Ohio.

AGENTS: Big returns, fast office sellers; particulars and samples free. One Dip Pen Co., 2 Daily Record, Baltimore, Md.

WANTED—Men or Women to represent us in each community to solicit subscriptions on our unusual special offer. Very liberal commission paid at time of sale. Write today for full particulars. Give two references. Popular Mechanics Magazine, 200 East Ontario Street, Chicago.

TAILORING Agents. Make \$50 To \$100 a week selling all wool 2 piece suits at \$21.50. Also our famous virgin wool suits at \$31.50—none higher. Commissions daily. Beautiful assortment of 6x9 swatches free. No experience needed. Can use spare time workers—if hustlers. Write J. B. Simpson, Inc., Dept. 694, 843 West Adams St., Chicago. See page 187.

AGENT: \$60.00 weekly selling newest sensation; Leather Link Belts going over big. Easy, quick sellers. Big profits. Write quick. Victory Belt Co., 1772 Wilson, Chicago.

SELF-THREADING Needles—\$2.75—100 papers. Aluminum pencil sharpeners—\$7.50 Gross. Sample 10c. Hutter-Specialties, Milton, N. Y.

AGENTS—Silk fibre knitted neckties sells the whole year round; send \$36.00 for a gross, 100% clear profit; dozen \$3.25; if you can't sell them we will refund your money. Raymond Mfg. Co., 132nd St. and Madison Ave., New York.

PAY Your Way Anywhere with Oriental Mystic Rings. People amazed at these values. Sterling sample ring \$1. Sells for \$2.50 up. Orient Exchange, 21-P Park Row, New York.

A BUSINESS of your own: Make sparkling glass name plates, numbers, checkerboards, medallions, signs; big illustrated book free. E. Palmer, 307, Wooster, O.

MAKE \$17 daily—Finest Extracts, Food Products, Toilet Preparations, Household Necessities. Credit: Sample Case Free. Write for amazing offer. Perkins Products, B-6, Hastings, Nebr.

AGENTS: \$16 a day. Latest improved portable talking machine. Does more than machines costing five times its price. Built-in just like a suitcase. Fully guaranteed. Pay you daily. Write Perry-Ludlow Co., 8-1962, Dayton, Ohio.

\$100 WEEKLY. Agents, Crew Managers. Absolutely new articles selling big to housewives. No capital required. Commissions paid in advance. No collections. No delivery. Exclusive territory. Write quick. Pioneer Corp., 6301 Yale Ave., Chicago, Ill.

AGENTS. Make \$10 to \$20 daily, selling small kitchen necessity. Over 200% profit. Sells rapidly everywhere to miss out of ten women. New plan make sales easy. Premier Mfg. Company, Dept. 813, Detroit, Mich.

WONDERFUL discovery. Charges batteries in ten minutes. Gallon free to Agents. Radiolite Co., St. Paul, Minn.

WANT Distributing Agents everywhere for Hanslik, the new original powdered handsoap. Removes grease, grime, ink, paint, and most anything from the hands without injury to the skin. Every mechanic and auto-owner, everybody who gets his hands dirty will be a customer. A great opportunity for a hustler to get in business for himself. Full information free. Send 10 cents, coin or stamps, for liberal sample can. Solar Products Company, 122 West Lake Street, Chicago.

ANY man handy with paint brush or light tools can start new mechanical business on nearly nothing; needed everywhere; nearly all profit; experience not required. John Brace-Jard, 1457 So. Ninth, Philadelphia, Pa.

AGENTS: Big profits. Best and cheapest window letters made. Easily applied. Dime brings five samples. Particulars free. Stalbritt Co., 1115 Second Ave., New York.

AMAZING auto necessity. Retail \$4.00. Your profit \$2.50. Territory going. Write Super, 1306 Fondulac, Milwaukee, Wis.

MAKE Big money selling rubber rugs, duplicating rag rugs in appearance; every home a prospect. Write or wire Trump Bros. Rubber Co., Akron, Ohio.

SELL everyone an Auto-Oil-Tester—Quick sales—Big profits—Sample \$1.00. Viscostitor Mfg. Co., Toledo, O.

RUMMAGE Sales make \$50,000 daily. We start you. Representatives wanted everywhere. "Wholesale Distributors," Dept. 92, 609 Division Street, Chicago.

EVERY home a prospect. Zenith Cleaner and Polish for Automobiles and Furniture. Agents make 100%. Sample 25 cents, refundable first order. Absolute repeater. Zenith Products Company, 202 Clay Ave., Rochester, N. Y.

FREE Sample, "Rain Shield Wiper." Retail \$1.00—Costs (25c). Sold, Clear and Rainy Days. No Cloth—No Paste—No Attachment. (1) Rub keeps Windshield Clear (18) Hours. Experience unnecessary. Nullife Corporation, Hartford, Conn.

At last! A dry, odorless, washable metal polishing cloth. Sample and extraordinary offer. T. L. Powers, Box 191, Roxbury, Mass.

ARE you ambitious to get ahead, to have a fine home, a fine car, and a substantial bank account? If that is your ambition, we cordially invite you to join our organization of successful General Sales Agents to attain it. We have a wonderful General Agent proposition for you. Address The Hursy-Bassett Co., Inc., Dept. P-1, Crisfield, Md.

\$12 DAILY easy introducing ladies' and men's sweaters in silk, wool and artificial silk. 23 colors. Latest novelties. Going like wildfire. You simply show samples we furnish, take orders. We deliver and collect. Your pay daily. Mac-O-Chee Mills Company, Form 1101, Cincinnati, Ohio.

AGENTS: Will show you how to make \$6 to \$20 daily, introducing our guaranteed hosiery. We make deliveries. Famous Fitch-Hugh, Incorporated, Station K, Philadelphia, Pa.

PATENTS Procured. Send sketch or model today for examination, prompt report and advice. No charge for preliminary advice. Write for free Booklet and blank form on which to disclose your idea. Highest references. Promptness assured. Clarence A. O'Brien, Registered Patent Lawyer, 58-A Security Bank Building, Directly across the street from Patent office, Washington, D. C.

FORMULAS, Processes, Trade Secrets—Different, dependable, profitable. Catalog free. B. Thaxly Co., Washington, D. C.

SALESMEN—Get into the tailoring game—one of the most profitable of all specialty selling fields. Experience not necessary. We show you how to take measures, teach you how to sell our line and supply you with everything necessary to go out and make from \$10.00 to \$20.00 a day from the very first day. Our selling outfit is the finest of its kind ever gotten together and shows more than 100 large cloth samples of finest woolsens. You do no delivering. You just write your orders. We do the rest. Your profits run big and you get them cash with order. If you want to get into this most profitable of all lines, write us quick. Address Dept. 750 Goodwear Chicago, Inc., 814 W. Adams St., Chicago.

300% PROFIT: "Free Automobile"—Whirlwind Seller. Tremendous repeater. "Kleanrite." Marvelous Discovery. Washes clothes without rubbing. Premiums for customers. Sells 25c. You make 18c. Free samples make easy sales. Write quick. Best-ever Products Co., 1941 K-1, Irving Park, Chicago.

EXCEPTIONAL Opportunities, with our goods. Entertain, mystify and sell real money. Big illustrated catalog free. Magic Co., Berlin, Wis.

AMAZING Imitation Diamonds, defy experts, modern solid mountings. Start your mail-order or Agents, wholesale only, first time offered. Pauer (Importer), 152 DeWitt, Buffalo, N. Y.

AGENTS: Big money Monogramming by Transfer Method. Catalog Showing Over 50 Styles and Particulars Free. Motorists' Accessories Co., Mansfield, Ohio.

WHY Work for others? Start and operate your own business. Our system proprietary specialty business offers wonderful opportunities to make \$100 to \$500 weekly. Openings everywhere. We furnish everything and show you how. Booklet free. National Scientific Laboratories, 298 Monroe, Richmond, Va.

DELICIOUS Desserts—\$1.00 an hour selling Stuart's delicious desserts, pudding powders and pie fillers. Write for terms and free samples. C. H. Stuart & Co., 5867 B'way, New York.

THE wonderful arch support and shoe preserver for every shoe; unequalled for agents. S. M. P. Co., 359 Pearl St., New York.

HEATING with oil is in its infancy. Get in while the getting is good. Our burners make good. Agents wanted. Exclusive rights. Economy Oil Burner Co., 718-721 Second St., Webster City, Iowa.

AGENTS: A sale in every home for our beautiful dress goods, silks and general yard goods. Quick sales! Big profits. Large book of nearly 1,000 handsome fabric samples furnished to agents. Write today. National Importing & Mfg. Co., Dept. 6X, 573 Broadway, New York, N. Y.

YOU can sell every merchant in town our changeable signs. Large profits; easy sales. Write for territory now. Changeable Sign Co., 381 East 102nd, Cleveland.

MAN in each town to plate auto parts, reflectors, bathroom fixtures, refinish beds, mirrors, chandeliers; by new method. No capital or experience required. Simple plan of manufacturing at home starts you in big money-making business. Outfit furnished. Free particulars and proofs. Gun Metal Co., Ave. H, Decatur, Ill.

EARN \$10 daily silvering mirrors, plating and refinishing metalware, autos, chandeliers, bedsteads, headlights. Outfits furnished. E. Decie Laboratories, 1133 Broadway, New York.

AGENTS. Get acquainted with America's greatest agents money maker. Scott's Specialty Mfg. Co., Dept. 72, 116 W. 6th Street, Mansfield, O.

AGENTS—An Unusual Article to Sell—The Automatic Talking Machine Record Brush. Long been in demand, simply applied, no competition. Commission big. Write for particulars. Sturgis Novelty Wks., Medina, N. Y.

BE Your Own Boss. Start in business. 40c pair profit. \$2.00 hour spare time. Everyone buys stockings. Hopkins Hosiery Co., 433 Washington St., Boston.

AGENTS—Go into business for yourself. Be your own boss. Work for yourself, not the other fellow. No travelling. Start manufacturing or mail order business in your own town. Write quick for particulars. Central Book Co., 127 South Liberty St., Indianapolis, Ind.

WE pay \$200 monthly salary, furnish car and expenses to introduce our guaranteed poultry and stock powders. Bigler Company, X248, Springfield, Ill.

WONDERFUL Scientific Discovery; pure "White Sapphires" rival finest diamonds, \$2 carat. "Rainbow Sapphires" changes color, greenish purple to ruby red, \$2 ct. "Meteor Sapphires" like golden diamonds, \$2 ct. Pearls, Amethysts, Diamonds, solid gold mountings; also Imitation Diamonds; wholesale prices; be our Agent. Pauer (Importer), 152 DeWitt, Buffalo, N. Y.

PORTRAIT Agents and Others. Get Big Profits. Sell Perry Photo Medallions. You charge \$2.98; make 400% profit, \$16 daily easy. Big exclusive line. 4-day service. Perry Photo Novelty Corporation, Section 16, 360 Bowers, New York.

RUG Salesmen—Get next to the biggest seller of the year—Loomrite Felt Rugs. Sell at sight at \$2.50, cost \$13 dozen. Big, complete Rug Catalog. Free. Maitley-Payne Mfg. Co., 104-D Hanover St., Boston, Mass.

MAKE \$25 to \$50 Week, representing Clow's Famous Philadelphia Hosiery, direct from mill—for men, women, children. Every pair guaranteed. Prices that win. Free book "How to Start" tells the story. George Clow Company, Desk 31, Philadelphia, Pa.

OUR Ex-Cel Luminous Crucifix "shines brilliantly in the dark." Sells on first demonstration. Big profits. Free Selling Talk with first order. W. G. Hannan Co., Dept. B, 57 E. 18th St., Chicago.

IF you want good live agents—fellows who can get the business—ask me how others are doing it. I'll gladly render the necessary assistance. Geo. F. Baker, Mgr. Classified Advertising, Popular Mechanics Magazine, Chicago.

WE pay \$8 a day taking orders for In-syde Tyres. Guaranteed to prevent punctures and blowouts. Double tire mileage. Any tire. Tremendous demand. Low priced. Write quick for agency. American Accessories Co., B278, Cincinnati, Ohio.

AGENTS Everywhere! Women's and children's guaranteed shoes direct to wearer. We deliver. A. P. Condon, Sales Manager, The Allen Shoe Co., 110 Summer St., Boston, Mass.

ABSOLUTELY free box Bassett's Native Herbs sent to introduce. For Constipation, Indigestion, headache, rheumatism. Big money selling, all or part time. Established 1879. Bassett, Dept. I, Columbus, Ohio.

EASY, pleasant work for Mechanics, Shop Men, Clerks, during spare hours; will add many dollars to their salaries. Also want persons who can give full time. Big wages assured. Novelty Cutlery Co., 67 Bar St., Canton, Ohio.

SELL Necessities. Everybody needs and buys the "Business Guide." Bryant cleared \$300.00 in July. Send for sample. It's free. Nichols Co., Box 4-B, Naperville, Ill.

AGENTS—\$15 a day—Easy, quick sales—Free Auto—Big weekly Bonus—\$1.50 premium Free to every customer. Simply show our Beautiful 7-Piece Solid Aluminum Handle Cutlery Set, Appeals instantly. We deliver and collect. Pay daily. New Era Mfg. Co., 808 Madison St., Dept. 21-V, Chicago.

AGENTS get Klokquik the newly invented door spring. Whirlwind seller. Retailer for 50c. You make 100% or more. Sell 50 to 80 a day easy. Write for 43c sample and easy starting offer. Klokquik Mfg. Co., Dept. A, 17 West 42nd St., New York.

EIGHT Dollars for seven hours! Peck's Rivets quickly mend leaky kitchenware. Sell everywhere on sight. Samples free. Box 25c. Peck Company, 7 Medina, N. Y.

EARN big money fast applying gold initials to autos. Every owner buys—\$1.35 profit on \$1.50 sale—particulars and samples free. Write quick. Lithogram Co., Dept. 17, East Orange, N. J.

VEST-POCKET Magnetic Extractor, removes foreign bodies from the eyes. Agents' sample 50c. Gem Extractor, 531 So. Dearborn St., Chicago.

MEN Wanted. We have positions open now that will pay from \$15 to \$100 a week. We are organizing a sales force to introduce the Cole Visible Gasoline Gauge, a low-priced, scientifically accurate instrument for Ford and Chevrolet cars. Prevents running out of gas. Guards against short measure. Fits on instrument board—always in sight. Big selling records. We want one good man in each county. Campaign is just beginning. We will help you start. Capital not necessary. Territory going fast. Write quick to The Stemo Co. Engineering Co., 119 Webb St., Dayton, Ohio.

WANTED—Tailoring salesman, make \$60 to \$125 per week. Biggest merchants in many towns have started with our lines. We are the largest made-to-measure tailoring house in the country, furnishing elaborate sample equipments, including 500 all wool fabrics and guaranteed absolute satisfaction, perfect fit, best workmanship, or no sales. Write me for line and all accessories to be sent free. Tell us all about yourself. Address G. H. Mitchell, Sales Manager, Box 483, Chicago, Ill.

A SERVICE agency for magazine and newspaper classified advertisers. Complete advertising service free of charge. We edit and place your copy. Send for our free lists and explanation. Sweet & Phelps Advertising Agency, 214 E. Ohio St., Chicago.

AGENTS—Enormous demand, steady repeat; costs 5c, sells 25c. Sample for dime. Utility Co., Chippewa Falls, Wis.

AGENTS, Salesmen, Demonstrators, you will have the devil's own time trying to find a better seller than "Zippe." If there was such a thing we'd have it. Splendid profit on 50c "Go Getter" repeat article that sells on ten second demonstration. Works While You Watch It. Demonstrates value, while others waste time making claims. New Discovery! Greatest Scientific Triumph of the age. It's the berries. Haven't room to tell our story here. Write immediately. Karam-Smith Co., 401 Bozart St., Ft. Wayne, Ind.

AGENTS—Earn \$50 to \$100 a week. New household invention sells quick and fast. Repeat orders. Permanent business. Chance of lifetime. Advertising help furnished. Maco, Box 929, New Orleans, La.

DISTRIBUTORS wanted for new rheumatic ointment. Enormous demand. Remedy Co., 1019 N. J. Ave., Washington, D. C.

HIGH-GRADE SALESMEN WANTED

\$300 PROFIT Weekly. Installing automatic advertising directories in hotels, etc. The 12 ads sell quickly. Automatic information of train schedules, road maps, etc. Flash illuminated on opaque glass. Get particulars. Territory. Yes! Sterling Service, Ocean View, Va.

ASKO—Salesmen to sell Auto sec. as side line; can carry sample in vest pocket; sells on sight. Big comm. Write for sample. Allen Specialty Co., 2751 West Lake Street, Chicago.

LIGHTNING Strange Battery Compound. Charges discharged batteries instantly. Eliminates old method entirely. Gallon free to agents. Lightning Co., St. Paul, Minn.

WHY Work for others? Start and operate your own business. Our system proprietary specialty business offers wonderful opportunities to make \$100 to \$500 weekly. Openings are everywhere. We furnish everything and show you how. Booklet free. National Scientific Laboratories, 298 Monroe, Richmond, Va.

WORLD'S Fastest Selling Auto Accessory! County distributors wanted; write today. G. L. W. Spring Oiler Co., San Diego, Calif.

SALESMEN; can increase their income each week selling Salesbooks. Used by every Merchant. Write for proposition. The F. D. Crane Company, Box 236, Canisteo, N. Y.

BEST Seller: Jem Rubber Repair for tires and tubes; supersedes vulcanization at saving of over 800%; put it on cold, vulcanizes itself in two minutes, guaranteed to last life of tire or tube; sells to every auto owner and accessory dealer. Get particulars how to make big money and free sample. Amazon Rubber Co., Philadelphia, Pa., Dept. 510.

SALESMEN—Advertising Pencils, Ready Sellers. Excellent side-line. Write for proposition. North American Pencil Works, 32 So. Clinton St., Chicago.

SALESMEN Wanted. Amazing Invention—almost human. The Little Draftman—a wonderful labor saver, automatically opens furnace or boiler while owner sleeps. Pays for itself in fuel saved. Simple, efficient, can be installed by anyone in five minutes, 100% profit. Thousands being sold. \$25 daily easily made. Act quick. Address: Little Draft-Man Co., Dept. A, Grand Rapids, Mich.

STATE Distributors: Envelope Sealer seals 60 envelopes minute; marvelous new invention! No competition. Retailer \$4. Worth \$20,000 yearly. Consolidated Co., 100 Boylston, Boston, Mass.

SALESMEN: If You Think in terms of \$6,000 for Next Year. Write now. Strong line for retail stores. Nationally advertised; established concern. Liberal weekly advances to producer. George R. Williams, 1929 Euclid, Cleveland, Ohio. Dept. 290.

SALESMEN. We pay larger commissions than any other brush house in the country to men selling our line of sanitary twisted-in wire brushes. Sanitary Wire Grip Brush Co., 15 Mercer St., New York City.

A REMARKABLE winter auto specialty fully guaranteed, that Dealers are glad to handle, now ready for high class salesmen with established trade or time to interview automobile trade. Good profits—certain sales—put out by old reliable house. Meeco, 6136 Broadway, Chicago.

SALESMEN can make \$5.00 a day selling Income Tax Records. Indispensable to merchants. Also Cash Books, Remittance Books and Petit Ledgers. Fine side lines; big profits; easy sellers. Pershing & Co., Dept. C, South Bend, Ind.

SALESMEN Make \$120 Weekly. Free Radio Instrument. Ozarka is the longest distance receiver. Introduce it to your friends and secure your own free. No canvassing. Two sales weekly nets you \$120. Sharpe of Colorado made \$955 one month. Our plan sweeping country. Write today giving name your county. Ozarka Incorporated, 892 Washington Blvd., Chicago, Ill.

FOUR \$7.50 sales to merchants net you \$20.00 daily. Sayers Systems, 2803 Sheffield Ave., Chicago, Ill.

SALESMEN and Agents: take orders for Rhinestone Hair Ornaments. Men's Initial Buckles and novelties. Big commission. Investigate. Chaton Novelty Co., 716 W. Madison, Chicago.

SALESMEN to sell labor-saving service tool to garages. Sales on two out of four calls. Full time or side line. Three hundred dollars per month and up easily made. R. H. Barber, 200 North Jefferson St., Chicago, Ill.

SALESMEN (main, sideline)—Sell "Zim's Peerless Collector." Quickest seller; surest collector. Creditors' Association, E-312 McKnight Bldg., Minneapolis, Minn.

\$60-\$200 A WEEK. Genuine Gold Letters for store windows. Easily applied. Free samples. Liberal offer to general agents. Metallic Letter Co., 438-B North Clark, Chicago.

CALIFORNIA Rosebuds selling like hot cakes. Agents coining money. Absolutely new. Big profits. Catalog free. Mission Factory SP, 519 No. Halsted, Chicago, Ill.

SALESMEN Can make \$5.00 a day selling our Calendars, Penicils, Signs, Advertising Novelties, Yardsticks, Whistles, etc. Liberal terms. Sells entire year. Fine side line. Local and traveling agents. Model Calendar Co., Dept. 226, South Bend, Ind.

\$742 LAST month for Beck of Buffalo. Introducing latest advertising plan; nothing else like it; every merchant wants it; easy sales; no deliveries; no collections; specialty salesmen write quick for offer. National Adv. Service, P. O. Box 50, LaGrange, Ind.

1,000 DOLLARS monthly proposition. Particulars free. A. Yonover, 1637 Roosevelt Road, Chicago.

DISTRIBUTORS, salesmen, agents wanted everywhere to handle the Morey Rim Tool; quick, easy sales; big profits; chance to earn \$300-\$500 monthly; trade and consumer buy on sight; monopoly rights to those who mean business. Get opportunity folder today. Morey Rim Tool Co., Blissfield, Mich.

SPLENDID proposition—sell gummed tape. Rapidly replacing twine. \$50.00 to \$150.00 weekly—full or part time. Sager Company, Manufacturers, Dept. 8 101, 1637 Roosevelt Road, Chicago.

TAILORING Salesmen—Fastest selling line, suits, overcoats, made to measure—\$32.50—one price, all wool. Profits in advance. Biggest old reliable house. W. D. Smith & Co., Dept. 66, established 1895, Chicago.

SPECIALTY Salesmen, sell the Wonder Bag "5 in 1," and the Night Light Vanity. Large profits, quick sales. Write for full details and protected territory. The Universal Leather Goods Co., 446 N. Wells St., Chicago, Ill.

*** SALESMEN—Sideline pays five to ten dollars a day taking orders for Specialty printed gummed advertising and Match Box Stickers. Write for proposition, samples, etc., today. Beardsley's Printery, Rock Island, Ill.**

A WONDERFUL Seller! Any man, woman, boy or girl can make big wages. Some agents make from \$8.00 to \$20.00 per day. Crimp Grip Clothes Line Fasteners are a simple, time-saving device for holding a rope—also used for many other purposes. It pays for itself quickly in time saved on wash days. No knots—it fastens and releases quickly. Every home a prospect. Every housewife who uses Crimp Grips—and there are thousands of them—is a booster. There is but one Crimp Grip. Write for particulars, or send 50c for one pair and a mounted sample, with full particulars to agents. Crimp Grip Company, Belvidere, Ill.

TRAVELING Salesmen calling on retail stores wanted by large manufacturer to sell unique line of business-boosting articles. Year round, fast selling, main or side line. If not earning \$150 weekly, address Elsasor Works, 222 Charles St., Boonville, N. Y.

WERE You Ever Offered a Grocery Store? Our Proposition is Better. You can handle Sugar, Flour, Canned Goods, Dried Fruit, Coffee and entire line of Groceries, as well as Paints, Roofing, and Automobile Oils, with no rent to pay; no money invested; take large orders from samples. Goods are guaranteed and proven quality. Selling experience not necessary. Steady, profitable work for "workers." Address Hitchcock-Hill Co., Dept. 200, Chicago, Ill. Reference: Any Bank or Express Co.

DISTRICT Managers! Are you making 200% on your sales? If not, get our proposition. High-grade line of Household Necessities. Write for territory and full particulars. Midwest Drug Co., 185 East Eighth St., Columbus, Ohio.

MAKE \$10.00 Per Day, side line phoning our Home Protection Contracts. A wonderful opportunity to build a permanent income. Only takes a part of your time. Write for details. North American Benefit Corp., Box 544, Springfield, Ill.

\$4.00 PROFIT on Every \$5.00 sale. "Free Sample"—New Specialty. (Money Getter.) Every Storekeeper, Doctor, buys quickly. Experience unnecessary. Territories open. Box 596, Hartford, Conn.

100 DISTRICT Managers wanted, 1,000 Agents; experience unnecessary; 14 Hosiery Numbers, 18 Patterns in Men's Neckwear. We deliver; largest commission. Bonus to full time workers, organizers and District Managers. Samples to be paid for when placed. Dept. 1085, S. Q. S. Co., Lexington, Ky.

SALESMEN to sell Terry's Liquid Shu Sole, certificate of Guarantee with every bottle to double the life and absolutely waterproof leather shoe soles. Send 50c for regular 75c bottle and our proposition. Terry Sales & Mfg. Co., Inc., Colo. Springs, Colo.

SALESMEN: Manufacturers of Duplex Ad Lamp have opportunity for two live specialty men in this territory. Earnings \$120 weekly. Crystal Co., 11 W. Kinzie, Chicago.

ADVERTISING Novelty. Side line salesmen calling on Druggists, Dentists, Hosiery, Etc. Mark's Tooth Brush Guard. State Agency to live salesman. The McKenzie Co., P. O. Box 9, Long Beach, Calif.

BIG Money Selling Ford Accessory. Drednaut Equalizers for Ford Cars. Big profits.—Past sellers—Nationally advertised. Strong factory cooperation. Tremendous market. 1,500,000 Ford production this year. Exclusive state contracts offered Live Wire business men—permanent connection. \$1,000 to \$2,000 working capital required. Already 27 states under control. Write quick for open territory. Auto Specialties Mfg. Co., 10 Graves St., St. Joseph, Mich.

SALESMEN—Crew Managers. You will have the devil's own time trying to find a better seller than "Zippo." If there was such a thing we'd have it. Splendid profit on 50c "Go Getter" repeat article that sells on ten second demonstration. Works While You Watch It. Demonstrates value while others waste time making claims. New Discovery! Great scientific triumph of the age. It's the berries. Haven't room to tell our story here. Write immediately. Karam-Smith Co., 6601 Bozan St., Fort Wayne, Ind.

HELP WANTED

EARN \$10 daily silvering mirrors, plating and refinishing metalware, autos, chandeliers, bedsteads, headlights. Outfits furnished. E. DeCle Laboratories, 1133 Broadway New York.

YOUNG Men, Attention! Learn my short, quick method to read meters. Go any place in U. S. and earn salaries ranging from \$110.00 to \$150.00 per month. Send \$1.00 for complete instructions to E. C. Armstrong, 510 Harker St., San Pedro, Calif.

750 MEN—boys, 18 up, wanted immediately to prepare for U. S. Government Positions. Railway Mail Clerks, City Mail Carriers, Post Office Clerks, Income Tax Examiners. \$117 to \$250 month. Steady work. Short hours. Paid vacation. Influence unnecessary. Write today for schedule of examinations. Franklin Institute, Dept. E-3, Rochester, N. Y.

GOVERNMENT positions pay \$1,400 to \$3,000 annually. Thousands of openings each year. Vacations and sick leave with full pay. Common education sufficient. Our thirty-six page booklet tells how to obtain one of these desirable life positions. Write immediately. Chicago Civil Service College, A-41, Keener Building, Chicago.

MEN—Age 18-40, wanting Railway Station-Office positions, \$115-\$250 month, free transportation, experience unnecessary. Write Baker, Supt., 74 Wainwright, St. Louis.

MEN—women, 18 up. Get Government Jobs. Big pay. Steady. List positions free. Write immediately, Franklin Institute, Dept. E-20, Rochester, N. Y.

EARN \$25-75 Weekly Writing Nu-Way Showcards. Previous experience unnecessary. Complete outfit furnished. Dept. 30, National Studios, 6121 Dorchester, Chicago.

SALESMEN—Become Independent. Own your business; experience unnecessary; selling our \$7,500 Accidental Death, \$50 Accident, \$25 Sick Weekly Benefits; \$12.50 yearly; other amounts proportionate. Guaranteed steady income from renewals. \$250,000 deposited Insurance Department. Registration Dept. A, Newark, N. J.

ALL men, women, boys, girls, 17 to 65, willing to accept Government Positions, \$117-\$250 traveling or stationary. Write Mr. Oment, 101 St. Louis, Mo., immediately.

WANTED: Railway Mail Clerks—\$1,600 to \$2,300. Exams everywhere. Write today for full information. Patterson, Civil Service Expert, Box 4625, Rochester, N. Y.

WRITE articles, stories, news, in spare time for newspapers and magazines. Big pay. Copyrighted book free Press Syndicate, 533, St. Louis, Mo.

\$35 WEEK. Boys—men. Become Automobile experts. Earn while learning. Write Franklin Institute, Dept. E-401, Rochester, N. Y.

MAKE money writing Photo-plays; details free to beginners. No correspondence course. Producers' League, 230 Wainwright, St. Louis.

LOCOMOTIVE Firemen for railroads nearest their homes—everywhere; beginners \$150-\$200 monthly. Railway Association, Desk M1, Brooklyn, N. Y.

INVENTORS desiring to secure patents should write for our book "How to Get Your Patent," tells our terms and methods. Send sketch for our opinion of its patentable nature. Randolph & Co., Patent Attorneys, 620 F, Washington, D. C.

OUR genuine gold window sign letters are an excellent money-making proposition for handy men. Slann Sign System, Bethune Ave. E., Detroit, Mich.

START Silvering Mirrors, Headlights, Tableware, Replate stoves, jewelry, Plans free. Clarence Sprinkle, Dept. 28, Marion, Ind.

SILVERING Mirrors, French plate, Easily learned; immense profits. Plans free. Address, Wear Mirror Works, Excelsior Springs, Mo.

MEN—Boys, Railway Mail Clerks, \$133-\$192 month. List positions free. Write today. Franklin Institute, Dept. E-20, Rochester, N. Y.

CLERKS for Government Postal and other good positions. \$1400-\$2300 yearly. Experience unnecessary. Full particulars free by writing G. W. Robbins, Civil Service Expert, 411 Burchell Bldg., Washington, D. C.

FIREMEN, Brakemen, Baggage-men, Sleeping car, train porters (colored). \$140-\$200. Experience unnecessary. 810 Railway Bureau, E. St. Louis, Ill.

WANTED—Railway Mail Clerks, \$1600. Experience or correspondence course unnecessary. Write Mr. Selby, D68, Willow Hill, Ill.

RAILWAY Mail Clerks—Start \$133 month; expenses paid. Specimen examination questions free. Columbus Institute, E-2, Columbus, Ohio.

U. S. GOVERNMENT wants help. Men—women 18 up. \$92-\$250 month. Steady. Vacation. Influence unnecessary. List positions free. Write immediately. Franklin Institute, Dept. E-20, Rochester, N. Y.

\$5 to \$15 DAILY easy—Introducing New Style Guaranteed Hosiery. Must wear or replace free. No capital or experience required. Just show samples, write orders. Your pay in advance. We deliver and collect. Elegant outfit furnished, all colors, grades including silks, wool, heathers. Mac-O-Chee Mills Company, Room 2691, Cincinnati, Ohio.

STORIES, poems, plays, etc., are wanted for publication. Good ideas bring big money. Submit manuscripts or write Literary Bureau, 522, Hannibal, Mo.

\$60-\$200 A WEEK. Genuine Gold Letters for store windows. Easily applied. Free samples. Liberal offer to general agents. Metallic Letter Co., 438-C, North Clark, Chicago.

MEN—Boys, Become Railway Mail Clerks, \$133 month. Write immediately. Franklin Institute, Dept. E-20, Rochester, N. Y.

SALESMEN earn \$50 weekly selling custom made shirts at ready-made shirt prices; 100 latest patterns; prices \$2.35 up. Shirts individually cut; unconditional guarantee. Jacobs Custom Blt Shirt Co., 536 Broadway, New York City.

BE a Finger Print Expert. Demand increasing. Write for special free offer. American Finger Print System, 1966 Broadway, New York.

FINGER Print Experts—Excellent paying positions; particulars free. Finger Print Headquarters, 188 East 79th, New York.

MEN wanting forest ranger or railway mail clerk positions. Write for particulars. Mokane, B-12, Denver, Colo.

IF you want to distribute free circulars, samples, etc., in your own locality write to Mutual Advertising Association, Box 628, Zanesville, Ohio. Absolutely no selling. Excellent pay.

INFORMATION

COMPLETE, accurate, information on any subject \$1. National Information Bureau, 1429X Milton St., S. E. Grand Rapids, Mich.

GUARANTEED information, any subject \$1.00. Doris Chemical Laboratories, East Cleveland, Box 59, Cleveland, Ohio.

BUSINESS SERVICE

FOR investigations, collections, general or legal services write the Pacific Co-operative Service Bureau, 823-C Lowe's State Bldg., Los Angeles, Calif. Highest references furnished.

INCORPORATE, Organize, lowest cost. Financor. C. W. Barrick, New Martinsville, W. Va.

TYPEWRITERS AND SUPPLIES

TYPEWRITERS—All makes rebuilt, re-constructed and guaranteed ten years, \$15.00 up, shipped privilege 30 days' trial. Get our prices and agents' proposition. Typewriter Co., 2316 University Ave., New York City.

UNDERWOOD Typewriters at far less than manufacturers' price; rebuilt, all worn parts replaced, guaranteed good as new. Cash. Installment payments. Write for Catalog 1311. Shipman-Ward Mfg. Co., estab. 1892, Montrose and Ravenswood Ave., Chicago, Ill.

TYPEWRITERS All Makes. Save one-half. Thoroughly rebuilt in our factory by the famous "Young Process." Fully guaranteed. Free trial. We handle all standard makes. Cash or sold on easy terms. Write for Catalog. Young Typewriter Co., Dept. 502A, Chicago, Ill.

TYPEWRITERS, all standard makes, \$10 up. Fully guaranteed. Free trial. Write for complete illustrated lists. Northwestern Typewriter Exchange, 320 West Goethe Street, Chicago.

REGULAR \$1.00 Black Record Typewriter Ribbons—50c postpaid. Any machine. Forest City Supply Company, 406 Seventh Street, Rockford, Ill.

ADDING MACHINES

FREE Trial, Marvelous new Adding Machine. Adds, Subtracts, Multiplies, Divides, automatically. Work equals \$350.00 machine. Price only \$15.00. Speedy, durable, handsome. Five-year guarantee. Used by largest corporations. Write today for catalog and free trial offer. Lightning Calculator Co., Dept. E, Grand Rapids, Mich.

NEW \$3.50 Automatic Adding Machine. Adds, Subtracts, Multiplies. Absolutely accurate. Capacity \$999,999.99. Fully guaranteed. 75,000 pleased users. Makes adding easy, positive, quick. Eliminates mistakes. Saves Time. Postpaid \$2.50. Bassett Co., 1458-B, Hollywood, Ave., Chicago.

DUPLICATORS AND DEVICES

YOU can make 50 to 100 copies of a letter, notice, etc., at a cost of three cents on a Hoyer Quality Duplicator. Write for free trial offer. The Hoyer Duplicator Co., 14 S. Wells St., Chicago, Ill.

"MODERN" Duplicators save Time, Labor, and Money. Gets business. Reproduces Typewritten or Panned Letters, Drawings, Lessons, Music, Menus, Bids, Notices, Specifications, Maps or anything in one or more colors. Prints Two per minute. Special Sale On 30 Days' Free Trial. \$2.25 up. Booklet Free. J. E. Durkin-Reeves Co., Pittsburgh, Pa.

STENCIL Duplicators—Note \$3.00. Letter \$4.50. Hand Use. Typewriting—Handwriting. On Approval. Primos Specialty Co., 3-M, Primos, Pa.

RUBBER STAMPS

YOUR name and address on a two-line rubber stamp, 25c. Self-inking pads, 20c. Catalog. Rubber Stamp Shop, Muncie, Ind.

PRINTING, ENGRAVING AND MULTIGRAPHING

500 GUMMED Labels. Name and Address, 30c. Eastern Label Co., Clintonville, Conn.

QUALITY Printing! Reasonable Prices! Tell us your wants and let us quote our Money-Saving prices. Best Work. We print anything. Ernest Pantus, 525 South Dearborn Street, Chicago.

PRINTING Outfits—Presses, type supplies, type novelties. Send stamp for catalogue. Model Press, York, Penna.

JOB Printing, All Kinds—Cards to Catalogues, Quality work. Smith-Roberts Printing Co., Watseka, Ill.

250 BOND Letterheads or Envelopes \$1.50. Geyer Printery, Box 886A, Dayton, Ohio.

PRE-USED Printing Presses, Type and supplies. List for stamp. Popular Bargains, Richmond, Pa.

500 IMITATION Typewritten Letters \$4.10, with printed heading. Bargains in Envelopes, Letterheads, etc. Prompt service. Samples and Price List. William Carlson, 8743 Essex Avenue, Chicago, Ill.

WE print everything. Stationery, Booklets, Catalogs, Circulars, Samples. Commercial Press, Batavia, Ohio.

250 LETTERHEADS, 250 white envelopes, printed and mailed, \$3.00. Samples printing free. Sunco, Mohawk, N. Y.

1,000 LETTERHEADS or Envelopes, \$3.00. Sent Prepaid. Samples Free. Monitor Press, Morrisville, Pa.

GILT lettered Advertising-Pencils for you. Buy direct; save entire middleman's profit. Samples free (no agents). Address S. Musial & Co., 10-12 Lincoln St., Yonkers, N. Y.

ALL Printing Prices Smashed. 5,000 Letterheads or envelopes \$13.85. Samples, Quality Printshop, Marietta, Ohio.

EMBOSS Stationery, business or personal. Samples for stamps. Daniels Co., Pittston, Pa.

PRINTING at reasonable prices. Exceptional workmanship. Write, O-B Company, Fargo, N. D.

1,000 **HAMMERMILL** letterheads, envelopes, \$3.25; 250, \$1.25. Samples Free. Trob Press, 98 Providence, Worcester, Mass.

1,000 **LETTERHEADS**, Envelopes, Cards, \$2.75; 500, \$1.75. Free Samples. Printcraft Press, 68 Houghton, Worcester, Mass.

500 **EACH** Hammermill letterheads and envelopes \$3.25. Bond letterheads, envelopes, statements, 1000, \$2.75. Postpaid 3rd zone. Standard Printers, Box 342, Nashville, Tenn.

RUBBER Stamps, Gummed Labels. Lists free to offices, factories, stores, Canvasers. McPherson Stamp Works, Middletown, Conn.

OUR Art Blotters will help your business. Send for samples and prices. Lorraine Press, Beverly, Mass.

1,000 **EIGHT-PAGE** 6 in. x 9 in., 4,800 word book-paper catalogs—\$25.00 postpaid. Twelve-page—\$35.00. Hansen Company, One, Brookings, S. Dak.

150 **EACH** Letterheads and Envelopes, \$1.50. Jacobus Service, Irvington, N. J.

225 **BOND** letterheads, envelopes, billheads, cards, \$1.25 each. Combination, \$1.00. Economic Press, Leonia, N. J.

EVERYTHING Printed. Samples free. Franklin Press, B-32, Milford, N. H.

FOR MEN

ARE you old at forty? See our advertisement on page 146 of this issue. The Electro Thermal Company, 2129 Main St., Steubenville, Ohio.

FOR SMOKERS

"BUTLER" Smoking Stands. Year round seller. Particulars. L. Martel, 496 Lincoln St., Marlboro, Mass.

RAZORS AND BLADES

BLADES resharpened, 2c any make; guaranteed service. Standard Safety Razor Corp., Pittsburgh.

SAFETY Blades resharpened, single edge 1c, double 2c, regardless of condition. Work guaranteed, 426 N. Colorado Ave., Indianapolis, Ind.

BLADES, resharpened, one edge 2c; double 3c. New York Edge Co., Glen Cove, N. Y.

FURS

YOUR raw furs made into beautiful garments. Enormous savings. Catalog free. Arthur Felber Fur Co., 25 N. Dearborn St., Dept. P. M. 4, Chicago, Ill.

OPTICAL GOODS

ONE 2 1/2 in. 45 Power, Telescope, complete with Astronomical and Celestial eyepiece and suitable tripod. A bargain at \$30. One Carl Zeiss Prism Telescope, 12-24 and 42 Power, complete with heavy leather carrying case and panoramic tripod, \$137.50. One B. & L. Student Microscope, complete, \$27.50. Send for Photograph. DeFranco, Importers, 169 N. Dearborn St., Chicago, Ill.

DIAMONDS, WATCHES AND JEWELRY

SACRIFICE large, blue white, perfect diamond—wonderful ladies' mounting, cost \$325.00, take \$150.00. Send any bank allowing examination. Herman Bryens, 1397 Waldheim Building, Kansas City, Mo.

WONDERFUL Bargains in beautiful new Rings, Mesh-Bags, etc. Send for free folder. McDowell Company, B-627, Providence, R. I.

FOR THE HOME

LOOMS—Only \$9.90—Big money in weaving rugs, carpets, portieres, etc., at home, from rags and waste material. Weavers are rushed with orders. Send for free loom book. It tells all about the weaving business and our wonderful \$9.90 and other looms. Union Loom Works, 480 Factory St., Boonville, N. Y.

MAKE your coal range an oil burner—guaranteed plans, \$1.00; cooks, heats. Made for \$3.00. Agents send stamped envelope. McCormack Specialty Co., Guilford, Conn.

CONCRETE Handbook, for the Amateur. We have just published a book describing 173 ways of using concrete in the home, shop and on the farm, with full directions for doing these things yourself with ordinary tools. 138 illustrations. It is "written so you can understand it." Price 50 cents, postpaid. Popular Mechanics Book Dept., 206 E. Ontario St., Chicago.

ANTIQUES, WAR RELICS AND INDIAN GOODS

SEND 5c for list Coins, Indian Relics, Firearms. F. E. Ellis, Webster Groves, Mo.

INDIAN Baskets, Blankets, Wampum Mats Wholesale. Catalogue. Gilham, Kelseyville, Calif.

RELICS from Europe's Battlefields. Firearms, helmets, medals, etc. Illustrated catalogue with sample War Photographs, 23c. Lieut. Welsh, 2117 Regent Pl., Brooklyn, N. Y.

PHONOGRAPHS AND RECORDS

BUILD Your Phonograph. Quality phonographs. Quality Serenade motor and motors of other types. Electric Motors, tonearms, reproducers, amplifiers, case materials, accessories. Free blueprints and building instructions. Big saving. Wonderful results. Prompt delivery. Catalog mailed for ten cents. Hoosier Manufacturing & Supply Co., 313 Baldwin Block, Indianapolis, Ind.

BUILD your own phonographs. We can supply you with motors, tone arms and all accessories at wholesale prices. Write for catalogue AX. Pleasing Sound Phonograph Co., 204 East 113th St., New York, N. Y.

SUPERIOR equipment at lowest price for building fine phonographs. Superior Phonographs Co., Erie, Pa.

BUILD a genuine Choraleon phonograph and save over half. Big profit building and selling. We furnish motors, tone-arms, full instructions and all necessary parts. Send for catalog and free blueprint offer. Choraleon Phonograph & Radio Co., 124 11th St., Elkhart, Ind.

BUILD Your Own Phonograph. We furnish everything. Write for catalog and free Blue-print offer. American Phonograph Co., 3515 North Crawford, Chicago.

MUSIC AND MUSICAL INSTRUMENTS

WRITE Songs. Big money and reputation. Write for information, J. Gordon Pub. Co., 291 N. Hoyne Ave., Chicago.

"MUSIC Composed" to words. Bauer Bros., (formerly of Sousa's Band), Oshkosh, Wis.

DIRECT the band like John Philip Sousa. Play the Cornet like Herbert Clarke. Let me teach you how. Full particulars free. VanderCook's School, 1632 Warren Avenue, Chicago, Ill.

WE sell and exchange New and used player rolls. Send for free catalog. Standard Music Exchange, 30 E. Randolph, Chicago.

GENUINE Amber Violin varnish. 2 oz. \$2.00. Perin, Rushville, Ind.

CORNETISTS—Trombonists—Saxophonists—Clarinetists. Send for "Free Pointers No. 2." Name Instrument. Virtuoso Music School, Concord, Mass.

VIOLINS, Deep, Mellow, Soulful—on credit. Easy terms for wonderful instrument. Get details today. Gustav F. Henning, 2424 Gaylord St., Denver, Colo.

COMPLETE, easy self-instructors—Harmonica, Violin, Piano, Drum, Ocarina, Mandolin, Accordion, Saxophone 25c each. G. Elsen, Bowling Green, Ohio.

I WANT song poems. Casper Nathan, Garlick Theater Building, Chicago.

EVERY person playing Hawaiian guitar should use a Rollers Royce Rolling Bar. They don't slide, they roll. Agents wanted. Hawaiian Rolling Bar Co., Sayville, N. Y.

PROMINENT London Music Publisher is open for available Songs by American Writers. Amateur or Professional; Songs judged on merit—not writers' reputation. For further particulars, write to American representative, Jack Mahoney, Dept. P, 145 West 45th St., New York.

PATENT ATTORNEYS

INVENTORS—"How to sell ideas before getting patents," and Evidence of Ownership document free on request. Inventor's Economy Guide Company, 3 Fendall Building, Washington, D. C.

MONROE MILLER, Ouray Bldg., Washington, D. C. Patent Attorney; Mechanical, Electrical Expert. Free Blue Book gives candid advice.

PATENTS Procured; Trade Marks Registered—A comprehensive, experienced, prompt service for the protection and development of your ideas. Preliminary advice gladly furnished without charge. Booklet of information and form for disclosing idea free on request. Richard B. Owen, 30 Owen Bldg., Washington, D. C., or 2276-R Woolworth Bldg., New York.

PATENTS, Booklet free. Highest references. Best results. Promptness assured. Send model or drawing for preliminary examination. Watson E. Coleman, Patent Lawyer, 644 G Street, Washington, D. C.

PATENTS, Trade-Marks, Copyrights and Patent Litigation. Write for advice and instructions how to proceed, costs, etc. Hand Book with illustrations of 100 Mechanical Movements sent free on request. Albert E. Dieterich, Patent Lawyer and Solicitor, 621 Ouray Bldg., Washington, D. C.

PATENTS—Before disclosing an invention the inventor should write for our blank form "Record of Invention." This should be signed, witnessed and returned to us together with model or sketch and description of the invention and we will give our opinion as to its patentable nature free. Our Three Books mailed Free to inventors. Our Illustrated Guide Book, "How to Obtain a Patent," contains full instructions regarding patents. "List of Patent Buyers" sent Free, contains unsolicited letters from manufacturers and others who are constantly writing us regarding the purchase or leasing of meritorious patents. Victor J. Evans & Co., 834 Ninth, Washington, D. C.

UNPATENTED Ideas can be sold. I tell you how and help you make the sale. Particulars free. Write W. H. Greene, Jenifer Building, Washington, D. C.

HERBERT JENNER, patent attorney and mechanical expert, 606 F Street, Washington, D. C. I report if patent obtainable and exact cost. Send for circular.

"INVENTORS' Guide" free on request; gives valuable information and advice for all who have original ideas or improvements. Frank Ledermann, Registered Attorney and Engineer, 15-P Park Row, New York.

"INVENTOR'S Advisor," the valuable Patent book with 139 mechanical movements and illustrations, sent free upon request. M. M. Labiner, Patent Attorney, 3 Parkrow, New York.

COMMERCIALIZE your ideas according to My Cooperative Plan. Booklet free. Ralph Burch, Patent Lawyer, Jenifer Building Washington.

INVENTORS: Record invention legally before disclosing to others. Our Invention-Record and Data Sheet shows how. Sent free and valuable information given on patent procedure, costs, etc. Report on patentability includes copies of patents nearest your idea. O'Connell & O'Connell, Jenifer Bldg., Washington, D. C.

THE PATENTOME is free. A liberal education in patents. Anderson & Son, Attorneys, estb. 1865, 635 F St., N. W., Washington, D. C.

INVENTORS—Send for form "Evidence of Conception" to be signed and witnessed. Form, fee schedule, information free. Lancaster and Albaine, 221 Ouray Bldg., Washington, D. C.

PATENTS and Trade-marks obtained. Prompt service. Write for our new book on patents. Established in 1889. D. Swift & Co., 309 7th St., Washington, D. C.

MILLIONS spent annually for Ideas! Hundreds now wanted! Patent yours and profit! Write today for free books—tell how to protect yourself, how to invent, ideas wanted, how we help you sell, etc. American Industries, Inc., 560 Kresge Bldg., Washington, D. C.

PATENTS Procured. Send sketch or model today for examination, prompt report and advice. No charge for preliminary advice. Write for free Booklet and blank form on which to disclose your idea. Highest references. Promptness assured. Clarence A. O'Brien, Registered Patent Lawyer, 58-A Security Bank Building, Directly across the street from Patent office, Washington, D. C.

PATENTS—My own attention to all business. Twenty years' experience. Charges reasonable. Booklet on request. C. E. Trainor, 503 Kresge Bldg., Washington, D. C.

PATENTS promptly procured. Personal, careful and efficient service. Highest references. Moderate fees. Send sketch or model for actual search and advice. George P. Kimmel, Master of Patent Law, 54-A Loan and Trust Bldg., Washington, D. C.

PATENTS. My fees in installments. Advice book free. Frank Fuller, Washington, D. C.

PATENT, trade-mark, copyright specialist. Free Duplex conception form. Personal service exclusively. M. E. Jones, Lawyer, 509 Seventh, Washington, D. C.

PATENTS. Trade marks, copyrights. Prompt, personal, reliable service. Over 36 years' active practice. Write for terms. Book free. Address E. G. Sizgers, N. U. Bldg., 918 F St., Washington, D. C.

LACEY Patent Sense. See page 158.

PATENTS, Trademarks, Copyrights procured; all countries; Booklet Free; 20 years' experience; very reasonable; my personal attention to every case; ask about Free Sales Service. H. Sanders, Registered Patent Attorney, 7 Rand-McNally Building, Chicago, Ill.

INVENTORS: Send sketch or model of invention for opinion concerning patentable nature and exact cost of patent. Book "How to Obtain a Patent," sent free. Tell what every inventor should know. Established twenty-eight years. Highest references. Prompt service. Reasonable charges. Address Chandless & Chandless, 456 Seventh, Washington, D. C.

INVENTORS should write us for our book, "How to Obtain a Patent," which clearly sets forth what may be patented and the necessary steps to protect an invention; it describes the procedure in patent office and tells about assignments, licenses and trade marks, and gives many useful facts about patents which every inventor should know; many persons well versed in patent matters have pronounced the book the best of its kind they have ever read; it is written so you can understand it; copy free upon request. Talbert & Talbert, Patent Lawyers, 481 McGill Bldg., Washington, D. C.

STORAGE battery and kindred inventions specialized by lawyer formerly engaged in battery manufacture. M. E. Jones, 509 Seventh, Washington, D. C.

H. F. LOWENSTEIN, Registered Patent Attorney, Technical expert. McLachlen Building, Washington, D. C.

FOR INVENTORS

PATENTS. If you have an invention which you wish to patent you can write fully and freely to Munn & Co. for advice in regard to the best way of obtaining protection. Please send sketches, or a model of your invention and a description of the device, explaining its operation. All communications are strictly confidential. Our vast practice, extending over a period of seventy-seven years, enables us in many cases to advise in regard to patentability without expense to the client. Our Handbook on Patents is sent free on request. This explains our methods, terms, etc. in regard to Patents, Trade Marks, Foreign Patents, etc. "Scientific American" contains Patent Office Notes, Decisions of Interest to Inventors and particulars of recently patented inventions. Munn & Co., Solicitors of Patents, 623 Woolworth Bldg., New York; Scientific American Bldg., Washington, D. C.; 801A Tower Bldg., Chicago, Ill.; Hobart Bldg., San Francisco, Calif.

HAVE You an Invention! If so, write for our free book, "How to Get Your Patent" tells our terms and methods. Send model or sketch for our opinion of its patentable nature. Randolph & Co., Dept. 114, Washington, D. C.

GET your own patents. Application blanks, complete instructions \$1. Cutting Sons, Campbell, Cal.

INVENTORS' Educator: 900 Mechanical Movements, 50 Perpetual Motions. How to procure and sell patents. Mechanical Movements greatly assist Inventors, suggest new ideas. Explains how to select an attorney and avoid Patent Sharks. Price \$1.50. Postage Free. Albert E. Dieterich, 621 Oway Building, Washington, D. C.

INVENTORS should write us for our book, "How to Obtain a Patent," which clearly sets forth what may be patented and the necessary steps to protect an invention; it describes the procedure in patent office and tells about assignments, licenses and trade marks, and gives many useful facts about patents which every inventor should know; many persons well versed in patent matters have pronounced the book the best of its kind they have ever read; it is written so you can understand it; copy free upon request. Talbert & Talbert, Patent Lawyers, 481 McGill Bldg., Washington, D. C.

INVENTORS—Write for our Guide Books, List of Patent Buyers and "Record of Invention Blank" before disclosing inventions. Send model or sketch of your invention for our free opinion of its patentable nature. Victor J. Evans & Co., 157 Ninth, Washington, D. C.

UNPATENTED Ideas can be sold. I tell you how and help you make the sale. Particulars free. Write W. T. Greene, Jenifer Bldg., Washington, D. C.

PATENT Application, including one sheet drawings, prepared for \$15. Further particulars. A. M. Benner, Olympia, Wash.

I SELL Patents: Established in 1900. A business-like, efficient, honorable Service. Employed by the best of business men. Why not you? Charles A. Scott, 773PM Carson Avenue, Rochester, N. Y.

TO sell your Patent, Write me; experienced handling, immediate action. Address Arthur S. Billings, Suite 401 Dekum Bldg., Portland, Ore.

SPECIALIZED service for inventors. You furnish the idea, we'll work it out. Expert machine designing. Drafting. Opinions given on practicability of ideas. Confidential dealings. Your ideas fully protected. Write for full particulars. Otis Engineering Co., Desk C D, Omaha, Neb.

MODEL Making and experimental work. Modern Shop; expert workmen. Manufacturing. Lamson Electrical & Mfg. Co., 625 W. Jackson, Chicago.

GET Patents Yourself. Complete instructions, blank and 17 valuable money savers. 50c. Inventive Science, 406 N. Denver, El Dorado, Kan.

PATENTS Procured. Send sketch or model today for examination, prompt report and advice. No charge for preliminary advice. Write for free Booklet and blank form on which to disclose your idea. Highest references. Prominence assured. Clarence A. O'Brien, Registered Patent Lawyer, 58-A Security Bank Building, Directly across the street from Patent office, Washington, D. C.

MONROE MILLER, Oway Bldg., Washington, D. C., Patent Attorney; Mechanical, electrical Expert. Before proceeding, read free Blue Book.

PATENTS Procured: Trade Marks Registered—A comprehensive, experienced, prompt service for the protection and development of your ideas. Preliminary advice gladly furnished without charge. Booklet of information and form for disclosing idea free on request. Richard B. Owen, 39 Owen Bldg., Washington, D. C., or 2276-R Woolworth Bldg., New York.

INVENTOR'S Special: List 600 Manufacturers' Addresses just for \$4.00. Write now. The M. L. A., 873 Garden Str., Milwaukee, Wis.

KEEP supplied with photographic drawings of your inventions, at one cent per print. I make the negatives. \$5.00. Write Emil Dahlene, Manson, Iowa.

CANADIAN and foreign patents secured. Fine references. Reasonable rates. Prompt, personal service. The Ramsay Co., 273 Bank St., Ottawa, Canada.

PATENT Sense—"The book the inventor keeps." Free. See Lacey ad, page 158.

PATENT Application Blanks free to inventors. Patent News-D, Washington, D. C.

INVENTORS, if you have a practical, useful invention (patented or patent pending) to sell, write American Patents Corporation, Barrister Building, Washington, D. C.

DRAFT Your Own Patents. Complete instructions, 50c. Patent Drafting Syndicate, Box 858, Schenectady, N. Y.

PATENTS sold for cash or royalty; quick action. Blanchet & Co., 347 5th Ave., New York.

INVENTIONS Developed and Perfected. Working Drawings for Models, Machine Designing. Henry Wettstein, M. E., 150 Nassau St., New York.

PATENTS FOR SALE

IMPROVED clothes dryer for sun drying—a necessity in every house. Outright or royalty. Patented U. S. A. 581,562, and Canada 273,317. J. E. Pieterick, Cayuga, N. Dak.

FOR Sale—Spark Plug Patent. P. V. Carpenter, Worth, N. C.

FOR Sale—Patent rights on locking hinges especially used for folding articles. Offers wanted. K. Gober, 325 Broadway, Oakland, Calif.

OUTRIGHT or royalty—Self-adjusting nut wrench. R. J. Boehm, 37 Barclay Ave., Grand Rapids, Mich.

IMPROVED Rail-Joint, Number 1,272,498, Railway Tie, Number 1,266,139. Outright or royalty, or will exchange for other property. Full particulars. M. S. Monday, Deputy Court Clerk, Atoka, Okla.

HOLLOW Concrete Wall Mold, Patent Number 1,030,480, Contractors and Builders want it. Sure Money-maker. Full particulars. D. Packard, Box 1635, Huron, S. D.

FOR Sale—Patent No. 1,398,114, for heating, roasting and cooling coffee. No. 1,398,115, process roasting coffee. Makes pound coffee go 20% further. Address F. J. Kuhlmeier, Burlington, Iowa.

YOU have a worth-while patent, haven't you. Why don't you tell our two million readers about it? Most of them are specially interested in patents and new inventions. Ask me to tell you how other inventors successfully sold their patents. Geo. F. Baker, Manager, Classified Advertising, Popular Mechanics Magazine, Chicago, Ill.

FOR Sale, patent No. 1,380,960, Rubber Crochet Thimble. V. Homan, R 1—B 23, Phillips, Wis.

CANADIAN garden tool patent, United States household article patent. Costs 2c, sells 25c. John Natismith, Ryland Building, San Jose, Calif.

FOR Sale—my new invention. Most practical butt gauge. Patent Pending. Investigate. Gust Hjert, 514 North 100 St., Seattle, Wash.

COLLAPSIBLE Mitre Box. Outright or royalty. Herbert Abramson, Benson, Minn. Route 5.

HAIR Curler, Sale or Royalty. One-piece steel double curler for short and long hair. Locks ends. Battersby, patentee, 4635 Sanson, Philadelphia, Pa.

AUTOMOBILE Towing Dolly, adjustable for width and height, center extension for lifting cars, preparatory to blocking. Speedy and practical. Outright sale desired. C. T. Jacobsen, 48 Tehama St., San Francisco, Calif.

STRIKINGLY novel Baby Carrier; an adornment to mother, a beneficial support to baby. Royalty basis to progressive concern. Address: Blekastad, Southworth, Wash.

PATENT on Modeling Dress Form. I. F. Koblinsky, 402 Columbus Ave., Bay City, Mich.

MANUFACTURERS and others investigate. Sanitary tooth cleaner gum massager, patent pending, used once and thrown away; more efficient than tooth brushes; large profits; partner with capital and factory space wanted; million dollar proposition when promoted. R. C. Tuthill, Red Lodge, Mont.

AUTO Robe Protector—never anything like it on market; no more stolen robes. Sell outright or on royalty. Chas. Lamberton, P. O. Box 877, East Akron, Ohio.

FOR Sale, Patents; Nut and Bolt Locks, designed to resist vibration; Metal toy Aeroplane, useful and decorative Weather-vane for barns, garages, etc. M. R. Humfelt, South Lima, N. Y.

FOR SALE—Patent rights on a combination tool Hammer, Pliers and Wire Cutters. Hans Larson, Box 491, Seattle, Wash.

PATENT on household "Knife Sharpener," a real seller. Manufactured cheaply. Arrid Bohlin, 71 Mulberry St., Trenton, N. J.

PATENTS For Sale: To sell, buy or obtain patents, write Patent News-P, Washington, D. C.

UNITED STATES and Canadian Patent on improvement for Roller Skates. Produces exceptionally durable skate at low cost. Outright or royalty. Theodore Fedun, 6650 Mercer St., Detroit, Mich.

DRAWING INSTRUMENTS AND DRAFTING SUPPLIES

DIRECT Importation, 10-piece Precision Mechanical Drafting Set in plush case. Finest German Silver. Special, each \$4.50. Photo free. De Franke, Importers, 149 N. Dearborn Street, Chicago, Ill.

SURVEYING INSTRUMENTS

NEW and used surveying instruments direct from factory. Satisfaction guaranteed or money refunded. Wissler, 619 Broadway, St. Louis.

MODELS AND MODEL SUPPLIES

WE make working models for inventors and do experimental work and carry a complete stock of brass gears and model supplies. Send for catalogue. The Pierre Model Works, Tinley Park, Ill.

INVENTORS—Write for our Guide Books and "Record of Invention Blank." Send model or sketch of inventions for our free opinion of patentable nature. Victor J. Evans & Co., 165 Ninth, Washington, D. C.

DIES, Tools and General Manufacturing. Models and Manufacturing of new inventions our specialty. Logan Machine Co., 222 S. Clinton St., Chicago, Ill.

MODEL Making Supplies—2 in.—4 in. diameter special thin brass tubing for Model Boilers, 10¢—20¢ per inch. Machined ends, per pair, 2 in., 75¢; 4 in., \$1.50. Miniature machine screws, 3-32 in. up. Finished Boiler Fittings. Catalogue 26c. Batho Mfg. Co., Dept. D, 5214 Woodland Ave., Philadelphia, Pa.

MODELS and Tools. Send sketch for estimates. Arthur Schmidt, 394 Canal St., New York.

WE Build Models, design, develop, and manufacture articles in large or small quantities. Homeyer Machine Products & Mfg. Co., 1885 E. 17th St., Cleveland, Ohio.

MODEL Making and experimental work; Modern Shop, expert workmen. Manufacturing. Lamson Electrical and Mfg. Co., 625 W. Jackson, Chicago.

PATENTS Procured. Send sketch or model today for examination, prompt report and advice. No charge for preliminary advice. Write for free Booklet and blank form on which to disclose your idea. Highest references. Promptness assured. Clarence A. O'Brien, Registered Patent Lawyer, 58-A Security Bank Building, directly across the street from Patent office, Washington, D. C.

BEFORE you buy model engines, boilers, send stamp for our new illustrated list of machined castings, parts for boilers, boat fittings. Model Machine Shop Co., 417 East 71st St., New York City.

FOR MANUFACTURERS

WANTED—Metal Stamping and Model work taken on contract basis. We are ideally located and equipped to develop patents. Meyers Company, Box 326, Bedford, Ind.

MANUFACTURING

EXPERIMENTS developed, dies, models and manufacturing machine designing. Estimates and information promptly given. Address Schroer Bros. Machine Works, 512 East 25th Street, Kansas City, Mo.

LET Us Manufacture It For You. We will cooperate with you in every way possible. Our experience in developing, simplifying and selling new devices at your disposal. Ideas worked out and developed. Models made. Metal parts made to drawing or sample. Special Machinery designed and built. Dies and other special tools for manufacturing furnished. Simplex Tool Company, Woonsocket, R. I.

WANTED—By a well equipped metal manufacturing plant having 25 stamping and punching presses and 25 automatic screw machines, staple and volume products to manufacture either outright or on royalty basis. Company's work at present largely automobile parts. The Ziegler Manufacturing Co., Alexandria, Ind.

LONG established manufacturer of auto accessories which are daily sold by practically all wholesale and retail accessory houses will consider manufacturing and distributing new automobile products, capable of equally wide sale through same channels. Patented articles preferred. Address Auto Accessory Manufacturer, 1512 North American Bldg., Chicago, Ill.

SCREWS, nuts, screw machine products, all metals. Autoscrew Works, 355 West Broadway, New York City.

WIRE Goods, all kinds, made to order. Cooley Mfg. Co., 524-530 N. Western Ave., Chicago.

PATENTED Articles, Models, Brass Work, Machine Construction; Dies Made. Baum's Metal Specialties, Kansas City, Mo.

DRAFTING and Engineering Service. Experimental, Model, Tool, and Production Work. Your ideas developed and inventions manufactured at most favorable rates. Write us. Independent Service Co., La Crosse, Wis.

WE can design and manufacture special machinery of every description, automatic or semi-automatic. Jigs, fixtures, punches, dies, and special production tools of all kinds. The John Steptoe Company, Stock Yards Station, Cincinnati, Ohio.

MANUFACTURING—Our Well-Equipped Factory Can Handle Your Job. We Specialize on Small Work. Inventions Developed and Made Practical. Prices Right. Sheldon Tool Company, Rosedale, Kans.

METAL-CRAFT manufactures dies, stampings, die-casting, screw-machine, and wire products reasonable. Plating, Enamelling, Burnishing. Prompt, efficient service on any size contract. Modern equipped plant. A dependable source of supply. Metal-Craft Manufacturing Co., Box 259, Chicago.

WE design and build machinery. T. A. Oberholmann, 2194 Railway Exchange Bldg., St. Louis, Mo.

IRON, Brass, Aluminum Castings, Models, Patterns, Light Manufacturing. Welch Brothers Co., North Chicago, Ill.

PATTERNS, wood and metal. Models, tools and dies. Brass, bronze, aluminum and iron castings. Screw machine work, production work of all kinds. Write Modern Machine & Pattern Co., Terre Haute, Ind.

WE specialize on Dies, Making Stamping, Light Mfg. The Times Mfg., 410 Kimball St., Danville, Ill.

BOLTS, nuts, rivets. O. L. Dickey, 48 Trask, Bayonne, N. J.

WITH our low overhead modern shop, we make dies, tools, jigs, etc., at \$1.20 hour. Light manufacturing, press-work, etc., 75¢ hour, or per M. or by contract. J. McDonnell, 3501 S. Kedzie, Chicago.

MACHINERY, TOOLS AND SUPPLIES

STEEPLE'S medium priced line of Shapers, Milling Machines, Lathes, and Die Slotters will reduce your manufacturing costs. Established since 1845. Catalog upon request. The John Steptoe Company, Stock Yards Station, Cincinnati, Ohio.

ALL Steel Hydraulic Press, vertical, with pump, one hundred and fifty ton, fully automatic. Either light or heavy work. R. L. Barrett, 114 E. Grand Ave., Chicago, Ill.

NIAGARA Punch Press, 1/2 in. stroke, 15 in. throat, \$70.00. Walltek Electrical Works, 1012 M St., Lincoln, Neb.

FOR Christmas—A Wonder Saw Table—with motor—\$45.00. Write for particulars. Mechanics Supply Co., Dayton, Ohio.

250-HP. Alternating Generator. Freight, Passenger and Hand elevators, Lathes, Shapers, Millers, Punch Presses, Drill Presses, Steam, Gas, Gasoline Engines, Pumps, Blowers, slightly used machinery. Bargains. Raffner Elevator Works, Kansas City, Mo.

CONCRETE Building Block Machines and Molds. Catalogue free. Concrete Machine Co., 303 South Third St., St. Louis, Mo.

ENGINES, MOTORS AND DYNAMOS

BIJUR Generators, brand new, 6 volts, maximum output 22 amperes at 2000 r. p. m. Government paid \$45.00 each, our price \$10.00. General Sales Company, 1919 S. Michigan Avenue, Chicago, Ill.

MOTORS—G. E. 1/4 hp. \$15.00—1/2 hp. \$22.50—1 hp. \$32.50. Generators 8v. 19 amp. \$15—32 v. 500 watt \$30. Other sizes low prices. Motor Specialties Co., Crafton, Pa.

GOVERNORS to control Auto Engines when used as stationary engines. Circulators. Candee-Smith Governor Co., Springfield, N. Y.

ELECTRICAL

CARBON brushes, plates, rods and specialties. Pittsburgh Carbon Brush Co., 127 Fancourt St., Pittsburgh, Pa.

NEW, up-to-the minute Electrical Dictionary including radio terms and diagrams, just published. 188 pages. Cloth cover, vest-pocket size, 35¢ postpaid. Popular Mechanics Book Dept., 206 E. Ontario St., Chicago.

ELECTRICAL Experimenters—Here is the book you have been waiting for—"How to Make Things Electrical." 256 articles, 427 pages, 353 illustrations. Price \$2 postpaid. Popular Mechanics Book Dept., 206 E. Ontario St., Chicago.

FOR MECHANICS

PATENTS—Write for our Guide Books. List of Patent Buyers and "Record of Invention Blank" before disclosing inventions. Send model or sketch of your invention for our free opinion of its patentable nature. Terms Reasonable. Victor J. Evans & Co., 184 Ninth, Washington, D. C.

MECHANICS, Carpenters, Contractors, Send for a Master Folding Rule. Made of Selected, Seasoned, Flexible Hard Wood, with Solid Brass Patented Joints, 5 ft. 50¢; 6 ft. 60¢. No Stamps. Master Folding Rule, 2448 W. 127th St., Cleveland, Ohio.

1,000,000 INDUSTRIAL Facts, Calculations, Receipts, Processes and Trade Secrets for every business are contained in the 1,016-page book "Moore's Universal Assistant and Complete Mechanic." 500 Engravings. Cloth. Price \$2 postpaid. Popular Mechanics Book Dept., 206 E. Ontario St., Chicago.

BLACKSMITHS

SENSATION of the season; the new Hossfeld Wrenchless Universal Bender; bends Eye bolts, U's, Angles, etc. Bends 1 1/4 in. standard Pipe cold. Also rolls perfect Automobile Spring Eyes. Machine can be instantly set for any kind or size of work without the use of a wrench. Simple, Powerful, Inexpensive. Send for circular. Universal Iron Bender Co., Inc., Winona, Minn. Representatives Wanted.

BLACKSMITHS, Listen: Any Handy man can make more money doing hard jobs easy. Forging and welding solid, with Toy's Modern Methods of Blacksmithing. Hardening and tempering to a standard with colored tempering charts. All for one dollar. Samples Free. W. M. Toy, Sidney, O.

FOR THE SHOP

POPULAR Mechanics Shop Notes are published annually in book form; price 50 cents postpaid. The latest volume containing all notes in the magazine during 1922 is ready. Better send \$1 today for the two latest issues and get acquainted with these wonderful aids in your work. Back volumes are in great demand and we can supply 15 of them at 50¢ each. Altogether they make an encyclopedia of mechanical information that is priceless to the owner. Popular Mechanics Book Dept., 206 E. Ontario St., Chicago.

FOR SALE—MISCELLANEOUS

ADDRESSOGRAPHS, Letter Folders, Multigraphs, Envelope Sealers, Duplicators, less than half price. Guaranteed. Pruitt Co., 170 N. Wells, Chicago.

ALL sizes printing presses, type and materials; make easy money printing for self and others. Watson, 160 William St., New York.

BUY—Exchange—Sell! Many of our readers have for sale or exchange the article you are looking for—and lots of them are looking for the very items you want to turn into cash. Get together! Let our two million readers know your wishes—they'll help you! Send your ad today to Geo. F. Baker, Manager Classified Advertising, Popular Mechanics Magazine, Chicago.

GASOLINE Lamps and Lanterns. Catalog Free. Little Wonder Light Co., Terre Haute, Ind.

POCKET Maps. We will send you a reliable and comprehensive Rand-McNally indexed pocket map, tourists' and shippers guide of any state in the Union, Canadian provinces, Alaska, Mexico or Central America, postpaid, upon receipt of 25 cents; also a splendid pocket reference map of practically any foreign country at 50 cents postpaid. Popular Mechanics Book Dept., 206 E. Ontario St., Chicago.

WINDOW Trimming, Show Card Writing, and Salesmanship course, nearly new, all for \$60.00. B. Schrag, 3211 Fairfield Ave., Cincinnati, Ohio.

FOR Sale—Auto Knitting machine. Saerfsee \$55.00. Herbert Johnson, Bellevue, Ia.

FOR Sale, \$10,000, three rare Newspapers, Museum purpose, and three unpatented inventions. Paul Madansich, 514 Cedar St., Oakland, Calif.



YOU ARE WANTED FOR A BETTER JOB

That was the good news they brought him just a few short months ago. Then, he held an ordinary job working long and hard on small pay. Today he is a high salaried Draftsman earning nearly \$100 a week. How did it happen? It isn't a long story, because it's all so simple, so easy. You can do just what he has done if you'll start by reading every word—clear down to the coupon that marks your way to better pay.

It all started one evening while he was sitting at home—reading. He saw the advertisement of the COLUMBIA SCHOOL OF DRAFTING and he knew it was his opportunity to earn from \$50 to \$100 a week, in an uncrowded field with a big, sure future. He sent in the coupon. Later he enrolled for the COLUMBIA course. Today he's making real money. His brain is working, as well as his hands. He's standing on the threshold of a brilliant future with all that it means—**independence—money—success—happiness.**

Made \$275 EXTRA in 3 Days

He recently received \$275 for one drawing that he made in spare time in three days.

How About You? Are you working up hill or down? Count the money in your pay envelope next pay day. You'll find the answer there.

Make \$50 to \$100 a Week. COLUMBIA will train you to be an expert Draftsman in your spare time at home by mail. There's lots of room for you if you act now.

Promotion is Quick. We'll Qualify You for a high-salaried position in the Drafting field and keep you in touch with openings for Draftsmen in the big machine shops, industrial plants and United States Government departments. Men who start as Draftsmen are often advanced to Chief Draftsmen, Chief Engineers, Production Managers and so on.

Get the RIGHT Training. Mr. Clafin, the founder and director, stands personally in back of the COLUMBIA SCHOOL OF DRAFTING. You spend no time in long-winded theories—useless and expensive to you. You start on actual drawing work the day you receive your first lesson.

You Need No Previous Training. The course is easy to understand and easy to follow. Many students are qualified even before they complete the course.

Success Calls Men of Action Only. If you are a man of action clip the coupon now and show that you are a man of action. Keep right on top of this opportunity to make real money. Don't go looking for a pair of scissors. Tear the coupon off and mail it right now. Get started now.

WHAT WE GIVE YOU

Practical Problems. You are carefully coached in practical Drafting work.

We Help You Get a Job. We help you get a position as a practical Draftsman, as soon as you are qualified.

Personal Instruction and Supervision Throughout the Course. You receive the personal instruction and help of Roy C. Clafin, President of the COLUMBIA SCHOOL OF DRAFTING and a practical Draftsman of many years' experience.

Draftsman's Equipment. We furnish you with a full set of First Class Drawing Equipment and Drafting Instruments as shown in the picture below when you enroll. You keep both sets on completing the course.

Consultation Privileges. You are free to write us at any time for advice and suggestions regarding your success.

Diploma. The diploma we give you on completing the course attests to your proficiency as a Draftsman. It is an "entering wedge" to success.

Free Subscription to Drafting Publication, "The Compass." You are given free a subscription to our helpful, inspiring publication, "The Compass."

U. S. Civil Service Commission Needs Draftsmen. The following are a few of the many positions open in Government Departments from time to time. The salaries are starting salaries, subject to increase. Practically all of them carry a bonus of \$240 a year additional: Architectural Designer, \$4,000; Chief Draftsman Naval Aircraft Factory, \$15.04 per day; Aeronautical Draftsman, Field Service of Navy Dept., \$5.20 to \$12 per day.

Free Book. Send in this coupon today. Immediately on receipt of it we will send you our book, "Drafting—Your Success," which tells about Drafting and its opportunities for you as well as the special easy method of learning Mechanical Drafting through COLUMBIA methods.

THE COLUMBIA SCHOOL OF DRAFTING

ROY C. CLAFLIN, President

Dept. 2245 14th and T Sts., N. W.

WASHINGTON, D. C.



FREE DRAFTING OUTFIT

We give you Free, with our course, this professional Drafting outfit. It is yours to keep when you complete the Course.

— — — FREE BOOK COUPON — — —

COLUMBIA SCHOOL OF DRAFTING,
Dept. 2245, 14th and T Sts., N. W., WASHINGTON, D. C.

Please send me without charge your free illustrated book on Drafting, telling me how I can secure your complete Home Study Course and your help in securing a position as Draftsman.

Name.....

Address.....

City..... State.....

Continued from Page 46

ROOTS AND HERBS

GINSENG and other Plants for Medicine, Perfume, Dyes. How to gather. Address of Buyers Book 30c, O. Twitchell, Berlin, N. H.

SEEDS, PLANTS, TREES, ETC.

WANTED—Everyone interested in gardening to write for free copy of our beautiful Seed and Plant Guide. Our new specialties will interest you. H. W. Buckbee, Rockford Seed Farms, Dept. 901, Rockford, Ill.

WANTED—MISCELLANEOUS

DEAL direct, we pay cash, full value for Old False Teeth, any description, Bridge-work, Crowns, Old Gold, Silver, Discarded Jewelry and Diamonds. Goods returned should our offer be unsatisfactory. Mail Bullion Department, Kimberly Diamond Exchange, 1307 Waldheim Building, Kansas City, Mo.

CASH for old gold, silver, platinum, watches, diamonds, magneto points, gold crowns, false teeth, and other valuables. Merchandise returned if offer unsatisfactory. Busch Products, Dept. 30, 144 Fifth Ave., New York.

CASH Via Wire Within One Hour. Simply Mail Jewelry, Diamonds, Old Gold, Platinum Points, Unused U. S., Canadian, Postage, Thrift, Stamps, Bonds, Silver, Teeth, Job-Lots, Anything Valuable, Valuables Held Returnable Ten Days if Price Unsatisfactory. L. Simon, Reliable Refiner, 315 Hippodrome Bldg., Cleveland, Ohio.

WILL buy good patent. What have you? Gordon, 114 N. Seventh St., St. Louis.

WANTED—Copies of Popular Mechanics Magazine of September and October, 1923. Must be in good condition. Will pay 25 cents per copy. Address, Room 311, Popular Mechanics Bldg., 200 East Ontario, Chicago, Ill.

MAIL us your discarded Jewelry, Gold, Crowns and Bridges, Watches, Diamonds, Silver, Platinum, and old False Teeth. Money promptly mailed. Goods returned if offer refused. United States Smelting Works, (The Old Reliable), Dept. 71, Chicago.

WANTED—Encyclopaedia Britannica, Vol. 4, Bis-Cal Inc. Published by the Cambridge University Press. Address G. F. Baker, Room 304, Popular Mechanics Magazine, 200 E. Ontario St., Chicago, Ill.

REAL ESTATE, FARM AND ORCHARD LANDS

TAX Sale Lands. Buy these bargains by mail; \$73 for 122 acres choice lake frontage. \$75 for 25 acres, trout stream accessible. \$97 for 50 acres, beautifully wooded—shooting. \$105 for 50 acres, hunting camp site. \$19 for small acreage, Georgian Bay. \$125 for good acreage, big game district. \$215 for large acreage, hunting camp site. \$285 for mining claim, may be worth a million. Also beautifully situated hunting camps and fishing lodges, where there is real hunting and fishing. Summer cottage sites, islands of all sizes, heavily wooded acreages all situated in Muskoka, Georgian Bay District, with its ten thousand islands, Algonquin Park with its 300 lakes, Highlands of Ontario, Lake of Bays, and the famous Muskoka Lakes region. All offered at 10 cents on the dollar of their value, and on easy monthly payments of \$5.00 and upwards. Send for illustrated list of the above and one hundred other properties seized and sold for taxes. If you are interested in the forthcoming boom in Canadian Gold and Silver mines, and would like a mine all your own for two or three hundred dollars send for list 240A. Every property is fully described and offered at a stated price. Send no money. Send for list today, so you will have first chance. If you wish you may make the payments to your local trust company. Tax Sale Service, 72 Queen Street, West, District 15, Toronto, Ontario, Canada.

FOR Sale—Three full sections in McKenzie County and two sections in Billings County, North Dakota. Each section contains land suitable for crops, balance for cattle. Each section has valuable deposits of lignite which some day will alone be worth many times the present value of the land. This part of the state is developing very rapidly with good schools within easy access. As owner cannot use this land himself, will sell one or more sections at a price which almost anyone can afford to pay. Address W., care Popular Mechanics, 200 East Ontario St., Chicago.

FREE Book of Florida Facts. Own your own orange grove in beautiful Fruitland Park. A few cents a day you now waste will buy it for you. A few dollars a month may provide you with a life income. Schmitzler sold his twenty acre grove here for \$40,000—two thousand an acre. He saw the same opportunity that's offered to you and planted a grove. Result—he reaped a small fortune. You have the same chance but you must act now. Write today for Free Book of Actual Photographs, Florida Facts and the interesting story of a Fruitland Park Farm. Learn of crops that help you buy it. Address today, Lake County Land Owners' Association, 93 Sunset Way, Fruitland Park, Fla.

SELL your property quickly for cash, no matter where located. Don't pay big commission. Particulars free. Real Estate Salesmen Co., Desk B, Lincoln, Neb.

\$5.00 DOWN, \$5.00 monthly; 10 acres unimproved poultry, fruit, stock, woodland; \$100; Ozarks, Fishing, hunting, trapping. Alfred Zimmerman, 1800 N. Fifth, Kansas City, Kan.

WANT to hear from owner having farm for sale; give particulars and lowest price. John J. Black, Chippewa Falls, Wis.

EQUIPPED Poultry Farm and Attractive Home; Only \$700. Near fine high-school town; motor bus road; 7 acres tillage; good 10-room house, big barn, houses for 500 to 1,000 hens, shed, garage, \$700, winter's hay, wood and vegetables, tools, 52 hens included. Part cash. Page 7 Catalog Bargains—many states. Copy free. Strout Farm Agency, 1507 Nassau St., New York City.

\$10 TO \$50 starts you on 20, 40 or 80 acres; near bustling city in Michigan; balance long time. Write for free illustrated booklet. Seigart Land Co., P-1259 First Nat'l Bank Bldg., Chicago.

FARM Wanted—Sell for cash, in any state. No big commissions. R. A. McNow, 312 Wilkinson Bldg., Omaha, Neb.

REAL Estate Educator—The most valuable, concise and comprehensive work on real estate selling, buying, advertising, appraising, investing, leasing, sub-letting, transferring, insuring, mortgaging, etc., ever compiled. 208 pp. Cloth, \$2 postpaid. Popular Mechanics Book Dept., 206 E. Ontario St., Chicago.

CALIFORNIA home for sale. Photo 10c stamps. John Naismith, Ryland Building, San Jose, Calif.

DOGS AND PETS

HEALTHY, Intelligent Mammoth Great Danes for Sale. Box 23, New Richmond, Ind.

PONIES, goats, dogs, cats, rabbits, canaries. Jos. Berg, Hendrum, Minn.

SILVERBLACK Foxes \$300.00; Muskrats, Time Payments. Arthur Schumacher, Lockland, O.

HUNDRED Hunting Hounds Cheap. Trial. C.O.D. Kaskennels, P.M.C., Herrick, Ill.

POULTRY

PLANS for Poultry Houses. All styles, 150 illustrations; secret of getting winter eggs, and copy of "The Full Egg Basket." Send 25 cents. Inland Poultry Journal, Dept. 74, Indianapolis, Ind.

SUNNYSIDE Pullets, 256 egg stock, \$3 each. "Raised in Bristol, lay everywhere." Sunnyside Poultry Ranch, Bristol, Va.

PERSONAL

TOBACCO Kills manly Vigor. Quit easily. Cigarettes, chewing, smoking, snuff conquered or no charge. Small sum if satisfactory. Stops craving; harmless. Full treatment on trial. Perkins Co., 31-A, Hastings, Neb.

TOBACCO or Snuff Habit cured or no pay. \$1.00 if cured. Remedy sent on trial. Superba Co., TP, Baltimore, Md.

ARE you bashful, self-conscious, easily embarrassed? These troubles overcome. Send dime for particulars. C. Veritas, 1400 Broadway, New York, N. Y.

FREE—Information of a scientific nature that has brought happiness through perfect health to thousands. No charge; no obligation. Enclose stamp for reply. C. O. Wood & Co., Colorado Springs, Colo.

FREE—Stop using tobacco. We will give free information how to conquer habit easily and permanently. Results guaranteed. Anti-Tobacco League, Box K, Omaha, Neb.

YOUR Horoscope—Business, Character Changes, Friends, Enemies. Send birth date and ten cents (stamps) for remarkable test reading. Zanya, 202-C. W. 105th St., New York City.

UNUSUAL Horoscope—Six pages, consisting of extensive four-page Special Horoscope, Astro-Analysis, and two-page valuable guide giving daily and monthly advice covering entire year. Send 50c and birth date. Money returned if dissatisfied. Prof. Bolles, Box 5, Percham Station, New York, N. Y.

SHOPMEN: Do your feet pain you? Do they perspire excessively? Have you Chills? Foot-Frotio (Anti-Bromidrosis) is not an acid or chemical but a preparation of natural excretion in the removing of foot disorders and freely restoring the feet to a healthy condition. After you have used it, your feet will become climatized to the kind of shoes you wear and the atmosphere of your shop. Lessens undue perspiration and stops that tired and aching feeling. Send 50c and receive a sealed package prepaid. The Standard Products Company, Howell, Mich.

150 "FUNNY" Parodies on Latest Songs, "Yes! We Have No Bananas," "To-Day," etc., 25c. P. M. Collins Co., 197 Fulton Street, Brooklyn, N. Y.

KNOW thyself life chart; send birthdate and dime. Professor West, Yakima, Wash.

ARE You Old at Forty? See our Advertisement on page 146 of this issue. The Electro Thermal Company, 2129 Main Street, Steubenville, Ohio.

QUIT Tobacco easily, inexpensively. Send address. Franklin Stokes, Mohawk, Fla.

TOBACCO, liquor and morphine habits can be overcome with the aid of Hill's Chloride of Gold preparations. Liquor remedy can be given secretly. Particulars free. Ohio Chemical Works, Dept. 9, Westfield, N. Y.

MISCELLANEOUS

ARTIFICIAL Eyes, \$3. Booklet free. Denver Optic, 559 Barclay, Denver, Colo.

HOMEOPATHIC and Biochemic preparations sent postpaid to all parts of the world. Manual and booklets free. Halsey Bros. Co., 111 N. Wabash Ave., Chicago, Ill. Established 1835.

CUTS anybody can make. Simple, cheap process, \$1. Specimens, particulars, 2c stamp. M. Day, Windfall, Ind.

"AUTOMATIC Government" — World's greatest discovery to save civilization. \$1. New World, Benton Harbor, Mich.

CHEWING Gum 45c per box. Mahan Smith, Jefferson City, Mo.

MAKE big money opening Safes and Setting Combination. Wayne Strong, Box 22, Eagle Rock, Calif.

LOCKSMITHS—Send \$1, get valuable chart for cutting tumbler padlock keys. Globe System, 278 Washington St., Newark, N. J.

ROCKS and Minerals for sale—hundreds of varieties—price List Free. Peter Zoda, 157 Wells St., Peekskill, N. Y.

ART Metal Workers—You will find our book "Metal Work and Etching" a complete manual on making book ends, desk sets, pad corners, paper knives, letter openers, stationery racks, rocking blotters, desk calendars, arts and crafts jewelry, etc.; 96 pp. illus. Price 50 cents postpaid. Popular Mechanics Book Dept., 206 E. Ontario St., Chicago.

"VENTRILQUISM"—Complete instruction book, 10c G. Eisea, Bowling Green, Ohio.

MUSIC Books, Voice Production, Amusement oddities, Medical Charts, Lectures, Mechanical Figures, Advertising Freaks. Catalogue 10c. William Duke, Three Rivers, Mich.

GREENHOUSE cut flower plant support. No twine or tying necessary. Grows with plants. Lasts long as greenhouse. Wm. Robinson, Box 94, Morton Grove, Ill.

FANCY novelty beads \$1. Parker, 1806 So. Logan, Denver, Colo.

BLUE-FINISH Guns at small cost. Instructions \$1.00. Ed. Simon, Dane, Wis.

MONEY in Minerals. Many common minerals have market value. List 10c. Minerals tested. Mineralogist, Joplin, Mo.

LOCKSMITHING, complete 500 tricks of the trade, new edition, many added features, \$1.50; money back if dissatisfied. H. Houston, 3406 Andover St., Oakland, Calif.

ARE You Old at Forty? See our advertisement on page 146 of this issue. The Electro Thermal Company, 2129 Main Street, Steubenville, Ohio.



This Dental Laboratory Expert earns \$20 a day!

What's the use of training for the old, overcrowded trades? If you're going to prepare for big-salaried jobs

Easiest, pleasantest work you ever saw! Your own boss, money and success yours from the very beginning. You can start with a "shoe-string." We prepare you in a few months to run a business of your own, to do any job. Common schooling, ability to use your fingers **ALL YOU NEED!**

Jobs at \$60 to \$125 a Week!

In a business where there are many times as many jobs as Experts, salaries are high, hours are easy, opportunities are everywhere! McCarrie-trained Experts always get the preference—Dentists everywhere recognize the high-standing of our graduates. No books here—learn with tools and instruments. Start quick—get ready in 12 weeks for your big opportunity! *Mail Coupon today!*

RUBBER PLATES

Learn to make partial upper or lower plates with soldered, cast or wire clasps, with palatal bars; with lingual bars. McCarrie-trained Experts learn to make full rubber plates of every type, including Vulcanite base-plates, buttoned gums, carved gums, etc.

CROWNS

Here's only a small part of your practical training in Crown-work: Two-piece, seamless, open-face, Richmond, cast-base porcelain, Carmichael, split-pin, carved (swaged) cusp, cast cusp, etc.

BRIDGE WORK

Complete training in both fixed and removable bridge-work. Interchangeable teeth, gold dummy, Sanitary, porcelain dummy jobs—Roach, Gilmore, Blasehoff and all forms of cast-clasp work is taught—not with books but in actual Laboratory.

METAL BASE DENTURES

Cast bases of Aluminum, gold, Watt's metal, etc. are included in your training. Both centrifugal and air pressure casting machines are used. Free Catalog contains complete list of subjects in course.



FREE!
R.R.
Fare
to
Chicago

or a profitable business of your own **GET INTO THE NEWEST PROFESSION**—*"Laboratory Dentistry."* Biggest opportunity for success of the century, because there are ten times as many jobs as men to fill them, because there are a dozen cities crying for Laboratories for each **EXPERT** capable of operating one!

60,000 DENTISTS NEED LABORATORY WORK!

Only a few hundred Laboratories in all the U. S.—most of them in Chicago and New York. Dentists can't afford to do their own mechanical jobs. They can buy the services of a Laboratory Expert at \$3.00 an hour and sell their own time at \$6 to \$15 an hour. Dentists will encourage you to learn mechanical work, start a "Lab" of your own, give them quicker service than sending to Chicago or New York. Dentists can't wait and keep their patients waiting.

OPEN a LABORATORY of your OWN!

Joe Wilk of Chicago started a couple of years ago **ALONE**. Today he employs 60 Experts and his Laboratory is one of the biggest in the U. S. *Boos* in Minneapolis is reported to employ 125 men and to clear \$40,000 to \$50,000 a year. Start with the same tools you use in this big **SCHOOL-LABORATORY**. Start your own Laboratory with as little as \$100 investment. No limit to profits you can make in this wonderful new profession.

INTERESTING CATALOG—FREE!

Right this minute we can place 150 Dental Laboratory Experts in locations where they can make \$5,000 to \$20,000 a year. But you can't cash in, take advantage of these OPPORTUNITIES until you're **TRAINED**. Catalog tells you how quickly and easily you can get ready, how hundreds of others have **SUCCEEDED!** Tells you how you learn in few months **BY DOING ACTUAL LABORATORY JOBS** under world's greatest Mechanical Dentist! Brings you **FREE R. R. Fare** offer and other big inducements. *Write for free Catalog today!*

EARN while you LEARN!

Day students make all or part cost of course by part-time night work. Night students can find plenty of good jobs in Chicago. We'll help you!

McCarrie School of Mechanical Dentistry

Dept. 401, 34 W. Lake St., Chicago

McCarrie School of Mechanical Dentistry, Dept. 401, 34 W. Lake St., Chicago

Without obligation, please send me your *Free R. R. fare* offer and free catalog with complete information about how I may become a Dental Laboratory **EXPERT**.

Name.....

St. No. or R. F. D.....

City.....State.....



Posed by Miss
Ann Forrest,
Famous Movie
Star, and Arthur
Murray, the
Vanderbilts' In-
structor

Why Good Dancers Are Popular

THOUSANDS of men and women are compelled to pass up many a good evening's fun just because they don't know how to dance. Yet there is no need for anyone to be a wallflower. Arthur Murray, America's foremost authority on social dancing, has perfected a method by which you can learn the steps of any of the latest dances in a few minutes. You don't need to go to a dancing class—you don't need to take private lessons—you don't need to bore your friends by getting them to teach you. Through Arthur Murray's method of easily understood diagrams and simplified instructions you can quickly learn to become a perfect dancer right in the privacy of your own room without either music or partner. And just as quickly as you have mastered the steps you can dance perfectly on any floor to any kind of music and keep step or follow correctly with the best dancer in your set.

Five Dancing Lessons FREE

Even if you don't know one step from another, send for these five free lessons and let them prove that you can learn to dance at home in one evening through Arthur Murray's new methods. More than 90,000 persons have learned this way and there is no reason why you should not do as well.

The five free lessons are: How To Gain Confidence, The Secret of Leading, A Lesson in Fox Trot, the Correct Dancing Position, and How To Follow. These lessons are sent free, but to pay for mailing and wrapping just enclose 10 cents. Learn in private—surprise your friends—write today for the FREE LESSONS.

ARTHUR MURRAY, Studio 959, 290 Broadway, New York City

McGraw-Hill Home-Study Courses

Practical Guides on Electrical, Machine Shop and Power Plant Practice, Shop Management, etc. 100,000 in use. Free examination—easy monthly payments. Write for booklets.

McGraw-Hill Book Co., 370 Seventh Ave., New York



BECOME A RAILWAY MAIL CLERK

No strikes. No lockouts. When everybody else is worrying about his job or looking for work, the U. S. Civil Service Employee is earning good, steady pay in a pleasant occupation of his own selection. **Earn \$1600 to \$2300.** Let me train you to pass the U. S. Civil Service Examination with **high rating** so you can get a position **quickest** at \$1600 to \$2300 a year as a Railway Mail Clerk or in Customs, Internal Revenue, Departmental, Immigration, Postmaster, Post Office and Rural Branches. I have trained thousands to successfully pass the examination. Money refunded if unsuccessful in securing a position. Write today. Mail coupon for catalog.

PATTERSON CIVIL SERVICE SCHOOL
Dept. 81
ROCHESTER, N. Y.

Patterson
Civil Service School,
Dept. 81, Rochester, N. Y.

Send me without charge
your catalog, describing this and
other U. S. Government Positions.

Name.....

Address.....

DRAW CARTOONS

Cartoonists Trained by W. L. EVANS



MAKE MONEY

SOME of the cleverest cartoonists in America today are former students. They studied during their spare time and are now making good money. Cartoonist Evans' system of teaching is so simple, easy and practical that it is not hard to learn to draw originals. The school has a long established reputation and is recommended by well-known cartoonists because they know the students are handled right.

If you like to draw, send us a sample of your work, either a copy or an original. You may have more ability than you think. We will send you a portfolio of cartoons and full details about the school.

The Course is NOT EXPENSIVE

**THE W. L. EVANS SCHOOL
OF CARTOONING**

821 Leader Bldg. CLEVELAND, OHIO

FREE FIRST LESSON RECORD

Learn to Play

Violin, Mandolin and Banjo-Mandolin quickly. No embarrassment. You learn to play or pay nothing. Play for money in two months.

Beautiful Instrument FREE

No charge for Instrument to one pupil in each locality. Few cents a week pays for lessons. Write for First Record—Sent without cost on 1 week's approval with complete details of Personal Instruction Record Course.

SCHNEIDER SCHOOL OF MUSIC
Dept. B-1, 238 Vermont St., Blue Island, Ill. (A suburb of Chicago)

Our BUREAU OF INFORMATION will answer all questions regarding articles appearing in this magazine.



ALSO IN ONE COURSE

ALSO IN ONE COURSE

ALSO IN ONE COURSE

ALSO IN ONE COURSE

ALSO IN ONE COURSE

ALSO IN ONE COURSE

ALSO IN ONE COURSE

ALSO IN ONE COURSE

ALSO IN ONE COURSE

ALSO IN ONE COURSE

ALSO IN ONE COURSE

ALSO IN ONE COURSE

ALSO IN ONE COURSE

ALSO IN ONE COURSE

ALSO IN ONE COURSE

ALSO IN ONE COURSE

ALSO IN ONE COURSE

ALSO IN ONE COURSE

ALSO IN ONE COURSE

ALSO IN ONE COURSE

ALSO IN ONE COURSE

ALSO IN ONE COURSE

ALSO IN ONE COURSE

ALSO IN ONE COURSE

ALSO IN ONE COURSE

ALSO IN ONE COURSE

ALSO IN ONE COURSE

ALSO IN ONE COURSE

ALSO IN ONE COURSE

ALSO IN ONE COURSE

ALSO IN ONE COURSE

ALSO IN ONE COURSE

ALSO IN ONE COURSE

ALSO IN ONE COURSE

ALSO IN ONE COURSE

ALSO IN ONE COURSE

ALSO IN ONE COURSE

ALSO IN ONE COURSE

ALSO IN ONE COURSE

Neglect of Home-Study Training Cost This Man \$47,424!

How much are you paying to stay untrained?

The other day we received a letter which every man working for a living ought to read—whether he's making \$20 a week or \$200. Here it is:

"During the forty years that I have been working, my salary has averaged less than twenty-four dollars per week with the exception of the last two years while I have been acting as foreman of a department. I made good in this position on a small scale and saw, thru the failings of others, what would happen to me unless I found a way to train for larger responsibilities.

"I had read of correspondence courses and began searching for that which I thought would benefit me. I found it in the LaSalle Modern Foremanship course, and benefited by it, my salary being nearly doubled, and I was promoted from foreman to factory superintendent.

"This happened in a period of about ten months, and by devoting only about four or five hours per week to the studies.

"I am now enrolled as a member of the Industrial Management Efficiency course, and find the work very interesting and beneficial. It can be applied every day in the factory, and brings results.

"I regret that I put it off to so late a day in life to reap the benefits I am now enjoying, and can truthfully say to younger men that if they would only profit by the experience of others they can gain more knowledge thru one year's training by LaSalle methods than can be obtained in ten years' practical experience by hard work."

SHERMAN C. WOOD, Maryland.

We quote the above letter not because Mr. Wood is now making a staggering salary as a result of his training, but because it illustrates so clearly the principle behind LaSalle training.

Here is a man who all his life had accepted the thought that he was compelled to work for little or nothing.

For one thousand, nine hundred and seventy-six weeks the writer of this letter *paid at least \$24 a week for the doubtful privilege of staying in the ranks of untrained men.*

Can anyone doubt that training would have doubled his salary just as easily when he was thirty-eight years younger—when he could attack his work with the abundant energy of a younger man?

Yet his neglect of this one main avenue of business progress cost him—leaving simple and compound interest out of the reckoning—the appalling sum of \$47,424—a fortune in itself.

**If You Could Use \$47,424,
Pause Before You Turn This Page**

Perhaps you are now making quite as much as Wood—perhaps more. Perhaps, on that account, you may think that Wood's experience does not apply to YOU.

But if training in Higher Accountancy—or Modern Salesmanship—or Business Management—or Law—or Business Correspondence—or any of a dozen other branches of business could change your forty-eight dollars into \$96 a week—and if you now NEGLECT to advance yourself thru the training you need—will you not find it difficult, thirty-eight years from now, to explain to those who are dear to you why you threw away—not \$47,424, but *fully \$95,000?*



We're not going to moralize. We're not even going to cite you any of the thousands of letters from men who have not merely doubled but tripled and quadrupled their incomes thru home-study training under the LaSalle Problem Method. We have the letters. We will show them to you, if you like. But understand, please, that they would not alter the facts—they would merely *emphasize* them.

Below this text there's a coupon.

We believe that if you will re-read that letter from Sherman C. Wood and will face your problem of advancement squarely, you will not turn this page until you have clipped the coupon, filled it in, and by placing it in the nearest mail-box placed *yourself* on the road to real success.

LaSalle Extension University

The Largest Business Training Institution in the World

Dept. 164-R Chicago, Illinois

Upon request, the book, "Ten Years' Promotion in One," and material completely descriptive of the course and service that interests you, will gladly be sent without cost or obligation. Indicate your choice by checking, and write below your name and address.

- Business Management
- Modern Salesmanship
- Higher Accountancy
- Law—Degree of LL.B.
- Traffic Management
- Railway Station Management
- Commercial Law
- Industrial Management Efficiency
- Banking and Finance

- Modern Business Correspondence and Practice
- Modern Foremanship and Production Methods
- Personnel and Employment Management
- Expert Bookkeeping
- Business English
- Commercial Spanish
- Effective Speaking
- C. P. A. Coaching

Name.....

Present Position.....

Address.....

BE A RAILWAY TRAFFIC INSPECTOR

EARN UP TO \$250 Expenses Paid



Per Month
Many
Chances
for
Advance-
ment
In This
Uncrowded
Profession

Stanley W. Dress writes: "I have worked as a Traffic Inspector for some time and have found it the most satisfactory and pleasant work that I have ever been engaged in. The hours are short. In some places I work only five and six hours while in others I work eight hours. I have never worked over eight hours.

Many Opportunities To Travel

"This work has satisfied one of the ambitions of my life and that is traveling. There is no other work that gives more opportunities to travel than that of a Traffic Inspector and at the same time is interesting and instructive.



"I can recommend the course to anyone seeking a position that is pleasant and profitable and to which there is no end of advancement for the person who sticks to it. It requires so little of one's efforts and no one need stay at home to study it. The Course can be studied during spare time and any person with a common school education can easily make a success of it."

POSITION GUARANTEED

Upon Graduation

Hundreds of Openings. We train you at home in spare time. Any average man can qualify in three months. We guarantee you a position upon graduation, paying at least \$110 per month and expenses, or refund what you have paid.

Unlimited Opportunities. Glen O. Trego writes: "I find that being a Railway Traffic Inspector does not only enable a man to receive higher positions in railways but it also verses one so he is more capable of conducting any kind of business which may be chosen for the future. I must admit that the price paid for the Course of Traffic Inspection is the best investment I ever made."

This interesting work places you in contact with high railway officials. Many opportunities to travel—or remain near home. **Railroads need more trained traffic inspectors—we must supply them.**

You take no risk! Send for full details of this unusual opportunity. Mail coupon today.

Standard Business Training Institute
BUFFALO, N. Y.



MAIL COUPON

Standard Business Training Institute
Buffalo, N. Y.

Send me, entirely free, Booklet No. D-63, giving full particulars about course in Railway Traffic Inspection.

Name.....

Street.....

City..... State.....

Please Mention Popular Mechanics

SMASH Your Way Through To Success



Lionel Strongfort
Perfect Man

Life's race is to the STRONG. The fittest survive. The weakling perishes. Your Success in business, in society, in all the relations of life, depends fundamentally on your Physical Health and Strength. If you have some physical weakness gnawing at your vitals and robbing you of the very essence of success, you are a beaten man.

You Can Win

Life's biggest prizes are YOURS if you have the Physical Power to DEMAND them. Where do you stand? Are you a business drudge—one of the "Yes, sir," boys, humbly taking orders from others who haven't half your ability but who DO have a surplus of Health and Energy? Or—Are you the fighting, planning, DOING sort of MAN—the man who leads and directs other men—the man who is respected and looked up to by men and women alike? Are you? You CAN be.

IT'S EASY

My amazing discovery of the workings of Natural Forces makes gaining of glorious health and physical strength EASY—and as natural as breathing. By my methods, YOU can acquire perfect Health, Lion-like Strength, and compelling Personal Power. I can help you as I have helped thousands. I will put you on the high road to MASTERFUL Achievement. I will put the punch and power in you that will enable you to smash your way through to Success.

I build men scientifically through STRONGFORTISM, the Modern Science of Health and Strength. Results are astounding—almost miraculous. I have lifted thousands of men from the deep pit of failure and despair and shown them how to gain Health, Strength and Vitality. No matter if you are weak, ailing, nervous or the victim of some stubborn chronic ailment, I can put you back in the game and give you the fire and energy of Physical Perfection.

Startling Book FREE

STRONGFORTISM—the Science that makes physical and mental super-men out of weaklings, that makes business giants, social successes and leaders in trade and commerce out of weak, disease-racked, discouraged, hopeless men, is fully described in my new book, "Promotion and Conservation of Health, Strength and Mental Energy." Let me send you a copy of this FREE book, beautifully illustrated from living figures and crammed with startling facts. Fill out the Free Consultation Coupon and send to me TODAY with ten cents (one dime) to cover mailing cost.

LIONEL STRONGFORT
PHYSICAL AND HEALTH SPECIALIST

Department 1358

Newark, New Jersey

----- CONSULTATION COUPON -----

Absolutely Confidential

Lionel Strongfort, Dept. 1358, Newark, N. J.

Please send me your big 54 page book. I enclose ten cents (one dime) for postage. Send me special information on subjects marked (x) below without obligation.

.... Colds Skin Disorders
.... Catarrh Debility
.... Too Fat Torpid Liver
.... Too Thin Vitality Restored
.... Stomach Trouble Muscular Development
.... Flat Chest Great Strength
.... Bad Blood Rupture
.... Nervousness Lumbago
.... Constipation Neuralgia
.... Despondency	

Other Ailments.....

Name.....

Age..... Occupation.....

Address.....

Copyrighted material

MEN WANTED!

I am teaching trades to men who want to get out of white collars and into overalls. Who want to quit being wage slaves whose job a strike or bad business or employer's whim can terminate without warning. Who want a chance to be independent, make real money and own their own business. I refer you to sixty thousand men who found the way to success by sending for my catalog.

Earn \$50 a Week and Up!

If you are looking for work at \$50 a week and up, if you would like to get into something sure and solid that will give you success and independence, and can put in a few weeks this winter in TRAINING write me today.

With over TWELVE MILLION automobiles running the demand for mechanics, demonstrators, chauffeurs, truck drivers, garage men, etc., is greater than ever before. Countless opportunities in cities and towns and even remote places. I estimate there are 20,000 Sweeney trained men owning their own garage or business.

FREE CATALOG AND SPECIAL OFFER

Get my big FREE 64-page catalog. It shows hundreds of actual photographs of men at work in my magnificent new school. Tells all about wages, profits, opportunities in auto and tractor business. Explains step by step how you learn. Interesting letters from graduates telling how they made good. Shows how men come from all over the world to this big school. Makes you want to join the crowd. Tells everything you want to know. I will gladly send you a copy beautifully illustrated. I'll tell you how to get into business for yourself. No colored students accepted.

E. J. SWEENEY, President

LEARN A TRADE—
Sweeney
AUTOMOTIVE & ELECTRICAL SCHOOL
1263 SWEENEY BLDG. KANSAS CITY, MO.

Send this NOW!

The white-collar worker contemplating a shift into a manual trade will find, with a little investigation, that the trades themselves are shifting. Yesterday he would have tackled something like carpentering, bricklaying, plastering, painting or typesetting. Today he finds a demand for men who understand automobiles, internal-combustion engines, electricity, oxy-acetylene cutting and welding, and other crafts of comparatively recent development. Ten or fifteen years ago many of them did not exist. They have come into existence with the growth of internal-combustion power and the changed character of building.

—Saturday Evening Post
"The White Collar Shifts Into Overalls"



SWEENEY System of Practical Instruction

is the ONLY way to learn if you want to save time and money and be properly trained. You get this at the famous trade school, the MILLION DOLLAR SWEENEY SCHOOL and you get it nowhere else. I have helped 60,000 men to success. The way to learn is easy. You don't need any experience, age makes no difference. I teach with tools, not books. You learn by actually doing the work. I am making a *Special Thirty Day Offer*. That is why you should not delay. The first step is to send for my big Free Catalog.

EMORY J. SWEENEY, President
Dept. 1263, Sweeney Building, Kansas City, Mo.

Send me free, without any obligation on my part, your 64-page catalog and Special Offer!

NAME

GIVE AGE

P. O.

STATE



HOW MUCH do ARTISTS EARN?

WOULD you like to earn \$100 a week as a commercial artist? If you like to draw, you should develop your talent, for well-trained artists earn \$75, \$100, \$150 a week, and oftentimes much more. Beginners who can do practical work soon command \$50 a week.

The Federal home-study course develops your talent on a sure foundation by the **quickest possible method**, and makes the work truly a pleasure. It is the **original, practical** course in commercial art, created by men with more than 25 years' experience in the field, and after 8 years of unequalled success today stands supreme as America's Foremost Course in Commercial Designing. It contains **exclusive** lessons from leading American artists, gives you individual personal criticisms on all lessons and teaches you the methods that make your drawings worth real money.

Send Today for "YOUR FUTURE"

If you are in earnest about your future, send 6c in stamps today for this book. It is beautifully illustrated, tells every detail about the Federal Course, gives you convincing proofs of its merits and shows work done by Federal Students. Fill out and mail the coupon NOW, kindly stating your age and occupation.



COUPON

Federal School of Commercial Designing
697 Federal Schools Bldg., Minneapolis, Minn.
Gentlemen: Please send me "YOUR FUTURE" for which I enclose 6c in stamps.

Name.....

Age..... Occupation.....

Write your address plainly in margin.



John Davey's organization needs young men

John Davey's organization, The Davey Tree Expert Co., Inc., has a limited number of openings for ambitious young men between 20 and 30 years of age, single men preferred. The opportunity is unusual, offering good pay at the start, permanent employment in the Davey organization, and thorough scientific training in the profession of Tree Surgery. Advancement rapid, according to merit. The work is fascinating, offers chance to travel extensively, and association with fine fellows. Only clean, red-blooded young Americans, lovers of the outdoors, need apply. Write, giving full information, to The Davey Tree Expert Co., Inc., 56 City Bank Bldg., Kent, Ohio.

BE AN ARTIST

We can teach you **DRAWING** in your own home during your sparetime.

Our 18 years of successful teaching prove our ability. 10 Courses in Commercial and Illustrative Drawing, Teachers Normal and Applied Art. Endorsed by high art authorities. Students trained by members of our Faculty are filling high-salaried positions. Artist's Outfit FREE to Enrolled Students. Write today for Art Year Book.

OUR HANDSOME ART YEAR BOOK FREE TO YOU!

SCHOOL OF APPLIED ART
ADDED ART BLDG. NO. 2 BATTLE CREEK MICH.

LEARN TO GET DOLLARS OUT OF WATCHES.
WATCH-REPAIRING, ENGRAVING, JEWELRY REPAIRING.

WRITE NOW.

ENICAR TRADE SCHOOL
530 W. MONUMENT SQUARE, RACINE, WIS.

Try This on Your Hair 15 Days

Then let your mirror prove results. Write Today for FREE Trial Offer. Your hair need not thin out, nor need you be bald, for a way has been found to destroy the microbe that destroys the hair. This new and different method will prevent thinning out of the hair, dandruff, lifeless hair, baldness, gray hair, by strengthening and prolonging life of the hair for men and women. Send now before it is too late for the 15-days' free trial offer.

AYMES CO., 3932 N. Robey St., M-390 Chicago

For You at Last—

THE knowledge of science that has come to be so necessary a part of the education of the cultured man or woman.

The understanding of the miracles going on around us that will bring every day some thrilling experience.

The enjoyment of the most amazing romance in all the world—the story of man's conquest of the Universe.

This Free Book

tells the whole remarkable story of an epoch-making work that opens the doors to the wonder-world of science. Without cost or obligation to you, we will send you a copy, with four plates in full color and over thirty half-tone illustrations. You will find it a fascinating book in itself with full information about the most important publishing event in many years—*The Outline of Science*.

The Most Fascinating Romance in the World

The Outline of Science is the magic story that tens of thousands are eagerly reading—the story of man, the miracle worker; whose marvelous scientific achievements have disclosed the most wonderful secrets of nature and gained control over her greatest forces.

In one simple, flowing story you read of all scientific progress since the beginning—The Romance of the Heavens—The Story of Evolution—Man's Rise from His Earliest Ancestry—The Struggle for Existence—Marvels of the Insect World—The People of Air and Sea—The Kingdom of the Animals—Plant Life—Wonders of Microscopy—Miracles of Electricity—Psychoanalysis, Aviation, Wireless, Chemistry, and hundreds more subjects just as fascinating.

It is all told so simply and clearly that anyone can understand—so fully and accurately that the whole scientific world has given it unqualified endorsement. Nearly a thousand superb illustrations form a pictorial history of the progress of science.

The Outline of Science

has been proclaimed by hundreds of authorities an unprecedented achievement. Thousands of reviews have been unanimous in its praise. "Should be read by every human being," says *William Beebe, the famous scientist*. "A fine triumph," agrees *Vernon Kellogg*. "Here are the foundations of our civilization," writes *Dr. Frank Crane*. "More interesting to read than any romance,"—*New York Globe*. "A tensely absorbing narrative,"—*Providence Journal*. "An epoch-making performance,"—*New York Herald*. "Has no rivals. There is no other work in existence that presents all the sciences from the modern point of view in familiar language,"—*The Bookman*.

The four handsome volumes of *THE OUTLINE OF SCIENCE* form a romance of a thousand thrills that will hold you spell-bound for many an hour. And the free booklet will show you why.

Send the Coupon Now No Obligation—No Expense

for this booklet. You will find it highly interesting reading and it will give you full information about *The Outline of Science*, and the easy way by which you may own and enjoy it.

G. P. PUTNAM'S SONS

Dept. 216

2 West 45th Street

New York



G. P. Putnam's Sons
Dept. 216

2 West 45th St., New York

Send me by mail, without cost or obligation on my part, the free booklet, with three color plates and over thirty half-tone illustrations, describing *The Outline of Science*.

Name.....

Street and Number.....

City and State.....

Occupation.....

**NOW ONLY
\$2.80 DOWN**



12 Big LAW BOOKS

This world-famous library needs no introduction. It is the recognized authority among schools, colleges and practitioners everywhere. It covers every phase of the law including International Law, Patent Law, Mining and Irrigation, Federal Courts and procedure. Nothing is omitted. Think of it—a complete law course in book form, written by the highest authorities in interesting, fascinating form. Prepared especially for home reading, with quiz questions on every subject.

**SPECIAL LAW OFFER
Reduced from \$110.00**

Here is your easiest, quickest and cheapest opportunity to get a legal training at a bare fraction of the usual cost. A complete law course covering all subjects for bar examination. Business firms and corporations are looking for the man who knows law. Gain a knowledge of law and you can command an executive position—a position of responsibility at big pay. Make these 12 massive volumes of over 5,000 pages your law school. Splendidly bound in rich law buckram with red and black labels and titles in gold.

Send No Money FREE READING COURSE

We will ship the complete Law Library right to your home or office for full 7 days free examination upon your simple request. Examine and study them 7 days free. If you decide to keep them pay \$2.80 down and the balance in small monthly payments of \$4.00 until the special price of \$48.80 is paid.

Act at once and we will include, extra and free, our Reading Course of 33 complete lectures in law which will help you prepare for the bar examination. This Reading Course together with the books to a complete course in law.

Regular price \$110. Think of it—a saving of \$63.20—and a full year to pay. Act quick as this cut price offer holds good only on 482 sets. So rush the coupon.

THE JOHANSEN CORPORATION, 611 Marshall Bldg., CHICAGO
Please send your 12-volume Home Study Course in Law for 7 days' examination, shipping charges collect. I will either send \$2.80 as initial payment and \$4 a month thereafter until \$48.80 is paid, or return the books within 7 days at your expense.

Name.....
Address.....
Employed by..... Age.....
\$10 required with order outside of United States.



"Peppy" and powerful tone quality, scientifically accurate scale, strong, durable construction with exclusive Gibson "easy-to-play" features, make this Gibson Junior banjo a wonderful value. A full sized instrument with solid ebony fingerboard and genuine Gibson construction throughout. Send now for complete information, FREE, about this or any other Gibson instrument: New Mastertone, Tenor Banjo, Mandolin Banjo, Guitar Banjo, Cello Banjo, Mandolin Mandola, Mando-Cello, Mando Bass, Guitar, Harp-Guitar.

GIBSON MANDOLIN-GUITAR CO.
111 Parsons St. Kalamazoo, Mich.



T. M. TEVIS, Box 25K, CHILlicothe, MO

**+ To Your Knowledge
X Your Earning Power**

There's a better job just ahead of you—if you fit yourself for it. The more you know, the more you can earn. Add to your knowledge and you will surely multiply your earning power. Train yourself to be worth more money—then GET IT.

We can help you to earn more money—perhaps double your present salary. Check, on the coupon below, the occupation you think you would like, fill in your name and address. We'll tell you where you belong and how to get there through an American School Course. The lessons are simple, you study right at home in your spare time, the results are sure. The cost is low, terms easy, satisfaction guaranteed.

Fill out coupon now. Learn how to make great big money in the line of work you should be doing. Full information free.

American School, Dept. G-174-B Drexel Ave. & 58th St., Chicago

American School, Dept. G-174-B Drexel Ave. & 58th St., Chicago

- Send me full information on the subject checked.
- .. Architect
 - .. Building Contractor
 - .. Carpenter
 - .. Automobile Engineer
 - .. Automobile Repairman
 - .. Civil Engineer
 - .. Advertising Manager
 - .. Business Manager
 - .. Financial Manager
 - .. Sales Manager
 - .. Cert. Pub. Accountant
 - .. Accountant & Auditor
 - .. Bookkeeper
 - .. Draftsman & Designer
 - .. Electrical Engineer
 - .. General Education
 - .. Personal Analyst
 - .. Business Law
 - .. Lawyer
 - .. Machine Shop Practitioner
 - .. Photoplayer Writer
 - .. Mechanical Engineer
 - .. Shop Superintendent
 - .. Employment Manager
 - .. Steam Engineer
 - .. Foremanship
 - .. Sanitary Engineer
 - .. Surveyor [& Mapping]
 - .. Telephone Engineer
 - .. Telegraph Engineer
 - .. High School
 - .. Fire Insurance Expert
 - .. Wireless-Radio
 - .. Undecided

Name.....
Address.....
Occupation.....

Learn Radio At Home



Earn \$2,400 to \$10,000 a Year

The man who would be a success in business today must be a specialist. The market is already crowded with clerks, stenographers, accountants and detail men of every description. That is why the chances are so strongly against their getting big pay. But look at the men who are earning real big money today. In practically every case we find them to be specialists!

RADIO NEEDS TRAINED MEN

There is probably no other field today where specialists are needed more than in Radio. Trained men are needed in every branch of this fascinating, profitable profession. And the opportunities for trained men are great—almost without limit. Even in this field, the men who stand the best chance of landing big are those who enter this field NOW while Radio is growing so rapidly.

Just consider the possibilities of Radio. The shores of every continent are dotted with radio stations. Every ship has its radio equipment. Hotels, railroads, government departments, and commercial houses are flashing their messages 'cross rivers, mountains and seas. At night, millions are "listening in" on radio programs.

This amazing growth of Radio has created a tremendous demand for radio experts. Factories, banks, the shipping industry, newspapers and business houses are employing Radio Experts in every branch. And the demand for trained men is far short of the supply.

Pick Out the Job You Want—We Will Help You Get It

This is a brief list of the positions in the Radio field today, and the salaries paid—

Broadcasting station operator, \$125 to \$250 a month.

Commercial land station operator, \$150 a month and up.

First-class ship operator, \$105 a month in addition to all expenses paid.

Radio Engineer, up to \$10,000 a year.

Radio Inspector, \$1800 to \$4500 a year.

Radio Salesman, \$2000 to \$10,000 a year.

Radio mechanic, \$1500 to \$4000 a year.

Radio instructor, \$150 to \$250 a month.

Radio draftsman, \$7 to \$15 per day.

Radio executive, up to \$10,000 a year.

You Can Qualify at Home Easily and Quickly

If YOU are sick of plodding along in the daily grind of monotonous office routine—held down by thousands of men doing the same work you are—get out of the rut into a big paying

profession. Learn Radio at home. A short course of training will quickly enable you to be independent, to travel and see the world if you care to, or to establish a business of your own. It will make you a specialist with the unlimited opportunities that are open to a specialist in this tremendous uncrowded field of Radio.

FREE BOOK — Describes Opportunities

To any man who is eager to better his condition, and is interested in the remarkable opportunities in Radio, we will gladly send a copy of our newly published book on radio—*absolutely free*. You assume no obligation whatever in sending for this interesting, helpful book. It is yours for the asking.

Send for your copy of "How to Learn Radio at Home" and learn all about the wonderful opportunities that are opening in Radio, how we train men for them and help them to the best positions. Read actual experiences of many of our students since we have trained them. "Tune in" on a real job. Mail the coupon for this interesting FREE BOOK today. It will pay you!

National Radio Institute
Dept. 15AA
Washington, D. C.

National Radio Institute
Dept. 15AA
Washington, D. C.

Without any obligation on my part, please send me a FREE copy of your book, "How to Learn Radio at Home." Also tell me how your Free Employment Service will help me to a position and send details of your special short-time offer.

Name.....

Street.....

City..... State.....

NOTE: Radio Firms—Secure practical Radio Experts among our graduates. Write us today.





Established
1905

Learn Autos in Los Angeles

Hundreds of Big-Pay Jobs Open! Garages Needed! You can Win Success in California—Where Opportunities are Greater!

Men Come to Los Angeles from Every Part of the World to Get National Training, and to Take Advantage of the Remarkable Business Opportunities in California

EVERYWHERE in America there's a big demand for Automotive experts. Over thirteen million autos in use—think of the great volume of business automatically created for garages, electrical repair shops, vulcanizing shops, etc.

In California alone there are more than 1,300,000 autos. One in every four persons owns a car. Nowhere else in this country are there the many opportunities for speedy success in the auto business as there are in California today. And this is especially true of Los Angeles.

National Automotive — A Showplace of Los Angeles

And nowhere else will you find such an automobile school as National. This great institution, founded in 1905, the oldest automotive school on the Pacific Coast, has kept pace with the rapid growth of the automotive industry and the development of Los Angeles. Today, National Automotive occupies a new building, with more modern equipment than has ever before been assembled for training purposes.

Quality Training Offers You a Better Chance for Success

There's a reason for the amazing progress made by National.

NATIONAL AUTOMOTIVE SCHOOL
Dept. 56, 4004 So. Figueroa, Los Angeles
Please send me, absolutely free, your big, 84-page illustrated catalog, "The Gateway to Golden Opportunity."

Name.....

Address.....

City..... State.....



California has about one-tenth of all automobiles in the entire United States.

Arthur Brisbane says:

In America things change rapidly. There are now in this country 13,308,128 registered automobiles. In California, that earthily heaven to which many of the wise, good and prosperous go before they die, there is one automobile for every four persons.

This school is founded on the ideal of giving every man the best training that can be had. As a result, thousands of successful graduates have said the word—"Go to National for Automotive Training."

You Can Do What Other Men Have Done

Look about you. See the prosperity that is enjoyed by automobile men everywhere. Make up your mind now to get into this interesting money-making business. You have the same opportunity today—perhaps greater—to share the prosperity of the automobile industry and of California.

Learn Autos at National Earn \$40 to \$125 a week

Be an automotive expert. Learn autos now. National gives you thorough practical shop training in every branch of automotive engineering—auto construction, mechanics, electrical training, lathe work, vulcanizing, salesmanship and business management.

Earn Your Room and Board While You Learn

The Welfare Department at National watches out for your best interests. If you desire to earn your room and board while learning, we will find a job for you without charge. Get the most out of life—live in California, where winter time is like a glorious summer day.

Mail the Coupon for Our Catalog

Find out at once about National Automotive, the many special advantages of National training, and of the tremendous opportunities in the auto business in Los Angeles and all California. Send for the FREE 84-page, illustrated catalog—"The Gateway to Golden Opportunity"—it explains everything.

Read the stories from real life written by men who have gained success, money and independence through National training. You can do as well, and perhaps better. Send for this book now—it tells the short easy way to bigger pay.

National Automotive - Los Angeles

How You Can Make Money In Your Spare Time

By Learning to Play Your Favorite Musical Instrument this New Easy Way

"I BOUGHT a house and a lot, and paid \$1,100 toward it; all earned through teaching piano," writes Mrs. Mary A. Olsen, 3715 Wadsworth St., Los Angeles, Cal. "I would not take \$1,000 for my financial and social gain through your lessons. I don't know how you can give as much for so little. I think your method is just wonderful."

Mrs. Olsen is only one of more than three hundred thousand men, women and young people who have become accomplished musicians through this wonderful new method. All the intricate "mysteries" of music have been reduced to a system of amazing simplicity. Every step is made as clear as A. B. C. You don't have to know anything whatever about music. You learn to play your favorite instrument right in your own home, quickly, easily and without endless study and practice. Long before you now think it could ever be possible, you will actually play well enough to be in demand as a well-paid entertainer, teacher or musician.

\$10 to \$40 in Two Hours

A busy mother, Mrs. Anna M. Lewis of Northfield, Ohio, recently learned to play the violin in just the few odd moments she could spare from her household duties, and now earns many welcome dollars to help clothe and educate her four children. "At weddings and church socials I get from \$10 to \$40 for a couple of hours playing," she writes. "I am invited everywhere, and my home is so much happier."

The new way is fun—not drudgery. You'll begin to play melodies almost from the start. You don't have to tie yourself down to regular hours and regular classes. You practice whenever you can, and learn as quickly as you please.

Save Months of Time

"I have learned to play better than many a conservatory student in easily one-eighth the time," writes Miss Kitty Breany, 154 Warren St., Paterson, N. J. "The lessons are so interesting that they seem like play. A lady I know spent \$400 for a private teacher, but her playing cannot begin to compare with mine."

You can do what Miss Breany has done. Youngsters of from 10 to 12 years have done it, and people as old as sixty have found new interest and enjoyment in learning to play a musical instrument. You don't have to listen while others entertain. You can be the talented person who is the center of attraction; who holds the audience fascinated; who wins the applause—and the dollars.

Plays in Orchestra and Band

"In three months I was playing saxophone in the High School orchestra. The fourth month I organized a profitable orchestra," writes George Johnson, 402 Newton St., Salisbury, Md. "And now, at college, I play in concerts of the Musical Club in New York, Philadelphia, Atlantic City, etc."

Learn to Play Any Instrument

Piano	*Cello
Organ	Harmony and Composition
Violin	Sight Singing
Drums and Traps	Ukulele
Banjo	Guitar
Tenor	Hawaiian Steel
Banjo	Guitar
Mandolin	Harp
Clarinet	Cornet
Flute	Piccolo
Saxophone	Trombone
Voice and Speech Culture	
Automatic Finger Control	

Three Months from Today You, Too, Can Play

Is it the piano that you wish to play, or the organ, violin, guitar, harp or cello? Do you want to learn to sing from notes? Are you eager to play on the banjo, clarinet, saxophone, trombone, or the drums and traps? Does the cornet call to you, or the flute or piccolo? Would you love to learn the ukulele (the Hawaiian steel guitar)? Choose your favorite—and play it three months from today.

You will learn by notes—the only practical way for you to learn. There are no "numbers" and no "tricks" in this marvelous method. You learn to read your notes just as you are able to read the letters that make a word, and you will be able to recognize and play them so that they will make a melody. You learn harmonies like you learn phrases and expressions of speech and you learn time like you learn pronunciation.



HARRY W. FULTON

U. S. School Student Wins \$1,000.00 Prize

I have completed my two years' course of music on the Cornet and am ready for my Certificate. I am a student at New York Military Academy, Cornwall on Hudson N. Y.

I won my tuition with my horn for this year, worth \$1000.00. Will also make it for 1924.

I am a member of the School Band. For reference you can write there. I took up the Baritone at midyear to give the band better service. I can fill the place of many of the players with three valve instruments.

I expect to make my living out of Music when through school.

HARRY W. FULTON
512 Pruner Street, Osceola Mills, Pa.

FREE Book Explains All—Send To-Day

Send for this free, valuable book, "Music Lessons in Your Own Home." It costs you nothing. With it will be sent an illustrated Folder which proves, better than words, how delightfully quick and easy the famous Print-and-Picture-Method is.

It will tell you how you can make music a delightful hobby or a money-maker for your spare hours; how you can take the first steps to a profitable musical career if you are dissatisfied with your present life work; how you can be a social favorite, and go everywhere or have fun at home; how you can do these delightful things quickly, easily and at a cost so low that it will surprise you.



Special Short-Time Offer

This Free Book also tells about a Special Short-time Offer now being made to music lovers. Mail the coupon at once for your copy. Act now before the supply is exhausted!

U. S. SCHOOL OF MUSIC,
71 Brunswick Bldg., N. Y. C.

U. S. SCHOOL OF MUSIC

71 Brunswick Bldg., New York City

Please send me your free book, "Music Lessons in Your Own Home," illustrated Folder and particulars of your special offer. I am interested in the following course:

(Name of Instrument or Course)

Name (Please Write Plainly)

Address

City State



Are You Reaching for the Truth?

I will tell you
FREE

Under which Zodiac Sign were you born? What are your opportunities in life, your future prospects, happiness in marriage, friends, enemies, success in all undertakings and many other vital questions as indicated by **ASTROLOGY**, the most ancient and interesting science of history?

Were you born under a lucky star? I will tell you free, the most interesting astrological interpretation of the Zodiac Sign you were born under.

Simply send me the exact date of your birth in your own handwriting. To cover cost of this notice and postage, **enclose twelve cents** in any form and your exact name and address. Your astrological interpretation will be written in plain language and sent to you securely sealed and postpaid. A great surprise awaits you!

**Do not fail to send Birthdate and to enclose 12c.
Print name and address to avoid delay in mailing.**

Write now—**TODAY**—to the

ASTA STUDIO, 309 Fifth Ave., Dept. 138, New York

Get 1,268 Plans That Make Money

50,000 trained men needed to market farm products. Staff of 100 national marketing experts will train you at home. Easy terms. See ad page 51 November Popular Mechanics. Write for 64-page **FREE BOOK "Profitable Marketing"** today.

THE AMERICAN INSTITUTE OF AGRICULTURE
Dept. 32-S 326 West Madison St., CHICAGO

FORD RUNS 57 MILES ON GALLON OF GASOLINE

A new automatic and self-regulating device has been invented by John A. Stransky, 2097 Fourth St., Pukwana, South Dakota, with which automobiles have made from 40 to 57 miles on a gallon of gasoline. It removes all carbon and prevents spark plug trouble and overheating. It can be installed by anyone in five minutes. Mr. Stransky wants agents and is willing to send a sample at his own risk. Write him today.—*Adv.*

NO MORE BALD HEADS



WHEN our **VACUUM CAP** is used a few minutes daily. We accept no pay until you have tried the Cap 30 days and are satisfied. The Vacuum Cap is an appliance that draws the blood to the Hair Roots and starts a new healthy crop of hair. It stops Dandruff, stops the hair from falling out.

Bought by Doctors and men who know that it is the only reasonable **HAIR GROWER** known to science. No Drugs Used. Write for application blank, testimonials, and booklet on "HAIR," sent sealed in plain envelope. **FREE.**

THE MODERN VACUUM CAP CO.

R 559 BARCLAY, DENVER, COLO.

Perfect Health Absolutely FREE through a Natural Law

Address **ALOIS P. SWOBODA**
1194 Berkeley Bldg. **NEW YORK**

WANTED—RAILWAY MAIL CLERKS

\$133 to \$192 a Month for Life

Every second week off with full pay—no "lay offs" because of strikes, poor business, etc.—sure pay—rapid advancement to higher positions. City and country residents stand same chance. Common sense education sufficient—no political influence.

TRAVEL—SEE YOUR COUNTRY

DON'T DELAY—ACT AT ONCE

Send Coupon today—sure. Every day's delay means so much less chance of appointment from the next examinations—so write at once.

FRANKLIN INSTITUTE, Dept. E177, ROCHESTER, N. Y.

**Take this First Step for
a U. S. Government Job
Use Coupon Before You Lose It**

COUPON

FRANKLIN INSTITUTE, Dept. E177, Rochester, N. Y.
Kindly send me, entirely free of charge, (1) A full description of the position checked below; (2) Sample examination questions; (3) Free copy of illustrated book "Government Positions and How to Get Them"; (4) A list of U. S. Government Jobs now obtainable; (5) Tell me how to get the position here checked.

.... Railway Postal Clerk (\$1600 to \$2300) Customs Positions (\$1100 to \$2000)
.... Postoffice Clerk (\$1400 to \$1800) Internal Revenue (\$1100 to \$2000)
.... City Mail Carrier (\$1400 to \$1800) Rural Mail Carrier (\$1800 to \$2600)
.... Income Tax Auditors..... (\$2040 to \$3000)

Name.....

Practical TRAINED-MEN



Repair Shop Practice



Work on Real Tractors



You Do the Welding.

**GET THE
Big Pay
JOBS**

MAKE \$75 to \$200 A WEEK

I guarantee to teach you this big pay trade, the practical way only, with real tools; no books, studies, or blackboard work. Kerr jumped from \$1,248 to \$2,496 a year; Loos jumped from \$24 week to \$75 week; Hartmann's profits average \$400 monthly; I trained them and will do the same for you. Come to my big school shop and work with real tools on actual jobs on automobiles, tractors, trucks and aeroplanes. Just think! 12,000,000 automobiles need attention. You can see the wonderful opportunity awaiting you as a practical, trained mechanic. Send for my FREE 72-page copyrighted Catalog.

GARAGE OWNERS MAKE FROM \$2,000 TO \$10,000 YEAR

You, too, can own a business of your own, the same as many of

my students are doing and are making more money than they ever dreamed of making before they took my practical training course. **THINK!**—you make money for others—why not for yourself? I will show you how.

THIS IS WHAT YOU GET WHEN YOU COME TO MY SCHOOL

My complete auto and tractor course covers all branches of the automobile business. I teach you all about automobiles and tractors, how to build, repair and run them, how to repair tires and radiators, battery repairing, the care and repair of farm lighting plants, welding, salesmanship and garage management, and I give you a complete electrical course which covers every electrical apparatus on automobile, tractor and aeroplane.



Students get Actual Work on
Twin-Six Packard.

READ WHAT MY STUDENTS SAY

Use the COUPON below—mail it today sure—then I will send you your personal copy of my big 72-Page Copyrighted Book, "Sworn Proof of Success in 8 Weeks." This wonderful, illustrated Catalog is full from cover to cover of pictures of my students at work on actual repair jobs in my big practical training school.

ACTUAL LETTERS FROM MY BOYS

It gives actual letters from boys I trained and who are now making as high as \$10,000 a year in the automobile, tractor, electrical and aeroplane business. My Catalog also carries endorsements from people who know what you have a right to expect from a training school. I want you to read these things for yourself, so you will know that the Ohio State Practical Motors School is worthy of your utmost confidence and can and does put its students in line for real jobs at big pay.

WHITE STUDENTS ONLY

Ohio State Practical Motors School

117-119 W. PEARL STREET

CINCINNATI, OHIO

**Sworn Proof
of Success
in 8 Weeks
IN AUTO BUSINESS**



My Students own their own
Garages and Repair Shops.

MY BOYS IN BIG DEMAND

Ohio State Practical trained men are in tremendous demand everywhere, because everybody knows they are trained right. This is your life's opportunity, as I positively guarantee to teach you the business in every department. No previous experience necessary and common education is sufficient.

I MAKE A SUCCESS OF YOU

I will make a success of you. You are trained under my personal supervision, and in eight weeks you will be ready to take a big pay job, or to start a business of your own. My big FREE Catalog tells you EVERYTHING you want to know about this wonderful field of opportunity—send for it NOW. The man who acts is the man that succeeds.

Send me your FREE 72-Page Copyrighted
Catalog of Sworn Proof of Success
in 8 Weeks in Auto Business.

Name

Street or R. F. D.

Town..... State.....

Mail this Coupon NOW →

BE A HOTEL EXECUTIVE

**EARN \$2,500 TO \$12,000
PER YEAR
GOOD POSITION
for YOU**

IN A FIRST-CLASS HOTEL

Would you like one of these fine hotel positions shown here, or one of dozens of others such as supt. of service, house cashier, head houseman, paymaster, asst. mgr., with opportunities to advance rapidly amid pleasant surroundings, good associates, board and often room furnished? Many executive hotel positions are open, paying \$2,500 to \$12,000 a year.



Chief Room Clerk



Steward

HOTEL TRAINING WILL OPEN THE DOOR FOR YOU

Thousands of men and women needed yearly in hotels for splendid positions—many more than the supply of ambitious men and women to fill them. First choice, best

positions go to those showing a real desire to serve and ambitious to succeed, by training for them through the Hotel Operation and Management Course. You can prepare in your spare time at home, in a few weeks. No previous experience necessary.

S. B. T. I. TRAINING THE BEST RECOMMENDATION

S. B. T. I. trained men and women are ready to step into good hotel positions immediately upon graduation or even before.

They know what hotel service means, the fundamentals of this great business, the requirements of every position and the relation of each to the hotel. Not only are their services in demand but they are usually the ones first chosen for promotion. There is almost no limit to the opportunities to which S. B. T. I. trained employees can rise—not after years of experience—but quickly, easily.

When vacancies occur, leading hotel executives turn to S. B. T. I. graduates and students. Almost daily the Standard Business Training Institute receives such applications—more than we can fill. **Send coupon today** for particulars of S. B. T. I. training, efficient Employment Service and splendid opportunities awaiting you.



Asst. Manager



Supt. of Service

Standard Business Training Institute,
Carlton Court, Buffalo, N. Y.

Send me Free Booklet H166, giving full information about Hotel Operation and Management Course.

Name.....

Street.....

City.....State.....

Play TENOR BANJO Same Day You Get It!

I have taught thousands to play in 21 years as head of Music department at New York University, and now I have worked out a way so simple that you can play this Tenor Banjo the same day you get it and afterwards learn all the popular songs quickly and easily.

You Don't Have to Know Music

All you need to learn is three easy motions, of which I show you pictures. You can't go wrong. Easiest, quickest way there is.

Free Phonograph Records

So you can see you are playing our records, I send you three Phonograph Records of myself playing the songs you are learning. This is the only course giving these records. It makes all the difference in the world.

BE POPULAR

Very soon you will be playing *See's Knees*, *Crying for You*, *You've Got to See Mama Every Night*, and all the popular ones. Great demand for people who can play Tenor Banjo. They're always the center of every gathering. Others have learned easily—why not you?

For a limited time only to students who enroll in our conservatory we will give absolutely free this \$18.00 full size professional banjo with full equipment.

Send us your name and address on a postcard for circular giving full particulars on just how Professor Six has been able to teach thousands to play—and how he can teach you so you will play from the first lesson on. Send the postcard today, as Professor Six can give his personal attention to a limited number only, and you want him. A delightful Christmas gift for your friends.

New York Conservatory of Music, Desk I-J, 212 Fifth Avenue, New York City



Professor Six has taught thousands—he can teach you.

**\$18.
Tenor Banjo
FREE**

IGNITION GET IN THE GAME

Train with a real company that will use you when your training is finished.

Here's a company that will train you, put you in one of their shops for practical experience, and go into business with you after you finish. Some day we are going to control the Automobile Electrical Service game and are training men for our own use. Will you be with us?

FOR INFORMATION WRITE TO
MOTOR CAR IGNITION CO., Inc.
Central Division
5036-38 West 25th Street, Cicero, Chicago, Illinois
Automobile Electrical Service—Coast to Coast.

MAKE BIG MONEY Put Yourself on Easy Street

Learn the trade and master the art of making beautiful, sparkling, highly polished, marble, granite, agate, and turquoise, faced brick, building blocks, tile, table tops, monuments and kindred products from common Portland cement at one tenth cost. For full particulars address Master Cement Worker of the World, 433 West 46th Street, Los Angeles, California.

ELECTRICITY LEARN AT HOME

Send for catalog which tells how Burgess Home Training enables men and boys to get good jobs and keep them.
BURGESS ELECTRICAL SCHOOL, Dept. P1, 741 E. 42nd Street, CHICAGO



WANTED! RAILWAY MAIL CLERKS Work for the Government

MEN AND WOMEN 17 TO 45 YEARS

\$1600 to \$2600 a Year Common Education Sufficient. Travel—see the country. No lay-offs—lifetime Job. Holidays with pay. Write today for free list of positions obtainable and information how to get positions with UNCLE SAM.

United Business Tr. Inst., 214 Dinan Bldg., Detroit, Mich.

Everybody likes exceptional **STRENGTH** in a man

DO PEOPLE ADMIRE YOUR FIGURE

and envy your strength? All your acquaintances would like to look upon you as a man who possesses great strength of will and physique, which you can bring into use whenever the occasion arises. They may not demand that you continually perform feats of strength to prove it, but they do demand that you **look the part**. Unless you have great strength and a fine physique, you can neither impress those around you nor be sure of your own ability to make good in life.

Your health and strength must come first. And if you will but follow my instructions, I will give you this *health, strength, energy, will-power* and *appearance* that will lift you out of the commonplace and put you in the class with the great.

Weakness and the knowledge that you are physically inferior and insignificant are two main reasons why a man is *not* a man in the true sense of the word. If you are weak and yet not aware of it, you are even more unfortunate. But why do you choose to continue in the rut of physical *weakness* after having been lucky enough to read this? Of course, most men *think* themselves as good as the next. But why be a bluff when it is just as easy to actually be far better than most men? Don't be one of the type who has the impulse to *jump* every time some one says *frog*.



CHARLES MACMAHON

YOU WILL GET A PHENOMENAL DEVELOPMENT

a 15 or 16 inch upper-arm; a 16 or 17 inch neck; a 42 or 44 inch chest; thighs that measure 23 or 24 inches, and a 15 or 15½ inch calves through my method. But you do not get muscles of this size from my course for the sake of size alone. The value of a 16 inch arm is in its ability to move—to move swiftly, accurately, and with force or power. My methods teach muscular co-operation; the kind that make you efficient in any walk of life; the kind that renders you peppery, untiring, **unconquerable** and good to look at. There is only

One Type of Person I Can't Help

and that type is you who sit there month after month reading what I have to offer, and haven't the energy, the determination, the will-power to get up on your feet and mail the coupon at the bottom of this page. And if you continue to sit there you are most likely excusing yourself by saying, "But I'm not interested—I don't need exercise." To this I say, "If you are not interested in your appearance; your own health and happiness, **why have you read this far?**"

Don't fool yourself—time will tell. You won't feel as good at thirty as you did at twenty, or as good at forty as you did at thirty, unless you dip a few minutes a day into the only Fountain of Youth that ever existed—Good Physical Exercise. Try the first plunge anyway by sending for

My 64-Page Book

It does not obligate you in the least. The title is "The Royal Road to Health and Strength." This book gives you more real physical culture pointers than any other book of this class. There are many new pictures of myself and my pupils; a thorough explanation of my methods; and actual description of hand-balancing, tumbling and muscle-control feats. These last feats are just some of the extra service I give along with my body-building and muscle-developing course. I not only give you a fine body, but I also teach you how to use it. If you haven't gotten up before this, see if you can't do it now and send in to me for this book.

CHARLES MACMAHON

2109 N. Orianna St., Studio D-2, Philadelphia, Pa.

CHARLES MACMAHON, 2109 N. Orianna St., Philadelphia, Pa.
 Studio D-2
 Please find enclosed 10¢ for which send me your Book
 "THE ROYAL ROAD TO HEALTH AND STRENGTH" without obligation on my part.
 Name.....
 Address.....
 City and State.....

3 BILLION DOLLARS SPENT ON Automobiles IN 1923

How YOU can get YOUR Share

Three Billion Dollars! That is the amount spent on automobiles, accessories, and repairs in 1923. You can easily be one of the trained men who will reap their share of this golden harvest in 1924 by making repairs and selling cars and accessories. Trained automobile mechanics are always sure of their jobs. There is a crying demand for them now. Jobs paying \$50, \$75, or more are open right now if you act quickly.

Now You Can Learn This Trade In Ten Weeks In New York

And be assured of a living while you learn. In the big, splendidly-equipped shops of the Stewart Automobile School you can qualify as an expert auto mechanic, repair man and chauffeur in only 10 weeks time. Here you can lay the foundation for a successful career in the world's largest industry. You can learn how to be your own boss—and can step immediately into a big pay job as soon as you graduate. Men need no longer serve an apprenticeship for 4 years at trifling pay. **YOU Can Do It Easily.**

The Stewart Automobile School has thousands of successful graduates. There is no mystery—it is not difficult in any way as you will see from our catalogue.

The Stewart System Makes Learning Easy

Stewart instructors—all hand picked men—have perfected the "personal instruction" policy of this school. Each man is studied—his individual characteristics noted—then he receives his instruction in the way that he can grasp most readily. The course is *thorough*—every point is driven home—yet no one is rushed. The complete catalogue (which you will receive as soon as you send in the coupon) contains a *guarantee* that every man can remain until entirely satisfied with his course.



A Living While You Learn

Our Employment Department will find a job for you while you are taking the course—while you are shaping your future career in the heart of New York.

NOW—Special Business FREE Course

For a limited time the Stewart Automobile School will conduct a business course—free. You will learn how to sell your own services; how to manage a garage, service station or business of your own. It will give you the fundamentals of bookkeeping and how to figure overhead; it will teach you how to systematize your work, how to finance yourself, how to keep cash and charge sales records, etc. Find out about this special course now—before the offer closes.

Free Book—Send for It

You can open up the way to newer and better things by a mere scratch of the pen or pencil. You can take advantage of the great opportunities in the rapidly expanding automobile business. Investigate now. It costs you nothing and does not obligate you to buy anything. But find out—investigate—take a new lease on life. Send the coupon for our new big **FREE** book which explains all details. Here is the Coupon. Send it now!

STEWART AUTOMOBILE SCHOOL
225 W. 57th St., Dept. 1771, New York, N. Y.

Please send me your free book that describes your school and the opportunities in the **Automobile Business**. I am under no obligation.

Name.....

Address.....

City.....

State.....

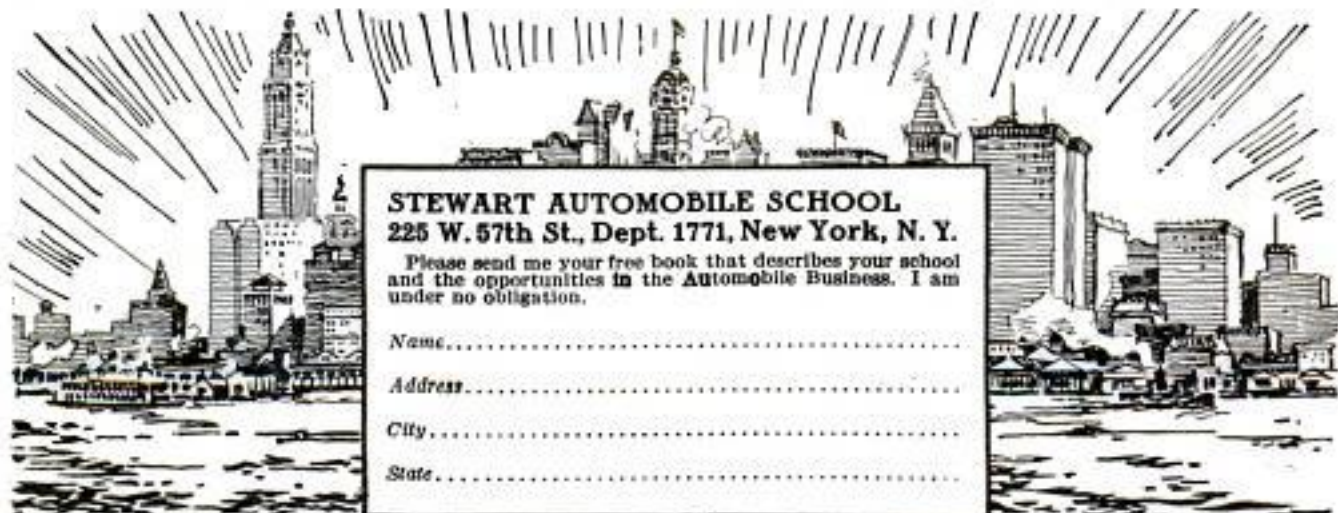



**Says
Goodbye
to \$22 a Week**

—At 27 Earns \$4,500 a Year

"Three years ago," writes A. J. Klick, "I was just an average young man of 24, possessing a fair education, liking a (so-called) good time, occupying a bookkeeper's high stool and receiving \$1,100 a year.

"A crisis in my affairs woke me up and I began the serious study of Higher Accountancy.

"Before the year was over, I was making progress financially. Interested in my work, advancing steadily, more confident of myself, by the time I had finished the course, I had an executive position and \$3,000 a year.

"Last year I became comptroller of a good-sized corporation. My work became a pleasure; salary increased to \$3,800.

"This year I accepted a similar position with a larger corporation, with broader responsibilities and an initial salary of \$4,500. The future years are full of promise."

Unusual Opportunities in Accounting

Klick is *right*. His future years are full of promise!

Never in the history of business has the need for trained accountants been so great or the rewards so attractive. The files of LaSalle Extension University contain literally thousands of letters reporting rapid advancement—incomes doubled, trebled and quadrupled as the result of a comparatively few months of home-study training. Where these men were getting \$1,500 or \$2,000 a short time ago, they are earning from \$3,000 to \$10,000 today, and they are on the up-grade.

Their chance is yours—if you will take it!

Train by the "Problem Method"

Why let the *other* fellow walk away with the better job when the training you need is readily within your reach?

Right in your own home you can master Higher Accounting just as well as they! By the LaSalle Problem Method, you will be trained under the direct supervision of William B. Castenholz, A. M., C. P. A., former Comptroller and Instructor, University of Illinois, assisted by a large staff of Certified Public Accountants, including members of the American Institute of Accountants. You will be guided step by step through every phase of modern accounting practice—Auditing, Cost Accounting, Business Law, Organization, Manage-

ment, Finance and Income Tax Procedure. You will handle practical accounting problems lifted bodily from business life. You will be given special preparation for the C. P. A. examinations.

Send for further information regarding the opportunities in accounting; read the enthusiastic testimony of men still in their twenties and early thirties who have broken away from the low-pay ranks and today are expert accountants—with incomes ranging from \$5,000 to \$10,000 a year. With this information we will send you particulars of our *convenient-payment plan*; also a copy of that inspiring book, "Ten Years' Promotion in One." "Get this book," said a prominent Chicago executive, "even if you have to pay five dollars for it." We will send it *free*.

Mark—Sign—Mail the coupon—NOW.

LaSalle Extension University

The Largest Business Training Institution in the World

Dept. 164-HR

Chicago, Illinois

Please send me catalog and full information regarding the course and service I have marked with an X below. Also a copy of your book, "Ten Years' Promotion in One," all without obligation to me.

Higher Accountancy

Training for positions as Auditor, Comptroller, Certified Public Accountant, Cost Accountant, etc.

Other LaSalle Training Courses

LaSalle is the largest business training institution in the world. It offers training for every important business need. If more interested in any of these courses, check here:

- | | |
|----------------------------------------------------------------------|--------------------------------------------------------------------|
| <input type="checkbox"/> Business Management | <input type="checkbox"/> Banking and Finance |
| <input type="checkbox"/> Modern Salesmanship | <input type="checkbox"/> Modern Foremanship and Production Methods |
| <input type="checkbox"/> Traffic Management | <input type="checkbox"/> Personnel and Employment Management |
| <input type="checkbox"/> Railway Station Management | <input type="checkbox"/> Expert Bookkeeping |
| <input type="checkbox"/> Law — Degree of LL. B. | <input type="checkbox"/> Business English |
| <input type="checkbox"/> Commercial Law | <input type="checkbox"/> Commercial Spanish |
| <input type="checkbox"/> Industrial Management Efficiency | <input type="checkbox"/> Effective Speaking |
| <input type="checkbox"/> Modern Business Correspondence and Practice | <input type="checkbox"/> C. P. A. Coaching |

Name.....

Present Position.....

Address.....

DETROIT

Is the Logical Place to Learn ^{the} Automobile Business

Detroit factories turn out 73% of all the Automobiles in the world. Study Automobiles where Automobiles are made, and who can tell you any more about them than the people who make them? These are the people who have helped outline our courses. These are the men you meet in the Auto Center, the manufacturers, their service managers, and dealers. They are glad to talk to our students, advise them, etc. You visit their factories,—Packard, Cadillac, Hudson, Ford, Studebaker, Lincoln, Paige, Hupp, Maxwell, Chalmers, etc., etc. You study factory methods of assembly, repair and service. This is a big advantage and can only be enjoyed at the M. S. A. S. in Detroit, the Automobile Center.

DETROIT TRAINED MEN EARN MORE MONEY

Another big advantage in learning in Detroit, the Auto Center, is that Detroit trained men get preference every time and get jobs quickly. It means a whole lot when you graduate to go back home and tell people you trained in Detroit, the Auto Center. Customers will go miles out of their way to take their jobs to Detroit trained men. It brings you business, jobs, success. Detroit trained men get the best jobs and the highest pay. Your M. S. A. S. diploma is a valuable money-making asset—these are the advantages you get at the M. S. A. S.

GET INTO THE AUTOMOBILE BUSINESS

There are 14,000,000 automobiles in the U. S. Think of the wonderful opportunities in the manufacture and repair of 14,000,000 cars, 70,000,000 tires, 12,000,000 batteries, 14,000,000 ignition systems. More garages, battery shops, tire shops and electric service stations are needed to take care of these cars. Trained men are needed. Get one of these good jobs or open a shop of your own. Without any previous experience—just a liking for mechanics—you can learn the automobile business in a few short weeks at the M. S. A. S. in the auto center, by factory endorsed methods.



Life Scholarship Your enrollment entitles you to a life membership, with privilege of our service any time you want it. Many students come back to brush up on latest automotive ideas and new equipment. It doesn't cost a penny extra. The position of the M. S. A. S. (The Detroit Auto School) in the heart of this industry, insures most thorough, most practical, systematic training, at a cost so low and terms so easy that any man, anywhere, can afford it.

Earn While You Learn If necessary we can assist students to secure part time work to earn a small amount each week. Or students who wish to take our evening course will be assisted to full time day jobs. Ask for details, and when writing please explain your circumstances fully.

The AUTOMOBILE CENTER

Learn at the Only School Endorsed by ^{the} Manufacturers

The M. S. A. S. has unqualified endorsements from the Automobile Manufacturers. They are the people who know **what** instruction is required and **how** it should be given and they know that the M. S. A. S. trains you properly and endorse it.

Why? Because they helped outline our courses, they cooperate with us, advise with us, work with us, employ our graduates. They are the best judges of an automobile school, they **know**; and when they say you will make no mistake in enrolling in the M. S. A. S. they know what they are talking about. And their advice should be worth a lot to you.

The M. S. A. S. established in 1911, is the premier automobile school of the world. Read what the manufacturers say.

Learn in a Few Weeks—Start Now

You can take a full Automotive Course, or specialize in any one of its money-making branches; you can be an Auto Electrician; a Tire Expert; a Battery Service Man; a Repair-Man; a Welder; a Machinist; or specialize in motorized farming, with truck, tractor and farm electric-lighting and farm engine training. Garage Management, Business Methods and Selling are taught in all courses. Classes are always open. You need make no special arrangements—you can start at once—now—and that's the thing to do.

GET OUR BIG CATALOG

Get all the interesting facts from our big catalog. It's a book of information concerning **your future** that you must not fail to get. It gives complete information about all courses, which make it easy to decide. It's alive with photos of classes, school, equipment and graduates. It tells you how you can get a good paying job—how you can go into business for yourself with little capital. Let us send it to you **FREE** without obligation. Mail the coupon or send us a postcard today. Write now.

The Factory Endorsed School
MICHIGAN STATE AUTOMOBILE SCHOOL
In Detroit the Auto Center

A. G. ZELLER, Pres. and Gen. Mgr.

301 Auto Building, 3729 Woodward Avenue
DETROIT, MICH.

Read What Factories Say:

PACKARD MOTOR CAR CO., DETROIT

"We do not believe you would make any mistake in attending this school if you wish to become thoroughly experienced in the automobile business."



BUICK MOTOR COMPANY

"We believe the MICHIGAN STATE AUTO SCHOOL, Detroit, would best meet your requirements, as its course in technical training is most thorough and complete in every detail."

THE STUDEBAKER CORPORATION

OF AMERICA

"We do not know of a better automobile school than the MICHIGAN STATE."

HUDSON MOTOR CAR COMPANY

DETROIT, MICH. U.S.A.

"This school is thought very highly of by the automobile men of Detroit, and is considered one of the best equipped and most efficient schools in the country. You will make no mistake in attending the M. S. A. S."

DODGE BROTHERS

INCORPORATED

DETROIT, U.S.A.

"We believe the Michigan State Automobile School of this city to be an exceptionally high class school, and no doubt a diploma from this school would assist materially in obtaining employment with big class automobile dealers."

FREE CATALOG
MICHIGAN STATE
AUTO SCHOOL

Mail Coupon To Day

Michigan State Automobile School 301 Auto Building, DETROIT, MICHIGAN

Send me **FREE** and without obligation your 100-page catalog and Auto School News, giving complete information about Detroit-training to make the most money. I am interested in Resident Course at your School.

Home Study Course.

Name

Street or R. F. D.

City State



"Look At Him Today!"

"Six years ago he started in here just as you are doing. Now he's General Manager and makes more in a day than he used to make in a week. The first week he was here he began to train for the job ahead by studying in spare time with the International Correspondence Schools. Inside of six months he got his first promotion. You've got the same chance he had, young man. Follow his example. Take up some I. C. S. course right away. What you are six years from now is entirely up to you."

This is the story of thousands of successful men. They did their work well, and in spare time, with I. C. S. help, trained themselves for advancement. That's the thing for you to do. Whatever your chosen work may be, there is an I. C. S. Course that will prepare you right at home for a better position with bigger pay.

More than 180,000 men are getting ready for promotion right now in the I. C. S. way. Let us tell you what we are doing for them and what we can do for you. The way to find out is easy. Just mark and mail this coupon.

INTERNATIONAL CORRESPONDENCE SCHOOLS Box 5571-D, Scranton, Penna.

Without cost or obligation, please tell me how I can qualify for the position or in the subject before which I have marked an X:

BUSINESS TRAINING COURSES

- | | |
|------------------------------------------------------------------|---------------------------------------------------------------------------|
| <input type="checkbox"/> Business Management | <input type="checkbox"/> Salesmanship |
| <input type="checkbox"/> Industrial Management | <input type="checkbox"/> Advertising |
| <input type="checkbox"/> Personnel Organization | <input type="checkbox"/> Better Letters |
| <input type="checkbox"/> Traffic Management | <input type="checkbox"/> Show Card Lettering |
| <input type="checkbox"/> Business Law | <input type="checkbox"/> Stenography and Typing |
| <input type="checkbox"/> Banking and Banking Law | <input type="checkbox"/> Business English |
| <input type="checkbox"/> Accountancy (including C.P.A.) | <input type="checkbox"/> Civil Service |
| <input type="checkbox"/> Cost Accounting | <input type="checkbox"/> Railway Mail Clerk |
| <input type="checkbox"/> Bookkeeping | <input type="checkbox"/> Common School Subjects |
| <input type="checkbox"/> Private Secretary | <input type="checkbox"/> High School Subjects |
| <input type="checkbox"/> Spanish <input type="checkbox"/> French | <input type="checkbox"/> Illustrating <input type="checkbox"/> Cartooning |

TECHNICAL AND INDUSTRIAL COURSES

- | | |
|-------------------------------------------------|----------------------------------------------------------------------|
| <input type="checkbox"/> Electrical Engineering | <input type="checkbox"/> Architect |
| <input type="checkbox"/> Electric Lighting | <input type="checkbox"/> Blue Print Reading |
| <input type="checkbox"/> Mechanical Engineer | <input type="checkbox"/> Contractor and Builder |
| <input type="checkbox"/> Mechanical Draftsman | <input type="checkbox"/> Architectural Draftsman |
| <input type="checkbox"/> Machine Shop Practice | <input type="checkbox"/> Concrete Builder |
| <input type="checkbox"/> Railroad Positions | <input type="checkbox"/> Structural Engineer |
| <input type="checkbox"/> Gas Engine Operating | <input type="checkbox"/> Chemistry <input type="checkbox"/> Pharmacy |
| <input type="checkbox"/> Civil Engineer | <input type="checkbox"/> Automobile Work |
| <input type="checkbox"/> Surveying and Mapping | <input type="checkbox"/> Airplane Engines |
| <input type="checkbox"/> Metallurgy | <input type="checkbox"/> Navigation |
| <input type="checkbox"/> Steam Engineering | <input type="checkbox"/> Agriculture and Poultry |
| <input type="checkbox"/> Radio | <input type="checkbox"/> Mathematics |

Name.....
Street.....
Address.....
City..... State.....

Occupation.....
Persons residing in Canada should send this coupon to the International Correspondence Schools Canadian, Limited, Montreal, Canada.

Please Mention Popular Mechanics

MY 3 NEW INVENTIONS Will Enable You to Quickly Learn

You have always longed to play the sweetest of all music—the Violin. Now with the aid of my 3 new inventions—mastery of the Violin is easily within your reach! My system of teaching by written and pictured instructions is far advanced over any other method! Endorsed by the foremost violinists of the country! I make it as simple and easy that

You Will Play a Complete Piece Your First Lesson

Just think of it!—you play real music at once! No boring scales—no long, dreary hours of practice. Under my instruction you will actually play a complete piece your very first lesson—and a new piece each succeeding lesson.

FREE VIOLIN OUTFIT

Most Complete Violin Outfit Ever Offered—furnished free to my students with the complete Conservatory course of 62 lessons. No extras to buy—everything is furnished. Outfit includes splendid toned Imported Violin, Bow, Extra Strings, Tuning Fork, Mute, Rest, handbow, nickel-trimmed Carrying Case, etc. etc. as shown, and my 3 Remarkable Inventions.

Write Me Today

—and I will gladly tell you all about my 3 New Inventions and how I guarantee to teach you Violin quickly and thoroughly. Here is the opportunity you have waited for so long!

Prof. A. Hinchcliffe, First Hawaiian Conservatory of Music, Inc., Dept. 70

FREE
This \$20.00 Outfit



We Import Our Violins Direct From Europe

Woolworth Bldg., 233 Broadway, New York

Learn to PAINT SIGNS and SHOW CARDS

Big field—unlimited possibilities—increasing demand for men with creative ideas. Our course develops ability and originality. Work intensely interesting.

EARN \$25 TO \$75 WEEKLY

You can do it if ambitious. Successful graduates everywhere. Our course thoroughly covers every phase of work. Our graduates command big salaries. Write for catalog, samples, guarantee and Free Outfit Offer.

Detroit School of Lettering, 621 D. S. L. Bldg., Detroit, Mich.



Learn Watchwork, Jewelrywork and Engraving.

A fine trade commanding a good salary, and your services are always in demand. Address **MOROLOGICAL**, Dept. P, Bradley Institute, PEORIA, ILL., for our latest catalog.

100 PARODIES ON Latest Songs 25c

Callagher & Shaan, All for Love of Mike, 3 O'clock in the Morning, Peggy O'Neil, Carolina in the Morning, Smiles, Indiana, Michigan, and many others. Comic Dialects.

Complete, 25c; 3 for 50c p. p.

J. C. DORN 723 South Dearborn Street Dept. 3, CHICAGO



WANTED
Railway Postal Clerks
\$1600-\$2300 Yr.
MEN - BOYS 18 UP
Mail Coupon Immediately

Franklin Institute, Dept. E197, Rochester, N. Y.
Send me without charge (1) Specimen Railway Postal Clerk Examination questions; (2) List of Government jobs obtainable; (3) Send examination positions and tell me how I can get a government position.
Name.....
Address.....

Give Me 20 Weeks

To Prove That I Can Fit
You for \$3,500 to \$10,000
ELECTRICAL JOBS—
This New Way!



Chief Engineer Smith of the famous S & H Electrical Works, Chicago, is the man at the left. He is the inventor of the wonderful new way of training in actual shop type electricity, so that you can become an electrical expert in a very

short time. By this remarkable new system Mr. Smith has trained such capable men that he has been able to place them easily with some of the biggest concerns in the country. His personal instruction is now within your reach.

READ THESE

"You will remember that before Mr. Unholt and I took your course of training we were doing common labor. To jump from this to a prosperous business of your own is some jump, but thanks to your wonderful training we've done it."
D. FARINA, U. & F. Electrical Co.

"Although I have only finished 20 lessons of your training I have received a promotion and am getting a third more salary. I am grateful to you."
ANTHONY DeGANNAER

"I am enclosing a drawing and complete explanation of my electric safety razor. It is just such training as is given by S&H that enables a student to turn his ideas into big money. I already have orders for 8,000 of these razors."
CHARLES J. NOVAK

Amazing New Shop Type Training In Your Own Home—FREE **ELECTRICAL BOOK**

I can train you in amazingly short time to be an electrical expert commanding \$3,500 to \$10,000 a year and up. I say this to you without a single reservation, because I have trained hundreds of men who now hold big money positions in the electrical world. S & H men are in constant demand in the big electrical shops everywhere. Many had never gone beyond the eighth grade in school—and yet they have stepped into big pay and independence.

When I discovered this new simple easy way to carry practical shop type electrical training to you in your home, I knew I had at last solved the one big difficulty of teaching men electricity outside of college. And electrical men everywhere quickly recognized this. They have hailed my method as the one, sure way of training for the thousands of big money jobs that await the electrical expert in this fast growing field. Since making my discovery I have turned out hundreds of men who are succeeding. In all branches of big money electrical work they are proving that the S & H shop type training is the greatest system ever devised as a quick, easy way to the best jobs in electricity. You can get S & H actual shop type practice nowhere else. It is fully protected by U. S. copyright.

All Branches of Electricity

No matter what branch of electricity you want to learn my training gives it to you. In a few months I make you a thorough, competent electrical technician, with the title E. T. I train you so that when you are graduated there is no phase

of electrical work you are not familiar with—and know a lot more about than the other fellow. My training covers every type of work in electricity.

Men Are Needed

Do you know that more than half the business of the United States is electrical in nature! This great field pays big money and is alive with countless opportunities. Every day we have the opportunity to place men in the better jobs. When you enter the profession you can't afford to be without the prestige and backing of the S & H Electrical Works.

Free Outfit

If you will mail coupon at once you will be entitled to my remarkable offer of a complete outfit of electrical apparatus, instruments and appliances for experimental and practical home shop work. Just as the famous EMPLOYMENT SERVICE AND UNLIMITED ADVISORY SERVICE of the S & H Electrical Works is without cost so is this COMPLETE OUTFIT, ABSOLUTELY FREE to my students,—but for a short time only. And even that isn't all. I have yet another remarkable offer, but haven't space to tell it here. You must act AT ONCE. Send coupon right now.

S. V. Smith,
S & H ELECTRICAL WORKS,
Dept. 1-A,
1422 W. Monroe St.,
Chicago, Ill.

Mail For Free Offer
Chief Engineer Smith, S & H ELECTRICAL WORKS,
Department 1-A, 1422 W. Monroe Street, Chicago, Illinois
I want your training and full particulars of your training in practical electricity and details of your remarkable free offer in this state mail me in any way.

Name.....
Address.....
City.....
State.....



Radio Officer N. C. Kumler, graduate of the Radio Institute of America, awarded a gold medal by the city of Los Angeles, and \$500 by the Radio Corporation of America for heroic services at the sinking of the S.S. Honolulu.



Wanted— Trained RADIO Men

Over 6,000 operators have already graduated from our school. And many more trained men are needed. Study at home in your spare time.

You may know nothing of radio today. But in a few months study, you can earn your U. S. Government operator's license.

The Radio Corporation of America, which places more operators than any other organization in the world, prefers our graduates, for their thorough training. Many among them have become the biggest men in radio today.

Advanced Radio Course

Great popular demand by the advanced student, experienced amateur, and wireless operator has led to the opening of an **ADVANCED HOME STUDY RADIO COURSE**, specializing in C. W., I. C. W., telephone and radio measurements. Investigate!

Radio Institute of America

(Formerly Marconi Institute)
Established 1909

326-A Broadway, New York City

Indicate by a cross X the course you are interested in:

Radio Institute of America,
326-A Broadway, New York.

Please send me full information about radio opportunities today, and your

COMPLETE RADIO COURSE
ADVANCED RADIO COURSE

Name.....

Address.....

Please Mention Popular Mechanics

LAW BOOK FREE

Send for it today

Whether you are a corporation president or a clerk, capitalist or wage earner—whatever your ambition is—this book will be of vital interest to you—be of direct positive value. It tells you frankly about the amazing secrets of successful lawyers and law trained men in business. It proves conclusively how a law education will quickly fit you for a better position and bigger pay. It shows true stories of successful men who before taking this course slaved for practically nothing. Three year course covers preparation for bar examination. Degree of LL.B. conferred. Here

\$5,000 to \$12,000 a Year

as a lawyer or law trained man in business. Read at home—aided by reading course. Moneyback guarantee if not satisfied upon completion. Low fee, easy monthly terms include complete up-to-date 12 volume library by the highest authorities. Send for free book now. No obligation to you whatever.
HAMILTON COLLEGE OF LAW
431 S. Dearborn St., Dept. 91
Chicago, Ill.



Deafness



Perfect hearing is now being restored in every condition of deafness or defective hearing from causes such as

Relaxed or Sunken Drums, Roaring or Hissing Sounds, Perforated, Partially Destroyed Drums, etc.

Wilson Common Sense Ear Drums

"Little Wireless Phones for the Ears"—require no medicine but effectively replace what is lacking or defective in the natural drums. They are simple devices, which the wearer easily fits into the ears where they are invisible. Soft, safe and comfortable to wear at all times.

Write today for our 168 page FREE book on DEAFNESS, giving you full particulars and plenty of testimonials.

WILSON EAR DRUM CO., Incorporated
431 Inter-Southern Building LOUISVILLE, KY.

STOP USING A TRUSS

Do Away With Steel And Rubber Bands

FREE TRIAL



Inner surface is made adhesive to secure the FLAPAO-PAD firmly to the body, keeping the PLAPAO continually applied and the pad from slipping. No straps, buckles or springs attached. Soft as velvet—easy to apply.

It's the Non-Slip- ping, yet Non-Rigid Pad and What is Within It That Counts

FREE to 5,000 Truss Sufferers

To the extent of 5,000 sufferers who may apply I will send, ABSOLUTELY FREE, a sufficient quantity of the Plapao to positively convince them that this is the only logical, common-sense way of treating rupture. Plapao is a highly astringent medication placed within the Plapao-Pad and being absorbed through the skin, creates a wonderful feeling of relief and at the same time tends to strengthen the weakened muscles and thus permanently close the rupture opening. The process of recovery is natural, so you'll have no use for a truss—you can throw it away forever! Old and young have testified under oath that the Plapao-Pads cured their rupture—many of them long-standing, aggravated cases—without delay from work. Patent allowed in U. S. and foreign countries. Awarded Gold Medal at Rome and Grand Prix at Paris.

Send No Money—for a sufficient quantity of the Plapao is sent without charge to enable you to give it a thorough test; you pay nothing for this trial now or ever. Write for it and full information today. Address: Plapao Laboratories, Block 1427 St. Louis, Mo.

Only 50 days Between You and Big Money in AUTOMOTIVE ELECTRICITY



Four Times His Former Salary

"I was making \$40 a week as Head Bookkeeper when I took up your training. Last week I made \$175, and hardly a week passes by which I don't make at least \$100. No labor either. I locate the trouble and the mechanics do the work."

"HENRY L. LUDLOW, Indiana."

**Come to Chicago
or Train at Home
for this New Field
that Covers 78% of
AUTOMOBILE
TROUBLES**



Makes \$1000 a Month

"I trained with you 7 weeks. Then I started right to work with a big garage. Averaged about \$150 a week. After 5 weeks I opened my own shop. Find it easy to get any price I choose to charge. Clearing over \$1000 a month."

"W. C. ELLERD, Neb."

YOU'D probably be willing to take a four year college course if you could earn \$132.00 a week when through. But you don't have to. **FOR YOU CAN BE READY IN FIFTY DAYS** to earn that much and more, just like any number of my former students are doing. Get my book that gives the facts and figures.

Ambu has even improved on the original plan by **not admitting more than 20 men to a class. No other school does this** and the smaller the class the more you learn.

When my graduates are grabbed up at big salaries; when men like Ludlow jump from a \$40 a week bookkeeping job into an income of \$175 a week as Automotive Electrical Expert; when fellows who want to be their own boss, like Ellerd, clean up \$1000 a month; everybody simply **HAS** to agree that Ambu Training can't be beat. Get my book and see the proof.

Big Jobs Open

This fascinating new profession is clamoring for men. Garage and Repair Shop Owners can get all the ordinary mechanics they need. Mechanics can learn in a shop, but Auto-Electrical Experts are study-trained. That's why shops can't get the man who knows automobile electricity. And yet they have to have him. Auto-owners will no longer pay for 10 hours' service while an ordinary mechanic fiddles around trying to find what is wrong. When you consider that 78% of all automobile troubles are electrical troubles you'll realize why the car owners are combing the market for experts. My **free** book will give you some surprising facts.

Get Out of the Grease

I know what a demand there is for my graduates. I know what remarkable earnings they are making. I know how employers are glad to get their services. I have hundreds of letters that show how Ambu graduates "make good." I'll send you copies of them; tell you to write these former pupils; let them tell you what a fascinating, easy profession it is. In my free book I show you how you can get paid big for **headwork**, not handwork; how you keep out of the grease, lifting, labor, etc., which the ordinary mechanic has to do.

QUALIFY For One of These Big Pay Jobs

\$132 a week is not out of reach for Automotive Electricians. Fascinating work. No heavy lifting. No grease. Work is 90% headwork or directing and 10% handwork. Automotive Electricity is a Profession, not a Trade. It offers every man the road to quick success.

Get FREE Book

Everything is explained in a remarkable eye-opening book that will be a revelation to you. It shows how my graduates are equally expert whether they come to classes here in Chicago or **LEARN IN SPARE TIME AT HOME.**

Get it at once. It is free. If you act quick you'll also be able to take advantage of a most unusual short-time offer I am making. Mail coupon today.

C. J. BUCKWALTER, Pres.

AMBU ENGINEERING INSTITUTE
Dept. 11, 2132 Prairie Ave.
CHICAGO



C. J. Buckwalter, Pres.
AMBU ENGINEERING INSTITUTE
Dept. 11, 2632 Prairie Ave., Chicago

Please send me **FREE** book and complete information about the "big pay" opportunity in the field of Automotive Electricity. Explain also your remarkable short time offer. I am interested in

Home Study Course Resident Course at Chicago

Name..... Address..... City..... State.....

No Experience

Best of all, you can get in this big pay profession in 50 days—without knowing about electricity or automobiles beforehand. If you can read and write, you can succeed. We teach you everything in a practical, brass tacks way, which my book explains fully.

Amazing New Way to Train

When the government needed Auto-Electrical Experts for the war there was no time to waste. Men had to be trained 100% right and sent out almost overnight. The man who invented the 50-day method was the man to whom Uncle Sam went for help. Results were amazing. Never before had such a thing been accomplished by anyone. A complete, practical, thorough training in 50 days. So remarkable that after the war, and at a great cost, it was made available to Ambu students only.

This Test Shows whether or not you need Sherwin Cody's New Invention

THOUSANDS of people make little mistakes in their everyday English and don't know it. As the result of countless tests, Sherwin Cody found that the average person is only 61% efficient in the vital points of English. In a five-minute conversation, or in an average one-page letter, five to fifty errors will appear. Make the test shown below, now. See where you stand on these 30 simple questions.



SHERWIN CODY

MAKE THIS TEST NOW

1. Would you write—?

I did it already	or	I have done it already
Who shall I call?	or	Whom shall I call?
It's just as I said	or	It's just like I said
The river has overflowed	or	The river has overflown
its banks	or	its banks
I would like to go	or	I should like to go
I laid down to rest	or	I lay down to rest
Divide it among the three	or	Divide it between the three
The wind blows cold	or	The wind blows coldly
You will find only one	or	You will only find one
Between you and I	or	Between you and me

2. How do you say—?

evening	or	eve-ning
ascertain	or	as-cer-tain
hospitable	or	hos-pi-ta-ble
abdomen	or	ab-do-men
mayoralty	or	may-or-al-ty
amenable	or	a-me-na-ble
acclimate	or	ac-cli-mate
profound	or	pro-found
beneficiary	or	ben-e-fi-sh-ary
culinary	or	cu-li-nary

3. Do you spell it—?

calendar	or	calender	or	repetition	or	replition
receive	or	recieve	or	separate	or	seperate
reprieve	or	reprevie	or	acomodate	or	accommodate
donkeys	or	donkies	or	trafficking	or	trafficking
factories	or	factories	or	acesible	or	accessible

New Invention Improves Your English in 15 Minutes a Day

For the past twenty years, Mr. Cody has studied the problem of creating instinctive habits of using good English. After many experiments he discovered a remarkable new way of learning correct language, at home, which he calls the 100% Self-Correcting Method. The name itself describes Mr. Cody's invention. This wonderful self-correcting device is simple, fascinating, time-saving, and incomparably efficient. You can write the answers to 50 questions in only 15 minutes, and correct your work in 5 minutes more. You waste no time in going over the things you already know. Your efforts are concentrated on the mistakes you yourself are in the habit of making, and through constantly being shown the right way, you soon replace incorrect habits with correct habits. There is no tedious copying. There is no heart-breaking drudgery or memorizing rules.

FREE Book on English

Every time you talk, every time you write, you show what you are. Your English reveals you as nothing else can. When you use the wrong word, when you mispronounce a word, when you misspell a word, when you punctuate incorrectly, when you use flat, ordinary words, you handicap yourself. Write for our new book "How to Speak and Write Masterly English." Merely mail the coupon and it will be sent by return mail.

Sherwin Cody School of English, 51 Searle Building, Rochester, N.Y.

Sherwin Cody School of English, 51 Searle Building, Rochester, N.Y.

Please send me at once your Free Book "How to Speak and Write Masterly English."

Name.....

Address.....

City.....State.....

ANSWERS

1. I have done it already
Whom shall I call?
It's just as I said
The river has overflowed its banks
I should like to go
I lay down to rest
Divide it among the three
The wind blows cold
You will find only one
Between you and me

2. eve-ning
as-cer-tain
hos-pi-ta-ble
ab-do-men
may-or-al-ty
a-me-na-ble
ac-cli-mate
pro-found
ben-e-fi-sh-ary
cu-li-nary

3. calendar repetition
receive separate
reprieve accommodate
donkeys trafficking
factories accessible

Make Money Taking PICTURES



Got \$100 for Flood Pictures
"I took pictures of a flood and sold them for \$100. I have been able to buy my house and lot from the sale of pictures."
C. M. COLE,
Washington.

\$97 in Two Days!
"I made \$295 in December. Went out two days, last week on home portrait work and made \$97."
A. G. HUNTER,
Kentucky.

Tremendous, big-paying opportunities are open for ambitious men in Modern Photography. This is the picture age. Magazine and newspaper publishers buy thousands of photographs each year. Every manufacturer sends out high priced pictures of his products. Every home wants portraits. Photography is a business running into millions of dollars each year. And there is a great shortage of trained photographers.

EARN \$3,000 to \$10,000 a YEAR

Hundreds of men are earning big money and establishing their own businesses. Even during spare time, while training, you can make \$75 a week easily—no matter where you live!

Amazing New Easy Method

I show you, at home, how to do the kind of work turned out by the big studios in New York and Chicago! I show you how to make big money within 30 days! C. M. Cole bought a home with money he had made when only half way through his training. So well do I know what I can do for you that I guarantee under bond to return every cent of your tuition if you are not thoroughly satisfied.



Professional View Camera FREE!

Write at once for Free Camera Offer—I give you, free, a splendid professional view camera. You will be astonished and delighted. This offer open for short time only—so act quick! No obligation.

INTERNATIONAL STUDIOS, Inc.
Dept. 1191, 3601 Michigan Ave., Chicago, U. S. A.

MUSIC LESSONS FREE



IN YOUR OWN HOME
You can read music like this quickly
Piano, Organ, Violin, Mandolin, Guitar, Banjo, etc.
Beginners or advanced players. One lesson weekly. Illustrations make everything plain. Only expense about 2c per day to cover cost of postage and music used. Write for FREE booklet which explains everything in full.

AMERICAN SCHOOL OF MUSIC, 50 Lakeside Building, CHICAGO

Factory to Rider

Saves \$10 to \$25 on the Ranger Bicycle you select. You can have your choice of 44 Styles, colors and sizes. Delivered free on approval, express prepaid, for 30 DAYS' FREE TRIAL.

12 Months to Pay If desired. Possession and use at once on our liberal year to pay plan. Parents often advance first payment.

Tires best quality, at factory prices, express prepaid. Large, wheels and equipment, low prices. Send No Money, do business direct with makers.

Mead Cycle Company
Dept. F18 Chicago

Write today for free Ranger Catalog, factory prices and marvelous easy payment terms



PIMPLY SKIN made WELL

When a few applications of this wonderful working lotion has cleared faces of pimples, blackheads, acne eruptions on the face or body, barbers itch, eczema, enlarged pores, oily or shiny skin, you can realize why CLEAR-TONE has been tested and approved in over 100,000 Test Cases. The simplicity of the treatment, and The Story of How I Cured Myself are all explained in my free booklet, "A Clear-Tone Skin." Write for your copy today and learn of the results gotten by thousands of men and women.



E. S. GIVENS, 128 Chemical Bldg., Kansas City, Mo.

Why not be *Perfectly* Happy?

You can make Life a complete satisfaction to you and get all the possible good out of it.

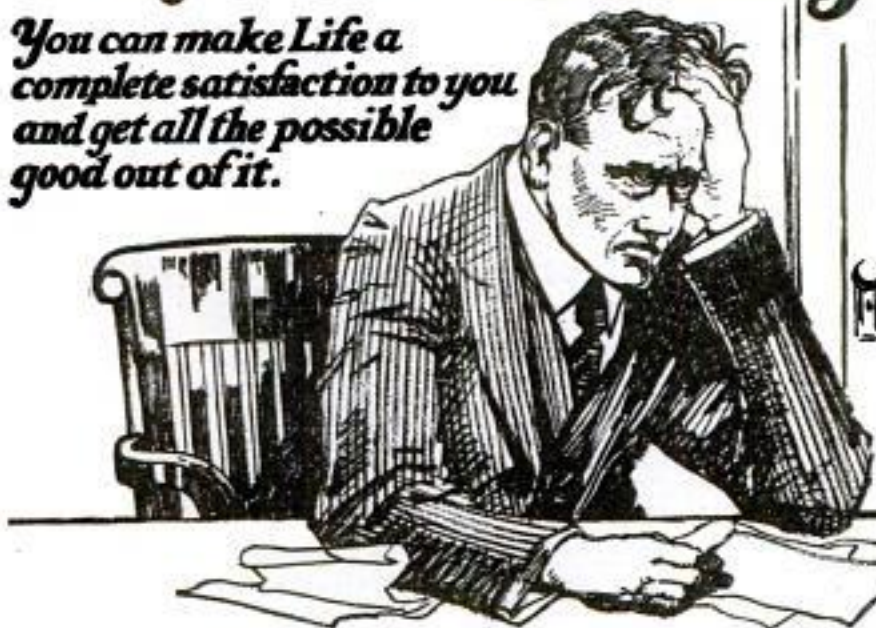

FRANKLY, now, have you ever felt so full of zest, so eager for whatever might happen that you fairly eat up work and trouble and enjoy it—that you are always seeking for harder problems to solve, for greater difficulties to conquer, always yearning to pit your strength against the barriers that lie between you and success? If you have the strong and healthy body that you ought to have, you will also have this fighting, winning spirit. **Nothing can stop you!** Nothing should bar you from the attainment of your life's ambition, provided you have the **Physique** to back up your desires.

Health and Strength Mean Success!

They also mean Happiness, Power, Fame! Why be half a man or a tenth of a man, when you can be a Superman? It's comparatively easy to be a Superman nowadays, because the great majority of human beings are below standard. The man with a strong, well-balanced body towers above them like a mountain. People look up to him. He has Opportunities that do not come to others. If you are a "below-standard" man physically,

you will probably have to take a lower place in business and in all the other departments of life. Your life may even be shortened—perhaps much more than you think possible. Why not get out of the ruck now, and be a MAN? No matter whether your weak body is the result of carelessness in living habits or because you have never developed it, I can remodel it. I make a business of trading

New Bodies for Old

Always working in accordance with Nature's laws, I have restored happiness and insured prosperity and success to many thousands of men and women. I have built some of the World's greatest athletes, and I have put athletic bodies on business men, clerks, ministers, lawyers, doctors, women, and, in fact, persons in every walk of life.

When such men as Rolandow, Arthur Saxon and the Great Barnes—three of the strongest men in history—to say nothing of thousands of others, use my System and declare that it is the greatest for Health and

Body-Building that they have ever seen, there must be something in my claims. I want a chance to prove these claims to you. Let me prove to you that I CAN ADD AN INCH TO YOUR ARM MEASUREMENT IN 30 DAYS!

I have had wide experience as a Physical Culturist. I built my own body with the methods which I will pass on to you. I have never had a dissatisfied client. I have no fear that I cannot do the same for you that I have done for thousands of others. Will you give me a chance to try?



PROFESSOR HENRY W. TITUS
as he is to-day

Pronounced by the Medical Faculty as the strongest and most symmetrically developed athlete of his weight in America.

Get My 57-Page Free Book "BUILDING BETTER BODIES"

It is the clearest and most interesting treatise on the improvement of health and the development of strength ever written. There are numerous fine pictures of famous athletes and strong men who have been MADE by my System. Instead of charging a considerable price for this book, as I would be justified in doing, I will give it to you absolutely FREE. All I ask is that you send me 10 cents to help pay postage, wrapping, etc., and it will come to you by return mail. There will be no obligation on your part. Don't delay a moment. Fill out the coupon and send it to me today.

PROF. HENRY W. TITUS
107 East 13th Street NEW YORK CITY

PROF. HENRY W. TITUS
Dept. 728, 107 East 13th Street, New York City

Dear Sir: I enclose 10 cents, for which please send me at once your book, "Building Better Bodies." It is understood that there is no obligation on my part whatsoever.

Name

Street No.

City State



How This Man Won Success As an Electrical Expert

General Manager of his company at 28 years of age! His own boss—owns his home—married and happy and prosperous—that's the remarkable success achieved by Wallace H. Rohrschneider, now General Manager, Secretary and Treasurer of the Hustisford Light, Power and Manufacturing Company of Hustisford, Wisconsin. Mr. Rohrschneider got his start toward his quick and brilliant success at School of Engineering of Milwaukee. There he received the practical, intensive and specialized training that enabled him to make good in a big way.

Why Don't You Get Into This Big Pay Field?

The same kind of training that put Mr. Rohrschneider into the ranks of the highly-paid Electrical Specialists will qualify you for brilliant success in this fascinating field of unlimited opportunities. **Come to America's Great Institution of Electrical Education.** Learn by actual practice in our big laboratories with their magnificent equipment, including motors, dynamos, switchboards, ignition and lighting systems, etc. **Recognized experts** give you personal instruction every step of the way.

Earn Your Way Through This Great College

You can earn money to help defray your expenses while learning. Our wonderful co-operative plan brings an Electrical Career within the reach of every ambitious man. Our Free Employment Department secures positions for those students who wish to earn part or all of their expenses. In addition, **the Department will help you get a good position in the Electrical Industry when your training is completed.**

BIG BOOK FREE—Mail the coupon today for our big new illustrated catalog. Check the course that interests you most and we will send you special information. Read about the School that trains men for **practical and quick success.** See how easy it is for you to get the training that will enable you to step to a splendid position and a handsome income. Mail the coupon right NOW. No cost or obligation.

SCHOOL of ENGINEERING of Milwaukee

Dept. PM-1, 415 Marshall Street, Milwaukee, Wis.
MAIL COUPON NOW

SCHOOL OF ENGINEERING OF MILWAUKEE

Dept. PM-1, 415 Marshall St., Milwaukee, Wis.

Please send me without any cost or obligation, full particulars of the electrical course I have checked and your big Free Book telling about your institution and how it will fit me for a big position in the electrical field. Also tell me about your Earn-While-You-Learn plan.

(Check courses interested in, and be sure to give your education.)

—**School of Practical Electricity**—6 months or 1 year course. Complete general course, covering entire electrical field.

—**Institute of Electrotechnics**—12 to 30 months' course. Practical electrical training combined with thorough Academic education.

—**Electrical Home-Service Training** with laboratory facilities, for those who cannot come to Milwaukee.

—**College of Electrical Engineering**—3 years' course. Regular collegiate work granting B. S. Degree. 14 High School units or diploma from our Institute of Electrotechnics required for entrance.

—**Commercial Electrical Engineering**—1 year course. Thousands of Trained Men wanted in this new profession. 14 High School units or diploma from our Institute of Electrotechnics required for entrance.

—**School of Automotive Electricity**—3 to 6 months. Covers all systems of starting, lighting, ignition, and storage batteries for automobiles, tractors, aircraft, etc. Intensive practical course.

—**Armature Winding and Motor Generator Repair Course**—3 to 6 months' course. Brief, but intensely practical, leading to well-paying positions.

Name.....
Street.....
City.....State.....
Age.....Education.....



How to Box 40c

By Terry McGovern, James J. Corbett, J. Gardner Smith, M.D., Arthur P. Keeley and Gus. E. Keeley.

How to Box to Win, How to Build Muscle, How to Punch the Bag and How to Stand, Walk or Run.

This interesting book written by experts is known also as "The Book of Health and Strength." It will greatly assist everyone in keeping fit, in putting them in condition to master a strenuous undertaking either physical or mental.

62 illustrations. Size 4 1/2 x 7 1/2 in. Paper cover. 133 pages
SHREWSBURY PUBLISHING CO.
5311 West Lake Street, CHICAGO, ILL.



We have a wonderful new copyrighted system of teaching Note music by mail! To first pupils in each locality we will give free a \$20 superb Violin, Tenor Banjo, Ukulele, Hawaiian-Guitar, Banjo, Mandolin, Banjo-Ukulele, Banjo-Mandolin, Cornet or Banjo-Guitar absolutely free. Also teach Piano and Organ. Very small charge for lessons only. Four lessons will teach you several pieces. Over 100,000 successful players. We guarantee success or no charge. Complete outfit free. Write today, Dept. 167. No obligation.
SLINGERLAND SCHOOL OF MUSIC, 1815 Orchard Street, CHICAGO, ILLINOIS

LAW High-Grade Instruction

By Correspondence
Prepares You for the Bar—Est. 1892
University Methods.
Standard Text-Books. Approved by Bench and Bar. Graduates practicing in every state. Send today for Free Catalog and Rules for Admission to the Bar.
Chicago School of Law
520 Reaper Block Chicago, Ill.



BE A CARTOONIST

\$1 New book of thorough instruction in professional cartooning, containing 12 easy lessons—over 150 sketches. All the knocks and tricks. Teach yourself. Send ONE DOLLAR NOW. Book sent complete. Postpaid.
CHICAGO ART SHOP, Dept. 2, 1146 Independence Blvd., CHICAGO, ILLINOIS

FREE BOOK LEARN PIANO

This interesting Free Book shows how you can become a skilled player of piano or organ at quarter usual cost. It shows why one lesson with an expert is worth a dozen other lessons. Dr. Quinn's famous Written Method includes all of the many important modern improvements in teaching music. Brings right to your home the great advantages of conservatory study. For the beginner or experienced player. Endorsed by great artists. Successful students everywhere. Scientific yet easy to understand. Fully illustrated. All music free. Diploma granted. Write today for free book.
Quinn Conservatory, Studio PM81, 598 Columbia Road, Boston 25, Mass.

LEARN AUTOS AND TRACTORS

Wonderful opportunities constantly offered trained men—we train you thoroughly to start your own business, or to make good money as motor expert, driver, shop foreman, etc., and furnish you with a \$12.00 tool kit free of charge. This is the pioneer autoschool. Over 7000 graduates making good.
Catalog free.
CLEVELAND AUTOMOBILE SCHOOL, 1814 East 24th Street, Cleveland, Ohio

DON'T WEAR A TRUSS

BE COMFORTABLE—Wear the Brooks Appliance, the modern scientific invention which gives rupture sufferers immediate relief. It has no obnoxious springs or pads. Automatic Air Cushions bind and draw together the broken parts. No salves or plasters. Durable. Cheap. Sent on trial to prove its worth. Beware of imitations. Look for trade-mark bearing portrait and signature of C. E. Brooks which appears on every Appliance. None other genuine. Full information and booklet sent free in plain, sealed envelope.
BROOKS APPLIANCE CO., 215 State St., Marshall, Mich.





get in on the BIG MONEY

**THE KEY TO
BIG
MONEY**

Salaries of Motion Picture Trades

Salaries paid in the various motion picture trades are high, because the work requires specially trained men. Because the industry is new and is expanding so rapidly, the supply of trained men is limited. The list below gives a fair idea of what experts are paid:

Camera Man	\$75.00 to \$300.00 per wk.
Laboratory Supt.	\$103.00 per week and up.
Studio Electrician	\$50.00 to \$150.00 per wk.
Projector Operator	\$45.00 to \$100.00 per wk.



Years of experience both in practical work and as a teacher have fitted Mr. McCrystle remarkably well as head of this great school and instructional staff.

You know that the big money is paid for jobs that there are only a limited number fitted to fill. The country today is calling for experts in every line. One of the largest industries in the world—the Motion Picture Industry—needs experts more than any other at the present time. There is a shortage of thoroughly trained and competent men.

Learn a Motion Picture Trade

Right here is your opportunity. Fit yourself to occupy one of these positions. Never has an industry continued to grow so rapidly as this one. Consequently the demand for skilled and expert cameramen, projector operators, studio electricians, laboratory superintendents and others, has increased beyond the available supply. Many who are now drawing big pay have never had the training this school affords. With it they would be far ahead of their present standing. Think what this means to you.

How to Become a "Certified Cinematographer"

The industry today wants trained cameramen. They want men who have a sound knowledge from the ground up—who know what the results will be when they turn the crank. This is the only school that will teach every fundamental necessary to a thorough technical knowledge of the business. Secure this training now and qualify as a "Certified Cinematographer." Many openings for the trained man. Our employment department will place you when qualified.

McCRYSTLE MOTION PICTURE TRADE SCHOOL

1107 No. Western Avenue

Box 40

HOLLYWOOD, CALIF.

McCrystle Motion Picture Trade School Box 40, 1107 No. Western Ave., Hollywood, Calif.

Please rush all information regarding your courses in the Motion Picture Trades. This does not obligate me in any manner.

Name.....

Address.....

TODAY

Why haven't
you
clipped this
coupon

TEAR OUT HERE

INTERNATIONAL CORRESPONDENCE SCHOOLS
Box 5570-D, Scranton, Penna.

Without cost or obligation, please tell me how I can qualify for the position or in the subject before which I have marked an X:

BUSINESS TRAINING COURSES

- | | |
|------------------------------------------------------------------|---------------------------------------------------------------------------|
| <input type="checkbox"/> Business Management | <input type="checkbox"/> Salesmanship |
| <input type="checkbox"/> Industrial Management | <input type="checkbox"/> Advertising |
| <input type="checkbox"/> Personnel Organization | <input type="checkbox"/> Better Letters |
| <input type="checkbox"/> Traffic Management | <input type="checkbox"/> Show Card Lettering |
| <input type="checkbox"/> Business Law | <input type="checkbox"/> Stenography and Typing |
| <input type="checkbox"/> Banking and Banking Law | <input type="checkbox"/> Business English |
| <input type="checkbox"/> Accountancy (including C.P.A.) | <input type="checkbox"/> Civil Service |
| <input type="checkbox"/> Cost Accounting | <input type="checkbox"/> Railway Mail Clerk |
| <input type="checkbox"/> Bookkeeping | <input type="checkbox"/> Common School Subjects |
| <input type="checkbox"/> Private Secretary | <input type="checkbox"/> High School Subjects |
| <input type="checkbox"/> Spanish <input type="checkbox"/> French | <input type="checkbox"/> Illustrating <input type="checkbox"/> Cartooning |

TECHNICAL AND INDUSTRIAL COURSES

- | | |
|-------------------------------------------------|----------------------------------------------------------------------|
| <input type="checkbox"/> Electrical Engineering | <input type="checkbox"/> Architect |
| <input type="checkbox"/> Electric Lighting | <input type="checkbox"/> Blue Print Reading |
| <input type="checkbox"/> Mechanical Engineer | <input type="checkbox"/> Contractor and Builder |
| <input type="checkbox"/> Mechanical Draftsman | <input type="checkbox"/> Architectural Draftsman |
| <input type="checkbox"/> Machine Shop Practice | <input type="checkbox"/> Concrete Builder |
| <input type="checkbox"/> Railroad Positions | <input type="checkbox"/> Structural Engineer |
| <input type="checkbox"/> Gas Engine Operating | <input type="checkbox"/> Chemistry <input type="checkbox"/> Pharmacy |
| <input type="checkbox"/> Civil Engineer | <input type="checkbox"/> Automobile Work |
| <input type="checkbox"/> Surveying and Mapping | <input type="checkbox"/> Airplane Engines |
| <input type="checkbox"/> Metallurgy | <input type="checkbox"/> Navigation |
| <input type="checkbox"/> Steam Engineering | <input type="checkbox"/> Agriculture and Poultry |
| <input type="checkbox"/> Radio | <input type="checkbox"/> Mathematics |

Name.....
Street.....
Address.....

8-3-23

City..... State.....

Occupation.....

Persons residing in Canada should send this coupon to the International Correspondence Schools Canadian, Limited, Montreal, Canada.

Please Mention Popular Mechanics



THIRTY-FIVE EASY LESSONS IN RADIO 50c

A systematic course of elementary principles written in a simple and concise lesson course, easily understood. Thousands have taken up Radio for entertainment and are operating their own amateur sets.

This book embodies all the principles and application of everyday radio for the home and in business. Paper cover.

Price postpaid 50c

SHREWSBURY PUBLISHING COMPANY
5311 West Lake Street CHICAGO, ILL.

Anyone CAN LEARN

No talent or experience necessary. Fascinating work. Pays big money. Complete instruction book tells about: Alphabets, Colors, How to Mix Paints, Show Cards, Window Board and Wall Signs, Handy made letters, Gilding, Tricks of the Trade, also gives 100 Alphabets and Designs. Book bound in flexible art. leather, gold-edged, and four half bearing Show Card Fans. Sent postpaid \$3.00. (C. O. D. Incon.)
Sylvia Pub. Co., 57 Ruse St., Dept. 50, N. Y. City

EARN MONEY IMMEDIATELY— WE FURNISH EQUIPMENT TO START !!



Eliminate the Electrician Everybody's Electrical Handbook

New edition tells how to safely do wiring for bells and lighting, also repair electrical appliances. 90 per cent of trouble in appliances can be fixed in a few minutes, yet you pay dollars to have it done. This is the most complete book on everything electrical in the home.

Send No Money Just your name and address, pay postage \$1.00 plus a few cents postage, or send a dollar bill with order. Money back if not satisfied. Circular Free.
HOME BOOK CO., 383 EB Arcade Bldg., Cleveland, Ohio

FREE Finger Print Outfit

Everything you need to gain practical experience in finger print work while you are training to become a great Finger Print Expert. The Big Money Finger Print Experts and secret service men are ones who know the finger print branch of this profession. Easy to learn in spare time at home. Write now for Free Offer.
U. S. SCHOOL OF FINGER PRINT, Dept. 13-51, 7003 N. Clark St., CHICAGO, ILL.

I can show

how you can make \$75.00 a week without money or experience and get your pay daily, selling men's \$50 suits for \$31.75. Get the facts. Write me at once.
LOUIS S. SCHWARTZ, Mgr.

GOODWEAR, Inc., Dept. 751, CHICAGO

13 WEEKS FOR 15 CENTS

The Pathfinder

SHOWS THE WAY THROUGH THE JUNGLE OF EVENTS

You've heard your neighbor praise the Pathfinder, the wonderful weekly news and story magazine with over half a million subscribers. Unbiased digest of national and world affairs. Check full of just the kind of reading you want. Fun, fashions, question box, books, health—entertainment and instruction for all. Exciting serial and short stories. Send 15c (coin or stamps) today for this big \$1 paper 13 weeks. Money back if not satisfied. **PATHFINDER, 552 Langdon St., Washington, D.C.**

You! can be a \$500 Auto Expert!



Garage Owner or Manager



Automotive Expert



Automotive Electrician



Salesman, Demonstrator

"What Big-Pay Work Can I Learn Quickest?"



J. R. Bayston, M.S.A.E., Pres.
CHICAGO AUTOMOTIVE
INSTITUTE

Originator of the "Job-Way" System of Training
I give you this Tool Kit FREE
and train you to use it

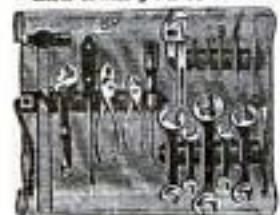

18 Piece Master Mechanics' Tool Kit FREE!

This Complete \$15.00 outfit doesn't cost you one penny! Full size, everything you need to do the "Jobs." 75 lessons, 150 Jobs, 12 lectures and many Free features in the C. A. I. course. And "Cigarette Money" pays for it!

"THE C. A. I. JOB-WAY TO BIGGER PAY!"

LOAN me an hour of your spare time a day! I'll guarantee to put you in the \$100.00 a week class quicker than you can learn any other big-pay work! **Don't quit your job! Stay home!** Thousands of men **no better than you** are making big salaries, holding down important jobs, earning enormous profits in their own business. I know how you can do the same, and I'll tell you how!

Learn Auto Repairing! Learn Automotive Electricity! Learn Vulcanizing, Welding, Battery!

My copyrighted "Job-Way" system teaches you in an hour what ordinarily takes a month to learn! The speed with which C. A. I. students get ALL the work of the complete course has astonished educators everywhere! So simple a school-boy can understand it. Think of it! 13,000,000 autos to repair each year—13,000,000 batteries to service—13,000,000 ignition systems to keep going—65,000,000 tires to sell and repair—3,000,000 trucks to overhaul. Do you realize how hungry employers are for competent men? Do you know what they're willing to pay for Automotive Experts? Can you imagine the opportunities today to make big money in a business of your own?

Coupon Brings FREE BOOK and FREE LESSON!

I don't ask you to risk a penny. I know you can learn to earn \$3,000 to \$8,000 a year as an Automotive Expert. So I guarantee in writing to return every cent of your money if you don't think it's the most profitable investment you ever made. I want you to send for my free book, read the free lesson, find out about my wonderful "Job-Way" method. See why I offer the most complete Automotive course for the least money, and on easiest payments. Mail Coupon or postal today!

MEN WANTED!

Thousands of big-pay jobs open right now, all over the U. S. Our Employment Service FREE to both students and graduates, reaches employers in every part of the Country. Look at this:

Master Mechanics	\$3,000 to \$8,000
Electrical Experts	- - \$3,600 up
Garage Manager	- - 3,000 up
Battery Expert	- - 2,400 up
Expert Welder	- - 2,400 up
Salesman	- - 3,000 up
Tractor Engineer	- - 2,400 up

My graduates own money fast enough to go into business. Own your own Garage, Battery Station, Janitor Service, Repair or Welding plant.



Mail Coupon for
FREE BOOK!

Bigger-Pay Coupon!

J. R. Bayston, M.S.A.E., Pres.
Chicago Automotive Institute
Dept. 502, 536 So. Clark St., Chicago

Without a penny of expense or the slightest obligation, please send me Free Book about your rapid course in Automotive Master Mechanics, and Free Tool Kit offer. Explain your money back guarantee. I want to see a Free Lesson, too.

Name.....

Address.....

CHICAGO AUTOMOTIVE INSTITUTE

J. R. Bayston, Pres., Dept. 502, 536 So. Clark St., CHICAGO

LEARN AT HOME THE C.A.I. JOB-WAY



High School Course in Two Years!

You Want to Earn Big Money!

And you will not be satisfied unless you earn steady promotion. But are you prepared for the job ahead of you? Do you measure up to the standard that insures success? For a more responsible position a fairly good education is necessary. To write a sensible business letter, to prepare estimates, to figure cost and to compute interest, you must have a certain amount of preparation. All this you must be able to do before you will earn promotion. Many business houses hire no men whose general knowledge is not equal to a high school course. Why? Because big business refuses to burden itself with men who are barred from promotion by the lack of elementary education.

Can You Qualify for a Better Position

We have a plan whereby you can. We can give you a complete but simplified high school course in two years, giving you all the essentials that form the foundation of practical business. It will prepare you to hold your own where competition is keen and exacting. Do not doubt your ability, but make up your mind to it and you will soon have the requirements that will bring you success and big money. YOU CAN DO IT.

Let us show you how to get on the road to success. It will not cost you a single working hour. Write today, it costs you nothing but a stamp.

American School

Dept. H174, Drexel Ave. and 58th St., Chicago

American School

Dept. H174, Drexel Ave. and 58th St., Chicago

Send me full information on the subject checked and how you will help me win success.

- | | |
|-----------------------------|---------------------------|
|Architect |Lawyer |
|Building Contractor |Machine Shop Practice |
|Automobile Engineer |Photoplay Writer |
|Automobile Repairman |Mechanical Engineer |
|Civil Engineer |Shop Superintendent |
|Structural Engineer |Employment Manager |
|Business Manager |Steam Engineer |
|Cert. Public Accountant |Foremanship |
|Accountant and Auditor |Sanitary Engineer |
|Bookkeeper |Surveyor (& Mapping) |
|Draftsman and Designer |Telephone Engineer |
|Electrical Engineer |Telegraph Engineer |
|Electric Light & Power |High School Graduate |
|General Education |Fire Insurance Expert |
|Vocational Guidance |Wireless Radio |
|Business Law |Undecided |

Name

Address

Please Mention Popular Mechanics

I Can Train You For A \$3500 Hotel Job in 20 weeks



The Hotel Business offers wonderful opportunities to the trained man or woman! Now fourth largest industry in America. Hundreds of high-salaried executive positions now standing open — waiting for the trained worker. You can easily qualify for one of these big-paying jobs—in your spare time at home. No previous experience necessary.

I Guarantee to Teach You

in my 50-lesson home-study course on hotel work, all that the leading hotel experts know about the business — men making from \$5,000 to \$50,000 a year! My students are eagerly sought by the biggest and best hotels in the country. You won't have to look for a job. Big pay, fine living, free meals and apartment, fascinating work — these are only a few of the many advantages of hotel work.

Send for FREE Book

20 Years' Experience in 20 Weeks is what this wonderfully complete course gives you. Course prepared by Clifford Lewis, a hotel expert of national reputation. Endorsed by managers of such hotels as Biltmore, Waldorf-Astoria, Copley-Plaza, Commodore, etc. Interesting free book explains all. Send for it today.

LEWIS HOTEL TRAINING SCHOOLS

Founded 1916. The Original Hotel Training School
CLIFFORD LEWIS, President

Room 330 Washington, D. C.
The National Institute for Hotel, Restaurant and Tea Room Training

ARTIST'S OUTFIT - FREE

Write quick for our remarkable offer. Learn NOW at home, in spare time, by our new instruction method. Commercial Art, Cartooning, Illustrating, Designing. Delightful, fascinating work in big demand. \$50.00 paid for one drawing. Hand-some book free explains everything. SEND FOR IT TODAY
WASHINGTON SCHOOL OF ART, Inc.
Rm. 301, 1115-15th St. N.W., Washington, D.C.

HAPPINESS MARRIAGE

LUCKY

HEALTH WEALTH

What is your Zodiac Sign? What does it mean to your future?—happiness in marriage?—friends, enemies, success in all undertakings?—and other important questions? We tell you FREE.

Your future is governed by Astrology, the science that has foretold events with almost unflinching accuracy since 1200 years before Christ. The dependability of its truths has been investigated.

Let us give your Astrological interpretation. To cover packing, enclose TEN CENTS, (stamps or coin) your name, address, exact birthdate and receive yours by return mail. Learn the truth. A big surprise. Write today. DO NOT FORGET TO ENCLOSE YOUR BIRTHDATE.

ZODIAC RESEARCH SOCIETY
415-58 St. Suite 303 Brooklyn, N. Y.



Herbert Dickerson,
Warrenton, Va.,
makes \$7,500 a year *



Automotive Electricity pays W. E. Pence,
Chehalis, Wash., over \$9,000 a year



J. R. Morgan, Delaware, Ohio, makes \$30
to \$50 a day in business for himself

Electrical Experts Are in Big Demand I Will Train You at Home To Fill a Big Pay Job

It's a shame for you to earn \$15 or \$20 or \$30 a week, when in the same six days as an Electrical Expert you can make \$70 to \$200 a week—and do it easier—not half so hard work. Why then remain in the small-pay game, in a line of work that offers no chance, no big promotion, no big income? Fit yourself for a real job in the big electrical industry. I'll show you how.

Be an Electrical Expert Earn \$3,500 to \$10,000 a Year

Today even the ordinary Electrician—the "screw driver" kind—is making money—big money. But it's the trained man—the man who knows the whys and wherefores of Electricity—the "Electrical Expert"—who is picked out to "boss" the ordinary Electricians—to boss the Big Jobs—the jobs that pay \$3,500 to \$10,000 a Year. Get in line for one of these "Big Jobs" by enrolling now for my easily learned, quickly grasped, right up-to-the-minute, Spare-Time Home Study Course in Practical Electricity.

Age or Lack of Experience No Drawback

You don't have to be a College Man; you don't have to be a High School Graduate. As Chief Engineer of the Chicago Engineering Works, I know exactly the kind of training you need, and I will give you that training. My Course in Electricity is the most simple, thorough and successful in existence, and offers every man, regardless of age, education, or previous experience the chance to become, in a very short time, an "Electrical Expert," able to make from \$70 to \$200 a week.

FREE Electrical Working Outfit FREE

With me, you do practical work—at home. You start right in after your first few lessons to work at your profession in the regular way. For this you need tools, and I give them to you absolutely free—a whole kit, a complete outfit, one that would cost you \$12 to \$15.

Your Satisfaction Guaranteed

So sure am I that you can learn Electricity—so sure am I that after studying with me, you, too can get into the "big money" class in electrical work, that I will guarantee under bond to return every single penny paid to me in tuition, if when you have finished my Course, you are not satisfied it was the best investment you ever made.

Guarantee Backed by a Million Dollar Institution

Back of me in my guarantee, stands the Chicago Engineering Works, Inc., a million dollar institution, thus assuring to every student enrolled, not only a wonderful training in Electricity, but an unsurpassed Student Service as well. It's this Service that makes "Cooke" training different from any other training. It's this Service, plus "Cooke" Training, that makes the "Cooke" Trained Man the "Big-Pay Man," everywhere.

Be a "Cooke" Trained Man and earn \$12 to \$30 a day—\$70 to \$200 a week—\$3,500 to \$10,000 a year.

Get Started Now—Mail Coupon

I want to send you my Electrical Book and Proof Lessons both Free. These cost you nothing and you'll enjoy them. Make the start today for a bright future in electricity. Send in Coupon—NOW.

L. L. Cooke, Chief Engineer,

CHICAGO ENGINEERING WORKS

2150 Lawrence Avenue Dept. 511 Chicago, Ill.

Use This "FREE OUTFIT" Coupon

L. L. COOKE, Dept. 511
2150 Lawrence Ave., Chicago

The Man Who Makes
"Big-Pay" Men

Dear Sir: Send at once, Sample Lessons, your Big Book, and full particulars of your Free Outfit and Home Study Course, also the Free Radio Course—all fully prepaid without obligation on my part.

Name

Address

Occupation..... ABC.....

The "Cooke" Trained Man is the "Big Pay" Man



Are You Earning Big Jobs \$100 a Week?

Would you like to be a star salesman? Men who have mastered salesmanship—who are really proficient—name their own salaries. \$5,000 to \$10,000 a year and better not uncommon. Big money and opportunities in business always open to men who can SELL. Success in selling field leads to highest executive positions. Demand enormous. Old theory about "born salesman" exploded. Any man of average intelligence can now learn to sell thru scientific coaching. Training, the secret. Write today for free book, "MODERN SALESMANSHIP." It tells how you can quickly get into the selling game and win your way to the big-pay jobs. Learn in spare hours at home principles and methods of ablest sales organizations in America. Successful salesmen report sales doubled and trebled thru scientific study of salesmanship under LaSalle Problem Method. Low tuition fee—easy terms. Write now for information.

LASALLE EXTENSION UNIVERSITY

The Largest Business Training Institution in the World
Dept. 164-SR Chicago, Illinois

Gentlemen: Send without obligation to me information regarding course indicated below:

Modern Salesmanship

LaSalle is the largest business training institution in the world. It offers training for every important business need. If more interested in any of these courses, check here:

- | | |
|------------------------------------------------------------------|----------------------------------------------------------------------|
| <input type="checkbox"/> Business Management | <input type="checkbox"/> Modern Business Correspondence and Practice |
| <input type="checkbox"/> Higher Accountancy | <input type="checkbox"/> Modern Foremanship and Production Methods |
| <input type="checkbox"/> Traffic Management—Foreign and Domestic | <input type="checkbox"/> Personnel and Employment Management |
| <input type="checkbox"/> Railway Station Management | <input type="checkbox"/> Expert Bookkeeping |
| <input type="checkbox"/> Law, Degree of LL. B. | <input type="checkbox"/> Business English |
| <input type="checkbox"/> Commercial Law | <input type="checkbox"/> Commercial Spanish |
| <input type="checkbox"/> Industrial Management Efficiency | <input type="checkbox"/> Effective Speaking |
| <input type="checkbox"/> Banking and Finance | <input type="checkbox"/> C. P. A. Coaching |

Name.....

Present Position.....

Address.....

WANTED

RAILWAY POSTAL CLERKS

\$1600 to \$2300 Year

MEN — BOYS 18 UP.

MAIL COUPON IMMEDIATELY

Steady work. No layoffs. Paid Vacations

Common education sufficient:

TRAVEL—SEE YOUR COUNTRY

Thousands of our Graduates are Earning
\$ **6000.00** A YEAR
You too can Become an
AUTO EXPERT
in a Few Short Weeks



The Country's Leading Industry

Millions are invested in Cars, Trucks, Tractors. Demand for trained experts is greater than the supply. Step into this big paying field quickly thru our course.

Individual Instruction

by experienced men. Practical training in all departments—motors, starting, lighting, ignition, batteries, tires, etc.

Thousands of Graduates

of our school making big money in their own business.

Make Your Start NOW

Write for big illustrated catalogue and see actual photographs of large classes at work.

We Pay Your Railroad Fare

to Pittsburgh. Come—investigate—GET BUSY.

Pittsburgh School of Auto Engineering

Dept. 121 405 Penn Ave Pittsburgh, Pa.

HOW TO BECOME A PROFESSIONAL PHOTOGRAPHER

EARNING \$35 TO \$125 A WEEK



Three to six months' course. Motion Picture, Commercial, Portraiture. Practical instruction. Modern equipment. Ask for Catalog No. 49.

N. Y. INSTITUTE OF PHOTOGRAPHY
NEW YORK CHICAGO BROOKLYN
141 W. 36th St. 630 So. Wabash Ave. 505 State St.



"BECOME A LIGHTNING TRICK CARTOONIST"

MAKE MONEY CHALK TALKING. SEND \$1.00 FOR SHARPER PROGRAM OF TRICK DRAWINGS WITH INSTRUCTIONS BY A PROFESSIONAL CARTOONIST. SATISFACTION GUARANTEED. CIRCULAR FREE. BALDA ART SERVICE, DL OSHKOSH, WIS.



Wonderful, new device, guides your hand; corrects your writing in few days. Big improvement in three hours. No failures. Complete outline FREE. Write C. J. Osment, D-34, St. Louis, Mo.



FRANKLIN INSTITUTE, Dept. E178, Rochester, N. Y.

First: Send me without charge, (1) Sample Railway Postal Clerk Examination questions; (2) List of government jobs now obtainable; (3) Send free illustrated book, "How to Get Government Jobs."

Name.....

Address.....

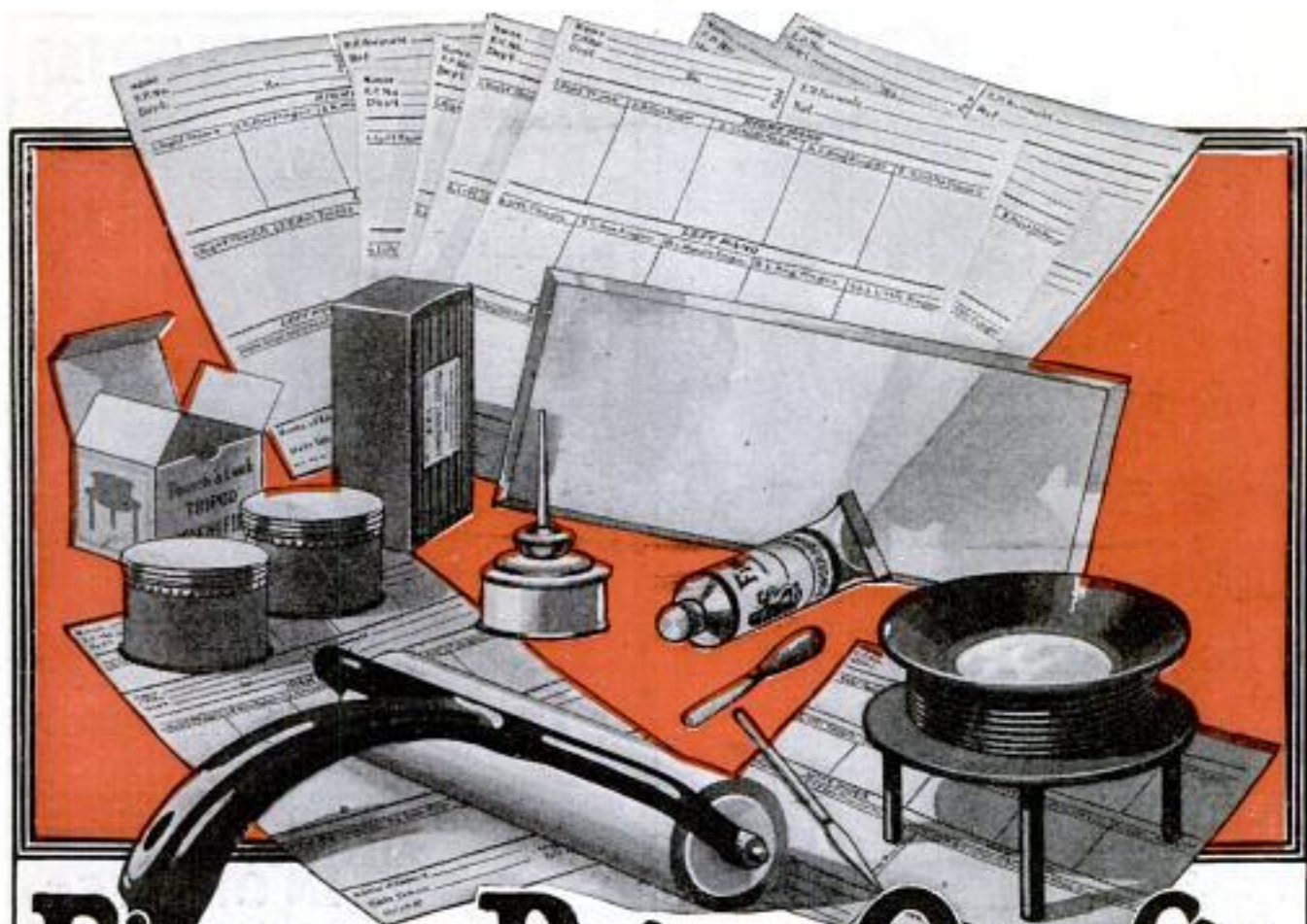

Finger Print Outfit FREE

Great Finger Print Experts use an outfit just like this one. With it you can take finger prints—develop latent (invisible) finger prints—study the minute peculiarities of different prints greatly enlarged under the powerful magnifying glass. I believe in practical work—not mere theory. That's why I insist on every one of my students having an outfit like this. They cost \$11.00 retail, but to all who enroll in my course, I will give it absolutely free. Send today for full information about the wonderful opportunity awaiting you in the newest of all professions, and this special offer, now open to you.

Can You Meet This Test?

- 1—Can you read and write?
- 2—Are you ambitious to earn big money?
- 3—Would you give thirty minutes a day of your spare time to preparing yourself for this profession?
- 4—Would you like a life of excitement and thrilling adventure?

If you can answer "YES" to these questions, I will show you how you can attain all that your ambition demands—High Position—a life of action—steady employment with big earnings. Mail the coupon NOW!

T.G. COOKE, Pres.—University of Applied Science
1920 Sunnyside Avenue, Dept. 13-51, Chicago, Illinois

University of Applied Science,
1920 Sunnyside Ave., Dept. 13-51, Chicago, Ill.

I can answer "Yes" to the four questions at the left. Tell me how I can get the Free Finger Print Outfit and become Finger Print Expert.

Name.....

Address.....

Age.....



The Hour That Counts!

When you see a man putting in his noon hour learning more about his work, you see a man who won't stay down. He'll never be satisfied until he hits the top. And he'll get there!

In shops, factories, offices, stores, in every line of industry, men are holding splendid positions won through spare time study with the International Correspondence Schools. Today they are earning four or five times—yes, some of them ten times as much money as when they started.

Employers everywhere are looking for men who really want to get ahead. If you want to make more money, show your employer that you're trying to be worth more money.

For 32 years the International Correspondence Schools have been training men and women right in their own homes.

Thousands of men have stepped up in just this way. More than 180,000 are studying now. Can you afford to let another hour pass without making your start toward something better? Here is all we ask—without cost, without obligation, mark and mail this coupon!

INTERNATIONAL CORRESPONDENCE SCHOOLS Box 5574-D, Scranton, Penna.

Without cost or obligation, please tell me how I can qualify for the position or in the subject before which I have marked an X:

BUSINESS TRAINING COURSES

- | | |
|---------------------------------------------------------|-------------------------------------------------|
| <input type="checkbox"/> Business Management | <input type="checkbox"/> Salesmanship |
| <input type="checkbox"/> Industrial Management | <input type="checkbox"/> Advertising |
| <input type="checkbox"/> Personnel Organization | <input type="checkbox"/> Better Letters |
| <input type="checkbox"/> Traffic Management | <input type="checkbox"/> Show Card Lettering |
| <input type="checkbox"/> Business Law | <input type="checkbox"/> Stenography and Typing |
| <input type="checkbox"/> Banking and Banking Law | <input type="checkbox"/> Business English |
| <input type="checkbox"/> Accountancy (including C.P.A.) | <input type="checkbox"/> Civil Service |
| <input type="checkbox"/> Cost Accounting | <input type="checkbox"/> Railway Mail Clerk |
| <input type="checkbox"/> Bookkeeping | <input type="checkbox"/> Common School Subjects |
| <input type="checkbox"/> Private Secretary | <input type="checkbox"/> High School Subjects |
| <input type="checkbox"/> Spanish | <input type="checkbox"/> Illustrating |
| <input type="checkbox"/> French | <input type="checkbox"/> Cartooning |

TECHNICAL AND INDUSTRIAL COURSES

- | | |
|-------------------------------------------------|----------------------------------------------------------------------|
| <input type="checkbox"/> Electrical Engineering | <input type="checkbox"/> Architect |
| <input type="checkbox"/> Electric Lighting | <input type="checkbox"/> Blue Print Reading |
| <input type="checkbox"/> Mechanical Engineer | <input type="checkbox"/> Contractor and Builder |
| <input type="checkbox"/> Mechanical Draftsman | <input type="checkbox"/> Architectural Draftsman |
| <input type="checkbox"/> Machine Shop Practice | <input type="checkbox"/> Concrete Builder |
| <input type="checkbox"/> Railroad Positions | <input type="checkbox"/> Structural Engineer |
| <input type="checkbox"/> Gas Engine Operating | <input type="checkbox"/> Chemistry <input type="checkbox"/> Pharmacy |
| <input type="checkbox"/> Civil Engineer | <input type="checkbox"/> Automobile Work |
| <input type="checkbox"/> Surveying and Mapping | <input type="checkbox"/> Airplane Engines |
| <input type="checkbox"/> Metallurgy | <input type="checkbox"/> Navigation |
| <input type="checkbox"/> Steam Engineering | <input type="checkbox"/> Agriculture and Poultry |
| <input type="checkbox"/> Radio | <input type="checkbox"/> Mathematics |

Name.....

Street.....

Address.....

City..... State.....

Occupation.....

Persons residing in Canada should send this coupon to the International Correspondence Schools Canadian, Limited, Montreal, Canada.

PICTURES HAWAIIAN GUITAR

Show you how to play in half an hour!

Greatest musical invention of the age. You don't have to know any music at all. Only four motions to learn. No previous musical knowledge necessary. We show you pictures of these so clearly that in half an hour you can play the famous Hawaiian song ALOHA OE and other popular favorites.

HAWAIIAN TEACHERS GIVE YOU PERSONAL ATTENTION

No wonder our pupils say "Easiest, quickest way to play we ever heard of!"

ONLY COURSE GIVING FREE PHONOGRAPH RECORDS

So You Know You Are Playing Right No wonder thousands have learned this quick easy way. So can you. Just send us your name and address on a post-card, and we will send you circular in colors, giving full details of entire course, so you can prove to yourself right away that this easy picture method is the course which will teach you to play Hawaiian Guitar right away. Send the postcard now. 52 PAGES POPULAR MUSIC FREE.

New York Conservatory of Music
Desk 52-J, 212 Fifth Avenue, New York



FREE \$18 HAWAIIAN GUITAR of beautiful tone and genuine Hawaiian correct model with full equipment for a limited time only to students who enroll in our conservatory.

ELECTRICAL ENGINEERING men with training area in demand. For more than a quarter of a century this school has been training men of ambition and limited time, for the electrical industries. Condensed course in Electrical

enables graduates to secure good positions and promotions. Theoretical and practical Electricity, Mathematics, Steam and Gas Engines, Mechanical Drawing. Students construct dynamo, install wiring and test electrical machinery. **IN ONE YEAR** Course with diploma, complete



Thoroughly equipped fireproof dormitories, dining hall, laboratories, shops. Over 3000 men trained. Write for catalog. 31st year begins Sept. 26, 1923.

BLISS ELECTRICAL SCHOOL

104 TAKOMA AVENUE, WASHINGTON, D. C.

RANGER \$5 a Month

Finest bicycle built—44 styles, colors and sizes. Factory to rider prices FREE delivery, express prepaid on 30 days Free Trial. Cash or easy pay'ns.

TIRES lamps, wheels and equipment at half usual prices. Send no money. Write today for big catalog, special Factory Prices, free trial plan and marvelous offers.



MEAD CYCLE CO. Dept. F-108 CHICAGO

STAMMERS

I can teach you to speak normally. Send for free booklet telling how. BOSTON STAMMERS' INSTITUTE, FOUNDED 1887 Samuel A. Robbins, Director, 248 Huntington Av., Boston 17, Mass.

TELEGRAPHY

BOTH Morse AND WIRELESS taught thoroughly. Big salaries; tremendous demand. Oldest, largest school. Endorsed by Telegraph, Railway, Wireless and Government officials. Expenses low—opportunities to earn large portion. Catalog free.

DODGE'S INSTITUTE, Jones Street, Valparaiso, Ind.



Physical Magnetism Yours

Increase your personal power, develop your power of will. Secure great physical magnetism. Stand out from the humdrum crowd as a MAN among men. Attain superb and radiant health. Send NOW for my amazing 64-page book full of extraordinary pictures that will thrill you and make you want to be the man or woman you should be. Send at once for this wonderful book, which fully reveals these astounding secrets. Enclose a dime to cover wrapping and mailing. Grasp this opportunity of learning the rare secrets of becoming physically perfect, and do it now. Address

PROF. CHARLES ATLAS Twice pronounced the world's Most Perfect Man, receiving two \$1,000 First Prizes. No other living man can claim this title.

PROF. CHARLES ATLAS 96 Fifth Ave., Apt 231, New York City

AGENTS



DROP EVERYTHING For This Amazing Money Maker

The best agents in the country have taken up this new line because it doubles their earnings. Montell started without capital and banked nearly \$5,000 in 6 months. Many others are doing almost as well. Investigate! It will be a revelation to you.



A twist of the wrist brings a fire in a second—a warm house on rising—a hot oven in a jiffy. Models for each type of range, heater and furnace.

If you've kept up with the times you know how devices that turn every heater, range or furnace into a gas burner, in a jiffy, have taken the country by storm. The government uses them and Domestic Scientists advise their use in every home. They do away with high priced coal and wood and their dust, dirt and drudgery. Even the very earliest burners sold like wild-fire and agents made small fortunes.

New Type of Burner

Then came "NU-HEAT"—a device based on later discoveries which eliminated many unnecessary parts. It did better work and cost less. It has been called the "Ford" among oil burners in price but it has "twin-six" efficiency. It mixes one part of coal/oil (Kerosene) with TWENTY TIMES its bulk of air and the result is a cheaper gas than city gas.

Sells Like Wild-fire

Every housewife has read time and again of the economies she could effect and the drudgery she could avoid by using oil burners. And when the new low price put such a device within the reach of everyone, sales were made in a way that broke all records. The shrewdest agents in the country were quick to take up NU-HEAT and the factory was soon working at full capacity.

Now we have increased our factory fourfold and can see more good agents in every section in either spare time or full time.

WADE HILL MFG. COMPANY
Dept. A-40 ST. LOUIS, MO.

\$100.00 THE FIRST WEEK

"I've made \$100.00 my first week. Now one customer tells others and I get enough requests to call to keep me busy, so I expect soon to double this."

Arch B. Thayer,
Michigan.

BUSINESS FORCED ON HER

"I didn't start out to be a saleswoman. I put a NU-HEAT in my stove and was so delighted with it I began to brag about it. Many of my friends asked me to get burners for them and of course I collected the commissions. That started me. Now I make more than my husband and that's saying a lot for he's the best lawyer in the county."

Mrs. Laura M. Marston,
Tennessee.

WORTH \$100,000.00 TO HIM

"I wouldn't give up the work for \$100,000.00. For I'm earning at the rate of \$15,000.00 a year and that is interest on a quarter million."

Harley Jackson,
Massachusetts.



FREE Sample Case Offer

If you want a PERMANENT connection that may double your present earnings, get full details about our line, our remarkable personal cooperation and our free sample case offer. Write

quick for exclusive territory. Low price, high quality, and extraordinary demand will all help to make it the most profitable step you ever took.

Mail Money Bringing Coupon Now

**Wade Hill Manufacturing Co.,
Dept. A-40, St. Louis, Mo.**

Show me why agents double their incomes selling NU-HEAT. Explain your personal cooperation and free sample case offer.

I am interested in (check which)

Full Time Spare Time Proposition

Name

Address

City..... State



"From This Day You Get Bigger Pay"

"And so I was promoted. The boss seemed surprised, until I told him I had been studying nights—to learn more about my job, and how to do it better." An American School Course will put you in the way of earning big money in the line of work you like best. Look over the Coupon, check the Branch you want to learn, mail it and we will send you full information FREE. Pay no money until you know all about what we can do for you. The cost is low, the terms easy and the results insured by our money-back guarantee. The pay increases you will get will more than pay for your course in a few week's time. We have thousands of successful graduates holding big jobs today. You can join this money-making class. Fill out the coupon, mail it today. Get your start in life.

American School, Dept. G-1744 Drexel Ave., & 58th St., Chicago, Ill.

American School, Dept. G-1744 Drexel Ave. & 58th St., Chicago

Send me full information on the subject checked.

- | | | |
|-------------------------------------|--------------------------|--------------------------|
| .. Architect | .. Accountant & Auditor | .. Employment Manager |
| .. Building Contractor or Carpenter | .. Bookkeeper | .. Steam Engineer |
| .. Automobile Engineer | .. Draftsman & Designer | .. Foremanship |
| .. Automobile Repairman | .. Electrical Engineer | .. Sanitary Engineer |
| .. Civil Engineer | .. General Education | .. Surveyor & Mapping |
| .. Advertising Manager | .. Personal Analysis | .. Telephone Engineer |
| .. Business Manager | .. Business Law | .. Telegraph Engineer |
| .. Financial Manager | .. Lawyer | .. High School |
| .. Sales Manager | .. Machine Shop Practice | .. Fire Insurance Expert |
| .. Cert. Pub. Accountant | .. Photoplay Writer | .. Wireless-Radio |
| | .. Mechanical Engineer | .. Undecided |
| | .. Shop Superintendent | |

Name.....

Address.....

HISTORY of the WORLD

AT A BARGAIN

WE WILL name our Bargain Price and easy terms of payment only in direct letters to Popular Mechanics readers. A coupon for your convenience is printed at the bottom of this advertisement. Tear off the coupon, write name and address plainly and mail now before you forget it.

\$1
A Week
Pays
for this
Great
Set of
Books



Free

A beautiful 32-page booklet of sample pages to all who mail the coupon.

Six Thousand Years of History

NOW as never before you should know the progress of mankind. Reading this work will increase your fund of knowledge, improve your mental powers, and increase your earning capacity in any business or occupation. The man or woman who knows history has infinitely better chances of success than the uninformed. "Show me a family of readers," said Napoleon, "and I will show you the people who rule the world." Mail the Coupon.

FREE COUPON

WESTERN NEWSPAPER ASSOCIATION
140 So. Dearborn St., Chicago, Ill.

(1-24)

Please mail your 32-page free sample booklet of The History of the World, containing sample page and illustrations, and write me full particulars of your special offer to Popular Mechanics readers.

NAME.....

ADDRESS.....

WHAT ABOUT THAT BEAUTIFUL BODY OF YOURS



YOUNG MEN can now become perfect human Masterpieces with Tremendous Muscles—

Old Men can have Perfect Health—Unlimited Vitality and a Perfect Body. You may now banish the fear

of approaching years without the use of Medicine, Drugs, Stimulants, or any artificial aid. **ANALYZE YOURSELF** and you will be shocked at the poison in your System. **PEOPLE DIE TOO YOUNG** because they do not give nature a chance externally, or internally. **DOCTORS CANNOT CURE YOU** unless nature assists them. **CONSTIPATION** often causes High Blood Pressure and some of our most fatal diseases.

KILL CONSTIPATION

or it will surely kill you. If you have that Tired Feeling—Poor Memory—Can't Sleep—Nervous Indigestion—Headache—Constipation—Weak Back—Thinness—Flat Chest—Round Shoulders—Short Windedness—Endurance—or a Drug Addict. Write us for our latest scientific improved way of treating by nature at home without Drugs. **THERE ARE FIVE HUNDRED MUSCLES** in your body. Give them a Chance. We can Increase the Muscle in your Arm one inch, and your chest two inches within Thirty Days—Then Watch them Grow. **WE CAN PUT MUSCLES ON YOU** that will be the envy of all your friends and make you afraid of no man. You will then pity the poor weakling and **WAKE UP FULL OF PEP—With Eyes Sparkling—Brain Clear, and EAT LIKE A KID.**

It is a crime not to be Physically Fit—Why be Just Average when you can Be Admired By Everyone?

FREE Send name and address for Proof and Free Copy of Strength, Health and Happiness sent absolutely Free in Plain Cover.

UNITED STRENGTH & HEALTH INSTITUTE
214 Dinan Building DETROIT, MICHIGAN

FREE

\$20 Fine Tone Musical Instruments



We have a wonderful new copyrighted system of teaching note music by mail. To first pupils in each locality we will give free a \$20 superb Violin, Tenor Banjo, Ukulele, Hawaiian-Guitar, Banjo, Mandolin, Banjo-Ukulele, Banjo-Mandolin, Cornet or Banjo-Guitar absolutely free. Also teach Piano and Organ. Very small charge for lessons only. Four lessons will teach you several pieces. Over 100,000 successful players. We guarantee success or no charge. Complete outfit free. Write today, Dept. 155. No obligation.

SLINGERLAND SCHOOL OF MUSIC, 1815 Orchard Street, CHICAGO, ILLINOIS

MAKE \$100 A DAY BE AN AUCTIONEER

18 yrs. one of the largest Auction Schools in the World. W. H. Adams, Utah, made \$20,000 second year after graduating. 1923 Annual Free. MISSOURI AUCTION SCHOOL, 818 Walnut St., Kansas City, Mo.



WANTED MEN AND WOMEN TO LEARN PHOTOGRAPHY!

Photographers and Photo-Engravers earn \$200 to \$500 a month. The field is uncrowded. Learn these profitable and fascinating professions. Taught by largest and best college of its kind in the world. Established over 30 years. Demand for our graduates far exceeds supply. Good positions secured. Tuition and living expenses low.

Get this FREE Book! Write today for free beautifully illustrated book describing wonderful opportunities in this field.

Illinois College of Photography, Box 414, Effingham, Ill.

STEADY JOBS at GOOD PAY

Earn \$50 to \$125 Per Week

Record-breaking automobile sales have created thousands of \$50 to \$125 per week jobs for men practically trained in automotive work. Hundreds of requests for such men—Greer Graduates—come to our free employment bureau. We have more jobs than we have men to fill them. YOU can be next in line if you will start right now. Eight short weeks at Greer College will equip you to step out and make big earnings for life.

EARN WHILE YOU LEARN JOBS GUARANTEED

If you are in need of assistance we guarantee to place you at once in positions paying up to \$30 per week. Only a small payment down on the course selected is necessary. We have helped many men to an earning competence in this way. The instruction awaiting you will completely hold your interest. Here in the big Greer shops you get actual work on 4, 6, 8 and 12 cylinder engines. Electricity thoroughly covered. All known Lighting, Starting and Ignition units used. Special courses in Machine Shop, Batteries, Welding and Vulcanizing. Individual road lessons given.

You'll Be An Expert On All These

Complete Greer Course includes Machine Shop Practice—Shop Management—Selling—Truck, Tractor and Automobile Repairing—Lighting—Starting—Vulcanizing—Storage Batteries, Driving—everything required to equip you for the highest paid automotive positions anywhere.

We Pay Your Railroad Fare to Chicago

This special offering is made to fill the openings that now exist. Chicago is the place to train and opportunities for jobs are unlimited. Within ten blocks of Greer College are at least 25 large Automobile Sales Agencies. Throughout the city are approximately 6,000 Garages and Repair Shops. We will help you find a job and a home. Write us, and come to Chicago.

DAY AND EVENING CLASSES

Any job we get for you need not interfere with instruction. Day and Evening Classes are arranged to suit the convenience of every man who has the ambition to learn.

MAIL THE COUPON

It will bring you a big FREE BOOK, "How to Succeed in the Automobile & Tractor Business." It will also bring you special Tuition Offer and complete information about jobs. Mail it at once!



Many former Greer Students now own their own places of business. This means independence, no boss, and earnings that run from \$200 to \$5,000 per month.



Promotion to Head Automotive Mechanic is usually a question of but a short time for Greer-trained men. Salaries here average \$150 to \$500 per month.



The Greer-trained Truck and Tractor Repairman need never be lacking a steady job in any community. Pay average \$6.00 to \$15.00 per day, and higher.



Automobile Salesmen make up to \$20,000 per year.



This magnificent new building—its 80,000 square feet of floor space filled with repair shops and modern shop equipment—is entirely devoted to training Greer Students. This is where you will prepare yourself for a lifetime of pleasant work at big pay.

GREER COLLEGE

of Automotive Engineering

2051 S. Wabash Ave.
CHICAGO, ILL.

**How To Succeed
in the
Automobile & Tractor
Business**

ERWIN GREER, President
2051 S. Wabash Ave., Chicago, Ill.

Send me your Free Book, "How to Succeed
in the Automobile Business," and Special
Tuition Offer.

Name.....
Address.....

LEARN Modern Barbering

NEW EASY WAY

Earn \$50 to \$150 EACH WEEK



NO matter what you are now doing, no matter how much you earn, our amazing new system of training for the barbering profession enables you to step into this clean, pleasant, profitable business in a few short weeks. Start right in earning \$50 to \$150 a week.

J. E. McGregor, of New Orleans, writes: "I have never been out of a job since you sent me to the one from the Post Graduate department a year ago. I have saved up a nice bank account. I am glad I learned Modern Barbering with you."

F. Erbat, of Chicago, writes: "I own my own home! I have my own automobile! I am independent! Have made it all since graduating from your school five years ago."

What Moler System Means to You

Our national advertising educates the public to the safety, comfort and economy of Moler post graduate work. It makes you the sought-after barber in your locality. It keeps your chairs filled and turns profits into your pocket. You as graduate are a part of a national institution which assures steady, profitable business. Through no other method can you get this.

We Equip Your Shop on Easy Terms

If you own your own shop your success is assured. If you are a worker you are assured of steady employment.

Send for This
Free Book
Today

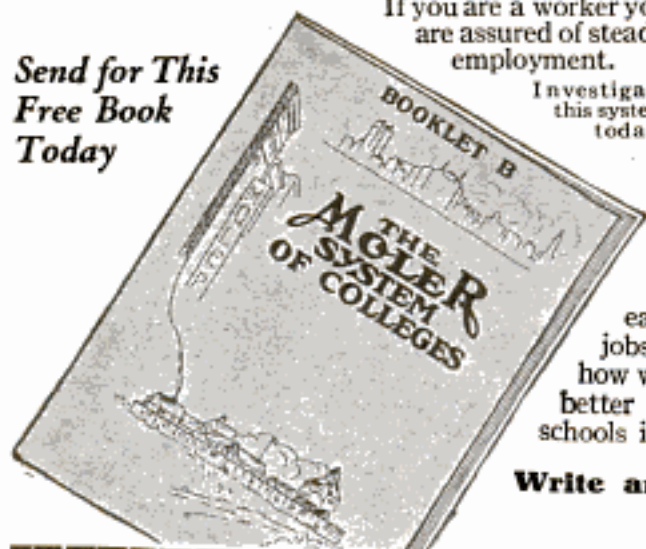

Investigate
this system
today.

We Train You to Be An Expert IN A FEW WEEKS

You want to get ahead—you want to make more money—big money. Our short, practical course gives you a complete training in modern barbering, including the electric hair cutter, the mechanical massage and scientific treatments. It also affords a study, if one desires, on hair and skin—it makes you an expert and expert barbers are always in demand.

Easy Work Always Busy BIG PAY

A trade that enables you to travel and see the world—one that pays in tips and commissions in addition to salaries. Moler System graduates are in great demand and have no trouble in securing good jobs.

Write for Free Book

Our catalog that we mail free tells how we enable you to earn while learning, how we put you into the best city jobs, how we equip your shop on easy payments. In fact, how we take you just as you are, make your life's work easier, better paying and more independent. We have 33 branch schools in leading cities. We have one near you.

Write anyone of the following addresses for our booklet B. Do it today.

MOLER SYSTEM OF COLLEGES

Address Nearest Branch →

Please send me without obligation on my part your Booklet B.

Name.....

Address.....

City.....State.....

The Moler System of Colleges

157 Third Ave. New York, N. Y.	215 Huron Rd. Cleveland, Ohio	23 N. Forsyth St. Atlanta, Ga.
105 S. Wells St. Chicago, Ill.	1045 Cass Ave. Detroit, Mich.	80 N. 2nd St. Memphis, Tenn.
810 N. 6th St. St. Louis, Mo.	1229 17th St. Denver, Colo.	910 Main St. Dallas, Texas
544 Main St. Kansas City, Mo.	110 S. 14th St. Omaha, Nebr.	712 Franklin Ave. Houston, Texas
206 E. 4th St. Cincinnati, Ohio	513 E. Water St. Milwaukee, Wis.	727 W. Commerce St., San Antonio, Texas
	1005 Canal St. New Orleans, La.	

EARN BIG PAY BY THE A. E. E. WAY

**\$15.00
to \$35.00
a day in
Electrical
Work—**

Let these men—Directors of the Associated Electrical Engineers—help YOU to succeed



A. E. E. BOARD OF ENGINEERS ANNOUNCE AMAZING IMPROVEMENT IN ELECTRICAL HOME TRAINING—OLD METHODS "SHELVED"

Big Pay Electrical Field Now Open to Any Ambitious Man

Do you want to earn \$75 to \$200 a week as an electrical expert? Do you want to get a share of the millions that are being spent in the electrical industry—the fastest growing industry in the world today?

You can do it—now!

For now, at last, electrical home training is offered by a system that takes out all the "kinks"—a training that is absolutely free from technicalities, theories, and things the average man finds it hard to understand.

How the New Way Was Found

Here's electrical home training that's different from any that has ever been offered before!

It is the product of the combined efforts of a powerful group of technical men and educators—the men selected to act as Directors of the Associated Electrical Engineers of America. These men have taught thousands through home training. They have worked "out on the job." They have

TO EMPLOYERS

Our members are the kind of ambitious men that you need in your business—men who believe in electricity and have the vision to grasp opportunity. Write and we will put you in touch with the men you need

studied all that has been done in this great field—and out of their long experience they have found the new, simplified method that is making it easy for ambitious men to get a thorough training in electricity—quickly and at low cost.

Schooled or Unschooled—You Can Understand this Course

The practical-minded engineers of the A. E. E. have made their training so clear and sensible that you don't need a high school or college education to get at the "solid meat" in their System of Electrical Training. You learn by *doing*, not by theory! All you need is education enough to read plain, every-day English. There aren't any frills in the A. E. E.'s simplified training.

You Get Into the Big-Money Class Quickly

By starting you right from the ground up and giving you good, sound, practical information from start to finish, we carry you over the shortest route to the big pay jobs that are now so plentiful in the great electrical field. We know you want action—quick advancement—and our engineers have devised the system that lets you get it!

Wonderful Working Outfit FREE

To let you learn by *doing things*, we supply you with the most practical and complete electrical working outfit ever devised by a home training school. And it doesn't cost you a cent extra. Radio and Automobile electrical training, too, are thoroughly covered in this course.

Backed by Legal Guarantee

The man who becomes a member of the A. E. E. and takes up our course of training, doesn't run any risk at all. Every

penny of the small fee you pay is returned to you if you are not thoroughly satisfied when you finish your training.

With this protection to rely on, you owe it to yourself to investigate the money-making possibilities of the great electrical field and the training system we offer.

BIG FREE BOOK Tells the Story

Our great new book, just off the press, is ready for you. Don't delay! Ask for it now—on the coupon below.

SEND TODAY



Here's Opportunity's Wide Open Door

ASSOCIATED
ELECTRICAL ENGINEERS

Dept. A-3, 537 South Dearborn Street
Chicago, Illinois

Without any obligation, please send me FREE, your 64-page book on Electricity and full details of how I can make big money as a member of the Associated Electrical Engineers.

Name.....

Address.....

Associated Electrical Engineers OF AMERICA

Dept. A-3 537 S. Dearborn Street, Chicago

LUMINOUS PAINT

Make Your Watches, Clocks, Etc., Visible by Night

The very latest discovery in the scientific world, hitherto, practically unobtainable except at an exorbitant price, we have at last succeeded in producing this remarkable LUMINOUS PAINT, which, applied to the surface of any article, emits rays of white light, rendering it perfectly visible in the dark. **THE DARKER THE NIGHT, THE MORE BRIGHTLY IT SHINES.** Quite simple to use. Anyone—you can do it. A little applied to the dial of your watch or clock will enable you to tell the time by night. You can coat the push buttons or switch plates of your electric lights, match boxes, and innumerable other articles; make your own Luminous Crosses, Luminous Rosaries, etc. Small bottle, price 25c. Larger sizes, 50c and \$1 postpaid.

Serpent's Eggs

Box contains 12 eggs. When lit with a match, each one gradually hatches itself into a snake, several feet long, which curls and twists about in a most life-like manner. Price per box, 10c postpaid, 3 for 25c.



Potmend

Mends Ironware, Agate-wares, etc. Also, pots, pans, boilers, etc. Also, copper, aluminum, iron pipes, cracks in stoves, broken china, porcelain, brick-heat, glass, crockery, woodenware, marble, etc. Comes in powder form. Just mix with water and apply. **HARDENS LIKE IRON.** Makes a big hole or a small crack. PRICE 15c, 3 for 40c, postpaid.

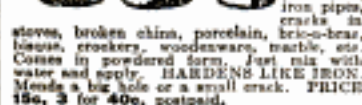

Midget Bible

GREAT CURIOSITY Resilient Bible in the World. Size of a postage stamp. 300 Pages. Held to letters good luck to the owner. A genuine work of art. Must be seen to be appreciated. **Send good money** willing them to friends, church acquaintances, etc. PRICE 15c each, 3 for 40c, 12 for \$1.35, 100 for \$7.50.



STAGE MONEY

With a bunch of these bills, it is easy for each person of limited means to appear prosperous by flashing a roll of these bills at the proper time and peeling off a genuine bill or two from the outside of the roll, the effect created will be found to be all that can be desired. Prices, postpaid: 15 Bills 10c, 50 Bills 25c, 125 for 50c, or \$3.50 thousand.

Wonderful X-Ray Tube

A wonderful little instrument producing optical illusions both surprising and startling. With it you can see what is apparently the bones of your fingers, the lead in a lead pencil, the interior opening in a pipe stem, and many other similar illusions. A mystery that has been able to satisfactorily explain. Price 10c, 3 for 25c, 1 dozen 75c. Johnson Smith & Co.



Good Luck Ring

Quaint and Novel Design

A VERY striking and uncommon ring. Silver finish, skull and crossbones design, with two brilliant, flashing gems sparkling out of the eyes. Made by money to bring Good Luck to the wearer, hence its name. **Good Luck Ring.** Very unique ring that you will take a pride in wearing. **ONLY 25 CENTS.**

Address orders for all goods on this page to

JOHNSON SMITH & CO.
Dept. 50 RACINE, WIS.

Our large catalog (356 Pages) of all the newest and best novelties, unobtainable elsewhere, free with every order.

The Dying Pig



The most laughable novelty yet produced. Made of rubber, and you have only to blow it up and stand the pig on his feet, when he begins to squeal as he slowly collapses and finally lies down and dies in the most natural manner. You can blow him up as often as desired, and each time he will go through the same performance to the great amusement and delight of your friends. Price, 15 cents; 3 for 40c; one dozen \$1.35, mailed.

Popular Watch Charms

15c
ONLY
3 for 40c; \$1.35 doz.

Very pretty little curiosities and decidedly novel. Fitted with Magnifying Lenses that enlarge the pictures to a very surprising degree; in fact, it seems almost incredible that a close picture could be possible in such a small compass, and have sharp and distinct they show to whom you look through. Come in assorted views—Actresses, Views of Panama Canal, Lord's Prayer in type, etc.

Mystic Skeleton

A jointed figure of a skeleton 14 in. in height, will dance to music and perform various gyrations and movements while the operator may be some distance from it. **10c pd.**

NEW BOOK ON ROPE SPLICING

Useful Knots, Hitches, Splices, etc. A most practical handbook giving complete and simple directions for making all the most useful knots, hitches, rigging, splices, etc. Over 100 illustrations. All about wire rope attachments, lashing, blocks, tackles, etc. 37 Heraldic Knots Illustrated. Of great value to mechanics, riggers, carpenters, boatmen. Price 20c postpaid.

MAGIC FLUTE

Wonderfully Sweet Toned and Musical
The Magic Flute, or Human Stone, is a unique and novel musical instrument that is played with nose and mouth combined. There is just a little knack in playing it which, when once acquired after a little practice will enable you to produce very sweet music that somewhat resembles a flute. There is no fingering, and once you have mastered it you can play all kinds of music with facility and ease. When played as an accompaniment to a piano or any other musical instrument, the effect is as charming as it is surprising.



BLANK CARTRIDGE PISTOL

Protection against Burglars, Tramps & Dogs

Prices
50c
\$1.00



Well made and effective; modelled on latest type of Revolver; appearance alone is enough to scare a burglar. When loaded it may be as effective as a real revolver without danger to life. It takes standard .22 Cal. Blank Cartridges obtainable everywhere. Price 50c, superior quality, \$1.00 postpaid. Blank Cartridges, by express, 50c per 100. Johnson Smith & Co., Dept. 50, Racine, Wis.

DANCING BEAUTIES

Get a Kinetograph and see the picture move. Franco's latest sensation. A great surprise. Is worth twice what they cost. Are made of solid brass, highly nickled and very durable. Satisfactory or your money back. **50c**



Johnson Smith & Co., Dept. 50, Racine, Wis.

BOYS!

BOYS!

BOYS!

THROW YOUR VOICE



Into a trunk, under the bed or anywhere. Lots of fun fooling the teacher, policeman or friends.



THE VENTRILLO

A little instrument, fits in the mouth out of sight, used with above for Bird Calls, etc. Anyone can use it.

Never Fails. A 32 page book on ventriloquism, the Ventrillo, ALL FOR 10 CENTS

1000 Silk Remnants

for patching, Crazy Quilts, Sofa Cushions, Head Rests, Pin Pads etc. Large pieces, all colors and shades. Sure to delight you. For 10 Cents stamps, we send a large package and Book of quilt designs. 3 packages 25c. 1 pound makes a lovely large quilt. Price 75c postpaid. Our silk is the best. JOHNSON SMITH & CO., Dept. 50, RACINE, WIS.

LOOK 50c LOOK



Wonderful Instrument. Greatest thing yet. Nine separate articles in one. Everybody delighted with it. Odd, curious and interesting. Lots of pleasure as well as very useful. It is a double microscope for examining the wonders of nature. It is also an Opera Glass, a Stereoscope, a Burning Lens, a Reading Glass, a Telescope, a Compass, a Pocket Mirror, and a Laryngoscope—for examining eye, ear, nose and throat. It is worth all the cost to locate even one painful cinder in the eye. Folds flat and fits the pocket. Something great—you need one. Don't miss it. Sent by mail, with 356 page Novelty Catalog. **Only 50c or 3 for \$1.25**

Resurrection Plant

One of the most wonderful plants known. Possesses the strange power of turning in a few minutes from an apparently lifeless, dry herb to a beautiful living fernlike plant of a dark green color. Simply place the plant in saucer of water, it will open up and start to grow in 20 minutes. When taken out it will dry up and go to sleep until placed in water again. Fine house plant—summer or winter. 10 cents each or 8 for 25c. **AGENTS WANTED** postpaid. JOHNSON SMITH & CO., Dept. 50, RACINE, WIS.





PLAY PIANO BY EAR

Be a Jazz Music Master

Anyone who can remember a tune can easily and quickly learn to play popular jazz or American rhythm by ear at a very small cost. The New Niagara Method makes piano playing wonderfully simple.

No matter how little you know about music—even though you "have never touched a piano"—if you can just remember a tune, you can quickly learn to *play by ear*. I have perfected an entirely new and simple system. It shows you so many little tricks that it just comes natural to pick out on the piano any piece you can hum. Beginners and even those who could not learn by the old-fashioned method grasp the Niagara idea readily, and follow through the entire course of twenty lessons quickly. Self-instruction—no teacher required. You learn many new styles of bass, syncopation—blues, fill-ins, breaks and trick endings. It's all so easy—so interesting that you'll be amazed.

A Simple Secret to Success

No need to devote years in study to learn piano nowadays. Special talent unnecessary. Every lesson is so easy, so fascinating that you just "can't keep your hands off the piano." Give it part of your spare time for 90 days and you will be playing and entertaining almost before you realize it. No tiresome scales, no arpeggios to learn—no do-re-mi—no difficult lessons or meaningless exercises. You learn a bass accompaniment that applies to the songs you play. Once learned, you have the secret for all time—your difficulties are over and

You Become Master of the Piano

Even talented musicians are amazed at the rapid progress of Niagara School students and can't understand why this method was not thought of years ago. Naturally, the Niagara Method is fully protected by copyrights and cannot be offered by any other school. A special service department gives each pupil individual attention.

Learn at
home in
90 days

Be Popular in Every Crowd

One who can sit down at any time without notes or music, reel off the latest jazz and popular song-hits that entertain folks, is always the center of attraction, the life of the party, sought after and invited everywhere. Make yourself the center of attraction—master the piano by spending an hour a day studying the fascinating Niagara Method.

As easily as thousands of others have learned, so you too, can learn and profit—not only through the pleasure it provides, but also by playing at dances, motion picture houses and other entertainments.

Decide to Begin Now!

Just spend a part of your spare time with a few easy, fascinating lessons and see how quickly you "catch on" and learn to play. You will be amazed, whether you are a beginner or an advanced student.

Write for interesting, illustrated booklet, "The Niagara Secret"—it describes this wonderful new method of playing piano by ear. **This booklet sent FREE.**

Enclose 6c in stamps and you'll also receive an interesting chart.

Ronald G. Wright, Director, NIAGARA SCHOOL OF MUSIC, Niagara Falls, N.Y.



This Book
FREE

CLIP THIS COUPON NOW

Niagara School of Music, Dept. 616, Niagara Falls, N. Y.
Without obligation mail me your booklet, "The Niagara Secret."

Name.....
St. and No. or R. F. D.....
Town..... State.....
Age..... Ever take piano lessons?..... How many?.....



"Mary, I Owe It All to You"

"MR. WILLIAMS called me into his office today and told me he was going to raise my salary \$50 a month.

"I am glad to give you this opportunity," he said, "for the best reason in the world. You deserve it.

"You may not know it, but I've been watching your work ever since the International Correspondence Schools wrote me that you had enrolled for a course of home study. Keep it up, young man, and you'll go far. I wish we had more men like you."

"And to think, Mary, I owe it all to you! I might still be drudging along in the same old job at the same old salary if you hadn't urged me to send in that I. C. S. coupon!"

How about you? Are you always going to work for a small salary? Are you going to waste your natural ability all your life? Or are you going to get ahead in a big way? It all depends on what you do with your spare time.

More than 180,000 men are getting ready for promotion right now in the I. C. S. way. Let us tell you what we are doing for them and what we can do for you.

Mail the Coupon To-day

INTERNATIONAL CORRESPONDENCE SCHOOLS
Box 5573-D, Scranton, Penna.

Without cost or obligation, please tell me how I can qualify for the position or in the subject before which I have marked an X:

BUSINESS TRAINING COURSES

- | | |
|------------------------------------------------------------------|---------------------------------------------------------------------------|
| <input type="checkbox"/> Business Management | <input type="checkbox"/> Salesmanship |
| <input type="checkbox"/> Industrial Management | <input type="checkbox"/> Advertising |
| <input type="checkbox"/> Personnel Organization | <input type="checkbox"/> Better Letters |
| <input type="checkbox"/> Traffic Management | <input type="checkbox"/> Show Card Lettering |
| <input type="checkbox"/> Business Law | <input type="checkbox"/> Stenography and Typing |
| <input type="checkbox"/> Banking and Banking Law | <input type="checkbox"/> Business English |
| <input type="checkbox"/> Accountancy (including C.P.A.) | <input type="checkbox"/> Civil Service |
| <input type="checkbox"/> Cost Accounting | <input type="checkbox"/> Railway Mail Clerk |
| <input type="checkbox"/> Bookkeeping | <input type="checkbox"/> Common School Subjects |
| <input type="checkbox"/> Private Secretary | <input type="checkbox"/> High School Subjects |
| <input type="checkbox"/> Spanish <input type="checkbox"/> French | <input type="checkbox"/> Illustrating <input type="checkbox"/> Cartooning |

TECHNICAL AND INDUSTRIAL COURSES

- | | |
|-------------------------------------------------|----------------------------------------------------------------------|
| <input type="checkbox"/> Electrical Engineering | <input type="checkbox"/> Architect |
| <input type="checkbox"/> Electric Lighting | <input type="checkbox"/> Blue Print Reading |
| <input type="checkbox"/> Mechanical Engineer | <input type="checkbox"/> Contractor and Builder |
| <input type="checkbox"/> Mechanical Draftsman | <input type="checkbox"/> Architectural Draftsman |
| <input type="checkbox"/> Machine Shop Practice | <input type="checkbox"/> Concrete Builder |
| <input type="checkbox"/> Railroad Positions | <input type="checkbox"/> Structural Engineer |
| <input type="checkbox"/> Gas Engine Operating | <input type="checkbox"/> Chemistry <input type="checkbox"/> Pharmacy |
| <input type="checkbox"/> Civil Engineer | <input type="checkbox"/> Automobile Work |
| <input type="checkbox"/> Surveying and Mapping | <input type="checkbox"/> Airplane Engines |
| <input type="checkbox"/> Metallurgy | <input type="checkbox"/> Navigation |
| <input type="checkbox"/> Steam Engineering | <input type="checkbox"/> Agriculture and Poultry |
| <input type="checkbox"/> Radio | <input type="checkbox"/> Mathematics |

Name.....
Street..... 8-3-23
Address.....

City..... State.....

Occupation.....

Persons residing in Canada should send this coupon to the International Correspondence Schools Canadian, Limited, Montreal, Canada

Make \$200 a month with this incubator in your spare time

Millions and millions of baby chicks are sold yearly by chick hatcheries all over the country — thousands doubtless sold right in your neighborhood. Why don't you get into the hatchery business for yourself and get these profits? We start you with complete information on chick hatchery operation, management, how to sell, etc. This 2640-egg Buckeye Mammoth Incubator is the machine that has started 1600 successful hatcheries in the most profitable business in the world. Let us tell you how to start small and grow big with a small investment. Write to



The Buckeye Incubator Co. Dept. 781 Springfield, O.

Raise Poultry for Profit!



Make money from poultry; YOU CAN; we show you how. We can show you how to get most winter eggs, and how to hatch and brood strong, healthy chicks; how to make money from poultry. Mr. Harry M. Lamon, President of this Institution, is recognized as the Master Poultryman of the world, and ours is the only poultry correspondence course endorsed by leading agricultural colleges.

Send Today for New Free Book

Tells you all about the many opportunities for profit from poultry, whether you live in city, suburbs, town or country. This book is FREE! Send for your copy TODAY. Special offer now being made — for those who act promptly.



The National Poultry Institute
Dept. 312-A Washington, D. C.



64 BREEDS Most Profitable chickens, ducks, turkeys and geese. Choice, pure-bred northern raised. Fowls, eggs and incubators at low prices. America's great poultry farm. At 31 years. Valuable 100-page book and catalog free. **R.F. NEUBERT Co., Rr 908, Mankato, Minn**



POULTRY Big money. Mrs. Berry tells how in 144-page book, 215 pictures, years of experience, **START** you with Poultry, Eggs, incubators, **BABY CHICKS**, etc. Wonderful book mailed for only a nickel. **Berry's Poultry Farm, Box 78 Clarinda, Iowa**



RAISE BELGIAN HARES
New Zealand Reds — Flemish Giants — American Blues. **BIG PROFITS, WE PAY \$1.50 TO \$3 EACH.** Also Cavies, Mink, Skunk, Fox, Muskrat, Etc. Easily raised anywhere. **FREE!** page Catalog and Contract. Illustrated book "COMMON SENSE RABBIT RAISING," quarterly journal, and copy of America's leading small stock magazine, all for 10 cents. Address **Outdoor Enterprise Co., 1105 D. E. Bldg., KANSAS CITY, MO.**

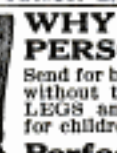

WHY NOT IMPROVE YOUR PERSONAL APPEARANCE?

Send for booklet showing photos of Men with and without the **PERFECT LEG FORMS** for **BOW LEGS** and **KNOCK-KNERS**. Also **BRACES** for children for **PERMANENT CURE**.

Perfect Sales Co., 140 N. Mayfield Ave. Dept. 5, Chicago, Ill.

DEAFNESS IS MISERY



I know because I was Deaf and had **Head Noises** for over 30 years. My invisible Antiseptic Ear Drums restored my hearing and stopped Head Noises, and will do it for you. They are **Tiny Megaphones**. Cannot be seen when worn. Effective when Deafness is caused by Catarrh or by Perforated, Partially or Wholly Destroyed Natural Drums. Easy to put in, easy to take out. Are "Unseen comforts." Inexpensive. Write for Booklet and my sworn statement of how I recovered my hearing.

A. O. LEONARD, Suite 226, 70 5th Avenue, New York City



"I wouldn't take \$1000.00 for what these books and your Consulting Service did for me. They doubled my pay."

E. B. BARTON, Peoria, Ill.

\$1 Brings These Big Pay Helps Right Into Your Home

Do you know that without books and what we learn from them we Americans would all be as badly off as the Chinese coolies, working for a few cents a day?

To earn more, you must learn more.

Men like you are wanted for BIG PAY JOBS all over the country, but to get them and keep them you must KNOW MORE than the average worker. There's only one way to KNOW—READ, PRACTICE AND LEARN.

280,000 Ambitious Men Found Success Through One of These Roads to Bigger Pay

There is no job too big for you, if you will post yourself. Read and gain—strive and rise—practice and perform! These books will show you how to help yourself to bigger things. Read the list, select the set that tells about the job you want or the one you seek to know more about so you can go to the top, then find out below how it will be delivered to your home for \$1.



200 Big Experts Wrote These Pay-Increasers

- 5 vols. Carpentry and Contracting—was \$37.50 now.....\$19.80
- 12 vols. American Law and Practice (including free reading course and 250 page book of standard legal forms)—was \$97.50 now..... 49.80
- 8 vols. Applied Electricity—was \$60.00 now..... 29.80
- 6 vols. Auto Engineering—was \$45.00 now..... 21.80
- 9 vols. Civil Engineering—was \$67.50 now..... 34.80
- 7 vols. Employment Management and Safety Engineering—was \$52.50 now..... 24.80
- 8 vols. Business Management—was \$52.50 now 29.80
- 7 vols. Steam and Gas Engineering—was \$52.50 now..... 24.80
- 4 vols. Sanitation, Heating and Ventilating—was \$30.00 now..... 14.80
- 4 vols. Fire Prevention and Insurance—was \$30.00 now..... 14.80
- 6 vols. Modern Machine Shop Practice—was \$45.00 now..... 21.80
- 4 vols. Telephony and Telegraphy—was \$30.00 now..... 14.80
- 4 vols. Drawing—was \$30.00 now..... 14.80

\$1 Brings the Books And FREE Membership

This is the most liberal offer ever made. The price of the books has recently been reduced to rock-bottom. We will send you any one of the 12 libraries for \$1. Test the books in every way—use them in your shop or office—show them to your friends and to the boss—ask their opinion. If, at the end of a week's examination and trial, you do not honestly believe they will help you earn more money and put you in the BIG PAY CLASS—to say nothing of the value to you of the Consulting Membership, alone worth many times the price of the books—send them back at our expense, and we will cheerfully refund your dollar.

Don't overlook this GREAT OFFER. Fill out the BIG PAY COUPON below and mail today, with your dollar. It will prove the best investment you ever made, as it has for nearly 300,000 others.

American Technical Society
Dept. X119 Chicago, U. S. A.
© A.T.S. 1924

Free Consultation and Advice For One Year

Each subscriber to a set of these books is entitled to a FREE CONSULTING MEMBERSHIP in The American Technical Society for ONE YEAR. This consulting privilege alone may be worth a thousand dollars to you, just as it was to Mr. Barton. Here is how it works: You are free at all times to make use of our resident staff of 20 practical experts. Ask them to solve any problems you encounter in your business. Ask them about the latest methods and best ways of doing things. Let them check over work you have already done to safeguard against errors. Get their advice on what to do when you come to a fork in the road and don't know which way to turn. Let their expert knowledge guide you step by step when you change your job and mount to bigger, better things. Let this PAY-RAISING CONSULTING STAFF be your SILENT PARTNER in business. Write or wire at any time and an immediate answer and solution to your problem will be sent. Just imagine getting such a power to lean upon—for one whole year—without one cent above the cost of the books!

AMERICAN TECHNICAL SOCIETY, Dept. X119, Chicago.

I am enclosing \$1.00 as deposit. Please send me a set of..... for seven days' Examination, shipping charges collect. I will examine these books thoroughly, and if satisfied, will send \$2.50 within seven days and \$3 a month until I have paid the special price of \$..... If I decide not to keep the books, I will return them within one week at your expense and you are to return the \$1.00 I am sending. It is understood that if I keep the books I am entitled to a FREE Consulting Membership.

Name.....
Address.....
Referen ce.....
(Please fill out all the lines, give local merchant, banker or employer as reference.)

BOYS



Learn Electricity

How would you like to earn two or three dollars every evening after school and prepare yourself for a fine big job at the same time? Here's the opportunity of a lifetime for you fellows who like Electricity. Begin right now to prepare yourself for a regular man's size job in this fascinating field. Your chances for a big success are simply wonderful—the pay is big (\$70 to \$200 a week) and advancement comes swift and sure.

I Will Train You at Home

Look What This Boy Is Doing

"Although the School term is coming to a close, and I am pretty busy with my examinations, I manage to keep up with my electrical studies and work.

"I guess I forgot to tell you I am now in business for myself. Am doing fine, but owe it all to you. If it had not been for your Course, I, being under age, could not have secured my license in this town. But I got it, and now have all the work I can do, averaging \$20 to \$30 a week through spare time work.

"I went out on a job tonight after school, on which I made \$2 and brought home another on which I made \$2.50—\$5.50 for 4 hours work and no material furnished by me."

ROGER SMITH,
1215 Chestnut St.,
Greenville, N. C.

With my easily learned, spare time Electrical Course I will train you at home like I have trained hundreds of other boys who are now big successful men. It will not interfere with your school work and you can earn more than the small cost of the course doing odd electrical jobs in your spare time. The Course pays for itself. I will show you how to get this work and how to do it. Some of my boy students make \$10 to \$15 a week this way.

Tools, Apparatus and Radio Course FREE

Send me the coupon below and I will tell you all about the big outfit of tools, apparatus and instruments and a new Radio Course that I am giving to my students for a limited time. I will send you my big interesting Electrical Book and a sample lesson, too—all Free. You will be tickled with the things I will send you Free. Mail the coupon right now.

L. L. COOKE, Chief Engineer
Chicago Engineering Works
Dept. A-11 CHICAGO

Use This "FREE OUTFIT" Coupon

L. L. COOKE, Chief Engineer,
Chicago Engineering Works,
Dept. A-11, 2150 Lawrence Ave., Chicago

Send me your Free Outfit Offer, your big Electrical Book, Sample Lesson and particulars of your Electrical Course and Free Radio Course. This will not obligate me in any way.

Name.....

Address.....

For use of boys 15 years old or more.

Get Poultry Money Now!

Send for this
FREE BOOK!

No matter where you are located—you can make splendid money with poultry. Thousands are cutting living costs and selling eggs at fancy prices. Prof. T. E. Quisenberry's New Book, "Dollars and Sense in the Poultry Business," outlines easy-to-apply methods which bring startling results.

Make Your Back Yard Pay Big!

Mrs. Wildt made \$2,000.00 with 500 hens. Mr. Luttrell averaged \$5.00 per hen profit. Began with just a few. Wonderful records natural when you follow the "QUISENBERRY WAY." All outlined in this 96-Page FREE Book.

60 More Eggs Per Hen Guaranteed

We tell you how to add 100 Eggs or more per hen. Advanced methods not available elsewhere. Will revolutionize poultry industry! Tells How to Get More Eggs in Winter; How to Save Feed; How to Cull Out Non-Layers; How to Raise Baby Chicks without Loss, etc. The Book is FREE. If you send 25c we will send you 25 colored leg bands to mark your best layers. Mention Breed of Hens. Send at once.

**FREE
BOOK**
96
Pages

American Poultry School
Dept. 161
KANSAS CITY, MO.



LET THE "SUCCESSFUL" RELIEVE YOU OF HATCHING WORRIES



31 Years
of Big Success

Des Moines Incubator Co., 689 Second St., Des Moines, Ia.

Mail a postal—get our offer. Poultry lessons free to every buyer. Booklet, "How to Raise 48 out of 50 Chicks," sent free on request. Catalog FREE. Make green, egg-making feed in "SUCCESSFUL" Grain Sprouters.



American Poultry Journal

OLDEST, LARGEST and BEST
4 MONTHS' TRIAL 25 cents

1 Yr. 75c. 2 YEARS \$1 5 Yrs. \$2

Averages over 100 pages per issue—tells how to feed, house and breed; how to secure high egg production, how to hatch and rear poultry successfully. Established 1874. Only 25 cents for 4 months. Stamps accepted.

American Poultry Journal, 14-523 Plymouth Ct., Chicago

POULTRY MILLER'S GUIDE

—tells all about chickens—care, feeding and raising for profit. Also describes IDEAL INCUBATORS, Hot Water and Electric IDEAL RECODERS—Coal and Oil Burning—FREE Baby Chicks, Eggs for Hatching. Special Low Prices.

J. W. MILLER CO., Box 12, ROCKFORD, ILL.



PLANS for Poultry Houses!

All styles. 150 illustrations; secret of getting winter eggs, and copy of "The Full Egg Basket." Send 25 cents. INLANDPOULTRY JOURNAL, Dept. 74, Indianapolis, Ind.

SQUAB BOOK FREE!

Squabs are selling at highest prices ever known. Greatest market for 20 years. Make money breeding them. No mixing feed, no night labor, no young to attend. Start small, grow big. Start now. Read how our customers sell squabs for \$12 a dozen. We have been established for 23 years. Better look into this. Let us send you, at no cost to you, our big, illustrated free book telling how to make money breeding squabs. Address



Plymouth Rock Squab Co., 634 H St., Melrose Highlands, Mass.

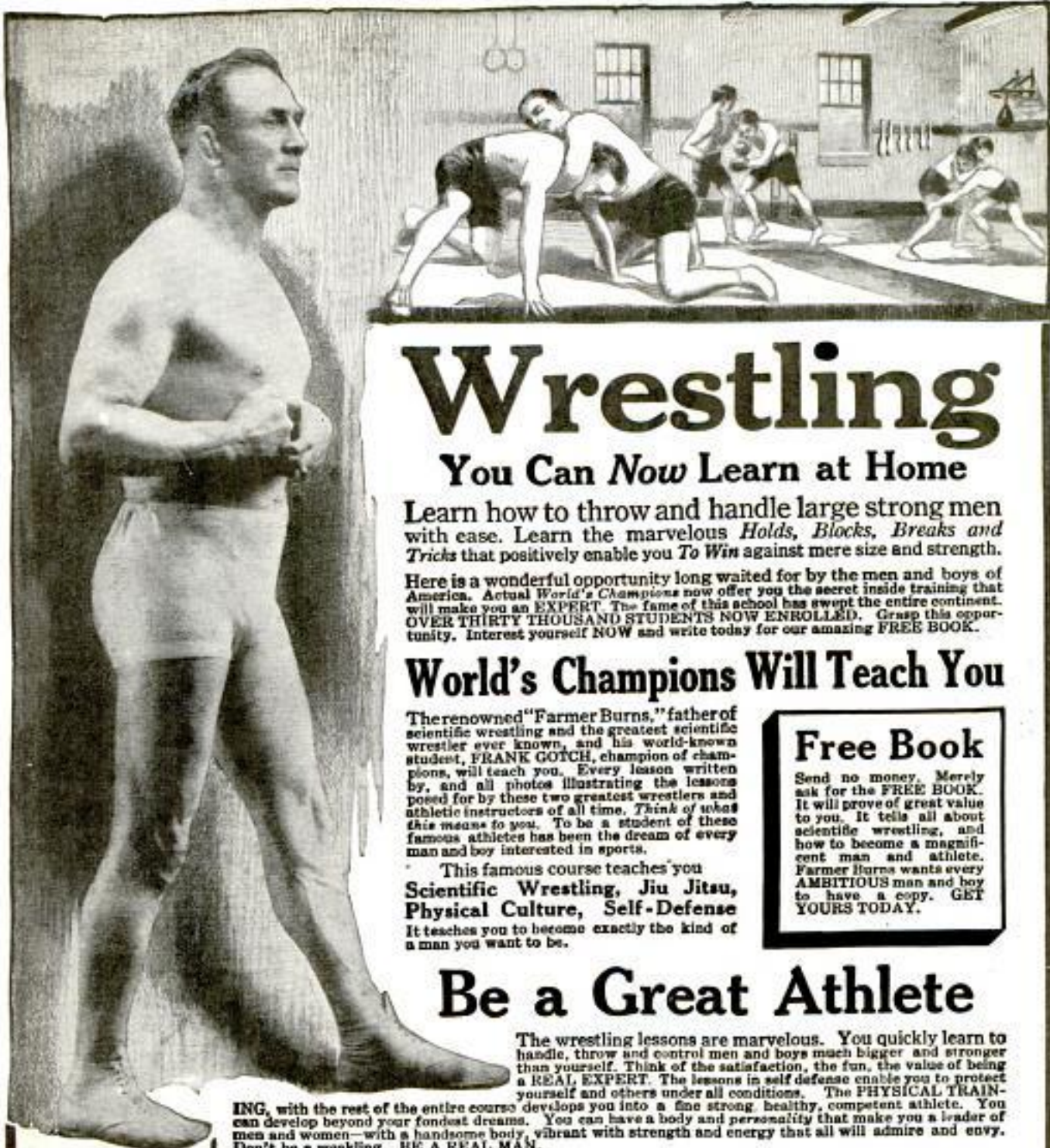

Wrestling

You Can Now Learn at Home

Learn how to throw and handle large strong men with ease. Learn the marvelous *Holds, Blocks, Breaks and Tricks* that positively enable you *To Win* against mere size and strength.

Here is a wonderful opportunity long waited for by the men and boys of America. Actual World's Champions now offer you the secret inside training that will make you an EXPERT. The fame of this school has swept the entire continent. **OVER THIRTY THOUSAND STUDENTS NOW ENROLLED.** Grasp this opportunity. Interest yourself NOW and write today for our amazing FREE BOOK.

World's Champions Will Teach You

The renowned "Farmer Burns," father of scientific wrestling and the greatest scientific wrestler ever known, and his world-known student, FRANK GOTCH, champion of champions, will teach you. Every lesson written by, and all photos illustrating the lessons posed for by these two greatest wrestlers and athletic instructors of all time. Think of what this means to you. To be a student of these famous athletes has been the dream of every man and boy interested in sports.

This famous course teaches you **Scientific Wrestling, Jiu Jitsu, Physical Culture, Self-Defense**. It teaches you to become exactly the kind of a man you want to be.

Free Book

Send no money. Merely ask for the FREE BOOK. It will prove of great value to you. It tells all about scientific wrestling, and how to become a magnificent man and athlete. Farmer Burns wants every AMBITIOUS man and boy to have a copy. GET YOURS TODAY.

Be a Great Athlete

The wrestling lessons are marvelous. You quickly learn to handle, throw and control men and boys much bigger and stronger than yourself. Think of the satisfaction, the fun, the value of being a REAL EXPERT. The lessons in self defense enable you to protect yourself and others under all conditions. The PHYSICAL TRAINING, with the rest of the entire course develops you into a fine strong, healthy, competent athlete. You can develop beyond your fondest dreams. You can have a body and personality that make you a leader of men and women—with a handsome body, vibrant with strength and energy that all will admire and envy. Don't be a weakling. BE A REAL MAN.

ING, with the rest of the entire course develops you into a fine strong, healthy, competent athlete. You can develop beyond your fondest dreams. You can have a body and personality that make you a leader of men and women—with a handsome body, vibrant with strength and energy that all will admire and envy. Don't be a weakling. BE A REAL MAN.

Farmer Burns

The world's greatest wrestler and athletic instructor. His school is a real sensation. His students are tremendously enthusiastic and secure results beyond their fondest dreams. You can become the student of this famous man and of the peerless FRANK GOTCH. If you are a man or boy with red blood, and ambitious to become a real man and to SUCCEED, then by all means do not lay this magazine aside until you have written the school for full particulars.

WIN

Write Today!

Get our new FREE BOOK, brimful of interest and fascination. It tells you how to learn right in your own home in spare time to be A SKILLED EXPERT WRESTLER, wonderful at self defense, and how to WIN all games and physical contests. It will open to you the road to success in everything you undertake. You OWE it to yourself to INVESTIGATE. May we send the FREE BOOK? Ask today.

Farmer Burns School
1771 Railway Exchange, Omaha, Neb.

FREE Book Coupon

FARMER BURNS SCHOOL
1771 Railway Exchange, Omaha, Neb.

Please send at once without obligation on my part, your FREE BOOK on Scientific Wrestling, Physical Culture, Self-Defense and How to Win.

Name.....

Address.....

Age.....

\$90 Drafting Course FREE

**\$300 a Month Salary—
\$450 on the Side at Home**



Chief Draftsman Dobe

That's the kind of money my drafting students make. Read what this one says: *"As a beginner I am doing fine. Am earning a salary of \$300 per month, besides I made over \$450 at home the last two months, drawing plans for private parties. The practical drafting training you gave me by mail but me where I am in less than six months' study. Thank you for all your personal interest and help you gave me so far."*

—(Signed) J. B. (Name and address upon request).

I Guarantee to Train You
until you are holding a position paying
up to \$250 and \$300 a month!

I do this by a method that is entirely original with me. I give you personal training at home by mail until you are actually placed in a position paying up to \$250 and \$300 a month. Write for full particulars.

Drawing Table FREE!

I am giving this practical folding Chief's Own drawing table to each of my students positively without cost. I am making this offer to get men everywhere interested in the great future which a draftsman has. More draftsmen are in demand today—right now—than ever before. It has been estimated that there are 6,000 calls for draftsmen every month.

So, I want students to enroll early.

Pocket Rule FREE!



To everyone who writes now for the offers which I am making, I will send this Ivorine pocket rule free. All you need tell me is that you are more than 16 years old and that you are interested in becoming a draftsman. I want you to have this reminder of the great future which will be in store for you if you become a draftsman.

Drawing Outfit FREE

To every student enrolling now I give an opportunity also of getting a regulation draftsman's outfit made up of the very same instruments which I use myself. The outfit contains everything necessary for the performance of your work in drafting. Every student gets this splendid set without cost. I am making this splendid offer because all men who want to become draftsmen working under fine, clean conditions and with opportunities for fast advancement should enroll NOW!

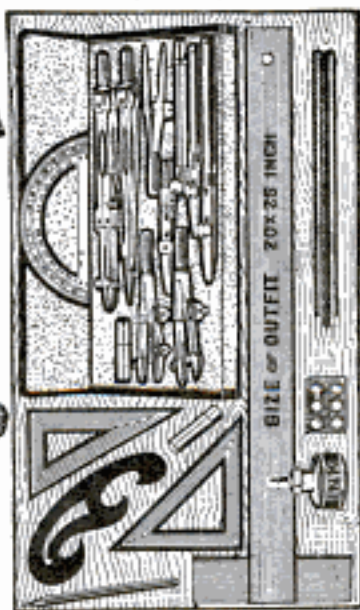
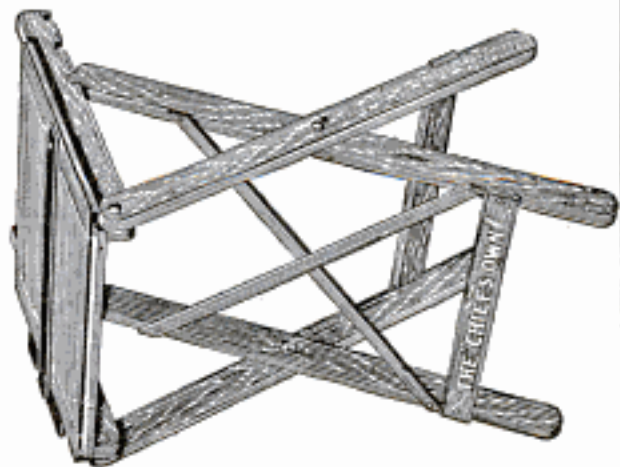

Chief Draftsman, Engineers' Equipment Co.
1951 Lawrence Ave., Div. 13-51, Chicago, Ill.

Without any obligation to me please mail your book "Successful Draftsmanship" and full particulars of your liberal "Personal Direction" offer to a few students. Also full information as to how I can get a \$80 Drafting Course Free.

Name.....

Address.....

← Send Coupon

Send coupon for my free book, "Successful Draftsmanship". Also full information as to how you can get a \$90 Draftsman's Course Free. Send coupon now for free book.

Chief Draftsman, Engineers' Equipment Co. 1951 Lawrence Avenue Div. 13-51, Chicago, Ill.

POPULAR MECHANICS

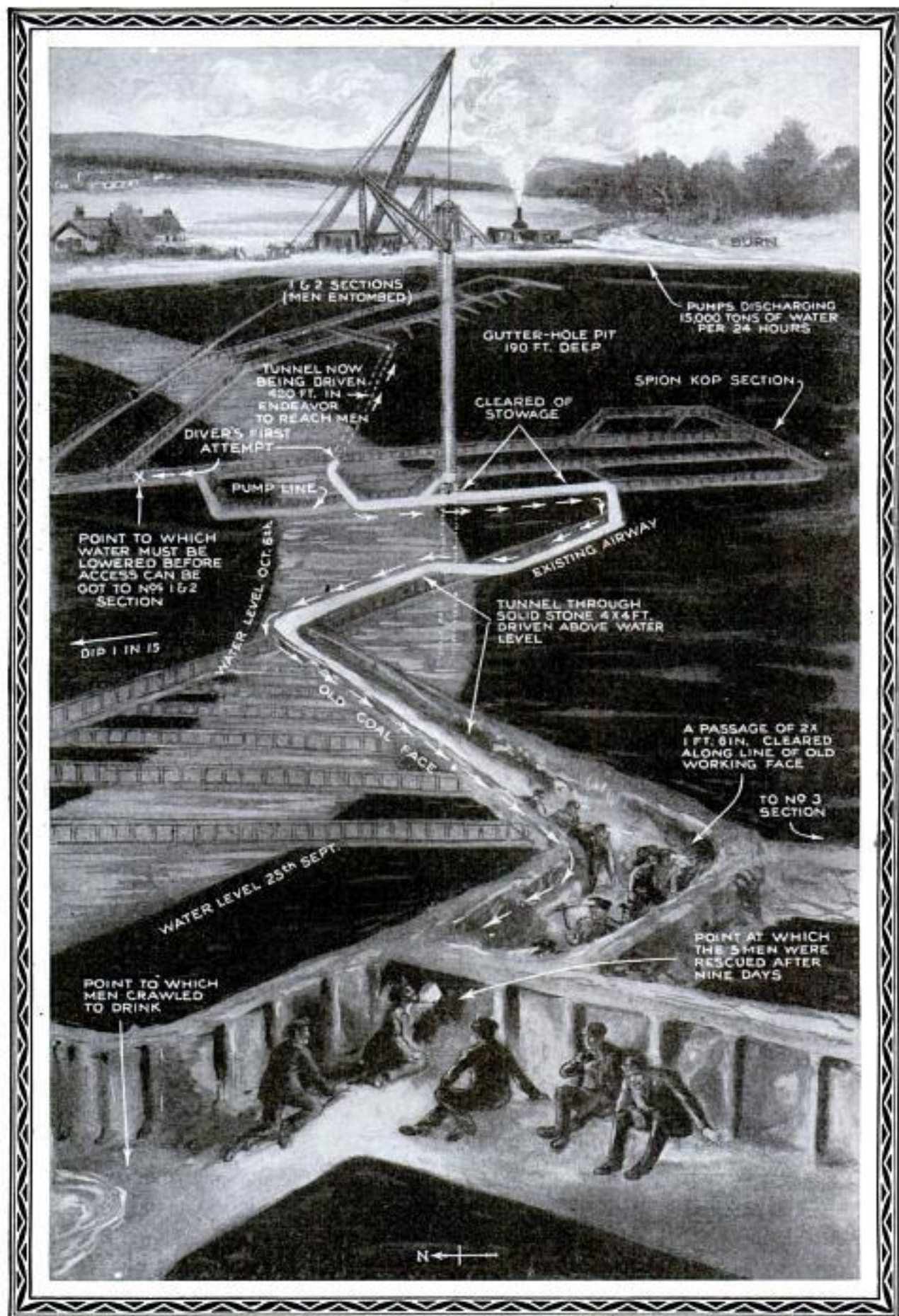

Rescuing the Five Men Imprisoned by a Scottish Mine Disaster Required Nine Days of Valiant Work. Divers Attempted to Penetrate the Wall of Water Surrounding the Victims. [Courtesy The Sphere, Copyright]

Popular Mechanics Magazine

REGISTERED IN U. S. PATENT OFFICE

WRITTEN SO YOU CAN UNDERSTAND IT

Vol. 41

JANUARY, 1924

No. 1

3743 Miners Rescued After Nine Days in Pit

Trapped by Flood Waters from an Underground Stream, with Only Crust of Bread as Food

IMPRISONED for nine days far below the surface in the damp workings of a flooded mine in Scotland, their only food a single slice of bread, five miners recently were found alive, and not seriously harmed by their experience. The same waters that trapped them caught 75 others, some of whom, near the surface, escaped alive.

For more than a week in the inky darkness, the men wandered about the chambers untouched by the flood, seeking fresh air and a means of exit. Lights were impossible, for the explosive "black damp" was too heavy, yet the little group steadfastly resolved to perish or live together.

On the first day they waded waist deep to a place of safety, where, when pangs of hunger attacked them, they divided the slice of bread. The second day passed, after hours of torment and anxious waiting for sounds that would indicate rescue crews were blasting their way toward the barrier behind which the victims finally had stationed themselves.

Near the end of the first 48 hours, a dull

boom broke the tomblike silence. It was quickly followed by another, and still another. To the imprisoned, the shots brought joy and hope, for they heralded the approach of help. Hands were clasped and thanks voiced for their expected deliverance. But their hopes soon dwindled as the long hours dragged on and it be-

came apparent that their would-be rescuers faced more than a possibility of losing the race against time.

Yet not entirely giving way to despair, the five waited expectantly behind their shelter, crawling up and down the workings to keep from becoming cold and cramped, and occasionally making their way to the underground stream to drink. Farewell notes were prepared for loved ones.

But no other eyes ever saw their letters.

For, just as the ninth day was drawing to a close, the raspings of picks on the walls of their living crypt were plainly heard. Their vigil was almost ended.

As the last blow was struck by the rescuers, the sandstone wall opened. A hand



Breaking Through the Last Barrier that Formed a Living Tomb for the Patient Captives Far Underground

The Sphere October 13, 1923

Copyrighted material

was thrust forward from within and a voice was asking for a cigarette. The first one to reach the imprisoned men was a young miner.

"I never saw a cheerier lot of lads than those men at that moment," he said. "The strange thing about it is that, even with good air, they were able to endure such a long time underground. I should fancy

men would have been driven insane by such an experience."

Displaying but a few outward signs of the effect of their lengthy imprisonment, the five crawled to the tunnel that led to freedom and the world above, insisting on going to the shaft unaided. Above ground, physicians met them, but only one was found near a state of complete collapse.

4103

FALLEN BRIDGE WEIGHT HALTS TRAFFIC ON CANAL

When a huge concrete balance weight, used to raise and lower a 300-ton "jack-knife" bridge over the Lachine Canal, became detached from its supports, the span fell across the stream and for a few days tied up shipping into Montreal, Canada. The block, weighing 1,800,000 pounds,

crashed down just as a steamer had passed and the falling bridge narrowly missed the boat. Two large scows were placed under the fallen structure and as the water level in the canal was raised by closing the locks, the span was floated until it could be swung ashore and repaired.



Heavy Concrete Balance Weight of Drawbridge which Crashed Down as the Great Span Was Being Lowered

ARTILLERY AND SIRENS PLAY SOVIET "JAZZ" 4123

Dispatches from Russia recently told of an attempt by the Soviet government to produce a new bolshevist "jazz" in Moscow. The occasion was the sixth anniversary of the revolution, and the orchestral din that arose was beyond description. Meager reports from the seat of the noise have failed, perhaps because of the stupor in which the music left the populace, to give details of the symphony. Musicians in this country have speculated, however, on the possibilities of some such combination of "instruments" with interesting results. Factory sirens are, of

course, not all tuned to the same key, nor are locomotive whistles. It would, therefore, be entirely possible for a city, in which there were a large number of factories and railroad yards, to find a sufficient variety of tones to "carry the tune." Of course, there would be little smoothness to the resultant melody, for not all whistles or sirens are equal in power. In the Russian "orchestra," the rattle of machine guns took the place of snare drums, and the boom of artillery furnished the rhythm of the bass drum. The conductor "led" by means of electrical signals flashed from the top of the Moscow power plant, which is easily seen from all sections of the city.

*Cont. W. F. Rouse, c/o Montreal Star
St. James Street, Montreal, Canada*

New York Herald

WAR ON EAGLES THREATENS BIRD'S EXTINCTION

4138

Alaska's campaign against the bald eagle threatens extinction of the species. The territorial authorities some years ago authorized a bounty of 50 cents on each bird destroyed, and it is estimated that fully 18,000 have been killed in the last six years. The eagle lives principally upon salmon, and, as that industry is one of the most important in the territory, some such action was deemed imperative to safeguard the interests of the salmon packers. Great numbers of white men and Indians joined the ranks of the hunters, attracted by the rewards as well as the sport of the chase.

overhead wires runs a motor-driven propeller in the barge's stern. Only one man is needed to steer, and operating costs are

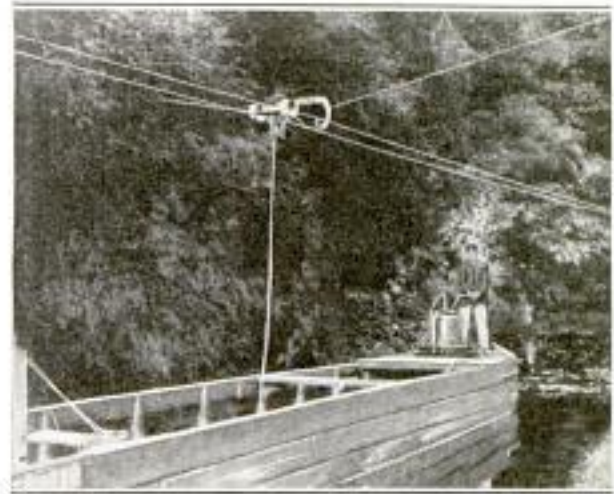

Electric Barge that May Replace Horse-Drawn Boats, Gliding Along an English Canal

CANAL BOAT LIKE STREET CAR RUNS BY TROLLEY

3957

Experiments in driving canal barges with an electric trolley are reported to have been successful in a recent trial in England. Greater speed is said to have been attained, and the economy of the method may lead to electrification of other canals in that country. Power taken from

expected to be reduced 50 per cent. In the trial, a fully loaded barge attained a speed of four miles an hour, approximately doubling that of the average horse-drawn boat.

International Museum

4061

HOMES FOR WORKMEN SPRING UP LIKE MUSHROOMS

To provide cheap homes for thousands of working people of New York City, who are facing the serious problem of finding suitable living quarters at low rentals, a development company is building complete

frame houses at the rate of two a day on Long Island. Each structure is large enough to accommodate an average family comfortably. In 120 working days, 280 dwellings were practically finished.



Underwood

Copyright, Underwood & Underwood
Colony of Frame Dwellings Built on Long Island at Rate of Two a Day to Provide Cheap Living Quarters for Working People of New York City

*Ford Houses. Realty Associates, New York
Sheephead Bay, L.I.*

**INSULATORS ON WARSHIP LIKE
3916 STRINGS OF BEADS**

Every rope and stay of the "Colorado," Uncle Sam's new electrically driven warship, is thoroughly insulated, the knobs



Ropes and Lines on Warship Studded with Insulator Knobs Resembling Strings of Beads

giving it the appearance of being decorated with strings of large beads. Because of the great amount of current generated aboard the vessel and also because the radio is so necessary for its guidance, no electrical leakages can be permitted anywhere aboard. According to navy officials, the craft is one of the best insulated ships afloat.

**SUGAR MADE FROM CHEMICALS
4081 RIVALS CANE PRODUCT**

Synthetic sugar manufactured from chemicals by a carefully guarded secret process is said to have been produced in the laboratory of an Australian scientist. It is so like the natural article that experts, according to reports, have been unable to tell the difference between it and that extracted from cane. The method consists of combining by artificial means, certain elements which are condensed by sunlight in the natural growth of the cane.

discovered by an Australian scientist - Prof. Bradley
Cml A. White *Norma, Sydney*
Mount St. Brathfield, N.S.W. Australia

**FIRES OF QUIET VOLCANO
4084 HEAT CITY**

Because it lies at the foot of a partly extinct volcano, the streets of Rabaul, capital of Pomerania, are reported to grow so hot at times that citizens are unable to walk upon them even when wearing thick-soled shoes. The temperature in the main thoroughfare several years ago, is said to have risen 37 degrees in two and a half hours. Steam rose through the ground, and the residents, fearing a volcanic eruption, prepared to flee. Scientists say that there is little danger, and that the disturbances, which are accompanied by mild earthquake shocks, are due to the temporary thinning of the earth's crust during cooling and settling.

4027

**NOVEL BOOSTER FOR CROPS
IN NEBRASKA EXHIBIT**

Sheaves of grain and bright-colored ears of corn were fashioned into figures of a farmer, a pig, and a model barn, to emphasize to growers attending a recent county fair in Nebraska, the importance of raising more corn and hogs. The man was shown emerging from the miniature building to lead a campaign for greater agricultural production. The barn was decorated with festoons of large vegeta-



Attractive Exhibit at County Fair in Nebraska Shown in Campaign for Paying Crops

bles, and designs were traced in split ears of corn nailed to the siding on the outer walls. The roof was thatched with stalks.

ⓄDynamite was used to remove a huge iron pulley in a western city recently. Although the building was small and 30 sticks of explosive were used, no harm was done to the walls.

3987 Frederick W. Jensen,
 106 West St, New York City
 POPULAR MECHANICS Watchmaker

CLOCKS IN ODD FIGURES SHOW MAKERS' SKILL

Showing skill possessed by watchmakers long before members of this ancient craft had advantages of modern tools, a collection of old timepieces owned by an eastern jeweler, provides an interesting contrast with similar creations of a machine age. Many clocks were framed in queer human figures. One was cleverly made in a suit of armor that moved the

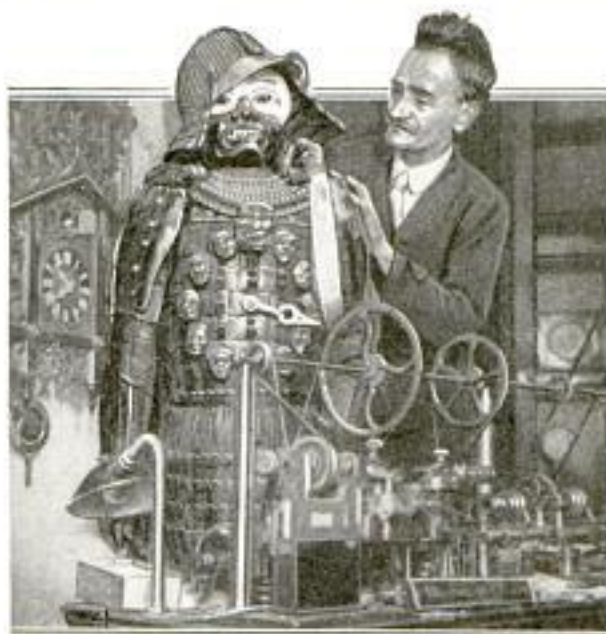

hands around the chest and opened and closed the eyes and mouth, at every hour. After five and a half years of labor, one man completed an odd mechanical clock containing 298 moving figures, carved from oak with a penknife. They depict various historical scenes. Experts say that the watches in this display of mechanics of a past day are marvels of art and workmanship.



Photos Copyright Kerstone View Co., Inc.

Odd Clocks Built in Imitation of Persons and Scenes of Long Ago: Above, Timepiece as an Armored Knight; the Mouth and Eyes Moved as Each Hour Struck

3980

CHECKER FOR LUNCH ROOM SAVES ERROR ON BILLS

Elimination of error and loss is claimed for a novel method of automatic restaurant control recently demonstrated. The system presents the customer with an itemized bill, totaled and correct, and keeps an equally close check at the point where the waiter receives the food. A series of compartments labeled with the items on the menu are controlled by a machine. The

name of the item and its price are printed on the ticket when inserted in the slot of any section. A slug is also ejected which the waiter exchanges with the kitchen attendants for the article stamped on the slip. When the order has been filled, the check is placed in the totaling device which adds it and prints the amount.

Despite the great cost of radium, it is estimated that 50 per cent of the treatments given with it have been free.

Inv. H. Russell Brand
 1 Park Row, New York.

Copyrighted material

3965

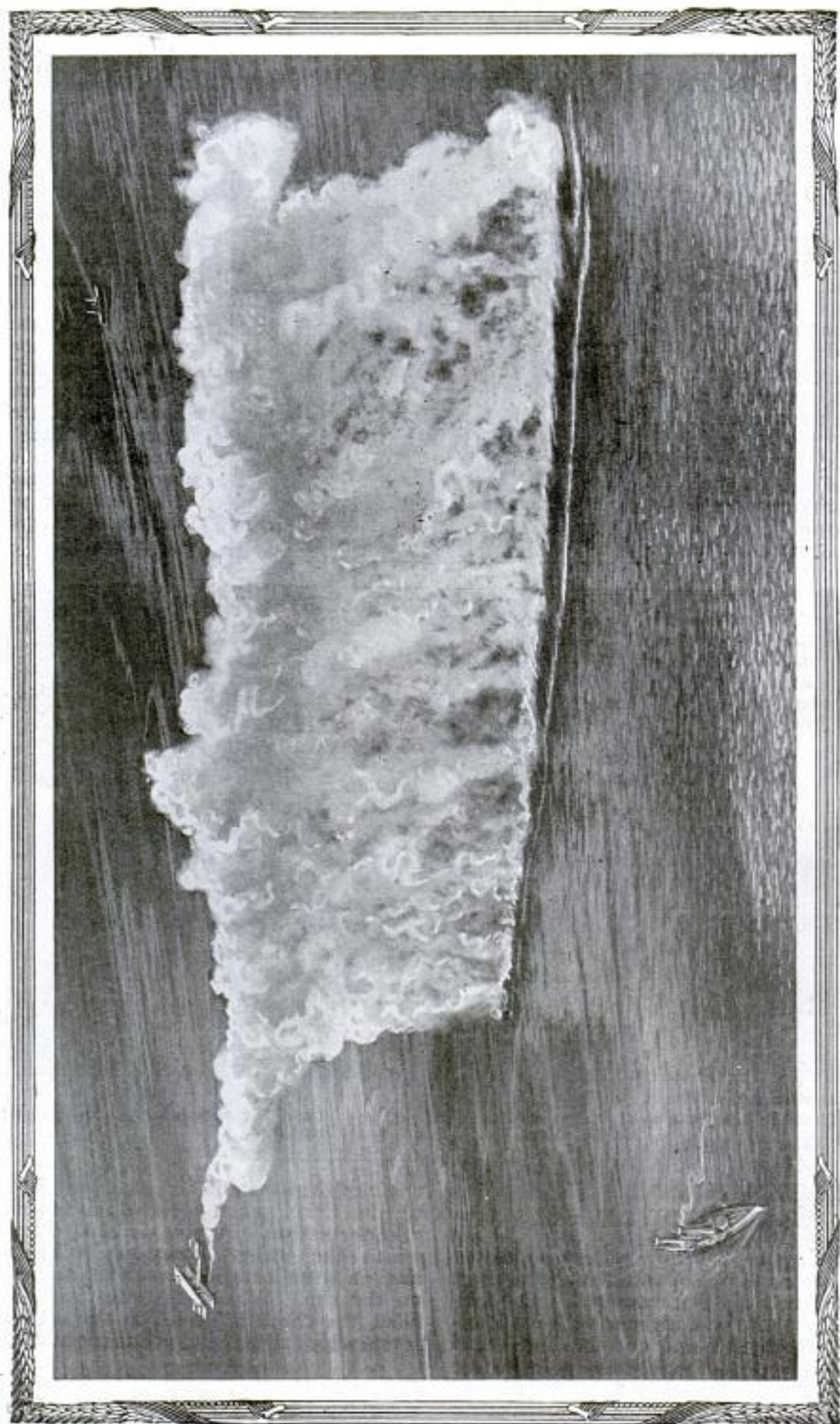

Smoke Curtain Created by Airplane to Hide War Vessels: Note the Thin Stream of Gas Leaving the Nozzle on the Plane; the Mass of Vapor Spreads Downward to the Surface of the Sea, Hanging in a Heavy Screen

Martin Lumber

Dr. J. E. Heasche
2827 Silver St.

POPULAR MECHANICS Los Angeles Calif

AIRPLANE SMOKE CURTAIN HIDES NAVY FORCES 3965

Appearing to grow from the surface of the sea a smoke screen laid down in recent naval trials held by the government, was created by chemicals dropped by an airship. As the plane rushed through the air, the gases were literally sprayed in its wake. Instead of rising, the vaporous mass settled toward the surface of the water, creating a curtain behind which both warships and aircraft could have maneuvered unseen by enemy observers at sea level.

MOTOR CHAIR FOR THE AGED IS EASILY OPERATED 4130

Designed for the convenience of aged persons or invalids, a three-wheeled electric motor chair, with storage batteries, has been constructed by a western inventor. It runs on two speeds, six or twelve miles an hour, and is steered like a tricycle by a handbar attached to the front wheel. The current is controlled by a lever at the left.

"STONE FISH" OF TROPICS HAS DEADLY STING 4078

Although only 10 inches long, the "stone fish" of the tropics is one of the most deadly denizens of the seas. It has a sharp spine near the end of its tail, and when trodden upon it injects a virulent poison into the wound caused by this spicule. The venom affects its victim in much the same manner as the poison curare: paralysis, convulsions, and sometimes death, or at least the loss of a limb. This fish frequents shallow water on a reef, or is to be found near the sandy border of a beach.

See page 1930-916



Motor-Operated Vehicle that is Boon for Old People

Emb. A. Whitehorn
Mumford St., Strathfield
Sydney, New South Wales Australia

3910 June

EXACT TOUCH OF PIANIST PUT ON PLAYER ROLLS

To do away with the need of correcting master music rolls from which player-piano selections are made, a device that registers the exact touch of the pianist has been invented by a noted musician. With

this apparatus, it is said, the original is turned out free from errors, thus resulting in a considerable saving. Usually all corrections must be performed by hand, requiring much time and energy.

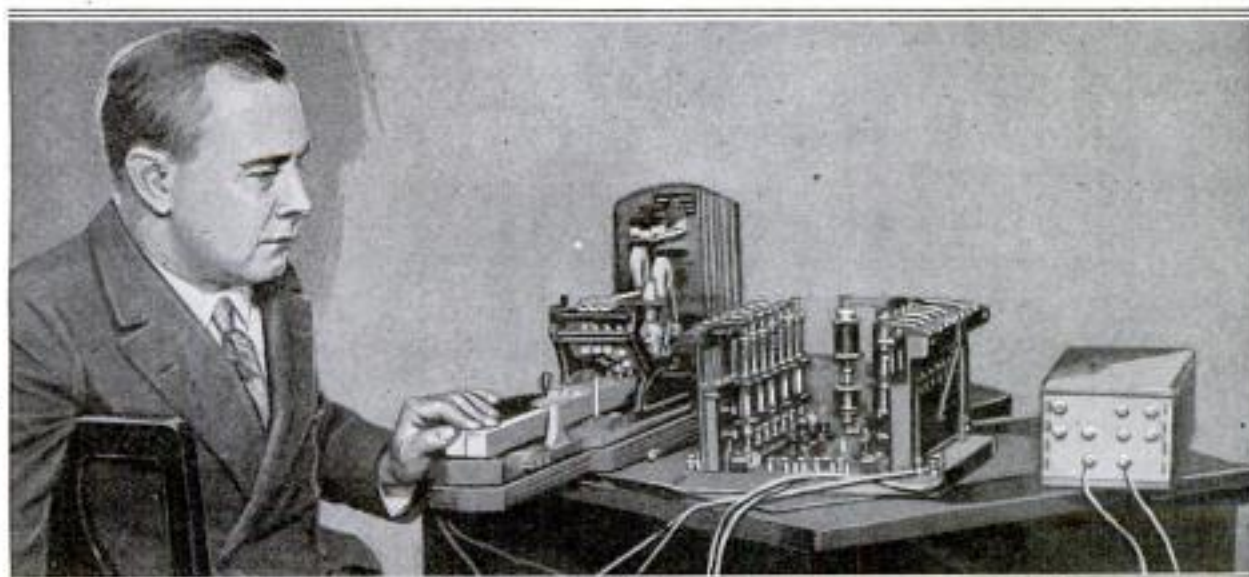

Costly and Laborious Hand Corrections of Player-Piano Rolls Eliminated by Invention of Famous Musician, which Automatically Performs the Work

Inventor Joseph Hofmann 90 Woffen material
Musical Bureau, 8 E. 34th St. New York

Hidden Stars Make Glitter for Opera's Stage

By J. JOSEPH SOLOMON

OF the thousands of dollars annually spent in the production of grand opera, almost one-fifth is said to go into the scenery, costumes, and other properties that depict the colorful backgrounds of the plays.

In the designing of the massive drops and sets used by one of the largest opera companies, 28 miniature scenes, models of those to appear in the portrayal of the repertoire, were painted by a skilled artist. Tiny figures in imitation of the players were posed about so that no detail should be overlooked when the final "sets" were completed.

Even the miniature scenes for such operas as "Carmen" and "Madama Butterfly" are so carefully made that they suggest the spirit of the countries in which their stories are laid. In the street scenes, carts, animals, and figures of people are created with such artistry that, though small, they rival reality itself. Color combinations are carefully worked out. The position of the houses, gardens and walls, and the effect of light on the various objects, are all studied in order to mimic as closely as possible the nature of the locality and the general styles that marked it during the period in which the action is supposed to have taken place.

Armed with these patterns, the craftsmen behind the scenes begin to create from mountains of materials, the massive properties. Great curtains or drops are built from a strong fabric. Painters, masters of



the brush whose business is entirely confined to the designing of stage scenery, work up forested backgrounds, sunsets and dawns that vie with those made by nature.

In the meanwhile, from drawings furnished him, the director of properties gathers the articles needed in interiors. If a church scene, say of the twelfth century, is to be produced, there are altars, candlesticks, an organ, seats and like objects that must appear as really belonging to the time. First, museums and art galleries are consulted for records, picture or copies of such things. Photographs are then furnished the carpenters and cabinet makers to guide them in their task of artful imitation. Ordinary woods are used in the furniture, and surfaces are carefully stained to resemble the originals. Where a fireplace must be made, a skeleton of

framework is put up, and over this is tacked a covering of burlap or other coarse cloth drawn tightly about it. The matter of the outside is one which the type of the article itself determines. An ordinary plaster, marked in squares, serves to imitate dressed stone. If the affair is to be a rough finish, ground cork mixed with glue is smeared over the cloth, and a finishing coat of proper color is applied in paint. The electrician then wires it for the fire which glows from colored incandescent lamps.

Whether the set is a peasant's home in Italy, the dwelling of a struggling villager of Russia or the castle of an ancient king, no piece of property, however small, is overlooked. Everything from a broom to a throne room is accurately checked up for style. Should the inside of a hovel be shown, great care is taken that none of its furnishings belongs in a mansion. A village blacksmith of the fourteenth century could not be properly portrayed by an actor wearing boots that might have been worn by a cavalier. Neither would the cavalier be correctly dressed in a pikeman's helmet. Even the letters, papers, and documents which are handled during plays are true copies of some that once

existed. Some singers refuse to pretend to read from blank papers, but must have printed copies of the original documents costing big sums of money to obtain.

To avoid any errors in this policy of realism, each piece of a set is labeled and kept in its proper case or trunk which also bears a similar mark to guide the property men. Acres of space would be filled by the cases and hampers which contain complete equipment for more than 25

operas. A system of records makes it possible to locate and unpack any desired material in a few moments.

The fact that the various articles needed to make up a scene can hardly ever be obtained from dealers in antiques, necessitates the establishment of shops and studios wherein these things can be worked up by a large staff of specialists. To have them made by outsiders would send the cost to prohibi-

tive heights. For instance, in one scene of an opera the principal character must simulate insanity. Waiting for the execution of a sentence of death which has been pronounced upon him, he counts the hours as he watches the clock. Madness attacks his mind and to his delirious eye the hands of the clock seem to whirl around the dial. A bronze eagle which is perched on top of the timepiece as an ornament appears to him to flap its wings and try to escape. In permitting the audience to see with the madman's eyes, a clock was made with a mechanical arrangement that would produce this effect. At a given signal, an attendant back stage works it by means of a rope and a small pulley.

In "Samson and Delila," the properties call for immense columns that, in accordance with the story of the opera, are overthrown by the captive giant. Although these are made of substantial materials, hardly a performance of the play takes place without some injury to them, necessitating frequent repairs. New paint must be put on and perhaps a few patches of plaster. This mending is generally done on the stage between performances.

The carpenter shop is a constant scene of activity. Furniture, of the Louis XV

Opera as an Industry

SEVERAL millions of dollars are invested in properties and other stage equipment by one of the big opera companies. Over five thousand huge scenic curtains measuring sixty by forty feet are tucked away much like books in a library. Each one is labeled and numbered with its position in a set. It is estimated that several hundred pounds of paint are necessary properly to cover one of these drops.

The workrooms of the property men are constantly busy throughout the year replacing and repairing scenery and costumes and making new material.

The costumes alone would require two railroad cars to transport them. The home stage of this company is entirely mechanically operated. It is built in five sections which can be raised or lowered from ten to twenty feet by steam rams. Not more than a few minutes is necessary to complete such a change in its level.

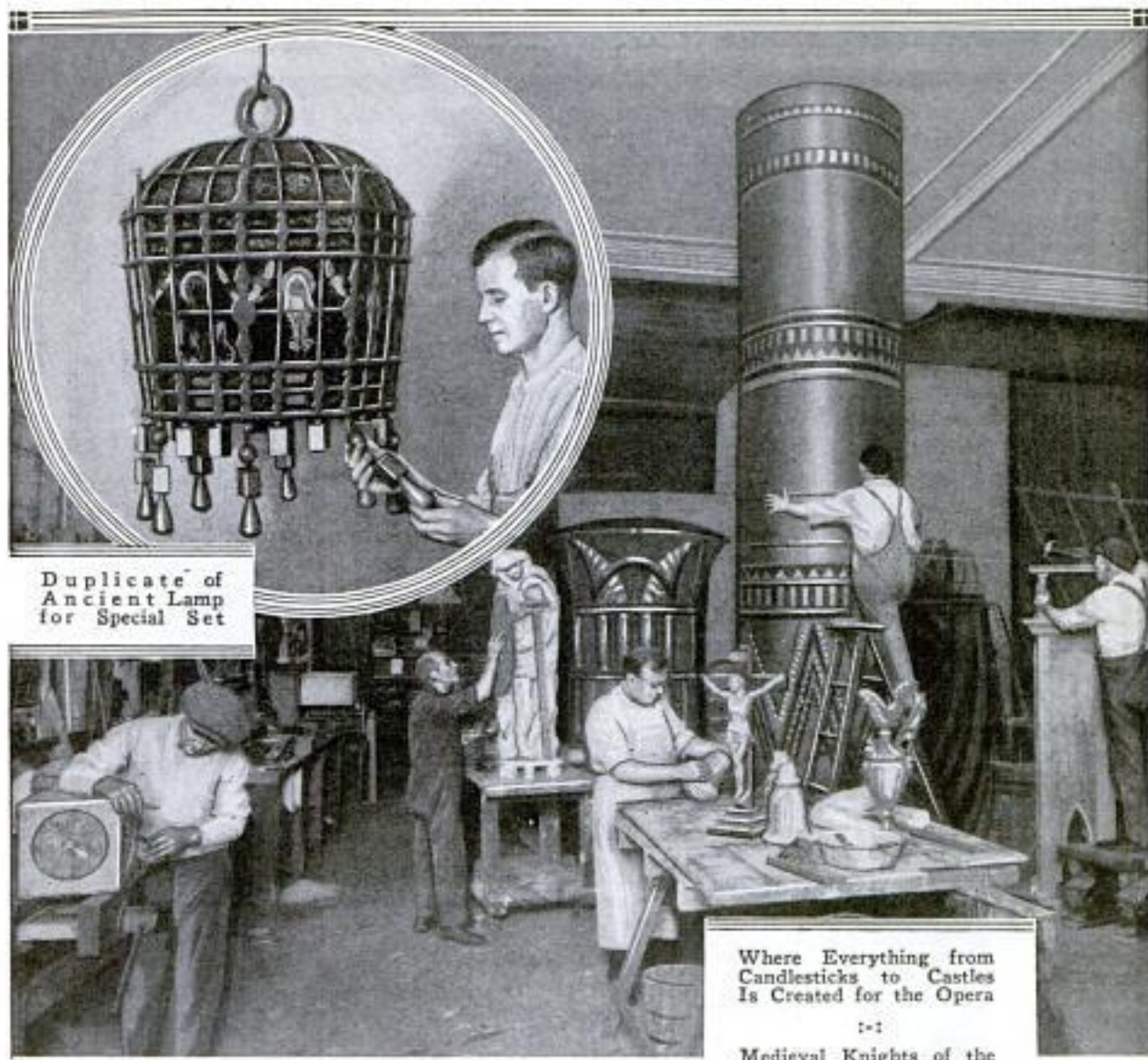

Duplicate of
Ancient Lamp
for Special Set

Where Everything from
Candlesticks to Castles
Is Created for the Opera

:-:

Medieval Knights of the
Stage Get Burnished
Garb from the Armorer

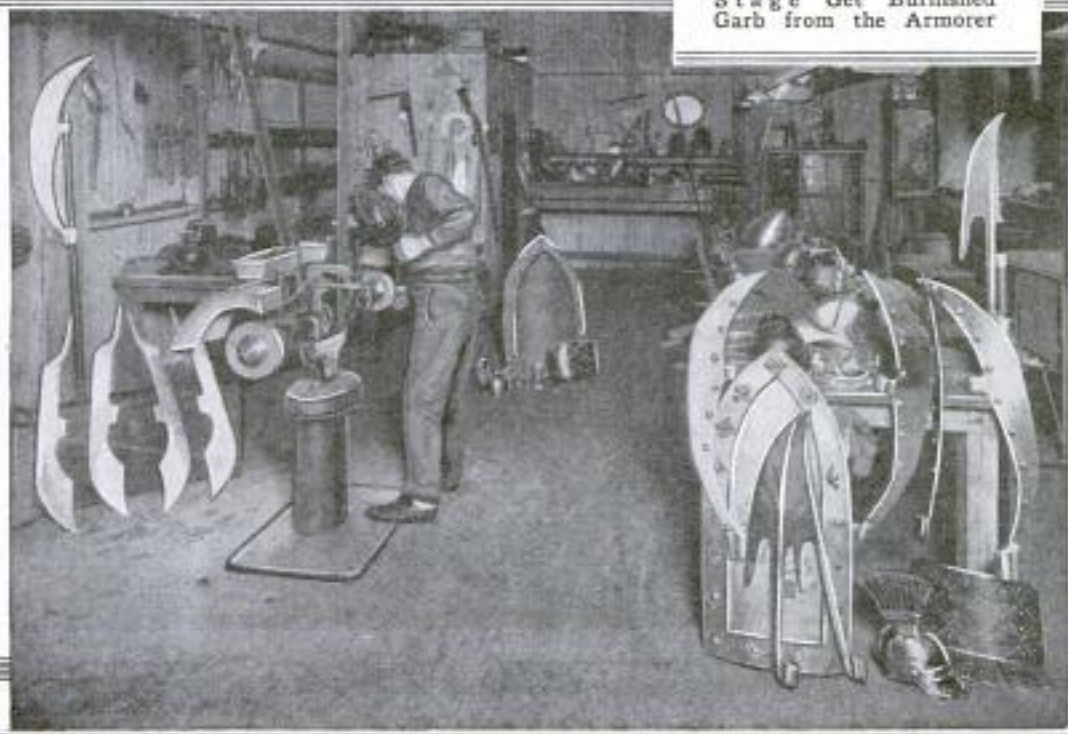

3763

Julien Love, of Chicago's Civic Opera Co., 58 E. Congress, Chicago

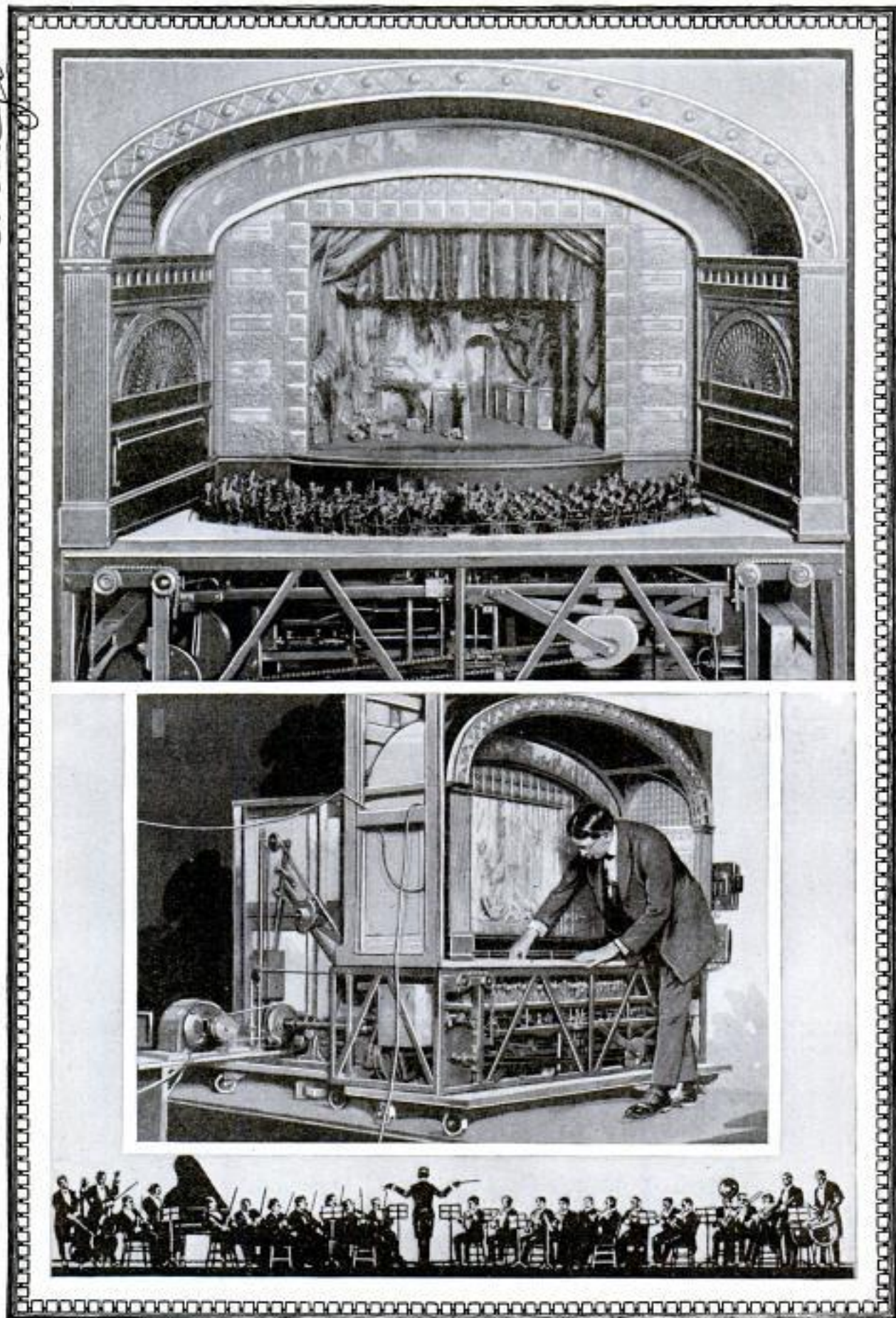

Copyright, Underwood & Underwood

Above: Mechanical Miniature of Orchestra and Opera Stage that Automatically Changes Scenes. Below: Curtain Closed and Figures of Musicians Lowered while New Set Moves into Place

force that it split in two. Mechanics had again performed the task. Under an iron plate on the anvil a trigger was placed. As the player struck that spot it released the sections of the anvil, allowing them to fall apart.

When traveling about the country, a large opera company has need for almost as much equipment as is used in the home theater. While there is seldom a stand of less than two days, the property staff must be able to set up a complete stage in a few hours. The electrical effects carried amount to several tons. Wire reels, huge floodlights, incandescent bulbs of every description, and even small power plants, all neatly arranged in durable crates that are built to withstand the roughest handling, are needed.

On entering one large hall where several performances were to be given, it was learned that there was no stage. One had to be built. As preparations were made to erect the platform, the workmen were informed by the owners that no nails could be driven into the floor. Only four hours away the performance was scheduled to begin. Several hundred bags of sand were hastily brought in, and over and against these, heavy timbers were placed to which scenery could be attached.

Even many large circuses do not carry much more material than does an opera company with a repertoire of but ten plays. As many as sixty railroad cars have been used by one company to carry their properties and players from city to city.

Probably the most important department of the opera stage aside

from the actors, is the costumery. Under the direction of a master of the wardrobe, hundreds of gowns, uniforms, hats and helmets are cataloged for characters ranging from Roman slaves to pompous kings and gorgeously garbed nobles of later times. Huge chests of bright hued boots and shoes and hundreds of pairs of fancy slippers await the needs of the cast or the chorus master.

As an added aid to the preliminary planning of the opera builders, members of the mechanical staff of a Chicago company built an automatic working model of its stage and orchestra. Operated by an electric motor, it changes scenes every few minutes to produce the actual effect of the spectacles as seen by the audience. Two years of careful designing and many thousands of dollars were spent in its construction. In the orchestra are eighty-one tiny bronze figures representing the various musicians. Each is worked individually by delicate mechanisms inside of the forms.

At a given signal from the "director" the players manipulate the imitation instruments with motions startlingly like those of living musicians. A satin curtain is drawn back and the setting appears on the stage, flooded with lights from below and above similar to those used in an actual performance. After a few moments, the orchestra becomes quiet, the curtain drops, and the operation repeated with a new scene.

To obtain correct patterns of the frescoed arch and proscenium for models, magnifying glasses were used.

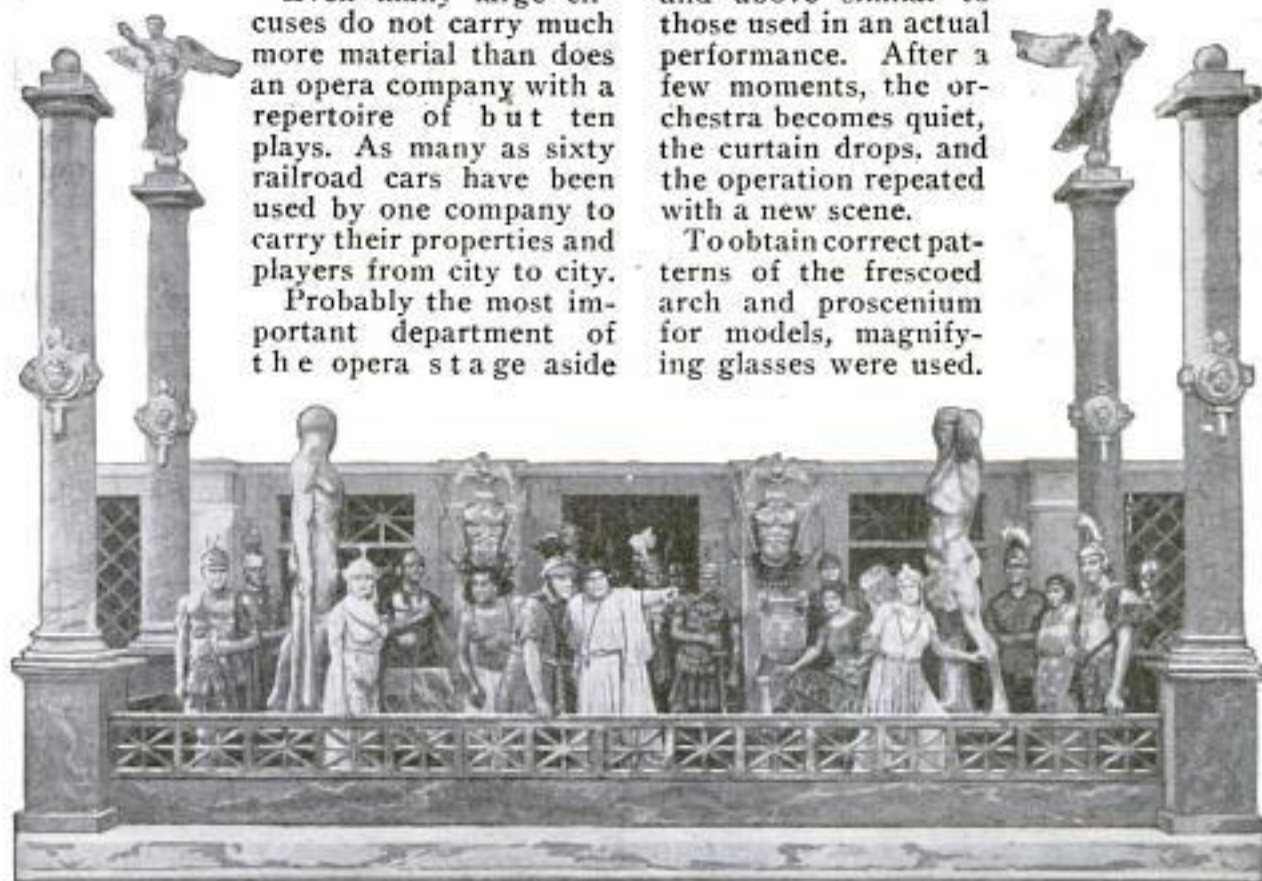

Towering Columns and Massive Walls are Built to Harmonize with the Period Costumes that Glitter in Regal Splendor Under the Dazzling Lights of the Opera Stage

Pacific + Atlantic Photos

25 Park Place
POPULAR MECHANICS

14
4023

New York
SPEED OF MACHINE AND MAN CAUGHT BY CAMERA



Speed Camera Registers a Difficult Goal and Catches Auto Racer Rounding Turn at Terrific Pace

Thrills that electrified spectators at an automobile race and soccer game are reproduced by lucky "snaps" of quick-action cameras. The player in one picture has

just made a goal by bunting the ball through the posts with his head, a feat seldom witnessed, but the photographer caught the play. And as the mechanic of a speeding car in a recent road race in Germany was looking out for tire trouble, the other picture was snapped as the car rounded a curve at terrific speed. Despite the rapidity of the camera shutter, the quickness of movement of both subjects caused distortion.

403
RECEIVER ON PHONOGRAPH AIDS IN SELECTING RECORDS

For demonstrating phonograph records, a talking machine has been invented with a receiver that prevents sounds reaching other than the listener's ear. Thus, it

does away with the need of individual booths and aids in saving floor space in a store. It has the appearance of an ordinary instrument and can be attached to a counter or table.



Talking Machine for Demonstrating Phonograph Records Can Be Heard Only by the Listener

4080
QUININE-BEARING BARK FOUND ON TREES IN NEW GUINEA

Quinine in great quantities has been found in the bark of certain trees native to New Guinea. Nearly ten per cent more quinine can be extracted from this bark than from other plants now known, it is said. An American scientist, traveling through that country, discovered the value of the bark, and with others has planted 100,000 of the trees for producing the drug. Until 1867, manufacturers depended almost entirely upon South America for their supply of the material which is drawn from cinchona bark. Small quantities have also been procured from trees growing in Java, India, Ceylon, and Jamaica.

(see December, 1922)
By a new attachment it is possible to convert a small tractor into a ditch digger.

Chas. J. Sapping Machinery Co.
1204 Howe Bldg., Pittsburgh, Pa.

Andale Co., 565 Fifth Ave New York.

cond. A. White, Norma Mounk St., 240 W. 11th St., N. Y. C.

Box 842, Dayton, Ohio

RED LIGHTS LURE INSECTS TO DEADLY FUMES 4003
ODD ANCIENT VOLUMES SHOW PROGRESS IN BOOKMAKING 4091

Winged night insects in tropical regions are sometimes lured by red lights into poison fumes which kill them. An ordinary electric bulb, or the outer glass of an oil lamp, is painted with a red substance and placed near a vessel containing a strong solution of acid. When the pests swarm toward the bright rays the vapor from the liquid destroys them. Persons are protected against contact with the acid by placing it in a bottle fitted with a funnel, into which the flying bugs fall when overcome.

Since the invention of printing, early in the fifteenth century, the progress of book-making has kept pace with that of printing.

HINGED WINDOW IN AUTO DOOR AID FOR ARM SIGNALS 3941

For motorists who drive closed cars, added safety while making traffic signals is provided by a hinged lower section of the glass door at the driver's side. The device, perfected by a western inventor, allows the lower part of the door to swing outward horizontally when pushed by the driver's arm. It is high enough so that signals can be made freely in the space when the section lies flat on its outer support, a rod bracket fastened to the car. The section is closed by a lever or a weighted pull-cord controlled from the interior of the car. It may also be opened by a lever. When closed, the swinging



Book that is as tall as a man and locks by three hasps on the cover

Pacific & Atlantic Photos

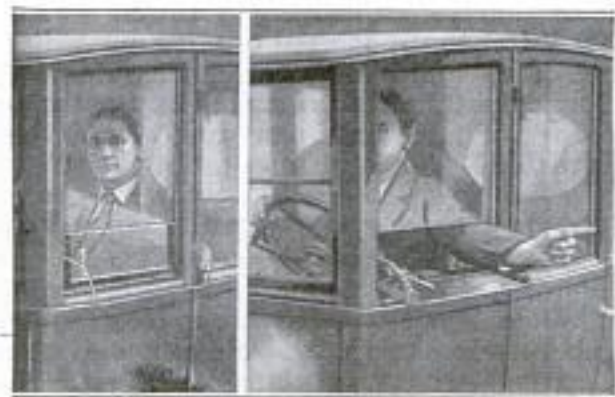

Hinged Window Section for Automobiles that Permits Hand Signaling on Outside of Closed Car

section is made to fit to the upper part of the door snugly and a brace keeps it from falling through on the seat.

Cherokee Indians gave their children a concoction made from burs to strengthen their memory, under the impression that as a bur will stick to anything, a man lined with burs will be able to hold all useful information.

Soon after the first books were run off the old hand presses, many queer volumes have appeared. Among them is a very large one, as tall as a man, which is now the property of a university in Holland. The institution also owns another that is small enough to be concealed in the hand, which was penned instead of printed.

STATUE SEALED IN BOTTLE MADE TO "BLEED" 4008

One of the favorite tricks of magicians in India is to draw "blood" from a clay statue some time after it has been placed inside a glass bottle, sealed so that it cannot be tampered with. The flask is put in a temple and the people are told that in about ten days a worker of magic will make red drops issue from the figure. The trick is done by use of a germ unknown to the observers. When a culture of this microbe remains in a warm spot for about ten days, it produces a liquid that resembles blood so closely that the difference can hardly be determined.

2034 Elm St., Dubuque, Iowa.
W. A. Erner
Com. R. White

Underwood
Kadel + Herbert

16
3927

MOVING "SIDEWALK" OF SEATS FOR NEW YORKERS

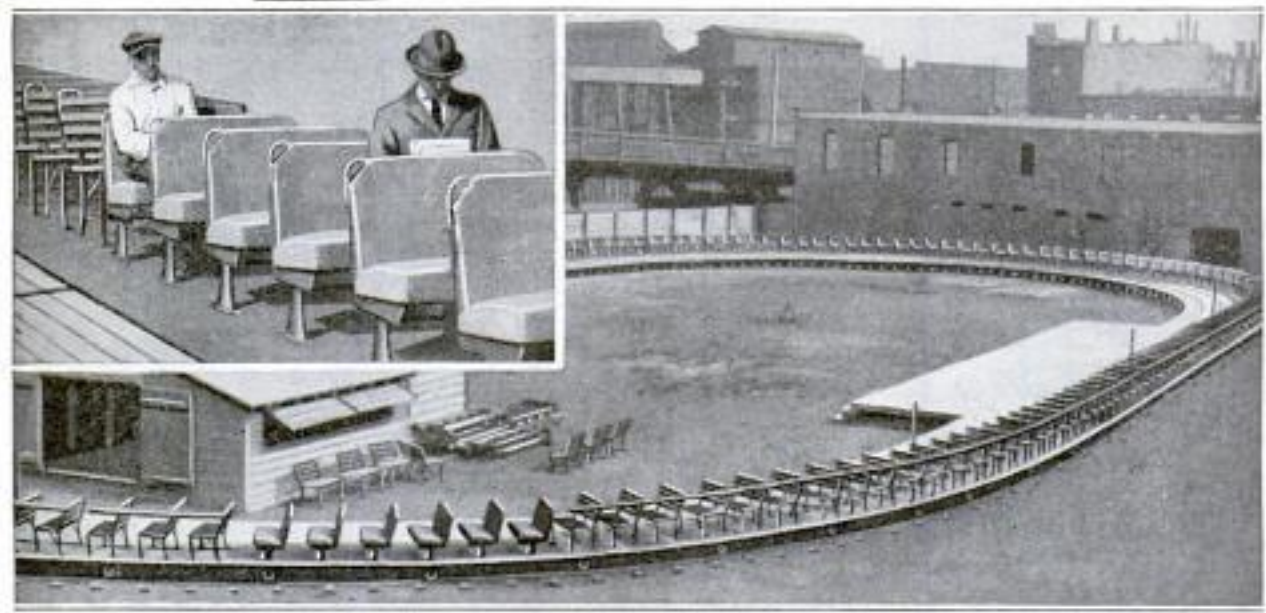

Copyright, Underwood & Underwood

Moving "Sidewalk" of Seats Suggested as Means for Relieving Crowded Subways and to Accomplish Transfers of Passengers over Long Distances Between Platforms: Above, Close View of Benches

Fitted with seats, a moving "sidewalk" similar to that demonstrated at the Chicago World's Fair, was recently offered the city of New York as a means of taking the place of subway trains that now connect the east and west-side lines. Three parallel platforms, running at 3, 6, and 9 miles an hour, respectively, would be arranged in an endless chain if the sugges-

tion of the inventors was followed. A continuous walk inside the low-speed carrier would permit passengers to board or leave at any designated point along the route. At present, persons wishing to change from one to the other of the subway lines, must at certain stations walk several blocks. The sidewalk is also offered to do away with this inconvenience.

Dani. Sneed Co. 64 S. Division St. Buffalo, N.Y.

PAPER BATH SLIPPERS TO KEEP FEET CLEAN WHILE DRESSING

Sanitary bath sandals are being made of tough crepe paper so they can be thrown away when once worn. Slipping them on after a tub or a shower, the bather can

than that of laundering a towel, which not infrequently is used to wipe away dirt picked up while walking about barefooted. Conveniently placed in a rack on the bathroom wall, a fresh pair can always be available. 4015

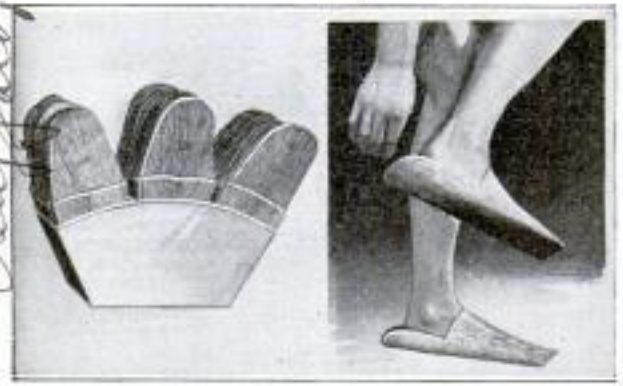

Bath Slippers Made of Heavy Paper to Be Worn Once and then Discarded

stand on an uncarpeted floor in comfort and dress without soiling his feet. Besides insuring cleanliness, they are inexpensive, for their cost is said to be less

MOUSE SHORT-CIRCUITS POWER SYSTEM, WRECKS PLANT

When a small mouse crept into an air gap between two 6,000-volt cables at the electrical generating plant of a European city recently, it caused a disruption of the entire system served from the station. The door of the switch chamber at the power house was blown out, the main cables and much machinery were wrecked, and the building was filled with smoke from burning insulation, set afire by sparks caused by the short circuit.

China's first attempt to spin cocoons according to the machine system was made in 1873. There are now 207 steam spinning mills in that country.

Eng. F. Christie 356 Union Station, Winnipeg, Canada.

SKYSCRAPER IS BEST REFUGE IN STORM, SAYS EXPERT ³⁸⁶⁸

Big buildings act as lightning shields to protect the people inside of them during storms, according to an expert who spoke recently before the International Fire Prevention Congress. The safest place during an electrical disturbance, it was declared, is a large metal, or metal-frame building. After that comes a small structure equipped with lightning rods, and, last, outdoors, in the open. People were urged to avoid metal conductors, such as telephone and electric-light systems connected to the outside, screened doors and windows, down spouts, stoves, and fireplaces. Comparative safety may be found, if outdoors, in thick timbers and depressions, such as deep valleys and canyons.

SCREEN MADE OF MELTED COINS RELIC OF FORGOTTEN ART

Skillfully carved in beautiful designs and gilded with liquid gold, made by dissolving coins in sea shells, a church screen in a



Rare Screen Gilded with Melted Gold Coins in Lost Art of Early Spanish Craftsmen

OUTRIGGER PONTOONS ON BOAT TO PREVENT ROCKING ³⁸⁴⁸

So his small yacht would ride smoothly in rough seas, a western man fitted it with pontoons, one on each side, similar to Hawaiian outrigger canoes. The craft glides through the water without tipping or rocking, and there is less danger of it being overturned by strong winds or high waves, as these air-tight appliances tend to keep it on an even keel. For those not accus-



Pleasure Boat Fitted with Pontoons to Keep It from Rocking in Heavy Seas

western museum recalls the splendor of a long-forgotten art. Though, with modern machinery, many new ways of handling minerals have been perfected, no one has discovered how Spanish artisans in early days wrought exquisite patterns from melted coins. It is said that these were reduced to a fluid state and applied before the mass could cool.

EXECUTED FOR BURNING COAL UNDER BAN OF KING ³⁸⁷⁰

About 600 years ago men were beheaded in England for burning coal. A king's proclamation forbade its use for fuel, because the gases were said to be detrimental to health and vegetation. Mysteries of the smoke and odor were not solved until the middle of the 17th century. Today research chemists obtain from it gas, dyes, poisons, explosives, substitutes for sugar, perfumes, tanning materials, flavoring extracts, photographic developers, antiseptics, and medicines.

☐To warp the liner "Majestic" into its pier recently, 18 tugs were required.

tomed to the motion of a sailing boat, the attachment lessens the possibilities of seasickness and adds to the enjoyment of the sport.

Invented by a resident of San Pedro, Calif.

Kansas City Times 10/13/23

Fighting Seas of Fire in Timber Lands

3563

Chicago
Watchful Knights of the Forests Who Save Lives and Property from Conflagrations that Destroy Miles of Wooded Areas

WITH the shipment overseas of millions of feet of raw and dressed lumber to supply Japan with material to replace the thousands of homes destroyed by the recent disaster, attention has again been turned to the dwindling timber resources of the United States.

Greater caution has been urged to reduce the drains on the available tracts, few of which have not been touched by the woodsman's ax. Some states have even gone so far as to discuss more stringent laws looking to conservation. The forestry department of the government is constantly at work on the problems of halting the inroads threatening to devour a resource that once looked as though it could indefinitely defy time to destroy it.

Perhaps the greatest source of waste is the continual forest fires that annually rage among the densely wooded regions during the dry periods of the hot summer months. These have cost the nation millions of dollars in lumber values each year, not to consider the damage suffered by village, town, and hamlet that find themselves engulfed by flame and cut off from willing but powerless aid.

No one ever seems to know just when or how these blazes begin. A spark from a railroad locomotive as it speeds through the wilderness falls unseen and unheeded in the midst of a bed of crisp leaves. A careless camper does not thoroughly extinguish his fire, or an inexperienced visitor might knock the glowing ashes from his pipe, innocent of the danger of such an act.

But the column of smoke floating menacingly

above the forest, a couple of hours later, serves warning to the isolated timber dweller a few miles away that he had better shift himself and his belongings from the path of any wind that might rise to add its draft to the sweep of flame that is sure to follow.

But the incident does not go unobserved by those whose duty it is to guard the country against just such tragedies. Far up on a high point of land, or seated in the loft of a lookout tower erected to command the region for miles around, that thin wisp of lazy smoke spells action to Uncle Sam's "lifeguards of the timber." If the weather be favorable—that is, when there are no high winds to drive the flame deeper into the expanse of ready fire-fodder—beaters on excited horses are on their way in answer to the alarms and directions that go out from the watch station, summoning the

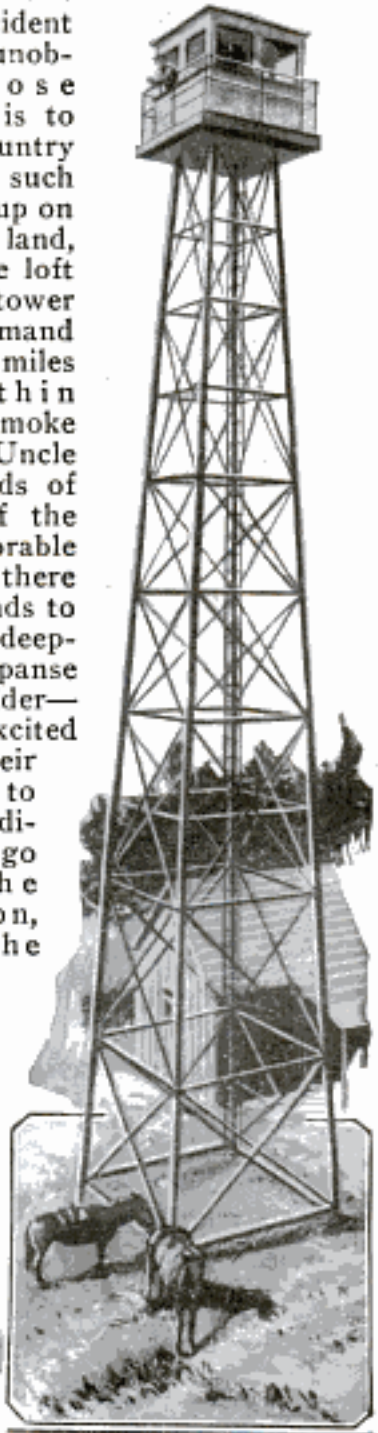

Infinitesimal Details of the Forested Regions Are Learned by Trained Operators and Marked on the Guide Maps. Right, Observer Station Where Fire-Fighters Watch for Signs of Danger



Where Water and Hose Would Be of no Value. Forest Firemen Resort to the Soil and Shovel to Smother the Spreading Flames of Tinder-Fed Conflagrations

3503

valiant fighters of the forestry division to the scene.

Armed with picks, shovels, and brimming water buckets, and equipped to combat the blanket of choking smoke which the enemy throws off in seeking to defeat them, the crews of the forestry fire department enter upon a task that may last for days and weeks before the conflagration is finally checked and extinguished.

There is no day and night in the life of these heroes. **Sundown** means merely an incident in their tireless struggles against an often almost inaccessible monster. In the darkness of night they have the glow of the flames to guide them to their battlegrounds. Daylight leads them to it by the inevitable smoke signal. Where either of these is thickest, there is the goal they seek.

In the hands of each district crew are maps of the territory to which the fighters are assigned. On it can be found in a twinkling the necessary information to guide the men in their work. Each particular stand of trees, whether they be spruce, hemlock, mixed, or whatnot, is identified on the drawing. All streams—for they are of utmost importance on occasions—are shown. Then, when the alarm is given by telephone, telegraph, or flag signal, and these lifeguards of the forest are familiar with the various means of sign language, the scattered forces need but to refer to their maps for detailed directions as to the location and kind of a tract they are to reach.

Nor is the airplane overlooked in the effort of the foresters to reduce fire losses to the lowest possible figure. Patrols are regularly sent out to reconnoiter from a position of three to five thousand feet above the woods. In case of trouble, these aerial scouts report the location of the fire, its extent, and in other ways keep the ground men advised of any peculiarities that attend the spread of the flames. Often the blaze will sweep for hours slowly toward some important point that may

mean serious loss if it should be reached, and then, with a sudden and uncanny twist, turn in another direction as though guided by a knowing hand.

During the dry seasons the forests of the North and West are always in danger of fires, which sometimes burn for weeks and die out only when they have reached their limits and nothing lies in their paths to feed them. And as often, just as they threaten defeat to the loyal and tenacious energies of the firemen, the clouds will send the much-needed aid to quench the raging flames—rain. This ally of the skies is never more welcome, never more prayerfully expected,



Engineer of the Forestry Service Gathering First-Hand Data of Timbered Lands for Use of Field Crews

than it is when the forest green becomes a thing of terror to those who have learned at such times to hate the big woods for the dangers they might hold.

3906

**PINS IN PAPER-ROLL HOLDER
TORN OFF AS NEEDED**

So that pins may be instantly available, a glass holder is being made for desks from which they are unwound as needed from



Holder that Keeps Pins in a Paper Roll from which They Can Be Easily Picked

a paper roll. When one is wanted, it can be easily picked out of the container without risk of scratching or pricking the fingers against points of others. As the pins are used, the paper is pulled out and thrown away. A separate compartment is provided for clips.

Wild animals of India's jungles killed 3,263 persons in 1922.

Harder's Lake +
Franklin, Chicago

Copyrighted material



Even Thunder Storms Do not Escape the Untiring Vigil Kept Night and Day by the Loyal "Lifeguards of the Mountain Ranges" in Lofty Towers that Crown the Highest Peaks

The Williams Service
32 Union Square, E.
22

Pacific Ready-Cut
Homes of me,
Los Angeles
Calif

POPULAR-MECHANICS

MAGNETS HOLD DIVING BELL
TO SIDES OF SHIP

READY-CUT MODEL HOUSES
SENT TO QUAKE VICTIMS

Heavy magnets firmly grip a new type of diving bell to the side or bottom of a ship, while as many as four men, breathing

Modern ideas in home building will invade the Far East as a result of the shipment of American ready-cut houses to help replace the million or more homes leveled by the recent earthquake in Japan. The first model sent across the Pacific was a five-room California bungalow, weighing 30,000 pounds. Each piece of material was prepared in the mill, ready for actual nailing in place. Also, such items as glass, hardware, electrical and plumbing fixtures were shipped with the lumber.

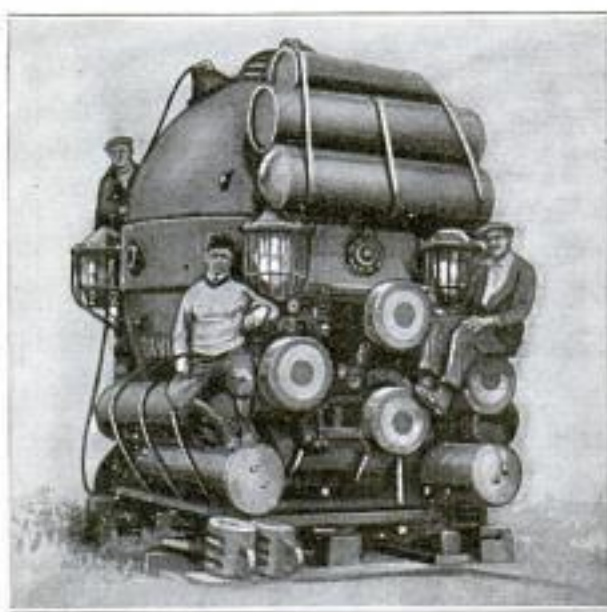

Diving Bell that Magnets Hold to Ship while Several Men Work Many Hours under Sea

HORSE TAKES TEN-FOOT FALL,
RESCUED BY DERRICK

Unscratched by a 10-foot fall from a runway to the top of a high pile of timbers in a middle-western lumber yard, a heavy draft horse was rescued recently by a derrick. The animal lay quietly in its dangerous position while straps were wrapped about its body. It was quickly swung through the air to more solid foot-



Using Derrick to Raise Horse Unscratched by 10-Foot Fall to Lumber Pile

MUSICAL PLUG FOR HORNS
CREATES "JAZZ" TONES

Distorting the tones of cornets and trombones to get "jazz" music may be accomplished by a recently invented device, that fits the bell of the instrument like a plug. Moving it back and forth produces wavering, mute sounds. It can also be fixed so that the pitch will not change. A perforated disk over a vibrator at the



Musical Plug for Bell of Horn that Gives Peculiar "Jazz" Effect to Instrument's Tones

end of a metal tube, blends and spreads the notes to a peculiar blare.

ing, and a few minutes after the accident, was again hitched to a working mate and resumed its daily tasks.

United News Fishers 461-8th Ave, New York

Planning to eventually supplant the present telegraph lines with wireless systems, the Canadian government has sent a party to the Yukon to erect the first two of a series of four radio stations, which will be equipped with powerful receiving and broadcasting sets.

No information as to maker or inventor.

The Guy B. Haines Co.
4803 9 Prairie Ave.
Chicago

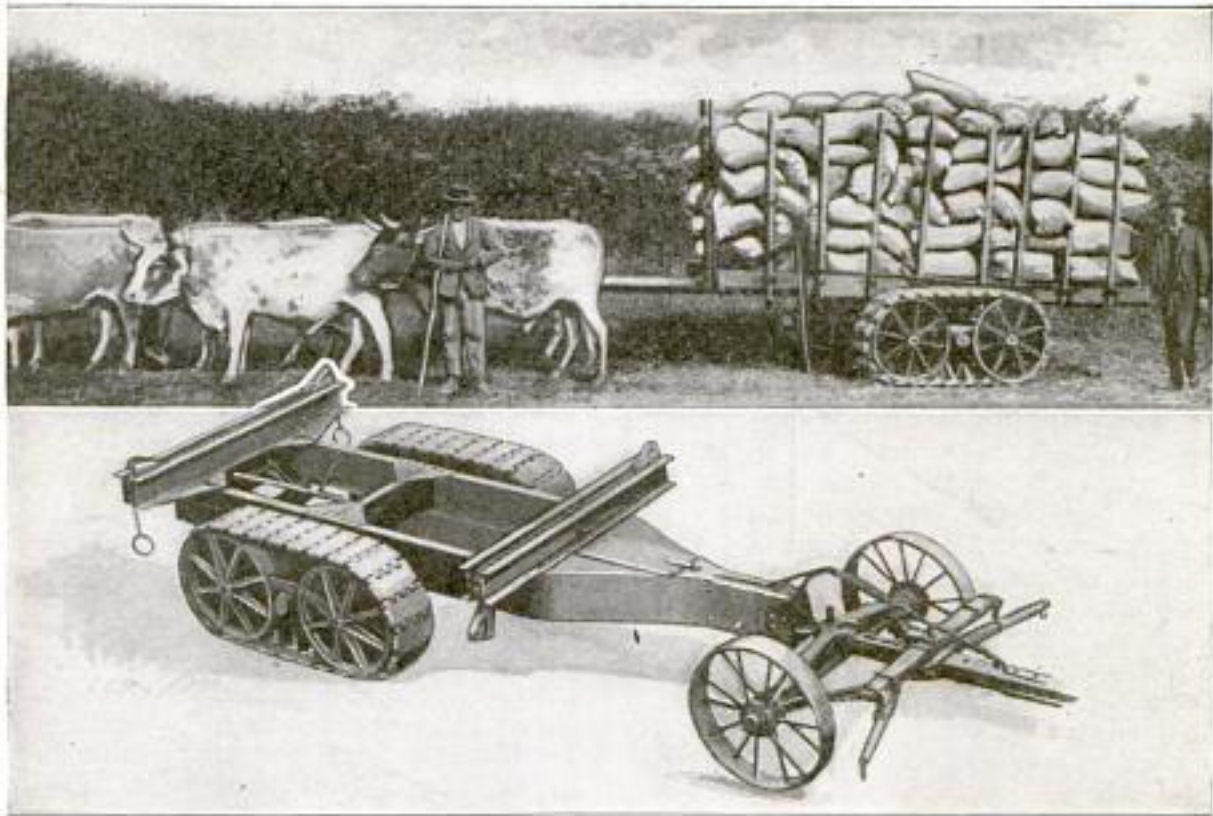

130 n. Wells

Above: Oxcart Fitted with Tank Tread that Makes Hauling over Rough Roads Light on the Animals. Below: Steel Frame of Horse-Drawn Truck with Banded Wheels

For hauling heavy loads over mud and sand, an animal-drawn truck is being built with wheel treads like the army-type tractors. It is claimed that they can be used anywhere—over cane fields, through logging woods, or behind motor vehicles.

Wherever oxen can walk or tractors can travel, they make it possible to haul heavy loads with remarkable ease. Mud picked up by the truss bands is sliced off as though cut by a knife, when they come together at the top.

AIR IS VULCANIZED IN TIRE TO AVOID PUNCTURES

In an effort to make an unpuncturable and undeflatable tire, a French inventor has perfected a process for vulcanizing rubber over compressed air. In its completed form, the tube contains several hundred individual compartments, each of which is inflated under equal pressure. Every "pocket" is a separate leakproof chamber in itself and ranges, according to the size of the tire, from half an inch to three-quarters in diameter, the length being governed by the tube size. It is manufactured from what is said to be a secret rubber compound, the holes being drilled separately. Over this form is laid rubber of another composition to inclose the holes, into which air is then pumped and the whole vulcanized. The outer wall of the tube is three-quarters of an inch thick, making it practically impossible for

a nail or other sharp substance to enter the compartments. Once adjusted to the wheel no further inflation is required by it.

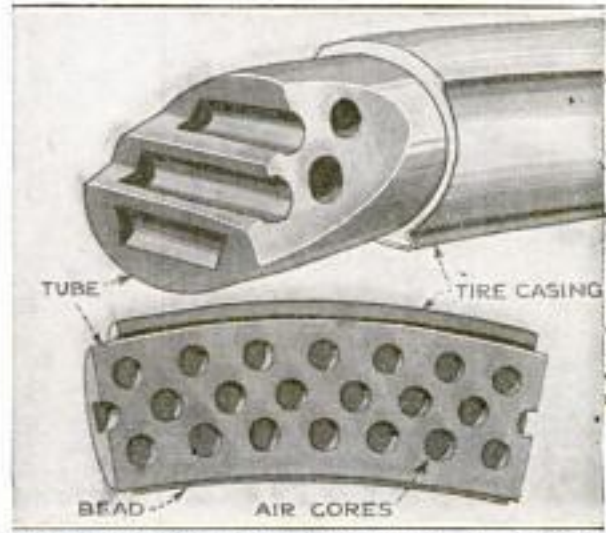

Puncture-Proof Tire Filled with Small Air Chambers that Needs no Other Inflation

info. Henry M. Winters, 10 Rue de Valenciennes, Paris

Wm. Ralph C. Osbey, 84 No. W. S. Eastern Ave., Akron, Ohio

International

3678

U. S. Warships on the Auction Block

Tons of Chopped-Up Metal All that Remains of Historic Vessels; Powerful Guns Broken into Scrap

CHOPPED into junk, all that remains today of a score of historic warships of the United States Navy is a mass of twisted metal. Condemned under the disarmament treaty, their guns have been spiked, their engines dismantled, and their costly equipment put out of commission.

First, the side armor plate was removed from the inside shell of teak in sections weighing from 25 to 40 tons. These were swung to upright positions and cut with oxyacetylene torches into pieces of a convenient size for feeding into the charging boxes of steel furnaces, where they will be remelted and, later, reformed.

After removing the steel plates, the "nerve centers" of the ships, such as gun-turret machinery, ammunition hoists, and refrigerating systems, were taken down. These were broken up by workmen and then reduced to small scrap by pile drivers with a 110-ton impact. Scrap, thus obtained, is sold to the gray-iron foundries, where it is treated in combination with inferior grades of iron ore. The product resulting is low-tensile iron such as is used, for instance, in harvesting machinery and engine bases. When the work of destruction is completed, Uncle Sam will have only 18 battleships and no battle cruisers; vessels valued at approximately \$200,000,000 will have been put on the auction block and uncompleted ships costing nearly \$100,000,000 will have been scrapped. Among the doomed ships is the "Connecticut," the flagship of

"Fighting Bob" Evans on the famous cruise around the world, and several that former President Roosevelt ordered to circumnavigate the globe at the time, to "fight or frolic" as the case might be.

Among the ships remaining are the new light cruisers, "Detroit," "Milwaukee," "Marblehead," "Omaha," "Cincinnati," "Raleigh," "Concord," "Richmond," "Trenton," and "Memphis." Three outstanding features of these vessels are: First, the tremendous speed obtained; second, a powerful offensive battery, and, third, a cruising radius large enough to make any of the seven seas their home. In describing the "Concord," all of the light cruisers are pictured, as they are sister ships. Imagine a ship seven times as large, and built with streamlines of a destroyer. Five hundred and fifty-five feet in length, with a beam of about 55 feet, they have the foremast of the tripod type found in the British navy, the mainmast of straight spar variety, and four funnels between masts.

Faster than any ocean liner afloat, each one has enough power to supply the entire public utilities of a city like Baltimore, or the combined utilities of the states of Louisiana and Mississippi. There is enough electricity to light and operate 21 big hotels. In the oil tanks, when loaded, is enough fuel to run a fleet of automobiles 400 miles.

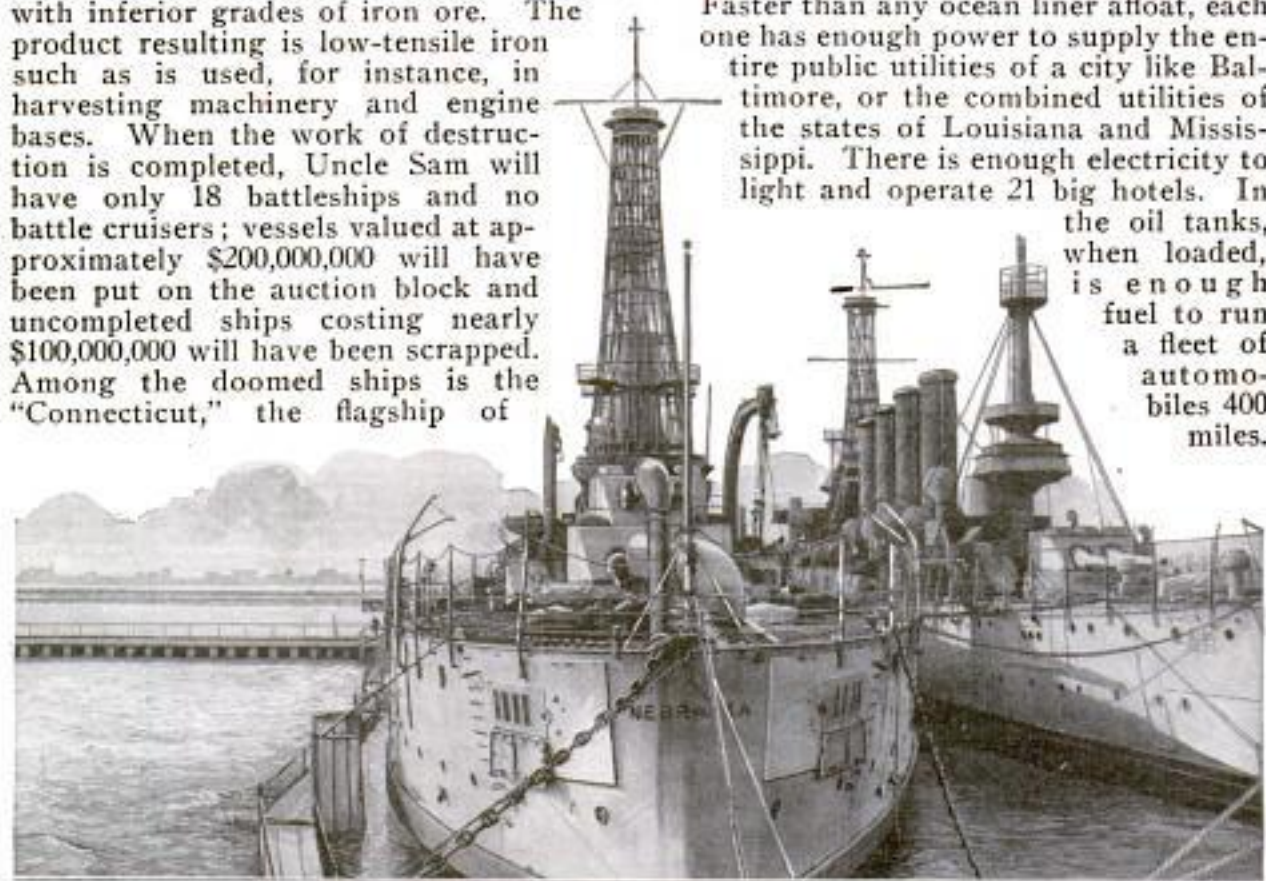

Historic Battleships, the "Nebraska" and the "Georgia," that Are Being Junked at the Mare Island Navy Yard Where Their Guns Have Been Spiked and Their Engines Dismantled

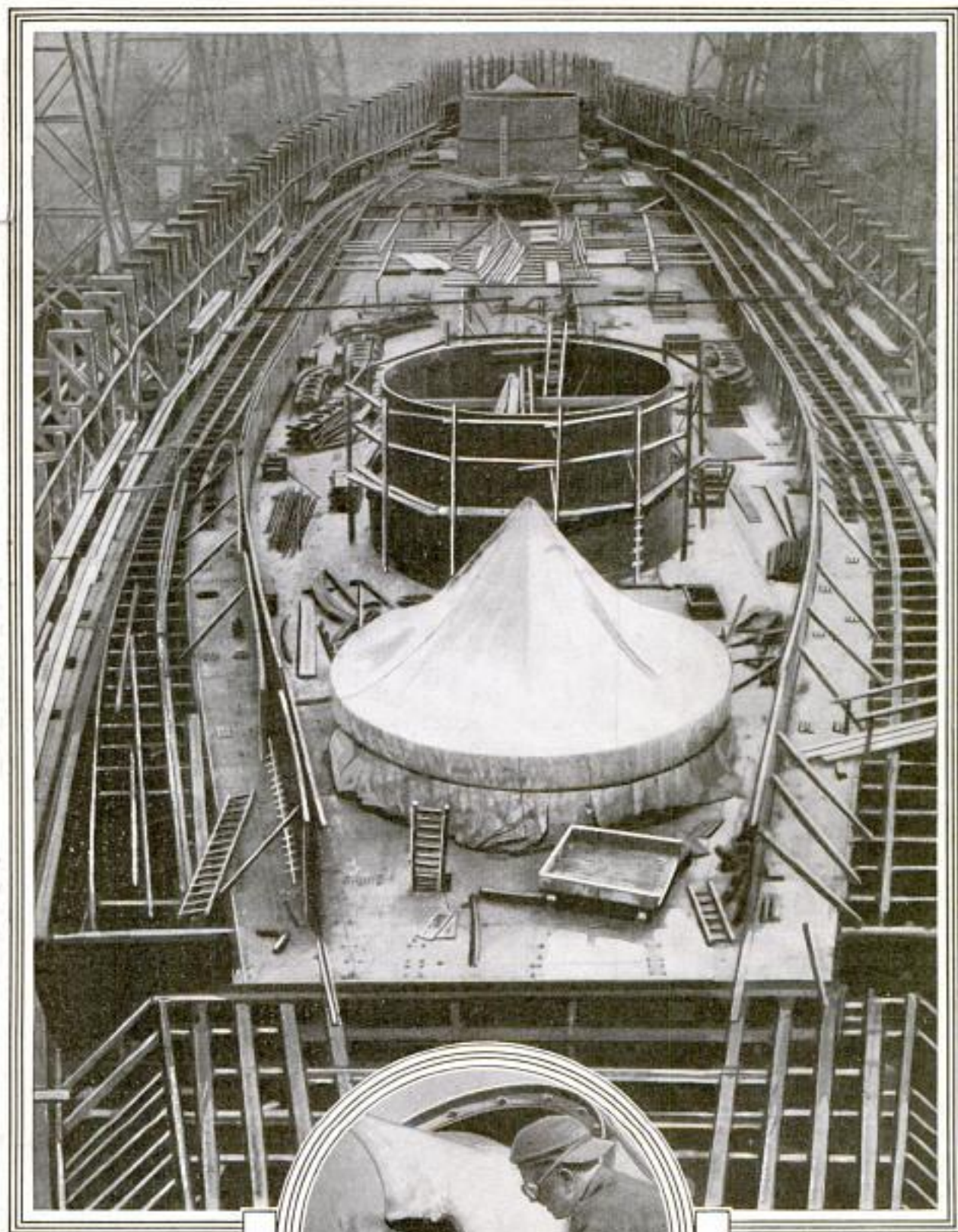

—:—
 The United States Steamship "South Dakota" under construction, but which will be junked



—:—
 Guns of warship being cut apart with torch in keeping with the Disarmament Treaty

26
 3801

SUGAR-CANE "LUMBER" RESISTS HEAT AND COLD

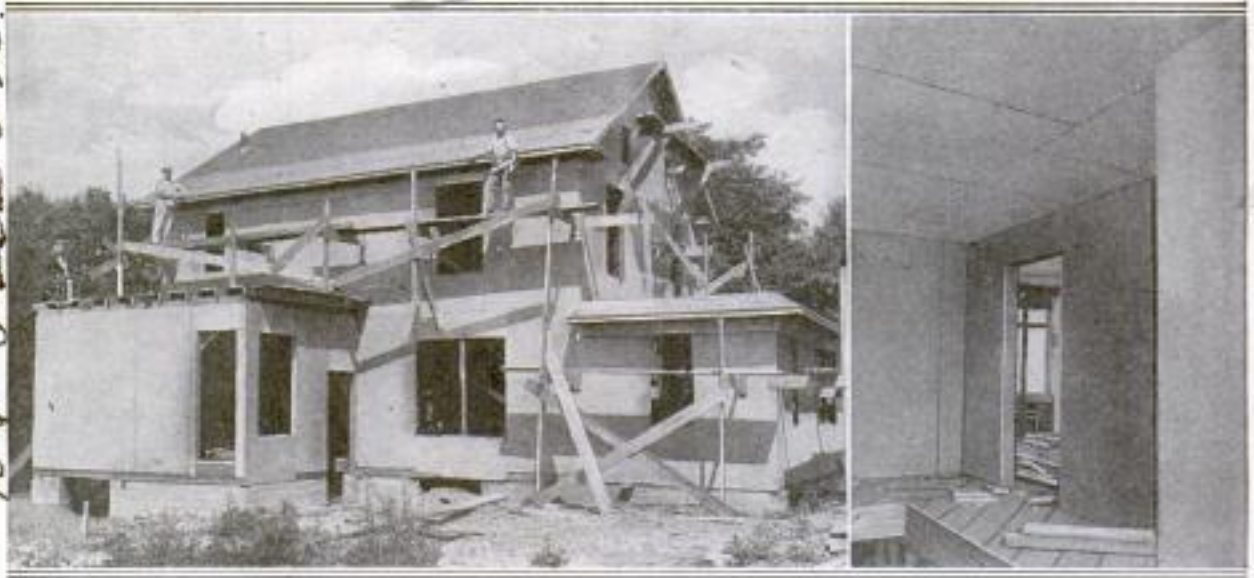

Lumber for this Dwelling Is Made from Fibrous Wastes Left after Sugar Cane Has Been Crushed. Right: Wall Board of the Same Material Utilized for the Interior

Bagasse, the fibrous waste which remains after sugar cane has been crushed, is now being made into insulating lumber that is strong and tough, and light in weight. It can be sawed, painted, grained, stained, or stuccoed like ordinary timber, and is adaptable for sheathing, plaster base, and interior or exterior finish. In addition to its cheapness, it tends to keep out the cold in winter and the heat in

summer. Discovery of the process came after years of experiments, and now thousands of tons of it are transformed into wood substitute. Entering the plant, bagasse is fed through a shredder and cooker, the pulp mixed with a waterproofing substance, and then run through a machine which presses it into boards 12 feet wide. It is then cut into standard widths and lengths.

3881
AIRPLANE WITH MOVING WINGS TO RISE FROM ROOFTOP

Intended for rising out of narrowly limited spaces or from the roofs of ordinary buildings, an airplane which has wings that

will carry the machine up, down, ahead, or backward, according to the designer, who expects his craft to even stand still in mid-air without changing the direction of the wings' rotation. It gets its power from an airplane engine, which drives the propellers by means of chains.

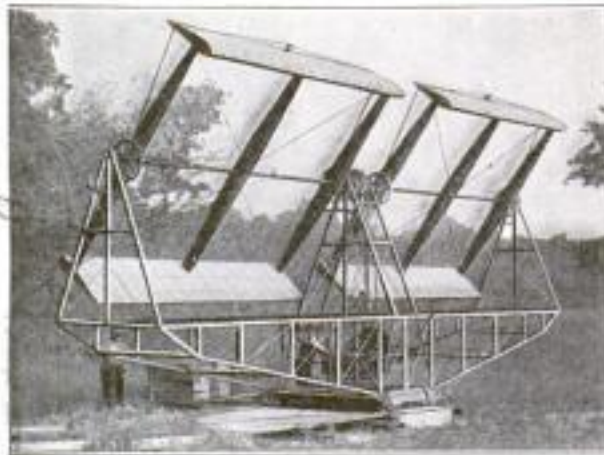

Helicopter with Revolving Wings that is Designed to Rise Directly from Narrowly Limited Spaces

resemble paddle wheels is being built by an inventor. These, with forward motion,

3885
BOUQUETS IN BLOOMING TREES INCREASE ORCHARD'S YIELD

Placing fresh bunches of flowers in the tops of his orchard trees several times during the blossom season, resulted in a large increase in the yield of fruit for a Washington grower, according to a recent announcement. The first test was made when bouquets of blossoms from a certain kind of cherry tree were put in three orchards of other varieties. The pollenization, brought about by bees, flies, and other insects, produced a record crop. Flowers of plum, peach, pear, apple, and cherry trees have been mixed in this way after their buds have opened, greatly benefiting the quality and yield of fruit, it is reported.

Indianapolis News
 10/15/25
 Copyrighted material

see also. December
 1921 800 of type are
 new York P. B. Co. are
 Dr. Stephen Hemenet Ford Shendane
 & Lincoln
 Chicago

**PAPER MONEY BECOMES FAD
 OF COLLECTORS**

3856

Collecting foreign paper money, issued by cities during periods of financial stress, is reported to offer profitable diversion. The script is usually redeemable after certain lengths of time, and if not presented then, becomes valueless as exchange. Known in Germany and the surrounding countries during the war of 1870, its use became widespread in the world war and the years that have followed. Some of them now are rare and command high prices from collectors. As the practice of making "notgeld," as it is called in central Europe, under the sanction of the Reich-banks grew, the designs became more ornate, and from 1918 to 1922, leading artists, engravers, and printers were employed to produce them. Many of the scripts picture historical and romantic incidents of a community. A town that claims the distinction of being the birthplace of Baron Munchausen illustrates some of his alleged feats on its money.

Smuggled money sold by George D. Johnson Co. by Bob W. Washington to Mr. Charles

**CLOCK STARTS COOKER'S HEAT,
 FOOD CAN'T BURN**

3835

Watching food to prevent burning is not necessary with an electric stove being made, whose heat is automatically kept at the proper point through a switch controlled by a clock.

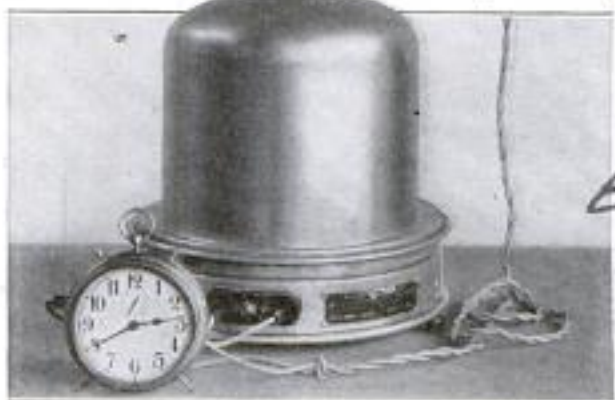

Electric Stove Controlled by Alarm Clock that Keeps Heat Below Burning Point after Food Is Cooked

By setting the timepiece, current can be turned on at any predetermined time and the oven will not remain sufficiently hot to burn its contents, after they have been cooked. To keep odors from escaping, the steam is condensed on the inside of the cover and retained. As water is not required, meats may be cooked in their own juices. Of small size and easily carried about, the stove may be set up at any place where it can be connected to a light socket.

**GAS MASK AND RUBBER GLOVES
 TO PROTECT PAINTERS**

3844

To safeguard painters against lead poisoning, frequently contracted while working with materials containing that min-



Protecting Gloves and Mask for Use of Painters to Guard Them from Lead Poison

eral, a respirator and rubber gloves have been devised. Without discomfort or inconvenience when worn, these articles prevent the workmen from getting the liquid on their hands, which may result in irritating skin diseases, or breathing the fumes, said to be injurious to the lungs. Strapped over the head, the mask does not obstruct the craftsman's sight.

3844
Marked at
San Francisco Calif.
Product Co. 625

**NATURALISTS LEARN OF EARTH
 CHANGES BY STUDY OF BUGS**

3886

Studies to determine changes in the earth's crust that occurred millions of years ago have been aided by bugs, according to scientists, who explain that the relations insects of one region bear to those of another indicate that certain islands were once connected. In Jamaica, recently, they explored a very ancient section of that country that has been above the sea for a longer time than its neighboring land and which shelters insect tribes of great age. This discovery leads authorities to believe that animal life of that isle is more closely associated with those of Haiti or Cuba, and that it originally found its way from the mainland over a land bridge, long since engulfed by the ocean.

Philadelphia Public Ledger
10/14/23



With Teeth that Cut Like Steel and Giant Blows from Powerful Paws, Two Polar Bears, Twisting and Writhing Like Acrobats, Locked for a Struggle to Death in Their Zoo Tank

Wide World Photos, 229 W 43rd St
New York

POPULAR MECHANICS

Drawing Master Club of America, National Day, 3813 Cleveland, Ohio.

POLAR BEARS FIGHT DEADLY BATTLE IN ZOO TANK *3684*

In their tank in the London Zoo, two polar bears in deadly combat, attacked each other with such ferociousness that only the timely interference of the keeper prevented the death of one or both of the captive beasts. The other animals in the building became panicky from the roars of rage and pain set up by the mad brutes. Their powerful jaws, penetrating the heavy fur, sank teeth sharp as steel into each others' throats, while giant blows of their paws whipped the water into foam. After a hard struggle the attendant succeeded in prying the battlers apart. Neither showed signs of exhaustion.

CHALK DRAWING IS MADE EASY BY AN EXTENSION ARM

To assist school-teachers in sketching on blackboards, a pantograph has been made with which even the unskilled can make enlarged copies of maps, figures, and



Form of Pantograph that Can Be Operated by Anyone for Enlarging Drawings on Walls

BANK ON OCEAN LINER SERVES THOUSANDS EACH TRIP *3837*

Banking accommodations are available to passengers on the giant ocean liner, "Leviathan," through a branch established aboard the ship by an eastern trust company. An average of about 4,000 persons take advantage of the service each trip—a larger number of patrons than some bigger institutions ashore are called upon to serve in a week. The main business is cashing travelers' checks and drafts and changing money from one form of currency to another. On the trip to Europe the latter transactions are confined mostly to exchange of dollars to pounds and francs, but on the return, the company takes in almost every kind of foreign money, for which it pays in American coin at the rates of exchange received by radio from the main office. It also issues letters of credit and pays money on wireless orders from London, Paris, and other big cities. While the bank does not handle stock deals, it bulletins each day wireless quotations which are in great demand.

charts. It operates quickly and easily and reproduces illustrations up to 32 inches square. As it marks either lines or dots, it may be used to indicate the extreme points of a figure, and these may be later connected by free-hand work, thus providing a means of training pupils. Drawings that only skilled persons can create, may be copied on the wall, adding to the attractiveness of the schoolroom. While designed primarily to aid in saving instructors' time, it helps them in their teaching, for subjects being studied can be pictured in crayon. *no price*

NERVES OF EARTHWORMS HELP THEM TO REMEMBER *3841*

Earthworms have memory and can be trained, according to a scientist who recently conducted an experiment with 500 of them. In the tests, they were put in a T-shaped receptacle, covered with glass. As they crawled to the crossway, about half turned one way and half the other. Those that took the left-hand course were given a mild electric shock. After going through this experience about 200 times, nearly all took the right turn. When the current was changed to that side, they learned to shift their route after only 65 trips. When cut in two, the fragments of a worm's body showed ability to distinguish between the two roads of travel, indicating that they remember with every one of their nerves, which are on the under part of their bodies.

PENKNIFE LIKE SAFETY RAZOR HAS CHANGEABLE BLADES *3814*

Flat as a key, a penknife is being made with a safety-razor blade, which can be replaced when it becomes dull. After cutting edges have been discarded as unfit for shaving, they may be used in the holder as an eraser, clipper, pencil sharpener, seam ripper, and glass scraper, or for many other purposes.



Isit, Co., 5512 Potomac Ave. Chicago

3844 RIVER CUTTING NEW COURSE UNDERMINES SHORE

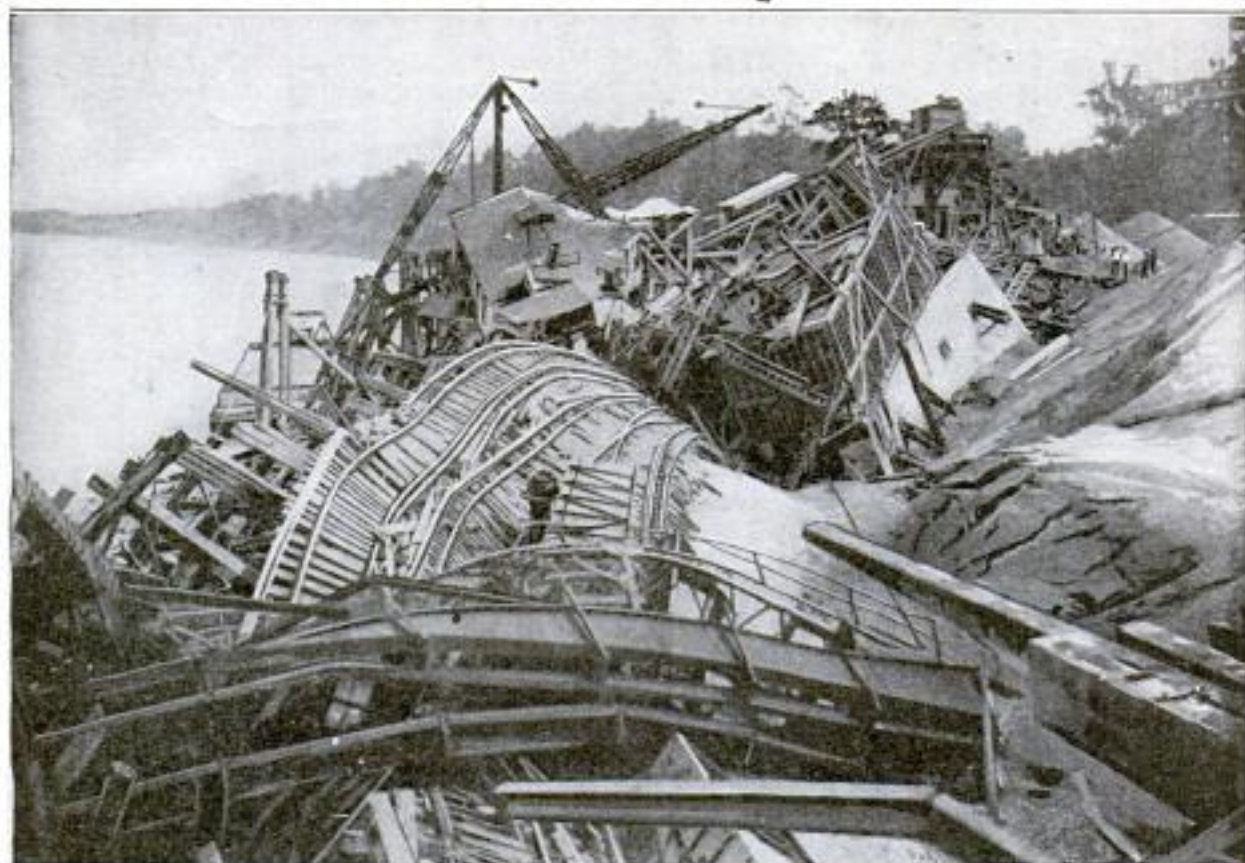

In Cutting a New Course, the Strong Current of the Mississippi River Undermined a Large Section of the Bank, which Collapsed and Caused Great Property Loss

Against the high bluffs that form its shore in Tennessee, the Mississippi River is waging relentless warfare. Large sections of the bank become undermined and topple into the water, carrying with them whatever structures they might support. The swift stream is cutting a new channel

at this point, that even breakwaters have not been able to prevent. A part of the bank was worn away recently to such an extent that a wide piece of land collapsed, taking with it the entire plant of an industrial concern, and causing a big property loss at other points.

3842

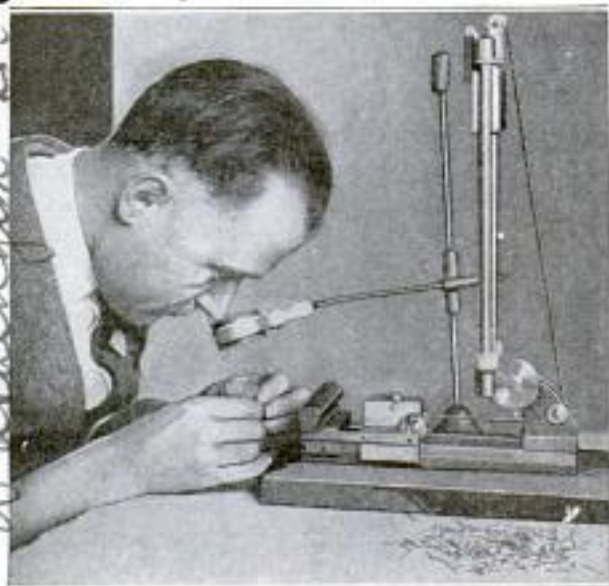

Engraver Examining Pin Head on Which He Carved Portrait and Name of Late President Harding

PORTRAIT OF HARDING CARVED ON HEAD OF PIN

On an ordinary pin head, an eastern engraver recently carved the portrait and name of the late President Warren G. Harding. From this, a die was made to be used in manufacturing large quantities of the novelty, and the artist has invented a press by which the "copies" can be stamped out. He also engraved the national capitol building in the same way as another example of his expertness.

☐ The Popular Mechanics' Bureau of Information offers its free service to all readers of our magazine. Names and addresses of manufacturers and dealers in articles described, and any other details in our possession, will be promptly furnished by addressing the Bureau.

August Hadecht, Engraver, Memphis, Tenn
no street address
Washington D.C.

ANCIENT TABLETS TELL STORY OF NOAH IN PARADISE

3843

Ancient tablets, unearthed in Mesopotamia and recently translated, tell a story of a race of men created from clay by a feminine deity, who when the great flood came, protected her creations by saving Noah and guiding him to Paradise. There, according to the records, he fell from grace of his own accord, the incidents following somewhat those related in the book of Genesis, but in a different order. The documents describe how the Sumerians, a race of unknown origin, worshiped their gods, how their ceremonies were performed in the temple of Nippur, corresponding to Rome in our day, and give a valuable insight to the manners of life 5,000 years ago, according to scientists.

AIR WARMED IN STEEL CABINET CONTROLLED BY PUSH BUTTON

3836

To cut the cost of heating in a building where all space is not continuously occupied, small steel-cabinet heaters, for individual use in rooms, are being made in the middle West. By pressing an ordinary push button, the temperature can be raised in a few minutes. Drawn inward by the machine, through an opening to the outside, clean air is warmed to the desired degree and blown by its fans so that drafts are avoided. The device, which is motor-operated, is built of sheet metal and can be placed on the floor, or where space is scarce, it may be supported overhead on brackets or put on a platform against a wall.



Fresh-Air Heater Cabinet, that is Operated by Push Button, for Individual Use in Rooms

Recent investigations show that nearly 80 varieties of mushrooms are poisonous.

TUNNEL BORED INTO SIERRAS GETS WATER FOR POWER

3866

Generating 105,000 horsepower, what is believed to be the largest water-power elec

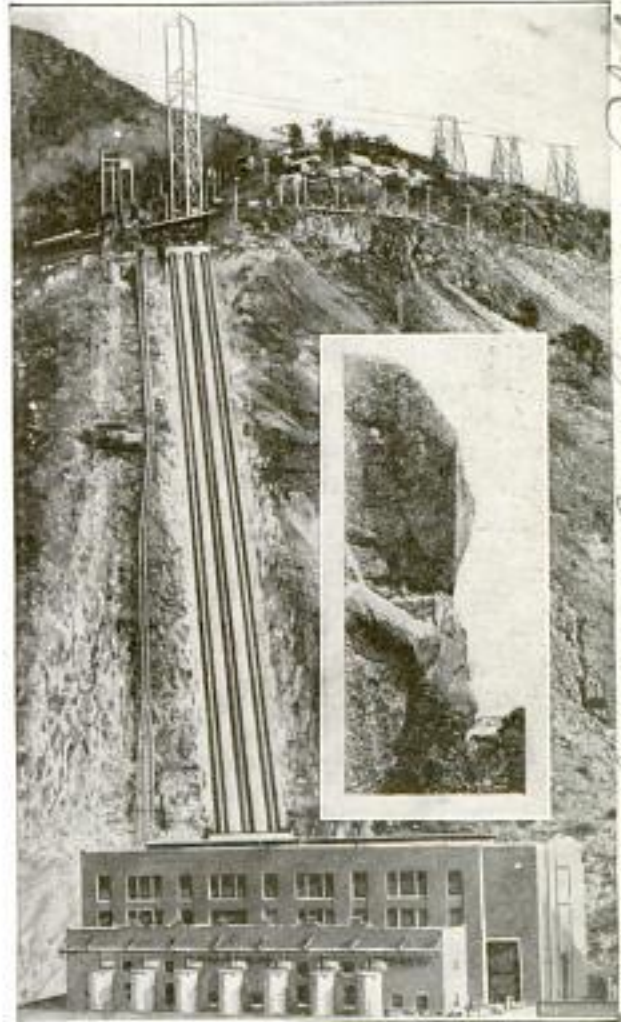

Where Water Begins Its Toil for Farm and Factory: Insert, Near Tunnel Mouth

tric station in the Pacific West, recently was placed in operation. From the San Joaquin River far up on the slopes of the Sierras, water is carried six miles by a tunnel and dropped 760 feet through three immense pipes to turn the wheels of this plant. The electricity is spread over a system of some 300 cities, towns, and rural communities in southern and central California. In this territory it serves 60,000 homes, 500 factories, and furnishes energy for irrigating 260,000 acres of land. Its present capacity is capable of being doubled when the Florence Lake tunnel, nearly 14 miles long, and reported the largest in the world, is completed. This excavation will make possible an output of 1,407,000 horsepower. Current from the present works is transmitted over lines in some instances 275 miles in length, at 220,000 volts pressure.

Southern California Edison Co. Los Angeles Calif.

Duckeye Blower Co., Columbus Ohio 425 W. 7th

White

3691

SEWAGE PLANT OF CITY FACTORY FOR FERTILIZER

In disposing of its vast volume of sewage the city of Chicago has undertaken a process of converting the waste to fertilizer. Even the industrial refuse alone is heavily laden with materials that enrich soils and are necessary in the cultivation of farm lands. The sludge is first activated by blowing air bubbles into the liquid and changing the solid matter to a dry, lumpy product. After this is removed, a fluid remains that is so clear and clean that fish can live in it, and any water stream that it might enter is not harmed by it. An experimental farm has been op-

erated to determine the value of the fertilizer as compared with various others. It has been highly successful when sown with corn, bush beans, and sugar beets. It is also being used to improve lawns in the parks, and growers of roses and peonies have made use of it for the treatment of rare species of flowers, while cotton raisers of the South have entered on trials with the article. With this process it is believed that not only better sanitation will result, but the production of the fertilizing materials will offset the cost of the installation of the drainage plants.



Chemists Are Constantly Analyzing the Sludge in Search for Matter that Enriches Soils



Experimental Farm, Surrounding Sewage Plant where Fertilizer Undergoes Tests in Actual Use with Various Crops: Its Effect on Each Is Carefully Studied and Compared with Other Materials

SNOWFALL OF TODAY AS HEAVY AS IN GRANDPA'S TIME

Official records, according to the weather bureau, will not support the assertions that "we don't have such heavy snowfalls now as we did when I was a child." According to the figures, the winters now are just as severe as they were in the days of our grandparents. It is a fact, say the experts, that the deep snow remembered by the man who was a boy in the '70's or '80's, which reached his shoulders, would be less than knee deep compared with his present stature. For example, the statistics show that in New York City and Albany, N. Y., the heaviest snowfalls occurred more than 30 years ago, but there have been few winters with more snow than fell at those places in the season of 1915-16. Records at Springfield, Ill., dating since 1884, indicate that the greatest fall, 43 inches, was in 1913-14. In New

Haven, Conn., the heaviest occurred in 1915-16, although there seems to be a gradual lessening of the total each season. Boston's best figure, 96.4 inches, was in 1873-74, but two years later there was only 5.3 inches, while Portland, Me., experienced 125.5 inches in 1886-87; last winter's total was only 1/2 inch less.

NEBRASKA ONCE HOME OF APES UNearthED TOOTH SHOWS

Scientists unearthing fossils in Nebraska have found a tooth, which they say belongs to a prehistoric ape and shows that such an animal once lived in that region. The skull of a giant camel was also dug up, together with bones of piglike beasts as large as a rhinoceros. Remains of a three-toed horse are among the collection, which according to the discoverers, proves that this animal roamed America more than 2,000,000 years ago.

New York Times 10/9/23

New York Times 10/12/23

New York Times

10/21/23

POPULAR MECHANICS

Pacific & Atlantic
Photos, dupes
25 Park Place
New York

FAILURES OF LIGHTNING ROD CAUSE SLUMP IN ITS USE

3978

Though 75 years ago there were lightning rods in every hamlet in the United States, it is said that a government report, citing many failures of conductors to protect property, has caused such a slump in their use that today the government census does not record one factory making the apparatus. Invented by Benjamin Franklin in 1752, this protection against the dangerous electrical flashes was widely used until the report of the Lightning Research Committee in 1905 caused the public to lose faith in its value.

PULLING SHIP'S "TEETH" TAKES CRANE AND HUGE FORCEPS

3912

Occasionally an ocean liner requires the services of "dentists," if it is to be kept in good condition. Its "teeth" are its bow

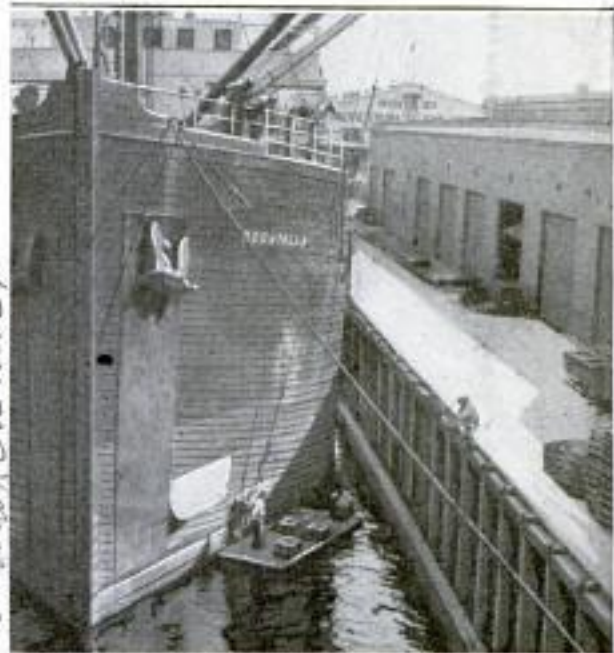

Cable and Crane Drawing Steel "Teeth" or Bow Plates from Hull of Vessel for Repairs

TREES DYED ANY COLOR WITH CHEMICALS THAT CURE WOOD

3998



Copyright, Underwood & Underwood

Dyeing the trunk and branches of a living tree any desired color, and at the same time curing the lumber, thus eliminating the necessity of seasoning when it is cut into boards, can be accomplished in two days with a process recently invented by two eastern chemists, they assert. The cost is less than one dollar a tree.

Fluids pass through a rubber hose from a tank to holes that are bored in the trunk close to the ground. These colors are absorbed by the tallest tree, giving it the tint of the mixture.

PLYMOUTH ROCK TRANSPORTED FROM CANADA BY GLACIER

4017

Examination of Plymouth Rock by a scientist recently has established the fact that it was carried from Canada perhaps 40,000 years ago by one of nature's freight cars, the huge glacier that at one time covered the northern part of the continent with ice. When this huge sheet began to melt and recede, tons of boulders and silt were deposited over New England. Among the huge stones was this historical rock which welcomed the Pilgrims.

plates, which, in a measure, protect the forward part of a vessel's hull from injury in case of collisions with other boats or submerged wreckage. A crane and forceps 10 feet high, are used to remove these strips of armor, when they are to be replaced by new ones. But they must first be loosened by workmen before they can come away without damaging the craft.

NAME PLATES ON KEYS HELP IDENTIFY THEM

3929

Small name plates, designed to aid in identifying the door or receptacle which any particular key opens, are being made in the form of eyelets that clamp into the hole. These tags, which are neat in appearance and do not interfere with attaching the key to a ring, are printed with luminous paint which may be read at night. The name plates are easily attached, simply by the use of a hammer, a blow clinching them into place like a rivet.

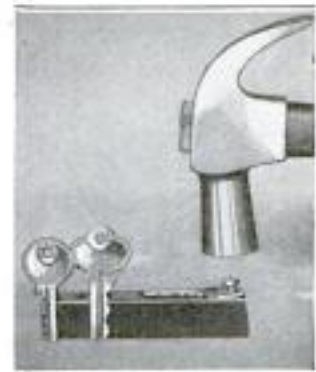

2024 Arch St.

Herbert Hoover Bureau Chemist

Christian Science Monitor
10/24/23

A. J. Matter
4431 Dearborn Chicago

Two Decades Ago in Popular Mechanics



Million-Pound Sand Wheel for Stamp Mill



Windmill on Locomotive
to Light Train

WHEN Popular Mechanics Magazine surveyed the field of invention a score of years ago, 1904 was just dawning, full of promise for the world in general. The past twelve months had seen the growth of the Louisiana Purchase Exposition at St. Louis, that was to memorialize a century of progress.

In industry, the mining world marveled at a giant sand wheel weighing a million pounds that was to lift gravel, water, and sand from a stamp mill to a trough 65 feet in the air. Locomotives were expected by one inventor to help light the passenger trains they hauled, by means of a rotary fan that operated from contact with the wind.

Speed in transportation, then as now, was sought by the traffic world and an electric car was built that attained 80 miles an hour in test.

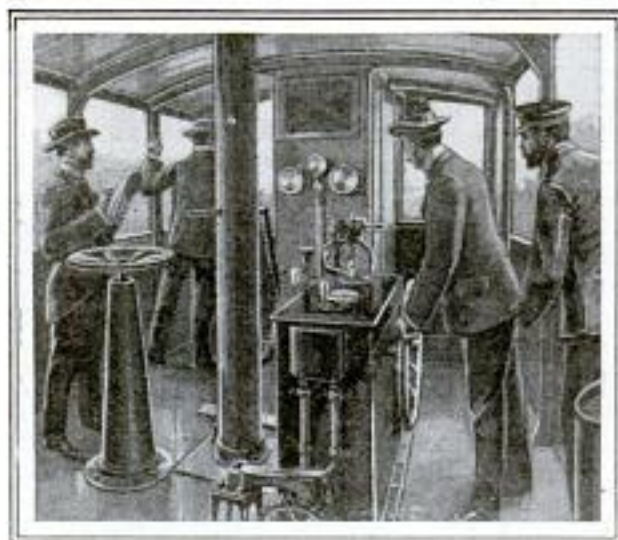

Control Room of High-Speed Electric Car

One of Principal Buildings
Louisiana Purchase
Exposition

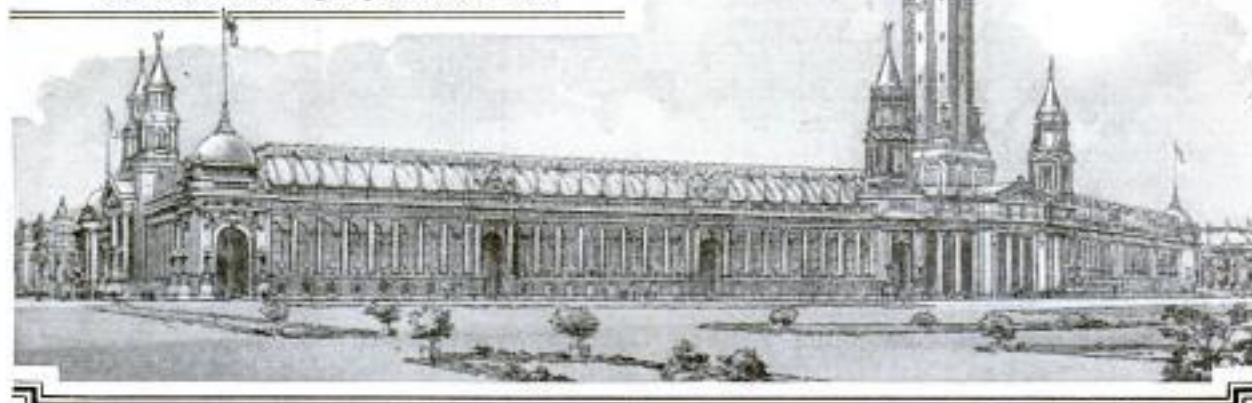

**RUINS OF OLD CITY FOUND
 MAY ANTEDATE ROME**

4046
 Buried under debris which covered the graves of its inhabitants, and had almost obliterated carvings on fragments of buildings, the ruins of a city thought to be 1,000 years older than Rome have been found near Ferrara, Italy. More than 100 tombs with the remains of persons buried in them and containing vases decorated with designs resembling Grecian forms, bits of jewelry, and wearing apparel, have been unearthed. Pieces of stones, which were evidently part of a large temple, are being put together in an attempt to decipher the inscriptions. Some experts say that the ruins may be those of the town of Spina or of an Etruscan city, whose people spoke some language now unknown.

**EXPERTS BREAK DISHES TO TEST
 HARDNESS OF CHINA**

4008
 Striving to establish standards of strength for china and porcelain, an expert in a government bureau smashes dishes daily with an apparatus built especially to measure the force of blows required to break various kinds of crockery. Hanging over the frame on which the dishes are placed is a weight that is pulled back and then swung against the piece

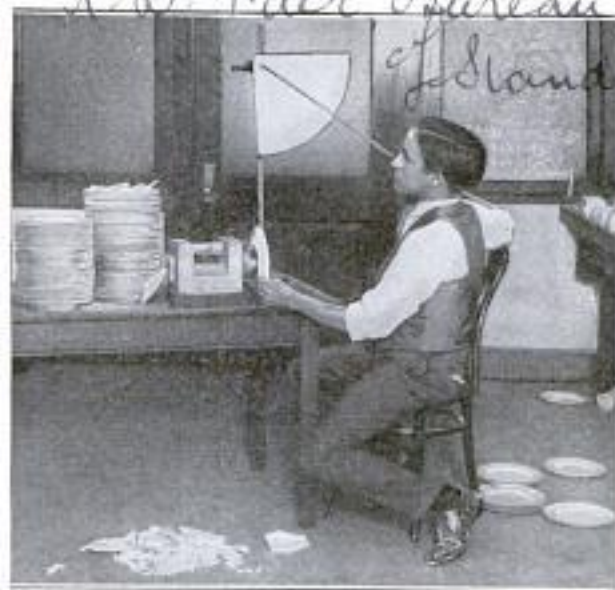

Breaking Dishes in Government Bureau to Help Establish Standards of Strength for China and Porcelain

being tested. Noting the angle to which this hammer is raised for the blow, enables the tester to compute its force.

Ⓞ Bags for the storing of grain are now being treated to make them weevil-proof.

**GLIDER WITH RAISED MOTOR
 SPEEDS ON TOP OF WATER**

3966
 While running 70 miles an hour on the surface of the water, a recently invented hydroglider is said to use only half the

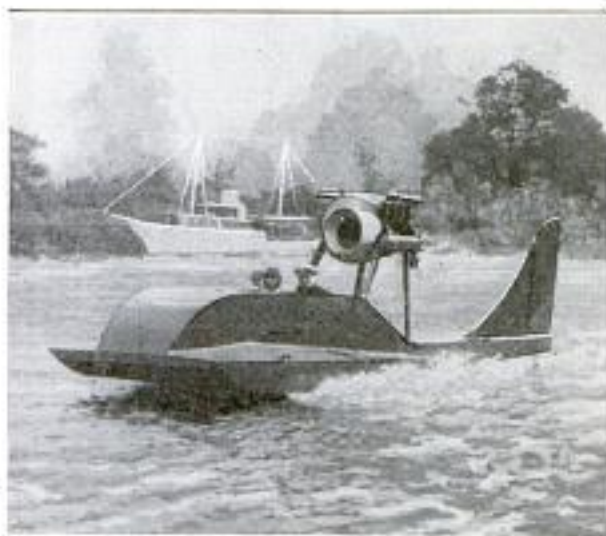

Hydroglider that is Driven on Water's Surface by Raised Motor that Saves Gas

amount of gasoline consumed by other types. The craft is almost entirely above the surface, when traveling more than a mile a minute, drawing little more than one inch of water. Mounted above and behind the passengers, an air-cooled motor turns the airplane propeller blades. Wind rushes through a large opening in front of the hood that covers the engine. With airplane tail several feet high, wide pontoon sides, a cabin that resembles a war tank, and the elevated engine, the ship presents an unusual appearance. For three years the inventor worked to perfect it.

**CONCRETE WHEEL BLOCK LOCKS
 AUTO TO BOX-CAR FLOOR**

399
 For safely anchoring an automobile while it is being shipped, a concrete block has been invented, which locks the machine's wheel to the floor of the freight car, making movement impossible. Weighing only a few pounds, it can be quickly placed in position, and as easily removed. Its face is concave, so that the inflated tire fits readily into it. The device then may be returned to the factory for further use or may be used in the garage, replacing the wooden stops, which are inferior in wearing qualities.



Inv. A. J. Curtis
 W. Washington, Chicago

Jan. 1923 - 56
 Feb. 1922 - 834
 June 1922 - 909
 Aug. 1922 - 243
 Oct. 1921 - 585

3741



Washing a Mountain into the Sea to Make an Extension of New Land for a South American City's Business District: Seven Million Cubic Yards of Ground Were Transferred

WASHING A MOUNTAIN INTO THE SEA

Contractors years ago began to move a mountain from the heart of a South American city into the sea. They used mule-drawn carts to haul the soil and rock away to be dumped inside the sea wall that marked the limits of a new water front. Shortly after the work was started it was estimated that under this method the cost would be almost prohibitive, and that the task would require eight years. It was finally decided to wash away as much as possible of the hill with hydraulic force. Twelve giant streams of water under pressure from three high-powered pumps were turned against the mountain, and it slowly began to crumble downward. At its summit stood an old monastery, erected by the early residents of the city. Aban-

done by its former occupants, it fell with the ground that supported it. Stones too large to be moved by the force of the water, were broken up by dynamite and sluiced away. Over 7,000,000 cubic yards of earth and rock have already been poured from this hill into the bay, making an extension to the shore three miles wide. Sixty new blocks will be available to the business section of the city when the transfer has been completed. Since the more modern methods of destruction were adopted two years ago, dynamite, steam shovels,



Abandoned Monastery Crumbles as Man's Forces Destroy Nature's Obstruction on which It Stood for Years

construction trains, dirt trucks, hydraulic equipment, and human energy have been tearing at the obstruction. Hydraulic pumps and dredge pipes have replaced steam shovels, dirt trucks and trains.

NEEDLE, ONCE BONE OR STICK, STAMPED FROM WIRE 40/0

Needles for the sewing baskets of housewives or the machines of factories had their beginning at the hands of prehistoric man, who made them from sharp bones or sticks through which he punched holes for the threads. Fine steel wire supplied in coils is now used in their manufacture. Powerful shears cut it into pieces, each long enough for two needles. Several thousand of these, bound in a bundle, are made red-hot and straightened by pressure and rolling. Both ends are then pointed on a grindstone. The eyes are stamped, with the two heads, at the center of the length, in one operation. Through these perforations thin wire is threaded and the needles are broken apart. Tempered by fire and an oil bath, they are then scoured, washed, and polished. This requires much labor, for the process is repeated.

*Chas. Edwin Jarvis
The Paragon, Washington Co.*

3900

INK SUPPLY OF FOUNTAIN PEN SEEN IN CLEAR STEM

So the user can tell when its ink supply is low, a fountain pen recently placed on the market is fitted with a stem of transparent material. It is said to hold a much larger quantity of writing fluid than many other models do. The article is made with either ordinary pen points or a pencil tip.



Fountain Pen with Transparent Barrel in which Ink Supply Can Be Seen

parent material. It is said to hold a much larger quantity of writing fluid than many other models do. The article is made with either ordinary pen points or a pencil tip.

Manufacture of building paper from sugar-cane waste has been developed.

Order, Lake Park, Chicago

SEAPHONES TRACK "FOOTSTEPS" OF UNSEEN CRAFT

Trailing unseen ships as they plow their ways over the ocean has been developed as part of the United States coast defense through the invention of delicate submarine phones. The system, known as underwater sound ranging, is manned by a special branch of the Coast Artillery. Although in its infancy, engineers believe it is destined to be the adopted way of obtaining firing data on enemy vessels that cannot be located by other means. Recent results indicate that a ship can be spotted 10,000 yards from

shore with an accuracy sufficient to permit shelling, although it may be traveling at full speed. Individual boats are picked out from others by distinguishing sounds, such as an engine knock or squeak and the impulses of its machinery. When the days were calm and there was only one vessel in the areas being tested, it was possible to

track tugboats, tramp steamers, and other craft within a range of one to two miles, and huge liners and freighters could be trailed for distances ranging from three to four miles.

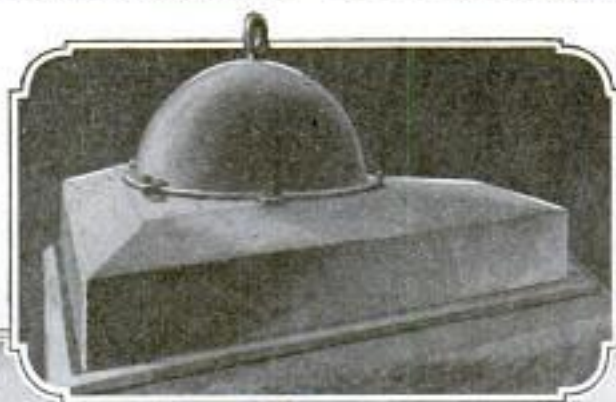

Types of Underwater Phones and Sound Detectors Used by the Coast Artillery Service in Tracking the "Footsteps" of Unseen Ships along the Atlantic Seaboard

FRUIT DISPLAY ON MOTOR TRUCK USED BY GROWERS 3985

For exhibition purposes in the creating of new markets, automobile trucks are being used by western apple growers to carry loads of their choicest fruit into the middle West and South. The boxed dis-

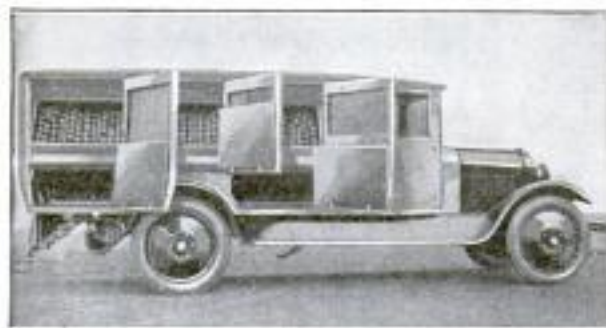

Exhibit of Apples Carried by Auto through Middle West and South to Open New Markets

plays, arranged in tiers, may be viewed by opening the several side doors of the closed cars. Heavy felt lining in the compartments prevents bruising of the products during transit. A few years ago railroad cars were used for a similar service by western farmers and growers.

GLAZE FOR ENAMELED PAPER FROM CHINAWARE CLAY 4012

Clay from which chinaware is made is being used for the coating of highly polished art papers. Applied in a fluid form it is given a rubbing treatment to produce the hard glaze. The material is also employed to a great extent in the manufacture of newsprint, in the preparation of cotton fabrics, and in the chemical industry. Recently a process was discovered by which artificial ultramarine coloring can be made from the clay.

Cmt. Edmn Jansse, District Material
 The Farragut, Washington, D.C.

U. S. War Department
 Hood River Apple Growers' Association, Hood River, Ore.

New York Times
10/28/33

Keystone View Co.
91. 7th Ave.
New York
39

POPULAR MECHANICS

3989

**BONES OF PREHISTORIC BRUTES
USED AS "MEDICINE"**

4047

Fried fossil bones of prehistoric animals are made into healing potions by some Chinese druggists, according to an eastern scientist, and are in wide demand among suffering natives. The "medicine" is taken in powder form, fried with oil in a skillet, or mixed with sour wine. The doses are prescribed for nervous diseases and liver and heart disorders. The bones have been mined, ground, and sold in this strange industry for centuries.

musical

**JAZZ INSTRUMENT MINUS KEYS
"PLAYED" BY HUMMING**

3934

Producing music with a "jazzy" effect, a keyless reed instrument is being made which can be "played" by anyone who can hum a tune. Equipped with a rest, it can be kept in the proper position without being held by the hands, and can be used



Horn without Keys that Produces "Jazzy" Music When "Player" Hums Tune into it

Price - \$10.00

to accompany any selection. Having sufficient volume and carrying power, it is suitable for orchestral work

Lyon & Healy, Chicago

**"EYES" FOR AIRPLANES AID
FLIERS IN DENSE FOGS**

4045

Automatic "eyes" to show aviators the heights of their planes when making night landings, or the distance from other objects while flying in fogs, have been demonstrated by an eastern inventor. The device consists of attachments placed on the wing tips and is connected to an indicator in the cockpit. A reading is shown when the craft is within 100 feet of any object, giving the distance in feet.

Demonstrated by Major Junius Jones at Mitchell Field near Garden City N.Y.

**FOOLPROOF TWO-SEATER AUTO
CAR PROPOSED AS TAXICAB**

Because of its cheapness of operation, a two-seated auto car recently invented in Europe, is proposed as a substitute for the



Copyright, Keystone View Co., Inc.
Foolproof Auto Car, Proposed as Substitute for Taxicab in Europe, Seats Two Passengers

much larger and more expensive taxicab. It is so simply built, the maker claims, that anyone can drive it without previous experience or training. Somewhat similar in appearance to the side car of a motorcycle, it is propelled by a small engine and guided by a huge steering wheel nearly twice the size of an ordinary one. It has only three wheels, two small ones at the rear, and a larger one in front. Besides the driver, it seats two persons. On heavily traveled boulevards, the machine is said to make rapid headway, as it is able to dart in and out among the larger vehicles.

**NOTCHED-EDGE BREAD KNIFE
CUTS WITHOUT TEARING**

3926

With its sawlike teeth arranged to cut on both forward and backward strokes of the hand, a bread knife is being made that produces clean slices. It goes through a fresh or stale loaf equally as well, without tearing the bread or making many crumbs, as the notched edge does not "pull." Made of hardened, tempered steel, the blade will



Bread Knife with Notched Edge that Cuts Either Stale or Fresh Loaf without Tearing
Burns Mfg. Co., 297 Seattle St.
last for years. When it becomes dull it can be sharpened in a few minutes.

Cobra Knife Co. New York
Cobra N.Y.
Syracuse N.Y.

When Pioneer "Ideas" Were Jests

Chance as Well as Necessity Responsible for Origin of Things Believed Indispensable to Mankind

WHILE necessity has long been accredited with being the mother of invention, it is safe to suppose, from the experience of striving geniuses, that accident has had much to do with the birth of a great percentage of the ideas which have astonished, as well as benefited, mankind.

What the loss to the world would have been had the phonograph not been discovered while its inventor was supposed to have been experimenting with the early telephone, is a matter for easy conjecture. Not only has it improved the tenor of life in many homes, but it has rendered aid to the business world in recording dictated letters for later repetition to typists. The industry

that it represents has an annual output valued at more than 158 million dollars.

It was not so long ago that an Ohio merchant, while on a trip across the ocean, visited the engine room of the ship that carried him. His attention was drawn to the mechanism which registered the number of revolutions the propeller made each minute. When he returned to his home, he began work on a machine that would record the amount of purchases made in his store. Thus, we are told, was the cash register born.

Each new discovery or amazing invention, although it may be admitted to be the last word in progress, seems only to open the path of research further. After steam was found to be a force that could be harnessed and put to work moving cars and boats, it was soon learned that brakes were also needed to check the momentum of railway trains when stopping. This

need led to the airbrake, which in its early days was the subject of much derision among mechanical minds. Today, the rail transportation system that failed to equip its rolling stock with the device would be thought worthy of more laughter than that which greeted its first appearance.

Barbed wire for fences, which has figured prominently in peaceful agricultural pursuits for years, and recently as an instrument of defense in warfare, came from the suggestion of a farmer lad that sharp prongs on metal strands might keep roving animals from forcing their way into grain fields. His father was first to adopt that form of protection for his farm. It

may not have worried the intruders so much as it did their owners when their cattle returned home with badly scratched hides.

Had the automatic dial telephone been looking for some one to invent it, it is questionable whether or not it could have reached the Kansas home of another farmer boy who is said to have given the invention to commerce.

From a half-penny toy once made in England, the motion-picture machine is said to have received its start on the road to perfection. This was a cardboard disk with a string passing through its center. On it was a series of little pictures of children at play. By whirling the card on its pivot a sort of motion was given to the figures as they passed before the eye. Later came another contrivance to give movement to photographs. Its origin is credited to two wealthy gentlemen who



Pictures Pasted on Disks Spun on Pivots May Have Suggested the Motion-Picture Machine



This "Writing Automat" Was Invented Two Centuries Ago

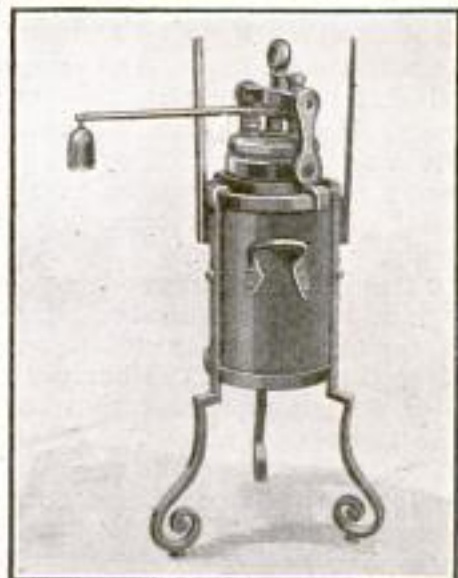

Steam and Gases Were Once Tested in Queer Tanks

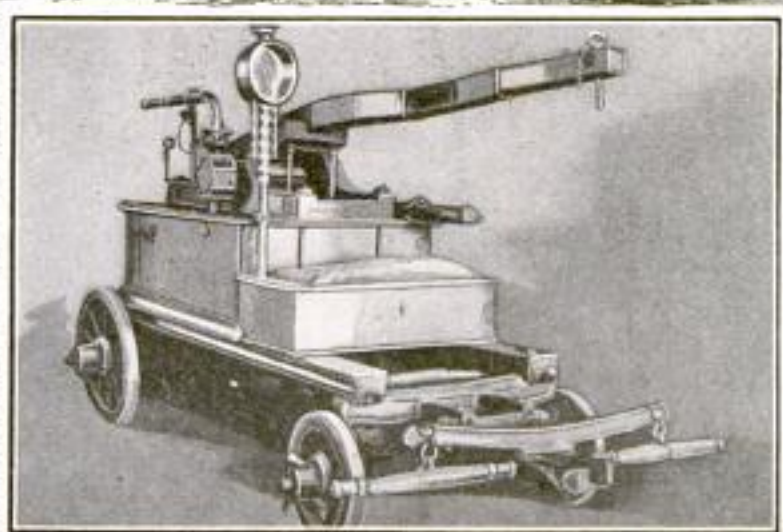

In 1602 this Horse-Drawn, Hand-Pumped Fire Engine Began to Replace the Bucket Brigade

Center: Early Mule-Drawn Street Car. Left: When the House Dog Worked for the Cook

had a wager as to whether or not a trotting horse lifted all his feet from the ground at the same time while running.

A row of cameras were set at intervals along the path the animal was to take, and at a level that commanded a view of his entire body. As the horse passed each camera it was operated. The resulting photographs were later pasted to a circular metal plate, placed on a pin, and spun rapidly.

In 1780 the first baby buggy is reported to have been built by a coachmaker, for the daughter of an English nobleman. It was patterned much like the horse-drawn vehicles of that day, except that it was pushed by a person walking. What becomes of the thousands of its descendants annually worn out, is a question that might be answered by almost any boy, for the homemade soap-box cart generally looks to the cast-off perambulator for its wheels.

In 1864 the first submersible boat is thought to have been launched off the shores of New Jersey, though several earlier attempts at such a craft had been made without success. However, among the relics in an eastern navy yard may be seen a forerunner of the elusive submarine

boat that picks its path beneath the waves, and rises at will under the impulse of powerful engines. This first device was propelled by hand and carried a crew of ten men. In size it was inferior to many whales which it must have resembled as it slid slowly through the water. Although dependent on man power for its motion, a speed of four knots an hour is said to have been attained under "full steam."

It was about fifty years before the appearance of the underwater craft that the pioneer ship of the steam navies was slid into the sea. Unlike its modern prototypes, it was constructed entirely of wood with the exception of the machinery that was to drive it through the waves. A half century later the ironclad sides were added to the fortresses of the seas, and became a standard that was to revolutionize the building of battleships.

In like manner the locomotive has superseded the steam wagon, and the dirigible airship has grown from the balloon.

Among the simple articles of everyday use which have come down to the present day out of a past that is all but lost to history, is the safety pin. The Romans had them, and so had the early Egyptians, and



Alchemists of Olden Days Led Secluded Lives of Study and Research in Ill-Lighted Laboratories Fitted with Odd Contrivances that Often Disclosed Amazing Secrets

2769

they were probably old when Greek civilization was new.

It is interesting to note that this handy little article possibly originated with the cave dweller of the stone ages. When facing strong winds or fleeing before an enemy, it might have occurred to him that his fur garment could

be kept secure by tying one end of a fastening bone pin about another with a cord.

Some of them to be seen in museums are artistically fashioned from gold and silver, and many have been set with precious stones. They have been improved from time to time, but none of those found in the ruins of ancient cities differ greatly from the safety pins of today.

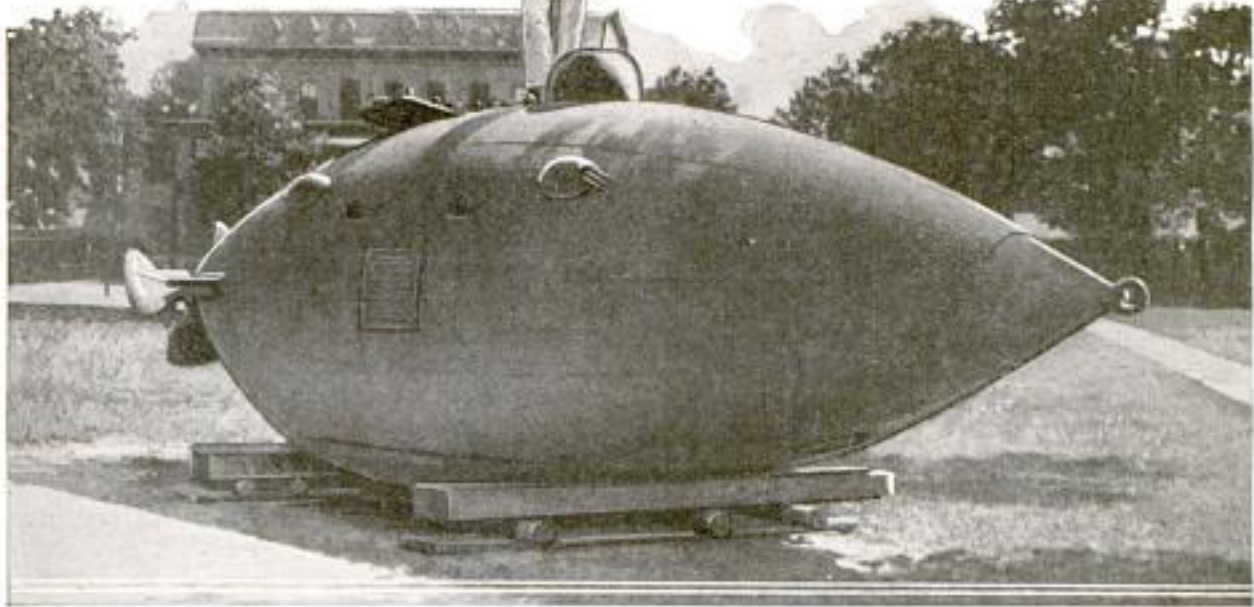

Once Called "Mechanical Whale," the Forerunner of the Deadly Submarine Was a Comparatively Small Affair which Was Operated by Hand but Carried a Crew of Ten Men

NATURE'S "MELTING POT" FOUND IN SOUTH AMERICA 3981

Among the mountains of the west coast of South America, explorers have found four distinct zones of plant and animal life, all within an area of a few miles. On the snow-capped peaks live birds and beasts akin to those that inhabit the polar regions, while lower down toward the valleys conditions and creatures exist similar to those of temperate climates. From there, it is but a step to the abode of tropical animals.

HAND PUMP FOR DRAIN PIPES REDUCES PLUMBING BILLS

Designed to reduce plumbing bills and to save housewives the inconvenience of torn-up floors and pipes, a small hydraulic lift and force pump for removing obstructions from clogged drains, sink traps, and other outlets, is a recent invention. The device is adapted to fixtures of standard size but may be quickly changed for odd-size pipes. A spraying nozzle can also be used for garden purposes, and as a radiator cleaner for blowing out accumulated rust and dirt before the steam is turned on.

*Hershel Pump Co
10 2nd Widenor Bldg. Phila*

BRASS HORN TWELVE FEET LONG PLAYED BY SIX MIDGETS

Measuring 12 feet in length, a giant horn requires at least two men to play it, as it is so cumbersome that one person cannot carry it. Recently, at a convention in the South, six midget men were necessary to handle the instrument: one at the mouth-



Massive Brass Instrument that Is Played by Two Midgets while Four Others Hold It

piece, another at the keys, and four to support it. This huge band piece was made in Paris and brought to this country about 75 years ago.

*Owned by New Orleans
Jerusalem Chamber Temple*

ACCIDENTS IN BIG CITIES OCCUR ON STREETS MOST CROWDED

Keeping tab on traffic accidents in a large eastern city by spotting them on a



Copyright, Underwood & Underwood
Map that Shows Proportion of Accidents Occurring in Busy Streets of Large City

street map, shows that the majority occur in the congested business district, where great numbers of vehicles and pedestrians

gather. On the more passable boulevards, where greater speeds are permitted to automobiles, the number is less. Pins of three different colors indicate the scenes of the mishaps; red for a fatal mishap, blue for a serious one, and black for a minor injury. According to this record practically all of the serious accidents take place in the busiest thoroughfares.

CHEMISTS TRY TO MAKE GOLD BY BREAKING UP ATOMS

Granted the possibility of producing a current of a million volts, scientists of a government bureau feel that it would be possible to create gold and other metals by shooting electricity through atoms of the elements to be changed. Already experiments have indicated that by breaking down the atom, chemists are on the track of a method to transmute metals and perform other amazing services that may result in benefits of great value to the human race. The problem of battering down the tiny particles now depends largely upon discovery of the right force to direct into them, experts say. When this is solved some inventions of stupendous importance may follow. Possibilities are seen in the curative value of radium.

new York Times 10/21/23

WARRIORS OF THE SEA NOW CHAINED TO DOCKS

Among the millions of dollars' worth of war machines built in frantic haste by the United States Government to combat the prowess of its foes during the war, are more than 100 warships of various types now lying idle in an eastern port. Chained to the docks, these warriors of the sea await the time when either they shall be put into service again, or dismantled under the terms of the disarmament convention.

Stored closely together along the quays, they float idly on the quiet water, those which might be put into service denied the freedom of the ocean because there are not enough men attracted to service in the navy to form crews for them. Some are to be sold to the highest bidder, while others will be broken up because they are not modern, even though they might have been kept in service despite the treaty.



More than One Hundred Warships of Various Types Lying Idle in an Eastern Port: They Were Built by the Government During this Country's Participation in the Great War

Pacific & Atlantic Photos, 25 Park Place, New York

BROOM HAS DETACHABLE FIBER FOR RENEWING WORN WISPS

Economy and serviceability are aided by a broom that is being made with a detachable handle to permit replacement of the fibers when they are worn down. This makes the buying of a new article unnecessary. Light in weight, it is balanced so that it can be used with little effort. It is said to sweep fine rugs without injury to them and to be equally effective on the sidewalk or porch. Designed to make house-cleaning easier, it is less tiring to the worker.

PAPER COMBS AFFORD PUBLIC SANITARY UTENSIL

For public places, such as hotels and barber shops, a paper comb has been offered, giving every patron a clean, sanitary article, which, when used once, may be thrown away. Since it is specially treated with a waxlike composition, it slips through the hair as easily as a comb of rubber or bone, and if it is cleaned it will



Individual Paper Comb to Promote Sanitation in Barber Shops, Hotels, and Like Establishments

not break easily. Tightly sealed in an "individual" package, it is protected from dirt until needed.

HIGH-SPEED MOTION BECOMES SLOW FOR CRITIC'S EYE

Making machines appear to stand still or move slowly while actually running at high speed, an instrument has been invented for studying the action of moving bodies. Intended to eliminate the risk of guesswork in designing, the device permits the observer to see clearly movements



Observing Working Machinery through Instrument that Reduces High Speed to Slow Motion for Eye

that might appear blurred, when viewed with the naked eye. Errors in timing of parts, speed variations, and other important details of working machinery can be discovered through its lens, it is said. The invention is also being used by salesmen of automatic tools to demonstrate their abilities in actual service, without need of lengthy explanations.

POCKET DATE STAMP CHANGED BY TURN OF HANDLE

So compact that it will slip into the pocket, a date stamp has been patented that carries its own ink pad. Numbers are placed about the rim, indicating the day, and a turn of the handle sets a small pointer opposite the one desired. The



Pocket Date Stamp, Carrying Own Ink Pad, Changed by Turn of Handle

month is indicated by rubber type in the center. Also there is room for any advertising desired.

Pennsylvania Comb Co., Phila.
 1411 Walnut St.

The Autostat Instrument Co.,
 600 W. Leigh Ave. Phila.

Sold by Hordern, Lake & Franklin Chicago

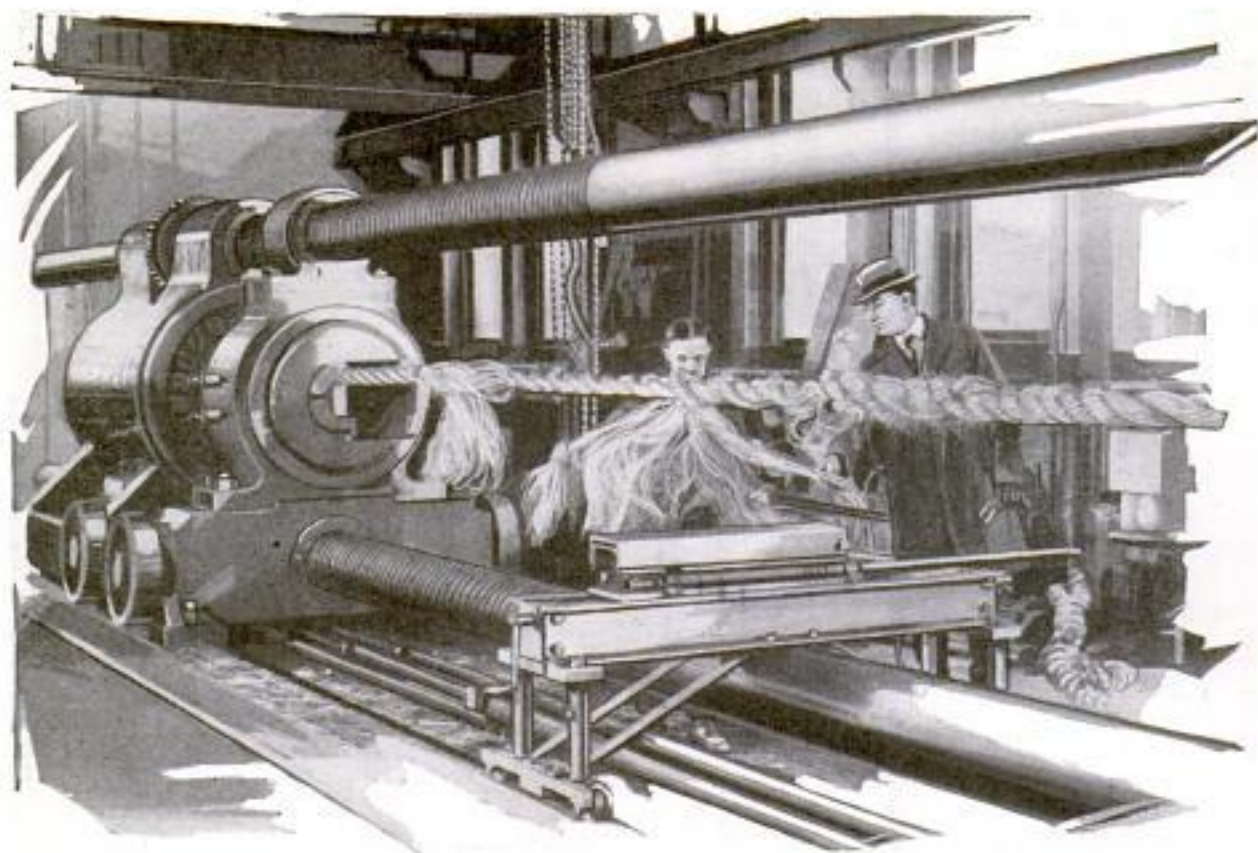

Photos Copyright, Underwood & Underwood
Inspecting Manila Hemp Hawser as It Is Being Broken by Machine Capable of 2,000,000-Pound "Pull"

"Chemical Detectives" on the Case

Industries, Faced by Loss or Ruin, Find Sleuths of Science Aids in Solving Baffling Problems

SPECULATION as to what the world of a hundred or a thousand years from today will be, continues to engage the minds of the nation's leaders in business and in science. Some of these prophecies are seemingly extravagant, but an inquiry into the extent to which science has penetrated business, serves to open a volume of real romance.

"The man who puts into words some of the things he believes chemistry will do, would seem a fit subject for an insane asylum," Irene du Pont, a well-known manufacturer, recently declared, and a review of what the chemist is doing for business lends a firm ground on which almost unlimited possibilities may be faced. The "chemical detective" today ferrets out more seemingly baffling mysteries than Sherlock Holmes cleared up in his palmiest days.

A certain large corporation in a western metropolis found that every Thursday, about 10 o'clock in the morning, their telephone switchboard, having some fifty con-

necting lines, went out of business. No one could reach the plant by phone, nor could the employes obtain outside lines. The telephone company was repeatedly called in, and although the equipment was entirely replaced three times, the trouble continued. Finally, an appeal was made to the chemical detective. After a few days' investigation he found that the contact points in the switchboard became coated each Thursday with a fine dust, which interrupted the electrical current. Analyzing the dust, it was found to be particles of burned paper. The chemist learned that, because of the heat of the summer, the windows in the room in which the switchboard was located were left open during the day. Investigating further, it was disclosed that the janitor of the building burned the week's collection of waste paper on Thursday morning at 9:30 o'clock. It was a simple matter to deduce that the fine ashes of burned paper, escaping from the chimney, were blown in through the windows and found their

way into the switchboard cabinet. As carbon is a conductor of electricity the ashes had short-circuited the electrical contacts. Thus, by simply closing the windows for an hour or so on that one day each week, the trouble was ended.

Deciding to add two stories to his building for the accommodation of his growing business, a macaroni manufacturer installed more machinery on the top one of the new floors. Thereafter, for weeks, he suffered losses, because the product turned out by the new equipment did not equal the goods that had gained him his reputation. Although he even went to the extent of exchanging it with the old machinery, no improvement resulted. After trying every means he and his advisers could think of, without success, he called in the chemists. They found that the air on the higher floor contained a different degree of moisture from that circulating on the lower floors. As a result, the dough could not be prepared satisfactorily. The fault was remedied and thereafter the trouble ceased.

The owners of a factory, making bearings and tools, found a great

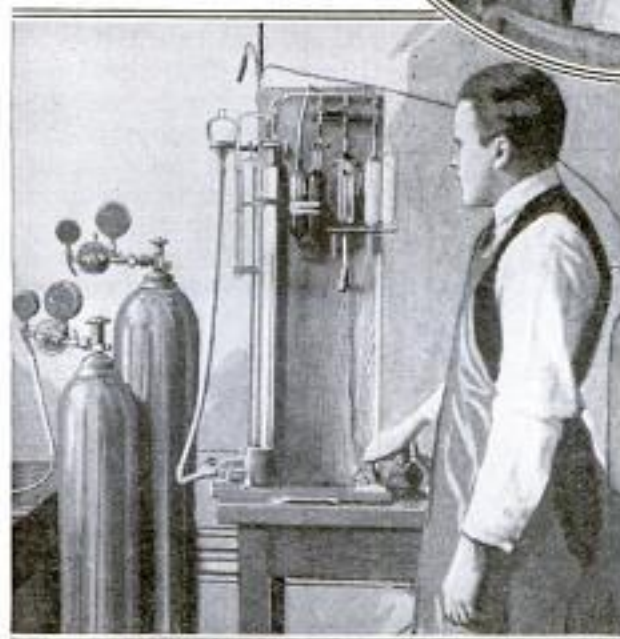
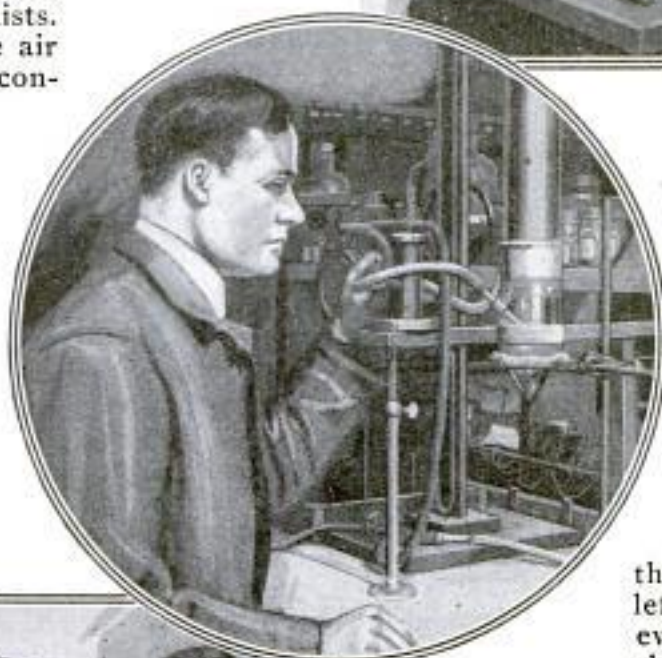

Top: Testing Drinking Cups; Center: Examining Air from Cement Factory; Below: Testing Compressed Gas

many shipments being returned because of peculiar stains appearing on their products. Steel experts were put on the matter and could find nothing wrong with the grade of metals used. A rigid inspection disclosed no faults existing in the tools when they left the factory. However, the industrial chemist who was summoned,

found that the tools were wrapped in paraffin paper for shipment to protect them against moisture. He also knew that sulphur and acid combined in the paraffin developed a solution that spotted the steel. The remedy was apparent.

Somewhat similar is the case of a manufacturer of tennis shoes who faced ruin when his product began to be returned in large numbers by his customers. The retail merchants pointed out that the white canvas tops turned black or became streaked, after the shoes had been on their shelves a short while. A score of attempted remedies failed to correct the defect and a chemist was finally called on the case. He found that the sulphur used in curing the rubber of which the soles were made, caused the stains, when it came into contact with another substance mixed in the



Planting Typhoid Germs in Test Tubes Used to Develop Vaccine



Testing United States Army Shoes at Bureau of Standards

white dressing that was used on the canvas.

Water for the boilers of a small-town factory had been obtained from a near-by well. Business prospered so that the owner was forced to enlarge his plant, which meant the addition of more boilers to the equipment. He then found it necessary to deepen the well in order to obtain sufficient water for them. Soon thereafter he began to have trouble. The boilers became coated on the inside. After some months spent in vainly trying to solve the problem, his friends persuaded him to call in a chemist. The latter found that in enlarging the well, the borers had broken through rock into deeper strata. The water from this level contained a mineral which formed a crust on metal surfaces under intense heat.

The matter of water has so engaged the attention of manufacturers that paper makers find it profitable to send samples of it from the proposed sites of new mills to laboratories for analysis. Frequently, such water has been found to be injurious to the product that it was proposed be made, and thus many a dollar has been saved.

A large corporation in the middle West made and sold reaping machines, which,

among other things, tied a piece of twine around a sheaf of grain. Soon after the device was put on the market, farmers from Texas to Minnesota complained that during the night, after a field of wheat had been cut, the strings broke, allowing the sheaves to be blown apart. Investigators were sent out by the company to look into all such reports. They learned that the string apparently had been cut in each case and had not really broken. The chemical detectives were put to work and found that crickets were gnawing the cords apart. Further observation showed, according to one report, that the crickets did not like to eat the twine, and according to another, they did. Following out the first statement, it was asserted that when the reapers had finished with the field, the insects were disturbed, and thereafter attacked anything foreign in their surroundings. The string, being the only unfamiliar object within reach, became the target for their rage. In any event, the twine was soaked in a chemical that repelled the crickets and the complaints ceased. These are but a few of the instances where chemistry has ferreted out solutions to perplexing problems that have faced industry.

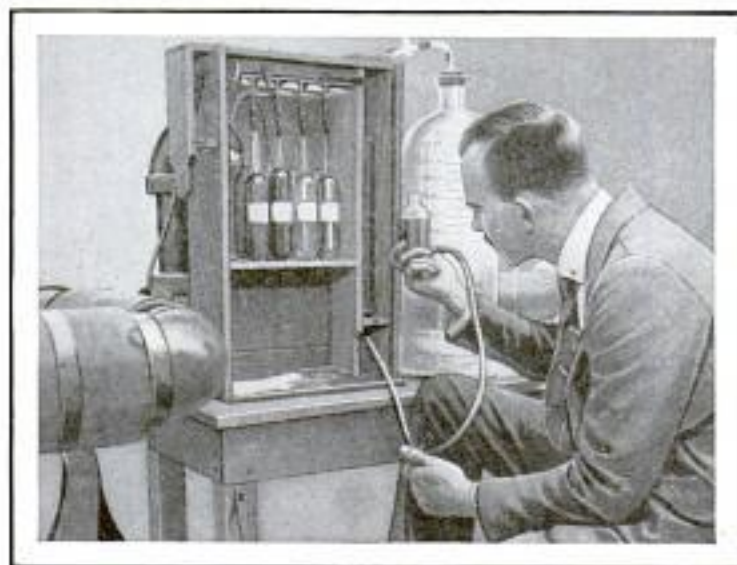

Studying Various Gases in Order to Learn How Best to Use a Furnace

GOVERNMENT ASKED TO RETURN BOOTY OF ANCIENT PIRATES

8974

Swept from the high seas long ago, bold pirates and plundering privateers of the eighteenth century are once again recalled in long-standing damage claims which now are being pressed against the government by various individuals. These interests seek enactment of a law that will restore to them wealth that was taken from their ancestors, who in the days of the "Jolly Roger," were owners of ships that were looted by highwaymen of the trackless ocean. Listed among the claimants, in addition to members of prominent families of Philadelphia, New York, and New England, are certain insurance companies, and one eastern city. A measure, known as the "French Spoliation Claim," authorizing payment for losses of ships and cargoes between 1793 and 1800 at the hands of French privateers, has been reviewed by Congress. The demands are made against the United States rather than the French government because of certain early agreements between the two countries. After a long delay, the whole subject was referred to the U. S. Court of Claims in 1885, and since then, several suits amounting to nearly \$4,000,000 have been settled. An attempt is being made now to dispose of the last of those favorably considered, involving \$3,246,888.

Although carrier pigeons normally fly at the rate of about 30 to 36 miles an hour, they sometimes attain a speed of 60 miles an hour or more when "homing."

ANCIENT VOLUME THAT TAUGHT BOOKKEEPING WORK OF MONK

3975

What is believed to be the first textbook on the methods of bookkeeping, has been presented to the library of a western



Volume, Almost Five Centuries Old, in which Italian Monk Explained Bookkeeping Methods

university. It is printed in Italian and Latin and was published in 1494. The author, Luca Paciloi, an Italian monk, is supposed to have originated in this work many of the familiar mathematical signs, such as "plus" and "minus" marks. The volume is still in good condition and can be easily read. The letters stand out sharp and clear, and the ink shows few signs of fading. The leaves are intact and the binding in good condition despite the volume's age.

Printed in 1494 in Venice. Author: Luca Paciloi, an Italian monk.
 Built by Pacific Car & Foundry Co. Wash. Seattle.

Estate of ...

TRACTOR SO LARGE AUTO CAN PASS UNDER IT

3894

So large that an automobile can pass underneath it, a tractor, weighing 10 tons, has been made for logging operations in California. It replaces several teams of horses and requires the attention of only a few men.

Slung beneath the body and between its wheels, one pair of which is 10 feet in diameter, immense tree trunks can be handled with ease. It has a wheel base of 18 feet, so it can carry logs of great length.



Mammoth Tractor Built for Logging Operations, so Huge that Automobile Can Pass between Its Wheels, One Pair of which is 10 Feet in Diameter

Used by Fruit Growers' Supply Co. Susanville, Calif.

Mr. The Fairway Golf Supply Co.

50

POPULAR MECHANICS
INDOOR GOLF TEE TO HELP IN PERFECTING STROKE

3788

Wherever there is space to swing a club, a golf tee for home and indoor practice, which has been invented recently, can be

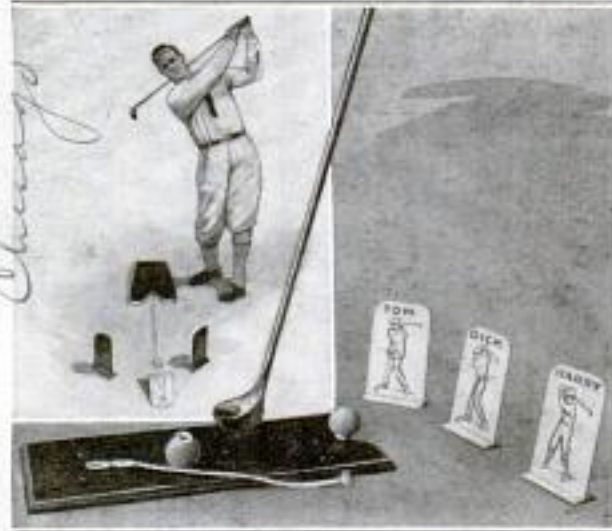

Indoor Golf Tee with Elastic Cord to Hold Ball that Indicates Accuracy of Drives

used by players who want to preserve their "swing," or improve without visiting a course. The ball is attached to a rubber driving platform and re-tees itself after each drive. Shots may be aimed at tin figures set between two and four feet away, the direction of the pellet's flight indicating the degree of accuracy in the stroke.

SKUNK IS FRIEND OF FARMER, NOT HEN-ROOST ROBBER

Next to the muskrat, the skunk is now the most important fur-bearing animal in the United States. In 1858, only 18,255 pelts of this little animal were sent to market. Then the supply began to increase until the record number of 1,921,000 pelts was gathered in 1914. Occasionally, the average price was as high as \$12, but in 1922, the top figure was \$5.90. Commercially considered, according to government figures, the skins of skunks mean a total business of about \$3,000,000 a year in this country. Experts of the agriculture department declared that the skunk is the most maligned of all dumb creatures; that, in fact, it is the most gentle, the most harmless, and most easily domesticated of all wild things that harbor on the fringe of farm lands. It is not true, according to the statement, that they kill chickens, steal eggs, or bother with any of the live things on a farm. Grasshoppers and crickets form a large percentage of their diet.

CASCADES OF FIRE PLUNGE HALF MILE TO VALLEY

3529

As part of a nightly program of entertainment, a western resort has a cascade of fire passing over a high ledge in the mountains and dropping almost a half mile to the stony floor of the valley below. At the top of the lofty point lives a man whose duty for some years has been the building of the "fiery falls." About dusk each evening he lights a huge bonfire of logs. After they have burned to a pile of glowing embers, they are pushed over the edge of the rocky wall with a long metal scoop, to drop in a spectacular, blazing avalanche that can be seen by the resort's guests several miles away.

SHIP ROCKED BY EARTHQUAKES WHILE IN MID-ATLANTIC

3879

Sailing in mid-Atlantic, a vessel bound from Halifax to England recently felt four severe earthquake shocks, the longest of which was of 30 seconds duration. Each caused the ship to tremble from stem to stern. When the first came, the captain thought the ship had run afoul of submerged wreckage and was on the point of stopping the engines as the second occurred. It was even more violent. North of the craft's location at that time, the skipper reported, three peaks rose up from the bed of the ocean. Soundings indicated that the sea floor surrounding them was from 1,300 to 2,200 fathoms below the surface. In the opinion of experts, these mountains may have been in volcanic activity.

CINDER IN EYE EXTRACTED BY MAGNETIC LOOP

3864

To extract cinders or other foreign particles from the eye, without risk of causing infection, is the purpose of a pocket in-



Instrument that Removes Cinders from the Eyes, and which is Magnetized to Extract Metal Particles

strument with a small wire loop, recently marketed. It is magnetized so it can easily remove a metal chip that may become lodged in the tissues. To keep sanitary, it fits into a tiny glass vial containing a sterilizing liquid. Many railroad men, motorists, and mechanics find this simple invention of great service.

Coulter Optical Co.,
87 S. Wabash,
Chicago

Sold by Von Lengerkes Antwerp, 130 S. Wabash, Chicago

New York Times 10/11/23

Vol. 11, p. 128/28

3529 Mrs. Jane M. Elwyn,
Arlington Hotel
POPULAR MECHANICS 51
480 Ellis St., San Francisco
Calif.



Cascade of Fire Seen by Guests of Western Resort: Like a Shimmering Ribbon of Red against the Black Wall of the Mountain, It Falls to the Valley Far Below

Yosemite Valley.

52

3791

The Explosives Engineer
Wilmington, Del. 1923

**DANGER FROM MINE BLASTING
 REDUCED BY SOUND TRACER**

For preventing accidents from mine and tunnel blasting, a delicate listening instrument called the geophone, is reported to be proving of important service. With

this device, which, it is said, is modeled after those used during the war to detect the presence of underground operations, sounds so faint that the listener has a sensation more of feeling them than of hearing, can be detected and identified. With a type now used to increase safety in mining, talking has been heard through 125 feet of solid earth and rock, and the hammering of a sledge underground has been heard 3,000 feet. Vibrations in the earth, set up by pounding, digging, or talking, alternately compress and rarefy air in the chamber of the instrument, and the sound is carried through a tube to the receiver.



Listening with an Instrument that Can Locate Underground Sounds Half a Mile Away

Sold by Warner for Clay

3853
**DIAMOND FIELDS OF ARKANSAS
 YIELD MANY FINE STONES**

Nearly 6,000 diamonds have been found in the Arkansas fields, the biggest weighing 21.25 carats. Many of them, according to experts, are as good as those mined in any part of the world. In describing some of the brown, yellow, and white jewels from this state, experts have stated that they are absolutely perfect. A few of them, it is said, have been sold for as much as \$600 a carat, but most of them are uncut and have been placed in private and museum collections. The first field was discovered by a farmer, whose mule kicked up a stone of unusual brilliancy.

Best County
Compressed Air Magazine
Oct. 1923

Vitalux Cinema Co.
Milwaukee, Wis.

3755 **TUBULAR FILMS BRING MOVIES TO HOME**

To bring motion pictures into the home, a camera and projector are being made that use tubular films costing a little more than the average "still" photograph. One strip, which is of noninflammable film, will carry 1,664 pictures. The camera may be loaded in daylight. One reel equals 150 feet of standard film, and can be purchased

for 75 cents. In projecting, rewinding and threading of the reels have been eliminated. The device may be attached to any electric-light socket. The camera is made of aluminum and differs little from the ordinary apparatus. The lens is always in focus, making it easy for the amateur to "shoot" pictures.



Tubular Film that Takes Motion Pictures for Reproduction in Homes and Offices: Left, Inserting Reel in Machine, and Right, Showing an Industrial Subject in an Office

Watry + Heidkamp, 17 W. Randolph
Chicago

Copyrighted material

3849 Operation performed by

Prof Hans Finsterer, Vienna

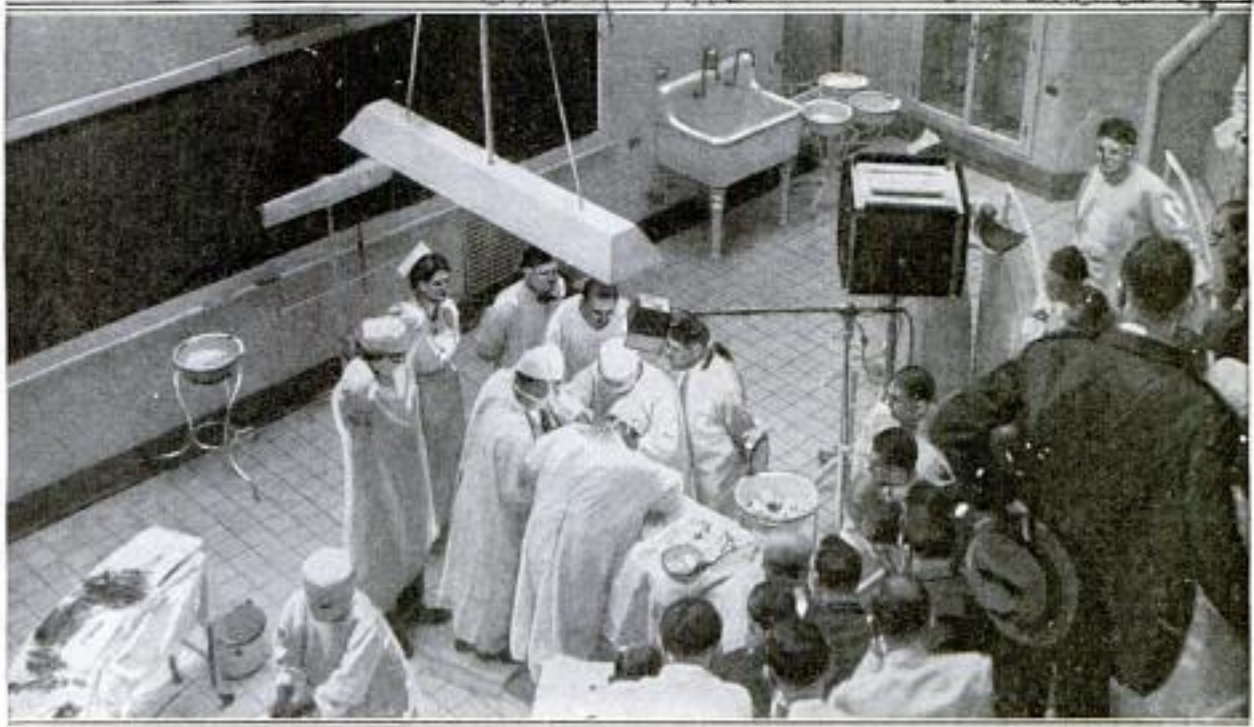

Surgeon Performing an Operation without Resorting to Usual Anesthetic: Although the Patient Was Entirely Conscious and Could Watch the Doctor Working, He Did not Feel Pain

SURGEON WORKS ON PATIENT WHO WATCHES OPERATION

Without using a general anesthetic, a noted Vienna surgeon deadens the nerves of the body surrounding the point of operation, leaving the patient entirely conscious. In Chicago, recently, he performed a major operation on a man 52 years old, while the patient still retained his senses and could see the doctor at work. With only the nerves of the solar plexus treated, a gastric ulcer was removed from the stomach. Many prominent physicians who were present pronounced the feat remarkable.

Special

AIR BLOWER ON DIESEL MOTOR INCREASES POWER

For increasing the power of normal four-cycle Diesel motors, a special air compressor has been devised in Europe that adds 30 per cent in working capacity and four per cent in over-all efficiency without straining the engines. With this device the weight of air that enters the cylinders in advance of the fuel is considerably increased, so that the engines are capable of consuming a greater quantity of oil. No part of the engine is said to be stressed any more than under ordinary conditions, for the maximum pressure remains almost the same. The burned gases are said to be completely removed from the cylinders more thoroughly, re-

sulting in better combustion and with less impurities in the exhaust valves and other units. The perfection of this apparatus, according to engineers, indicates that there are possibilities of further improvements.

ADJUSTABLE HINGE FOR DOORS TO STOP RATTLE AND JAMMING

Rattling of a door by wind or sticking of the jamb from dampness is stopped by turning the center pin in a recently patented hinge, it is said. This action loosens

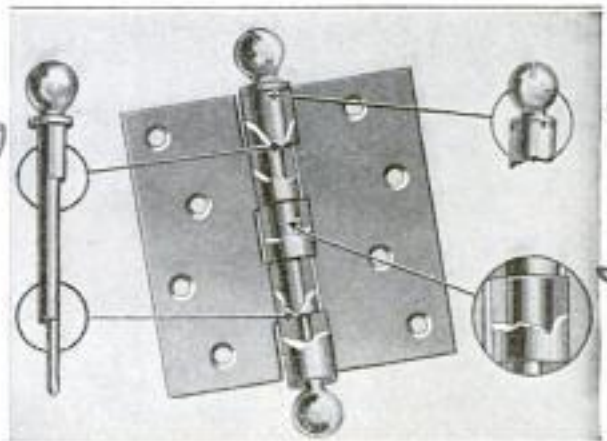

Adjustable Hinge that Is Said to End Door Rattling or Jamming with Turn of Center Pin

or tightens the door in the frame and quickly changes clearances, when weather causes wood to expand or contract, or when a building sags a trifle.

*Built by Allgemeine
Electricalgesellschaft, Berlin.*

*Way Works Co. Hurdlow, Phila.
2052*

Wm. C. Flanagan, Art Glass,
Decorators, Automobile Glass,
3677 312 W. Illinois
Chicago

Glories of Man- kind Told in Art- Glass Windows

OF all conveniences met with in everyday life, glass is one of most ancient in origin. Authorities differ regarding its beginning, but it is said to have been made by the Egyptians almost 8,000 years ago. And the coloring of it can be traced as far back as the remote eras of Chinese civilization.

Colored glass was first employed to make imitations of the brightly hued gems, such as rubies, sapphires, and emeralds with which the ancient nobles decked themselves and their horses in barbaric splendor. It was not until demand for the material to be used in flat subjects was born that it was rolled into sheets.

One of the first steps in this art of painting in glass, which enshrined and glorified national, religious, and romantic characters in churches and universities of the Middle Ages, was the discovery that under action of fire a solution of silver would stain a clear glass yellow. This find marked a beginning of stained glasswork. Nobility, clergy, and artists became enthusiastic over it. It brought to the seat of learning and culture the master glassworkers of the world, persuaded by the rich fields that these places offered for their services.

Money was raised on all sides by public-spirited persons, and studios furnished to these artists, who set about to ornament the classic pages of history with skill, the results of which are still to be seen among the architectural beauties of the Old World.

The early artists began by producing borders and scrolls, simple things compared to their later achievements. But soon some courageous adventurer in color craft inserted



Artist Adding Finishing Touches to Painting which Is to Be Reproduced in Exact Colors on Glass

a slight peep of a country landscape into a corner of his subject. At first, the wise ones wagged their knowing heads and pronounced it foolhardy to attempt to do that with glass, which they had been taught the brush alone could accomplish. But later another invaded the outer world for an inspiration, and when he had finished his task his patrons beheld a daintily wrought human figure, done with tinges of color, that set them to clamoring for more of the same.

Thus it was that medallion windows came into vogue, and these were followed by ornate canopied patterns and massed groups of pictured men and women, which cover the spreading walls of many of the Gothic structures left to the modern world by builders of old Europe.

Time and again the hand of disaster laid upon the work. Wars, and invasions they caused, halted the progress of the art, which was just as often revived. As architecture developed, it began to take account of the new ornament, and structures were planned with a view



Pasting the Paper Patterns to the Surface of Clear Glass before It Is Cut



Like the Cathedrals of the Middle Ages the Modern Church Employs the Artistic Utility of Stained Glass to Depict Scenes and Characters that Relate to Its History



Above: Fitting in the Glass Fragments on the Paper Guide. Below: Burning the Colors in Under Intense Heat



Above: Applying Cement Dressing for Waterproofing Window

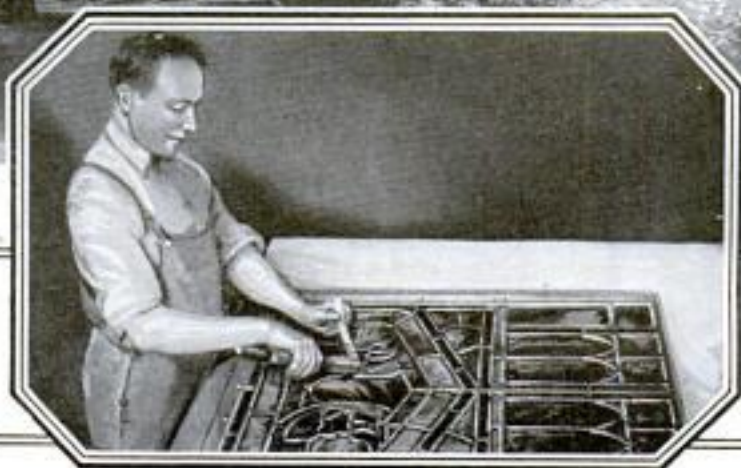

Left: Uniting the Glass Segments with Soldering Metal

to admitting the art window into their designs. Thus greater demand was put upon the creators of these fantastic affairs. Vying with one another, they spurred to higher aims. Masterpieces resulted, and fresher subjects were wrought into the windows. Many of the creators of these failed to leave any certain identification, and a number of the finest specimens which delight present-day tourists in the Old World, bear no marks by which their modelers can be credited.

Each set of artists had their own style. As these impressed those who could afford to have such marks of luxury to distinguish them and their houses, importations of foreign craftsmen became the practice. Spaniard and Italian invaded France, seeking a market for their services, and in turn the Frenchman passed with his art into other countries.

Often, to the leaders among them, entire windows were given over by their owners for the illustration of some heraldic figure set in imitation of a noble who generally desired to be remembered in this way by those destined to take over his house and his lands after his demise.

Many of the faces of the earlier figures that entered into these patterns were distorted, owing to the inability of the designer to produce in glass and colors with equal detail, what he could set down on canvas. They frequently were incorrectly posed and assumed grotesque positions, vastly unlike the original drawings that first appeared on paper. Other figures were not properly proportioned.

As in the olden times, the present-day artist in stained glass first paints the picture he is to reproduce on paper or canvas. From this original a pattern is made of the same material with the shapes of the inlays drawn to their exact sizes. Double-lipped shears then trim a narrow strip along each line, separating the sections as they are to be after the lead or zinc joints are in place. Glass of the required shades is then selected and cut into bits of the shapes and sizes of the paper pieces.

After they are put in place on a skeleton easel, they undergo a sort of critical test as to arrangement of group, color, lights, and shadows. This test is always made against a northern light, since an even blend of the sun's rays is available from that direction.

Though the opening chapter of the history of stained glass seems to have taken place some time in the Middle Ages, when colored windows were made as a kind of story-book picture, few changes have since been adopted. Steel tools have re-



Design of Window Cut from Cardboard with Painting Underneath It

placed diamonds for cutting, and zinc occasionally is used instead of lead for joints. The invention of the double-lipped shears used in cutting the patterns out of paper is said to be the only other new implement in an industry that was old long before America was discovered.

HIDDEN WORLD'S LIFE SHOWN WITH MAGIC LANTERNS

3962

For screening microscopic slides of plant stems, flowers, and insects with the ordinary magic lantern, such as is used in elementary

schools, a magnifying attachment is being made. With this device, pictures of living things of the "unseen world," so minute as to be invisible to the unaided eye, are thrown on a curtain with accuracy and clearness. The lens, easily adjusted, produces enlargements 60 times the size of the subject at 10 feet, 120 at 20 feet, and 180 at 30 feet. Held rigidly in place by a screw, the apparatus can be removed when the ordinary type of work is desired.

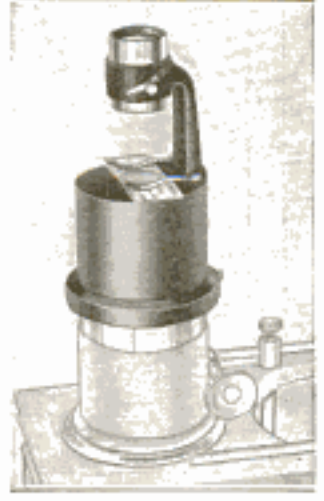

Rausch & Lomb Optical Co., Rochester, N.Y.

3683

58

Cont. Es. H. - 20 acy.
national Press Club,
POPULAR MECHANICS
Washington, D. C.



From Snow-Clad Mountain Peaks, High above the Clouds, to Hot Desert Sands, Uncle Sam's Map-Makers Risk Lives to Put the Nation on Paper

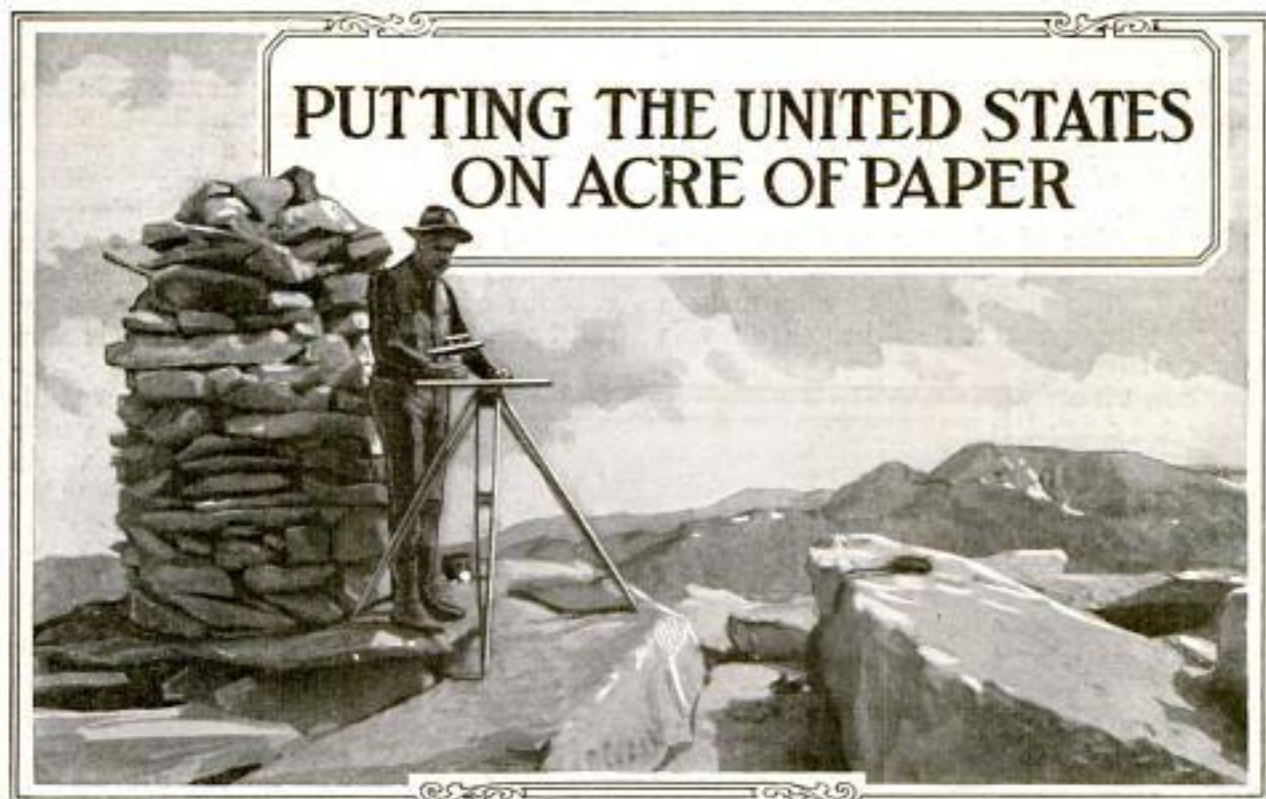

SHOWING every "bump and dent" in the land surface of the United States, the largest and finest picture map of its kind in the world is in the making in Washington at a cost estimated at 100 million dollars.

It is being made piecemeal style on an extraordinarily large scale, one mile of the natural lay of the land being represented by one inch of map surface. All the integral parts of the map dovetail together like the tiles of a mosaic. One of the maps can be carried in the vest pocket, yet, if spread out and pieced together, the geographical picture of our country would cover more than an acre of ground.

The national map-makers ascend all the mountains and towering crags in the country, brave the heat of the southwestern deserts and the penetrating cold of Alaska, and perform "dare-devil" stunts close to the clouds or away below sea level as their regular daily routine. Their lives are filled with adventure and romance such as the colonial pioneers, the early California gold seekers, and other settlers of the great American wilderness of a century ago experienced.

Four hundred of the most expert topographical engineers in America with their assistants, rodmen, camp attendants, and cooks take the field from their Washington headquarters as soon as the songs of the first spring birds are heard in the latitude of our national capital. These fed-

eral scientists scatter to every section of the country, where the mapping activities are in progress. They remain afield until the appearance of Jack Frost and his colleagues—ice and snow—which prevent further mapping operations. They then return to Washington, where the winter months are spent in inking in and perfecting their pencil-sketched field maps, and in supervising the engraving of everlasting copper records of the scientific data.

Other surveying parties, which aggregate 100 topographers and their aids, are gaining complete familiarity with every square inch of land surface in Alaska. Often, these scientific scouts of the Northland work for months at a time, 300 to 400 miles from the nearest white man's habitation. The clothes which they wear in the frosty summer are made of fur, for in the interior of Alaska, even during the season when everyone is sweltering in Chicago and New York, the mercury hovers around the zero mark.

Just to illustrate how the hazards of mapping in moderate climes are almost as dangerous as those experienced in Alaska, mention of the marvels encountered in the course of a 90-mile stretch of country in California is worth while. From the sky-high summit of Mt. Whitney, 14,501 feet above the ocean level, the experts laboriously wormed their way to safety in a risky descent. Mile by mile, they continued their painstaking survey of every hill and hollow that lay in their path until

finally they came to Death Valley, a notable "no-man's land" of the far West. Venturing the difficulties of that famed region, the map-makers began to go down hill and continued their gradual descent until they finally stood 276 feet lower than the level of the sea.

Irrespective of whether or not a mammoth mountain has previously been climbed, the government map-makers ascend to its peak, if need be. From this

perilous perch, they study the lay of all the surrounding land and transfer its features to paper, using pencils with the hardest lead obtainable to make these technical sketches. Prowling predatory animals, such as grizzly bears, wolves, and coyotes, mean nothing to them. They boldly invade the secret lairs of man-killers in search of their land bump-and-dent data. They work on the Arizona desert where the heat of the sun is terrific. Along the northern border of the United States, they pursue their novel occupation under as trying temperature conditions, the mercury often standing 10 to 40 degrees below zero.

Most of the mapping work connected with the gathering of facts and figures for putting the United States on paper is, of necessity, performed on foot. Lately, however, airships have been recruited for the novel task. Flying at altitudes of about 8,000 feet, the national birdmen, by the use of specially contrived cameras, photograph the land as it streams by in panorama below. Subsequently, these films are pasted together to form a complete picture of the area as it is taken through the lens.

Approximately three centuries ago, the curious business of mapping the United States and its boundary waters was begun. John Smith, a prominent English explorer at that time, inaugurated a mapping survey of Chesapeake Bay. After several months' work, however, his attention was diverted to other activities. Thereafter, little was done in reducing the shape and contour of the New World to parchment until after the Civil War, when Uncle Sam

began to explore every hill-top and valley from Canada to Mexico, between the Atlantic and Pacific oceans.

After four decades of painstaking work, less than one-half of continental United States has been accurately charted. Unless the mapping campaign is speeded up it will take another century of constant labor to complete the herculean task.

A topographic map is a veritable crossing and criss-crossing of intersecting lines. These scientific networks are of

the greatest importance to transcontinental railroad engineers and to all agencies interested in mining, commercial engineering and industry. They portray the shapes and contours of the countryside and constitute a complete dictionary of altitudes for all named and unnamed places in the entire nation.

In this great enterprise of producing a picture of the nation, the country is divided into unit areas or quadrangles, each of which is 225 miles square. Uncle Sam pays between \$3,000 and \$8,000 for surveying and mapping each of these portions, depending on its ruggedness of topography and degree of settlement. As each quad-

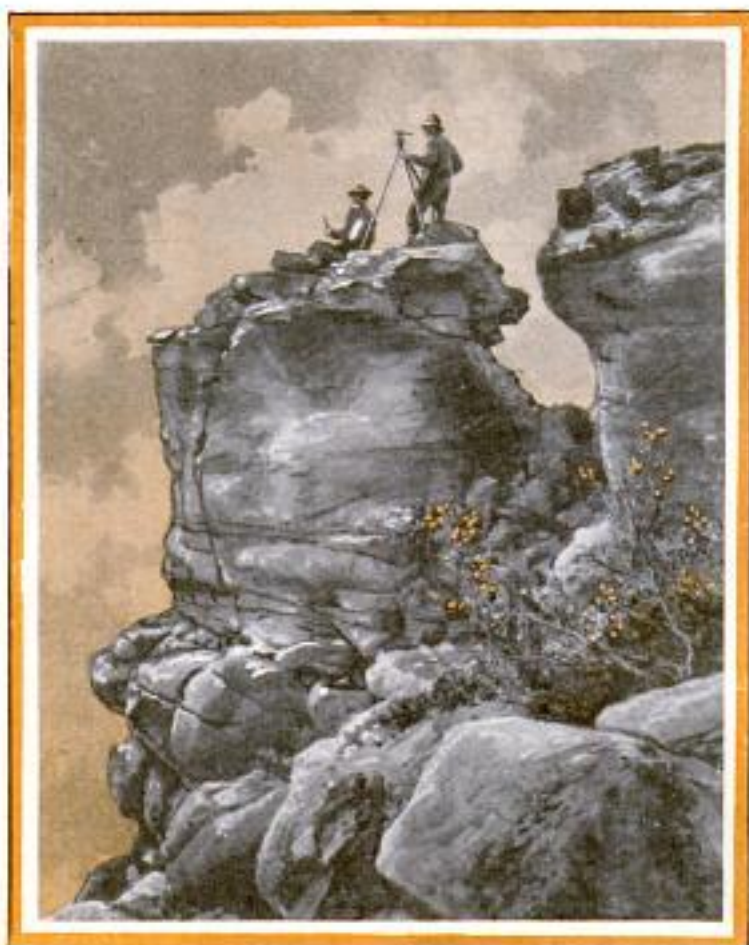

Burdened by Heavy Instruments, Scientists Struggle to the Top of Mount Whitney, Thousands of Feet above the Sea Level



Dog Teams Carrying Map-Makers through Uncharted Wilds of Alaska, where They Face Arctic Cold for Eight Months of the Year Before Returning to the States

range is mapped, the resultant scientific data reproduced in map form is sold for 10 cents a copy. If a similar map were prepared and distributed by a commercial agency, the price would be many times that amount.

Three thousand quadrangles, equivalent to approximately 675,000 square miles of land and water surface, have already been mapped. These fit together like a picture puzzle. In the leading mining sections of the country, the topographic maps are made on larger and more detailed scales than most of the other regions.

The federal topographer will survey and map about one square mile of land area daily, during his field work. In the small space of one square inch, he will set down

every outstanding physical, natural, and artificial feature and landmark, by the finest of hairline drawing and lettering. Thereafter, each map is engraved and printed in three colors.

Never were any valuable documents of state or nation more carefully and zealously guarded than are these precious scraps of paper which the federal map men make.

Already both the army and navy have mapped large areas by this method. While in many cases the principal elevations and depressions are shown on the photo-map, the minor changes escape. Nevertheless when the ground is level, aerial photography often becomes an invaluable aid to the topographer.



Map-Makers' Pack Train on Way over Mountain

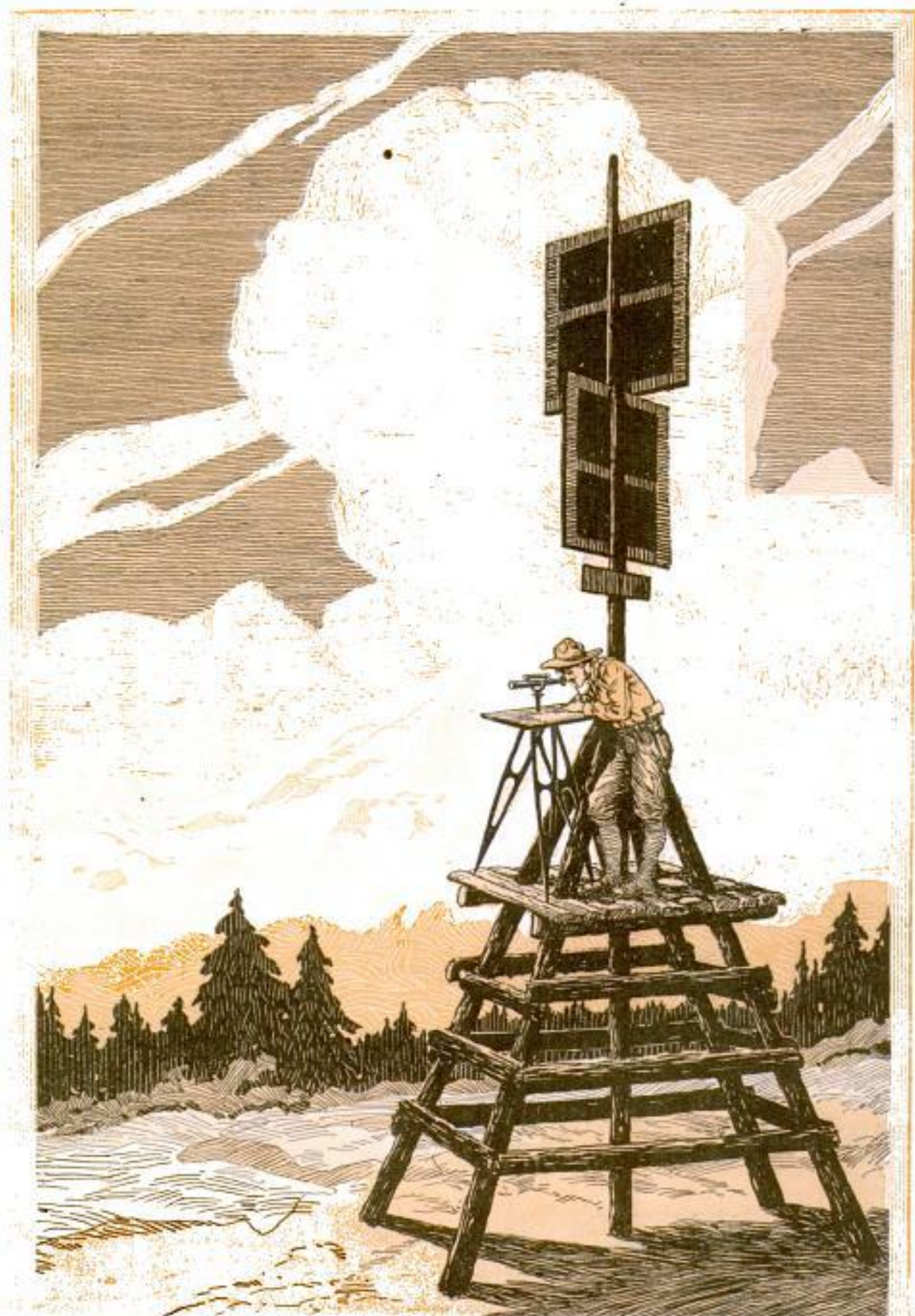

Signs' Station Built on Mountain Top by Uncle Sam's Scientists: This Target May Be Seen for a Long Distance and Is of Great Aid in the Making of Maps

**PLANTS REVEAL RICH ORES
 OVER WHICH THEY GROW**

3948
 Plants that generally grow over certain mineral deposits aid miners of Australia in locating rich ore deposits. Where the calamine violet thrives, they look for a zinc called calamine, because the flower favors earth containing this substance. Iron is often indicated by a copse of birch trees, while bindweed suggests the presence of phosphate. Lead may be discovered where there is a poisonous plant of the sumach family, and limestone is revealed by beech trees.

**PUSH BUTTONS ASSIST WHEEL
 FOR STEERING SHIP** *3822*

Push buttons on the bridge of a ship are used to control a new type of rudder, which is intended to do away with much signaling between navigator and engineer, and to make docking easier. After a recent test, engineers predicted that the electric system may simplify handling of even the largest ocean liners. A row of buttons near the compass and an indicator dial

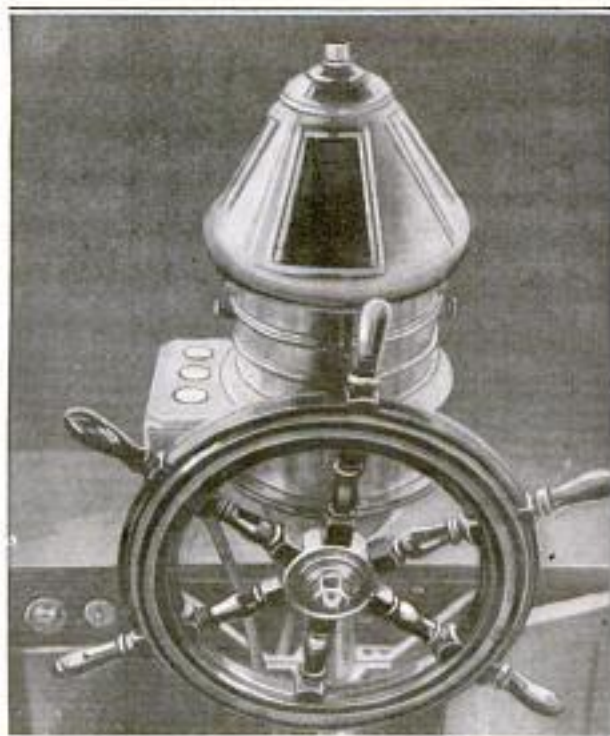

Pilot House with Electric Buttons and Indicator Dial to Steer Boat, Making Docking Easier

showing how to use them to regulate a motor in the stern, are used in steering. The motor moves the rudder.

International

Alaska has yielded gold worth 328 million dollars.

**DUSTLESS ASH SIFTER SAVES
 FUEL, PREVENTS DIRT**

3858
 By sifting unburnt coal from stove ashes, a device is being made in Europe to enable housewives to reduce the cost of



Ash Sifter which Saves Fuel and Operates without Permitting Dust to Escape

fuel. Tightly constructed, it prevents dust from escaping and may be used in any part of the house. Resembling an ice-cream freezer and operated by a crank, the machine quickly separates the waste material from that which may be unconsumed, the good particles remaining in its upper section, while the refuse drops into the lower part.

3933

**FORTY-THOUSAND-MILE FLIGHT
 GETS BEE POUND OF HONEY**

Flights totaling more than 40,000 miles must be made by a bee to gather enough nectar from the flowers to make a pound of honey, experts have recently figured. Gathering the sweet liquid within a radius of two and a half miles from its hive, it is estimated that the little housekeeper travels at least one and one-half miles for each drop. It takes one-half gallon of this substance to make one pound of honey. At the same time, it is said, the busy worker also carries plant pollen and water with which the young brood is fed.

Christian Science Monitor *10/11/23* *free material*

Discovered by Prof.
Francis McBride,
Field Museum.

POPULAR MECHANICS

FIND CACTUS PLANT LIKE MASS OF SERPENTS

3883

Found recently by museum workers in South America, a type of cactus new to



Odd-Looking Cactus of a Type New to Science that Was Found in South America

science, presents an odd appearance. The leaves are long and thorny and resemble snakes more than they do parts of a plant. Scientists, who made the discovery, have been unable to determine any special service that the curious growth might perform, even in its native habitat.

3880

POROUS BRONZE BEARINGS HELP PROLONG LIFE OF AUTO

Absorbing oils and greases up to 25 per cent of its volume, a copper-tin bronze automobile bearing recently developed is expected to simplify the problems of lubrication and to aid in prolonging a car's life. Under a test, it was found of service in all ordinary uses and in many cases satisfactory for replacing ball and roller types. Thousands of tiny pores give the metal the qualities of a blotter or a wick. In a demonstration, a kerosene lamp was fitted with a bushing of this material, instead of a cotton wick, and burned as long as the liquid lasted.

Kansas City Star 10/14/23

PIPE A BLOCK LONG TESTS EINSTEIN THEORY

With a length of sewer pipe a block long, scientists are testing the Einstein theory of relativity. By observing whether light rays are bent in passing through a vacuum tube and being reflected by mirrors back to the source, they hope to solve the question as to whether air is stationary or is drawn along by the motion of the earth. If two beams of light, flashed

from opposite directions in the tube, displace each other, it will mean that the theory is correct, say the experimenters. About 95 per cent of the air was withdrawn from the tile tube by a vacuum pump, and delicate instruments in little houses at both ends record the results of the trials studied by the observer.

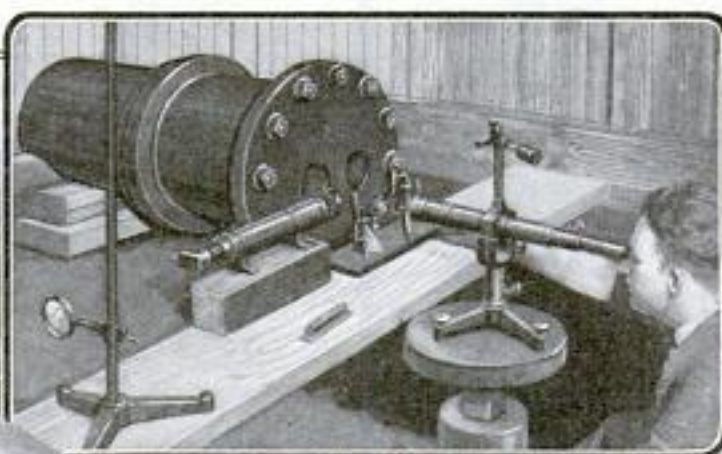
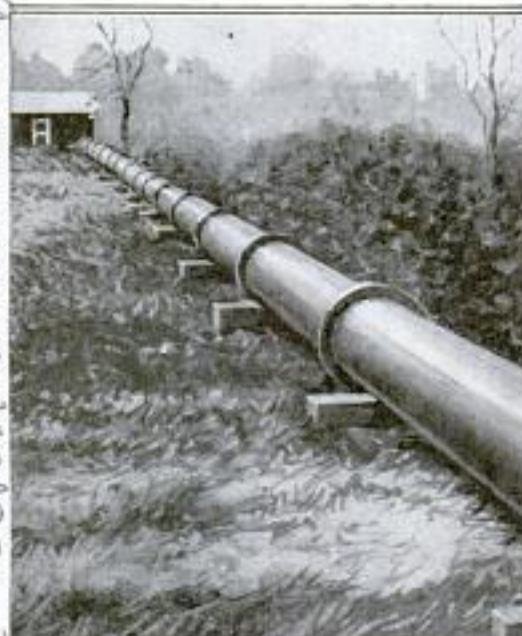

For Testing the Einstein Theory of Relativity this Vacuum Chamber Was Built of Sewer Pipe. Above: Instrument to Aid Scientists in Study of Action of Light in Tube

Experiment conducted by University of Chicago Prof. Albert A. Michelson

Cont. H. H. Dwyer 2722
Prunice St., Berkeley,
Calif.

66

POPULAR MECHANICS

Tracking Fish of the Deep with Seaplanes

3386

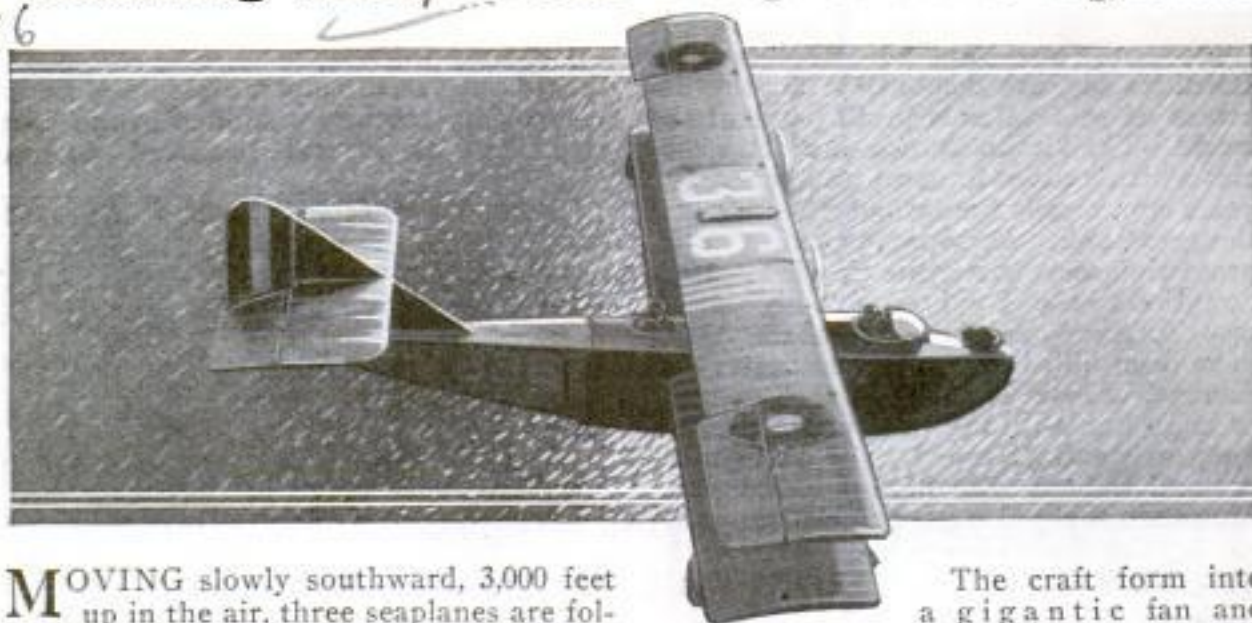

MOVING slowly southward, 3,000 feet up in the air, three seaplanes are following the coast line of southern California eight or ten miles out from shore. Suddenly the observer in one of them, peering through the floorless bottom of the cockpit, reaches over to a switch and a radio message crackles into the air. The plane swings into an elliptical course, two miles north and south and a half mile wide. The other planes continue in a straight course.

At North Island, one of the federal aviation stations on the Pacific coast, a wireless operator leans to a telephone and speaks clearly and slowly:

"Sardines, two by a half; one mile north-northwest Coronado Islands."

On the water front of San Diego, a minute later, a shrill whistle cuts the air and from 50 to 250 motorboats put to sea in battle formation. Toward the Coronados they drive, and nearing there a few minutes later, they sight a seaplane moving languidly above. A flag is run up the mast of the leading boat; the seaplane drops to almost water level and directs a course; the flotilla of boats follow, spreading out as they proceed to the point.

The craft form into a gigantic fan and then at a concerted signal throw their nets overboard and steer for a common center. They proceed spasmodically, stopping to haul in their nets laden with sardines and casting out again. The plane is no longer necessary and it rises to join its fellows.

As the boats reach their capacity and no more fish can be piled on the decks, they turn shoreward. Here, tied up, they shovel their cargoes onto the dock and await another message from the airship.

How effective this mode of fishing is may be judged from the increase of production of fisheries along the coast near San Diego since the planes have been used. Last year approximately 10,000 tons of fish were landed without the use of aircraft. This year it is believed that there will be a 20 to 25 per cent increase.

When the fish are running normally and in their usual seasons, the planes are not necessary, as the fishermen locate them by the flocks of gulls that follow them by day, and by the phosphorescence they give off at night. However, with these aids, "fishing by plane" is more productive.



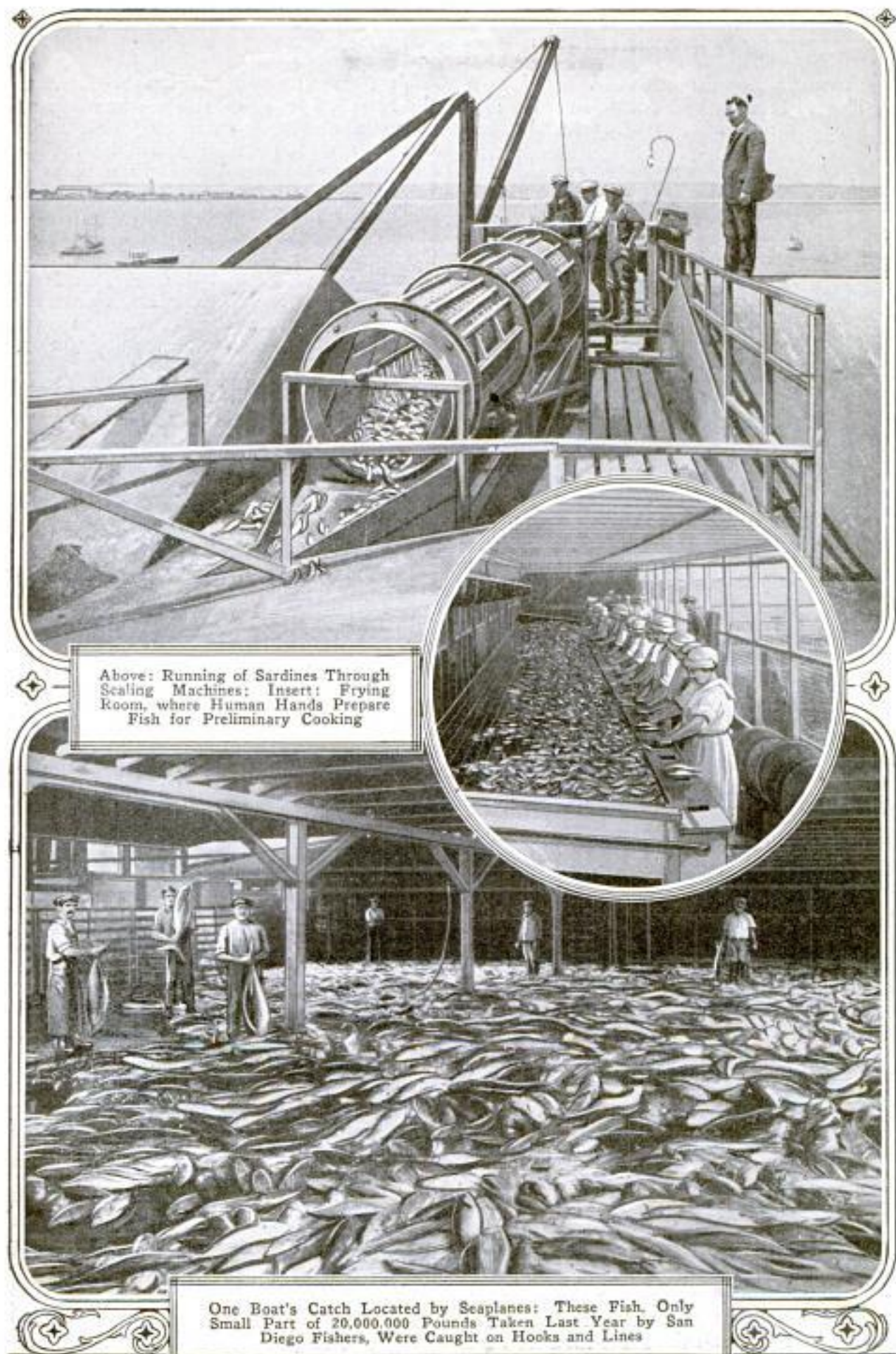

Underwood.

Cmdr. J. White "Norma"
Mount St. Strathfeld
Sydney, New South
Wales
Australia

**PERISCOPE AIDS GOLF PLAYERS
TO SEE HIDDEN GREEN**

**SOIL OF ORIENT BECOMES BANK
FOR SUSPICIOUS NATIVES**

3999

4085

Players on a golf course in Wales locate a hidden green by using a periscope. Attached to the side of a shed, and extending

Vast amounts of buried treasure in the form of gold and silver coins and ornaments are lying in the soils of India, China, and the Malay Peninsula. The coolies, in years past, took this means of protecting their meager hoards against the rapacity of those in authority. Bankers place the total amount of capital thus withdrawn from circulation at hundreds of millions of dollars. Officials in India have attempted to persuade the common people to deposit their savings in the banks, but their efforts have not been entirely successful. The silver market of the world is greatly dependent on India and China for an outlet for a large share of the bullion.



Copyright, Underwood & Underwood
Golf Players Using Periscope to See Lay of the Land Before Driving Off

about fifteen feet in the air, the device affords an unobstructed view of the fairway. Before driving off the tee, each player looks through the lens to determine if the green is clear, thus avoiding the possibility of striking persons who may be near it. It also aids the golfers in directing "shots."

**BUNGALOW BUILT IN TREE TOP,
4041 MAKES AIRY HOME**

Built among the sawed-off branches at the top of a tree, but equipped with a roof garden and other luxuries, such as are found in modern homes, the abode of a Civil War veteran is one of the sights of a soldiers' home in California. Preferring the airy dwelling to one on the ground, he rented the structure and fitted up comfortable quarters. Two large rooms, a kitchenette, and a veranda reached by an outer stairway, compose the building.

Los Angeles County



Where Civil War Veteran Lives in Completely Appointed Bungalow Perched in Tree Top

**SCISSORS GET SHARP EDGES
4051 CUTTING METAL SHEETS**



By cutting sheets of metal foil, now being sold in Europe, scissors are easily sharpened, good edges being obtained with a few slashes. Knives also may be dressed by drawing them across the material while it lies on a

flat surface in much the same manner that an oil stone is used.

Built by - Comrades
Amos Aksey, Civil War
Veteran

India led
3 Elbe St. "Acropolis"
W.C. London, Eng.

Native Tells of Great Quake

From Popular Mechanics Magazine's Japanese Correspondent,

N. SAKATA OF TOKYO

Eschome Tida-machi, Tokyo-suburb

[Popular Mechanics Magazine believes it need offer no apology for presenting an account of the Japanese earthquake at this late date, when it is the experience of a native eye-witness, N. Sakata, this magazine's special correspondent in Tokyo. The tale is a moving one and written from the native point of view. In the stress of his emotions, Mr. Sakata seems to have suddenly developed a fluency in English, which former contributions lacked to some extent. His "copy" has been edited in order that his pitiful adventures may be more readily grasped by the reader.—Editor's Note.]

THE morning of September first was stormy. A strong wind was blowing, and I could scarcely hold an umbrella. It was raining heavily, but when I reached my office it began to clear up, and the dark sky changed to a cheerful blue.

At 11:58 o'clock I heard a strange sound from the earth through the building wall, but since it was so slight, and, because I afterwards learned that other men did not notice it, I paid little attention. Soon afterwards, the building began to shake very softly. Inasmuch as we Japanese are familiar with small earthquakes, I paid little attention to it and felt that it would soon pass, but, alas! it grew into an uncomfortable shock.

I heard the crying of women and the sounds of the cracking of the adjacent building walls. We had in our room a large case for filing papers which measured about 10 feet high and 20 feet wide.

This now began to sway from left to right, and back. Finally, it fell over forward. The bookcase crashed to the floor and my writing cabinet fell over. The huge body of the office building was still shaking, giving off an indescribable sound.

The movement of the first shock still continued, and I cannot tell you how dreadful it was to me. The walls had not cracked in my room, but I could hear them from all sides. I supposed, of course, that my room would finally crush in, and in my mind I said farewell to all my brothers, my mother, and my sister. I crawled under the heavy desk, hoping that I might thus be saved.

After the first tremendous shock, I resolved to go to the Imperial Palace Square, which is a very wide field and near our building. As I rushed out the front door, I noticed that the huge buildings all about me were broken. A man,





terribly hurt, was sitting on the ground by the building. I ran on to the square.

Many fires now arose throughout the city. Black smoke and red flames were cast over the sky. I could not see the natural color of the sky anywhere because of the

dense smoke. Hunger and thirst came next.

Indeed, the first night of the earthquake, September first, was a very dreadful one. I still find it difficult to believe that it is all true. In every direction one might look, the city was a mass of flames. The Imperial Palace Square was the middle of a great furnace. Crimson flames and billowing clouds of smoke covered the city.

We could find no light or gas in the square, for these had been extinguished at the producing station because of the danger of fire. There was, however, no need of man-made illumination, for the holocaust provided as brilliant a light at night as the sun did in the daytime. The temperature of the air being raised, we were forced to breathe quickly, the heavy air almost stifling us. I could not sleep, for I was nearly frantic thinking about my mother and sister whom I had left at home.

Hunger attacked us. Tokyo is very cold in September, and although the flames gave off great heat, the midnight air chilled us.

I tried to get out of the crowds. There were more than 100,000 gathered in this small square, so it was very difficult to get away. Indeed, I could not get a bit of space to stand up. It took me 30 minutes of crawling and stumbling to move 200 feet, but finally I emerged.

After a very long time, and by devious routes, I reached my home. Alas! I found my house burned to ashes, and I could not find any members of my household. I searched and searched in the clouds of smoke for my mother and sister. The smoke



filled my eyes and I could not see. I tried to find even a bit of my mother's burned body, but I could not. After hours of vain search, my eyesight nearly gone from smoke, I had to stop, and I could only hope that my mother might have escaped to safety

somewhere. I could not think of any place she might be. All the homes of my relatives were destroyed. "Oh, where could she be!" I asked myself, and cried and cried. I thought that I might not be able to find them anywhere any more in this world. All my courage had disappeared.

It was in this state that, as I was walking along the river which is near my house, I saw a woman dimly through the smoke—just an outline. The phantom shape seemed to resemble my mother. I approached and asked her who she was, and then, I could not believe it was real! I thought it must be a dream, but it was not. It was my mother! It was my mother! She and I embraced each other again and again, thanking God, and again I cried and cried for joy.

Coming home from my office I saw hundreds of dead bodies of men and women. I had had nothing to eat for more than three days, and the odd odor of the hot wind often caused me to fall down fainting. But my mother and sister were safe, so my courage had returned to me. Everywhere, I saw thousands of people running to escape from the city to the suburbs. I had taken my mother and sister to the suburbs, and was trying to get into the city. I understood fully that I might be wounded or killed by fire and falling buildings, but we nevertheless kept on our way.

Occasionally I was asked who I was by a policeman. They urged me to stay out of the city, and at times even attempted to prevent me, for by this time the government had declared the city under martial law, and soldiers stood on the road with their guns loaded and swords bared. If we insisted, then it would

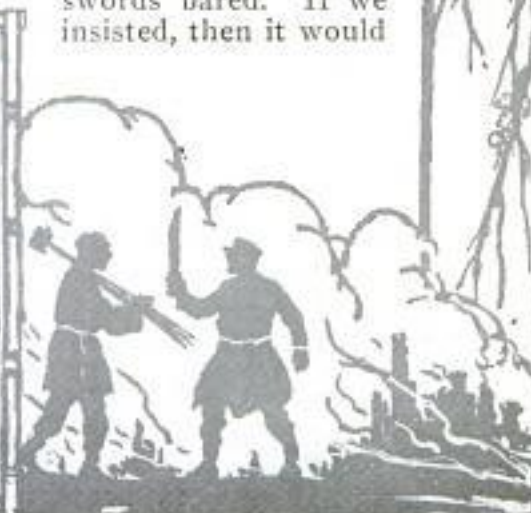

mean we would be shot or cut down. Sometimes we were attacked by flames and smoke. Frequently, to protect ourselves against such terrors, we were forced to dash into the water and get ourselves wet from head to foot. It was very dangerous work. The fire continued eight days.

We Japanese have one thing in mind to tell you; that is, our great thanks for the wonderful help you gave us. If you will, please, print on your pages that the Japa-

nese people are thanking the American people, and will never forget your kindness at this time.

I am now at Shibaura, which is the shipping center on Tokyo Bay. I can see many ships flying the American flag on the calm sea. It is an inspiring sight, and I thank God for it.

U. Sakata

ELECTRIC "VALET" FOR PRESSING TROUSERS IN HOME

For pressing trousers quickly and conveniently, an electrical device is being



Copyright, Underwood & Underwood

Device Operated by Electricity to Press Trousers Quickly and Conveniently in the Home

marketed that attaches to the ordinary light socket. There are two sections, the lower one, which is heated and over which the trousers are laid, and the upper, which is attached to the former by clamps. In pressing, one has only to fasten the two sections together and turn on the electricity. Within a few minutes, the garment is reshaped and ready to wear.

SHIPS PASS ABOVE LOFTY HILLS IN JOURNEY OVER SEAS

By means of a new method of surveying the floors of oceans, it has been possible to chart some of the deepest waters. These maps show that transocean steamer paths pass over mountain chains, valleys, and plateaus that lie hidden beneath the seas. From the eastern shores of the United States, ships sail above continental slopes, extending far out like a great shelf, beyond

which is a vast rolling plain, unbroken until it rises and forms a great ridge of mountains south of Iceland, virtually dividing the waters.

SHEETS OF METAL TO REPLACE PLASTER AND WALL PAPER

Thin metal sheets are being used instead of plaster and wall paper in France. Among the advantages claimed for the plates are that they cost less, and can be put on cheaper than the old materials. The air in a house thus equipped is said to be easily maintained at an even temperature, as the walls are almost air-tight. The sheets, which are sold in standard sizes, are mounted on laths. They are stamped with decorative designs which can be painted in any colors desired. A dwelling lined in this way is also reported to be proof against many insect pests.

HOLDER FOR SERVING SPOONS KEEPS HANDLES FROM FOOD

To prevent spoons from slipping into food in a serving dish, a metal holder, to be attached to the rim of the vessel, has been placed on the market in Europe. It is



Metal Holder Placed on Edge of Serving Dish to Keep Spoons from Slipping into Food

specially designed to keep the handle of a ladle well above the edge of a container for sauces, gravy, and other liquid foods.

Serman, no data on maker

same as March 1925
Home Appliance Mfg. Co., Camden, N.J.
399 S. 1st, Market St.
Kansas City Star
10/28/1923

4089
4038
4048

Archaeology
New York Times
10/21/23

United Newspictures
461-8th Ave
New York
73

**PICKS AND SHOVELS TO RIFLE
OLD TOMBS OF MYSTERY**

8977

While excavators are exploring the last resting places of ancient Egyptian monarchs, other scientists in a half-dozen places are seeking out more old mysteries of that country. Others are at work in the fields of Greece and near-by Asiatic lands. All over the world, men with picks and shovels are striving to dig up and reconstruct glories of other days. Explorations planned for the future are expected to add substantially to vast collections of relics now being studied. Digging is to be resumed at El Amarna, site of the city founded by the father-in-law of Tut-Ankh-Amen.

**LIFELIKE MOVING PICTURES
TAKEN BY SUPER CAMERA**

3592

Moving pictures that "stand out" from the screen as naturally as though the objects were being viewed through a window

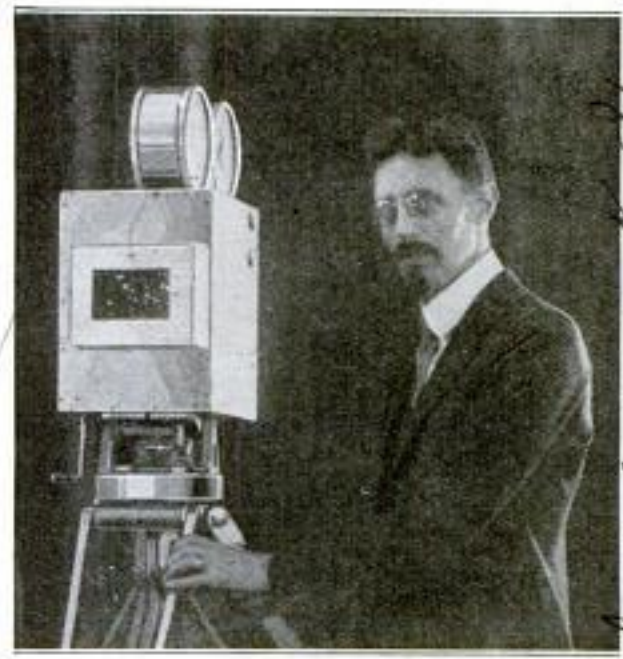

Huge Camera for Taking Motion Pictures that Appear to Have Depth on the Screen

**METAL SPLINTS FOR FRACTURES
EASILY ADJUSTED**

4020

Adjustable aluminum splints, designed to be used on any kind of fracture, were exhibited at a conference of surgeons in the middle West recently. They are held together with rivets and bolts and can support any part of the body rigidly. Be-



Copyright, Underwood & Underwood
Patient with Limb Set in Metal Brace that Replaces Splints for Broken Bones

cause of their construction, they allow for free circulation of air around the injured parts.

have been produced by a camera and projecting machine designed by a middle-western inventor. Films three times the size of those now in use are employed. The screen is 40 by 20 feet in size. Through the application of the principle of the stereoscope, or double vision, the pictures have the appearance of possessing depth instead of the present flatness. Also, there is no distortion when viewed from the side.

**NOTCHED WEDDING RING WORN
TO DENOTE DIVORCE**

3988

Many women in England, who have been divorced from their husbands, continue to wear the wedding ring, but have a fracture cut in it by a jew-



indicate the number made in the edge of the gold band, it is said.

We regret we do not know who the jeweler is, who sells the "Divorce ring", due to the fact that a picture was bought from an out-of-town photographer us.

deck downward on the bottom of the Mediterranean Sea since 1916, when it struck a floating mine. As the vessel reached the surface, keel upward, it turned over and the gas, rushing through openings in the deck, exploded. Grain was blown high into the air and scattered over the sea, while the boat filled with water and sank again.

More than 100 different languages are spoken in India.

Com. F. Christie
356. Union Station
Winnipeg, Canada.

Mr. George A. Spoon
% Esplanade Film Co. 1345 Argyle
Keystone News Co. 91. 7th Ave., New York

396 SPRING CLIP ON RACQUET
HOLDS TENNIS BALLS

For conveniently carrying tennis balls, a spring clip holding two of them, attaches to a racquet press. Encircled by the wires,



Spring Clip Attached to Racquet Press, Holding Tennis Balls Firmly without Cutting Them

the balls are held firmly in position with no danger of the rubberized fabric being cut, and a slight pressure on the device releases them.

53 STEAMSHIPS ON NIGHT TRIPS
CARRY ILLUMINATED ADS

To advertise their products, certain English firms equip ships that ply at night with gigantic electric signs. The ads are made of sheet metal 10 feet high and are carried between the vessels' masts by ropes. Hundreds of bulbs flood them with light. By a mechanical arrangement the current is alternately turned off and on, a



English Steamship Equipped with Electric Signs Spelling Advertising Messages During Trips at Night

different letter appearing each time and the message is spelled out to the observers.

397 FOOTPRINTS IN STONE MAY
MARK EARLY WHITE RACE

Huge footprints impressed in the surface of Enchanted Mountain, in the southern Blue Ridge range, have led to the belief that perhaps America was at one time in the prehistoric past inhabited by a white race of immense stature. The tracks seemingly were made when the stone was still soft soil. There are 26 outlines of the human foot, all bare except one, which evidently was incased in a moccasin. One of these prints measured more than 17 inches in length and over 7 inches in width. Beside it is the mark of a finely shaped hand. Old Indian legends tell of a mysterious white race that once occupied that region.

Laundry

4035 ELECTRIC IRON IN VANITY

SET FOR TRAVELERS

More compact than a small handbag, a toilet set has been devised by an eastern man for the use of women travelers. Fit-

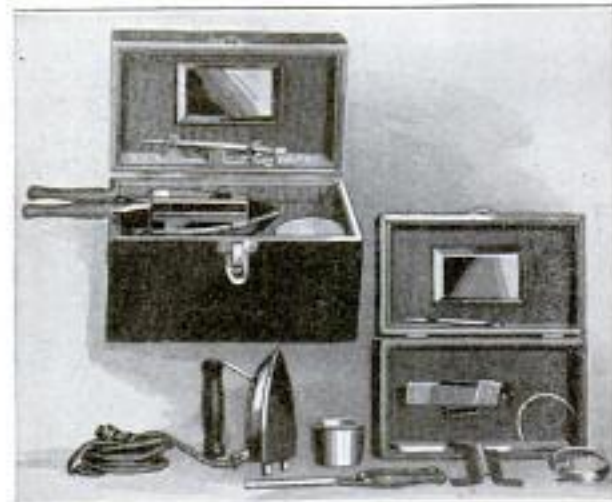

Vanity Case for Women Travelers that Contains Electric Iron, Heating Cup, and Hair Curler

ting securely into a socket at the bottom of the case is an electric iron with a curling iron attached to it. A holder is also included for a cup which may be used for heating liquids. The entire equipment weighs slightly more than five pounds and may be conveniently slipped into a traveling bag. It contains many other implements generally found on the dressing table.

Phila. Mr. Muehle, Pennsylvania.

☛ Vaccine for the dreaded foot and mouth disease, prevalent among cattle, has been discovered in France; it is expected to check the mortality among the animals.

Cont. C.A. Aldroyd, Barron-in-5, 127, Abbey Road, Furness, Eng. J.W. 1923 - somewhat similar to, 615 S. Park Ave. Bacto, 615 S. Park Ave. d. independent, ms.

3996 Cont. C. Moran,
3825 13th St. N.W.,

POPULAR MECHANICS

Washington, D.C. 75

TRAPPING BOLL WEEVIL IN FIGHT ON PEST



Armed with Traps, Cotton Workers Labor to Rid Crops of Destructive Boll Weevils. This Method Is Believed to Be as Effective as Poison, and Less Expensive

Finding the poison-dust method too expensive, small cotton growers of the South are using traps to rid their fields of boll weevils, which annually cause enormous loss. One of the most popular snares, easily made by the planter, is formed by wrapping finely meshed screen around two semi-hoops, which are connected at the



Hitched to a Mule, These Snares Clear Two Rows at a Time

bottom to a trough. These, mounted on a sled drawn by a horse or mule, or carried by laborers, are taken through the rows of plants, the dangling wires inside them brushing off the insects. At the end of each row, the weevils are removed and destroyed. Although inexpensive, this system has been found to materially increase the yield.

TWIN TUBES IN TUNNEL CARRY TRAFFIC BENEATH RIVER

In constructing the Hudson River traffic tunnel between New York City and New Jersey, engineers are said to have provided a means of clearing the 14,000 feet of traffic tubes of noxious gas fumes that will be generated from thousands of automobiles passing through them. The tunnel will rest on concrete and steel piles imbedded in solid rock 250 feet below the river bed and will consist of two channels, each big enough for two lines of travel. Under the river, it will be 3,375 feet long, but its total length, including the approaches, will be 9,250 feet. When the plans were first drawn, experts estimated that the structure would prove adequate for at least ten

years. Recent traffic surveys have caused them to cut five years from that period, and there are indications that further modifications will be made. The tunnel's capacity is figured at 46,000 vehicles daily.

HARD RUBBER REPLACES REED FOR MUSICAL INSTRUMENTS

Tone qualities of the saxophone and clarinet are said to be improved, and ease in playing the instruments made possible, by the use of mouthpieces molded from a hard-rubber composition, instead of reed ones. The manufactured article is claimed to be proof against warping, and does not irritate the lips. They come in varying degrees of flexibility and vibrate equally as well as those of cane wood.

New York Times
10/21/1923

The Saxophone Shoppe,
84 Old Arcade
Cleveland, Ohio

FLOATING TOPS FOR OIL TANKS REDUCE LOSSES

In an attempt to provide means to check evaporation and fire losses, which cost the oil industry more than \$200,000,000 a year, a floating steel roof for oil storage tanks has been designed. Resting on the surface of the liquid, the roof would

about three feet of water, on which was poured 1,000 gallons of gasoline, covering the water with three inches of the inflammable fluid. After the floating top was put into place, fire was applied to the patented seal around its edge, but the flames

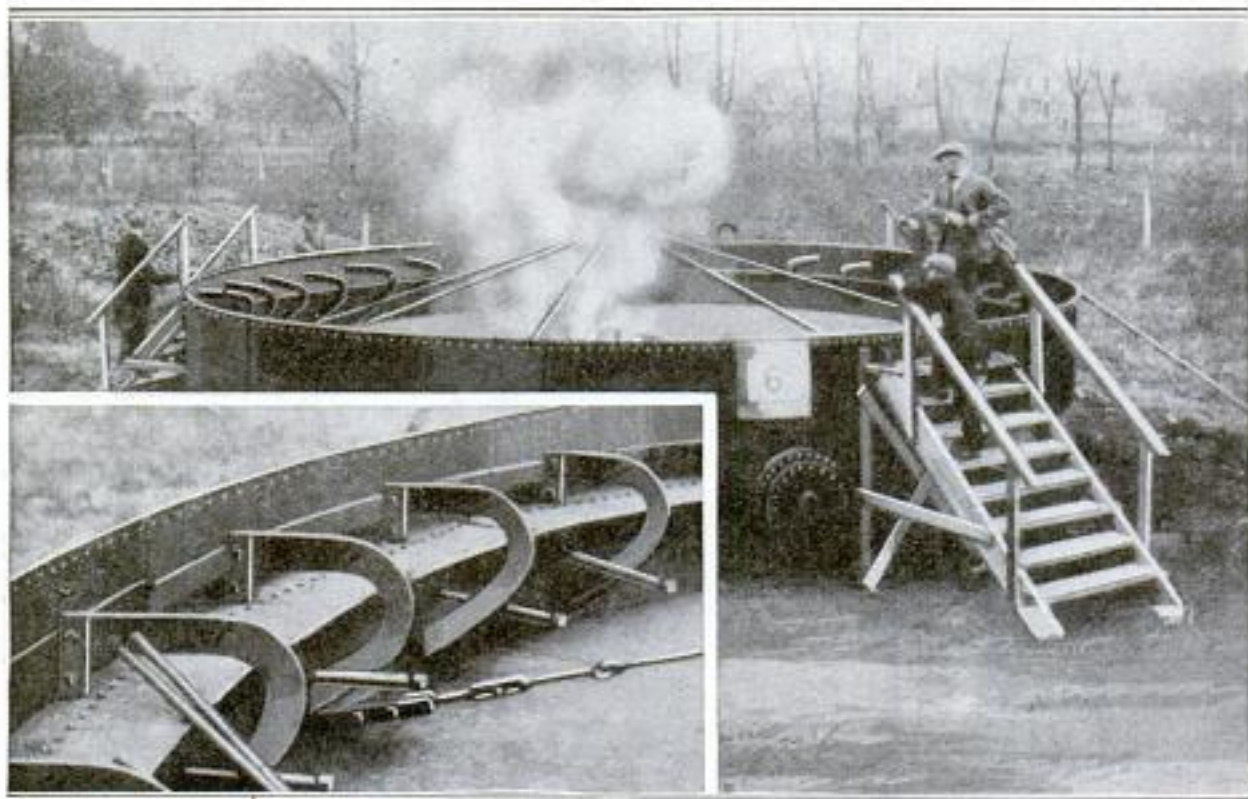

Floating Steel Roof for Oil Tanks to Reduce Evaporation and Fire Losses by Preventing Air Circulation at the Top: Left, Sealing Braces that Make Edges Tight

seem to eliminate the fire hazard always present when there is an air space between the surface of the contents and the top of an ordinary tank. It is also claimed that by this means evaporation is retarded. Tests, recently made of the invention, were conducted with a steel tank containing

did not spread. A torch was also placed at one of the small air vents, and while smoke and flames immediately belched forth, they lasted less than a minute. A bucket of gasoline was poured on the roof and ignited, but after burning five minutes failed to affect the contents of the tank.

POP CORN BURSTS OPEN
IN HEAT OF SUN

Pop corn popped in the field by the sun's rays is reported from northern California. Kernels of a dozen ears in one field, it is



Cob with Pop-Corn Kernels that Were Burst Open by Heat of Sun

said, had burst out crisp and almost as full as though they had been placed over a fire. The owner found that the corn, of a kind which pops at a lower temperature than usual, had ripened to full maturity and grew in a place where it was directly exposed to the sunlight. Ears in more sheltered parts of the patch were not affected.

Road building belongs close to the top in the list of big businesses in the United States, according to an estimate compiled by the Bureau of Public Roads. This estimate announced that 40,000 miles of surfaced roads were built last year.

Emb Jane Elwyn, Arlington
Hotel, 480 Ellis
Call San Francisco

3936

CITIES HALF CENTURY HENCE TO BE "BUILT IN AIR" 3973

Moving the calendar ahead fifty years, some noted experts see American cities with towering skyscrapers, beside which even the tallest and most beautiful buildings of today will seem very ordinary. Even the small towns will have structures as large as those now considered huge. Street traffic will have been almost eliminated, workers will travel in subways, dirigibles, or on elevated roads at high speed. The telephone will have added improvements. Radio sets will be essential in every office and home. Houses will be heated by electricity in a few minutes, and little coal will be used in either homes or office buildings. The camera will have been discarded for pocket motion-picture outfits, and "movies" in the theaters will have been given speech. College students will report their lessons by wireless, and ministers will broadcast their sermons.

ODD-SHAPED EGG BEATER DOES WORK RAPIDLY 3945

For whipping eggs, a beater with a coiled-wire base is being made which does the work rapidly and thoroughly. It is operated by an up-and-down motion of the hand. The coil flattens out on the downward stroke and as it springs back, draws the egg with it, producing air bubbles. It does not tire the arm, it is claimed, and is readily cleansed with hot water.



Coiled-Wire Egg Beater that Works by Strokes that Compress Spring Base

Empire Notion Co.,
72 Madison Ave.
New York.

TESTING CORDS OF NETS CUTS NATION'S FISHING BILL 4028

Through tests of various kinds of cord used in making nets, government experts

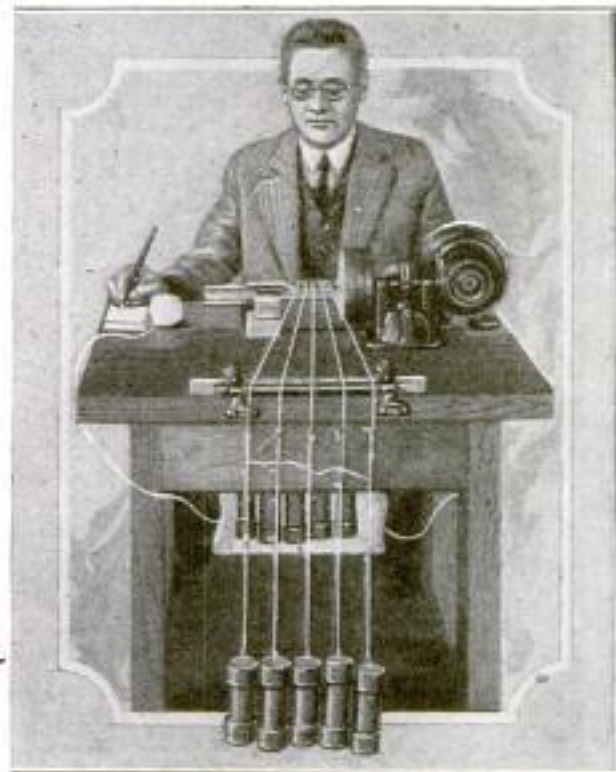

Testing Cords that Are to Be Used in Fish Nets to Determine Strength

have devised a method by means of which fishermen can prolong the life of their old equipment. As a result, it is estimated, persons who seine the waters of the deep for sea food have been saved more than \$2,000,000. Pieces of many types of twine are examined for strength and durability, and the facts thus determined are made public to aid weavers in turning out products which give longer and better service.

HUNT FOR ORIGIN OF AMERICA'S NAME LEADS TO DARK AGES 3994

Delving into ancient documents, experts disagreeing with the theory that Americus Vesputius was responsible for the name of America, point out that Indians called this land "Amaroke" long before the white man came. Researches, it is said, have shown that the word, in one form or another, was widely known in pre-historic times as the name of the "new world." In a highland region of Nicaragua, a province is still called Amerisque, a title it has retained since early antiquity. Because of this and other findings, certain authorities believe that Vesputius took his name from the new hemisphere.

New York Times
Copyrighted material
10/23/23

FORESTS BURNED TO INCREASE GROWTH OF TREES



Photo Courtesy American Lumberman

Kindling Fires in Forest of Valueless Trees to Clear Ground for Planting Better Timber: Only Expert Woodsmen Are Permitted to Take Part in this Work

Timber "stands" of little or no commercial value are being removed by fires to clear the tracts for the planting of fir trees, the wood of which is in great demand by the lumber industry. These fires are kindled in the woods of the West by squads of men trained in the building and control of such blazes. This treatment is usual over land occupied by inferior growths of hemlock and "scrub." When

the fire-hazard season in the forest ends, the work of clearing begins. In one state a law requires that this be done at least once a year. Fires started in the spring sometimes smolder until late summer and then break out with such fierceness as to cause big losses before they are extinguished. Cold and damp weather after autumn is selected as the best time to do the burning.

Prof. J. B. Horner, Oregon Agricultural College, Corvallis, Ore.



Skull of Prehistoric Cow that Lay Buried for 50,000 Years in Bed of Western River

SKULL OF STONE-AGE COW

465² DUG FROM RIVER BED

Dredgers working in a western river have recently uncovered what is believed to be the skull of a broad-faced cow which was buried for at least 50,000 years, below the bottom of the stream. The animal to which the fossil belonged, scientists say, was the forerunner of the buffalo, the cow, and others of the bovine family. Horns measuring 20 inches around their base were still attached to the specimen.

Cont. R. White "horma."
 Mount Street, Strathfield,
 Sydney, Australia

**EVIDENCE OF EARLY ROMANS
 FOUND IN NEW GUINEA** 407

Bits of pottery and part of a sword believed to be of Roman origin lately found in the Humboldt Bay region of New Guinea, have partly convinced explorers that wandering galleys may have reached the northwestern end of the island more than 2,000 years ago. Further evidence to support the theory is the fact that several words in the dialect of the natives are derived from Latin roots, scholars say, and an old legend which has become part of the folk lore of the inhabitants strengthens the belief. They tell of a huge, many-legged beetle that climbed out of the sea ages ago, carrying men on its back who camped in the bushes near by while it rested on the sands. It is now believed that the "beetle" legend arose from the appearance of a Roman galley, the legs having been, in reality, the long oars of the vessel and the men hardy adventurers who had drifted far from their native shores. Though there is no account of such a voyage in Roman history, it is pointed out that the men who reached the island may never have returned home to tell of their exploit.

**ELECTRIC DRILL ON WHEELS
 CUTS CONSTRUCTION COST** 4036

With an electric drill mounted on wheels, an eastern firm has found a way of reducing construction costs, as the de-



Copyright, Underwood & Underwood
 Electric Drill on Wheels that Is Easily Moved and
 which Two Men Can Operate

vice does the work formerly performed by many men and in much less time. It has been employed in drilling rivet holes on a viaduct job, only two men being required to operate it, one to hold the frame at the right angle while the other guides the drill.

Van Horn Electric Tool Co. }
 2978 Woodhill Road } Cleveland, O.

**CLOTH SHIELDS PROTECT AUTO
 WHILE MECHANICS WORK** 3931

To protect the interior of an automobile from dirt while it is being overhauled by mechanics, cloth covers are being used,

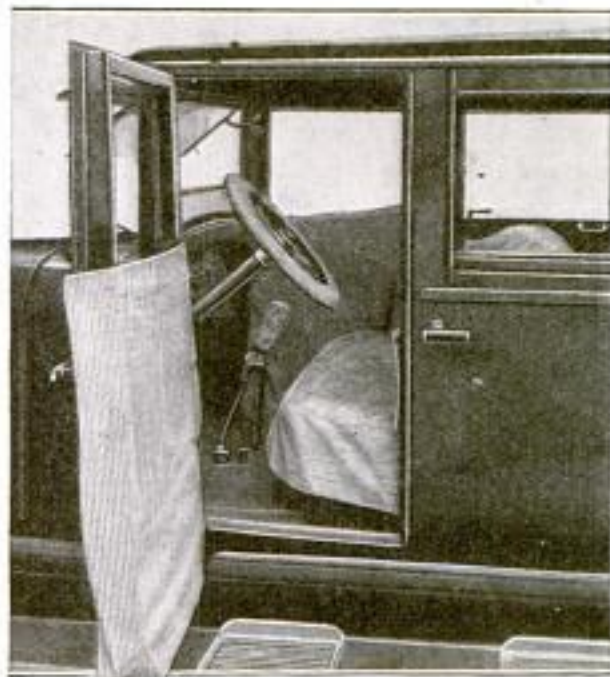

Snugly-Fitting Cloth Covers Protect Surface while Auto Is Being Repaired by Workmen

which fit snugly over the various parts. By this means, workers can perform their tasks without danger of soiling the car. Such shields may be placed on the steering wheel, gearshift, and brake levers, while the upholstery is guarded from the greasy clothing of the repairmen in the same manner. They also prevent scratches for tools used by the workmen.

**CAP FOR "SQUEEZE" CONTAINER
 PREVENTS LEAKAGE** 3950

Instead of the usual caps for tube-shaped "squeeze" containers, patented covers are being made in Europe which spread the contents evenly and cleanly over surfaces as it comes out of the holder. They are suitable for applying pastes, shoe cream, shaving soap, and similar commodities. Protecting lids fit over the device when not in use, keeping them from leaking.



Automotive Fabric Co. 703 Cass St. Denmark, Wis.
 Andersen + Bruns Fabricer, Copenhagen.

Accomplished by Hotel
1111 Coronado

80 POPULAR MECHANICS
CORONADO BEACH CALIF.
ENTIRE GOLF COURSE LAID OUT IN CITY BLOCK

4029 Within the area of a single city block, a triangular spot at the intersection of three streets, a western hotel has laid out a nine-hole golf course, with hazards and bunk-

gineers were able to confine the links to the limited space. Built for patrons of the hotel, it provides a recreation field within the heart of the town, where guests who

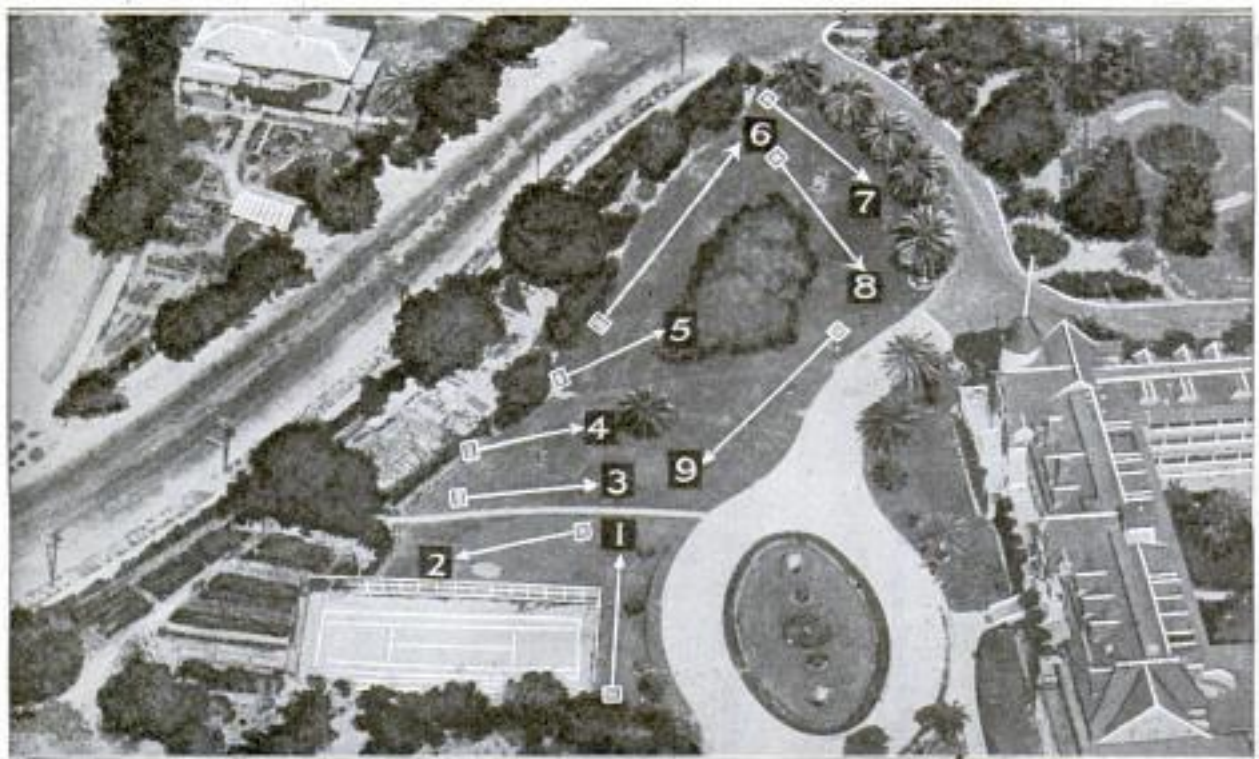

Miniature Nine-Hole Golf Course with Bunkers and Hazards Laid Out for Hotel by Engineers in the Space of a Single Triangular City Block

ers, like a ground of the regular size. By cleverly arranging the greens and reducing the usual distance between them, the en-

are enthusiasts of the game can play without journeying farther than across a thoroughfare.

ICE FROM ANCIENT GLACIER PRESERVES SHIPPED FISH

Ice formed centuries ago in the glaciers of the North is used at an Alaska cannery



Age-Old Glacier Supplies Ice to Keep Fish Fresh Till Arrival at Market

to keep fish fresh while being shipped to the markets. Unable to meet the expense of a cold-storage or refrigerating plant, the owner of the cannery makes use of the fields of ice near by. A fleet of gasoline launches keeps the storehouse filled by making frequent trips to the fields.

MISSING LINK OF FOSSILS FOUND IN MONGOLIA

4100 Science has linked the horned and unhorned reptiles. An American expedition, recently returned from Mongolia, found fossils in such numbers that one hundred years will be none too long in which to study the finds. Two discoveries were outstanding: a complete skeleton of a dinosaur with collar of plated bones, and about twenty-five eggs, one of which contained a perfect embryo of the species. The collared skeleton forms the missing link between the horned and unhorned reptiles.

Petersburg, Alaska

4100
Com. Francis Dickie
Heriot Bay, B.C., Canada

3967

Com. A. W. Lee.
Box 252 Seattle Wash

Copyrighted material

newspaper clipping
appear

**RADIOPHONE ON LINER WORKS
— LIKE WIRE INSTRUMENT**

3978

Differing only slightly from the ordinary broadcasting outfit, a wireless-telephone set has been put on a large ocean liner plying between New York and England, which performs in a manner identical to that of the land wire instrument. A conversation may be carried on and the speakers can break in on each other's talk in the ordinary way. With the aid of shore operators, it will soon be possible, according to experts, for passengers and officers of the vessels to establish contact with friends or business associates in their homes or offices, and speak to them with the same ease that conversations over the "wire" are accomplished.

**ROOF OF BIG SCHOOL HELD UP
WHILE STORY IS ADDED**

Washington, D.C. 3850

In adding a story to a big school building in an eastern city recently, the roof was supported at a height of 12 feet above

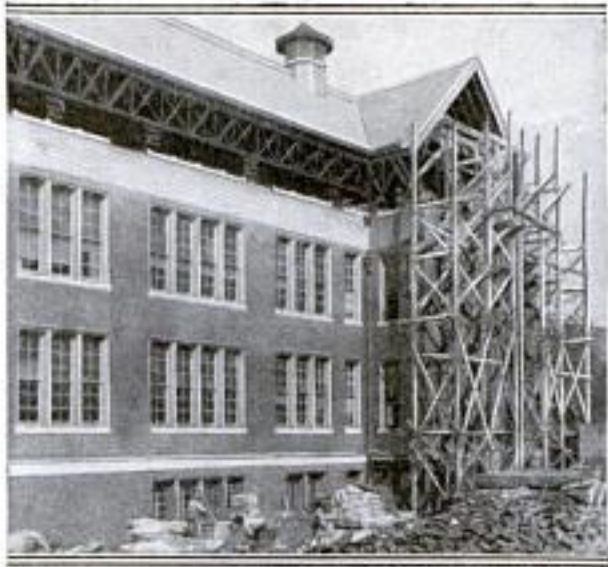

Inserting Extra Story at Top of School Building after Roof Was Raised

the walls. The extra floor was then built in over a space 150 by 75 feet. When the work had been completed, the top was lowered and secured to its new base. Large jacks, all operated at the same time, were employed for the task, which was carried out without damage to any of the structure. *Thompson Spade School.*

Writing on the back of an ordinary post-card, a French bank cashier recently succeeded in inscribing 203 lines, containing 17,450 words, equivalent to the amount of print on two pages of a newspaper.

**RESERVOIR IN FLOWER BOX
FEEDS WATER TO PLANT**

3824

Plants and flowers may be kept fresh and healthy all year round with very little attention by a self-watering steel box that

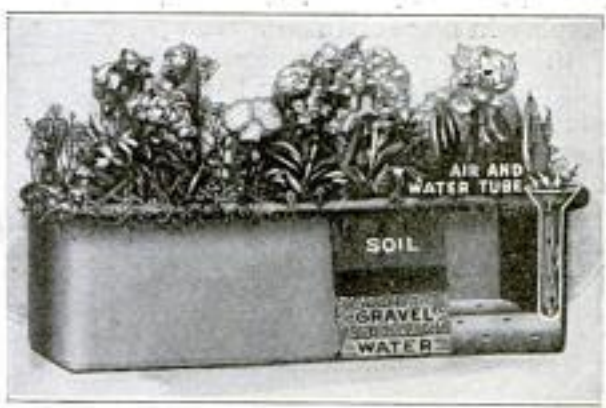

Flower Box that Keeps Plants Fresh Year Round and Requires Water Once a Week

has been patented. Moisture and air are directed to the roots through a series of perforated tubes fed from a reservoir that requires filling only once a week. It is said the plants cannot be overwatered by this device. A pipe with an opening receives the supply of water and acts as a reserve tank, in addition to carrying air beneath the soil.

**MILKER WORKS LIKE HANDS
AND IS SELF-CLEANSING**

3898

Milking at least 18 cows an hour, a gasoline-driven, self-washing machine, designed to save time and labor, is being made which can be operated easily by a boy or a woman. Copying the gentle, easy motion of the hands, but performing the task more uniformly, the apparatus is said to be less annoying to the animals. A wide wheel base prevents it from tipping and makes it easy to move over uneven

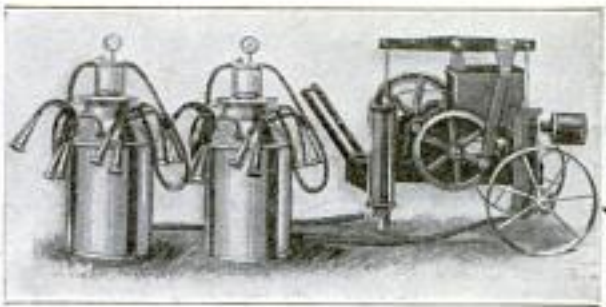

Self-Cleaning Milking Machine that Performs Work as Gently as when Done by Hand

surfaces. Between milking times, the engine can be used about the farm or dairy to run other light machinery.

*Ottawa Mfg. Co.
Kano.*

Savo Mfg. Co., 111 W. Monroe, Chicago

\$202.00. up.

NATION'S CAPITOL IN MINIATURE IS PRIZED MODEL

3882 Regarded as one of the best products of the modeler's art, a miniature reproduction of the nation's capitol is admired every year by thousands of visitors to Washington. It is on display in a special room along with other valued relics. In minute detail, it pictures the gracefulness and grandeur, the broad steps, wide facades, and towering dome of

the imposing edifice, where public servants watch and direct the destiny of the republic. It was made 15 years ago by a French artist to guide architects who were at that time considering plans for extending the original building. Through the years it has been on exhibition, it has been carefully guarded from curio seekers, who perchance might have defaced it.

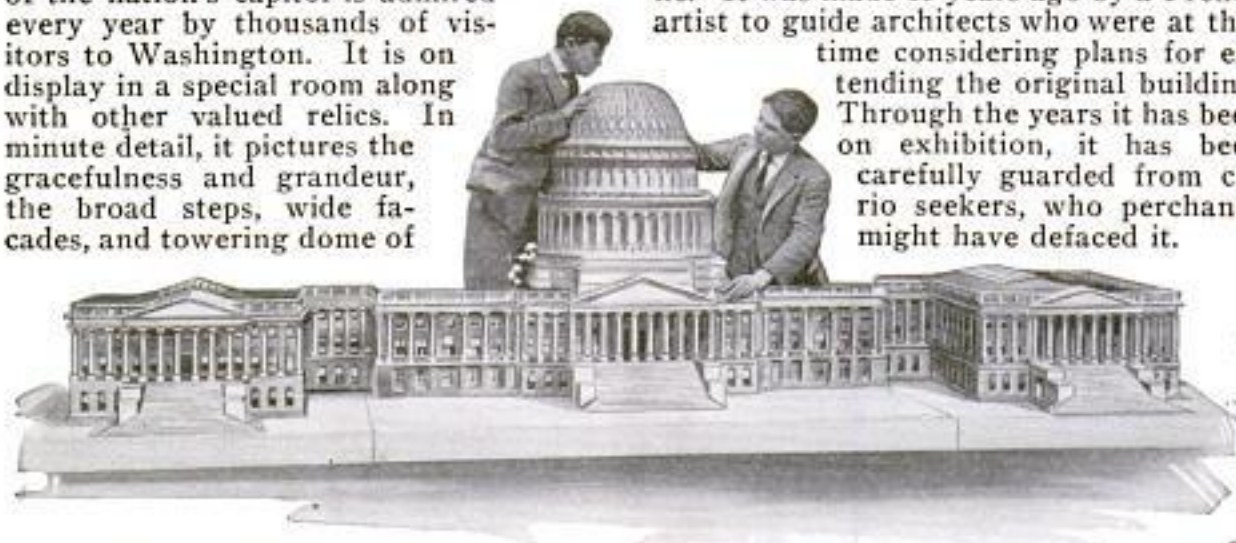

Valued Model of Nation's Capitol, Showing all the Beautiful Lines of that Imposing Structure, which is Viewed Annually by Thousands Who Visit Washington

Chatterfield, Eng.

PICTURES WOVEN IN RUGS SHOW RACE'S GLORY

Past glories of the Navajos, now hardly more than legends, are kept alive in the government Indian schools, which teach the children of that tribe how to weave pictures into rugs and blankets. Patiently

romantic history of their people. The word-of-mouth stories, from which these subjects are drawn, have been handed down for centuries. Although the Navajo population is dwindling away, these tales of a power that once was theirs are still cherished.



Navajo Indian Girl Weaving Story of Past Glories of Her Race into Rug

working at a hand loom, not much different from those used by their ancestors, the students make designs in the yarns, which proclaim the deeds of some chieftain, long since dead, or other achievement in the

BRIGHT-COLORED WALLS CUT COST OF LIGHTING

How bright-colored walls reduce the cost of lighting, by reflecting rays, and how dark tints increase expenses, by absorbing beams, were shown in some recent tests by British decorators. To keep a room bright they found that white serves best, as it takes up only thirty per cent of the brightness, and that deep chocolate is least desirable, as it absorbs ninety-six per cent. Between these, in the order of their value, are chrome yellow, orange, yellow, light pink, emerald green, dark brown, vermilion, blue-green, and cobalt.

HUGE PLUME COMBINES BEAUTY OF TEN THOUSAND FEATHERS

In making a display recently, the owners of a western ostrich farm composed a single, beautiful plume of 10,000 white feathers of the finest quality. It weighed 250 pounds and was 15 feet long and 8 feet wide. The material alone was worth eight thousand dollars.

Emb. Edwin Jarvis of the Harpagon Washington, D.C.

London. Japan view road.

3531 Cont. S. A. Winters,
District National Bank Bldg

Machine-Made "Stars and Stripes" Replace the Flags of Betsy Ross' Day

Washington, D. C.

Uncle Sam's Factory Turns Out Nation's Colors

IT is a far cry from the handmade flag of Betsy Ross to the production of flags by machinery, and yet the cradle of the "Stars and Stripes" has remained in Philadelphia since the symbol of our nation was born there 145 years ago. The traditional scene of this woman patriot patiently fingering the colors of a new nation, has shifted to the operation of scores of machines, increasing production a thousandfold.

Yet, Uncle Sam's flag factory is maintained in the Quaker City, as a branch of the War Department, charged with the responsibility of making all the flags used by the army. This obligation involves the manufacture of a variety of forms of the Stars and Stripes, and storm flags. There, are also made automobile, distinguishing, and transport flags, and ensigns, harbor-boat "jacks," and pennants, together with guidons in vast assortments.

The making of "Old Glory" in great quantities and in response to the dictates of economy is of comparatively recent origin. Progress in this direction has marked time with the development of the needle-machine industry. Not unlike Betsy Ross, who fashioned the national emblem with her fingers, not so very long ago an entire flag was constructed by a single operator. Today, the task

is allotted to 13 units of operation. Each worker in Uncle Sam's flag factory is assigned the task of contributing a definite bit of workmanship, these progressive units making for a finished product.

Bunting—a thin woolen stuff used primarily for making flags—is painstakingly inspected before being issued to the machines. It is placed one ply upon another and divided into specified lengths until a section 100-ply high is available. Then the material is marked and subjected to an electrically driven cutting machine, which parcels the bunting into strips of two sizes, these entering into the manufacture of the stars and stripes. The procedure followed with the blue bunting for the field is not dissimilar to that of cutting the long and short red and white stripes. The elasticity of the material involves the exercise of utmost care in the laying out and separating of it, lest precision be sacrificed, as accuracy is necessary in joining the stripes on sewing machines. Stars are made by cutting them out with a steel die on a stamping machine. This insures maximum production and uniformity in size and shape. The canvas heading on the flag is fashioned in a similar manner.

After the cutters have performed their work, the different parts of the potential Old Glory



"Old Glory" in Days of Betsy Ross

The Swastika is a national emblem of the War Department. Philadelphia, Pa.



Although Machines Now
Do Most of the Work,
Women's Fingers Still
Put Finishing Touches to
Nation's Colors



Stitching the Stars on Blue Fields in Uncle
Sam's Flag Factory



are bundled together and consigned to the operating room. The short stripes are joined together, alternately red and white, on a double-needle sewing machine, which negotiates two rows of stitching at the same time. In like fashion the long stripes are joined and the field is made. The blue fabric is placed on a table, all wrinkles removed, and the correct position of the stars indicated on each field by a perforated pattern. After being subjected to a squaring process it is cut to exact dimensions. A piece of white percale is fastened on the underside of the field, and a star placed in the same position on the upper side. This insures three thicknesses of cloth. The operator then sews cautiously around the edge of the star with a zigzag machine. Once the stars have been fastened on the field, a trimmer cuts off any excess percale on the underside.

The blue ground and short stripes are then united and both are joined to the long stripes. Then, the flag is smoothed out again on a table, and squared and cut to precise dimensions. The fly end is turned in and hemmed with three rows of stitching. The other end is reinforced at each corner with a triangular strip of bunting and stitched into a canvas heading. It is strength-

ened by means of a heavy stitching, and each flag is equipped with a galvanized iron staple and ring for hitching to the halyard, the rope or tackle by which it is raised and lowered on the mast. The completed national emblem then undergoes a rigid inspection and, if approved, is folded and consigned to supply headquarters for disposition.

Stars, contrary to the hand-fashioned articles of Betsy Ross, are manufactured of solid embroidery silk on a machine. The blue-silk fields are placed in frames on this mechanism, which is capable of producing a stitch not unlike hand embroidery—that is, both sides are alike. This machine, provided with numerous needles, all threaded with white silk, perforates the field, back and forth, thus laying out the design for the embroidery stitching.

National colors are carried by unmounted troops, and standards by mounted military units. The inconsequential distinction between the two is that the standards are not as large as the colors and do not possess cords and tassels. The colors are four feet four inches at the hoist (top to bottom), and five feet six inches at the fly, which is the length stripeways.



or. 55 Sherman Place,
Manhattan, N.Y.

Kansas City Star
10/2/23

Dr. W. Moritz Stehr
Paul Mehlis & Sons
509 Fifth Ave. New York

Chas. W. Lane.
Asst. Editor
Office of the Earth
U.S. & S.F. Reg.
Topeka, Kans.

86
POPULAR MECHANICS
PIANO HAS DOUBLE KEYBOARD
TO SIMPLIFY FINGERING

With a double piano keyboard devised by an eastern man, fingering of the keys has been greatly simplified. Duets that



Double Keyboard for Piano that Simplifies Fingering and Is Convenient for Duet Playing

ordinarily require two instruments may be played on the same one. The keys are so arranged that the players do not get in each other's way. The same inventor has designed a single keyboard, intended to simplify fingering, that can be installed in place of the usual type without making changes in the case or action. In this pattern, the white keys are the same width at both ends, so that they can be touched either in front or behind the black ones, which are shortened for that purpose.

FATHER OF BASEBALL HONORED
BY MEMORIAL PICTURE

Recalling the growth of baseball's popularity, an oil painting was hung in an eastern railroad station recently as a memorial to Major-General Abner Doubleday, "inventor" of the national game. While playing with boys in a field near the village almost a century ago, he devised rules to govern plays and marked out a 90-foot diamond on the ground with a stick. This dimension still applies to those laid out nowadays. However, the original rules of the game have been modified, changes have taken place in the styles of the ball, and gloves, pads, and masks have been altered.

RIVER MADE RIBBON OF FIRE
BY WRECKED OIL TRAIN

Part of the bridge over which it was passing was torn away when an oil train on a mid-western railroad was wrecked recently by one of its cars that jumped the track, derailing 14 other tanks. Burst by the crash, the steel containers rolled into the river below and took fire, pouring a flood of burning oil over the surface of the water. The heat and flame grew to such heights that the metal framework of the bridge was quickly reduced to a mass of melted and twisted iron. Passing into the middle of the river, the flaming fluid moved downstream, spreading as it went, until it became a veritable ribbon of fire. By valiant work, the wrecking crew of the railroad, assisted by firemen from near-by towns, succeeded in extinguishing the flames. The damaged bridge was replaced in a few days by a temporary structure.

LIGHT WITHOUT HEAT SOUGHT
IN ELECTRIFIED VACUUM

Hoping to produce light without heat, as the glowworm is said to do, but in a different manner, a French scientist passes an electric current through a vacuum tube of glass, lined with a phosphorescent material. With a small amount of energy a glow of extreme brightness is created.

COFFEE MILL LIKE CARTRIDGE
COMBINES GRINDER AND POT

Combining a coffee grinder and pot, a brass mill used in Albania, an old country of eastern Europe, looks like a large empty gun shell. Made in two sections, the top part contains the grinding wheel, turned by a handle that can be folded up, and the bottom chamber receives the coffee after it has been ground into powder. Sugar is mixed with the powder in this "pot." Hot water is added and the drink is served in tiny cups without



straining. Decorated with exquisite hand carving, it becomes a thing of beauty.

3838
- Cont. Miss V. B. Jones,
1115 Church St.
Evansville, Ind.



Reduced to a Mass of Charred Timbers and Twisted Metal by a Cascade of Flaming Oil, this Railroad Bridge Was Replaced in a Few Days' Time by Valiant Workers

Built by Albert S. Filson,
San Diego, Calif.

Chicago news
10/13/23

BASS VIOL SO LARGE PLAYER STANDS ON PEDESTAL

3851

Measuring 14 feet from tip to base, a bass viol has been made by a western man, who claims it is the largest in the world.



Giant Among Bass Fiddles that Can Be Played Only from an Elevated Platform

In order to play it, the musician must stand on a pedestal five feet high. The same maker constructed another of the big fiddles which measured 10 feet. Formerly the largest known instrument of this kind, 11 feet 7 inches tall, was located in New York. It required two players, one to stop the strings and the other to handle the bow.

BLOW FROM GIANT HAMMER TESTS RAIL COUPLINGS

3875

To prevent railroad accidents, car couplings and drawbars are carefully tested by a recently devised machine. Fastened to a heavy anvil, they are subjected to the blows of a two-ton hammer. Each piece must withstand several impacts without cracking and without showing dents beyond certain definite limits. If the coupling should break, the hammer continues the motion of the stroke and travels up two circular tracks, fitted with teeth, which keep it from damaging the machinery by preventing another stroke.

PHOTO TEST FOR EFFICIENCY REVEALS LOST MOTION

3877

How efficiency of workers is reduced by lost motions is being shown through detailed photographic studies. Observation of bricklayers of ordinary training, who are said to use the same methods that have prevailed for 7,000 years, and of that most ancient of craftsmen, the berry picker, are said to give no indication that the best way to do these tasks is to follow instinct. The layer of brick can be trained to do three times as much work with the same effort, according to the tests. Similarly, the berry picker can increase his harvest fifteenfold, it is said.

AIRSHIP WITH FLAPPING WINGS TO TAKE FLIGHT LIKE BIRD

3811

With flapping wings, shaped like those of a bird and moving in much the same manner, an airship recently built by a European mechanic, it is said, gets its power from pedals operated by the flier's feet. The machine is of light but strong construction and the pilot's seat is in a canvas inclosure. An early record of similar attempts to imitate the birds contains an account of an English monk, who strapped crude wings to his shoulders and jumped from a high cliff. The trial ended in failure and injury to the experimenter, who fell to the ground like a shot.

TINY CLOTHES WASHER CLEANS DELICATE FABRICS IN HOME

3830

Cleaning like larger machines, a miniature electric clothes washer is being made which, it is said, handles without injury, garments that housewives do not care to send to a laundry. Blouses and lingerie of light material, and other pieces of delicate fabric can be run through it without risk of being torn. No larger than a kettle, it can be set on a stove to heat the water and removed to a table for operating.



It is small enough to use in the bathroom or on the drain board of the kitchen sink. Durable, as well as light and compact, it can be easily stored out of the way when not required.

Eden. Isellespie Corp.
Paterson, N.J.
Copyrighted material

sup. Mess. W. + J. Avery Ltd
Parrmingham, England

foundations
ingering W. H. H. New York

Strange Scenes in the World's Dark Corners

RETURNING from travels across the "no man's lands" of the uncivilized spots of the world, hunters and explorers tell of seeing people and animals and passing through adventures so strange that they were impelled to take the evidence of them by trap or camera, even though these things did not come within the purposes of their trips.

Recently, a young member of an exploring party which had entered the forbidden regions of Tibet in Asia decided to take up the venture alone when the rest of the party turned back at one of the most dangerous points. Selecting a few native servants who declared they were brave enough to accompany and assist him, he resumed the journey through precarious wilds.

As the party proceeded, the natives began to lose courage, until after a great deal of jabbering among themselves, one who seemed to be the leader approached the explorer with the information that they had voted to abandon the trip. Entreaty and the promise of more money failed to persuade them to go on. Then, flying into a rage, the young scientist leaped into the midst of the cowardly crew and administered to several of them a severe pommeling with his fists until they agreed to continue the trip.

Appointing their leader as chief of the party and with himself disguised as a cook's helper, they went on. Even the suspicious outposts set to guard against such intrusions failed to note anything about them that would warrant arrest. After weeks of weary travel, during which sickness often laid out almost his entire company, he arrived at a town where he became bold



Civilization Still Fails to Attract Millions of Wild Tribesmen

enough to reveal himself to the ruler of the tribes. His visit with that individual won him the right to gather data and relics of ancient peoples of that country.

Racked with fevers, their clothes and shoes torn by battle against almost impassable jungle growths, a party lately returned to civilization from an expedition into the upper Amazon River in South America, told of scaling jagged peaks to catch eagles, wading through swamps filled with deadly reptiles, and struggling with wild tribesmen disputing their path into forested depths.

Fevers and strange diseases made the native guides wary of venturing far into unknown territory. Frequently, game was scarce and they had to subsist on nuts and wild fruits. The ammunition supply ran out, and had it not been for the guides, who killed birds and animals with bows and arrows, starvation would have loomed as another enemy to fight.

Cannibal tribes were met. Short skirmishes ensued in which they were driven off by the white men's wea-



Travelers on the Dark Continent Are Often Beguiled from Their Journeys to the Chase of Big Game

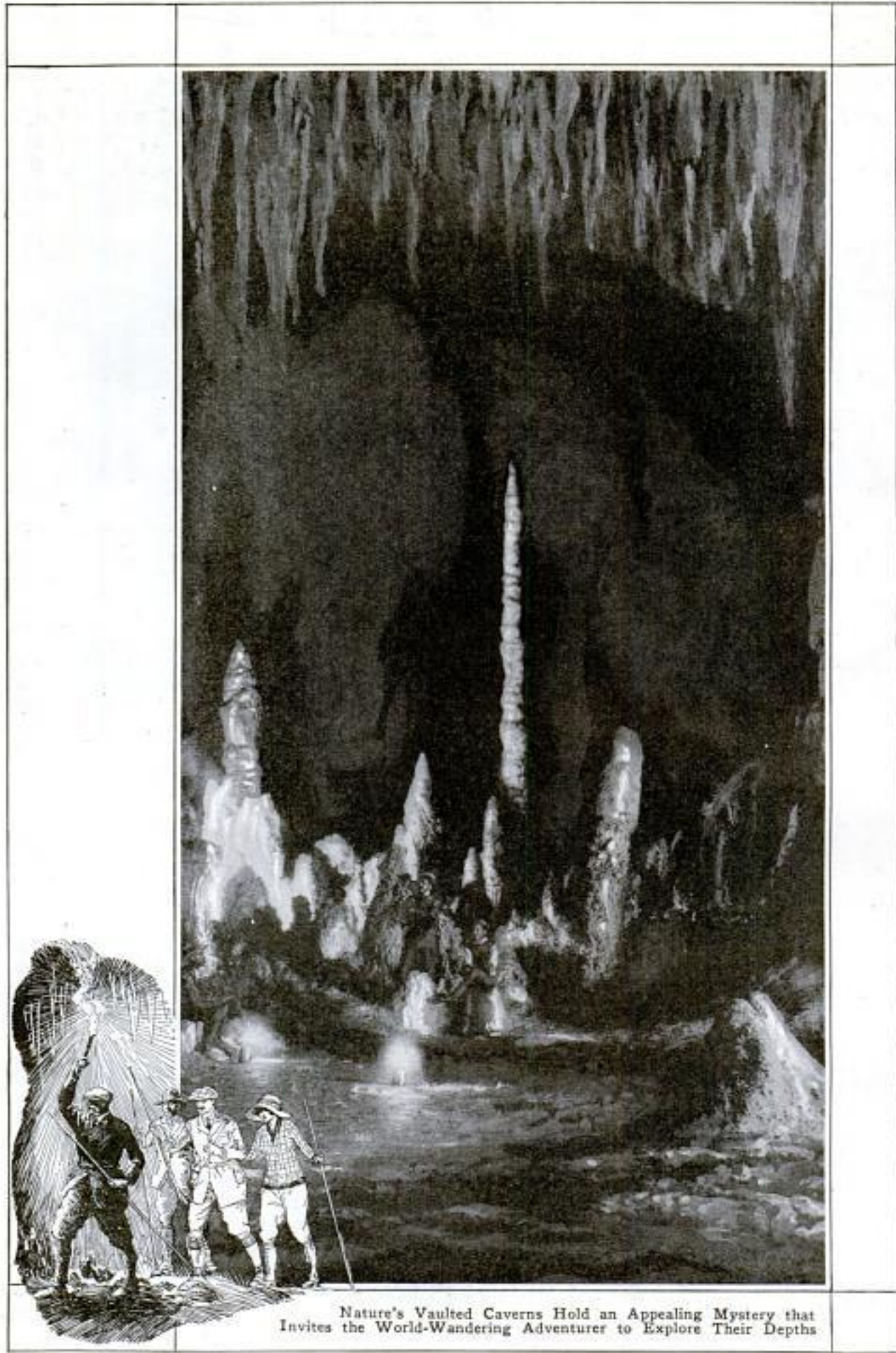

Nature's Vaulted Caverns Hold an Appealing Mystery that Invites the World-Wandering Adventurer to Explore Their Depths



Adventure Causes Remote Places of the Earth to Be Invaded by Camera, Gun, and Trap, Instruments that Often Bring Marvelous Revelations to the Halls of Learning

pons whose noise struck them with terror. Other dangers lurked in the marshes and underbrush, in which were found boa constrictors, man-killing beasts, and poisonous insects that attacked their victims in clouds, their bites often causing illness.

In the waters were vicious fish but a foot long, so strong that in taking one alive, a member of the party suffered the loss of a finger bitten almost off by its powerful jaws.

One of the first animals to be captured in the forest was a "coati mundi," a bright-red little fellow of the raccoon family. So fierce was it, that two dogs were torn to shreds before it finally was entangled and caged by the guides.

Cannibal peoples have also been discovered, recently,

in Australia by game hunters, who have come onto several tribes which have revived their gruesome practice during the past few years. Tribal fires have been rekindled and the denizen of the "bush" refuses the advances which civilization makes him.

In Africa, several of the countries are inhabited by swarthy peoples who have set up local governments that in many cases seem to pattern after those of the white man. While in the quest of big game in the Kongo, a band of white hunters stopped overnight near a native village, where criminals were tried and sentenced by a council of petty chiefs that listened to charges and evidence similar to the courts of more progressive countries.



Copyright, Underwood & Underwood

A Kongo Executioner Beheds the Condemned Criminal

Harry Levey, Pres., National Am. Theatrical
 Motion Pictures Inc.
 POPULAR MECHANICS
 130 W. 46th St. New York

92
 3667

X-RAY MOVIES SHOW MACHINERY IN OPERATION

All of the interior activities of great power plants, from the water rushing down the penstock to the interior of the

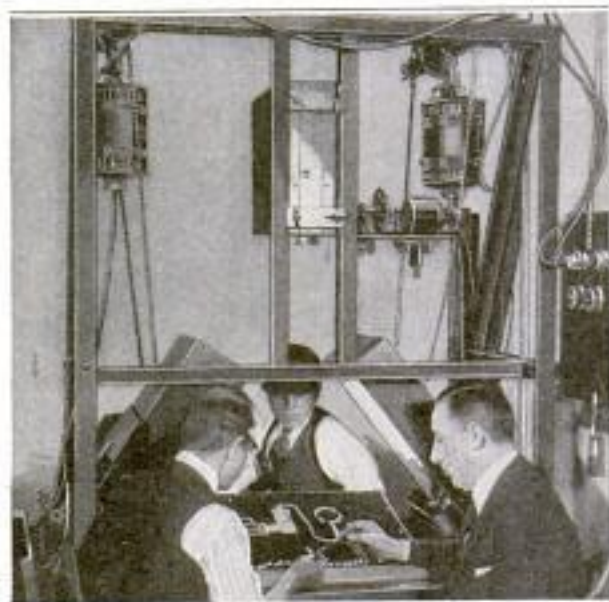

Photos by Harry Levey, N. Y.

Laying Out a Mechanical "Set" from which Movies Can Be Made for Study of Machinery

great turbines spinning under the impulse, are now being shown on the moving-picture screen, true to life in every detail.

Also, it is possible to exhibit the flow of gases without the use of arrows, dots, and dashes, or other symbols, which would detract from the appearance of reality. Smoke and steam, clouds and lightning, look real and not like drawings. Even the after glare of a flash of electricity glows on the screen.

In displaying the picture of an induction motor and its revolving magnetic field, it is, of course, necessary to assume that electricity looks like something and that magnetism is visible. It is possible, however, to illustrate these and still keep the impression of realism, bringing out clearly, principles that are extremely hard to grasp by the ordinary textbook method.

All this is accomplished through animated mechanical and technical drawings and models, as developed by Harry Levey. The models are usually made of especially prepared fiber board, drawn, cut out, and washed with air brush and by hand so as to resemble closely the real object. One of the secrets of the process is, that where an actual object is presented, the picture does not look like an animated drawing but like the thing itself.

To increase similarity, as well as to facilitate execution, the original objects, themselves, or parts of them, are used with

the model wherever possible. The method of photography is somewhat similar to the process used in making animated cartoons, the models being rearranged after each picture, so that when the film is shown, the action will seem continuous. To obtain this effect, there is a base drawing upon which the moving parts are mounted. Paper, cardboard, sheet metal, and other materials are used as occasion may demand. Thus, in making a picture of a power-driven tire pump, a thin section of an actual automobile tire was used instead of a drawing. The ordinary observer is unable to determine where the drawing leaves off or actually begins.

In this way, not only machine action, but surgical operations and microscopic studies may be displayed, and dull, uninteresting statistics, diagrams, plans, and organization and policy charts can be

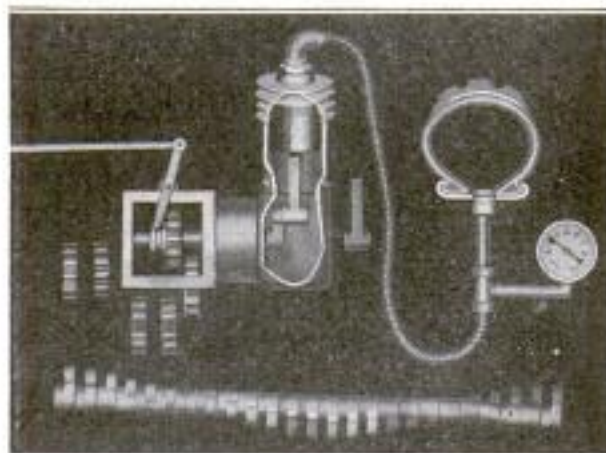

Cardboard and Disguised Drawings Are Used to Make Machinery Look Real on the Screen

brought to life. Physics, chemistry, mechanics, biology, astronomy, and architecture also may be made plain to students.

LURED BY GOLD, AMERICANS

385 BRAVE SIBERIAN COLD

Lured by the dream of riches, which through the centuries has enabled prospectors to endure hardships, about twenty Americans are braving the northern Siberian cold, panning the rivers for gold, just as their forefathers did in western mining camps 70 years ago. With Chinese, Korean, and Japanese placer miners, they have journeyed many miles inland, over frigid, barren country, ever hoping to make a big strike. Though no one yet has found great wealth, many of the Americans are spending their second winter there.

Detroit Free Press

10/11/23

Copyrighted material

3767

Installed in Masonic Temple, Haverport, Ova.
POPULAR MECHANICS

CHANDELIÈR SERVES AS BANQUET HALL

Big enough to accommodate a small dinner party, a chandelier, 12 feet in diameter and with all its fixtures weighing over a ton, has been installed in the auditorium of a recently erected building in a western

to the main floor 50 feet below by the ceiling, which curves down to meet the bowl. The lower part of it is gilded, painted, and ornamented, and to illuminate it, another cluster of bulbs, sufficient

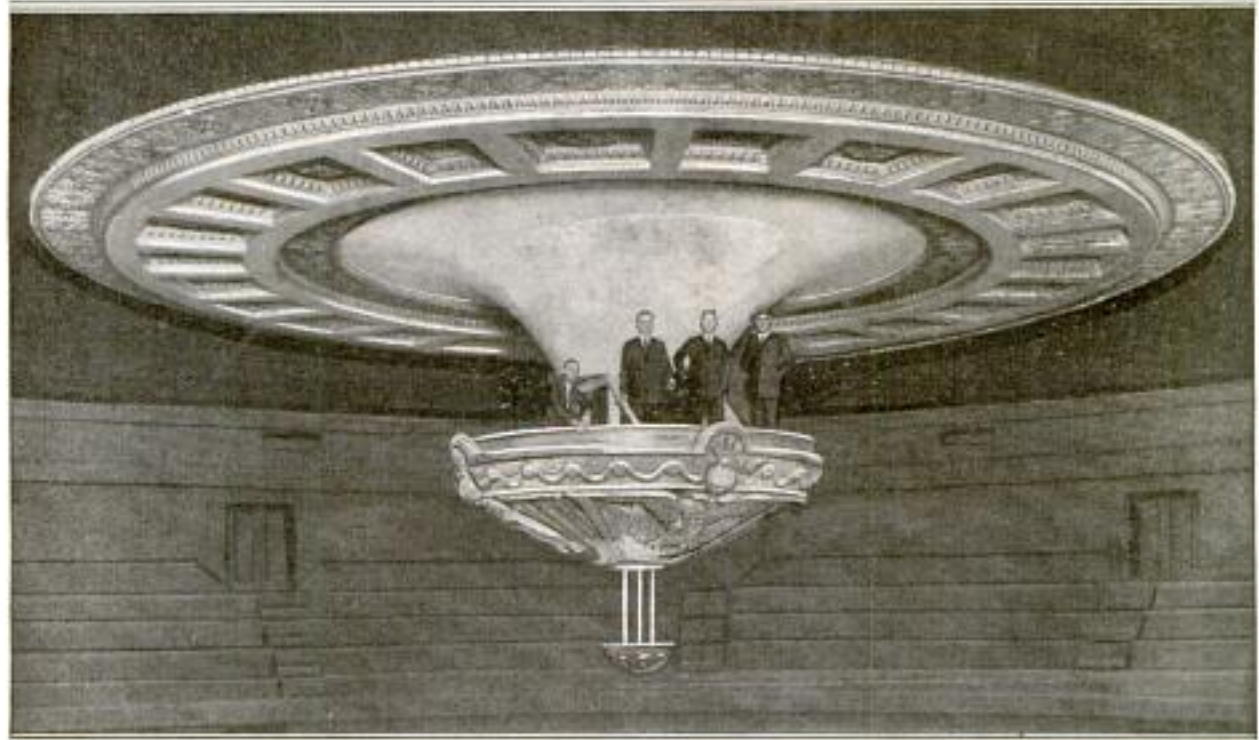

Chandelier that Weighs Over a Ton and Is Large Enough to Seat a Small Banquet Party: A Reflector Beneath Illuminates the Outside of the Inverted Canopy

city. Plans already have been made for holding a banquet in it. There are more than 70 light receptacles and reflectors within it, and the rays from these are cast

to light a small assembly hall, is suspended from the underside. Access to the chandelier is gained through a trapdoor and a steel ladder from the attic.

TAGS ON AUTOS GIVE VISITORS TOWN'S TRAFFIC PRIVILEGES

3863

In certain western towns, parking regulations are not applied to visiting motor-

tion, out-of-town drivers attach aluminum tags to their automobiles, bearing the names of their home cities. Traffic officers are instructed not to include such cars under the rules that apply to the local machines.



Visitors' Tag on Automobile that Marks Occupants as Privileged Guests of a Town

COAL TAR MAY HOLD REMEDY TO COMBAT LEPROSY

3807

Scientists are studying a reported remedy for leprosy, said to be made from a coal-tar extract. Its discoverer, a Javanese doctor, believes that it will give permanent relief from the disease. Already a halt has been called in planting of chaulmoogra trees, which yield an oil said to be the most successful treatment now employed. Many victims who have taken the treatment have had relapses, but are regarded as "arrested" cases and no longer as menaces to their communities.

ists. To save themselves the embarrassment of arrest and a trip to the police sta-

only Hale A. Van Horn, Walter Nebr.

Honolulu Chemists
Director - Paac - Pacific Union Honolulu Hawaii



Landing the Cable from Ship's Cutter: So Great Was the Joy of One of the Workers when an Early Cable Was Brought Ashore, that He Fell on His Knees and Kissed It:

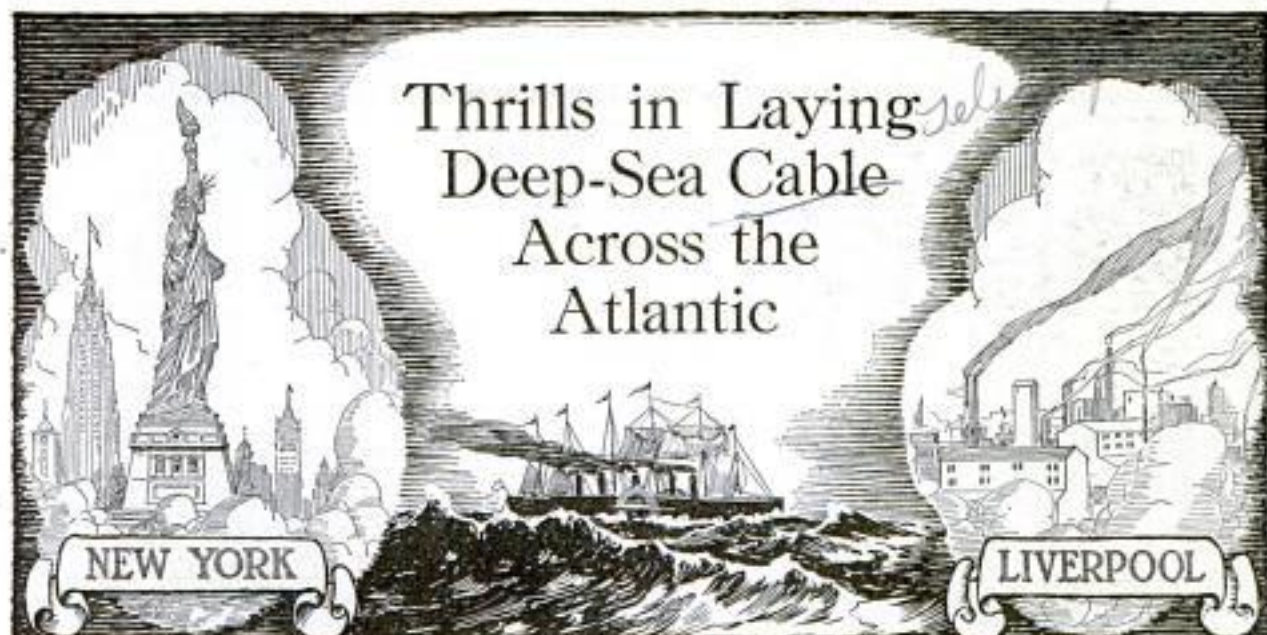

WHILE, 57 years ago the world noted the fact that the steamship "Great Eastern" had completed its memorable work of connecting America with Europe by the first successful Atlantic telegraphic cable, the recent landing on the south shore of Long Island of a new line of communication attracted little attention.

Nevertheless, this latest undertaking marked the closer binding together of the New World and the Old, for, despite the advent of the wireless and the establishment of powerful radio stations, which are capable of spanning vast terrestrial distances, the fact remains that this newer method of electrical intercourse has not scrapped the older order of long-range telegraphy.

Traffic over the submarine cables linking North America with Europe has increased fourfold in the last decade, and yet, until recently, nothing has been done within that period to add to these undersea nerves of communication. The cost of the new cable, representing the present height of scientific knowledge concerning such things, has been put at

\$15,000,000; and to get it properly in place on the sea bed has required the service of specially constructed craft manned largely by a crew trained for that hazardous and extremely exacting work.

Few persons realize what painstaking skill is required in building a submarine cable properly insulated and duly armored with a wrapping of steel wires, strong enough to withstand the rub of a rocky bottom and the continual sweep of tidal currents. Not only that, but this conduit, by which the feeble electrical impulses carry the daily heartbeats of national life from

shore to shore, must be proof against the penetrating persistence of deep-sea worms, and sufficiently sturdy to hold its own against attack of swordfish and other large denizens of the ocean. Should it break or be severed, when once in place, the task of picking up the parted sections, or of raising the defective cable at the right point, may require grappling for it miles below the surface and sweeping wide areas of the sea. In short, the story of cable-laying is an epic well calculated to hold one spellbound.



Hauling Shore End of Cable through the Surf and onto the Beach from a Distant Ship



Pouring Concrete over the Shore End of the Cable and Its Guides to Hold Them Permanently to Their Moorings and to Protect Them from the Pounding Surf

Life aboard a cable-laying vessel is filled with excitement. Off the coast of Spain, recently, two tons of oysters were hauled on board an Eastern Telegraph Company boat, when a cable was pulled up for mending and had to be hacked off before the repair could be effected. Again, in the Gulf of Suez, a cable was brought up coiled around the body of a small whale. Sponges, coral, old fishing nets, and all sorts of shells are brought to the surface, and the refuse of civilization, washed down the rivers into the sea, has been picked up as far as 500 miles from land.

Between about 1845 (when gutta-percha made submarine telegraphy a practical possibility) and the middle '70's (when cables became part of the ordinary routine of civilization), tremendous excitement was aroused by every new attempt to establish such communications across the ocean. The first cable between Dover and Cape Grisnez amused the mid-Victorian loafers on the beach, for they thought the thing was to be worked like a bell pull and tugged from either coast of the English Channel. That was in 1850.

People soon grew better informed and



wildly enthusiastic. Even the cable laid during the Crimean war between Varna and Balaklava—an unheard-of distance, 356 miles—although it failed to work, was hailed as a signpost of progress. The 1856 Atlantic cable began from western Ireland, under the eyes of the Lord Lieutenant, while prayers were offered from the beach for its success. The current, nevertheless, stopped mysteriously at intervals, and finally halted altogether. In the next year communication with America was kept up for only a month. Soon after this there was a pause, while a commission sat to examine the whole question. Over this early adventure three to four millions had been lost.

The commission reported that, despite its discouraging and expensive past, submarine telegraphy had an infinite future. Encouraged by this, the believers in progress watched the "Great Eastern" with confidence. The ship lost the 1865 cable while paying it out. But in 1866 it triumphed. After this the cables were woven very swiftly into a network that covered all the seas of the world. So great was the excitement, that during the landing of an early Atlantic cable at Heart's Content, Newfoundland, one of the workers fell on his knees and kissed it.

The men primarily responsible for linking the Old World with the New were Cyrus W. Field and Samuel Morse. When the latter announced in 1857 that messages

could be sent from America to Europe through means of thin strands of wire stretched along the ocean's bed, the people of the day hooted. Morse had shown the world the wonders of telegraphy a short time before and had flashed to Alfred Vail, his co-worker, that epoch-making message, "What hath God wrought!" That happened May 24, 1844, and came after he had faced discouragement and rebuffs that would have driven an ordinary man mad.

Came 1857, and Field, a New York merchant, Morse, and a group of associates, decided that a transatlantic cable would not be an impossibility. Interest in the venture became intense and on Aug. 7, 1857, the ship "Niagara" left Valentia Bay, Ireland, with its rolls of cable. Four days later the brakes on the cable-laying apparatus were put on, while the stern of the boat was down in a swell. The cable parted, thus ending the venture for that year.

"We knew it!" croaked the scoffers on each side of the water. "The whole thing is a humbug. Did those men think we would swallow everything they said?"

Another attempt in 1858, which also failed, brought a wave of comment from all over the United States and Europe. Newspapers were unanimous in pointing out a hundred reasons why a cable never could be laid, and in sympathizing with those who had sunk their money in it. Three other unsuccessful attempts followed, victory not greeting the efforts until 1866.

BAKERY GENERATES OWN GAS TO HEAT LARGE OVENS

3952

By producing gas from coal in its own yard, a large Copenhagen, Denmark, bakery has brought about a saving of twenty-five per cent in fuel and, in addition, has done away with harmful soot and smoke. Its 16 ovens, in use every day, are found to be more uniformly heated, resulting in better baking. From the generating plant, which has been patented by the designer, the vapor is piped into each unit, the flow being regulated by special valves, so that an even temperature is maintained.

ALARM SET ON AUTO SOUNDS IF THIEF STARTS MOTOR

3834

Sounding a loud rattle to attract attention when the motor is started while it is set, a combination alarm and keyless lock for automobiles helps to prevent theft. As long as the engine runs, the device sends out the warning, which can be heard above the din of traffic. It can be either shut

off or fixed so that it will work when the car is left unguarded. The device is con-

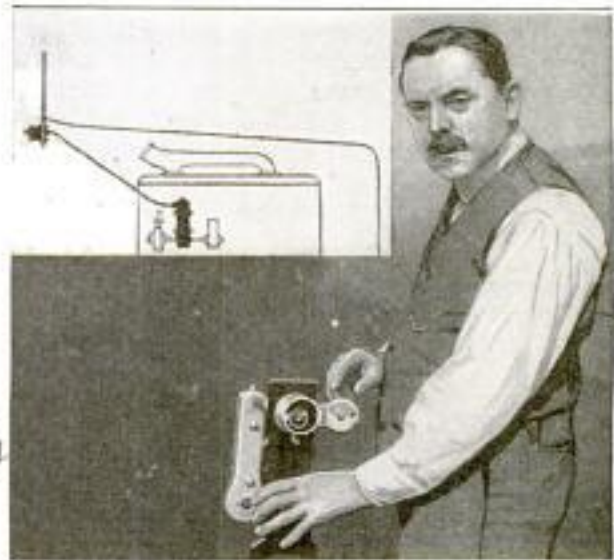

Auto-Thief Alarm, Connected with Crankshaft, that Sounds Loud Rattle when Engine Is Started

nected to a specially designed noise-maker in the crankshaft.

*draw. Louis Reichert
former
German engineer
in Germany.*

*ingenieur, S. Krayer
Chersey 33 Hellerup
Denmark*

98
3984



Unusual Footbridge Made of Chicken Wire and Planks

**FOOTBRIDGE OF CHICKEN WIRE
REPLACED BY CONCRETE**

Made of chicken wire with a floor of planks, a picturesque footbridge that spans a western river is soon to be torn down to make room for a modern concrete structure. The improvised bridge is of a suspension type and the central section, more than 300 feet in length, swings high above the water. On account of the swaying of the structure whenever an adventurous person steps upon it, high sides of poultry netting have been made to keep the walker from falling into the river.

**DIES AND ACIDS DRAW
"INVISIBLE" WIRES**

Drawn into strands as fine as 200 millionths of an inch in diameter, wires that are invisible to the unaided eyes are used in minute electric bulbs, necessary to the operation of long-distance telephone lines. So thin are these metal threads that it is necessary to weld them under a microscope. After passing through dies, the filaments are eaten down to the required size by acid. One hundred of them form a strand no larger than a hair.

Western Electric Co
463 West St.,
New York.

Phy. review
May 1924

**CHECKER ENTHUSIASTS PLAY
ON MAMMOTH BOARD**

3959

Playing checkers on a huge outdoor court has been found by northern enthusiasts of the game to combine pleasantly both bodily and mental exercises. The thrill still remains, the walking and lifting that is done during the course of a contest add to its enjoyment, while an exciting sport is provided for the spectators. The pieces are cylinders fitted with wire stays, by means of which they are moved about with a hook. The "board" is made of

cement measuring 15 feet in width and length and has squares of light and dark color. Only one player has the court at a time. When he completes a move, his opponent then takes his place. One set of "men" is painted black and the other white.

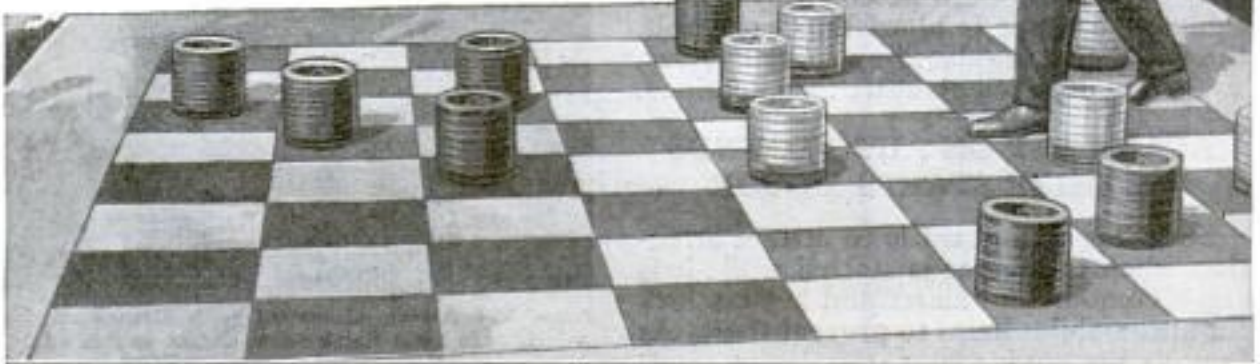

On Huge Court of Cement, Marked with the Required Number of Squares, Game of Checkers Is Adapted to Outdoor Playing, Providing Both Mental and Physical Exercise

International

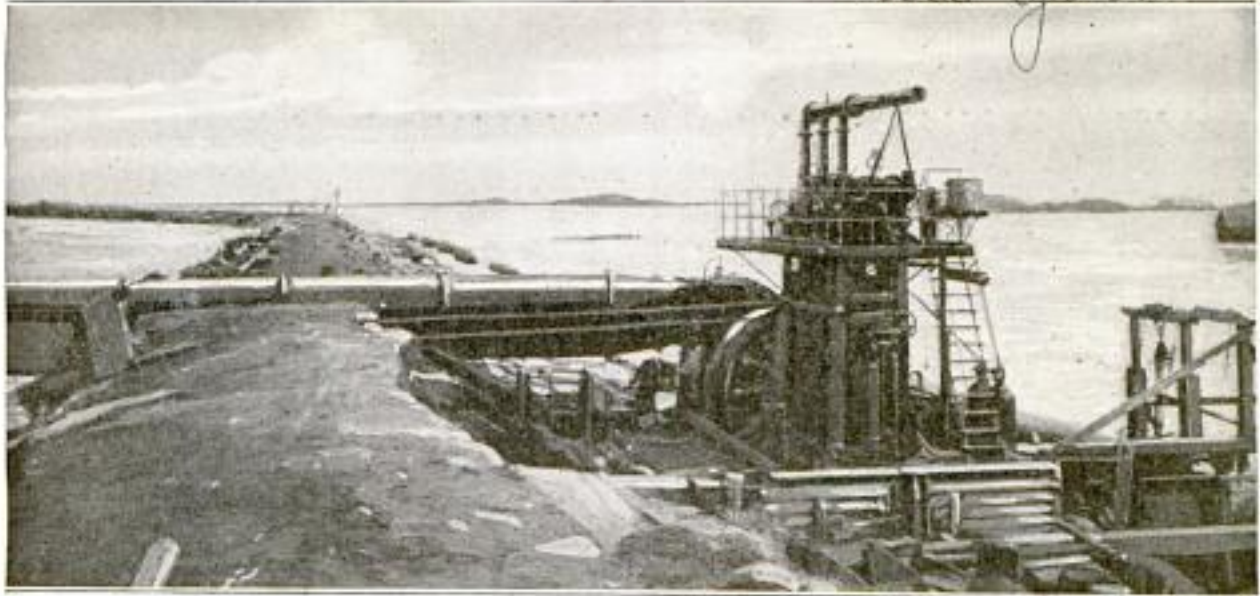

Electric Pumping Station of the Type that Is Rapidly Displacing Picturesque Windmills Behind Holland's Dikes

WINDMILLS OF HOLLAND GIVE WAY TO OIL ENGINES

MODERN machinery is taking the place of romantic windmills that long have guarded the dikes of Holland against the encroachment of water. Fuel-burning engines have fast supplanted the quaint winged structures, until now even the pumps are run by motor when the wind fails. With the coming of up-to-date equipment, the typical Dutch panorama has been greatly transformed by the chimney stacks of the pumping works. Everywhere along the lowlands these are to be seen. As a result, the engineers are facing a problem—that of retaining the beauty of the landscape that received its most picturesque touch from the windmills. Already steps have been taken to beautify the modern plants, for it is feared that the capital value of Holland's scenery will be materially de-

creased unless belching smokestacks and machinery are concealed in structures pleasing to tourists' eyes. Part of the country is below sea level, and for centuries the

farmers have been waging a battle against the sea. It was to this work that the windmill was first adapted in the beginning of the 15th century. Now the task is largely done by oil, steam, or electrically driven pumps. Some of them are huge. One of the largest of such stations serves 45,000 acres, removing 100,000,000 tons of water annually. Powerful equipment, such as this, seems to have increased the activities in reclaiming land from the sea. But in the many such ventures that are now under way, the windmill has no part, for the passing of time has rendered it useless, except on small farms.



Photos Courtesy Oil Engine Power

Where the Wind Works for Prosperity of Lowland Farmers

3890

San Mateo

HARVESTING SALT CROP FROM NATURAL BEDS

From deposits in California, 20,000 tons of salt are harvested annually as part of the country's yearly output of this mineral.

As to when rock-salt formations were first found, history does not say, for not until 1000 A. D. was its mining mentioned. Probably the most famous salt mines are in Galicia, where the worked-out rooms have been decorated and converted into chapels and assembly halls by the miners. In these workings there are underground brine lakes upon which small ferryboats run, railways with stations, and other conveniences found in large cities. It is claimed that these pits were once the property of the Romans. The oldest

salt mine in the United States is said to be located in Louisiana, where thousands of tons have been removed since it started operation.

Here it lies in a solid mass over 2,000 feet thick, in which a series of chambers have been dug, arranged like the squares of a checkerboard, with arched roofs supported by pillars of salt. The rooms are 70 to 80 feet high. Another method of procuring the mineral from the earth is by drilling wells, and in many places there are huge surface beds that have been formed by evaporation of large bodies of water. For centuries salt has been made by using the sun as a heat source, but this method is practicable only where there are few cloudy days.



Lump of Rock-Salt Crystals Taken from Vats After Moisture Has Passed off

COMBINED BRUSH AND TOOTH-PASTE HOLDER 393

Designed to at once insure freedom from dirt and save space, a combined tooth-brush and paste holder has been placed on the market, the invention of an easterner. The brush and handle fold up so

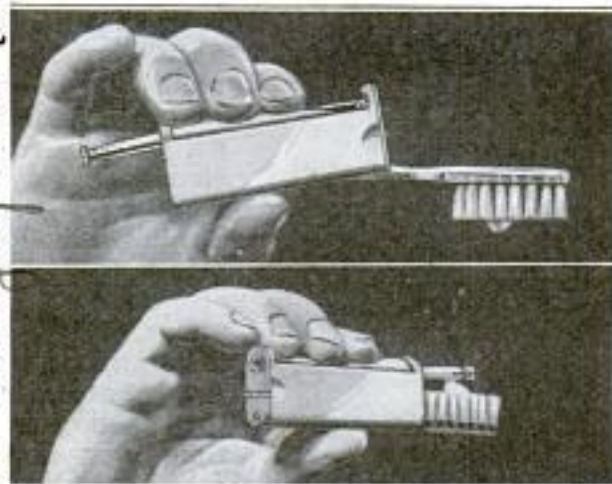

Tooth Brush and Paste Combined in Small Holder that Saves Space and Insures Cleanliness

that the article is less than two inches in length, which makes it of special value to travelers, who may carry it in their vest pocket or traveling bag. The dentifrice may be applied without removing the tube from the container. Sanitation is provided for, in that the brush is not exposed to the air when the device is folded.

MOTOR-DRIVEN ERASER SAVES 4013 LOSS IN PRINTING

On a job of 200,000 postcards, an eastern printer discovered a small error that seemed to necessitate the destruction of the lot. Instead he rigged a motor-driven eraser which was applied to the postcard over an opening in a brass sheet and completely removed the objectionable part. The cards were then reprinted according to the correct copy. *Emb. Edwin Paruse of The Farragut.* Quintana Roo, Mexico's unexplored territory, lying adjacent to Yucatan, is being invaded by Americans, the first white occupation since the days of Cortez.

Ans. Robert H. Lieberthal, 881 Lafayette St. Bridgeport, Conn.

Washington, D.C.



Piled Outside the Refinery, Rock Salt Assumes Forms that Recall the Glaciers of the Arctic

Lakes that Have Evaporated Under Ages of Sun's Heat Left Surface Beds of Salt that Are Easily Mined



3884

OIL-VAPOR LIGHTS TO MARK HIDDEN SEA DANGERS

Oil-vapor lamps, said to be twice as bright as paraffin lights, have been put on buoys along the English coast to warn ships of lurking dangers. With their range on a

make the ocean highways brighter for the numerous craft that ply the waters around the British Isles. They guide liners, freighters, and smaller boats from the menaces of shoals, floating derelicts, and other perils that clutter the trackless roadways of the sea, thus lessening the possibilities of serious accidents, due to vessels

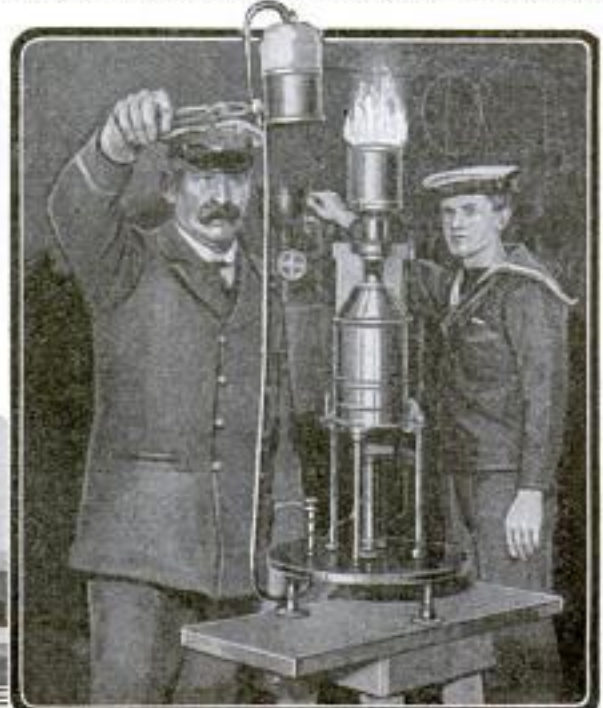
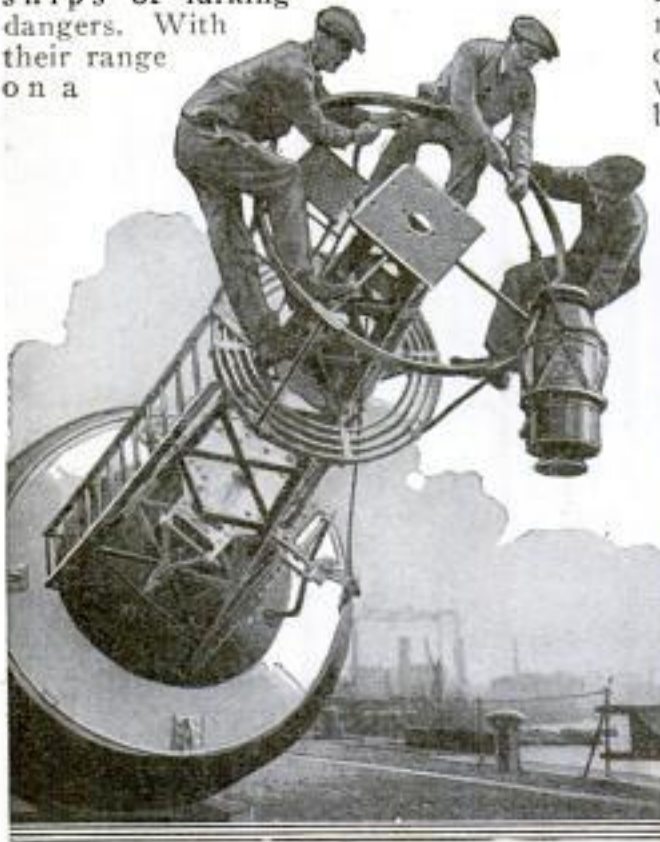

Attaching Powerful Oil-Vapor Lamp to Sea Buoy. One of Many that Guide Ships along English Coast at Night: Right, Regulating Light before Installing It

clear night limited only by the earth's curvature, these signals are reported to

wandering from the safe paths of travel during hazy weather or extreme darkness.

HAND TOOL RETHREADS SCREWS THAT ARE BADLY WORN

For rethreading screws that are badly worn, a hand tool that cuts from eight to

sixty threads an inch on any diameter, has been invented in England. It consists of a specially designed file that is fitted to a guide by adjustable clamps. The "V"-shaped edges fit the screws for recutting.



Tool that Rethreads Badly Worn Screws by Hand Cutting Brought Out in England

SKULLS EXPLODE SCIENTISTS' THEORY ON INDIANS

That Indians resembling prehistoric man resided on the Pacific coast at an age many centuries earlier than heretofore known, is now claimed by scientists as a result of the recent finding of two skulls. Digging in a mound, upon the site of an early home of the Santa Barbara tribe, the explorers found the relics, which are believed the oldest ever unearthed on this continent. They were lying on the surface of hard pan 44 inches beneath an age-old deposit of loam which showed no traces of having been disturbed previously. Almost gorillalike, the skulls are very thick, with

Chicago Post 10/25/23 Copyrighted material

The Vee Tool Co., England Exmouth, England

de Blauke Patent
Kalkvaerker, Balle

Rockford, Ill

Dr. Frustrup, Denmark

POPULAR MECHANICS Traction 103

Company

abnormally prominent brow ridges, sharply retreating foreheads, long faces and massive jaws. Beside each skeleton was found a black volcanic-stone spearhead, one of which was $4\frac{1}{2}$ inches long and $1\frac{3}{8}$ inches wide, and square ended.

MOWER HITCHED TO TROLLEY CAR TO CUT WEEDS

Hitched to the rear end of a trolley car, a mower is used by a middle-western traction company to cut weeds and grass along

FIVE SIZES OF STONES SORTED BY DANISH MACHINE

With a capacity of 800 tons daily, a modern mechanically operated plant in Denmark crushes and sorts stones into five sizes for the national railroads. The machine automatically discharges into cars.

DASH LIGHT FOR AUTOMOBILE HAS ADJUSTABLE SHADE

Annoying glares from ordinary lights on the instrument board of an automobile are absent in a shaded dash lamp that has been lately patented. When the shutter is in normal position, subdued rays fall on all the dials and the entire board is under a flood of light that does not tire the eyes or impair the driver's vision. A slight movement of the shade gives sufficient il-

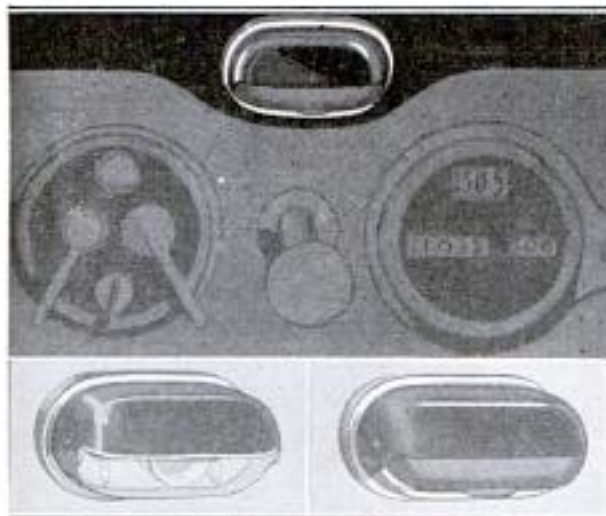

Adjustable Shade Dash Lamp that Lights Up Instrument Board without Producing Annoying Glares

lumination to enable the autoist to read his watch or maps, find tools, or inspect the battery. It can be attached in a few minutes to any size car and its simple construction is intended to insure correct operation at all times. Made of brass or bronze, its socket is formed so as to keep the bulbs from sticking.

From an 8-ounce package of Sudan grass seed sent to this country from Khartum in 1909, what is now a \$10,000,000 forage crop has been produced in the West.



Mower, Pulled over Rails by Trolley Car, Cuts Weeds Growing along Right of Way

its right of way. The machine has a long sickle that can be raised or lowered at will to prevent striking obstructions that may lie in its path. It rides the track on flanged wheels. With one man operating the machine, work formerly requiring many laborers is accomplished in a few hours.

OPEN SANDALS ARE ADVISED IN WAR ON HIGH HEELS

As a correct substitute for high-heel pumps, which he considers are destructive to the general health of women and the beauty of their feet, open-work leather sandals have been offered by a famous English surgeon. These shoes, he asserts, are more comfortable, promote bodily vigor, and do not cause spinal and nervous



Sandals of Open-Work Leather that Are Recommended by Surgeon as Proper Shoes for Health

disorders, which may result from wearing those that have elevated arches and heels.

Dr Herbert Barber, Hamilton House, 12-a, Park Lane, W, London, Eng.

3795

CAGELESS DEN IN ZOO IS BUILT FOR KING OF BEASTS

Covering the side of a canyon, a unique concrete grotto for lions has been constructed at the San Diego, Calif., zoo. To all appearances, the three animals kept there wander at will over a terraced hillside, with apparently only a three-foot hedge of cactus to restrain them from joining the audience. In reality, a wide moat, concealed by the hedge, provides safety for the spectators.

Here, there is no small and confined cage which invariably challenges sympathy for the animals, nor are there the usual heavy iron bars to interrupt the view. And yet, there is no point where it would not require a 16-foot leap for the king of beasts to escape. The top walls are built with an interior overhang.

Another notable departure in zoo spectacles has been staged in London, where

the tribal wars of many colonies of ants are being shown. The tiny creatures are placed on a tablelike platform, and large magnifying glasses are available, through which the wonderful performances may be watched. After one notable battle between the ant forces, the victors could be seen taking their prisoners of war and the spoils—such as building material and food—back to their own colony.

One of the newest and most modern of European zoological gardens is at Rome. Rock-ribbed inclosures and other installations permit the animals to be seen practically in their natural habitats. One of the features is the aquarium, where tanks of fish are kept to be fed to the fish-eating birds, which are allowed to dive down and help themselves, instead of having their food thrown to them.

"WALKING" STEPLADDER MOVED BY USER AS HE WORKS

3938

By throwing the weight of his body from side to side, a workman using a late type of stepladder is enabled to move it to a new

BICYCLE IS BOON TO VICTIMS OF JAPANESE EARTHQUAKE

Kansas City Star 10/28/33

4044

Thousands of Japanese on bicycles pedaled their ways through wrecked streets, seeking safety and aid after the recent earthquake. Motor cars, trucks, and jinrikishas were useless in most sections of the country. Soon after the disaster, a bank clerk is reported to have carried an important message from Tokyo to Kobe, a distance of 300 miles, in 34 hours, riding his bicycle over roads made impassable to other vehicles. It is estimated that more than 3,000,000 bicycles are used by natives throughout those islands.

SHEET TIN AROUND TREE LIMBS DEFIES SQUIRRELS

4001

Sheet tin, wrapped around the upper limbs of almond trees in a western orchard, keeps ground squirrels from climbing over the branches to get the nuts. Damage formerly done to a crop near old pasture land led to the invention of this simple method. Shaped like a stovepipe and put on close to the bark, the protection cannot be crossed by the little animals, because of its smooth, glassy surface.



Stepladder So Designed as to Permit User to Move It About as Though on Stilts

position without descending. The two sections of the ladder are hinged together at the top in a rather loose connection which permits easy operation. The upper ends of each part of the ladder are offset, thus permitting the swinging action referred to.

dw. Mr. Cape Anlauf
Professor, Princeton

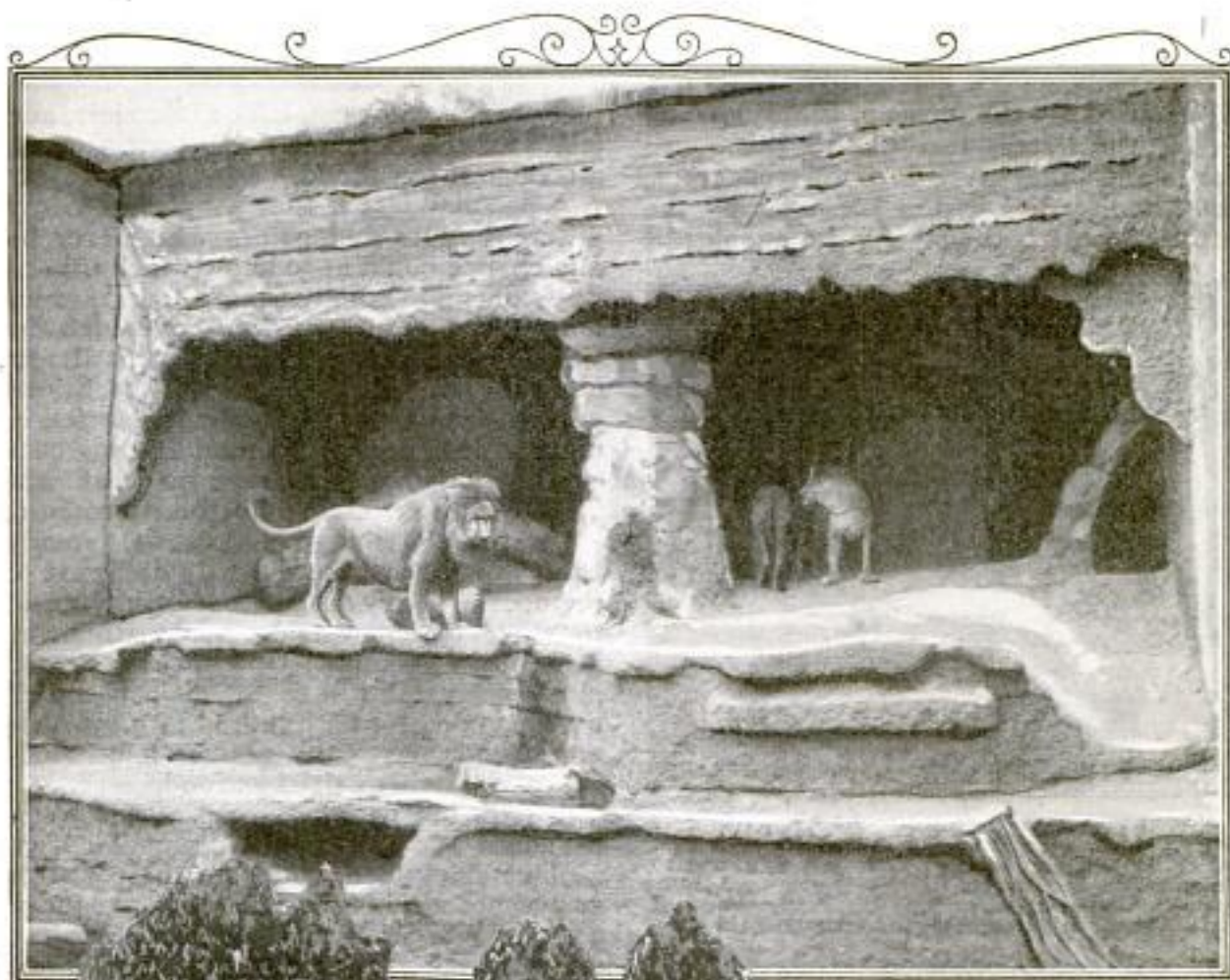

Something of the Lion's Native Haunts Is Seen in Terraced Approaches of the Zoo Cave



High Unscalable Walls Replace Iron Bars and Bare Cages that Restrain Most Captive Animals



With Freedom Only Surpassed in Its Natural State Young King of Beasts Romps in the Cageless Den

Trapping Strange Fishes in South Seas

SO varied are the forms of fishes inhabiting the waters surrounding the South Sea Islands, that myriads of different traps, nets, hooks, and spears are used by the natives to catch them. As the peoples of

provide the Samoans, Ellice Islanders, and tribes of the Solomon Island group with a means of livelihood.

A peculiar fact is that peoples of vastly different races and colors who never by any chance could have known each others' ways, fashion their fishing tackle very much alike. The same hook by which the Gilbert Islander catches his shark is almost identical with that used by the cod fishers of British Columbia. Implements used in making nets in the Solomon Islands bear a remarkable resemblance to that employed by the crofter of northern Scotland.

In the Washington Islands, square traps are set to take the wily denizens of the ocean. They are built of bamboo held together by coir string made from the husk of the coconut. One of these is used particularly for the castor-oil fish, which lives at a depth of a hundred fathoms, and another ensnares the conger eel. Both fishes are highly prized as food.

A crab net used by some of the other islanders has a bottom piece made from a giant clam shell, which in these waters sometimes attains the enormous weight of a ton or more. As the net is lowered into position, the shell sinks to the bottom of

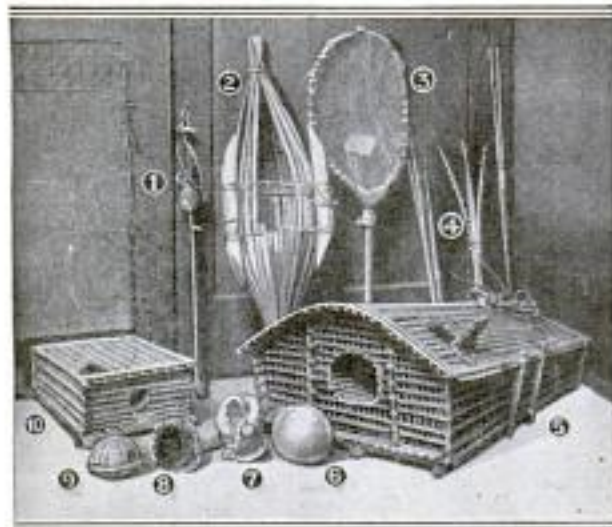

Photos Courtesy Frank Burnett

Ingenious Traps for Ensnaring Fish—Number 1, Float for Hooks, Solomon Islands; 2, 5, 6, 7, 8, 9, and 10, Traps Made by Natives of Washington and Ellice Islands; 3, Hand Net for Catching Palolo Worm; 4, Spears; 6, Parrot Fish, Inflated and Dried

this region depend largely on the sea for food, these queer implements are an important part of their every-day life.

In the Gilbert Islands, the natives go out in frail canoes alongside of the reefs, where the sharks are usually found, and with large baited hooks catch the monsters from three to fifteen feet long. Balancing upright in their boats the hunters, with an ability few white men can equal, play the huge captives until they are sufficiently weak from exhaustion to be drawn alongside and clubbed to death.

Sometimes the boat is capsized in the struggle and the agile native finds himself in the sea on an even plane with his vicious antagonist. But even then, if armed with a knife, the angler is equal to almost any shark. If the enemy charges, the swimmer, awaiting the right moment, dives under the quarry and in a flash rips it up the soft underside of the body.

Beautifully wrought hooks of pearl shell dangle at the ends of lines used by these fishermen to troll for albacore, bonito, sea pike, and corphœna, fish that are seldom heard of in the civilized quarters of the world. Still other models of hooks and fishing gear are to be seen among the weapons of the New Guinea angler, and many different kinds of barbs and spears

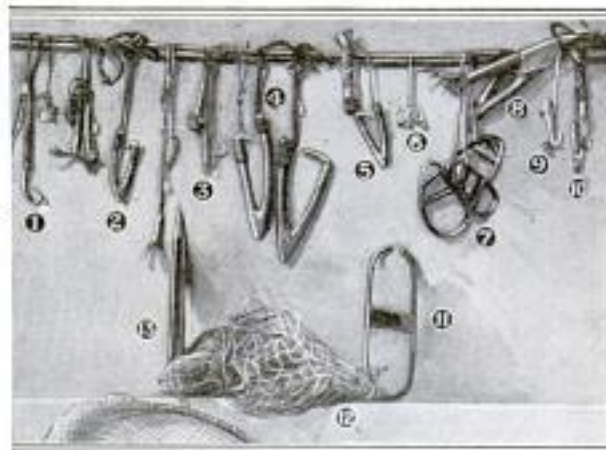

Fish Hooks and Netting Needles of South Seas—Number 1, Hook Used in New Guinea; 2 and 4, Shark Hooks of Gilbert Islanders; 3, Samoan Hook; 5, Ellice Islanders' Hook; 6, Hook Made by Solomon Islander; 7 and 8, Cod Hooks of British Columbia; 9 and 10, Hooks Carved from Pearl Shell; 11 and 13, Weaving Needles for Making Net Shown at 12

the sea and automatically opens the mouth of the trap. When a crab enters, the fisherman who can see clearly in the water to great depths, pulls the mouth closed.

Another peculiar net is that used to catch the mysterious palolo, a strange oceanic worm which comes to the surface only on one day of the year, and is considered to be a rare tidbit on the feast table. Com-

ing up from the reefs below during the night, it dissolves into small particles shortly after the sun rises. Each of the tiny pieces becomes the beginning of a new worm. The natives, who claim that they can tell the exact hour of the day that the creature will reach the top of the water, often catch huge quantities of the worm before it can break up and sink again.

In the Solomon group, the fishermen resort to a float to which is attached a number of hooks. When the prey takes the bait, it causes a little ball that stays on top of the water to move. The float is made large and buoyant enough to take quite a large-sized fish.

Perhaps the rarest of all those of the tropical waters is the queer parrot fish. When it is drawn out of the water it swells with fear and anger, and assumes an appearance much like a globe.

MOTH HELPS PLANTS INCREASE SO LARVÆ CAN GET FOOD 3995

To insure a proper food supply for her future larvæ, the little white moth acts as a foster-mother to the yucca plant, helping the weed to increase by bearing seed from one flower to another. After laying an egg in the pollen, the insect rams it down into the pistil so that it will fertilize, and thus maintain life for her young ones. The process is so cleverly effected that scientists say man cannot equal it, as artificial attempts are rarely successful. The plant is said to be the only one that depends on a single species of insect for this service.

new York Times 10/22/23

CAMERA "SEES" SUN'S COURSE IN POLAR DAY 3803

In obtaining a photograph showing the exact course of the sun in the far North on December 21st, the shortest day of the year, a prospector made several exposures on the same plate, one every 12 minutes from the top of a high mountain peak in Alaska. Only two hours passed between

PHONE RECEIVER HELD TO EAR BY BRACKET; FREES HANDS 3792

Free use of both hands is permitted a person using a telephone equipped with a folding steel arm recently invented, that



Holder for Telephone Receiver that Permits Free Use of Both Hands while Talking

holds the receiver to the ear. Clamped to the stand, it is easily adjusted to any position desired. With a single movement of the arm, the receiver hook is raised to signal the operator. To disconnect, the holder is folded back. Its weight is counterbalanced by a plate fitted under the telephone.

Joban Receiver Holder Corp. New York 347 41 7th Ave.

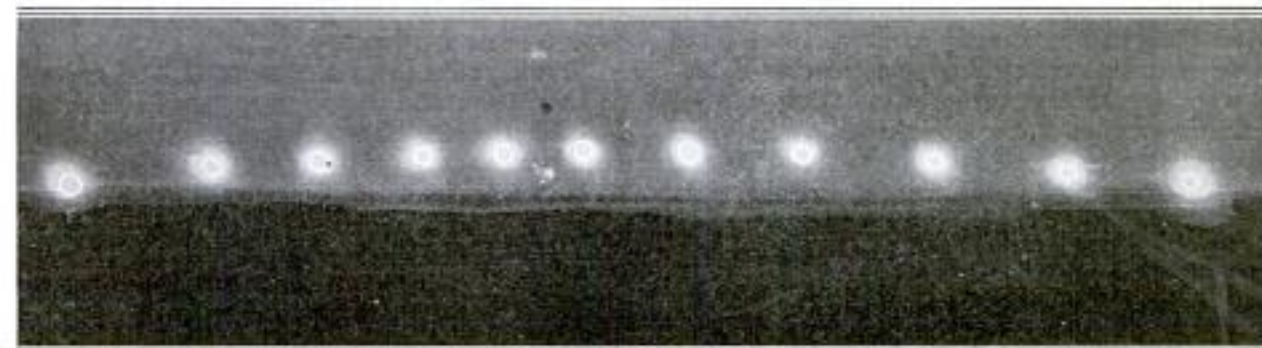

Sun's Course on Shortest Day of Year Photographed from Point in Arctic Circle

*Comd. Francis Luke Heriot
Pray, B.C. Canada*

Com. Earle W. Isaacs,
Asheville, N.C.

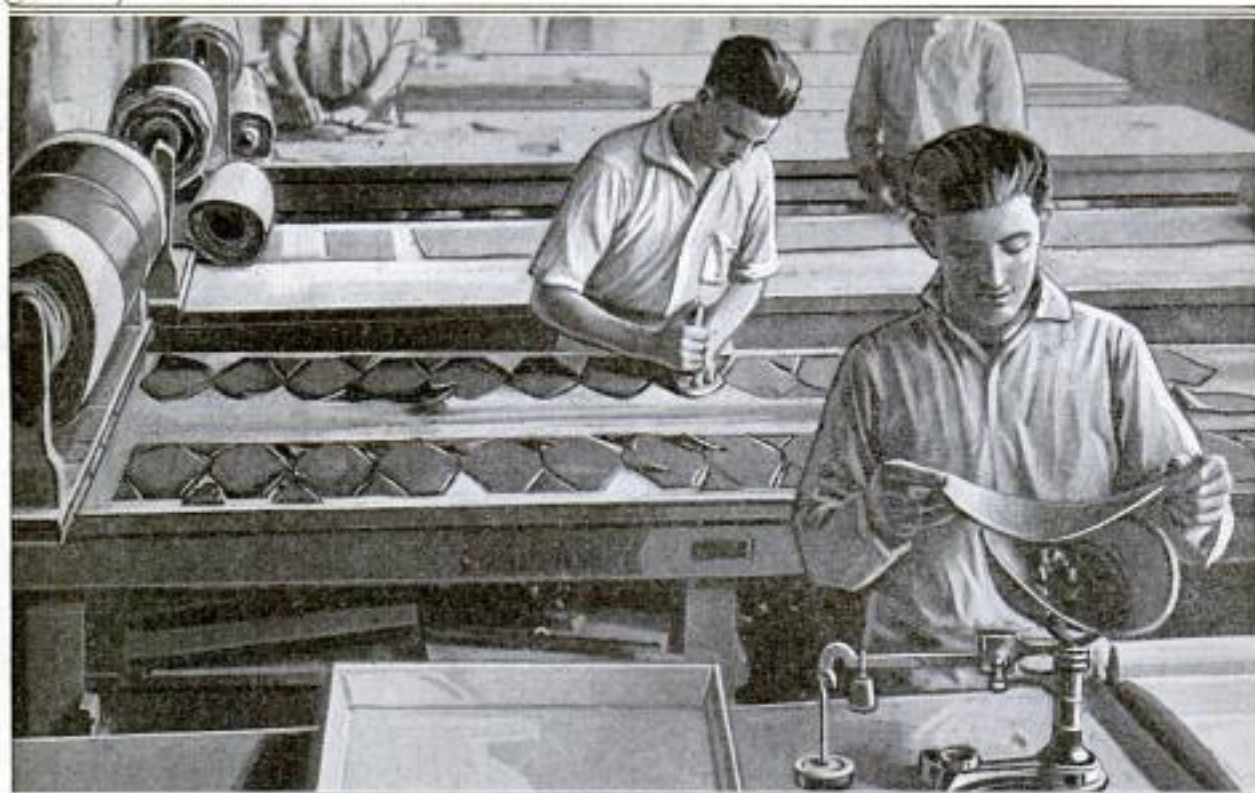

Only Expert Workmen Are Permitted to Mix the Proportions of Crude Rubber and Chemicals which Are Formed into Sheets for the Fabrication of Heavy Vehicle Treads

Jungle to Factory—Trail of Auto Tire

Sidewalk from Chicago to New York Could Be Built from Rubber Annually Consumed in Making Treads and Tubes

ABOUT seven-tenths of the value of rubber products made in the United States is represented in automobile tires and inner tubes, while 75 per cent of the world's entire output of the material is consumed in their manufacture.

Until recent years the "rubber trail" took its traders into the wildest lands of the tropics, where they confronted untold hardships in order to provide the motorist with velvet shoes for the wheels of his car. Now, the rapid production of rubber on cultivated plantations makes the collecting of the various grades a far easier task.

In the Far East and countries about the equator, great orchards of Para trees have been planted under the direction of Europeans, but lately many American rubber manufacturers have developed their own plantations in these lands. Instead of the ungraded mixed shipments, which formerly came up from the headquarters of the collectors of "wild" rubber, each variety is now carefully selected at the time it is drained from the trees. Kept separate from the other grades, it reaches the market or factory in clean condition, ready

for the process of refining for its various purposes.

This cultivation of the rubber trees has forced the "wild" product almost entirely from the markets, although about 40,000 tons are still bought up each year. Seed from the Para tree, the plant which furnishes the sticky fluid, was first planted in a public garden in London in 1876, where it thrived and grew to normal size. Following this experiment, seedlings from it were carried to southern India, Sumatra, Java, and neighboring states. The first crop that resulted from these early plantations produced not much more than four tons of raw rubber.

Seven years later the output had grown to 1,000 tons and in another decade reached 200,000 tons. The cultivated article now constitutes a supply of rubber that helps to make more than forty million tires required by the pleasure and commercial motor-driven vehicles in operation in this country alone. If in one mass, it could form a sidewalk from Chicago to New York.

It takes eight and three-tenths pounds

3648



Native Workers on a Rubber Plantation in India Gathering Sticky Sap of the Para Tree

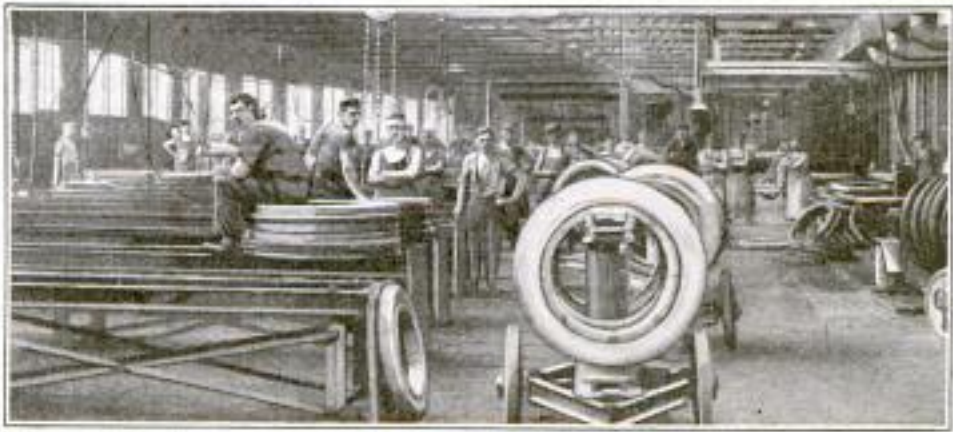

Vulcanizing Room of an Automobile Tire Factory where Casings Are Cured After Being Built Up of Raw Rubber



of the raw substance to make one of the average tires, and about two pounds for an inner tube. For the casing, four and a half pounds of cotton are also required.

Plantation rubber when brought to the factories is stored away in cool bins until needed, but the "wild" variety is chopped into small pieces and soaked in warm water to soften it. It is then passed into a "cracker" machine where rolls with sharp knobs break it up into a coarse, spongy mass. Water flowing over it washes out the sand, dirt, bits of bark, and other foreign substances that get into it during its preliminary treatment at the hands of the

jungle gatherers. After drying, the rubber is mixed with other materials and becomes the uncured or "green" compound.

An added step in the trail of the rubber from the jungle to the factory has been lately taken by one large manufacturing plant, which loads the milky fluid, called latex, into tank boats as it is gathered, and thus conducts it directly to the treating rooms. There it is pumped into large vats, and is sprayed by a recently invented machine into a heated chamber where it becomes a spongy mass deposited on the moving floor of the room, quite free from dirt frequently found in baled rubber.

SCULPTOR'S ART MODELS COW FROM BLOCK OF BUTTER

3919

Modeled in butter, the figure of a dairy cow, weighing 375 pounds, graced an exhibit at a fair held in the South, recently. In shaping the "statue," the sculptor's chisels and hammers were replaced by knives and other light pointed tools. Unlike the marble variety of such objects of art, in case a bad stroke was made, the damage could be easily repaired without

Exhibited at Southeastern Fair, Atlanta, Ga.



Figure of Dairy Cow Modeled by Sculptor from Block of Butter for Southern Exhibit

leaving any evidence of it. While the artist plied his craft, the subject was kept in a cold place so that the material would

not become soft. The interior of the case in which it was shown, also had to be kept at a low temperature during the exhibition.

INVENTOR COMBINES HAND BRUSH AND PUMICE

3925

Vigorous and often painful scrubbing of the hands with a brush of coarse bristles may be avoided by the use of a device placed on the market by a middle-western inventor, which combines the hand brush with a piece of pumice stone. The latter is inserted in the back of the brush, and provides an easy means of cleansing the skin. The combination is also offered manicurists who constantly use pumice to clean the hands of their patrons.



188 N. La Salle Chicago

STREET-CAR WIRES DISTURB

4011

TELEGRAPH CABLE Disturbances, due to the corroding effect of electricity that found its way from a near-by trolley wire, caused trouble with the submarine telegraph cable in South Africa, according to a recent report. When the recorder showed signs of disorder, the cable was examined and discovered to be corroded for a distance of a mile where it ran parallel to a street-car line, a half mile distant. To offset this a dummy cable with an earth plate was placed as nearly as possible over the old conduit. Tramways in London have seriously affected the earth's magnetic field around Greenwich, where all British compasses are corrected, and the laboratories were forced to move several miles from any electric line. In the United States a number of magnetic observatories have been disturbed by near-by trolleys.

*Com. Edwin Taruse
c/o The Harrington
Washington, D. C.*

SKULLS OF EARLY AFRICAN MEN MAY REVEAL NEW RACE

4006

Finding of two skulls in southern Africa may bring to light an unknown race of giant men that once dwelt on the southern tip of the Dark Continent. They were dug up in a cave, several feet below the remains of other primitive men of a later date, indicating to scientists that the cavern was occupied by at least two different peoples, one much lower in civilization than the other. Hitherto the earliest known inhabitants of that section were the "shore-runners." Over the near-by country, particularly along the rivers, specimens of chipped stone were discovered, but no trace of those who had worked them.

HOT-WATER HEAT FOR AUTOS PIPED FROM RADIATOR

3935

Clean, odorless heat for inclosed automobiles is provided by an easily attached valve that makes use of the hot water from the car's radiator instead of the exhaust

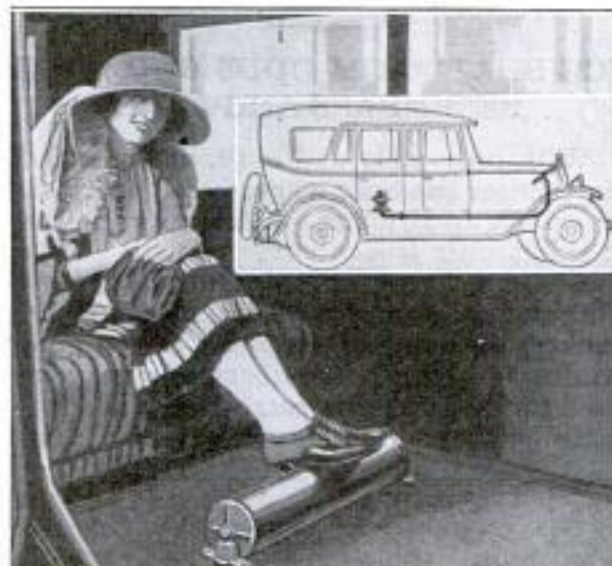

Heater that Warms Interior of Automobile with Heat from Hot Water of Radiator

gases. This not only keeps the interior of the car at an even temperature, but helps to control the heat of the motor, assuring easier starting and smoother operation. Also, it eliminates noise, carbon, and soot. It is said that the system provides heat within four minutes after the motor is started and keeps it up at any speed.

Names and addresses of manufacturers of articles described in this magazine will be furnished free by our Bureau of Information.

American Water Heater Corp 2838 W. 21 St. Chicago

HARD HAT PROTECTS WORKERS FROM HEAD INJURIES

3887

Workers, such as miners, steel erectors, and ship builders, can protect themselves from serious head injuries resulting from



Wearing Hard Hats, These Two Workmen Escaped Possible Serious Injury from Falling Objects

falling objects by wearing a hard cap now being marketed in the West. Light and comfortable, it is said to be a nonconductor of electricity, and proof against fire and water. A shipyard laborer wearing one of the guards was struck on the head by a 12½-pound piece of steel which fell six feet. He was knocked to his knees, but was uninjured. Another, provided with the cap, was struck down by the impact of a 20-ounce bolt falling 42 feet. He was not hurt, nor was the headpiece broken. For those who labor in poorly lighted places, the article is a safeguard against accidents due to contact with low ceilings and overhead projections.

COLUMN GUIDE FOR LEDGERS TO HELP BOOKKEEPERS

3904

To reduce the possibility of errors by bookkeepers, when posting entries in ledgers, a column guide has been recently patented that directs the worker's eye to the proper line for individual groups of figures. It also saves time by making repeated references to the top of the page to find the



Ledger Guide for Bookkeepers Enables Them Easily to Locate Proper Spaces for Entries

proper division unnecessary. Backed with a strip of absorbent paper it eliminates need of reaching around for a blotter when a line of ink is to be dried. The cardboard guide is protected by a transparent cover.

Louis Ogden 18 S. La Salle Chicago

ms. E. 20. Paulsard, 413 Chamber of Commerce, 1308 Broadway, Los Angeles, Calif.

3845



Completed Bust of Abraham Lincoln, and Beside It the Small Model which Guided the Sculptor

TINY MODEL GUIDES SCULPTOR IN FIFTEEN-YEAR TASK

Representing a task that will take him 15 years to complete, a model of the New York war memorial was recently made by an American sculptor, who was commissioned to do the work. Following this design, the artist will chisel the subject in stone. Some idea of the difference in size between the model and the finished monument may be gained by noting the size of the figure which was used in creating a sculptured bust of Abraham Lincoln.

STUDY SOUND BY RECORDING REVERSED SPEECH

3992

Reversing ordinary conversation may be an aid in the study of sound. In connection with this research, a device has been invented that reproduces sounds either in correct or inverted order. Impressed upon a ribbon of steel, spoken letters are repeated in their right form if the wire is run in the same direction as that in which it moved when the original record was

George Gray Barnard

Cmd. Edwin J. Janssen
c/o The Harrington, D.C.
Washington, D.C.

Belber Trunk + Bag Co, Phila. + arch St.
~~22nd St.~~

made. If it unwinds in the opposite way, the sounds are changed. In this case, although the reversed words are definite in character, they constitute a widely different language related in a simple mechanical way to the first taken down. When a sentence is uttered backward the instrument translates it.

Belber Trunk + Bag Co

TURN OF LOCK OPENS TRUNK BY PRYING SIDES APART

390 114 + 1st Market, Phila.

Just the turn of a lock opens a new wardrobe trunk by prying the sides apart. In this way, it simplifies the task of packing or unpacking, as one movement of the hand secures or unlocks the trunk at four different points. Drawers, suit hangers, shoe compartment and laundry bag are also provided.

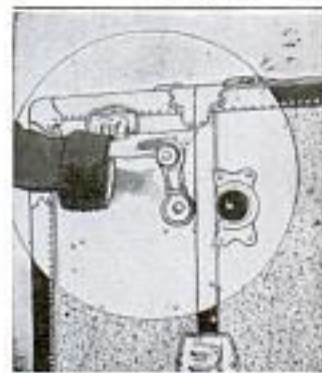

Sold by Boston Store

ICE BOAT FROM ODDS AND ENDS RESEMBLES AIRPLANE

4022

With only odds and ends, an inventive northerner has built a speedy ice boat that resembles an airplane. Although wingless, it skims over frozen surfaces with all the grace of a flying craft. The maker first obtained a discarded plane fuselage. A junked automobile supplied the engine, while a few pieces of lumber and steel were used to form the runners. A special apparatus on the tail rudder guides it, while an-



Speedy Ice Boat, without Sails, Built from Odds and Ends, Resembles Airplane

other device beneath the motor prevents it from tipping. Its cockpit seats two persons, the pilot and a passenger. A propeller replaces the usual sails.

Built by A. Gordon Unswell, Lake Geneva Wis.

These Articles Are for Everyday Use But— Can You Name Them?

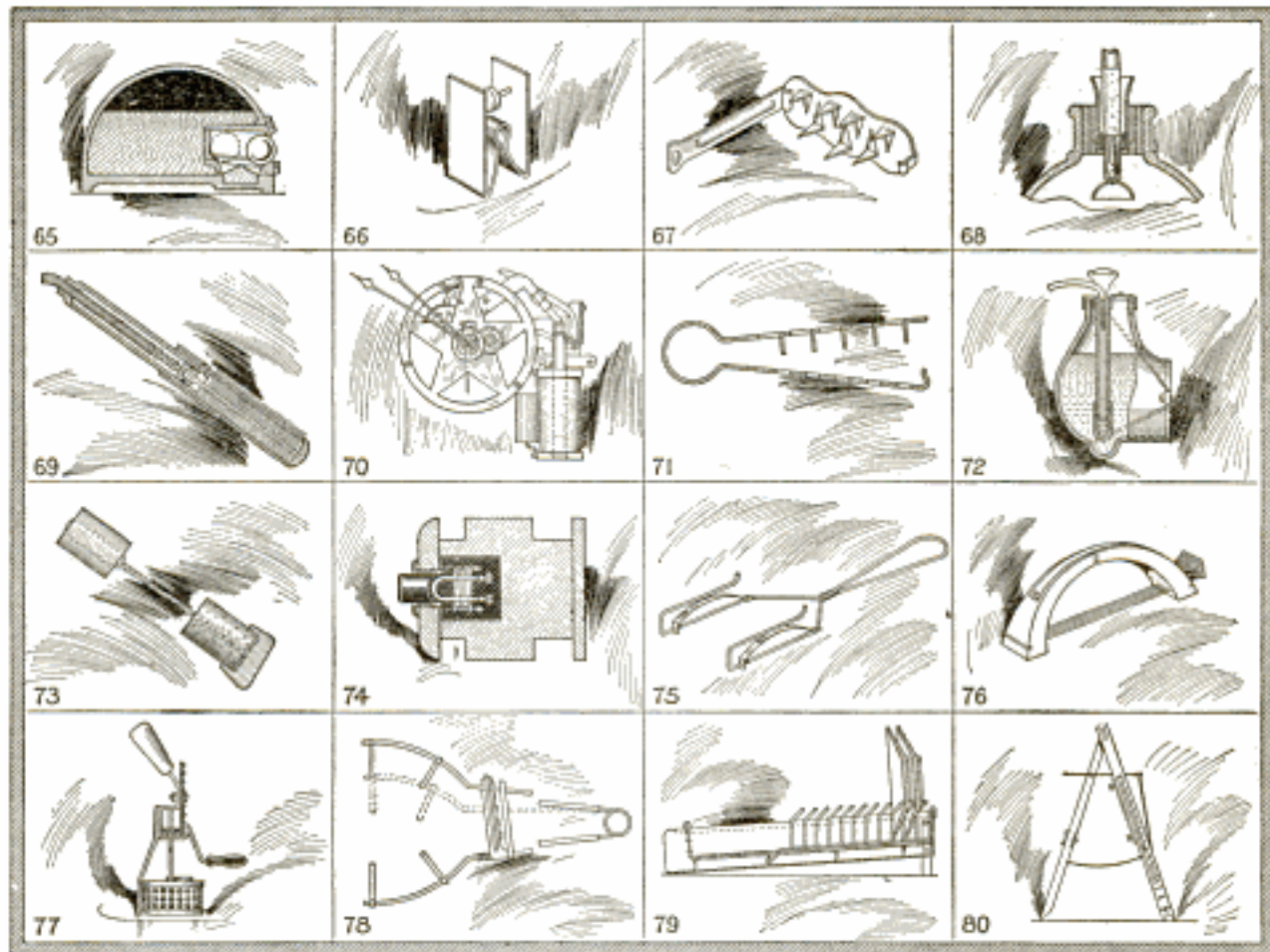

JUST to help you, the use for which the articles are intended is as follows: No. 65, in office or home. No. 66, on wearing apparel. No. 67, for women. No. 68, in office or home. No. 69, in the home. No. 70, anywhere. No. 71, on the farm. No. 72, in public places. No. 73, in the home. No. 74, in buildings. No. 75, in the home. No. 76, in the home. No. 77, in the home. No. 78, in the home. No. 79, in home or business. No. 80, in a profession.

Popular Mechanics Magazine offers no prizes for correct answers to these problems, but presents them for the interest it believes its readers will find in attempting to determine the nature of the various articles shown.

If you think you have the right answers you can find out by comparing them with the correct list which will appear in Popular Mechanics Magazine for February.

In December the following articles were shown. No. 49, toothpick to be fitted on finger. No. 50, shoe-tree. No. 51, can opener. No. 52, cigar cutter. No. 53, case for eyeglasses. No. 54, chicken roost. No. 55, branding iron and holder. No. 56, envelope flap moistener. No. 57, combination helmet and muffler. No. 58, cork puller. No. 59, ice skates "head on." No. 60, shoe scraper for doorstep. No. 61, broiler. No. 62, sanitary drinking fountain. No. 63, cigar clipper made safe for fingers. No. 64, guard for wrist-watch crystal.

LOG'S PLUNGE RIVALS GEYSERS CAST UP BY NATURE

3630
Striking a lake after traveling several hundred feet down a chute at a speed of 100 miles an hour, logs that are cut high up in the mountains of British Columbia, send up geysers that rival the tallest of nature's own spouts. Rolled upon a trough made of rough timber, which extends down steep slopes, the tree trunks gather terrific speed from their great weight. Few of them are less than four feet in diameter, and when they plunge into the pond easily displace many times their volume of water. Occasionally

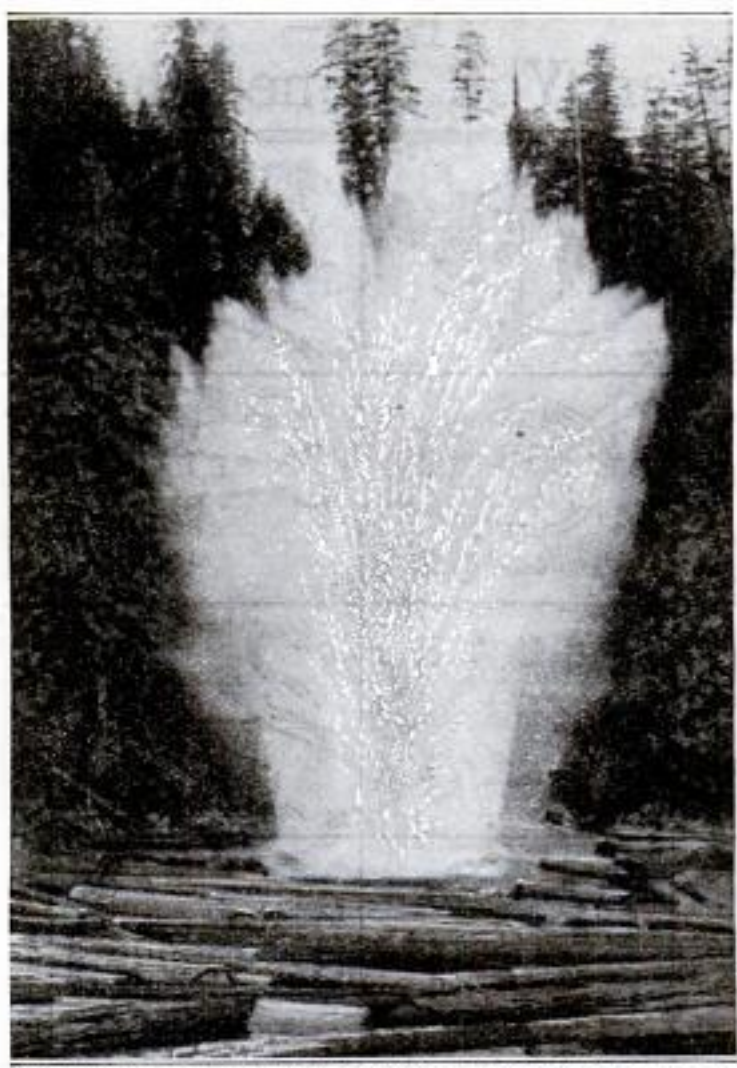

Giant Geyser Created in Lake by Impact of Big Log Shot Down Side of Mountain where Trees Are Felled

big logs "jump the track," and the momentum sends them crashing and bounding with tremendous force against the stout sides of the runway. Their speed spent, they settle alongside the incline and serve to break the fall of others which leave the course, but they are not allowed to lie for long, as they would soon pile up. Some difficulty is experienced in setting these runaways back on the grooved track, where they resume the interrupted journey downward to the log pond to await their turn at the mill.

BONES OF MEN FOUND BURIED EIGHTY THOUSAND YEARS

3746
Fossilized bones of a race of men who are believed to have lived about 80,000 years ago, and who resembled the Neanderthal type, recently were dug up in France. The relics were found in a clay bank where they evidently had been washed from a prehistoric village which was situated on the bluff above. As a result of the discovery, scientists say that more facts will be learned concerning these strange, animal-like humans, who have vanished from the earth, leaving no traces. The Neanderthal man, as pictured by authorities, was short and powerfully built, with a large head and face, deep-set eyes, low, slanting forehead, and no chin. He walked in a crouching position with knees half bent like some beasts of the prehistoric forests. His chest was triangular in shape and his hands were huge, with

short, stumpy fingers. He could not talk, but expressed himself in grunts. For weapons he carried a crude stone dagger and a club. Although stupid, he buried his dead with ceremony and practiced a form of religion.

PHOTOGRAPHS OF WIND'S PATH AID AIRMEN'S FLIGHTS

3783
To aid pilots of aerial gliders, accurate maps of air currents over rolling country are made by photographing the trail of the wind. As a result, it has been determined that the course of moving atmosphere follows the outlines of large obstacles fairly closely. Prior to the start of a contest, an airplane throwing off streams of smoke travels over the hills, moving at right angles to the breeze. These clouds, readily caught by the camera, serve as a basis for measurements which the glider pilots may use in gaining altitude.

Perfected by Major Camille Flammarion
Harvard University
meteorological office

Discovered by Prof. H. U. Hall, University of Pennsylvania

France

Perfected by Prof. *Ryoji Saeguchi* *Owned by Stark Bros*
Johns Hopkins University POPULAR MECHANICS *Golden Delicacies*
 MERCURY BURNED UNDER SEA BURGLAR-ALARM CAGE GUARDS
 FOR FLASHLIGHT PHOTOS RARE APPLE TREE

Flashlight photographs under water are now being made with the invention of a Japanese scientist. Mercury is drawn through a fine bore in a glass tube to serve as a lamp filament. When a low-voltage current is turned into it, the heat explodes the fluid almost instantly, shattering the tube and producing a brilliant burst of light of short duration. It is used to take instantaneous pictures for the study of metal vibrations and for other purposes requiring an intense ray for a brief period. The rolling of model-ship hulls is also said to be clearly shown by photographs taken with the submerged light bulbs.

Protected by a burglar-alarm cage, a rare apple tree, valued at \$5,000, stands on a mountainside in West Virginia. Surround-

WORLD'S FAIR LIBERTY BELL'S FATE SHROUDED IN MYSTERY

Efforts to find the huge bell made for the World's Fair in 1893, as a companion piece for "Old Liberty," have failed. It was sought so that it might be rung on the 30th anniversary of the exhibit, its tones to be broadcast by radio to all parts of the country. More than 250,000 persons donated money and historical relics to be melted into the piece, when it was cast.



What Was Once Known as the World's Largest Bell, the Fate of which Is Veiled in Mystery

At that time, it was declared to be the largest bell in the world. What disposition was made of it after the Fair is shrouded in mystery.

☐ We want all our readers to write us freely and often whenever they wish additional information on articles published in this magazine. Address Bureau of Information, Popular Mechanics, Chicago.

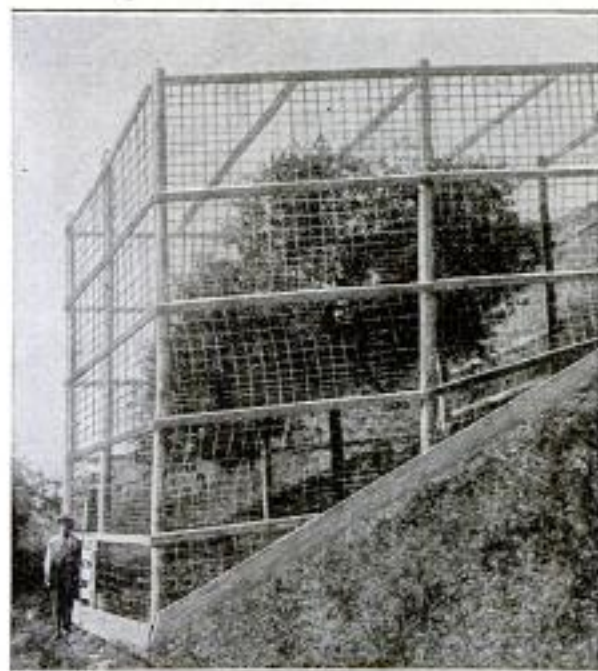

Wire Cage Fitted with Burglar Alarm that Protects Valuable Apple Tree from Men and Animals

ing all its branches, a steel-wire inclosure prevents intruders from plucking the blossoms or carrying away the fruit. Other precautions are taken to guard it against harmful insects and foraging animals. At intervals it is inspected by experts and once a year sprayed with insecticide. It is vigorous and healthy, and annually bears crops, one of which totaled 35 bushels.

BABY SULKY HAS LOCK SEAT TO HOLD OCCUPANT IN

To prevent a baby from falling out of the seat while being wheeled about, a sully is being made with a front piece that fits across the occupant's legs, securely locking him in place. Slightly flexible, curved steel supports attached to the basket partly absorb shocks, thus making riding easier. Disk wheels and other metal parts are enameled black, while the body is painted gray.



Perfection Mfg Co
 2505 N. Jefferson
 Chicago, Ill.

St. New York
Co., 50 Church St.

Cont. H. Huth 520
Taylor St.

Cont. Hjalmer
Lundquist 713

116

San Francisco Calif POPULAR MECHANICS
Los Angeles Calif

BACKYARDS OF JAPAN STUDIOS OF ART AND INDUSTRY
NINE-STORY BUILDING MOVED BY TWELVE HORSES

3579

Backyard factories in Japan, which form one of the country's greatest institutions, hum with constant activity all the year

3308

Weighing 11,000 tons, an apartment house, nine stories high, was recently moved by 12 horses. The building was carried by a framework of girders that rested on rollers placed across iron beams, which formed a track. Six vertical winches, installed at a distance, were each turned by a pair of horses, and all worked together. The runway was built so level and the motion of the load so even, that no part of the walls was disturbed.

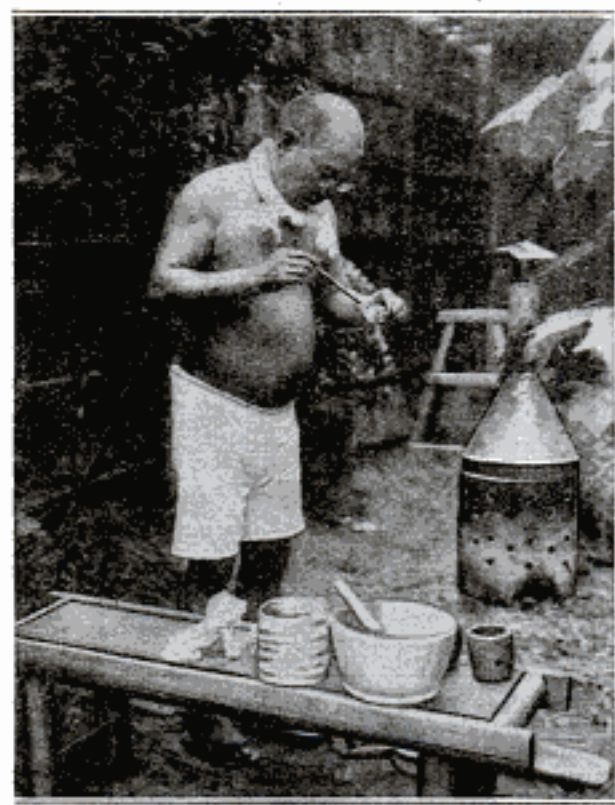

Workman in One of Japan's Many Backyard Factories Putting Finishing Touches to a Carved Figure

round. Almost every property owner who is fortunate enough to have a plot of ground at the rear of his dwelling, has turned it into a studio or a shop in which he toils patiently day after day. As a rule the factory force consists only of the proprietor and perhaps one or two assistants. Yet the products of their labors are many and varied and of excellent workmanship. Some of these craftsmen turn out miniature statues carved from ivory or bone that are realistic and lifelike, toys, novelties, bric-a-brac, and oriental games.

RADIO BRINGS COLLEGE STUDY TO STUDENTS AT HOME

Actual college study by radio has been started in Oregon by the state university. Certificates are issued to those who listen to a series of twelve lectures. Questions regarding the course are answered by mail. While lectures by professors are a popular feature of the programs of most of the large broadcasting stations, this is said to be the earliest effort to give a real course by wireless.

HEAT OF AUTO ENGINE GOVERNS GAS SUPPLY AND SAVES OIL

By automatically cutting down the supply of gasoline as the motor warms up and increasing the flow as it cools, a thermostatic control invented recently is said to make starting easier. Reduction in carbon formation and oil consumption, less battery strain and spark-plug trouble, are also said to be results of the use of this device. Full power when the engine is cold, lower speeds on high gear, and 40-per-cent saving in fuel are claimed for it. A coil of metal, which expands and contracts with heat and cold, is so placed on the manifold that, as it is affected by temperature, it turns the lever of the needle valve, regulating the flow of gasoline.

BRUSH "SCREWS" IN PAINT CAN TO CLOSE TOP

To prevent waste, paint cans are being made with tube-shaped tops into which round brushes "screw" when the articles are not in use. Others are made with rectangular openings, where brushes may be placed to close them. The painter may rest a wet brush in these troughs, where it can drip without spotting surrounding surfaces. Extending above the upper edges of the receptacle, the brush cannot



overturn. When stowed away, evaporation is reduced, as the bristles, immersed in the fluid, are pulled downward by the paint's weight until the handle fits snugly.

The Toy Paint Co.
1514 1/2 E. 1st St. - Edin Park
Chicago, Ill.
Copyrighted material

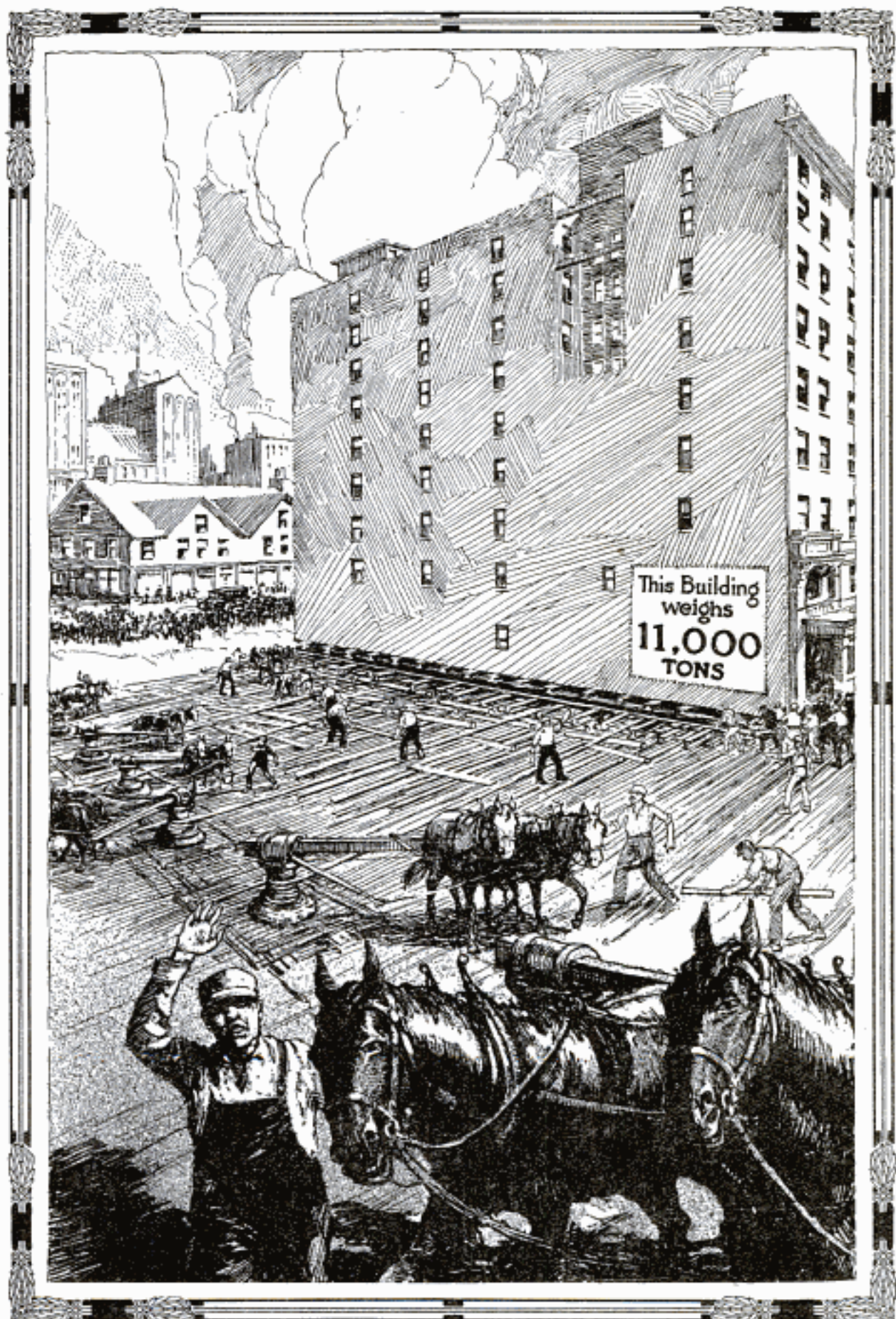

Moving Nine-Story Apartment Building with Power Furnished by Dozen Horses: The Even Motion of the Winches and Smoothness of the Track Keeps the Walls Undisturbed During the Journey

*Kress House Moving Co.,
728 Sunset Blvd. Copyrighted material
Los Angeles Calif.*

37¹¹⁸ 72

MILLIONS IN BAD MONEY DEVoured BY MACHINE

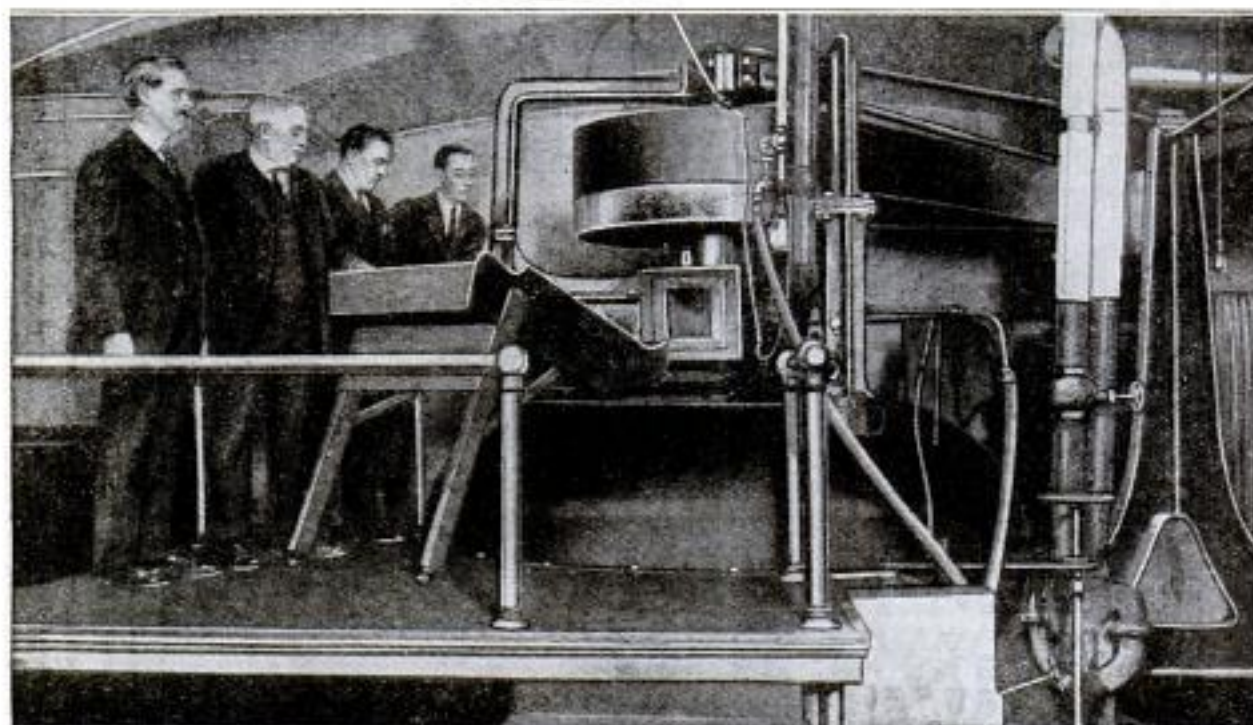

Giant Machine in United States Treasury Department, One of Ten, that "Eats" Millions of Dollars in Paper Money Which Are no Longer Fit for Circulation

Millions of dollars in redeemed paper currency, no longer fit for use, are chewed to pieces every day by 10 huge steel machines in the treasury department at Washington. About noon, these giant contrivances open wide their maws and vast fortunes in bills to be destroyed are

poured into them. This task is performed by four men, composing the destruction committee, who represent the treasurer, the secretary, and the controller of currency, each of whom holds one of the three keys necessary to open the lids of the macerators.

**FOLDING RACK FOR WASHTUBS
KEEPS THEM NEAR WRINGER**

Holding two washtubs and a clothes basket, a folding bench has been designed,

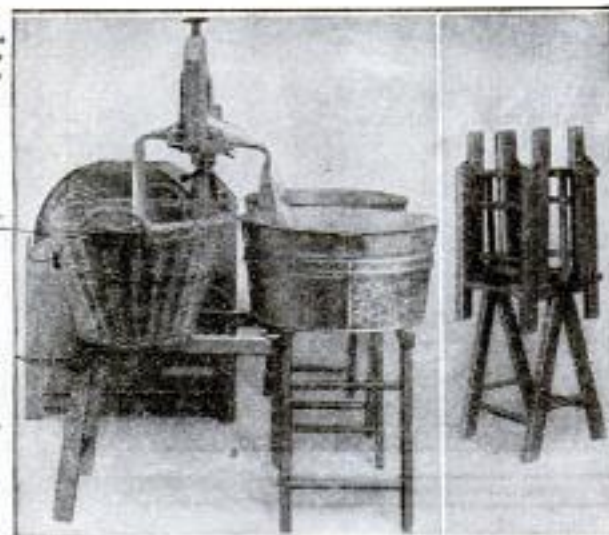

Left: Folding Washtub and Clothes-Basket Rack in Use; Right: Bench Ready for Storing

which keeps them close to the wringer. As the receptacles are supported at the proper height, the wet garments do not have to be lifted more than a few inches. The floor can also be kept dry, because the pieces, in passing through the rollers, do not drop far enough to splash the rinsing water. The stand is braced so that it will not collapse or shake while in use. When closed up, the stand can be placed out of the way in a small space.

**GEYSER OF BOILING MUD SEEN
IN ALASKAN VOLCANO**

Tons of boiling mud, hurled 200 feet into the air by a geyser rising from the bottom of the smoking, rumbling crater of an Alaskan volcano, were seen recently by a scientist, who, with a Swiss guide, descended the steep walls of the pit. Venturing within 100 feet of the curious fountain, when the vapor mists parted, the party obtained a clear view of a mud pool about 100 feet in width.

New Orleans Times-Picayune 10/9/23

*Wincedo Bench Co.,
Edinburg, d. md.*

**QUICKSILVER, ONCE ELUSIVE,
 IS "ROASTED" FROM SOIL**

Difficulties of extracting mercury from ores have been overcome in Australia, where are said to be the most important quicksilver deposits in the British Empire. For a considerable time, the discoverers of this field worked at the problems with discouraging results. When cinnabar, sulphide of mercury, was treated in the furnace, the bulk of the elusive metal passed up the flue and vanished in thin air. Recently devised appliances changed that and now the plant is capable of treating 20 tons of ore a day. Broken into small pieces, it is fed into a heater, where it is thoroughly "roasted" and the metal driven off in the form of vapor. Passing through a series of condensers, immersed in cold, running water, it finally emerges in a refined, liquid state.

**QUEER DRAWINGS GUARD BABES
 FROM EVIL SPIRITS**

True to beliefs in the power of mysterious ceremonies to overcome the wiles of evil spirits they believe to be seeking to



Copyright, Keystone View Co., Inc.
 Mother in India Painting Queer Designs on Ground to Keep Evil Spirits from Harming Her Babies

To harm little children, some mothers of India resort to strange devices to ward off the unseen demons. In one section of the country, the parent protects her babies' health by drawing strange designs on the ground around the dwelling. This is supposed to drive off any harmful influences that might attempt to cast a spell over the youngsters.

**TOY CALCULATOR HELPS STUDY
 FOR PUPILS IN FIGURES**

To arouse children's interest in arithmetic problems, and to make such studies easier, a small pocket-size calculator has been designed for teaching them to add, subtract, multiply, and divide.



Aided by this device, which is easy to operate and accurate, it is said pupils in the primary grades quickly learn the various tables. Simple examples

in mathematical subjects are speedily worked out and illustrated by the machine. It is fashioned from metal and made so that it cannot be easily damaged.

**CAN OPENER PUTS DULL EDGE
 ON TIN TO PROTECT HANDS**

Bending down the edge as it cuts, to prevent possibility of scratching the hands, a recently invented can opener makes a rounded, smooth-rimmed top. With slight pressure of the thumb, a sharp-pointed cutter pierces the tin, and then the cover



Can Opener that Protects Hands from Cuts by Putting Rounded Edge on Tin

may be removed with a forward and backward movement of the handle, which at the same time turns the jagged edge under.

**GASOLINE ENGINE IS STARTED
 BY EXPLODING CARTRIDGE**

Gasoline engines that operate the trucks of big disappearing guns of the nation's coast defenses are started by the explosion of a shotgun shell in one of the cylinders. A blow of the hand on a small knob fires the charge, which has sufficient force to "turn over" the shaft several times. Before the operator has reached the control switchboard, the engine usually has attained such speed that the dynamo it operates is able to supply sufficient current to move the cannon.

Com. Edwin Tarzese
The Harriet
Washington, D.C.

Wetmore-Lubbock
Co. 312 Montgomery
Blair, Milwaukee

Blair, Milwaukee, Ellis

H-3 H

378/

3812

3816

379

317 9 47



Steep Slopes of Formerly Barren Mountains Covered with Stone-Walled Terraces which Are Irrigated by Water Brought from Great Distances through Sluices Built by Head-Hunting Tribesmen

*Emb. Ralph Nicholas
% Editorial Research
Association, 36 W. 1214
New York*

WILD TRIBES IRRIGATE STEEP SLOPES OF BARREN HILLS

3444 3732

Rivaling irrigation works of the more modern world, wild head-hunting tribes of the Philippine Islands have converted steep, barren hillsides into fertile areas for cultivating rice. Brought in crude troughs built around rugged mountains, the water flows through a maze of terraces, confined between stone walls eight feet high. It is estimated that the total length of these barriers is more than 12,000 miles, or one-half the distance around the earth. Although the natives are little inclined to agriculture, the greater part of their farming efforts is employed in the cultivation of grains for food.

VOLCANO UNDER SEA CASTS STEAM ABOVE WATER

3808

Over a volcano, erupting far beneath the surface of the water, mariners in the South Seas recently noted a column of steam 100 feet in width and almost as high. Trailing out over the ocean for more than a mile, the vapor became dissipated, though there remained a marked disturbance and discoloration of the water in a large area. At first the sailors mistook the white clouds for the smoke of a passing vessel.

Undersea News 10/12

PAPER FOR SERVING OYSTERS HIDES SHELLS AND ICE

3758

For serving raw oysters in an attractive manner, a paper doily is being made that covers the cracked ice in which they

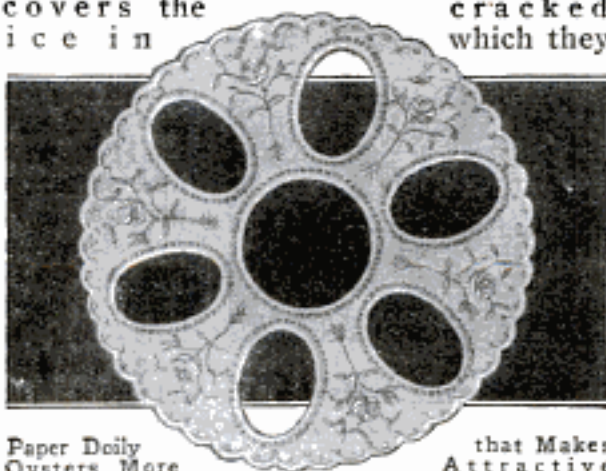

Paper Doily Oysters More

that Makes Attractive

are imbedded thus giving them a more appetizing appearance. Circular in shape, the covering is provided with openings to admit six shells, while a larger perforation in the center fits a cup for cocktail sauce. Inexpensive, this garnishment adds distinction to the service.

Marshall Field & Co. Chicago

MOVIES SHOWN IN DAYLIGHT OR ON ILLUMINED STAGE

Motion pictures can now be shown in daylight or on a lighted stage with a new type of screen that also prevents distortions.

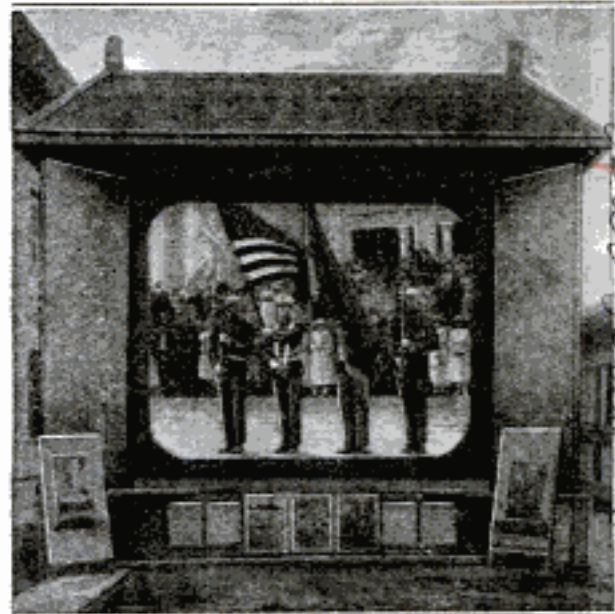

Showing Motion Pictures in Daylight on Screen that Also Prevents Distortions

Pictures appear true to form, viewed from either the front or back of the curtain, or from any angle. Instead of being located in front of the screen, as in darkened theaters, the projector is placed behind it. This arrangement, it is pointed out, is safer in case of fire, as the audience would be shut off from the flames. For homes, schools, and like places, portable outfits are being made that can be packed into a small case and carried about. One of the hardest problems in developing the material was caused by damp weather, during which the screen stretched like a piece of elastic. No loom could be found to weave the fabric without destroying its luminous qualities. One was finally devised that would turn out a piece of silk 20 feet wide without a single seam. The screen is nonflammable, waterproof, and has a fine corrugated surface which gives the picture depth and prevents glares.

DUSTLESS CHALK TO PROTECT HEALTH IN SCHOOLROOMS

To promote health and cleanliness in schoolrooms, dustless blackboard chalk is being made in the South. Ribbed, so it can be easily held, the crayon is said to leave no powder on the hands, clothing, or writing surface, thus helping to keep the air pure and rooms clean.

Hershey Bros. Atlanta, Ga.

Trans-ster daylight picture screen, dustless chalk

American Pulley Co

122

Philadelphia Pa
POPULAR MECHANICS

4200 Wisconsin Ave.

LATHE TURNS BOTH ENDS
OF SHAFT AT ONCE

For turning automobile axle shafts, cam
and drive shafts, and similar parts, both

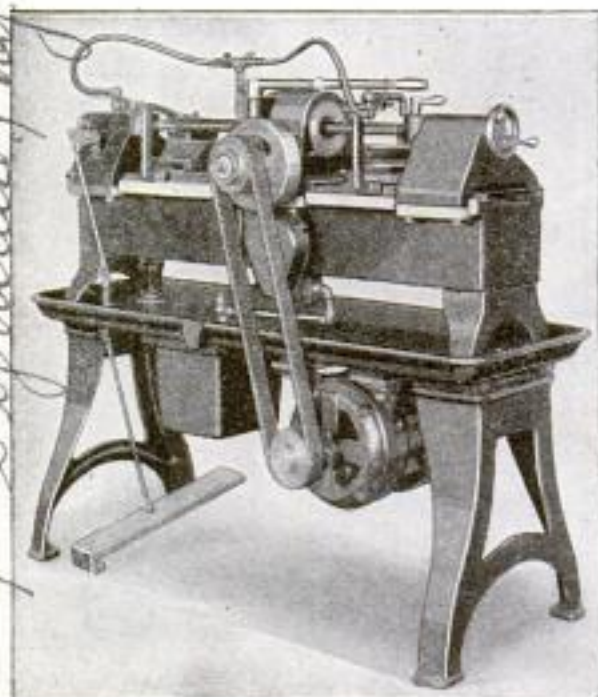

Both Ends of Automobile Axle Shafts and Similar
Parts Are Turned at Once on This Lathe

ends of which can be turned at the same
time, a special lathe has been developed.

The headstock is in the center of the
bed, and has a hardened and ground
spindle, with a 2 1/8-in. hole through it.
It is driven, through a worm drive, by a
constantly running clutch, which is ar-
ranged to stop the lathe the instant it
is thrown out.

The carriages are cam operated, and
both straight and taper work can be
turned with them. An important feature
is that the carriages are automatically re-
turned to the starting point after reach-
ing the end of the cut, thus relieving the
operator of all operations other than load-
ing, unloading, starting, and stopping the
machine. All screws are provided with
chip shields, and the sprocket and chain
drive to the headstock are adequately
covered.

**LEADIZING PROCESS PROTECTS
PIPING AND PLATES**

No practical protective coating has,
until recently, been available for piping
and steel plates subject to corrosion. The
galvanizing process is not reliable, as it
affords no protection from acid fumes,
and the coating is easily damaged, and

flakes off when the pipe or plate is struck
or bent. A new process, by which the
metal is coated with lead, offers complete
protection against acid, even at threaded
joints, where the greatest trouble was
encountered previously.

After the material has been thoroughly
freed from grease, oil, rust, and scale,
it is immersed in a bath of hot acetate of
lead, which leaves a thin, homogeneous
coating of lead on the surface. The ma-
terial is then placed in a bath of acetate
of lead and iron sulphate, and plated,
using lead anodes. The final step is to
paint the pipes or plates, and the paint
adheres firmly to the treated surface, as
it has a natural affinity for the lead
coating.

The coating is even, malleable, and is
not subject to damage from bending or
distortion. In the case of steel tanks
used for boiler-washing systems, the
plates are coated after cutting and punch-
ing, then bent to shape before erection,
and assembled with lead-treated rivets,
driven cold, the formed heads being placed
inside the tanks, and exposed to the water.

**RUGGED SHAFT HANGER MADE
OF PRESSED STEEL**

Made entirely of pressed steel, a shaft
hanger now on the market possesses ele-
ments of distinct novelty.



The hanger is
of the four-
point set-
screw type,
and "parts"
so that the
shaft or bear-
ing may be
readily re-
moved. All
bolts, nuts,
and setscrews
are of stand-
ard sizes, and
are accessible
and conven-
ient for re-
placement.

The bearing nuts on the setscrews that
support the shaft load are flush with the
inside edge of the shaft opening, thus
permitting a minimum amount of over-
hang for the setscrews themselves. The
appearance of the hanger is unusually
neat, and the frame is smooth, with
rounded surfaces that eliminate dust
pockets. The hanger is made in regular
drops—7 to 24 inches—and for all shaft
sizes up to 3 inches.

Porter-Cable Machine Co
1708 N. Sahine St
Chicago
Chicago Exchange Bldg
Chicago
National Boiler & Railway Carriage Co
Washington

"PICK-UP" STREET SWEEPER IS MOTOR DRIVEN

Although horse-drawn vehicles have largely passed into history as the chief problem of street sanitation in American cities, the civic pride of progressive communities continues to support the cost of clean streets. Dirt cannot be avoided, under present conditions, but when it is allowed to accumulate, or is only partly removed by the manual labor of "white wings," it presents an unfavorable indication of the character of city housekeeping.

Even small municipalities can afford to modernize their street-sweeping methods now that a "pick-up" motor sweeper has been developed that not only has a special gutter-broom attachment, thus dispensing with manual labor entirely, but that has a comparatively low initial cost, and is economical to maintain.

The automatic gutter broom works in and out with the curb line, without attention from the driver, and the rear broom is so designed that wear automatically shortens the distance between

^{80 m} broom and conveyor. A 150-gal. water tank is provided for the sprinkling system. Only one man is required for the operation of the machine, and all levers are so arranged that the operator

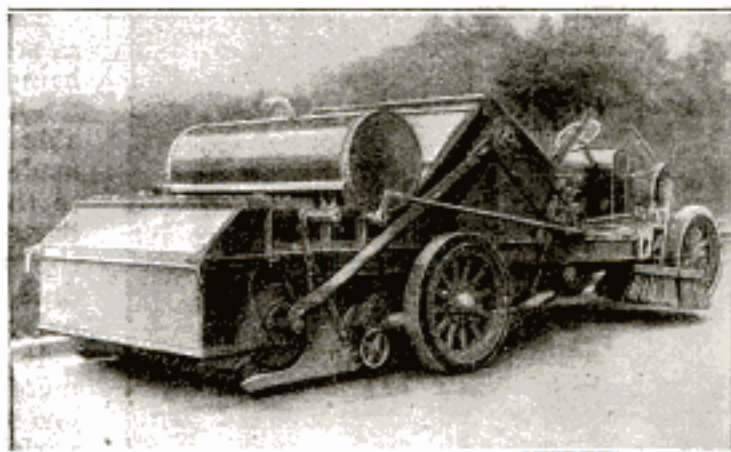

One-Man Motor Street Sweeper with Gutter Broom, that Eliminates Manual Labor Completely

has complete and convenient control without leaving his seat. The working speed of the sweeper is 9 miles per hour on average pavement.

VARIETY OF TOOLS HANDLED BY CUTTER GRINDER

^{56 m}
The increasing demand for a small universal cutter grinder capable of handling a variety of small drills, mill-

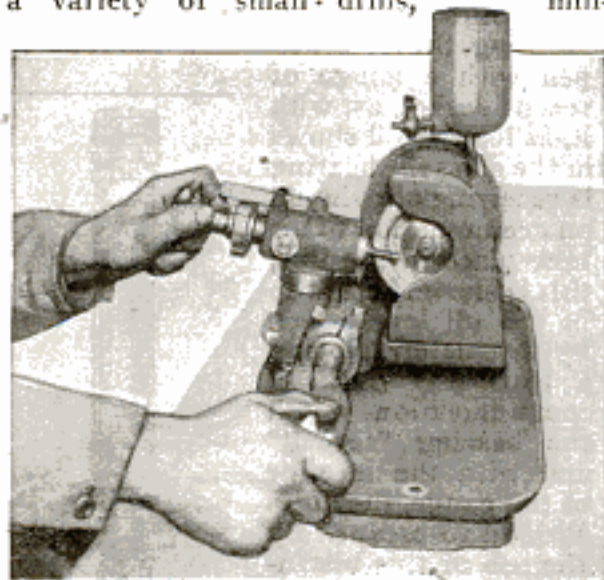

Drills, Milling Cutters, and Engravers' Tools Can Be Accurately Ground on This Bench Machine

ing cutters, and engravers' tools has resulted in the development of a tool especially adapted for this work.

With this grinder, all tools of a particular variety can be ground to a predetermined angle, even by an inexperienced man. The work produced with tools uniformly ground is much superior to that done by a "hit or miss" method, and the life of tools is correspondingly prolonged; in addition, the time lost in regrinding tools is considerably reduced, and the labor of a skilled mechanic is not required.

The new machine is a compact bench tool, simple and rigid in construction. It has a universal head that makes it adaptable for the grinding of many types of cutters, with all kinds of angles and reliefs, while a smooth-running, specially designed motor furnishes a high speed for the wheels. An auxiliary wheel is furnished, which permits free hand grinding when desired, thus giving greater flexibility to the machine. Both wheels are completely guarded, and the guards are designed so that the wheels may easily be removed from the spindle. The capacity of the cutter spindle is from $\frac{1}{8}$ to $\frac{1}{2}$ inch, and an index plate is furnished to provide for the grinding of various cutters having flutes up to $1\frac{1}{4}$ inches in length.

Read-Prentice Co.
667 Cambridge St.

Worcester, Mass.

Sawyer Specialty
 124 *Scales Co.* POPULAR
Jacksonville
 CULTIVATING AND SPRAYING
 86 *m* CROPS AT SAME TIME

McCadden Machine
 Works, St. Cloud,
 MECHANICS
minn

Designed to be attached quickly to either riding or walking cultivators, a new

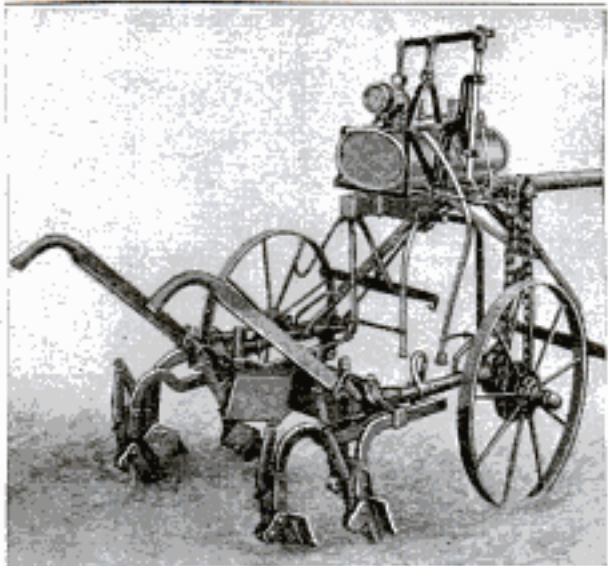

Light and Compact Spraying Outfit Mounted on Cultivator

spraying unit has been very successful in combating the boll weevil in the South.

The spraying is done at the best time—while the crop is being cultivated—without any additional labor expense. The machine is completely automatic, a regular valve controlling the pressure on the spray nozzles, and keeping it uniform regardless of variations in the speed of the pump, which is driven by sprockets and chain.

RING-OILED GLAND FEATURE OF COOLING-FLUID PUMP

Difficulties encountered in the use of pumps for cutting lubricants, due to the abrasives present, are eliminated by a new design of motor-driven centrifugal pump. There is only one working part, the impeller, and the shaft is fitted with a ring-oiled packing gland, which keeps the bearings from coming in contact with the liquid being pumped and provides a positive supply of oil. A priming chamber enables it to work within its suction capacity above the level of supply, without the use of check or foot valves, which are not reliable for this service. The unit has sufficient capacity to supply a group of machines from a central point, and is

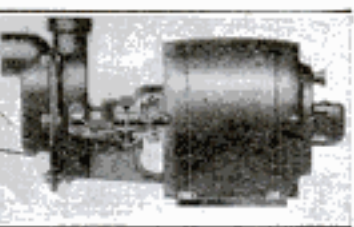

very compact. It may be used for either floor or wall mounting, and may be located in isolated places, where little or no attention will be given it over long periods.

69 *m*
FLUID HARDENS CAST IRON

That it will harden cast iron as easily as steel is the claim made for a fluid now being marketed by a western concern.

The fluid is mixed, for use, with a suitable quenching oil. If the iron is to be made medium-hard, the mixture is made in the ratio of 1 part of the fluid to 100 parts of oil, and for extreme hardness the ratio is 50 to 75 parts oil to 1 part fluid. The metal is heated to a red heat, below scaling point, and quenched.

It is stated that the temperature of the metal and the strength of the solution govern the hardness of the metal, so that various degrees of hardness can be obtained. The metal may be annealed and returned to its original degree of hardness by reheating and allowing it to cool slowly in air. It is said that castings treated with the fluid will measure 450 on the Brinell scale, and resemble high-carbon steel in general properties.

53 *m*
TURBINE OIL-PRESSURE GAUGE DETECTS AIR

Ordinary pressure gauges, being generally placed at the highest point of the turbine oil-discharge line, may register a pressure of air when no oil is actually reaching the bearing. This cannot happen with a gauge of recent design, as, with it, as long as oil shows in the glass the bearing is receiving oil; should an accumulation of air take place in the line, this is shown by a drop in the oil level, then, by alternately placing a three-way cock in communication with the bearing "saveall" and with the interior of the gauge, the air is allowed to escape. By the use of this instrument the usual test cock on the oil line is eliminated. Having no moving parts, it is unaffected by vibration, and may be mounted directly on the bearing covers.



Victoria S. Scotland
Glasgow, Scotland

Arrow Pump Co.
534
Brush Bldg. Detroit Mich.

C. & A. Stewart
Port Eglinta Brass
Foundry, Falkland S.



All Shop Notes published in 1922, in book form—Fifty Cents—from our Book Department.

Driving the Farm Pump Electrically

By J. R. KOONTZ

IN these days of private electric-light plants on the farm, and with the extension of city light and power lines far out into the country, the thoughts of the farm dweller naturally turn to the utilization of the current in as many practical ways as possible.

One of the best uses to which it can be

trying to do the job by electricity. The fact that a $\frac{1}{4}$ -hp. motor is plugging merrily away every day on my farm, pumping water from a 180-ft. well for nearly 150 head of horses, cattle, and hogs proves that a large, expensive motor is not by any means necessary.

An ordinary pump jack such as used

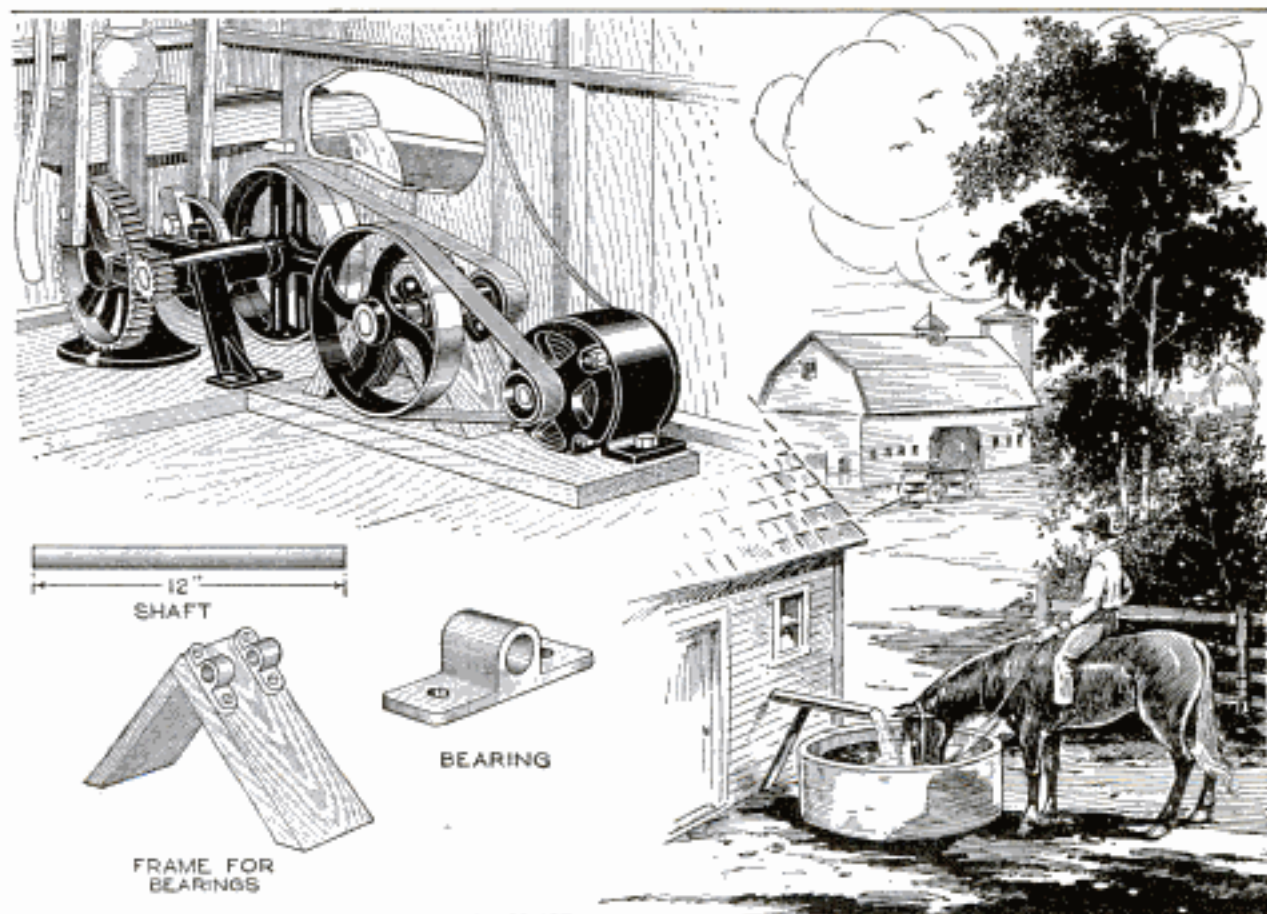

Adapting the Farm Pump to Electric-Motor Drive Is a Simple Job, but One that Will More than Pay, in Comfort and Convenience, for the Time Spent on It

adapted is that of pumping the daily supply of water. The price of a good motor is considerably less than that of a gas engine, and the motor is much easier to handle. It is generally thought that a motor of at least 1 hp. is necessary to drive the pump, and this deters many farmers from

with a gas engine, is used; if there is one already on the pump, so much the better. To reduce the speed of the motor to the correct speed for the pump, it is necessary to provide a secondary jack, or countershaft, and this can readily be made from material found around the farm, or at any

junk dealer's. Two pulleys will be needed, one 12 in., the other 4 in. in diameter, by 3 in. face; also a piece of 1-in. shafting, 12 in. long, and two bearings or pillow blocks to fit the shaft.

Two pieces of 2 by 8-in. plank, one 10 in. long, the other 12 in., are spiked together to form an inverted vee, as shown in the details, and the V-frame bolted to another piece of 2 by 8-in. plank, long enough to carry the motor also. Bolt the bearings in place as shown, taking care to shim them so that the shaft will run freely, then attach the pulleys.

Bolt the motor to the end of the plank, with its 1½-in. pulley alined with the 12-

in. pulley on the V-frame, then fasten the plank so that the 4-in. pulley will aline with the 12-in. pulley on the regular jack. It is best to cut slots in the plank for the motor and V-frame bolts, so that the belts can be tightened easily. Cut and splice the belts in place, and connect the motor to the switch, and the job is complete. The pulley sizes given here are correct for a motor speed of 1,750 r.p.m., with a 1½-in. pulley on the motor, and a 12-in. pulley on the pump jack.

The running expenses for this outfit have been only 27 cents per month during the hottest months of the year, when the most water is consumed.

A Work-Chute Distributor

The drawing illustrates a very simple distributing device, used in connection with a chute that delivers the work from

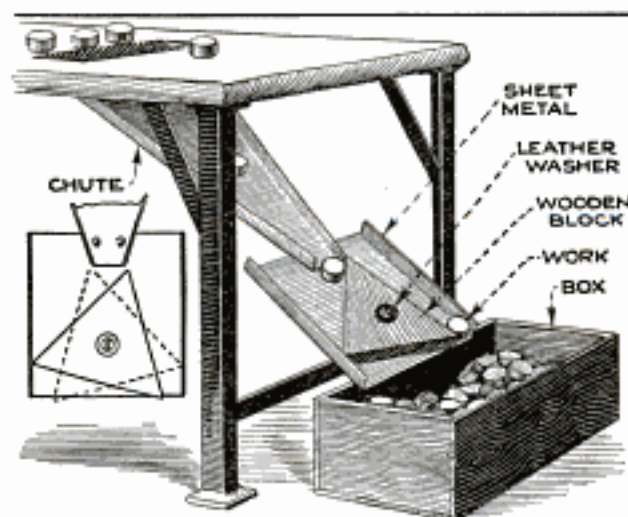

Distributing Work from Machine So that Box Is Evenly Filled

an automatic cutting machine into a box beneath. Before this attachment was used, considerable trouble was experienced, as the pieces always dropped in the same place and formed a pile, which "overflowed" before the box was actually full. The attachment consists of a square piece of sheet iron, with the outside edges turned up, riveted to the chute. Loosely attached to this by means of a nut and screw and two leather washers is a triangular piece of wood. The device works as follows: As one piece drops down the chute it slides down one side of the triangular block, and, in passing between this and the turned-up edge of the metal to which it is attached, forces the block over so that the next piece drops down the opposite side. The process is thus repeated

until the box is filled, which is done evenly without any attention from the operator.—Harry Moore, Montreal, Can.

Transferring Hole Centers

The usual practice, when transferring the centers of large holes, is to scribe around the diameter and afterwards mark off the center of the scribed circle. The work is simplified considerably with the use of the tool shown in the drawing, which is made especially for this kind of work. A piece of good, straight tubing is drilled through for a scriber or pointer, and a short piece of round bar is also drilled the same size. This part is also drilled and tapped at one end, to take a knurled tightening screw, which extends up to the hole drilled through it.

When finished, the parts are assembled as shown, with a light coil spring over the scriber. To transfer the center of a hole already drilled to another piece to be drilled the same size, the body of the tool is placed on top of the hole, and the scriber pushed down to touch the face of the second piece. Then with the knurled screw tightened, the tube is pressed down snugly and rocked back and forth once or twice, the same procedure being carried out after the tool has

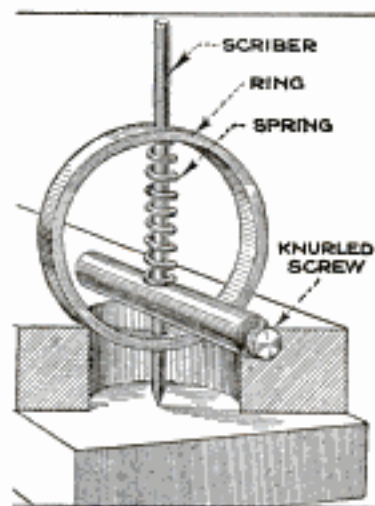

been turned to a position at about right angles to the first. The result is a cross marked in the exact center of the hole. No accuracy is required when setting the scriber to depth; it must, of course, touch the face of the second piece, but if set a little heavy it will lift on the high spot as the tool is rocked.

Unscrewing Separable Plugs

The usual method of unscrewing separable plugs for cleaning, putting in new gaskets, or replacing porcelains, is to hold the body of the plug in one hand by means of a wrench, while the packing nut is unscrewed with another wrench, or a pair of pliers. A much handier method is shown in the drawing.

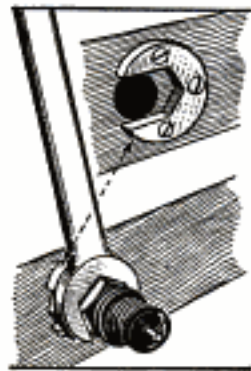

A hole is bored in the edge of the bench, large enough to receive the porcelain head, and over this hole is screwed a metal plate, shaped like the head of a wrench, and with an opening that fits the packing nut. It is but the work of a moment to slip the plug between the jaws, and to loosen the body with a wrench.

Holder for Inside Micrometer

When using an inside micrometer, it must be moved vertically and horizontally, and considerable adjustment is necessary to obtain an accurate measurement. The work can be greatly facilitated by using the attachment shown in the illustration, which makes it possible to set the tool across the center of the bore at once. The attachment is a circular disk of brass, or steel, with a boss which is drilled to a good sliding fit on the thimble of the micrometer, so that it can be slipped on and off easily. The diameter of the disk is about $2\frac{1}{2}$ in. when used for bores having a diameter of 5 in. or more. For smaller bores, the diameter should be about $2\frac{1}{2}$ inches.

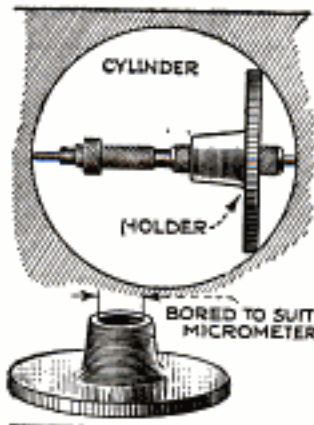

Lowering Storage Tanks

While various methods are employed for installing underground storage tanks, the method shown in the drawing has been

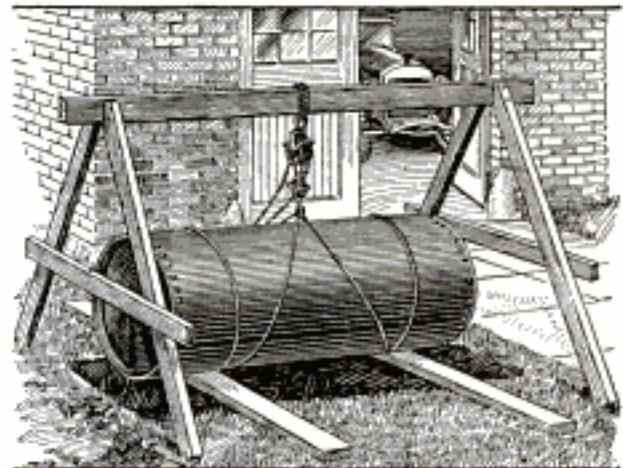

A Simple and Convenient Method of Lowering Large Metal Storage Tanks into Pits Dug for Them

found highly satisfactory, as it is only necessary to dig a pit that is just large enough to receive the tank, and because the tank can easily be turned around so as to bring the openings to their proper positions. Planks are placed over the pit and the tank is rolled on these until it is directly over the pit and in position to be lowered. The chain or rope slings are then put in place and the tank is raised a little with the block and tackle, which is lashed to the simple wooden frame shown in the illustration. The boards are then removed from under the tank and it is lowered into place. This method makes it unnecessary to dig an incline on one side of the pit to slide the tank down on skids.

Improvised Polishing Wheel

A simple and effective polishing wheel can be made by mounting a wooden disk on the shaft of a small motor, or on the screw chuck of a lathe, and covering the circumference of the disk with ordinary friction tape, which is then sprinkled with carborundum powder of suitable fineness. The disk must be turned down to a true edge and the tape must be wound in the direction that the wheel revolves, otherwise it will unwind in use. The carborundum powder should be well rubbed and patted into the tape, and, as it is quite easily torn from the tape by polishing, it must be renewed frequently. For the finest grades of powder it is well to rub the surface of the tape with tallow, before applying the powder.

Casters Facilitate Tinsmith's Work

Ordinary furniture casters, set in holes in the workbench, as shown, have been found to facilitate the handling of milk

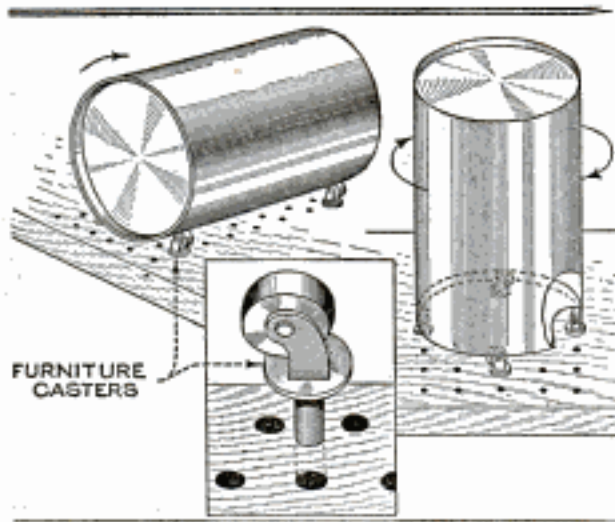

Furniture Casters, Set in Holes on the Workbench, Facilitate the Handling of Cylindrical Containers

cans and other cylindrical work, while soldering or repairing. A number of holes, large enough to receive the shanks of the casters, are drilled in the benchtop, and four casters inserted at points most convenient for the work, whether in horizontal or in vertical position. The time-saving features of this idea will be understood instantly by anyone who has done much repairing on such work.

Lubricating Lathe Centers

While running work at high speed in the lathe, the centers are apt to run dry, and if this is not detected in time, to burn out. With the device illustrated, there is always a small supply of oil at the center, and when necessary, the oil can be forced out quickly.

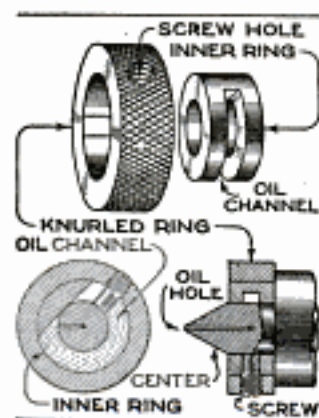

leaving a solid segment on one side, as shown. Another and larger ring is made,

First, a small hole is drilled down along the axis of the center, and another is drilled through the side to break into this. A ring of cold-rolled steel is made, the hole being a snug fit on the straight part of the center. This piece is then slotted in the center,

the hole of which is a nice working fit on the outside diameter of the inner ring. The outside ring is knurled, and tapped for a special screw; the latter has a plain part extending into the slot in the inner ring, in which it is a good sliding fit.

The device fits on the center in the position shown. To fill with oil, remove the screw, and pour the lubricant through the hole. The oil is held in the slot in the inner ring, which forms a reservoir. Replace the screw and tighten until it touches the center. It will be seen that the screw holds the two rings together, and that, when the outer ring is turned to the right, the oil in the slot or reservoir will be forced out by the plain part of the screw through the small holes to the center of the work.

Wedge Jack for Planer

The small wedge jack shown in the drawing is for use on the planer, under castings where there is not enough space

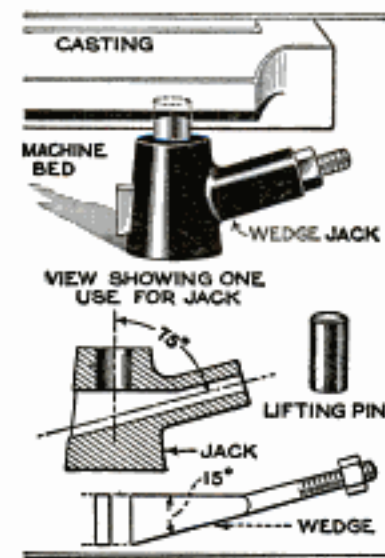

to use a screw jack. The jack consists of four pieces; the jack body, a lifting pin, and a wedge, with a nut on the threaded end. The jack is a steel casting of the shape shown; the holes are drilled at a 75° angle, and the upper surface of the wedge hole is slotted as shown, so

that the two sides are at an angle of 15°, the surface of the wedge being machined to suit. In use, the wedge is inserted in the jack, the nut screwed on the threaded end, and the lifting pin put in place. By turning the nut, the horizontal surface of the wedge is lowered or raised, and this, of course, lowers or raises the lifting pin. The shanks of the jack and wedge can be made as long as necessary so that they will clear the work.

Do not use paint containing compounds of lead about stables or outbuildings where the fumes of decaying organic matter arise, as these gases are likely to darken the color of lead paints.

Cocoa Mats for Workers

There are numerous places where it is not desirable to use wooden gratings or slat flooring for protecting the workers' feet from hard concrete floors. Under such conditions it will be found that ordinary cocoa matting will afford a cheap and durable protection.

Wheelbarrow for Soft Soil

An ordinary wheelbarrow has little value on soft or sandy soil, as the wheel sinks into the ground, and it becomes almost impossible to push the barrow ahead. However, a wheelbarrow of the kind shown in the photo, will easily carry a heavy load over soft ground. It does not resemble an ordinary wheelbarrow, but has a drum about 1 ft. long and the same in diameter, substituted for the



A Wheelbarrow Equipped with a Drum Instead of a Wheel Is Convenient to Handle on Soft Ground

wheel. The drum is made by cutting two circular pieces of wood about 10 in. in diameter, from 1-in. boards, to form the ends. These ends are reinforced with cleats of 1 by 4-in. material, nailed or screwed across the grain of the disks. Strips of wood, 1 ft. long and 1 in. square, are nailed to the edges all around the disks, to form the drum. A 1 $\frac{1}{4}$ -in. hole is drilled through the ends in the exact center, and a 1 $\frac{1}{4}$ -in. pipe pushed through, to serve as an axle or shaft. It is securely fastened to the ends of the drum by drilling a small hole through the pipe, on each side of the drum, driving a small rod through each hole, and then fastening the rod to the drum with staples. The load is carried on a frame made of any material convenient, mounted above the drum, and pivoted on the axle shaft, as shown in the photo.—W. W. Fairbanks, Fort Bragg, Calif.

Power Hacksaw Made from Auto Engine

The photo shows an efficient power hacksaw made from an old automobile engine. The cylinder block of the engine,

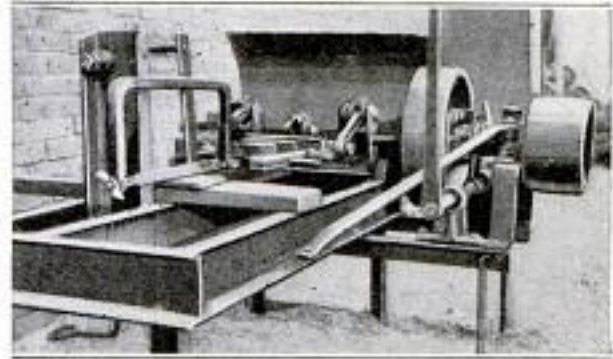

An Efficient Power Hacksaw, Made from an Old Automobile Engine Mounted on a Steel Frame

with the crankshaft in place, was turned upside down, and set at one end of a channel-steel frame. The block was then cut so that the connecting rods of the first and last cylinders could be swung outward on one side. To the ends of these connecting rods is attached a frame that holds the sawblade frame, which is made from a steel bar, bent to the shape shown. The regular flywheel and clutch are left in place and a pulley is fitted on the end of the crankshaft so that a belt can be used to run the saw.

Making a Leather Pulley

A homemade leather pulley that was used on an electric motor is shown in the illustration. It was made from a number of leather disks, two steel collars, and a steel bushing. The leather disks were cut from old belting, to a diameter larger than the finished size of the pulley, and were glued together. A hole was drilled through the center so that they would fit snugly on the bushing, which was cut from steel tubing and threaded on both ends; the collars were drilled and tapped to fit the bushing. When the collars had been drawn up so as to clamp the leather disks as tightly as possible, the pulley was put in the lathe and crowned.—R. M. Thomas, Denver, Colorado.



Built-Up Pipe Vise

The drawing shows a built-up steel pipe vise that is much stronger than the usual cast or malleable-iron pipe vise. The jaws used are taken from an ordi-

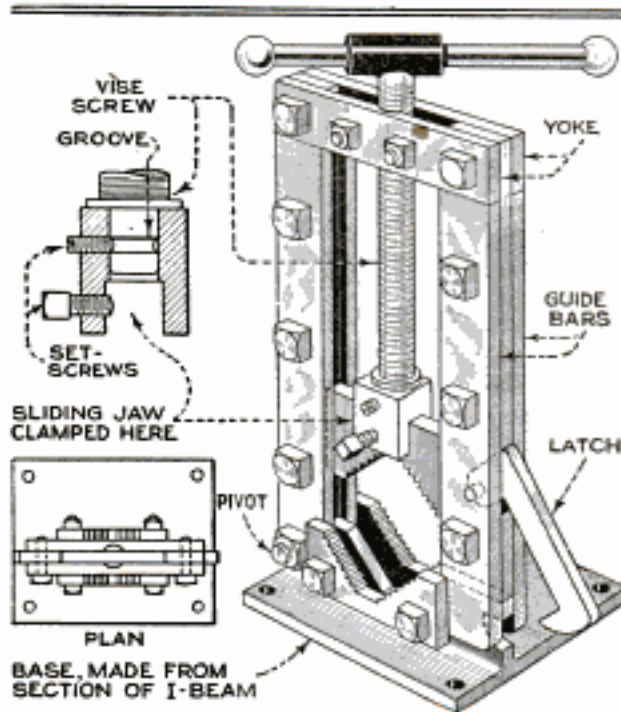

A Homemade Pipe Vise, Made from a Section of I-Beam and a Number of Short Steel Bars

nary vise, or they can be sawed and filed from tool steel, and then hardened and tempered. Owing to the various sizes and shapes of these jaws, and the different methods of holding them, no dimensions have been given, but with a set on hand the vise can be built up around them, changing the design to suit.

All parts of the vise are made of stock sizes of structural and machine steel. The base is part of a short section of I-beam, the fixed jaws being bolted to each side of the central web as shown, using shims if necessary, to set them out far enough. The frame consists of two central bars, joined at the top by a yoke, riveted or bolted on. The central bars must be of the same thickness as the web on the base. Two sets of guide bars, which may be of thinner stock than the yoke, are bolted to the sides of the center bars to guide the movable jaw. One center bar is cut and filed to take a latch, which pivots on a pin driven through the side of the bars. The opposite set of guide bars is drilled for a pivot bolt and the end of the web is rounded off to permit the frame to swing open when inserting the pipe.

It is best to fill up the center of the yoke with a steel filler, riveted in place securely. The yoke is then drilled and tapped for the vise screw, which is made of a machine bolt $\frac{3}{4}$ in. in diameter, and threaded up to the head. A hole is drilled through the square head to accommodate a steel tightening bar or handle. A rectangular groove is drilled and filed in the end of a piece of square or round machine steel to take the sliding jaw, which is held securely by a setscrew. If the jaw has bolt holes in it, a long yoke of different pattern will have to be made. The easiest method of attaching the vise screw to the movable-jaw yoke is to turn down the end to fit into a hole drilled in the yoke. A hole is drilled through the side of the yoke and partly into the end of the vise screw, then the screw is removed and a groove turned in it where it is spotted by the drill. The hole is tapped and a setscrew fitted; this will prevent the vise screw from coming out as the jaw is raised. When turning the end of the vise screw a flange is formed, which must take the pressure when the movable jaw is turned down, and for this reason it should be as wide as possible. The stationary jaws are bolted in place and the center part of the web is cut down to conform to them in shape. A notch is also cut in the edge of the web to take the latch.

Corn-Shock Tightener

The illustration shows a quick-acting corn-shock tightener that has been found very convenient. It is made from a length of rope, long enough to go around the shocks, and a piece of wood 1 by 2 by 10

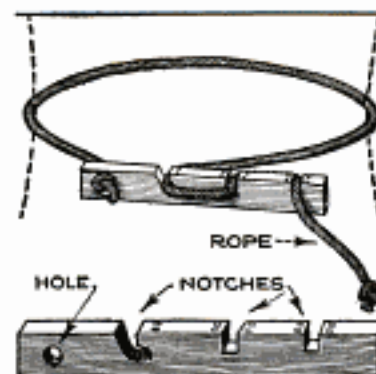

in. in dimensions. A hole is drilled near one end, and notches are cut at the points indicated, all being large enough to admit the rope. Small nails are then driven into the wood, to prevent it from splitting between the notches, and the rope is knotted at one end and passed through the hole. The method of bringing the rope around the shock and tightening it in the grooves is clearly shown in the upper illustration.—
A. L. Gillis, Mount Pleasant, Ia.

Repairing Auto Clutch Shaft

A certain type of automobile has two $\frac{5}{8}$ -in. fine-thread screws fastening the yoke end of the clutch shaft to the clutch, as shown in the illustration, at the upper left. These screws often become loose, and are then likely to strip, making it impossible to release the clutch.

This happened on my own car, and to make a quick, but permanent repair, the job was done in the following manner: The clutch and its shaft were taken out of the car, and after the two screws were removed, the screw holes were reamed out to exactly $\frac{5}{8}$ in. in diameter. This removed all the threads and left the surfaces of the holes perfectly smooth. Long capscrews were then obtained, and the threaded ends were cut off, leaving plain studs, about $1\frac{1}{2}$ in. long. With the yoke and studs in place, holes were drilled, as indicated, for $\frac{9}{32}$ -in. tool-steel pins; these were a tight fit, and kept in place with a piece of soft wire, passed through small holes in the ends and then brought around the clutch hub and twisted, as shown.

This repair was found to be just as strong as the screw arrangement, and there was much less danger of its com-

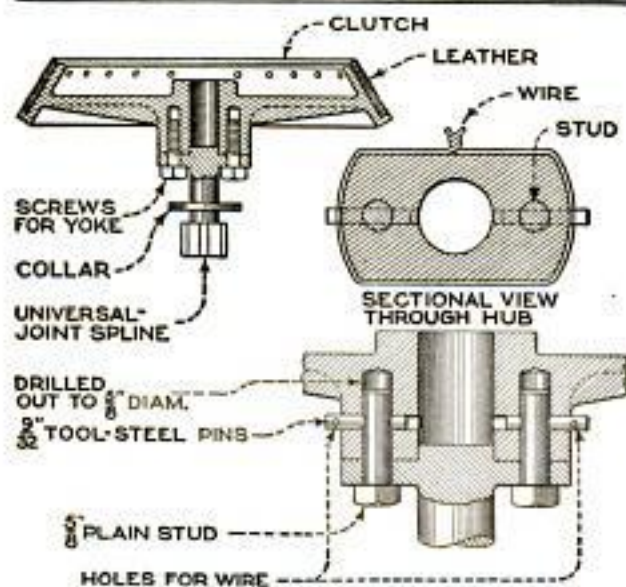

Quick Repair on an Auto Clutch: The Screws Are Removed and Plain Studs Substituted for Them

ing loose than before. Furthermore, it was easy to dismantle the clutch when necessary.—J. V. Romig, Allentown, Pa.

☞ A test-tube brush, obtainable at any wholesale druggist's or laboratory-supply house, has been found to be very satisfactory for cleaning chips and dirt from the hollow spindle of a small lathe.

Circle-Marking Tool

The tool shown in the drawing and photograph was made for the purpose of scribing true lines around light rods, the

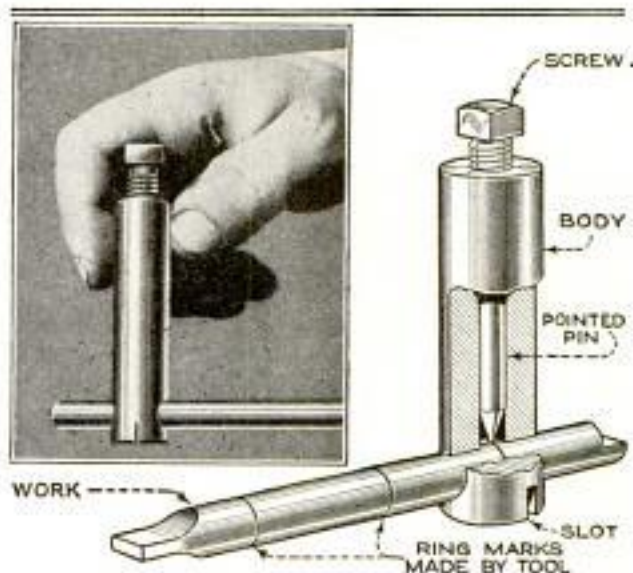

An Easily Made Tool for Scribing Circles on Light Rods Accurately and Quickly

lines being afterward used to locate the position of holes drilled partly through the rods. The body of the tool is round cold-rolled steel. A hole is drilled lengthwise in the center to take a pointed pin and the hole is tapped at the end for a screw. Another hole, the approximate size of the rods, is drilled at right angles to the first at one end, and a slot is cut in the end at right angles to the hole for the rods. In using the tool the position of the circle on the work is first determined and after marking this with a fine punch the tool is slipped on and located in line with this mark by bringing the mark in the center of the slot. The screw is then turned in until the hardened point of the pin touches the rod, when, by revolving the tool, a true line is marked around the rod.

A Simple Spirit Lamp

A new oil can with a wick of cotton string makes an excellent spirit lamp. For applying intense heat at a small joint it is only necessary to press the bottom of the can; the pressure will then force out a hot flame, making the lamp act as a blow-torch. On small work the lamp may be used sideways or at an angle, which is not possible with the ordinary kind of spirit lamp. For soldering small wires in radio work, or for light brazing, this lamp has few equals.



A VERTICAL - SPINDLE BENCH SANDER

By
J. V. Romig



A VERY handy and profitable type of bench machine for the small wood-working shop is the vertical-spindle sander. This type of sander is particularly useful in the finishing of internal surfaces, and irregular shapes on patterns, either wood or metal, coreboxes, circular work, etc., being worked in far less time than they can be finished by hand.

On pattern work, the necessary draught is obtained by tilting the table to the required angle, and this eliminates the trouble due to "back draught," so often found on hand-finished patterns.

The sander described in this article is easily built, and will give years of efficient service. It is practically fool and accident proof, as the driving belt runs in the hollow sub-base which guards the operator in case of belt breakage.

The base of the machine is an extra-heavy 2-in. pipe flange, which is used just as purchased, without any further machining. The standard is a 6-in. length of 2-in. extra-heavy pipe, machined for the bearings and threaded as shown in the detail drawing. The lower thread is cut standard length, and screwed into the flange; the upper thread is $1\frac{3}{4}$ in. long, and is screwed into the tapped hole in the table support. The inside of the pipe is bored 2 in. deep at each end, for the oilless spindle bushings. These bushings are made of wood, impregnated with oil; they take on a high internal polish with wear, and provide enough oil for the spindle so that lubrication after installation is un-

necessary. They should be a good press fit in the standard.

The table support may be a casting, machined out of a block of machine steel, or built up, by welding, out of steel plate. The top is drilled and tapped to fit the standard, and the sides drilled and tapped for the $\frac{3}{8}$ -in. studs that clamp the table.

The table may also be a casting, or built up from plate; the semicircular slots in the sides should have as their center the

point shown in the drawing, on the table top, so that the table may swing on the four studs accurately, with the spindle as a center. The top of the table is ground and polished to a perfectly flat surface, the smoother the better. Two lines should be deeply scribed on the surface of the table, one parallel to the axis, the other at right angles to it, to assist in placing and moving the work.



Finishing Irregular Work on the Home-made Vertical-Spindle Sanding Machine

The spindle of the machine is made of a good grade of steel, to the dimensions shown in the drawing. The top is threaded to take the roll-tightening nut, and the bottom is faced perfectly square, and polished. A collar is made to be pressed down over the $\frac{3}{4}$ -in. diameter of the spindle, and to the bottom of this collar is screwed a sheet-metal dust cap, shaped like an inverted dish, which keeps the dust out of the bearing. The collar and cap seat on the shoulder of the spindle.

The spindle is supported by a thrust

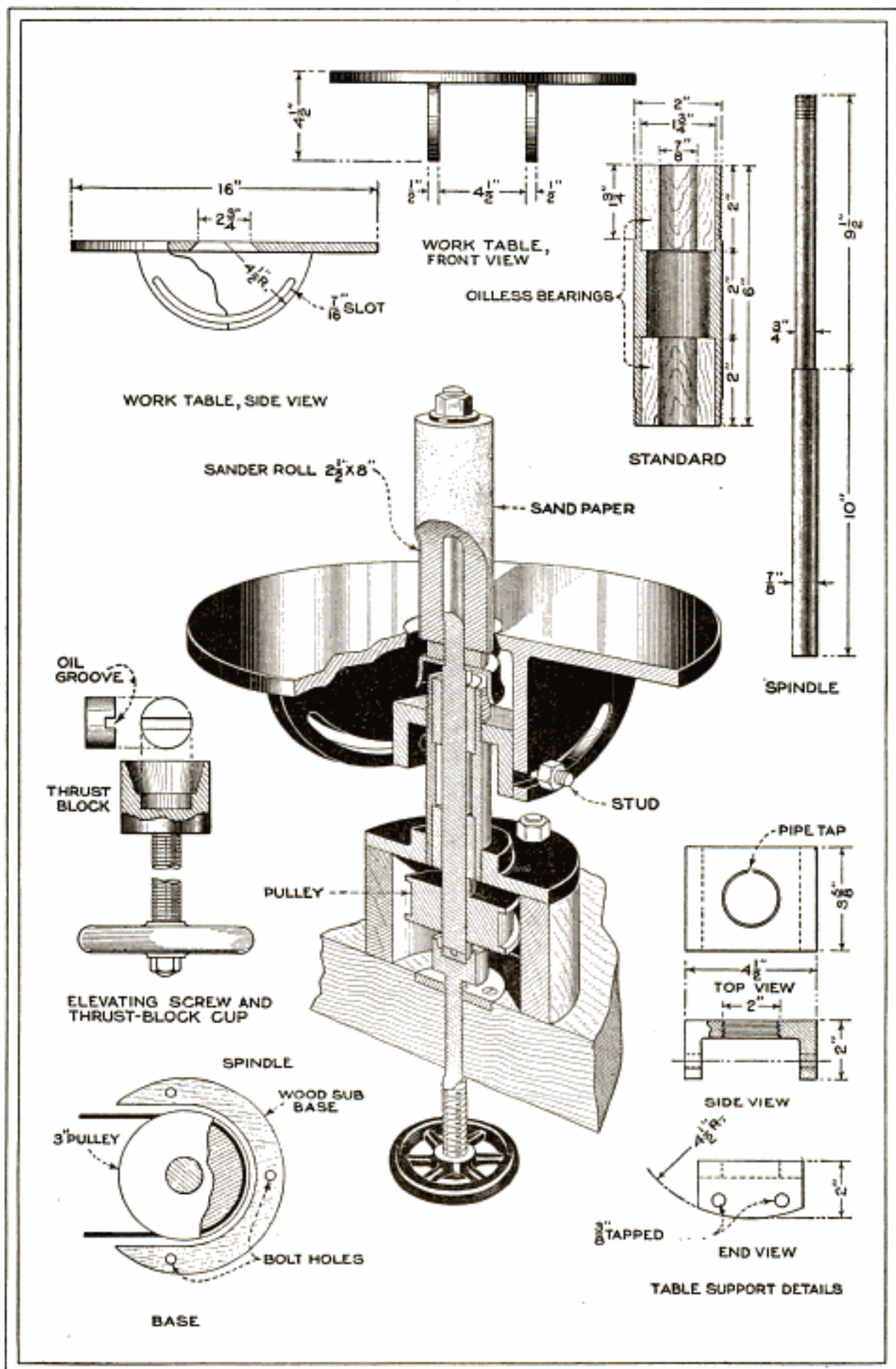

A Vertical-Spindle Sander that May Be Built in Any Small Shop, and that Will Prove of Great Value to Woodworkers and Patternmakers

bearing consisting of a bronze disk, slotted as shown, to insure that a constant supply of oil will reach the bottom of the spindle. The disk is carried by a thrust-block cup, which is machined so as to form an oil reservoir. The cup is machined on the top of a $\frac{3}{4}$ -in. elevating screw, working through a plate-steel nut screwed to the top of the bench, directly under the center of the spindle. A large square nut, sunk into the bench, can be used here, if desired. The bottom of the screw is fitted with a hand wheel, which may be taken from an old valve.

The driving pulley is made of steel or cast iron, turned with flanges to prevent the belt from running off; it may be fastened to the spindle either by a key or by two headless setscrews. The face should be made to carry a 1-in. belt.

The sub-base is cut out of hardwood, on the band saw, and mounted on the bench with the belt opening to the rear of the machine.

The sander rolls may be made either of steel or cast iron, and should be per-

fectly smooth and straight. The bore must also be true with the outer surface. The roll is raised by means of the elevating screw when being covered with abrasive paper or cloth, and lowered for working until the lower edge is below the level of the table top.

The abrasive paper can be purchased in rolls or sheets, and in many grades of fineness. A piece is cut that will fit neatly around the roll, the ends meeting closely, without any lap, and it is cemented to the roll with a special adhesive sold for the purpose. After applying, the roll is tightly wrapped with heavy string and allowed to remain until the cement is dry.

Garnet paper is generally used for wood finishing, and emery paper for metal-pattern work.

The machine is driven, by means of a quarter-turn belt, from a small motor; the speed of the roll should be from 1,600 to 1,800 r.p.m.

A snap switch should be located on the front edge of the bench, for convenience in controlling the motor.

Flattening the Ends of Coil Springs

The illustration shows a handy tool for flattening the ends of coil springs, and one that can be made in a few moments to suit

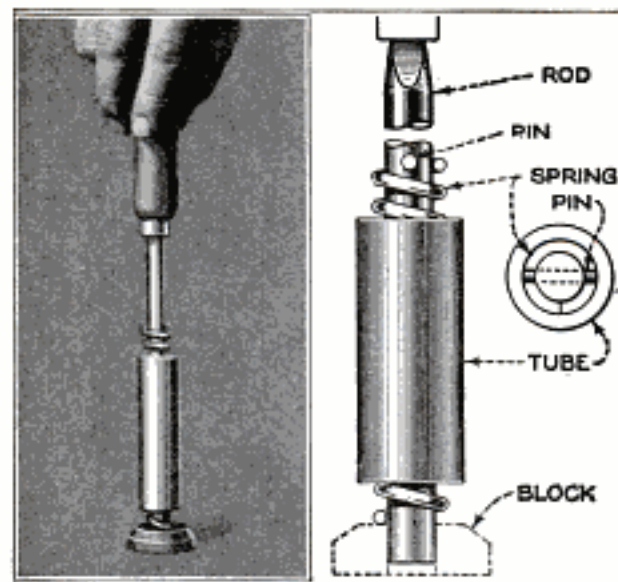

An Effective Tool for Flattening the Ends of Coil Springs Can Be Made from Scrap Stock

any size spring. It consists of two parts; a length of round-steel rod to fit the inside diameter of the spring, and a piece of pipe or tube to fit the outside diameter. The rod is driven into a wooden handle and drilled for a pin, as shown. The tube, which is only half the length of the rod, is

used to cover the spring except the last coil, which is to be held over a gas flame, the tube protecting the rest of the spring from the heat. The spring is held in the flame long enough to anneal the exposed part, and then, while this end is hot, the end of the rod is slipped into a hole drilled in any convenient metal block and the handle pressed down quickly. The coils, will, of course, close for a certain distance before the end is pressed back and the tube will slide back over the pin as the tool advances into the hole. This method of flattening the end is particularly effective in case of brass springs.

Avoiding Waste of Envelopes

Frequently, in my office, I found that envelopes had become practically useless due to the gummed flaps sticking to the back, which was caused by the dampness of the storeroom. Having a supply of these envelopes on hand one day, I instructed the porter to attempt to pry the flaps open, my own attempts having resulted in tearing them. The porter spread them out on a long table until he had finished the work he was doing. Upon returning, he found that the air circulated by the ceiling fan, which was located directly above the table, had dried the gummed flaps so thoroughly that no trouble was experienced in opening them. —L. H. Unglesby, Baton Rouge, La.

Raising Sunken Floor Boards

The flooring defect shown in Fig. 1 of the drawing is a common one. The primary cause is, of course, careless workmanship, or defects in the sub-floor, which allow the edge of one piece of flooring to drop down from $\frac{1}{4}$ to $\frac{3}{8}$ in. below the level of the remainder of the floor. A simple method of remedying this is shown

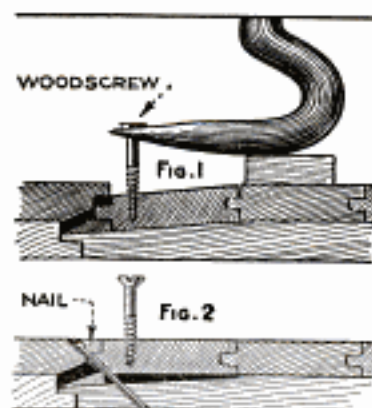

in the drawing. A screw is driven in near the edge of the sunken piece, and using a wrecking bar with a block of wood as a fulcrum, the edge is pulled back into place, as indicated in Fig. 1. Then

holes are drilled and 8-penny finishing nails driven along the edge as far as necessary, as shown in Fig. 2. When the nail and screw holes have been puttied and stained, the repair is unnoticeable.

Adjustable Spanner Wrench

Every shop has some machines or tools fitted with slotted nuts, and it usually happens that one of the hardest things to find is a spanner wrench to fit a particular nut.

An adjustable spanner that will accommodate itself to nuts of different sizes can be easily made, and when it is remembered that these nuts are quite generally abused with a hammer and chisel when no wrench is at hand, such a tool is well worth making. The body, it will be seen, is similar in appearance to the frame of a micrometer caliper. One end is drilled and tapped to take a screw, which is turned from a piece of $\frac{5}{8}$ -in. cold-rolled steel. A pin, driven in the opposite end of the tool, is turned to the form illustrated. The tapered points of the plug and screw are casehardened.

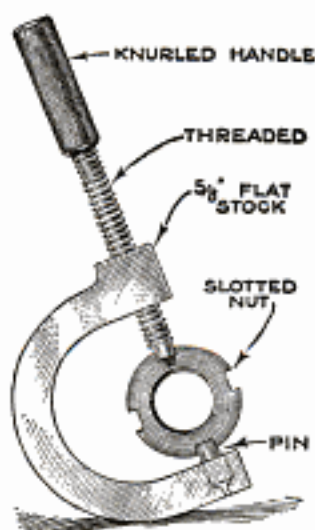

Vat for Scalding Hogs

The most arduous job in the task of butchering hogs on the farm is the handling of the carcass, which usually weighs



A Large Vat for Scalding Hogs Is Set over a Trench and a Fire Is Built under It

more than 200 pounds. To facilitate the work of scalding the carcass, and to make carrying of hot water unnecessary, an Oklahoma farmer built the movable scalding vat shown in the drawing. It measures 6 ft. long and about 30 in. wide, and is made of 2 by 14-in. material, the bottom and sides being covered with sheet zinc. In use, it is placed over a small trench dug for the purpose, and a fire is built under the vat to heat the water. Three 8-ft. lengths of chains are attached to two handles as shown, and with their help the hog is lifted in and out of the boiling water, two men being required to do the work. A length of stovepipe is set at one end of the fire trench, to serve as a chimney.—J. M. Collins, Kansas City, Mo.

Packing Piston Head on Pump

The piston head on a pump was packed with square 1-in. packing, which upon being worn out could not be replaced by any local supply house, and this made it necessary to devise an emergency packing. Having plenty of $\frac{3}{4}$ -in. packing on hand, we fitted a $\frac{1}{8}$ -in. iron band on the head and put the packing over this, which resulted in a good fit. Although this packing was intended for temporary use, it has proved as satisfactory as 1-in. packing.—L. W. Brown, Braemar, Tenn.

Auxiliary Handle for Shovel

When a shovel is used on work requiring little high lifting, as is the case when clearing away snow, usually more of a



An Auxiliary Handle on a Shovel Used for Clearing Away Snow, Is of Considerable Assistance

pushing operation than a lifting one, an extra handle attached to the shank of the shovel handle as shown will prove to be of considerable assistance. The auxiliary handle is cut from an old discarded shovel, and is fastened on the shank by means of sheet-metal straps.—Harold E. Benson, Boulder, Colo.

A Homemade Sprayer

The photo shows an efficient sprayer for combating potato bugs. It is made from an old milk can, a length of rubber hose, some lengths of $\frac{1}{4}$ -in. pipe, and fittings that can usually be found in every farm workshop. The cover of the can is soldered tight and a short length of pipe put through a hole in the top and soldered in place, the lower end being about $\frac{1}{2}$ in. from the bottom, so that the entire contents of the



can will be used. The upper end of this pipe is fitted with a valve and nipple,

and a length of rubber hose is attached to the latter. A tire valve is also soldered in the top of the can, so that the liquid can be put under pressure by means of a tire pump. The sprayer is carried by two men and has been found to be just as satisfactory as any portable sprayer on the market.—Elmer Raihala, Floodwood, Minnesota.

Machining Two Cone Pulleys on One Mandrel

By forging or grinding a double-pointed lathe tool, two cone pulleys, or similar castings may be machined while in place on a single mandrel. A roughing tool is first used, making both longitudinal and end cuts. Its cutting edge is the same as the ordinary lathe tool but a double point is provided, as shown in the drawing, for cutting in opposite directions, the shank of the tool being clamped parallel to the cross slide. The pulleys can be set closely enough together so that both ends can be faced at one cut; the tool is then withdrawn, and the

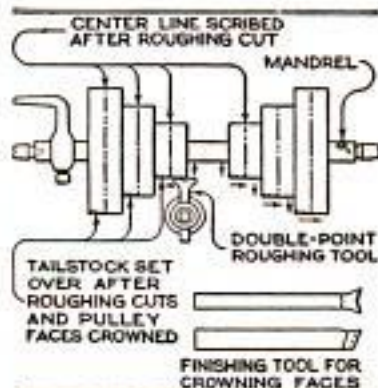

small step of one pulley faced, then fed over without changing the cross feed, and the second casting faced. The second step of this pulley is then faced, and the tool fed along up to the end of the largest step, when, reversing the carriage, it is moved over to the second step of the other pulley. The third step is then end-turned and surface-turned, and the tool is fed over to the third-step surface of the opposite casting. This will rough-turn both pulleys to identical diameters, the face widths being turned to measurement. Next the center line of each step is determined and scribed off, and the tailstock set over enough to turn down the pulley faces to the requisite crown. All steps are beveled until the cuts touch the scribed center lines; the tailstock is then set over in the other direction, or the mandrel reversed, for finishing the opposite tapers, which also meet the scribed lines, thus crowning the steps and completing the job. The finishing tool used for the crowning is similar to the roughing tool except that the noses are ground sharper.

Shaft-Centering and Calipering Tool

The drawing shows a serviceable and convenient tool for centering shafts and measuring their diameters directly without using calipers. It consists of a steel plate $\frac{3}{8}$ in. thick, 4 in. long, and $2\frac{1}{4}$ in. wide, having a V-shaped cut at one end as shown, the included angle of the vee being $38^{\circ}-56'$. A groove for the scale to slide in is cut in one side of the plate, with one edge bisecting the apex of the cut. Index marks for reading the scale are made on the surface of the plate at the point of the vee, and at right angles to the slot. A small spring, made of $\frac{1}{2}$ -in. spring steel, of the shape shown, is riveted on the plate, to hold the scale when adjusted.

The method of reading the diameters of shafts and cylinders is illustrated in the upper detail. The vee is pressed against the shaft as shown, and the scale is then pushed down until it touches the shaft. The distance from the index line to the point where the scale touches the shaft is equal to the diameter of the shaft and is read directly on the scale. When used for centering shafts, the scale is slid over the vee, as shown in the lower detail, and a line is marked with the scribe across the

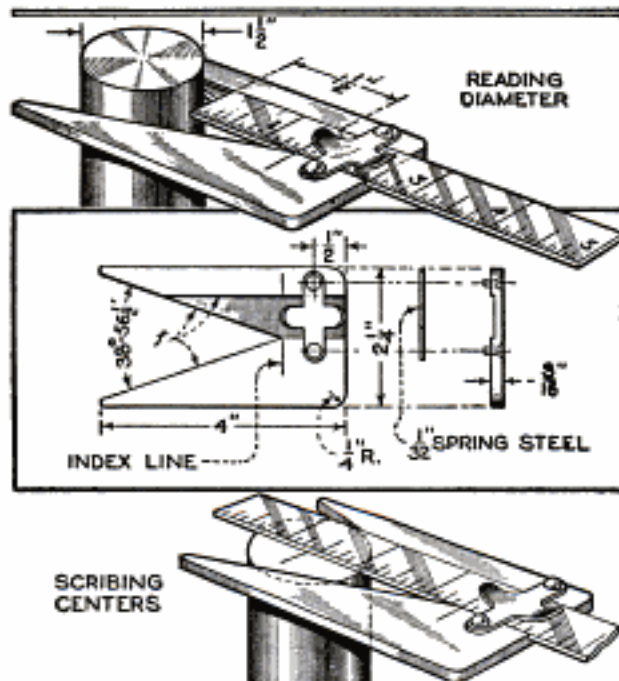

A Serviceable and Convenient Tool for Centering and Measuring Shafts

end of the shaft. Another mark is scribed at right angles to this, the point of intersection being the center of the shaft.

☞ For a first coat on wood, wood turpentine should be used as a thinner.

A Hand-Operated Riveter

The work of riveting small parts can be greatly facilitated by providing a small riveter of the kind shown in the drawing, and

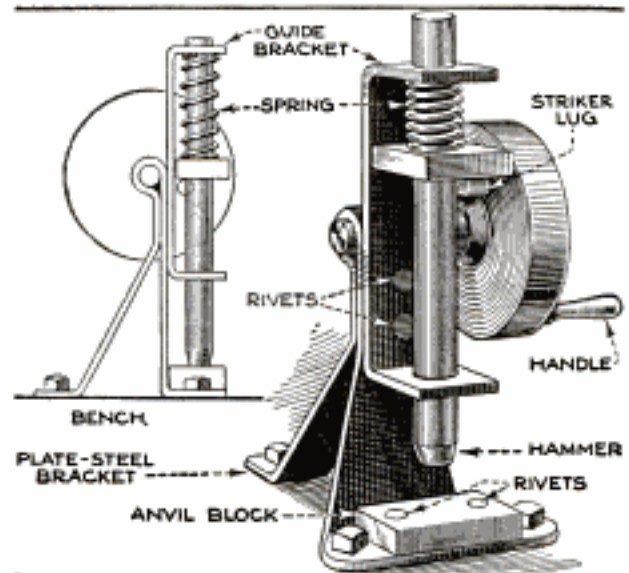

A Simple Hand-Operated Machine which Facilitates Riveting Operations Considerably

much more work can be done with it than is usually done by hand.

The riveter is simple to make; it consists of a steel-plate bracket on which is mounted an anvil block, a hammer, a wheel, and a coil spring. The main bracket is screwed to the benchtop and is bent to the shape shown, with an eye bearing at the top to receive the spindle on which the wheel revolves. A guide bracket, also made of steel plate, is riveted to the main bracket at the point indicated; the ends are drilled and bent over so that both holes will be in line to receive the hammer, which is a short round rod of tool steel. A hole is drilled through the hammer and a square collar is pinned on at this point. A strong coil spring is placed between the flange and the upper guide, so that the hammer is held down on the anvil block with considerable pressure. The anvil block is riveted to the base of the bracket, as indicated, and a heavy steel or iron wheel is mounted on the spindle. The wheel is fitted with a striker lug or roller to lift the hammer, and a handle is provided on the other side so that the wheel can be turned by hand. Almost any type of pulley or heavy-rimmed flywheel can be used for this purpose. The ease with which the tool can be operated depends on the weight of the wheel and, therefore, the heavier the latter is, the more smooth and satisfactory will be the operation of the riveter.

A Septic Tank for the Farm

By A. J. R. CURTIS

THE farmer and small-town dweller can easily obtain all the advantages of running water and bath, with perfect protection against contamination of water supply and filth diseases, by means of a septic tank. This method is the most satisfactory for the disposal of household and other wastes, where a regular sewer system is not available, and the ordinary septic-tank installation is not at all difficult to make.

Household wastes are carried from the house sewer or plumbing outlet directly to the tank, where the solid portions are converted into liquids and gases. The bacteria that cause this change are vigorous only in the absence of oxygen, so the tank chamber should be sealed to exclude air. The sewage should remain in the tank at least 24 hours. After leaving the tank, the liquid, in a semi-purified state, flows into a tile line, where an entirely different kind of bacteria, known as aerobies, which require air in order to live, attack the liquids and complete the process of purification.

The simplest form of septic tank, and one that gives successful results for small-residence use, is a plain, watertight, concrete tank set below ground. Its size will vary with the amount of sewage to be treated. The tank should be made so that a depth of not less than 4 ft. of liquid may be maintained, and any increase in capacity may be obtained by extending the length rather than the width. In this way the sewage has a longer path to travel before being discharged from the tank and the septic action is more thorough. The wastes should enter the tank at the lowest possible velocity, and for this reason the tank end of the house sewer should have very little pitch. A baffle board must be erected immediately in front of the sewer outlet to reduce the velocity of the flow still further. Likewise, the discharge of the treated sewage should be made with a minimum of disturbance to the contents of the tank. To allow this, the outlet must be provided with an air vent.

The concrete for the tank should be made of a mixture of 1 part of cement, 2 parts of sand, and 3 parts of pebbles or clean broken stone. The walls and floor should be 6 in. thick and reinforced with $\frac{1}{4}$ -in. steel rods spaced 12 in. apart in both directions, or with heavy woven wire. The reinforcement should extend down the walls and across the bottom, forming a sort of basket. The cover should be not less than 4 in. in thickness and reinforced with $\frac{1}{4}$ -in. rods spaced 4 in. apart. It should be made in slabs to make it easily removable for cleaning. In case the tank must be set at a considerable depth, with the weight of several feet of soil upon its top, the cover must be made thicker and stronger than this. A hollow extension to the surface of the ground, large enough

to admit of cleaning when necessary, may also be found advisable.

The smallest size tank that is practical is one for a family of five persons, which upon the assumption that the daily sewage production is 50 gal. per person, should have a capacity

of 250 gal., if the general practice of sewage retention for at least 24 hours is to be followed. In most cases septic action will begin practically as soon as sewage enters the tank but in rare cases it may be necessary to introduce a quantity of septitized sewage from some other tank. Once started, the action rarely ceases.

The forms for the tank are very simple; the inner form consists of a box, with holes bored in the ends to receive the sewer-pipe "ells" that form the inlet and outlet of the tank. Strips of wood are nailed to the sides at the points indicated, to form grooves in the inner walls for the reception of the baffle boards. Where the soil is self-supporting, an outer form may be dispensed with, and the earth itself used to support the concrete. Where the soil is loose, however, an outer form, consisting of a bottomless box, must be used. The lumber used for the forms should be clean, preferably surfaced, and the joints must be made tight to prevent leakage of the

DIMENSIONS OF SEPTIC TANKS				
NO. OF PERSONS	CAPACITY IN GAL.	WIDTH	LENGTH	LENGTH OF TILE IN FT.
5	250	2'-0"	4'-0"	150 TO 250
10	500	3'-0"	5'-4"	300 " 500
15	750	3'-6"	6'-10"	450 " 750
20	1000	4'-0"	8'-0"	600 " 1000
25	1250	4'-6"	9'-0"	750 " 1250
ALL TANKS 5 FEET IN DEPTH				

Table Showing Dimensions of Septic Tanks for Various Sizes of Residences

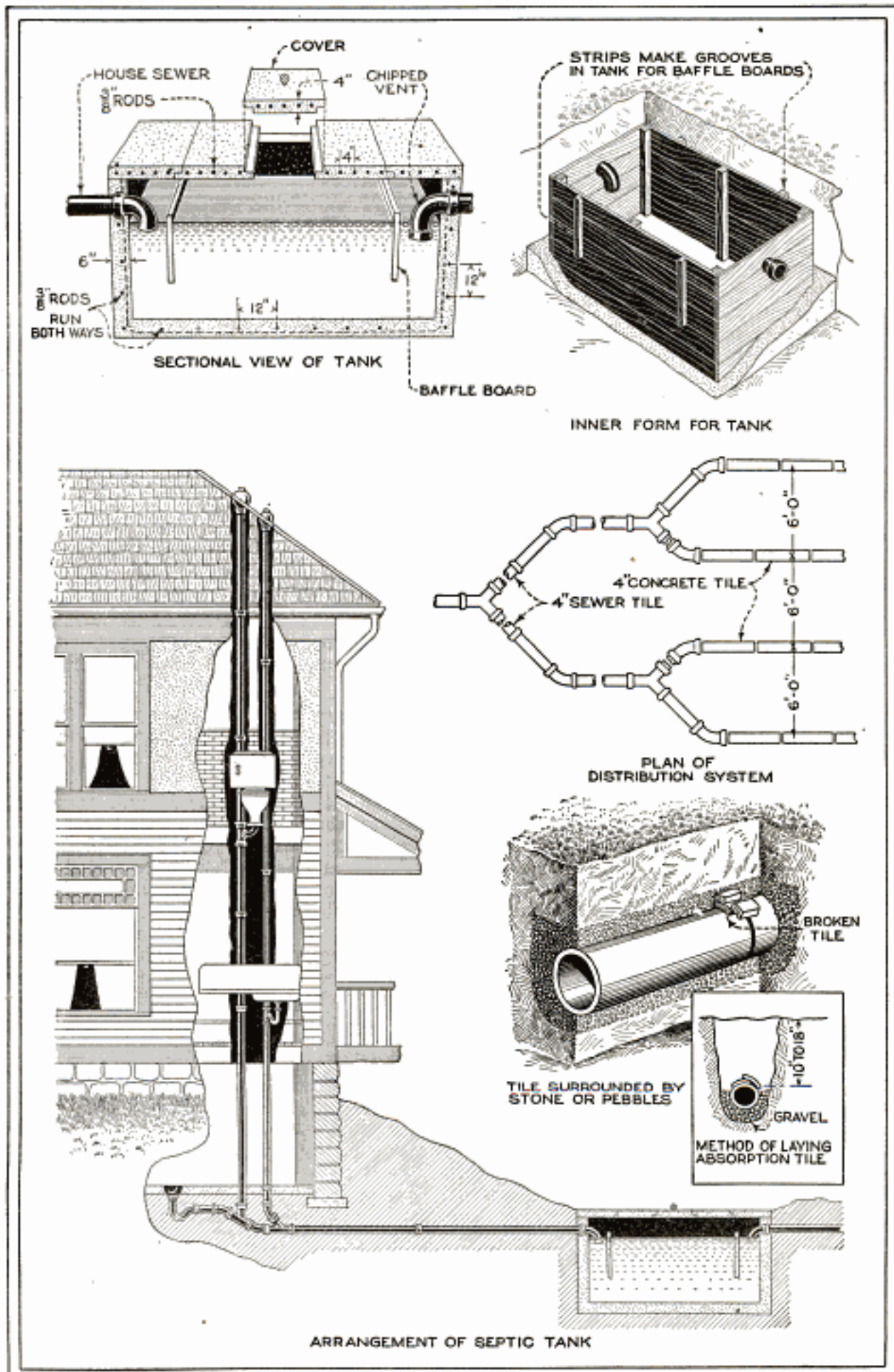

Details of the Making and Installation of a Simple Concrete Septic Tank: This Allows the Farmer to Install a Modern Plumbing System Where Sewers Are Not Available

concrete. A thorough wetting of the form before placing the cement will swell the wood and assist in making the joints tight. The forms should be greased or oiled before placing the concrete and the mixture must be well spaded in the forms to insure filling all corners.

Since the purifying action is only partly completed in the septic tank, the tile distribution system, in which the aerobic bacteria complete the process, is of almost equal importance to the tank. The liquids should never be allowed to pass directly from the tank into a pond or stream, neither should they be discharged directly into a sump or on the surface of the ground.

The disposal or distribution system should consist of a line or lines of 4-in. drain tile, preferably laid as indicated in the drawing, in order to get a maximum length of tile in a small area. If the septic tank is located near the residence, as is usually the case, the tile leading from this point to the disposal or absorption field should be laid as closely together as possible and sealed with cement mortar in the same manner as a sewer. In the absorption field, however, the tile are laid with

open joints near the surface, where the soil carries an abundance of oxygen.

In mild climates 10 in. is sufficient depth for the distributing tile, this being increased to a maximum of 18 in. in colder regions. The open joints are protected by pieces of broken tile to prevent dirt from falling into them and clogging the line. Uniform absorption by the soil along the entire length of the distributing tile will be facilitated by laying the tile to an accurate grade with a fall of about 2 in. per 100 ft. Some authorities prefer a steeper grade at the beginning, changing gradually to a level grade at the end.

The length of the lines of tile will depend upon the amount of sewage discharged and upon the character of the soil. In sandy soils of an open texture which admit of an even absorption, good practice indicates that 3 ft. of tile should be laid for each 5 gal. of daily discharge. In tight, clayey soil this should be increased to 1 ft. or more for each gallon. In certain cases where thorough absorption seems difficult, it is well to surround the distributing tile with gravel, cinders, broken stone, or some other similar porous material.

Moisture-Resisting Coats for Wood

Shrinking and swelling, and internal stresses that cause wood to warp and check, are caused by changes in the moisture content. Such changes are occurring continually when wood is exposed to changing atmospheric conditions, and the only way to prevent or retard them is to protect the wood from the air with some moisture-resisting finish or coating.

In order to determine the protection against moisture afforded by various coatings, a series of tests is being conducted by the U. S. Forest Service, at the Forest Products Laboratory, Madison, Wis. No coating or finish which is entirely moisture proof has yet been discovered, but several have been found that are very effective.

Linseed oil, although it is probably recommended more frequently than most of the other materials for moisture proofing wood, was found in the absorption tests to be quite ineffective. Five coats of hot oil followed by two coats of floor wax failed to give any great protection.

Oil paints form a film over wood which is very durable even in exterior locations. Laboratory tests show, however, that such a film, although it may be continuous, does not prevent moisture changes in wood.

Graphite paints and spar varnish are about as effective as the ordinary oil paints with the heavier pigments.

The cellulose lacquers rank somewhat higher than the foregoing in moisture resistance, and considerable improvement can probably be effected in them by the addition of solids. They have the advantages of being fast drying and forming a film over the wood that is very elastic.

Rubbing varnishes afford much more protection against moisture than do spar or long oil varnishes. The larger amounts of gum solids present in rubbing varnish probably account for their greater moisture resistance.

Enamel coatings made by the addition of pigments, such as barytes, to ordinary varnish are about as effective as rubbing varnish. A "bronze" coating, composed of a cheap gloss oil and aluminum powder proved in test to be superior in moisture resistance to any of the coatings mentioned above. This mixture is very fast drying; three coats can be applied in the course of half an hour.

The aluminum-leaf coating developed at the Forest Products Laboratory particularly for the protection of airplane propellers is highly efficient in preventing moisture changes in wood. Such a coating can best be applied to large, unbroken sur-

faces. The laying of the leaf on small intricate parts or assemblies is less practical.

Some asphalt and pitch paints are highly moisture resistant. They are rather cheap and may be applied almost any place where their color is not objectionable. Attempts to discover a means of covering asphalt and pitch paints with lighter-colored materials have met with little success.

For temporary protection against moisture changes, vaseline smeared over varnish is one of the most moisture-resisting coatings yet tested. Another good temporary protection is a heavy coat of paraffin. Neither of these coatings, however, can be used on surfaces subjected to wear.

Straightening Sheet Metal

From various causes light sheet metal often becomes bruised or dented along the edges, and before the material can be used, it must be straightened. Wooden or soft-metal hammers are generally used for this

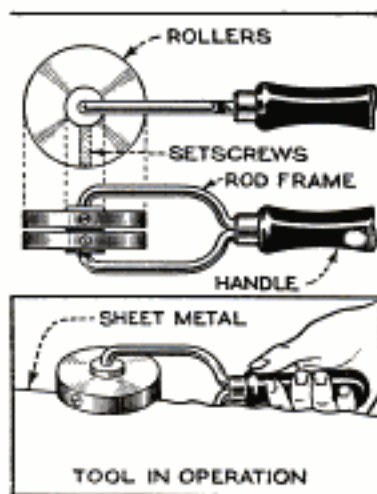

purpose, but it is difficult to make the metal perfectly flat with these. For this reason one shop uses the "follow-up" tool shown in the drawing. It consists of two rollers, each fitted with a setscrew to tighten it on a

sleeve, which, in turn, is drilled to turn on a frame made from a round steel rod, bent to the shape shown. The shank of the frame is driven into a wooden handle. To operate the tool, it is first set so that the metal fits snugly between the rollers, and after these are tightened on the sleeve, the tool is rolled along the edge of the sheet, with the result that the edge of the metal is made as flat as it was originally.

Handy Fixture for Woodworker's Bench

Many irregularly shaped pieces of wood cannot be held in an ordinary clamp vise when shaving, scraping, or sandpapering them, and for this reason the fixture shown in the drawing has been found very useful. It consists of a 2 by 4-in. frame about 5 ft.

long, with a fixed clamp at one end and an adjustable clamp at the other. The frame is held by vertical pieces, also of 2 by 4-in. stock, nailed to the edge of the bench. The adjustable clamp is made from a length of

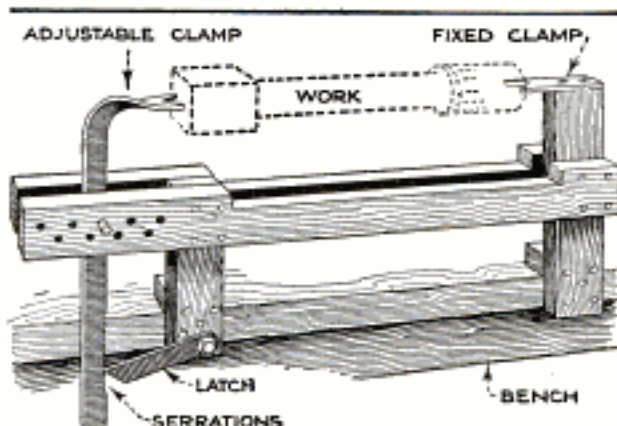

A Simple Clamp for the Woodworker's Bench Holds Work for Scraping, Shaving, or Sanding

flat steel, bent to shape, and drilled to receive a steel pin, which fits in a number of holes drilled through the end of the frame, and staggered as shown. Serrations are filed in the edge of the adjustable clamp near the lower end, as shown, for a latch, which is also made of flat steel. The method of using the fixture is obvious.

Adjustable Cable Hook for Hoist Tackle

The hooks generally used in connection with slings or hoist tackle are clamped with screws or bolts, and, when they must be adjusted, it is usually necessary to search for tools, causing much loss of time. A hook adapted for general hoisting work, which can be adjusted without delay, is shown in the illustration.

The hook proper is a simple flat-steel forging, drilled for a loose rivet and for the cable or sling. A U-shaped catch is made as shown, and riveted over the hook, the edges being first rounded off to prevent cutting the cable.

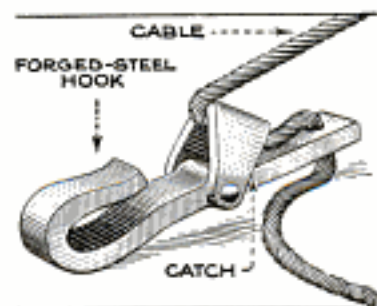

The cable or rope is passed under the catch and through the hole in the hook as indicated. When necessary, the end of the cable can be hitched around the hook, for additional security. It will be seen that the greater the strain on the cable the tighter the catch will hold.

Soldering Thin Pieces

One source of annoyance when soldering thin pieces end to end is the liability of the work moving during the operation; often a slight touch of the soldering iron

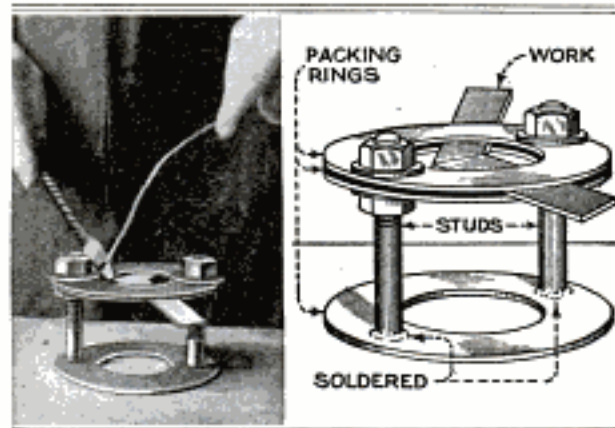

A Useful Clamp Made from Rings and Studs, Used for Holding Thin Pieces While Soldering

is sufficient to disturb their position. A clamp that holds pieces of this character together securely is shown in the photo and drawing; it can be made in a short time from three old packing rings, or something similar, two studs and four nuts, and washers to fit.

One ring forms the base of the tool, and into it are driven the studs, directly opposite each other as shown, a touch of solder holding them permanently in position. The other rings are a loose fit, adjustment being effected by the nuts. The work is held between the top rings, the nuts being tightened by hand. When using this holder, one will also find that the soldering iron will hold its heat much longer than if the pieces are laid on a metal surface as usual.

Glucose for Antifreezing Solution

A substitute for denatured alcohol, in antifreezing solutions for automobile radiators, has been discovered by the chemist of the Bureau of Foods of the Pennsylvania Department of Agriculture. Tests conducted over a period of four years have demonstrated that the substitute is, within certain limits, as efficient as an alcohol or other antifreeze solution, and much more economical.

The substitute is ordinary glucose, a simple sugar made from starch, and extensively used by confectioners and bakers. Glucose is about one-half as sweet as ordinary sugar and costs only 5 or 10 cents per pound. It comes in the form of a colorless liquid.

The investigations conducted prove that a solution consisting of $1\frac{1}{2}$ pt. (1 lb.) of glucose, dissolved in 1 gal. of water, will not freeze until the temperature drops to 5° F. The mixture becomes "slushy" at 10° , but does not freeze, and this does not interfere in any way with the circulation.

The glucose will not evaporate, and is in this respect entirely different from alcohol, which evaporates rapidly upon exposure to air. One filling of water and glucose will last for months, provided there are no leaks in the circulating system. Another point in favor of glucose is the fact that it has no harmful effects on the radiator, engine, or on the rubber connections. For the ordinary small car, 3 lb. of glucose are sufficient; larger cars require more.

To farmers and others not having heated garages, the above-mentioned solution is invaluable. When the temperature drops below 5° F., however, the system should be flushed out, drained, and an alcohol solution used.

Drawing an Ellipse by Projection

Every machinist has occasion to do some sketching and drawing at one time or other, but is handicapped considerably by not having the proper instruments, and is therefore "stumped" when confronted with the problem of drawing a figure such as an ellipse. Two tacks and a length of string are sometimes resorted to, but this method is not always satisfactory. A better method is shown in

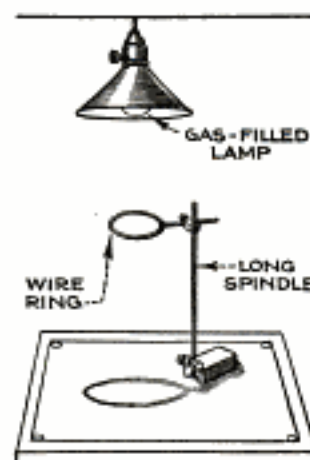

the drawing. A wire ring is fitted to a surface gauge instead of the usual scriber, the long spindle of the gauge being used. The drawing board is then placed directly under a strong electric lamp of the gas-filled type, and the ring placed under it so that a distinct shadow is thrown on the paper. The gauge is placed on the board so that the axis of the wire ring is parallel to the major axis of the ellipse to be drawn. By moving the ring up or down on the spindle of the gauge, the size of the shadow can be varied. When the correct size is obtained for the major

dimension, the ring is turned until the minor dimension measures correctly. The shadow is then traced and a fairly accurate ellipse will be drawn. Of course, no method of this kind can be precise, as it is intended only for sketching and rough layout work.—Edwin J. Bachman, Fullerton, Pa.

Mixing Paint

An eggbeater, such as every house-keeper uses in the kitchen, is far superior to a wooden stick or paddle for mixing paints. When different colored paints are used, it will be found convenient to use a separate beater for each color. They cost only a few cents apiece and can easily be cleaned by working them in kerosene after using.—Walter Chas. Michel, Jersey City, New Jersey.

Quick-Action Can Opener

The can opener illustrated has been found to be of considerable assistance in hotel kitchens and restaurants where a great number of cans are opened every day. The opener consists of a 1-in. board

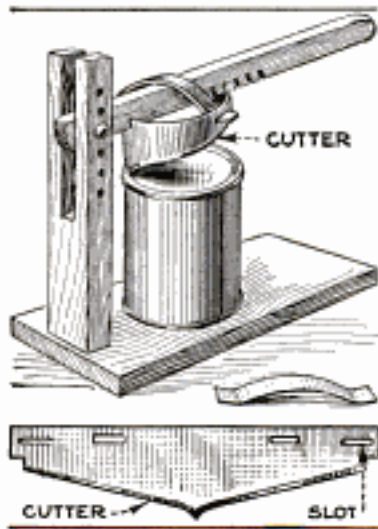

about 6 in. wide and 10 in. long and a 2 by 2-in. upright, which is slotted to receive the end of a handle. A number of holes are drilled through the upright, as shown, so that the handle can be quickly adjusted to any desired

height by means of a pin, which also serves as the fulcrum for the handle. The cutter is made from a strip of sheet steel, cut to the shape shown in the lower detail, and sharpened on one edge. It is bent to a circular form, the ends being held together with a bolt and wingnut. The ends should be slotted so that the diameter can be varied to suit cans of different sizes. The cutter is held in place by a strip of spring steel passed over the notched handle and having the ends passed through slots made in the sides of the cutter.—G. A. Luers, Washington, D. C.

Preventing Scouring of Bridge Abutments

In repairing a stone bridge having a 16-ft. span, it was necessary to devise a method of preventing scouring at the



A Concrete-Covered Stone Floor on a Stream Bed to Prevent Scouring of Bridge Abutments

bridge abutments, as the stream had a swift current and a sandy-loam bottom. A stone floor, made of heavy "riprap" stones, and about 18 in. thick, was built on the bed of the stream, the smaller stones being wedged and tamped between the larger ones, and a wet mixture of concrete poured over the floor, making it a solid mass. A wall 30 in. deep was built on the upstream side at the end of the floor, to prevent the water from undermining it.—R. F. Mundorff, Kansas City, Missouri.

Acid Clears Clogged Pipe

The 1-in. drain pipe carrying away the warm cooling water of a small gasoline engine became clogged with cotton waste at an elbow located under the concrete floor. Clearing the pipe was found to be a problem, as the elbow could not be unscrewed, and a wire stiff enough to push the obstruction away could not be used, as there was another elbow in the way. However, the pipe was cleared in an hour's time by treating the cotton waste with acid. The water above the obstruction was pumped out by means of a small hand pump and a length of rubber tubing, which was only $\frac{3}{8}$ in. in diameter and could easily be dropped into the pipe. About 10 oz. of concentrated sulphuric acid was then poured into the latter, and this removed the waste completely.—C. A. Oldroyd, Barrow-in-Furness, England.

Removing Roller or Ball-Bearing Races

If a special puller or driver is not available for removing the ball or roller-bearing cup of an automobile steering

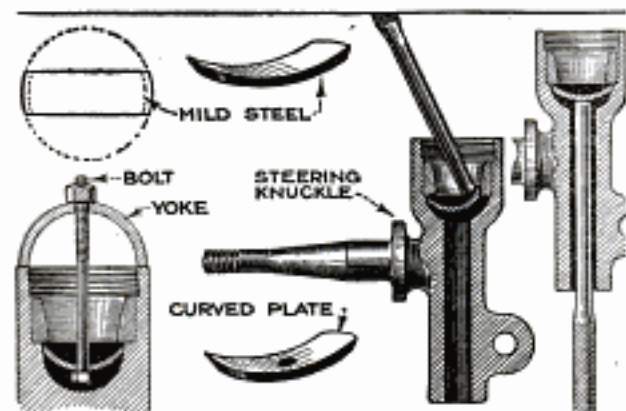

Method of Extracting Roller-Bearing Race without Distorting the Shell

knuckle, the cup must be broken before it can be removed, and this should not be done if possible to avoid it, because the hammer blows necessary to break the cup will distort the shell, and the new bearing will not fit properly.

A good method of removing the cup is shown in the illustration. A piece of steel, $\frac{3}{16}$ by 1 in., and $\frac{1}{4}$ in. longer than the smallest inside diameter of the cup, is bent to form a curved plate, which can easily be forced under the cup. The ends of the plate are rounded to conform to the curvature of the shell. By applying a long punch under the plate the cup can easily be driven out. Where this cannot be done, the cup can be pulled out by drilling a hole in the center of the curved plate, and attaching a long bolt with yoke and nut.

Breaking Off Lathe Cuttings

Accidents are often caused by long, curled lathe cuttings wrapping around the work, or becoming entangled with the chuck or faceplate, and striking the operator as they fly around. This danger can



be avoided by cutting or breaking the cuttings off before they become very long. A simple tool for this task is shown in the illustration. It consists of a short strip of flat iron with a hole

drilled near one end, and a V-shaped piece cut out as shown. The size of the tool can

be varied to suit heavy or light work. To use the tool, the V-end is pushed over the cutting, which enters the hole. Then the tool is twisted and given a quick jerk to break off the cutting. The best results are obtained if the tool is ground on both sides and hardened, and the hole reamed.

A Simple Acid Pump

Pouring acids and other corrosive liquids from carboys or large bottles is in most cases a highly dangerous operation, and therefore special pumps are often used to transfer the liquids. These pumps are usually quite expensive and for this reason, the homemade pump shown in the illustration was made in one laboratory and found entirely satisfactory. It can be

made from odds and ends of broken apparatus found in every laboratory, which makes the cost negligible.

The pump cylinder consists of a test tube with a broken bottom, the rough edges of the break being filed or ground off smoothly. A glass rod, fitted with a rubber stopper, forms the plunger and piston. A rubber stopper with two holes drilled through it, fitted in the lower end of the test tube and lengths of glass tubing are pushed through the holes as shown. A conical depression is cut over one of the holes for a marble to fit in snugly, forming the inlet valve. The outlet valve is made from a thistle tube with the stem broken off; it is fitted with a rubber stopper, having a hole drilled through it for the glass tube from the cylinder, and a seat cut in for a marble. A length of rubber tubing is then attached to the end of the thistle tube.

The joints must be airtight and the piston should be well greased. When the piston is drawn up, a vacuum is created and the inlet valve is opened, which allows the acid to flow in. On the downstroke of the piston the inlet valve is closed and the outlet valve opened, allowing the acid to flow through the thistle tube and into the receiving vessel.

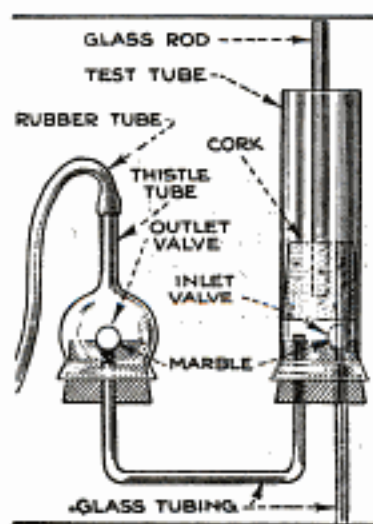



A Homemade Baseball Game

By ROLAND B. CUTLER

PARLOR baseball games are usually quite complicated and "pepless" affairs, but all the skill and chance of a real baseball game are embodied in the homemade baseball board shown in the drawing.

The board is very easy to make and nearly all the material required can be

nailed across the bottom. A back stop, $\frac{3}{8}$ by 1 by 20 in., is nailed to the end of the board, on top, and the inner edge is beveled to a thickness equal to half the diameter of the balls, which are ordinary marbles. The barrier piece near the other end measures $\frac{1}{2}$ by 3 by 20 in.; it is loosely pivoted

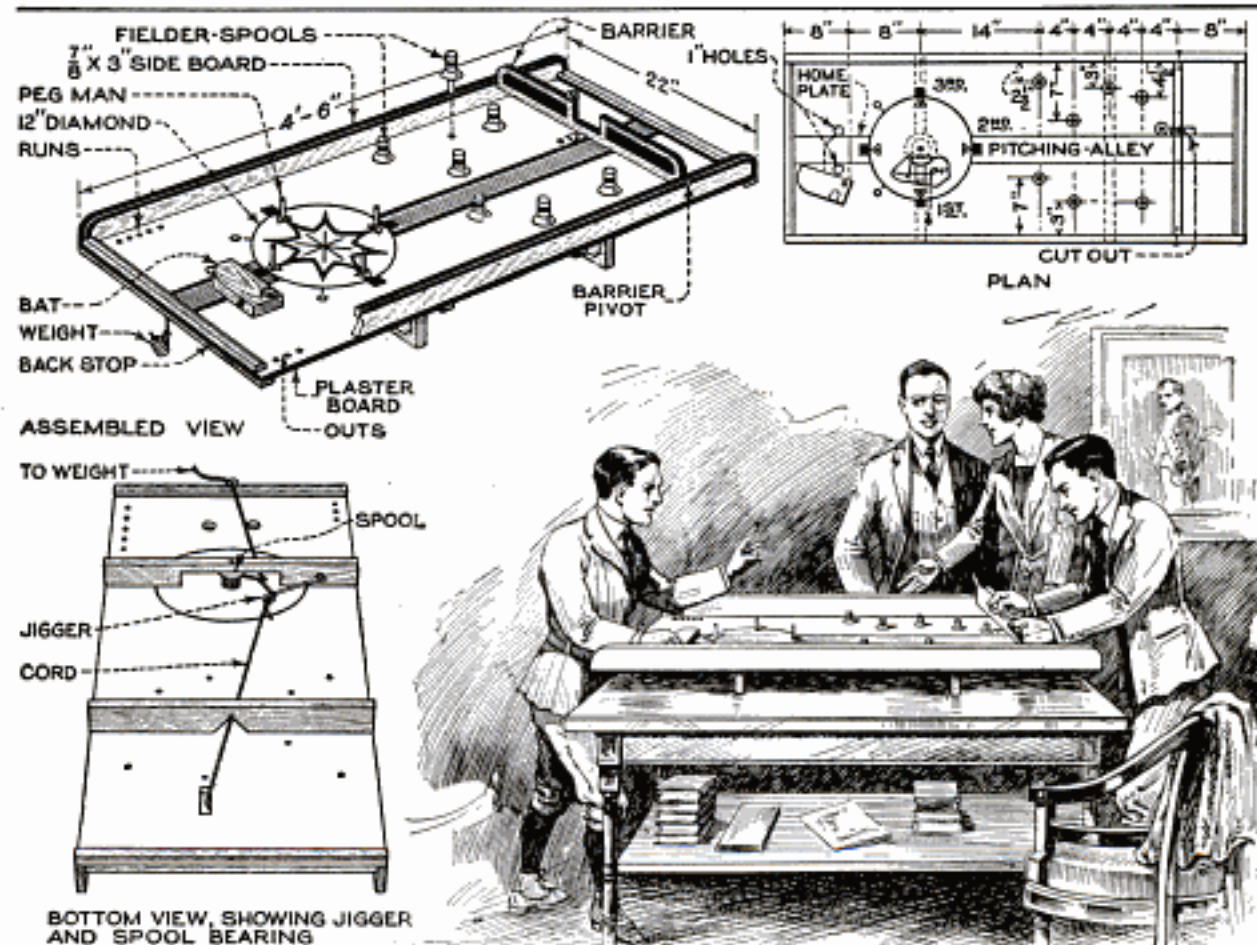

A Homemade Parlor Baseball Game that Will Provide the Young "Fan" with All the Thrills of the Actual Game: The Details of Construction Are Simple, and the Materials Easily Obtained

found around the house or workshop, except possibly the piece of wallboard used for the "floor." This piece measures 22 in. by 4 ft. 6 in. in dimensions, and the smoothest side should be up. Two $\frac{3}{8}$ by 3-in. side boards are nailed along the top edges, and two supporting cleats, $\frac{3}{8}$ by $3\frac{1}{2}$ by 22 in., and two end cleats, $\frac{1}{2}$ by 2 by 22 in., are

at each end with a wood screw, and its lower edge clears the top of the wallboard by about $\frac{1}{8}$ inch.

A disk, accurately cut out of the wallboard, serves as the diamond. It is 12 in. in diameter and its center is located equidistant from the sides and directly over the supporting cleat nearest the back stop.

A wooden spool, about 2 in. in diameter and about 2 in. long, nailed to the underside of the disk in the center, serves as a bearing on which the diamond rotates. A recess, 2 in. deep and 8 in. long is cut in the cleat to provide clearance for the spool and for the "jigger"—the wire device used to turn the diamond. A wooden pin, driven in a hole drilled in the center of the cleat, serves as a spindle on which the spool and disk revolve.

The jigger is made of No. 10 galvanized wire, or from a pail bail of the same thickness, bent to the shape shown. One end is stapled to the support cleat; a cord is tied to the eye that is formed at the bend, and it is run along the underside of the board, through a V-slot cut in the other support cleat, through a slot cut in the field, and the end is tied to a screweye on the barrier piece. In the upper left-hand figure the barrier piece is shown raised but in its normal position it is dropped, the slot in the board allowing plenty of clearance for the head of the screweye. One end of a 4-ft. length of cord is stapled to the spool under the diamond, and, after it is passed around a hook bent in the short arm of the jigger, runs underneath the board and through a screweye under the back stop; the other end is fitted with a wire hook on which is hung a weight consisting of several iron washers.

The diamond is rotated by winding up the 4-ft. cord on the spool and adjusting the weight so that the diamond will rotate about a quarter turn when the barrier is jerked up quickly. As soon as the barrier is dropped to its normal position the weight will take up the slack in the 4-ft. cord, without causing the diamond to move back again.

The face of the diamond is neatly laid out as shown, a small 1-in. triangle being drawn at four equidistant points around the edge, and a $\frac{1}{8}$ -in. hole is drilled in the center of each triangle to take a short wooden peg, which represents the man batting or running. About a dozen or more of these "peg men" should be provided. Four jerks of the barrier will rotate the diamond a complete revolution, giving each man a run.

The pitching alley is laid out about 3 in. wide, and the positions of the three bases and home plate neatly marked with black ink; the bases should each be made about 1 in. square and the home plate about 2 in. square. Halfway between the home plate and first base, and also between the home plate and third base, a small O-mark is made, which figures in scoring.

A wooden bat is arranged behind the

home plate. It is made of 1-in. stock, 3 in. wide, and 6 in. long, with a screw hole drilled at one corner so that it can be pivoted loosely on a screw. On the opposite side, about $1\frac{1}{2}$ in. from the end, a finger hole is drilled. In use the bat is set in the position shown in the upper right-hand figure and when the ball is pitched the bat is swung around with the index finger to strike the ball, and it will then occupy the position indicated by the dotted lines.

A small ball hole, about 1 in. in diameter, is drilled on each side of the pitching alley, and about 1 in. behind the home plate, in order to make the pitcher "put 'em over;" all balls running into or outside of these holes allow the batter to "take his base."

A number of $\frac{1}{8}$ -in. holes are drilled in the field at the points indicated in the upper right-hand figure, and the small spools used as fielders are fitted with pins to fit in the holes; the upper rims of the spools are cut off for the sake of appearance. A fielder must be situated directly in front of the slot cut under the barrier to prevent the balls from rolling into it. A row of $\frac{1}{8}$ -in. holes is drilled on one side of the board in which to set pegs for runs, and three similar holes on the other side for outs. When completed the board can be neatly painted and varnished, if desired, in order to make it presentable.

The game, if played correctly, is very interesting and has all the thrills of a real baseball game. The 4-ft. cord is first wound on the spool by turning the disk to the left, and the diamond is brought around so that one triangle is located exactly in front of the home plate. The pitcher then rolls the ball through the slot in the barrier, down the pitching alley, and the batter tries to strike it as it passes over the home plate. If a ball is pitched into or outside of the two ball holes the triangle is advanced to the O-mark, and a peg man is inserted in the hole. But if the batter hits the ball into the field without striking a fielder, it is a fair ball. The barrier is then jerked up and the batter advanced to first base, this move also advancing all the peg men on the diamond. If the ball, upon being hit strikes a fielder, it is supposed to be caught by that fielder, which places the man in an out hole. The same also applies to the batter hitting one of the base runners. On a strike the man on first base is brought back to the O-mark, and consequently this brings every man on the diamond back a short distance. The first two foul balls made by a batter count for strikes as in real baseball. A run is scored by any base runner reaching the

home plate and he is then placed in a run hole. If the pitcher hits a base runner with the ball, the peg men are all advanced a base, or half that distance, or such an offense may be counted as a run for the batting team. If a pitched ball jumps the back stop, the batter is advanced to the O-mark, and a batted ball that jumps the back stop is a foul.

Of course, the rules for the game can be made to suit the players, and they may vary from those given above. However, the more closely the rules comply with actual baseball playing, the more realistic and interesting the game will be.

Cover for Egg Crock

The illustration shows a two-piece wooden cover for a large earthenware crock used for storing eggs. It has been found to be much more convenient than a one-piece cover, besides being air-tight, which the one-piece cover is not. The cover is made of a circular piece of wood, a little larger than the top of the crock, cut in two and hinged as shown. One of the pieces is securely clamped to the crock by

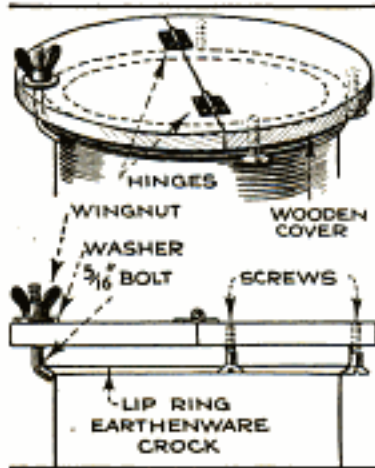

means of wood screws driven into the underside, with the heads projecting over the lip ring. A $\frac{3}{16}$ -in. bolt, with the head cut off and the end bent over to fit the lip ring, is provided on the other half, and is fitted with a washer and wingnut. This makes a clamp that can be tightened or loosened instantly with the fingers.—M. E. Duggan, Kenosha, Wis.

Making Plateholders Fit

Sometimes slides in photographic plateholders become swollen on account of dampness or other causes, with the result that they are hard to push in and out of the plateholder. This trouble can easily be overcome by filing down the swollen parts with a small file. It will be found that it takes but a few moments to make the slide fit perfectly.—Edward H. Flaherty, Denver, Colo.

Illuminating the Christmas Wreath

When a wreath is used in the window at Christmas time a very pretty effect can be obtained by illuminating it in the manner shown in the drawing. A small tin can about 4 in. in diameter and 3 in. high is obtained; a can in which hand soap is sold was used by the writer for the purpose. A five-pointed star is laid out on the bottom of the can, and it is cut out with small tin snips or heavy scissors. A slot 1 in. wide is then cut around the side, leaving only about 1



in. uncut. At this point, a small porcelain socket is mounted on the inside as shown; the socket can be purchased in any 5 and 10 cent store. A piece of yellow or red tissue paper is pasted inside of the box over the star, and a small 4-volt lamp is screwed into the socket. A length of flexible lampcord is led through a hole punched in the tin and connected to the socket. The outside of the can is painted with aluminum or gilt paint, and the lamp is mounted inside the wreath at the top.—Thomas W. Benson, Philadelphia, Pa.

"Fenders" for Auto Hood

The enamel on the auto radiator and cowl is frequently scratched by raising and lowering the hood carelessly. This can be prevented by providing small leather "fenders" on the corners of the hood as shown. They are made from pieces of leather about 2 in. square, folded over as indicated, and riveted to the corners of the hood. Besides preventing scratches when the hood is raised or lowered these fenders also lessen hood rattle, when the hood clips are loose.

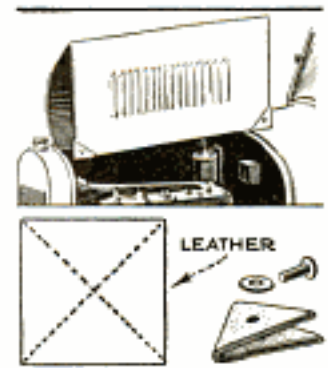

Brush for Washing Cars

Washing the running board, wheels, and underside of the fenders of an automobile is usually a tedious and laborious

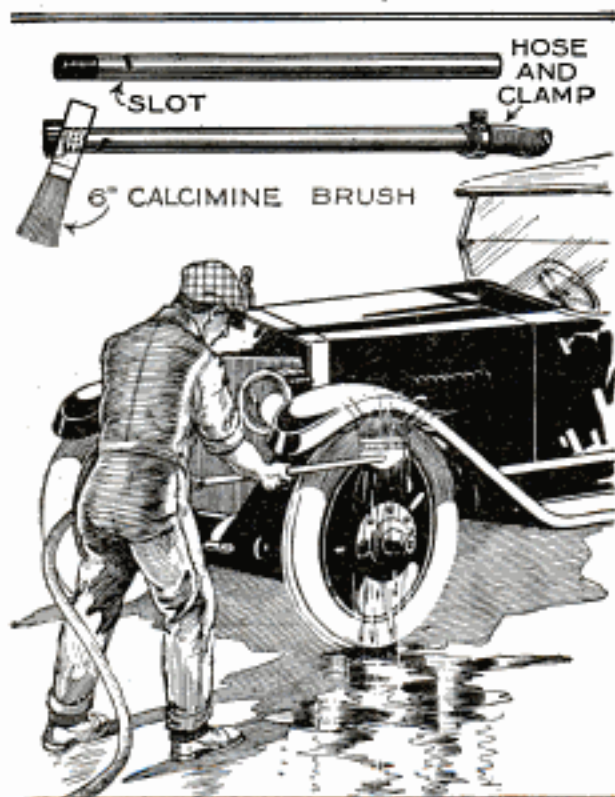

A Combination Brush and Water Nozzle for Washing the Underside of Auto Fenders and Running Boards

task, as the use of a hose alone is not sufficient to remove the caked mud quickly and thoroughly. The work is greatly facilitated by means of a special washing brush of the kind shown in the drawing. This fixture is attached directly to the water hose and causes a constant stream of water to flow on the surface where the brush is being used.

The brush used for this purpose is an ordinary calcimine or whitewash brush, about 6 in. wide, and having fairly stiff bristles. It is drilled through the wooden part as indicated to fit tightly on the threaded end of a 3-ft. length of $\frac{3}{4}$ -in. pipe. A small slot is cut in the pipe at an angle, so that the water will be directed against the bristles. A cap, of course, is fitted on the end of the pipe, and the water hose is connected to the other end. If the brush tends to work loose on the pipe, the pipe can be threaded further, and provided with a locknut and tapered washer on each side of the brush.

☛ The sleeves of old raincoats can be used to make bags for carrying rubbers.

Catch for Sliding Screen

Convenience and simplicity are embodied in an easily made catch for the sliding screen. A piece of wire, about 12 or 14 gauge, is bent to the shape shown in the drawing, to form a catch about 1 in. long. The part above the loop is a little longer than that below, and the catch is screwed loosely to the window sash, about $\frac{1}{8}$ in. from the screen. Two nails are also driven into the sash to keep the catch in the position indicated. When the screen is raised, the weight of the upper end causes the catch to drop under the lower part of the screen and hold it up. To lower the screen, it is raised slightly, and the top of the catch pulled back. The only necessary manipulation of the catch is when the screen is lowered, as it works automatically when pushed up, the heavier end falling in place itself.—George L. Michel, Jersey City, N. J.

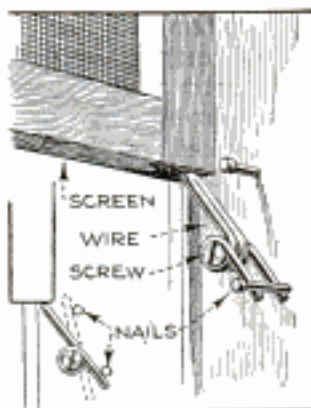

Cellar Drain Converted into Trap

In some localities where the sewer system is too small to carry away the water of an exceptionally hard rain immediately, the water will temporarily back up through the basement floor drain.

In cases of this kind, the ordinary bell-trap floor drain can also be made to act as a back-water trap, as shown in the drawing. A wooden ring is cut from a piece of white pine, to form a valve seat, fitting snugly in the outlet. A brass strip is screwed across the top of the ring to guide the stem of a float; a wooden ball from a small-size croquet set, or a similar ball, makes a good float. The stem is a short

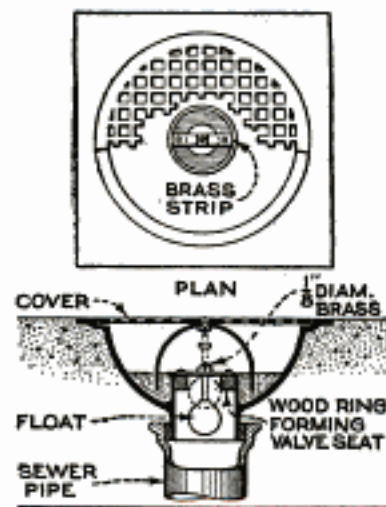

length of $\frac{1}{8}$ -in. brass rod, screwed into the float and fitted with a nut at the other end to keep the float from dropping through the guide strip. The opening through the valve seat allows the water to flow into the drain, but prevents it from coming out, as the ball rises and closes the opening until the water recedes.—Fred G. Koper, Charleston, W. Va.

Turned Posts for Homemade Furniture

The appearance of homemade tables and other furniture can be improved considerably if round legs are used instead of square ones, which immediately give the job away, no matter how well done. It is not necessary, in most cases, to go to the trouble of having legs made especially for this purpose, or to ransack the market for them, as ordinary stair balusters, which are available in a variety of sizes and forms, can be procured from any dealer in lumber and millwork. These balusters make as neat table, pedestal, and chair legs as can be desired and cost very little.

Mooring Small Motor Boats

An unusual method of mooring a small motor boat was used at a summer resort on the Canadian shore of Lake Erie. A framework of 2-in. pipe and fittings, made large enough for the boat to be floated under it, was constructed as shown in the photograph. A windlass, also made of pipe and fittings, was provided at each end of the frame so that the boat could be



Motor Boat Completely Protected from Storms by Novel Mooring

hoisted clear above the surface of the water whenever necessary, as in stormy weather. Strong chains were provided on each windlass, and these were looped under the boat at the bow and stern as shown. The handle of each windlass can be pushed toward the inside, so that it bears against the frame upright, in order to prevent it from unwinding.—John E. Mason, Hamilton, Can.

A Ski Toboggan

The exhilarating sport of sliding downhill on the snow crust has much to commend it. It also has its dangers, as the crust softens toward spring, and a heavy



A Sled Made from a Pair of Skis Is Much Safer than the Ordinary Kind on Crusted Snow

sled is liable to break through, catapulting its passengers headlong into the frozen snow, which breaks up and presents jagged cutting edges capable of inflicting considerable injury. A sled that is so built as to practically eliminate this danger is shown in the drawing.

It is made from a pair of old skis, securely fastened together by means of three crosspieces and two diagonal braces, as shown in the upper details. The top board and foot rail are attached to this framework by means of wood screws, and a hole is drilled through the end of each ski to take a $\frac{1}{4}$ -in. rope. This sled will slide just as easily and just as far as any other sled, and will not break through the snow crust, or turn over, due to the width of the runners. It is also light in weight and can be easily managed by small children.—C. M. Wilcox, Torrington, Conn.

Putty for Floor Cracks

Cracks in a floor that is stained and varnished may be filled with a putty consisting of 2 parts of glue, 14 parts of water, 4 parts of plaster of paris, and 2 parts of litharge. This putty will take the stain and varnish well.



VACUUM TANKS

BY JAMES TATE



THE principle upon which the gasoline-system vacuum tank operates is very simple, and the tanks themselves are sturdily built and get out of order but seldom—but I have found that the average owner regards the vacuum tank as more mysterious than the theory of relativity, and, when it does get out of order, hasn't the slightest idea what to do.

A very little trouble will enable the car owner to understand the gasoline system thoroughly, and he will then know what to do when trouble develops.

The most widely used type of vacuum tank is that shown in the upper drawings in the full-page illustration. It consists really of two tanks, one fitting within the other, and forming an upper and a lower chamber. The upper chamber has four openings at the top; the gasoline inlet, which is connected to the supply tank, and through which the gasoline is drawn, the vacuum inlet, which is connected to the inlet manifold, an air vent, and an opening into which a pipe plug is screwed. It has one outlet, an L-shaped pipe, with a flap valve at the bottom.

The lower chamber has two outlets; one is a connection to the carburetor, the other receives a plug or cock which can be opened for draining or cleaning the tank, or from which gasoline may be drawn for priming the engine or other purposes. The upper chamber contains a float, which, by means of an arrangement of levers and springs, operates valves in the air-vent and vacuum lines.

The operation of the tank is as follows: The pumping action of the pistons in the engine creates a high suction or vacuum in the intake manifold, and this suction is transferred, through copper tubing, to the upper chamber of the tank. When the float is down, the valve in the vacuum line is open, and that in the air vent closed, consequently gasoline is drawn into the upper chamber from the main tank. The float rises with the incoming fluid, until the springs pass over the pivot of the levers, when they suddenly snap the vacuum valve shut and the air-vent valve

open. This allows the gasoline to flow out of the upper chamber into the lower one by gravity. The float now sinks, allowing the vacuum valve to open, and the process is repeated. As the lower chamber is always open to the atmosphere, the gasoline simply flows from it, by gravity, to the carburetor.

Before blaming the vacuum tank when trouble develops, make sure that the fault does not lie elsewhere. When the engine refuses to start, and it is found that there is gasoline in the carburetor, it is obvious that the vacuum tank cannot be at fault, since its work is merely to get the gasoline to the carburetor. If there is no fuel in the carburetor, the fault may be in the method of starting the engine, and not actually in the tank. The tank may only have been partly filled to start with, the carburetor may have leaked, or the engine may have been choked too much in starting. When the latter is done, the raw gasoline is quickly sucked up through the carburetor, and an excessive suction set up in the carburetor and the outer chamber of the vacuum tank. The inner float is probably down and the passage between inner and outer chambers practically closed, so that the engine merely sucks air from the outer chamber. The proper thing to do in such a case is to push in the choke, close the throttle, and crank the engine half a dozen times, either with the starter or by hand; this refills the tank and the engine will start easily.

If the carburetor is dry, and there is plenty of fuel in the vacuum tank, there is probably an obstruction in the line from tank to carburetor, or dirt in the carburetor itself, so both should be examined carefully.

In case the vacuum tank is dry, and the cause is not as before described, make certain that there is gasoline in the main tank. Then remove the strainer under the gasoline inlet to the tank and examine it for dirt. See that the supply line is clear, by blowing through it, and examine every connection and all piping for leaks. If there are any air leaks in the suction pipe

Byrne, Kingsta & Co., Kokomo, Ind.

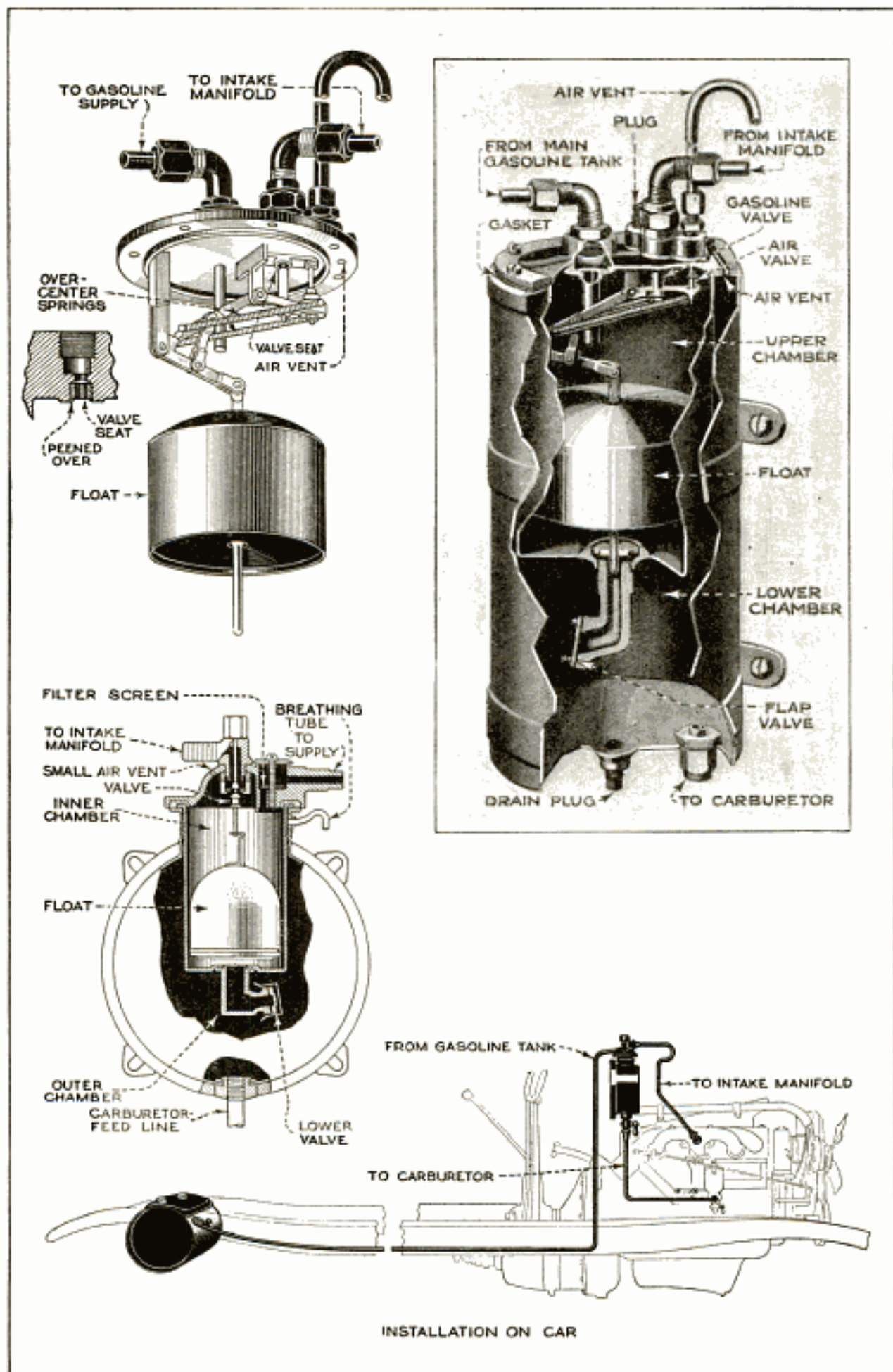

Above, Most Widely Used Type of Vacuum Tank, Showing Operating Mechanism; Below, a Simple, Compact Tank, and Its Mounting and Connections on the Automobile

they will, of course, make the system inoperative. Finally, remove the plug in the top cover and pour in about half a pint of gasoline; there may be dirt under the flap valve, holding it open and thus preventing a good vacuum from being built up, and the gasoline will wash this out. This flap valve sometimes acquires a black carbon coating, which prevents it from seating properly. To remove the

coating, the upper chamber must be removed; to do this, remove the screws on top, and carefully run a knife blade between the cover and body of the tank around the top, so as to separate the gasket from the tank without damaging it.

When the upper tank has been removed, the valve and seat may be scraped clean with a knife, or cleaned with a fine, flat file. When replacing the cover, make sure that the gasket is

undamaged, and coat it with shellac, as this joint must be airtight.

While carburetor trouble cannot possibly be attributed to the vacuum tank, occasionally the vacuum valve may become deranged, allowing raw gasoline to be drawn directly into the manifold. One case of this kind comes to mind, when the engine used up 10 gal. of gasoline in two hours, without being out of the garage. It would "load up," backfire, spit, and stall, in spite of all the adjustments that were tried on carburetor and ignition. The trouble was finally traced to the seat of the vacuum valve, which had become loose and prevented the valve from seating, thus allowing raw gasoline to be drawn directly into the cylinders. The brass seat was removed and $\frac{1}{8}$ in. filed from the bottom end; it was then replaced, and the aluminum peened over it, as shown in the detail drawing. This cured the trouble at once. When trouble of this kind is suspected, the suction-pipe connection at the manifold may be disconnected while the engine is running, and the two parts held $\frac{1}{8}$ to $\frac{1}{4}$ in. apart; if gasoline is running down this pipe, it will drip at the opening.

The air vent allows an atmospheric condition to be maintained in the lower tank, and the long tube on it prevents an overflow of gasoline when descending steep grades. If occasionally a small quantity of gasoline escapes no harm is done, and no adjustment is needed, but, if the vent regularly overflows, it may be found necessary to move the tank, which may be too close to the hot motor. The bottom of the tank should be at least 3 in. above the carburetor, so this should be checked; also, the hole in the main

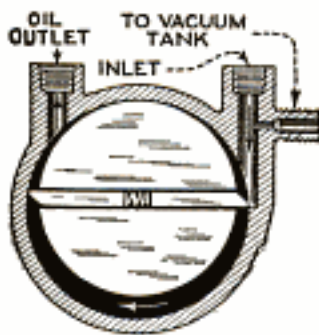

SECTION OF PUMP

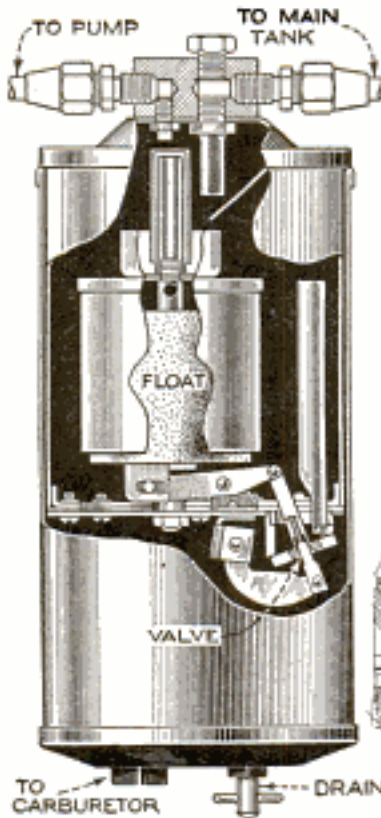

SECTION OF TANK AND VALVE MECHANISM

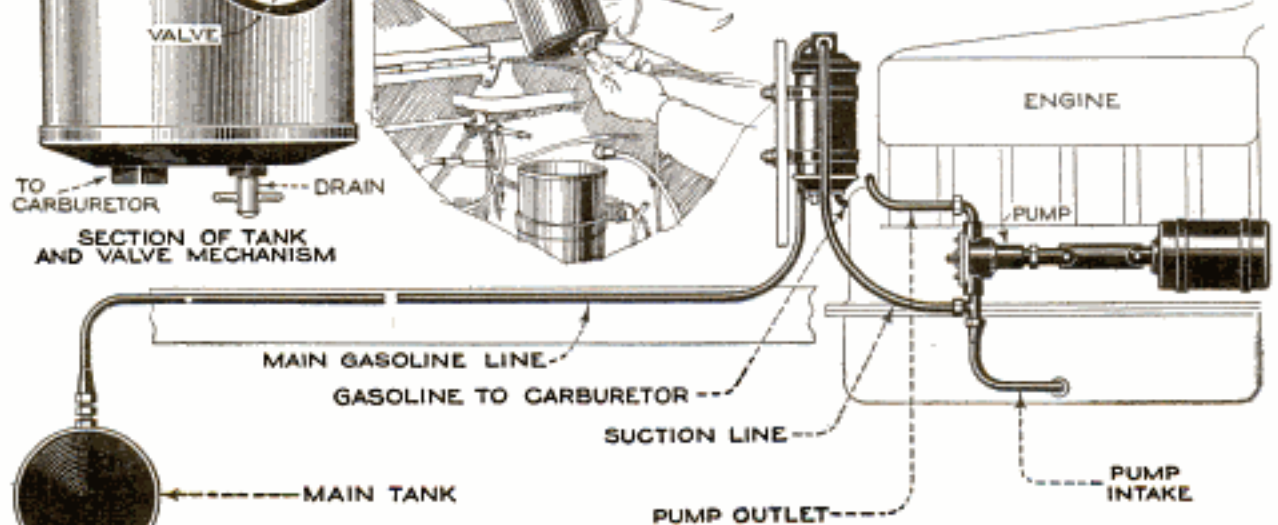
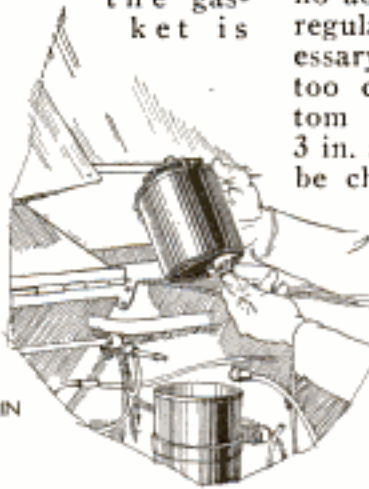

New Form of Vacuum-Tank System in Which the Suction Is Derived from a Specially Designed Oil Pump: When the Oil Runs Low, the Engine Stops

gasoline tank cap may be stopped up, or may be too small. It should be $\frac{1}{8}$ in. in diameter. Persistent overflowing, which cannot be cured by any of the foregoing remedies, may be stopped by attaching a length of tubing to the vent tube, and carrying it to the highest point inside the hood.

If the float should develop a leak and fill with gasoline, it will not rise and shut off the suction, and consequently the tank will flood over. It is not necessary to remove the entire tank to repair a float, but merely to remove the top, as for repairing the flap valve. The float is of copper, nickel-plated to withstand any possible corrosive effects of the gasoline. To repair the float, punch a small pin hole in it, so that the gasoline will run out of the leak, drain the float, then set it in a warm, dry place until the gasoline has all evaporated. Now solder the leak and the pin hole, using the smallest quantity of solder possible, to avoid changing the weight of the float. To test the float, dip it in hot water, when a train of bubbles will immediately mark the leak, if there is one.

To enable one to reach home with a leaky float, remove the plug in the cover when the tank is full. This permits the tank to function as a gravity tank, and the motor will run until the supply is exhausted. The tank is then filled by replacing the plug and running the engine, and the operations repeated.

A simple method of determining if there is dirt under the flap valve is to disconnect the tube leading to the carburetor, start the motor, and hold the finger over the opening in the bottom of the tank. If suction is felt continuously it is evident that the flap valve is being held off its seat; this can be remedied, in many cases, by simply tapping the side of the tank.

Unless gasoline is filtered through a screen or chamois when filling the main gasoline tank, some dirt or sediment will collect in the tank; part of this may be drawn into the vacuum tank, and the strainer under the gasoline-inlet elbow should therefore be cleaned every three weeks. The tank itself should be disassembled and cleaned thoroughly every six months, and some gasoline should be drawn off at the drain plug every two or three weeks. When the tank is taken down for cleaning, examine every part carefully to see that it is in first-class condition.

The vacuum tank shown in the lower part of the full-page illustration works on exactly the same principle as the one previously described, but it will be seen, by

referring to the sectional view, that the suction valve is directly connected to the float. The tank is mounted and connected in exactly the same manner as the preceding one, as shown in the illustration, and the remarks applying to the first may also be taken as applicable to the second.

The tank shown in the second illustration, while utilizing the vacuum principle, applies it in a radically different manner. The suction line from the vacuum tank runs, as shown, to the suction side of a specially designed oil pump. When there is plenty of oil in the engine, there is also plenty of suction in the tank, but just as soon as the oil supply runs low, so that it is dangerous to operate the engine, the suction stops, and the vacuum tank refuses to operate. Oil and fuel are both equally important in the operation of the engine, and the designer of this system has insured that an engine that doesn't get oil won't get gasoline either—a splendid safety device.

Another advantage of this system is that the vacuum produced increases with the speed of the motor, thereby keeping the vacuum tank full under the increased demand for fuel. In addition, it is claimed for this system that the oil is kept cooler, due to the admixture of air.

In this tank, the float is of cork, of sufficient size to afford a good factor of safety, so that "gas-logging" will not affect its proper functioning, and is, of course, immune from leakage. Only one valve is employed, and, as this is always immersed in gasoline, air leaks are reduced to a minimum. The gasket is also immersed in gasoline, and there is no need to break the joint to remove the inner tank for inspection of the valve, as it merely slips into the outer one. The entire mechanism of the operating chamber is mounted on its bottom plate, which is removed merely by taking out eight screws. To refill the tank, the plug at the top is removed and about a pint of gasoline poured in. The plug is then screwed home tightly, and the motor started.

These few directions, and the illustrations accompanying, should take the mystery out of the operation of the vacuum tank. The owner should let the tank alone as long as gasoline is reaching the carburetor, and, even if it is not, should always examine the connections and tubing first, to make sure the fault is not there, before opening the vacuum tank.

☞ A good filler for cracks in stoves and furnaces is made by mixing equal parts of salt and wood ashes into a paste.

Locking the Closed Car

Many small closed cars are not provided with door locks, and the owners do not always want to pay the price demanded for

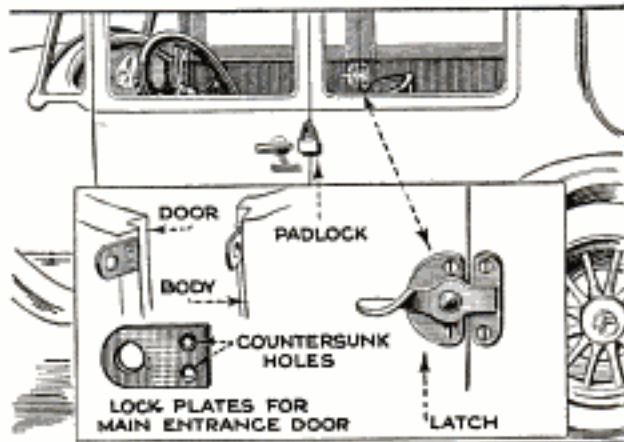

Simple Method of Locking the Doors of a Small Closed Car Using Only One Lock

handles of the locking type, or regular pillar locks.

A car of this type may very easily be locked by means of a padlock, however, thus making it a safe place to leave clothing and packages, as well as affording additional protection against car theft. As indicated, the left front door is provided with two flat-iron lock plates, one being screwed in a recess cut in the door edge, the other in the casing, so that the screws are covered when the door is closed. The remaining doors are fitted with simple latches, or sliding bolts, which are fastened before leaving the car.

These fittings are inexpensive, and, with a neat padlock of good make, do not detract from the appearance of the car, while adding to its security against theft.

Regulating Fireplace Dampers

The old-fashioned fireplace is becoming more and more popular with home builders every year; not only for ornamental purposes but for the appearance of cosiness and comfort presented by the open fire. The addition of an open fireplace, however, may cause the main heating plant to waste large quantities of fuel if the damper is not regulated properly, according to weather conditions, when the fireplace is not in use.

In cold and windy weather a strong suction is caused in the fireplace chimney, and consequently much of the warm air escapes, allowing the cold air to leak in through the cracks of the doors and windows. For this reason the fireplace draft should be closed in such weather.

In damp and sluggish weather, however, when it seems impossible to start a circulation of warm air within the house, and very little heat comes from the registers, it is advisable to open the damper of the fireplace. The draft of air moving upward through the chimney will be too slow to draw much cold air into the house from the outside, but will be sufficient to stimulate a stronger circulation through the furnace.

A Cork Extractor

An effective cork extractor, which pulls the corks without breaking them, can easily be made from a large tin-opener key. A small piece of metal, the same thickness as the key, is riveted loosely to the lower end of the key so that it can be turned easily, and both are ground down to a point as shown. In use the small piece is set in line with the key as shown on the right, and the key is pushed down through the cork. By tapping the key lightly the small piece falls to a position at right angles to the key and it is then an easy matter to pull the cork out.—Harold E. Benson, Boulder, Colo.

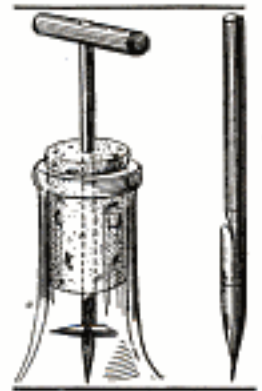

Opening Sardine Tins

Anyone who has opened a sardine tin knows that while it is very easy to roll back the cover by means of the key until it is in the position shown in the illustration, it requires a very powerful pressure on the key to force the rolled cover past the corner of the tin. If, however, when this point is reached, the point of an ice pick, or similar tool, is inserted through the handle of the key in the manner indicated,



a leverage is provided that makes it very easy to strip off the remainder of the cover. This kink will be appreciated by the feminine members of the family, whose fingers are not strong enough to apply the necessary force to the key.

Testing Battery Polarity

A simple method of determining the polarity of a battery or cell, and at the same time roughly measuring its strength, is as follows: Dissolve 1 part of potassium iodide in 25 parts of water; place the solution in a shallow dish, soak several pieces of white blotting paper in it, then remove them and allow to dry. To use, moisten a piece of the prepared paper and touch it with wires leading from both poles of the battery, keeping them about $\frac{1}{2}$ in. apart. A dark-brown spot will immediately be produced where the wire from the positive pole touches the blotter. A dead cell or battery will produce no spot. A little experience in judging the rapidity with which the spot is formed, and the shade of the color produced, will soon enable one to tell the condition of the battery fairly accurately, whether it is nearly dead, half charged, or fully charged. This method is applicable to both storage batteries and dry cells, although the wires must be further apart in the case of storage batteries.—Henry D. Hirsch, Chicago, Illinois.

Buggy-Spring Saves Pump Repair Bills

A Wisconsin farmer who had considerable trouble in keeping his windmill and pump in repair concluded that it was the erratic action of the mill that was to blame. The weight of the rods, together with the

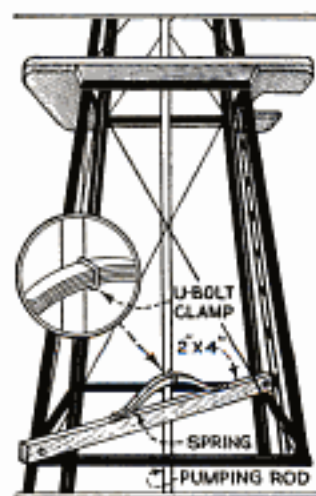

water being lifted, steadied the mill on the up-stroke but, in a strong wind, the downward motion was always jerky and naturally wearing on the mill and pump parts. To overcome this, he mounted a half section of a buggy spring on a 2 by 4-in. oak crosspiece as shown in the drawing, and fastened the spring to the plunger rod as indicated. The result was that both strokes were more evenly balanced than before and the jerky action was entirely eliminated, making the mill run smoothly and quietly. The owner claims that this attachment has paid for itself many times over by the elimination of shut-downs and repairs.—G. E. Hendrickson, Argyle, Wis.

An Amusing Trick

An amusing trick that can be performed with a mirror, two pieces of paper, and a pencil is shown in the illustration. One

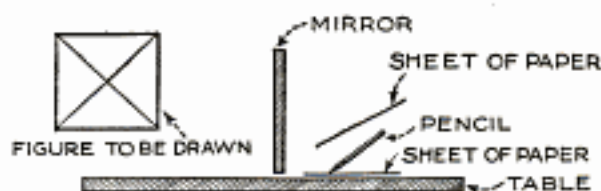

An Amusing Trick, the Materials for Which Are Available Everywhere

person is seated at a table and is instructed to draw the figure shown in the upper left-hand corner, first drawing the square and then the cross inside of the square. This must be done by looking in a mirror which is held vertically as shown, a piece of paper being used as a shield to prevent the victim from seeing the pencil movements directly.

It will be found rather easy to draw the square, but mysteriously difficult to draw the cross inside. In fact, many people find it absolutely impossible to make the pencil start diagonally in the proper direction, and very few can draw a straight line, even when they do make the pencil move in the right direction.—J. R. Minter, Washington, Ind.

Shellac for Floors

A good and durable finish for floors, stairways, and other surfaces that are subject to heavy wear is obtained by applying a coat of shellac over the filler coat, before using the regular varnish. The shellac should not be mixed with the varnish, and if any thinner is required alcohol should be used. The wear-resisting qualities of the shellac will offer a pleasant surprise to anyone who has to varnish floors often, and the gloss obtained has a long life.

Keeping the Clothespins Handy

The drawing shows a novel method of keeping clothespins handy, much better than carrying them around in a bag or



An Idea that Not Only Keeps Clothespins Handy, But Prevents Them from Being Lost

apron. The clothespins used for this purpose are of the spring type, and a number of them are strung on a length of galvanized wire suspended about 4 in. above the clothesline, as shown in the lower insert. The clothespins can be snapped on the line at any desired point, and when not in use they are pushed to the end of the wire.

Dry-Plate Holder Reduces Handling

When handling developed plates that must still be fixed and washed there is always some danger of scratching or imprinting finger marks on them, and for this reason the plate holder shown in the photo was constructed. The frame is made of soft-iron wire, and the slides of short lengths of $\frac{1}{4}$ -in. copper tubing, cut lengthwise and soldered to the frame as shown. After the plates are developed

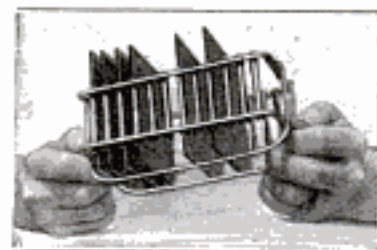

they are placed in the holder and immersed into the hypo solution, then the holder is immersed in running water to re-

move all traces of hypo. In this way the individual plates are not handled from the time they leave the developing solution until they are dry, and there is very little danger of damaging them.—John H. Schalek, Pittsburgh, Pa.

Easy-Starting Fluid for Autos

Many clothes-cleaning preparations on the market are nothing more than pure high-test gasoline, and they form ideal priming fluids for the auto in winter. Purchase a can of cleaning fluid at the drug store—the smell will tell if it is of the gasoline family—and have the druggist put a few drops of ether into the can. The next time the engine is hard to start, prime with this, and the results will be surprising.

A Furnace-System Humidifier

A humidifier for the home using furnace heat can be constructed from a length of $\frac{1}{8}$ -in. brass tubing and a petcock. It is arranged as shown in the drawing, the brass tubing being connected to the hot-water system, so as to conduct warm water to a register, where it is emitted in a fine spray into the hot-air current. The warmest register in the house should be selected for this purpose. A hole is drilled in the

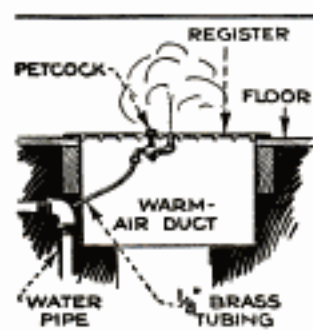

nearest hot-water pipe, and tapped for $\frac{1}{8}$ -in. brass tubing. A piece of the tubing, long enough to extend to the register, is screwed into the hole, bent as indicated in the drawing, and a petcock screwed on the upper end. The

petcock is fitted with a nozzle, made from a short length of brass tubing closed at one end, and having a pin hole punched through it so that a fine spray will be emitted when the petcock is opened. The spray is adjusted by the petcock and should not be allowed to flow so fast that it cannot all be vaporized at once; for this reason the pin hole must be very small. When the spray is once adjusted it will operate without much care or attention. No harm will result if the water is allowed to flow too freely by mistake, as it will then drain down the warm-air duct into the furnace where it will instantly be vaporized.—Paul L. Fetherston, Jackson, Mich.

MAKING AN INEXPENSIVE CRYSTAL RECEIVER

THERE is a wide field for a simple and inexpensive crystal detector, both among beginners and "old-timers." The beginner does not usually want to invest much money in a set, until he thoroughly understands the principles involved, and a crystal receiver is ideal for him; the more advanced radio enthusiast, also, can use a crystal set to advantage as a standby for the not infrequent occasions when his large set "goes on strike"—usually when

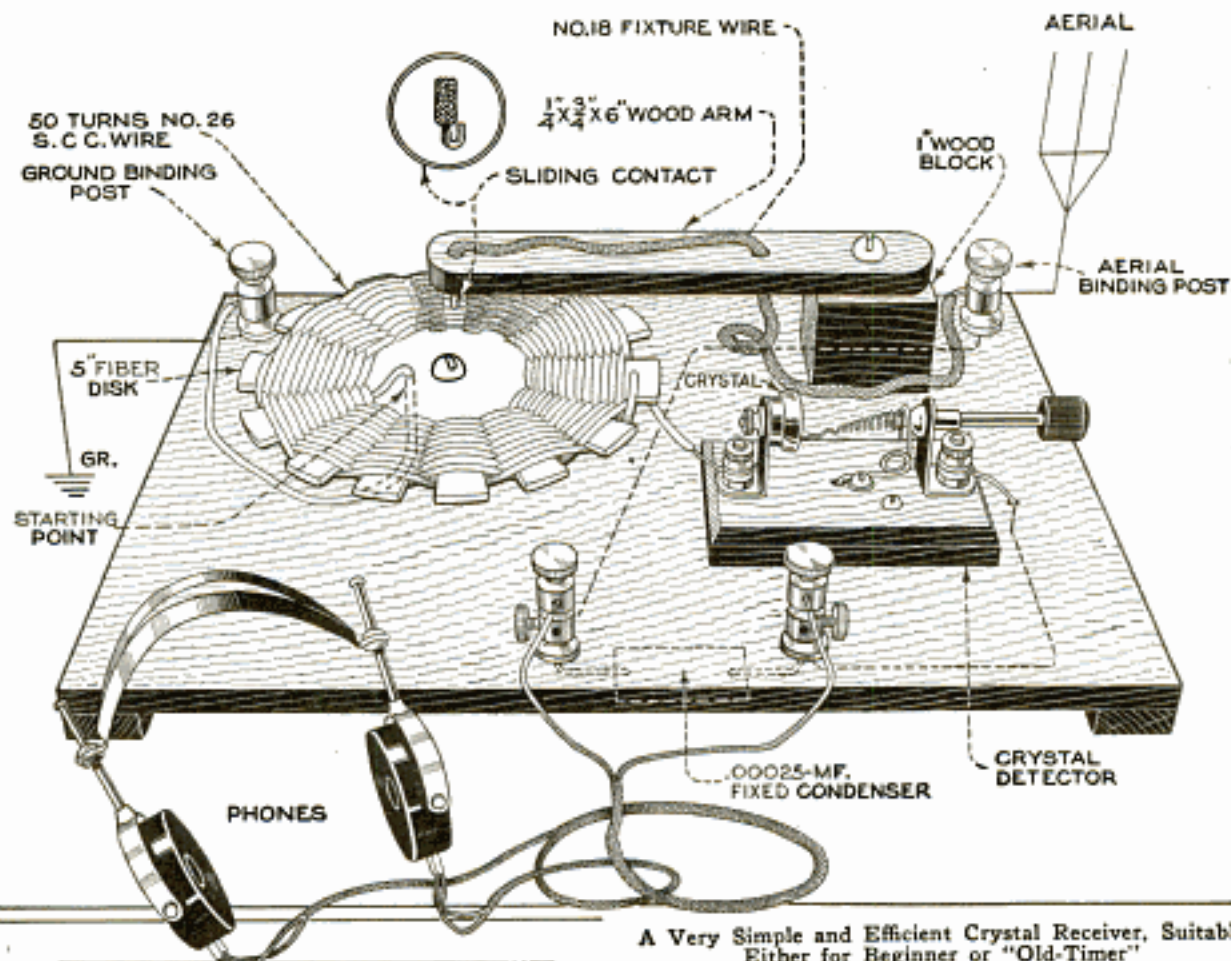
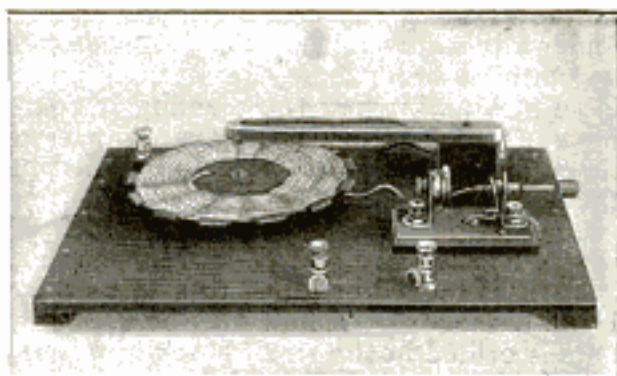

A Very Simple and Efficient Crystal Receiver, Suitable Either for Beginner or "Old-Timer"

a particularly interesting concert or lecture is "on the air."

The crystal receiver described in this article is easy to build, is always ready to use, will give excellent results up to a distance of 20 miles, and costs only about 65 cents to build.

The coil, which is of the spider-web type, is wound on a form consisting of a slotted fiber disk, $\frac{1}{8}$ in. thick, and 5 in. in diameter. There are 13 "spokes" in the form, and, if fiber is unobtainable, heavy cardboard may be used instead. Fifty turns of No. 26 single cotton-covered wire are wound on the form, the wire being led through a small hole drilled near the center of the disk and then wound on

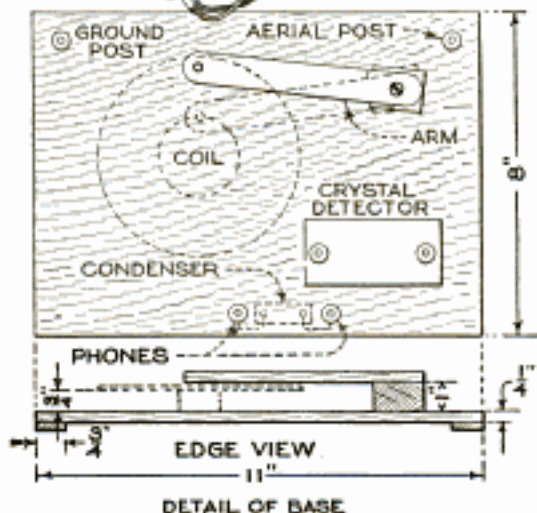

the form from the center out, over and under alternate spokes. The turns should be counted every time the starting point is passed, and, when the winding is completed, the end of the wire is passed through another small hole and drilled in the end of one of the spokes.

The coil is screwed to a small block of wood, 1 in. square and $\frac{3}{4}$ in. high, which, in turn, is tacked or glued to a $\frac{1}{4}$ by 8 by 11-in. baseboard. A bolt may be used if a hole is drilled in the small block and base, and the bolt passed through both. A strip of wood, $\frac{1}{4}$ in. thick and $\frac{1}{4}$ in. wide is then cut to a length of 6 in. and the ends rounded. Two small holes are drilled in this strip to take No. 18 insulated fixture wire, and a hole drilled for a screw or bolt. The strip is mounted on a block of wood 1 in. high, and screwed or bolted to the base so that the arm can move freely. The binding posts, detector, and .00025-mf. condenser are then screwed to the baseboard, the condenser being screwed to the underside, between the phone posts.

A length of No. 18 fixture wire with one end bared and doubled over as indicated in the detail, is threaded through the holes in the contact arm, and the other end connected to the aerial binding post. The arm is then moved so as to mark the path of the doubled end of the wire over the coil, and the insulation is carefully scraped off each turn along this path. This is best done with a small piece of emery cloth, doubled and used on edge. Care must be taken that no two turns touch at

the bared spots, and the doubled end of the bared contact wire must be cleaned, and adjusted to make good contact with the coil turns.

The starting end of the coil is now connected to the ground binding post, and the other end to the crystal side of the detector. The "cat-whisker" of the detector is connected to one of the phone posts, the other phone post connected to the aerial post, and the condenser connected across the phone posts, all this wiring being done under the baseboard, as indicated in the drawing.

A strip of wood, $\frac{1}{4}$ by $\frac{3}{4}$ by 8 in., glued to each side of the base, completes the instrument.

Connect a good pair of phones to the phone posts, solder or clamp a lead from the ground post to a water pipe, and connect up the aerial lead, and the instrument is ready for use. The installation of a suitable aerial and ground for a detector of this type was illustrated and described in the May, 1923, issue of this magazine. If an overhead aerial cannot be used, for any reason, the reader can still get good results by laying three complete turns of ordinary bell wire around the picture molding of the room, leaving one end "open," and connecting the other end to the aerial lead.

This instrument will tune to all wave lengths used by broadcasting stations, and for longer wave lengths it is only necessary to use smaller wire and more turns on the coil.—F. L. Brittin, Chicago, Ill.

Emergency Garage Heater

An emergency garage heater, which is simple but very effective, can be made from a blowtorch, a 1½-ft. length of 8-in. stove-

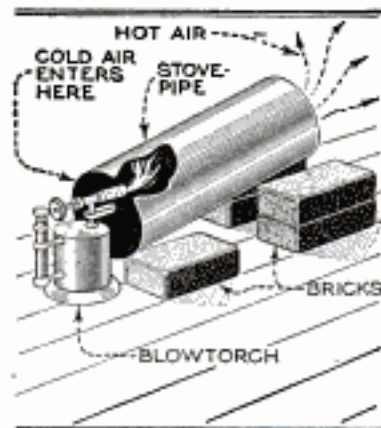

pipe, and a few bricks, arranged as shown in the drawing. The stovepipe is set on the bricks at an angle to the floor, and the blowtorch is set at the lower end. It is adjusted to give a bluish flame, which

gives the most intense heat, and a circulation of air is immediately set up through the pipe, the cold air entering the lower

end, and, after being heated, issuing from the upper end. An improvised heater of this kind will heat a small garage or shed in a very short time.—Perry Chandler, Hillside, Mass.

Trimming Clarinet Reeds

The reeds used for clarinets and saxophones must always be trimmed to take off the rough edges, or to make them stiffer. It is almost impossible to do this perfectly with a knife or shears, but two coins, preferably 5-cent pieces, may be used with good results. Place the reed between them so that the edge to be trimmed projects as much as necessary, having the coins perfectly even, above and below. Hold them with the thumb and finger, and burn off the projecting end of the reed with a match. Run the finger over the burnt edge to take off the charcoal, and this will leave the edge perfectly smooth and round.

Homemade Coal Cabinet

The coal cabinet shown in the illustration is much neater and more convenient than the ordinary kitchen coal scuttle, with its attendant dirt and dust. It is made of strong matched lumber, and,



when stained and varnished, makes a presentable addition to the kitchen furniture. A door is fitted at the bottom of the front side, and, directly above the door opening, on the inside an "apron" is nailed, which deflects the coal away from the door; this, with the sloping threshold, prevents pieces of coal from dropping out onto the floor when the door is opened. A ring on the front of the cabinet slips over the door knob and holds the door open when shoveling out coal. The weight of the door holds it shut without any catch.—Jos. C. Coyle, Colorado Springs, Colorado.

prevents pieces of coal from dropping out onto the floor when the door is opened. A ring on the front of the cabinet slips over the door knob and holds the door open when shoveling out coal. The weight of the door holds it shut without any catch.—Jos. C. Coyle, Colorado Springs, Colorado.

Emergency Cotter Pin

A short length of brass or steel wire, bent with a pair of pliers as shown in the drawing, makes an excellent cotter pin, which is self-locking and can easily be attached or removed with the fingers.

The wire is first bent over with a pair of flat-nosed pliers as shown in Fig. 1, the end being allowed to project a little. The wire is then given a second twist around the end, as indicated in Fig. 2, and cut off. Fig. 3 shows a pin of this kind used on a bolt, and Fig. 4 how it is used on a clevis pin. An emergency cotter pin, made in this way, serves the purpose just as well as the split cotter commonly used.

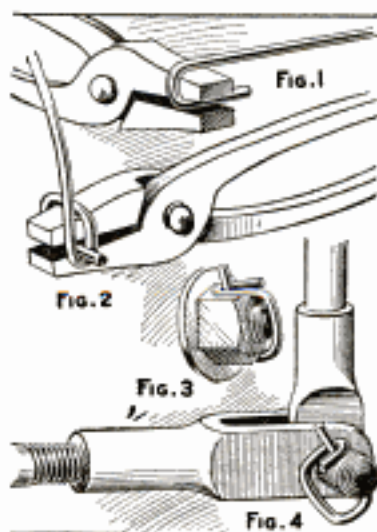

Detachable Runners for Baby Carriage

The drawing shows a set of easily made runners for the baby carriage that can be attached or detached in a few moments,

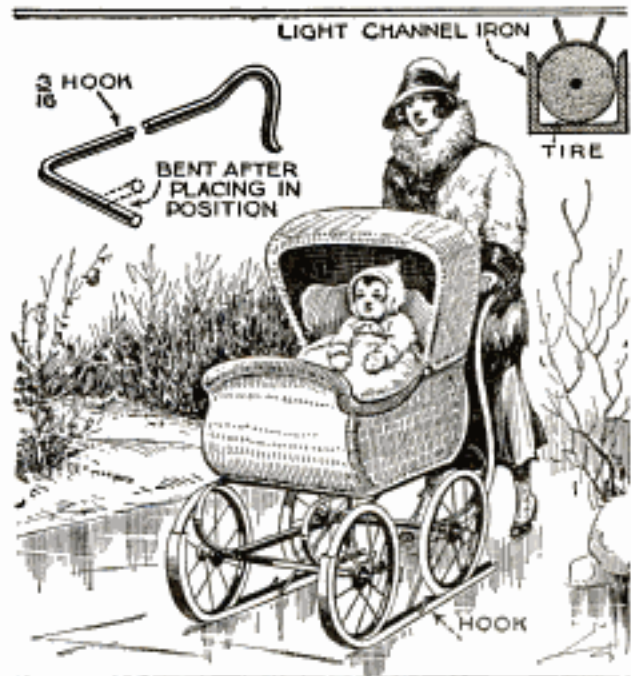

Runners for the Baby Carriage Are Easily Made and Can Be Attached in a Few Moments

without removing the wheels. The runners are made of light channel iron in which the tires fit fairly snugly, and they are held in place by means of $\frac{3}{16}$ -in. iron hooks, bent and attached as shown. The front ends of the runners are bent to conform to the curvature of the wheels, and the rear ends should extend about 8 in. beyond the rear wheels. One end of each hook is permanently attached to the runner, and the other end is snapped over the rear axle. The hook should be made a trifle short, as there is a little "give" in the rubber tires, and in this way a tight fit can be obtained.

Vacuum Bottle Aids in Starting Engine

A vacuum bottle, filled with hot water, has been found to be of considerable assistance in starting an automobile engine during cold weather. The intake manifold is wrapped with a woolen rag and the hot water contained in the vacuum bottle is poured over the rag. The object in using a woolen rag is to retain the heat around the manifold as long as possible, wool being an excellent nonconductor of heat. It will be found that sufficient heat is imparted to the mixture inside of the manifold to cause it to vaporize readily.

Remodeling an Old Sewing Machine

An old sewing machine, which was in perfect mechanical condition, but was mounted on an old dilapidated wooden

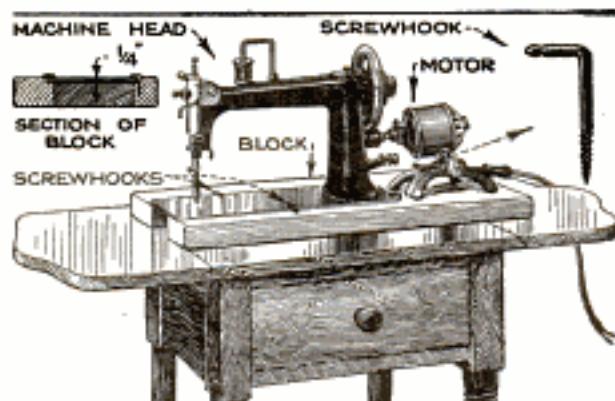

An Old Sewing Machine Made Portable and Run with an Electric Motor

frame, was made portable by fitting it on another base, and running it by means of an electric motor.

A block of wood 2 by 10 by 21 in. in dimensions, was planed and sandpapered smooth. The head was removed and the space in which it fitted was traced on a piece of paper, making a pattern $6\frac{1}{2}$ by 14 in., with the corners slightly rounded. The pattern was then traced on the new base, leaving a space of 7 in. on the right side, $2\frac{1}{2}$ in. on the back, and $1\frac{1}{2}$ in. on the front. Inside of this mark another rectangle was drawn, $\frac{1}{2}$ in. smaller than the first on all sides except the left side, where it was 2 in. smaller. The block was then cut out on the inside marks, and an opening cut in the left side, as shown in the drawing, so that the bobbin could be manipulated easily. On the outside lines the wood was cut down to a depth of $\frac{1}{4}$ in., to form a shoulder for the iron base of the machine head. Brass screwhooks of the type indicated, and about $2\frac{1}{2}$ in. long, are screwed into the base on each side of the machine head to hold it in place securely. The base is stained and varnished to give it a neat appearance.

A small motor suitable for running sewing machines can be purchased at any electrical supply store. The motor is clamped in place with one long screwhook of the same type as those used to clamp the head. —A. Seefhoff, Bellerose, N. Y.

When cranking an automobile engine with an electric starter, throw the clutch out; this allows the starter to turn the engine alone without turning the clutch and the idler-shaft gears, and consequently prolongs the life of the battery.

Improving Binding Posts

An ordinary screw binding post can be improved considerably by slotting it with a hacksaw as indicated in the drawing. The wire then can be inserted in this slot and the nut screwed down, making it unnecessary to bend the wire. With such a slot cut in the binding post, the phone terminals of a radio set and similar tips can be held securely without the danger of slipping from under the nut, or the necessity of obtaining regular phone posts.

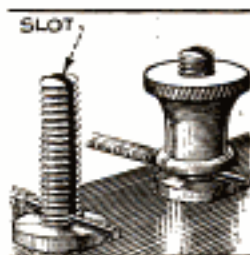

Paste That Will Not Sour

A paste that will not sour is composed of 3 quarts flour, 3 teaspoonfuls powdered alum and $\frac{1}{2}$ teaspoonful powdered blue vitriol. Mix in dry state and make in the usual way. It is safe to make a barrel of this paste at a time if much of it is used.

Poultry Waterer Made from Carburetor

A neat and efficient poultry waterer was made from a discarded carburetor by a Nebraska farmer. The bowl of the carburetor, with the float mechanism, was removed and set into a shallow hole in the ground. The inlet was then connected to a tank set on a post about 2 ft. high, by means of copper tubing. The tank was merely a tin pail, with the tubing soldered into a hole cut in the bottom, and the whole apparatus was located in a shady spot, so

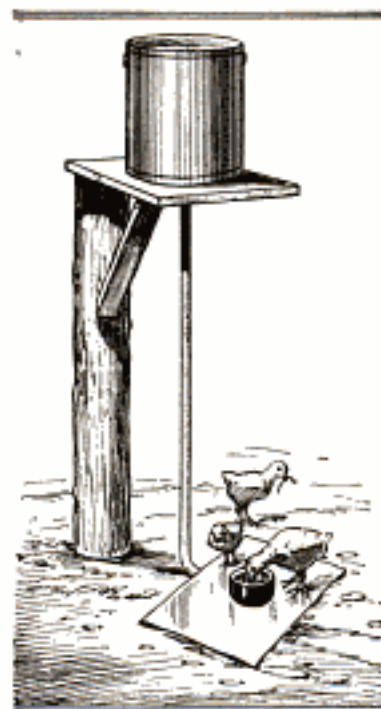

that the water would remain cool during hot weather. A sheet of tin, with a hole cut in it for the bowl, was placed on the ground. The float keeps the bowl full.

Saving the Cherries

On many farms having cherry trees, considerable annoyance is experienced in having birds pick the trees bare, even before the cherries are ripe. This can easily be prevented by mounting a stuffed owl on a long slender pole, and setting the pole against the tree so that the owl is among the top branches. The birds will then give the tree a wide berth. If no stuffed owl is available, a mounted black snake will answer the same purpose.—C. A. Martin, Lewisburg, Pa.

Radiator Used as Still

The drawing shows a simple apparatus for distilling water, consisting of an old automobile radiator placed in a tub of water.



The lower outlet of the radiator is connected by a short length of hose to an iron pipe, which is passed through the side of the tub; the upper outlet is connected to the steam pipe. The steam condenses very quickly in the radiator, due to the considerable surface exposed to the cold water in

the tub. A constant stream of cold water is admitted into the tub through a pipe that extends nearly to the bottom, and the water, upon rising, passes off through a short overflow pipe.

Guard for Ax Handles

A southern lumberman, who did much timber splitting, had considerable trouble due to his ax handles wearing close to the head, causing them to break easily at this point, and he therefore devised the simple shield shown in the drawing to prevent the trouble. The shield consisted of a rectangular piece of thin sheet iron, bent over and screwed securely to the handle as shown.

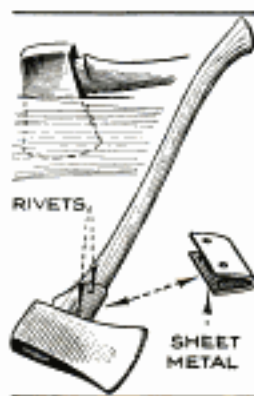

Quick Method of Removing Leaves

The drawing shows an easy method of carrying a large quantity of leaves. A piece of 1-in. wire mesh about 4 ft. wide



An Easy Method of Carrying Large Quantities of Leaves, by Means of a Piece of Chicken Wire

and 6 ft. long is laid alongside the leaves, which have been raked together as compactly as possible, and the pile is raked onto the wire. Then by picking up the edges as shown, the whole pile can be carried away at once.—Mrs. A. K. Hinkley, Rowley, Mass.

A Multiple-Phone Connector

The amateur radio "fan" who has two or three sets of head phones will find the arrangement shown in the illustration a quick and convenient means of switching from one set of phones to two or three sets, as he may desire.

Six binding posts, and a small 1-in. switch, with 3 switch points, are mounted on a small rectangular piece of bakelite, and the switch points and binding posts are connected as shown.

The first binding post and the switch blade are connected to the two phone binding posts on the panel. Moving the switch blade from one point to another puts one, two, or three sets of phones into use. The wiring, of course, is done on the underside of the bakelite.

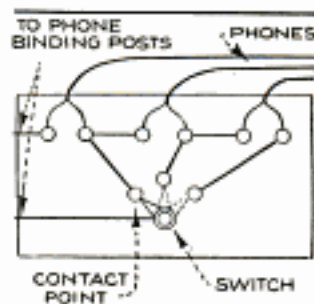

Hints for the Amateur Mechanic

By J. V. ROMIG

THE amateur mechanic will greatly improve the quality of his work if he takes advantage of the following suggestions, relative to design, selection of materials, and constructional details.

Before starting actual construction, sketch the job in at least three views, giving all dimensions, so that it will be seen just how the finished article is to look, from any point or angle. The design thus roughly sketched can usually be improved by changing a few lines or dimensions, which takes but a few moments. Minutes spent in sketching mean hours saved in construction. In designing any article, the amateur mechanic should always endeavor to hold to simplicity of design, combined with strength.

The best aid to the amateur in learning how to design, in addition to textbooks, is the reading of catalogs and trade journals pertaining to machinery, etc., that can be obtained from many sources. Catalogs should be kept in order; it is best to file them in alphabetical order, or number them, and keep an index book handy so that any book can be found in a moment.

In the selection of materials, the amateur mechanic must have a good knowledge of sizes and shapes usually available. In wood selection, use the tables of comparative strength to be found in handbooks and catalogs. Also select the proper wood for each particular use, as some woods are only good for inside use, while others will withstand the effects of weathering. First-grade lumber costs more, but is worth it. Rather buy dressed lumber from the planing mill than attempt to plane it down from the rough at home, and have the planing mill make extra-thick and wide sections by laminating, as it is equipped with the proper facilities for gluing and pressing.

Steel-shape books are obtainable from all leading steel companies, and, in these, the designer has available the dimensions of I-beams, H-columns, channels, and angles, as well as tables of their strength and other factors. These figures on beams, etc., are particularly useful in the designing and fabrication of small machinery, for which such materials may often be used instead of castings. Structural-steel shapes are easily procured at a few cents a pound, cut and drilled to the buyer's specifications. A knowledge of pipe and pipe fittings is also advisable. Handbooks and catalogs contain tables that show both internal and external

sizes, weight per foot, strength, etc., and all such data should be religiously filed and applied.

Mill supplies, such as hangers, shafting, belting, and pulleys, are listed, together with a complete line of tools and equipment, in the mammoth catalogs sent out by large mail-order houses. Their mill and hardware-supply catalogs also give an accurate description and price of each article, and enable one to estimate the cost of completed machines. In many cases, material can be obtained from these houses that cannot easily be obtained locally. Another valuable source of material is the local scrap or junk yard. Here pulleys, flywheels, and gears and wheels from discarded farm machinery and automobiles are found in all sizes. Pulleys that are too small can be rebored, while those that are too large can be bushed down. Shafting can be sawed to suit. Such junk should be bought by the pound, and should not cost more than one-half the amount of similar new materials per pound. Pipe and fittings for high-pressure work, however, should never be bought at the junk yard, but from dealers selling hydraulic and refrigerating machinery and supplies.

When, in the building of any machine or article, special castings are required, the patterns for them should be made as simple as possible. If only one or a few similar pieces are needed, omit, if possible, the cores, as holes can be drilled cheaper than a corebox can be made. Round off all corners of the patterns with fillets of generous size, as castings with sharp corners pour badly, and are apt to crack and break at the sharp juncture of the two angular surfaces. Observe all rules for shrinkage of metal and give sufficient draft to allow the free withdrawal of the pattern from the sand. Fit dowel pins accurately, as a casting never comes out better than its pattern. When building a pattern for a casting, allow for all necessary machining by extra thickness of metal, but try to hold machining down to a minimum. Always have a spare casting or two made up if possible; the added cost is usually not high and saves one the trouble of going into the work again in case the first one is spoiled or broken. Many small bearings can be cast solid in bronze or brass, saving the trouble of bushing a casting made in iron.

Time and expense can often be spared if standard ready-made parts are used, instead of trying to make them.

Prize Offers and Announcements

4196
THEATER TO PAY ONE HUNDRED DOLLARS FOR AN OUTDOOR PLAY

For an original play suitable for presentation on its outdoor stage (56x60 feet), during the summer of 1924, the Forest Theater of Carmel, Calif., offers a prize of \$100. Manuscripts should be in the hands of the secretary of the theater before February 1. A nom de plume is not necessary. Play should approximate two hours acting time. There is no limitation as to subject or scope.

4196
NEW USES FOR PRESSED METAL BOUGHT BY COUNCIL THAT PAYS FOR IDEAS

Ideas of new ways to use pressed metal are paid for by the Pressed Metal Trade Extension Council, Chicago, Ill., which issues a free metal booklet describing various things now made with it. Some of these are stewpans, auto bodies, door knobs, railway cars, and shoe eyelets. Pressed metal is anything that can be produced by stamping sheets of steel brass, copper, aluminum, or any other common metal.

2973 27 W Juncy St.
HUNDRED DOLLARS OFFERED FOR POEMS PUBLISHED QUARTERLY IN MAGAZINE

One hundred dollars in prizes are given for poems published in each quarterly issue of The Poet and Philosopher, 32 Union Square East, New York City. The conditions of the contest change with each issue of the magazine.

4199
AWARD FOR BLACKBERRY-BRIAR KILLER OFFERED BY NEW ZEALAND MAN

Frank L. Newberry, Shaw St., Reefton, New Zealand, offers an award of 750 pounds sterling for an effective blackberry-bush exterminator that will pass test conducted by New Zealand government experts. It must impregnate itself in roots of bushes without harming surrounding plants.

2976
PRIZES FOR PHOTOS AWARDED MONTHLY BY A MOTION-PICTURE MAGAZINE

Prizes of \$25, \$15, and \$10 are awarded monthly by Shadowland, 65 E. 56th St., New York City, for photographs not previously published. Information stating date and hour of exposure, stop number used, printing medium, and character of print used is required.

2961
PAY FIVE HUNDRED DOLLARS FOR VERSE FOR NEW SONG

For the best second verse for a future song release (Where Is Your Smile?) a \$500 prize is to be paid by Handy Bros. Music Co., 2573 8th Ave., New York City. A free copy of the song and rules of the contest will be sent to prospective competitors.

2964
SHORT SALES TALKS ABOUT DRUG-STORE ARTICLES GET MONEY EACH MONTH

Drug clerks and salesmen are offered a first prize of \$10, second of \$5, and third of \$2 for a 100-word statement boosting things sold by the store. Photographs of articles, partly cut to make identification difficult, appear in Drug Topics, 291 Broadway, New York City, monthly.

408
ESSAYS TO WIN TEN THOUSAND DOLLARS AND UNIVERSITY SCHOLARSHIPS

Ten thousand dollars in cash prizes and scholarships to Yale, Vassar, and other universities and colleges are to be awarded in a prize-essay contest conducted by the American Chemical Society, Munson Building, New York City. It is open to students of high and secondary schools and is intended to stimulate interest in the development of chemical science. Six prizes of \$20 in

gold are to be given in each state of the Union and the authors of the six best essays from all over the country will win scholarships carrying with them tuition for four years of chemistry or chemical engineering in Yale and Vassar and \$500 in cash. Scholarships in other colleges will be awarded. Full terms of the contest are being distributed by the society to high schools and libraries throughout the country.

2977
PAYS TWO HUNDRED EACH MONTH FOR BEST JOKE IN MAGAZINE

For the best joke of less than 100 words, \$200 is paid each month by Gloom, Los Angeles, Calif. Three hundred dollars more are awarded monthly, in amounts from \$100 to \$10, for winning jokes.

2971 - 230 Court St.
TEN DOLLARS PAID FOR FUNNY STORIES THAT ARE ORIGINAL AND SHORT

Ten dollars for the best story, \$5 for the next, and regular rates for all others printed are paid weekly by Judge. Original short, funny stories, that have not been published before, are wanted.

627 W. 43rd, New York.
BUY SHORT ARTICLE ON THE COMMUNITY FOR FIFTY DOLLARS EVERY MONTH

For the best article of not over 500 words on various phases of community improvement The Delineator, New York City, offers a monthly prize of \$50. The subject is changed each month.

2966
FIVE DOLLARS FOR MISTAKES IN MOVIE PAID BY A FILM MAGAZINE

Mistakes seen in the movies, if brought to the attention of Film Fun, 627 West 43rd St., New York, will be published. Five dollars is paid monthly for the winning "film flaw."

2870
TEN DOLLARS FOR HOUSEHOLD IDEAS SAVING TIME AND MONEY

For the best suggestion each month on how to save the housekeeper's time or money The Delineator pays \$10.00. All other ideas printed are bought for \$5.00 each.

CONTESTS PREVIOUSLY ANNOUNCED

Medals, Diplomas, and Money Awards: Announced August issue, 1921; awards offered by the Franklin Institute. The Franklin medal is for workers in technology; the Elliott-Cresson is for original research work and invention; the Howard N. Potts is for important development of previous discoveries and inventions. Each award consists of a gold medal with a diploma. There are also a silver medal, and a Certificate of Merit awarded for meritorious discoveries, and cash premiums for certain work in optics.

Awards to Further Science of Electricity: Medals and prizes, amounting in all to about \$20,000; announced February issue, 1923.

For Best Work by American Chemist: An annual award of \$25,000; announced February issue, 1923.

Names for Great Lakes Steamers: Two prizes of \$50 each; announced February issue, 1923; suggested names must be submitted before the opening of navigation season in 1924.

Essay on Economic Subjects: Prize \$1,500; announced March issue, 1923. closed

Pulitzer Prizes, Columbia University: For best work in various literary and journalistic lines; announced April issue, 1923; nominations of candidates must be made before Feb. 1, 1924.

Scholarships for War Nurses and Ex-Service Men: Numerous scholarships provided at colleges and universities throughout the country under the will of the late La Verne Noyes; announced April issue, 1923.

Committee on prize essays

Most Practicable Device for Recording Mine-Shaft Signals: Prize of £250, or about \$1,100; announced May issue, 1923. *closed.*

Prizes for Essays: Three yearly prizes of \$2,500, \$300, and \$200; announced June issue, 1923; for articles on subjects relating to business development and the modern trust company; closes August 31, each year.

Boys' and Girls' Short-Story Contest: Two first awards of \$160, and other prizes; announced May issue, 1923.

Greatest Benefit to Community Rendered by Women's Club: Prize, \$1,000; announced May issue, 1923. *closed.*

Prizes for Essays on Purchasing Power: Three prizes of \$1,500, \$800, and \$500; announced June issue, 1923. *closed.*

Students' Essays on Municipal Government: Prizes \$250 and \$100 for postgraduates; \$100 for undergraduates; announced May issue, 1923.

Preventive of "Klieg Eyes": Award of \$50,000; announced August issue, 1923.

Prize for World Peace Plan: Edward W. Bok, of Philadelphia, offers \$100,000 for "the most practicable plan by which the United States may co-operate with other nations to achieve world peace"; announced October issue, 1923.

Prizes for Essay on Plumbing: Two prizes of \$100 and \$50; announced October issue, 1923. *closed.*

Awards for Movie Titles: Prize of \$10,000 for one word; \$20,000 for two words; \$25,000 for three words; announced October issue, 1923.

Valuable Hardware Ideas: Trade magazine will pay \$10 for best each month and \$2 for others accepted; announced October issue, 1923.

Electric Storage-Battery Mine Locomotive: Prize, £1,000; announced August issue, 1923. Working trials of machines selected will be announced later.

Vertical Airplane Flights: Prizes aggregating £50,000; announced August issue, 1923; entries must be received before April 30, 1924.

Science Notes for Daily Use

TELEPHONE RECEIVERS BEST TESTED BY ACTUAL RECEIVING CIRCUITS

The most generally satisfactory method of testing telephone receivers in determining the delicacy and accuracy with which they respond to speech is by comparing one with another in listening to the sounds of the human voice. No strictly scientific method for testing them mechanically, or independent of human observation and estimate, has yet been devised. A musical note is not satisfactory, for two reasons, one is that a sound of such a uniform character tends to pack the carbon granules of the transmitter and its action becomes defective, and the other that the ear, in hearing a note of constant pitch, is quickly fatigued so that a proper estimate of the sound reception cannot be made.

MATCHES CAUSE SKIN DISEASE

When placed in pockets close to the skin, matches have been found by physicians to cause a skin disease that is characterized by unsightly eruptions. The malady starts from the contact of chemical substances in the matches with the skin, usually brought about by perspiration. It is found to be more prevalent among farmers and others who labor in hot weather clad only in light garments.

FLAX LILY OF NEW ZEALAND TO PRODUCE LINEN

As a substitute for flax, the plant from whose fibers linen is made, it has been suggested that the flax lily, which grows in abundance in New Zealand, be used to make the cloth. Through a scarcity of the fabric it has risen in value. The new plant can be grown successfully in many parts of Europe and America and is said to be cultivated with less difficulty than is flax. So far, yields of the crop have produced as much as 2,240 pounds to the acre.

EXPLOSIVES NOW SAFE ITEM FOR RAILROAD TRAFFIC

During one year, railroads of the United States hauled almost 600,000,000 pounds of explosives and a large tonnage of fireworks, according to a report, with but a single personal accident. In addition to these items,

IN accordance with the editorial policy of this magazine never to accept compensation in any form for what appears in our reading pages, and also to avoid all appearance of doing so, we are obliged to omit the name of the maker or the seller of any article described. This information, however, is kept on file and will be furnished free, by addressing Bureau of Information, Popular Mechanics Magazine, Chicago. [Editor.]

a great volume of materials reclaimed from war munitions was carried. The total property loss caused from the only explosion recorded for the 12 months amounted to \$75. The damage was done by a bomb which had been in some way placed in a baggage car.

SWATTING FLY NOT ENOUGH AS MOST BLOWS ONLY STUN THE PEST

That 90 per cent of "swatted" flies are not dead but return to life, is the assertion of a scientist. In the course of his researches, he assaulted numerous flies with swatters of mosquito wire, sheet rubber and other materials. In the great majority of cases, he found that the pests were not killed, but were merely suffering from internal injuries and shock and that in most cases the victim recovered sufficiently to climb up a wall to the ceiling, which always is its health resort. As a result of his studies, he urged that the swatting be followed by other means to kill the flies.

WHAT BECOMES OF OLD PINS?

Every year about 10,000,000,000 pins, or approximately 4,000,000 pounds, are made in the United States. The industry has grown to such proportions that it employs over 10,000 persons and annually consumes 26,000 tons of coal, 27,000 cubic feet of gas, and 2,500 barrels of fuel oil. Connecticut, leader in the pin-making business, produces 85.6 per cent of the common variety and 45 per cent of the miscellaneous kinds. The value of one year's output is estimated at \$14,000,000. Machines for the manufacture of pins were invented in this country in 1775, but the industry did not start growing until 1836.

TABOO ON HOT FOOD SHOWN IN TEETH FOUND IN INDIAN MOUND

Well-preserved teeth of Indians taken from a mound recently explored in the West indicate that the aborigine was not an eater of hot foods, scientists say. Their theory is that these people used fire in cooking but, since it was done in the open, the food became cold before it was served, thus helping to avoid decay of the teeth.

We recently received a number of technical papers from a gentleman who signed himself merely M. Weiss or Weuss, Germany. We would be glad to receive the full address of this contributor.

*C.A. Bangs
152 (Cable) 14th St. N.W.
Wash. D.C.*

Feller

Explosives Engineer, May 1923

4195

3119

2948

Kansas City, Mo. 7/23

Compressed Air Mag July 1923

Dr. Edmund J. Hodge.

Albany, Ar.

The Business Man's Time-Saver

for Economical Transportation



Utility-Coupé \$640 *f. o. b. Flint, Mich.*

The heavy and increasing demand for this model has compelled us largely to increase our production schedules and facilities.

This car was designed and built particularly for business uses, providing most economical transportation for salesmen on the road or for business men in daily trips to and from office or factory. It is also very popular with physicians, teachers and young couples.

It combines enduring quality, comfort and great economy.

Chevrolet Motor Co., Detroit, Mich.

Division of General Motors Corporation

Five United States manufacturing plants, seven assembly plants and two Canadian plants give us the largest production capacity in the world for high-grade cars and make possible our low prices.

Chevrolet Dealers and Service Stations everywhere. Applications will be considered from high-grade dealers only, for territory not adequately covered.

Prices f. o. b. Flint, Mich.

Superior Roadster	\$490
Superior Touring	495
Superior Utility Coupe	640
Superior Sedan	795

Commercial Cars

Superior Commercial Chassis	395
Superior Light Delivery	495
Utility Express Truck Chassis	550

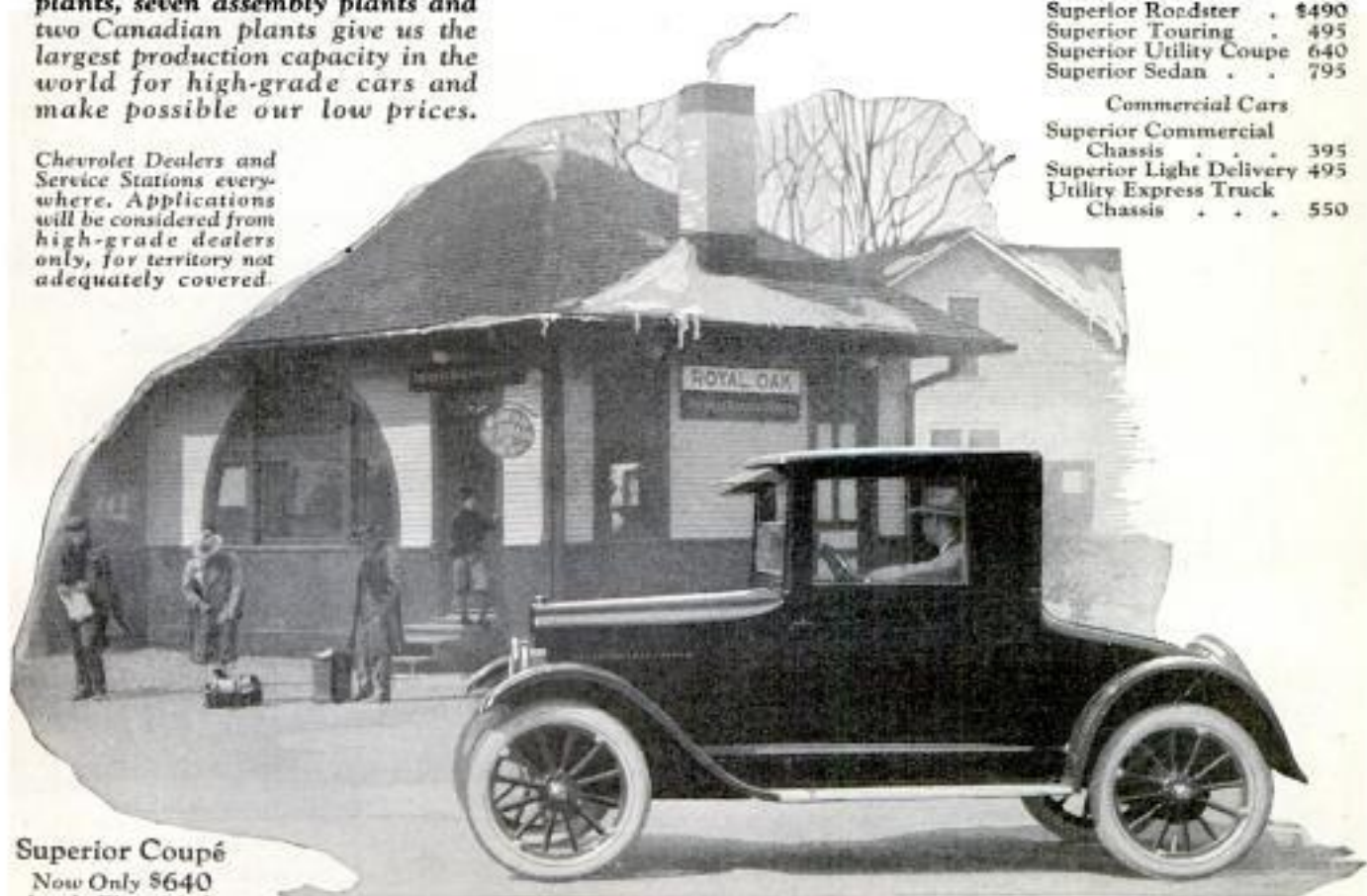

Superior Coupé
Now Only \$640
f. o. b. Flint, Mich.

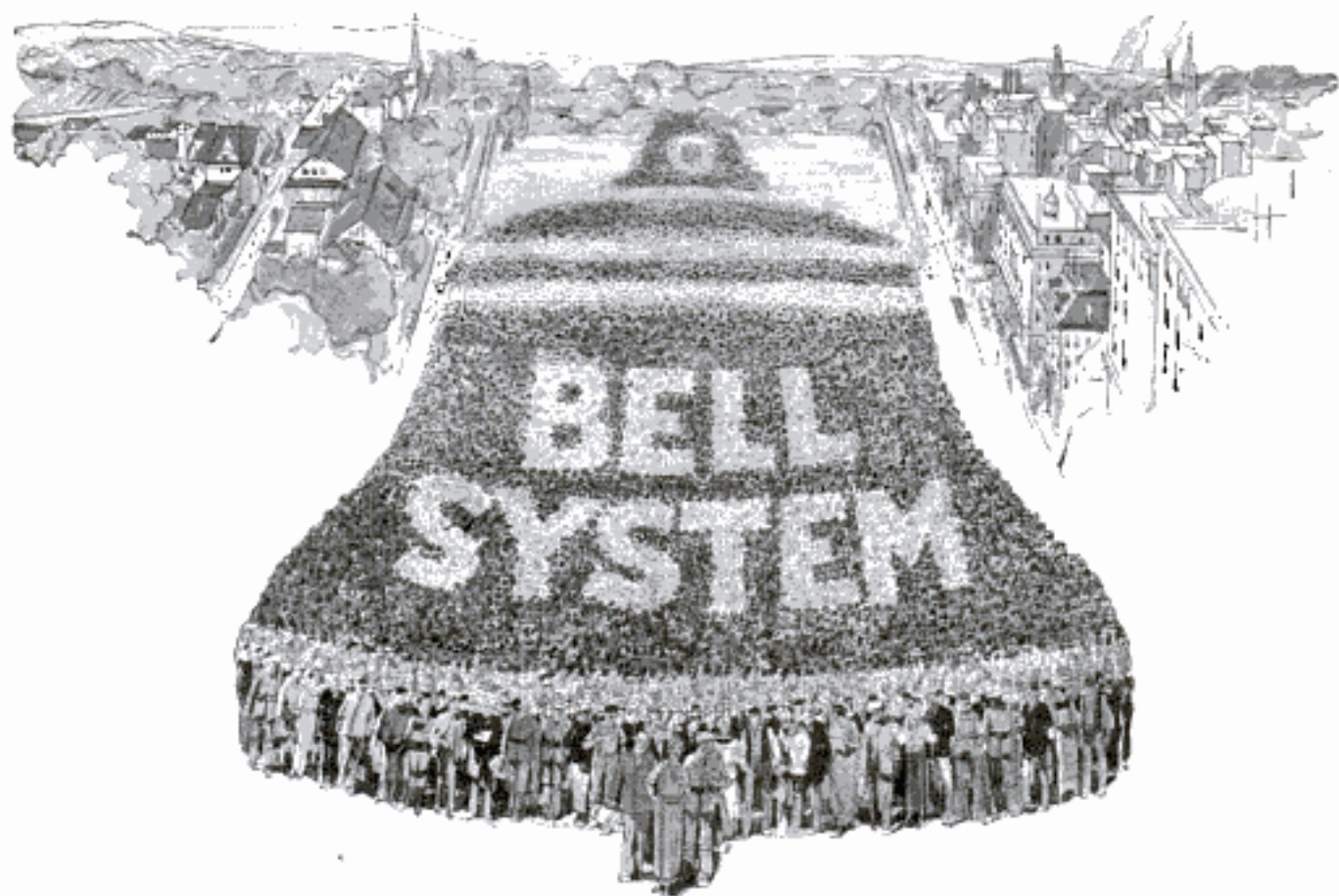

Giving the Telephone Life

Wherever your thought goes your voice may go. You can talk across the continent as if face to face. Your telephone is the latch to open for you any door in the land.

There is the web of wires. The many switchboards. The maze of apparatus. The millions of telephones. All are parts of a country-wide mechanism for far-speaking. The equipment has cost over 2 billion dollars, but more than equipment is needed.

There must be the guardians of the wires to keep them vital with speech-carrying electrical currents. There must be those who watch the myriads of tiny switchboard lights and answer your commands. There must be technicians of every sort to construct, repair and operate.

A quarter of a million men and women are united to give nation-wide telephone service. With their brains and hands they make the Bell System live.

"BELL SYSTEM"

AMERICAN TELEPHONE AND TELEGRAPH COMPANY
AND ASSOCIATED COMPANIES

One Policy, One System, Universal Service, and all directed toward Better Service



Ten Days

**Bring surprises when
you combat the film**

Make this test

Here is a test which will be a revelation to you. It has brought to millions the glistening teeth you see everywhere today.

Ask for it and watch the results. They will amaze and delight you.

Why teeth discolor

That viscous film you feel on teeth is what hides their luster. Much of it clings and stays. Soon it becomes discolored, then it forms dingy coats which brushing does not effectively remove.

Film also holds food substance which ferments and forms acid. It holds the acid in contact with the teeth to cause decay. Germs breed by millions in it. They, with tartar, are the chief cause of pyorrhea. Few escape these film-caused troubles under old-way methods.

Dental science has found two ways to effectively fight that film. One acts to disintegrate the film at all stages of formation. One removes it without harmful scouring.

Protect the Enamel

Pepsodent disintegrates the film, then removes it with an agent far softer than enamel. Never use a film combatant which contains harsh grit.



After many tests, these methods were embodied in a new-type tooth paste. The name is Pepsodent. Now careful people of some 50 nations employ it daily, largely by dental advice.

No harshness

Some results are quickly seen and felt. No one can doubt their benefits.

But Pepsodent also multiplies the alkalinity of the saliva and multiplies its starch digestant. Those are Nature's agents for fighting acid and starch deposits on the teeth. Every use of Pepsodent gives them manifold effect.

Thus Pepsodent protects the precious enamel in natural and gentle ways, and without any harmful scouring.

Make this ten-day test. Note how clean the teeth feel after using. Mark the absence of the viscous film. See how teeth become whiter as the cloudy coats disappear.

This is vastly important to you and your family. Cut out coupon now.

Pepsodent PAT. OFF.
REG. U.S.

The New-Day Dentifrice

Now advised by leading dentists the
world over

10-Day Tube Free

1306

THE PEPSODENT COMPANY,
Dept. 565, 1104 S. Wabash Ave., Chicago, Ill.
Mail 10-Day Tube of Pepsodent to

.....
.....

Only one tube to a family.

Diamonds for Christmas

\$1.00 Brings Your Choice



XA10—A fine quality, perfectly cut diamond, hexagon set in solid platinum ring with fancy pierced top and engraved shank. \$125.



XA17—Brilliant diamond set in this fancy, hexagon top. 18K white gold ring with fancy carved and pierced shank. \$90.



XA22—Artistically designed and executed, heart shaped lavalliere set with a blue white diamond. Delicately carved drop. 14K gold chain. \$30.



XA16—Sweet's engagement ring set with a superior quality, perfectly cut diamond in 6 white gold prongs. 14K gold shank. \$100.



XA18—7 perfectly cut and matched diamonds expertly set in platinum to resemble one large solitaire. Fancy white gold prongs. 14K gold shank. \$45.50.



XA20—More fancy, massive ring of 18K white gold set with a sparkling, blue white diamond. Engraved top, grooved shank. \$75.



XA21—Fine quality, sparkling diamond set in this square top, exquisitely carved and pierced solid platinum ring. \$90.



XA23—Perfectly cut diamond, hexagon, set in diamond shaped genuine onyx ring. Fancy pierced white gold bezel shank. \$22.50.



XA24—Handsome carved and pierced, 18K white gold ring set with a fine, blue white diamond. \$65.



XA27—Gent's massive solitaire cluster. 7 perfectly cut and matched diamonds, expertly set in platinum to resemble one large diamond. 14K, carved and engraved shank. 18K white gold top. \$67.50.



XA26—Popular, rectangular shaped wrist watch of 14K solid white gold. 15 jeweled and expertly adjusted movement guarantees accuracy. Furnished with silk green grain ribbon and 14K white gold fittings. Sapphire jewel crown. \$26.50.

10 MONTHS TO PAY

Just Think! ANY of these appropriate Xmas gifts will be sent you immediately upon receipt of only \$1. Our friendly credit terms enable you to buy worthwhile gifts at less than cash prices. \$1 at Sweet's does the work of \$5 elsewhere.

SEND ONLY \$1.00

and your choice will be immediately sent you for your examination. After you have convinced yourself that it is an exceptional value, keep it and pay only 1/5th of the price. 10 MONTHS NEXT YEAR TO PAY THE BALANCE!

NO DELAY—NO RED TAPE

Special Xmas Service insures prompt delivery. Satisfaction guaranteed or money refunded. Transactions strictly confidential.

EVERY DIAMOND GUARANTEED

All SWEET diamonds are perfect cut, blue white, superior quality gems. You are protected by the Guarantee Value Bond given with every diamond. 7½% YEARLY INCREASE for exchange purposes guaranteed. FREE: A postal brings the Sweet Diamond Book with over 3,000 appropriate Xmas gifts. Everything on our generous credit terms. Send for it TODAY to Dept. 64-F

FREE BOOK



XA25—Sweet's engagement ring set with a perfectly cut diamond in 6 white gold prongs. 14K gold shank. \$75.

"THE HOUSE OF QUALITY"
CAPITAL \$1,000,000.

L.W. SWEET INC.

DEPT 64-F 1650-1660 BROADWAY, NEW YORK

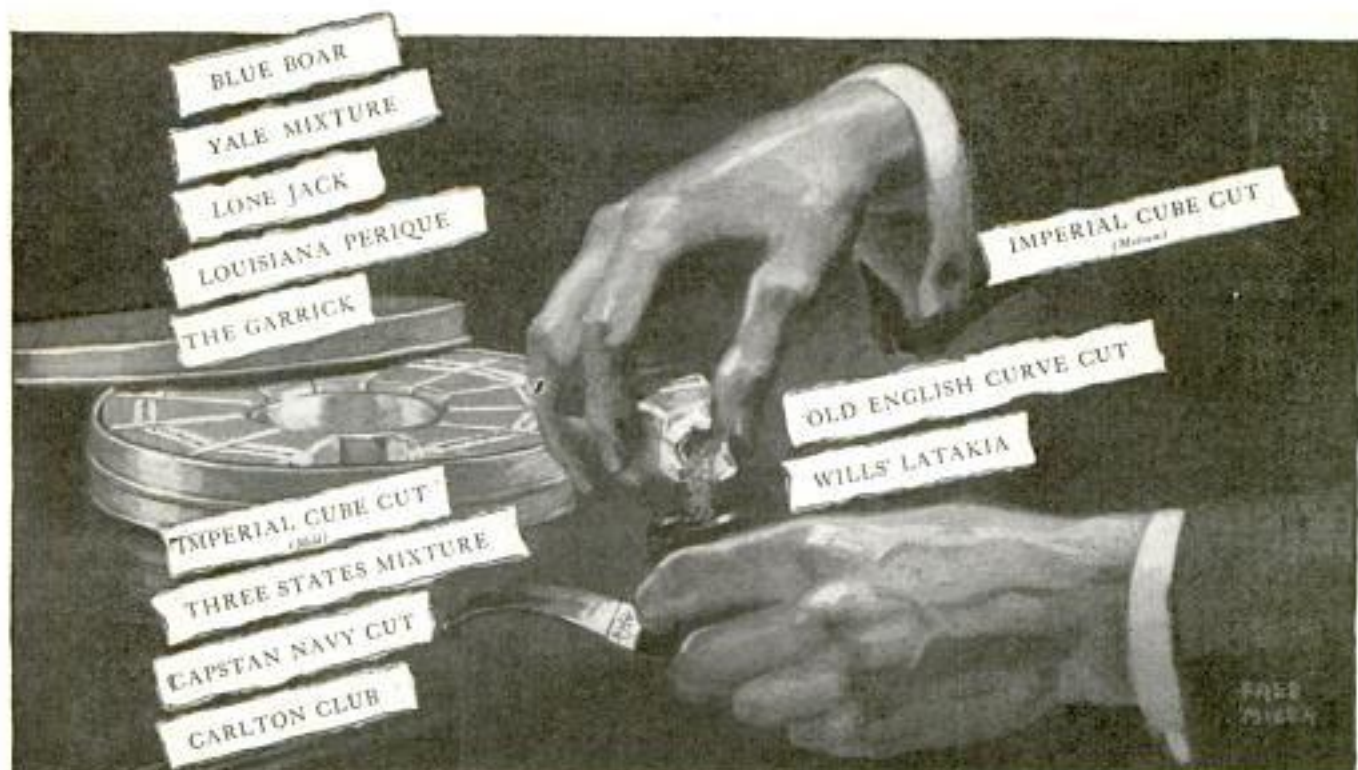

Men! May we send you this *Humidor Sampler* of the world's finest smoking tobaccos?

A new idea for pipe-smokers; twelve famous blends—each the finest in its class—shipped to you in a handsome humidor—to help you find the "Soul-Mate" for your pipe

GUARANTEED BY

The American Tobacco Co.

THERE'S been a need for this idea a long, long time. For your average pipe-smoker is the greatest experimenter in the world. He's forever trying a "new one"—confident that some day he'll stumble on the real affinity for his pipe.

But there's no reason why the quest for a perfect tobacco should be an endless Pilgrim's Progress—full of sorry mis-steps and disillusion. There are myriads of different brands of smoking tobaccos on the market. But of them all, there are 12 distinctive blends which stand in a class by themselves.

If a man could only segregate these twelve decisive blends from the hundreds of duplicate blends—and turn his taste to testing these twelve blends exclusively—he'd settle his tobacco problems in a hurry.

So that's what suggested the Big Idea to The American Tobacco Company.

We said, "Why not pick out twelve of the world's finest and most distinctive tobacco mixtures—pack a liberal quantity of each in an attractive Humidor Box—and offer it to pipe-smokers, direct by mail, at a price no pipe lover can afford to resist!"

Thus a man could get the "whole works" in tobacco blends in one assortment—with the certainty that among them, he'd find his long-sought tobacco-affinity.

A \$3.05 test for \$1.50

It might take you years to "happen on" all twelve of these flawless blends, and it would cost you \$3.05 to buy a full-size standard package of each. But through the Humidor Sampler, you can get a liberal get-acquainted quantity of all twelve of these blends for \$1.50—with the attractive Humidor case included.

Sent on 10-Day Approval

Send no money. Your name and address on the coupon is all that's needed now. It will bring you the complete Humidor

Sampler of these twelve peerless pipe mixtures—direct from our factories to your den. When the postman brings the package—deposit the price with him (\$1.50), plus postage. If a ten days' test of these tobaccos doesn't reveal the ideal tobacco you've always hoped to find for your pipe, the cost is on us. Simply return the Humidor—and we'll send back your \$1.50 and postage by return mail.



Send No Money—Just Mail Coupon

The American Tobacco Co., Inc.
Marburg Branch, Dept. 21
Baltimore, Md.

Please send me, on 10 days' approval, one of your Humidor Samplers of twelve different smoking tobaccos. I will pay postman \$1.50 (plus postage) on receipt—with the understanding that if I am not satisfied I may return Humidor in 10 days and you agree to refund \$1.50 and postage by return mail.

Name

Address

Note:—If you expect to be out when postman calls you may enclose \$1.50 with coupon and Humidor will be sent to you postpaid.

A \$3.05 Test for \$1.50

If you were to try all 12 of these tobaccos in full size packages, the cost would be:

Blue Boar25
Capstan30
Imperial Cube Cut30
(Mild)	
Imperial Cube Cut30
(Mild)	
Old English Curve Cut15
The Garrick30
Carlton Club15
Yale Mixture25
Three States25
Lone Jack10
Wills' Latakia45
Louisiana Perique25
Total	\$3.05

But through the Humidor Sampler you get a liberal "get acquainted" quantity of each for \$1.50



No. 185
Mr. Punch
 The Automatic
 Drill
 Price \$2.50

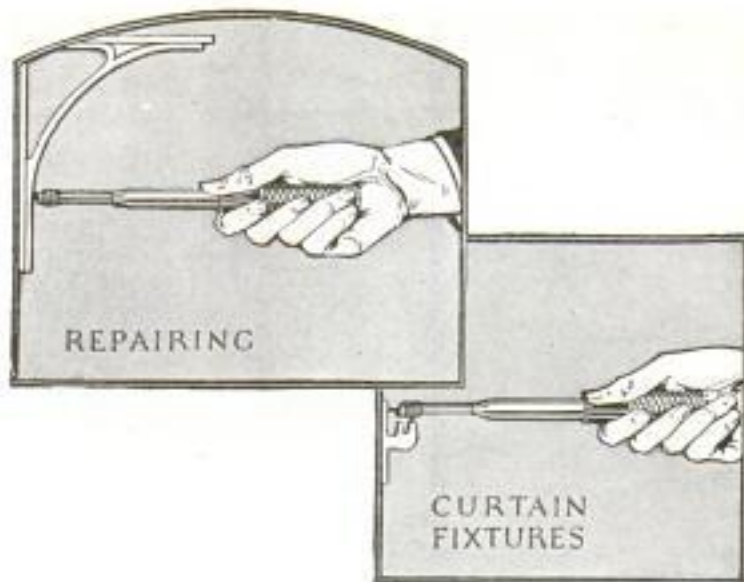

"I bore holes" says Mr. Punch

"Do one thing—and do it well, is my motto. That's why I specialize on boring holes. I've found the way to make clean holes through hard wood without splitting it, through soft wood without mushing it, through plaster without cracking it."

Mr. Punch is the Goodell-Pratt Automatic Drill. Inside the handle are eight different size drill points varying from 1/16 to 11/64 inch. You pick out the size you want, fit the point into the chuck, and Mr. Punch bores the hole in a jiffy.

All exposed metal parts are polished, nickel-plated and buffed. Length, 10 inches; weight, 8 ounces.

Sold by good hardware stores everywhere. If your dealer hasn't it, write us.

Write for free Catalog No. 15

Illustrates and describes each of the Goodell-Pratt 1500 Good Tools. Your name and address on a postcard brings your copy.

GOODELL-PRATT COMPANY, Greenfield, Mass.

Toolsmiths

GOODELL-PRATT
1500 GOOD TOOLS

ALL WOOL

Sport Model Overcoat!



Only
\$100
 DOWN
 6 Months to Pay
 Total Price \$21.85

This handsome, sport model overcoat is yours for less than half the usual price. We are giving you the advantage of our best buy this season. But you had better hurry and order now. These wonderful coats will not last long. We'll have to raise the price when the lot is gone. Only \$1.00 down! You have 6 months to pay! Just think, you get 6 months additional wear out of your coat while you are buying it. If you aren't satisfied in every way with this overcoat after you have tried it on and inspected it carefully, send it back. Your money will be cheerfully refunded.

This heavy, double breasted overcoat will give you dandy service. It is beautifully made of dark brown heather mixture wool mixed coating. It is as good looking as it is serviceable. Large, broad lapels and convertible collar, split seam sleeves, full belt, two large, sporty patch pockets, adjustable cuff straps and long vent in back. Length 45 to 47 inches. Sizes 34 to 46 inches chest measure. Give chest measure taken over vest. Order by number 4680.

Order Today

Don't miss this wonderful chance to get your winter overcoat at this amazingly low price. If you aren't satisfied with this high quality overcoat at this remarkably low price, your money will be refunded. Our new catalog showing amazing values in boy's and men's suits and overcoats is just off the press. Send for it NOW.

Babson Bros., Dept. 13-51

19th Street and Marshall Blvd., Chicago, Ill.

Enclosed please find \$1.00. Send me the double-breasted wool mixed overcoat at the advertised price. If I am not satisfied when I receive the overcoat, I can return it and get my money back. If satisfied, I will pay \$4.00 after inspection and \$4.00 per month — total \$21.85. Order by No. 4680. My measures are:

Chest (measured over vest) Height Weight

Name

Address

City State

Age Occupation

Munroe Great Coat

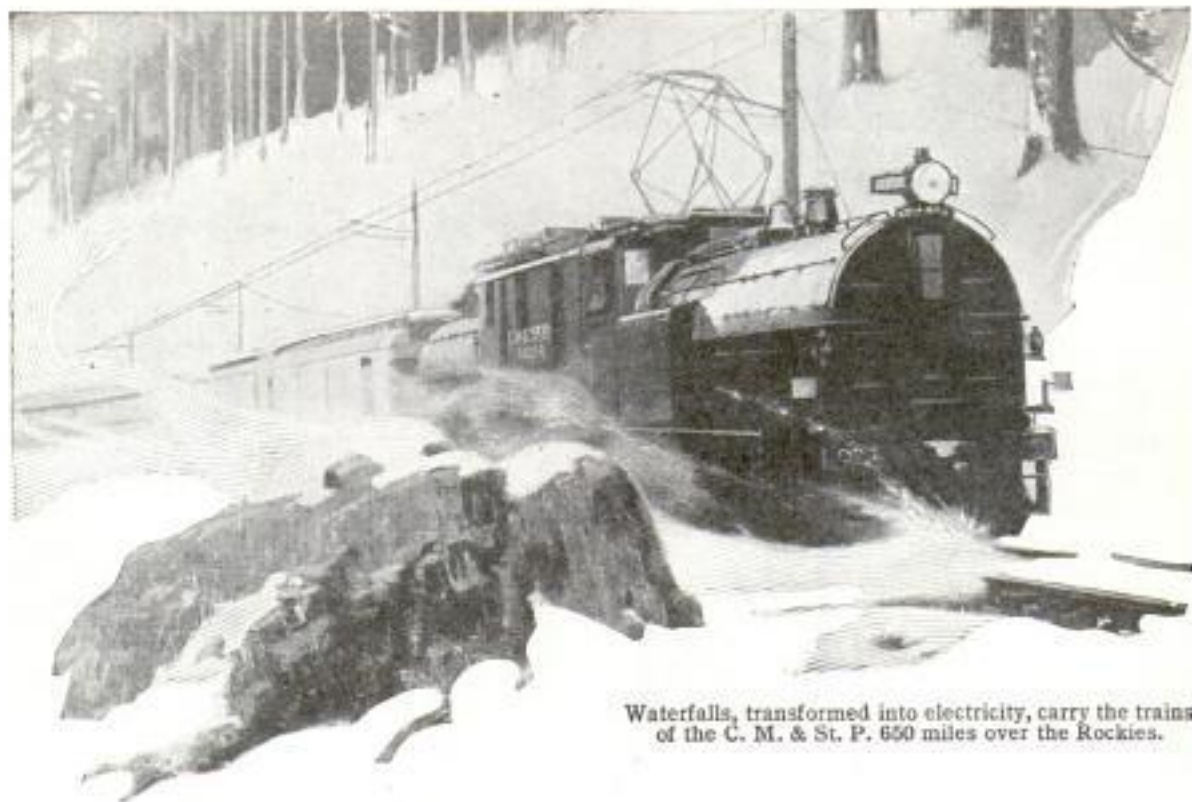

Waterfalls, transformed into electricity, carry the trains of the C. M. & St. P. 650 miles over the Rockies.

And you know what coal costs!

Fifty-one G-E electric locomotives are now doing the same work which 130 coal and oil-burning engines used to do on the 650 mile electrified sections of the Chicago, Milwaukee and St. Paul.



Saving coal is important, but saving human energy is much more important. General Electric Company designs and produces the equipment by which electricity does *both*.

Engineers estimate that the complete electrification of our railroads would save over 100 million tons of coal a year.

GENERAL ELECTRIC



Winter Sports!

SKATING, skiing, tobogganing, ice boating — there's a thrill in each, but none of these can match the sport of winter motorcycling on a 1924 Harley-Davidson!

Speeding with the snowflakes, over trails or roads, with a pal in the sidecar to share the exhilaration that makes you feel ten years younger!

Harley-Davidson's '24 gives you motorcycling at its best. Aluminum-alloy pistons reduce vibration, prevent overheating, add speed and power; full-floating, 49-in. springs make the roomy sidecar easier riding; olive green finish, maroon striped — handsomer than ever; Alemite lubrication (first on any motorcycle).

Take a **FREE** demonstration ride today — or Saturday afternoon — with your dealer. Ask him about his Pay-as-You-Ride Plan. (And mail us the coupon below).

HARLEY-DAVIDSON MOTOR CO.
Dept. P, Milwaukee, Wis.

Money-making sales opportunities in open territories. Write for particulars.

Harley-Davidson

The Motorcycle

Send me descriptive literature, showing 1924 Harley-Davidsons and Sidecars in actual colors.

Name _____

Address _____

AMPLION

The World's Standard Loud Speaker

A few practical points about Amplion supremacy

The Amplion requires no power amplifier—no battery. You simply attach it to regular head phone connections.

The diaphragm is made of a special alloy, found to have no equal after years of experiment with all other materials.

The electro-acoustical device is insulated entirely from the horn to eliminate distortion, ring or resonance.

Its Non-vibrating wood horn surpasses all other materials for true tone and clearness.

An Adjustable feature makes the Amplion sound true with any make of receiving set, and ensures faithful reproduction.

The Amplion mechanism is not new—it has not been hurriedly devised to meet the radio boom. Rather, it is a development, for radio purposes, of a loud speaking device used for years by leading Navies of the world.

The Amplion is manufactured by the oldest manufacturer of loud speakers in the world.

The Mahogany horn—the enameled sound conduit—the highly polished nickeled base—the reproducing mechanism—all are of the highest quality.

Ask your dealer for a demonstration.

Patentees: ALFRED GRAHAM & CO.

SIGNAL ELECTRIC MFG. COMPANY
Sole United States Distributors Menominee, Michigan

BURNDENT OF CANADA, LTD.
Canadian Distributors—172 King Street W., Toronto

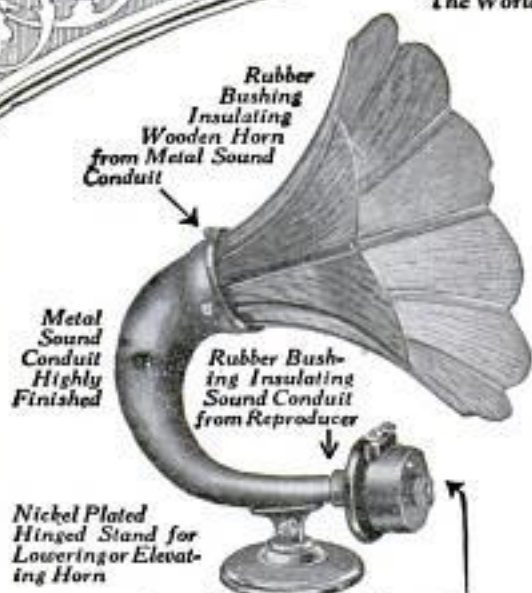

Screw for adjusting diaphragm to meet all conditions of Rec. Sets

Amplion Deagon AR-19

\$40.00

Phonograph Unit AR-35
\$24.00



Amplion Beauty AR-15
\$46.00

Amplion Junior DeLuxe AR-45
\$26.00



Amplion Portable AR-61
\$50.00

Amplion Junior AR-39
\$18.00

The Supremacy of The Amplion is The Supremacy of Actual Performance



\$3 and it's YOURS

The Greatest Typewriter Bargain Ever Offered

Right now we are making you the greatest typewriter offer you ever dreamed of—an eye opener. This wonderful standard Shipman-Ward Rebuilt Underwood only \$3.00 down. Ten days' free trial and the easiest monthly payments, shipped direct to you from our big factory.

10 Days' Free Trial From Factory to You

Yes, only \$3.00 down puts this genuine late model Shipman-Ward Rebuilt Underwood in your home. You can try it, test it, and then decide. See for yourself how new it is, how it writes. You must be satisfied. Your \$3.00 unconditionally returned if at the end of ten days you are not satisfied. The entire transaction will not cost you one cent.

EASY Monthly Payments

Little more than rental. Balance of payments so small you will hardly notice them, while you enjoy the use of this wonderful machine. You don't have to scrimp and save to pay cash. All at a big saving to you.

5 Year Guarantee

With every typewriter we give a written guarantee. These machines are rebuilt like new by the famous SHIPMAN-WARD PROCESS. Equipped with late improvements. You can't tell them from a new machine. The world's standard typewriter, the same models as sold by the Underwood Typewriter Company today, at a big saving to you. Act now! Get this splendid offer and save money.

These machines are shipped direct from our factory—the largest typewriter rebuilding plant in the world. They are rebuilt by the famous SHIPMAN-WARD PROCESS. Developed through 30 years in the typewriter business. Through our money saving methods of rebuilding and elimination of a large expensive sales force we are able to make this wonderful money saving offer to you. ACT TODAY, take advantage of it and you will SAVE MONEY.

ACT NOW! Mail this coupon today.

Free Book of Facts

Write for this free book of facts explaining Shipman-Ward's wonderful system of rebuilding typewriters. We show you exactly how it's done. How you are able to buy them. Complete and valuable information about the typewriter industry, both instructive and educational.

FREE with Every Typewriter

A complete course in touch typewriting. You don't have to know how to operate a typewriter. You can learn to operate this machine in one day. We also give free a waterproof cover and all tools that come with a typewriter.



All Shipments made direct to you from our modern factory—the largest typewriter rebuilding plant in the world.

FREE BOOK COUPON

SHIPMAN-WARD MFG. CO.
2121 Shipman Bldg.
Montrose and Ravenswood Aves.
CHICAGO

Send by return mail your wonderful offer of Shipman-Ward Standard Rebuilt Underwood, also your book of facts. (This is not an order and does not obligate me in any way.)

NAME.....

STREET.....

POST OFFICE.....STATE.....

SHIPMAN-WARD MFG. CO.

2121 Shipman Bldg., Montrose and Ravenswood Aves., Chicago

From New York to Honolulu With Erla Synchronizing Transformers

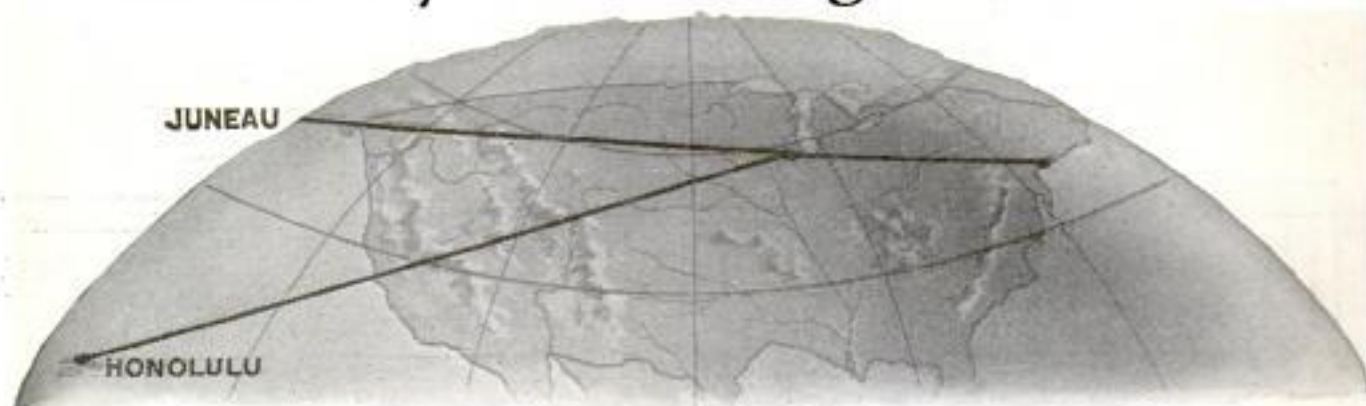

Unequaled range and power, over a waveband of 200 to 700 meters, is assured by Erla synchronizing reflex transformers. List, \$5 each



Solve crystal troubles by installing an Erla fixed crystal rectifier. Once installed, no attention is required. Jolt and jar proof. List price, \$1



Erla is the only condenser guaranteed to test to the exact capacity for which it is marked. Made in eleven sizes, 30c to 75c each

"All U. S. Stations on Loud Speaker, Using Only Three Tubes"

Typical of the thousands who have discarded complicated multi-stage receiving units in favor of simple, efficient Erla reflex design, is the experience of J. G. Hamock, 1917 So. Western Avenue, Chicago, who writes:

"During my first week with your three-tube hook-up, tuning through high power Chicago stations, I got Jefferson City, Dallas, Memphis, Atlanta, Omaha, Kansas City, St. Louis, New York, Springfield, Pittsburg, Harrisburg, Louisville, Cincinnati, Fort Worth and Tampa.

"The Sunday following I added Fresno, Denver, Astoria, Los Angeles, Honolulu, Hawaii Naval Maneuvers; and Juneau, Alaska, the Alaska Electric Light and Power Co.

"The United States Stations all were clear on the loud speaker. Also I re-tuned every station by checking them with my twelve-year old son, who would get them on the re-tune, when I would, as required, sharpen the re-tune myself."

Such power, selectivity and ease of control, with three tubes, are attainable only through Erla reflex design, incorporating Erla synchronizing r. f. and a. f. transformers. Guaranteeing the perfect synchronization of received and reflexed currents having the same phase characteristics, Erla transformers enable vacuum tubes to do triple duty as simultaneous amplifiers of received radio frequency, reflexed radio frequency and reflexed audio frequency currents.

For complete details, ask your dealer for Erla Bulletin No. 14, giving Erla one, two and three-tube reflex hook-ups. Or write direct, giving your dealer's name.

Electrical Research Laboratories
Dept. J 2515 Michigan Avenue' Chicago

ERLA



Unduplicated amplification without distortion enables Erla audio transformers to improve any receiving unit. Ratios: 3½ and 6 to 1. \$5



Attractive Erla telescoping bezels, in bright nickel or dull black enamel, fit any 1/8" to 1/4" panel. Made in 1" and 1½" diameter. List, 20c



Mechanically and artistically, Erla sockets occupy first place. Heavy, triple nickeled shell on polished Radion base. List price, \$1

No Better Holiday Present for \$3.00

than a year's subscription to

POPULAR MECHANICS MAGAZINE

Containing 3600 Pictures and 3600 Articles

Much of It Interests Everybody

Most of It Interests Anybody

All of It Interests Somebody

Order through your Newsdealer or address the Publisher

POPULAR MECHANICS COMPANY

200 East Ontario Street

CHICAGO, ILL.

now ^{\$} **only 14²⁴** _{Down} puts this **WITTE**

on **YOUR PLACE** for **90 days FREE trial**

An All-Fuel Engine—This Standard WITTE Burns Kerosene, Gasoline, Distillate or Gas

(No Special Attachment Needed)

Here is the answer to the demand for cheaper power—and the opportunity to show a profit of \$1,000.00 or more this year. With the WITTE Throttling-Governor Engine you can do all the jobs easily and quickly at a fraction of the cost of "hired help."



ED. H. WITTE
President

Makes All Farm Work Easy and Cheap

This WITTE Engine stands alone as the standard of farm power—with steady and reliable performance at any speed. Regardless of the work—pumping, grinding feed, sawing wood, churning, etc.,—it makes all work easy and cheap. Easily moved from place to place, you can save the work of several men all the time.

The Real ALL-PURPOSE Engine

This WITTE Engine burns any fuel,—kerosene, gasoline, distillate or gas—the cost of operation is always small. Equipped with the WITTE Speed Regulator, the power range enables you to do all jobs at a big saving.

Equipped with the Famous Wico Magneto The WITTE Engine is equipped with the famous WICO MAGNETO—a guarantee of efficient operation in all weather and temperatures. The most dependable and best ignition system known today. Far superior and more economical than the old style battery ignition.

Sold DIRECT from FACTORY to YOU

Remember this—my engine is sold direct to you by the man who builds it and I have over 100,000 satisfied customers all over the world. This WITTE Engine, at the lowest price in history, is the result of over 40 years devoted to building engines in the largest individual engine plant in the world.

Write Today For My Big Free Engine Book

I want every progressive farmer to write me today for my big free illustrated engine book and my special selling plan which puts a WITTE to work on your place for only a few dollars and gives you nearly a year to pay. **NO OBLIGATION**—just write me—that's all.

—ED. H. WITTE, President

WITTE ENGINE WORKS

1747 Oakland Avenue, KANSAS CITY, MISSOURI
1747 Empire Building, PITTSBURGH, PENNSYLVANIA

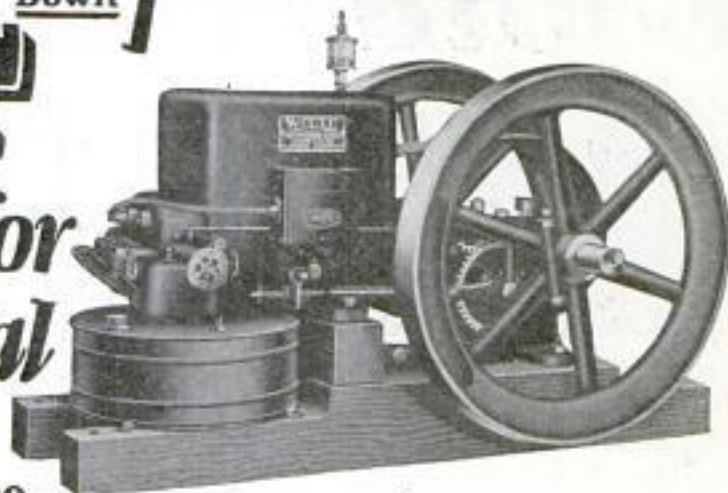

The Best All-Purpose Engine Built Today!

Note These Superior Points:

- 1—Light-weight, yet so durable that the WITTE is sold on a LIFETIME guarantee.
- 2—Valve-in-head—the standard engine design for surplus, dependable power.
- 3—Throttling governor—even, steady speed with any fuel.
- 4—Burns all fuels—no special attachments necessary.
- 5—WICO-MAGNETO—the perfect high tension ignition.
- 6—Self-adjusting carburetor—no chance to waste fuel.
- 7—Speed Regulator makes one engine handle many jobs.

These are only a few of the 50 special features that make the WITTE ENGINE the standard—and the best engine you can use at any price.

All sizes 2 to 25 H. P.

90 Days FREE TRIAL

So confident am I that the WITTE Engine will solve every power problem that I offer to send it on 90 days test—use it on the hardest **LIFETIME** work and if it is not right, I'll make **GUARANTEE** it right, without expense to you. I guarantee the WITTE Engine for a LIFETIME.

Mail This Coupon Today!

ED. H. WITTE

WITTE ENGINE WORKS

1747 Oakland Avenue, Kansas City, Mo.

1747 Empire Bldg., Pittsburgh, Pa.

Without obligating me in any way, please send me at once your big engine book and full details, prices, etc.

Name

Address

City

State

Stylish Moleskin Cloth Coat

\$1⁰⁰
Down

\$20.00 value
Special Price
\$13⁶⁵

**Rain
Proof**

**Plaid
Backed**

**No
C. O. D.
Charges
to Pay**

Send only \$1 with coupon for this coat. Guaranteed rain proof and is also suitable for stylish top coat. Made from good weight m'eskin cloth, a smooth, soft-finished material resembling chamois leather. Warm and comfortable in the coldest weather. Swagger double-breasted belted style with stylish plaited patch pockets. Adjustable strap on sleeve. Yoke back with inverted plait, giving the coat plenty of fullness. Collar can be converted into military style, buttoning close up to neck or worn as shown in illustration. Ventilated armholes. Ivory buttons. Backed with fancy plaid fast colored woven lining with extra coating of rubber between. All seams sewed, strapped and cemented. 45 inches long. Sizes 34 to 46. Rich Leather Brown shade.

Order by No. F-19.

Terms, \$1 with coupon, \$2.10 monthly.
Total price, \$13.65

6 Months to Pay

Buy the Elmer Richards way. You can always be well dressed and pay in small monthly sums, so small you will never miss the expense. Money back if not satisfied. No charge for credit. Don't miss this bargain. Supply limited at this special bargain price.

Elmer Richards Co.

Dept. 1771, West 35th Street, Chicago, Ill.

Enclose \$1. Send Moleskin
Cloth Coat No. F-19. Size.....

If I am not satisfied when I receive the coat I can return it and get my payment back with charges. Otherwise I will pay advertised terms, \$1 with coupon, \$2.10 monthly. Total price, \$13.65.

Name

Address

Post Office..... State.....



**Mail This
Coupon Today**

Write for our
Monthly Bulletin of men's,
women's and
children's
clothing and
shoes.

Fix it with BERNARD PLIERS



Like
Extra
Fingers

with superhuman strength, Bernards do all the pesky jobs around the house, and save time, money and tempers. Useful every day in the year. Learn to depend upon Bernards. They cut and grip as no other pliers can. At good Hardware Stores.

Booklet "P" Free on Request



**BERNARD
PLIERS**
Wm. SCHOLLHORN CO.
NEW HAVEN, CONN.



THIS LOG AND TREE SAW \$21.95
Fitted with Atkins Silver Steel Guaranteed Saw



9 Cords in 10 Hours by one man. It's King of the woods. Catalog Y115 free. Established 1890.

FOLDING SAWING MACHINE CO., 1025 East 75th Street, CHICAGO, ILLINOIS



AN IDEAL GIFT
Only 50c Postpaid or C.O.D.
Pocket Identification Holder It is always necessary to have identification, badge or fraternal receipt, or some valuable paper with you—attached to watch chain or key ring—it can't be lost! Weather proof! Handsomely nickel-plated. Order yours today—ask for circular of other items.

INSTITUTE MFG. CO., Dept. 281, 311 Main St., Worcester, Mass.

AT ALL
5 and 10 Cent
STORES

QUICK TO STICK
SOLD TO
HOLD



**IRON
GLUE**

10¢
15¢
SIZES

MCCORMICK & CO., Baltimore

New 1/4 H. P. 110 Volt Guaranteed Motors
Complete with Cord, Plug and Pulley



60 cycle A. C. 1740 speed . . \$13.00
60 cycle A. C. 1160 speed . . 16.50
25 cycle A. C. 1450 speed . . 16.50
Direct current 1740 speed . . 17.25
Direct current 1160 speed . . 19.75

HYRE ELECTRIC CO.
615M S. Dearborn St., Chicago, Ill.

ATKINS METAL CUTTING SAWS



Use
Atkins
"Non-Breakable"
Hack Saw
Blades

Cut Faster, Easier and Do Not Break

ATKINS AAA Non-Breakable Hack Saw Blades are made of selected steels, hardened and tempered by an exclusive gas and oil process which makes the cutting edge extremely hard and the back unusually tough and flexible.

This not only prevents practically all blade breakage, but makes them cut faster and easier.

You can reduce your metal-cutting costs and avoid losses due to blade breakage by using Atkins Hack Saw Blades. Let us prove it. Tell us what metal you cut, enclose ten cents and we'll send you a sample blade that will give you remarkable cutting results.

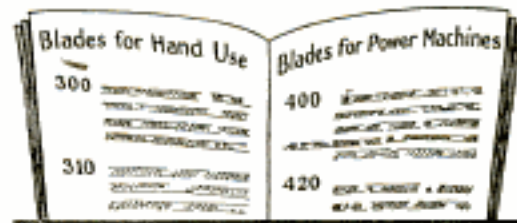

Get This FREE Hack Saw Chart

It will save you time and money. Shows the right hack saw blade to use for each metal-cutting job—in hand frames or power machines. If you buy or use hack saws, you need it. Just write your name, address and dealer's name on the margin of this page, and mail TODAY.

E. C. ATKINS & CO., Inc.
DEPT. P, INDIANAPOLIS, IND., U. S. A.

Makers of "Silver Steel" Saws and Tools:—Hand saws, band saws, circular saws, pruning saws, cross cut saws, etc. Send for free booklets.

Please Mention Popular Mechanics

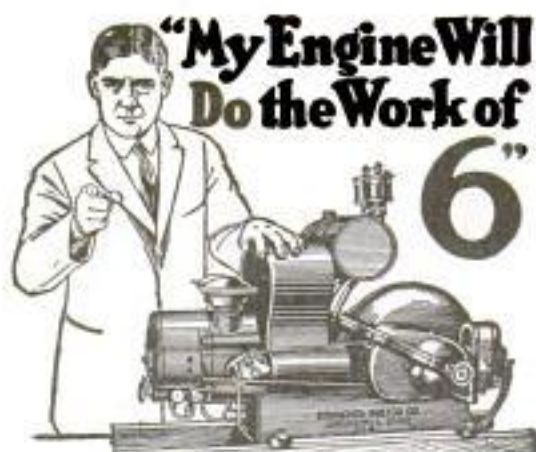

Try This Remarkable Engine

FREE The Edwards Farm Engine sells direct to you at low factory price. No other engine like it. 1½ to 6 H. P. in one engine. Change power while running. Efficient at all powers.

Fits Every Farm Job

Pumps, saws, grinds, cuts ensilage, runs spray rig, concrete mixer, washer—anything up to 6 H. P. Portable. Burns kerosene or gasoline. No cranking. All moving parts enclosed. Work it anywhere without fastening down. Endorsed by thousands of users.

**EDWARDS
FARM
ENGINE**

**For Special
FREE TRIAL
Mail Coupon
Now**

EDWARDS MOTOR CO.

418 Main Street, Springfield, Ohio
Without obligation, send complete description of engine, also free trial offer.

Name _____

Address _____

WHITE FLAME

BURNERS make your old kerosene lamps and lanterns give a brilliant white light better than electricity or gas. Doubles your light. Saves oil. **NO MANTLE TO BREAK.** Guaranteed Safe and Reliable. Delights every user. Send now for complete sample postpaid 50 cents, stamps or coin, 3 for \$1.25. Money Back if Not Satisfactory. Live Representatives Wanted. Exclusive Territory.

WHITE FLAME LIGHT CO., 68 Clark Bldg., Grand Rapids, Mich.



Send No Money for this General Utility Motor



Completely equipped with Cord, Plug, Pulley, Grinding Wheel and Buffing Wheel. Can be used for cleaning and polishing silver, sharpening knives, operating sewing, washing or other household machines. Simply call up your electric light company; ask them what kind of current you use and its voltage. Send us the information, and we will ship you the proper motor.

Completely Equipped \$17.95

The price is only \$17.95 for 1/6 H. P., 32 and 110 Volt D. C. or 110 Volt A. C., 50 or 60 Cycle Motor.

**SATISFACTION GUARANTEED
OR MONEY REFUNDED**

PETER BROS. MFG. CO., Algonquin, Ill.

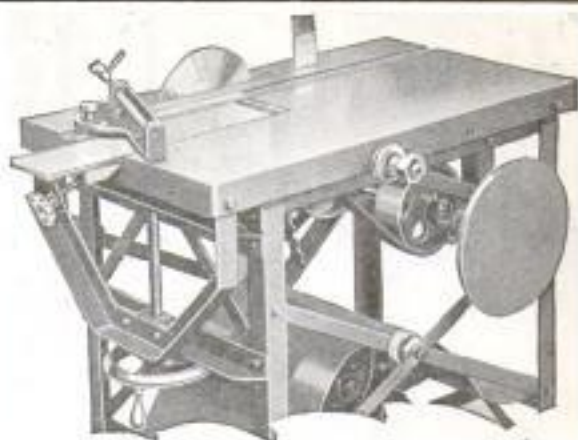

JUST what you've wanted! A real variety woodworker for small shops. This Parks Cabinet Shop Special includes 8-inch rip and cross-cut saw, 4-inch jointer, borer, sander, and universal motor. Shaper, lathe and band-saw may be added. Strong, durable, guaranteed 10 years. Handiest woodworker ever designed, at a startling low introductory price. Price with motor \$157.50 to \$225—depending on attachments desired. Send for bulletin C-S.

THE PARKS BALL BEARING MACHINE CO.
1500-1540 Knowlton St. Cincinnati, O.

Canadian Factory: 200 Notre Dame East, Montreal, Canada

PARKS

WOODWORKING MACHINES



PILLIOD Tool Cases Excel

Machinists, Tool Makers and Carpenters find them most satisfactory in construction, appearance, service and price. Immediate shipment.

Booklet describing 20 styles on request.

THE PILLIOD LUMBER CO.
Dept. 1 Swanton, Ohio



LATHES

9 to 18-inch Swing

List price \$165 and up according to size. When ready to buy send for Lathe Catalog and prices.

W. F. & John Barnes Co.

100 Ruby Street, ROCKFORD, ILL.

MAKE MORE MONEY TORIT ACETYLENE TORCH NO. 13

For soldering, heating, melting, tempering, auto radiator repairing, battery repair work, and for all kinds of small jobs requiring a hot flame instantly. Usually pays for itself in a single day.

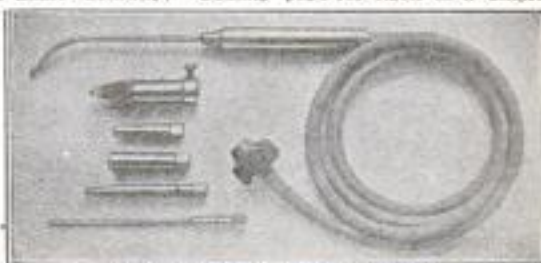

USES ACETYLENE GAS ONLY

Torch with 4 tips for different kinds of work, soldering copper, 5 ft. tubing and connection for auto-acetylene tank..... \$7.50

Order from your jobber. If he cannot supply you send your order to us.

St. Paul Welding & Mfg. Co., 177 W. 3rd St., St. Paul, Minn.



5 SIZE TAP AND DIE SET, ONLY \$3.00 FOR THE HOME - THE FARM - THE WORKSHOP DIRECT FROM THE FACTORY TO YOU!

Our No. 12 Automobile Set furnished in our highly finished chestnut box contains 5 each taps and dies 1-4, 5-16, 3-8, 1-16 and 1-27, in the S. A. E. thread, 1 die stock, and one tap and reamer wrench.

Our No. 11 Set is the same as No. 12 except that the thread is U. S. S. instead of S. A. E. You are purchasing a splendid set at a very low figure.

Send us your order at once and be one of our many satisfied customers. Let us also send you one of our circulars illustrating our full line of Handy Tools. WORCESTER STEEL PRODUCTS CO., Dept. 24, 25 Union Street, Worcester, Mass., U. S. A.

"Interlox" Make Quick Measurements

accurately, whether inside or outside. Rule slides instantly—no annoying folding. Strong; brass-trimmed. Any length 2 to 8 feet. 20c per lineal foot. If not at dealer's, sent postpaid.

Master Rule Mfg. Co., Inc. 841-43 East 136th Street NEW YORK CITY
Dealers and Agents; Request Attractive Proposition.



BURN YOUR NAME ON TOOLS WITH ARKOGRAF

Protect your tools from theft. Write any name, engrave any design on metal with electricity like writing on paper with pen or pencil. Complete outfit \$3.50, prepaid anywhere. Interesting description circular free. Write today. Agents Wanted. Arkograf Pen Company 481 East Couch St. Portland, Oregon



THE SCREWDRIVER THAT HOLDS THE SCREW

As Good as a Third Hand in Assembling anything from a Watch to an Automobile

Appeals Especially to Radio amateurs and professionals. A wonderful (patented) improvement.

Jobbers, Dealers and Agents. Favorable discounts THE COBURN TOOL CO., 114 Bedford St., Boston \$1.00 Postpaid

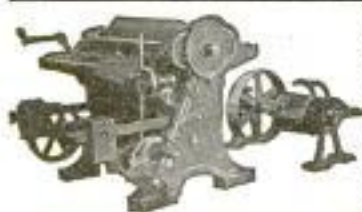

It is the well known quality of CRESCENT machines that justifies you in selecting one of them each time you have need for wood working machinery. The CRESCENT line is better than ever and will always give you satisfaction in every particular. Ask today for catalog of hand saws, saw tables, jointers, shapers, planers, borers, planers and routers, sawing mills, disk grinder, cut off table, hollow chisel mortiser, variety wood worker, Universal wood workers.

THE CRESCENT MACHINE CO., 93 Columbia Street, Leontia, Ohio

CLASS PINS

FREE CATALOG GIVE NAME OF SCHOOL OR CLUB AND NUMBER IN CLASS



Either pin illustrated made with any 3 letters and 2 figures, 1 or 2 colors enamel Silver plate, 25¢ ea., \$2.50 doz. Sterling silver, 40¢ ea., \$4.00 doz. Write for catalog of sterling and solid gold pins and rings.



Baritan Bros. Co. 548 Boston Bldg., Rochester, N.Y. 35-69

MYERS WONDERFUL SEWING AWL



Tools in Hand

Have it when you need it. Don't stop work. A complete repair shop in itself. Sew anything heavy or light. Leather, Shoes, Harness, Automobiles or Huggy Tops, Canvas, Bolts, etc. Price to introduce, \$1.00 Postpaid. C. A. MYERS CO., 6339 Woodlawn Ave., CHICAGO, ILL.

Write for this BULLETIN



16" x 6' Quick Change Gear \$466

16" x 6' Standard Change Gear \$406

"LATHE WORK SIMPLIFIED" contains 52 illustrations of up-to-date lathe operations that every mechanic should study. Over 30,000 users attest to the performance, accuracy and durability of SOUTH BEND LATHES.

Lathe	Standard	Quick-Change
9' x 3'	\$211.00	\$241.00
11' x 4'	248.00	288.00
13' x 5'	304.00	354.00
15' x 6'	376.00	431.00
16' x 8'	438.00	498.00
18' x 10'	656.00	721.00

Write today for the Bulletin. Catalog No. 83 will also be sent you without obligation.

SOUTH BEND LATHE WORKS

555 E. Madison Street South Bend, Indiana



SOUTH BEND LATHES

In tight corners



Put it up to the thin nose types of Crescent Pliers to reach in and do the work where other pliers won't go at all. Both straight and bent-nose types, drop-forged, hardened, oil-tempered steel. Hand-finished. Special "checkerdot" knurling gives sure grip without hurting hands. Retail price 50c, at hardware stores and accessory stores everywhere.



CRESCENT TOOL CO., JAMESTOWN, N. Y.

"The CRESCENT WRENCH People"

CRESCENT PLIERS



The HARDEST WORK NEEDS

MOSSBERG

Chrome Manganese Steel

Wrenches and Tools

DON'T send a boy to do a man's work—or an inferior wrench to tackle a nut or bolt that's hard to handle. Make sure that the wrench or tool you select for that difficult job is a Mossberg.

Each Mossberg Wrench is designed and built for a particular job—and the Mossberg idea is to have that wrench do the job a little better than any other. Hence the use of chrome manganese steel throughout the entire line—the one piece, solid construction of the majority of Mossberg Wrenches—the exclusive designs.

Ask your dealer to show you Set No. 1900—three socket wrenches with twelve openings. Note the rugged construction of these wrenches—they are typical of the Mossberg line, in economy, strength and simplicity.



FRANK MOSSBERG CO.
Lamb Street Attleboro, Mass.

Car Owners Wanted



—To show and sell the greatest improvement in Spark Plugs since Gasoline Engines were invented. Unbreakable, translucent core shows at a glance just which cylinders are firing.

Beacon Life Spark Plugs You Can See Them Fire

Just lift the hood and look. See instantly which cylinders are "dead." No gumming. No testing. Cost no more than ordinary plugs. Burns fine. Extra durable. Sold only by "Paul Men". Agents smashing all existing records. Exclusive territory. Write quick.

THE PAUL RUBBER CO. (15)
25 Paul Park Salisbury, No. Car.

FORDS Get More Mileage

on GALLON of GASOLINE



Using automatic spark regulator. Dots away with use of spark lever. Eliminates carbon. Renders back-kick impossible. Gives more power at less cost under all road conditions.

Sent on 10 DAYS TRIAL

Makes hills on high easy. Will outlast any other type of Ford Timer. Attach yourself. Low priced. Pays for itself in a short time. Take advantage of our special 10-day trial offer.

Agents wanted!

AMERICAN ACCESSORIES CO., Dept. 476, Cincinnati, O.

You Can Save \$35.00



Recover your old auto top frame yourself.

\$3.85 and up

Custom tailor made to fit all makes and

forces Ford Ford models of cars. Any person that can drive a car can put it on. Roof and quarters sewed together, with rear curtain, fasteners, welts and tanks complete. Give name, year and model number of your car and we will send you catalog with samples.

LIBERTY TOP & TIRE CO., Dept. E-7, Cincinnati, O.

SEND for the INTERNATIONAL CATALOG

FOR FORD—
PRICES FROM \$27.95 UP.

Factory to Consumer direct—
Pay only one profit.



Our net price list. Full line of auto bodies and accessories for Fords at Wholesale Prices

Save big money on bodies by buying direct from factory.

INTERNATIONAL BODY WORKS, Dept. 7, 914 W. Ohio Street, CHICAGO, ILL.



AGENTS Make Big Money

Selling D-REN-U Safety Signal to automobile owners; complies with safety laws; guaranteed. Write today for wholesale price to agents and get territory quick. Big Winter Seller. Address Comstock-Bolton Co., Dept. K, 1925 E. 15th St., Kansas City, Mo.

AGENTS!

If you are making less than \$150 a week, better write for information about selling SAAL HEAVY OIL SYSTEMS.

H. G. SAAL CO., Dept. 1001, 1800 Montrose Ave., CHICAGO



Steady Work

in a fast growing business with Vanderpool Latest Improved Vulcanizer. Made in America.

Ask for Catalog

Vanderpool Co., Dept. 1P, Springfield, Ohio

F. H. DIBB, Agent for British Isles
26 Fairfield Rd. Winchester, England

Imperial Sanitary Floor

Base and Floor one solid piece

Put on like Plaster
Wears like Iron
-waterproof
fireproof
resilient
noiseless
dust-less

A composition material easily applied in plastic form over practically any kind of floor. Laid about 1/8 inch thick. Imperial floor does not crack, peel or come loose from foundation. A continuous, fine grained, smooth, non-slipping surface. No crevices to gather grease, dirt, dust, disease germs or moisture.

Ideal Floor for Kitchen, Pantry, Bath Room, Laundry, Porch, Garage, Restaurant, Theatre, Hotel, Factory, Office Building, Railroad Station, Hospital—wherever a beautiful, substantial floor is desired. Several practical colors. Full information and sample FREE of your first and second choice of colors.

Imperial Floor Co., 132-134 Halstead St., Rochester, N.Y.

A Success for 15 Years



ALVAN CLARK TELESCOPES

Famous throughout the world as the highest grade Astronomical and Terrestrial Instruments. Now bringing to you at a reasonable price, these wonderful instruments—a source of pleasure and education—for the home—the school—the college. Send for circular and prices.

ALVAN CLARK & SONS CO.
Makers of the great "YERKES" and "LICK" Telescopes
55 Henry Street Cambridge, Mass.

SHAW MOTOR ATTACHMENT MAKES YOUR BIKE A MOTORCYCLE!

A high grade 2 1/2 H. P. motor attachment quickly clamped on any bike frame. Speed 4 to 40 miles an hour. 90 to 125 miles per gallon of gas. **Special Low Price Now!** Write today for Complete Description and Special Low Prices on SHAW Motor Attachments and the SHAW Complete Motorcycle. **SHAW MANUFACTURING COMPANY** Dept. 37 Galesburg, Kansas



30 Days' Free Trial

Select from 44 Styles, colors and sizes, famous **Ranger** bicycles. Delivered free on approval, express prepaid, at **Factory Prices**. You can easily save \$10 to \$25 on your bicycle.

12 Months to Pay on any Ranger if desired. Parents often advance first deposit. Boys and girls can easily earn small monthly payments.

Tires best quality, at factory prices, express prepaid. Lamps, wheels and equipment, low prices. Send No Money, do business direct with makers.

Mead Cycle Company Dept. 108 Chicago

Write today for free Ranger Catalog, factory prices and marvelous easy payment terms.

MOTORCYCLE BARGAINS

Save 25% to 65%

on Slightly used and Rebuilt Motorcycles, Side Cars, Johnson Motor Wheels, Evans Power Cycles, Bicycles. Send for **Free Bargain Bulletin** and **Money Saving Message**, listing hundreds of Bargains in used, rebuilt and new machines, supplies, accessories, etc.

AMERICAN MOTOR CYCLE CO. CHICAGO
Dept. 122, 2047 W. Chicago Avenue.

VITALIC Bicycle Tires

TRADE MARK REGISTERED
Tougher Than Elephant Hide

MOTORCYCLES

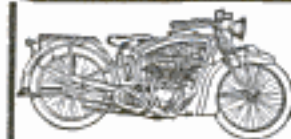

RELIABLE STANDARD MAKES that you can **DEPEND** on. Enjoy the glorious experience of going wherever you like—when ever you like. The price is within your means—25% to 30% less than others. These machines are slightly used, thoroughly overhauled or rebuilt. Send for catalogue.

MYEROW BROS.
258 Columbus Ave., Boston, Mass.



Get This Wonderful Ring. If You Can Tell It From a Genuine Diamond Send It Back

These amazing, beautiful **CORODITE** diamonds positively match genuine diamonds in every way—same blazing flash and dazzling play of living rainbow fire. They, alone, stand the diamond tests, including terrific acid test of direct comparison. Lifetime experts need all their experience to see any difference. Prove this yourself.

Wear a Corodite Diamond 7 DAYS FREE

Make this test. Your risk nothing. Wear a genuine Corodite and a diamond side by side on the same finger for 7 days. If you or your friends can tell the difference, send it back; you won't be out a single penny. That's fair enough. If you keep the ring, price printed here is all you pay. No installments. Remember, Corodites alone have the same cutting as genuine stones.

SEND NO MONEY Keep your money right at home. Just send name, address and number of ring wanted and sizes as shown by slip of paper. (Size slip to end around finger joint. Your ring will come by return mail. When ring arrives deposit amount shown above with postman. If you decide not to keep ring after 7 days' wear, send it back and your money will be immediately returned. Send today.

E. RICHWINE CO.
19 West Jackson Blvd., Dept. 875, Chicago, Illinois
Sole Importers Genuine Corodite Diamonds



"Been on a vacation Bill?"

"No, Jim—I've stopped smoking. Gained six pounds in a week. You know how I used to smoke—a package of cigarettes and a cigar or two a day—it sure had some hold on me. But I'm cured—

took a scientific home tobacco treatment—fixed me up in two weeks.

"Wasn't hard on me at all—noticed improvement the first day—I feel like a new man. It didn't interfere with my work—didn't leave any druggish after-effects—the money I saved in the last two weeks has paid for the treatment alone.

"Why don't you take it? It has cured men like you and me for over forty years—it is a doctor's individual prescription that sure fixes you up. Just send the coupon for full information NOW. No obligation. All correspondence is strictly confidential."



A Doctor's Prescription

The Keeley Institute, Dwight, Ill.

Please send me, without any obligation on my part, your free booklet which will tell me how to rid myself of the tobacco habit.

Name.....

Town.....

Street..... State..... P.M.-1

Going to Build Remodel or Repair?

DON'T think of planning a new home or repairing an old one without copies of our two free books.

Our Building Material Catalog shows latest ideas and most advanced styles for everything in building. We ship everywhere everything in the way of high grade lumber roofing, doors,

windows, porchwork, screens, builder's hardware, paints, wallboard, interior woodwork, plumbing, heating and water supply outfits—all at money saving prices direct to you. Plan Book shows skillfully planned homes of all kinds, bungalows, city houses, suburban residences, country homes, barns. Tells you how to get building plans FREE. Write today. No obligation. Let us develop plans from your rough sketches. Send your material bills for free estimate price.

Material Complete for Houses from \$500.00 Up

Catalog of 6000 Price Bargains

Beautifully Illustrated PLAN BOOK

CHICAGO MILLWORK SUPPLY CO., 1444 W. 37th St., Chicago, Ill.
PLEASE SEND ME YOUR FREE BOOKS.

Name _____
Town _____
State _____
Occupation _____

St. No. _____

Books Are Free

Learn to Play SAXOPHONE EASY PAYMENTS

"C Melody"

Artists' Model Saxophone

Boy, it's a WOW! As easy to play as one-finger tunes on a piano—easiest fingering, easiest blowing, richest TONE "Sax" ever! The choice of teachers and professionals all over the world. Now offered direct from factory at wholesale price, on small payments!

Complete Professional Outfit

10 MONTHS TO PAY!

Thousands of snappy young fellows have made their ARTISTS' MODEL SAXOPHONE pay for itself in spare time earnings! Now at last you can be Everybody's Favorite—you can turn your saxophone playing into pleasure and profit!

FREE TRIAL (Sensational offer rich now!) Big complete outfit on 6 DAYS' FREE TRIAL! Consists of \$10 case, self-instruction book, sheet music, reeds, strap, pearl keys, etc. \$1 restores your Saxophone. Small first payment, then only \$1 a month! Highest quality PROFESSIONAL Saxophone now within your reach. Write for catalog today!

Standard Music Co., Dept. 1722, P. O. Box 502, Chicago

CATALOG FREE!

HOME LOVERS' BARGAIN BOOK FREE

Showing Over 10,000 Furniture Bargains

All selections loaned free for a month. Take a year to pay if satisfied, paying little by little almost as you please.

SPiegel, MAY, STERN CO., 1108 W. 35th St., Chicago

Different from all others—the NEW BENJAMIN

AIR RIFLE

Made on a different principle from all other Air-Rifles.

The Benjamin is really a strong air-pump used to compress the air in the air chamber to any degree of power desired. From one to six strokes of the pump give all the force necessary. Each additional stroke gives increased power. The Benjamin works on the same principle as all air-drills and air-hammers—with this difference:

You control the shooting force as you desire. Look at this block of hardwood. It shows how Benjamin power is regulated as you wish.

You can't have accidents with a Benjamin. It's safe, always, because you control the power. The Benjamin never loses shooting force, and has no springs to get out of order or shake your aim. Write us for an interesting folder about this wonderful air-gun.

If your dealer does not handle ours, send direct to factory.

(PRICE \$5) POSTPAID

BENJAMIN AIR-RIFLE & MFG. CO., 415 N. Broadway, St. Louis, Mo.

Ask your dealer for demonstration.

Pacific Coast Representatives THAYER & BOWEN, Los Angeles, Calif., and San Francisco, Calif.

\$\$\$\$ MAKERS

You can look far and wide—to the four corners of the globe—and then not find as rapid a seller as the money-back guaranteed Standard Art Products. Special FREE offer to every prospect.

Exclusive territory now open

STANDARD ART PRODUCTS CO.
Desk 101, FORT WAYNE, IND.

Every boy loves boats and trains

Send 10 cents to The Ives Manufacturing Corporation, Bridgeport, Conn., for complete catalog of Boats and Trains.

IVES TOYS MAKE HAPPY BOYS

Build This Phonograph Yourself

TREMENDOUS SAVING IN COST

Easy, fascinating work with our SIMPLIFIED PLANS. We furnish blue prints, diagrams, motor, cabinet pieces, ready-built horn, etc. You don't need to be a cabinet maker. A few hours assembling and you will have a fine instrument at one-quarter the regular retail price. AGENTS MAKE MONEY making and selling these instruments. Write today for full details and our FREE OFFER. Address

LUPERL PHONO PARTS CO.
2648 W. Chicago Ave. Dept. 9 CHICAGO, ILLINOIS



The Beginning—(1912)

"If I hadn't been all through it myself, I wouldn't have the assurance to tell you to 'cheer up.'"
ERICKSON.

Those who wear them say: **ERICKSON LEGS** are Wonderful because they do not chafe, overheat or draw end of stump.



If you have had a recent amputation send for new booklet on TEST LEGS for beginners.
E. H. ERICKSON CO.
38-A Washington Av. N.
MINNEAPOLIS - MINN.

Help Wanted

We require the services of an ambitious person to do some special advertising work right in your own locality. The work is pleasant and dignified. Pay is exceptionally large. No previous experience is required, as all that is necessary is a willingness on your part to carry out our instructions. If you are at present employed, we can use your spare time in a way that will not interfere with your present employment—yet pay you well for your time.

If you are making less than \$150 a month, the offer I am going to make will appeal to you. Your spare time will pay you well—your full time will bring you in a handsome income.

It costs nothing to investigate. Write me today and I will send you full particulars by return mail and place before you the facts so that you can decide for yourself.

ALBERT MILLS, Gen. Manager Employment Dept.
48 American Bldg. CINCINNATI, OHIO

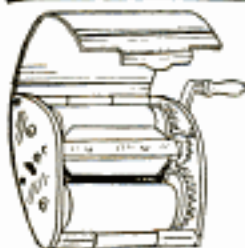

Tank Safety Blade Stropper FOR GILLETTE BLADES

Send \$2.75 Stop your own blades!
We Pay Postage Imported Safety Razor Blade Stropper.

Rollers move laterally from right to left. Perfect action! Perfect stropping! Keeps blades always sharp. GUARANTEED.

CHARLES KELLERT CO.
116 Bedford St. Dept. 501 Boston, Mass.
Territory open to agents. Dealers write for quantity prices.

\$3 Cash Buys Typewriter



Balance Only \$5 Monthly

Save 35 to 60% on all standard makes—Underwood, Royal, Remington, etc. Every machine thoroughly rebuilt and GUARANTEED. Try five days at our expense before you buy.

WRITE at once for Free Descriptive Circular and Special Low Prices.

5 DAYS FREE TRIAL

WYNN TYPEWRITER EXCHANGE 13 Reliance Bldg. Kansas City, Mo.

Art Corner Your Pictures—Album

where you can keep them safe and enjoy them always.



5 Styles **Engel** 5 Colors
"Art Corners"

are on sale at Photo Supply and Album counters everywhere. They are the only Quick, Easy, Artistic, No Paste, No Fold way to mount Kodak Prints, Greeting and Souvenir Cards, Clippings, etc.—on anything, anywhere. A dime brings 100 and samples to try. Write

ENGEL MFG. CO.
Dept. 2A 4711 N. Clark Street, Chicago



Do Your PRINTING



Cards, circulars, labels, tags, book, menus, paper, Press, \$12. Larger \$35. Job Press \$150 up. Save money. Print for others. BIG PROFITS. All easy, rules sent. Write factory TODAY for press catalog, TYPE, cards, paper. **THE PRESS CO. D-37, MERIDEN, CONN.**

New 300 Candle Power Lamp

BURNS 96% AIR

Greatest lamp improvement of age—patented. Twenty times brighter than wick lamps at one half the cost. Brilliant, soft, white light. Restful to eyes. No smoke—no soot—no odor—easy to operate. Absolutely safe. Lights with match. Most economical made. Burns 96% air—4% gasoline or kerosene (coal-oil).

30 Days Trial Prove for yourself. Use it 30 Days at our risk. No obligation. Get Free Trial plan and special introductory offer. Send for attractive catalog describing table lamps, wall lamps, hanging lamps and lanterns. Write now—today.

Agents Make Big Money. Write Quick for Free Outfit Offer.

The Akron Lamp Company
2181 Lamp Bldg., Akron, Ohio



21 Jewel ~ Extra thin STUDEBAKER The Insured Watch

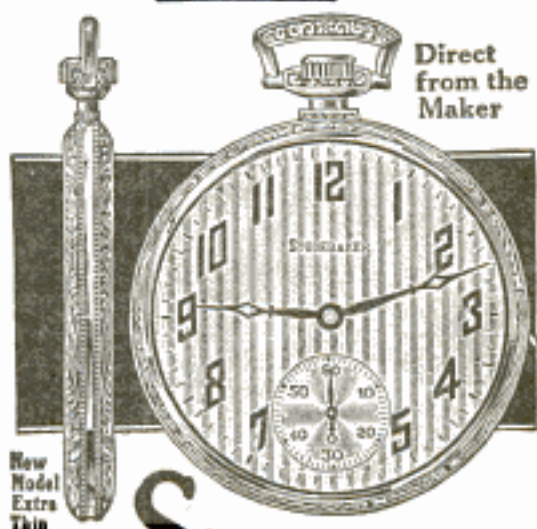

Direct from the Maker

New Model Extra Thin

SENT FOR

\$1.00 DOWN!

Only \$1.00! The balance in easy monthly payments. You get the famous Studebaker 21 Jewel Watch—Insured for a lifetime; a choice of 54 new Art Beauty Cases; Adjustments, including heat, cold, isochronism and 5 positions—direct from the maker at lowest prices ever named on equal quality. Write today for FREE BOOK of Advance Watch Styles.

Fine Chain FREE!

For a limited time we are giving away FREE with every Studebaker Watch a beautiful pattern Studebaker Watch Chain. Write now while offer lasts.

Mail Coupon for FREE Book of Advance Watch Styles

Send at once and get a copy of this book—FREE! See the newest, beautiful, advance styles in Studebaker Art Beauty Cases and Dials. Read how you can buy a 21 Jewel Studebaker Insured Watch direct from the maker—save big money—and pay for it on easy monthly payments.

Write! For our free book, it will post you on watch styles and watch values. Send coupon at once. Get Free chain offer today while it lasts.

Studebaker Watch Co.
Dept. 221 South Bend, Ind.



STUDEBAKER WATCH CO.
Dept. 221 South Bend, Indiana

Please send me your Free Book of Advance Watch Styles and particulars of your \$1.00 down offer.

Name

Address

City State

Please Mention Popular Mechanics

Copyrighted material



TANGOS

5¢

Peanuts—crunchy, golden—with fluffy marshmallow—Bunte blended chocolate—creamy maple—all in one. A favorite for years!



A *Bunte* Candy

BUNTE BROTHERS · CHICAGO

BUILD THAT HOME



KEITH
Will
Help
YOU
—
See
Offer

No better time to build—no better way than this! Ideal house designs; tested, built-from plans. Modern construction, striking features, those deft touches that make attractive, desirable homes. No disappointments, no costly "extras" with Keith's plans and specifications!

336 Plans Send \$4.50 for De Luxe Plan Book with pictures and plans of Bungalows, 1½ Story, and 2 Story Homes and Keith's Magazine for homeowners a whole year. Book of 112 Plans of any one class (state choice) and Keith's Mag. 8 months. \$2. Keith's Mag. 6 months' trial \$1. Rare value; offer limited; send now to **KEITH CORPORATION, 22 N. 7th St., Minneapolis**

SHOTGUN or RIFLE

There's remarkable gun value in a Stevens. Write for the interesting catalog describing our line.

J. STEVENS ARMS COMPANY
Dept. 550 Chicago Falls, Mass.
Owned and Operated by the Savage Arms Corporation

Build It Better—Quicker—Easier

Hundreds of users are doing ripping, mitering, grooving, rabbeting, tenoning, sanding, grinding and many other operations with speed and accuracy on the

Boice Junior Bench Saw

A small compact, low-cost, precision machine of all metal construction. Saws 1½" stock with ease. Dadoes ½" x ½". Easily driven by ¼ or ½ h. p. motor or from line shaft. Top 10" x 13" easily elevated for grooving or tilted to 10 degrees for beveling. Attaches to any light socket. Built of best materials; bronze bearings. Sold on guarantee of satisfaction or money refunded.

Write today for descriptive literature on Boice-Built Bench Saws, Lathes, Drills, Jointers, Band Saws and Motors.

W. B. & J. E. Boice, 1730 Norwood Avenue
Dept. P. M. 1 Toledo, Ohio



No. 28—
Congressional;
speedy and
flexible.



No. 40—
Medium
point, all
round
ability.



Standard of the world's writers for more than half a century and made so well that they outwear two ordinary pens. Here's smoothness of action and an age of service than none but this finely worked, hand-finished pen can provide. And there's one of the many Spencerian styles to fit your handwriting.

SPENCERIAN
PEN CO.
349 Broadway
New York

A dozen sample pens for a dime and our handwriting booklet, free.

No. 42—
Gold and
silver
pointed;
smooth
action.



No. 1—
College,
fine point,
double
elastic.



Spencerian Personal Steel Pens



Planning a NEW HOME?

Let these books be your guide. Beautiful California Styles, with Pictures and plans for all-climate homes.

"South-West Stucco Homes" Spanish, English, some 2-family—\$1

"All-American Homes" 50 Houses—7 to 10 Rooms—\$1

"The New Colonials" 50 Houses—6 to 10 Rooms—\$1

"West Coast Bungalows" 50 Houses—6 and 7 Rooms—\$1

"Little Bungalows" 25 Houses—2-4-5 Rooms—\$1

SPECIAL OFFER:

Send \$2.50 for any three of these books and get Garage Folder FREE.

Money back if not satisfied.

E. W. STILLWELL & COMPANY, Architects, 121 California Building, LOS ANGELES

Beautiful HOUSES \$900 and BUNGALOWS

CAN BE BUILT FOR AND UP

This and many others in my new book, Building Plans for Modern Homes, will save you hundreds of dollars. One of the most complete and comprehensive books of plans ever published by any architect. New edition just off the press. Nearly 500 floor plans and photographs of bungalows, Colonial homes, etc., costing from \$200 up; gives sizes and cost to build.

Sent postpaid for \$2.00



FREDERICK H. GOWING
ARCHITECT

181 Tremont St., BOSTON, MASS.

NO. 1 \$2.63 NO. 2 \$3.25

NO. 3 \$5.90 NO. 4 \$4.98

WEAR SEVEN FREE DAYS

OUR MARVELOUS MEXICAN DIAMONDS

have delighted thousands of customers for 18 years. They positively match genuine diamonds. Same perfect cut, same dazzling play of rainbow fire. Stand in close side by side comparison with genuine. Noted experts positively need their experience to detect any difference whatsoever. Perhaps the gems you admire on your closest friends are MEXICAN DIAMONDS and you never knew it. **Test a MEXICAN DIAMOND FREE; you risk nothing.** Wear it seven days side by side with a genuine diamond. If you see any difference, send it back; it won't cost you a cent.

HALF PRICE TO INTRODUCE

To introduce to new customers, we quote these prices which are all you pay and just half our catalog prices.

No. 1—Ladies 1 ct. Solitaire, fine 14k gold I. \$2.63
No. 2—Gents Heavy Tooth Belcher, 3 ct. gem, 14k gold I \$3.25
No. 3—Ladies 3 stone Duchess ring, fine platinum finish, two 5/8 ct. first water Mex. diamonds, one blue sapphire, \$5.90
No. 4—Gents Ex. Heavy Gyppy ring, platinum finish, black inlay on sides; 1 7/8 ct. first water Mex. Diamond. \$4.98

SEND NO MONEY Just send name, address and slip of paper that meets around ring finger to show size. Say which ring you want. We ship promptly. On arrival, deposit price with postman. If you decide not to keep it, return in 7 days and we'll refund your money. Write TODAY. Agents wanted.

MEXICAN DIAMOND IMPORTING CO.
Dept. ET LAS CRUCES, N. MEX.
Exclusive Controllers of Mexican Diamonds for 18 years.

Agents: \$50 a Week

For your spare time. Men or women selling guaranteed hosiery. Must wear 12 months or replaced free—all styles, colors and fancy stripes, including silk hose.

Sell for Less Than Store Prices

Often sell dozen pair to one family. Every man or woman, young or old, can make big money selling this quality line. Write for samples.

THOMAS MFG. CO., H-3048, Dayton, Ohio



Home Guard Olive Drab \$3.50 OVERCOATS 3

Brand new. Like cut. All sizes. Weight 5 to 7 lbs. Parcel Post extra. An excellent coat for dress or work. Arms and other goods in catalog. It's free.

W. STOKES KIRK

1627 PM North 10th St. Philadelphia, Pa.

Clear-Tone FOR PIMPLES

Your skin can be quickly cleared of Pimples, Blackheads, Acne Eruptions on the face or body, Enlarged Pores, Oily or Shiny Skin. \$1,000.00 Cold Cash says I can clear your skin of the above blemishes.

FREE WRITE TODAY for my FREE Booklet—"A Clear-Tone Skin"—telling how I cured myself after being afflicted for fifteen years.

E.S. GIVENS, 129 Chemical Bldg., Kansas City, Mo.

Great *New* Invention for seekers of Health Power Beauty



Elco Health Generators at last are ready for you! If you want more health—greater power to enjoy the pleasures and delights about you, or if more beauty is your desire—write! Ask for the book on these inventions which has just been prepared. It will be sent to you without cost. It tells you how Elco Health Generators aid you in leaving the lethargy and hopelessness of bad health and weakness behind forever. Re-vitalize yourself. Bring back energy. Be wholly alive. Write today!

10 Days Free Trial—Write for Free Book!



These great new inventions generate Violet Ray, Vibration, Electricity and Ozone—combined or separate **Free Trial**

They operate on the electric light in your home or on their own motive power at less than 50 cents per year. Elco Health Generators are positively the only instruments which can give you in one outfit Electricity, Violet Ray—Vibration and Ozone—the four greatest curative agents. Send the coupon below. Get the Free Book NOW!



For All These:

Paralysis
Pimples
Falling Hair
Headache
Lumbago
Nervousness
Rheumatism
Sore Throat
Asthma
Black Heads

Catarrh
Insomnia
Skin Diseases
Hay Fever
Neuralgia
Deafness
Pain
Development
Neuritis
Obesity

Mail Coupon for FREE Book!

Do not put this paper down without sending the coupon. Don't go on as you are with pain and with almost no life and energy. You were put here to be a better man or woman. You were put here to enjoy life—not just to drag through it. So do not rest another day until you have put your name on the coupon here. That will bring the whole story of these great new inventions. Do it today—now.



Lindstrom & Company

442-448 N. Wells Street, Dept. 13-51 Chicago, Ill.

Please send me your free book, "Health—Power—Beauty" and full information of your 10-day Free Trial Offer.

Name

Address

State Representatives Wanted

WINDOW SIGNS



AGENTS 500% PROFIT

Genuine Gold Leaf Letters

GUARANTEED TO NEVER TARNISH



For store fronts, office windows, Bank windows, Office Doors, Panels, Board Signs, Trucks, Automobiles and Glass Signs of all kinds. Anyone can put them on and make money right from the start without previous experience. All you have to do is to show your samples; the letters are very attractive and easy to sell. Letters costing 3½¢ sell for 25¢. One agent says: "Your Letters are the best thing I have seen in years: I have made \$125.00 the first week and still going strong." Paul Clark says: "Smallest day \$28.70." H. Gilder made \$835.00 in six weeks.

\$60 TO \$200 A WEEK

GENERAL AGENTS—It is easy to appoint sub-agents for this line. We pay you 20% cash commission on all orders we receive from local agents appointed by you anywhere. We allow you 50% discount on your own orders. You can sell to nearby trade or travel all over the country, as you please. Large demand for window lettering everywhere. Write today for free sample, full particulars and liberal offer to general agents.

Metallic Letter Co., 433-B N. Clark St., Chicago

QUIT TOBACCO OR SNUFF RUINING YOUR HEALTH WASTING YOUR MONEY

Harmless treatment quickly overcomes craving for cigars, cigarettes, pipe, chewing or snuff. Sent on trial. Costs \$1.00 if it cures, nothing if it fails. Used by over 400,000 people. Superba Co. H-2 Baltimore, Md.

LOFTIS BROS. & CO. EST'D 1858

Genuine **DIAMONDS** Guaranteed

Cash or Credit



The Loftis Carved "Perfection" Diamond Ring illustrated is Solid 14-K Green Gold, Diamond set in White Gold, Bridal Diamond design.

WEDDING RINGS TO MATCH 14-K White Gold, 17 Jewels, \$35
14-K White Gold, 15 Jewels, \$29

Blue White Brilliant, Perfect Cut Diamond. Marvelous Values at \$50, \$75, \$100, \$125 and up

SEND FOR FREE CATALOG

Over 2,000 bargains in Diamond-set Jewelry, Watches, Wrist Watches, Pearls, Mesh Bags, Silverware, etc. Sent prepaid for your Free Examination. Catalog explains everything.

CREDIT TERMS on all articles: One-fifth down, balance divided into equal payments within eight months. **SEND FOR CATALOG.**

LOFTIS BROS. & CO.
Dept. H894, 108 N. State St., Chicago, Ill.
Stores in Leading Cities

CLUB FEET



Infantile Paralysis caused my son to have club feet. I took him to McLain Sanitarium in 1919. He was 6 years old and could neither stand or walk on his bare feet. Now he has normally shaped feet, plump straight legs and can walk as good as any boy. I strongly recommend McLain's.

JOHN NELSON,
Galena Bay,
Arrowhead, P. O.,
British Columbia, Canada

Walter Nelson was brought 2500 miles to have his feet straightened. Edgar Franco was brought from Quito, South America, 3000 miles; Dennis Burrows was brought from Kingston, Jamaica, British West Indies, 2000 miles, to have their feet straightened. Harry G. Bayers came from Halifax, Nova Scotia, 1500 miles, to have his deformity, resulting from Infantile Paralysis, corrected.

Hundreds nearer home have come for treatment of various paralyzed and deformed conditions. Parents of crippled children and young adults should know of this institution.

Information and Literature mailed free.

McLAIN ORTHOPEDIC SANITARIUM
902 Aubert Ave. St. Louis, Mo.

GR-535

MAKE THAT LUGER INTO A RIFLE!



LUGER CARBINE, 16" barrel, Model No. 1222.

Mall us your Luger for equipment of the above Long Barrels with \$80 yard sight. Free labor. Shoot 200 accurate shots per minute with our J2-shot magazines and holster-stocks, equalling 8 riflemen. World famous V. Chr. Schilling super-accurate Mausers; Maasilcher sporters and other ultra-modern arms. Pacific Arms Corporation, Liberty Bank Bldg., San Francisco, U.S.A.

Catalog 1 Ten Cents

"I Would Not Part With It for \$10,000"

So writes an enthusiastic, grateful customer. In like manner testify over 100,000 people who have worn it. Conserve your body and life first.

The Natural Body Brace



Overcomes **WEAKNESS** and **ORGANIC AILMENTS** of **WOMEN** and **MEN**. Develops an erect and graceful figure. Brings restful relief, comfort, energy and pep, ability to do things, health and strength. Does away with the strain and pain of standing and walking; replaces and supports misplaced internal organs; reduces enlarged abdomen; straightens and strengthens the back; corrects stooping shoulders; develops lungs, chest and bust; relieves backache, curvatures, nervousness, ruptures, constipation, after effects of Flu. Comfortable and easy to wear.

Costs You Nothing to Try It

Write today for illustrated book, free, with full information and measurement blank. Address
HOWARD C. RASH, Pres. Natural Body Brace Co.
223 Rash Building SALINA, KANSAS

NEW LAMP BURNS 94% AIR

Beats Electric or Gas

A new oil lamp that gives an amazingly brilliant, soft, white light, even better than gas or electricity, has been tested by the U. S. Government and 35 leading universities and found to be superior to 10 ordinary oil lamps. It burns without odor, smoke or noise—no pumping up, is simple, clean, safe. Burns 94% air and 6% common kerosene (coal oil).

The inventor, H. E. Johnson, 609 W. Lake St., Chicago, Ill., is offering to send a lamp on 10 days' FREE trial, or even to give one FREE to the first user in each locality who will help him introduce it. Write him to-day for full particulars. Also ask him to explain how you can get the agency, and without experience or money make \$250 to \$500 per month.



**DIVINE
RED DEVIL
Water Motors**

Simple—strong—durable. Wonderful little workers for all sorts of household and shop uses. Thousands in use. For all light power purposes. Attaches to faucet.

Two sizes: 4"—\$4.25
6"—\$6.75

The higher the water pressure the more work they do.
Send today for catalogue.
Divine Water Motor Company
Utica, N. Y.



Sell Shirts

Sell Madison "Better-Made" Shirts, Pajamas, and Nightshirts direct from our factory to wearer. Nationally advertised. Easy to sell. Exclusive patterns. Exceptional values. No experience or capital required. Large steady income assured. Entirely new proposition.
WRITE FOR FREE SAMPLES.
MADISON SHIRT CO., 503 E'way, N. Y. City

TAILORING SALESMEN

We Pay You Salary and Commissions

Greatest money-making line in America. Made to measure suits, overcoats, one price, \$33.65, express prepaid, all wool, all wool linings, hand tailored, finest workmanship. No extra charges for style or oversize. Bigger advance commissions, weekly salary besides. Protected territory. Apply at once.

GREAT WESTERN TAILORING CO.
Dept. P, 837-841 W. Jackson Blvd. CHICAGO, ILL.

**A NEW WAY
TO GET YOUR CLOTHES
ABSOLUTELY FREE**



and Make Big Money during your spare time—something different, better, bigger, more liberal than any offer ever made. Lower prices—better clothes—bigger cash profits—express or postage paid on everything.

DOUBLE PAY

Free Clothes and Cash Profits Besides. You can easily earn \$50.00 cash, extra, every week during your spare time, taking orders for our made-to-measure clothes. We don't ask you to use your cash profits for your own clothes. That's not our way of doing business. Ours is a new and better plan.

Fifty-six stylish, real cloth samples—FREE colored fashion plates; inside wholesale prices—everything FREE. Just drop us a line today and we will send complete outfit FREE.

SPENCER MEAD CO. Dept. A-245 Chicago

A Home and Income For You in Sunny Florida



Be Independent—Own a Grapefruit and Orange Grove—A Truck or Poultry Farm. Increase Your Income

You Can Start a Grove Today Under Our New Plan

Develop a profit-earning fruit farm without leaving your present position—provide for your future. A small payment now and a few dollars invested each month.

A profit-producing fruit grove is a permanent investment and provides protection against old age.

**THE RIGHT LAND
IN THE RIGHT LOCATION AT
THE RIGHT PRICE**

We Have It—Any Size Farm

These splendid lands are suburban to Tampa, the metropolis of South Florida. Here you find the most healthful, the most delightful climate in North America. For ten years we have been right here helping develop Hillsboro—the banner agricultural County of Florida, and we are still here to serve you and to help you obtain the farm you want, on very easy payments extending over 2 or 3 years' time to suit.

Groves Developed for Non-Residents

If you want to remain in your present position for a few years we can develop a grapefruit and orange grove for you. When you are ready we will clear your land, furnish fruit trees, plant and care for your grove until you are ready to look after it.

We Raise Our Own Guaranteed Citrus Trees in Our Own Nurseries

This insures every purchaser the best fruit trees that can be grown. This also insures a successful grove. We can save you money on planting and caring for your grove.

\$300.00 to \$500.00 Per Acre Profit

This is not an unusual return for truck farmers in the Famous Tampa district. All kinds of vegetables can be grown. Big prices are paid for early potatoes, Winter cabbage, Bermuda onions, tomatoes, celery and dozens of other vegetables during the Winter and early Spring, when the north is covered with ice and snow. Strawberries, Melons and other small fruits, also yield large profits.

Write for Facts About Sunny Florida

IT COSTS YOU NOTHING TO LET US PROVE TO YOU that we have the land you want—in the location you want—at a price you can afford to pay and on the easiest terms you can imagine. Let us show you.

Fill out and mail us the coupon today and receive our large descriptive book FREE!

NORTH TAMPA LAND CO.

404 Zack Street TAMPA, FLA.

Coupon for FREE Book on Florida

NORTH TAMPA LAND CO.
404 Zack St., TAMPA, FLA.

Please send me your large illustrated Book, "The Call of the Southland," on choice Citrus Fruit and Truck Farms suburban to Tampa, Florida, and information on how I can have a grove developed on the monthly payment plan. P.M. 1-24.

Name.....
St. No.....
City.....
State.....

Please Mention Popular Mechanics

GENUINE ONLY
BLUE WHITE \$2
DIAMONDS DOWN

\$48 **\$4.60**
 A MONTH



**IF YOU CAN
 DUPLICATE IT FOR
 LESS THAN \$75.00
 WE WILL RETURN
 YOUR MONEY**

10 DAYS TRIAL **18K** **NO RED TAPE**

Just send \$2.00 deposit to show your good faith (or pay postman \$2.00 on delivery) and we will send this beautiful, latest style diamond ring. If satisfied after trial, pay only \$4.60 a month for only ten months. Total price \$48.00.

SET WITH BLUE SAPPHIRES

The sparkling, blue white, perfectly cut, genuine diamond in the center is set off attractively by the two deep blue sapphires set on either side in the shanks of mounting. The ring is 18 karat solid white gold, hand engraved and pierced, and looks like solid platinum. Send for it!

ORDER IT ON FREE TRIAL

Compare it with any \$75.00 diamond. We will give you a written guarantee that every penny you paid will be returned, if you are not satisfied, and return the ring within the ten days' trial. Can not be equaled as a present.

Write for BARGAIN CATALOG

It brings our large jewelry store right into your home. Compare our prices! \$1,000,000 Stock. Real Bargains!
STERLING DIAMOND & WATCH CO.
 Diamond Importers, Established 1870.
 63 Park Row, Dept. 1327, New York



**GOLD SEAL
 HOMCHARGER**

**Charges Radio and Auto Batteries
 at Home Over Night for a Nickel**

No stopping—no sticking—no muss—no fuss—no trouble. Self-polarizing—high-charging rate—finished in mahogany and gold—approved by Underwriters. Price \$18.50 complete with ammeter (\$25.00 in Canada)—no extras to buy—at all good dealers.

FREE Ask your dealer or send direct for free HOMCHARGER list of broadcasting stations and GOLD SEAL bulletin.

Insist on the GOLD SEAL

It's your guarantee against substitution and appears on name-plate and package. No other charger is just as good.

Automatic Electrical Devices Co. 129 West Third St., Cincinnati, O.
 Largest Manufacturers of Vibrating Rectifiers in the World



Branston D. L. Honeycomb Coils

and Geared Back and Front Panel Mountings
BEST for SELECTIVE TUNING

Superior construction and venier adjustment give better results in your set. Licensed under DeForest Patents. Send 2c for new Radio Manual with 5 Honeycomb Coil "Hook-ups."

CHAS. A. BRANSTON, Inc.
 819 Main St. Buffalo, N. Y.
 In Canada—Chas. A. Branston, Ltd., Toronto

**CATALOG E19-100
 PAGES
 FREE**

LATEST REFLEX AND NEUTRO DYNE CIRCUITS

One of the largest complete stocks in the world.

DEALERS ALL OVER THE U.S.

Making big profits handling our supplies. 24-hour service. Goods shipped same day order received.

**QUALITY AMERICAN RADIO SERVICE
 WHOLESALE MFG. CO. DISTRIBUTORS**

Dept. O, 6 W. 14th St. KANSAS CITY, MO.

**Before starting
 your new Radio Set**

**Better
 Tuning
 B-T**
 Price 10c

—read B-T's new booklet, "Better Tuning." It tells you why—the photo diagrams show you how. It is the result of thousands of inquiries we have had from both beginners and seasoned radio men. Sent on receipt of 10c or free with each Tuner.

**The B-T Vernier \$500
 Tuner (3-circuit
 coupler)**

has revolutionized many of the best circuits. Replaces coils on Reinartz Ultra Audion circuits, etc. Improves R. F. and Reflex circuits. Connections made to binding posts; easily changed to any circuit.

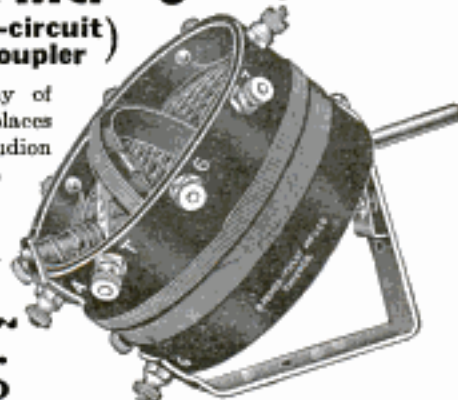

**BREMER-TULLY MFG. CO.
 542 S. Canal St. CHICAGO**

The Real Metal Solder in Paste Form

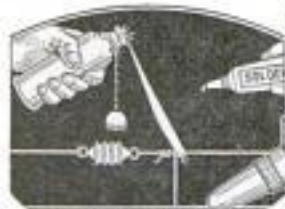
SOLDERALLIntroducing Our New
SOLDERALL BLOW TORCH
of Heavy Solid BrassIndispensable in the Home, Garage
and to the Electrician. For solder-
ing Radio, House Wiring, Jewelry,
Ignition, Kitchen Utensils, etc.IMPROVED
BRASS TORCH \$1.25SOLDERALL
TUBE 25¢**SOLDERALL CO. Dept. P Newark, N.J.**WEIGHS
ONLY
8 OZ.THE
PHONE
IT
TOOK
A SOLID YEAR
TO DESIGNA "200,000" COMPANY
stands squarely back
of the guarantee on
every Scientific headset**SEND NO MONEY!**20,000 TURNS
EQUIVALENT TO
5,000 OHMSOrder Today
by Postcard
and Pay
Postman
on arrival**2.95**
POST-PAID
LOUD
SPEAKER
UNIT '1935We Guarantee The Scientific Headset to be the greatest
value on the market. Try it for five days. If not satisfactory send it
back and your money will be refunded immediately. Circulars on
request. Dealers wanted.**THE SCIENTIFIC ELECTRIC WORKS**
86 Brookline Ave. BOSTON, MASS.**FREE RADIO CATALOG**
CONTAINING
LATEST **HOOK-UPS**14 UP-TO-DATE HOOK-UPS AND LIST OF
STANDARD QUALITY PARTS AT REDUCED PRICES

Service and Quality Built This House

GREAT LAKES RADIO CO. 136 W. Lake St. Chicago, Ill.
Dept. P-2**Vacuum Tubes Repaired**SAVE AT LEAST 1/2 THE COST OF NEW
UV200 and UV201..... \$2.75 each

UV201-A, WD-11 and WD-12..... 3.50 each

GUARANTEED EQUAL TO NEW

Opportunity for boys to make big money
by collecting tubes in quantities.All tubes received and returned parcel post, C. O. D.
HARVARD RADIO LABORATORIES
200 & 204 Old Colony Ave., So. Boston, Mass.**FREE Radio Text Book and Catalog**
A Post Card Brings It**CONTAINS 75 VACUUM TUBE
HOOK-UPS**

300 ILLUS. 500 RADIO ARTICLES

All Armstrong Circuits: These impor-
tant circuits are explained clearly, all
values being given, leaving nothing
to puzzle you.Also 75 full, clear diagrams, explanations
and instructions for all important vacuum
tube circuits, from the simplest to the
most advanced. How to make a wave-
trap — how to increase wave length of
set — aerial data — tube data — battery
data — reflex — regeneration — radio am-
plifiers — audio amplifiers — loud speakers
— tables of component parts, and endless
other radio subjects covered in simple,
understandable way.The 75 diagrams in book form alone would cost
you \$5 to \$8. Get this all FREE. Send for it
right away. Offer limited.**RADIO SPECIALTY COMPANY, 98 E. Park Place, N. Y. City***Cunningham***RADIO TUBES***The Heart of Your Receiving Set*IN the case of all living things the heart is the most
vital organ. Weaken, injure or destroy the heart and
life is accordingly weakened, endangered or destroyed.In a radio receiving set the tube is analogous to the
heart. Remove it entirely and the set will cease to
function. Use an inferior tube and the results will be
inefficient and generally not pleasing to listen to.In living things a perfect heart does not always insure
a healthy body, but on the other hand it is indispensable.
The same is true of the radio receiving set. It may be
perfect in every detail, but unless the best tubes are
used the results will not be perfect.Cunningham Radio Tubes were developed in the
great Research Laboratories of the General Electric
Co., and are now being made in that company's mod-
ern and mammoth factories under the supervision of
highly skilled engineers.Better tubes are not attainable. There is a model
specially adapted to every set, every circuit and every
socket used today. Every radio dealer can supply you
with Cunningham tubes. Buy them for replacements.
Insist that they be included when purchasing a new
set—and you will know that your receiving set has a
perfect heart.The care and operation of each model of Receiving Tube
is fully explained in our new 40-page "Radio Tube Data
Book." Copies may be obtained by sending ten cents to
our San Francisco office.**Patent Notice:** Cunningham tubes are covered
by patents dated 11-7-05, 1-15-07,
2-18-08, and others issued and pending. Licensed for
amateur, experimental and entertainment use in radio
communication. Any other use will be an infringement.**Cunningham Radio Tubes**

C-301A—6 Volts 1/4 amp. Amplifier.....	\$6.50
C-299 —3 Volts .06 amp. Dry Battery Det. & Amp.....	6.50
C-300 —6 Volts Gas Content Detector.....	5.00
C-11 —1.1 Volt .25 amp. Dry Battery Det. & Amp. Special Base.....	6.50
C-12 —Similar to C-11 with standard base....	6.50

*E. J. Cunningham Inc.*Home Office: 182 Second Street, San Francisco, Calif.
154 W. Lake Street Chicago, Ill. 30 Church Street
New York City, N. Y.

Please Mention Popular Mechanics

Copyrighted material



FANSTEEL
Balkite
PATENTS APPLIED FOR *Battery Charger*

Noiseless and Indestructible

A new battery charger for Radio "A" (6 volt) batteries. Entirely noiseless. Has no moving parts, requires no attention or adjustment, and cannot get out of order. Simple and unfailing in action. Can be used while the radio set is in operation. A positive economical charger for home use. Can also be used to charge automobile batteries. Write for folder giving full description.

Dept. P10-Fansteel Products Co., Inc.
North Chicago, Illinois

FREE RADIO
VACUUM TUBE SET



Receives
100 Miles or More

Send name and address.
Learn HOW you can get
a Vacuum Tube Radio Set
ABSOLUTELY FREE

Write today for Free Radio Plan.
RELIABLE SALES CORP.
434 Broadway, N.Y. City, Dept. 533



THE TRINITY LOUD SPEAKER

The only device of its kind in the radio field.

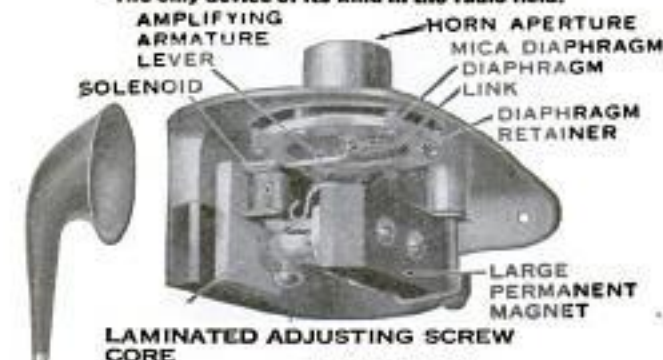

TYPE B \$12.50

Study the illustration carefully and you will understand why it produces full, clear natural tones with perfect reproduction of all vocal and instrumental music. May be used with phonograph or built into your set.

TRINITY RADIO CORPORATION
446 TREMONT ST., BOSTON, MASS.

Type A1, \$25.00
21" Fibre Horn

Please Mention Popular Mechanics



FREE! Book of tested hook-ups.
Send 2c stamp for postage.

RAULAND MFG. CO.

200 N. Jefferson St., CHICAGO

Over 300,000



in service



MIRACO
GETS 'EM
FROM
COAST TO
COAST

PRICE ONLY \$29.50

At rock-bottom prices you get the efficiency of sets costing three times as much. Users tell us that Miraco Radio frequency receivers pick up stations from coast to coast. Operate either on dry cells or storage battery. Solid mahogany cabinets — finest workmanship throughout. Order direct or send for bulletin.

Two tube outfit . . . \$29.50
Four tube outfit . . . \$4.50

DEALERS—AGENTS—Write for proposition quickly—It's a winner
THE MIDWEST RADIO COMPANY
807 Main Street, Cincinnati, Ohio

FREE RADIO BOOK



An easily understood explanation of Radio, written by Powell Crosley, Jr., President of Crosley Mfg. Co., Cincinnati, and The Precision Equipment Co., Cincinnati.

WRITE TODAY FOR THIS BOOKLET

Crosley Manufacturing Co.

115 Alfred Street

Cincinnati, O.

SIGNAL **Radio Cabinets**

Made in 29 different stock sizes. Rich Mahogany finish, special sizes and shapes to order. Write for illustrated folder, also particulars of our Radio Table.

SIGNAL ELEC. MFG. CO. 1910 Broadway
Menominee, Mich.

REMINGTON
PORTABLE TYPEWRITER
Dealers and Branches Everywhere

Reliable
RADIO
Goods

Results are sure with **RELIABLE** goods

And it's easy to get such goods—anything you want in radio equipment. Big, complete stock—everything guaranteed; quick service; right prices. And you're sure it's reliable when it comes from Andrae. Get our complete catalog—free.

JULIUS ANDRAE & SONS CO., 118 Michigan St., Milwaukee, Wis.

ANDRAE In Business Since 1860

Variocouplers
\$7.00
Variometers
\$6.50



Right now is your opportunity to get a set that will give you distance and volume. A Pioneer Variocoupler and two Pioneer Variometers gives you a tuning element hard to beat. Don't buy cheap instruments or you'll only get cheap results; buy the best, they cost less in the long run. Thousands and thousands of Pioneer instruments are nightly bringing results to their owners. Get yours at once. Ask your dealer or write us.

PIONEER RADIO CORPORATION
104 Pioneer Ave. Galesburg, Illinois

PIONEER

TIRES RUN 30,000 MILES

J. D. Cooper says their Cadillac Car ran 30,000 miles without changing a tire after equipping with a new puncture proof tube, invented by I. C. MILBURN, 339 W. 47th Street, Chicago, Ill. This wonderful tube in actual test has stood

500 NAIL HOLES WITHOUT LOSS OF AIR

and it costs no more than ordinary tubes. Mr. Milburn wants distributors. You can become his salesman. Write to-day.

Rings Bells Without Batteries

Avoid the annoyance of having bells out of order. At a nominal cost you can install this little device which will ring electric bells, buzzers, annunciators, electric heat regulators, door-openers, etc., from the same current that lights your home.

ONLY \$2.00
Canada \$3.00

Air-Way Bell Ringer Transformer

Connects direct to lighting-current, and eliminates forever the use of troublesome dry batteries. Does not use enough current to register on meter. Buy it from any electrical dealer, or we will send it anywhere postpaid upon receipt of price. Your money back if you are not satisfied.

JOBBERS, DEALERS, AGENTS—Write for selling proposition.
AIR-WAY ELECTRIC APPLIANCE CORPORATION
Toledo, Ohio



Super Transformer Audio Frequency

Does your receiving set refuse to amplify the bass notes of the piano? Does it make organ music sound like that of an accordion? If so, you are not getting the maximum enjoyment from radio.

Recent experiments in the Thordarson Laboratory have proven that the low notes of the heavy instruments can be amplified as readily as the high C of the soprano.

The Thordarson Super Transformer reaches its amplification constant at approximately 600 cycles and continues at even amplification well past the highest frequency of audibility.

Such manufacturers as the Colin B. Kennedy Co. and the Zenith Radio Corporation, convinced of the perfect reproduction of the Super Transformers, are incorporating them in all their sets.

Install a pair of Thordarson Super Transformers in your set and you will hear a radio concert as you have always wanted to hear it.

FREE BOOKLET

Write for our free Booklet No. 6, which contains many helpful suggestions regarding radio receiving.

PRICE (MOUNTED ONLY)

High Ratio 6 to 1 \$4.50
Low Ratio 3½ to 1 4.00

Sold by good dealers everywhere

THORDARSON

ELECTRIC MFG. CO.

Huron and Kingsbury Streets, CHICAGO

A Fine Holiday Gift

A REAL AUTOMOBILE

Any man or boy can build it or buy it complete. Power supplied by famous 2½ H. P. SHAW motor. Write for FREE Particulars and Special Low Prices or send 25c for COMPLETE BOOK OF BUILDING PLANS.

SHAW MFG. CO.
Dept. 37-5 GALESBURG, KANS.

MAKE YOUR FORD INTO THIS SPORT CAR—SAVE \$50 to \$150 WITH Red-i-Kut Life-Size Patterns \$6.40 COMPLETE

Famous Red-i-Kut life-size patterns and picture-fit instructions show you how you can easily convert your Ford into this Fast, Snappy, Sport Car as thousands have done, with easily obtained materials. No need to lay up the car. LOOK AT WILFRED ENO'S PAL. Eno says, "Total material cost with steel and paint for my Pal only \$14.50. It took me just 3 Sundays to build it and I was as proud to hear them say 'It's built like every sport car.' I never cut any steel or did any woodwork before but was out on a swing with Kuempel patterns." (Overland City, Mo. The "Pal" with crossed metal streamline rear, life-size patterns for each part of the body so you can't go wrong, picture instructions and CONICAL DISK WHEEL PATTERNS Only \$5.45 delivered. Order now while we can make good delivery, and really enjoy these wonderful days in your "Pal." Keen, Classy, Up-to-the-minute. You can build it. Over 11,000 in use. Don't hesitate. "Swing Lo" Underpiling frame, no frame cutting kind, only \$7.85. Send 5c even for new assortment of other distinctive speed body patterns from \$2.00 up. "R&G" Steel "Swing-Lo" Frame, "Big" Tone and "Gambel" Windshields. Order Right Now. Kuempel Co., 44 Kuempel Bldg., Guttenberg, Iowa

Easy-to-Understand Instructions and Tail Delivered

38-inch, Easy-riding seat

CLASS CLASS SNAP

**An Easy Way
to Cut Out
Interference**



The Ferbend "Wave Trap" Makes Every Night Silent Night

Get the station you want quickly. Listen in on the distant stations without annoying squawk-k-k-s or irritating whistles. Listen like this St. Louis user—"Heard Havana clearly with three St. Louis stations broadcasting. My receiver works like a new set. The 'Ferbend' is certainly a wonder!"

YOU Can Obtain These Remarkable Results

You can obtain results as satisfactory as this St. Louis user. If you don't, it doesn't cost you a penny, for the "Wave Trap" is sold with a positive guarantee that it will tune out interfering stations. Don't wait. Order now at our risk.

Send No Money You need not send a penny. Pay Postman \$6.00 (plus postage). If you prefer, send \$6.00 with order and "Wave Trap" is mailed postpaid. Money back guarantee either way. You see you take no risk, so order **TODAY**.

"Wave Trap" can also be supplied complete for use mounted on formica panel in mahogany finished cabinet 6x5x6 at \$8.50. Complete circular on request.

Ferbend Electric Co.

15 E. S.

Water St., Chicago

Send for a Ferbend "Wave Trap." I will pay Postman \$6.00, plus postage. I understand you guarantee "Wave Trap" to tune out interfering stations or refund money.

Name.....

Address.....

FERBEND ELECTRIC CO.

15 E. South Water Street, CHICAGO

FERBEND

Wave Trap

"It's a Morrison!"

"Exactly what I wanted—the whole family will enjoy radio now!" Several thousand lovers of real radio will say something like that Christmas morning when they open a package containing "Morrison Loud Speaker." Give a Morrison and you are sure to please.

Attach to your phonograph or use it with a horn. Morrison is the Loud Speaker that reproduces music and voices naturally without vibration—as loud as you like it. You can adjust tone soft or loud by simple turn of thumb screw on back—no other adjustment necessary—nothing to break or get out of order.

We guarantee you money back if not satisfactory

Complete with 5 foot cord.

Nickel Plated Model **\$10**

Gold Plated Model **\$15**

If your dealer doesn't carry it order direct from factory.

Beautifully Illustrated Catalog free on request

DEALERS

Be sure to stock up now for Holiday business. Orders filled in turn as they come in. Christmas sales will break all radio records. Wire or write today for our special offer.

MORRISON LABORATORIES, Inc.
337 Jefferson Ave., East, Detroit, Mich.

Morrison

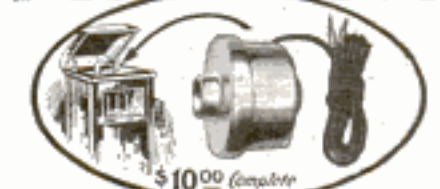

Loud Speaker

This Palatial Florida Home

can be purchased at a very reasonable price. It is the finest estate in a community of 30,000 situated amid 5 acres of orange, grape fruit, sweet bay, palmetto and a large variety of semi-tropical trees and foliage. A water front of 400 feet, with entrance from a Boulevard, affording every modern convenience. House recently completed and never occupied. Has every modern improvement, large sun parlors, sleeping porches and 8 bath rooms. Inexhaustible supply of soft water, steam heat, high, light basement under entire house. Surf bathing all winter within 5 minutes' walk.

For full details, photographs and price address

OWNER,

200 E. Ontario St. CHICAGO, ILL.



\$11⁵⁰

COMPLETE
\$12.00 East of
Buffalo

Alfred's Ice King
The Skate for Pleasure

The Finest Tubular Skate and Shoe Made

Used by the World's Greatest Amateur and Professional Skaters. For Sale by All Good Dealers or Direct from Factory.

Factory and Salesroom

Dept. PM, 2846 W. North Ave., Chicago, Ill.

Our 21 Jewel BURLINGTON SMASHES PRICES



LOOK!

Adjusted to the Second
Adjusted to Temperature
Adjusted to Isochronism
Adjusted to Positions
21 Ruby and Sapphire
Jewels
25 Year Gold Strata Case
Your choice of Dials
(Including Montgomery Railroad Dial)
New Ideas in Thin Cases

Only \$1⁰⁰ Down

Only One Dollar Down buys this 21 Jewel Masterpiece—this exquisite example of the watch maker's utmost skill. The balance you pay in small monthly payments, and the total price of this superb watch is far below that of other high grade watches. Moreover, you have a wonderful variety of the finest thin model designs and latest styles to choose from. Learn how you can see the Burlington and judge for yourself. Write today for our *Free Watch Book and Special Offer*.

See the Burlington Before You Buy

The Burlington is such a masterpiece of perfect timekeeping that it is used in practically every vessel in the United States Navy, and it is just as beautiful as it is accurate. We want you to see this watch without the slightest expense to you. After admiring its exquisite appearance, look carefully at the works. There you will see a perfect 21-Jewel timepiece, adjusted to positions, temperature and isochronism. And when you realize what an *aristocrat* among watches the Burlington really is, you'll simply be amazed at our low price and easy terms!

Send Coupon *While This Special Offer Lasts!*

Write today for the Burlington Watch Book. Find out at once about our great special offer made for a limited time only. You will know a great deal more about watch buying when you read this book. You will be able to "steer clear" of the over-priced watches which are no better. Write for the Watch Book and Special Offer NOW!

Burlington Watch Company

19th Street and Marshall Blvd., Dept. 13-51, Chicago, Ill.
Canadian Address: 62 Albert Street, Winnipeg, Manitoba

Burlington Watch Company
19th Street and Marshall Blvd.
Dept. 13-51 Chicago, Ill.

Canadian Address:
62 Albert Street, Winnipeg, Man.

Please send me (without obligations and prepaid) your free book on watches with full explanation of your \$1 down offer on the Burlington Watch.

Name.....

Address.....

All FORDS Can Be Filled Without Raising Cushions

A Gasoline Gauge, Too, Always In Sight

Attached in 10 Minutes



You Can Make Big Profits Selling

Kirstin

Fil-O-Meter

A GASOLINE GAUGE AND FILLER COMBINED

Eliminates bother, dirt, and loss of time in filling Ford (or Chevrolet) gasoline tanks. It is a filler and gauge combined. Automatic Air Vent, allows full flow from pump. Accurate gauge with glass covered dial, always in plain sight. Prevents running out of gas and short measure at filling station. Made of aluminum. Weighs only two pounds. Easy to install—clamps into regular gas tank opening.

SELLS FOR \$5 — BIG PROFIT

Retail price \$5.00 (\$5.50 on Pacific Coast). Big profit—Easy Seller. Ford owners now paying \$6.00 for gas gauges alone! KIRSTIN FIL-O-METER at \$5.00 gives visible gauge besides providing the only comfortable, clean, easy way of filling tank. Magnuson made \$48.00 in one day. Laux, as a sideline, cleared \$56 in 3 days.

TERRITORY GOING FAST — WRITE TODAY

Get our proposition TODAY. Closing territory fast. Sample sent on 10 days Money-Back Trial.

A. J. KIRSTIN COMPANY

14 First Street

ESCANABA, MICHIGAN

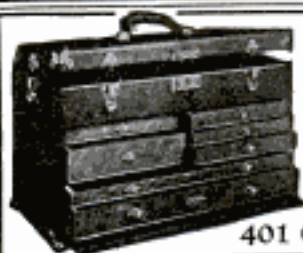

Tool Cases for Toolmakers and Machinists
Are shown in our New 1924 Catalog. Write to-day for a copy. Thirty sizes and styles shown. One to suit your needs.

H. Gerstner Sons

401 Columbia St., Dayton, O.

DIAMONDS

FOR A FEW CENTS A DAY

Don't send a single penny. Ten days' Free Trial. When the ring comes, examine it—If you are not convinced it is the *Greatest Bargain in America*, send it back at our expense. Only if pleased, send \$1.50 weekly—at the rate of a few cents a day. This Bargain Cluster Ring with 7 Blue-White Perfect Cut Diamonds can be yours. No Red Tape. No Risk.

\$1.50 a Week
SEND NO MONEY
Looks like \$350 Solitaire No. 61 only \$59.50
We Trust You

FREE Million Dollar Bargain Book

Send for it today. It pictures thousands of Bargains. Address Dept. 171

J.M. LYON & CO.
2-4 Maiden Lane N.Y.

I have averaged \$7000 Per Year for 3 Years—

Have Made Over \$90

Profit in One Day

This is the statement of Frank DePries, one of our live-wire representatives. Keeton of Mississippi made \$252 on his first sale. Vickers of Alabama made \$118 in one week. Conant quit a \$6,000 job to come with us.



DePRIES

AGENTS WANTED



We need more men likethese, because the demand for our *Super Fyr-Fyter* is growing by leaps and bounds. Sells to garages, stores, factories, schools, homes, hotels, auto owners.

Approved by the Underwriters. If you are willing to work and ambitious to make some real money, get our plan. You need no experience, as we train you without cost for the work. No great capital required. Good territory going fast. Better write us at once.

Ford Auto FREE!

We have a plan whereby our active workers can get a Ford without cost, in addition to their big cash earnings. Get the plan—quick!

THE FYR-FYTER CO.
1730 Fyr-Fyter Bldg.
Dayton, Ohio.

Boys: The Gilbert 1924 Year Book is a Wonder!

Chuck full of interesting articles and pictures. Also catalog of Gilbert Toys and Radio. 10c postpaid. THE A. C. GILBERT COMPANY, 215 Blatchley Ave., NEW HAVEN, CONN.

SENSATIONAL SALE GUARANTEED TYPEWRITERS



Limited quantity fully guaranteed standard make typewriters. Five Days' Free Trial. Lowest prices ever offered. Easy monthly payments. Send today for FREE booklet of Valuable Typewriter Information and Special Sale Bulletin.

SMITH TYPEWRITER SALES CO.
300-360 E. Grand Avenue, CHICAGO, ILL.

"73 Years Young"

Is my age writes H. B. Ruth, Colorado man, yet for years Mr. Ruth suffered with prostate gland disorder. "Used medicines with no avail—had about given up hope until a Doctor recommended your treatment," he writes.



Thousands of men like Mr. Ruth are finding renewed health and vitality thru a wonderful discovery that has brought the most amazing results in Prostate trouble, frequent nightly risings, sciatica, aches in back and feet and chronic constipation. Statesmen, Bankers, Lawyers, Doctors use and endorse this method. Yet you can use it right in your own home—no drugs, electric rays or book—a simple but quickly effective new hygienic principle. No matter what your age—or what you have tried, find out about this discovery at once. "Why Many Men Are Old at 40" is the **FREE BOOK** title of an interesting book that will be sent absolutely free. You may find relief from these distressing conditions the same as thousands of other men. Write at once to THE ELECTRO THERMAL COMPANY, 2129 Main St., Steubenville, O.

\$60 a Day to AGENTS

Amazing new kind of oil burner based on later discoveries than others. Does better work with fewer parts. Therefore so *cheap* every housewife can buy. Mixes 1 part coal oil (kerosene) with 20 parts air and makes cheaper gas than city gas. Installed in a minute—makes every range or heater a gas stove. Absolutely Safe.

Drop Everything For This Amazing Money-Maker

Our agents average 6 sales from 10 calls, \$60 a day. Low price does it. More full time and spare-time Agents wanted. Personal co-operation. Write quick for amazing proof of big earnings, Free Sample Case Offer and Protected Territory.

Wade Hill Manufacturing Co.
Dept. A-39 St. Louis, Mo.



"Lighting Fixtures"

READY TO HANG

(Direct from Manufacturers)

Completely wired, including glassware. New designs. Send for catalogue No. 24. Send for DEALERS' proposition.

ERIE FIXTURE SUPPLY CO.
STA. A ERIE, PA.



CAMERAS

Over a Hundred Styles and Sizes

Send for new illustrated catalog showing latest reduced prices. It's Free.

10 days' trial given

SENECA CAMERA MFG. COMPANY
300 Central Avenue Rochester, N. Y.



"LYON" WINTER TOPS

ROADSTER

\$31.25

TOURING \$41.25

FOR

**FORD and
CHEVROLETS**

Late models. Warm, roomy and comfortable. Easily ventilated when desired. Don't envy others. Be comfortable yourself. Send for our "Special Fall Bulletin" containing also our full line of racing bodies.

AUTO TIRE SALES CO., Dept. P16
1346 S. Michigan Ave. CHICAGO Body Division

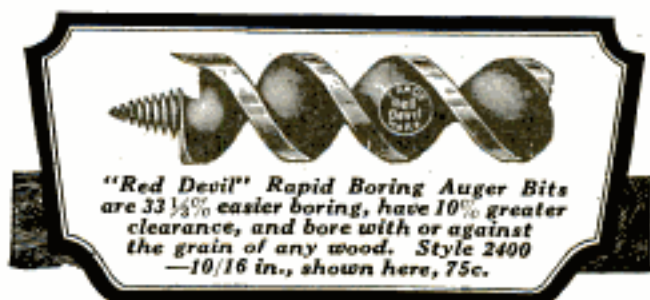

"Red Devil" Rapid Boring Auger Bits are 33 1/3% easier boring, have 10% greater clearance, and bore with or against the grain of any wood. Style 2400—10/16 in., shown here, 75c.

Red Devil Tools For Better Service

REG. U.S. PAT. OFF.

MADE of better-than-ordinary materials, they give better-than-ordinary service, and stand a lot of hard use. There's a "Red Devil" Tool for every practical purpose. Ask your dealer to show you the complete line.

"Red Devil" Long Nose Side Cutting Plier

A serviceable, forged steel tool with long nose for getting into hard-to-get-at places. The cutting edges cut and stay sharp; spring tempered handles have powerful leverage. Style 654—6 in., \$1.20 each.

"Red Devil" Mechanic's Snips

For roof repairs, soldering jobs, for cutting tin, sheet zinc, sheet iron, stove pipe, window screen wire, and for kindred work, you'll find a pair of metal cutting shears mighty handy. Style 578—7 in., 90c each.

"Red Devil" Tools are sold by all dealers, or if not in stock, send dealer's name and order direct.

Send for the "Red Devil" Mechanic's Tool Booklet.



SMITH & HEMENWAY CO., Inc.

Manufacturers of "Red Devil" Tools
260 Broadway New York, N. Y.

"Red Devil" Glass Cutters—the glaziers' standard tools of the world. "It's all in the wheel." Made in 40 styles. No. 024 shown here, 20c.



Please Mention Popular Mechanics

Copyrighted material

PLANERT'S "NORTHLIGHTS" The World's Best Tubular Skates



Safest for Amateurs

Planert's Northlight Skates are made of the finest and strongest steel obtainable. They are made to give lifetime service and lasting pleasure. They are safe for boys and girls because of the quality which has been maintained for 25 years.

Makers of Champions

Planert's Skates have made many champions. They are built to stand the strain of hard skating, yet an easy glide is possible without effort, because of their sterling qualities.

A Guaranteed Skate

Every pair of Planert's Northlight Skates are guaranteed against defect in material and workmanship. Behind this guarantee stands our reputation of 25 years.

Accept no substitutes. Ask your dealer for Planert's. If he can't supply you, write us giving your dealer's name.

F. W. PLANERT & SONS
Builders of Tubular Skates for 25 Years
939-41 N. Robey St. Chicago, Illinois



"How to Select Safe Bonds"

A coupon is appended below for the convenience of every interested investor in sending for our booklet, "How to Select Safe Bonds." It tells how you can make your investments pay an attractive yield (ranging as high as 7%) with absolute safety.

COUPON BRINGS YOUR COPY

In every banking circle the name of Geo. M. Forman & Company has always been associated with sound investments. This house has been in business for 39 years without loss to a customer. Mail coupon for your copy of this interesting book.

GEORGE M. FORMAN & COMPANY

Dept. 441 105 West Monroe Street CHICAGO, ILL.
GEORGE M. FORMAN & COMPANY, Dept. 441, 105 West Monroe Street, Chicago, Ill.

Guarantee:—Please send me at once your booklet, "How to Select Safe Bonds."

Name.....

Address.....

Please Mention Popular Mechanics

Secret Service



Stop!

Here is the only liquid that will quickly and easily find all leaks anywhere in automobile cooling system and stop them permanently in from 5 to 10 minutes. Simply pour it into the water in your radiator.

RADIATOR NEVERLEAK

is absolutely guaranteed not to impair or clog the cooling system in any way. It adds years to the life of the radiator by preventing rust and scale from forming. Radiator Neverleak is the original stop-leak compound. This secret formula is the result of 25 years' research. Entire satisfaction guaranteed or money refunded.

Write for free "Secret Service" booklet.

BUFFALO SPECIALTY COMPANY

357 Ellicott St.
Buffalo, N. Y.

50¢
and
75¢
a can

SELF-FILLING INK PENCIL "INDEPENDENT"

Guaranteed Improved Fountain Pen. Eliminates fatigue. Promotes efficiency. Writes uniform. A business necessity.

Meets all requirements. Self-filling, non-leakable, safety cap. Attached clip. Smooth writing gold style point.

\$2 By Mail

Your Name in Gold—25 Cents Extra

AGENTS WANTED

J. C. ULLRICH & CO., 161 Washington St., New York

100 Genuine 10c Cigars \$6⁹⁵

Regular Retail 10c Cigar, Havana Filler. Wisconsin Binder and Sonoma Wrapper. These cigars are nationally known for their wonderful quality. Satisfaction guaranteed or money refunded. Order Today.

OWENSBORO TOBACCO CO., Dept. 130, OWENSBORO, KY.

RADIO SET FREE!

Underslung Fixtures

SPORT BODIES \$29⁰⁰ UP



Racing Gears, Wheel Discs, Hi-Speed Camshafts

4, 8 and 16 Overhead Valve Heads, Sport Fenders for Underslung and Standard Fords.

With an order on a Fordspeed Body or other merchandise amounting to \$100, we will give Free a \$25.00 Standard DX Radio Set, regenerative type under Armstrong U. S. Patent, solid mahogany case, vernier dial controls. This offer is only good for a limited time. Send in your order with \$25.00 deposit and radio set will be forwarded immediately, balance of \$75.00 on delivery of other merchandise. If you are not ready for body now, place your order for future delivery. Enjoy your winter evenings by bringing to your home operatic artists; best orchestras playing classical and dance music; direct sporting and business news; and when spring comes, you will already have a good start on your classy Fordspeed car. Oh Boy! what a happy combination. Write immediately for body catalog and special Radio Offer. Radio sets for sale at \$25.

O. L. FORD SPEED & POWER EQUIP. MFRS., 250 W. 54th St., New York, 2nd Floor



WHITING-ADAMS BRUSHES

A brush expert says they are the best Hair Brushes made. They are penetrating. They go all through the hair to the roots and stimulate growth. They make a beautiful radiant sheen. The glory of woman is made more glorious with Whiting-Adams Hair Brushes.

Send for Illustrated Literature

JOHN L. WHITING-J. J. ADAMS CO.
Boston, U. S. A.

Brush Manufacturers for Over 114 Years and the
Largest in the World

FASTEN IT WITH AN AJAX EYELET FASTENER

Binds Paper, Cardboard, Leather, Cloth
It Saves Time by Punching the hole,
feeding the eyelet and clinching it in
one operation. Order from your Stationer

Machine Appliance Corp.
Dept. P. M. BROOKLYN, N. Y.

Delivered to You Free

For 30 days trial on approval. You can have your
choice of 44 Styles, colors and sizes of the famous
RANGER Bicycles. Express prepaid. Factory-to-
Rider Prices save you \$10 to \$25 on your bicycle.

12 Months to Pay easily save the small monthly pay-
ments. Pays off in advance first payment.

Tires, Lamps, wheels and equipment, low prices. Send
No Money, do business direct with makers.

Mead Cycle Company
Dept. 100 Chicago

Write today for Free
Ranger Catalog, fac-
tory prices and mar-
velous easy payment terms

Make \$60 to \$100 A WEEK

New 300 Candle Power Lamp—Burns 96% Air

Introduce wonderful patented invention.
Burns only 4% fuel—cheap kerosene or
gasoline. Uses less than wick lamps.
Greatest advancement in lighting of the
age. Table lamps, wall lamps, hanging lamps,
lanterns. Powerful, brilliant, soft, restful white
light—like daylight. Brighter than a score of wick
lamps. No Smoke—No Soot—No Odor.

FREE Outfit Offer Easy to earn big
money. No expe-
rience—no capital required. Work all or spare
time. Simply take orders. We deliver and collect
—pay you big commission same day. Vivian of
Minn. made \$400 in 39 days. Green of N. Y.
made \$33 in one day. Hundreds making \$10
to \$40 a day. Get territory quick. Big season now
on. Write today for Free catalog and special agents offer.

The Akron Lamp Co., 101 Lamp Bldg., Akron, O.



XMAS GIFTS

Sent for \$2



21—20K white gold
ring; diamond set in 21
cup setting. \$75.00.



22—Lady's 18K white
gold ring, perfect cut
diamond; sapphire on
each side. \$95.00.



23—Lady's ring, 14K
gold set with fine blue-
white diamond. \$50.00.



24—Gentleman's 14K
ring; five diamond set in
18K white gold top.
\$45.50.



25—Lady's seven dia-
mond cluster 14K white
gold pierced mounting.
\$62.50.



26—Gentleman's seven
diamond cluster set in
platinum. 14K chain.
\$63.00.



27—Newest style elegant wrist watch, 14K white gold.
Highest grade 15 jewel movement, lifetime guarantee.
\$24.50.

\$2.00 Brings Your Choice

NO RED TAPE—NO DELAY

Simply send \$2.00 and your choice goes to you
charges paid. You have ten days in which to
decide. Money back instantly if you are not
satisfied as to the quality and value.

A Full Year to Pay

After trial pay balance in 12 monthly pay-
ments. 10% discount for cash.

Free Royal Xmas Catalog

The most complete Catalog ever published of Diamonds,
Watches, Jewelry, Silverware, Cameras, Ivory Toilet
Sets, etc., sent FREE. Prices from \$5.00 to \$1000
—quality the highest. Ten days' trial and a full
year to pay on everything you order from our
\$2,000,000 stock. Send for your copy today. Dept. 978.

**ROYAL DIAMOND
& WATCH CO.**
170 Broadway - New York

Please Mention Popular Mechanics

Copyrighted material

START THE NEW YEAR WITH A STARRETT CATALOG

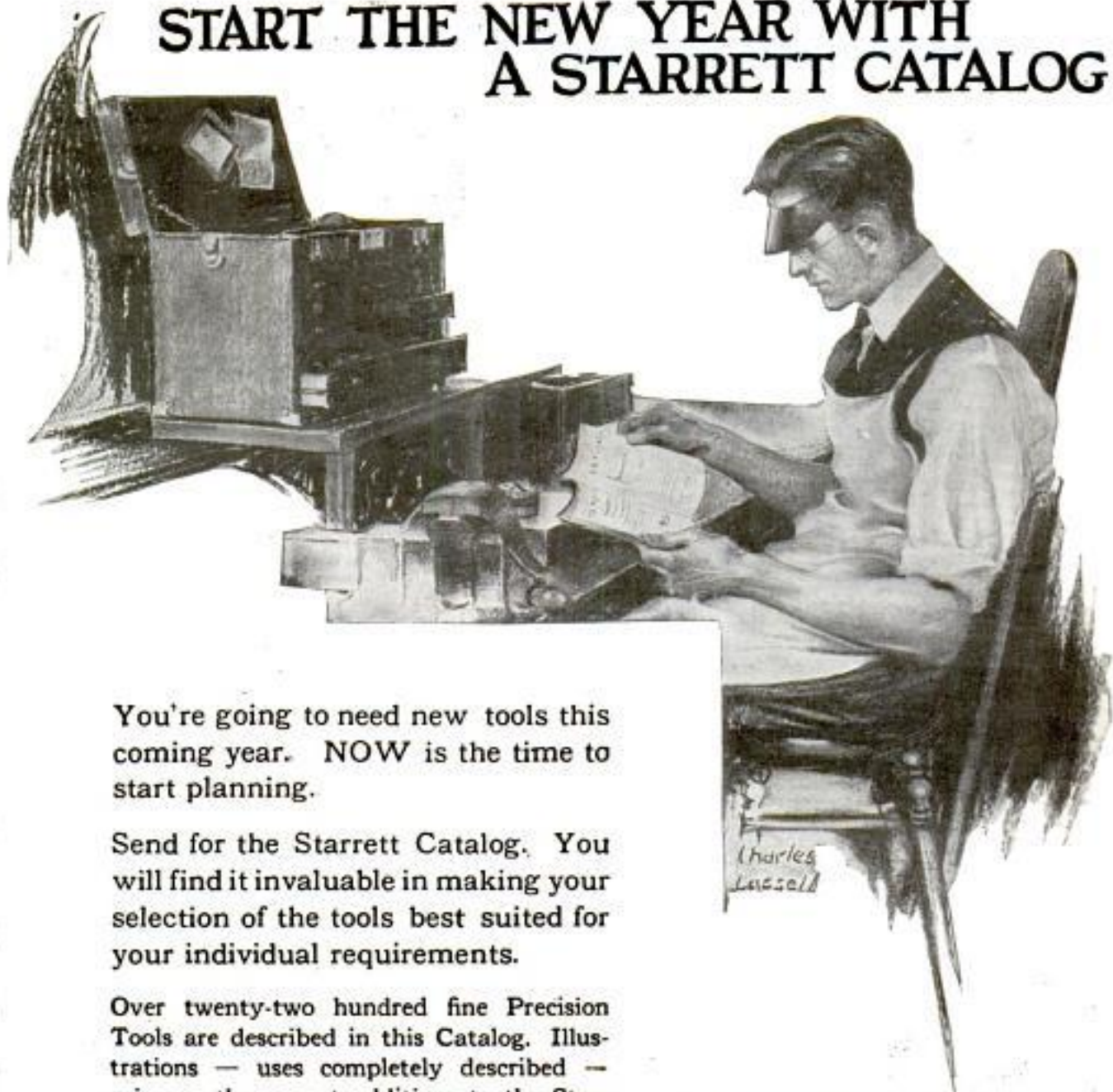

You're going to need new tools this coming year. **NOW** is the time to start planning.

Send for the Starrett Catalog. You will find it invaluable in making your selection of the tools best suited for your individual requirements.

Over twenty-two hundred fine Precision Tools are described in this Catalog. Illustrations — uses completely described — prices — the newest additions to the Starrett Line — the whole story in its 350 pages.

Write for it **TODAY**. Mailed promptly at our expense. Ask for Catalog No. 22"AP."

THE L. S. STARRETT CO.

The World's Greatest Toolmakers
Manufacturers of Hackaws Unexcelled
ATHOL, MASS.



Starrett Tools



Showing how the Starrett Catalog describes a tool and its uses. This free book has the information you want. Send for it.

Note FREE Offer

My Beauty

How I gained it
How I kept it to my age

By Edna Wallace Hopper

I have been a famous beauty 40 years and over—on the stage. At a grandmother's age I'm a beauty still. I still play youthful parts, and I look like a girl of 19.

I was naturally a plain girl but my mother took me to search the world for its supreme beauty helps. We found them in France, and they made me the rage. I have used them ever since. And now at 60, countless young girls envy my hair, my contours and complexion.

I know these same helps can bring to millions new beauty and new youth. So I have arranged that all may get them, as a duty to my sex. I found 32 of these scientific helps—the greatest beauty helps in existence. I have had them combined in four preparations. And I have supplied them to all druggists and toilet counters, so every girl and woman may enjoy the benefits I got.

White Youth Clay

One is my White Youth Clay. Not like the crude and muddy clays so many still employ, but a refined clay, clean and dainty—a super-clay, based on 20 years of scientific study.

The right clay is a beauty essential. It purges the skin of all that clogs and mars it. It brings that rosy afterglow which so amazes and delights. It firms the skin, combats all lines and wrinkles, reduces enlarged pores. It brings to any woman new beauty, new youth, and at once. This master clay—my White Youth Clay—sells for 50c and \$1.

My Facial Youth

This is my liquid cleanser. It contains no animal, no vegetable fat, so the skin cannot absorb it. It simply cleans to the depths, then departs. All the refuse, dirt and grime come with it. You cannot realize what a clean skin means until you try Facial Youth. The cost is 75c.

My Youth Cream

This is a cream which combines all the best the world knows to foster the fine texture of the skin. It contains both lemon and strawberry. Also many other factors to soften, whiten, feed and smooth the skin. The cost is 60c.



My Hair Youth

My hair is my greatest glory. It is heavy, thick, and lustrous. I have never had dandruff, falling hair, and never a touch of gray. All this I owe to my Hair Youth, which I apply every day with an eye-dropper. I simply moisten the scalp without massing my hair, and my luxuriant hair is the result. Hair Youth costs 50c and \$1.

Edna Wallace Hopper's Beauty Helps are now sold everywhere. But I will gladly send you a test of one, and with it my Beauty Book. Check in this coupon the one you want and send it in today.

YOUR CHOICE FREE

Insert your name and address. Mark the sample you desire. Mail to Edna Wallace Hopper, Inc., Waukesha, Wis.

- Youth Clay Youth Cream
 Facial Youth Hair Youth

P. M. 1

SPORT BODIES for FORD and CHEV. 490 at \$34.50

Life-size paper patterns—You can build your own body at small cost.



UP
UNDER
SLUNG
PARTS
Per Set
\$6.75

We are manufacturers and our quantity production enables us to quote exceptional low prices. Our unique shipping methods save you 73% in FREIGHT CHARGES. Send at once for free particulars on Central Bodies. Our Book: "HOW TO BUILD A FORD RACER" sent anywhere on receipt of 25c in cash or stamps. WRITE TODAY!
Central Auto Supply Co. Dept. 129, Louisville, Ky.

Our BUREAU of INFORMATION will answer all questions regarding articles in this magazine. Address Popular Mechanics Magazine, Chicago.



FREE
Fine Tone
Musical
Instruments
\$20
We have a wonderful new copyrighted system of teaching note music by mail! To first pupils in each locality we will give free a \$20 superb Violin, Tenor Banjo, Ukulele, Hawaiian-Guitar, Banjo, Mandolin, Banjo-Ukulele, Banjo-Mandolin, Cornet or Banjo-Guitar absolutely free. Also teach Piano and Organ. Very small charge for lessons only. Your lessons will teach you several pieces. Over 100,000 successful players. We guarantee success or no charge. Complete outfit free. Write today, Dept. 167. No obligation.
SLINGERLAND SCHOOL OF MUSIC, 1815 Orchard Street, CHICAGO, ILLINOIS

SONGS Clean, catchy hits that everybody likes. Ballads, comic songs, novelty songs,coon songs; full sheet music with beautiful colored covers. "Mammy's Twilight Lullaby," latest hit, 30c. Many others. Hundreds of plays and entertainment books. Big catalog free.
T. S. Denison & Co., 623 So. Wabash, Dept. 200, Chicago

SELLS for \$1.25 AGENT'S SAMPLE 65c.!

New Self-Filling Bamboo Fountain Pen with Stylo Point



Imported from Japan

"It makes Carbon Copies"

Guaranteed for 1 year

An Ideal
Holiday Gift
Comes
in Holly
Box

Hustlers Making \$20 Daily! Money refunded if you don't think it's the best pen you ever wrote with. Just out! Up to 150 per cent Profit. Send for quantity price list and distributing plans.

F. SPORS & CO., 331 Main Street, Lesueur Center, Minnesota



No Money Down Sent on Approval

Our determination to this year double our sales of the world famous *Santa Fe Special* and *Bunn Special* Watches prompts this matchless offer.

While other watch dealers are raising their prices, asking you for larger monthly payments, and making payment terms harder for you to meet, we are offering you our new model *Santa Fe Special*, and the famous *Bunn Special*, no advance in price, no money down, easier terms and smaller monthly payments. WE realize the war is over, and in order to double our business we MUST give you pre-war inducements, better prices, easier terms, and smaller payments.

LOOK! Santa Fe Special AND Bunn Special Watches

Without one penny of advance payment let us place in your hands to see, to examine, to inspect, to admire, to approve a real masterpiece in watch creation.

Page 12 of Our Watch Book Is of Special Interest to You!

Ask for our Watch Book free—then select the watch you would like to see, either the famous *Santa Fe Special* or the 6 position *Bunn Special*, and let us explain our easy payment plan and send the Watch, express prepaid, for you to examine. No money down.

Santa Fe Watch Co., 16 Thomas Bldg., Topeka, Kans.

Please send prepaid and without obligation your Watch Book free, explaining your "No Money Down" Offer on the *Santa Fe Special* Watch.

Name

Address

State

REMEMBER No money down—easy payments buys a master timepiece—a 21 Jewel guaranteed for a lifetime at about half the price you pay for a similar watch of other makes. No money down—a wonderful offer.

Santa Fe Watch Company
16 Thomas Bldg. Topeka, Kans.
Home of the Great Santa Fe Railway

TRADE MARK **WURLITZER** REG.
SUPREMACY IN MUSICAL INSTRUMENTS



Learn to Play

You are always popular and sure of a good time if you can play some musical instrument. By yourself, with your friends around the piano, in orchestras or bands,—there is no end to the pleasure music will give you. And there is no easier way to earn money in your spare time. Choose your instrument now and let Wurlitzer help you buy it and learn to play it.

Try Any Instrument in Your Own Home At Our Expense

You may now have any known musical instrument for a week's free trial in your own home. There is no obligation to buy—no expense for the trial. You may return the instrument at the end of a week if you decide not to keep it.

Monthly Payments

The Wurlitzer plan makes it easy for you to own the instrument you want. Payments are conveniently arranged in small monthly sums—a few cents a day will pay.

Wurlitzer instruments are known everywhere for their unusual tone quality and excellence of workmanship. They are used by the greatest

professional musicians, bands and orchestras. Harry L. Jacobs of Sousa's Band, Brooke's Marine Band, and Chicago Grand Opera says: "I am proud to be the owner of one of your new cornets. It is positively superior to anything I have had in all my years of cornet playing."

Easy to Buy

Thousands of amateur musicians are playing on Wurlitzer instruments. Many of them could not have bought except through the Wurlitzer selling plan. Wurlitzer is the world's greatest music house, with stores and dealers in all parts of the country. But no matter where you live you will receive the same service by mail as though you lived next door to the factory. Send the coupon today.

Send for Free Catalog

The greatest musical catalog ever published. Over 3,000 articles—every known instrument described and illustrated—many of them shown in full color. Gives you all details of the Wurlitzer plan. Send coupon now.

The Rudolph Wurlitzer Co., Dept. 1771
117 E. 4th St., Cincinnati 329 S. Wabash Ave., Chicago
120 W. 42nd St., New York 250 Stockton St., San Francisco
Send me absolutely free, your new illustrated catalog of musical instruments. Also tell me how I may try any instrument in my own home at your expense and how the Wurlitzer plan makes it easy for me to buy. No obligation.

Name _____
Address _____
City _____ State _____
Instrument _____
(State instrument in which you are interested.)

PATENTS TRADE-MARKS AND COPYRIGHTS

OUR OFFER: No Charge for Examination and Instructions

HAVE YOU ANY NEW IDEAS?

Your First Step: Before disclosing an invention the inventor should write for our blank form "Record of Invention." This should be signed and witnessed and returned to us together with model or sketch and description of the invention for examination and instructions.

No Charge for the Above Information

Our Three Books Mailed FREE to Inventors

OUR ILLUSTRATED GUIDE BOOK

HOW TO OBTAIN A PATENT

Contains full instructions regarding Patents, Our Methods, Terms, and 100 Mechanical Movements illustrated and described; Articles on Patent Practice and Procedure, and Law Points for inventors.

Our Trade-Mark Book

Shows the value and necessity of trade-mark protection and gives information regarding Trade-Marks and unfair competition in trade.

Our Foreign Patent Book

We have direct agencies in all foreign countries and secure foreign patents in the shortest possible time and at the lowest cost.

Prompt Attention

Reasonable Terms

Highest References

All Communications and Data Strictly Confidential. Interference and Infringement Suits Prosecuted.



VIEW OF PRIVATE OFFICE, VICTOR J. EVANS, With view of Patent Office through Window

FREE COUPON

VICTOR J. EVANS & CO., Patent Attorneys

MAIN OFFICES: 722-724 9th Street, N. W.,

WASHINGTON, D. C.

Gentlemen: Please send me FREE OF CHARGE your books as described above.

Name.....

Address.....

OUR SERVICE IN PATENTS

Our Branch Offices

In order to assist our clients in patent matters and give them the advantage of every convenience and facility, we have established branch offices in New York, Philadelphia, Pittsburgh, Chicago and San Francisco. These branch offices being located in the principal commercial cities of the United States, together with our main office located near the U. S. Patent Office in Washington, D. C., enables us to more promptly handle business of our clients, particularly as the branch offices are in constant touch with the main office, and fully equipped to handle patent and trade-mark business in all its branches. Our branch offices also enable us to assist our clients in any negotiations regarding the sale or leasing of their patent rights.

Specialization—Our Staff

The field of invention is so vast that it is impossible for any one man to become an expert in all classes of invention. Only those skilled in the class to which the invention relates are capable of rendering efficient service. For this reason we employ a number of patent lawyers and draftsmen, who have been selected for their special knowledge and ability in certain lines of invention. Each case is placed in charge of an expert in the class to which the invention relates.

The Value of Your Patent

will depend upon the skill and care with which your case is prepared and prosecuted in the United States Patent Office. We spare neither time nor pains to secure the broadest possible patents that the invention will warrant. We shall be happy to meet inventors in person at our offices or to advise them by letter, and they are at liberty to write us any time they desire information. Their plans will receive careful consideration, an honest opinion and a prompt reply. We have a personal interest in the successful outcome of every case we handle, and inventors can rely on receiving the highest grade of work and the most thorough service from us.

We regard a satisfied client as our best advertisement, and will furnish to anyone, upon request, lists of clients in any state for whom we have secured patents.

FREE COUPON

VICTOR J. EVANS & CO.

Patent Attorneys

Main Offices: 722-724 9th Street, N. W.,
WASHINGTON, D. C.

Write Today.—Just fill in your name and address below and send to nearest office and we will send you Free of charge our Patent Books.

Name.....

Address.....



Our New York Office
1007 Woolworth Bldg.



Our Philadelphia Office
714-15 Liberty Bldg.



Our Washington Office
Victor Building



Our Chicago Office
1114 Tacoma Building



Our Pittsburgh Office
514 Empire Building



Our San Francisco Office
1010 Hobart Building

PATENT TRADE MARKS PROTECT

ANY NEW article, machine, design or improvement thereof, or any new combination of parts or improvements in any known article which increases its efficiency or usefulness, **may be patented**, if it involves invention.

If You Have Any New Ideas which you feel are useful, practical and novel, **take prompt action to protect your rights.** If you have invented any new machine, or new combination of parts of improvement, or any new design or process, **SEND DRAWING, MODEL OR DESCRIPTION** of it for information as to procedure to secure protection.



DRAFTING and SPECIFICATION ROOM of CLARENCE A. O'BRIEN, Registered Patent Attorney, Washington, D. C.

**Write Today for Blank Form
"RECORD OF INVENTION"**

USE THE COUPON attached, and immediately upon its receipt I shall send you this form to be returned to me with drawing, description or model of your idea; promptly upon receiving your idea I shall write you fully as to procedure and costs.

ALL COMMUNICATIONS

are held in strict confidence. My personal, careful and thorough attention is given to each case. I offer you efficient, reliable and prompt service—based upon practical experience. **Highest references.**

No Charge for Above Information

CLARENCE

**REGISTERED
70A SECURITY SAVINGS & COMMERCIAL BANK BLD'G WASHINGTON
MEMBER OF THE BAR OF COURT OF APPEALS, DISTRICT
SUPREME COURT OF UNITED STATES
PRACTICE CONFINED TO PATENTS**

NTS

COPYRIGHTS YOUR IDEAS

WRITE TODAY for free book, "How to Obtain a Patent." This book will give you valuable information, and it may save you much time and effort. Send for it, NOW. My practice is devoted exclusively to United States and Foreign Patents and Trade Marks. Write me freely, frankly and with full confidence; it is very probable that I can help you. **Write Today**



United States Patent Office as Viewed from My Office, Directly ACROSS THE STREET



CLARENCE A. O'BRIEN, Patent Attorney, 70A Security Savings & Com'l Bank Bldg. Directly Across Street from Patent Office WASHINGTON, D. C.

Please send me your free booklet, "How to Obtain a Patent," and blank form, "Record of Invention," without any obligation on my part.

Name.....

Address.....

(WRITE PLAINLY)

A. O'BRIEN

**PATENT ATTORNEY
D.C. DIRECTLY ACROSS STREET FROM U.S. PATENT OFFICE
OF COLUMBIA, UNITED STATES COURT OF CLAIMS:
SUPREME COURT, DISTRICT OF COLUMBIA
TRADE MARKS AND COPYRIGHTS**

PATENTS

Seventy-six Years of Practice

THE firm of Munn & Company filed its first application for a patent in 1846, and for seventy-six years has endeavored to keep pace with the inventive genius of the United States.

An experience of many years is at your disposal. If you have an invention which you wish to patent, send your sketches or model together with a description of your device, explaining its operation, and you will receive prompt, courteous attention.

Write for our Handbook on PATENTS

A full and complete booklet on Patents, Designs, Trade-Marks, Foreign Patents, Copyrights, Labels and Patent Office Practice with an explanation about our methods, terms, etc.

All communications strictly confidential.

Keep in touch with the inventions of the world by reading

SCIENTIFIC AMERICAN

The MONTHLY MAGAZINE with a special appeal to every man of inventive genius. Recent rulings of the Patent Office, descriptions of the latest patented inventions, legislation and court decisions affecting patents, are noted in this authoritative publication.

MUNN & COMPANY

Patent Attorneys

672 Woolworth Building, New York City

Scientific American Building, Room 2
625 F Street, Washington, D. C.

Suite 801, Tower Building, Chicago, Ill.
601 Hobart Building, San Francisco, Cal.

Have You An Invention?

If so the WORLD PROGRESS will show you how to **PROTECT AND PROFIT FROM YOUR IDEAS** Sample copy free. One year's subscription \$1.00. Send for free book,

"WHAT TO INVENT"

containing SUGGESTIONS TO INVENTORS as to Inventions Needed. We invite manufacturers to address us regarding inventions they want.

WORLD PROGRESS PUB. CO., Inc.
Room 203 Victor Bldg. WASHINGTON, D. C.

Patent Essentials

By John F. Robb, LL. B., LL. M., M. P. L.

How to procure a patent, how to protect it, how to draft patent claims and conduct cases and special proceedings. Everything pertaining to patents and patent law is covered in simple language in this new book by an eminent patent specialist. It will prevent worry and save money for inventors, Executives, Engineers and Lawyers. Satisfaction or money back.

8vo, Cloth. 452 pages. Illustrated. \$5.00, net; by mail, \$5.10
FUNK & WAGNALLS COMPANY, Dept. 690, New York



PATENTS

Send us sketch or model for patentability opinion and exact cost of patent. Our book "How to Obtain a Patent," sent free on request. It tells how to apply for Patents, Trade Marks, Foreign Patents, Copyrights, etc.; gives information on Patent Procedure; tells what every inventor should know. Thousands of Inventors, who are our clients, are our references.

Chandlee & Chandlee, 25 Years' Experience.
455 7th St. Washington, D. C.

PATENTS

C. L. PARKER
Formerly Member Examining
Corps, U. S. Patent Office
PATENT LAWYER
MCGILL BLDG.
WASHINGTON, D. C.

Patents, Trade Marks, Copyrights, Patent Litigation

Handbook for Inventors, "Protecting, Exploiting and Selling Inventions," sent free upon request.

PATENTS

Trade-Marks, Copyrights and Patent Litigation

Write for advice and instructions how to proceed, costs, etc. Hand Book with illustrations of 100 Mechanical Movements sent free on request.

ALBERT E. DIETERICH

Patent Lawyer and Solicitor

Successor to Fred D. Dieterich & Co. 621 Ouray Bldg., Washington, D. C.

INVENTORS

who derive largest profits know and heed certain simple but vital facts before applying for Patents. Our book Patent-Sense gives those facts: free. Write **Lacey & Lacey, 546 F St., Washington, D. C.** ESTABLISHED 1869.

PATENTS

REGISTERED PATENT ATTORNEY SINCE 1905
CHARLES W. LOVETT SECURITY BLDG. LYNN MASS.
(SEND FOR FREE BOOKLET)



Buchstein's Fibre Limb

is soothing to your stump—strong, cool, neat, light. Easy payments. Braces for all deformities.
D. BUCHSTEIN CO.
115 6th St. S., MINNEAPOLIS, MINN.

Send for Catalog Today

How inventive ability is now being developed

Develop your inventive ability. A single idea, which solves one of the millions of the world's daily problems, can make you independent for life. Fifteen famous inventors now make every step in invention as simple as A B C. Spare time at home quickly develops your native instinct for inventions.



RAYMOND F. YATES

FOR a long time it was commonly believed that every invention was a matter of pure luck—the result of some happy inspiration that suddenly flashed through a man's brain, and which made him fabulously rich without the slightest effort or thought. But you can prove for yourself that this is not so. You can prove for yourself that invention is

the result of thinking and acting along definitely exact, scientific lines.

Suppose, when you went home tonight, you found a window rattling. Through your mind would flash, almost instinctively, a regular order of thoughts which characterize the conception and completion of every invention the world has ever known. First, you would recognize a problem to be solved—the rattling of the window. Then you would think of several principles of science or mechanics which would solve your problem. You might think of the scientific fact that if you poured water on the frame the wood would swell and tighten the window. You might think of using a nail. But what you most probably would do, would be to use the oldest mechanical principle known to man, the wedge.

One Little Idea May Bring You a Fortune

With every new advance, with every new discovery that the world experiences more problems are coming up—and more inventions are needed to solve these problems. Now, as never before are new inventions wanted, and the world will pay a fortune to the man or woman who gives it just one of the inventions it needs now.

Little ideas have won fortunes for their originators. Eberhard, who invented the rubber on the end of a pencil, has been paid hundreds of thousands of dollars for his simple idea. The man who invented the metal tip for shoelaces, the man who conceived the idea of the "humped" hairpin, the man who developed the metal tape measure; all have achieved enormous wealth from their "little" ideas.

Edison Says: "Invention Should Be Taught as a Science!"

Although the fact has been universally recognized, that invention is governed by a few simple, easily acquired, fundamental principles, no one ever before thought of putting these principles in black and white so that everybody interested in invention could know them. But now it has been done. Fifteen famous inventors have at last given to the world the laws

and principles of Inventive Science. They have shown every ambitious man and woman how to invent. They are teaching invention, exactly as other people are teaching law, medicine, bookkeeping. Instead of spending years groping blindly, instead of wasting your time in useless, heartbreaking drudgery, you learn how to complete your ideas quickly; you learn how to think so you are sure to succeed. In simple, easy-to-understand language you are told how successful inventors work; you learn how to think along inventive lines, you learn the short-cuts to successful invention; you learn how to use the secrets of invention that convert a simple little idea into money.

But you learn more than just how to invent in this fascinating course. Thousands of inventors have lost the profits of their invention simply because they didn't know how to patent and sell their ideas. This complete course shows you just how to apply for a patent, how to protect your rights when your patent is granted, and how to dispose of your invention so you will get the greatest returns possible.

Not one step in invention has been omitted. Everything you want to know about invention—developing your ideas, securing information you need, how to apply for patents, how to protect your rights, how to sell your invention—are taken up, step by step, so that when you have completed the course you have a wealth of information worth thousands upon thousands of dollars.

FREE—New Book on Inventive Science

A wonderful new book has just come from the press that tells you all about the Science of Invention. It tells you how to avoid the pitfalls that have brought failure to thousands of would-be inventors. It tells you how to learn the secrets of practical invention, which famous inventors discovered only after years of heart-breaking effort, and discouraging mistakes, and it tells you how to do this in only fifteen minutes of your spare time each day. This fascinating book will be sent to all those who are genuinely interested. Get the advice of these fifteen famous inventors. Let them tell you how you can easily learn the secrets of successful invention. Send for this Book today, as only a limited number are available for free distribution. Send the coupon below NOW, or a letter or postal card will do. There is no cost or obligation. This bureau is not connected in any way with patent attorneys or manufacturers. Our only work is to help ambitious men and women to develop their inventive ability—to become successful inventors.

BUREAU OF INVENTIVE SCIENCE Dept. 31, Wisner Bldg., ROCHESTER, N. Y.

BUREAU OF INVENTIVE SCIENCE,
Dept. 31, Wisner Building, Rochester, N. Y.

Please send me your free book, "The Science of Invention."

Name.....

Address.....

City..... State.....

Can You Solve This Problem?

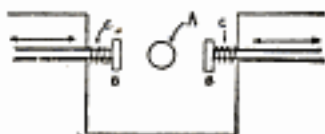

"A" is the end of a shaft. The two members "B B" are free to move in either direction indicated by the arrows. If they are pushed back, the springs "C C" will immediately pull them forward again. Our problem is to put some kind of an attachment on the revolving shaft "A" so that the members "B B" will be pushed back both at the same instant every time the shaft "A" makes a single revolution. The device on shaft "A" must also allow the two members "B B" to come forward once in every revolution. What would you suggest putting on the shaft "A"?

PATENTS

Booklet Free

Highest References

Promptness Assured

Best Results

Send drawing or model for preliminary examination

ALL BUSINESS GIVEN PROMPT AND PROPER ATTENTION

WATSON E. COLEMAN, Patent Lawyer, 644 G St., Washington, D. C.

PATENTS

To the Man with an Idea

I offer a comprehensive, experienced, efficient service for his prompt, legal protection and the development of his proposition.

Send sketch, or model and description, for advice as to cost, search through prior United States patents, etc. Preliminary advice gladly furnished without charge.

My experience and familiarity with various arts frequently enable me to accurately advise clients as to probable patentability before they go to any expense.

Booklet of valuable information and form for properly disclosing your idea free on request. Write today.

Richard B. Owen, Patent Lawyer
9-303 Owen Building, Washington, D. C.
2276-E Woolworth Bldg., New York City

Can You

think of a simple, practical idea that will fill one of the many requests we have on file for new inventions? It may mean a fortune for you. Thousands of things are needed **right now**. Your brains can help. Send today for our great new book—

"Inventions and Trade-Marks, Their Protection and Exploitation"

and learn more about making money from ideas than you ever knew before. It tells many things that are wanted, too.

**A postal will do—
It is free**

We Help Our Clients

without charge, to get the dollars out of their ideas—having facilities none others possess. Advice free. Don't delay—get the book at once.

American Industries, Inc.
200 Patent Dept.
WASHINGTON, D. C.

**Patents
Advertised
For Sale Free**
in Invention and
Manufacturing Supplement

Published for the man with an idea. Send for free sample copy. One year's subscription, 50c

INVENTORS PROTECT YOUR IDEAS

Send for our Guide Book, **HOW TO GET A PATENT**, and Evidence of Invention Blank, sent Free on request. Tells our terms, methods, etc. Send model or sketch and description of your invention and we will give our opinion as to its patentable nature.

RANDOLPH & CO.
600 F St., N. W., WASHINGTON, D. C.

NAME

STREET

CITY STATE

U.S. PATENTS



SEND FOR THIS FORM

DON'T LOSE YOUR RIGHTS TO PATENT PROTECTION

Before disclosing your invention to anyone send for blank form "EVIDENCE OF CONCEPTION" to be signed and witnessed. A sample form together with printed instructions will show you just how to work up your evidence and establish the same before filing application for patent. As registered patent attorneys we represent hundreds of inventors all over the United States and Canada in the advancement of inventions. Our schedule of fees will be found reasonable. The form "Evidence of Conception," sample, instructions relating to obtaining of patents and schedule of fees sent upon request. Ask for them—a post card will do.

PATENTS AND TRADE MARKS



480 Ouray Bldg. Washington, D. C.
Originators of forms "Evidence of Conception."

BLUE BOOK ON PATENTS

gives instructive information and candid advice.
MONROE E. MILLER, PATENT LAWYER
411-2 Ouray Building WASHINGTON, D. C.
ELECTRICAL AND MECHANICAL EXPERT



GEARS ALL KINDS SMALL

The most accurate made and prices reasonable. We carry a complete line of gears in stock for immediate shipment. Can also quote on special gears of all kinds. Send us your inquiries.

WRITE FOR CATALOGUE

CHICAGO STOCK GEAR WORKS
105-109 S. Jefferson St., CHICAGO

PIMPLES

CAN BE CURED. If you suffer from pimples, acne, blackheads, brown spots or eruptions I want to send you my simple home treatment under plain wrapper. It gave me a soft, velvety, smooth and radiant complexion, and cured thousands of men and women, after everything else failed. Simply send name for generous 10 day free trial offer of my secret home treatment.

W. H. WARREN 451 Gray Bldg. KANSAS CITY, MO.



Agents \$20 a Day

Earn \$20 a day selling this 14 Kt. gold-filled engraved 10 jewel lever movement watch, 29 yr. case this model, adjusted and regulated to keep perfect time. Watch sells retail for \$18. You can undersell and make at least \$8 on every sale. Our agents are making big money. Send for your sample to-day. Pay postman on arrival our WHOLESALE price of \$6.75 or send cash with order. SATISFACTION GUARANTEED. FREE: With every watch, good quality gold-filled Waldemar chain and knife. Order to-day.

SUPREME JEWELRY MFG. CO.
Importers of Watches, 434 Broadway, Dept. A144 N. Y. C.



King of 'Em All Means Auto Wheel

Here come Bill and his Auto-Wheel Coaster Wagon. They are old friends—Bill and the Auto-Wheel. Bill wouldn't give up his Auto-Wheel unless he was sure that he could get another just like it, for in his choice of coaster wagons, Bill knows that "King of 'Em All" means

Auto-Wheel Coasters and Auto-Carts

Bill and thousands of others like him are proud to own an Auto-Wheel because it has these fine mechanical features: rubber-tired disc wheels (oversize tires on three largest), or steel-tired disc or wood spoke wheels; mortised joints; self-contained friction-reducing roller bearings; bound brass; hand brake; special hub cap and locking pin; and solid maple bolsters.

Write for catalog showing all models of the Auto-Wheel and also all models of the Auto-Cart, the Auto-Wheel's junior companion for little brother or sister. If you send the names and addresses of three coaster wagon dealers in your town, telling which ones sell the Auto-Wheel, we will give you FREE a year's subscription to the "Auto-Wheel Spokes-man," a dandy little magazine for a boy like you.

AUTO WHEEL COASTER CO., Inc.
North Tonawanda, N. Y.

The Tone and Quality Long Looked For

Used by Heifetz, Kreisler, Casals, and all other great artists.



This Modern Scientific Construction has improved the almost perfect instruments since their creation. Try it and compare. If not satisfactory money refunded.

Free Catalogue of 1923-24 on request

VIRZI Violin Production

J. & J. VIRZI BROS., 503 Fifth Ave., New York City

WANTED RAILWAY POSTAL CLERKS



\$1600 FIRST YEAR

Raise to \$2300

Travel—See the Country
MEN, BOYS—18 UP
LIFE JOB

Mail Coupon Today Sure

FRANKLIN INSTITUTE
Dept. E199, Rochester, N. Y.

First: Send me at once, free of charge, Sample Railway Mail Examination questions, list of other U. S. Government positions now obtainable and free book describing them.

Name.....

Address.....

SLIDE SAXOPHONE

Not A Toy

A real musical instrument—So simple anyone can play it. No musical experience necessary. No keys, no fingering to learn, no pads to be bothered with or get out of order. Scale is engraved on side of saxophone. Easy to read and operate. If you can sing a melody you can play this "Slide Sax." Be the first in your town to play a "Slide Sax." Our supply is limited, so send your order at once. This magazine thought well enough of our "Slide Saxophone" that a description of it appeared on page 281 of their August, 1923, issue. Makes an "Ideal Holiday Gift." Big money is paid saxophone players. Learn in your spare time. The only reed instrument with crescendo effect over an entire octave.



Pat. Pend.

PRICE \$60⁰⁰
BRASS

If your dealer cannot supply you, send your order direct to us.

Write for Complete Catalog

REIFFEL & HUSTED

Mfrs. High-Grade Band Instruments

206 S. Wabash Avenue, CHICAGO, ILL.

SEND NO MONEY

2 GENUINE DIAMONDS $\frac{4}{100}$ Each

CUT STONES—NO CHIPS

Solid Gold

\$25

14 kt. White Gold Top.
Gold Emblem Inlaid
in Genuine

Hope Ruby

Can be had in all Lodge emblems and in all INITIALS (Old English). Send size of finger and ring will be sent for inspection.

Buffalo Jewelry Mfg. Co., "The Mail-Order House"
Dept. P, Brisbane Bldg., Buffalo, N. Y.



This  Reg. Trade Mark guarantees you genuine diamonds.

B U F F A L O Any Letter

FREE TRIAL

DETROIT Wire Hook BELT LACING



Whether you have one belt or a hundred we want you to try at our expense. We will send postage paid, this complete outfit including large box of belt hooks to lace every kind and thickness of belt together with a (Vise Tool) belt lacing machine.

\$1.50

If you want the outfit after trying it, send us your check for \$5, if not return it at our expense. Laces belts for one cent an inch. Used by International Harvester Co., Advance Rumely Co., and thousands of others.
Outfit \$5.00. Assorted lacing \$1.50 per box. Tool \$3.50.

DETROIT Belt Lacer Co., Detroit, Mich.

TYPEWRITERS



\$50 buys a brand new Corona, the Personal Writing Machine. Latest model with many improved features. Write for free booklet No. 8.

Corona Typewriter Co., Inc.
GROTON, N. Y.

FREE 1000 Illustrations ELECTRIC FIXTURE CATALOG!



Write today for your copy. Save 50% direct from Manufacturer. No Middleman's Profit. OUR SPECIAL: 8 Room Electric Set, ready to hang, \$24.50—Other bargains.

UNITED LIGHTING FIXTURE CO.
280 Bowery Dept. 120 New York



Only \$2.00 Selling Price

The Quickedge Knife and Shear Sharpener

We Want Agents at \$50 to \$90 a Week

New Invention—Just out. Needed in every home every day. Patented. Nothing else like it. Low priced—**Sells on sight.** Sharpens any kitchen knife, paring knife, carving knife, bread knife, or shears and scissors in **ten seconds.** Mechanical masterpiece. A child can use it. Just put knife in slot—turn crank—sharpens both sides at once automatically. **We want representatives at once—men and women hustlers.** Get this position where **profits start first day.**

No Experience Necessary—200% Profit

Make as much money next week as these men are making now. J. C. Lewis, of Kansas, says: "I have sold one hundred sharpeners in four days." Hobart Kerr, of Md., writes: "The women can hardly wait till they get them." Herbert Cain, of Ky., sold nine after supper. At the end of the first day, J. W. Gordon, of Pa., writes: "I sold two dozen and I sold to every one I saw." Wm. G. Hall, of N. J., says: "I think it is great. I sold six in about one-half hour. The machine is a mighty fine proposition. I am a mechanic and I know what I am talking about." You can make this money. **WRITE TODAY. TERRITORY FREE.** Get busy at once.

QUICKEDGE SHARPENER CO., 101 Sharpener Bldg., 159 West Pearl St. Jackson, Mich.

Fired!

Do you work for day wages? Are you working for someone else? If you are, you can more easily appreciate this fellow's misfortune—and you will understand more fully why, at the age when he should be well fixed and in a position to spend the rest of his life in comfort, dependent on no one for support, he is practically penniless—and out of a job, fired because he is too old to work.

Some Facts Straight From the Shoulder

Nearly everyone who works for others tries to save—tries to get enough money together to take care of him and his family when old age overtakes him—but how many are successful in their efforts to accumulate a fair sized savings account?

Government Figures Show

That 82% of the Country's Men, at the Age of 65, Are Dependent on Relatives or Friends for Support! The other 18%, who have money and are independent, are Business Men, Not Fellows Who Have Worked For Others All Their Lives! The working-man can't save. There are too many bills to pay. His pay check comes every so often, but so does the grocery bill, meat bill, light bill, doctor bill, dentist bill, and a hundred and one other incidental expenses. Then sickness often robs him of a couple of weeks pay. No Matter How Hard You Try, It's Practically Impossible to Save Enough Money From Day Wages or a Monthly Salary to Make You Independent in Your Old Age!

Did You Ever Hear of a Retired Workingman?

No, you never did—and what's more—you never will! You hear of retired Business Men, Business men Can Afford to Retire! The fellow who works for someone else (whether he wears a white collar or not) never leaves the job until he is forced to—until fired—replaced by someone younger.



What Are You Going to Be?

A Retired Business Man—or a Fired Working-man? It's up to you. Do your deciding right now! The floor surfacing business will make you and your family independent. The "American Universal," electrically driven, replaces six hand scrapers—and turns out much better work. There's \$25.00 to \$40.00 a day, and more, in it for you as a floor surfacing contractor. Requires a surprisingly small investment—no special training necessary. Beautiful work creates big demand—every floor (old or new) a prospect. Pleasant work—profits unlimited.

Write for Full Particulars at Once

Act Now—don't turn this page until you have written to us for full particulars and testimonials from "American Universal" floor surfacing contractors who are making big money, who are actually enjoying life—and who will continue to enjoy life as long as they live. Don't Wait Until Tomorrow. Write Today—Now!

American Floor Surfacing Machine Co.
523 South St. Clair St. Toledo, Ohio



60% of Market Price

Will Buy Diamonds Here

This 3/4-1/16 Ct. perfectly cut diamond, a stumpy, blazing solitaire, at \$42.65 among bargains in our lists. See the many big amazing values some as low as \$99 per Carat, other higher per Carat bargains. This is your chance to get Diamond Bargains from us all the world lends money on diamonds. Thousands of unpaid loans and other bargains. Must sell NOW.

Why Pay Full Prices

Costs Nothing To See. Any Diamond sent for absolutely free examination at our risk. No obligation. No cost to you. Latest Listings—Unpaid Loans. Sent Free. Describes Diamond Bargains in Detail, gives cash loan values guaranteed. Explains unlimited exchange privilege. Write Today. Postal card will do.

Joe. De Roy & Sons, 1916 De Roy Building, Pittsburgh, Pa. Only Opposite Post Office



This Ring \$42.65
3/4 - 1/16 Carat Perfectly Cut

SWEATERS SAVE 20%-30%

Any Style or Design for Men, Women, Boys, Schools, Clubs, Teams

Order direct from mill. Save from 20% -30%. Pick any style, any color, size or design from our regular stock or special to order. Finest virgin wool and pure worsted only. Custom tailored workmanship of highest grade. Closely knit. Warm, soft, snug. Real beauties you will be proud to wear.

FINEST QUALITY AT BARGAIN PRICES

FREE Always holds shape. Most customers get from 3 to 5 years wear easily. Can endure severe wear and retain bright, fresh appearance. Biggest values in history. Workmanship guaranteed. Prices slashed. Unusual chance to save. Special offers to schools, clubs, teams. Write for free illustrated catalog.

AMERICAN KNITTING MILLS 1538 Cloyd Avenue Dept. 18 CHICAGO



The Big VALUE in Hand Cleansers

Eighteen Liberal Ounces of **GIT HAND PASTE** FOR A DIME



GIT MFG CO
MILWAUKEE, WIS.

10¢ at F. W. Woolworth Co. McCrory and other stores

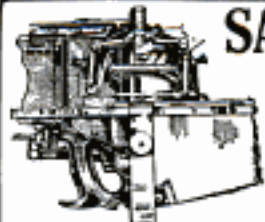

SAW FILING PAYS

Buy a Foley Saw Filer and Setter and establish an independent, profitable business. Prices and catalog on request. Territory open to interested parties.

FOLEY SAW TOOL CO.
3613 Portland Ave., Minneapolis, Minn.

GREEN AUTOMATIC MACHINE



ADD TO YOUR INCOME

WITH LITTLE EFFORT \$5 to \$10 A DAY MADE EASY WITH

New Improved Green Automatic Machine

Sharpens, Honors and Strops all kinds of safety razor blades, in one operation, from four to six blades per minute. For both Quality and Quantity, this machine is in a class by itself. There is nothing like it on the market. Let us send you our descriptive literature explaining everything, including the "AMERICAN" Key Cutter—cuts square, angular or round slots.

American Sharpening Machine Co., Cor. Taylor and South Sts., Kalamazoo, Mich.



Free *latest BOOK on* HEALTH and BEAUTY

VIOLET RAYS



Only \$1.00 DELIVERS
now *to Your Home*

ONLY \$1.00 brings this complete, scientific Violet Rays outfit to you. Treat yourself and family at home, save delay, costly doctors and medicines. Thousands use Violet Rays at home to relieve pain and sickness. The identical outfits doctors have bought from us for years and with which they successfully treat many ailments.



QUICK RESULTS—No Medicine

Violet Rays work quickly, it's scientific, goes after the cause. That's why results are quick, permanent. Dr. Duncan, Kewanee, Ill., writes, "Violet Rays is the finest thing I ever used . . . to relieve pain, treatments are so pleasant all my patients like it." Use it yourself at home, you save Doctor's bills.

BEAUTY AID

Brings natural, magnetic beauty of health, no dieting, exercise or drugs. FREE book tells in detail how high priced beauty specialists use it to improve scalp and skin.

EARN CASH

Men, women, without experience earn liberal profits in spare time showing Violet Rays to neighbors. Proves results first demonstration. Sells on sight. Get attractive offer and wholesale prices now.

SEND FOR FREE BOOK

Explains how Nikola Tesla discovered Violet Rays, how it works, why it heals. Tells what doctors and plain folks accomplish in conquering pain, disease and nervous trouble with Violet Rays.

Reveals Marvelous Scientific Discovery Shows charts of human body, explains where pains start, how to banish them. Offered FREE for a limited time only, to introduce Violet Rays. Send for FREE copy.

Mail Coupon—Send No Money

VI-REX ELECTRIC COMPANY
326 West Madison St., Dept. 21, Chicago

Please send me without cost or obligation your free book describing your VI-REX Violet Ray outfits, and details of your \$1.00 offer.

Name _____

Address _____

City _____

State _____

Please Mention Popular Mechanics

5 SQUARES IN 1 TOOL

TRI, MITER, OCTAGON,
BEVEL and PROTRACTOR SQUARE

all in one handsome tool



Blade locks instantly and automatically at ANY

ANGLE desired. Convenient, accurate, a time-saver. Always ready. Strong, durable, simple. If you use a saw you need this



SIMORE "Lightning Change" TRY-SQUARE

With 4 1/2 or 6 inch blade.....\$3.75
With 7 1/2 inch blade, postpaid..... 3.90

Money order or your check acceptable. Your money back if not satisfied. Dealers are invited to write for our proposition on this and other Simore "Lightning-Change" Tools. The Combination Knife and Screw-driver is a sure seller.

THE SIMON & SKIDMORE MFG. CO.

Dept. 5-1

SANTA ANA, CALIF.

A MOST EFFICIENT TOOL FOR HOME WORKSHOP

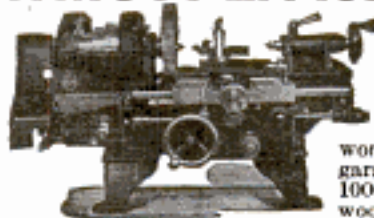

The MONARCH, Jr. Lathe is the ideal machine tool for the home workshop, repair shop and garage. Turns out, with 1000th-inch accuracy, small wood and metal parts. Experimenters, inventors, mechanics are enthusiastic over it. Completely equipped; auto-safety devices; semi-quick change gear. Priced within your means.

9 in. lathe—2 1/2 ft. bed—with bench legs. **\$245**

Also built with bed lengths up to 5 feet. Made in 11-inch swing size, too, at slightly higher price.

THE MONARCH MACHINE TOOL CO.
400 Oak Street SIDNEY, OHIO

1000 SHOT
ALL STEEL
MAGAZINE
AIR RIFLE

WE GIVE
TO BOYS
WITHOUT COST
Choice of six guns (on four easy plans) for selling our Magic Healing

HAMILTON
22 CAL.
HUNTING
RIFLE



Wav-o-lena at 25c box. We Trust

You! Order Seven Boxes Today On

Postal Card—we send promptly, pre-

paid. Easy to sell—used in every home

Return money as instructed, choosing

your gun according to one of the plans

shown in our Big Premium List. Also 200

other Gifts or Big Cash Commission if you

prefer. If you are prompt, a special Free Gift.

Waverly Co. 218 Tower Bldg., Monongahela, Pa.



RUSSIAN, GERMAN MONEY AUSTRIAN, SOVIET MONEY

Biggest selling business of the century. Everybody buys. Cheap, popular give-away advertising for Agents, Bookkeepers, etc. Will boost your sales tremendously. Largest Dealer, "Right at the market". See our MONEY on anything. Write

Many bargains and ideas for you in our big FREE dropper

HIRSCH EXCHANGE, 70 Wall St., N.Y.

GOLD FISH



\$2.00 brings by express a two-gallon bowl and 3 Gold Fish. Orders filled immediately from producer. Send now and you will have your GOLD FISH in a few days.

FALLS FISHERIES, 1533 B. F. Keith Bldg., Cleveland, O.



Permanent Built! —Now Within Your Reach

The combined efforts of thirty great departments in experimenting and testing materials and methods of construction have produced for you a GUARANTEED home, expert machine cut, bundled and marked—the last word in building economy.

Not One Penny in Advance

So sure are we of the super-excellence of our material and our GUARANTEED Ready-Cut System that we will ship you any HARRIS HOME without the payment of one cent down. Our plan Book explains our liberal terms fully.

BUILDING MATERIAL!

For over a quarter of a century, thrifty wise buyers have realized that here is the open door to real economy, whether it be a brand new home or material for improvements or repairs.

FREE BOOK OF PLANS!

The latest edition is waiting for you, contains our FREE PLAN OFFER and photographic reproductions, with floor plans and specifications of 100 beautiful homes. Mail coupon today.



FIRST FLOOR PLAN



Plumbing and Heating!!

Hot water and heating systems, warm air heating plants, pipeless furnaces and plumbing material of every kind—the product of America's leading makers. Our mammoth plumbing stock offers unlimited possibilities for you to save money. Our heating plants are guaranteed to heat your home in any weather with big fuel economy.



Bathroom Outfit Complete!

Consists of white porcelain enameled bathtub, 5 ft. long, complete with fittings, washdown closet outfit with white vitreous china earthenware bowl and tank fitted with mahogany seat and cover. Lavatory complete with indexed faucets, trap and supply pipes. This is but one of Many Wonderful Values in guaranteed Plumbing in Our Big Complete Stocks. Mail the Coupon!

Expert Engineers Waiting to Help You

A rough sketch of your building showing number and size of rooms, doors, windows and height of ceiling is all we need to give you complete information and low prices.

Dept. PG-7
HARRIS BROTHERS CO.
35th and Iron Sts., Chicago

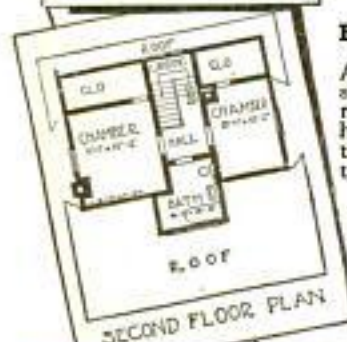

SECOND FLOOR PLAN

Free Book of Plans



MAIL THIS COUPON

HARRIS BROTHERS CO.

Dept. PG-7, Chicago

These books are FREE and sent postpaid. Mark an "X" in the squares to indicate which ones you wish.

- | | |
|--------------------------------------------|----------------------------------------------|
| <input type="checkbox"/> Harris Home | <input type="checkbox"/> Book of "Presto-up" |
| <input type="checkbox"/> Book of Plans | <input type="checkbox"/> Houses and Garages |
| <input type="checkbox"/> Building Material | <input type="checkbox"/> Plumbing and |
| <input type="checkbox"/> Catalog | <input type="checkbox"/> Heating Book |

Name.....
Address.....

TINY-TURN

A New and Superior Vernier Control

Tiny-Turn will add 1,000 miles to the range of your set by securing an exactness in tuning never before attained.

The increase of volume from the distant stations will surprise you. Adjustments are made quickly and easily. Body capacity is eliminated. TINY-TURN has a 30 to 1 gear ratio instead of only 4 or 5 to one as in the ordinary vernier. Can be instantly disengaged from the dial when desired. **INSTALLED ON ANY SET IN THREE MINUTES.** Folder on request.

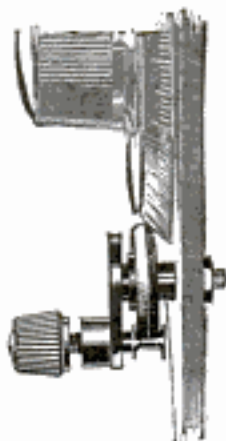

75c EACH

If your dealer cannot supply you, write us direct

Patents Pend.
Side View showing friction drive against dial.

RADIO UNITS INC

Manufacturers of the famous DUO-SPIRAL Indoor loop antenna.

841 Webster Bldg., CHICAGO, ILL. Factory: Maywood, Ill.

3
the

a pair of
MURDOCK
HEAD PHONES
\$4.00 or \$4.50

the new
MURDOCK
PLUG-JACK
for \$1.00

the complete
MURDOCK
LOUDSPEAKER
for \$5.00

best in
radio

AT ALL RADIO DEALERS

If your dealer cannot supply you, send money direct and your order will be promptly filled.

WM. J. MURDOCK COMPANY
349 Washington Avenue, Chelsea, Mass.

Please Mention Popular Mechanics



Natural
Re-PRODUCTION

Atlas
AMPLITONE
LOUD SPEAKER

ENTHUSIASTIC testimony
Trade Mark E straight from an authority.
The delicate overtones are faithfully re-born through the patented "double diaphragm." Adjustable to your set and individual receiving conditions. Ask for demonstration. **\$25**
Write for Illustrated Booklet "W."

Letters from Users Requested

Sole Canadian Distributors: Marconi Wireless Telegraph Company of Canada, Ltd., Montreal, Canada

Multiple Electric Products Co. Inc.

RADIO DIVISION
ORANGE ST., NEWARK, N.J.



Howard Micrometer Adjustment Rheostats

Instant adjustment. Made from special heat resisting materials; operates with single knob; positive smooth contact. Micrometer adjustment.

Rheostats, 6 3/4" — 25 or 40 Ohm, Plain, \$1.10; Micrometer, \$1.50
Power Rheostats, \$1.50
Potentiometers, 200 Ohm, \$1.50; 400 Ohm, \$2.00

Ask your dealer or write us. Complete catalog of Howard radio parts and book-ups free on receipt of 2c for postage. Jobbers write for discounts.

HOWARD RADIO COMPANY 4244 N. Western Avenue CHICAGO

AGENTS

Make \$10 to \$20 daily selling Premier Knife and Scissors Sharpeners.



200% PROFIT

or more. 9 out of 10 women buy. Produces keen edge quickly. Sells for 50c.

PREMIER MFG. CO.
Dept. 29, DETROIT, MICH.

Build Your Own PHONOGRAPH

IT'S EASY WITH OUR HELP

A few hours' interesting work saves over half and gives you a machine to suit your ideas. We furnish motors, tone arms, case material, blue prints and full instructions. Plays any record. Make fine profit building phonographs for your friends.

Write today for our **FREE** Blue print offer.

GET YOUR **RADIO SUPPLIES** FROM US

Cheraleon Phonograph & Radio Co.
124 1st St., Elkhart, Ind.



SAVE
OVER
HALF

A most desirable **GIFT** for Christmas
useful and unusual

Embury
SUPREME
ELECTRIC
LANTERNS



Unexcelled for Indoors and Out

HERE is a gift that everyone in the home, every motorist, sportsman, camper, or boy or girl scout will be delighted with. The Embury Supreme Electric Lantern is the **handiest** electric light ever invented.

It throws a bright light in **every** direction, and you don't have to hold it. You can hang it up or set it down anywhere, or hold it on your arm, leaving **both hands free**. No smoke, no smell, no trouble.

7 Reasons WHY

- something new
- lasts for years
- useful everywhere
- always dependable
- no fire danger
- weatherproof
- economical— burns 12 continuous hours or 6 months intermittently.



\$2.50

Complete with Battery

The Embury Supreme Electric Lantern is 8 inches high and 5 inches wide. Best materials and workmanship. Attractive as well as useful. Batteries renewed for 50c a set anywhere.

Indispensable—

for the home—

Wonderfully handy for dark corners and closets, attic, cellar, workshop and garage.

for the motorist—

Packed in strong carton and can be easily stowed in the car. Unequaled for making repairs or changing tires at night. **Leaves both hands free.**

for sportsmen—

For motorboating, canoeing, night fishing, or traveling through the woods or over lonely roads.

for campers—

Electric lights for the tent or shack, or for guidance through the woods. Thousands of campers are enthusiastic users.

Something New in a Portable Electric Light

EMBURY MANUFACTURING CO.
Warsaw Dept. N New York

Fill in and mail the coupon, or order from your dealer. Act quickly for prompt delivery. Lanterns mailed direct with your name on appropriate card as Christmas gifts to friends.

Mail Coupon TODAY.

Embury Manufacturing Co.
Dept. N, Warsaw, N. Y.

Enclosed please find check for \$.....
for which send.....lantern to:

Name.....

Street Address.....

City & State.....

To Dealers: Here is a lantern you can sell all year round. Big profits for hardware dealers, general and department and sporting goods stores. Also a wonderful proposition for premium users. Send for prices and discounts.

BUNN SPECIAL 21 JEWEL ILLINOIS R.R. WATCH

SEND **\$2.00** DOWN
PAY ONLY **\$5.50** FOR TEN MOS.



GUARANTEED TO PASS INSPECTION ON ALL R.R.'S

A watch good enough to pass the most severe inspection tests on every railroad in the United States, must be just about the best. Montgomery dial supplied without extra cost. Test it in your pocket on trial.

WEAR A SIX POSITION WATCH
Tests have shown the superiority of this watch adjusted to six positions over watches adjusted to only five positions. The gold filled case is guaranteed to wear like solid gold 20 years. Full description on request.

NO RED TAPE: NO DELAY
Just send the deposit and we'll send the watch for free trial. If it fails to keep time as guaranteed, we will return deposit. If satisfied, pay only \$5.50 a month for ten months. Total price \$67.50. Choice of dials.

WRITE FOR NEW CATALOG
Our big catalog of diamonds, watches and jewelry brings our store right into your home. Write today!

STERLING DIAMOND & WATCH CO.
The Great R. R. Watch House Since 1879
63 Park Row Dept. 1348 New York

F-F BATTERY CHARGER CHARGES

\$15
RADIO "A" & "B" & AUTO STORAGE BATTERIES Overnight For Few Cents From Any 110 Volt A.C. Lamp Socket. COMPLETE, PORTABLE, AUTOMATIC. No Skill Required. Screw Plug in Lamp Socket; Snap Clips on Battery Terminals Turn Switch & Battery is Charged in Morning. Batteries Last Longer. Charger Lasts Lifetime. 5 Types. POPULAR PRICES: TYPE A CHARGES 6 VOLT BATTERY AT 6 AMPERES \$ 15 TYPE B CHARGES 6 VOLT BATTERY AT 120 VOLTS OF B BARS \$20 TYPE 166 CHARGES 6 VOLT BATTERY AT 12 AMPERES \$20 TYPE 1612 CHARGES 12 VOLT BATTERY AT 7 AMPERES \$20 TYPE 1626 is a COMBINATION of TYPES 166 & 612 \$28 SHIPPING WEIGHTS COMPLETE 9, 12 & 16 lbs. PURCHASE from DEALER or Write Us To Ship C. O. D. ORDER NOW, or WRITE for FREE CHARGER Bulletin 24
FRANCE MFG. CO., 10424 Berea Road CLEVELAND, OHIO



Amazing Hand-Made Tools

Make \$20 Every Day!

That is a fact. Salesmen are making amazing incomes selling direct to mechanics, carpenters, shoemakers, etc. These tools, put up in kits, are made by our famous Cornwell secret formula. Every tool guaranteed the finest made in the world. Salesmen make sensational demonstrations of chisels, wrenches, punches, bearing straps, etc.

You Take No Money Risk!

We take all the money risk. You make instant sales and big cash profits. Tools like these never made before. Repeat orders tremendous. You make big money the very first day.

Write TODAY—Get Sample Outfit
Write or wire for complete sales plan, describing tools, money-back guarantee and offering sample outfit. Don't delay! Territories closing fast.
THE CORNWELL QUALITY TOOLS CO., Dept. 12, CUYAHOGA FALLS, OHIO

GET FACTORY PRICES ON GALVANIZED ROOFING



EDWARDS "REO" Metal Shingles

Absolutely rust-proof — edges as well as sides. Not the space of a pin point exposed to weather. Also fire and lightning proof. Reduce insurance. Outlast building. Need no repairs — and all roofing expense. Easy to lay — one man can do the work — hammer and nails only tools needed. Lay over old shingles if desired. Patent Interlocking Device makes water tight seams — all nail heads covered — no rust or leaks possible.

Exclusive "Tightcote" Process
Put all Edwards Galvanized Roofing in a class by itself. Bend, twist, strike it with a hammer as much as you like — you can't loosen or scale off the galvanizing — due to our "TIGHTCOTE" process which practically makes the covering a part of the metal sheet. No other galvanized roofing can withstand this test.

FREE Roofing Book Don't buy roofing until you get our big free book, describing Edwards famous "Tightcote"



Roofings, Sidings, and Ceilings, and our lowest factory prices. We sell you direct and save you in-between dealers' profits. Write for Roofing Book No. 150.

Low-Priced Garages
Lowest prices on Ready-Made Fire-Proof Steel Garages. Set up any place. Send postal for Garage Book showing styles.

THE EDWARDS MFG. CO. 100-150 Pike St. CINCINNATI, O.

FREE Samples & Roofing Book

Tailoring Agents \$5.00 to \$25.00 Daily And FREE SUIT



Our New Style Sample Outfit is a Dandy
American Woolen Mills Co., Dept. 2012, Chicago, Ill.

Full or spare time men with or without experience can earn \$5 to \$25 daily taking orders for world's greatest values in made-to-measure suits at \$18 and up. All delivery charges prepaid. Handsome assortment of woolsens and a brand new sample outfit that is a wonder. Free suit to one man in each community, on easiest, most liberal offer ever made. No experience needed. We furnish full information about styles, prices, agents' outfit, etc., — simple, clear, interesting and profitable. Write us — No obligation — A postcard will bring prompt reply.

Our BUREAU OF INFORMATION will answer all questions regarding articles in this magazine. Address Popular Mechanics Magazine, Chicago.

Prices Reduced



On All Standard Make Typewriters
Lowest Prices in Years

We will ship any make you choose for one week's trial, Underwood, Royal, L. C. Smith, Remington, Oliver, etc.

Easy Terms Pay less than rent each month and own a typewriter. Guaranteed good as new. Perfectly rebuilt by experts — the famous "Young Process."
Send for our free trial offer and new low price list now. Write today.

Young Typewriter Co.
World's Largest Dealers in Standard Typewriters
654 W. Randolph St., Dept. 1101, CHICAGO, ILL.

Easy to Play Easy to Pay



ZEZ CONFREY

Director Zez Confrey's Orchestra
A Paul Whiteman (Inc.) Orchestra

Composer of "Stumblin'" and "Kitten on the Keys," two of the greatest hits in history of American Music.

Hear his Buescher Band Instruments and Saxophones in Victor Records.

The new Buescher Saxophone is a marvelous instrument. It is one of the most beautiful of all musical instruments—by the range and wealth of its tones it takes the place of almost every other instrument—yet it is so perfected and simplified that it is the easiest of all instruments to play.

With the aid of the first three lessons, which are sent free (upon request) with each new Saxophone, the scale can be mastered in an hour; in a few weeks you can be playing popular music. Practice is a pleasure because you learn so quickly. You could even take a place in a band or orchestra within 90 days, if you so desired.

BUESCHER

True-Tone

Saxophone

Everyone has a desire to be able to play some musical instrument. Heretofore the making of music has been limited to the talented few; the average person has not the patience nor the time nor the money required to take lessons for months and years, and to practice incessantly, in order to learn to play.

But now it is different. With this wonderful new Saxophone, Buescher has made it possible for practically anyone, young or old, to quickly master this fascinating instrument—the instrument that has revolutionized the popular orchestras of today.

Wins a Welcome Everywhere

You are always welcome with a sweet-toned Buescher Saxophone. Thousands of men and women, of all ages, have found it an infallible key to social popularity. For home entertainment, for church, school or lodge affairs, the Saxophone is the most popular and adaptable instrument. Saxophone players enjoy, also, many opportunities of earning money. They are always in demand for dance orchestras.

Free Trial, Easy Payments

You may order any Buescher Saxophone, Cornet, Trumpet, Trombone or other Band or Orchestral Instrument and try it six days in your own home. Easy terms of payment may be arranged if preferred. Mention the instrument interested in and a complete catalog will be mailed free.

Free Saxophone Book

It tells which saxophone takes violin, cello and bass parts and many other things you would like to know. Also illustrates first lesson. Send coupon for your free copy.



JASCHA GUREWICZ
Former Soloist
with Sousa's Band
Electric Records



BEN SELVIN
Director
Selvin's Orchestra
Aeolian-Vocalion Records



DAN RUSSO
Director Orkido Orchestra
Brunswick Records



TOM BROWN
Director
Six Brown Brothers
Saxophone Sextet
Victor Records



BENNIE KRUEGER
Director Bennie Krueger
and His Orchestra
Brunswick Records

These Famous Saxophone Players

whose portraits are shown—use and recommend Buescher True-Tone Saxophones. Almost without exception, the great Professionals use Buescher Instruments exclusively. They are so flawless in scale, so perfect in tone and so accurate mechanically that more than 75 per cent of the popular Phonograph Records are played with them.

Buescher Band Instrument Co.
2575 Buescher Block, Elkhart, Ind.

Gentlemen:

I am interested in the instrument checked below:

Saxophone . . . Cornet . . . Trombone . . . Trumpet . . .
(Mention any other instrument interested in)

Name

Street Address

Town State

Buescher Band Instrument Company

Everything in Band and Orchestra Instruments
2575 Buescher Block Elkhart, Indiana



\$4⁹⁵ Secures This Great!
TOOL OUTFIT!
NOW

A bargain without an equal

Think of it—ten fine, guaranteed tools; every tool you usually need for work around the house. All packed in durable, sliding top, natural finish wooden chest. An outfit which would cost up to \$10—yours for \$4.95. This outfit No. 1 of

HOME-HELPER

Guaranteed
TOOLS

Contains one finely tempered spring-steel 22" saw with hardwood handle; 10" brace with alligator type chuck; 16 oz. steel head claw hammer; heavy duty solid steel, claw type hatchet; two excellent screwdrivers for heavy and ordinary service; 7" adjustable wrench; 6" slip-joint, drop forged pliers; 1/2" Jennings pattern steel bit; 2-foot zig-zag rule. Every tool is guaranteed. We will replace any tool that does not prove entirely serviceable.

WRITE TODAY for our Condensed Tool Catalog—It describes each of the tools in this outfit, besides many other splendid "Home-Helper" combinations. This illustrated folder catalog is **FREE**. **WRITE FOR IT TODAY!**

THE GREENJAY COMPANY
Dept. 201, 160 W. Whiting St., CHICAGO, ILL.

MOVIES In Your Home



Our marvellous, practical **Movie Machines** sell as low as \$5.00—and what's more, we have wonderful films at lowest prices—with a new film rental service. **DON'T MISS THIS!**

Write **NOW** for Free Catalogue

PARAMOUNT MFG. COMPANY
Box 1371, Dept. M2, Boston, Mass., U.S.A.

Turn Your Ideas Into Profits

On

Whether you are interested in light manufacturing, repairing or experimental work; whether you are a mechanic, engineer, amateur or student; whether you work in wood or metal, your ideas can be turned into profits with accuracy, speed and economy on

The *Baby Grand* Lathe

A sturdy, simple lathe of high quality at low price. Operation same as large lathes. Made of selected materials by skilled machinists who specialize on lathe building. Quantity production explains the low price. Not a toy but a practical machine for all small work. Sold direct from factory to you on positive money-back guarantee.

Write today for illustrated folder giving complete description and prices.

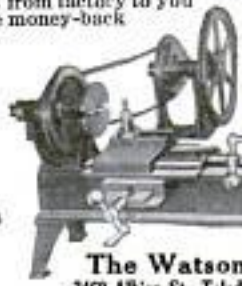

The Watson Mfg. Co.
2499 Albion St., Toledo, O., U. S. A.



Pleasure and Profit With a "KING" Saxophone

IT'S so easy to learn to play the famous KING saxophone! A few weeks' practice and you can play popular music—then join a band or orchestra and make good money playing for dances and other entertainments.

"KING" Band Instruments and Saxophones are easiest to play because they are built acoustically correct. Scientific design, finest skilled workmanship, careful supervision at each phase of construction make "KINGS" the most perfect instruments in the world. The tone quality is impossible to duplicate. Leading bands and orchestras insist upon "KINGS." Let us send you one for 10 days free trial.

Free Trial—Easy Payments

"KING" Band Instruments and Saxophones are fully described in beautifully illustrated circulars. Write today for complete information about our ten days free trial and our easy payment plan on any instrument. Ask for bargains in rebuilt instruments—old ones taken in trade.

THE H. N. WHITE COMPANY
5211-47 Superior Avenue, Cleveland, O.

1 1/2 HP. \$43⁴⁵



Now, a more dependable, durable, powerful engine Direct from Factory at Low Price. 2 1/4, 3 1/2, 5 and 7 horse-power sizes also at a Big Saving.

OTTAWA

Easiest Engine to Start.
30 Days' Trial! 10-Year Guarantee; Cash or Easy Terms.
FREE BOOK—"How to Know Better Engines." Also Special Offer. Write today!
OTTAWA MANUFACTURING CO.
531-Y King Street, OTTAWA, KANSAS
Desk 531-Y Magee Bldg., PITTSBURGH, PA.

FORDS—34 Miles



on Gallon of Gasoline with Air Friction Carburetor

We guarantee all other cars nearly double present mileage, power and flexibility, make hills on high formerly difficult on low. Models for any car, truck, tractor, marine or stationary engine. Makes old cars better than new. See wonderful mileage guarantees for other cars.

Ford.....34 ml.	Reo.....24 ml.	Chevrolet.....32 ml.
Buick 4.....30 ml.	Chalmers.....23 ml.	Maxwell (25).....30 ml.
Buick 6.....24 ml.	Olds 6.....23 ml.	Nash 6.....23 ml.
Hudson.....20 ml.	Paige 6.....20 ml.	Lincoln 8.....17 ml.
Hupp.....25 ml.	Oakland 6.....24 ml.	Stdbrk Lt. 6.....23 ml.
Dodge.....23 ml.	Overland 4.....32 ml.	Cole 8.....17 ml.

If your car is not mentioned here send name and model for particulars and our guarantee on it. **AGENTS WANTED.**

SENT ON 30 DAY'S FREE TRIAL

You can drive any car in heaviest traffic without shifting gears. Starts off on high in any weather without priming or heating—no jerking or choking. No more foul spark plugs or carbon in cylinders. No leaking of gas into crank case. Try it 30 days on our guarantee of money back if not entirely satisfied. No strings to our guarantee. **YOU ARE THE JUDGE.** Anyone who can handle a wrench can attach it. No boring of new holes or changing of operating mechanism. Write today.

AIR-FRICTION CARBURETOR CO.
261 Raymond Bldg. Dayton, Ohio, U. S. A.

Swear Off Tobacco

Tobacco Habit Banished Let Us Help You

Quick Results

Trying to quit the tobacco habit unaided is often a losing fight against heavy odds, and may mean a serious shock to your nervous system. So don't try it! Make the tobacco habit quit you. It will quit you if you will just take **Tobacco Redeemer** according to directions.

It doesn't make a particle of difference whether you've been a user of tobacco for a single month or 50 years, or how much you use, or in what form you use it. Whether you smoke cigars, cigarettes, pipe, chew plug or fine cut or use snuff—**Tobacco Redeemer** will positively remove all craving for tobacco in any form in a few days. Your tobacco craving will usually begin to decrease after the very first dose—there's no long waiting for results.

Tobacco Redeemer contains no habit-forming drugs of any kind and is marvelously quick, scientific and thoroughly reliable.

Not a Substitute

Tobacco Redeemer is in no sense a substitute for tobacco, but is a radical, efficient treatment. After finishing the treatment you have absolutely no desire to use tobacco again or to continue the use of the remedy. It helps to quiet the nerves, and will make you feel better in every way. If you really want to quit the tobacco habit—get rid of it so completely that when you see others using it, it will not awaken the slightest desire in you—you should at once begin a course of **Tobacco Redeemer** treatment for the habit.

Results Absolutely Guaranteed

A single trial will convince the most skeptical. Our legal, binding, money-back guarantee goes with each full treatment. If **Tobacco Redeemer** fails to banish the tobacco habit when taken according to the plain and easy directions, your money will be cheerfully refunded upon demand.

Let Us Send You Convincing Proof

If you are a slave of the tobacco habit and want to find a sure, quick way of quitting "for keeps" you owe it to yourself and to your family to mail the coupon below or send your name and address on a postal and receive our free booklet on the deadly effect of tobacco on the human system, and positive proof that **Tobacco Redeemer** will quickly free you from the habit.

Newell Pharmacal Company
Dept. 300 St. Louis, Mo.



Free Book Coupon

NEWELL PHARMACAL CO.,
Dept. 300 St. Louis, Mo.

Please send, without obligating me in any way, your free booklet regarding the tobacco habit and proof that **Tobacco Redeemer** will positively free me from the tobacco habit or my money will be refunded.

Name.....

Street and No.....

Town..... State.....



Tobacco Tells on
Nervous System



Tobacco Ruins
Digestion



Tobacco Stunts
Boy's Growth



Tobacco Robs
Man of Vitality



Tobacco Steals
from You the
Pleasures, Com-
forts, Luxuries
of Life

Radio Catalogue Free

**Write us
a post card—
Address Dept. 6-R**

and we will send you free this 52 page catalogue of radio sets and parts. It also contains explanation of radio terms, map and list of broadcasting stations and much radio information, including an explanation of successful hook-ups and circuits.

You will be amazed at the low prices Ward's quote. A complete tube set having a range of 500 miles and more, including tube, head set, batteries, and antenna equipment, as low as \$23.50.

This catalogue contains everything for the expert and amateur. Complete sets and every improved part for building sets, all the most up-to-date devices—at the lowest possible prices.

Headquarters for Radio

Montgomery Ward & Co. is headquarters for Radio, selling everything direct by mail without the usual "Radio-profits." Why pay higher prices? Ward quality is the best and the prices will often save you one-third. Everything sold under our Fifty Year Old Guarantee—Your Money Back if You Are Not Satisfied. Write today for your copy of this complete 52-page Radio Book.

**Write to our house nearest you. Address Dept. 6-R
Chicago Kansas City St. Paul Portland, Ore. Ft. Worth**

Montgomery Ward & Co.

The Oldest Mail Order House is Today the Most Progressive



YOUR APPEARANCE

is one of your greatest assets

CAPITALIZE ON IT Such men as lawyers, bankers, doctors, executives and successful business men, consider their personal appearance one of their greatest assets. This applies equally to yourself. Your chance of promotion may depend largely upon your appearance. Neat clothes, clean collar, trimmed hair and good taste today help considerably in the making of a business man. Perhaps the most important of these factors is your hair. What is more slovenly looking than when the hair grows down over the collar—and what is more easily remedied? Keep it neat appearing between trips to the barber by trimming it at home. It's simple and easily done with Brown & Sharpe Hair Clippers—used by barbers the world over.

The Clipper Your Barber Uses is the Clipper to Use at Home



These famous clippers may be bought in hardware, department and cutlery stores. The leading barbers' supply houses carry them. *The most popular sizes are 000-00-0-1.

Keep the neck clean. Anyone can do it for you.



The tapered effect is just as easy to obtain.



The side tabs can also be easily trimmed with the aid of a comb.



Keep a Brown & Sharpe Hair Clipper at Home for use between trips to the barber—for trimming the children's hair or sister's "bob," and for use on vacations or when a barber is not right at hand.

BROWN & SHARPE MFG. CO.
Providence, R. I., U. S. A.

MAIL THIS COUPON TODAY

Brown & Sharpe Mfg. Co., Providence, R. I.
Please send a free copy of your new booklet, "How to Use Clippers."

Name

Address

City State

"What a whale
of a difference
just a few cents
make"



All the difference

between just an ordinary
cigarette and the most skillful
blend in cigarette history.

FATIMA

— a mild cigarette

Hand
Forged
Razor Steel
Blades, No. 57



Direct at Factory Prices

This \$2 KNIFE \$1.18 Postpaid
Hand Forged Razor Steel Blades
Handy shaped Blade makes this
knife best for mechanics, sportsmen
and farmers; light but strong; re-
sharpened easily. Stag handle. Ger-
man silver finish; blades file tested,
hand forged from razor steel and
warranted.

Sample \$1.18 3 for \$3.00 Postpaid.

Send for our 100-page List and
"HOW TO USE A RAZOR" **FREE**

MAHER & GROSH CO., 106 A St., Toledo, Ohio



DIFFERENT Indian Scout

INDIAN Scout-ing gives you every-
thing in motorcycling.

Light but ruggedly built, the Scout is—light enough for a boy to pilot, heavy enough for any he-man.

Not too much power and speed, but just enough for any purpose.

Low initial cost, lowest operating and upkeep cost—clean, noiseless, trouble-free—absolutely DIFFERENT in all respects, absolutely DEPENDABLE in every respect.

Descriptive literature on request. Write Dept. P1

INDIAN MOTORCYCLE CO.
SPRINGFIELD, MASS.



Canada's 1923 Crops Beat All Records Share in Canada's Opportunities

In 1923 the wheat crop of Canada exceeded the 1922 crop by almost 100,000,000 bushels. In Alberta, the average yield was 26.5 bushels per acre and there were many individual cases where yields of 50, 60, 75 and 80 bushels were returned. Other crops showed a corresponding increase over previous years with equally high yields. These enormous yields on moderate priced land even at average prices for farm products have placed many farmers on the road to success.

Amazing New Farm Offer Leaves You a Surplus for Comfortable Living

The Canadian Pacific Railway now offers you a Farm Home in Western Canada on a New Long-Term Plan of Easy Payments that is Extraordinary. The plan makes it possible to own a farm home without taking all profits to meet land payments and leaves a surplus for the comforts and enjoyments of life.

Payments Extended Over 35 Years

FIRST YEAR Under this plan all the settler pays down is 7% of the purchase price—
FREE One year's free use of the land without any interest chargeable whatsoever.
USE OF LAND The balance of principal and interest will be amortized on an easy payment plan of 34 equal annual payments which makes the second payment fall due two years after the purchase of the land, which is figured on the basis of 7% (including principal and interest) of the balance of the cost of the land. For example, on a purchase of 160 acres costing say, \$3,000, the down payment will be \$210 and the annual payments, commencing at the end of the second year, will be \$195.30. After 35 years the settler will get clear title to the land—unless, of course, he wishes to pay sooner, which is his privilege.

NO TAXES ON IMPROVEMENTS

Taxes are moderate and there are no taxes on livestock, buildings, improvements, implements or personal effects. Good markets, modern schools, roads, churches, amusements make farm life in Western Canada desirable and attractive.

IRRIGATED FARM LANDS

In sunny Alberta—a district that is especially adapted to mixed farming and where irrigation has been proved beneficial—a vast irrigation system with an unending supply of water administered under the direction of the Government, has been constructed.

Irrigation in Southern Alberta—insures you a crop every year—increases your crops each year—makes you independent of weather conditions—produces great quantities of coarse grains, pastures, alfalfa, roots, etc., thus developing the livestock industry which is safer and ultimately more profitable than wheat farming—tends toward closer development, well-cultivated farms, good neighbors.

These lands are also for sale upon the same amortization terms as our other farm lands. Full details on application.

YOU CANNOT BUY UNTIL YOU INVESTIGATE

You must inspect the land before buying in order to judge of its fertility. Special inspection trips from points Chicago and West will leave on the first and third Tuesdays each month. Single fare plus \$2.00 for the round trip. Let us arrange details. Send this coupon now. It will give you without obligation complete information on the new and amazing plan. These terms are so easy that you can own your own farm home—instead of renting.

M. E. THORNTON, Supt. of Colonization,
Room 431, Canadian Pacific Ry. Bldg., Calgary, Alberta

M. E. THORNTON, Supt. of Colonization, Room 431,
Canadian Pacific Railway Bldg., Calgary, Alberta, Canada
I am interested in learning more about
Prairie Provinces of Canada.
Irrigation Farming in Sunny Alberta.
Business and Industrial Opportunities in Western Canada
Lloydminster and Battleford Districts.

My Name.....

Address.....

Town..... State.....

Manufacturer With National Distribution Wants More Local Representatives

The man we want is now employed, but finds it difficult to make both ends meet. He feels certain that there must be some way whereby he can better his condition. He may not be a salesman but he can talk convincingly on something he firmly believes in. He may not have much money but he is not broke.

The man we are looking for is mechanically inclined and willing to devote his spare time as a local manufacturer and representative for us—work that can be done at home which will pay a splendid profit and surely develop into a business which will justify giving it all his time.

The OZARKA PLAN will give such a man more money, more independence and a real opportunity to build up a permanent, profitable business of his own. It is fully described in a large illustrated book—a FREE copy is yours for the asking.

Unlike any book you ever read, the OZARKA PLAN is a true story of life, of men, of why they fail and how they succeed. It is founded on the principle that the world owes every man a good living, a home of his own and a surplus for a rainy day. This book proves the reason why some men are millionaires and why others, by the sweat of their brow, made them so.

In territory not now covered the right man is wanted—the OZARKA PLAN may be the turning point in your life, so in writing for the OZARKA PLAN book, tell us about yourself fully and give name of your county.

OZARKA INC.,

851 Washington Blvd. Chicago, Illinois



Ace Type 3C Consolette

This is a comparatively new addition to the Ace Family. It has beautiful solid mahogany, wax finished cabinet and greatly adds to the appearance of any home.

This set consists of a regenerative tuner, detector and two stages of amplification, with built in loud speaker. The tuning circuit is licensed under the Armstrong U. S. Patent No. 1,113,149 and due to the particular method of winding Crosley coils it is exceptionally selective. Has sufficient room inside cabinet for dry batteries, making a complete self-contained long range receiving outfit. Has phone jack for tuning with head phones. Crosley multistat; filament switch; Crosley moulded condenser, beautifully engraved formica panel. Uses all kinds of tubes. Price \$125. Prices do not include batteries or tubes.

Let an Ace Radio Set bring happiness to someone on Christmas morning. If your dealer cannot supply you, order direct, mentioning his name.

The Precision Equipment Co.

Powel Crosley, Jr., Pres.

115 Vandalia Ave. Cincinnati, Ohio

FROST-RADIO

Ask Your Neighbor

NEW PLUG

No. 140

2-FONE 60c



The biggest value in a high grade 2-Fone Plug on the market. Takes two pair of FROST-FONES. Holds cord tips tight—never lets go. Secure one today at your dealers.

HERBERT H. FROST, Inc.

154 West Lake Street, CHICAGO, ILLINOIS
30 Church St., New York 550 Gates Bldg., Kansas City, Mo.

Agents Wanted

for the Best and Fastest-Selling Automobile Proposition on the market!

There are a few more openings in exclusive territories for live agents to handle **Airlox Airtight Puncture-Proof Tubes and Hughes Valve Caps**. These tubes, together with the caps, make a combination which renders them absolutely airtight and puncture-proof.

Experience is not necessary; we train you. If you are a man who wants to make some money, let us tell you how you can make a big success with **Airlox Airtight Puncture-Proof Tubes and Hughes Valve Caps**. Write today for information.

AIRLOX RUBBER COMPANY

2054 W. Jackson Boulevard, Chicago



National Audio Frequency Transformers

The New 6 to 1 Ratio National Transformer is for use on the first stage of amplification. Its greater ratio means increased volume, but the tone qualities that characterize the 3½ to 1 ratio have been fully retained. Price of 6 to 1 ratio \$4.50 postpaid; of the 3½ to 1 ratio, \$4.00 postpaid. Dealers: Write for interesting sales proposition.

National Transformer Mfg. Co.
154 Whiting Street
Dept. 110 Chicago, Ill.

Quick Money for Christmas



This Check Protecting Fountain Pen Has Proved the Greatest Money-Maker Ever Sold by Agents.

A dozen of these pens often sold in one office in half an hour. A hundred customers often found in a single office building. No competition. Not sold in stores. You have a monopoly.

Side line men make \$25 to \$35 a week. Full time men make \$75 a week and up. Instant appeal account of wonderful combination of splendid fountain pen and check protector at the price of the pen.

Write Today for Agent's Plan

53 million dollars lost last year by forgeries, alterations, etc., in checks and important documents. 16 million dollars lost on "raised" checks alone — checks made out "away from the office." All such losses prevented by the

Security
CHECK-PROTECTOR
FOUNTAIN PEN

Carried in pocket, always ready. Absolutely defies crooks. Seventeen years' experience gives the Security superior writing qualities. The best pen, plus a feature everybody wants. Write quick for proposition. A ready seller for Christmas gifts. Now is the season for such sales.

Prices:
\$3.50
to
\$7.00

Security Pen Corporation
PM-900 West Jackson Blvd., CHICAGO

Send for 48-Page Catalog

Showing Lionel Electric Trains and Accessories in full colors. WRITE TODAY. Address Department 14. THE LIONEL CORPORATION, 48-52 E. 21st St., N. Y. C.



WEBER'S BEST laying, BEST reese & turkeys. Fine pure-bred quality. Fowls, Eggs, Incubators at new low prices. 42 years poultry experience, and my 100 page Catalog and Breeders' Guide Free. **W.A. Weber, Box 82, Mankato, Minn.**



Darche "CALL-ME" ELECTRIC ALARM CLOCK

The only clock of its kind; comes complete, ready to operate. No home complete without one. Can be used as an "alarm clock" and "mantel clock." Get one of these clocks FREE. **OUR OFFER WILL TELL YOU NOW.** Agents, here is a big money-maker — no competition, sells on sight. Comes in all cases — mahogany and otherwise. Size 10 1/2 x 8 1/2 x 4. Don't delay. Write today for our descriptive literature. An ideal HOLIDAY GIFT that anyone will be proud of. **DARCHE MFG. CO. 645 Washington Blvd. CHICAGO, ILLINOIS**

HOW TO MAKE DEVICES FOR OUTDOOR WINTER SPORTS

Motor-Driven Sleds and Ice Boats—Constructing Bobbeds and Toboggans—Skis—Gilders—Ice Yachts, etc., 64 pages. 25 cents, postpaid. Popular Mechanics Book Dept., 200 E. Ontario St., Chicago.



\$5.00
Special 200 Hr. 2 Volt. rechargeable. For W. D. 11-12 Tubes.

SAVE 50% WRITTEN 2-YEAR GUARANTEE
Buy a World Radio or Auto Battery

Auto Prices:	Radio Prices:
6 V—11 Plate \$12.25	6 V—60 A. . . . \$ 8.50
6 V—12 Plate \$14.00	6 V—80 A. . . . 10.00
12 V—7 Plate \$17.00	6 V—100 A. . . . 12.50
	6 V—120 A. . . . 14.50
	6 V—140 A. . . . 16.00

C. O. D. subject to inspection or 5% Discount for cash with order. Clip ad and mail now for special Free offer.

WORLD BATTERY CO., Dept. 6
1219 So. Wabash Ave., Chicago, Ill.

FREE
"B" Battery and Hydro-meter or Spotlight.



"Another \$50 Raise!"

"Why, that's the third increase I've had in a year! It shows what special training will do for a man."

Every mail brings letters from some of the thousands of students of the International Correspondence Schools, telling of advancements won through spare-time study.

How much longer are you going to wait before taking the step that is bound to bring you more money? Isn't it better to start now than to wait for years and then realize what the delay has cost you?

One hour after supper each night spent with the I. C. S. in your own home will prepare you for the position you want in the work you like best.

Without cost, without obligation, mark and mail this coupon. *Do it right now!*

INTERNATIONAL CORRESPONDENCE SCHOOLS
Box 5575-D, Scranton, Penna.

Without cost or obligation, please tell me how I can qualify for the position or in the subject before which I have marked an X:

BUSINESS TRAINING COURSES

- | | |
|------------------------------------------------------------------|---------------------------------------------------------------------------|
| <input type="checkbox"/> Business Management | <input type="checkbox"/> Salesmanship |
| <input type="checkbox"/> Industrial Management | <input type="checkbox"/> Advertising |
| <input type="checkbox"/> Personnel Organization | <input type="checkbox"/> Better Letters |
| <input type="checkbox"/> Traffic Management | <input type="checkbox"/> Show Card Lettering |
| <input type="checkbox"/> Business Law | <input type="checkbox"/> Stenography and Typing |
| <input type="checkbox"/> Banking and Banking Law | <input type="checkbox"/> Business English |
| <input type="checkbox"/> Accountancy (Including C.P.A.) | <input type="checkbox"/> Civil Service |
| <input type="checkbox"/> Cost Accounting | <input type="checkbox"/> Railway Mail Clerk |
| <input type="checkbox"/> Bookkeeping | <input type="checkbox"/> Common School Subjects |
| <input type="checkbox"/> Private Secretary | <input type="checkbox"/> High School Subjects |
| <input type="checkbox"/> Spanish <input type="checkbox"/> French | <input type="checkbox"/> Illustrating <input type="checkbox"/> Cartooning |

TECHNICAL AND INDUSTRIAL COURSES

- | | |
|-------------------------------------------------|----------------------------------------------------------------------|
| <input type="checkbox"/> Electrical Engineering | <input type="checkbox"/> Architect |
| <input type="checkbox"/> Electric Lighting | <input type="checkbox"/> Blue Print Reading |
| <input type="checkbox"/> Mechanical Engineer | <input type="checkbox"/> Contractor and Builder |
| <input type="checkbox"/> Mechanical Draftsman | <input type="checkbox"/> Architectural Draftsman |
| <input type="checkbox"/> Machine Shop Practice | <input type="checkbox"/> Concrete Builder |
| <input type="checkbox"/> Railroad Positions | <input type="checkbox"/> Structural Engineer |
| <input type="checkbox"/> Gas Engine Operating | <input type="checkbox"/> Chemistry <input type="checkbox"/> Pharmacy |
| <input type="checkbox"/> Civil Engineer | <input type="checkbox"/> Automobile Work |
| <input type="checkbox"/> Surveying and Mapping | <input type="checkbox"/> Airplane Engines |
| <input type="checkbox"/> Metallurgy | <input type="checkbox"/> Navigation |
| <input type="checkbox"/> Steam Engineering | <input type="checkbox"/> Agriculture and Poultry |
| <input type="checkbox"/> Radio | <input type="checkbox"/> Mathematics |

Name.....
Street.....
Address..... 8-3-23

City..... State.....

Occupation.....
Persons residing in Canada should send this coupon to the International Correspondence Schools Canadian, Limited, Montreal, Canada.

Genuine KEYSTONE MOVIEGRAPH

(PATENTED)

SHOWS BIG SIZE MOVING PICTURES

Safe for the Home **\$6.95** Non-Inflammable Safety Films
Reel of Charlie Chaplin—"GOLF PRACTICE"

The following reels are only a few in the film catalogue, and are genuine, posed by the actors themselves. The film is the same size as used in the theatre.

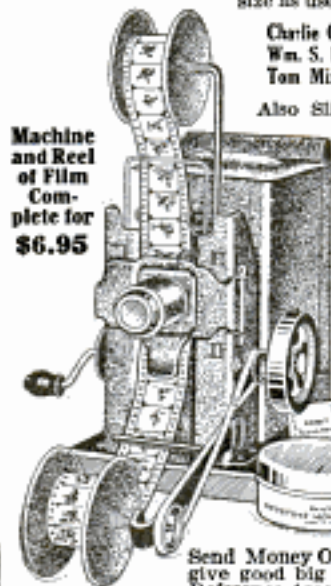

Machine and Reel of Film Complete for **\$6.95**

Charlie Chaplin in "Fun in the Bakeshop"
Wm. S. Hart in "The New Sheriff"
Tom Mix in "The Battle on Horseback"

Also Slides, Drawing Slides, Theatre Tickets, etc., included.

Every live boy should have at home or club a Keystone Moviegraph that shows pictures the same as in the movies with powerful French lenses and constructed along professional lines.

The electric cord is included for connecting to any lamp socket your electric bulb will fit. Can also be had for any Dry Cell Batteries for the home without electricity.

Nothing to get out of order. No complicated parts.

We have the largest comedy film service in the country for home machines.

Size of machine all set up is 15"x9". Weight 3 lbs.

Send Money Order or check. Guaranteed to give good big pictures or your money back. Reference American Trust Co., Boston, Mass.

Order your machine today in time for Christmas.



Price for Machine and Reel **\$6.95** complete, prepaid. Genuine Keystone Moviegraph Patented 1919, 1920, 1921.

LIBBEY & NICHOLS

Jet Sales Co.

Dept. P, 230 State St., Boston, Mass.

Play a CONN for Pleasure and Profit

Isham Jones and his famous orchestra are among the great popular stars who use and endorse Conn instruments.

Conn instruments are easiest to play because of the exclusive way they are made and many improvements, refinements, and features developed in the great Conn laboratories. You can play a tune in a few hours on the Conn saxophone—take your place in orchestra or band in a short time. Conn cost no more.

Free Trial; Easy Payments. Write now for Free Book and details, mentioning instrument which interests you.

C. G. Conn Ltd., Elkhart, Ind.
131 Conn Bldg.

CONN

WORLD'S LARGEST MANUFACTURER OF HIGH GRADE SAXOPHONES AND ORCHESTRAL INSTRUMENTS

CULTIVATE YOUR MUSICAL BUMP

\$50-\$300 a Week



Paint Cars in Auto Plants



Repaint Cars For Dealers



Own Your Own Shop



Be Head of Big Business

You, too, can make this by learning the highest paid work in the whole motor car industry—Auto Painting. Over 2,000,000 new cars each year—13,000,000 cars in use need repainting in 12 months. Only trained men can do this. Factories, dealers, custom shops, all bidding for men. Demand exceeds supply everywhere.

We Fit You for Big Pay in Few Weeks

This thoroughly equipped school—approved by big auto plants—teaches you in 8 to 12 weeks. Personal instruction by experienced, practical auto painters. Every branch covered, including big-money specialties—stripping and lettering. Go right from here to position. You can hold high-pay job or run your own shop—be the head of big business.

Get Facts Today

Write us today for facts about this wonderful trade and our methods. Don't delay! This is the greatest opportunity in any industry. Demand is growing faster than supply. Write today for details—then you be the judge.

Detroit Auto Painting School
1405 Van Dyke Ave. Detroit, Mich.

SARGENT PLANES save time

Ask your hardware dealer to explain the Auto-Set feature and write for booklet.

SARGENT & CO., 49 Water St., New Haven, Conn.

THIS WONDERFUL INVENTION



converts any ordinary cook stove into a gas stove. OXO-GAS is made from kerosene and air. Cheaper, cleaner and more efficient than coal. Responsible distributors wanted.

GLORIA LIGHT CO.
114 N. May St. Chicago, Ill.

FOOTBALL SPECIALS

\$2.50 Rugby Footballs Now \$1.25

A special for boys. Dandy quality pebble-grained leather, strong canvas lining. Full size. Will give good service.

\$3 Practice Balls Now \$2

English cowhide, excellent for practice. Answer same purpose as ball costing twice as much.

Reach LCF Footballs \$5

The kind used by the big colleges. Your chance to save one-half. These footballs complete with pure rubber bladder, rawhide lace and needle. **MONEY BACK IF NOT SATISFIED.**

A DANDY XMAS PRESENT

MOSKOWITZ & HERBACH
512 MARKET ST. PHILA. PA.

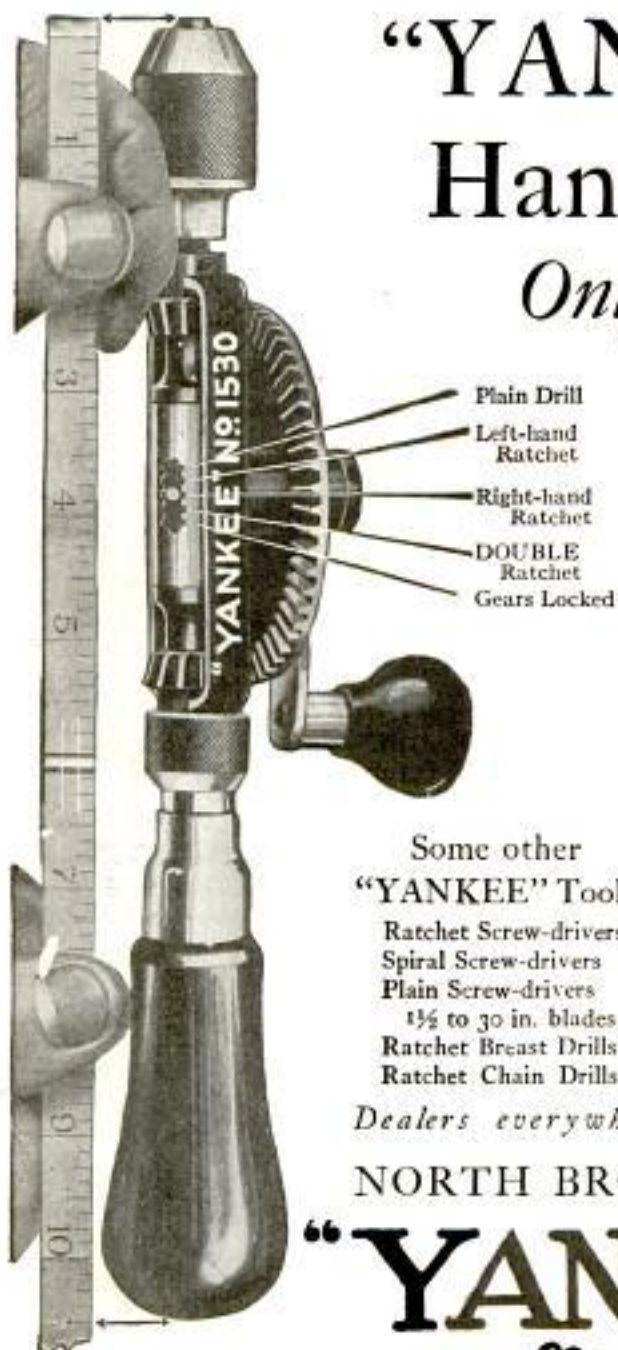

"YANKEE" Ratchet Hand Drill No. 1530

Only 10 1/2 inches long

Weighing only 20 ounces, and so small that it fits into the pocket, this remarkable Drill has every ratchet adjustment of the big "YANKEE" Ratchet Breast Drills. In cramped places where crank cannot be turned fully the DOUBLE Ratchet keeps the drill cutting continuously even if you can only move the crank an inch either way. Three-jaw chuck holds up to 3/16 in. drills.

Some other
"YANKEE" Tools

- Ratchet Screw-drivers
- Spiral Screw-drivers
- Plain Screw-drivers
- 1 1/2 to 30 in. blades
- Ratchet Breast Drills
- Ratchet Chain Drills

Dealers everywhere sell "YANKEE" Tools

FREE "YANKEE"
TOOL BOOK Mailed
on Request

Pictures and describes all the clever "YANKEE" Tools for saving time and labor and accomplishing impossible jobs. Write for it today.



NORTH BROS. MFG. CO., Philadelphia, U. S. A.

"YANKEE" TOOLS

Make Better mechanics

FREE

**300 Candle
Power
FARM
LANTERN**

The world's greatest contribution to light is the New Improved Wizard Gasoline or Kerosene Table Lamp, equipped with automatic cleaning needle. The discovery of "Theus" metal, used exclusively in Wizard Lamps and Lanterns, has revolutionized this industry. Now 10¢ worth of kerosene or gasoline will give 30 hours' pure white, soft yet intensely brilliant light. To introduce this remarkable lamp, we give absolutely **FREE** a genuine \$8.50 Wizard Gasoline or Kerosene Lantern with the purchase of one lamp. But you must act **quick**. Offer limited to 5000 Free Lanterns. Write at once for **Free** book showing style of lamp you like and details of **Free Offer**. No obligation. Write **now**. Agents send for unusual offer and exclusive proposition.

THE NAGEL-CHASE MFG. CO., 288 E. Erie St., CHICAGO



No Wick
No Smoke
No Odor

**AUTO SUPPLIES
WHOLESALE
3000 BARGAINS**

SEND FOR THIS
CATALOG -
it's FREE!

*Everything you need
in Auto Supplies at
Amazingly LOW PRICES.*

NEMCO BARGAIN SUPPLY HOUSE

33 to 49 No. Peoria St. Dept. P. CHICAGO, ILL.



EVINRUDE WILL

To insure delivery of a new
SPORT TWIN, order from your
dealer at once. Send for catalog.

EVINRUDE MOTOR CO., 207 Fremont Block, Milwaukee, WIS.

BE-OVER SOLD

DIAMONDS

\$2⁰⁰ DOWN

No. 1. The "Butterfly" Fiery blue white perfect cut diamond. 18k. white gold hand engraved and pierced ring. \$62.50—\$2 Down—only **\$1.50 a week.**

No. 2. "Vassar". Artistically pierced lace work design. 18k. white gold. Perfect cut blue white diamond. \$37.50—\$2 Down—only **\$1.00 a week.**

No. 3. "Cluster". 7 fine white diamonds set in platinum. Resembles \$750 solitaire. 14k green gold. Rare beauty. \$52.50—\$2 Down—only **\$1.50 a week.**

10 DAYS FREE TRIAL

FREE
Write for Catalog.
Diamonds
Watches Jewelry
\$10 to \$1000
on easy terms.
Wonderful values

No. 4. "Luxor". Man's 14k. green gold massive ring. 18k. white gold top. Fiery blue white diamond. \$37.50—\$2 Down—only **\$1.50 a week.**

TEN DAYS' FREE TRIAL
Easy for you to own or give as a gift any of these handsome rings. **Simply send \$2.** We will send ring you select on 10 days' trial. **Only if satisfied, make weekly payments until balance is paid.** If you do not agree it is an **amazing bargain**, return ring within 10 days and we will refund your \$2. **You take no risk.**

BAER BROS. Co.

6 MAIDEN LANE, NEW YORK. Established 1890

Address
Dept. 126

Guarantee Bond with Every Ring.

\$300 Profit Monthly



Only 20 Monthly 8 HOUR PAYMENTS

HB 8 HOUR Battery Charging Pays Big Monthly Profits

Small cash payment puts HB 8-Hour Battery Charger in your shop. **Your increased profits easily carry the small \$20 monthly terms**, with good surplus besides. HB 8-Hour service builds trade, beats competition. An HB saves you \$35 to \$115 over any other outfit on purchase price alone. Every HB outfit includes 30 days' free trial with money-back guarantee. You run no risk. HB Constant Potential saves current, labor and rental batteries. HB Patented Voltage Regulating Winding absolutely eliminates reversing. HB overize construction permits output of one-third more batteries than any other outfit of similar rating. Write today. Best season starting now. **HOBART BROS. CO., Box M14, TROY, OHIO**

Profits Easily Carry Small Monthly Payments

8 Hour Battery Charging PAYS BIG!



Small Cash Payment Pays Profits

SELL US A PRACTICAL IDEA

of some new and useful WAY to utilize Pressed Metal in place of other materials. The undersigned pays cash for every acceptable suggestion approved by our Engineering Advisory Board. Freebook synopsis the facts.

PRESSED METAL TRADE COUNCIL

27 QUINCY STREET, SUITE 1701, CHICAGO

Swing 4 in.; 11 in. between centers, 17 in. total length. Shipping weight 13 lbs. Bed of lathe is machined. Workmanship first-class. Equipped with wood turning chuck. Can be fitted with 3 in. face plate and drill chuck as special equipment. Order one today.



Price \$6.00 cash with order
Made also in larger sizes.

SYPHER MFG. CO.
Dept. D TOLEDO, OHIO

Jones EZ-Start Motor Heater

for FORDS

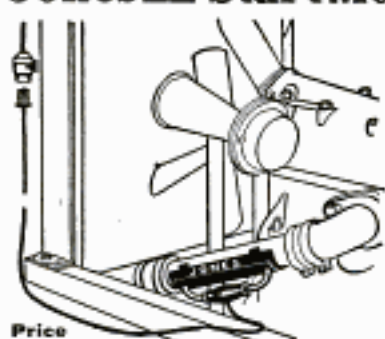

Keep your motor warm all night in the coldest garage. Simply slip heater on the water pipe, plug in on electric light socket, and turn on the current. In the morning your car starts like in summer because it's warm.

Saves gas, oil, battery, time and temper. Assures you the great pleasure of an easy-starting motor. Same current consumption as a 100-watt lamp—costs only 5¢ a night to operate. Surely easy starting is worth that much.

Jones EZ-Start Motor Heater heats the water only and not the garage or the inside of the hood. Puts the heat right where you need it without wasting it on the atmosphere.

For all Ford Cars, and Guaranteed to give Satisfaction
Sell every Ford owner in your town. Send for literature and prices on our complete line of Ford improvements.

PROCESS PRODUCTS COMPANY
ROBERT M. JONES, Pres. 508 S. Sangamon St., CHICAGO

BURN Home Made GAS

In Your Old COAL STOVES

Change your coal or wood stove into a gas stove in 3 minutes. A Child can do it. Burn kerosene Vapor Gas—hotter than coal or wood and costs less. Safe and simple.

FREE TRIAL

Just turn a valve and get even heat instantly. No ashes, no dirt, no smoke, no wood to chop or carry. No fires to build and feed. No fuel wasted. Cooks and bakes better. No damage to stoves. Makes its own gas from common coal oil, cheapest, cleanest fuel. Guaranteed five years. Money back if not satisfied after 10 days' trial. Write for FREE folder with proof and SPECIAL OFFER.

SIMPLEX UTILITIES MFG. CO.
110 Simplex Bldg. 1428 No. Wells St., Chicago

AGENTS WANTED



Big 3-Ft. Telescope Useful and Entertaining (In Five Sections)

See people and objects miles away, on land or sea, as if they were close. Wonder Telescope gives new pleasures to home, farm, camp, travel, sport. See moon and stars as never before. Opens out over 3 feet long; measures 12 inches closed. Brass bound; has powerful lenses. **Thousands pleased**—"Could tell color of aeroplane 4 miles away."—Mrs. Yarbrough. "Saw Provincetown Light, 28 miles away, as clear as if in front of me."—Clyde Scribner.

SEND NO MONEY

SPECIAL OFFER!

While they last

Because of a fortunate purchase from a large European manufacturer we can give you a big bargain. Be first in your neighborhood; entertain your friends. **Send no money** send only name and address for telescope complete by parcel post. On arrival deposit with Postman only \$1.85 plus a few pennies postage. **Satisfaction guaranteed or money refunded. Order today while the supply lasts.**

FERRY & CO., 75 W. Van Buren St. Dept. 1771 Chicago, Ill.

"Wouldn't take \$10 for mine."—L. H. McKee.
"See objects miles away that seem close at hand."—A. W. Stockholder.
"I will always recommend the Wonder, I have two of them."—Anna Bertha.
"Well pleased with Wonder, used but soon eye for distance enclosed."—W. H. Baker.
"More than pleased."—J. S. George.
"Please send telescopes to two of my neighbors and 5 brothers and sisters, names enclosed."—Anna Higgins.
"More than pleased, better than I expected."—Steve Bile.
"Live a mile from town and have much pleasure seeing things that distance."—Mrs. C. M. Campbell.

Columbia Dry Batteries

—they last longer



Packed with energy

for

- Motor boat ignition
- Gas engine ignition
- Tractor ignition
- Starting Fords
- Door bells
- Buzzers
- Ringing burglar alarms
- Calling Pullman porters
- Running toys
- Telephone and telegraph
- Lighting tents and out-buildings
- Firing blasts
- Heat regulators
- Electric clocks
- Radio A

INTENSE, fiery sparks start things moving and keep them going wherever Columbias are hitched. Lasting strength for heavy drains. Quick pick-up of fresh energy between uses in intermittent service. Easy to buy anywhere. Sell so fast that dealers are sure to have fresh stock.

Hot Shots contain 4, 5 or 6 Columbia Dry Cells in series in a neat, water-tight, weather-proof metal case.

Columbia Dry Batteries are sold by electrical, hardware and auto accessory shops, marine-supply dealers, implement dealers, garages, general stores. Insist upon Columbia—Fahnestock Spring Clip Binding Posts on Columbia Ignitor at no extra cost.

NATIONAL CARBON COMPANY, Inc.
New York, N. Y.

MOTOR BARGAINS

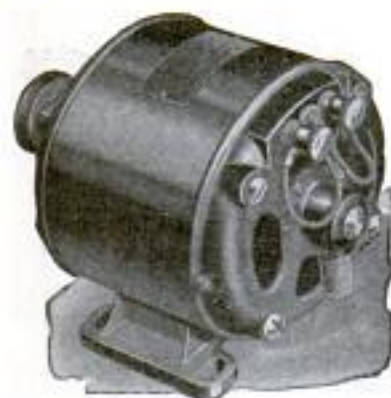

REBUILT
and NEW
Every Motor
Guaranteed

\$10⁵⁰
1/4 H.P.

110 Volts—60 Cycles

Every motor guaranteed O. K. If not satisfactory, you can return and your money (less return charges) will be refunded.

	Rebuilt	New
A. C. 110 Volt, 60 Cycles	\$10.50	\$13.50
D. C. 110 Volt, 60 Cycles	12.50	16.00

An Ideal Christmas Gift

NORTHWESTERN ELECTRIC CO.
408 South Hoyne Avenue CHICAGO

FORD START HARD?

EASILY AND CHEAPLY FIXED WITH

C-A

(ADJUSTABLE CENTER)

BEARING CAP \$3.75



CORRECTS END-PLAY and sets magneto for full efficiency without removing motor from car. Saves battery on cars with starter, saves the arm on cars without. Installed in few minutes. Guaranteed for one year. Ask your dealer, or sent pre-paid on receipt of..... \$3.75

ADJUSTABLE BEARING CO., Dept. P, Brazil, Ind.



Elto
3 HP Twin
Outboard
Motor

LESS THAN **17** POUNDS
THAN **17** PER H.P.

—and the **FASTEST**
"LIGHT TWIN"

Designed and built by Ole Evinrude. Easy to carry yet has one half more power and greater speed. Easiest of all motors to start. No spinning necessary. Safe rudder steering. "push button" instant reverse, weed-free propeller self-tilting in forward or reverse. Trouble proof carburetor. Fits in carrying case without taking apart. Write for catalog.

ELTO OUTBOARD MOTOR COMPANY

Manufacturers' Home Building

Dept. AA

Milwaukee, Wisconsin

I Offer You

\$48 a Week

and a

Buick
TOURING CAR

We want men and women as local representatives to demonstrate and take orders for Comer All-Weather Raincoats. New offer enables you to earn \$48 a week and Buick touring car. No experience necessary. Write quick.

Comer Mfg. Co., Dept. BW-590, Dayton, O.



No Joke To Be Deaf

—Every Deaf Person Knows That



I make myself hear, after being deaf for 25 years, with my Artificial Ear Drums. I wear them day and night. They are perfectly comfortable. No one sees them. They stop head-noises. Write me and I will tell you a true story, how I became deaf and how I make you hear. Address

GEO. P. WAY, Artificial Ear Drum Co. (Inc.)
80 McKeeney Bldg., 2631 Woodward Ave., Detroit, Mich.

**5 DAYS
FREE
TRIAL**

Send
No
Money



"INVINCIBLE" Rebuilt GUARANTEED
STANDARD No. 10 Self Starter Model
REMINGTON

New low prices. A remarkable bargain. Looks and writes like new. Full 84 character keyboard, standard size type, back spacer, automatic ribbon reverse, other late improvements. Order TODAY or write for circular. Many other standard makes. Shipments from nearest of our 28 stores. Time payments if desired. Resident salesmen wanted.

AMERICAN WRITING MACHINE CO. Estab. 1880
Factory: 452-R Central Ave., Newark, N.J.

EARN
Big Profits
With
HB & Hour Battery Service

\$300 PROFIT Monthly from HB & Hour Battery Charging

That's what Rockford Battery Shop makes. Pauley (Louisville), makes \$200 monthly; W. B. Battery Co., Montgomery, Ala., \$250; Diamond Grid, Asheville, N. C., \$400; Scott & Archibald, Oregon, \$255. Thousands more HB users make for monthly profits you can, too. HB & Hour Charging puts your shop ahead of competition. Only \$20 monthly pays for HB & Hour Battery Charging. Small cash payment brings HB outfit on 30 days' trial with money-back guarantee. Your profits easily carry \$20 monthly terms with nice surplus besides. HB outfit saves on current, labor, upkeep — handles more business, draws trade. Your best winter money-maker. Write today for Bulletin 247.

NOBART BROS. CO.

BOX M1

TROY, OHIO

Pays for Itself ~ Earns Big Profits

Only \$20 Monthly Brings
BIG PROFITS



HB & Hour Battery Service

AGENTS WANTED

to sell and introduce our **Eureka Battery**—Retail Price \$16.20, Agents Price \$10.80 Suitable for any Radio Set or Ford car. One year iron clad guarantee. For radio use battery comes in a mahogany stained case, with ball handle if desired. For Ford cars battery comes in a black wooden case. Price is the same to you on either battery with cases as described above. 6 volt 100 ampere. If you want to make big money write for our proposition and descriptive literature. Don't delay.

Eureka Battery Company

Dept. P M 2210 No. Clark St.
CHICAGO, ILLINOIS.



A Perfect Glareless Headlight At Last



Distributors—Agents and Dealers—Can Make \$3,000 to \$15,000 or More A Year

The Detroit Safety Headlight Devices absolutely solve the greatest menace to automobiling—the headlight glare. This

is a new, simple device and fits any model of any car. Installed easily and quickly by anyone.



Used with low priced plain glass lens. It adds style and dignity to any car. It absolutely concentrates the light down on the road, not up in others' eyes. Drive with all the courtesy of the road with bright lights on. The glare is positively eliminated. Will last a lifetime. Will not rust, corrode or deteriorate. Meets every legal requirement. They are the best headlight devices made and stand any test.

Detroit Safety Headlight Devices **Sell On Sight**

They sell on sight—a demonstration sells anyone. Easily demonstrated in store, home or on car. Sold on 30 day trial—never taken out. Appeals to fairness—no one wants to drive others to death in ditch. Owners urge others to buy. See illustrations as to installation and effect.

Exclusive Territory—Newspaper Advertising—Installed Free

Exclusive territory granted to right men—we run newspaper advertising and arrange for **Free** installation by competent garages. Printed matter and cards also furnished. We want men in every county who can handle men and sales and make from

\$3,000 to \$15,000 or more according to territory.

We have a special Bonus Offer of Syndicate Shares to those who take territory at once. This offer cancels itself when 100,000 fully participating shares are allotted.

FREE—One Set. Free Introductory Advertising Offer

One set of Detroit Safety Headlight Devices in a neighborhood makes everyone want them. It's the best kind of advertising for our representatives. Therefore, for a short time we will sell two sets for the price of one (\$2.00) or one set at wholesale price of \$1.00, postage paid. Buy two sets, sell one easily at \$2.00—yours will be free. This offer is open to everyone to advertise the devices. When territory Representatives are appointed offer ceases—so act now. Easily installed by anyone. Get literature—clip **FREE** coupon, fill in, pin \$1 or \$2 bills to coupon—act quickly **NOW**.

FREE—One Set Free Coupon

Motor City Syndicate,
Offices: 1217 Book Bldg., Dept. 21,
Detroit, Mich.

Gentlemen: Without obligations, please send literature on Detroit Safety Headlight Devices. Send such offer as I have marked below.

Do you want to sell?.....

What territory?.....

Make of your car..... Model..... Year.....

Make of other car..... Model..... Year.....

Fill in both for \$2.00 offer.

Are you interested in Bonus Offer?.....

Just use Dollar Bills if sending money.

Enclosed \$..... for offer as marked above. These to be mailed postage paid.

Name.....

Address.....

City..... State.....

Motor City Syndicate

Offices: 1217 Book Bldg., Dept. 21

Detroit, Mich., U. S. A.

Popular Mechanics Magazine

offers you

An opportunity to represent it in taking subscriptions in your community. Because of the fact that we are now equipped with additional press facilities in our own plant, we are prepared to materially increase the production of Popular Mechanics Magazine. For this reason we are able to offer

Very Liberal Commissions

to responsible parties to act as our agents in their community to solicit subscriptions to Popular Mechanics Magazine on our

UNUSUAL SPECIAL OFFER

If you cannot devote your entire time to this work you will find it well worth your while to solicit subscriptions during leisure hours.

Write us today for full particulars, giving two references.

POPULAR MECHANICS MAGAZINE
200 East Ontario Street, Chicago

"THE AIR IS FULL OF THINGS YOU SHOULDN'T MISS"



When Radio called, Eveready was ready

TWENTY-ONE years ago, when wireless telegraphy had its first birthday, National Carbon Company's dry cell batteries were nine years old. Even then, its batteries were world famous as convenient, economical and efficient sources of electric energy.

With the introduction of popular broadcasting, radio leaped into universal service. Radio engineers used Eveready Batteries as their standard in designing tubes and receiving sets. Eveready engineers, backed by the most complete research and testing

laboratories known to the industry, worked with them to discover how the known dry cell could be improved for radio work.

The fruit of these efforts is the Eveready family of radio batteries conspicuous for vitality and endurance—the right battery by test and proof for every radio use.

Insist on Eveready Batteries—they last longer.

Informative and money-saving booklets on Radio Batteries sent free on request.

NATIONAL CARBON COMPANY, INC.
New York, N. Y.

Headquarters for Radio Battery Information

If you have any battery problem, write to RADIO DIVISION, NATIONAL CARBON COMPANY, INC.
207 Manley Street, Long Island City, N. Y.



Eveready "B", 22½ volts,
No 766 with Six Fahnestock
Spring Clip Connectors

Radio has moved from the laboratory and amateur's work-table out into the refined surroundings of the family living room. In keeping with this new companionship we offer this reliable, long-lived Eveready "B" Battery, in an attractive, new metal case, worthy to stand beside the rich cabinets of fine radio sets.



EVEREADY

Radio Batteries

—they last longer

Cuts 36 Cords a Day With His OTTAWA LOG SAW



New Lower Prices!

The NEW 1924 OTTAWA Cuts Faster

MR. MARTIN'S report proves that the OTTAWA Log Saw is the Fastest-Cutting One-Man Outfit ever made. And the 1924 Model is still faster! Mr. Martin has the older model. The New OTTAWA does *more* work *quicker*.

350 Cuts a Minute: The New OTTAWA saws through toughest logs at the rate of 6 cuts a second! Every cut is made the human way because of the Power Force Feed.

New Improvements:

Clutch Lever control starts and stops saw while engine runs. Magneto equipped—no batteries needed. 4 H-P. Motor. Nickel Chrome valves—just like high priced automobile motor. All power needed for sawing and belt work. Wide, long-wearing bearings.

Easiest to Move: The OTTAWA is acknowledged the most practical One-Man Saw because it is easiest moved and operated by one man. The New 1924 Model is even more convenient to handle.

30 Days' Trial—10-Year Guarantee

Shipped direct from factory or 10 factory branches. You save freight. Guaranteed by World's Largest Log Saw Factory.

Cash or Easy Terms

New Lower Prices and Easier Terms of Payment enable any worthy man to own an OTTAWA. If you can't pay all cash—pay part down. Write for liberal selling plan.

Send for FREE BOOK!

My New Book in colors describing the New 1924 Model OTTAWA and showing how hundreds have paid for their outfits while sawing, is ready for mailing. Send at once for your copy.

H. C. Overman, Gen'l Mgr.

OTTAWA MFG. CO.

1742B Wood St.,
OTTAWA, KANS.

Room 1742B Magee Bldg.
PITTSBURGH, PA.

Read This Letter

Withee, Wisc.
September 20.

Gentlemen:

Our Ottawa Log Saw certainly works fine. I saw 36 cords a day with the Ottawa and never have any trouble.

We will start sawing again this week. It is no work at all with our fast cutting Ottawa.

Your friend,
FELIX MARTINS.



Quick change to Iron Saw and back to Log Saw.



Look at Buzz Saw sold alone or with Log Saw.

SAVE MONEY Get This Book

HANDY MAN BOOK

Install Your Own PLUMBING & HEATING

NEW EASY WAY - SAVE HALF

25c
Reg. Price 50c

Brings you this big Plumbing and Heating Encyclopedia-Catalog. Write for your copy today without fail.

Guaranteed Heating Plants

Our Handy-Man Book shows how. Big 256-page well-bound encyclopedia of Plumbing and Heating Outfits, Systems, Supplies, Fixtures and Accessories—10,000 items—illustrated. Hundreds of floor plans, elevations, diagrams, trade secrets, money and trouble-saving kinks, etc. "How to save coal in heating." "Easy repair methods." Every householder, contractor, farmer, mechanic, institution needs this book. Shows how to save wages, work and materials.



Hot Water Boiler

BIG HANDY BOOK

Tells how we help you plan and install. From rough sketch or description we supply working plans and clear instructions. We loan the tools needed. Any handy man can install. This is the place to buy on money-back guaranty. Plumbing Outfits and Supplies; Water Systems; Hot-Air, Water or Steam Heating Plants; Radiators, Pipes, Boilers or Septic Disposal Tanks.

Send 25c for Yours Today

We have spared no effort or expense to complete this remarkable and instructive book. To keep from sending it broadcast to disinterested persons, we request a deposit of 25c, which will be refunded on your first order—or send for our FREE Bulletin. Write today and save half.



Pipeless Furnace

HARDIN-LAVIN CO.

50 Years
at 4547-57
Cottage Grove Ave.,
CHICAGO



Bathroom Outfit



THE 1923 New OLIVER SPEEDSTER

Send for 1923 Oliver Catalog Showing New Standard three bank Keyboard. The Oliver Typewriter Co., Dept. 1091, Chicago



MOTORISTS SEND FOR THIS FREE REPAIR BOOK

Tells how to make dozens of motor and household repairs easily, quickly and economically.

Write for this book and learn how

SMOOTH-ON CEMENT No. 1

can save you many dollars. Sold by Hardware and General Stores in 6-oz. tins 30c (by mail, add 6c); also in 1-lb., 5-lb., and larger sizes.

SMOOTH-ON MFG. CO.
Dept. 37 JERSEY CITY, N. J.

SMOOTH-ON IRON CEMENT



A Post Card Will Do!

\$5000 to \$20000 a Week

Earned by Simpson Salesmen

You Have The Same Fine Opportunity

Simpson has presented the opportunity to earn big money to hundreds of men and now offers the same opportunity to you, the same glorious chance that freed Fred Kinyon from the drudgery of an office and doubled his earnings; the same chance that enabled E. C. Pack, William Garden, J. C. DeLonge, V. W. Lee, Morris Hart and many others to earn more than they ever made as owners and operators of retail stores; the same glorious chance that enabled J. Sullivan to leave a position he had held for 14 years and doubled his income overnight; the same chance that has brought happiness, contentment and prosperity to Geo. McCarter, Geo. Glick, E. A. Gignon, J. F. Schmitz, E. L. Drigs, Ernest Carlsen and scores of others.

J. B. Simpson, Inc., is one of America's largest tailoring concerns. We manufacture and sell direct to the wearer, through our own sales force, virgin wool tailored to order suits and overcoats. This direct way of selling eliminates all unnecessary in-between costs; and combined with our ability to manufacture in tremendous volume at low cost enables us to make and sell a wonderfully good suit of virgin wool cloth, style, fit and satisfaction guaranteed, at the surprisingly low price of \$31.50.

The work we offer you does not require previous tailoring or selling experience. Mr. Lee, whose picture you see here, worked for an export firm. Mr. DeLonge was a ladies' tailor for 30 years making high priced clothes for the elite of the middle west. Mr. Garden was a successful merchant for many years, but he likes his present occupation much better. Mr. Glick worked in a retail store for 8 years. Harry French was a division head in a mail order house for 14 years. A. Anderson was an engineer for 15 years. Sprake, now a branch manager for us, was a stock salesman. Glover was an oil operator; Marten was a newspaper reporter; Leavitt was a soldier for 8 years; Kinyon was a school teacher; Urban came from the farm; Szarzinski is an exiled Russian nobleman, speaking 8 languages. They come from all fields of endeavor and all walks of life, from every state in the union, but they all have one thing in common—a burning ambition to do the things that are worth while and the ability to work without ringing a time clock.

This is not a proposition that should interest the man who is looking for something temporary. It's for the man who wants a permanent connection; for the man who believes in sticking to a good thing. Our policy is to win satisfied customers and through them create prosperous salesmen. We are interested only in salesmen who have a sincere desire to serve their customers and satisfy them, for only through service can anyone win a real worth while and permanent success. Mail the coupon below, or if you are located in any of the following cities, please call in person.



E. C. Pack



Geo. McCarter



F. W. Trantum



Wm. Garden



V. W. Lee



J. F. Schmitz

MINNEAPOLIS—1108 Nicollet Avenue.
DETROIT—1550 Broadway.

CHICAGO—843 West Adams Street.

NEW YORK—19 West 34th Street.
MILWAUKEE—114 Grand Avenue.

FREE INFORMATION COUPON

J. B. SIMPSON, Inc., Dept. 686, 843 W. Adams Street, Chicago, Illinois.

I would be glad to have you tell me more about the wonderful opportunity you have for salesmen.

Name.....

Street.....

Post Office..... State.....

Territory Wanted.....

We have sales representatives in a thousand communities. If you are not interested in becoming a salesman, but would like to see our samples of all wool suits and overcoats at \$31.50, put cross in square No obligation, of course.

NEW CHEAP FUEL

AGENTS Salesmen—Distributors

Here is the fastest selling agent's proposition ever known. Housewives all over America are eager to get this wonderful, simple invention which banishes forever the dirt and drudgery of coal and wood.

If you want to earn \$75 to \$150 a week as a part-time salesman or \$5,000 to \$12,000 a year as a district manager, write us at once. We still have some choice territory open. Now is the season for this nation-wide sensation. Write or wire for special sales plan and new low price offer.

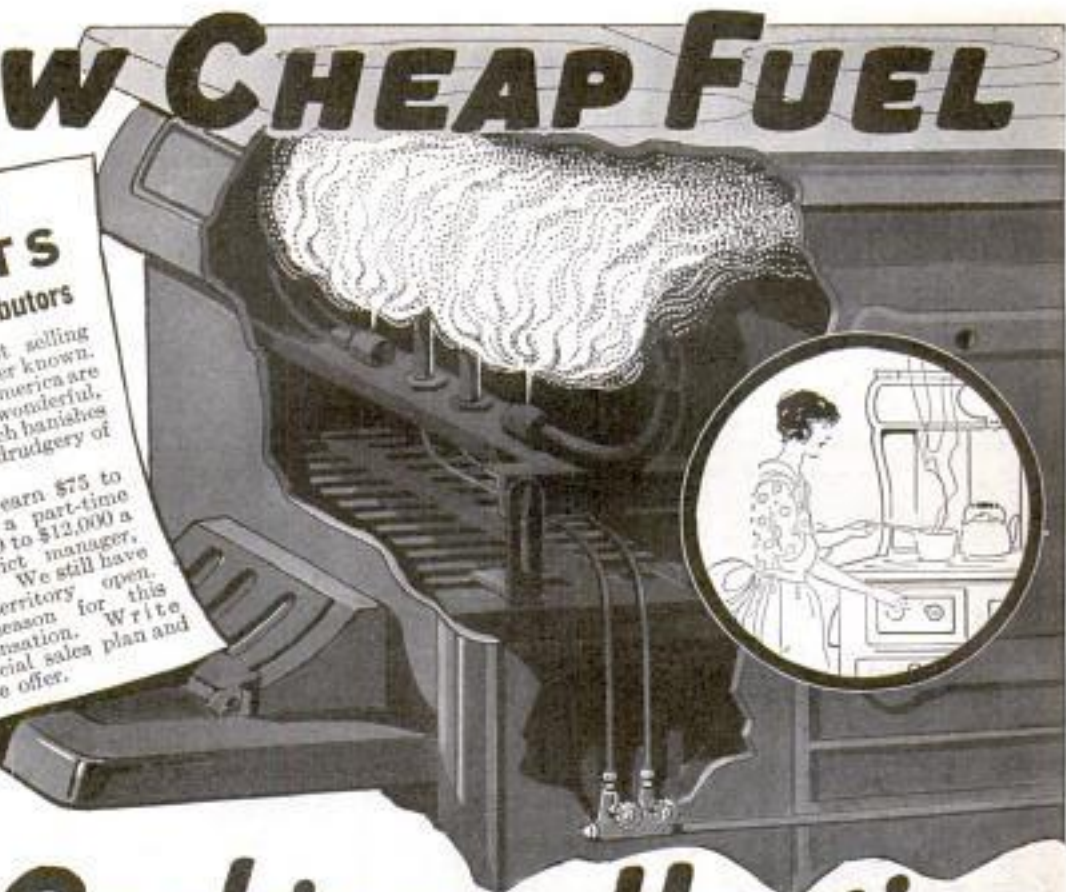

For Cooking and Heating

—Gives greater heat at less cost
—Does away with coal and wood

An amazing new scientific fuel—that is made right in your own cook stove or heating range—ends forever the dirt and drudgery of coal and wood. This marvelous new invention,

set into the fire box, converts any cook stove or range into a real gas stove—in a few minutes. All the heat you want for cooking and heating at the simple turn of a valve. No fire to build, no coal to buy, no wood to chop, no ashes to carry out or litter your floors and scatter dust over the whole house. No shivering in winter—no sweltering in summer.

Cheapest and Best Fuel Known

This wonderful invention, which gives far more heat

than either coal or wood, burns a scientific gas composed of 96% air and 4% coal oil (kerosene, the cheapest and hottest fuel known). The result is a steady, even, clean fire as hot or as low as you want.

Just Turn a Valve

Never before anything like this new device called the "Gas-Fire" Burner. A "Gas-Fire" actually makes your old stove a gas stove. Real gas burners—no wicks—no smoke or odor, for all the gas is consumed. A simple valve puts the heat at your control, and controlled heat is the secret of perfect cooking, baking, and roasting.

Fits Any Stove or Range

No holes to drill. No injury at all to your stove. Nothing to do but set this simple device into the fire-box and you have a wonderful new gas range. Lasts a lifetime. No mechanical or moving parts to break or get out of order. Absolutely safe.

Send for Free Book

Write quick! The "Gas-Fire" Burner is a nation-wide sensation. Thousands of housewives and home owners proclaim it the greatest invention of the age. Send for free book and special low introductory price offer. No obligation. Mail coupon now!

30 Days' Free Trial!

The "Gas-Fire" Burner will give you a gas stove as efficient as any city-home one—but we don't ask you to accept our word for it. Try it in your own stove or heater 30 days free. See for yourself what a wonderful labor and time saving device it really is.

THE HEAT APPLIANCE CORP.
110 N. May Street CHICAGO, ILL.

Why Gas-Fire Is Better Than Coal or Wood

1 Because Gas-Fire is a scientific fuel made right in your own cook stove, range or furnace from the most efficient and cheapest fuel known—kerosene.

2 Because Gas-Fire creates a steady, non-carbon flame of intense heat from a vapor mixture of only 4% kerosene and 96% air. It is the only device that really makes a gas, and burns this gas as cleanly and silently as a city-gas stove.

3 Because Gas-Fire operates from three to four hours on one gallon of kerosene, making (according to U. S. Government tests) heat units equal to 500 feet of city gas, or 100 lbs. of the finest coal.

4 Because Gas-Fire, although scientific in principle, is extremely simple—with no mechanical parts to get out of order—no wicks to trim or replace—no chimney to clean daily—nothing to burn out or break.

5 Because Gas-Fire is equally efficient Summer and Winter. Its heat can be regulated to perfection for any and all cooking, baking or heating.



THE HEAT APPLIANCE CORP.,
110 N. May Street, Chicago, Ill.

Please send me free your beautifully illustrated and special 30 Day Free Trial Plan.

I am interested in a Gas-Fire Burner for a

- Cook Stove Heating Stove
 Check here if interested in unusual agent's proposition.

Name.....

Address.....

City.....State.....

Copy this Sketch



and Get This Rule

FREE

and I also will tell you how you can get a

\$90 Drafting Course FREE

Make a copy of the sketch above. Send it to me at once and I will mail you free and prepaid the Draftsman's Ivorine Pocket Rule. I will also send you an offer I am making whereby you may have an opportunity of getting without any expense to you a \$90 Drafting Course. The only condition of this offer is that you must tell me your age. I am making this offer to find young men interested in drafting. Now is the time to learn drafting as thousands of draftsmen are in demand at big salaries. I will train you to become a draftsman and designer in a short time by my own personal method of giving regular, practical drafting-room work. You remain right at home.

Salaries up to \$250 and \$300 a Month

I don't give you just a "course in drafting" and then let you shift for yourself. I guarantee to train you until you are placed in a position paying you a salary of at least \$250 a month. I can make this guarantee because I limit and select my students. I know that the men I take as students if they will follow my practical instruction, are certain to land a big money-earning job. So, write to me today. Whether you copy the sketch or not send for my free book anyway.



FREE This Draftsman's Working Outfit

These are regular working instruments—the kind I use myself. I give them free to you if you enroll at once. Don't delay. Send coupon, postcard or letter for my free book.

Write Today!

The coupon shown below or a postcard or letter will bring my book telling you all about the career of a draftsman and all about other very exceptional offers I am making, such as, for instance, a fine folding drafting table which I am giving now to all my students. Write at once. Use this coupon, or send postcard or letter.

Chief Draftsman Engineer's Equipment Co.
1951 LAWRENCE AVE. DIV. 93-51 CHICAGO, ILL.

Chief Draftsman Engineer's Equipment Co.
1951 LAWRENCE AVE. DIV. 93-51 CHICAGO, ILL.

Without any obligation whatsoever, please mail your book, "Successful Draftsmanship", and full particulars of your liberal "Personal Instruction" offer to few students.

Name.....

Address.....

Age.....

**FREE**

Book on Wood Finishing

Gives complete instructions for finishing all wood—hard or soft—old or new. Explains just what materials to use and how to apply them. This book is the work of experts—illustrated in color. Contains a hundred wood finishing hints.

Tells how inexpensive soft woods may be finished so they are as beautiful as hard wood. Includes color charts—gives covering capacities, etc. Contains many practical suggestions on making your home more artistic, cheery and inviting.

Johnson's Wood Dye

S. C. JOHNSON & SON, Dept. PA1, Racine, Wis.

Please send me, free and postpaid, your instruction Book on Wood Finishing and Home Beautifying.

Name.....

Address.....

City & State.....

Dealer's Name.....

Johnson's Wood Dye is for the artistic coloring of all wood. It is very easy to apply—dries in four hours and will not rub off or smudge—penetrates deeply bringing out the beauty of the grain. Made in fourteen popular shades all of which may be easily lightened, darkened or intermixed.

S. C. JOHNSON & SON, Racine, Wis.

"The Wood Finishing Authorities"

(Canadian Factory—Brantford)

DON'T BURN COAL!

Amazing Invention. Does a way with Dirty Coal and Wood in any Stove or Furnace. No more smoke, no ashes, no soot.



Be comfortable this winter with this new kind of heat—3 Times Heat of Coal! Makes any home warm and cozy in coldest zero weather.

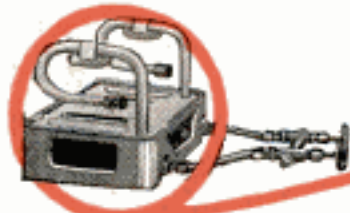

New Kind of Fuel—at a Price You Can Afford!

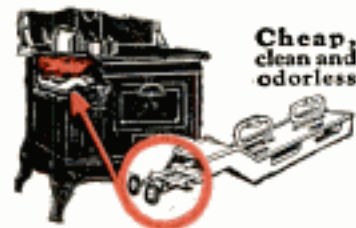

Cheap, clean and odorless

16 models fit any type of Hot Water, Hot Air or Steam Furnace; fit any type of coal or wood Heater or Cook Stove.



No more fires to build, bank or watch—no more dirty, heavy coal to carry and lift—no more clouds of ashes to breathe, or back-breaking scuttles to empty—no more worries about coal shortages, poor quality or high prices since this wonderful new invention. Here is the amazing new kind of heat that has ended forever the days of women's slavery to household drudgery. The wonderful invention of Mr. Oliver of St. Louis in one minute turns any coal or wood burner into a modern, up-to-date gas stove. It gives as much or little heat as wanted by simply turning a valve!

Cheaper Than Coal or Wood

Mr. Oliver calls his invention the Oliver Oil-Gas Burner, because it uses 95% air and only 5% oil, the cheapest fuel there is, turning them into an actual gas that burns with an intensely hot, clean flame. No wicks, no smoke, no odor.

16 Models to Fit Any Stove or Furnace

Made in 16 different models to fit any kind of cook stove, heating stove or steam, hot water or hot air furnace. No noisy motors, no gas or electrical connections, no moving parts, and installation can be made with no changes whatever. You can absolutely depend upon your Oliver to heat your home in coldest zero weather—it gives three times the heat of coal or wood. Cheap—foolproof—absolutely safe—lasts a lifetime—over 150,000 now in use! No wonder housewives are clamoring for this wonderful new device. Mrs. W. N. Spencer of Connecticut writes: "The Oliver in my heating stove works like magic. It is wonderful to have quick heat and no work." Mrs. Geo. Flynn of Michigan writes: "It is cleaner,

cheaper, hotter and steadier than coal or wood. Only cost me \$5.00 for two months."

Low Introductory Price

Now, once and for all time do away with household dirt and drudgery. Send immediately for the FREE ATTRACTIVE BOOKLET, "New Kind of Heat," telling all about this amazing new invention. Shows exactly how it works, how it is different from all other burners, how it will relieve you of the work of coal and wood fires.

Mail Coupon for Big Offer

If you mail the coupon at once you will be in time to receive Mr. Oliver's very low introductory price. But to get this low price you must write at once. Get your Oliver installed immediately. Mail the coupon now.

OLIVER OIL-GAS BURNER

OLIVER OIL-GAS BURNER COMPANY
A-50 Oliver Bldg. St. Louis, Mo.
Oldest and Largest Manufacturers of Oil-Gas Burners in the World
Canadian Distributors
A-55 Oliver Bldg. Toronto, Ont.

Oliver Oil-Gas Burner Co.,
A-56 Oliver Bldg., St. Louis, Mo.

Send me your FREE Book, "New Kind of Heat," and special Low Price Introductory Offer. I am interested in a burner for a
 Coal Heating Furnace
 Range Stove (Specify steam hot air or hot water)

Name.....

Address.....

City..... State.....

AGENTS AND DISTRIBUTORS

Here is your opportunity to cash in on the big money opportunity that this amazing invention is bringing to agents and spare time workers in every part of the country. People are clamoring for this burner. You have two or three hours of spare time every day that could easily be turned into real money.
F. W. Bentley of Philadelphia made \$215 in one day. J. Carney of S. Dakota, writes: "Making \$1000 a month." A. M. Russell, Conn., averaged \$600 the last six months. Mrs. Solder, Kansas, made \$100 a month in her home.
If you want to earn \$50 to \$100 a week in your spare time write to me at once for full details of my exclusive territory and Free Sample Case Offer. Address me personally, Mr. B. M. Oliver, at address given opposite.



Guaranteed for Life

Wonderful 32-Piece Aluminum Set consists of 2 Bread Pans; Doughnut Cutter; 2 Loaf Bottom Jelly Cake Pans; Combination Tea-Kettle and Rice Boiler with lid; Saucepan Set with lid; Dipper; Colander; Measuring Cup; Percolator; 2 Pie Pans; Complete Caster Set; Tea or Coffee Strainer; Fry Pan; also color set of 5 pieces—makes 11 utensil combinations: Preserving Kettle; Convex Kettle; Combination Cooker; Casserole; Padding Pan; Tubed Cake Pan; Colander; Roaster; Oven Popper; Steamer Set; Double Boiler.



FREE 10-Piece White Enameled Kitchen Set

No Money Down!

Just mail the coupon and we send this 32-Piece Aluminum Cooking Set, and the 10-Piece Kitchen Set Free. When the goods arrive, pay only \$2.00 and small postage charges on the Aluminum Set. Nothing for the Kitchen Set—it is FREE. Use both sets 30 days on Free Trial and if not satisfied send them back and we will refund your money and pay transportation both ways. If you keep them, pay for Aluminum Set, a little every month.



FREE Bargain Catalog and FREE GIFTS
This great 316-page book offers the world's greatest bargains in home furnishings, jewelry and farm machinery—all sold on easy monthly payment terms and 30 days' free trial on everything.

Wonderful Gifts
Catalog explains how you can get: Glassware, Silverware, Tablecloths, Napkins, etc., free with purchases. Send today. "Let Hartman Feather YOUR Nest!"

Complete 32-Pc. Aluminum Set and FREE Kitchen Set

Hartman's special, selected set of heavy gauge Aluminum Ware—a complete cooking outfit, light to handle, easy to clean, always bright as silver. Will never chip, crack or rust. We guarantee it for life. 32 utensils—everything for baking, boiling, roasting, frying. And—absolutely free—a Combination Kitchen Set, 10 utensils with pretty white handles.

Nearly a Year to Pay

You pay only \$2.00 and postage on arrival (on the Aluminum Set—not a penny to pay at any time on the Kitchen Set). The balance a little every month.

Order by No. 417EEM7. Price for Aluminum Set, \$18.95. No money down. \$2 and postage on arrival. Balance \$2 monthly. 10-Pc. Kitchen Set Free

FREE 10-PIECE KITCHEN SET

Not a penny to pay for this set. You get it absolutely free with Aluminum Set.
 Potato Masher
 Mixing Spoon
 Measuring Spoon
 Ice Pick
 Egg and Cream Beater
 Can Opener
 Vegetable and Pan Brush
 Fork
 Egg and Cake Turner
 Wall Rack
 All have white enameled handles and hang on wall rack, keeping them conveniently at hand.

HARTMAN FURNITURE & CARPET CO. Dept. 5853 Chicago, Ill.

Send the 32-Piece Aluminum Cooking Set No. 417EEM7, Price \$18.95, and 10-Piece Kitchen Set. Will pay \$2 and postage on the Aluminum Set on arrival. Kitchen Set is FREE. I am to have 30 days' free trial. If not satisfied, I will ship both sets back. If I keep them, I will pay you \$2 monthly until the price of the Aluminum Set, \$18.95, is paid. Title remains with you until final payment is made.

Name.....
 Occupation.....
 R. F. D., Box No.
 or Street and No.
 Post Office..... State.....
 If shipping point is different from your post office, fill in line below
 Send shipment to.....

HARTMAN FURNITURE & CARPET CO.
 Dept. 5853 Copyright, 1923, by Hartman's, Chicago CHICAGO, ILL.