

DECEMBER

25 CENTS

POPULAR MECHANICS

MAGAZINE

WITH WHICH IS INCORPORATED THE ILLUSTRATED WORLD

WRITTEN SO YOU CAN UNDERSTAND IT

REG'D. TRADE MARK. GREAT BRITAIN. No. 410426

REG. U. S. PAT. OFF.



SEE PAGE 850

Copyrighted material

Takes Only 60 Days to Get a Big Job

Automobile Tractor & Electrical Catalog

FREE



My Cincinnati School



I'll pay your railroad fare both ways, and pay your board and room; no extras; no incidentals—in 10 weeks you can get a real job at real pay.

My Chicago School



No Experience, no Education Necessary. You Learn with your Hands under Experts in a Wonderful Shop. No Books. Success Sure.

RAHE-TRAINED MEN IN DEMAND

Rahe-Trained men earn \$200 to \$600 per month—no lay-offs or strikes. You Can Do It, Too. Own Your Own Garage. Send the coupon NOW for my Big Free Catalog.

YOU CAN DO WHAT THESE RAHE MEN DID

"My garage is a big success. I owe it to Rahe training."

—G. Smith, W. Alexandria, O.

"I got a fine job the day after I left school."

—W. C. Wyatt, Mt. Sterling, Ky.

"I thank Rahe training for a great job in the best garage in Lima."

—Howard Metzger, Lima, Ohio.

"Rahe Training was the best investment I ever made."

—Colby Lord, Oakland, Maine.

BE AN EXPERT IN—

Auto and Tractor Mechanics, Ignition, Starting, Lighting, Vulcanizing and Machine Shop Work. Takes only 60 Days.

ELECTRICAL COURSE INCLUDED

All kinds of wiring and generator work. All this in addition to the famous RAHE Life Scholarship, which permits you to return to the school AT ANY TIME for further work WITHOUT COST.

SPECIAL TUITION OFFER—Short Time Only

*Send to My Nearest School for
Free Catalog*

Rahe Auto, Tractor & Electrical **School**

4445 Grand Boulevard
CHICAGO, ILLINOIS

Ninth and Walnut Sts.
CINCINNATI, OHIO

Desk 890
SEND ME YOUR BIG FREE CATALOG

Name _____

Address _____

City or R.R. _____

(No facilities for colored students)



Copy This Drawing Table — Get It FREE

On My Offer to Students

Any one sending in a sketch of the drawing of draftsman's table shown here, will receive free and postpaid an Ivorine draftsman's pocket rule. Be sure to state your age.

Complete Draftsman's Outfit Also FREE

These are the regular working instruments—the kind I use myself. The same kind that you will use when you have completed my course and have become a regular draftsman. Its value is \$25.00. I give them free if you enroll at once. This outfit includes Nickel Silver drawing instruments, drawing board, T square, triangles, French curve, ink, ruler, pencil, besides the free draftsman's table. Send in the coupon for information.

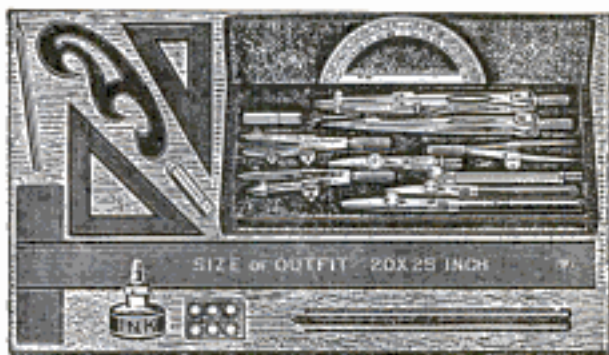

Salaries Up to \$250 to \$300 a Month

\$90 Drafting Course Given Away!

To every student enrolling now I give an opportunity of getting a \$90 drafting course absolutely without cost to him. Even if you don't send in a sketch send in the coupon today and learn all about this offer.

FREE this
Rule for
Sending
Coupon at Once

and also 6 x 9 Book on "Successful Draftsmanship". Act quick.

Chief Draftsman, Engineers' Equipment Co.
1951 Lawrence Ave., Div. 93-59 Chicago, Ill.

Positions paying up to \$250 and \$300 per month which ought to be filled by skilled draftsmen are vacant everywhere. There are in every part of this country ambitious men, who with practical training and personal assistance will be qualified to fill the positions. I can now take and train a limited number of students personally and I will give to those students a guarantee to train them by mail UNTIL placed in a permanent position at a salary up to \$250 and \$300 per month.

Chief Draftsman, Engineers' Equipment Co.
1951 Lawrence Ave., Div. 93-59 Chicago, Ill.

Without any obligation to me please mail your book "Successful Draftsmanship" and full particulars of your liberal "Personal Training" offer to a few students. Also full information as to how I can get a \$90 Drafting Course Free. Send Ruler to me FREE.

Name.....

Address.....

City..... Age.....

*“Stop Depreciation BEFORE IT BEGINS—
BUILD WITH CYPRESS AT FIRST!”*

Tide Water
Cypress
“The Wood Eternal”

“is the World’s Standard Specialty Wood for its particular uses—not merely an alternative commodity.”

We recommend Cypress only where it is best for you. Builders and prospective builders will be intensely interested in the following excerpts from the U. S. Government Report on Cypress—Bulletin 95, Department of Agriculture, Forest Service:

“CYPRESS is put to almost every use as an interior trim for houses natural color or stained contains little resin thus affords a GOOD SURFACE FOR PAINT, WHICH IT HOLDS WELL popular for kitchens, where it is subjected to dampness and heat *shrinks, swells or warps but little* For the parts of houses exposed to the weather it serves equally well. AS SIDING IT PRACTICALLY WEARS OUT BEFORE IT DECAYS made into porch columns it retains its shape, *holds paint*, and has sufficient strength It is placed as cornice, gutters, blinds and railing, and *is much used for Porch Floors and Steps* Much CYPRESS lumber is employed in the construction of SILOS The FARMER puts the wood to many uses ITS LASTING PROPERTIES FIT IT WELL for curbs *Resistance to decay* fits it for stable floors and timbers near the ground, as well as for gates, especially for fence posts one of the best available woods for picket fences, because it *shows paint well* and holds it for many years, *but lasts a long time without it* widely used for this purpose It is PRE-EMINENTLY FITTED for *greenhouse construction* where it is called upon to *resist dampness, excessive heat, and all the elements that hasten decay* sash, frames, benches, boxes, and practically all else the builder needs” (etc).

(You know the conservatism of Government Reports)

When planning a Mansion, a Bungalow, a Barn, a Garage, or just a Pasture Fence, remember—

“With CYPRESS You BUILD BUT ONCE”

SOUTHERN CYPRESS MANUFACTURERS' ASSOCIATION
1219 POYDRAS BLDG., NEW ORLEANS, LA., or 1219 GRAHAM BLDG., JACKSONVILLE, FLA.

INSIST ON TRADE-MARKED CYPRESS AT YOUR LOCAL LUMBER DEALER'S. IF HE HASN'T IT, LET US KNOW IMMEDIATELY.



Popular Mechanics Magazine

200 E. Ontario Street, Chicago, U. S. A.

H. H. WINDSOR, Editor

London: Hachette & Co.,
16-17 King William Street, Charing Cross, W. C. 2

Paris: Hachette & Co.,
111 Rue Reaumur

Melbourne, Australia
The Australasian News Co.

ISSUED MONTHLY

SUBSCRIPTION:

SINGLE COPY, 25 CENTS

In United States and its possessions, also Canada, Cuba, and Mexico, per year, postpaid . . . \$3.00

To all other countries in the Postal Union 3.50

All subscriptions are discontinued at expiration. Please examine the date printed on your wrapper.

Entered as Second Class Matter Sept. 15, 1903, at the Post Office at Chicago, Illinois, under Act of March 3rd, 1879.

Entered as Second Class Matter at the Post Office Department, Canada.

Published monthly by POPULAR MECHANICS CO.

Copyright, 1923, by H. H. WINDSOR. Copyright in Australia

Vol. 40

Contents for December, 1923

No. 6

Accidents—Safety First Signs	870	Drill and Reamer, Center, Has Inserted Blade	939
Acetylene Torch Resembles Revolver	844	Dynamite Blast, Hillside Shattered by	905
Ads. Revolving Stamp Prints on Wrapping Paper	921	Earth, Globe of, Carved from Solid Rock	893
Airplane Pilots, Testing the Endurance of	928	Earthquakes, Trail of Future, Traced	826
Airplane, Round-the-World Trip by	820	Earth's Inner Turmoil Moves High Peaks of Surface	860
Airplanes and Pilots that Reached the "Port of Missing Men"	890	Eggs of Stone Age Reptile Found	894
Airplanes, Secret Ray Damages	931	Electricity from Windmill Takes Place of Coal	833
Airship Metal Like Willow, Yet Strong as Steel	856	Electricity Made by Water Power	848
Airway Lighted over Atlantic Is Predicted	855	Elephant, Hunters Capture Herd Alive	894
Alligator Acts as Go-Devil	846	Elephants, Logging, for Canadian Forests	846
Ambergris, Gold of the Sea, May Have Chemical Rival	829	Engine, Electric, Burns Ashes for Motive Power	853
Animals, Tiny, Build Coral Islands	902	Ferry, Electric, Run by "Motorman"	857
Antelope Small as Rabbit	898	Fire Departments in Japan, Modern	898
Art Studio, Stone Age, Discovered	843	Fire Engine, Small, Operated by Gas Motor	937
Automobile Carries Tire, Tools, and Camping Outfit in Case	913	Fish Eggs Shipped in Ice, Hatched in Glass Tubes	830
Automobile Lock Alarm, Whistling, Prevents Theft	928	Fish, Metal, with a Rudder Made to Thrill Angler	864
Automobile, Safety Roof for	889	Fishing, Human Tarpon, Popular Water Sport	888
Automobile, Trap to Catch Thief in	893	Flashlight, Water Poured in, Starts Battery Action	860
Automobile Wheel, Balloon Tires on, Absorb Shocks	883	Flowers, Artificial, Tiny Electric Lights Concealed in	927
Automobile with Wheels Like Eggs	861	Flowers, Glass, Rival Nature's Wonders	899
Automobiles "Float" over Bumps on Blocks of Rubber	884	Fryer, Double, Forms Cup of Shredded Potatoes	910
Automobiles, Maze of Walls Slow at Railroad Station	820	Fuel, Waste "Liquor" of Pulp Mill Turned into	885
Automobiles Stored on Sliding Shelf in Garage	927	Gear, Automatic, to Replace Clutch on Autos	824
Automobiles, Used, How "Pepped" for Service	817	Gear Shaper Cutter Generates Threads	938
Bees, Color-Blind, Must Learn by Experience	831	Geysers, Icelanders Obtain Power and Heat from	932
Bell Wire, Invisible, Hidden Under Paper on Walls	885	Glass Cut on Two Sides to Reduce Waste	833
Bird, Condor, Passing from Lofty Home	883	Glass for Goggles, Iron Weight Cannot Break	864
Birds, Rare, Get Flight Space in Lofty Cage	832	Glass for Telephone Signal Lights	913
Boat, Adventurer Crosses Ocean in Ten Ton	916	Glove, Letters in, Enable Deaf and Dumb to "Talk"	848
Brushes, Toilet, Fold into Backs	932	Gold Dust on Floors, Mining	822
Bugs, Singing, Caged as Pets	896	Golf Balls, Process for, Guarded as Secret	833
Camels Take Horses' Place on Russian Farms	905	Golf Tees, Wood Pins for, Keep Hands Clean	825
Camera Men Risk Their Lives in "Shooting" Pictures	904	Greyhound, Speed Demon of Animal Kingdom	860
Can Opener, Spikes in Top of Pitcher Serve as	927	Hair Nets Handmade, Too Fine for Machine	913
Candles, Dried Fish Used as	931	Haircloth Is Thing of Past	917
Candles Made by Millions	914	Hammer, Electric, Has One Moving Part	925
Cannon, Sun's Rays Make Alarm Clock of	917	Hay Fever Cure from Weed	932
Carbon Paper on Typewriter Rolls on from Rack	830	Heat, "Canned Sunshine" for, to Aid Fuel Problem	831
Carpet Saves Ball Park from Flying Hoofs	930	Hemlock, Giant, Sanctuary Tenement for Birds	841
Cartoon Face, Armful of Junk Formed into	910	Horn Fifteen Feet Long Carved from Tree Limb	931
Cheese Was Popular Tidbit Among Early Peoples	930	Horse Hospital Has Operating Table	897
Children at Play "Hobbled" for Safety	825	Horse, Race, Rides in Special Automobile	821
City, Buried, in Dry Basin of Oregon Lake	895	Horses Leap River Forming Barrier in Race	861
Clock, Square, Marks Time by Sliding Down Holder	830	Hyacinths "Eaten" by Boat Turned into Paper	848
Cloth Made from Hemp Bark	846	Hydrangea Bloom, Color Scheme of, Solved	921
Cloth, Whirling Brush and Vacuum Take Dirt from	920	Ice Forms in Mines During Hot Weather	882
Coach, Royal, Is Gold-Plated	896	Ice, Million Spent Daily on, in United States	885
Coal Yields Smokeless Fuel, Gasoline, and Chemicals	864	Laboratory Still, Experimental Work Aided by	940
Colander Cleans Fruit without Shaking	932	Ladder, Three in One, Avoids Accidents	833
Combination Square Has Unusual Features	939	Lenses, First Twelve Inch Made in United States	916
Cooker on Radiator of Automobile	840	Lettering Pen, Guide for, Gives Skill to Novice	849
Corn Popper, Hand Crank on, Does Away with Shaking	937	Leviathan of Inland Waters Launched	856
Cornstalks Made into Sirup	902	Library in Park Lends Visitors Books	821
Coupling, Compact Flexible, Is Durable and Quiet	938	Light Clamped to Finger Aids Worker at Night	831
Cross of Sunshine and Cloud Give United States Wealth	832	Light Rays Cure for Burns and Skin Disease	846
Cutter, Metal Potato	841	Lighthouse, Net Built About, to Keep Off Birds	897
Deer, Volcanic Ash Kills	913	Liquids, Crank Driven Machine for Mixing	897
Diamonds, Searching for	887	Lumber, Artificial, of Hemp	840
Dreadnaught, Growth of U. S. Navy Halts with Big	844	Magnifying Glass, Light in, for Outdoor Night Work	844
Drier, Clothes, Attached to Radiator	849	Man, Wild, of Borneo as He Is Today	862
Drier, Hair, with Six Blowers	925	Mangle, Clothes, Built in Wall	883
		Mankind, Cradle of, May Lie Underneath Desert	830
		Marathon Run over Crater of Old Volcano	931
		Marble, Quarrying Carrara	923
		Mars to Approach the Earth	916

[Continued on Page 4]

This One



P1PH-67X-2F7N

*Index copy
2nd printing
#69*

[Contents—Continued]

Matches, World Uses Five Billion Daily 910
 Meteor Caught by Camera in Flight Across Sky 905
 Mexico, with Death at the Throttle in 834
 Model, Railway Track, Shows How to Avoid Wrecks 933
 Models, Toy, Found Useful 934
 Money, Fish Serve as, in Labrador 889
 Money, Two Dollar Note Is Victim of Superstition 856
 Motion Picture Camera Lies, How the 878
 Motorcycle on Speed Track Leaps Human Hurdle 853
 Mud, Hunters Use Skis and Boards to Walk over 909
 Natives, Stone Age Island, Paint Selves Yellow 933
 Nuts, Small, Cracked by Iron Fingers 937
 Oranges Gilded by Science 904
 Oil Boom in West Recalls Memory of Gold Rush 937
 Oil Waste, Automobile, to Help Solve Heating Problem 912
 Painting Wonders to Be Found under Sea 902
 Palace, Flood of Lights Covers 884
 Palace, Modern, on Roof Top 920
 Peat Bogs Furnish Rival to Coal as Power Fuel 843
 Pencil and Lighter Combined 894
 Phonograph, Beggar Plays, Instead of Hand Organ 889
 Photographic Guns of Navy Shoot at Sun's Eclipse 910
 Pipe, Copper, Relic of Ancient Plumber 928
 Popular Mechanics Records of 20 Years Ago 859
 Presser for Trousers 912
 Pump, One Man, Made to Combat Forest Fires 843
 Punch, Vise, Has Powerful Leverage 939
 Puzzle Page 929
 Rabbits Herded Like Cattle 857
 Race that Made Boomerangs Passing Away 882
 Races, Secrets of Long Lost, Sought in Ruins 865
 Radio Code Taught to Sleeping Students 917
 Radio, Color Picture Sent by, "Painted" on Receiver 925
 Radio Outfits, Rheostat to Fit All Tubes for 927
 Radio Receiver Held on Ear without Head Briddles 861
 Radium, Drop in Price 931
 Rail, Gold, from Spot Where President Harding Spoke 841
 Rings, Fruit Jar, Have Small Handles 883
 Rodents, Rabbit Like Ghost and Mouse with Pouch 884
 Roof on Depot, Glass, Like Futurist Painting 912
 Rubbers, Religion and Climate Cause Market for 932
 Scale Folds Against Wall When Not in Use 933
 Scrub Board, Small, Fits over Hand 882
 Sea, Superstitions of, Defy Age of Reason 851
 Sealing Tape, Ads Printed on as It Is Unwound 821
 Shelf Replaces Hammock in Pullman "Upper" 900
 Ship, Frame Built on Hull to Right 847
 Sidewalk, Second Story, May Aid Chicago's Crowd 849
 Silkworm Culture in United States 906
 Smokestack Is Snuffer for Well Fire, Rifle as Saw 825
 Spade, Motor Driven, Replaces Plow 929
 Stamp Holder Locked, Stops Theft and Saves Time 920
 Stamps, Forests Turned into 889
 Steel Bar, Pencil's Weight Bends, Detector Finds 857
 Steel Mills, Eight Hour Day Gradually Put in Effect 843
 Stoker, Electric, Fire Fed by, that Puts Ashes in Can 820
 Stone Cutting Machine Effects Economy 940
 Sugar Cane Planting, Machine for 938
 Suit, Fireproof, Invented 833
 Teapot Conceals Spout and Handle in Body 844
 Telegraph, Musical Tone on, Is Faster than Clicks 883
 Thresher, Centrifugal, Latest for Farmer 940
 Timber Supply, Artificial "Wood" May Save Shrinking 831
 Tomb, King Tutankhamen's, to Be Reopened 928
 Torpedo, Winged, Added to U. S. Coast Defense 853
 Trout, Four Lake, Tip Scale at 200 Pounds 902
 Tugboat Tows Huge Liner Across Atlantic 898
 Turtles and Anglemorms Become "Farm Crops" 909
 Typewriter Brush Cleans All Characters at Once 888
 Typewriter Pages in Rolls Save Time in Changing 860
 Typewriters, Line Guide on, Run by Motor 820
 Universe, Milky Way Is "Yardstick" to Measure 893
 Vibrating Machine for Smoothing Concrete Roads 895
 Watch Carved Out of Wood 897
 Watch, Tickless, Minus Hands Takes Time from Sun 844
 Watch, Wrist, Can Be Worn as Ring or Lavalliere 921
 Waterway, Lake-to-Gulf, Nears Completion 824
 Weeds "Turned into Mutton" by Chance Discovery 825
 White House, Behind the Scenes at the 918
 Window, Combination Lock and Sash Holder for 937
 Window Shade, Adjustable, to Replace Awning 904
 Women of White Africans Rule Tribal Homes 921
 Woodworkers, India's, Spurn Saws and Lathes 840

Belt, Cleaning Oil Soaked 959
 Bit, Using Broken 945
 Blueprints, Restoring Overexposed 958
 Boots, Keeping Dirt from, when Excavating 959
 Cadmium Sticks, Protector for 957
 Cementing Glass to Metal, Method of 950
 Chute, Handy for Unloading Hogs 952
 Clamp for Woodwork Bench, Homemade 959
 Clover Seed Huller and Scarifier, Making 946
 Compasses, Improving Carpenters' 957
 Color, Pattern, Denotes Material 956
 Door, Guard over, Prevents Accidents 957
 Drill Rod, Centering Accurately 942
 Fiber, Drilling 953
 Fuses, Lamps Indicate Blown 951
 Gauge, Handy, for Machinists 949
 Glass Work, Chipped 954
 Grooves, Planing Deep, in Metals 959
 Hacksaw, Making a Bench 941
 Holder for Drafting Scale and Triangles 943
 Holder for Filling Coal Bags 945
 Holder, Simple Screw 949
 Iron Plate, Breaking off 945
 Ironing Machine, Mirror for 943
 Jig, Repairing Cracked 944
 Lamp, Storing an Extension 944
 Lumber, Roller for Handling 953
 Mangle Rolls, Guard for 949
 "Oxidizing" Copper and Brass 958
 Patternmakers, Lesson for 960
 Pin Setter, Easily Made 950
 Pinch Bar, Adjustable, Pulls Gib Keys 956
 Pipe Crimping, Tool for 949
 Punch and Chisel Set, Convenient 942
 Punch, Shear and Riveter, Combination 950
 Screw, Removing Counterbored 951
 Stand for Light Testing Work 952
 Studs and Bolts, Safety Cut in 943
 Stumps, Simple Method of Pulling 958
 Tags, Stamping, Quickly and Neatly 950
 Tile, Removing Paint from 945
 Tools, How to Clean 957
 Upholsterers, Trimming Spreader for 958

AMATEUR MECHANICS

Automobile, Tool Kit in Door of 978
 Battery Connections, Making Tight 977
 Bell Contacts from Sparking, Preventing 969
 Bridge, Strong and Simple 964
 Camera Tripod, Stepladder Extension for 972
 Carburetor, Draft Shield for 975
 Cellar Door, Concealed Counterweight for 975
 Chimney Caps, Zinc Makes Durable 962
 Covers, Milk Can, Tool for Removing 970
 Crib, Baby, Made from Barrel 977
 Curtain Lights, Narrow, Repairing 970
 Dams, Spillways for Miniature 976
 Engine, Heating Radiator Cools 963
 Fence, Ice Block, for Hockey Field 964
 Gear, Making Tight 977
 Gut Leaders, Straightening 977
 Hanger, Simple, for Portable Lamp 976
 Kettle, Holder for Faucet 963
 Lawn Mower Repair, Simple 978
 Lawn, Shaving the 969
 Marble Clocks, How to Repair 964
 Photographs, Two-Tone 972
 Pistol, How to Make an Arrow 976
 Plow, Six Horse Evener for 963
 Porch Steps, Portable Handrail for 977
 Pulley Made from Pan Lids 976
 Rack, Drying, for Stoves 969
 Rack, Simple, Negative 971
 Radio Storage Batteries, Care of 973
 Robe, Storing, in Roadster 971
 Sink, Cleaning the 964
 "Snow Box" for the Amateur Stage 961
 Sodium Carbonate, Test for 964
 Spring, Fan Belt, Coupling for 972
 Square, Cigar Box Used as 975
 Steel, Testing on Emery Wheels 978
 Stove, Exhaust Gas Cook, for Campers 970
 Ties, Saving 970
 Tire Repairs in the Home Garage 965
 U-Bolt, Replacing Tool 962
 Watch Crystal, Tightening Loose 970
 Water, Method of Conveying, Up Steep Incline 975
 Wedges, Keeping, from Rebounding 971
 Winder, Barbed Wire 971
 Wire Fence Stretcher, Homemade 969
 Wrench, Horseshoe, for Oil Barrels 963

SHOP NOTES

Air, Compressed, Preventing Waste of 944
 Angle Plates, Machining, on the Lathe 943
 Automobile Springs, Oiling 950
 Bar Stock, Bevel Cutting Tool for 952
 Barn, Novel Dairy 951
 Barometers, Rehling 948

DRAKE'S PRACTICAL MECHANICAL BOOKS

THEY WILL RAISE YOUR PAY— ORDER ON 5-DAY TRIAL

The books listed below will perfect you in your chosen trade — pave the way to the big positions. Written in non-technical language—easy to read and understand. *Every book covers its subject completely. An entire course of instruction condensed into one volume.* Your choice sent postpaid — you benefit 5 days — money refunded in full if not entirely satisfactory. Order direct from this page.

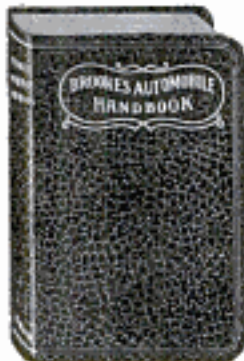

Automobile Books

- Automobile Ignition, by ManlyLeatherette \$2.00
Automobile Starting and Lighting, by Manly.....Leatherette \$2.00
Brookes' Automobile Handbook.....Leatherette \$2.00
Ford Motor Car, Truck and Tractor, by Manly.....Cloth \$1.50
Starting and Lighting Troubles, Remedies and Repairs, by ManlyLeatherette \$3.00
Automobile Battery, Care and Repair, by Manly.....Leatherette \$2.00
Automobile Catechism and Repair Manual.....Leatherette \$1.50
Tires and Vulcanizing, by TuffordCloth \$2.00
Gas and Oil Engine Handbook.....Cloth \$1.50
Automobile Upkeep and Care, by Manly.....Cloth \$1.50
Motorcycle Handbook, by ManlyCloth \$1.50

Shop Practice Books

- Sheet Metal Workers' Manual.....Leatherette \$2.00
Oxy-Acetylene Welding and CuttingCloth \$1.25
Slide Rule and Logarithmic TablesLeatherette \$2.00
Handbook for Millwrights.....Cloth \$2.00
Modern Blacksmithing.....Cloth \$1.25
Machine Shop Practice.....Cloth \$2.00

- Mechanical Drawing and Machine DesignCloth \$2.00
Pattern Making.....Cloth \$1.50

Carpentry Books

- Cloth Binding
Modern Carpentry, 2 vols.....\$3.00
The Steel Square, 2 vols.....\$3.00
Wooden Boat and Shipbuilding.....\$1.50
Modern Estimator\$1.50
Timber Framing\$2.00
Builder's Architectural Drawing.....\$2.00
Concrete\$1.50
Practical Bungalows\$1.00
Low Cost Homes.....\$1.00
Roof Framing, by Van Gasbeek.....\$1.50
Stair Building and Hand Railing\$1.50

Electrical Books

- Practical Applied Electricity....\$2.00
Alternating Current\$1.50
Electric Motor Control Systems.....\$1.50
Wiring Diagrams and Descriptions\$1.50
Electrical Tables and Data.....\$1.50
Armature and Magnet Winding.....\$1.50
Modern Electrical Construction...\$1.50
Modern Electric Illumination...\$1.50
Electricians' Operating and Testing\$1.50
Motion Picture Operation.....\$1.50
Drake's Electrical Dictionary...\$1.50
Electric Motors, D. & A.....\$1.50
Electrical Measurements and Meter Testing\$1.50
Drake's Telephone Handbook...\$1.50
Easy Experiments.....Cloth \$1.25
Wireless Telegraph and Telephone Handbook.....Cloth \$1.25
Telegraphy Self-Taught...Cloth \$1.25

Steam Engineering

- Swingle's Handbook for Steam Engineers and Electricians.....Leatherette \$4.00
Examination Questions and Answers for Marine and Stationary Engineers.....Leatherette \$2.00
Steam Boilers.....Leatherette \$2.00
Swingle's Catechism of Steam, Gas and Electrical EngineeringLeatherette \$1.50

Painting Books

- Scene Painting and Bulletin ArtCloth \$4.00
A Show at Sho' Cards.....Cloth \$4.00
Sign PaintingCloth \$4.00
Strong's Book of Designs.....Leatherette \$4.00
Strong's Art of Show Card WritingCloth \$4.00
Signist's Alphabets.....Cloth \$1.50
Modern Painter's Cyclopedia.....Cloth \$2.00
Automobile Painting.....Cloth \$1.50
Estimates, Costs and Profits, Painting and Decorating.....Cloth \$1.50
New Hardwood Finishing.....Cloth \$1.50
The Amateur Artist.....Cloth \$1.50
New StencilsCloth \$1.25
Chalk Talk and Crayon PresentationCloth \$1.25

Farm Books

- Farm Mechanics.....Cloth \$1.25
Farm Buildings.....Cloth \$1.25
Farm Engines.....Cloth \$1.25
Traction Farming.....Cloth \$1.50

Business and Reference Books

- Better Business Letters.....Cloth \$1.00
Better Business English.....Cloth \$1.00
Better Advertising.....Cloth \$1.00
Finger Prints SimplifiedCloth \$1.25
Practical BricklayingCloth \$1.25
Practical Instruction for DetectivesCloth \$1.00
Practical PlumbingCloth \$1.50
Hot Water Heating.....Cloth \$1.50
Elementary Chemistry.....Cloth \$1.50
Courses in Civil Service...Cloth \$1.50
Cyclopedia of Recipes...Cloth \$1.50
American Star Speaker...Cloth \$1.50

Modern Languages

- By Prof. P. S. Allen, U. of Chicago
French without a Teacher.....Cloth \$1.25
Spanish without a Teacher.....Cloth \$1.25
German without a Teacher.....Cloth \$1.25
Everyday French.....\$1.25
Everyday Spanish.....\$1.25

ORDER DIRECT FROM THIS PAGE—ON OUR MONEY-BACK PLAN

The books listed above are only a few of the many in our catalogue, which you will receive promptly after filling out and mailing us the attached coupon. For quick action order direct from this page—cross name of each book wanted and send in with price quoted. We prepay postage and send the books on our money-back plan.

FREDERICK J. DRAKE & CO.

PUBLISHERS

1008 Michigan Ave., Chicago
Drake Books Are For Sale at All Book Stores

FREDERICK J. DRAKE & CO.
1008 Michigan Avenue
Chicago, Ill.

GENTLEMEN:—Please send me free, postage paid, your illustrated catalogue which lists and describes over 100 Practical Mechanical Books for Home Study.

My name is

and my address

Mail Coupon For Free Catalogue
Your Guide to Home Study



Agents

"Ye Gods,
—some seller!
I made \$215 to-day"
—writes Bentley

Read what these Oliver agents say:

\$660 a month
"Have averaged \$660 profit a month for last six months."
A. M. Russell, Conn.

\$1000 in 4 weeks
"Am making \$1000 per month. I have made big money before, but did not expect so much. Your Burner is just the thing."
J. Carnegie, S. Dak.

Buys car with profit
"Have earned enough in one month to buy me a new auto."
E. W. Knappen, Cal.

Sells like beer in a dry town
"Am sending today for seven Oliver's. This is one day's orders (\$85 profit). Selling like beer in a dry town."
W. H. Drew, Mich.

\$43 in one evening
I made \$43 last night.
N. E. Cheban, Wash.

The Oliver Oil-Gas Burner

does away with coal and wood. Burns 95% air—5% oil. Turns any range, furnace or stove into a gas stove. 16 different models. Gives much or little heat by simply turning valve. Think of the appeal you can make in every community. Solves fuel problem. Cheaper than coal, wood or gas—absolutely safe. Does away with drudgery—no fires to make, no ashes, dirt, smoke, chopping, carrying coal and wood. Easy to install. Doesn't change stove. Protects health. Easy to demonstrate—slips in or out of stove in one minute. Show any woman what it will do right in her own home and sale is made. Big demand all year. Let the fuel shortage make you big money.

Big profit. Some Oliver agents earn as high as \$1000 per month. \$21 a day is easy.

Free Sample Case Offer
and book "New Kind of Heat"
Write for them now.

Oliver Oil-Gas Burner & Machine Co.

Oldest, largest Manufacturers
Oil-Gas Burners in the world.
2048-W Oliver Building
ST. LOUIS, MO.

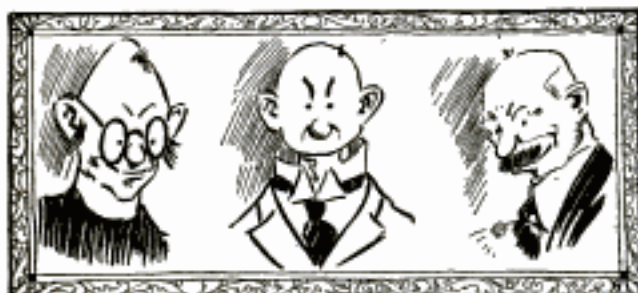

Learn to Draw at Home

Illustrators, Cartoonists, Commercial Artists earn big money. \$25 to \$100 a week and more. Learn at home in spare time under personal direction of one of America's most famous newspaper, magazine, advertising artists of 35 years' successful experience.

FREE COUPON

**WASHINGTON SCHOOL
OF ART, Inc.**

Room 3012, 1115-15th St.
N. W., Washington, D. C.

Send me particulars of FREE
ARTISTS' OUTFIT offer and
Free Book, "New and Easy Way
to Become an Artist."

Name.....
(State whether Mr., Mrs. or Miss)

Address.....

City..... State.....

BE AN ARTIST

Delightful, fascinating profession.
Wonderful new home study method
makes drawing easy! Send coupon
or postal today for special offer
telling of complete Artists' OUTFIT
FREE to new students. Write
for illustrated book, "How to
Become an Artist." Don't de-
lay—write or send coupon at
once. Address

**Washington School
of Art, Inc.**

Room 3012, 1115-15th St., N. W.
Washington, D. C.

STOP Making Mistakes In ENGLISH

Every time you speak or write you show just what you are. Mistakes in English reveal you as a person who lacks education and refinement. Lack of language power prevents you from presenting your thoughts in the strongest possible way. No matter what you do, real command of English will help you to your goal. Stop making mistakes in spelling, punctuation, pronunciation. Increase your vocabulary.

WONDERFUL INVENTION

Only 15 minutes a day with Sherwin Cody's New Invention — and you can actually SEE your English improve. It teaches by HABIT—makes it easier to do the RIGHT way. Wonderful self-correcting lessons include Spelling, Punctuation, Grammar, and Expression.



FREE BOOK ON ENGLISH AND 15 MINUTE TEST

Look of language power may easily be seen in you thousands of dollars every year. See what Mr. Cody can do for you; it costs nothing to find out. Mail a postal card or letter this very minute for free book, "How to Speak and Write Masterly English," and the 15 minute test, which you can take in your own home. It will prove a revelation to you. WRITE NOW. Address

Sherwin Cody School of English, 512 Searle Bldg., Rochester, N.Y.

BEA TRAFFIC MAN

Earn \$50 to \$150 Weekly

With the energetic revival of business activities, the demand for men trained to handle transportation problems is greater than ever before. Our highly specialized course prepares you for this high salaried profession. Personal attention and practical experience—with successful Traffic Men. Special plan to help pay your tuition. Post graduate course FREE. Write today for full information.

**INTERSTATE TRAFFIC SCHOOL
112 Traffic Bldg.
FORT WAYNE, IND.**

Why Be Without a TRADE?

When you have an opportunity to obtain all these instructions in book form. Any one can learn these trades with little study at home.

Body builder	Body dresser	Motor repairman
Top set up	Door framer	Wood repairman
Section framer	Door finisher	Final assembler
Body set up	Door trimmer	Chassis assembler
Door dresser	Door paneler	Body trimmer
	Rough stuff rubber	Body paneler

**\$2.00 Will Bring a Book With All Instructions.
UNIVERSAL SELF-TRAINING SYSTEM.
Box 43, Milwaukee Jet. DETROIT, MICH.**

TELEGRAPHY

BOTH MORSE AND WIRELESS taught thoroughly. Big salaries; tremendous demand. Oldest, largest school. Endorsed by Telegraph, Railway, Wireless and Government officials. Expenses low—opportunities to earn large portion. Catalog free.

DODGE'S INSTITUTE, Jones Street, Valparaiso, Ind.

STATEMENT OF THE OWNERSHIP, MANAGEMENT, CIRCULATION, ETC., REQUIRED BY THE ACT OF CONGRESS OF AUGUST 24, 1912, of Popular Mechanics Magazine, published monthly at Chicago, Ill., for October 1st, 1923.

State of Illinois, County of Cook, ss.

Before me, a notary public in and for the state and county aforesaid, personally appeared H. H. Windsor, who having been duly sworn, according to law, depose and say that he is the editor and business manager of the Popular Mechanics Magazine and that the following is, to the best of his knowledge and belief, a true statement of the ownership, management, etc., of the aforesaid publication for the date shown in the above caption, required by the Act of August 24, 1912, embodied in section 443, Postal Laws and Regulations, printed on the reverse of this form, to wit: First. That the names and addresses of the publisher, editor, managing editor, and business manager are: Publisher, Popular Mechanics Co., 290 East Ontario St., Chicago, Ill., Editor, H. H. Windsor, 293 East Ontario St., Chicago, Ill., Managing Editor, Charles H. Chabrel, Jr., 293 East Ontario St., Chicago, Ill., Business Manager, H. H. Windsor, 293 East Ontario St., Chicago, Ill. Second. That the owners are (Give names and addresses of individual owners, or, if a corporation, give its name and the names and addresses of stockholders owning or holding 1 per cent or more of the total amount of stock): H. H. Windsor, 293 East Ontario St., Chicago, Ill.; E. B. Windsor, 293 East Ontario St., Chicago, Ill.; W. H. Windsor, Jr., 293 East Ontario St., Chicago, Ill.; First Trust and Savings Bank, Trustee for H. H. Windsor, Jr., Chicago, Ill. Third. That the known bondholders, mortgagees, and other security holders owning or holding 1 per cent or more of total amount of bonds, mortgages or other securities are (if there are none so state): None. Fourth. That the two paragraphs next above, giving the names of the owners, stockholders and security holders, if any, contain not only the list of stockholders and security holders as they appear upon the books of the company, but also, in cases where the stockholder or security holder appears upon the books of the company as trustee or in any other fiduciary relation, the name of the person or corporation for whom such trustee is acting, is given; also that the said two paragraphs contain statements embracing affiant's full knowledge and belief as to the circumstances and conditions under which stockholders and security holders who do not appear upon the books of the company as trustees, hold stock and securities in a capacity other than that of a bona fide owner; and this affiant has no reason to believe that any other person, association, or corporation has any interest direct or indirect in the said stock, bonds or other securities than as so stated by him. H. H. WINDSOR, Editor. Sworn to and subscribed before me, this 25th day of September, 1923. J. GRAHAM, Notary Public. [My commission expires June 17, 1924.]

Please Mention Popular Mechanics

CARPENTERS

LET THIS NEW AUDEL SET SOLVE YOUR PROBLEMS

POCKET SIZE—
FLEXIBLE
COVERS—
3100 ILLUS-
TRATIONS
— 1600
PAGES

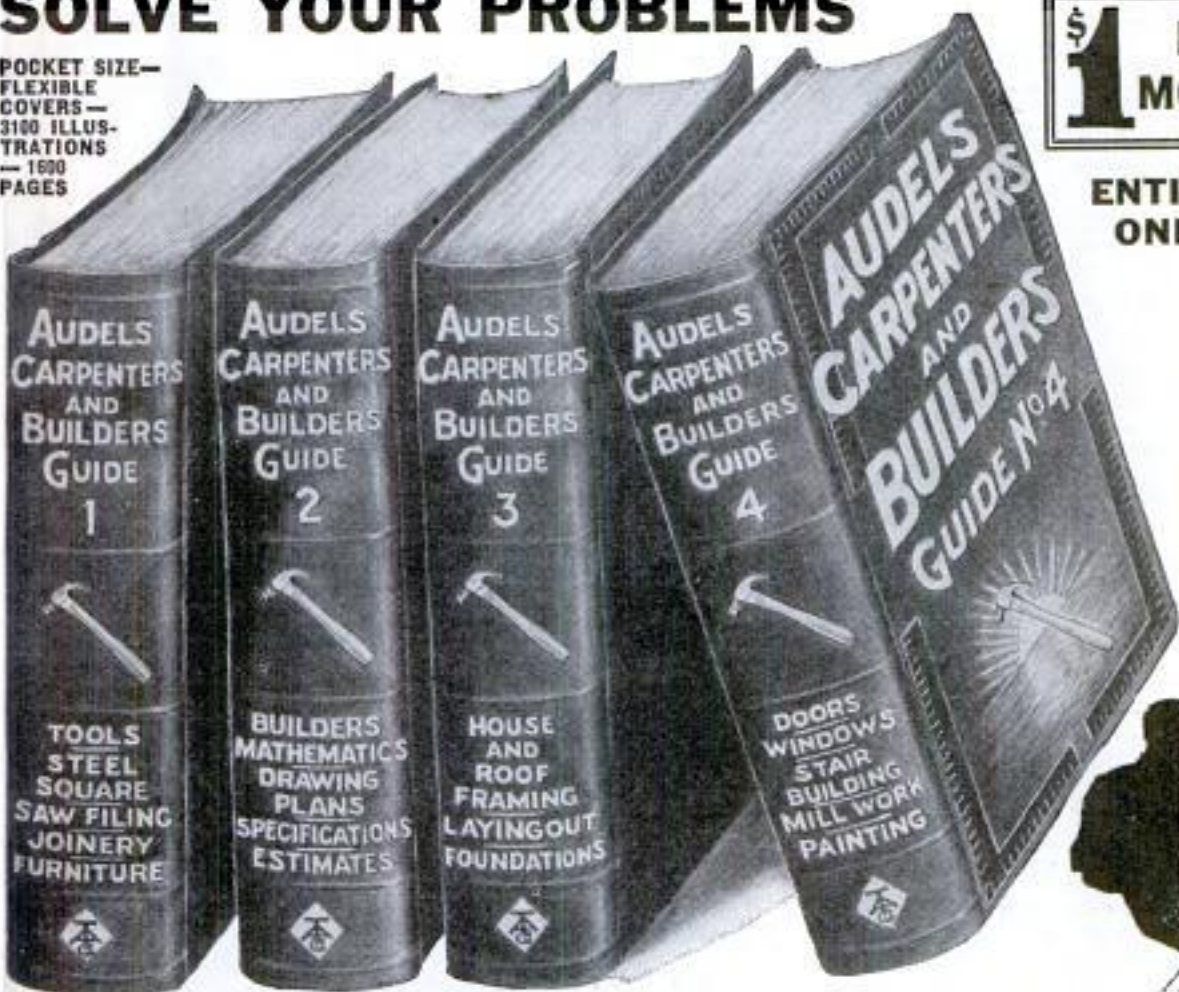

\$1 PER MONTH

ENTIRE SET ONLY \$6

JUST OUT!

Audel's Newest Set, Concise and up-to-date **FOUR Handy Volumes**



QUESTIONS AND ANSWERS—CLEAR ILLUSTRATIONS—SHORT CUTS THAT MAKE YOU A BETTER WORKMAN AND INCREASE YOUR PAY

Just available—Audel's Carpenters and Builders Guides—the short cut, professional information you want. A Guide that keeps you in close touch with your work and shows you how you may increase your earning power. No need to guess or take chances. Every day you have before you in this set, exact, practical, useful information to help you with your daily work.

HOW To Handle the Job That Puzzles YOU

There are thousands of examples of modern construction and building work—new methods, new ideas, proved efficiency plans, short cuts, time saving suggestions, new ways that cover the entire theory and practice of modern carpentry. Every point is easy to read and understand and clearly illustrated with sketches and forms. Inside Trade Informa-

tion for Carpenters, Builders, Joiners, Building Mechanics and all Woodworkers on—Care and Use of Tools—How to Use the Steel Square—File Saws—Make All Kinds of Joints—Draw and Read Plans—Write Specifications—Make Estimates—How to Frame Roofs and Houses—Lay Out Work—Put in Foundations—Full Instruction on In and Outside Building Work—Stair Building—Saw Mill Work—Practical Painting—Thousands of Short-Cuts that save time and money—Information usually obtained only by hard experience.

NO MONEY! MERELY SEND COUPON AND LOOK THE SET OVER AT THEO. AUDEL'S RISK

THEO. AUDEL & CO., 72 5th Avenue, NEW YORK CITY

Send me for free examination, AUDEL'S CARPENTERS AND BUILDERS GUIDES, 4 numbers. If satisfactory I will send you \$1 within 5 days and mail \$1 monthly until \$6 is paid.

Name.....
Address.....
Occupation.....
Employed by.....
Reference.....
P. M. Dec. 21

FREE EXAMINATION

Not a cent to pay until you see the books. No obligation to buy unless you are satisfied. Fill in coupon in pencil. Send now—today—get this great help library for carpenters and builders.

BE A HOTEL EXECUTIVE

Earn \$2500 to \$12,000 a Year

Unlimited Opportunities in Uncrowded Field

Fine position after little experience. A clerk, dissatisfied with his salary and opportunities, was persuaded to enroll for the Hotel Operation and Management Course. Even before he graduated he became chief room clerk in a large hotel, earning a much larger salary than he ever earned before, with the brightest opportunities for advancement. He writes: "This is to inform you of the new place I obtained with the Hotel as room clerk. The course has helped me wonderfully in securing this position. I know my brief hotel experience would never have gotten me the position so soon."

Increases Salary — Meals Furnished. Another student writes: "I wrote to Mr. Wiggins at your request and was employed immediately in an even better position than was originally open." This student, formerly an electrician, had absolutely no hotel experience. He is now stock room superintendent at an advanced salary with meals furnished and opportunities for advancement practically unlimited.

Woman Finds Work Attractive. Mrs. — became floor clerk at 75% increase in salary. Gives full credit to our training and employment service free to students.

Another woman graduate writes: "Hardly a day goes by that I am not offered a position." Others are qualifying as tea-room and restaurant managers.

Starts at Almost Double Present Salary. "I have gotten the position as steward at a salary of \$250 per month with free house and board." This student received this position before completing our course, having formerly held a job in a logging camp. His employer writes: "He is certainly the right sort of fellow and has been well trained. We feel that he will get along very well with us."

Assistant Manager in Two Weeks. Another advanced from clerk to executive with over 100% increase in salary. Another, no hotel experience, writes: "I am leaving to take the fine hotel position you secured for me."

Names of the above will be furnished on request.

Many Good Positions Open Trained Employees Wanted

Hotel men keenly feel the need of trained employees, both men and women, able to step at once into good positions in hotels, resorts, clubs, and cafeterias. Employees find the work easy, the path to advancement quick and certain, with a fascinating, enviable future. S. B. T. I. graduates and students are being called daily by leading hotels and are giving highest satisfaction. Read this: "You are doing a splendid work for the Hotel Fraternity and are to be congratulated upon your efforts," Hotel McCurdy, Evansville, Ind., and this: "Having heard that your school trains excellent hotel employees, we are writing you, suggesting various capacities you might assist us in filling." The Alamac Hotel Company, Inc.

Train in Your Spare Time

No large investment of time or money is necessary to avail yourself of this splendid opportunity. We train you thoroughly in a few weeks of your spare time by means of the concise, practical Hotel Operation and Management Course. When you graduate or even before, you will be in line for a good hotel position, which we help you get. **We have right now more positions open than we can fill.** Enroll now. Mail coupon for particulars.

Standard Business Training Institute
Carlton Court, Buffalo, N. Y.

Use the Coupon



Name.....
Street.....
City.....
State.....

Standard Business Training Institute
Carlton Court, Buffalo, N. Y.
Send me free Booklet H-100 giving full information about Hotel Operation and Management Course.



Chief Room Clerk



Stock Room Supt



Tea Room Manager



Hotel Manager

MY 3 NEW INVENTIONS

Will Enable You to Quickly Learn

VIOLIN

You have always longed to play the sweetest of all music—the Violin. Now with the aid of my 3 new inventions—mastery of the Violin is easily within your reach! My system of teaching by written and pictured instructions is far advanced over any other method! Endorsed by the foremost violinists of the country! I make it so simple and easy that

You Will Play a Complete Piece Your First Lesson

Just think of it!—you play real music at once! No boring scales—no long, dreary hours of practice. Under my instructions you will actually play a complete piece your very first lesson—and a new piece each succeeding lesson.

FREE VIOLIN OUTFIT

Most Complete Violin Outfit ever offered—valued \$750 to my students with the complete Conservatory course of 22 lessons. No extras to buy—everything is furnished. Outfit includes: splendid tone! Imported Violin, Bow, Extra Springs, Tuning Pipe, Mute, Rosin, handsome nickel trimmed Carrying Case—entirely an original, and my 3 remarkable inventions.

Write Me Today

—and I will gladly tell you all about my 3 New Inventions and how I guarantee to teach you Violin quickly and thoroughly. Here is the opportunity you have waited for so write me RIGHT NOW.

Prof. A. Hinchcliffe, First Hawaiian Conservatory of Music, Inc., Dept. 70
Woolworth Bldg. 233 Broadway, New York

FREE
This \$20.00 Outfit



We Import Our Violins Direct From Europe

\$100.00 EARNED BY YOUNG ARTIST IN 2 DAYS



Well-trained artists earn splendid incomes. The Federal home-study Course is a proven result-getter. If you like to draw, send 6c in stamps for 50-page book "Your Future." **FEDERAL SCHOOL OF COM'L DESIGNING**, 626 Federal Schools Building, Minneapolis, Minn.

LEARN PIANO TUNING

MAKING TRIALS OF TRUE TONE

By TUNE-A-PHONE



We furnish our accurate teaching device with tools, action model and lessons. Diploma given graduates. 25th year teaching this art by correspondence. Write today for free booklet and guarantee plan.

NILES BRYANT SCHOOL 30 BRYANT BLDG. AUGUSTA, MICH.



Gov't Help Needed

All men, women, boys, girls, 17 to 65, willing to accept Government Positions, \$117-\$250, traveling or stationary, sign name and address below and mail this ad to Mr. Orment, 111 St. Louis, Mo. immediately.

NAME.....
ADDRESS.....

What the Old Timer said to Charley

by
C.L. Hardy



“ONLY a few years ago, Charley, the man whose name you see on that door was just where you are today.

“I remember the day he came to work for us. He didn't know much about the business. But he was always asking questions—always anxious to learn.

“And by and by we got to noticing that Billy Stevens was getting ahead of some of us old fellows who had been around here for years.

“I can remember as clearly as though it were yesterday, the day Billy showed old Tom Harvey how to figure out the pitch of some new bevel gears we were making on an important contract.

“Tom told me afterward how respectful Billy was—nothing fresh, or ‘I know it all’ about him. He just made a suggestion and showed Tom a quicker way to start the problem and a shorter, surer way to finish it.

“One day I said to him—‘Where'd you get hep to all that fancy figuring, Bill?’ We were eating lunch and he was reading some little book he always carried. He looked up at me and said innocently: ‘Oh, I just picked it up!’ I knew different than that, so I quizzed him until he told me the whole story.

“‘Did you ever notice the old men around the shop,’ he asked—‘the men with families who drudge along day in and day out—never getting anywhere?’ I admitted that I had noticed quite a lot of them.

“‘Well,’ he said ‘I made up my mind I wasn't going to spend my whole life in a humdrum job at small wages. So I took a home-study course with the International Correspondence Schools that would give me special training for this business.

“‘I tell you frankly that I never dreamed it would be so fascinating and so helpful in my work. I'm making mighty good money—twice as much as formerly—and I'm going to have even a bigger job around here some day.’

“Well, Charley, that boy went straight on up. The members of the firm heard about his studying in his spare time and encouraged him to keep on. You see where he is today.

“And I—I'm still plugging along at the same old job—struggling to make both ends meet. I had just as good a chance as Billy Stevens, but I let it slip by. Yes, I let it slip by.

“Now, Charley, you've got to want your training bad enough to go get it. That's as far as I can help you; you've got to do the rest yourself.

“I've seen a lot of young men come into this business. Those who went ahead were always those who trained themselves for the job ahead. You can do the same thing.

“Start now! It will take only a moment to sign and mail that coupon. It doesn't obligate you in any way. But it's the most important thing you can do today. Some day I know that you will come to me and thank me for what I'm telling you.”

INTERNATIONAL CORRESPONDENCE SCHOOLS

Box 5562-D, Scranton, Penna.

Without cost or obligation, please tell me how I can qualify for the position or in the subject before which I have marked an X:

BUSINESS TRAINING COURSES

- | | |
|--|---|
| <input type="checkbox"/> Business Management | <input type="checkbox"/> Salesmanship |
| <input type="checkbox"/> Industrial Management | <input type="checkbox"/> Advertising |
| <input type="checkbox"/> Personnel Organization | <input type="checkbox"/> Better Letters |
| <input type="checkbox"/> Traffic Management | <input type="checkbox"/> Show Card Lettering |
| <input type="checkbox"/> Business Law | <input type="checkbox"/> Stenography and Typing |
| <input type="checkbox"/> Banking and Banking Law | <input type="checkbox"/> Business English |
| <input type="checkbox"/> Accountancy (including C.P.A.) | <input type="checkbox"/> Civil Service |
| <input type="checkbox"/> Cost Accounting | <input type="checkbox"/> Railway Mail Clerk |
| <input type="checkbox"/> Bookkeeping | <input type="checkbox"/> Common School Subjects |
| <input type="checkbox"/> Private Secretary | <input type="checkbox"/> High School Subjects |
| <input type="checkbox"/> Spanish <input type="checkbox"/> French | <input type="checkbox"/> Illustrating <input type="checkbox"/> Cartooning |

TECHNICAL AND INDUSTRIAL COURSES

- | | |
|---|--|
| <input type="checkbox"/> Electrical Engineering | <input type="checkbox"/> Architect |
| <input type="checkbox"/> Electric Lighting | <input type="checkbox"/> Blue Print Reading |
| <input type="checkbox"/> Mechanical Engineer | <input type="checkbox"/> Contractor and Builder |
| <input type="checkbox"/> Mechanical Draftsman | <input type="checkbox"/> Architectural Draftsman |
| <input type="checkbox"/> Machine Shop Practice | <input type="checkbox"/> Concrete Builder |
| <input type="checkbox"/> Railroad Positions | <input type="checkbox"/> Structural Engineer |
| <input type="checkbox"/> Gas Engine Operating | <input type="checkbox"/> Chemistry <input type="checkbox"/> Pharmacy |
| <input type="checkbox"/> Civil Engineer | <input type="checkbox"/> Automobile Work |
| <input type="checkbox"/> Surveying and Mapping | <input type="checkbox"/> Airplane Engines |
| <input type="checkbox"/> Metallurgy | <input type="checkbox"/> Navigation |
| <input type="checkbox"/> Steam Engineering | <input type="checkbox"/> Agriculture and Poultry |
| <input type="checkbox"/> Radio | <input type="checkbox"/> Mathematics |

Name.....

Street.....

Address..... 8-3-23

City..... State.....

Occupation.....

Persons residing in Canada should send this coupon to the International Correspondence Schools Canadian, Limited, Montreal, Canada

I Can Train You For A \$3500 Hotel Job in 20 weeks



The Hotel Business offers wonderful opportunities to the trained man or woman! Now fourth largest industry in America. Hundreds of high-salaried executive positions now standing open—waiting for the trained worker. You can easily qualify for one of these big-paying jobs—in your spare time at home. No previous experience necessary.

I Guarantee to Teach You

in my 50-lesson home-study course on hotel work, all that the leading hotel experts know about the business—men making from \$5,000 to \$50,000 a year! My students are eagerly sought by the biggest and best hotels in the country. You won't have to look for a job. Big pay, fine living, free meals and apartment, fascinating work—these are only a few of the many advantages of hotel work.

Send for FREE Book

20 Years' Experience in 20 Weeks is what this wonderfully complete course gives you. Course prepared by Clifford Lewis, a hotel expert of national reputation. Endorsed by managers of such hotels as Biltmore, Waldorf-Astoria, Copley-Plaza, Commodore, etc. Interesting free book explains all. Send for it today.

LEWIS HOTEL TRAINING SCHOOLS

Founded 1916. The Original Hotel Training School

CLIFFORD LEWIS, President

Room 330 Washington, D. C.
The National Institute for Hotel, Restaurant and Tea Room Training

Learn Expert Auto Painting



There is **Big Money** in auto painting and refinishing. Our Home Study Course in **Practical Auto Painting** will enable you to do the finest work and earn big wages. Wonderful opportunity for new money-making business of your own.

FREE circular tells all about this big new business. Be first. Write quick.

CHICAGO COLLEGE OF AUTO PAINTING
Dept. 123, 140 S. Dearborn St., CHICAGO, U.S.A.

Learn Watchwork, Jewelrywork and Engraving.

A fine trade commanding a good salary, and your services are always in demand. Address **Horological**, Dept. P, Bradley Institute, PEORIA, ILL., for our latest catalog.

DANCE And be Popular

Learn In ONE HOUR at Home

There's now no need of being a wall-flower. In one hour—at home—by mail—I can make you an easy confident dancer—popular in any ballroom.

New Easy Method

No Partner Needed—No Embarrassment

Over 60,000 men and women have become popular dancers of Fox Trot, One-Step, Waltz and all latest up-to-the-minute society dance steps through my new **Foto-tell** and **Fono-tell** Method set to music. Amazingly easy—fascinating. No other course like it. I teach you perfect time and rhythm—the secret of good dancing. Your success guaranteed.

SENT FREE ON TRIAL —NO DEPOSIT

Convince yourself at my expense how amazingly easy it is to learn modern dancing with my new method. For a short time only, I'll send the first six lessons of my course (in plain wrapper), including 10 inch dance instruction record, free and prepaid for five days trial. See, test and prove this remarkable new method in your own home. Then, if not delighted at your success, simply return record and lessons within five days and you'll owe me nothing. Write quick before this unusual offer expires. Please mention make of phonograph you have.



WILLIAM CHANDLER PEAK, M. S.
Studio 36. 4601-4611 Broadway, Chicago, Illinois



MAKE \$100 A DAY BE AN AUCTIONEER

18 yrs. one of the largest Auction Schools in the World. W. H. Adams, Utah, made \$20,000 second year after graduating. 1923 Annual Rev. **MISSOURI AUCTION SCHOOL, 818 Walnut St., Kansas City, Mo.**

BE AN ARTIST BIG PRICES PAID FOR DRAWINGS

Turn your talent into money. We can teach you drawing in your home during spare time. Well trained artists earn from \$40 to \$200 a week. Thousands of publishers and advertisers need the work of good artists. The **Modern Method** is an easy way to learn to draw original pictures. Send 3 stamps for full particulars showing opportunities for you. State your age. **MODERN INSTITUTE OF ART 7 East 42nd St., Dept. 101-A NEW YORK CITY**

SONGS Clean, catchy hits that everybody likes. Ballads, comic songs, novelty songs, coon songs; full sheet music with beautiful colored covers. "Mammy's Twilight Lullaby," latest hit, 30c. Many others. Hundreds of plays and entertainment books. Big catalogue free. **T. S. Denison & Co., 623 So. Wabash, Dept. 200, Chicago**

Whatever Your Question;—be it the pronunciation of **Bolsheviki**, the spelling of a puzzling word, the location of **Murman Coast**—the meaning of **blighty, ace, tank, ukulele, etc.**, this Supreme Authority—

WEBSTER'S NEW INTERNATIONAL DICTIONARY

contains an accurate, final answer 400,000 Words, 2700 Pages, 6000 Illustrations.
Regular and India-Paper Editions. **G. & C. MERRIAM CO., Springfield, Mass.**
Write for specimen pages, prices, etc. and **FREE** Pocket Maps per Popular Mechanics



WANTED

RAILWAY POSTAL CLERKS
\$1600 to \$2300 Year
MEN—BOYS, 18 UP

WRITE IMMEDIATELY
Steady work. No layoffs. Paid vacations
Travel—see the Country
Many Government Jobs Open to Women
Common education sufficient. Mail coupon today—**SURE**



FRANKLIN INSTITUTE, Dept. D-179, ROCHESTER, N. Y.

Send me without charge, (1) Specimen Railway Postal Clerk Examination questions; (2) List of government jobs now open to men and women, 18 up; (3) Send list of examination places; (4) Send free illustrated book, "How to Get Government Positions."

Name.....
Address.....

Look Here!

Are you ambitious—are you looking for the way to Success?

Do you want an easy, pleasant job?
Do you want to make from \$60 to \$100 a week?
Do you want to enjoy the luxuries of life?

Then Read My Offer!

I Guarantee

to train you right at home — to make you a DRAFTING EXPERT quick! I guarantee to prepare you to hold down any big pay job in any Drafting Office and to refund every cent of your money if you are not satisfied with my training. I guarantee to give you my practical JOB-METHOD instruction until you are actually placed in a drafting position paying at least

**\$250 to \$300
A MONTH!**



I have recommended Drafting as a life-work to thousands of men during the past 20 years — I have seen them step into big-salaried positions immediately after completing my course — I have thousands of letters to prove that my "Job-Method" instruction has made these men Successful DRAFTING EXPERTS — and I offer you now the same opportunity to get into a business where there are always more jobs than Experts to fill them, where salaries are big, hours short, work pleasant.

BE A DRAFTING EXPERT!

Learn at HOME in your SPARE TIME!

Common schooling all you need. Learn in a few months. Important jobs everywhere — railroads, factories, builders, Cities, Counties, States, the U. S. Government, shipyards, automotive plants, architects and dozens of other lines all need Expert Draftsmen. Salaries range from \$60 to \$150 a week. Draftsmen are always in line for promotion as superintendents, managers and other official positions. Before any machine, building or product can be made, a Draftsman must draw the plan! He's the key-man of Industry. Executives depend on him. Not a wheel can turn without him.

FREE! \$19 Professional Drafting Outfit

The Coyne "Job-Method" teaches you Drafting with the same instruments and outfits you will use as an EXPERT when employed at a big salary. In order to help you START RIGHT NOW, we offer this \$19 Outfit FREE to every Coyne student. Coupon brings complete information. *Mail it immediately!*

2 Drafting Books Free!

Mail coupon today and take advantage of this opportunity.

CHIEF DRAFTSMAN
COYNE SCHOOL OF DRAFTING
1-9 S. Ashland Ave., Dept. 919
CHICAGO, ILL.

Chief Draftsman
COYNE SCHOOL OF DRAFTING
1-9 S. Ashland Ave., Dept. 919, Chicago, Ill.

Without obligating me in any way, please send me your two books, "Drafting, the Foundation of Industry" and "Learn Drafting by the 'Job-Method'" — all absolutely free. Also complete information of your rapid home-study Drafting course, free instruments and other features.

Name

St. No.

City..... State.....

MAIL COUPON TO-DAY!



Own Your Own Home by Building Homes for Others



American School

The American School is not a money-making corporation, but, like resident schools and colleges, is chartered strictly as an "Educational Institution, not for profit."

More than 200 famous engineers and educators prepared the special instruction papers for our students.

For over a quarter of a century, Big Engineers, Educators and Business Men have recommended the American School. They know that our long experience as an educational institution guarantees the best training at lowest possible cost.

Every man should own his own home. Every man wants to but doesn't seem to get ahead fast enough to do it. Why not get in the building business and build your own home—after having made enough to do it through building homes for others?

Did you ever stop to think as you gazed at a big, modern building what its construction entailed? It started with a hole in the ground—then a foundation was laid—and then, miracle-like, the timber or steel frames were raised and the building completed. You can build your business career the same way, but before you go ahead with your plans, you must have a FOUNDATION. Training gives that foundation. The American School supplies you the training. You study at home from lessons compiled by twenty experts in Building and Contracting problems. They give you the benefit of their wonderful knowledge learned by having gone through the mill. They guide and direct you until you can go out and take a big job paying real man-size money.

It Costs Only 2c to Get Started

Send no money. Just fill out the coupon below, check the occupation you are interested in. If it isn't Building and Contracting, check what you are interested in. If you are undecided we'll send you full information and advice on what line you ought to take up and how to succeed in it. Here are but a few of the subjects covered in the Building and Contracting Course

Estimating, Carpentry and Masonry, Blue Print Reading, Building Regulations, Stair Building, Use of Steel Square, Water Supply and Drainage, Buying Material, Heating and Ventilating.

If you are interested in making more money and decide to take an American School Course, you will find the cost well within your reach—and the terms of payment easy. You get our positive money-back guarantee with your first payment. We practically insure your success. Fill out the coupon NOW and stop wishing and dreaming about what you hope to do—just START AND DO IT. You'll never regret the day you took the step.

AMERICAN SCHOOL, Dept. G974A, Drexel Ave. & 58th St., Chicago

© A. S. 1923

American School, Dept. G974A, Drexel Ave. & 58th St., Chicago

Send me full information on the subject checked.

- | | | | |
|---|--|--|--|
| <input type="checkbox"/> Architect | <input type="checkbox"/> Sales Manager | <input type="checkbox"/> Business Law | <input type="checkbox"/> Foremanship |
| <input type="checkbox"/> Building Contractor or Carpenter | <input type="checkbox"/> Cert. Pub. Accountant | <input type="checkbox"/> Lawyer | <input type="checkbox"/> Sanitary Engineer |
| <input type="checkbox"/> Automobile Engineer | <input type="checkbox"/> Accountant & Auditor | <input type="checkbox"/> Machine Shop Practice | <input type="checkbox"/> Surveyor (& Mapping) |
| <input type="checkbox"/> Automobile Repairman | <input type="checkbox"/> Bookkeeper | <input type="checkbox"/> Photoplay Writer | <input type="checkbox"/> Telephone Engineer |
| <input type="checkbox"/> Civil Engineer | <input type="checkbox"/> Draftsman & Designer | <input type="checkbox"/> Mechanical Engineer | <input type="checkbox"/> Telegraph Engineer |
| <input type="checkbox"/> Advertising Manager | <input type="checkbox"/> Electrical Engineer | <input type="checkbox"/> Shop Superintendent | <input type="checkbox"/> High School |
| <input type="checkbox"/> Business Manager | <input type="checkbox"/> General Education | <input type="checkbox"/> Employment Manager | <input type="checkbox"/> Fire Insurance Expert |
| <input type="checkbox"/> Financial Manager | <input type="checkbox"/> Personal Analysis | <input type="checkbox"/> Steam Engineer | <input type="checkbox"/> Wireless Radio |
| | | | <input type="checkbox"/> Undecided |

Name.....

Address..... Occupation.....

AUDEL'S GUIDES
ANSWER YOUR
QUESTIONS IN A
PRACTICAL WAY

YOUR FOREMAN
WILL QUICKLY
NOTICE THE SU-
PERIOR QUALITY
OF YOUR WORK

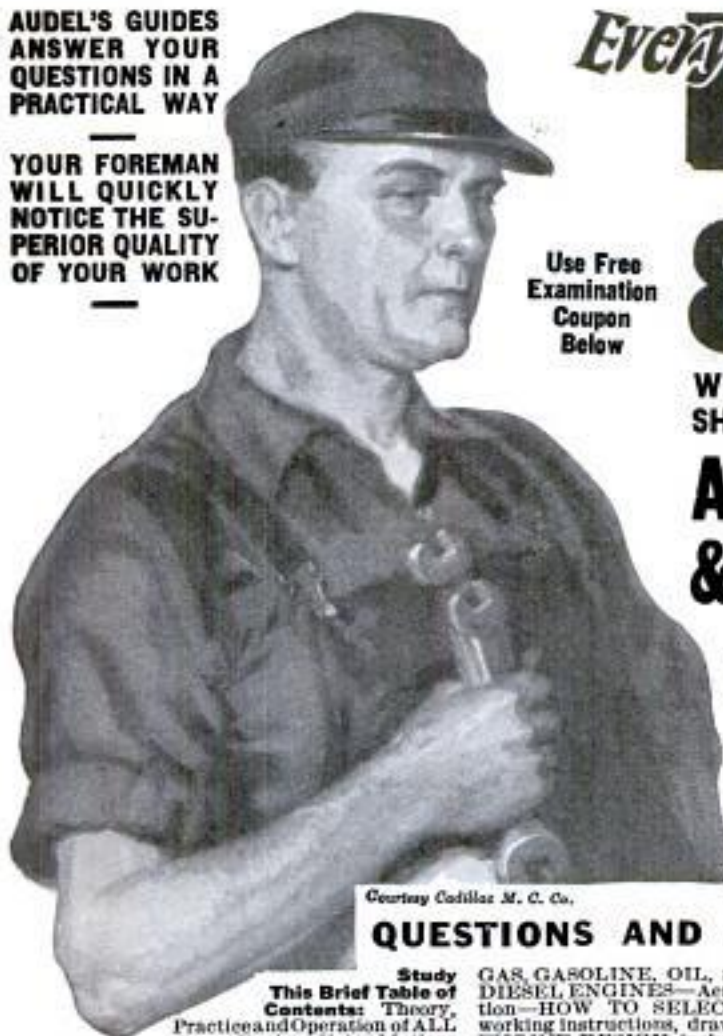

Courtesy Cadillac M. C. Co.

Use Free
Examination
Coupon
Below

Every ENGINEER & MECHANIC

WILL FIND PRACTICAL INFORMATION ON
SHORT CUTS AND MODERN METHODS IN
**AUDEL'S ENGINEERS
& MECHANICS GUIDES**

Every Engineer, Mechanic and Electrical Worker will welcome this new master set. It will answer your problems.

It will help you with your daily work.—A sure source of advancement and higher pay. Complete up-to-date information that is thoroughly and easily explained on every branch of modern engineering and electrical practice. **The entire set costs you only twelve dollars—knowledge and instruction that has cost thousands of dollars and years of time—yours for \$12.00—\$1.00 a month.**

QUESTIONS AND ANSWERS TEACH YOU QUICKLY

Study
This Brief Table of
Contents:

Theory, Practice and Operation of ALL Steam Engines, Valve Motions

—VALVE SETTING: complete information on All engines and pumps—CORLISS ENGINES and the Theory, Construction and Operation of all Steam Engines, including UNIFLOW and POPPET VALVE ENGINES, and LOCOMOBILES—Locomotive-Marine Engines; Turbines; Rotary Engines—the Indicator—Lubrications—PRACTICAL MANAGEMENT. How to use Indicator—

GAS, GASOLINE, OIL, SEMI- and FULL DIESEL ENGINES—Aeroplanes and Aviation—HOW TO SELECT AN ENGINE, working instructions, drawings on STEAM ENGINE DESIGN, including rules and formulae. Theory and Construction of ALL Steam Boilers; Heat-Combustion; Fuel and Flue Gas Analysis—CO₂ recorders—Characteristics of Boilers—Materials—Construction of all types of Boilers. (THE LATEST PRACTICE.)—Boiler Construction—Mechanical Stokers—Oil Burners—Setting—Chimneys—Mechanical Draught—HOW TO SELECT A BOILER—Complete instructions and draw-

ings on BOILER DESIGN based on A. S. M. E. BOILER CODE—OPERATION, including installation, FIRING; care and repair of Steam Boilers—Pipes, Fittings and Pipe Fitting—Heating and Ventilation—Refrigeration—Cooling Towers—Condensers—Distillation Apparatus—Elevators—Cranes and Hoisting Machinery—Ropes and Cables—Splicing—electric wiring in ALL branches; compendium of practical electrical engineering as an aid for engineers and electricians in obtaining a license—57 chapters—ready reference index, covering entire field of Modern Electricity.

AUDEL'S MASTER SET 8754 ILLUSTRATIONS 4750 PAGES

POCKET SIZE—FLEXIBLE COVERS

**TURN SPARE TIME INTO CASH
BY STUDYING THE GUIDES**

Take a volume with you where ever you go. They can be easily slipped in and out of your coat pocket without damage. Study the questions and answers. Fifteen minutes a day study will increase your pay.



NEW YORK CITY
72 Fifth Avenue, NEW YORK CITY

FREE EXAMINATION
Not a cent to pay until you see the books. No obligation to pay unless you are satisfied. Send coupon now—today and get this new master set for engineers.
Pay only \$1 a month.

THEO. AUDEL & CO., 72 Fifth Avenue, NEW YORK CITY.
Please submit me for free examination. AUDEL'S MASTER SET FOR ENGINEERS AND MECHANICS. Ship at once prepaid, the 8 numbers total cost \$12.00. If satisfactory, I agree to send you \$1 within seven days and to further mail you \$1 each month until paid.

Name.....
Occupation.....
Employed by.....
Home Address.....
Reference.....
P.M. Dec. 23

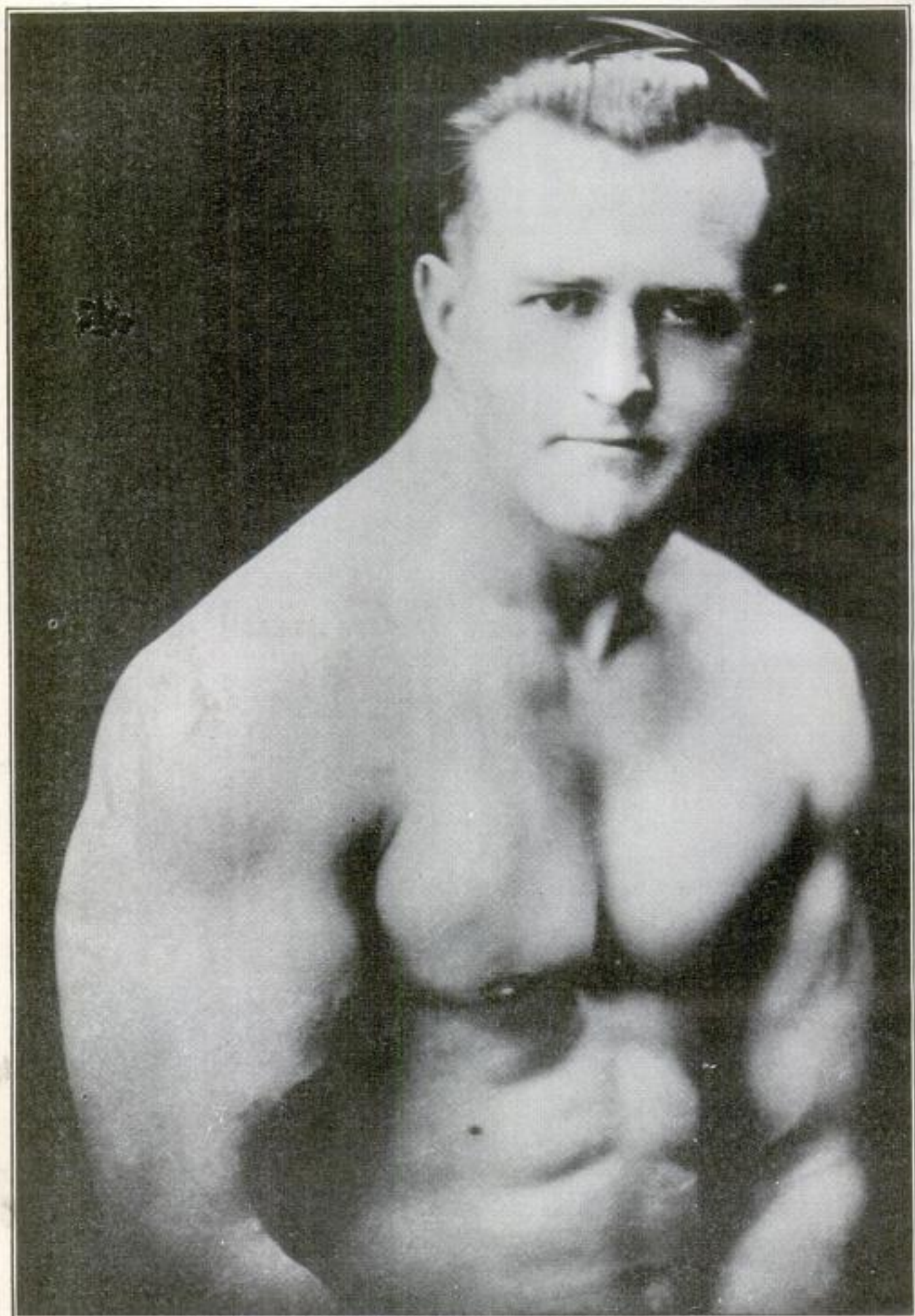

EARLE E. LIEDERMAN, *The Acme of Physical Perfection*

POPPIE Great to be Healthy

Geel! brimming with pep. Eat like a kid and off for the day's work horse. You don't care how much work awaits you, for that's what work and plenty of it. And when the day is over, are you tired? I Those days are gone forever. That's the way a strong, healthy man had chest breathes deep with oxygen purifying his blood so that his very with life. His brain is clear and his eyes sparkle. He has a spring to his confidence to tackle anything at any time.

the Weaking Don't you feel sorry for those poor fellows dragging along through life with a neglected body? They are up and around a full half hour in the morning before they are half awake. They taste a bite of food and call it a breakfast. Shuffle off to work and drag through the day. It's no wonder so few of them ever succeed. Nobody wants a dead one hanging around. It's the live ones that count.

Strength Is Yours

Wake up, fellows, and look the facts in the face. It's up to you right now. What do you plan to be—a live one or a dead one? Health and strength are yours if you'll work for them, so why choose a life of suffering and failure?

Exercise will do it. By that I mean the right kind of exercise. Yes, your body needs it just as much as it does food. If you don't get it you soon develop into a flat-chested, narrow-shouldered weaking with a brain that needs all kinds of stimulants and foolish treatments to make it act. I know what I am talking about. I haven't devoted all these years for nothing. Come to me and give me the facts and I'll transform that body of yours so you won't know it. I will broaden your shoulders, fill out your chest, and give you the arms and legs of a real man. Meanwhile, I work on the muscles in and around your vital organs, making your heart pump rich, pure blood and putting real pep in your old backbone. This is no idle talk. I don't promise these things—I guarantee them. If you doubt me, come on and make me prove it. That's what I like.

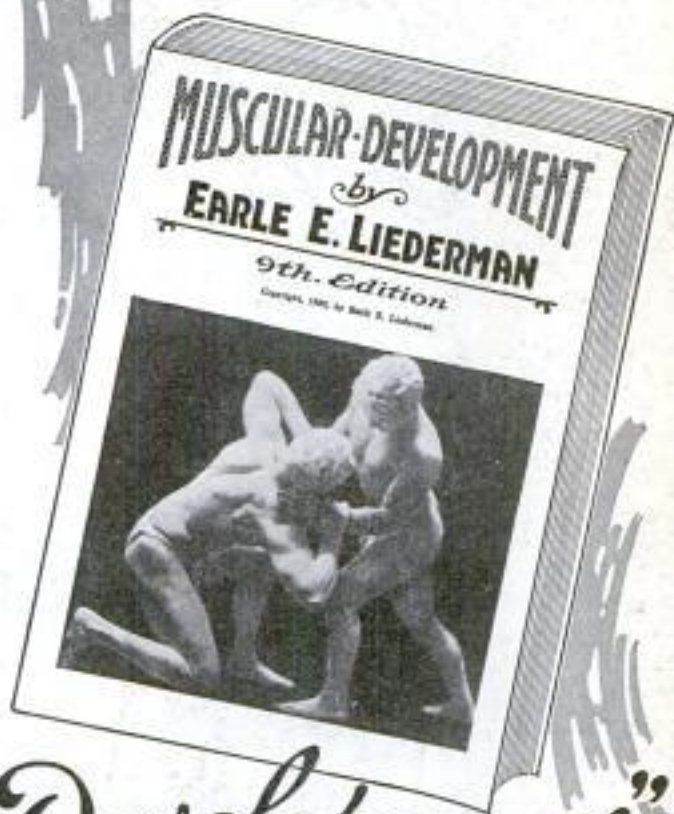

Send For My New
64 Page Book—

"Muscular Development"

It contains forty-three full-page photographs of myself and some of the many prize-winning pupils I have trained. Some of these came to me as pitiful weaklings, imploring me to help them. Look them over now and you will marvel at their present physiques. This book will prove an impetus and a real inspiration to you. It will thrill you through and through. All I ask is ten cents to cover the cost of wrapping and mailing and it is yours to keep. This will not obligate you at all, but for the sake of your future health and happiness, do not put it off. Send today—right now, before you turn this page.

EARLE E. LIEDERMAN
Dept. 2012, 305 Broadway, New York City

EARLE E. LIEDERMAN

Dept. 2012, 305 Broadway, New York City

Dear Sir:—I enclose herewith 10 cents for which you are to send me, without any obligation on my part whatever, a copy of your latest book, "Muscular Development." (Please write or print plainly.)

Name.....

Street.....

City..... State.....

Join these



If you could

YOU would be thrilled with their enthusiasm. Really, fellows, it's great to meet these chaps after they have once experienced the joys of health. They can hardly believe it themselves and never seem to tire talking about it.

The men pictured herewith are pupils selected at random. If I attempted to print all the letters of praise I daily receive, I would need to publish a magazine of my own to contain them.

But what pleases me is the fact that my system *never fails*. Just imagine a record like that. Not one person who has actually followed my instructions has failed to acquire the strong body I promised him. That is why I guarantee results. I could easily back it up with any amount of money for it's a sure thing.

And these men are not only transformed into big robust specimens of manhood, but are made successes in their business careers as well. A strong, healthy body means an active

EARLE E.
LIEDERMAN
Dept. 2012,
305 Broadway
New York City

Dear Sir: I enclose herewith 10 cents for which you are to send me, without any obligation on my part whatever, a copy of your latest book, "Muscular Development." (Please write or print plainly.)

Name.....
Address.....
City.....State.....

Lucky Ones



hear them talk

alert mind. No matter what your profession may be, I will help you. I will make you a better doctor, lawyer, merchant, mechanic or whatever line you have chosen for your business career.

Surely, I have proven to you by this time that I have something you need—something you must have if life is to be worth while. With it you will possess what every red-blooded man prizes. Without it, your life will probably be a failure and you will end up in days of misery and despair.

Remember, I don't promise these things—I guarantee them. I take the chance. You have a positive guarantee of success. Come on and make me prove it. Join the lucky ones whose pictures you see in the horse shoe.

Opportunity is knocking at your door. Decide this minute to let him in. Sign the coupon. This does not obligate you, but it will bring you the story of how it is done, and show you what your first step should be into this bigger and broader life which you were meant to live.

EARLE E. LIEDERMAN

305 Broadway DEPT. 2012 NEW YORK CITY

EARLE E.
LIEDERMAN
Dept. 2012
305 Broadway
New York City

Dear Sir: I enclose herewith 10 cents for which you are to send me, without any obligation on my part whatever, a copy of your latest book, "Muscular Development." (Please write or print plainly.)

Name.....

Address.....

City..... State.....

See Here!

You can make
\$75 to \$200
a week!

**LEARN TO DO
ANY JOB!**



The Cooke-Trained Auto Expert gets the big money because no job is too difficult for him. The JOB-WAY of instructions has shown him how to find the trouble instantly and repair it quickly!

Be An Auto Expert

Keep your Job—stay at home—loan me part of your spare time and I'll make you an AUTO EXPERT quick! A liking for machinery all you need. As Directing Engineer of the big CHICAGO AUTO SHOPS I train you the "JOB-WAY"—no books or useless theories in my course. I show you the short-cuts, the inside methods acquired during my 20 years in the auto business.

! I Guarantee



to prepare you to go into business for yourself where you can become INDEPENDENT. I guarantee to train you until you can hold down any EXPERT'S job at TOP SALARY. I guarantee to make you an expert right in your own home—to give you the most practical instruction ever devised in every branch of Automotive Mechanics, Automotive Electricity, Battery, Ignition, Welding, Vulcanizing, etc. And I guarantee to refund your money if you are not satisfied.

**B. W. COOKE, Directing Engineer
CHICAGO AUTO SHOPS**

NOW YOU CAN LEARN AT HOME!

\$18.50 REPAIR OUTFIT FREE!

Learn with tools! And make the course pay for itself like hundreds of my students have done! Mail coupon and get this money-making outfit FREE!

Get your share of the millions of dollars spent yearly for repairs on autos, trucks, tractors. Think of it! Now 15 million cars, trucks and tractors to keep going—15 million batteries to service—50 million tires to repair and replace—15 million electrical systems to maintain! Man alive!—where else can you find equal opportunities to make *real money!*

START NOW! Mail coupon today —get all facts quick!

My big free book tells you how you can get ready to cash in on the thousands of opportunities in the world's biggest business! Reduced prices and easy terms right now—\$18.50 repair outfit free right now—write me personally or mail coupon *immediately!*

**Directing Engineer Cooke
CHICAGO AUTO SHOPS**

Dept. 916, 1553 W. Madison St., Chicago, Ill.

Please send me Free Book and complete information about your "JOB-WAY" training at home. Tell me how I can become an AUTO EXPERT quick! I am mailing this promptly to secure FREE REPAIR OUTFIT and the reduced prices and special terms you offer now. Of course, I am not obligating myself in any way.

Name.....

St. No. or R.F.D.....

City.....State.....

B. W. COOKE, DIRECTING ENGINEER

CHICAGO AUTO SHOPS
Dept. 916

1553 W. Madison St., CHICAGO, ILL.

A BUSINESS of Your Own Paying \$5000 to \$15,000 a Year!

Garage
Repair Shop
Battery Shop
Welding Shop
Tire Repair Shop
Auto Electrical Shop
Auto Accessories Store
Tire and Battery Sales

Train for These Jobs Paying \$3000 to 10,000 a Year!

Master Auto Mechanic
Expert Auto Electrician
Automotive Engineer
Ignition Expert
Garage Manager
Service Station Superintendent
Master Salesman of Autos
Battery or Tire Expert





NOW FREE!

The Book That Has Shown Thousands the Way to Amazing Salary Increases

TAKE this situation. A man who had worked all his life in a routine job at low pay suddenly surprises his friends by moving into a better neighborhood, taking a big house, buying a car and blossoming out as a well-to-do and influential citizen in his new community. How did he do it? What is the secret that he used? Simple enough. He knew that the biggest money in business is in Selling, and though he felt that he couldn't sell a thing he learned the secrets that make Master Salesmen, and then began to make big money.

If only one man had found inspiration enough in this remarkable book to make a brilliant success in the Selling field—in a job paying him many times his former salary—then you might call it luck. But thousands have done it.

Your One Chance to Make the Biggest Money of Your Life

Not one of the men whose names appear at the right had ever sold a thing before—not a dime's worth. If you had told one of them that he could sell he would have laughed at you.

They were frankly skeptical. Yet every one of these men, through reading this book, discovered the fallacy of this vicious

old idea that Salesmen are "born." They learned that *Master Salesmen are made!* And in this book they found a comparatively easy way to go from low pay to better earnings.

Simple as A B C

Sounds remarkable, doesn't it? Yet there is nothing remarkable about it. There are certain ways to approach different types of prospects to get their undivided attention—certain ways to stimulate keen interest—certain ways to overcome objections, batter down prejudices, outwit competition and make the prospect act. If you will learn these principles, there is awaiting you a brilliant success and more money than you ever thought of earning. This book, "Modern Salesmanship," tells exactly how the National Salesmen's Training Association will make you a Master Salesman.

As soon as you are qualified and ready, the Employment Service of the National Salesmen's Training Association will help you to select and secure a selling position as city or traveling salesman.

Now Free to Every Man Who Will Act at Once

We are not making any extravagant claims about

what we will do for you. We don't have to. The records of the real successes for which we are responsible are so overwhelming a testimonial of the fact that any man of average intelligence can become a Master Salesman that we are willing to leave the decision entirely up to you. All of this proof and many important features about Salesmanship are contained in "Modern Salesmanship." It is yours—FREE. Send the coupon for it today. It will show you how you can quickly become a Master Salesman—a big money maker. It will tell you about the National Salesmen's Training Association system of Salesmanship training that has meant prosperity to so many thousands of men—about the National Demonstration Method that gives you actual experience while studying—and all about the fine opportunities that await you in the selling field. Failure to act may mean that you lose the one big chance of your life to leave forever behind you the low pay of a routine job. It may mean the difference between this and a real success at a big salary. Is it worth 2c to find out? Then, mail this coupon NOW.

National Salesmen's Training Association
Dept. 12-W Chicago, Illinois

National Salesmen's Training Association
Dept. 12-W, Chicago, Ill.

I simply want to see the facts. Send me FREE your Book, "Modern Salesmanship," and Proof that I can become a Master Salesman.

Name.....
Address.....
City.....State.....
Age.....Occupation.....

Read!

Charles Berry, of Winnetka, Ia., stepped from \$18 a week as a clerk to a position making him \$1,000 the very first month. J. P. Overstreet, of Denison, Tex., read this book, left a job on the Capitol Police Force, and in six weeks earned \$1,800. F. Wynn, Portland, Ore., an ex-service man, earned \$554.57 in one week. George W. Kearns, of Oklahoma City, found in this book a way to jump his earnings from \$60 a month to \$524.00 in two weeks, and C. W. Campbell learned from it how he could quit a clerking job on the railroad to earn \$1,632 in thirty days.

EMPLOYERS

are invited to write to the Employment Dept. of the N. S. T. A. We can put you in touch with just the men you need. No charge for this service to you or our members. Employers are also cordially invited to request details about the N. S. T. A. Group plan of instruction for entire sales forces. Synopsis and charts sent without obligation.

Why haven't
you
clipped this
coupon

TEAR OUT HERE

INTERNATIONAL CORRESPONDENCE SCHOOLS
Box 3564-D, Scranton, Penna.

Without cost or obligation, please tell me how I can qualify for the position or in the subject before which I have marked an X:

BUSINESS TRAINING COURSES

- | | |
|--|---|
| <input type="checkbox"/> Business Management | <input type="checkbox"/> Salesmanship |
| <input type="checkbox"/> Industrial Management | <input type="checkbox"/> Advertising |
| <input type="checkbox"/> Personnel Organization | <input type="checkbox"/> Better Letters |
| <input type="checkbox"/> Traffic Management | <input type="checkbox"/> Show Card Lettering |
| <input type="checkbox"/> Business Law | <input type="checkbox"/> Stenography and Typing |
| <input type="checkbox"/> Banking and Banking Law | <input type="checkbox"/> Business English |
| <input type="checkbox"/> Accountancy (including C.P.A.) | <input type="checkbox"/> Civil Service |
| <input type="checkbox"/> Cost Accounting | <input type="checkbox"/> Railway Mail Clerk |
| <input type="checkbox"/> Bookkeeping | <input type="checkbox"/> Common School Subjects |
| <input type="checkbox"/> Private Secretary | <input type="checkbox"/> High School Subjects |
| <input type="checkbox"/> Spanish <input type="checkbox"/> French | <input type="checkbox"/> Illustrating <input type="checkbox"/> Cartooning |

TECHNICAL AND INDUSTRIAL COURSES

- | | |
|---|--|
| <input type="checkbox"/> Electrical Engineering | <input type="checkbox"/> Architect |
| <input type="checkbox"/> Electric Lighting | <input type="checkbox"/> Blue Print Reading |
| <input type="checkbox"/> Mechanical Engineer | <input type="checkbox"/> Contractor and Builder |
| <input type="checkbox"/> Mechanical Draftsman | <input type="checkbox"/> Architectural Draftsman |
| <input type="checkbox"/> Machine Shop Practice | <input type="checkbox"/> Concrete Builder |
| <input type="checkbox"/> Railroad Positions | <input type="checkbox"/> Structural Engineer |
| <input type="checkbox"/> Gas Engine Operating | <input type="checkbox"/> Chemistry <input type="checkbox"/> Pharmacy |
| <input type="checkbox"/> Civil Engineer | <input type="checkbox"/> Automobile Work |
| <input type="checkbox"/> Surveying and Mapping | <input type="checkbox"/> Airplane Engines |
| <input type="checkbox"/> Metallurgy | <input type="checkbox"/> Navigation |
| <input type="checkbox"/> Steam Engineering | <input type="checkbox"/> Agriculture and Poultry |
| <input type="checkbox"/> Radio | <input type="checkbox"/> Mathematics |

Name.....

Street.....

Address.....

City..... State.....

Occupation.....

Persons residing in Canada should send this coupon to the International Correspondence Schools Canadian, Limited, Montreal, Canada.

You can easily learn to
play any music on the
TENOR BANJO

**You Play a Piece of Real
Music Your First Lesson**

Imagine the joy that will be yours when you surprise your friends with your wonderful playing of the TENOR BANJO. You will find it so amazingly easy to learn that you will thank your stars that you wrote us.

TENOR BANJO is the Most Popular Instrument of the Age—and Prof. Barker's method of teaching is so simple and easy that you will quickly learn to play any and all of the popular dance hits just as you have heard them played by expert musicians—in dance orchestras, on the stage—everywhere.

No Previous Musical Knowledge Necessary—Quick—Easy—Positive

Only 5 motions to acquire, and you learn them quickly; after that a short period of easy practice and long before you complete our Conservatory Course, you will be playing "Strawberry" "Three O'Clock in the Morning" "Hot Lips" and other popular hits. We furnish free a handsomely finished \$15.00 Banjo, and all necessary equipment—THERE ARE NO EXTRAS!

Be the Center of Interest Among Your Friends.

Don't hesitate because you may not be able to read music—simply write us on a post card—"I am interested in your FREE TENOR BANJO Offer and course of 65 lessons." When you get our amazing offer, we know you will enroll at once. Rush Post Card to us today.

Special courses under
Famous teachers:
Hawaiian Guitar
Violin • Ukulele
Instrument Free

**First Hawaiian Conservatory
of Music, Inc.**
Desk 63 223 Broadway, (Woodworth Bldg.)
New York City



THIS
\$15.00
TENOR BANJO
FREE

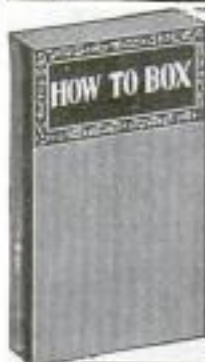

How to Box 40c

By Terry McGovern,
James J. Corbett,
J. Gardner Smith, M.D.,
Arthur P. Keeley and Gus. E. Keeley.

How to Box to Win, How to Build Muscle, How to Punch the Bag and How to Stand, Walk or Run.

This interesting book written by experts is known also as "The Book of Health and Strength." It will greatly assist everyone in keeping fit, in putting them in condition to master a strenuous undertaking either physical or mental.

63 Illustrations. Size 4 1/2 x 7 1/2 in. Paper cover, 135 pages
SHREWSBURY PUBLISHING CO.
5311 West Lake Street, CHICAGO, ILL.

MUSIC LESSONS FREE

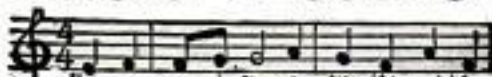

**IN YOUR
OWN
HOME**

You can read music like this quickly

Piano, Organ, Violin, Mandolin, Guitar, Banjo, etc.
Beginners or advanced players. One lesson weekly. Illustrations make everything plain. Only expense about 2c per day to cover cost of postage and music used. Write for FREE booklet which explains everything in full.

AMERICAN SCHOOL OF MUSIC, 51 Lakeside Building, CHICAGO

LAW STUDY AT HOME
Become a lawyer. Legally trained men win high positions and big success in business and public life. Greater opportunities now than ever before. Lawyers earn \$3,000 to \$10,000 Annually. We guide you step by step. You can train at home during spare time. Let us send you records and letters from capable students admitted to the bar in various states. Degree of LL. B. conferred. Thousands of successful students enrolled. Low cost—easy terms. We furnish all text material, including fourteen-volume Law Library. Get our valuable 125-page "Law Guide" and "Evidence" books FREE. Send for them—NOW.
LaSalle Extension University, Dept. 1264-L, Chicago, Ill.

LEARN WATCHMAKING

and become independent. Good-paying positions secured.

Easy to learn. Send for FREE CATALOG.

ST. LOUIS WATCHMAKING SCHOOL, Dept. 5, ST. LOUIS, MO.



Wonderful, new device, guides your hand; corrects your writing in few days. Big improvement in three hours. No failures. Complete outline FREE. Write C. J. Gament, D-34, St. Louis, Mo.

PRACTICAL ELECTRICITY SELF TAUGHT COMPLETE COURSE IN ELECTRICITY FOR FREE EXAMINATION



HAWKINS ELECTRICAL GUIDES

3500 PAGES—4700 PICTURES—\$1 A VOLUME—\$1 A MONTH—10 VOLUMES

OVER 5000
READERS
HAVE
OWNED
THIS
SET

Know the facts in Electricity. They mean more money and better position for you. Hawkins Guides tell you all you need to know about Electricity. Every important electrical subject covered so you can understand it. Easy to study and apply. A complete, practical working course, in 10 volumes. Books are pocket size; flexible covers. Order a set today to look over.

LEARN ALL ABOUT THESE IMPORTANT POINTS

Magnetism—Induction—Experiments—Dynamometers—Electric Machinery—Motors—Armatures—Armature Windings—Insulating of Dynamometers—Electrical Instrument Testing—Practical Management of Dynamometers and Motors—Distribution Systems—Wiring—Wiring Diagrams—Sign Flashers—Storage Batteries—Principles of Alternating Currents and Alter-

nators—Alternating Current Motors—Transformers—Converters—Rectifiers—Alternating Current Systems—Circuit Breakers—Measuring Instruments—Switchboards—Wiring—Power Stations—Installing—Telephone—Telegraph—Wireless—Bells—Lighting—Railways. Also many Modern Practical Applications of Electricity and Ready Reference Index of the ten numbers.

FREE Not a cent to pay until you see the books. No obligation to buy unless you are satisfied. Send Coupon now—today—and get this great help library and see if it is not worth \$100 to you—you pay \$1 a month for ten months or return it.

THEO. AUDEL & CO., 72 Fifth Ave., New York City

Please submit me for free examination, HAWKINS ELECTRICAL GUIDE. (Price \$1 a number). Ship at once prepaid, the 10 numbers. If satisfactory, I agree to send you \$1 within seven days and to further mail you \$1.00 each month until paid.

Name.....
Occupation.....
Employed by.....
Home Address.....
Reference.....

PM Dec. '23.



Will you accept a Big Pay Position?

**\$85⁰⁰ to \$200⁰⁰ Weekly
to SALESMEN**

You can quickly qualify to accept a sales position paying from \$85 to \$200 weekly with big, successful Corporations. I will train you quickly, in spare time, by my entirely different and proven successful method, the "Ward Actual Experience Method." Not a "college" or "book" course, the *real thing* direct from the "firing line."



I Pledge You Success

You get my personal directions, I let you in on "selling knacks" that enabled me to organize and train my own powerful sales organization. I also direct and guide you by weekly letters just as I do my own active road men, you simply can't fail to make good. Get my free book full of "Inside Facts" and latest Selling Science, it's FREE.

JAS. P. WARD, General Sales Manager

"The man who makes money makers"

JAMES P. WARD, Gen. Sales Mgr.
5109 Executive Offices,

1760-1774 Montrose Ave., Chicago

Dear Sir: Send me your book *Sales-Manship* and your special plan without cost or obligation.

FREE

Name _____

Address _____ City _____

State _____ Occupation _____

\$25 A DAY Clear Profit



—every day you work. Make \$5,000 to \$10,000 a year in the Floor Surfacing Business with the American "Universal" method. Work for yourself. Experience, special training or large investment unnecessary.

New Field; Big Profits

Better floors are demanded everywhere. American "Universal" electric machine, doing work of six men, assures **BIG PROFITS** in this new uncrowded field. Every floor,—old or new,—in town or city, is your prospect. Work easy to get. Profit possibilities unlimited. Positive guarantee and 5-day trial offer protects you. Write today for complete details.

AMERICAN FLOOR SURFACING MACHINE CO.
523 S. St. Clair St., TOLEDO, OHIO

Novelty



Musical Instruments

Not toys—but high-grade practical instruments for Symphony or Jazz orchestras. Great for solo work at Club, Lodge or Legion gatherings or home entertainments. Anyone can play with a few simple lessons, furnished with each instrument.

Musical Pitch Fork
Mando-Zi Harp

Gramophone
Musical Saw

Jazz-O-Netto
Hohner Sax

Free Trial Try any of these instruments for 15 days. If not satisfied, if you can't learn to play it quickly and easily, return at our expense. Remarkably low prices. Easy Time Payments. Send today for new, illustrated catalog describing complete line.

MUSSEHL & WESTPHAL 422 E. Water Street
St. Atkinson, Wis.

Anyone CAN LEARN



No talent or experience necessary. Fascinating work. Pays big money. Complete instruction book for: Signs, Colored, How to Make Signs, Show Cards, Window Board and Wall Signs, Ready made letters, Gilding, Tricks of the Trade, also gives 100 Alphabets and Designs. Book bound in flexible red, leather-fold edges, and four full bearing Show Cards. Price, \$3.00, C.O.D. U.S. Money.



EARN MONEY IMMEDIATELY—
WE FURNISH EQUIPMENT TO START!!

I can show

how you can make \$75.00 a week without money or experience and get your pay daily, selling men's \$50 suits for \$31.75. Get the facts. Write me at once.

LOUIS S. SCHWARTZ, Mgr.

GOODWEAR, Inc., Dept. 701, CHICAGO



MEN WANTED

Prepare as Firemen, Brakemen, Electric Motormen, and colored Train Porters. Hundreds put to work. No experience necessary. 500 more wanted. Name position you want.

RAILWAY INSTITUTE Dept. 35 Indianapolis, Ind.

MINSTRELS

Musical Comedies and Revues, with full instructions for staging. You can stage your own show with our books. Full line of plays, music, cross-fire, monologues, afterpieces, vaudeville acts and makeup. Catalogs Free.

T. S. DENISON & CO., 623 So. Wabash, Dept. 19, CHICAGO

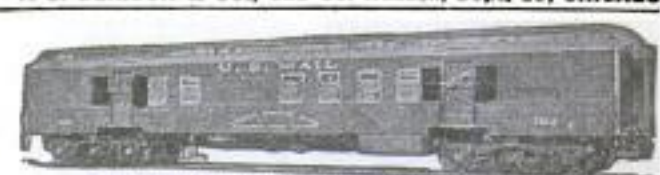

WANTED

RAILWAY POSTAL CLERKS

\$1600 to \$2300 Year

MEN — BOYS 18 UP.

MAIL COUPON IMMEDIATELY

Steady work. No layoffs. Paid Vacations

Common education sufficient:

TRAVEL — SEE THE COUNTRY

FRANKLIN INSTITUTE, Dept. D178, Rochester, N. Y.
First: Send me without charge, (1) Sample Railway Postal Clerk Examination questions; (2) List of government jobs now obtainable; (3) Send free illustrated book, "How to Get Government Jobs."

Name

Address

FREE Trial Lesson



This lesson in Drafting is sent free upon request. Learn from it how well qualified you are for this profession. See also how Chicago Tech. gives expert training by mail. While other schools require enrollment and payment of fee in advance, Chicago Tech. sends this lesson first. Just mail the coupon.



DRAFTING Train at Home in Spare Time

Make hours that you have now idle count in training that will double your income. By utilizing a little of your spare time under the direction of the Chicago Tech. experts, you can become a master Draftsman—you can command a high salary and hold an important position. No need to stay in a "blind alley" job, no need to wait years for real success when you can so easily acquire a profession which will put you among the men for whom great opportunities are always open.

You Can Double Your Earnings

There are not enough really able Draftsmen to supply the demand. Great industries everywhere are searching for men who have the training to handle the important problems which must be worked out practically and accurately—and the men who can do this work can name their own salaries. Don't put off a day—start now to get this Chicago Tech. training which gives you the short cut to a larger income.

Salary increased
75% since taking
the course.

T. F. Anderson

Income 300%
greater than be-
fore I enrolled.

R. L. Cary

Successful in own
business as result
of Chicago Tech.
Training.

O. L. Rosin

Get Practical Men Back of You

Chicago Tech. experts teach you the practical methods which enable you to take a job knowing just what to do and how to do it. No time put in on mere theories. Every lesson deals with actual problems and you have the direct, personal instruction of these experts at every step. All this, you get by mail in your spare time.

Chicago Tech. Men in Demand

Everywhere you find Chicago Tech. men in important positions, drawing high salaries, because they have the practical knowledge that makes them worth money to railroads, manufacturers, engineers, architects, contractors, electrical works and other great industries. This training given by mail or in day and evening classes at the College in Chicago.

Enrolled in the Chicago Tech. Home Study Drafting Course you get this complete Drawing Outfit (retail price \$25.00), without extra cost or you are given a credit on fees if you have an outfit.



Send the Coupon

Mail the coupon and get the Free Trial Lesson—also catalogs and full information about the Chicago Tech. Method of teaching Drafting by mail. Find out about the opportunities that Drafting offers to ambitious men. No cost to you—no obligation. Send the coupon.

Chicago Technical College,
1230 Chicago Tech. Bldg., Chicago, Ill.

Without cost or obligation on me please send instructive matter about opportunities in line I have marked with "X."

Drafting. (The Big Salary Course.) No experience necessary. Free Lesson sent now.

Building Trade Course. For men in the building lines.

Name

Address

Post Office State

To Employers:

Chicago Tech. men are practical. Write to us when you need Draftsmen.

CHICAGO TECHNICAL COLLEGE 1230 CHICAGO TECH. BLDG.
CHICAGO, ILL.

BOYS



Drawn from actual photograph of student doing spare time electrical work

Learn Electricity Make Big Money

How would you like to earn two or three dollars every evening after school and prepare yourself for a fine big job at the same time? Here's the opportunity of a lifetime for you fellows who like Electricity. Begin right now to prepare yourself for a regular man's size job in this fascinating field. Your chances for a big success are simply wonderful—the pay is big (\$70 to \$200 a week) and advancement comes swift and sure.

I will Train You at Home

With my easily learned, spare time Electrical Course I will train you at home like I have trained hundreds of other boys who are now big successful men. It will not interfere with your school work and you can earn more than the small cost of the course doing odd electrical jobs in your spare time. The Course pays for itself. I will show you how to get this work and how to do it. Some of my boy students make \$10 to \$15 a week this way.

Tools, Apparatus and Radio Course—FREE

Send me the coupon below and I will tell you all about the big outfit of tools, apparatus and instruments and a new Radio Course that I am giving to my students for a limited time. I will send you my big interesting Electrical Book and a sample lesson, too—all Free. You will be tickled with the things I will send you Free. Mail the coupon right now.

L. L. COOKE, Chief Engineer
Chicago Engineering Works
Dept. A-19 CHICAGO

Use This "FREE OUTFIT" Coupon

L. L. COOKE, Chief Engineer,
Chicago Engineering Works,
Dept. A-19 2150 Lawrence Avenue, Chicago

Send me your Free Outfit Offer, your big Electrical Book, Sample Lesson and particulars of your Electrical Course and Free Radio Course. This will not obligate me in any way.

Name.....

Address.....

This Coupon only for use of boys 15 years old or more.

Look What This Boy Is Doing

"Although the School term is coming to a close, and I am pretty busy with my examinations, I manage to keep up with my electrical studies and work."

"I guess I forgot to tell you I am now in business for myself. Am doing fine, but owe it all to you. If it had not been for your Course, I, being under age, could not have secured my license in this town. But I got it, and now have all the work I can do, averaging \$20 to \$30 a week, thru spare time work."

ROGER SMITH,
1216 Chestnut St.,
Greenville, N.C.

We Teach COMMERCIAL ART

Meyer Both Company, the largest Commercial Art Organization in the World

offers you an unusual opportunity for practical training, based upon twenty-three years of success. This nationally known organization each year produces and sells to advertisers over 15,000 commercial drawings. Meyer Both instruction is the difference between successful fact and experimental theory. This well paid profession equally open to men and women. Home study instruction.

Get Facts Before You Enroll in Any School

Ask the Advertising Manager of the leading newspapers in your city, anywhere in the United States, Canada, England or Australia about the Meyer Both Company—let them tell you about us. Write for our illustrated book telling about the success of our students—for one-half the cost of mailing—four cents in stamps.

MEYER BOTH COMPANY Department of Art Instruction

Michigan Ave. at 24th St., Dept. 16 CHICAGO, ILL.

Note—To Art and Engraving Firms: Secure practical artists among our graduates. Write us.

STAMMER

If you stammer attend no stammering school till you get my large FREE book entitled "STAMMERING, Its Origin and the Advanced Natural Method of Cure," bound in cloth and stamped in pure gold. Ask for special tuition rate and a FREE copy of "The Natural Speech Magazine." Largest, best equipped and most successful school in the world for the cure of stammering, stuttering, etc. No sing-song or time beat. Write today. The North-Western School, 2317 Grand Ave., Milwaukee, Wis.

Music Lessons At Home

With Celebrated TEACHERS

Lessons specially prepared for home study. Endorsed by Paderewski. Not a new method. Long established school now celebrating its 20th Anniversary.

Any Instrument Write naming course you are interested in—Piano, Harmony, Voice, Public School Music, Violin, Cornet, Mandolin, Guitar, Banjo or Reed Organ—and we will send FREE CATALOG. SEND for it NOW!

UNIVERSITY EXTENSION CONSERVATORY

844 Siegel-Myers Building

Chicago, Illinois

Learn to Mount Birds



Learn at home by mail, to mount birds, animals, game heads; tan furs, make rugs and robes. Complete lessons. Easily and quickly learned by men, boys and women.

FREE Write today for Free Taxidermy Book. Tells all about it. Every Sportsman, Hunter, Trapper and Nature lover should know this wonderful fascinating art. Save your trophies. Big profits. Success guaranteed. Our school is 20 years old—75,000 graduates. Investigate today. Write for Free Book.

Northwestern School of Taxidermy

1779 Elwood Bldg., Omaha, Neb.

LEARN WATCH REPAIRING



You can learn by our modern and original system of instruction every part of the Watch Repairing Trade at home as good or better than at a shop. You can earn money while learning and secure a well paying position or start in business after completing our course of instruction. Good watch repairers are always in demand and earn from \$30 to \$70 per week. For particulars apply to the Wisconsin School of Watch Repairing 140 Mason St., MILWAUKEE, WIS.

These Books FREE For One Week

Send no money—just fill out the coupon. After you receive the full set of books, express collect, read them over and test them out for seven days. If you don't want them, send them back at our expense. If you decide they will do for you what they have done for more than 100,000 others, pay \$2.80 within one week and \$3 each month thereafter until the special price of \$21.80 is paid. This amounts to only ten cents a day. Mail coupon NOW if you want a bigger, better job at higher wages.

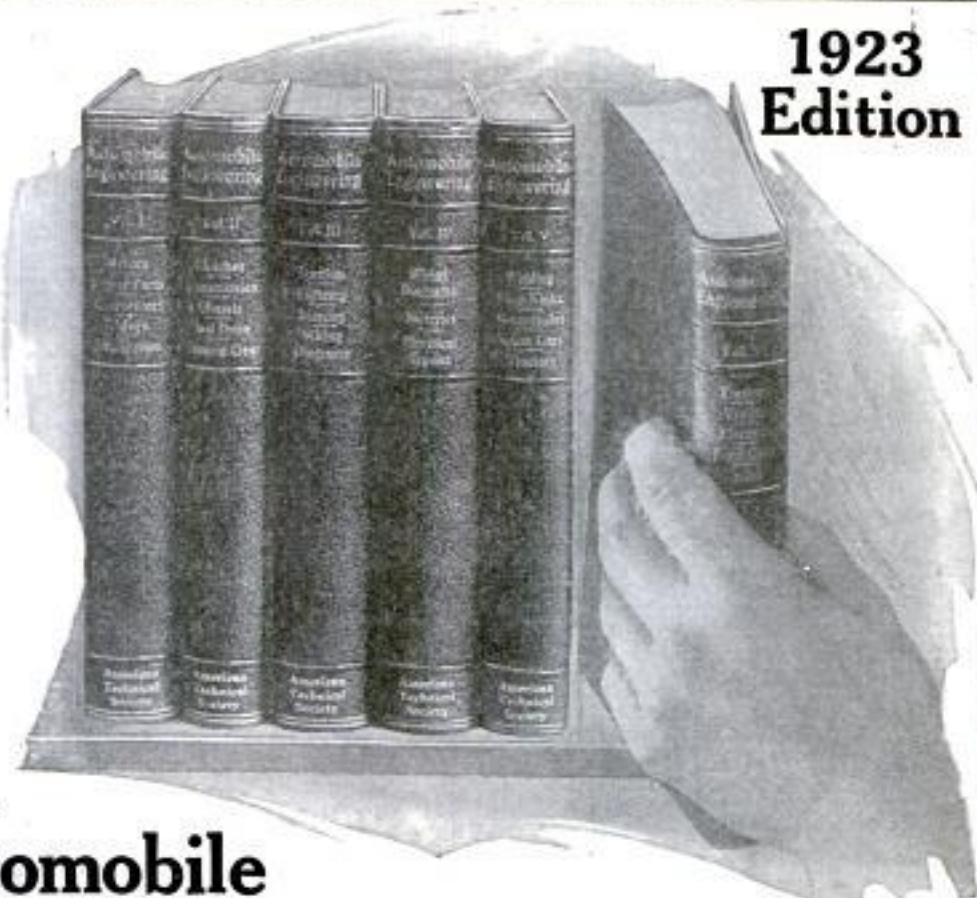

1923 Edition

All Automobile Engineering Facts at Your Fingers' Tips

Six Complete New Books for Study or Reference
Also Year's Consulting Membership in
American Technical Society—FREE

Here's the most practical set of books ever written on automobile engineering. Each book is brimful of information about the various phases of this work. 2,600 pages, 2,300 pictures and diagrams, 125 blue prints on every subject. Practical problems are solved in everyday language. They make automobile engineering as plain as day. Completely cross indexed for ready reference.

Know All About Automobiles and Earn Big Pay

These are just the books for the man who wants to know all about automobiles and fit himself for a big-paying job. They are interesting from start to finish and crammed with information. A little regular reading in them during spare hours will soon equip you for

the automobile business. Then after you get into the auto game, you'll still have them for reference.

Let These Books Solve Your Daily Problems

To the man now engaged as a mechanic or shop foreman, these books will give a world of help. They dig deep into the technical angles and theories and explain them in everyday words. If you have trouble on any point, you'll find the answer in these books. They are the work of fifteen auto experts who know from experience, the problems and difficulties of the shopman.

Repair Your Own Car

The car-owner will find these books extremely valuable as an aid in repairing his own car. Think of the heavy repair bills this will eliminate. Think of the money you can save.

© A.T.S. 1923

FREE Consulting Membership

A resident consulting staff of 18 practical experts is waiting to solve for you any auto, tractor or motorcycle troubles that you may have. A letter or a wire to the American Technical Society will bring you an immediate answer and the solution to your problems. This advisory staff of practical automobile men plus your library of Automobile Engineering will enable you to handle successfully any auto job. These men know all the latest methods and the newest and best ways of doing things. Let this pay-raising consulting staff be YOUR SILENT PARTNER. Use this service daily if necessary.

This free consulting membership offer is good for a limited time only and can be withdrawn without notice.

American Technical Society
Dept. A-919 Chicago, U. S. A.

AMERICAN TECHNICAL SOCIETY, Dept. A-919
Chicago, U. S. A.

Please send me a set of Automobile Engineering, for seven days' FREE EXAMINATION, shipping charges collect. I will examine these books thoroughly, and if satisfied; will send \$2.80 within seven days and \$3 a month until I have paid the special price of \$21.80. If I decide not to keep the books, I will return them within one week at your expense. It is understood that if I keep the books I am entitled to a FREE Consulting Membership in the Automotive Division of the Society.

Name.....

Address.....

Reference.....

(Please fill out all lines, give local merchant, banker or employer as reference.)



This Man Earns \$3500 to \$5000 a Year

—WORKING WITH A DENTIST—
THREE MONTHS' TRAINING
QUALIFIED HIM TO DO IT

There are thousands of these positions awaiting trained men in this profitable profession. After just a few months of specialized training hundreds of men will have become full-fledged members of the dignified profession of

MECHANICAL DENTISTRY

They will have the technical knowledge and skill to enable them to earn several thousand per year. You can be among them. The Dental Profession needs 2500 more Dental Mechanics right now and is constantly calling for graduates of the four great schools of this institution; salaries from \$35 to \$45 a week to start, with advancement up to \$125 a week.

FREE PARTIAL SCHOLARSHIPS

In order to meet this urgent demand for the men we train, we are offering for a limited time Free Partial Scholarships. You will want to get in on this exceptional offer—so don't delay. NOW is the time!

JUST COMPARE

Compare the unusual opportunities this profitable professional trade offers with what you are now doing—the earnings, the pleasant, dignified occupation. Compare also our ability to train you and put you in touch with the right opportunity—our four large, well-equipped schools, over 30 years of experience in this one line, our wide acquaintance with the Dental Profession throughout the nation!

SEND FOR CATALOG AND SCHOLARSHIP OFFER

Describes the field and why the demand. Shows how students "Learn by Doing" actual work through practical, individual instruction, day or evening session. Shows how you can "Earn while Learning."

BODEE DENTAL INSTITUTE

136 West 52d Street, NEW YORK

PHILADELPHIA BUFFALO BROOKLYN
1305 No. Broad St. 1226 Main St. 15 Flatbush Ave.

BODEE DENTAL INSTITUTE: Without obligation to me send me a Free Copy of your catalog and complete details of the Free Partial Scholarship Plan.

Name

Address

Please Mention Popular Mechanics



Play PIANO By Ear

No matter how little you know about music, if you can just remember a tune, I teach you to play Jazz, Ragtime, Popular Songs **BY EAR, easily, quickly**. Beginners and even those who could not learn by the old-fashioned method grasp the Niagara idea readily. Self-instruction—no teacher required. You learn many new styles of bass, syncopation—blues, fill-ins, breaks, trick endings, etc. Why spend years studying tiresome scales and finger exercises when I teach you to

Be a Master of JAZZ and RAGTIME Learn at Home in 90 Days

and play any tune you can remember, by ear—without notes. Original method: wonderful, easy. No do-re-mi—no scales—just a few simple rules, a little practice—results are amazing. Letters from hundreds of enthusiastic pupils and interesting book SENT FREE. No other course like it—fully protected by copyright. Simply write me name, address. State if you have ever taken piano lessons.

Ronald G. Wright, Director,
NIAGARA SCHOOL OF MUSIC
Department 609 Niagara Falls, N. Y.



Send for this Free Book

Rider Agents Wanted

Select from the 44 Styles, colors and sizes of Ranger Bicycles. Ride and exhibit sample Ranger and make money. Delivered free, express prepaid, on approval. Factory-to-Rider prices save \$20 to \$25.

12 Months to Pay on any Ranger if desired. Boys and girls easily save the small monthly payments. Parents often advance first payment.

Best quality, at factory prices, express prepaid. Tires, lamps, wheels and equipment, low prices. Send No Money, do business direct with makers.

Mead Cycle Company
Depts. 108 Chicago

Write today for free Ranger Catalog, factory prices and marvelous easy payment terms.



"STAMMERING

Its Cause and Cure"

You can be quickly cured if you stammer. Send 10 cents, coin or stamps, for 288 page cloth bound book on Stammering and Stuttering. It tells how I cured myself after Stammering and Stuttering for 20 years. BENJAMIN N. BOGUE
6904 Bogue Building, 1147 N. III. St. Indianapolis

LET THORNTON FISHER TEACH YOU CARTOONING

A Fascinating Profession

For the past twelve years, THORNTON FISHER has become intimately known to millions of readers of New York World and other leading newspapers for characteristic cartoons on sport and political subjects. In the height of his fame he resigned to teach others his art. Study Cartooning, newspaper illustrating and comic drawing now, at home, under the teaching of this high paid artist. The most fascinating work in the fascinating newspaper business. Pays \$75 to \$200 a week. Send 5 cents today for portfolio of Fisher's work and his booklet.

THORNTON FISHER SCHOOL
Box 133, Times Bldg., NEW YORK CITY



LEARN WATCH REPAIRING

Be a watchmaker—you can learn this profitable trade by correspondence in a few weeks in your own home by the De-Selms Chart System. After you complete the course you will know a watch from A to Z. You will know just what the matter is and how to repair it. When you graduate you will be a practical watchmaker and repairer and competent to fill any position. Positions for our graduates. Ask for our Free Book. It explains our system and terms.

THE De-SELMS WATCH SCHOOL
23 Perry Street ATTICA, INDIANA



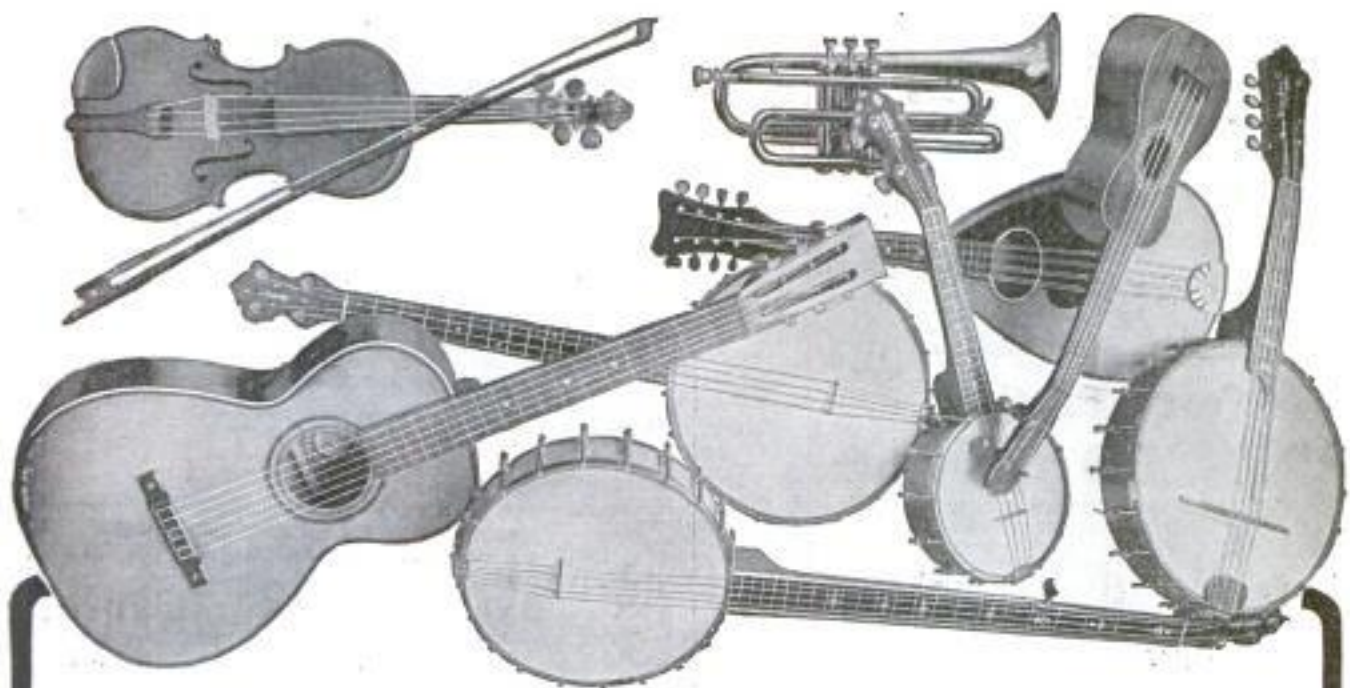

YOUR CHOICE \$
FREE 20 *Violin, Mandolin, Guitar, Ukulele, Hawaiian Guitar, Banjo, Banjo Mandolin, Tenor Banjo, Cornet or Banjo Ukulele*

Actually given away, absolutely free, to pupils in each locality. Last year we gave away thousands of high-grade musical instruments on this sensational offer, now repeated for YOUR benefit.

We have the most wonderful new system of teaching NOTE music by mail. Take your choice of any of these magnificent instruments absolutely free and learn to play by this easy to learn method. Can have you playing standard note music in 4 lessons. A very small charge for lessons—just a few cents a week—your only expense. Your success guaranteed. Pay nothing if you fail to learn; you take no risk. Complete outfit free with every instrument. Don't wait a minute, but mail the coupon NOW.

To Advertise Our Copyrighted Course

Our plan is, \$2.00 monthly for lessons. No charge for instrument. Ukulele and banjo ukulele given free with 20 lessons at 50c a lesson. Tenor banjo, banjo and Hawaiian Guitar given free with 32 lessons at 50c a lesson. Violin, mandolin, guitar and banjo mandolin given free with 56 lessons, 43 1/2c a lesson. Lessons are mailed one each week. Fill out the coupon and enclose \$2.00 or, we will send instrument and complete outfit subject to examination at express office C. O. D. \$2.00 for first month's lessons, and you will get an instrument you will be proud to own. At end of one week if you are not delighted with instrument and lessons, send outfit back and we will refund your money.

Do not delay, but mail the coupon today, before it is too late. Be sure to state whether you want a free Violin, Mandolin, Guitar, Ukulele, Hawaiian Guitar, Banjo, Banjo Mandolin, Tenor Banjo. We guarantee any one of these instruments positively worth \$20 or more. For cornet, piano, organ and further information, write for booklet.

Slingerland's Correspondence School of Music
 Department 2
 Corner Orchard and Willow Sts., Chicago, Ill.

FREE INSTRUMENT COUPON

Slingerland's Correspondence School of Music
 Department 2, Corner Orchard and Willow Streets
 Chicago, Illinois

Please send me one.....free.
(Name of instrument)

- Plan No. 1. I am enclosing \$2.00 for first month's lessons
- Plan No. 2. Send outfit and lesson C. O. D. \$2.00; but if I am not satisfied at end of one week's trial, I will return outfit and my \$2.00 is to be returned to me or, I will pay \$2.00 monthly until lessons are paid for.

Name.....
(Print or write plainly)

St. & Number.....

R. F. D.....

City.....State.....



He Earns \$200 a Week

Seems like a lot of money to the man in the routine job—\$200 a week—but not to the trained salesman.

Today, any number of men—and they're not unusual, either—are earning salary and commissions better than \$10,000 a year. They travel from one big city to another—live comfortably at the best hotels—mix daily with successful business men—and they are continually growing in a business way.

Perhaps you have thought that selling required some special gift. But it isn't true!

The successful salesman succeeds because he knows his line—and because he is master of the principles and methods of scientific salesmanship.

And you, too—if you have average intelligence—can acquire that understanding and you can go out and increase your earnings in a way that will actually amaze you.

FREE—Send for the book "Modern Salesmanship"

LaSalle training in Salesmanship is by the home-study method and is based on the successful experience of more than a thousand outstanding salesmen. An important part of the training consists in the solving of actual sales problems furnished by many of the leading sales organizations in the country. These companies have generously turned over to LaSalle their most effective sales methods—have revealed in detail the scientific selling processes responsible for their success.

Commenting on the LaSalle course in Modern Salesmanship, C. J. Jones, of Canada, writes:

"The first two texts have given me so much that I am firmly convinced that if I never learned anything more from the course, I would have a full return for the entire investment, and I will tell you frankly that I would not take \$25,000 for my contract if another could not be had."

If you are in a routine job with limited possibilities and have a real desire to become a salesman—or if you are now actually in the selling field and anxious to build your earning capacity to the highest possible point—you will find it greatly to your advantage to send for "Modern Salesmanship."

The coupon will bring it to you promptly and without obligation. Put it in the mail TODAY.

LASALLE EXTENSION UNIVERSITY
The Largest Business Training Institution in the World
Dept. 1264-SR Chicago, Illinois

Gentlemen: Send without obligation to me information regarding course indicated below:

Modern Salesmanship

LaSalle is the largest business training institution in the world. It offers training for every important business need. If more interested in any of these courses, check here:

- | | |
|--|--|
| <input type="checkbox"/> Business Management | <input type="checkbox"/> Modern Business Correspondence and Practice |
| <input type="checkbox"/> Higher Accountancy | <input type="checkbox"/> Modern Foremanship and Production Methods |
| <input type="checkbox"/> Traffic Management—Foreign and Domestic | <input type="checkbox"/> Personnel and Employment Management |
| <input type="checkbox"/> Railway Station Management | <input type="checkbox"/> Expert Bookkeeping |
| <input type="checkbox"/> Law, Degree of LL.B. | <input type="checkbox"/> Business English |
| <input type="checkbox"/> Commercial Law | <input type="checkbox"/> Business Spanish |
| <input type="checkbox"/> Industrial Management Efficiency | <input type="checkbox"/> Commercial Spanish |
| <input type="checkbox"/> Banking and Finance | <input type="checkbox"/> Effective Speaking |
| | <input type="checkbox"/> C. P. A. Coaching |

Name.....

Present Position.....

Address.....

Please Mention Popular Mechanics

BE AN ARTIST

We can teach you **DRAWING** in your own home during your sparetime.

Our 18 years of successful teaching prove our ability. 10 Courses in Commercial and Illustrative Drawing. Teachers Normal and Applied Art. Endorsed by high art authorities. Students trained by members of our Faculty are filling high-salaried positions. Artist's Outfit FREE to Enrolled Students. Write today for Art Year Book.

OUR HANDSOME ART YEAR BOOK
"FREE" 75¢ Book.

SCHOOL OF APPLIED ART
APPLIED ART BLDG. NO. 2 BATTLE CREEK MICH.

SHORTHAND IN ONE MONTH

Wonderful, Easy System—The **BOYD**
Writers hold World's Record
100 to 150 words a minute in 30 days guaranteed. Big demand for trained Stenographers and Private Secretaries. Learn a profession that pays big.

What Students Say:
"Your Course is Wonderful."—M. R. W.
"It beats all other Systems."—F. Z.

The Boyd can be learned in one-sixth the time of other systems. It is the NEW WAY in Shorthand. Dictation first week—in 30 days you are ready for a position. Send today for Catalog and Money-Back Guarantee.

CHICAGO HOME-STUDY SCHOOLS
802 Reaper Block Chicago, Illinois

ELECTRICAL ENGINEERING IN ONE YEAR

men with training are in demand. For more than a quarter of a century this school has been training men of ambition and limited time, for the electrical industries. Condensed course in Electrical Engineering enables graduates to secure good positions and promotions. Theoretical and practical Electricity, Mathematics, Steam and Gas Engines, Mechanical Drawing. Students construct dynamos, install wiring and test electrical machinery. Course with diploma, complete.

Thoroughly equipped fireproof dormitories, dining hall, laboratories, shops. Over 3000 men trained. Write for catalog. 31st year begins Sept. 26, 1923.

BLISS ELECTRICAL SCHOOL
104 TAKOMA AVENUE, WASHINGTON, D. C.

LEARN WATCHMAKING AND ENGRAVING

Earn while learning. Most practical watch school. Individual instructions. Graduates in great demand. Book free.

Chicago School of Watchmaking, Dept. 20, 4849 Lincoln Ave., Chicago

PIANO JAZZ

By Note or Ear. With or without music. Short Course. Adult beginners taught by mail. No teacher required. Self-Instruction Course for Advanced Pianists. Learn 67 styles of Bass, 180 Syncopated Effects, Blue Harmony, Oriental, Chime, Movie and Cafe Jazz, Trick Endings, Clever Breaks, Space Fillers, Sax Sturs, Triple Bass, Wicked Harmony, Blue Oblitango, and 247 other Subjects, including Ear Playing. 110 pages of REAL Jazz, 25,000 words. A Postal brings our FREE Special Offer.

Waterman Piano School, 250 S. Santa Theatre Bldg., Los Angeles, Cal.

POSITION GUARANTEED!

I Want You

The Finger Print Profession wants men immediately. Big pay, interesting work, no lay-offs or shut-downs. I will teach you quickly to become a trained Finger Print expert. I guarantee a position and back it up with a \$1,000 bank deposit. Write at once for full explanation and details about my Free Secret Service course, free Secret Service reports and special low price. Offer is limited. Write at once. No obligation.

U. S. SCHOOL OF FINGER PRINTS, Dept. 13-59, 7003 No. Clark Street, Chicago.

FREE!

You Are On Trial!

Will the Verdict be Death or Torture?



EVERY day every one of us is on trial for some violation, no matter how slight, of the laws of Nature. The courtroom is always crowded, but cases are handled rapidly, for someone is sentenced every second. To most people Nature is a severe and inexorable judge who accepts no excuses. Notice the culprits as they pass before this unrelenting Magistrate—thin, weak, pale, anemic, unfit-looking people, most of them. The punishments handed out to these offenders are sometimes pretty severe considering the trivial offense.

To one the sentence is, "One week in bed!"; to another, "Three months in the hospital!"; to another "Two years or toast and hot milk!"; to another, "Ten years of torture!"; to another "A crippled leg for life!" Now and then as some poor wretch comes up for judgment, the Magistrate draws on his black cap and solemnly pronounces the sentence, "DEATH!"

But occasionally a different sort of offender steps up to the rail—a lith, ruddy, clear-eyed chap whose smooth skin is plumply filled with sound, hard flesh which ripples under it in muscular cords

and knots. He has perhaps committed some error in diet or hygiene, but it is evident that the Judge is disposed to be lenient with him. He merely shakes his finger at him, trying to hide a smile as he does so, and says "You've been a pretty healthy citizen in the past, so I'll let you off easy this time. Discharged!" and his eye follows the powerful figure with approval as he strides out of the courtroom.

Whispers have gone about through the crowd, "Who is he?" "Aw, some fellow with a pull! Wish I could get into favor like that." **! You CAN do it, my friend!**



PROFESSOR HENRY W. TITUS
as he is to-day

Pronounced by the Medical Faculty as the strongest and most symmetrically developed athlete of his weight in America.

You Can Actually Have a "Pull" With Nature

All you need to do is to develop a strong, healthy, well-balanced body. Nature favors the man with a sound and powerful physique. He is proof against many diseases, exposures and accidents that would put other people in the hospital and perhaps kill them.

What about you? Are you one of those who are always suffering from some little illness, such as indigestion, colds, headaches, lack of energy, etc. Are you held back by this weakness so that you are failing to realize your ambitions? What

is the use of throwing away life's pleasures and profits when you can make yourself MASTER of all that you desire to achieve?

I have put thousands of Men and Women on the road to Efficiency, Happiness and Power. I have developed some of the World's greatest strong men—I have testimonials from these which you can read in my book described below. I can make an Athlete out of YOU, if you will follow my advice. For example, I can add an INCH to the MEASUREMENT of your ARM in 30 days.

Get My 56-Page Book "Building Better Bodies"

The clearest, soundest and most interesting treatise on Health and Strength ever written. It contains many photographs of famous Athletes and Strong Men who have been MADE by my System. My own weight-lifting records are mentioned, as well as those of others who have trained by my System. I give you this Book absolutely FREE. All I ask is that you send me 10 cents to help pay postage, wrapping, etc., and it will come to you by return mail. There will be no obligation on your part. Don't put it off; fill out the coupon TODAY.

PROF. HENRY W. TITUS
107 East 13th Street NEW YORK CITY

PROF. HENRY W. TITUS
Dept. 727, 107 East 13th Street, New York City

Dear Sir: I enclose 10 cents, for which please send me at once your book, "Building Better Bodies." It is understood that there is no obligation on my part whatsoever.

Name.....

Street No.....

City..... State.....



An Easy Way to Learn PHARMACY AT HOME

Graduate pharmacists are always in demand. The work is interesting and pleasant and salaries are good. Many young men open drug stores of their own and become independent.

There's an easy way to learn pharmacy right in your own home in spare time, without losing a day or a dollar from your present work.

The International Correspondence Schools course in Pharmacy supplies the knowledge which it will be necessary for you to have in order that you may pass your State Board Examination.

Just mark and mail the coupon printed below to the International Correspondence Schools, Box 5563-D, Scranton, Pa., and full particulars about the Pharmacy Course or any other work of your choice will come speeding to you by return mail.

INTERNATIONAL CORRESPONDENCE SCHOOLS Box 5563-D, Scranton, Penna.

Without cost or obligation, please send me full information about the subject before which I have marked an X in the list below:

TECHNICAL AND INDUSTRIAL COURSES

- | | |
|--|---|
| <input type="checkbox"/> PHARMACY | <input type="checkbox"/> Civil Engineer |
| <input type="checkbox"/> Chemistry | <input type="checkbox"/> Surveying and Mapping |
| <input type="checkbox"/> Automobile Work | <input type="checkbox"/> Mine Foreman or Engineer |
| <input type="checkbox"/> Navigation | <input type="checkbox"/> Steam Engineer |
| <input type="checkbox"/> Agriculture and Poultry | <input type="checkbox"/> Gas Engine Operating |
| <input type="checkbox"/> Mathematics | <input type="checkbox"/> Wireless <input type="checkbox"/> Airplane Engines |
| <input type="checkbox"/> Electrical Engineering | <input type="checkbox"/> Architect |
| <input type="checkbox"/> Electrician | <input type="checkbox"/> Contractor and Builder |
| <input type="checkbox"/> Mechanical Engineer | <input type="checkbox"/> Architectural Draftsman |
| <input type="checkbox"/> Mechanical Draftsman | <input type="checkbox"/> Concrete Builder |
| <input type="checkbox"/> Machine Shop Practice | <input type="checkbox"/> Structural Engineer |
| <input type="checkbox"/> Railroad Positions | <input type="checkbox"/> Plumbing and Heating |

BUSINESS TRAINING COURSES

- | | |
|---|---|
| <input type="checkbox"/> Business Management | <input type="checkbox"/> Salesmanship |
| <input type="checkbox"/> Industrial Management | <input type="checkbox"/> Advertising |
| <input type="checkbox"/> Personnel Organization | <input type="checkbox"/> Letter Writers |
| <input type="checkbox"/> Traffic Management | <input type="checkbox"/> Foreign Trade |
| <input type="checkbox"/> Business Law | <input type="checkbox"/> Stenography and Typing |
| <input type="checkbox"/> Banking and Banking Law | <input type="checkbox"/> Business English |
| <input type="checkbox"/> Accountancy (including C.P.A.) | <input type="checkbox"/> Civil Service |
| <input type="checkbox"/> Nicholson Cost Accounting | <input type="checkbox"/> Railway Mail Clerk |
| <input type="checkbox"/> Bookkeeping | <input type="checkbox"/> Common School Subjects |
| <input type="checkbox"/> Private Secretary | <input type="checkbox"/> High School Subjects |
| <input type="checkbox"/> Business Spanish <input type="checkbox"/> French | <input type="checkbox"/> Illustrating <input type="checkbox"/> Cartooning |

Name.....
Street.....
Address.....

City..... State.....

Occupation.....

Persons residing in Canada should send this coupon to the International Correspondence Schools Canadian, Limited, Montreal, Canada.

New Easy Way to Learn CARTOONING

You can now quickly learn to make comics, spot cartoons, animated and serious cartoons, etc. Cartooning is lots of fun—and fun that pays **big money!** Learn cartooning at home in spare time this amazingly easy way.

SEND FOR FREE BOOK

Mail postcard or letter today for Free Book on Cartooning. It tells all about this easy method perfected by one of America's most successful cartoonists—also is filled with interesting facts about cartooning. Mail card TODAY! Give Age if under 16 years.



Washington School of Cartooning
Room 3012, 1113-15th St., N. W., WASHINGTON, D. C.

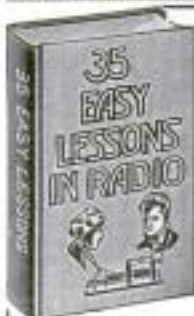

THIRTY-FIVE EASY LESSONS IN RADIO 50c

A systematic course of elementary principles written in a simple and concise lesson course, easily understood. Thousands have taken up Radio for entertainment and are operating their own amateur sets.

This book embodies all the principles and application of everyday radio for the home and in business. Paper cover.

Price postpaid 50c

SHREWSBURY PUBLISHING COMPANY
5311 West Lake Street CHICAGO, ILL.



FREE BOOK LEARN PIANO

This Interesting Free Book

shows how you can become a skilled player of piano or organ at **quarter** usual cost. It shows why one lesson with an expert is worth a dozen other lessons. Dr. Quinn's famous Written Method includes all of the many important modern improvements in teaching music. Brings right to your home the great advantages of conservatory study. For the beginner or experienced player. Endorsed by great artists. Successful graduates everywhere. Scientific yet easy to understand. Fully illustrated. All music free. Diploma granted. Write today for free book. Quinn Conservatory, Studio PH72, 598 Columbia Road, Boston 25, Mass.

HOW TO BECOME A PROFESSIONAL PHOTOGRAPHER

EARNING \$35 TO \$125 A WEEK



Three to six months' course. Motion Picture, Commercial, Portraiture. Practical instruction. Modern equipment. Ask for Catalog No. 49.

N. Y. INSTITUTE OF PHOTOGRAPHY
NEW YORK CHICAGO BROOKLYN
141 W. 36th St. 630 So. Wabash Ave. 505 State St.

STAMMER NO MORE

Kill the fear of stammering. Re-education the key. The widely famed Hatfield Method fully outlined in an accurate, dependable, worthwhile book—"HOW TO STOP STAMMERING." It has inspired thousands. Free copy today.

THE HATFIELD INSTITUTE, 109 N. Dearborn, Chicago, Ill.

HOME STUDY

Become More Efficient

through courses in Chemistry, History, Mathematics, English, Psychology, Education, Business and 35 other subjects

which the University gives by mail. They command credit toward a Bachelor degree and may be begun at any time.

The University of Chicago 15 Ellis Hall Chicago, Ill.

If New Hair Doesn't Grow After Using My Method — I Don't Want a Penny!

I mean just exactly what I say! I don't care how thin your hair may be—I don't care how many treatments you have taken without results. If my new discovery won't restore your hair, I don't want to keep a cent of your money! Furthermore I'll send you the proof of what I have done for others entirely FREE! Just mail the coupon below.

By ALOIS MERKE

Founder of Famous Merke Institute, Fifth Avenue, New York

AFTER 17 years' experience in treating baldness—which included long years of experimentation in Heidelberg, Paris, Berlin, and other centers of scientific research—I have discovered a startling new way to promote hair growth.

At the Merke Institute, Fifth Avenue, New York—which I founded—I have treated scores of prominent stage and social celebrities. Many have paid as high as \$500 for the results I have brought them.

Yet now, through a series of ingenious inventions, I have made it possible for everyone to avail themselves of my discovery—right in their own homes, and at a cost of only a few cents a day!

My Unusual Guarantee!

I know you are skeptical. I know that you have tried perhaps dozens of different remedies and treatments without results. All right. Perhaps my treatment cannot help you, either. I don't know. But I do know that it has banished falling hair and dandruff for hundreds of others. I do know that it has already given thick, luxuriant hair to people who long ago had despaired of regaining their hair. And

I am so downright positive that it will do the same for you that I absolutely GUARANTEE to grow new hair on your head—and if I fail, then the test is free.

Entirely New Method

What is my method? It is entirely new. It is entirely different from anything you ever heard of. No massaging—no singeing—no "mange" cures—no unnecessary fuss or bother of any kind. Yet results are usually noticeable even after the very first few treatments.

Many people have the idea when the hair falls out and no new hair appears, that the hair roots are always dead. I



have disproved this. For I have found in many cases that the hair roots were NOT dead, but merely dormant! Yet even if the scalp is completely bare, it is now possible in the majority of cases to awaken these dormant roots, and stimulate an entirely new growth of hair! I KNOW this to be true—because I do it every day.

Ordinary measures failed because they did not penetrate to these dormant roots. To make a tree grow, you would not think of rubbing "growing fluid" on the bark. Instead you would get right to the roots. And so it is with the hair.

There is only one method I know about of penetrating direct to the roots and getting nourishment to them. And this method is embodied in the treatment that I now offer you. The treatment can be used in any home in which there is electricity.

Already hundreds of men and women who only recently were bald or troubled with thin falling hair, have through this method, acquired hair so thick that it is the envy and admiration of their friends. As for dandruff and similar scalp disorders, these usually disappear after the first few applications.

Remember—I do not ask you to risk "one penny." You try it on my absolute GUARANTEE—and if after 30 days you are not more than delighted with the growth of hair produced, then I'll gladly return every cent you have paid me. I don't want your money unless I grow hair on your head.

Free Booklet Explains Treatment

If you will merely fill in and mail the coupon below I will gladly send you—without cost or obligation—an interesting 32-page booklet, describing my treatment in detail.

This booklet contains much helpful information on the care of the hair—and in addition shows by actual photographs what my treatment is doing for others.

No matter how bald you are—no matter if you are completely bald, this booklet will prove of deepest interest to you. So mail the coupon now—and it will be sent you by return mail.

ALLIED MERKE INSTITUTES, Inc.
512 Fifth Avenue, New York City, Dept. 1612

ALLIED MERKE INSTITUTES, Inc., Dept. 1612
512 Fifth Avenue, New York.

Please send me, without cost or obligation on my part, a copy of the new booklet describing in detail the Merke Institute Home Treatment.

Name.....

Address.....

City..... State.....

Actual Results

(Dozens of letters like the following are received every day by the Merke Institute.)

"Ten years ago my hair started falling. Four years ago I displayed a perfect full moon. I tried everything—but without results. Today, however, thanks to your treatment, I have quite a new crop of hair one inch long." F. H. B.

"The top of my head is now almost covered with new hair about one-half inch long. I have been trying five years, but could never find anything to make my hair grow until your treatment." T. C.

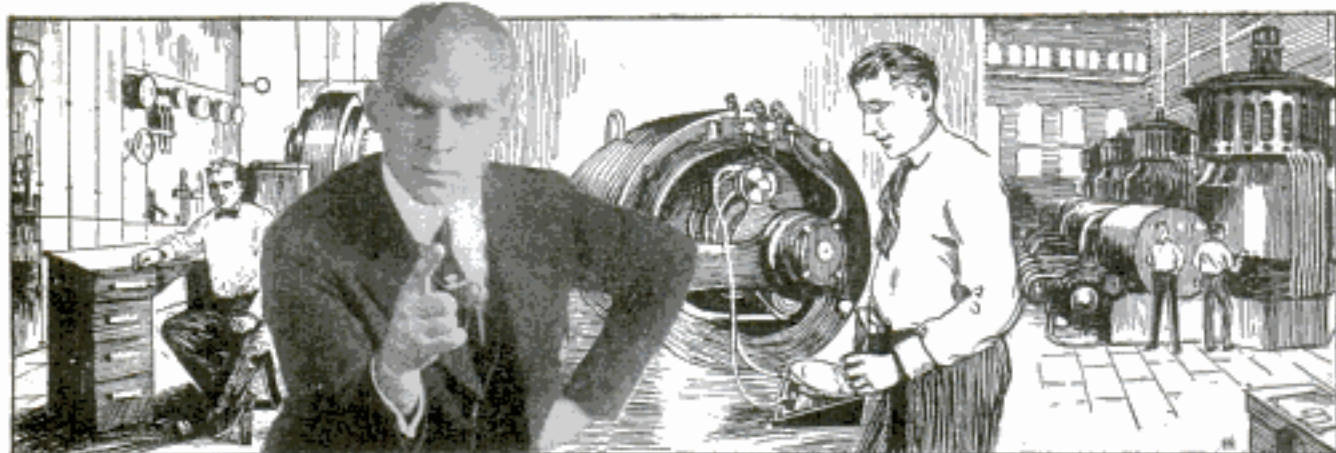

Electricity Needs You

I WILL TRAIN YOU AT HOME

Stop right here. This is YOUR opportunity! Electricity is calling you, and the Electrical Business is in for a tremendous increase. But it needs more trained men—at big pay. By my Home Study Course in Practical Electricity I can train you for these positions.

Earn \$70 to \$200 a Week

You've always had a liking for Electricity and a hankering to do electrical jobs. Now is the time to develop that talent; there's big money in it. Even if you don't know anything at all about Electricity you can quickly grasp it by my up-to-date, practical method of teaching. You will find it intensely interesting and highly profitable. I've trained and started hundreds of men in the Electrical Business, men who have made big successes. YOU CAN ALSO

Be a Big Paid ELECTRICAL EXPERT

What are you doing to prepare yourself for a real success? At the rate you are going where will you be in ten years from now? Have you the specialized training that will put you on the road to success? Have you ambition enough to prepare for success, and get it?

You have the ambition and I will give you the training, so get busy. I am offering you success and all that goes with it. Will you take it? I'll make you an ELECTRICAL EXPERT. I will train you as you should be trained. I will give you the benefit of my advice and 20 years of engineering experience and help you in every way to the biggest, possible success.

Chief Engineer Cooke
Chicago Engineering Works
Dept. 19, 2154 Lawrence Avenue
CHICAGO, ILL.

Dear Sir: You may send me, entirely free and fully prepaid, a copy of your book, "How to Become an Electrical Expert," and particulars about your Home Study Course in Electricity.

Name.....

Address.....

Occupation..... Age.....

Valuable Book Free

My book, "How to Become an Electrical Expert," has started many a man on the way to fortune. I will send a copy, free and prepaid, to every person answering this advertisement.

Act Now! Good intentions never get you anywhere. It is action, alone, that counts. NOW IS THE TIME TO ACT.

L. L. COOKE, Chief Engineer

**CHICAGO
ENGINEERING
WORKS**

2154 LAWRENCE AVENUE
Dept. 19 Chicago, U. S. A.

FREE!

BIG ELECTRICAL OUTFIT

A fine outfit of Electrical Tools, Instruments, Materials, etc., absolutely FREE to every student. I will also send you FREE and fully prepaid—Proof Lessons to show you how easily you can learn Electricity and enter this splendid profession by my new, revised and original system of Training by Mail.

RADIO COURSE FREE

Special newly-written wireless course worth \$45.00 given away free.

Earn Money While Learning

I give you something you can use now. Early in my Home Study Course I show you how to begin making money in Electricity, and help you get started. No need to wait until the whole course is completed. Hundreds of students have made several times the cost of their course in spare time work while learning.

Classified Advertisements

WORLD'S BEST WANT AD MEDIUM

Advertisements in this section, 25 cents per word, each insertion, minimum 10 words, payable in advance. To be inserted under proper classification in January issue, copy should be in our office November 18th.

ADVERTISING AGENCIES

TO secure agents or salesmen or for selling farms and reaching investors, use classified (want) ads in largest newspapers and magazines. Price list No. 39 sent free. Askrum Advertising Agency, 29 W. Jackson Blvd., Chicago, Ill. The largest classified advertising agency in the U. S.

ADVERTISING space in all publications sold at publishers rates. Send us particulars and \$5 for Plan. Capital Advertising Co., Munsey Building, Washington, D. C.

25 WORDS—335 Rural Weeklies, \$14.20. Ad-Meyer Agency, 4112-M Hartford, St. Louis.

A SERVICE agency for magazine and newspaper classified advertisers. Complete advertising service free of charge. We edit and place your copy. Send for our free lists and explanation. Sweet & Phelps Advertising Agency, 212 E. Ohio St., Chicago.

FOR ADVERTISERS

ADVERTISE in 24 Big Sunday Newspapers, 24 words \$15.00. Catalog listing 1,600 leading Dailies, Weeklies, Magazines, 4c stamps, Union Advertising, Baltimore Bldg., Chicago.

25 WORDS, 51 magazines, \$2.00. Auto-City Agency, 2747 Gladstone, Detroit.

I WRITE letters, folders, booklets, complete follow-up for manufacturers, mail-order dealers. Long experience. Write for details. L. Taylor, Box 44M, Freeport, Ill.

28 WORDS, 100 Newspapers, \$4. Inc. \$12. Beck Agency, 5406 Alaska, St. Louis.

INTERNATIONALIZE Your Business!!! Buy! — Sell! — Trade! Everything!!! Everywhere!!! 1c word; \$1.00 inch. Circulation worldwide! Trial, Six Months, 25c. Copy, 10c. International Opportunity, Brookings, S. Dak.

SALES PROMOTION

25 YEARS' Experience Developing daily sales, \$50 to \$50,000. Magazine, newspaper, mail campaigns planned. Letters, circulars, booklets written. One client's annual sales after 25 years totaled only \$150,000; following four years of my plans and copy exceeded \$1,000,000 annually. Another's \$25,000 yearly sales increased ten times first year by my plans and copy. From zero, another's direct-mail sales reached \$5,000,000 annually in six years through my plans and copy. Submit in detail your problems for free preliminary diagnosis. Ten years Sales Promotion Manager, Larkin Co., a thirty-million-dollar corporation. James C. Johnson, 118A Woodbridge Ave., Buffalo.

AUTOMOBILE SUPPLIES

RECHARGERS for all magnetos, \$5.00. Benner Manufacturing Company, Webb City, Mo.

TOWLINES; Guaranteed; \$2.50 each, \$15 doz. Agent's sample \$1 prepaid; C. O. D. \$1.10. Superior Mfg. Co., 211 High Ave., Cleveland, O.

AGENTS Easy Money. Interview motor-ists—Patented instrument every motor needs—It saves money three ways—Guaranteed. Thousands "Sold." Glad users everywhere. Big demand at your door. Pleasant work. Permanent business of your own—employ sub-agents—\$75.00 weekly up, all or part time. Experience unnecessary. This is a high class money-making proposition—Your opportunity for success. Whatever you do answer this ad quick. Wizard Mfg. Company, 453 Central Ave., Rochester, N. Y.

ONE Magneto Recharger, only with Agency, \$35.00. Reliable, Utica, N. Y.

LIBERTY Air Compressors, for garages, tire-shops, filling stations, also paint spraying equipment. Air Compressor Equipment Co., 1457 Carroll Avenue, Chicago, Ill. Distributors wanted.

QUICK seller to every owner of a passenger car or truck. Easy to demonstrate. No experience necessary. Ten dollars and receive a day taking orders for the Warner Oil-Gas. It turns what is now hard, long, dirty job of lubricating a chassis into a quick, easy, clean job. Nationally advertised and guaranteed by inventor of famous Warner Speedometer. Sold on money back basis. Send \$3 for your demonstrator. Immediate and permanent profits. Our selling plan insures your success. Get all the facts. Write at once Warner Patterson Co., 914 South Michigan Avenue, Chicago.

AUTOMOBILE owners, garagemen, mechanics, send for free copy America's popular motor magazine. Contains helpful, money-saving articles on repairing, overhauling, ignition, carburetors, batteries, etc. Automobile Digest, 507 Butler Bldg., Cincinnati.

TOURIST Auto Sleeping Beds—Camp Equipment. Vanderpool's, Springfield, Ohio.

AUTOMOBILE Parts—Used parts for most any car at half factory list prices. Allen, Briscoe, Buick, Cadillac, Chalmers, Chevrolet, Dodge, Ford, Grant, Hudson, Hugobone, Oakland, Overland, Oldsmobile, Reo, Studebaker, and many others. Send list of parts wanted. Maxwell Bros., 4106 Olive St., St. Louis, Mo.

COMPRESSOR, Automatic Air, \$35.00 brings it—balance terms. Particulars free. Hobart's, Troy, Ohio.

IMPROVED Alloyum Pistons for all cars, saves oil and gas; light weight; get more speed and power; circular free. Egge, 7704 S. Main St., Los Angeles, Calif.

AUTOMOBILE parts, guaranteed new for all cars. Save money; get our wholesale prices on gears, shafts and bearings. State make of car, model and parts wanted. Parts shipped immediately from stock. We refund your money, including transportation charges, if not satisfied. Mechanics Gear Co., 3708 No. Halsted St., Chicago.

TITAN A-C and Champion plugs all sizes each 35c. "775" Spark Plugs all sizes, each 20c. Auto Bulbs 50% off Mazda list. Spark plug and Auto bulb testing outfits each \$3.50. Free delivery anywhere. Terms C.O.D. Kelly Lamp Works, Oak Park, Ill.

AUTO-BRAKE Renewer, prevents slipping and squeaking, preservative for lining, excellent belt dressing, 60c per tube. Special offer, two tubes \$1.00 postpaid. Fred Kern, 1621 East 55th, Chicago.

RECHARGING Automobile Storage Batteries with Constant Potential 8-Hour Service Pays Big Profits. Easy payments paid by increased earnings. Particulars free. Hebesco, Troy, Ohio.

75% OF tire trouble lies in valve leakage. Hughes Airtight Valve Cap is absolutely guaranteed to stop this. Send \$1.50 for a set of five. Try them for ten days, and if not satisfactory, money will be gladly refunded. See our display ad on page 175. Airtex Rubber Company, 2051 Jackson Boulevard, Chicago.

AUTO and Truck Parts. Save 25-30%. New and used motors, gears, axles, bearings, springs, generators, \$10 up. New Zenith, Johnson, Rayfield, Stromberg carburetors, \$7.50 up; new waterproof Simms and Berling magnetos, \$15; Ford retopping, \$4-8; others cars, \$12 up. Brightman Auto Exchange, 321 Windsor Ave., Hartford, Conn.

AUTOMOBILISTS. Absolute auto necessity. The Met'l Fibre Au-Tow-Line is the strongest and lowest priced tow line made. Send \$1.50 for one direct from factory. Agents wanted. The Met'l Fibre Rope Co., Factories Bldg., Toledo, Ohio.

AUTOMOBILES

AUTOMOBILE owners, garagemen, mechanics, send for free copy America's popular motor magazine. Contains helpful, money-saving articles on repairing, overhauling, ignition, carburetors, batteries, etc. Automobile Digest, 507 Butler Bldg., Cincinnati.

PATENTS—Write for our Guide Books, List of Patent Buyers and "Record of Invention Blank" before disclosing inventions. Send model, or sketch and description of your invention for our free opinion of its patentable nature. Highest references. Reasonable terms. Victor J. Evans & Co., 185 Ninth, Washington, D. C.

LEATHER Coats, U. S. Aviators, \$10 to \$15. Wonderfully warm. 28 H. P. airplane motors, new, \$100. Smith, 403 Gogran Bld., Houston, Texas.

PATENTS Procured. Send sketch or model today for examination, prompt report and advice. No charge for preliminary advice. Write for free Booklet and blank form on which to disclose your idea. Highest references. Promptness assured. Clarence A. O'Brien, Registered Patent Lawyer, 310 Security Bank Building, Directly across the street from Patent office, Washington, D. C.

FOR FORD OWNERS

FORDS Get 25-45 Miles with Ford's Automatic Air-Friction Vaporizer. Something new. Guaranteed. Send today. Price \$3.00. Agents wanted. R. A. Reid, 19 Burget Ave, Medford, Mass.

AUTOMOBILE owners, garagemen, mechanics, send for free copy America's popular motor magazine. Contains helpful, money-saving articles on repairing, overhauling, ignition, carburetors, batteries, etc. Automobile Digest, 507 Butler Bldg., Cincinnati.

FORD Owners. Learn About Wonderful New Power Maker. Practically eliminates spark lever—stops misting—adds power and speed—saves gas and is waterproof. Price is low. Ask for booklet and learn about Free Trial Offer. A. B. M. Co., Box Z, Brightwood, Mass.

FORD Owners, Attention! Get our big money making offer to owners of Ford Cars. We will show any live Ford owner how to make big money with the fastest selling necessity for Ford cars in the world. No experience needed. We show you how. Write immediately for full details. Ault Mfg. Co., 8425 So. Chicago Ave., Chicago, Illinois.

COMPLETE Ford Transmission Lining Set from Factory. Ten thousand miles guaranteed. One dollar postpaid. Sberwood Manufacturing Company, Paterson, N. J.

UNDERSLING with "RKO" Swing Lo Irons. See "Red-i-Kut" ad, page 175.

FORD owners, stop that rousing chatter on your car. Install Bredar's Ball Shim. Price, \$1.10. Write for Information. Nic Bredar's Son Mfg. Co., Rock Island, Ill.

FORD Owners—Sell all Ford supplies, lowest prices, big profits, catalogs free. Cut-Rate Ford, 610 S. Dearborn St., Chicago.

MOTORCYCLES, BICYCLES AND SUPPLIES

WONDERFUL bargains in reconditioned motorcycles. Priced as low as \$35. Sidecars from \$25 up. Everyone expertly rebuilt and guaranteed in absolutely first-class condition. Don't delay. Send 2c for new big catalog showing 1923 bargains. Western Supplies Co., 359 Hayutin Bldg., Denver, Colo.

1922 HARLEY-DAVIDSONS, \$135; 1921, \$115; 1920, \$85; 1919, \$65; 1917, \$50; 1916, \$45; 1915, \$40; 1914, \$35. Guaranteed. Money refunded if not satisfied. Circular free. Wisconsin Cycle Sales Co., 726 National Ave., Milwaukee, Wis.

USED Motorcycle Bargains: Indians, Harleys, Excelsors at big reductions. \$50.00 up. Guaranteed and shipped on approval. Easy payments. Big fall sale now on. Send stamp for free catalog "A." Clymer, the Motorcycle Man, Denver, Colo.

'19 INDIAN 3 Speed \$75.00, '20 Indian 3 Speed \$95.00, '21 Indian 3 Speed \$125.00. Howard A. French Company, Baltimore, Md., Washington, D. C.

USED parts for all motorcycles, cheap. State wants, Schuck Cycle Co., 1922 Westlake, Seattle, Wash.

DON'T buy a Bicycle Motor Attachment until you get our new catalogue and prices. Also runs washers, pumps, and shop machinery. Shaw Mfg. Co., Dept. 27, Galesburg, Kans.

MOTORCYCLES!! Rebuilt by factory trained mechanics! \$50 up. Write for illustrated folder. Jim Clark, 23rd and Fondulac, Milwaukee, Wis.

TWIN Indian Engine, carburetor, magneto, \$35. Shaw Bicycle Motor complete, new, \$40. Twin Harley Motorcycle, speedometer, lights, horn, \$50. 500 volt generator, \$10. K. Bard, Manawa, Wis.

SEND for our Bargain Bulletin and Money Saving Message. It will save you money on Motorcycles, Side Cars, Motor Wheels, Repair Parts and Accessories. Some used parts at less than half. Cleveland and Ace Motorcycles our specialty. See our ad on page 157. American Motor Cycle Co., 2043-5-7 W. Chicago Ave., Chicago.

MOTORCYCLE Engines, Bargains, \$10 up, complete. New Rogers Side Cars, \$58.50 complete. Erickson, 438 W. 70th, Chicago.

AVIATION

AIRPLANES, new or slightly used, \$250 to \$1,000. Motors, wings and propellers—Bargains. Leather Coats, \$10 up. Smith Machinery Co., 403 Guggan Bldg., Houston, Texas.

THREE foot model aeroplane. Small cost. Circulars free. Aero Shop, 3050 Hurbit Ave., Detroit, Mich.

THE American School of Aviation announces a new correspondence course in Mechanics of Aviation, A thorough training in Practical Aeronautics, American School of Aviation, Dept. 186-B, 3601 Michigan Ave., Chicago, Ill.

HEATH propellers represent the most efficient method of aerial drive. Each propeller individually designed for the particular work to be done, as laid out by America's oldest aeronautical engineers. Propeller catalog, 6c. Heath Airplane Co., Chicago, Ill.

AIRPLANES complete, new, \$125 and up. V. B. Kennemer, Commo, Texas.

REAL Toy Airplane, flies 200 feet under own power; scientific; \$1.35 prepaid. Air Transport, L. I. City, N. Y.

GNOME 50, complete, overhauled, \$100. Inland Service, Rossmore, O.

BIGGEST, best catalogue Model Aeroplanes, Parts and Supplies; 5c Postpaid. Ideal Aeroplane Co., 72½ Green St., New York.

SEND one dollar for beautiful pair of sterling silver wings mounted on stick or bar pin with safety catch. Wear one to boost aviation. Money refunded if not absolutely satisfactory. Wallace Aero Company, Davenport, Iowa.

SEND 10c for our latest aeronautical catalog, listing a complete line of airplane goods at reduced prices. Ford or Motorcycle motored airplane catalog, 4c each. Heath Airplane Co., Chicago, Ill.

"PLANS for Building Airplanes." Motorcycle Engine Monoplane, No. 1. Ford motored Sportplane, \$2.50. "Knockdown Planes," \$100 up. Circular free. Aviation Engineering Co., Lawrence, Kan.

SPEEDY, motorcycle motored aeroblast. Build now, drive all winter. Drawings \$1.00. Sailplane, flies without motor, drawings \$1.00. Motors \$70. F. D. Burke, Downers Grove, Ill.

PROPELLERS—6 foot for Fords \$15; others in proportion. Motorcycle sleigh blueprints 75c. Ford size \$1.00. Pictures free. Crawford Motor, Aeroplane Manufacturing, Long Beach, Calif.

PATENTS Procured. Send sketch or model today for examination, prompt report and advice. No charge for preliminary advice. Write for free Booklet and blank form on which to disclose your idea. Highest references. Promptness assured. Clarence A. O'Brien, Registered Patent Lawyer, 309 Security Bank Building, Directly across the street from Patent office, Washington, D. C.

BUILD Your Own Plane. One or two seater. A Complete Flying Course. Everything in Aircraft Supplies. State Agents Wanted. Address, Lay, Station O, Cincinnati, Ohio.

LEARN to fly this winter; Special course; Special Price; Write for particulars. Varney Aircraft Co., Peoria, Ill.

TEN lessons in the air, of twenty minutes each, will make you a pilot, by our advanced method of training. This together with our five week shop course at \$100.00 makes America's oldest aircraft factory the most popular flying school. Work after class hours guaranteed. Heath Airplane Co., Inc., Chicago, Ill.

BOOKS AND PERIODICALS

FRENCH, language of 50,000,000 people; Primer, \$1.11 postpaid. French-English dictionary, \$1.98. French sound-chart, World-Romic system, 37c. French pronunciation-table, 30c. French phonic text, 13c. Speech-organs chart, 37c. Languages Publishing Company, 8 West 40th Street, New York.

FREE—Send for my Newthought, Self-culture, Occult, Mystic and Scientific book literature. A. W. Martens, Md., Burlington, Iowa.

AMERICA'S greatest employment magazine wants co-publishers everywhere. Rare money-making opportunity. Particulars and copy of magazine, 10c. Employment News, Hyannis, Mass.

25 DIFFERENT Mailorder publications 50c. Hansen Company Que, Brookings, S. Dak.

INDUSTRIAL Alcohol, Wright's book everybody wants. Full directions for making with drawings of necessary apparatus. \$2.50 postpaid. Spon & Chamberlain, 120 P. M. Liberty Street, New York, N. Y.

SPANISH, language of 40,000,000 people; Primer, \$1.94. Dictionary, \$1.98. Sound-chart, 37c. Pronunciation-table, 30c. Languages Publishing Company, 8 West 40th Street, New York.

TRADE, class, technical magazines. List free! Local agents wanted everywhere. Toepf Magazine Agency, Middletown, N. Y.

"LIGHTS, Colors, Tunes and Nature's Finer Forces," covering Vibrations; Odic-Auras; Cudi-lights; Radio; Inventions; 270 pages. Satisfaction guaranteed; \$2.90. Circulars Free. M. Stevens, Publisher, 242 Powell, San Francisco.

HYPNOTISM astounds, controls others. Wants gratified, 25 easy lessons, \$1.10. "Mindreading" (any distance), Wonderful, \$2.75. Popular Institute, D1014 Belmont, Chicago.

PRIZES offered to new writers. Send for free copy The New Writers' Circle, 2512 Cook St., Cincinnati, Ohio.

ENCYCLOPEDIA Britannica, India paper, Harvard Classics. Half price. Dalton Bldg., Cribby Bldg., Chicago.

ALCOHOL Book, Copyrighted. Best. Where to Buy 10,000 Things at Wholesale, etc. Particulars free. G. C. Shaver, Publisher, Oil City, Pa.

ELECTRICIANS' Examination book of questions and answers, with diagrams, symbols, tables, notes and formulas, for preparation for license, \$1.25. Address Reade Pub. Co., 296 Broadway, New York.

SECRETS, Mysteries of Applied Psychology. Great Book at \$1.00. Address, Dr. Grumbine, 317 East 24th, Portland, Oregon.

NOVELTIES, CURIOS, ETC.

IMPORTED Japanese Wonders, dropped into water, expand five times original size, turning into fish, flowers, animals, habile. Pretty package twelve assorted, 15c. 8"x5c. Thirteen \$1.00. Free! Hootch Insurance Policy, latest Prohibition joke, 10c, each order. Heinemann, 7242 Pinacree, Chicago.

BONE Hootch 50c. Bone Pendant \$1.00. Bone Necklace \$5.00. Cigarette holder 25c. A. Rosenberg, 1592 Eastern Parkway, Brooklyn, N. Y.

DELUXE jewelry; Unique novelties. Gift suggestions. Sample; Catalogs 10c. Smiths Novelty Co., 9145-47 Bishop St., Chicago, Ill.

ARMADILLO Baskets for Christmas gift. P. P. paid; Plain basket \$2.75; silk trimmed \$3.75 each. Satisfaction guaranteed or money back. Address: Charles Apelt, Comfort, Texas.

PICTURES AND POSTCARDS

ADIRONDACKS: Fifteen scenic views and copy Postcard Tourist, 25c. De Roire, Geneva, N. Y.

POSTCARDS of beautiful girls. Sample; catalogs; 12c. Smiths Novelty Co., 9145-47 Bishop St., Chicago, Ill.

50 CHRISTMAS Greeting Cards \$1.00. 25 Imported Art Study Cards \$1.00. A. Rosenberg, 1592 Eastern Parkway, Brooklyn, N. Y.

POST-CARDS—Lincoln's Home and others. Send 10 cents. Universal Sales Company, Box 152, Springfield, Ill.

JOIN Live Postcard club; Membership list, including Catalog, 10c. Harvey Teeple, Decatur, Ind.

JOIN the Old Reliable Card Club. Membership, 10c. Riverside Club, Frederick, Md.

GAMES AND ENTERTAINMENTS

200 KINDS Iron, wood and wire puzzles. Leader and illustrated list, 10c. Western Puzzle Works, St. Paul, Minn.

"PUTTING on a show" booklet and list of plays for boys and young men, 4 cents. Old Tower Press, 59 E. Adams St., Chicago.

FOR Comic Speakers! Original Funny-stuff For Clubs, Entertainments, Vaudeville, 35c. Fairmount, 3289 Cleveland Hgts., Ohio.

VENTRILLOQUISM taught almost anyone at home. Small cost. Send 3c stamp today for particulars and proof. George W. Smith, Room M-823, 125 N. Jefferson Ave., Peoria, Ill.

MAGIC TRICKS, BOOKS AND JOKERS' NOVELTIES

PLAYS, musical comedies and revues, minstrel music, blackface skits, vaudeville acts, monologs, dialogues, recitations entertainments, musical readings, stage hand-books, make-up books. Big catalog free. T. S. Denker & Co., 623 So. Wabash, Dept. 11, Chicago.

MAGIC books, cards, books, novelties. Catalogue free. C. Fenner, 2401 Jefferson, Louisville, Ky.

NEW and Original Magic. Massey, 205 pages, 28 page plates, \$3.15 postpaid. Spon & Chamberlain, 122 P. M. Liberty Street, New York.

THREE High-Class Tricks, 20c. Full instructions. No stamps. L. Smith, Rt. 7, Box 65, Salem, Ore.

EVERYTHING in Magic. Four Catalogs 15c. Gilmazico, Morran Park, Ill.

MAGIC—Tricks, Books and Supplies. For Amateurs as well as the great professionals. Anyone can learn through our instructions. Feature Acts in Mind Reading, Spiritualism, Rope Ties, etc. Large illustrated Professional Catalog, 10c. Chicago Magic Co., 140 S. Dearborn St., Dept. B, Chicago, Ill.

TRICKS, puzzles, jokes, magical apparatus, plays, stage supplies, mind-reading, sensational escapes, 160-page illustrated professional catalog, 10c. Oaks Magical Co., Dept. 5-8, Oshkosh, Wis.

FREE—Cur puzzle, trick, game, joke. Novelty Catalog, Wright & Son, 601-G Ind. Ave., Peoria, Ill.

GREAT-ST mind reading act ever sold. Not a toy. Easily mastered. Cannot be detected. Postpaid for \$1.00. The Benrills Co., Box 797, Macon, Ga.

STAMP COLLECTING

MYSTIC'S "Mysterious" Packet! Contains stamps from the lands of cannibals, heathens, sun worshippers, and wild savages. Included are Travancore, Malay, Dutch Indies, Liberia, Slam, Africa, Abyssinia, North Borneo, Nyasaland, Zanzibar, etc. This wonderful packet containing 110 all different (mostly unused) for only 8 cents to approval applicants. Mystic Stamp Co., Dept. 8, Camden, N. Y.

1,000 MIXED Stamps, 150 varieties, 25c. Charles Peugh, Elma, Wash.

FREE, 25 U. S. with approvals, references, 3c postage. St. Elmo Stamp Co., 2511 Southside Ave., Chicago.

BEST one-cent approvals in America. F. P. Hand, 1117 So. 60th St., Philadelphia, Pa.

FREE—"Leader" Pkt. to approval applicants sending 2c stamp. Earl Stamp Co., 1811 26th Ave., North, Minneapolis, Minn.

20 VARIETIES Niagara, twelve cents with approvals. Goodman, 620 So. Spring, Los Angeles, Calif.

250 MIXED stamps and souvenir photo, 10c. Phil Lundsted, Cape Cottage, Maine.

EXCHANGE Stamps of all Countries. Membership 25 cents. International Stamp Club, 4902 Brooklyn Ave., Seattle, Wash., U. S. A.

500 FINE Stamps only 25 cents. John Hammond, 1 W. Franklin St., Baltimore, Md.

FREE—3 Newfoundland with packet 100 different stamps 10c. Walter Oliver, 813 Richmond, Buffalo, N. Y.

START a Stamp Collection—70 different stamps from 70 different foreign countries, including Africa, Asia, Australia, Europe, West Indies, etc. Our pamphlet which tells "How to make a collection properly," and price list of albums, packets and sets all for only 16 cents. Queen City Stamp Co., Room 36, 694 Race St., Cincinnati, O.

FREE, 100 stamps, all different, with each request for my 1c and 2c approvals. John F. Miller, Box 838, New Haven, Conn.

2 NICE stamp set free to approval applicants. J. A. Flaten, Fertile, Minn.

FREE—50 varieties to approval applicants sending 2c. Richard P. Lamprecht, Valparaiso, Ind.

BIG Variety Packet Foreign Stamps Free for 2c postage. Gray Stamp Company, Station E10, Toronto, Canada.

ZAMBENIA, Zanzibar, Abyssinia, Herzegovina, Allenstein stamps, menagerie collection, hinges, 19c. Liberty, 3974 Arsenal, St. Louis, Mo.

50 DIFFERENT United States 10c; 10 Nyassa 1901 25c. Seidenberg, Merton, Wis.

100 RARE and valuable foreign stamps, all different, and big catalog, 7c. Stanton, Niantic, Conn.

\$3.00 FOR 12c!! 100 different Neurope, catalogued \$2.10; triangle stamp, Red Cross set, airplane set, perforation gauge, millimetre scale, fine wallet, 5 approval sheets, 250 hinges, scarce packet from Nyassa, Abyssinia, etc., price lists and approvals—all for 12c!! Atlanta Stamp Co., Box 532, Atlanta, Ga.

PACKET Free to Approval Applicants. Dan Reid, 639 Rhodes Ave., Toronto.

NEWFOUNDLAND Stamps sent on approval. Rev. Butler, St. Georges, Newfoundland.

24 VARIETIES Cuban stamps, 10 cents. List of 6,000 low-priced stamps free. Address Chambers Stamp Co., 1117 Nassau St., New York City, N. Y.

20 UNUSED stamps free. All different. Postage 2c. Fisk Stamps, Toledo, Ohio.

158 GENUINE Foreign Stamps. Mexico War Issues, Venezuela, Salvador and India Service, Guatemala, China, etc., only 10c. Finest approval sheets 50 to 60%. Agents Wanted. Big 72-p. Lists Free. We Buy Stamps. Estab. 20 years. Hussman Stamp Co., Dept. 54, St. Louis, Mo.

PACKET of 23 stamps, no two countries alike. Packet hinges. Set of \$1 and \$2 U. S. Rev., all for 5c. Mention paper. Miami Stamp Co., Toledo, Ohio.

STAMPS. 20 unused, all different, free. Postage 2c. Mention paper. Quaker Stamp Co., Toledo, O.

STAMPS, 50 varieties, Africa, Brazil, Peru, Cuba, Mexico, etc., 10c; 50 different U. S., 25c; 1,000 mixed, 40c; 1,000 hinges, 10c. List free. C. Stegman, 5948 Cote Brillante, St. Louis, Mo.

FREE! Loose Leaf Postage Stamp Album at rate of 8 pages each month given with subscription to monthly Journal. Send 2c stamp for prospectus. United Stamp Co., Marquette Bldg., Chicago, Ill.

FREE—Two sets Nyassa, 20 Diff. British Colonies Barbados and Jamaica pictorials and a packet of hinges—all for a request for my 1, 2 and 3c net approvals, none better. Chas. T. Egner, 4821 Frankford Ave., Frankford, Phila. Pa.

FAMOUS Barney Google packet to approval applicants—only 10c. 81d. Desk 11b, 740 Landon, Madison, Wis.

2,000 DIFFERENT Stamps \$5.65; 1,000, \$1.55; 500, 55c; 300, 25c; Michael, 5353 Calumet, Chicago.

100 DIFFERENT foreign—No English, French, German, Canadian, cheap unused European, ten cents. R. Lehr, 1309 Foulkrod St., Philadelphia, Pa.

100 DIFFERENT Stamps, 10 Cents. Sonnee Stamp Co., 675 Ivy, St. Paul, Minn.

50 VARIETIES free to approval applicants. Royal James, Uhrichsville, Ohio.

FREE—10 unused stamps sent to approval applicants on approval at 66% discount from standard catalogue prices. J. de Jong, 516 West 162 Street, New York, N. Y.

143 VARIETIES, including Schleswig, Roumania, Ukraina, 250 hinges, ruler, 4 blank approval sheets, 15 cents. Heuther-Info, 4910 Lyndale, So., Minneapolis, Minn.

30 DIFFERENT Sweden 10c; 50 different U. S. 10c; 10 different Ukraina 10c; 25 different Poland 10c. R. H. Carlson, 206 W. So. Temple, Salt Lake City, Utah.

FREE! World's smallest stamp. Approvals. Postage 2c. Cannon, 1419 Carey, Bayshore, Iowa.

ODD Monarchs—Old Stamps. Approvals for postal. Cdd Stamp Co., Sunset Heights, Asheville, N. C.

NEW Airplane Stamp Unused—3c, green, issued by Uncle Sam; also 25 French Colonials for 2c. Jacob Fischer, 4230 Crystal St., Chicago.

FOREIGN Stamp Collection Sent Free. Cornish Company, Schenectady, N. Y.

STAMPS on approval 1c up. Free premiums. Herbert Kelgwin, Middletown, N. Y.

FREE—8 Portuguese Colonials, to (50%) approval applicants only. Lampe, 423 West 42nd, New York.

\$1.00 PACKET selected stamps, all different, 5c. Wilson Argo Co., Box 1395, St. Louis, Mo.

TO Applicants for "Cleveland" Approvals: We offer Hinges, Pocket Album, Perf. Gauge, and 40 Var. of Postage Stamps from Africa, Asia, Oceania, including Sarawak, Johore, Nyassa, Abyssinia, etc. Price only, 16c. 202 Var. European, Azerbaijan, Ukraine, Liechtenstein, Danzig, etc. Free with a 3 mos. Subscription to Mekeel's Weekly Stamp News, The World's Finest Stamp Paper. The Cleveland Stamp Co., 323 Caxton Bldg., Dept. P, Cleveland, Ohio.

DANZIG Free—Nice Set Danzig Stamps with Biggest Lists Issued, 2c postage. Midland Stamp Co., Station E2, Toronto, Canada.

SET Austria, Bavaria, Bulgaria, free for 2c Stamp. Poste Stamp Co., 5418 Sanson Street, Philadelphia, Pa.

BOYS!! \$3.00 worth for 12c! 1 Triangle stamp, 1 Red Cross set, 1 Airplane set, perforation gauge, millimetre scale, 100 New Europe (cat. value \$2.00), pocket stock book, 5 blank approval sheets, 250 hinges, packet rare stamps from Nyassa, Africa, Australia, Abyssinia, etc., and price lists. All for 12c to approval applicants. William H. Bometsch, 1027 Housatonic Ave., Bridgeport, Conn.

206 DIFFERENT stamps, Liberia, Abyssinia, aeroplane and war issues, lists and approvals, only 12c. 500 different, 50c. J. B. Musick, 4440 Natural Bridge, St. Louis, Mo.

UNIVERSAL Packet, 100 varieties, all over the world, 10 cents. Covert Stamp, 39 State, Rochester, N. Y.

FREE Premium. Ask for money-saving approvals. John P. Borresen, Cedar Falls, Ia.

200 DIFFERENT stamps ten cents to approval applicants only. K. C. Stamp Co., Lee Bldg., Kansas City, Mo.

FREE Unused Set—14 varieties, to applicants, 1c approvals—Postage, 2c. Elmer, 39 Court St., Boston.

APPROVALS for more advanced senior collectors. Discounts to 80% of catalogue. Reference, International, 217 Regent Pl., Brooklyn, N. Y.

1,000 DIFFERENT STAMPS, \$1.50; 500, \$1.50; 300, \$1.25. Fred Onken, 630 79th Street, Brooklyn.

STAMPS sent on approval at 70% discount. Reference required. Emory Renold, Hanover, Pa.

GERMAN Air Mail Set Free to applicants for my 1 cent to 15 cent net approvals; also high priced stamps at 50% discount. Reference Required. Chas. W. Schmidt, 3227 Benner St., Washington, Philadelphia, Pa.

BIG \$4.00 outfit to approval applicants, 10c. Buckey, 712 Bowen, Dayton, Ohio.

100 DIFFERENT with Approvals, 6c. Co-operative Stamp Co., 865 Conway, St. Paul, Minn.

FREE! 100 different world-wide, many unused, to approval applicants enclosing 4c postage. Walter Medding, Rolla, Mo.

\$9 VALUE, 15c. Packet of scarce stamps from South and Central America, including Cuba, Hayti, Salvador, Venezuela, Uruguay, having catalog value of over \$9.00. Price to new applicants for Fenway net approvals, 15c. Fenway Stamp Co., Fenway Station, Boston, Mass.

50 DIFFERENT Portuguese Colonials, 15c. P. Buffham, Lake Av., Racine, Wis.

TRANSVAAL, 1895, 24p-10sh unused, 9 varieties complete, \$1.50. (Catalog value, \$6.10). Nickles, 123 Florida, Washington, D. C.

FRENCH Colonies Free—Pretty Picture Set, Native Chiefs, Tigers, 2c postage. Empire Stamp Company, 342 Lippincott, Toronto, Canada.

105 CHINA, etc., stamp dictionary, list, 2c. Album (500 illustrations), 2c. Bulard, Sta. A, Boston.

NYASSA Giraffes and packet of 52 different scarce stamps, Flume Triangle, large \$1.00 U. S. Rev., millimetre scale, perforation gauge and ruler for only 2c. To introduce our Sudden Service approvals. Fenestri Stamp Co. any, Dept. P, Fullerton Bldg., St. Louis, Mo.

"MEKEEL'S" sold stamps to your grandfather. Stamps for new and advanced collectors, sent on approval, 330 different stamps, mostly 19th Century, 50c. Mekeel Stamp Company, Bethlehem, Penn.

10 VARIETIES Irish Free State, 15c. postpaid. Allison, Angola, Ind.

APPROVALS, Better Grade; Reference. Raymond Stone, 562 West 190, New York City.

RARE COINS

44 DIFFERENT Foreign Coins, \$1.00 postpaid. Otto Oddehon, Independence, Mo.

OLD Coins Wanted. Have you an odd or old coin or bill? It may be worth several dollars. Get posted. Send 4c for Coin Circular. May mean much profit to you. Send now. Numismatic Bank, Dept. H, Fort Worth, Texas.

10 NEW Copper Coins Different Countries and Austrian Paper Bill—25c. Price Lists and Wild Cat Bill—6c, Nickel, 3c and 2c piece—15c. Al E. Bonsall, Richmond, Ind.

CALIFORNIA gold Quarter 27c; Half 52c; 1821 cent, 1834 1/2c, or silver 3c, 20c. A. Wylie, Wheaton, Ill.

1,000,000 GERMAN Marks, \$1.00, 10,000 Austrian Kronen, 35c, 100,000 Rubles, 25c. Write for Dealer Terms. George Grigoleit, 20 East Jackson, Chicago.

40 OLD coins, all different, \$1.00, 20 Confederate bills, all different, \$1.50, 200 all different Germany Bills, \$1.00. Claud Demery, Box 315, Dallas, Texas.

REAL curious Egyptian coin, 12c. Durso, 25 Mulberry, N. Y. City.

FLYING Eagle Cents are now out of circulation, but you can get one now, together with a 50-page illustrated Coin Catalog, by mailing this slip and 10 cents with your name and address. This is "just to get acquainted." Send Now. B. Max Mehl, Numismatist, Mehl Bldg., Dept. P, Fort Worth, Texas. Largest Rare Coin Establishment in the United States.

1,000,000 GERMAN Marks 50 cents, 1,000,000 Russian Rubles \$1.00. Price list on request. Craig Dare, 440-55th, Brooklyn, N. Y.

\$2 To \$50 each paid for hundreds of Old Coins. Keep all Odd or Old Money. It may be very valuable. Send 10c for New Illustrated Coin Value Book, 4x8. Get posted. We pay cash. Address Clarke Coin Co., Ave. 2, Le Roy, N. Y.

OLD Coins. Large Fall selling catalogue of coins for sale, free. Catalogue quoting prices paid for coins, 10c. William Hesslein, 101 A Tremont St., Boston, Mass.

FOR BOYS

MOUTH-ORGAN Instructor, 25c. Learn in one hour. G. Elsea, Bowling Green, Ohio.

"HOW to Put On an Amateur Circus"—Big new book for boys, tells how to organize show, construct animals, produce stunts, clown acts, etc.; instructions for complete performance. Over sixty photographs, diagrams and working drawings. Complete instructions that every boy can understand. Boardbound, postpaid, \$1.75. T. S. Denison & Company, 623 So. Wash Avenue, Dept. 158, Chicago.

BOOKS—"Ventriloquism," "Toymaker Book," "Boy Electrician," 10c each, all for 25c. G. Elsea, Bowling Green, Ohio.

BOYS and Girls make big money in your spare time selling dress fasteners in your neighborhood. Card containing twelve fasteners sells for ten cents. Costs you five. Send sixty cents for trial box of twelve cards. Duplicate Fastener, Eleven East Twenty-Sixth St., New York.

CAMERAS AND PHOTO SUPPLIES

HAVE You a Camera? Write for Free sample of our big magazine, showing how to make better pictures and earn money. American Photography, 116 Camera House, Boston, 17, Mass.

KODAK Enlargements, 5x7 25c, 8x10 35c. Kodafin, 387 Bellevue Place, Milwaukee, Wis.

JUST Published—Our new complete 128-page catalog and bargain book of new and used cameras and supplies. Our goods are guaranteed finest quality obtainable. We have thousands of satisfied customers. Write at once for this bargain bulletin, just hot from the press. Address Central Camera Co., 124-S. Wabash Ave., Dept. E 16, Chicago, Ill.

WANTED To Buy—Actual photographic prints of Scenery, Industries, Animals, etc., for post card views. A. P. Hollis, 1111 Center Street, Chicago.

SEND Us Your Films. \$530 in prizes given away. First prize, Ford Touring Car. Write us for Free Coupon entitling you to share in drawing held December 17, 1923. Trial roll of film developed for 5c. Prints 3c each. Roanoke Photo Finishing Co., 289 Bell, Roanoke, Va.

MODERN Photography in all its branches now taught by mail. New Successful Method. Students earning \$390.00 while learning. Big opportunity. Write for particulars and unusual offer open for short time. Dept. 3435 International Studios, Inc., 5611 Michigan Ave., Chicago.

KODAK Films—Special trial offer: your next Kodak film developed, 5c—prints, 2c each. Moser & Son, 1917 St. James Ave., Cincinnati.

AT Last! A Reflex Camera with an F:5.8 German Anastigmat Lens and a roll of Kodak Film at \$10.00. A marvelous value. Extra film 20c per roll. Order Quick! Shipped for examination for \$1.00 deposit. DeFrance, Importers, 109 North Dearborn St., Chicago, Ill.

SAMPLE enlargement, dime and negative (returned). Sample 6-exposure roll finished glossy, 25c silver. Brown Studio, Lake Elmo, Minn.

LEARN to make Photographs Without Light, Magic Photos, Moonlight Effects. Make pictures in bottle. Print picture on apple. To imitate Oil painting. To print on Cloth. Make pen and ink sketch from photographs. Make proofs before negative dries, and 22 other valuable instructions. Will send all for \$1.00 postpaid. Wanted solicitor for Miniatures, Portraits, Enlargements, Paintings, etc. Matzsch's Photo Art Shop, 1946 W. 21st St., Chicago, Ill.

BIG Money Saved on Photographic Lenses and Apparatus—goods exchanged; repairing done. Ralph J. Goleen, 1128 Argyle St., Chicago, Dept. P.

BUSCH—Goetz officers, 8 power, 40 mm. fieldglasses used in the German Army—while they last, \$12.50, with case. Carl Zeiss, \$17.50. Cameras, binoculars, telescopes, sold and exchanged. Write your needs. National Camera Exchange, 7th at Marquette, Minneapolis, Minn.

FILMS developed, prints made, prompt service. Z. Koscielniak, 17214 Lamont, Detroit, Mich.

SUPERIOR quality finishing and enlarging. Trial offer: Any size 6 exposure roll developed and printed, 25 cents. 8x10 enlargement unmounted, 30 cents. Carkhuff Photo Finishing Co., 2129 W. Van Buren St., Chicago, Ill.

FILM Developed 5c. Prints, Velvet 2c. Glossy 3c. or roll developed and printed 25c. 8x10 enlargement, any negative, 30c. Reliable Photo Finishing, Box 151, South Bend, Indiana.

MOTION PICTURES

VIC'S Movie Handwriter, 10c. Everybody delighted. Vic. Hansen, Wallace, Idaho.

ONE and two reel western film, \$5.00 per reel. One reel Broncho Billy western film \$10.00 per reel. Mutt and Jeff cartoons \$10 per reel. Monarch Theatre Supply Co., Dept. 8 W, 724 South Wabash Ave., Chicago.

BARGAIN Hiss Machines, Films, Supplies. National Equipment Company, Duluth, Minn.

\$35.00 PROFIT nightly. Small capital starts you. No experience needed. Our machines are used and endorsed by government institutions. Catalog free. Atlas Moving Picture Company, 682 Morton Bldg., Chicago.

REMARKABLE value: Light Weight Professional Motion Picture Projector, Mazda Illuminated, with 1,000 feet of film, \$37.50. Send for photograph. DeFrance, Importers, 109 No. Dearborn St., Chicago, Ill.

AMERICA'S Greatest Fortunes made in the Motion Picture Business. We furnish Complete Theatre Equipment on easy payments. Openings everywhere. Catalog Free. Monarch Theatre Supply Co., Dept. F—724 South Wabash Ave., Chicago.

FREE to Writers—A wonderful little book of money-making hints, suggestions, ideas; the A B C of successful story and play writing. Absolutely Free. Just address Authors Press, Dept. 12, Auburn, New York.

JUST in time to get in on the big money to be made! Bass will start you in the Motion Picture Making Business, enormous profits making Industrial Films, News Weeklies, etc. Catalogue and full information Free! The Cinema Handbook, 575 pages for \$3.00 postpaid. Bass Camera Company, 105 No. Dearborn St., Chicago, Ill.

FILMS: Special Features—Comedies—Cartoons—Dramas and Serials, Lowest Prices, Bargain List Free. Monarch Theatre Supply Co., Dept. 81, Memphis, Tenn.

MAKE money writing photoplays; details free to beginners. No correspondence course. Producers League, 230 Wainwright, St. Louis.

\$\$\$ FOR Ideas. Photoplay plots accepted any form; revised, criticized, copyrighted, marketed. Advice free. Universal Scenario Corporation, 296 Security Bldg., Santa Monica and Western, Hollywood, Calif.

ONLY \$98.00 starts you in this business. Wonderful opportunities for making Fortunes. Details Free. Monarch Theatre Supply Co., Dept. 46, Memphis, Tenn.

MOTION Pictures for your home. Excellent Westerns, Dramas and Comedies. Fifty-foot lengths one dollar. One hundred foot lengths two dollars postage paid. Eugene Cline, Seventh and Main Sts., Cincinnati, Ohio.

ONE Thousand Reels—Religious, Educational, Comedies, Dramas, Westerns and all other kind included. Write Queen Feature Service, Inc., Birmingham, Ala.

NEW Movie Home Projector, \$25. New Motor Driven suit case projector, \$75. New Hallberg suit case projector and 95 pound gasoline engine electric generator, \$250. 100 feet Movie Film, \$1.00 postpaid. 300 feet, \$3.00—Comedies, \$5.00—Films Rented. Pathoscope Films, Movie Carriers, fastest lens, \$45. New, \$125—50-foot Movie Camera, \$80. Ray, 324 5th Ave., New York.

BIG Money Nightly—Good assortment. Complete Outfits, installment plan. Splendid Home Outfit, \$25.00. Ralph J. Goleen, Dept. M, 1128 Argyle St., Chicago.

BARGAINS in used film and projectors. New miniature projectors, \$4.50 to \$30.00. New Professional projectors, \$150.00 to \$400.00. Werner Brothers, High Ridge, Mo.

SCENERY TO RENT

SETTINGS for Opera, Plays, Minstrels. Flush drops. Address Amelia Grain, Philadelphia.

EDUCATIONAL AND INSTRUCTION

YOU can have a business profession of your own and earn big income in service fees. A new system of foot correction; readily learned by anyone at home in a few weeks. Easy terms for training; openings everywhere with all the trade you can attend to. No capital required or goods to buy; no agency or soliciting. Address Stephenson Laboratory, 1 Back Bay, Boston, Mass.

IMPROVE your handwriting. Penmanship educator, patented device that will help you. Complete with instructions, 25c. Dept. C, Bartlett-Oudin Company, 44 Portland St., Worcester, Mass.

PERSPECTIVE drawing made easy. Fuller Simplified System makes beginners and junior draftsmen expert overnight. Send stamp for particulars. Earl Fuller, 602 Gumble Bldg., Kansas City, Mo.

BOOKKEEPING in a Week, \$1 Postpaid. Dukes, 1857 Walton Ave., New York.

WORLD-ROMIC System, Masterkey to All Languages. Primers, 23 languages, \$1.94 each language; Canteones, Swedish, French, German, Italian, Portuguese, Spanish, Pronunciation-Tables, 104 languages, 39c each language. Grammars, dictionaries, 1,000 languages: Afro-Asiatic, Amer-Indic, Eur-Indic, Indo-Pacific, Siberic, Sinitic. Languages Publishing Company, 8 West 40th Street, New York.

DOUBLE Entry Bookkeeping mastered in 60 hours with 8 keys; guaranteed; diploma. Our graduates lead in bookkeeping, auditing, accountancy, balance sheets, and financial statements. International Bookkeeping Institute, Dept. 8, Springfield, Mo.

STUDY a Profession at the Distinctive University. We will make you an expert Bacteriologist, Chiropactor, Osteopath, Chiropodist quickly. National University, 2925 Michigan, Chicago.

ARTICIAL Marble, sanitary flooring instructions, ornamental casting, concrete plaster, papier-mache decorations, garden furniture statuary, Rubber-moulds, Electro-metallurgy, particulars and 200 illustrations free. Chris Mahler, Box 122, Huntington, N. Y.

Let a Laboratory Exp't. Earn \$300.00 to \$500.00 a month. Study Microbiology, Bacteriology, Laboratory Technology, Sanitation. Interesting Extension and Residential Courses. Diplomas and Degrees granted. 71-piece Urinalysis Outfit Free to students. Write for Free 48-page Prospectus Today. Int'l Physicians and Surgeons College of Microbiology, Room 955, 550 Garfield Ave., Chicago, Ill.

WRITE a better signature. Yours written six styles on cards. Send dime. Meub, Expert Penman, 2651 N. Lake, Pasadena, Calif.

WRITE articles, stories, news, in spare time for newspapers and magazines. Big pay. Copyright book free. Press Syndicate, 552, St. Louis, Mo.

SHOW Card Writing, a pleasant, profitable profession. Quickly and easily learned through our new, simple method. No canvassing or soliciting. We show you how, no matter where you live. Full particulars and booklet free. American Show Card System Limited, 203 Adams Bldg., Toronto, Canada.

"What to Invent for Profit" free. Patent News-N, Washington, D. C.

USED educational matter, books, etc. sold, rented and exchanged. Big list free. Lee Mountain, Pisrah, Ala.

WRITE Photoplays that Sell. Our proposition will interest you. Address, Pribys Photoplay Service, Pa. Ave. Sta., Box 351-G, Washington, D. C.

SHORTHAND in three weeks; written with longhand characters; simple, speedy, legible. Teachers wanted, Dickinson, 331 Altman Building, Kansas City, Mo.

USED books and educational matter bought, sold, exchanged. List 1,000 items free. Students' Exchange, 47-A West Forty-second Street, New York, N. Y.

IF You Are Different let us tell how Better Jobs and Their Getting increase your pay. Newways Co., Box 161, New Brunswick, N. J.

USED books and educational matter bought, sold, exchanged. Bulletin free. Instruction Correspondence Exchange, 1969 Broadway, New York.

LEARN practical shoe repairing business in six weeks. If you are handy with tools, here is an exceptional opportunity. Millions of shoes repaired in the United States monthly. The business of shoe repairing can be started with very small capital. It pays up to \$100.00 weekly. Why work for others? Be your own boss. Send for United States copyrighted "Practical Shoe Repairing" tonight. The cost is \$3.00 postpaid, complete in United States. It can be obtained only through me. C. Bower, Box 1234, Seattle, Wash.

JOURNALISM—Photoplays—Short Stories, Plot Chart and Copyright Book free to those wishing to enter above professions or to dispose of manuscripts on Commission. (The Service offered is given by Professional Authors and Editors of high standing.) Harvard Company, 431, San Francisco, Calif.

WORK for Yourself Writing Show Cards. Invest 1 hour daily and earn \$50.00 weekly in short time. Easily learned. Full particulars free. Birch Speedy Correspondence System, 950 Eddy St., San Francisco, Calif.

TELEGRAPHY

TELEGRAPHY—Both Morse and Wireless—taught thoroughly and quickly. Tremendous demand. Big salaries. Wonderful opportunities. Expenses low; chance to earn part. School established fifty years. Catalog free. Dodge's Institute, H St., Valparaiso, Ind.

RADIO OUTFITS AND SUPPLIES

1700-MILE Guaranteed Radio Set with serial equipment, tube, batteries and headset ready to operate, \$38.00. Three tube set with storage battery, horn, tubes and necessary equipment, \$91.75. Quality Radio Company, 833 West 16th, Chicago.

DON'T risk time, money, and pleasure. Get Radio for you, for your home, for money making, or science, complete. Radio Encyclopedia and Directory illustrated; 20th Century Illustrated Radio, picture entire Radio of the whole world, best of all. Price for the whole thing only, \$2.75. Address E. Julius and Company, 2309 West Grand Ave., Chicago, Ill.

RADIO A Batteries—To introduce Marko Storage Batteries to new users, we will ship a 6 Volt, 90 Amp. Hr. guaranteed battery in rubber case on receipt of \$14.00. Regular price, \$17.50. Marko Storage Battery Co., 1492 Atlantic Avenue, Brooklyn, N. Y.

F. L. BRITTIN'S Simplified diagrams, personally selected tested standard parts, for building Neutrodyne, Rehnartz Spider Coil, Standard Regenerative Receivers. Quality, fair price. Rosemont Radio Supply Company, 1409 Rosemont Ave., Chicago, Ill.

YOU Don't Need Tubes to get out of town. If you want new stations on your crystal set. Write Me Today. Mine works 400 to 1,000 miles without tubes or batteries! Thousands have bought my plans and now get results like mine. Changes often cost less than dollar. Send self-addressed envelope for further information. Leon Lambert, 539A So. Volusia St., Wichita, Kansas.

FOR Sale—2,500 Mile Radio Outfit with Loud Speaker, Complete. Cost, \$125; sell for \$85. Arnold Werner, High Ridge, Mo.

THE Ferbernd Wave Trap will solve your radio interference problems. Send stamp for circular. Ferbernd Electric Company, 15 E. South Water Street, Chicago.

RADIO Desks, Tables, Cabinets. We also make any Radio furniture to order. We sell direct to you at only small factory profit. Our prices are for goods delivered, transportation prepaid. Send for free catalogue. The Southern Toy Corporation, Hickory, N. C.

EXPERIMENTERS! Send \$1.00 for The Newman-Stern Co. Microphone Button. This is a miniature telephone transmitter, 1" diameter, extremely sensitive. With this button you can make telephones, dictaphones, etc.; transmit music to distance; cause cans, boxes and other objects to talk. You can make radio telephones, microphones and loud speakers. We pay \$5.00 for new and acceptable ideas for using this button. The Newman-Stern Co., Newman-Stern Bldg., Cleveland.

BARGAINS, 2,000 Mile Reflex Set, \$24.50. Spider-web Coupler, \$2.00. 1½ Volt Tube Socket, Free, \$4.65. Others List Free. Lycoming Radio Laboratories, 511½ Franklin, Williamsport, Pa.

FREE—Complete price list Aitken Radio Co., 504 Superior St., Toledo, Ohio.

LOUD Speaking Crystal Set. Stations from over 1,000 miles have been brought in easily. Music can be heard all over the room right from your own crystal set with the Steinmetz Amplifier, only \$8.50. Complete catalog at your dealers or Steinmetz Wireless Mfg. Co., East End, Pittsburg, Pa. "Radio Library," most complete simplified radio publication, Now 25c.

TRADE SCHOOLS

PAINT Automobiles, Trim Automobiles. Become a certified Electrician. We fit you for a big-money job. Make you an expert, able to step right into a position paying \$45 to \$100 per week. We secure you a job while training that more than returns tuition costs and expenses. Come to Detroit, the Automobile Hub; the World's wonder city. Write today. Standard Trade Schools, 416 Woodward Avenue, Detroit, Mich.

LET us place you in a position to earn from \$10 to \$25.00 per day. That's what our Students are doing all over the country. You can learn in a few weeks at low cost to be a Sign, Auto and Pictorial Painter—Decorator, Paperhanger, Show-card Writer, Grainer and Marbler. No books used, all practical work. Send for Free Catalog. Chicago Painting School, 148 West Austin Ave., Chicago.

BUSINESS OPPORTUNITIES

INCH Display Advertisement 166 Magazines Thrice \$15, Year \$50, Page \$100. Wood's Popular Services, Atlantic City, N. J.

"WHAT to Invent for Profit" free. Patent News-C, Washington, D. C.

EARN big money, making and selling signs and house numbers. Easy to make. They sell at sight. Full instructions, \$2.00. F. O. Armstrong, 149 N. Essex Ave., Orange, N. J.

STATE or District Rights for Sale—New invention—"Artipoint," the wonder pencil. Leads cannot plug or become clogged. Lasts a lifetime. Made in three sizes, heavily plated in silver or 18 karat gold. Most beautiful workmanship throughout. Far superior to all others. In a class by itself. Everybody wants one. Millions will be sold. Worth fortune to State Agents. Our selling plan assures success. No bonus demanded. Simply pay cash for your orders. References required. Department 35, Artipoint Pencil Co., 1001 W. 16th St., Los Angeles, Calif.

BIG Money-Making Opportunity for one man in each community; Rustnot products sell homes, hotels, restaurants, boarding houses, etc. You can earn \$10 to \$15 daily, and double this when reorders come in; free folder tells how to start money coming fast. Rustnot Products Co., Albany, N. Y.

NO Convassing brings \$10.00 daily; steady income at home; costs 6c, retails \$1.00. Particulars Free. Westing Press, 530 Palisade Ave., Jersey City, N. J.

COMMON Sense and \$100 or more will establish cash business. Dept. M, Paul Kane, 149 Broadway, New York.

SEND Today for free sample copy of Writer's Digest, America's greatest magazine for writers. Filled with practical articles by leading writers. Will help you write and sell stories, photoplays, songs, etc. 603 Butler Bldg., Cincinnati.

MEXICO—The place of opportunities. Free country. Beautiful climate. Accurate data regarding oil, colonization, mining, timber, agriculture, industries. Fee: \$5.00 draft on New York or Chicago. Julio Deschamps, Isabel Catolica 51, Mexico City. References: Equitable Trust Co.

PATENTS—Write for our Guide Book, List of Patent Buyers and "Record of Invention Blank" before disclosing inventions. Send model or sketch and description of invention for examination and instructions. No charge for the above information. Victor J. Evans & Co., 192 Ninth, Washington, D. C.

START a pressing, cleaning and dyeing shop; excellent field, splendid profits. We tell you how. Write for booklet. Ben-Vonde System, Dept. C, Charlotte, N. C.

EARN \$3,000 to \$10,000 per year as income tax experts and public accountants. Send for full details and our pamphlet. Adams & Adams Public Accountants, 903-B Broad Street, Newark, N. J.

STOP making others rich. Hire yourself as boss. Start your own business. Small capital. Spare time. Get startling facts that helped several to wealth. Knights, 1188 West Ave., Buffalo, N. Y.

LEARN Candy Making. Make big profits at home or in shop. Big demand for good candy. Easily, quickly learned through our correspondence course. Write today for booklet 1-10. The Candy Institute, Sixty West Fiftieth Street, New York.

MAIL Order Business is your opportunity. Brenner's Famous Handbooks teach how to start small, grow big. Sell merchandise, service, ideas; enormous profits. Spare time to begin. Get complete set, 11 books, \$3.00, and be posted. Brenner, 335 Walnut, Philadelphia. Descriptive Catalog and big batch interesting mail order information. 25c. None free.

"HOW to Sell Patents" free. Patent News-H, Washington, D. C.

"GET into the Specialty Manufacturing Business" or "Why Work for Others?" may sound good to you, but you won't succeed in that business unless you possess Formulas that are absolutely reliable, the same required by leading manufacturers supplying the Best. Don't be lured into buying a Collection of cheap "Formulas" and expect to succeed. Send today for my valuable literature and Formula Lists and Real Money-Makers in the Specialty Manufacturing Business. 20 years supplying the Best. Miller, Chemist, 805 De Leon St., Tampa, Fla.

SILVERING Mirrors! My exclusive French Tartaric method opens enormously profitable business. Booklet free. H. Barstow, 514 23d Street, Oakland, Calif.

"SCHEMER Magazine," Alliance, Ohio, prints big profit schemes; one subscriber making \$25,000 from three; another \$10,000 from one. Try your luck. Year, only \$1.00; three months, 25c.

FREE Book—Start little mail order business anywhere; home employment evenings; beginner's working outfit furnished; 500 circulars, samples, things to sell; you deal direct with manufacturers; no stock to carry; instructive booklet free. Pier, 218-A, 74 Cortland St., New York.

RAISE guinea pigs. Pay better than poultry or rabbits; easy to raise; little space required. We guarantee market. Particulars and booklet how to raise free. Cavies Distributing Co., 3102 Grand Ave., Kansas City, Mo.

EARN \$3,000 to \$30,000 yearly. You can be a Professional man in Bacteriology, Pharmacy, Osteopathy, Chiroprody, Resident and Home courses. Begin now. National University of Sciences, 2923 Michigan, Chicago.

MARBLE mixing instructions, covering wood or cement flooring ½ inch thick, fire-proof, waterproof, low cost, sanitary, all colors. Particulars, 200 illustrations free. Chris Mahler, Box 122, Huntington, N. Y.

GOOD money easily earned at home spare time silvering mirrors; no capital. Free instructive book tells how. Patterson & Co., Brooksville, Ky.

GO into the Crispette business. Everybody likes Crispettes. You can make a lot of money. We start you. Write for facts. Long Eakins, 1959 High St., Springfield, Ohio.

STOP Plodding/ Be Successful. Operate a Tire Repair Shop. Make big profits in any locality. We teach you and furnish complete equipments, \$108.00 up. Book of Opportunity free. Haywood's, 1305 South Oakley Avenue, Chicago.

MONEY-MAKING opportunity; particulars free. Lemke, Box 572, Cincinnati, Ohio.

EXCEPTIONAL Opportunity for Sales Manager capable of handling state distribution. Marvelous new Adding Machine. Retail \$15. Work equals \$350 machine. Tremendous possibilities. Unlimited profits. Write quick for details. Lightning Calculator Co., Dept. B., Grand Rapids, Mich.

REAL Estate Business of your own or position worth \$3,500? Our Graduates can choose. Training at home prepares you in short time and we aid you to make good. Bulletin free. Penn Realty School, 19th and Ellsworth, Philadelphia, Pa.

WE Start You in Business, furnishing everything; men and women, \$30.00 to \$100.00 weekly operating our "New System Specialty Candy Factories" anywhere. Opportunity lifetime; booklet free. W. Hillyer Bagdale, Drawer 4, East Orange, N. J.

\$100.00 PER million population. Buys state manufacturing rights. Valuable patent. No competition. Enormous profits. Machinery unnecessary. Independence for life. Dr. Schmidt, Blanton, Fla.

ENTER a new business. Earn \$3,000 to \$6,000 yearly in professional fees making and fitting a foot specialty, openings everywhere, with all the trade you can attend to; easily learned by anyone at home in a few weeks, at small expense; no further capital required, no goods to buy, job hunting, soliciting or agency. Address Stephenson Laboratory, (1) Back Bay, Boston, Mass.

A RARE Opportunity. Men and Women make enormous profits. Article costs 5c, sells quickly for \$1.00. Can make \$15.00 to \$30.00 daily. Particulars free. Write quick. Isthm Novelty Co., 72 Mapes Ave., Newark, N. J.

NICKEL plate automobile accessories, hardware, electrical parts. Big profits. Requires no capital. Simple battery process. Write today, Webster Engineering Co., Webster Groves, Mo.

A MAIL-ORDER business of your own, selling movie patrons all year anywhere, free circulars. Wondo, M 31 Times Plaza, Brooklyn, N. Y.

START Your Own Business. Small capital. "Gilmer's Business Plans" gives formulas, trade secrets, processes for manufacturing forty fast-selling necessities. Complete with selling plans. Tells where to buy all materials. Price \$1.00. Gilmer's, 4450 West End Ave., Chicago.

608 WAYS to Make Money—2,716 Formulas "Encyclopedia Business Opportunities," 3 volumes, \$1. Ideal Book Shop, 5501-PV, North Robey, Chicago.

DOLLARS Yearly in your backyard. No mushroom dope. Particulars free. Metz, 313 East 89th, New York.

SUCCEED With Your Own Products—Formulas, Processes, Trade-Secrets. Different, dependable, profitable. Catalog free. B. Tauxly Co., Washington, D. C.

PATENTS Procured. Send sketches or model today for examination, prompt report and advice. No charge for preliminary advice. Write for free booklet and blank form on which to disclose your idea. Highest references. Promptness assured. Clarence A. O'Brien, Registered Patent Lawyer, 309 Security Bank Building, Directly across the street from Patent office, Washington, D. C.

PATENTS Procured; Trade Marks Registered—A comprehensive, experienced, prompt service for the protection and development of your ideas. Preliminary advice gladly furnished without charge. Booklet of information and form for disclosing idea free on request. Richard R. Owen, 59 Owen Bldg., Washington, D. C., or 2776-R Woolworth Bldg., New York.

MANUFACTURE Ready-Made Gold Window Sign Letters. Unlimited Profits! We furnish complete instructions, accurate patterns. Absolutely no experience required. Wonderful Business Opportunity! Particulars, Witherding, 3161 Abbott Court, Chicago.

LEARN the collection business. Good income, quick results. Interesting booklet, "Skillful Collecting," free. National Collectors Assn., Lomb St., Newark, O.

\$3,000 TO \$6,000 Yearly. Want It? Others are making it. Send check or money order today for our invaluable books "How to Sell Real Estate," \$3.00—and "How to Conduct Real Estate and Insurance Business," \$1.50. Absolute satisfaction guaranteed. Free catalogs. Realty Book Co., Dept. 52, Cleveland, Ohio.

SIGN Painting Self-Taught. Samples, 5c stamps. Healy Sign Co., 21 Old Colony Ave., Woburn, Mass.

CHEMICAL Expert furnishes manufacturing formulas with complete working directions, resulting products possessing distinct individuality and merit. Processes perfected. All lines. No lists of worthless stock formulas but reliable individual service. Charges reasonable, correspondence invited. Dr. Arthur VanHelden, 508 South Oakley Boulevard, Chicago.

\$50 WEEK earnings—I made it. Mail Order business; booklet for stamp tells how. Sample and plan, 25c. Free 12 articles worth \$3. Alpage Scott, Coboes, N. Y.

I MADE \$30 a Week Home. French Breadmaking. 15 years' experience! Free Booklet tells. Ashbrook 67, Marenco, O.

MANUFACTURE Extracts and other necessities, 200% profit; we tell you how. Write White Manufacturing Drug Co., 1426 Lakilaw Ave., Cincinnati, O.

START and Operate Your Own Business. Our System proprietary spec's to manufacturing offers wonderful opportunity to make \$100 to \$500 weekly. Openings everywhere. Either men or women. We furnish everything and show you how. Big explanatory book, "The Open Door to Fortune" free. Write for it now. National Scientific Laboratories, 208 Monroe, Richmond, Va.

BEFORE Starting in Business for yourself, insure your success by letting us help you. Vital, comprehensive, practical ideas, hints, points, and information by experts, on buying, selling, merchandising, banking and advertising. A new business. Unusual service. Write for free booklet today. Western Bureau Business Research, Room 509 B, 315 Montgomery St., San Francisco.

PUBLISH small magazine of your own and start mail order business. Plan and sample magazine, 10c. Harvey Teeple, Decatur, Ind.

SLOT Machines; Headquarters for Premium Machines, 1016 Germantown Ave., Philadelphia.

BE a Broker—Own your business, no experience required. Write for information. George Grigoletti, 29 East Jackson, Chicago.

START a Real Estate Office of your own. Earn from \$3,500 upwards. Our course of 21 lessons tells you how. Booklet M, on application. Frederick Jenkins, Corlier Heights, Schenectady, N. Y.

SIGNS, Banners and Cards Easily Painted with Letter Patterns. Write for free samples. John F. Bahn, A2433 Greenview Ave., Chicago.

HUNDRED stores paying \$5 monthly. You can do the same in your City. Few weeks qualifies. Cincinnati, Chicago, Detroit, York, Minneapolis, Newark closed. Only one person in each City chosen. Midnight Alarm System, 2965 Algonquin, Detroit.

EARN \$15.00 Daily at Home; Make automobile specialties. Reconvert old automobiles; tremendous demand—start shop with small outlay. Autorenuco, Sheboygan, Wis.

LEARN Mail Order Business. New system raise money. Taytexco, 25 School, Boston, Mass.

EARN \$10 daily silvering mirrors, plating and refinishing metalware, autos, chandeliers, bedsteads, headlights. Outfits furnished. E. Dele Laboratories, 1133 Broadway, New York.

1,000,000 German Marks, \$1.00; 10,000 Austrian Kronen, 25c; 100,000 Rubles, 25c. Write for Dealer Terms, George Grigoletti, 29 East Jackson, Chicago.

ATTENTION! You can have a business of your own. Establish and operate New System Real Estate Business, brokerage and insurance agency in your community. Office at home. Earn \$3,000 year. Representatives wanted everywhere. Send stamp free booklet. Hayes Realty Association, Cincinnati, Ohio.

WANTED County Distributors for World Fastest Selling Automobile Accessory. Write C. Benross Co., 384 East 144th Street, New York.

CHEMISTRY

YOUR chemical problem solved and working process furnished Five Dollars. Write me. W. Steiman Richards, Consulting Chemist, address, Box 2402, Boston, Mass.

CHEMICAL Service. Formulas, analysis, methods, experiments. Jacob Slayter, Chemist, 2525 East St., Davenport, Iowa.

PRODUCTS formulated, duplicated, improved, cheapened, marketed. Ethical, Box 1029, Chicago.

EXPERT chemist will make or analyze any formula desired. Results guaranteed for \$5.00. Edward Mease, 852 14th St., Des Moines, Ia.

"POPULAR Chemistry." Experimenters' Monthly, Half-year, 50c. D. Wright Laboratories, Caldwell, N. J.

FORMULAS AND TRADE SECRETS

3,000 RECIPES, \$1.25. Best formulas and processes for every business trade or occupation are in "Youman's Guide." Many never before published. Worth \$1.25 each. 530 pages. Paper cover, \$1.25. Cloth, \$2.00 postpaid. Book catalog free. Wells and Edwards, X852 George, Chicago.

500 FORMULAS, including Luminous Paint—Renewing Dry Batteries—Mechanics Soap—Gas Torch—25c. Catalog Free. Ideal Book Shop, 5501-PM, North Robey, Chicago.

FORMULAS—Best that Chemical Science can devise. Not "Better Sort" Formulas, but Guaranteed Reliable processes in all lines. Stamp brings valuable Literature and Latest Summer Sellers from an Analytical Chemist. Miller, Chemist, 807 De Leon, Tampa, Fla.

VALUABLE manufacturing secrets. Every one a money maker. Postpaid \$1.00. Your money back if not satisfied. S. Vignola, Ph. G., 135 Meadow St., Pittsburgh, Pa.

BIG, interesting formula catalog free. National Scientific Laboratories, 208 Monroe Street, Richmond, Va.

1,000,000 FORMULAS, 1,016 pages, \$2.500 Formulas Free if you order quick. Ideal Book Shop, 5501-PM, North Robey, Chicago.

20,000 FORMULAS, 557-page volume, \$1.39. Universal, 4047-PL, North Whipple, Chicago.

500 VALUABLE Formulas 25c. Circular free. Harvey Teeple, Decatur, Ind.

FORMULAS and instructions for 10 fast selling articles, \$1. Start a business. Own it. Clarendon Co., Cold Brook, N. Y.

"BEATS ALL" Auto Cleaner and polish combine. One operation. Cleans anything. Formula, full directions \$1. Flandt & Co., Wobroville, Ind.

SECRETS for putting up 60 fast-selling articles 25c, money-making opportunities included. Stearins Company, Waltham, Mass.

500 FORMULAS; resilvering mirrors, valuable collection, 20c. Universal, 4047-PL, North Whipple, Chicago.

FORTY Famous Formulas of every day necessities \$1.00. Gilmer Co., 4450 West End Ave., Chicago.

FORMULAS—Guaranteed. Catalog Free. Bestoval Laboratories, 4047-PL, North Whipple, Chicago.

AGENTS WANTED

NEW Invention: "Artpoint," the wonder pencil. Cannot be copied. Uses all leads—indelible, regular and marking—last a life-time. Made in three sizes, heavily plated with silver or 18 karat gold. Most beautiful workmanship throughout. Far superior to all others. Every demonstration makes a sale. Everybody wants one—millions will be sold. Exclusive territory right means small fortune. Get yours before too late. Office-to-office men are cleaning up. Sells for \$1.50 and \$3.50 each. Save time and send \$1.00 for sample by mail and full particulars our guaranteed sales plan. State territory desired. Desk 35, Artpoint Pencil Co., 1091 W. 16th St., Los Angeles, Calif.

SELL guaranteed Indestructible Pearls. \$25 quality sells for \$5.95. Your commission \$2. Write quick. Pohler, 6042 So. Mozart, Chicago.

WHY Work for others? Start and operate your own business. Our system proprietary specialty business offers wonderful opportunities to make \$100 to \$500 weekly. Openings everywhere. We furnish everything and show you how. Booklet free. National Scientific Laboratories, 208 Monroe, Richmond, Va.

MAGICAL Necklace. "Shines in the Dark." Absolutely new. Be the first to sell this charming and captivating necklace. 100% to 400% profit. Send \$1.00 for sample and territory protection. W. E. Hannan Co., Dept. E, 57 E. 18th St., Chicago.

FREE Sample. "Rain Shield Wiper." Retail \$1.00—Costs (25c). Sold, Clear and Rainy Days. No Cloth—No Paste—No Attachment. (1) Rub keeps Windshield Clear (48) Hours. Experience unnecessary. NuLife (H) Corporation, Hartford, Conn.

AGENTS—Big money, \$8 to \$16 a day. Aluminum handle cutlery set. Brand new. You display and take orders. We deliver and collect. Pay you daily. Sample free. Try it out. Jennings Mfg. Co., Dept. 1068, Dayton, Ohio.

\$60-\$200 A WEEK. Genuine Gold Letters for store windows. Easily applied. Free samples. Liberal offer to general agents. Metallic Letter Co., 438-D North Clark, Chicago.

WONDERFUL Invention—Eliminates all needles for photographs. Saves time and annoyance. Preserves records. Lasts for years. 12,000,000 prospects, \$15.00 daily. Free sample to workers. Everplay, Desk 1223, N.-C. Ave., Chicago.

AGENTS Easy Money. Interview motorists—Patented Instrument Every motorist Needs—It Saves Money Three Ways—Guaranteed. Thousands "Sold." Glad Users Everywhere. Big demand at your door. Pleasant work. Permanent business of your own—employ sub-agents—\$75.00 weekly up, all or part time. Experience unnecessary. This is a high class money-making proposition—Your opportunity for success. Whatever you do answer this ad quick. Wizard Mfg. Company, 453 Central Ave., Rochester, N. Y.

AGENTS—\$3 per hour and more!! Sell Iron Board Covers, Rubber Aprons, Shopping Bags, Embroidered Aprons, Satem Coverall Dresses. Free Sample offer. American Trading Company, Dept. P, 329 W. Monroe, Chicago.

NO Dull Times Selling Food. The greatest, surest and safest business in the world today is selling Federal Pure Food Products, and here is your opportunity to get into this business. You can make \$3,000, \$5,000, \$10,000 or more per year—the only limit is your ability to take care of the business. People Must Eat, and our food products are the fastest selling, surest and quickest repeat order getters in the world. Sell on sight in every home where food is used. Repeat orders immediate and every week thereafter. We supply you with effective Free Advertising Matter, Free Samples and a Free Course in Salesmanship. We also have over 100 high-grade beautifully packaged Toilet Preparations. Your future will be a financial success. A Real Big Business All Your Own. Every New Customer adds a great deal to your weekly income. Your business once established has a market value just like a store and can be easily sold. The greatest money-making opportunity of your lifetime, because you risk absolutely nothing, as we guarantee your sales, and we will not let you fail. Remember! Guaranteed! Best products, biggest sellers, surest repeat orders. No capital or experience is required. We furnish capital and everything necessary for you to become a Federal Distributor. Exclusive territory will be given honest men or women who will write at once asking us to send our "Success Guaranteed" proposition. Address, Federal Pure Food Company, Dept. A, Chicago, Ill. Largest inventors of and packers of Pure Food specialties in the world. Reference, any bank, Dun or Bradstreet rating agency, Express or Railway Company in America.

WE start You Without a Dollar. Soaps, Extracts, Perfumes, Toilet Goods. Experience unnecessary. Carnation Co., Dept. 201, St. Louis.

WANTED—Representatives to sell Automobile necessity. Kills headlight and sun glare. Write for sample. Dept. P. The Clark Products Co., Springfield, Ohio.

AGENTS make a dollar an hour. Sell Mendets, a patent patch for instantly mending leaks in all utensils. Sample package free. Collette Mfg. Co., Dept. 404-B, Amsterdam, N. Y.

AGENTS clear \$50.00 weekly selling Opaline Portraits. Expense money advanced. Credit given. Big line now ready. Samples and Catalog free. Consolidated Portrait Co., Desk 2, Chicago.

EVERYBODY uses extracts. Sell Duo Double Strength Extracts. Complete line household necessities. Big repeaters. Write today. Duo Co., Dept. E1, Attica, N. Y.

PATENTED Cigar Lighters with Glass Advertising Front. Also Electric Cigar Moisteners. Wonderful Sellers. No Competition. 17g Steady Profits. Proof, Cuts, Sales Plan Free. Drake Mfg. Co., Dept. M, Milwaukee, Wis.

AGENTS—Good salary and commission selling "Batskyll," new rat and mouse exterminator; ready for use; no bait required; non-poisonous; rodents die outside premises; no odor. Empire Specialties Co., 1549 N. Wells, Dept. 301, Chicago, Ill.

AGENTS—Steady income. Large manufacturer of handkerchiefs and dress goods, etc., wishes representative in each locality. Factory to consumer. Big profits, honest goods. Credit given. Send for particulars. Preetport Mfg. Co., 59 Main St., Brooklyn, N. Y.

AGENTS Wanted—Something New—Fire Fighter sells easily. Makes a spectacular demonstration; car owners, homes, factories, stores, practically buy on sight. Our men make \$10.00 to \$50.00 a day; exclusive territory. If you wish to establish a business of your own with unlimited possibilities for making big money, write us today. Fyr-Fyter Co., 103 Fyr-Fyter Bldg., Dayton, Ohio.

POLMET—The polishing cloth approved by "Good Housekeeping" and "Modern Priscilla." Sells fast at 25c. Sample free. Gale & Co., Inc., 15 Edinboro St., Boston.

LARGE Corporation wants a Service Man in every town to paste up its signs on store-keepers' windows. Excellent opportunity for reliable party. Steady work. No experience necessary. We also have attractive proposition for agents and salesmen. Guarantee Sign Service, 343 West Superior, Chicago.

AGENTS—Stamping names on Pocket Key Protectors; sample Check with your name and address, 25c. Stamping Outfits, Emblem Checks, Check Fobs, Name Plates, Hart Mfg. Co., Desk 2, 303 Degraw St., Brooklyn, N. Y.

THESE Advertisements of mine have appeared in Popular Mechanics for sixteen years. Hundreds of Successful Manufacturers today owe their success to my formulas and valuable information. Majority started with practically nothing. You can do the same—write today for my valuable literature relative to my Guaranteed Manufacturer's Formulas for making Non-Thermic Ice-Saving Cloths, Delicious Beverages for Home, Bottlers and Fountain sale. Pure Food Products, Non-Alcoholic Flavors, Launderite Washing Marvel, Zebest, greatest stain remover, Sia-Combed, Marcel Hair Curler, and latest Toilet specialties. Mexican Yucca Soap, Laundry Soaps, Flynnox, Sensol, and all latest disinfectants. Amazon Tire Repair, Toy Rubber Balloons and all latest selling goods in all lines. Don't compare these with "junk" commonly offered. Analytical work carefully done. Highest references. Miller, Chemist, Tampa, Fla.

AGENTS make 500% profit handling Auto Monograms, New Pictures, Window Letters, Transfer Flags; Novelty Signs. Catalog Free. Write Hinton Co., Star City, Ind.

VALUABLE Information I supply sells readily, 100% profit. K. Home, 1957 Warren, Chicago.

GET Our Free Sample Case—Toilet articles, perfumes and specialties. Wonderfully profitable. La Derma Co., Dept. A, St. Louis, Mo.

AT Last—World's Greatest Adding Machine. Almost human. Retail \$15; work equals \$300 machine. \$500 monthly easily made, demonstrating to stores, offices, garages, factories. Simple, easy; adds, subtracts, multiplies, divides automatically. Speedy, accurate, durable, handsome. Five year guarantee. Tremendous demand, amazing profits. Liberal trial offer. Protected territory. Write quick. Lightning Calculator Corp., Dept. F, Grand Rapids, Mich.

SELL Madison "Better Made" Shirts direct from our factory to wearer. No capital or experience required. Easily sold. Big profits. Write for Free Samples, Madison Mills, 503 Broadway, New York.

MOST Wonderful Seller. 96c profit every dollar. No stock to carry. License unnecessary. Sample free. Mission Factory PM, 519 No. Halsted, Chicago, Ill.

AGENTS—Send for sample "Fretnot"—the washday wonder. Be convinced you can do a whirlwind business. You can clear at least \$20 to \$100 weekly, according to spare or whole time. You don't have to talk; if she doesn't buy at sight, leave sample; she will be looking for you long before you are able to make the rounds again. Samples furnished free. Premiums for your customers. Exclusive territory guaranteed to agents who can produce. Credits given. Don't call. P. M. Motter & Sons, 20 E. Jackson Blvd., Chicago.

SELL Necessities. Everybody needs and buys the "Business Guide." Bryant cleared \$800.00 in July. Send for sample. It's free. Nichols Co., Box 4-B, Naperville, Ill.

EASY, pleasant work for Mechanics, Shop Men, Clerks, during spare hours; will add many dollars to their salaries. Also want persons who can give full time. Big wages assured. Novelty Cutlery Co., 67 Bar St., Canton, Ohio.

AGENTS—N-R-G Laundry Tablets, the old reliable moneymaker for live agents. Millions sold—used in many homes—sales waiting for you. Clothes washed spotlessly clean in 10 minutes without rubbing. Free samples. N-R-G Company, 732-A N. Franklin, Chicago.

AGENTS—Portraits, medallions, frames, luminous crucifixes, pearl paintings, pictures, sell easy, always, everywhere at big profit. Pan American, 1217A Monroe, Chicago, Ill.

PORTRAIT Agents—\$50,000 Profits I made canvassing. My valuable Free book explains all. Guaranteed Prints, Portraits, Frames, Photo-Pillow-tops, Sheet Pictures, shipped all over the world. Samples free. Picture Man Friedman, Dept. 8-H, 673 Madison, Chicago.

\$100 WEEKLY. Agents, Crew Managers. Absolutely new articles selling big to housewives. No capital required. Commissions paid in advance. No collections. No delivery. Exclusive territory. Write quick. Pioneer Corp., 6301 Yale Ave., Chicago, Ill.

LADIES—\$10.00 vanity case, electric lighted, full gold plated equipment, genuine leather. Sample \$3.00. Red Seal Leather Co., Elkhart, Ind.

300% PROFIT: "Free Automobile"—Whirlwind Seller. Tremendous repeater. "Kleanrite." Marvelous Discovery. Washes clothes without rubbing. Premiums for customers. Sells 25c. You make 18c. Free samples make easy sales. Write quick. Bestever Products Co., 1941 K12, Irving Park, Chicago.

AGENTS \$100 weekly selling fancy knitted ties. Sample 35 cents. Raymond's Mfg. Co., 31 East 132nd Street, New York.

CLARKE made \$18 an hour selling vest-pocket windshield cleaner needed by every autotist, motorman, engineer; one rub keeps glass clear 24 hours; 60,000 sold; amazing proposition free. Security Mfg. Co., Dept. 704, Toledo, Ohio.

WANT Distributing Agents everywhere for Hanslick, the new original powdered handsoap. Removes grease, grime, ink, paint, and most anything from the hands without injury to the skin. Every mechanic and auto-owner, everybody who gets his hands dirty will be a customer. A great opportunity for a hustler to get in business for himself. Full information free. Send 10 cents, coin or stamps, for liberal sample can. Solar Products Company, 122 West Lake Street, Chicago.

WHY Work for others? Start and operate your own business. Our system proprietary specialty business offers wonderful opportunities to make \$100 to \$500 weekly. Openings everywhere. We furnish everything and show you how. Booklet free. National Scientific Laboratories, 208 Monroe, Richmond, Va.

AGENTS—Clever Invention! Inkspoon makes every pen a fountain pen. Fast office seller; big profit, demand increasing everywhere. Exclusive territory offered. Sample free. H. Marul Company, Tribune Bldg., New York, N. Y.

AUTO owner tire agent wanted each locality to use and take orders for hand-made Mellinger fabric and cord tires; guarantee bond 8,000 and 12,000 miles (no seconds); shipped prepaid on approval; get your tires free; no capital or experience required; make \$100 to \$300 weekly. Write for wholesale prices and sample kit. Address, Mellinger Tire Co., Dept. 100, Kansas City, Mo.

35 PROFIT selling \$7.50 necessity. Write for sample. Merchants Ass'n, Minneapolis, Minn.

AGENTS: Big profits. Best and cheapest window letters made. Easily applied. Dime brings five samples. Particulars free. Statelrite Co., 1115 Second Ave., New York.

AGENTS sell made to measure gabardines, whipcords, \$14.50; reversible raincoats; \$75-\$100 weekly. Outfit free. Standard Raincoat, Dept. 5, 129 West 17th St., New York.

DELICIOUS Desserts—\$1.00 an hour selling Stuart's delicious desserts, pudding powders and pie fillers. Write for terms and free samples. C. H. Stuart & Co., 5867 B'way, Newark, New York.

AGENTS, sell shoes direct to ladies at home or at work. Fast selling line. Liberal pay. Splendid opportunity. Apply Now. Style-Arch Shoe Company, 503 Butler Bldg., Cincinnati, Ohio.

AMAZING auto necessity. Retail \$4.00. Your profit \$2.50. Territory going. Write Super, 1306 Fondular, Milwaukee, Wis.

AGENTS: New product no equal. 150% profit. 100% Repeater year round. Sells to everybody. Astonishing results from first day. Surety Manufacturing Co., 26 W. Washington, Chicago.

AGENTS—W. F. Omels, a former brush salesman, made over \$5,000.00 during 1922 selling our \$1.50 kitchen specialty. He is now a district manager. We are offering you the same proposition—an opportunity as big as you want to make it. You can do what Omels did. Write today to M. H. Tyler Mfg. Co., Manager's Desk, Muncie, Ind.

RUMMAGE Sales make \$50,000 daily. We start you. Representatives wanted everywhere. "Wholesale Distributors," Dept. 92, 609 Division Street, Chicago.

DUSTLESS Sponge Cloth. New Invention. Retail (50c)—Costs (16c). (1) Rub Cleans, Polishes Automobiles, Plants, Furniture. Nulife (A) Sponge, Hartford, Conn.

EVERY home a prospect. Zenith Cleaner and Polish for Automobiles and Furniture. Agents make 100%. Sample 25 cents, refundable first order. Absolute repeater. Zenith Products Company, 202 Clay Ave., Rochester, N. Y.

AGENTS: Vacuum Portable Heater—pumps cold air off the floor at 5/8 cent per hour. Every cent will return 100 per cent heat in rooms. Everybody write. Vacuum Portable Heater Co., 108 Main St., Tarrytown, N. Y.

\$100 WEEKLY is nothing unusual for men and women selling the Kelly Chemical Indoor Closet. Has given service and satisfaction for more than 15 years. Easily sold to every suburban, rural and farm home without sewer connection. No plumbing, carpentry, waterworks or cesspool. Easier to install than a stove. We now have a better article at a lower price with a bigger profit. Write—Kelly Mfg. Co., 4204 W. Adams St., Chicago.

MAKE Big money selling rubber rugs, duplicating rag rugs in appearance; every home a prospect. Write or wire Trump Bros. Rubber Co., Akron, Ohio.

AGENTS Easy Money. Interview motorists—Patented Instrument Every motor Needs—It Saves Money Three Ways—Guaranteed. Thousands "Sold." Glad Users Everywhere. Big demand at your door. Pleasant work. Permanent business of your own—employ sub-agents—\$75.00 weekly up, all or part time. Experience unnecessary. This is a high class money-making proposition—Year opportunity for success. Whatever you do answer this ad quick. Wizard Mfg. Company, 453 Central Ave., Rochester, N. Y.

GENERAL Distributors—Make \$100 to \$150 weekly as Distributor for World's Greatest Automobile Polish. Easily demonstrated, wonderful results, sure repayer. Sell to consumers, sub-agents, dealers. Big money-making proposition to hustlers. Write quickly for exclusive territory. The Arno Mfg. Co., N-130 Gosdiale, Columbus, Ohio.

MAKE \$25 to \$50 Week, representing Clow's Famous Philadelphia Hosiery, direct from mill—for men, women, children. Every pair guaranteed. Prices that win. Free book "How to Start" tells the story. George Clow's Company, Desk 31, Philadelphia, Pa.

BIG Money and Fast Sales. Every owner buys Gold Initials for his auto. You charge \$1.50; make \$1.35. Ten orders a day easy. Write for particulars and free samples. American Monogram Co., Dept. 48, East Orange, N. J.

PORTRAIT and Medallion Agents—Our Goods Will Make You Big Profits; delivery guaranteed; prompt shipments; low prices; send for latest catalog. Adam J. Kroll & Co., 602 Blue Island Ave., Chicago.

SELL everyone an Auto-Oil-Tester—Quick sales—Big profits—Sample \$1.00. Visconator Mfg. Co., Toledo, O.

BIG Steady Income. No investment. Protected territory. Sell Harper's ten-use brush set. Sweeps, scrubs, washes windows, cleans walls, etc. Big seller 14 years. Scores making up to \$30 daily. Investigate this. Harper Brush Works, 132 D St., Fairfield, Iowa.

PORTRAIT agents earn big money selling our Photo medallions. Photo medallion clocks, Religious medallions, Photo pocket mirrors, Photo buttons, Photo jewelry, and Fraternal Photo medallions. Send for free catalogue. Satisfaction guaranteed. Four-day service. Address Gibson Photo Jewelry Co., Apartment 7, 608 Gravesend Ave., Brooklyn, N. Y.

AGENTS make \$150 a month. Brand-new hosiery. All styles for men, women, children. Must wear or brand new hose free. Finest silk hose. Written guarantee with each pair. Orders filled promptly. Write for outfit. Jennings Mfg. Co., Dept. 1088, Dayton, Ohio.

CALIFORNIA Rosebuds selling like hot cakes. Agents coinng money; new stuff. Big profits. Catalog free. Mission Factory PM, 519 No. Halsted, Chicago, Ill.

27,000 RECORDS guaranteed with one Everlay Phonograph Needle; new—different; cannot imitate records; \$15.00 daily easy. Free sample to workers. Everlay, McClurg Bldg., Desk 121, Chicago.

AGENTS—The Big Seller of the year is the Universal Jar Opener. Has many uses. Sells for 50c. Costs \$2.00 dozen prepaid. Sample 25c. We offer agents the largest line of steel and wire specialties on the market. General Products Company, 7 Oliver Street, Newark, N. J.

AGENTS—Make big money selling Earl's "Cutwell" Imported Pocket Pencil Sharpener. Sample 15c prepaid. Sells on sight. B. G. Earl, 56 E. Randolph St., Chicago, Illinois.

SALESMEN—Get into the tailoring game—one of the most profitable of all specialty selling fields. Experience not necessary. We show you how to take measures, teach you how to sell our line and supply you with everything necessary to go out and make from \$10.00 to \$20.00 a day from the very first day. Our selling outfit is the finest of its kind ever gotten together and shows more than 100 large cloth samples of finest woolsens. You do no delivering. You just write your orders. We do the rest. Your profits run big and you get them cash with order. If you want to get into this most profitable of all lines, write us quick. Address Dept. 702 Goodwear Chicago, Inc., 844 W. Adams St., Chicago.

AGENTS: Big money Monogramming by Transfer Method. Catalog Showing Over 50 Styles and Particulars Free. Motorists' Accessories Co., Mansfield, Ohio.

EIGHT Dollars for seven hours! Peck's Rivets quickly mend leaky kitchenware. Sell everywhere on sight. Samples free. Box 25c. Peck Company, 7 Medina, N. Y.

AGENTS: \$18 a day. Latest Improved portable talking machine. Does more than machines costing five times its price. Built-in just like a suitcase. Fully guaranteed. Pay you daily. Write Perry-Ludlow Co., 8-1962, Dayton, Ohio.

INSTANT Weld, Repairs largest punctures without cement or heat. Lenn's profit one day, \$56. Write quick. Free sample; territory going fast. Tourists' Pride Mfg. Co., Desk T, Minneapolis, Minn.

AGENTS Everywhere! Women's and children's guaranteed shoes direct to wearer. We deliver. A. P. Condon, Sales Manager, The Allen Shoe Co., 110 Summer St., Boston, Mass.

NEVERUST cutlery agents make big money. Whole or spare time. No capital or experience required. The C. Westchester Co., 92 Vark St., Yonkers, N. Y.

BIG Profits Selling New \$3.50 Automatic Adling Machine. Absolutely accurate. Fully guaranteed. Quick sales. Ten daily easy. No competition. Pocket size. Business people everywhere positive customers. Thousands being sold. Tremendous demand. Here's high-grade money-maker. Bassett Co., 1438-A Hollywood Ave., Chicago.

AGENTS: \$75.00-\$100.00 weekly taking orders for popular price-smashing rain-coats, \$2.98. Largest commission advanced. Prompt shipment. We collect. Free coats. Eagle Raincoat Co., 588 Mid City Bank Building, Chicago.

CAN you sell Ford size tires at \$3.50 each? Write for plan. Details free. American Auto Accessories Co., Sales Dept. 78, Cincinnati, Ohio.

WONDERFUL discovery. Charges batteries in ten minutes. Gallon free to Agents. Radiolite Co., St. Paul, Minn.

AGENTS—Our soap and toilet article plan is a wonder; get our free sample case offer. Ho-Ro-Co., 2725 Dodder, St. Louis.

PHOTO medallion salesmen: Earn \$100 to \$200 every week selling P. & G. Photo medallions. No investment—free equipment. Guaranteed 4-day service—send for sales plan and free 1923 catalogue with 102 beautiful designs, including clock and religious medallions. Puddin' & Goldstein, 259 Bovey, Dept. A, New York.

FREE sample new embossed signs. Ready sellers to all kinds stores. 306 percent profit. Make \$75 weekly. National Display Signs, 18 W. 34th St., New York.

AGENTS wanted to sell electrical flower vases. Consists of 9 roses with light in center of each and rustic vase 5 feet high, of natural-bark appearance. Sells on sight. Agents now earning \$20.00 to \$30.00 daily. Write for full particulars. Rustic Basket Company, 1826 Grand Ave., Chicago, Ill.

AGENTS. Make \$10 to \$20 daily, selling small kitchen necessities. Over 200% profit. Sells rapidly everywhere to nine out of ten women. New plan make sales easy. Premier Mfg. Company, Dept. 813, Detroit, Mich.

MEN and Women—Sell "Never-Burn" hot plates; prevents loss of food by burning; used on any stove; endorsed by hospitals, cooking schools and thousands of users; easily sold; no competition. Write for particulars or send \$1.00 for sample plate and proposition. World Specialty Co., 4014A Benton, Kansas City, Mo.

SELL Auto Quickstart—a new sensation! Starts motor instantly in cold or foggy weather. 8 other rapid sellers. No investment. Big money easy. Write Jubilee Co., 13 Sta. C, Omaha, Nebr.

AGENTS: If you want the biggest, cleanest cut and snappiest money-making proposition you can find anywhere in the entire U. S. A., you will write today for the convincing facts. Nothing like it—A Necessity, patented and Guaranteed—Every motorist a "live, enthusiastic prospect." The work is pleasant and easy, and immensely profitable. Experience unnecessary. All or part time. If \$6.00 an hour or \$100.00 weekly interests you—Write quick for territory. Wizard Division, Seneca Camera Mfg. Company, Rochester, New York.

AGENTS—\$1.25 an Hour Spare Time Near Home. Light, pleasant work, showing samples and distributing tea, coffee, extracts, spices, food products, things people eat. 19 full-sized packages and complete outfit to first person in your locality answering. Write quick, Dept. 92, Harley Company, Dayton, Ohio.

MAKE \$17 daily—Finest Extracts, Food Products, Toilet Preparations, Household Necessities. Credit; Sample case Free. Write for amazing offer. Perkins Products, B-6, Hastings, Nebr.

WE Start You In Business. Good money operating our business leads. No experience required. Manufacturer furnishes everything. Cherokee Sales Company, Department P. M., Danville, Va.

EVERY Superior Outfit sold brings repeat orders that average \$25 a year. Selling three outfits a day, you have a \$25,000 a year business, of which half is profit. Send for particulars of the biggest repeat order proposition on earth. Lea Brothers, 145 East 23rd St., New York.

SELF-THREADING Needles find sales in every home. Fine sideline, easy to carry. Big profits. Sample free. Prentice-Lor, 143 East 23rd St., New York.

MAIL-ORDER houses and distributors: we pack big profit beauty creams, face powders, perfumes, toilet preparations with your label. Chemist, 944A No. Clark, Chicago.

AGENTS set Kiosquik, the newly invented door opening. Whirlwind seller. Returns for 50c. You make 100% or more. Sell 50 to 80 a day easy. Write for 45c sample and easy starting offer. Kiosquik Mfg. Co., Dept. A, 17 West 42nd St., New York.

AGENTS, both sexes, we manufacture and control new household article. Fast seller. Big profits. Exclusive territory. Write now. Connolly, 123 Liberty St., New York.

BOYS, Girls, Men, Women, Everywhere. Big profits selling the Haisaver. Protects any hat from rain, snow and dust. Weight one ounce. Carried in any hand bag. Three samples and instructions 25c. To be first in your territory and \$7.35 for one gross, postpaid. R. D. King, 302 South Dearborn, Chicago.

"SPICE-BOX," Imported novelty. \$25 daily easy. Sample 25c. Aircraft, Box 53, Omaha.

FLORIST'S Plant Food Prevents disease. Big profit. Four ounces 25 cents. DeMuth, Camden, Mich.

AGENTS: \$40 a week selling guaranteed hosiery for men, women and children. Must wear 12 months or replaced free. All styles and colors, including finest line of silk hose. Mrs. Schurman makes over \$2,000 a year. Mrs. Schurman averages \$50 a month working spare time. Gen. Noble made \$35 in one day. Write for sample outfit. Thomas Mfg. Co., Class 562, Dayton, O.

AGENTS—Finest line of silk hose you ever saw. Latest styles and colors. New style guaranteed hosiery for men, women, children. Must give satisfaction or new hose free. Write for samples. Parker Mfg. Co., Sample 278, Dayton, Ohio.

PORTRAITS, photo pillow tops, frames, sheet pictures, medallions, merchant's signs, water-proof and tea aprons, guaranteed hose, toilet requisites, luminous crucifixes; catalog, 50 specialties free, 50 days' credit. Jas. C. Bailey Co., Desk M 13, Chicago.

A SERVICE agency for magazine and newspaper classified advertisers. Complete advertising service free of charge. We edit and place your copy. Send for our free lists and explanation. Sweet & Phelps Advertising Agency, 214 E. Ohio St., Chicago.

AGENTS, Sell newest Christmas decoration; tremendous sales last year. Holiday Specialty Co., 807 Harrison St., Chicago.

AGENTS—Greatest Selling Specialty. Arsenal Laboratories Company, P. O. Box 43, Arsenal Sta., Pittsburgh, Pa.

AGENTS Wanted—to handle the Hughes Airtight Valve Cap. This cap replaces ordinary caps on inner tubes, and is guaranteed to let no air escape. Big commissions on this easy-to-sell accessory. Write today for information. See our display ad on page 175. Airtex Rubber Company, 2952 Jackson Boulevard, Chicago.

WHY Work for others? Start and operate your own business. Our system proprietary specialty business offers wonderful opportunities to make \$100 to \$500 weekly. Openings everywhere. We furnish everything and show you how. Booklet free. National Scientific Laboratories, 208 Monroe, Richmond, Va.

MAKE \$31.00 Profit—Cost You \$1.50. Complete Gold Monogramming Outfit. Transferred Instantly on Automobiles, Trunks, Bags, Windows. Experience unnecessary. Free Samples. Nulife (A) Monogram, Hartford, Conn.

TAILORING Agents—We've got a wonderful line of tailor-made suits to sell at \$18 and up. Beautiful assortment of fabrics, \$10 to \$25 cheaper than retail. No experience needed. Our free suit offer is a wonder. Write American Woolen Mills Co., Dept. 1852, Chicago, Ill.

WE pay \$8 a day taking orders for Insipid Tyres. Guaranteed to prevent punctures and blowouts. Double tire mileage. Any tire. Tremendous demand. Low priced. Write quick for agency. American Accessories Co., B278, Cincinnati, Ohio.

MAKE \$1000 monthly distributing our products. Big profits. Guaranteed sales. Exclusive territory. Permanent business. Write quick for particulars. Yonover, 1487 A12, Roosevelt Rd., Chicago.

AGENTS, Salesmen, Demonstrators, you will have the devil's own time trying to find a better seller than "Zippe." If there was such a thing we'd have it. Splendid profit on 50c "Go Getter" repeat article that sells on ten second demonstration. Works While You Watch It. Demonstrates value, while others waste time making claims. New Discovery! Greatest Scientific Triumph of the age. It's the berries. Haven't room to tell our story here. Write immediately. Karam-Smith Co., 612 Bozart St., Ft. Wayne, Ind.

AGENTS—\$15 a day—Easy, quick sales—Free Auto—Big weekly Bonus—\$1.50 premium Free to every customer. Simply show our Beautiful 7-Piece Solid Aluminum Handle Cutlery Set. Appeals instantly. We deliver and collect. Pay daily. New Era Mfg. Co., 803 Madison St., Dept. 21-U, Chicago.

AGENTS "Cleaning Up" Houses everywhere talking about wonderful new invention—Perfection Pressure Cooker. Saves money, time, labor. Easy to sell. Write quick. Jubilee Mfg. Co., 33 Sta. C, Omaha, Nebr.

HEATING with oil is in its infancy. Get in while the getting is good. Our burners make good. Agents wanted. Exclusive rights. Economy Oil Burner Co., 718-721 Second St., Webster Ctr., Iowa.

THE wonderful arch support and shoe preserver, for every shoe; unequalled for agents. S. M. P. Co., 359 Pearl St., New York.

EASY Money, Sell 35c article with \$25.00 Guarantee, 100% profit. Wunder Revolver, Pittsfield, Mass.

"HOW to Sell Patents" free. Patent News-O, Washington, D. C.

NEVA-LOST Gas Tank Cap for Automobiles sells on sight; 100 per cent profit. Big opportunity for producers. State territory desired. Trinity Mfg. Co., Hartford, Conn.

TAKE orders for Bleacho—the new amazing preparation for lightening skin. In enormous demand by colored people. Guaranteed to satisfy. Nationally advertised. Going like wildfire. Live agents earn from \$50 to \$200 a week easy. Write now for exclusive territory. Superior Drug Sales Co., 4909 Broadway, Chicago.

\$10 AND more daily easy. Selling household necessities direct from manufacturer to consumer. Write 507 Commercial Bank Bldg., Cleveland, O.

ABSOLUTELY free box Bassett's Native Herbs sent to introduce. For Constipation, indigestion, headache, rheumatism. Big money selling, all or part time. Established 1879. Bassett, Dept. I, Columbus, Ohio.

AGENTS, Sell Anti-Mist Compound. Keeps rain and steam off windshields and eye glasses for 24 hrs. Send 25c for sample and particulars. A. W. Brust, 210 S. Seely Ave., Chicago, Ill.

AGENTS Wanted—Full or part time, to sell on liberal commission new Thermostatic Automatic Carburetor Control Attachment for Ford cars. Increases mileage 100%. No holes to drill. Attached in two minutes. Does automatically exactly what Ford Manual instructs driver to do. Cadillac Car now using Thermostatic Carburetor Control under Blanche license. Write immediately. Blanche & Co., 602 W. Lake St., Chicago.

ANY man handy with paint brush or light tools can start new mechanical business on nearly nothing; needed everywhere; nearly all profit; experience not required. John Braceband, 1457 So. Ninth, Philadelphia, Pa.

SUCCEED With Your Own Products—Formulas, Processes, Trade-Secrets. Different, dependable, profitable. Catalog free. R. Thaxly Co., Washington, D. C.

LEATHER bill folds 50 cents. Agents wanted. Universal Sales Company, Box 152, Springfield, Ill.

WRINGER Mop—We have the best wringer mop made and can offer high-grade mop and brush salesmen exclusive territory and liberal profit. M. C. Newton, 1338 West 194th, Cleveland, Ohio.

SALESMEN and Agents: New Auto Accessory good for \$100.00 per week. Eureka Engineering Co., Box 1512, Rockford, Ill.

PATENTS Procured. Send sketch or model today for examination, prompt report and advice. No charge for preliminary advice. Write for free Booklet and blank form on which to disclose your idea. Highest references. Promptness assured. Clarence A. O'Brien, Registered Patent Lawyer, 310 Security Bank Building, Directly across the street from Patent office, Washington, D. C.

WE have the finest needle case, \$50.00 to \$200.00 weekly. Send 10c for sample; sells 25c. Empire Specialties Co., 1549 N. Wells, Dept. 301, Chicago.

YOU can be your own boss with our Key-Check outfit. Good for \$5 a day stamping names on pocket key checks, fobs, etc. Sample check with your name and address, 20 cents. Pease Die Works, Dept. M, Winchester, N. H.

MAN in each town to plate auto parts, reflectors, bathroom fixtures, refinish beds, mirrors, chandeliers; by new method. No capital or experience required. Simple plan of manufacturing at home starts you in big money-making business. Outfit furnished. Free particulars and proofs. Gun Metal Co., Ave. H, Decatur, Ill.

WONDERFUL Little Article; something new; make it yourself; men and women make \$15 daily; experience unnecessary; article cost 5c, retail \$1. Particulars Free. Taylor's Novelty Shop, Columbia City, Ind.

AGENTS—Go into business for yourself. Be your own boss. Work for yourself, not the other fellow. No traveling. Start manufacturing or mail order business in your own town. Write for particulars. Central Book Co., 127 South Liberty St., Indianapolis, Ind.

BUILD a lasting business in your own community, with the Waterizer—big profits—cumulative—clean cut. James R. Lund, Manufacturer, 19 S. La Salle, Chicago.

MAKE \$8 a day selling Imported Bamboo Fountain Pen. Whirlwind seller. Free sample. Mehler, Dept. 5, 416 S. Dearborn, Chicago.

AGENTS—Advertising Pencils, Ready Sellers. Excellent side-line. Write for proposition. North American Pencil Works, 32 So. Clinton St., Chicago.

PORTRAIT Agents. Linder Art Company is known the world over for Good Work. Exact Likeness. Speedy Service. We make a portrait that delivers without schemes, kicks or arguments. Your customer pays you cheerfully. Try us—seeing is believing. Linder Art Company, 549 Washington St., Chicago.

\$50 DAILY! Automotive invention sells like wildfire! \$3. Free newspaper advertising over your name as agent makes success positive! Official test by Automobile Club of Missouri shows 63% more miles per gallon gasoline! Write quick. Philips Mfg. Co., St. Louis, Mo.

AMAZING new ways to make money: Every issue of Opportunity contains over 50 pages of money-making ideas. Send 10c now for sample copy. Opportunity, 407 Webster Bldg., Chicago, Ill.

AGENTS—Distributors—make easily \$100 to \$200 a week. Be a "Pie-Rench Man." Get into a permanent business with growing profits. Sell the marvelous Eifel-Flash Pie-Rench Tool Kit—Guaranteed to Do The Work better, quicker, and easier of 60 pounds of the best other tools costing \$50.00. Only kit that does all work around Home, Car, and Shop. Weighs 1½ Pounds. Sells quickly, when shown, at \$5.50. On market 3 years—thousands sold. Extra good for agents with cars. Fine side line—carry in pocket. State how you sell, territory wanted. The Flash Sales Corp., Dept. Q., 4809 North Ashland Ave., Chicago.

EMBLEM Goods are fastest Xmas sellers. Wall and auto emblems, buckles, billfolds, cigarette cases, jewelry. Kier Emblem Co., 456 Como Bldg., Chicago.

AGENTS—OPPORTUNITY of a lifetime, \$50.00 per month easy with our Met'l Fibre Autowline. Every auto owner wants one. Exclusive territory. Send \$1.50 for sample. Met'l Fibre Rope Co., 1817 Vermont, Toledo, Ohio.

WONDERFUL Scientific Discovery; pure "White Sapphires," rival finest diamonds, \$2 carat. "Rainbow Sapphires" chances color, greenish purple to ruby red, \$2 ct. "Meteor Sapphires" like golden diamonds, \$2 ct. Pearls, Amethysts, Diamonds, solid gold mountings; also Imitation Diamonds; wholesale prices; be our Agent. Fauer (Importer), 152 Dewitt, Buffalo, N. Y.

GENUINE Gold Leaf Letters anyone can put on store windows. Guaranteed to never tarnish. Large profits. Enormous demand. Free samples. Write today. Metallic Letter Co., 438-A North Clark, Chicago.

AUTO Safety Signals—Every Auto owner wants it. Easy Seller. Every Auto owner Recommends. Agent's cost \$1.25, Retail \$5.00. Perfect working services guaranteed every user. Press Foot, Brake Automatically flashes bright red warning light to rear. First Dozen ordered secures exclusive sales rights any uncontracted county. Agent's Price \$15.00 Dozen Delivered. Postage Prepaid. Automatic Signal Co., 701 Berger Bldg., Pittsburg, Pa.

A BUSINESS of your own: Make sparkling glass name plates, numbers, check-boards, medallions, signs; big illustrated book free. E. Palmer, 307, Worcester, O.

FLEXIBLE Steel wire Carbon Scraper. Good side line. Order sample, 60c. Be convinced. Marshall, Box 724, Springfield, Mass.

RUSSIAN, German, Austrian, Soviet money. Sensational sellers. Cheap, attractive giveaway advertising for Agents, Merchants. Big Circular Free. 100 banknotes \$2.00, splendid assortment. Hirsch Importing, 847 Huntspoint Ave., New York.

AGENTS—Send for sworn proof of \$5 to \$15 daily—Introducing New Style Guaranteed Hosiery. 57 styles, 17 colors. No capital or experience required. Just write orders. We deliver and collect. Your pay daily, also monthly bonus. Free auto offer besides. Complete outfit furnished. All colors—grades including silks—wool—healthers. Mac-O-Cheo Mills Company, Desk 25612, Cincinnati, Ohio.

AGENTS—Big Money, Fire extinguishers for automobiles Retail \$1.50. Send stamp for reply. F. & S. Extinguisher Co., 10th and Perry, Erie, Pa.

AGENTS—Best seller: Jem Rubber Repair for tires and tubes; supersedes vulcanization at saving of over 800 per cent; put it on cold, vulcanizes itself in two minutes, and is guaranteed to last the life of the tire or tube. Sells to every auto owner and accessory dealer. For particulars how to make big money and free sample, address Amazon Rubber Co., Amazon Bldg., Philadelphia, Pa., Dept. 50.

FOUR \$7.50 Sales to Merchants Net you \$20.00 Daily. Sayer Systems, 2815 Sheffield, Chicago.

WHY Work for others? Start and operate your own business. Our system proprietary specialty business offers wonderful opportunities to make \$100 to \$500 weekly. Openings everywhere. We furnish everything and show you how. Booklet free. National Scientific Laboratories, 208 Monroe, Richmond, Va.

EARN \$10 daily silvering mirrors, plating and refinishing metalware, autos, chandeliers, bedsteads, headlights. Outfits furnished. E. Doris Laboratories, 1123 Broadway, New York.

WANTED—Tailoring salesmen, make \$60 to \$125 per week. Biggest merchants in many towns have started with our lines. We are the largest made-to-measure tailoring house in the country, furnishing elaborate sample equipments, including 500 all wool fabrics and guaranteed absolute satisfaction, perfect fit, best workmanship, or no sales. Write me for line and all accessories to be sent free. Tell us all about yourself. Address G. H. Mitchell, Sales Manager, Box 483, Chicago, Ill.

MAKE \$20 to \$30 a day selling electric lighted Flower Baskets and Illuminated Xmas Wreaths. Every home and store a prospect. Send for samples today. Basket \$6.50, Wreath \$3.00 postpaid. Bromberg, 150 E. Grand Ave., Chicago.

HELLO Boys! A Message from the Salesmen of the Alexander Film Company: We are members of a square shooting, smiling, fighting firm that treats a fellow like a partner. Selling Motion Picture Publicity that is par with big feature productions in art and settings. Advertising and Sales Course, family spirit. You know what that means. Come on, join us—we are challenging only permanent fighters who demand big income for consistent efforts. Alexander Film Company, 3589 So. Broadway, Denver.

SUCCESS in Business and Personal Affairs! Read character by handwriting and features. Conlin System. Low price for entire course. Write, H. E. Conlin, Dept. B, 21 St John's Place, Buffalo, N. Y.

PORTRAIT Agents and Others. Get Big Profits. Sell Perry Photo Medallions. You charge \$2.98; make 400% profit. \$10 daily easy. Big exclusive line, 4-day service. Perry Photo Novelty Corporation, Section 16, 360 Bowery, New York.

AGENTS—If you have formerly sold felt rags, write for our new proposition concerning new goods. It's a winner. Newark Felt Rug Company, 27-C 16th Ave., Newark, N. J.

EARN big money fast applying gold initials to autos. Every owner buys—\$1.35 profit on \$1.50 sale—particulars and samples free. Write quick. Lithogram Co., Dept. 17, East Orange, N. J.

OUR Ex-Cel Luminous Crucifix "shines brilliantly in the dark." Sells on first demonstration. Big profits. Free Selling Talk with first order. W. B. Hannan Co., Dept. B, 57 E. 18th St., Chicago.

CHRISTMAS Greeting Cards—Make \$100.00 weekly. Spare time. Wholesale Prices. Manufacturer, 1235 Arch, Philadelphia, Pa.

MAKE Big Money. Spare or full time. Everybody loves Popular Music. Few hours a day with unique plan builds cumulative income. Representatives cashing in. Reserve territory. Get particulars quick. Crocker-Steinkamp, Dept. C-12, Quincy, Ill.

AGENTS. Make Money; sell California Specialties. Sample 25c. W. Bedell, 789 So. 18th St., Newark, N. J.

AGENTS: Can start you in Mail Order Business immediately. Been at it 17 years. Small capital needed. Particulars stamp-home Business Expert, Valdosta, Ga.

KAPFORM holds soft caps in shape. Neat, Dressy, Easily attached. 25c, Six \$1.00. Kapform Agency, 3518 Ellis Av., Chicago.

PLENTY of money, plenty of leisure, a fine home, and a fine car, with freedom from financial worries, representing us as our General Agent in your district. For one of the best propositions ever offered an agent. Address: The Horsey-Bassett Co., Inc., Dept. P, Crisfield, Md.

AGENTS—Easy sales. Every woman and girl live prospect for my beautiful manicuring set. Write quick. Miller, Sales Mgr., 643 E. 61st, Chicago.

WE pay \$50 a week and expenses and give Ford auto for men to introduce poultry and stock compounds. Imperial Co., D-23, Parsons, Kan.

JUST out—new auto invention—selling like wildfire. Make \$25 to \$40 day easy. Exclusive territory. Great opportunity for general agents. Nothing like it. Write quick to Nelson J. Quinn, Sales Manager, Toledo, Ohio, for details.

AGENTS—Ladies silk and wool hosiery, \$2.00 per pair; silks, \$1.25 per pair; over 60% commission. 18 patterns men's silk knit ties in Christmas boxes, over 80% profit. We deliver. Dept. 1046, The Lexington Company, Lexington, Ky.

QUICK seller to every owner of a passenger car or truck. Easy to demonstrate. No experience necessary. Ten dollars and more a day taking orders for the Warner Oil-Gut. It turns what is now hard, long, dirty job of lubricating a chassis into a quick, easy, clean job. Nationally advertised and guaranteed by inventor of famous Warner Speedometer. Sold on money back basis. Send \$3 for your demonstrator. Immediate and permanent profits. Our selling plan insures your success. Get all the facts. Write at once Warner Patterson Co., 914 South Michigan Avenue, Chicago.

DARN E-Z. Universal Fabric Patching Cement; sells to nearly everybody again and again; new uses command instant attention. Special selling system assures generous income. Dept. P-M-1, Darn E-Z Lab., Mutual Home Bldg., Dayton, Ohio.

AGENTS Make \$25.00 spare time, \$50.00 up weekly full time. Staple necessity; every home prospect. Cost \$1.50, sells \$5.00. High class guaranteed product. Address New Vision, Care General Delivery, Charlotte, N. C.

35% PROFIT makes 8 to 10 dollars daily. Samples free. Brighton Co., 2950 No. Ashland Ave., Chicago.

AGENTS: Where to buy 12,000 articles Wholesale. Actually worth \$50. Enclose stamp. Wholesale Supply Co., Valdosta, Ga.

AGENTS. Distributors, Energetic Men everywhere earn \$10 daily handling the HyKon Sewing Machine Belt; a new household necessity; sells on sight to homes, dressmaking and tailoring establishments. Be first; get this money-maker; put out sub-agents. Opportunity folder free. HyKon Mfg. Co., Alliance, Ohio.

PAY Your Way Anywhere with Oriental Mystic Rings. People amazed at these values. Sterling sample ring \$1. Sells for \$2.50 up. Orient Exchange, 21-P Park Row, New York.

AGENTS: Big returns, fast office sellers; particulars and samples free. One Dip Pen Co., 2 Daily Record, Baltimore, Md.

BIG. Quick Money for agents, distributors, men and women everywhere; good for \$10-\$15 daily; everybody buys; rapid cash sales; repeat orders come fast; your opportunity for permanent business; samples, circulars furnished free. Send for facts without fail. Paul M. Smith, Kutztown, Pa.

AGENTS sell made to measure gaberdines, whipcords, \$14.50; reversible raincoats; \$75-100 weekly. Outfit free. Standard Raincoat, Dept. 5, 129 W. 17th St., New York.

RAINCOAT Agents. Get Our Prices. Sell made-to-measure raincoats. We deliver and collect. Outfits free. World Raincoat Co., 659 Morris Park Ave., New York.

CHEAPEST Self-Wringing Mop made. Big Seller, 100% profit. Eastway Company, 405 St. Paul, Baltimore, Md.

AGENTS—Steady Income. Large manufacturer of soaps, perfumes, toilet articles and pure food products, etc., wishes representatives in each locality. Manufacturer direct to consumer. Big profits. Honest goods. Whole or spare time. Cash or credit. Send at once for particulars. American Products Co., 8846 American Bldg., Cincinnati, Ohio.

HIGH-GRADE SALESMEN WANTED

\$60-\$200 A WEEK. Genuine Gold Letters for store windows. Easily applied. Free samples. Liberal offer to general agents. Metallic Letter Co., 438-B North Clark, Chicago.

SALESMEN Can make \$5.00 a day selling our Calendars, Pencils, Slips, Advertising Novelties, Yardsticks, Whistles, etc. Liberal terms. Sells entire year. Fine side line. Local and traveling agents. Model Calendar Co., Dept. 226, South Bend, Ind.

BARNES makes \$30.00 daily selling "Zim's Peerless"—the "humdinger." Collection Service. So can you. Merchants reorder constantly. Creditors' Association, E-312 McKnight Bldg., Minneapolis, Minn.

\$742 LAST month for Beck of Buffalo, introducing latest advertising plan; nothing else like it; every merchant wants it; easy sales; no deliveries; no collections; specialty salesmen write quick for offer. National Adv. Service, P. O. Box 50, LaGrange, Ind.

SALESMEN Wanted—Local or traveling, part or full time, to sell calendars, fans, air swatters, brushes rulers, etc. Over two hundred stock designs of paraffin signs, ice cards, etc., for all merchants. Fine side line, liberal commission. The Harrison Co., Union City, Ind.

TAILORING Salesmen—Fastest selling line, suits, overcoats, made to measure—\$29.50—one price, all wool. Profits in advance. Biggest old reliable house. W. D. Smith & Co., Dept. 66, Established 1895, Chicago.

SPLENDID proposition—sell gummud tape. Rapidly replacing twine, \$50.00 to \$150.00 weekly—full or part time. Sager Company, Manufacturers, Dept. 8 112, 1637 Roosevelt Road, Chicago.

TRAVELING Salesmen calling on retail stores wanted by large manufacturer to sell unique line of business-boosting articles. Year round, fast selling, main or side line. If not earning \$150 weekly, address Elksaver Works, 222 Charles St., Beonville, N. Y.

SPECIALTY Salesmen, sell the Wonder Bag "5 in 1," and the Night Light Vanity. Large profits, quick sales. Write for full details and protected territory. The Universal Leather Goods Co., 446 N. Wells St., Chicago, Ill.

WANTED, high-grade man as salesman distributor. A timely opportunity. A paying proposition. This is not an "investment proposition" or "door bell ringer" job, but an attempt to find right man in each town or city to represent nationally advertised household article. Write or wire Crown, Richmond, Ind.

SALESMEN Make \$120 Weekly. Free Radio Instrument. Ozarka is longest distance receiver. Introduces it to your friends and secure your own free. No canvassing. 2 sales weekly nets you \$120. Sharpe of Colorado made \$955 one month. Our plan sweeping country. Write today giving name your county. Ozarka, Incorporated, 802 Washington Blvd., Chicago, Ill.

SALESMEN—Become Independent. Own your business; experience unnecessary; selling our \$7,500 Accidental Death, \$50 Accident, \$25 Sick Weekly Benefits; \$12.50 yearly; other amounts proportionate. Guaranteed steady income from renewals. \$250.000 deposited Insurance Department. Registration Dept. A. Newark, N. J.

SALESMEN: If You Want \$6,000 This Year, write now. Strong line for retail stores. Nationally advertised; established concern. Liberal weekly advances to producers. George R. Williams, 1920 Euclid, Cleveland, Ohio, Dept. 208.

SALESMEN—Sideline pays five to ten dollars a day taking orders for Specialty printed gummud advertising and Match Box Stickers. Write for proposition, samples, etc., today. Beardsley's Printery, Rock Island, Ill.

WERE You Ever Offered a Grocery Store? Our Proposition is Better. You can handle Sugar, Flour, Canned Goods, Dried Fruit, Coffee and entire line of Groceries, as well as Paints, Roofing, and Automobile Oils, with no rent to pay; no money invested; take large orders from samples. Goods are guaranteed and proven quality. Selling experience not necessary. Steady, profitable work for "workers." Address Hitchcock-Hill Co., Dept. 200, Chicago, Ill. Reference: Any Bank or Express Co.

\$4.00 PROFIT on Every \$5.00 sale. "Free Sample"—New Specialty. (Money Getter.) Every Storekeeper, Doctor, buys quickly. Experience unnecessary. Territories open. Box 596, Hartford, Conn.

SALESMEN—You can easily make \$40 to \$80 weekly taking orders for best fitting, rich looking, all wool, made to order men's suits and overcoats (guaranteed) \$18.50 and \$27.50; each garment "Larvex" Moth Proofed; same goods sells in retail stores at \$35-\$50; we deliver, collect and furnish advertising. Tailoring experience unnecessary. Outfit shipped for free examination. Wholesale Direct Tailors, Dept. 100, Buffalo, N. Y.

DISTRICT Salesmen with car to call on the hotel, restaurant, drug, grocery, variety, hardware and garage trade. Selling products of The Plymouth Chemical Co., Plymouth, Ind.

SALESMEN—You can make \$130 per month in your spare time selling only one policy a day! Five policies a day pays you \$730 monthly! Policy pays \$5,000 death and \$25 weekly benefit for sickness or accidental injury. Total cost \$10 yearly. You get amazing results using our Direct-By-Mail Selling Plan. Write quick for territory. Underwriters, Dept. RL, Newark, N. J.

SALESMEN—We pay larger commission than any other Brush House in the Country to men selling our line of Sanitary twisted-in wire Brushes. Sanitary Wire Grip Brush Co., 15-17 Mercer St., New York.

WORLD'S Fastest Selling Auto Accessory! County distributors wanted; write today. G. L. W. Spring Old Co., San Diego, Calif.

CALIFORNIA Rosebuds selling like hot cakes. Agents coinng money. Absolutely new. Big profits. Catalog free. Mission Factory 8F, 519 No. Halsted, Chicago, Ill.

SALESMEN—Crew Managers. You will have the devil's own time trying to find a better seller than "Zippe." If there was such a thing, we'd have it. Splendid profit on 50c "Go Getter" repeat article that sells on ten second demonstration. Works While You Watch It. Demonstrates value, while others waste time making claims. New Discovery! Greatest Scientific Triumph of the age. It's the berries. Haven't room to tell our story here. Write immediately. Karam-Smith Co., 6512 Reoan St., Fort Wayne, Ind.

1,900 DOLLARS Monthly Income. Particulars Free. A. Davis, 1637 Roosevelt Road, Chicago.

OFFICE Specialty—Costs 25c; sells \$1. Many buy hundreds. Big profits. Exclusive rights. Mfg., 3240 N. 13th St., Philadelphia.

WHY Work for others? Start and operate your own business. Our system proprietary specialty business offers wonderful opportunities to make \$100 to \$500 weekly. Openings everywhere. We furnish everything and show you how. Booklet free. National Scientific Laboratories, 208 Monroe, Richmond, Va.

ASKO—Salesmen to sell Auto Acc. as side line; can carry sample in vest pocket; sells on sight. Big comm. Write for sample. Allen Specialty Co., 2751 West Lake Street, Chicago.

SALESMAN Wanted. Amazing invention—almost human. The Little Draft-Man—a wonderful labor-saver, automatically opens furnace or boiler while owner sleeps. Pays for itself in fuel saved. Simple, efficient, can be installed by anyone in five minutes. 100% profit. Thousands being sold. \$25 daily easily made. Act quick. Address: Little Draft-Man Co., Dept. A, Grand Rapids, Mich.

\$4 MADE on \$6 sale retail, \$12 on dozen sale to garage. Sunbeam Indicator is a beautiful and useful automobile radiator meter. Weight, one pound. A new selling plan. A fine side line. Write for sample. Sunbeam Co., Milwaukee, Wis.

BEST Seller: Jem Rubber Repairs for tires and tubes; supercedes vulcanization at saving of over 50%; put it on cold, vulcanizes itself in two minutes, guaranteed to last life of tire or tube; sells to every auto owner and accessory dealer. Get particulars how to make big money and free sample. Amazon Rubber Co., Philadelphia, Pa., Dept. 519.

FULLEMUP Kuff Buttons—Marvelous Convenience—shirt savers—Fifty other Jewelry specialties that Sell to Retailers. Sideline Salesmen Wanted. Flexo, Sheboygan, Wis.

HELP WANTED

RETIRED Railway Postal Clerk writes: "My proudest moment was when telegram came to report for Duty in Uncle Sam's Mail Cars. Wish I could live it over again." You can experience that "proud moment" by preparing for Railway Postal Service. Start \$123 month; railroad pass; hotel expenses paid. Hold your present job and study for examination held near you. When ready, cut loose and take better job with Uncle Sam. Chance to run on railroad through your town. Older men retiring with pensions. Young men must take their places. Why not you? Test examination free. Columbus Institute, E-17, Columbus, Ohio.

YOUNG Men Wanted at once. Become Draftsman and earn \$50 to \$100 a week. No experience required. Big demand; splendid opportunities; clean work. Learn in spare time at home. Send for our Free Book. Just out. No charge. Address: Department 2240, Chicago Tech., 118 E. 26th St., Chicago.

WANTED—Men 18 up. Commence \$133 month. Steady. Railway Mail Clerks. Travel, see country. Schedule examination places—free. Write immediately. Franklin Institute, Dept. D-20, Rochester, N. Y.

WHY Work for others? Start and operate your own business. Our system proprietary specialty business offers wonderful opportunities to make \$100 to \$500 weekly. Openings everywhere. We furnish everything and show you how. Booklet free. National Scientific Laboratories, 208 Monroe, Richmond, Va.

FIREMEN, Brakemen, Baggage-men. Sleeping car, train porters (colored), \$140-\$200. Experience unnecessary. 810 Railway Bureau, E. St. Louis, Ill.

MEN Wanting Railway Station-Office positions with transportation furnished, experience unnecessary, write quick. Baker, Supt., Dept. 74 Wainwright, St. Louis.

WANTED By U. S. Government. Railway Postal Clerks. Men—boys, 18 to 35. Steady work. Commence \$133 month. Quick raise to \$192 month. Travel, see the country. Life position. Paid vacation. Experience unnecessary. Common education sufficient. List positions obtainable and schedule examination places—free. Write Franklin Institute, Dept. D-20, Rochester, N. Y.

\$60-\$200 A WEEK. Genuine Gold Letters for store windows. Easily applied. Free samples. Liberal offer to general agents. Metallic Letter Co., 438-C, North Clark, Chicago.

WANTED: Railway Mail Clerks—\$1,600 to \$2,300. Exams everywhere. Write today for full information. Patterson, Civil Service Expert, Box 4025, Rochester, N. Y.

WRITE articles, stories, news, in spare time for newspapers and magazines. Big pay. Copyrighted book free. Press Syndicate, 553, St. Louis, Mo.

MAKE money writing Photo-plays; details free to legitimers. No correspondence course. Producers' League, 230 Wainwright, St. Louis.

INVENTORS desiring to secure patents should write for our book "How to Get Your Patent," tells our terms and methods. Send sketch for our opinion of its patentable nature. Randolph & Co., Patent Attorneys, 620 F. Washington, D. C.

WANTED—Men—Railway Mail Clerks. \$133 month. Write for particulars. Franklin Institute, Dept. D-20, Rochester, N. Y.

OUR genuine gold window sign letters are an excellent money-making proposition for handy men. Sign Sign System, Bethune Ave. E., Detroit, Mich.

EARN \$110 to \$250 monthly, expenses paid as Railway Traffic Inspector. Position guaranteed after completion of 3 months' home study course or money refunded. Excellent opportunities. Write for Free Booklet CM-46, Standard Business Training Inst., Buffalo, N. Y.

SILVERING Mirrors, French plate. Easily learned; immense profits. Plans free. Address, Wear Mirror Works, Excelsior Springs, Mo.

U. S. GOVERNMENT Jobs, \$95-\$192 month. Men—women. Steady. Many open. List free. Write immediately. Franklin Institute, Dept. D-20, Rochester, N. Y.

ALL Men, Women, Boys, Girls, 17 to 65, willing to accept Government Positions \$117-\$250, traveling or stationary, write Mr. Ozment, 101, St. Louis, Mo., immediately.

LOCOMOTIVE Firemen for railroads nearest their homes—everywhere; beginners \$150-\$200 monthly. Railway Association, Desk M1, Brooklyn, N. Y.

EARN \$25-\$75 Weekly Writing Nu-Way Showcards. Previous experience unnecessary. Complete outfit furnished. Dept. 30, National Studios, 6121 Dorchester, Chicago.

START Silvering Mirrors, Headlights, Tableware. Replate stores, jewelry. Plans free. Clarence Sprinkle, Dept. 28, Marion, Ind.

BOYS—Men, Become automobile experts, \$35.00 week. Learn while earning. Write. Franklin Institute, Dept. D-401, Rochester, N. Y.

BE a Broker—own your business, no experience required. Write for information. George Grigolett, 20 East Jackson, Chicago.

BE a Finger Print Expert. Demand increasing. Write for special free offer. American Finger Print System, 1966 Broadway, New York.

\$5 TO \$15 daily easy—Introducing New Style Guaranteed Hosiery. Must wear or replaced free. No capital or experience required. Just show samples, write orders. Your pay in advance. We deliver and collect. Elegant outfit furnished all colors—grades including silks, wool, heathers. Mac-O-Chee Mills Company, Desk 20012, Cincinnati, Ohio.

GOVERNMENT Wants Railway Mail Clerks, \$133 month. List positions open—free. Write today. Franklin Institute, Dept. D-20, Rochester, N. Y.

STORIES, poems, plays, etc. are wanted for publication. Good ideas bring big money. Submit manuscripts or write Literary Bureau, 523, Hannibal, Mo.

EXPERIENCED Pattern Maker, Pittsburgh Lumber Company, Braemar, Tenn.

GOVERNMENT positions, \$1,400-\$2,300 yearly. Many openings. 56-page information booklet free. Chicago Civil Service College, A-41, Kesner Building, Chicago.

\$133-\$192 MONTHLY. Railway Postal Clerks. Sample questions, list positions, free. Chicago Civil Service College, A-51, Kesner Building, Chicago.

EARN \$10 daily silvering mirrors, plating and refinishing metalware, autos, chandeliers, bedsteads, headlights. Outfits furnished. E. Decie Laboratories, 1133 Broadway, New York.

MEN Wanted Learn Automobile and Tractor Business, in eight weeks. Make \$75 to \$200 per week. Tuition reasonable. No colored students. Ohio State Practical Motors School, X-5 Cincinnati, Ohio.

INFORMATION

COMPLETE, accurate, information on any subject \$1. National Information Bureau, 1429X Milton St., S. E. Grand Rapids, Mich.

MAILING LISTS

WE sell accurate names farmers, mail order buyers, housewives, \$7.00 thousand. Mention State. Martinek Company, Corona, N. Y.

NEW names and addresses. Guaranteed Correct. J. H. Benson, Thorp, Wis.

TYPEWRITERS AND SUPPLIES

TYPEWRITERS, all standard makes, \$10 up. Fully guaranteed. Free trial. Write for complete illustrated lists. Northwestern Typewriter Exchange, 320 West Goethe Street, Chicago.

UNDERWOOD Typewriters at far less than manufacturers' price; rebuilt, all worn parts replaced, guaranteed good as new. Cash. Installment payments. Write for Catalog 1519, Shipman-Ward Mfg. Co., estab. 1892, Montrose and Ravenswood Ave., Chicago, Ill.

SIMPLEX Typewriters \$3.00, Remingtons \$8.00, Smith Premier, \$9.00. Demeo, Miantonomi Court, Providence, R. I.

TYPEWRITERS—All makes rebuilt, re-constructed and guaranteed ten years, \$15.00 up, shipped privilege 30 days' trial. Get our prices and agents' proposition. Typewriter Co., 2316 University Ave., New York City.

TYPEWRITERS All Makes. Save one-half. Thoroughly rebuilt in our factory by the famous "Young Process." Fully guaranteed. Free trial. We handle all standard makes. Cash or sold on easy terms. Write for Catalog. Young Typewriter Co., Dept. 502A, Chicago, Ill.

OLIVER Typewriter, L. C. Smith and other makes; also fine binoculars to exchange for shotguns, Graflex cameras and Microscopes. National Camera Exchange, 7th and Marquette, Minneapolis, Minn.

ADDING MACHINES

FREE Trial. Marvelous new Adding Machine. Adds, Subtracts, Multiplies, Divides, automatically. Work equals \$350.00 machine. Price only \$15.00. Speedy, durable, handsome. Five-year guarantee. Used by largest corporations. Write today for catalog and free trial offer. Lightning Calculator Co., Dept. E, Grand Rapids Mich.

NEW \$3.50 Automatic Adding Machine. Adds, Subtracts, Multiplies. Absolutely accurate. Capacity 999,999.99. Fully guaranteed, 75,000 pleased users. Makes adding easy, positive, quick. Eliminates Mistakes. Saves Time. Postpaid \$3.50. Bassett Co., 1458-B, Hollywood Ave., Chicago.

DUPLICATORS AND DEVICES

"MODERN" Duplicators save Time, Labor, and Money. Gets business. Reproduces Typewritten or Penned Letters, Drawings, Lessons, Music, Menus, Bids, Notices, Specifications, Maps or anything in one or more colors. Prints Two per minute. Special Sale On 30 Days' Free Trial. \$2.25 up. Booklet Free. J. E. Durkin-Reeves Co., Pittsburgh, Pa.

YOU can make 50 to 100 copies of a letter, notice, etc., at a cost of three cents as a Heyer Quality Duplicator. Write for free trial offer. The Heyer Duplicator Co., 14 S. Wells St., Chicago, Ill.

STENCIL Duplicating Outfit for Hand Use, \$3.00. On Approval. Prints Typewriting—Handwriting. Primos Specialty Co., 3-M, Primos, Pa.

PRINTING, ENGRAVING AND MULTI-GRAPHING

EMBOSSED Stationery, business or personal. Samples for stamps. Daniels Co., Pittston, Pa.

250 BOND Letterheads or Envelopes \$1.50. Geyer Printery, Box 886A, Dayton, Ohio.

PRINTING Outfits—Presses, type supplies, type novelties. Send stamp for catalogue. Model Press, York, Penna.

JOB Printing, All Kinds—Cards to Catalogues. Quality work. Smith-Roberts Printing Co., Waukegan, Ill.

500 GUMMED Labels, Name and Address, 30c. Eastern Label Co., Clintonville, Conn.

QUALITY Printing! Reasonable Prices! Tell us your wants and let us quote our Money-Saving prices. Best Work. We print anything. Ernest Fantus, 525 South Dearborn Street, Chicago.

GILT lettered Advertising-Pencils for you. Buy direct; save entire middleman's profit. Samples free (no agents). Address 8, Musial & Co., 10-12 Lincoln St., Yonkers, N. Y.

PRE-USED Printing Presses. Type and supplies. List for stamp. Popular Bargains, Richland, Pa.

500 IMITATION Typewritten Letters \$1.10, with printed heading. Bargains in Envelopes, Letterheads, etc. Prompt service. Samples and Price List. William Carlson, 8743 Essex Avenue, Chicago, Ill.

GUMMED Labels, Advertising Stickers. Samples Free. Lara Grindem, Goodell, Iowa.

OUR Art Blotters will help your business. Send for samples and prices. Lorraine Press, Beverly, Mass.

1,000 HAMMERMILL letterheads, envelopes, \$3.25; 250, \$1.25 postpaid. Samples Free. Troil Press, 93 Providence, Worcester, Mass.

WE print everything. Stationery, Booklets, Catalogs, Circulars, Samples. Commercial Press, Batavia, Ohio.

RUBBER Stamps, Gummed Labels. Lists free to offices, factories, stores, canvassers. McPherson Stamp Works, Middletown, Conn.

250 LETTERHEADS, 250 white envelopes, printed and mailed, \$3.00. Samples printing free. Sunco, Mohawk, N. Y.

FREE Card Case with your name printed in gold on case with calling card order. 20 cards, 25c, 100, 50c. Samples free. Mail Order Prtg. Co., 2519A S. Twelfth, St. Louis.

225 BOND letterheads, envelopes, billheads, cards, \$1.25 each. Combination, \$4.00. Economic Press, Leonia, N. J.

1,000 LETTERHEADS or Envelopes, \$3.00. Sent Prepaid. Samples Free. Monitor Press, Morrisville, Pa.

1,000 HAMMERMILL envelopes or letterheads, \$3.10. 1,000 Bond statements, billheads or envelopes, \$2.40, postpaid. Model Printers, 809 North 5th St., Nashville, Tenn.

150 EACH, Letterheads and Envelopes, \$1.50. Jacobs Service, Irvington, N. J.

POSTPAID—500 Envelopes, \$2.50; 100, 75c. A. Sturm, Stratford, Wis.

FOR MEN

ARE you old at forty? See our advertisement on page 88 of this issue. The Electro Thermal Company, 2128 Main St., Steubenville, Ohio.

WEARING APPAREL

SAVE 50%. Buy Direct Men's Silk Neckties. Fine Christmas Assortment Now. Box of Six, \$4.00. Send No Money. Satisfaction Guaranteed. Box 450, Madison Square Station, New York City.

FOR SMOKERS

CIGARS—Save 75%. Make your own—We teach you. Universal Cigar Co., 17 Liberty St., Grand Rapids, Mich.

RAZORS AND BLADES

BLADES, resharpened, one edge 2c; double 3c. New York Edge Co., Glen Cove, N. Y.

BETTER Shaving—Blades Resharpened 3c. any make. Standard Safety Razor Corporation, Pittsburgh.

BOATS AND LAUNCHES

ROWBOATS easily made. Blueprint list free. Weesbo-Uco, West Market, Detroit, Mich.

BUILD yourself a 12 foot Rowboat. Plans in The Rudder July, 1923—price, 25 cents. The Rudder, 9 Murray Street, New York City.

ROWBOATS—easily made. Literature free. Weesbo-Uco, West Market, Detroit.

FURS

YOUR raw furs made up into beautiful garments. Enormous savings. Catalog Free. Arthur Felber Fur Co., 25 N. Dearborn, Dept. P. M. 4, Chicago, Ill.

OPTICAL GOODS

SIX Power Binocular, \$5.00. Famous Wollensak Binocular, pocket size. Light weight, excellent optical quality, fine illumination, handsome, durable finish. Complete with case, only \$5.25 postpaid. Money-back guarantee. Wollensak Optical Company, 17-19 Clinton Ave. N., Rochester, N. Y.

ONE 2 1/2" 45 Power, Telescope, complete with Astronomical and Celestial eyepiece and suitable tripod. A bargain at \$30. One Carl Zeiss Prism Telescope, 12-24 and 42 Power, complete with heavy leather carrying case and panoramic tripod, \$137.50. One B & L Student Microscope, complete, \$27.50. Send for Photograph. DeFrame, Importers, 109 N. Dearborn St., Chicago, Ill.

ANTIQUES, WAR RELICS AND INDIAN GOODS

WAR Relics for Collectors; Relics from Europe's battlefields. Firearms, shells, medals, helmets, etc. Illustrated catalogue and sample War Photographs 25c. Lieut. Welsh, 2117 Regent Place, Brooklyn, N. Y.

INDIAN Baskets, Blankets, Wampum Mats Wholesale. Catalogue. Gilham, Kelseyville, Calif.

SEND 5c for list Coins, Indian Relics, Firearms. F. E. Ellis, Webster Groves, Mo.

RELICS from Europe's battlefields. Firearms, helmets, medals, etc. Illustrated catalogue with sample War Photographs, 25c. Lieut. Welsh, 2117 Regent Pl., Brooklyn, N. Y.

FOR THE HOME

KEEP warm this winter. Save 20 to 50% on your coal bills. Eliminate smoke and deadly gases. Equip your heating plant with a Crown Fuel Saver and learn what winter comfort means. Over 10,000 satisfied users are getting steeper, cleaner heat. The Crown fits the feed door of any heating plant. Requires no attention. Works automatically. Pays for itself in coal saved. Write for details and free booklet. Crown, Dept. A, Richmond, Ind.

LOOMS—Only \$9.90—Big money in weaving rugs, carpets, portieres, etc., at home, from rags and waste material. Weavers are rushed with orders. Send for free loom book, it tells all about the weaving business and our wonderful \$9.90 and other looms. Union Loom Works, 480 Factory St., Rosville, N. Y.

THREE brand new kitchen necessities every home will appreciate. Special Xmas sale. Circular Free. Lumite Products Co., 409 Walnut, N. E., Canton, Ohio.

GRANDFATHER Clock works, \$5.00. Build your own case; Instructions free; make good profits selling your friends. Clock works with chimes for old or new cases. Write for full particulars. Clock Co., Ruffner St., Philadelphia.

DIAMONDS, WATCHES AND JEWELRY

WATCHMAKERS: Earn highest wages. Understand adjusting thoroughly. Circular free. Write Walter Kleinlein, Publisher, Waltham, Mass.

PHONOGRAPHS AND RECORDS

TRADE your old phonograph records or player rolls on new ones. Stamp brings list. Fuller Exchange, Wichita, Kan.

SUPERIOR Equipment at lowest price for building fine phonographs. Superior Phonographs Co., Erie, Pa.

BUILD Your Phonograph. Quality phonographs. Quality Serenade motor and motors of other types. Electric Motors, tonearms, reproducers, amplifiers, case materials, accessories. Free blueprints and building instructions. Big saving. Wonderful results. Prompt delivery. Catalog mailed for ten cents. Hoosier Manufacturing & Supply Co., 313 Baldwin Block, Indianapolis, Ind.

BUILD Your Own Phonograph or Radio Set; catalogue for stamp. Dayton Phonograph & Radio Store, 118 West Court Street, Dayton, Ohio.

BUILD your own phonographs. We can supply you with motors, tone arms and all accessories at wholesale prices. Write for catalogue AX. Pleasing Sound Phonograph Co., 204 East 113th St., New York, N. Y.

BUILD a genuine Choraleon phonograph and save over half. Big profit building and selling. We furnish motors, tone-arms, full instructions and all necessary parts. Send for catalog and free blueprint offer. Choraleon Phonograph & Radio Co., 1223 11th St., Elkhart, Ind.

BUILD your own Phonograph. We furnish everything. Write for catalog and free blueprint offer. American Phonograph Co., 3515 North Crawford, Chicago.

MUSIC AND MUSICAL INSTRUMENTS

"MUSIC Composed" to words. Bauer Bros. (formerly of Sousa's Band), Oshkosh, Wis.

WRITE Songs. Big money and reputation. Write for information. J. Gordon Pub. Co., 201 N. Hoyne Ave., Chicago.

GENUINE Amber Violin varnish, 2 oz. \$2.00. Perlin, Rushville, Ind.

COMPLETE, easy self-instructors—Harmenica, Violin, Piano, Drum, Ocarina, Mandolin, Accordion, Saxophone 25c each. G. Eise, Bowling Green, Ohio.

I WANT song poems. Casper Nathan, Garrick Theatre Building, Chicago.

CORNETISTS—Trombonists—Saxophonists—Clarinetists. Send for "Free Pointers No. 2." Name instrument, Virtuoso Music School, Concord, Mass. Formerly of Buffalo, N. Y.

DIRECT the band like John Philip Sousa. Play the Cornet like Herbert Clarke. Let me teach you how. Full particulars free. VanderCook's School, 1852 Warren Avenue, Chicago, Ill.

EASY way to play the harmonica or mouth organ, 25c. Mercatus Co., Box 1422, Indianapolis.

SAXOPHONISTS: Eby's Saxophone Method, 44 Divisions, 340 pages. Price, \$4.00. Virtuoso Schools, Concord, Mass.

GENUINE Amber Violin varnish, 2 oz. \$2.00. Perlin, Rushville, Ind.

VIOLINS—Deep, Mellow, Soulful—on credit. Easy terms for wonderful instrument. Get details today. Gustav F. Henning, 2424 Gaylord St., Denver, Colo.

PATENT ATTORNEYS

PATENTS—Before disclosing an invention the inventor should write for our blank form "Record of Invention." This should be signed, witnessed and returned to us together with model or sketch and description of the invention and we will give our opinion as to its patentable nature free. Our Three Books mailed free to inventors. Our Illustrated Guide Book, "How to Obtain a Patent," contains full instructions regarding patents. "List of Patent Buyers" sent free, contains unsolicited letters from manufacturers and others who are constantly writing us regarding the purchase or leasing of meritorious patents. Victor J. Evans & Co. 934 Ninth, Washington, D. C.

STORAGE battery and kindred inventions specialized by lawyer formerly engaged in battery manufacture. M. E. Jones, 509 Seventh, Washington, D. C.

HORACE L. WOODWARD, registered patent attorney and mechanical expert, Washington, D. C., renders quality service to inventors. Recommended by manufacturers. Advice free. Seventeen years' practice. Reasonable cost.

HERBERT JENNER, patent attorney and mechanical expert, 624 F Street, Washington, D. C. I report if patent obtainable and exact cost. Send for circular.

PATENT, trade-mark, copyright specialist. Free Duplex conception form. Personal service exclusively. M. E. Jones, Lawyer, 509 Seventh, Washington, D. C.

PATENTS promptly procured. Personal, careful and efficient service. Highest references. Moderate fees. Send sketch or model for actual search and advice. George P. Kimmel, Master of Patent Law, 54-O Loan and Trust Bldg., Washington, D. C.

"INVENTORS' Guide" free on request; gives valuable information and advice for all who have original ideas or improvements. Frank Ledermann, Registered Attorney and Engineer, 15-P Park Row, New York.

PATENTS. Booklet free. Highest references. Best results. Promptness assured. Send model or drawing for preliminary examination. Watson E. Coleman, Patent Lawyer, 624 F Street, Washington, D. C.

BEFORE or after filing application for patent on your invention it will pay you to read over my "Inventor's Advisor No. 3," free for asking. M. Labiner, Registered Patent Attorney, 3 Park Row, New York.

MONROE MILLER, Ouray Building, Washington, D. C., patent attorney, mechanical and electrical expert. Best quality of work and results. Moderate charges.

INVENTORS—Send for form "Evidence of Conception" to be signed and witnessed. Form, fee schedule, information free. Lancaster and Allwine, 221 Ouray Bldg., Washington, D. C.

H. F. LOWENSTEIN, Registered Patent Attorney, Technical expert, McLachlin Building, Washington, D. C.

PATENTS. I give personal service. Twenty years' experience. Charges reasonable. C. E. Trainor, 503 Kresge Bldg., Washington, D. C.

MILLIONS spent annually for ideas! Hundreds now wanted! Patent yours and profit! Write today for free books—tell how to protect yourself, how to invent, ideas wanted, how we help you sell, etc. 500 Kresge Bldg., American Industries, Inc., Washington, D. C.

PATENTS and Trade-marks obtained. Prompt service. Write for our new book on patents. Established in 1888. D. Swift & Co., 369 7th St., Washington, D. C.

EDWARD C. SASNETT, formerly a Principal Examiner U. S. Patent Office. Personal Service. 516 McGill Bldg., Washington, D. C.

SEND sketch for search report. Get my latest book on Patents. H. L. Woodward, 714 9th St., Washington.

INVENTORS: Record invention legally before disclosing to others. Our Invention-Record and Data Sheet shows how. Sent free and valuable information given on patent procedure, costs, etc. Report on patentability includes copies of patents nearest your idea. O'Connell & O'Connell, Jenifer Bldg., Washington, D. C.

PATENTS Procured. Send sketch or model today for examination, prompt report and advice. No charge for preliminary advice. Write for free Booklet and blank form on which to disclose your idea. Highest references. Promptness assured. Clarence A. O'Brien, Registered Patent Lawyer, 309 Security Bank Building, Directly across the street from Patent office, Washington, D. C.

PATENTS Procured; Trade Marks Registered—A comprehensive, experienced, prompt service for the protection and development of your ideas. Preliminary advice gladly furnished without charge. Booklet of information and forms for disclosing idea free on request. Richard B. Owen, 39 Owen Bldg., Washington, D. C., or 2276-R Woolworth Bldg., New York.

PATENTS, Trademarks, Copyrights procured; all countries; Booklet Free; 20 years' experience; very reasonable; my personal attention to every case; ask about Free Sales Service. H. Sanders, Registered Patent Attorney, 7 Rand-McNally Building, Chicago, Ill.

PATENTS, Trade-Marks, Copyrights and Patent Litigation. Write for advice and instructions how to proceed, costs, etc. Hand Book with illustrations of 100 Mechanical Movements sent free on request. Albert E. Dieterich, Patent Lawyer and Solicitor, 621 Ouray Bldg., Washington, D. C.

PATENTS. My fees in installments. Advice book free. Frank Fuller, Washington, D. C.

INVENTORS should write us for our book, "How to Obtain a Patent," which clearly sets forth what may be patented and the necessary steps to protect an invention; it describes the procedure in patent office and tells about assignments, licenses and trade marks, and gives many useful facts about patents which every inventor should know; many persons well versed in patent matters have pronounced the book the best of its kind they have ever read; it is written so you can understand it; copy free upon request. Talbert & Talbert, Patent Lawyers, 481 McGill Bldg., Washington, D. C.

INVENTORS—Complete list of Washington patent attorneys, with addresses and type of business specialized in, \$1.00, postpaid. Our recommendation, if desired. Washington Service Bureau, 417 District National Bank Bldg., Washington, D. C.

INVENTORS: Send sketch or model of invention for opinion concerning patentable nature and exact cost of patent. Book "How to Obtain a Patent," sent free. Tells what every inventor should know. Established twenty-eight years. Highest references. prompt service, reasonable charges. Address Chandler & Chandler, 456 Seventh, Washington, D. C.

COMMERCIALIZE your ideas according to My Cooperative Plan. Booklet free. Ralph Burch, Patent Lawyer, Jenifer Building, Washington.

M. P. LAUGHLIN—Patents—Engineer—Attorney, 45 E. 41st St., New York.

LACEY Patent Sense. See Page 90.

FOR INVENTORS

FURNACE Oil Burner Company, long established, willing to buy new patent rights outright on furnace oil burner of proved merit. Patented device only considered. State patent number and complete details in first letter. Address George A. Beck, 2850 Pennsylvania Ave., St. Louis, Mo.

PATENT Sense—"The book the inventor keeps." Free. See Lacey ad., page 90.

PATENTS. If you wish to patent you can write fully and freely to Munn & Co. for advice in regard to the best way of obtaining protection. Please send sketches, or a model of your invention and a description of the device, explaining its operation. All communications are strictly confidential. Our vast practice, extending over a period of seventy-seven years, enables us in many cases to advise in regard to patentability without expense to the client. Our Hand-Book on Patents is sent free on request. This explains our methods, terms, etc., in regard to Patents, Trade Marks, Foreign Patents, etc. "Scientific American" contains Patent Office Notes, Decisions of interest to inventors and particulars of recently patented inventions. Munn & Co., Solicitors of Patents, 623 Woolworth Bldg., New York; Scientific American Bldg., Washington, D. C.; 801A Tower Bldg., Chicago, Ill.; Hobart Bldg., San Francisco, Calif.

INVENTORS—Write for our Guide: Books, List of Patent Buyers and "Record of Invention Blank" before disclosing inventions. Send model or sketch of your invention for our free opinion of its patentable nature. Victor J. Evans & Co., 157 North, Washington, D. C.

PATENT Application Inventing one sheet drawing prepared for \$15. A. M. Benner, Olympia, Wash.

HORACE L. WOODWARD'S Advice on Inventions Free. Send sketch today. Ninth at G, Washington.

DRAWINGS—Inventions developed. Expert machine designing. Working drawings for models. Henry Wettstein, 150 Nassau St., New York.

INVENTORS, turn your ideas or patents into cash. We want something new in toys, household or farm appliances. Finance, buy or manufacture on royalty. R. C. Burnham, Richland Center, Wis.

INVENTORS should write us for our book, "How to Obtain a Patent," which clearly sets forth what may be patented and the necessary steps to protect an invention; it describes the procedure in patent office and tells about assignments, licenses and trade marks, and gives many useful facts about patents which every inventor should know; many persons well versed in patent matters have pronounced the book the best of its kind they have ever read; it is written so you can understand it; copy free upon request. Talbert & Talbert, Patent Lawyers, 495 McGill Bldg., Washington, D. C.

PATENTS, Trade marks, copyrights. Prompt, personal, reliable service. Over 36 years' active practice. Write for terms. Book free. Address E. G. Siggers, N. U. Bldg., 918 F St., Washington, D. C.

I SELL patents. Established in 1900. A service for the inventor that serves. Bankers, Lawyers, Patent Attorneys, Corporations, Mechanics, men in every walk of life are my clients. Why not you, if you have a patent to sell? Charles A. Scott, 773 PM Garson Avenue, Rochester, N. Y.

TO sell your Patent. Write me; experienced handling, immediate action. Address Arthur S. Billings, Suite 401 Dekum Bldg., Portland, Ore.

GET your own patents. Application blanks, complete instructions \$1. Cutting Sons, Cambell, Cal.

INVENTORS' Educator; 900 Mechanical Movements, 50 Perpetual Motions. How to procure and sell patents. Mechanical Movements greatly assist inventors, suggest new ideas. Explains how to select an attorney and avoid Patent Sharks. Price \$1.50. Postage Free. Albert E. Dieterich, 621 Ouray Building, Washington, D. C.

UNPATENTED Ideas can be sold. I tell you how and help you make the sale. Particulars free. Write W. T. Greene, Jenifer Bldg., Washington, D. C.

INVENTORS—Send your ideas for manufacturing development in our modern sheet metal and angle-iron fabricating plant. Those pertaining to dust collecting or ventilating preferred. Liberal payment for accepted inventions. Kirk & Blum Manufacturing Co., 2831 Spring Grove Ave., Cincinnati, O.

HAVE you an invention! If so, write for our free book, "How to Get Your Patent" tells our terms and methods. Send model or sketch for our opinion of its patentable nature. Randolph & Co., Dept. 114, Washington, D. C.

PATENT Application Blanks free to inventors. Patent News-D, Washington, D. C.

MODEL Making and experimental work. Modern Shop; expert workmen. Manufacturing. Lamson Electrical & Mfg. Co., 627 W. Jackson, Chicago.

INVENTION and Patent Promotion Magazine. Interesting information and helpful advice. Send for circular. Burckett, Box 34-M, Station 8, New York City.

PATENTS Procured. Send sketch or model today for examination, prompt report and advice. No charge for preliminary advice. Write for free Booklet and blank form on which to disclose your idea. Highest references. Promptness assured. Clarence A. O'Brien, Registered Patent Lawyer, 310 Security Bank Building, Directly across the street from Patent office, Washington, D. C.

PATENTS Procured; Trade Marks Registered—A comprehensive, experienced, prompt service for the protection and development of your ideas. Preliminary advice gladly furnished without charge. Booklet of information and forms for disclosing idea free on request. Richard B. Owen, 39 Owen Bldg., Washington, D. C., or 2276-R Woolworth Bldg., New York.

PATENTS FOR SALE

FOR Sale: Patent on Switch for Street Railways. Motorman throws switch while car is in motion. Chas. Strayer, 127 Leslie St., Johnston, Pa.

CANADIAN Patent. Restaurant equipment improvement. Reed, Box 42, Orwigsborg, Pa.

MOST efficient cooking utensil cleaner yet invented. Easily and cheaply manufactured. A proven success. Nothing similar on the market. Outright or royalty. N. J. MacLean, 201 N. Chilton Ave., Bay City, Mich.

U. S. PATENT for Sale. No. 1,442,378: Applicable either as padlock or door-lock. For particulars consult R. L. Williamson, Erwin, Tenn.

FOR Sale—Patent No. 1,408,756. Others pending. Here is your chance to get in on good proposition. J. Brower, Inventor, 4417 Bethoven, St. Louis, Mo.

IMPROVED clothes dryer for sun drying—a necessity in every house. Outright or royalty. Patented U. S. A. 581,562, and Canada 273,317. J. E. Pieterick, Cayuga, N. Dak.

FOR Sale or Royalty—Commercial-type sectional Bookcase, projectable shelf, disappearing door, wood or metal design, fire resisting, stamp job, practical. Model to demonstrate. J. C. Farquhar, 351 Putnam Ave., Zanesville, Ohio.

PENCIL Eraser holder: Pocket mate's box; Drawer with latch. Request specifications. A. M. Benner, Olympia, Wash.

REFRIGERATOR without drip pan or drain pipe. Fountain Manufacturing Instrument. Sponge filled Absorbent Pad. Writing Board. Gift Novelty. M. V. Bauer, 601 McLachlen Bldg., Washington, D. C.

CALENDAR Attachment for Fountain Pens. Daily dating. Simple and practical. Best offer buys patent. Ashby, 624 Anothyst St., Los Angeles, Calif.

THE only faultless Internal Steel Washer Patent. Outright or Royalty. Peter Berglof, Isanti, Minn.

FOR Sale—U. S. and Canadian Patents on Automobile lock and Thief alarm. Appearance and Operation like that of a Safe Combination. While ignition is off, and front wheels cramped to either right or left, car can not be moved silently. C. A. Johnson, Box 44, Saratoga Springs, N. Y.

VALUABLE Patent, Pending, for sale, to utilize exhaust from gasoline motors, saving 30%. George Crichton, Pearl River, N. Y.

FOR Sale: Patent on Concrete Mold. Makes all shapes and sizes with same mold. Patent granted 1916. Chas. Strayser, 127 Leslie St., Johnstown, Pa.

FOR Sale—Patent rights on locking hinges especially used for folding articles. Offers wanted. K. Gober, 325 Broadway, Oakland, Calif.

FOR Sale—Spark Plug Patent. P. V. Carpenter, Worth, N. C.

PATENT For Sale. Self-feeder for food-cutters; simple, cheap, efficient; fits any machine. Kolarik, 1225 Walnut St., Milwaukee, Wis.

PATENTS For Sale: To sell, buy or obtain patents, write Patent News-P, Washington, D. C.

INVENTION, Combination Plane Rabbit, Smooth and Block combined. Patent No. 1,448,775 for sale. Chas. A. Trump, Derry, Westmoreland Co., R. F. D. No. 1, Box 37, Penna.

PATENT on household "Knife Sharpener." A real seller. Manufactured cheaply. Arrid Bohlin, 71 Mulberry St., Trenton, N. J.

PATENT For Sale—Steering attachment for sleds; steers like Automobile. Wilbur Rogers, 604 Tremont, Boston, Mass.

'OUTRIGHT or Royalty," patent potato check-row planter. No. 1,444,127. John Mailloux, McIntosh, Minn.

FOR Sale, Patents: Nut and Bolt Locks, designed to resist vibration; Metal toy Aeroplane, useful and decorative. Weather-vane for barns, garages, etc. M. R. Hamfelt, South Lima, N. Y.

I WANT financial aid in marketing a patented airtight automobile tire. E. E. Cathart, Lexington, Neb.

PATENTED Fan, operated by rocking-chair! Speed like electric fan; cost making, 50 cents; sell, \$2.00. Outright or royalty. Arrid Carlin, 43 Keeler Ave., Mamaroneck, N. Y.

STRAW Spreader—13904; Clam Opener—14,303; Douche Table—12,889; Vibrometer—13,769; Type Cleaner—14,179; Trap—13,970. Talbert & Talbert, McGill Bldg., Washington, D. C.

SASH Retainers—Best and simplest yet invented. Outright or royalty. Money-making proposition. Full particulars. Jacob Pittenger, Milburn, N. J.

OUTRIGHT or Royalty. Twin Leg Hinge. Never loosens. Manufactured cheaply. American, Canadian, British Patent. J. E. Bellevue, 92 Shirley St., Halifax, Canada.

SPOKE Grip for vehicles, including Autos. Secures broken spokes to rim firmly as new. Will sell outright to highest bidder for cash. United States and Canadian rights. M. M. Colvin, Koroka, Ontario, Canada.

FOR SALE—Patent on Safety-Nuts. Patent No. 1,421,090. Hans Larsen, Box 491, Seattle, Wash.

DRAWING INSTRUMENTS AND DRAFTING SUPPLIES

DIRECT Importation, 16-piece Precision Mechanical Drafting Set in plush case. Finest German Silver. Special, each \$1.50. Photo free. De France, Importers, 109 N. Dearborn Street, Chicago, Ill.

NEW Invention: drawing outfit combined in one simple instrument. Book of instructions furnished which enables any one to quickly learn to make maps, plans and do mechanical drawing. Price, only \$3. Money refunded if not satisfactory. Or write for details. Dept. 4, Golden Compass Co., Denver, Ind.

SURVEYING INSTRUMENTS

NEW and used surveying instruments direct from factory. Satisfaction guaranteed or money refunded. Wisler, 619 Broadway, St. Louis.

MODELS AND MODEL SUPPLIES

INVENTORS—Write for our Guide Books and "Record of Invention Blank." Send model or sketch of inventions for our free opinion of patentable nature. Victor J. Evans & Co., 165 Ninth, Washington, D. C.

WE make working models for inventors and do experimental work and carry a complete stock of brass gears and model supplies. Send for catalogue. The Pierce Model Works, Tinley Park, Ill.

MODEL Making and experimental work; Modern Shop, expert workmen. Manufacturing. Lamson Electrical and Mfg. Co., 625 W. Jackson, Chicago.

BEFORE you buy model engines, boilers, send stamp for our new illustrated list of machined castings, parts for boilers, boat fittings. Model Machine Shop Co., 417 East 71st St., New York City.

PATENTS Procured. Send sketch or model today for examination, prompt report and advice. No charge for preliminary advice. Write for free Booklet and blank form on which to disclose your idea. Highest references. Promptness assured. Clarence A. O'Brien, Registered Patent Lawyer, 310 Security Bank Building, Directly across the street from Patent Office, Washington, D. C.

MODEL Made any invention, \$10.00. Send complete description. N. J. Rains, 1740 Euclid St., Washington, D. C.

FOR MANUFACTURERS

WANTED—Metal Stamping and Model work taken on contract basis. We are ideally located and equipped to develop patents. Meyers Company, Box 328, Bedford, Ind.

MANUFACTURERS wishing representation Singapore, apply Room 304, Popular Mechanics Magazine. Only guaranteed lines acceptable. Samples, terms, necessary.

IF you want dies and metal stampings write us. Lyons Machine Works, Lyons, Ia.

MANUFACTURING

UNUSUAL opportunity for dies, stamping, die-casting, plating, enameling, screw-machine and wire products. Reasonable. Large, excellent equipped factory. Metal-Craft Manufacturing Co., Box 239, Chicago.

PATENTED Articles, Models, Brass Work, Machine Construction; Dies Made. Baum's Metal Specialties, Kansas City, Mo.

WANTED—By a well equipped metal manufacturing plant having 25 stamping and punching presses and 25 automatic screw machines, staple and volume products to manufacture either outright or on royalty basis. Company's work at present largely automobile parts. The Zeigler Manufacturing Co., Alexandria, Ind.

LONG established manufacturer of auto accessories which are daily sold by practically all wholesale and retail accessory houses will consider manufacturing and distributing new automobile products, capable of equally wide sale through same channels. Patented articles preferred. Address Auto Accessory Manufacturer, 1512 North American Bldg., Chicago, Ill.

SCREWS, nuts, screw machine products, all metals. Autoscrew Works, 335 West Broadway, New York City.

PATTERNS, wood and metal. Models, tools and dies. Brass, bronze, aluminum and iron castings. Screw machine work, production work of all kinds. Write Modern Machine & Pattern Co., Terre Haute, Ind.

LET Us Manufacture It For You. We will cooperate with you in every way possible. Our experience in developing, simplifying and selling new devices at your disposal. Ideas worked out and developed. Models made. Metal parts made to drawing or sample. Special Machinery designed and built. Dies and other special tools for manufacturing furnished. Simplex Tool Company, Woonsocket, R. I.

WIRE Goods, all kinds, made to order. Cooley Mfg. Co., 521-530 N. Western Ave., Chicago.

EXPERIMENTERS developed dies, models and manufacturing machine designing. Estimates and information promptly given. Address Schroer Bros. Machine Works, 512 East 25th Street, Kansas City, Mo.

OUR factory will make your models, manufacture your articles as well as build your tools, dies and fixtures. Standard Die & Specialty Co., 817 W. Washington Blvd., Chicago, Ill.

WE Specialize on Dies, Making Stamping, Light Mfg. The Times Mfg., 410 Kimball St., Danville, Ill.

SPRINGS made to order. Wright Bros., 5616 Huron St., Chicago.

IRON, Brass, Aluminum Castings, Models. Patterns. Light Manufacturing. Welch Brothers Co., North Chicago, Ill.

MACHINERY, TOOLS AND SUPPLIES

10 KW Fairbanks-Morse, 3 phase, 60 cycle, 2300 volts, with exciter, \$300. 25 Horse St. Mary's oil engine, \$250. 25 KW Diesel, 110 volt, belted, DC, and switchboard, \$150. 25 KW 220 volt, DC, belted Fairbanks-Morse, with switchboard, \$150. 60 Horse Diesel Snow, crude oil engine, \$1500. 50 KVA, 250 volt, 3 phase, 60 cycle, Fairbanks-Morse, with field rheostat, \$400. 50 KW, 3 phase, 60 cycle, 2500 volt, Atlas Chalmers, with exciter, \$400. 35 KW General Electric 3 phase, 60 cycle, 2300 volt, direct connected to Skinner steam engine, exciter and switchboard, \$800. All prices P. O. B. cars, machinery guaranteed. Oklahoma High Line Construction Company, Tulsa, Okla.

ALL Steel Hydraulic Press, vertical, with pump, one hundred and fifty ton, pulley automatic. Either light or heavy work. R. L. Barrett, 114 E. Grand Ave., Chicago, Ill.

PNEUMATIC Tools—700 tools consisting of riveting and chipping hammers and air drills. Write for list. Machinery & Supply Corporation, Joplin, Mo.

CONCRETE Building Block Machines and Molds, Catalogue free. Concrete Machine Co., 303 South Third St., St. Louis, Mo.

6-11" x 4' ARTISIAN engine lathes, brand new. Price \$156.00 each, 16" Davis Shaper \$175.00. We handle everything in machinery and supplies. Write us. Cincinnati Machinery Supply Co., 218 E. Pearl St., Cincinnati, O.

BUY or Sell Engines, Boilers, Pumps and used machinery. Send for free copy Buyers and Sellers Exchange List. Modern Engine & Supply Co., 53 W. Jackson Blvd., Chicago, Ill.

ENGINES, MOTORS AND DYNAMOS

GOVERNORS to control Auto Engines when used as stationary engines. Circulars. Candee-Smith Governor Co., Springfield, N. Y.

BLUR Generators, brand new, 6 volts, maximum output 22 amperes at 2000 r. p. m. Government paid \$45.00 each, our price \$10.00. General Sales Company, 1919 S. Michigan Avenue, Chicago, Ill.

STEAM Engines, one H. P. \$18.00; 1/2, \$12.00. James Chambliss, Bessemer, Ala.

BUILD Your Own Engine, Pump or Motor, 40 styles and sizes to pick from. Our catalogue sent postpaid 20c stamps. (Two dimes preferred.) Refunded first order. Write today. Modern Engine & Supply Co., 53 W. Jackson Blvd., Chicago, Ill.

GENERAL Electric, Motors, Generators, Turbines, and Radios. Anthony Donato, 312 Front St., Schenectady, N. Y.

ELECTRICAL

CARBON brushes, plates, rods and specialties. Pittsburgh Carbon Brush Co., 127 Fawcett St., Pittsburgh, Pa.

STEP OUT *from the* CROWD

You can be a

Dental Laboratory EXPERT!



**This Expert
Is Making
\$15 to \$20
a Day!**

Easiest, pleasantest work you ever saw! Your own boss, money and success yours from the very beginning. You can start with a "shoe-string." We prepare you in a few months to run a business of your own, to do any job. Common schooling, ability to use your fingers ALL YOU NEED!

Rubber Plates

Learn to make partial upper or lower plates with soldered, cast or wire clasps, with palatal bars; with lingual bars. McCarrie-trained Experts learn to make full rubber plates of every type, including Vulcanite base-plates, butted gums, carved gums, etc.

CROWNS

Here's only a small part of your practical training in Crown-work: Two-piece, seamless, open-face, Richmond, cast-base porcelain, Carlschale, split-pin, carved (swaged) cusp, cast cusp, etc.

BRIDGE WORK

Complete training in both fixed and removable bridge-work. Interchangeable teeth, gold dummy, sanitary, porcelain dummy jobs—Roach, Gilmore, Bischoff and all forms of cast-clasp work is taught—not with books but in actual Laboratory.

METAL BASE DENTURES

Cast bases of Aluminum, gold, Watt's metal, etc. are included in your training. Both centrifugal and air pressure casting machines are used. Free Catalog contains complete list of subjects in course.

Jobs at \$60 to \$125 a Week!

In a business where there are many times as many jobs as Experts, salaries are high, hours are easy, opportunities are everywhere! McCarrie-trained Experts always get the preference—Dentists everywhere recognize the high-standing of our graduates. No books here—learn with tools and instruments. Start quick—get ready in 12 weeks for your big opportunity! Mail Coupon today!

FREE!
R.R.
Fare
to
Chicago

What's the use of training for the old, overcrowded trades? If you're going to prepare for big-salaried jobs or a profitable business of your own GET INTO THE NEWEST PROFESSION—'Laboratory Dentistry.' Biggest opportunity for success of the century, because there are ten times as many jobs as men to fill them, because there are a dozen cities crying for Laboratories for each EXPERT capable of operating one!

60,000 DENTISTS NEED LABORATORY WORK!

Only a few hundred Laboratories in all the U. S.—most of them in Chicago and New York. Dentists can't afford to do their own mechanical jobs. They can buy the services of a Laboratory Expert at \$3.00 an hour and sell their own time at \$6 to \$15 an hour. Dentists will encourage you to learn mechanical work, start a "Lab" of your own, give them quicker service than sending to Chicago or New York. Dentists can't wait and keep their patients waiting.

OPEN a LABORATORY of your OWN!

Joe Will of Chicago started a couple of years ago ALONE. Today he employs 60 Experts and his Laboratory is one of the biggest in the U. S. Boos in Minneapolis is reported to employ 125 men and to clear \$40,000 to \$50,000 a year. Start with the same tools you use in this big SCHOOL-LABORATORY. Start your own Laboratory with as little as \$100 investment. No limit to profits you can make in this wonderful new profession.

INTERESTING CATALOG—FREE!

Right this minute we can place 150 Dental Laboratory Experts in locations where they can make \$5,000 to \$20,000 a year. But you can't cash in, take advantage of these OPPORTUNITIES until you're TRAINED. Catalog tells you how quickly and easily you can get ready, how hundreds of others have SUCCEEDED! Tells you how you learn in few months BY DOING ACTUAL LABORATORY JOBS under world's greatest Mechanical Dentists! Brings you FREE R. R. Fare offer and other big inducements. Write for free Catalog today!

EARN while you LEARN!

Day students make all or part cost of course by part-time night work. Night students can find plenty of good jobs in Chicago—to see them thru. We'll help you!

McCarrie School of Mechanical Dentistry

Dept. 301, 34-36 W. Lake St., Chicago

McCarrie School of Mechanical Dentistry, Dept. 301, 34-36 W. Lake St., Chicago

Without obligation, please send me your Free R. R. fare offer and free catalog with complete information about how I may become a Dental Laboratory EXPERT.

Name.....

St. No. or R. F. D.

City.....State.....

Continued from Page 46

FOR MECHANICS

PATENTS—Write for our Guide Books, List of Patent Buyers and "Record of Invention Blank" before disclosing inventions. Send model or sketch of your invention for our free opinion of its patentable nature. Terms Reasonable. Victor J. Evans & Co., 184 Ninth, Washington, D. C.

CONTINUOUS cutting Handy Metal Shear, \$6.00 prepaid. Iron Works, Sioux Rapids, Iowa.

TOOLMAKERS, Machinists, Send Use for a Safety Pocket Scale Clip. Agents, Dealers, Write. F. A. Corson, Jersey Shore, Penna.

1,000,000 INDUSTRIAL Facts, Calculations, Receipts, Processes and Trade Secrets for every business are contained in the 1016-page book, "Moore's Universal Assistant and Complete Mechanic," 500 Engravings, Cloth. Price, \$2 postpaid. Popular Mechanics Book Dept., 206 E. Ontario St., Chicago.

BLACKSMITHS

BLACKSMITHS, Listen: Any Handy man can make more money doing hard jobs easy. Forging and welding solid, with Toy's Modern Methods of Blacksmithing. Hardening and tempering to a standard with colored tempering charts. All for one dollar. Samples Free. W. M. Toy, Sidney, O.

SENSATION of the season: the new Hossfeld Wrenchless Universal Bender; bends Eye bolts, U's, Angles, etc. Bends 1 1/2" standard Pipe cold. Also rolls perfect Automobile Spring Eyes. Machine can be instantly set for any kind or size of work without the use of a wrench. Simple, Powerful, Inexpensive. Send for circular. Universal Iron Bender Co., Inc., Winona, Minn. Representatives Wanted.

FOR SALE—MISCELLANEOUS

THREADERS—threads sewing-machine and ordinary needles. Threads in dark, saves time, eyes, patience. Only two all-over dimes. O. Gerling, Ellendale, N. Dak.

MOCCASINS, Great for foot comfort. For hunting, fishing, street or camp wear. Free catalogue. Park Hill Shoe Co., Auburn, Maine.

COLORED Leads for all Everpointed Pencils—Red—Blue—Green—Yellow. Twenty-five cents per tube. A. W. Faber, Newark, N. J.

ADDRESSOGRAPHs, Letter Folders, Multigraphs, Envelope Sealers, Duplicators, less than half price. Guaranteed. Pruitt Co., 112-B N. La Salle, Chicago.

GASOLINE Lamps and Lanterns. Catalog free. Little Wonder Light Co., Terre Haute, Ind.

MUSICAL Instruments. Send for Bargain Prices. Lehnert's Piano Co., St. Paul, Minn.

ALL sizes printing presses, type and materials, make easy money printing for self and others. Watson, 160 Williams St., New York.

ROOTS AND HERBS

GENSENG and other Plants for Medicine, Perfumes, Dyes, How to gather. Address of Buyers Book 30c. O. Twitchell, Berlin, N. H.

WANTED—MISCELLANEOUS

MAIL us your discarded Jewelry. Gold Crowns and Bridges, Watches, Diamonds, Silver, Platinum, and Old False Teeth. Money promptly mailed. Goods returned if offer refused. United States Smelting Works (The Old Reliable), Dept. 71, Chicago.

WANTED—Copies of Popular Mechanics Magazine of September and October, 1922. Must be in good condition. Will pay 25 cents per copy. Address Room 311, Popular Mechanics Bldg., 206 East Ontario, Chicago, Ill.

CASH for old gold, silver, platinum, watches, diamonds, magneto points, gold crowns, false teeth, and other valuables. Merchandise returned if offer unsatisfactory. Bush Products, Dept. 50, 144 Fifth Ave., New York.

WANTED—Encyclopedia Britannica, Vol. 4. Hrs-Cal Inc. Published by the Cambridge University Press. Address, G. F. Baker, Room 304, Popular Mechanics Magazine, 206 E. Ontario St., Chicago, Ill.

WANTED—Complete files of Popular Mechanics Magazine for the years 1902, 1903, 1904 and 1905. Must be in good condition. Will pay \$5.00 for full sets of each year. Address, Geo. F. Baker, Room 304, Popular Mechanics Bldg., 206 East Ontario, Chicago, Ill.

REAL ESTATE, FARM AND ORCHARD LANDS

SELL your property quickly for cash, no matter where located. Don't pay big commission. Particulars free. Real Estate Salesmen Co., Desk B, Lincoln, Neb.

\$300 GETS Farm with furniture, horse, cow, poultry, tools; 25 acres near village; 2-story 6-room house, 40-ft. barn, etc. \$900 gets all, only \$300 needed. Picture page 62 New Catalog Bargains. Copy free. Strout Farm Agency, 150P Nassau St., New York City.

GOOD Farm Lands! Near hustling city in Michigan; 20, 40, 80 acre tracts; clay loam soil; \$10 to \$50 down; balance long time. Write today for booklet. Swigart Land Company, P-1259, First Nat'l Bank Bldg., Chicago.

WANTED—I want farms for cash buyers. Describe and state price. R. A. McNew, 312 Wilkinson Bldg., Omaha, Neb.

\$5.00 DOWN, \$5.00 monthly; 10 acres unimproved poultry, fruit, stock, woodland; \$100; Ozarks. Fishing, hunting, trapping. Alfred Zimmerman, 1800 N. Fifth, Kansas City, Kan.

BIG returns from Pecan, Orange and Fig Groves. Guaranteed care. Small monthly payments. Dept. M, Suburban Orchards Co., Biloxi, Miss.

100 FARMS, 80 Acres Each, Eastern Montana, Prairie County, \$25 acre. \$100 Cash, Bal. \$200 year for 8 years. Rich soil, close R. R. J. L. Wells, 22 W. Monroe St., Chicago.

ATTENTION—"Get acquainted." Cash for your property. Farm, Hotel or Retail Store, no matter where located; confidential service. Hayes' Business Agency, Cincinnati, Ohio.

REAL Estate Educator—The most valuable, concise and comprehensive work on real estate selling, buying, advertising, appraising, investing, leasing, sub-letting, transferring, insuring, mortgaging, etc., ever compiled. 208 pp. Cloth. \$2 postpaid. Popular Mechanics Book Dept., 206 E. Ontario St., Chicago.

DOGS AND PETS

HIGH Class Fox, Wolf, Deer, Coon hounds. A few still-trailing coon and varmint dogs. Rabbit hounds. Stephens Kennels, Marshall, Ark.

TRAINED Beagles, Foxhounds, Rabbit Dogs, Broken Coon Dogs, Trial, Setters. Geo. A. Brown, Lancaster, Pa. No. 5.

GUARANTEED Hunting Dogs—Coon, Mink, Opossum, Skunk, etc. Hounds or mixed breeds. Prices right. Catalog Ten Cents. Burrow, Pochontas, Ark.

COLLIES for Sale. Training Book 25c. Sunnyside Kennels, Bloomington, Ill.

PONIES, goats, dogs, cats, rabbits, canaries. Jos. Berg, Hendrum, Minn.

COLLIE puppies, grown dogs and a few tried brood matrons for sale at reasonable prices. Best possible breeding for work or show. Wonderfully intelligent companions for children or adults. Write Oak Run Collie Kennels, Boston, Ky.

SILVERBLACK Foxes \$300.00. Musk-rats. Time payments. Arthur Schumacher, Lockland, O.

POULTRY

SUNNYSIDE Pullets, 25¢ egg stock, \$3 each. "Raised in Bristol, lay everywhere." Sunnyside Poultry Ranch, Bristol, Vt.

PLANS for Poultry Houses. All styles, 150 illustrations; secret of getting winter eggs, and copy of "The Full Egg Basket." Send 25 cents. Inland Poultry Journal, Dept. 74, Indianapolis, Ind.

PERSONAL

YOUR Horoscope—Business, Character, Chances, Friends, Enemies. Send birth date and ten cents (stamps) for remarkable test reading. Zanya, 202-C, W. 105th St., New York City.

TOBACCO or Snuff Habit cured or no pay, \$1.00 if cured. Remedy sent on trial. Superba Co., TP, Baltimore, Md.

UNUSUAL Horoscope—Six pages, consisting of extensive four-page Special Horoscope, Astro-Analysis, and two-page valuable guide giving daily and monthly advice covering entire year. Send 50¢ and birth date. Money returned if dissatisfied. Prof. Bolles, Box 5, Fordham Station, New York, N. Y.

TOBACCO Kills manly Vigor. Quit easily. Cigarettes, chewing, smoking, snuff conquered or no charge. Small sum if satisfactory. Stops craving; harmless. Full treatment on trial. Perkins Co., 31-A, Hastings, Neb.

FREE—Information of a scientific nature that has brought happiness through perfect health to thousands. No charge; no obligation. Enclose stamp for reply. C. O. Wood & Co., Colorado Springs, Colo.

ARE you bashful, self-conscious, easily embarrassed? These troubles overcome. Send dime for particulars. C. Veritas, 1400 Broadway, New York, N. Y.

YOUR greatest asset is Personality. Add to your stock. Success Tips and Self-Rewiring chart, 10c. Thomson Heywood, Dept. PM, Chronicle Bldg., San Francisco, Calif.

FREE Book: Elijah Coming before Jesus. Meghilo Publishers, Rochester, N. Y.

FREE—Stop using tobacco. We will give free information how to conquer habit easily and permanently. Results guaranteed. Anti-Tobacco League, Box K., Omaha, Neb.

ARE You Old at Forty? See our advertisement on page 88 of this issue. The Electro Thermal Company, 2128 Main Street, Steubenville, Ohio.

LUTHY'S Five-Minute, Thoroughgoing, Basic Physical Exercises \$5. Have no equal in the whole field of physical culture. Book sent prepaid on receipt of price. Chas. T. Luthy, 914 Sanford Street, R-20, Peoria, Ill.

TOBACCO, liquor and morphine habits can be overcome with the aid of Hill's Chloride of Gold Preparations. Liquor remedy can be given secretly. Particulars free. Ohio Chemical Works, Dept. 9, Westfield, N. Y.

SEND Birth Date and Dime, get Horoscope. KENNAGH, 2312 Douglas St., Omaha, Neb.

MISCELLANEOUS

LOCKSMITHS—Send \$1, get valuable chart for cutting tumbler padlock keys. Globe System, 278 Washington St., Newark, N. J.

ARTIFICIAL Eyes, \$3. Booklet free. Denver Optic, 559 Barclay, Denver, Colo.

CUTS anybody can make. Simple, cheap process. \$1. Specimens, particulars, 2c stamp. M. Day, Windfall, Ind.

ROCKS and Minerals for sale—hundreds of varieties—Price List free. Peter Zolac, 157 Wells St., Peekskill, N. Y.

ANYONE desiring a pair of genuine Indian-made moosehide moccasins, send address and size wanted to North Star Trading Co., Peace River, Alta., Canada. No money required.

WORLD'S best auto polish formula for \$3.00. Edward Messer, 852 14th, Des Moines, Iowa.

ARE You Old at Forty? See our advertisement on page 88 of this issue. The Electro Thermal Company, 2128 Main Street, Steubenville, Ohio.

LOCKSMITHING, complete 500 tricks of the trade, new edition, many added features. \$1.50; money back if dissatisfied. H. Rouson, 3406 Andover St., Oakland, Calif.

MONEY in Minerals. Many common minerals have market value. List 25c. Minerals identified. \$1.00. Mineralogist, Jexlin, Mo.

REBLUE Guns at home, small cost. Instructions \$1.00. Ed. Simon, Dane, Wis.

Get The Pay of the Man Higher Up!



\$200
per week

\$150
per week

\$100
per week

\$75⁰⁰
per week

\$50⁰⁰
per week

\$25⁰⁰
per week

\$20⁰⁰
per week

\$18⁰⁰
per week

You are not the kind of man who is always going to take orders from others. What you want is to give—not take orders. You want the bigger pay that goes with that kind of work; and here in this great Library of Practical Books for Self-training, you are offered the sure way of getting what you want.

In these books you will find a wealth of the very information you need to GET MORE MONEY in the trade you are following. There are thirteen sets, each set devoted to one particular line of work. Each set is written by a group of highly trained practical experts who cover the entire subject from a technical standpoint yet do it so clearly and illustrate every thing so plainly with diagrams and blue prints that you can't fail to understand every word.

Thousands of men who have read and studied these books have gained by it. If you were to get only one idea that helped you prove an UNUSUAL knowledge of your work, that one idea would be worth what a dozen sets would cost you. Every book is simply packed with such ideas and helpful information.

Reference Books That Make Happy Days of Pay Days Select Your Own Line From This List for Week's Free Use

5 vols. Carpentry & Contracting—was \$37.50 now.....	\$19.80	8 vols. Business Management—was \$52.50 now.....	\$29.80
12 vols. American Law & Practice (including free reading course and 250 page book of standard legal forms)—was \$97.50 now.....	49.80	7 vols. Steam and Gas Engineering—was \$52.50 now.....	24.80
8 vols. Applied Electricity—was \$60.00 now.....	29.80	4 vols. Sanitation, Heating & Ventilating—was \$30.00 now	14.80
6 vols. Auto Engineering—was \$45.00 now.....	21.80	4 vols. Fire Prevention & Insurance—was \$30.00 now.....	14.80
9 vols. Civil Engineering—was \$67.50 now.....	34.80	6 vols. Modern Machine Shop Practice—was \$45.00 now...	21.80
		4 vols. Telephony & Telegraphy—was \$30.00 now.....	14.80
		4 vols. Drawing—was \$30.00 now.....	14.80

Free Consulting Membership

A resident consulting staff of from 15 to 20 practical experts is waiting to solve for you any difficulty that you may have. A letter or a wire to American Technical Society will bring you an immediate answer and the solution to your problems. This advisory staff of practical men plus your working and reference library will enable you to handle successfully any job in your line. These men know all the latest methods and the newest and best ways of doing things. Let this pay-raising consulting staff be YOUR SILENT PARTNER. Use this service daily if necessary.

This free consulting membership offer is good for a limited time only and can be withdrawn without notice.

Use Books FREE For One Week—Send No Money

—just fill out the coupon. After you receive the full set of books, express collect, read them over and test them out for seven days. If you don't want them, send them back at our expense. If you decide they will do for you what they have done for more than 200,000 others, pay \$2.80 within one week and \$3.00 each month thereafter until the special price is paid. This amounts to only ten cents a day. Mail coupon NOW if you want a bigger, better job at higher wages.

Here's your opportunity, if you want to EARN MORE MONEY. Remember, we are taking all the chances—you pay NOTHING unless you are absolutely satisfied after seeing the books. Isn't this about the fairest proposition that was ever put up to you?

American Technical Society, Dept. X-919 Chicago, U.S.A.

© A.T.S. 1923

AMERICAN TECHNICAL SOCIETY, Dept. X-919 Chicago

Please send me a set of for seven days' FREE EXAMINATION, shipping charges collect. I will examine these books thoroughly, and if satisfied, will send \$2.80 within seven days and \$3 a month until I have paid the special price of \$..... If I decide not to keep the books, I will return them within one week at your expense. It is understood that if I keep the books I am entitled to a FREE Consulting Membership in the Society.

Name.....

Address.....

Reference.....

[Please fill out all lines, give local merchant, banker or employer as reference.]

Come to Detroit

In Detroit business is fine. New records are being made every day in the marvelous automobile industry. Four million cars will be made this year. More trained men are needed all the time. Jobs wait for trained men, in the auto plants, in garages all over the country, and opportunities to start a successful garage business of your own are to be seen in nearly every town.

Learn the Automobile Business

To succeed in a real way in this business you must have real training—the kind that you can get at the Michigan State Automobile School in Detroit, the Auto Center. M. S. A. S. training is not just one man's idea, it is the result of years of keen co-operation with the big factories here in the "Heart" of the Auto Industry. The biggest, best and most successful men in every branch of the industry have helped in outlining our course. The factories loan equipment, send us the heads of the departments for practical lectures and assist us in every way.

Make \$125 to \$500 or More Monthly in a Fine Job or in Business for Yourself

With M. S. A. S. Detroit training, our graduates are successful—we have trained more than 18,000 men who are located in all parts of the world, either holding big pay jobs or in business for themselves. Men often leave our school to go right into business and make money from the start—it's the M. S. A. S. thorough training that makes the successes.

13,000,000 Motor Vehicles in Use

Just think what that means—over thirteen million cars in the U. S. alone; four million made this year. Thousands of new garages and dealers are needed. Men who get started now at this school **surely will succeed.**

Quality Instruction; Complete Equipment

Our school is thoroughly and well equipped—we have \$250,000 in equipment just for students to study and work on; nothing is slighted in the entire course. Mechanical and electrical subjects thoroughly taught. **Garage management is included.** Our policy is to give the best course in the land and to hold our tuition within the reach of all. Anything worth having is worth paying reasonably for and at the M. S. A. S. you get the biggest money's worth to be had.

Start Any Time

Start learning the day you arrive. The welfare department arranges for room and board. Nothing to worry about—just get right down to business. No previous experience is necessary. We can secure positions for our graduates—we have more calls for men than we can supply. Now is the time to get started.

Jump on the Train and Come Now

Hundreds of men have not waited, but after reading our advertisement have jumped right on the train and come to Detroit. The factories say you will make no mistake by coming to the M. S. A. S. If you prefer, just fill in the coupon and mail it at once. It will bring you catalog and complete information **FREE.**



WHAT AUTO LEADERS SAY



HUDSON MOTOR CAR COMPANY

DETROIT, MICH. U.S.A.

This school is thought very highly of by the automobile men of Detroit. You will make no mistake by entering for a course.



I do not believe you would make any mistake in attending this school if you wish to become thoroughly experienced in the automobile business.



BUICK MOTOR COMPANY

We believe the Michigan State Auto School, located at Detroit, would best meet your requirements, as its course in technical training is most thorough and complete in every detail.

THE STUDERAKER CORPORATION OF AMERICA

We do not know a better automobile school that we could recommend to you than the Michigan State.

MAXWELL MOTOR SALES CORPORATION AUTOMOBILES

DETROIT, MICH.

We heartily recommend the Michigan State Auto School of this city.

MICHIGAN STATE "The Detroit Auto School"

312 Auto Building 3729 Woodward Ave.

the Auto Center

Study and Learn Now—it is the thoroughly trained men who make the big successes in the auto, truck and tractor business. M. S. A. S. training will make you independent the rest of your life. You will secure in a few weeks of pleasant, practical study and training what hard times or adverse conditions can never take from you. Trained heads and hands always get first call on big money jobs.

Only Factory Endorsed School in the World

When the Michigan State Automobile School first started in 1910, we called in the big men of the industry. Detroit was first in this tremendous field. It has maintained the lead until now 73% of all motor vehicles are made right here and a total of 94% within 100 miles. The big factories gave us their hearty co-operation at first and have continued to do so, for they needed the highest type of men and this school was giving the thorough training needed. Write to any automobile factory, business house or bank in Detroit and ask them about us.

Visit Detroit Factories

Training in Detroit at the M. S. A. S. gives you another advantage enjoyed by our students. Regular trips are made weekly or oftener through the factories. The Packard, Paige, Jewett, Ford, Fordson, Studebaker, Lincoln, Cadillac, Hudson, Maxwell, Chalmers, this is only a partial list and the big engine and accessory factories are also visited. You meet the factory heads, study methods of assembly and repair. This is a big advantage and cannot be enjoyed except in Detroit at the M. S. A. S.

Factory Trained Instructors

Many of our instructors had early training in the big factories—they practically grew up in the business. Those who did not, have gone into the factory methods in co-operation with the factory heads and give you the result of this intense research and training.

Instructors Long With School

Most of our instructors at the head of departments have been with us a long time. Some, three years; others, eight years. These men have developed in their departments and are able to pass on their experience to you.

Complete Auto, Truck and Tractor Course

Our complete course includes training in the construction, operation, upkeep and repair of automobiles, trucks, tractors, farm lighting plants and stationary engines of every kind. We teach how to apply the knowledge to all motor vehicles. We have a large general garage for actual garage practice. We own a farm with all types of tractors for operation and upkeep practice. The course includes thorough training in automotive electricity with actual practice in overhauling, rebuilding all types of starting, lighting and ignition systems; also training in business methods, garage management, selling. You get everything from A to Z. We educate the head and train the hand in a thorough, complete way.

Tire Repairing

We have a separate course in this branch of the auto business—the best equipment and instructors train you. Our graduates are very successful.

Battery Repair

This important branch of the industry is also taught in a separate and complete course which equips our graduates to immediately go into this big profit business.

Welfare Department Gets Good Rooms

Our Welfare Department is every student's friend. The day you arrive, it locates you in a nice room and directs you to good table board. It helps you with personal matters, tells you where your church is located, helps you get the best care and attention. The M. S. A. S. Welfare Department is known around the world.

Mail the coupon for catalog and Auto News—all FREE—or, better still, just jump on the train and come right to the school.

AUTOMOBILE SCHOOL
 "Endorsed by All Leading Manufacturers"
DETROIT, MICHIGAN, U. S. A.

LETTERS FROM GRADUATES

L. C. Boyer, of Deary, Idaho: "The training I received in your Welding Department and your special electrical course has paid me larger dividends per dollar, than any money I ever spent."

Samuel Thomas, New Kensington, Pa., says he has one of the good jobs, due to his M. S. A. S. training. He writes: "I graduated from the M. S. A. S. in 1920. I returned home and got a job immediately and worked three months as mechanic and then became foreman of the Dodge and Liberty garage at a salary of \$200 a month."

F. W. Johnson, Cleveland, was a "pencil pusher" at \$13.50 a week before coming to the M. S. A. S., now is an auto electrician averaging more than three times that.

J. B. Nelson, Worcester, N. Y., took our course when 17 years old, now has five men working for him.

E. R. Greve, Fowler, Cal., writes: "Last year's business bought us a nice little home here, and we have started buying another this year."

Geo. H. Purvis, Detroit, writes: "Am now experimental electrician with the Packard Motor Car Company. Here we get about everything there is in auto electrical work. I give your school all the credit."

These men are not exceptions. They are just ordinary fellows, but training put them in the successful class. You can be there too, just as easily. Come to the M. S. A. S. now and get your start.

MONEY BACK GUARANTEE

We guarantee that a graduate of our Automobile and Tractor Course will be qualified to fill a position as assembler, demonstrator, tester, repair man, auto electrician, chauffeur, tractor operator, or farm lighting expert, or we will refund his tuition fee.

Mail Coupon To Day

MICHIGAN STATE AUTOMOBILE SCHOOL
 312 Auto Bldg., DETROIT, MICH.

Please send me (without any obligation on my part) your 100-page catalog about your training for success.

Name

St. or R. F. D.

Town

State

(Do you prefer to start your training at our School in Detroit or at home?



"We pay him \$100 a week"

AND he's worth every cent of it. Came here several years ago asking for a job. He got just that—a small job at a small salary.

"Then I forgot about him—hardly knew he was on the payroll until one day I got a letter from the International Correspondence Schools telling me that he had enrolled for a course of home study. It was remarkable the way he went ahead.

"We pay him \$100 a week now and he's going to be earning even a larger salary some day. I wish we had more men like him."

HOW do you stand when your employer checks up his men for promotion? Does he think of you? Is there really any reason why you should be selected? Ask yourself these questions fairly. You must face them if you expect advancement and more money.

One hour after supper each night spent with the I. C. S. in your own home will prepare you for the position you want in the work you like best.

Yes, it will! Put it up to us to prove it. Without cost or obligation, just mark and mail this coupon.

INTERNATIONAL CORRESPONDENCE SCHOOLS Box 5588-D, Scranton, Penna.

Without cost or obligation, please tell me how I can qualify for the position or in the subject before which I have marked an X:

BUSINESS TRAINING COURSES

- | | |
|--|---|
| <input type="checkbox"/> Business Management | <input type="checkbox"/> Salesmanship |
| <input type="checkbox"/> Industrial Management | <input type="checkbox"/> Advertising |
| <input type="checkbox"/> Personnel Organization | <input type="checkbox"/> Better Letters |
| <input type="checkbox"/> Traffic Management | <input type="checkbox"/> Show Card Lettering |
| <input type="checkbox"/> Business Law | <input type="checkbox"/> Stenography and Typing |
| <input type="checkbox"/> Banking and Banking Law | <input type="checkbox"/> Business English |
| <input type="checkbox"/> Accountancy (including C.P.A.) | <input type="checkbox"/> Civil Service |
| <input type="checkbox"/> Cost Accounting | <input type="checkbox"/> Railway Mail Clerk |
| <input type="checkbox"/> Bookkeeping | <input type="checkbox"/> Common School Subjects |
| <input type="checkbox"/> Private Secretary | <input type="checkbox"/> High School Subjects |
| <input type="checkbox"/> Spanish <input type="checkbox"/> French | <input type="checkbox"/> Illustrating <input type="checkbox"/> Cartooning |

TECHNICAL AND INDUSTRIAL COURSES

- | | |
|---|--|
| <input type="checkbox"/> Electrical Engineering | <input type="checkbox"/> Architect |
| <input type="checkbox"/> Electric Lighting | <input type="checkbox"/> Blue Print Reading |
| <input type="checkbox"/> Mechanical Engineer | <input type="checkbox"/> Contractor and Builder |
| <input type="checkbox"/> Mechanical Draftsman | <input type="checkbox"/> Architectural Draftsman |
| <input type="checkbox"/> Machine Shop Practice | <input type="checkbox"/> Concrete Builder |
| <input type="checkbox"/> Railroad Positions | <input type="checkbox"/> Structural Engineer |
| <input type="checkbox"/> Gas Engine Operating | <input type="checkbox"/> Chemistry <input type="checkbox"/> Pharmacy |
| <input type="checkbox"/> Civil Engineer | <input type="checkbox"/> Automobile Work |
| <input type="checkbox"/> Surveying and Mapping | <input type="checkbox"/> Airplane Engines |
| <input type="checkbox"/> Metallurgy | <input type="checkbox"/> Navigation |
| <input type="checkbox"/> Steam Engineering | <input type="checkbox"/> Agriculture and Poultry |
| <input type="checkbox"/> Radio | <input type="checkbox"/> Mathematics |

Name.....
Street.....
Address..... 8-3-23

City..... State.....

Occupation.....
Persons residing in Canada should send this coupon to the International Correspondence Schools Canadian, Limited, Montreal, Canada.

Learn to Write

I Teach by Mail

I can make a good penman of you at your home during spare time, no matter where you live or how poorly you now write. My simplified system has shown thousands the way to good penmanship during the past twenty-five years—IT CAN and WILL do the same for YOU.

My beautifully illustrated 32-page Book
"How to Become a Good Penman" **FREE!!**

It contains many beautiful specimens of penmanship showing what others have accomplished by the Tambllyn System, with testimonials and general information about our courses. (Your name elegantly written on a card if you enclose stamp for postage.) Ladies taught successfully at home. Write Today. Address
F. W. TAMBLYN
410 Ridge Bldg. Kansas City, Mo., U. S. A.

F. W. Tambllyn

MUSIC LESSONS FREE

IN YOUR OWN HOME

You can read Music like this quickly

Piano, Organ, Violin, Mandolin, Guitar, Banjo, etc.

Beginners or advanced classes. One lesson weekly. Illustrations make everything plain. Only expense about 25¢ per day to cover cost of postage and music used. Write for **FREE** booklet which explains everything in full.

AMERICAN SCHOOL OF MUSIC, 50 Lakeside Building, CHICAGO

Be a Newspaper Artist!

Win Fortune and Fame. **MANUEL ROSENBERG COURSE IN NEWSPAPER ART** tells you how. 71 lessons and 150 illustrations. Drawing made easy. Complete instruction in layouts, lettering, illustration, cartooning and sketching. Ten years' experience as staff artist of important American dailies. Send \$5 or pay the postman C. O. D.

MANUEL ROSENBERG
Butler Building Cincinnati, O.

Cheapest Way to Go

to work or school and recreation is on a **Ranger** bicycle. You can have your choice of 44 Styles, colors and sizes. **30 DAYS' FREE TRIAL.** Express prepaid. **Factory-to-Rider Prices** save you \$10 to \$25.

12 Months to Pay if desired. Saved time and care—free easily made the small payments. Parents often advance first payment.

Tires—best quality, at factory prices, express prepaid. Lamps, wheels and equipment, low prices. Send **No Money**, do business direct with makers.

Write today for free **Ranger Catalog**, including prices and marvelous easy payment terms.

Mead Cycle Company
Dept. D108 Chicago

STAMMERERS

I can teach you to speak normally. Send for free booklet telling how.

BOSTON STAMMERERS' INSTITUTE, FOUNDED 1867
Samuel A. Robbins, Director, 248 Huntington Ave., Boston 17, Mass.

BIG VALUE FOR 10 CTS.

6 songs, words and music; 25 Pictures Pretty Girls; 40 Ways to Make Money; 1 Joke Book; 1 Book on Love; 1 Magic Book; 1 Book Letter Writing; 1 Dream Book and Fortune Teller; 1 Cook Book; 1 Base Ball Book, gives rules for games; 1 Toy Maker Book; Language of Flowers; 1 Morse Telegraph Alphabet; 12 Chemical Experiments; Magic Age Table; Great North Pole Game; 100 Conundrums; 3 Puzzles; 12 Games; 30 Verses for Autograph Albums. All the above by mail for **10 cents**, and **2 cents** postage.

ROYAL SALES CO. Desk 133 South Norwalk, Conn.

LEARN

IN THE GREAT SHOPS OF

COYNE

ELECTRICITY

Be An Electrical Expert

THE whole world of electricity is open to the Coyne trained Electrical Expert. Come to Chicago—the Electrical Center of the World. Get your training at Coyne—the oldest, largest and best school of practical electricity in the country—the only school endorsed by the Electrical Industry. Coyne trains you in all branches of electricity. We do not offer a number of individual courses—we give you just one *Complete* course so that you will be an *Electrical Expert* capable of commanding big pay. Let ordinary electricians do the small jobs. You can become an *Expert* and get the big money in any branch of electricity if you seize this chance to come to Coyne. Opportunities for *Experts* are unlimited. Get started now!

**You Work on \$200,000
Worth of Electrical
Equipment**

No books or useless theory. You are trained on \$200,000 worth of electrical equipment in 3½ months (stay longer if you wish). Every thing from door bells to power plants. You work on Circuits, Housewiring, D. C., A. C., Armature and Stator Winding, Drafting, Auto, Truck and Tractor Electricity, Battery Building and Repairing and Radio—everything to make you an expert ready to step right into a position paying from \$50 to \$125 a week.

Coyne Trains You for Life

We furnish every student with a Life Scholarship which enables you to stay as long as you want or come back for further training at any time without charge. We also assist students to good paying positions after graduation.

We give you free a course in Radio—the marvel of the age. Constructing, installing and operating. You can build your own radio receiving set.

Hundreds of Coyne graduates are making big money as Electrical Experts. You can do the same if you get started at once. The electrical industry is crying for EXPERTS—don't pass up a chance to train yourself for one of these big paying jobs.

Earn while you learn! We help students to secure jobs to earn a good part of their expenses while learning

Send this Coupon Now

Send this coupon now. Determine today that you are going to become a part of the world's greatest force—electricity. Assure your future by sending this coupon now. It brings you full information. Think of it—if you send the coupon today, you can be fully equipped for a fine paying electrical job in a few months. Send coupon now before the special offer we are making is withdrawn.

COYNE
Electrical School

Endorsed by Electrical Industry

1300-1310 W. Harrison St.,

Dept. 13-59

Chicago, Ill.

Coyne Electrical School,
1300-1310 W. Harrison Street,
Dept. 13-59 Chicago, Illinois
Gentlemen: Please send me free
your big catalog and full information
about your 3½ month's practical
training and special offer.

Name.....

Address.....

MAKE
\$150
to
\$400
A MONTH

IN
3½
MONTHS

University of Applied Science

Frank Ernest Hollands

has completed the full Course of Instruction in the
Finger Print Department
of the
University of Applied Science
and because of his proficiency and integrity of character is awarded the

DIPLOMA

Given at Chicago, Illinois this 13th day of April 1920

This is the Diploma that puts you in a position to Win

\$1,000 REWARD

DAYS FULL OF EXCITEMENT. Giving "expert" testimony in a famous court trial. A conference with the "Chief" on a knotty problem; a conviction that brings a rich reward; these are everyday incidents in the life of that specialist of detectives—The Finger Print Expert.

Demand for men trained in this work grows greater every day. Men like YOU are needed. A short course of training taken evenings at home in your spare time will bring you this diploma—the same as those hanging in the offices of the most successful Finger Print Chiefs in the country. You will be a graduate of the most famous school of its kind in the whole world. No special advance training is required. Not even a high school course. Here is a profession which gives a chance to men who cannot afford a long costly education.

UNIVERSITY OF APPLIED SCIENCE

Dept., 13-59 1920 Sunnyside Avenue, Chicago, Ill.

Gentlemen:—Without any obligation whatever, send me your new, fully illustrated, FREE book on Finger Prints and your offer of a FREE course in Secret Service Intelligence and the Free Professional Finger Print Outfit.

Name.....

Address.....

Age.....

Send the coupon below for full information, interwoven with pictures and stories of famous crimes solved by finger print evidence. Here is your great opportunity. Seize it NOW.

FREE Professional Finger Print Outfit—just like that used by the Finger Print Expert, free to all who enroll now. Also a free course in Secret Service Intelligence. Don't put it off and risk missing this special offer. Send the coupon TODAY.

University of Applied Science
1920 Sunnyside Avenue, Dept. 13-59, Chicago, Ill.

YOU CAN PLAY THE HAWAIIAN GUITAR

Just Like the Hawaiians!

Because Our Native Hawaiian Instructors Will Show You How!

Be the Most Popular Member of Your Set, Play "When You Walked Out," "Ten Ten Tennessee," "Stella," "Louisville Lou." All the Late Song and Dance Hits. You can play First Selection in Half an Hour and Harmonious Chords AT ONCE.

Here is your chance to get in the swim—to learn to play the most fascinating of all instruments, the Hawaiian Guitar, **just as the Hawaiians do**, and in an amazingly short time. Our method is so simple, plain and easy that you begin a piece your first lesson. In half an hour you can play it! Thousands of successful students prove this to be true. It is quite astonishing to find the ease with which you can master the Hawaiian Guitar—no matter how little your knowledge of music may be you can positively learn to play by our plain and easy method.

Expert Hawaiians Teach You to Quickly Master Their Secrets of This Fascinating Music

The instructions you receive from such world famous experts as Lawrence Kalaluki, Walter Kolomoku, Frank Ferrer, Carl Seville and others are invaluable. **No other Conservatory can even begin to give you the expert teaching and knowledge you gain through us.** And remember, while it is conceded that the Hawaiian Guitar produces the sweetest music, yet its mastery by you will be simple and quick, since there are

ONLY 4 EASY MOTIONS

to learn to be able to play **any music**—popular, dance, classical, native Hawaiian airs, or old time melodies and hymns. Just think of it! **You need never have read a musical note in your life!** For that matter, even though you haven't the slightest knowledge of any musical instrument we guarantee to teach you how to play just like the Hawaiians!

A Complete Conservatory Course!

Never before has such a complete and easily understood Conservatory Course in Hawaiian Guitar been offered. We are able to grant you this opportunity of quickly learning how to play the Hawaiian Guitar through acquiring the services of real Hawaiians to teach you.

How well this has been accomplished is proved by the fact that this is the **only Conservatory teaching Hawaiian Guitar** exactly as played by the Hawaiians. It is your good fortune as well as ours, that these Native Masters of Hawaiian Guitar came to this Conservatory to teach—and best of all

We Furnish Everything

When you enroll as a student in this Conservatory you receive **FREE** a handsome, expert toned Genuine Hawaiian Guitar—valued at \$15.00—52 especially arranged lessons and 52 carefully selected pieces of music, as well as all necessary picks, Steel Playing Bar, etc. There is **nothing** extra to buy, everything is furnished.

SEND FOR DETAILS TODAY

of this remarkable course—simply fill in the coupon, mail to us and we'll gladly send you full details of our complete Conservatory Course and **FREE Hawaiian Guitar Offer!** We know you will not let another day go by without enrolling as a student in this Conservatory, once you learn how quickly and easily you can master this most popular of all instruments—the Hawaiian Guitar—**So mail the Coupon NOW.**

First Hawaiian Conservatory of Music, Inc.
Dept. 48, 233 Broadway (Woolworth Bldg.) N.Y.

Special Courses Under Famous Teachers: TENOR-BANJO
VIOLIN, BANJO-UKULELE and UKULELE

This Makes a Splendid Christmas Gift



FREE

This Genuine
HAWAIIAN
Guitar—

A Real
\$15.00
Value



MAIL THIS COUPON NOW!

First Hawaiian Conservatory of Music, Inc.
Dept. 48 233 Broadway, (Woolworth Bldg.), New York

Please mail at once full details of your 52 easy lessons and **FREE** Hawaiian Guitar offer. This, of course, does not obligate me in the least.

Name _____

Address _____

City _____ State _____

(Please PRINT name and address clearly)

EARN UP TO \$250 Per Month

EXPENSES
PAID

In This
Uncrowded
Profession



BE A RAILWAY TRAFFIC INSPECTOR

Hundreds of Successful Inspectors



Read what Mr. Dewey Burcham writes: "The chances of advancement in this line of work are unlimited—I find the work very interesting and I like it better than anything I ever did."

J. A. Smallick states: "After one year's work in the capacity of Traffic Inspector, I find myself in a position which pays \$180 a month plus expenses. Due to the completeness and easily understandable language of your course, what would in other channels take years to learn can be learned in a few short months."

other channels take years to learn can be learned in a few short months."

Paid More than Guaranteed



Raymond A. McCue writes: "A little more than six months ago you sent me to a position with a guarantee that it would pay not less than \$110 a month to start. I started at \$120 a month—and am now earning \$180 a month. I am an inspector no longer, but still working for the same system in a strictly confidential line, and am daily in touch with the officials and inspection department."

Ralph E. Becker states: "Finished my course five months ago and **ten days after receiving my diploma** I was given a position with a large railway company in the East."

(Addresses of these men will be furnished upon request.)

POSITION GUARANTEED Or Money Refunded

You prepare for this fascinating profession, in your spare time at home, with absolute assurance that if, upon graduation, you do not receive a position paying at least \$110 a month and expenses, your money will be refunded. **You take no risk.** You have many opportunities to travel as Railway Traffic Inspector. Places you in contact with high railway officials. Pleasant, healthful, outdoor work; short hours; steady employment. **Advancement rapid with experience.** Prepare in three months' spare time. Any average man can qualify. **Railroads need more trained men—we must supply them.**

DON'T DELAY—ACT NOW
Mail coupon for full information contained in free Booklet No. D63.

Standard Business Training Institute
BUFFALO, N. Y.

Standard Business Training Institute
Buffalo, N. Y.

Send me, entirely free, Booklet No. D-63, giving full particulars about course in Railway Traffic Inspection.

Name.....

Street.....

City.....

Learn AUTO PAINTING

\$25 TO \$50 A DAY

AND MORE

Thou-
sands of Men
Are Wanted Now
10,000,000 Autos
Need Painting

Factories calling on us for men—you can start a business or get a job painting autos in any town or city—100% GUARANTEED PAY in the industry. START A BUSINESS without capital—all you need to start business is a few brushes, some paint and Our Training.

Get Free Book "Mixing Paint With Brains" Write for catalog and information. We have the best instructors and equipment. You'll like the course — AUTO PAINTING without capital—our methods and employ our men. Now in our new location, 30,000 sq. ft. of floor space.

Experience not necessary. We teach you Auto Painting from A to Z in 8 to 10 weeks.

Earn While Learning
We can teach you one operation, then we get you factory job and get the balance of the course in 8 or 2 hours.



DETROIT AUTO PAINTING SCHOOL

The Pioneer, the largest and best equipped school in U.S.A.

32 D. A. P. S. Bldg., 1471 Van Dyke Ave., Detroit, Mich.

EARN \$35 TO \$100 A WEEK

AS A MECHANICAL DRAFTSMAN. Write today for Free Book telling how we train you in spare time, at home, and help you secure a position. Fine set of professional Drafting Instruments furnished Free. Write today. **COLUMBIA SCHOOL OF DRAFTING**
Dept. 2206, 14th & T Sts., N. W., Washington, D. C.



LAW
IN YOUR SPARE TIME
Learn law with only institution giving same course by correspondence as was given for years at resident classes of this college. **DEGREE OF LL. B. CONFERRED.** One year business law course prepares you for success in business. Law trained business men in demand. Three year university course covers preparation for bar examination. **Money back guarantee if not satisfied.** Low fee, easy terms, includes complete 1921 thirteen volume library, text material and all expenses. Write for **FREE BOOK.**
Hamilton College of Law
431 South Dearborn St.,
Dept. 69 Chicago

BE AN ARTIST

Comics, Cartoons, Commercial, Newspaper and Magazine Illustrating, Patent Design Portable and Fashion. Our simple method quickly develops your talent in spare time. By Mail or Local Classes. Write for terms and list of successful Students. **ASSOCIATED ART STUDIOS**
87-8 Flatiron Building, NEW YORK



WANTED MEN AND WOMEN TO LEARN PHOTOGRAPHY!

Photographers and Photo-Engravers earn \$200 to \$500 a month. The field is uncrowded. Learn these profitable and fascinating professions. Taught by largest and best college of its kind in the world. Established over 30 years. Demand for our graduates far exceeds supply. Good positions secured. Tuition and living expenses low.

Get this FREE Book! Write today for free beautifully illustrated book describing wonderful opportunities in this field.
Illinois College of Photography, Box 4123, Effingham, Ill.



“What to do?” — the question that makes men—or breaks them

ALMOST every day in any large business some unusual problem arises which is beyond the experience of even the best informed men in the organization. It is then that the right answer to the question “What to do?” will often make a man—the wrong one break him.

It is not unfair to say that an institution such as LaSalle—with its millions of dollars in financial resources—its staffs of highly specialized experts—its organized files of business data—its facilities for business research—is, because of the very nature of its work, in a position to give advice which no single individual could possibly attempt—no matter how important his work—no matter how wide the scope of his experience.

Daily we have cases arise where opportunity is knocking at the door of a LaSalle student—provided he answers correctly the “What to do?” of the immediate moment.

By means of a broad Consultation Service—open to all LaSalle members—law suits are averted—financing problems are solved—sales are increased, for individuals and corporations—thousands of dollars are saved in freight charges—factory costs are cut—production is increased—emergency situations are promptly and properly dealt with—all by our students, with the advisory facilities of LaSalle back of their actions.

These unusual resources are at the call of every LaSalle student. He is not limited to the department in which he is enrolled, but may avail himself of the full advisory resources of any or all of our highly specialized departments and staffs.

When a person enrolls with LaSalle, it is, in general, for the immediate purpose of increasing his earning power, by a training which will enable him to function successfully in the more liberally rewarded fields of business endeavor.

But LaSalle's interest does not rest with supplying specialized training.

On the contrary, it follows the man “on the job”—goes with him as he advances in position and responsibility—helps him make good, every step of the way. Thru all the years of his business activity the entire educational and research facilities of LaSalle stand solidly behind him—

ready to help him solve any new or unusual business problem with which he or his employer may be confronted.

It is this character of service that has been responsible for the growth of LaSalle—to proportions far beyond what any man would have dreamed a correspondence institution could reach in the field of business training.

As I look back over the decade past—consider the four hundred thousand men who have enrolled with LaSalle—everything we have done or tried to do—both in our business training courses and in our supplemental services—centers in the important

work of helping ambitious men to answer with soundness and authority the “What to do's?” of business life.

The man who realizes what LaSalle training and LaSalle consultation service might mean to him and his future, but who fails to go further—to investigate—is answering his most vital “What to do?” with inaction—is deliberately turning away from Opportunity.

J. J. Hopkins
President
LaSalle Extension University

LaSalle Extension University

The Largest Business Training Institution in the World
Dept. 1264-R Chicago, Illinois

Upon request, the book “Ten Years' Promotion in One,” and material completely descriptive of the course and service that interests you, will gladly be sent without cost or obligation. Indicate your choice by checking, and write below your name and address.

- | | |
|---|--|
| <input type="checkbox"/> Business Management | <input type="checkbox"/> Modern Business Correspondence and Practice |
| <input type="checkbox"/> Modern Salesmanship | <input type="checkbox"/> Modern Foremanship and Production Methods |
| <input type="checkbox"/> Higher Accountancy | <input type="checkbox"/> Personnel and Employment Management |
| <input type="checkbox"/> Law: Degree of LL. B. | <input type="checkbox"/> Expert Bookkeeping |
| <input type="checkbox"/> Traffic Management | <input type="checkbox"/> Business English |
| <input type="checkbox"/> Railway Station Management | <input type="checkbox"/> Commercial Spanish |
| <input type="checkbox"/> Commercial Law | <input type="checkbox"/> Effective Speaking |
| <input type="checkbox"/> Industrial Management Efficiency | <input type="checkbox"/> C. P. A. Coaching |
| <input type="checkbox"/> Banking and Finance | |

Name

Present Position

Address

HOME-STUDY
By the LaSalle Problem Method
MAKES THE EXPERIENCE OF SUCCESSFUL MEN YOURS



LEARN BY DOING

Every phase of all branches of

ELECTRICITY

TAUGHT BY ACTUAL PRACTICE

In America's foremost and oldest institution for trade training.

NO BOOKS USED
Individual Instruction Start Any Day

A SPECIAL and SEPARATE Course in Ignition, Auto Lighting and STARTER Systems.

Write for FREE 64-Page Catalog

THE NEW YORK ELECTRICAL SCHOOL
44 West 17th Street NEW YORK CITY



PROF. CHARLES ATLAS
Twice pronounced the
World's MOST PER-
FECT Man, receiving
two \$1000.00 FIRST
PRIZES.

Let the World's Most Perfect Man Show You the Way to Radiant Health and Energy

Be physically perfect—develop your power of will—overcome disease—Prof. Atlas will show you how. Send for new amazing 64-page book full of extraordinary living pictures of specimens of perfect manhood. Enclose 10 cents to cover wrapping and mailing charges. Grasp this opportunity of learning these rare secrets of becoming physically perfect. Do it now. Address

PROF. CHARLES ATLAS
96 Fifth Ave., Suite 227, N. Y. City



THE BART CHALK-TALK

If you can draw a little, you can do the Bart Chalk-Talk. Send 4c in stamps for Chalk-Talk folder and complete catalog of art and Chalk-Talk Supplies.

Bart Supplies, Euclid Bldg., Minneapolis, Minn.

PIMPLY SKIN made WELL

When a few applications of this wonder-working lotion has cleared faces of **pimples, blackheads, acne eruptions** on the face or body, **barbers itch, eczema, enlarged pores, oily or shiny skin**, you can realize why CLEAR-TONE has been tested and approved in over **100,000 Test Cases**.

The simplicity of the treatment, and **The Story of How I Cured Myself** are all explained in my free booklet, "A Clear-Tone Skin." Write for your copy today and learn of the results gotten by thousands of men and women.

E. S. GIVENS, 128 Chemical Bldg., Kansas City, Mo.



WANTED—RAILWAY MAIL CLERKS

\$133 to \$192 a Month for Life

Every second week off with full pay—no "lay offs" because of strikes, poor business, etc.—sure pay—rapid advancement to higher positions. City and country residents stand same chance. Common sense education sufficient—no political influence.

**TRAVEL—SEE YOUR COUNTRY
DON'T DELAY—ACT AT ONCE**

Send Coupon today—sure. Every day's delay means so much less chance of appointment from the next examinations—so write at once.

FRANKLIN INSTITUTE, Dept. D180, ROCHESTER, N. Y.

Take the First Step for
a U. S. Government Job
Use Coupon Before You Lose It

COUPON

FRANKLIN INSTITUTE, Dept. D180, Rochester, N. Y.
Kindly send me, without any obligation whatsoever on my part and entirely free of charge, (1) A full description of the position checked below; (2) Sample examination questions; (3) Free copy of illustrated book "Government Positions and How to Get Them"; (4) A list of U. S. Government Jobs obtainable; (5) Tell me how to get the position here checked.

..... Railway Postal Clerk (\$1400 to \$2300) Customs Positions (\$1100 to \$2000)
..... Postoffice Clerk (\$1400 to \$1800) Internal Revenue (\$1100 to \$2000)
..... City Mail Carrier (\$1400 to \$1800) Rural Mail Carrier (\$1800 to \$2600)
..... Income Tax Auditors (\$2040 to \$3000)

Name

You! can be a \$5000 Auto Expert!



Automotive Mechanic



Automotive Electrician



Salesmen, Demonstrator



Garage Owner or Manager

"What Big-Pay Work Can I Learn Quickest?"



J. R. Bayston, M.S.A.E., Pres.
CHICAGO AUTOMOTIVE INSTITUTE

Originator of the "Job-Way" System of Training
I give you this Tool Kit FREE
and train you to use it



18 Piece Master Mechanics' Tool Kit FREE!

This Complete \$15.00 outfit doesn't cost you one penny! Full size, everything you need to do the "Jobs." 75 lessons, 150 Jobs, 12 lectures and many Free features in the C. A. I. course. And "Cigarette Money" pays for it!

"THE C. A. I. JOB-WAY TO BIGGER PAY!"

LOAN me an hour of your spare time a day! I'll guarantee to put you in the \$100.00 a week class quicker than you can learn any other big-pay work! **Don't quit your job! Stay home!** Thousands of men **no better than you** are making big salaries, holding down important jobs, earning enormous profits in their own business. I know how you can do the same, and I'll tell you how!

Learn Auto Repairing! Learn Automotive Electricity! Learn Vulcanizing, Welding, Battery!

My copyrighted "Job-Way" system teaches you in an hour what ordinarily takes a month to learn! The speed with which C. A. I. students get ALL the work of the complete course has astonished educators everywhere! So simple a school-boy can understand it. Think of it! 13,000,000 autos to repair each year—13,000,000 batteries to service—13,000,000 ignition systems to keep going—65,000,000 tires to sell and repair—3,000,000 trucks to overhaul. Do you realize how hungry employers are for competent men? Do you know what they're willing to pay for Automotive Experts? Can you imagine the opportunities today to make big money in a business of your own?

Coupon Brings FREE BOOK and FREE LESSON!

I don't ask you to risk a penny. I know you can learn to earn \$3,000 to \$8,000 a year as an Automotive Expert. So I guarantee in writing to return every cent of your money if you don't think it's the most profitable investment you ever made. I want you to send for my free book, read the free lesson, find out about my wonderful "Job-Way" method. See why I offer the most complete Automotive course for the least money, and on easiest payments. Mail Coupon or postal today!

MEN WANTED!

Thousands of big-pay jobs open right now, all over the U. S. Our Employment Service FREE to both students and graduates, matches employers in every part of the Country. Look at this:

Master Mechanics	\$3,000 to \$8,000
Electrical Experts	- - \$3,600 up
Garage Manager	- - 3,000 up
Battery Expert	- - 2,400 up
Expert Welder	- - 2,400 up
Salesman	- - 3,000 up
Tractor Engineer	- - 2,400 up

My graduates earn money fast enough to go into business. Own your own Garage, Battery Station, Ignition Service, Repair or Welding plant.



Mail Coupon for
FREE BOOK!

Bigger-Pay Coupon!

J. R. Bayston, M.S.A.E., Pres.
Chicago Automotive Institute
Dept. 402, 536 So. Clark St., Chicago

Without a penny of expense or the slightest obligation, please send me Free Book about your rapid course in Automotive Master Mechanics, and Free Tool Kit offer. Explain your money back guarantee. I want to see a Free Lesson, too.

Name.....

Address.....

CHICAGO AUTOMOTIVE INSTITUTE
J. R. Bayston, Pres., Dept. 402, 536 So. Clark St., CHICAGO

LEARN AT HOME THE C.A.I. JOB-WAY

Are You the Boss? —or Are You Riley?

THE BOSS gives the orders—Riley takes them and does what he is told. Both started the same, had equal ability to begin with. Riley works harder than the BOSS and gets less money. What is the answer?

Training did it. Your brain is an engine that needs fuel. Study and training supply the fuel that makes it go. And when you mix brains with your work you **SIMPLY CANNOT HELP BUT GET AHEAD.**

Be a Contractor or Builder

Fit yourself for a big job in the Contracting or Building business. Train for it right at home. The Course is easy to learn, is simple but thorough, is taught by experts who have made it their life study. We teach you Estimating, Blue Print Reading, Building Regulation, Use of Steel Square, Water Supply and Drainage, Heating and Ventilating, etc.

The cost is low, terms easy, results quick and sure. Our money-back guarantee insures satisfaction. Thousands are earning **BIG MONEY** in this business today. Get ready to get yours. Fill out the coupon now. Check the Course you are interested in. It costs you nothing but a 2c stamp for full information. It will mean much for your future.

American School

Dept. G-974 © A. S. 1923
Drexel Ave. & 58th St. CHICAGO



"Riley—Take up These Bricks" "All Right Boss"

AMERICAN SCHOOL,
Dept. G-974, Drexel Ave. & 58th St., Chicago
Send me full information on the subject checked.

- | | |
|-------------------------------------|--------------------------|
| .. Architect | .. Business Law |
| .. Building Contractor or Carpenter | .. Lawyer |
| .. Automobile Engineer | .. Machine Shop Practice |
| .. Automobile Repairman | .. Photoplay Writer |
| .. Civil Engineer | .. Mechanical Engineer |
| .. Advertising Manager | .. Shop Superintendent |
| .. Business Manager | .. Employment Manager |
| .. Financial Manager | .. Steam Engineer |
| .. Sales Manager | .. Foremanship |
| .. Cert. Pub. Accountant | .. Sanitary Engineer |
| .. Accountant & Auditor | .. Surveyor (& Mapping) |
| .. Bookkeeper | .. Telephone Engineer |
| .. Draftsman & Designer | .. Telegraph Engineer |
| .. Electrical Engineer | .. High School |
| .. General Education | .. Fire Insurance Expert |
| .. Personal Analysis | .. Wireless-Radio |
| | .. Undecided |

Name

Address

Occupation



has enabled John G. Anderson, Aurora, Ill., to keep on the payroll since his right arm was amputated some years ago. The reproduction (from an actual photograph) shows Mr. Anderson at work on an intricate machine using his Carnes Artificial Arm.

INCONSPICUOUS - SERVICEABLE

The Best Substitute for the Natural Arm.

To see him on the street you would not realize that his right arm was artificial. Wearers of this wonderful arm find that it practically takes the place of the natural arm. With it you can dress yourself, use knife and fork, carry grips, write, pick up large and small objects—in fact, do practically everything that was possible before. Even though the amputation be at the shoulder, the **CARNES ARTIFICIAL ARM** bends at the elbow and wrist, and the fingers open and close as desired.

WONDERFUL BOOK SENT FREE Every armless man or woman should write today for the wonderful illustrated 100 page book showing with actual photographs what can be done with this invention. Write today to

CARNES ARTIFICIAL LIMB CO.
208 CARNES BUILDING KANSAS CITY, MO.

STOP USING A TRUSS

Do Away With Steel And Rubber Bands

FREE TRIAL



Inner surface is made adhesive to secure the **PLAPAO-PAD** firmly to the body, keeping the **PLAPAO** continually applied and the pad from slipping. No straps, buckles or springs attached. Soft as velvet—easy to apply.

It's the Non-Slipping, yet Non-Rigid Pad and What is Within It That Counts

FREE to 5,000 Truss Sufferers

To the extent of 5,000 sufferers who may apply I will send, **ABSOLUTELY FREE**, a sufficient quantity of the **Plapao** to positively convince them that this is the only logical, common-sense way of treating rupture. **Plapao** is a highly astringent medication placed within the **Plapao-Pad** and being absorbed through the skin, creates a wonderful feeling of relief and at the same time tends to strengthen the weakened muscles and thus permanently close the rupture opening. The process of recovery is natural, so you'll have no use for a truss—you can throw it away forever! Old and young have testified under oath that the **Plapao-Pads** cured their rupture—many of them long-standing, aggravated cases—without delay from work. Patent allowed in U. S. and foreign countries. Awarded Gold Medal at Rome and Grand Prix at Paris.

Send No Money—for a sufficient quantity of the **Plapao** to give it a thorough test; you pay nothing for this trial now or ever. Write for it and full information today. Address **Plapao Laboratories, Block 1427 St. Louis, Mo.**

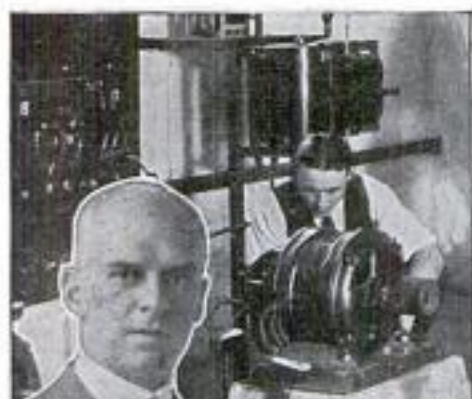

Herbert Dickerson,
Warrenton, Va.,
makes \$7,500 a year



Automotive Electricity pays W. E. Pence,
Chehalis, Wash., over \$9,000 a year



J. R. Morgan, Delaware, Ohio, makes \$30
to \$50 a day in business for himself



Electrical Experts Are in Big Demand I Will Train You at Home To Fill a Big Pay Job

It's a shame for you to earn \$15 or \$20 or \$30 a week, when in the same six days as an Electrical Expert you can make \$70 to \$200 a week—and do it easier—not half so hard work. Why then remain in the small-pay game, in a line of work that offers no chance, no big promotion, no big income? Fit yourself for a real job in the big electrical industry. I'll show you how.

Be an Electrical Expert Earn \$3,500 to \$10,000 a Year

Today even the ordinary Electrician—the "screw driver" kind—is making money—big money. But it's the trained man—the man who knows the whys and wherefores of Electricity—the "Electrical Expert"—who is picked out to "boss" the ordinary Electricians—to boss the Big Jobs—the jobs that pay \$3,500 to \$10,000 a Year. Get in line for one of these "Big Jobs" by enrolling now for my easily learned, quickly grasped, right up-to-the-minute, Spare-Time Home Study Course in Practical Electricity.

Age or Lack of Experience No Drawback

You don't have to be a College Man; you don't have to be a High School Graduate. As Chief Engineer of the Chicago Engineering Works, I know exactly the kind of training you need, and I will give you that training. My Course in Electricity is the most simple, through and successful in existence, and offers every man, regardless of age, education, or previous experience the chance to become, in a very short time, an "Electrical Expert," able to make from \$70 to \$200 a week.

FREE Electrical Working Outfit FREE

With me, you do practical work—at home. You start right in after your first few lessons to work at your profession in the regular way. For this you need tools, and I give them to you absolutely free—a whole kit, a complete outfit, one that would cost you \$12 to \$15.

Your Satisfaction Guaranteed

So sure am I that you can learn Electricity—so sure am I that after studying with me, you, too can get into the "big money" class in electrical work, that I will guarantee under bond to return every single penny paid to me in tuition, if when you have finished my Course, you are not satisfied it was the best investment you ever made.

Guarantee Backed by a Million Dollar Institution

Back of me in my guarantee, stands the Chicago Engineering Works, Inc., a million dollar institution, thus assuring to every student enrolled, not only a wonderful training in Electricity, but an unsurpassed Student Service as well. It's this Service that makes "Cooke" training different from any other training. It's this Service, plus "Cooke" Training, that makes the "Cooke" Trained Man the "Big-Pay Man," everywhere.

Be a "Cooke" Trained Man and earn \$12 to \$30 a day—\$70 to \$200 a week—\$3,500 to \$10,000 a year.

Get Started Now—Mail Coupon

I want to send you my Electrical Book and Proof Lessons both Free. These cost you nothing and you'll enjoy them. Make the start today for a bright future in electricity. Send in Coupon—NOW.

L. L. Cooke, Chief Engineer,

CHICAGO ENGINEERING WORKS

2150 Lawrence Avenue Dept. 519 Chicago, Ill.

Use This "FREE OUTFIT" Coupon

L. L. COOKE, Dept. 519
2150 Lawrence Ave., Chicago

The Man Who Makes
"Big-Pay" Men

Dear Sir: Send at once, Sample Lessons, your Big Book, and full particulars of your Free Outfit and Home Study Course, also the Free Radio Course—all fully prepaid without obligation on my part.

Name.....

Address.....

Occupation..... Age.....

The "Cooke" Trained Man is the "Big Pay" Man



Tobacco Is Hurting You

Look at the facts square in the face, Mr. Tobacco User. You may think tobacco is not hurting you.

That is because you haven't as yet, perhaps, felt the effects of the nicotine poison in YOUR system. For you know that nicotine, as absorbed into the system through smoking and chewing tobacco, is a slow working poison. Slow, yes—but sure.

Tobacco is lowering your efficiency. It slows a man down. Makes it harder for you to concentrate your mind on your work. You haven't near the amount of "pep" and energy you would have if you stopped using it. There's many a man twice as old as you in years who's twice as young in energy, simply because he lets tobacco alone.

Some day you will realize to what an alarming extent tobacco has undermined your system.

When your hands begin to tremble—
and your appetite begins to fail—
and your heart seems to "skip a beat" now and then—
and slight exertion makes you short of breath—
then you have a right to suspect that
TOBACCO is getting the upper hand.

Any well-informed doctor will tell you that these are only a few of many symptoms of tobacco poisoning.

And YOU know that the use of tobacco in any form is an expensive, utterly useless habit. You know you ought to quit.

Tobacco Habit Banished Let Us Help You

It doesn't make a particle of difference whether you've been a user of tobacco for a single month or 50 years, or how much you use, or in what form you use it—whether you smoke cigars, cigarettes, pipe, chew plug or fine cut or use snuff—**Tobacco Redeemer** will positively remove all craving for tobacco in any form in a very few days. Not the slightest shock to the nervous system. Your tobacco craving will usually begin to decrease after the very first dose—there's no long waiting for results.

Tobacco Redeemer contains no habit-forming drugs of any kind and is marvelously quick, scientific and thoroughly reliable.

It is in no sense a substitute for tobacco. After finishing the treatment you have absolutely no desire to use tobacco again or to continue the use of the remedy. It helps to quiet the nerves and make you feel better in every way.

Results Guaranteed A single trial will convince you. Our legal-binding, money-back guarantee goes with each full treatment. We will refund every cent you pay for the treatment if after taking it according to the easy-to-follow directions, it should fail to banish the tobacco habit completely.

SEND Coupon for Free Proof Let us send you our free booklet on the deadly effects of tobacco, together with testimonial letters from men all over the country telling how they have been absolutely freed from the tobacco habit by this simple home treatment. You could not ask for stronger proof that **Tobacco Redeemer** will free you from the habit than the evidence we will gladly send on request. Just mail the coupon—or a postal will do.

NEWELL PHARMACAL CO.
Dept. 300 St. Louis, Mo.



Free Book Coupon

NEWELL PHARMACAL CO.
Dept 300 St. Louis, Mo.

Please send, without obligating me in any way, your free booklet regarding the tobacco habit and proof that **Tobacco Redeemer** will positively free me from the tobacco habit or my money will be refunded.

Name

Street and No.

Town..... State.....

He thought he could throw me—



Dear Tom: You know how Ted Brown has always been saying he could throw me with one hand tied behind him, if he wanted to, and you know how he's always bullying the kids smaller'n he is. Well, yesterday, he and I had it out. Gee, I wish you'd been there. You know how much bigger Ted is than I. Well, right off the bat he grabbed hold of me and pretty nearly busted me in half. He thought he had me licked dead easy—

but



But I wriggled around and got a hold on him that I'd learned from the Farmer Burns School of Wrestling. The next second—KERFLOP, and I had Mister Ted Brown on the ground, tied up so he couldn't move and yelling for me to quit. Gee, Tom, wrestling has it all over boxing for defending yourself. Why it's a cinch to handle a fellow half as big again as you are if you know the *secret holds*. If I were you I'd write to Burns School for their free book about wrestling. See you next week. So long—FRED.

Learn Wrestling Secrets

from Worlds Champions *Farmer Burns and Frank Gotch*

Learn the marvelous holds, breaks, blocks and tricks that will enable you to handle big, strong men with ease. Here is a wonderful opportunity long waited for by young men and boys of America. The renowned FARMER BURNS—"father of scientific wrestling" and the greatest scientific wrestler ever known, and FRANK GOTCH the world's champion of champions, prepared a series of lessons in which they have revealed the inside secrets of training that will make YOU, too, an expert wrestler. All the great secrets of *self-defense* and *jui-jitsu* illustrated by printed word and picture. The lessons teach you how to become a *great athlete*, and secret knowledge enabling you to throw boys and men far larger and stronger than yourself—how to deal with bullies and ruffians so that they will positively fear you. Best of all, you can learn in your own home, in your spare time!

Start Now! A weak undeveloped body means failure. A splendid athletic physique means SUCCESS IN EVERYTHING. On the gridiron, on the base ball field, in class room, at social gatherings, in business, a strong body wins respect and admiration and helps you get ahead amazingly fast. If you already have a strong body we can still help you immensely. If you are a weakling don't delay a single day learning all about wrestling. Start RIGHT NOW!

Send for FREE Book

Our FREE ILLUSTRATED BOOK tells you all about the advantages in health, vigor and respect for you, that being able to wrestle brings one. It tells you how to learn to become a skilled wrestler *in your spare time*. From cover to cover it is brim full of interesting information about wrestling. Also lots of pictures. INVESTIGATE. Write today for this free book. No obligations. Tear out and mail the coupon NOW!

Farmer Burns School
1779 Railway Exchange Bldg. Omaha, Nebraska

Farmer Burns School
1779 Railway Exchange Bldg., Omaha, Neb.

Please send me at once without obligation your FREE illustrated booklet on Scientific Wrestling, Physical Culture, Self-Defense, and How to Win.

Name.....

Address.....

Age.....



"Here's an Extra \$50!"

"I'm making *real* money now! Yes, I've been keeping it a secret until pay day came. I've been promoted with an increase of \$50 a month. And the first extra money is yours. Just a little reward for urging me to study at home. The boss says my spare-time training has made me a valuable man to the firm and there's more money coming soon. We're starting up easy street, Grace, thanks to you and the I. C. S."

To-day, more than ever before, money is what counts. You can't get along on what you have been making. Somehow, you've simply got to increase your earnings.

Fortunately for you there is an unerring way to do it. Train yourself for bigger work, learn to do some one thing well, and employers will be glad to pay you real money for your special knowledge.

It is the business of the International Correspondence Schools to prepare men and women for better positions at better pay. They have been doing it for 31 years. They are training over 180,000 right now. They are ready and anxious to help you.

Here is all we ask—without cost, without obligating yourself in any way, simply mark and mail this coupon.

INTERNATIONAL CORRESPONDENCE SCHOOLS Box 5565-D, Scranton, Penna.

Without cost or obligation, please tell me how I can qualify for the position or in the subject before which I have marked an X:

BUSINESS TRAINING COURSES

- | | |
|--|---|
| <input type="checkbox"/> Business Management | <input type="checkbox"/> Salesmanship |
| <input type="checkbox"/> Industrial Management | <input type="checkbox"/> Advertising |
| <input type="checkbox"/> Personnel Organization | <input type="checkbox"/> Better Letters |
| <input type="checkbox"/> Traffic Management | <input type="checkbox"/> Show Card Lettering |
| <input type="checkbox"/> Business Law | <input type="checkbox"/> Stenography and Typing |
| <input type="checkbox"/> Banking and Banking Law | <input type="checkbox"/> Business English |
| <input type="checkbox"/> Accountancy (including C.P.A.) | <input type="checkbox"/> Civil Service |
| <input type="checkbox"/> Cost Accounting | <input type="checkbox"/> Railway Mail Clerk |
| <input type="checkbox"/> Bookkeeping | <input type="checkbox"/> Common School Subjects |
| <input type="checkbox"/> Private Secretary | <input type="checkbox"/> High School Subjects |
| <input type="checkbox"/> Spanish <input type="checkbox"/> French | <input type="checkbox"/> Illustrating <input type="checkbox"/> Cartooning |

TECHNICAL AND INDUSTRIAL COURSES

- | | |
|---|--|
| <input type="checkbox"/> Electrical Engineering | <input type="checkbox"/> Architect |
| <input type="checkbox"/> Electric Lighting | <input type="checkbox"/> Blue Print Reading |
| <input type="checkbox"/> Mechanical Engineer | <input type="checkbox"/> Contractor and Builder |
| <input type="checkbox"/> Mechanical Draftsman | <input type="checkbox"/> Architectural Draftsman |
| <input type="checkbox"/> Machine Shop Practice | <input type="checkbox"/> Concrete Builder |
| <input type="checkbox"/> Railroad Positions | <input type="checkbox"/> Structural Engineer |
| <input type="checkbox"/> Gas Engine Operating | <input type="checkbox"/> Chemistry <input type="checkbox"/> Pharmacy |
| <input type="checkbox"/> Civil Engineer | <input type="checkbox"/> Automobile Work |
| <input type="checkbox"/> Surveying and Mapping | <input type="checkbox"/> Airplane Engines |
| <input type="checkbox"/> Metallurgy | <input type="checkbox"/> Navigation |
| <input type="checkbox"/> Steam Engineering | <input type="checkbox"/> Agriculture and Poultry |
| <input type="checkbox"/> Radio | <input type="checkbox"/> Mathematics |

Name.....
Street.....
Address.....

8-3-23

City.....State.....

Occupation.....

Persons residing in Canada should send this coupon to the International Correspondence Schools Canadian, Limited, Montreal, Canada.

Please Mention Popular Mechanics

A FILE

Stop Forgetting

Make Your Mind an index from which you select facts, figures, names, faces. Develop concentration, self-control; overcome habitations, forgetfulness.

Write today for FREE memory and concentration test and illustrated booklet, "How to Remember."

PROF. HENRY DICKSON
Dept. 705-Z Evanston, Ill.

NOT A FILE

LEARN ENGINEERING

Great Demand for Practical-Technical Men. Big Salaries. Wonderful Opportunities. Beautiful New Building. Extensive Laboratory and Shop Equipment. Not a trade school but a Practical-Technical College. Faculty of Trained Experts. 3 mo. courses in Practical Electricity and Steam. 1 and 2 year courses in Mechanical and Electrical Engineering. Architectural, Structural, Mechanical Drafting. Day and night. Degrees awarded. 22nd year. Write for catalog D.

FINLAY ENGINEERING COLLEGE, Kansas City, Mo.

LEARN

Penmanship

I Teach Penmanship by Mail

Small Cost. Spare Time. Write for my Free Book, "How to Become an Expert Penman." It contains specimens and tells how others became expert writers by the Tevis Method. Your name written on card if you enclose stamp. Write Today.

T. M. TEVIS, Box 25K, CHILLICOTHE, MO.

Use Forceful English

In your Letters, Talk and Advertising
3 GREAT BOOKS (Pocket Size)

By PROF. MANLY (Univ. of Chicago) and J. A. POWELL. Will show you how to write and speak perfect English. Non-technical. Full of examples. Per copy, \$1.00.

BETTER BUSINESS LETTERS
BETTER BUSINESS ENGLISH
BETTER ADVERTISING

Money back in 5 days if not satisfied.

Send for catalog of 150 Home-study Books.

F. J. Drake & Co., Pubs., 1011 Michigan Av., Chicago

Money — Position — Power

can be yours. Thousands of men placed on Road to Success. Wonderful vocational chart enables you to find and take your rightful place in life. Why drift along in a rut? Write for inspiring free literature.

Bolger Vocational Service, Inc., 158-G W. 45th St., N. Y.

Do Your PRINTING

Cards, circulars, labels, tags, book, menus, paper, Press, \$12. Larger \$35. Job Press \$150 up. Save money. Print for others, BIG PROFITS. All easy, rules sent. Write factory TODAY for press catalog, TYPE, cards, paper, THE PRESS CO., D-78, MERIDEN, CONN.

WRITE JOKES

EARN FROM \$60 TO \$150 PER WEEK

writing jokes, epigrams and humorous stories for publications. Tremendous demand for material. Our short course in Humor Writing teaches you to write humorous material that sells. Learn in your spare time—earn in your spare time. Complete marketing plan and markets furnished.

Write for full particulars

AMERICAN INSTITUTE OF HUMOR
Office J, 414 Park Bldg., Cleveland, Ohio



13 WEEKS FOR
15 CENTS

The Pathfinder

SHOWS THE WAY THROUGH THE JUNGLE OF EVENTS

You've heard your neighbor praise the Pathfinder, the wonderful weekly news and story magazine with over half a million subscribers. Unbiased digest of national and world affairs. Check full of just the kind of reading you want. Fun, fashions, question box, books, health —entertainment and instruction for all. Exciting serial and short stories. Send 15c (coin or stamps) today for this big \$1 paper 13 weeks. Money back if not satisfied. **PATHFINDER**, 522 Langdon St., Washington, D.C.

Your Copy of this great book



*You can Boss
the Job*

Mark These 9 Feature Points of A.E.E. Service

- 1 Life Membership in the Associated Electrical Engineers
- 2 Our exclusive and copyrighted method of training
- 3 Unlimited Placement Service throughout your career
- 4 Unlimited Consultation Service
- 5 A wonderful Laboratory and Experimental Outfit
- 6 A Complete Course in Automotive Electricity
- 7 A Complete Course in Radio
- 8 A Complete Course in Business for the Electrical Expert
- 9 A Legally Binding Guarantee of Satisfaction

We Train You At Home in your spare time, quickly and surely, by our EXCLUSIVE AND COPYRIGHTED METHOD to qualify to **Earn \$75 to \$200 a Week** as an Electrical Expert or in business for yourself—and

We Help You "Cash In" through our Placement Department and our great FREE BUSINESS COURSE, which will show you how to get the big-money Electrical jobs and how to establish your own independent, profitable Electrical business.

Our Book Tells the Story Our BIG 64-PAGE ILLUSTRATED BOOK will tell you fully about every one of the 9 remarkable features of

Associated Electrical Engineers Service, and how they will be the stepping stones for you from futureless, low-paid jobs up into the limitless, big-money opportunities in Electricity.

You Have Education Enough

If you have the AMBITION to succeed and make big money as an Electrical Expert, we will guarantee the rest.

Mail the Coupon NOW

Get this remarkable book. It is FREE. You will incur no obligation in asking for it. We want every ambitious man in America to have one and receive this great message. Your copy is ready. Send for it TODAY.

FREE Send for it TODAY



*This is the mark of
the Associated Electrical
Engineers
Follow it to SUCCESS!*

**ASSOCIATED ELECTRICAL ENGINEERS
Dept. A-2 537 S. Dearborn St., Chicago, Ill.**

Here's Opportunity's Wide Open Door

Associated Electrical Engineers
Department A-2
537 S. Dearborn St., Chicago, Ill.

Without obligation, send me your 64-page illustrated book on Electricity, together with full details of your remarkable plan of home training and membership in the A.E.E.

Name

Address

Associated Electrical Engineers OF AMERICA



High School Course in Two Years!

You Want to Earn Big Money!

And you will not be satisfied unless you earn steady promotion. But are you prepared for the job ahead of you? Do you measure up to the standard that insures success? For a more responsible position a fairly good education is necessary. To write a sensible business letter, to prepare estimates, to figure cost and to compute interest, you must have a certain amount of preparation. All this you must be able to do before you will earn promotion.

Many business houses hire no men whose general knowledge is not equal to a high school course. Why? Because big business refuses to burden itself with men who are barred from promotion by the lack of elementary education.

Can You Qualify for a Better Position

We have a plan whereby you can. We can give you a complete but simplified high school course in two years, giving you all the essentials that form the foundation of practical business. It will prepare you to hold your own where competition is keen and exacting. Do not doubt your ability, but make up your mind to it and you will soon have the requirements that will bring you success and big money. YOU CAN DO IT.

Let us show you how to get on the road to success. It will not cost you a single working hour. Write today. It costs you nothing but a stamp.

American School

Dept. H974, Drexel Ave. and 58th St., Chicago

American School

Dept. H974, Drexel Ave. and 58th St., Chicago

Send me full information on the subject checked and how you will help me win success.

- | | |
|------------------------------|----------------------------|
| Architect | Lawyer |
| Building Contractor | Machine Shop Practice |
| Automobile Engineer | Photoplay Writer |
| Automobile Repairman | Mechanical Engineer |
| Civil Engineer | Shop Superintendent |
| Structural Engineer | Employment Manager |
| Business Manager | Steam Engineer |
| Cert. Public Accountant | Foremanship |
| Accountant and Auditor | Sanitary Engineer |
| Bookkeeper | Surveyor (& Mapping) |
| Draftsman and Designer | Telephone Engineer |
| Electrical Engineer | Telegraph Engineer |
| Electric Light & Power | High School Graduate |
| General Education | Fire Insurance Expert |
| Vocational Guidance | Wireless Radio |
| Business Law | Undecided |

Name.....

Address.....

Make Money Taking PICTURES



Get \$100 for Flood Pictures

"I took pictures of a flood and sold them for \$100. I have been able to buy my house and lot from the sale of pictures."
C. M. Cole,
Washington.

\$97 in Two Days!

"I made \$225 in December. Went out two days last week on home portrait work and made \$97."
A. G. Hyman,
Kentucky.

Tremendous, big-paying opportunities are open for ambitious men in Modern Photography. This is the picture age. Magazine and newspaper publishers buy thousands of photographs each year. Every manufacturer sends out high priced pictures of his products. Every home wants portraits. Photography is a business running into millions of dollars each year. And there is a great shortage of trained photographers.

EARN \$3,000 to \$10,000 a YEAR

Hundreds of men are earning big money and establishing their own businesses. Even during spare time, while training, you can make \$75 a week easily—no matter where you live!

Amazing New Easy Method

I show you, at home, how to do the kind of work turned out by the big studios in New York and Chicago! I show you how to make big money within 30 days! C. M. Cole bought a home with money he had made when only half way through his training. So well do I know what I can do for you that I guarantee under bond to return every cent of your tuition if you are not thoroughly satisfied.



Professional View Camera FREE!

Write at once for Free Camera Offer—I give you, free, a splendid professional view camera. You will be astonished and delighted. Offer open for short time only—so act quick! No obligation.

INTERNATIONAL STUDIOS, Inc.
Dept. 1199, 3601 Michigan Ave., Chicago, U. S. A.

INSTRUCTION BOOKS, MUSIC



These books are illustrated and gotten up to make the method of self-teaching so simple that any one without any knowledge of music could learn to play any of the following:

SAXOPHONE - 25c	MANDOLIN - 25c
ACCORDEON - 25c	PIANO - 25c
BANJO - 25c	UKULELE - 25c
GUITAR - 25c	VIOLIN - 25c

The above prices are postpaid. Any above 5 titles, \$1.00, postpaid.
J. C. DORN, 725 So. Dearborn St., Dept. 17, CHICAGO, ILL.

SHOW-CARD WRITING

A pleasant, profitable profession, easily and quickly learnt by our new, simple graphic block system. Artistic ability not necessary. We teach you how. Distance no object. Full particulars and booklet free. Wilson Methods Limited, Dept. 53-M, East Richmond, Toronto, Canada.

LEARN TO GET DOLLARS OUT OF WATCHES.

WATCH-REPAIRING. ENGRAVING. JEWELRY REPAIRING.
WRITE NOW.
ENICAR TRADE SCHOOL
530 W. MONUMENT SQUARE, RACINE, WIS.

EXPERT ELECTRIC MOTOR REPAIRING

Course in FOUR MONTHS specializing in ARMATURE, STATOR, ROTOR and COIL WINDINGS. WINTER DAY and NIGHT CLASSES START January 7, 1924. Send for Catalog E-10.

Harrisburg Mechanical School BOX 433 HARRISBURG, PENNA.



Your Foundation for Success

QUALITY TRAINING—the foundation on which rests the success and reputation of this famous automotive school is the foundation on which you can build **YOUR FUTURE—YOUR HAPPINESS—YOUR INDEPENDENCE**. Decide now to make quality training your foundation for success.

Be a Trained Man

Everywhere you will find National trained men. Some are owners of garages, electrical repair shops, vulcanizing shops, and service stations; others are garage foremen, auto electricians and auto salesmen—**ALL** are **SUCCESSFUL** and making **BIG MONEY**. You, too, can join these leaders among men. Learn autos! Be a trained man! Step right into the big-pay class and get your share of the tremendous prosperity enjoyed by those in the automotive industry.

The Shortest Way to Bigger Pay

Let National help you win success. Learn autos quickly and thoroughly by our practical system of shop practice and individual instruction. Thousands of men will tell you that **QUALITY TRAINING** is the shortest way to bigger pay. And the cost is no more! In fact you save time and money by training at National.

Unusual Advantages at National

Since 1905 National has trained men to become auto experts. Today, this great school which occupies a new \$300,000 building with over \$200,000 in equipment, has training facilities not to be equaled anywhere. You get actual practice on popular makes of cars such as Packards, Cadillacs, Fords, etc. Standard batteries, magnetos, electrical wiring systems are

here for your personal use and instruction. You **KNOW** autos when you get your National Automotive diploma. Expert instructors give you individual training.

The Wonder City! The Wonder School!

And Los Angeles will amaze you. Every man has a better chance to succeed in this fastest-growing city. Likewise, National will be a revelation. You will be enthusiastic about the big sunlit training shops, the great rows and rows of automobile engines, the electrical equipment—the completely equipped machine shop—**EVERYTHING**. You can't help but succeed with the co-operation you will receive from the President, the instructors—in fact, everyone connected with the school will lend you a helping hand, for upon your success depends the success of National. You'll appreciate this fine Western spirit of good fellowship.

Mail Coupon for Catalog

Send for the intensely interesting story of National Automotive which explains why **QUALITY TRAINING** is the shortest way to bigger pay. It is of the utmost importance to **YOU** that you find out. This catalog tells about National's Welfare Dept. that watches out for your personal interests; finds you a job to earn while you learn, if you wish; finds you a big-pay automotive job when you qualify; helps you to succeed. Send for this big, 84-page, illustrated catalog now. It explains everything and answers all questions. Just clip the coupon and mail it.



National Automotive School
Dept 55, 4004 S. Figueroa St., Los Angeles

I want to know the shortest way to bigger pay. Send me your free catalog, "The Gateway to Golden Opportunity."

Name.....

Address.....

City..... State.....



National Automotive ~ Los Angeles



LEARN LAW

Read law in your spare time and become a lawyer or a law-trained man in business. Great opportunities for wealth, prestige and power awaits you in the profession of law. Equally great opportunities in being a legally trained man in business. Business firms and corporations are looking for the man who knows law, for law enters into every phase of business, into every single business transaction. Gain a knowledge of law and you can command an executive position—a position of responsibility at big pay! Why don't you learn law in your spare time? Here is a real chance to get a legal training at a bare fraction of the usual cost.

\$280 After Examination

Make these 12 large volumes your law school. They contain all the law. A complete text, the work of the highest authorities. Prepared especially for home study with quiz questions on every subject. Every subject in commercial and professional law covered. Every point made clear. No tiresome daily lessons.

Written in interesting, fascinating form. Never before so complete and thorough a law course as this. Never before so masterly a presentation of the law in easily learned form. Already several of the leading law schools have made application for the use of these volumes as class-room texts. Splendidly bound in law Buckram, with red and black labels and titles in gold. Only 482 sets to be sold at slashed price on this special introductory offer. Act quick to get in on this offer.

Send No Money See Before You Buy

We'll ship the whole set right to your home or office for 7 days' free trial upon your simple request. If after the 7 days' free examination you are highly pleased and decide to keep them simply pay the small initial payment of \$2.80, and then only \$3.00 a month until the special reduced price of \$44.80 is paid. Regular price \$110. Think of it—a saving of \$65.20—and over a year to pay—only 75¢ a week. Offer holds good only on 482 sets.

FREE!

Reading Course

Act at once and we will include, extra and FREE, our Reading Course of 33 complete lectures in law, which will help you prepare for the bar examination. This with the books amounts to a complete course in law.

Act quick, as this cut price offer holds good only on 482 sets. So rush the coupon.

NOW!!

Mail the coupon now. Get the books for 7 days' trial. Decide for yourself whether you want to keep them or not.

\$5.00 required with order outside of United States.

The Johansen Corporation
 618A Manhattan Bldg., Chicago

Please send your 12-volume Home Study Course in Law for 7 days' examination, shipping charges collect. I will either send \$2.80 as initial payment and \$3 a month thereafter until \$44.80 is paid, or return the books within 7 days at your expense. (Special cash with order price \$39.80.)

Name
 Address
 Employed by Age



John Davey needs young men

John Davey's organization, The Davey Tree Expert Co., Inc., has a limited number of openings for ambitious young men between 20 and 30 years of age, single men preferred. The opportunity is unusual, offering good pay at the start, permanent employment in the Davey organization, and thorough scientific training in the profession of Tree Surgery. Advancement rapid, according to merit. The work is fascinating, offers chance to travel extensively, and association with fine fellows. Only clean, red-blooded young Americans, lovers of the outdoors, need apply. Write, giving full information, to The Davey Tree Expert Co., Inc., 56 City Bank Bldg., Kent, Ohio.

U. S. Government Needs Men!

Wonderful opportunities in Civil Service. Thousands of men and women appointed every year. Generous salaries, short hours, liberal vacations. Positions open in Washington and in every other city of the country, as well as in Porto Rico, Alaska, Hawaii and the Philippines. Write to-day for 48-page FREE BOOKLET on CIVIL SERVICE, which tells you how you can get a good-paying position with the United States Government.

INTERNATIONAL CORRESPONDENCE SCHOOLS
 Box 5567-D, Scranton, Penna.



"BECOME A LIGHTNING TRICK CARTOONIST"

HAVE MONEY CHALK TALKING. SEND \$1.00 FOR SNAPPY PROGRAM OF TRICK DRAWINGS WITH INSTRUCTIONS BY A PROFESSIONAL CARTOONIST. SATISFACTION GUARANTEED. CIRCULAR FREE. BALDA ART SERVICE, 611 OSHKOSH, WIS.



Earn \$45 to \$90 a Week
 Learn at Home while Earning

FREE LESSONS
 Expert AUTO GAS ENGINE WORK

File demand this Spring. Mail Coupon today sure.

FRANKLIN INSTITUTE
 Dept. D438
 Rochester, N.Y.
 Kindly send me, absolutely free, sample lessons in Motor and Auto Operation and Construction.

Name
 Address

The Most Important Thing in the World

is the way you feel. Health means more than having just enough energy to get through your daily work. Real health means the possession of considerable muscular strength combined with great powers of endurance. It means that your internal organs are in first-class working order. It means that immunity from temporary sickness and chronic disease which shortens life.

The next most important thing is the way you look. Your personal appearance counts for a lot in these times. It is nice to look well in a bathing suit; but it is far more important to be able to create an impression when in your street clothes. To have people exclaim "My, what a *finely built* chap!" after one glance at the broad shoulders, deep chest, trim waist and beautiful proportions which are noticeable even when you are fully dressed.

Your aim in training should be, **not health alone, not appearance alone, not strength alone**, but that combination of all three which is the surest sign of real vigor.

I am looking for the man who wants to save time. The man who knows that he needs to improve his physical make-up, who has very little time to exercise and who **must have results**.

I have an entirely new training method which contains a time-saving element found in no other course of training. The principal muscles are exercised in groups. There are but few exercises in each lesson and after you have mastered these exercises, you drop them and substitute the more advanced exercises in the next lesson. Under my tuition you never have to practice more than a few minutes a day. The effect is so sure and rapid that:

1st. Weak beginners, who can't even chin themselves with both arms, soon find that they can easily chin the bar with one arm.

2nd. The stout beginners who cannot even reach their ankles can soon learn to bend over and put the palm of their hands on the ground, without bending their knees (and incidentally reducing their waist girth by 8 or 10 inches).

3rd. That scrawny beginners soon find themselves gaining weight and shapeliness as a result of their increased digestive powers.

4th. That undeveloped beginners soon find themselves taking pride in their unusually large and clean-cut muscles.

5th. That non-athletic beginners soon find that they are in possession of the speed and strength that makes them winners in sports and games.

I suggest that you send 10c (stamps or coin) and obtain one of my art booklets. The name of the book is

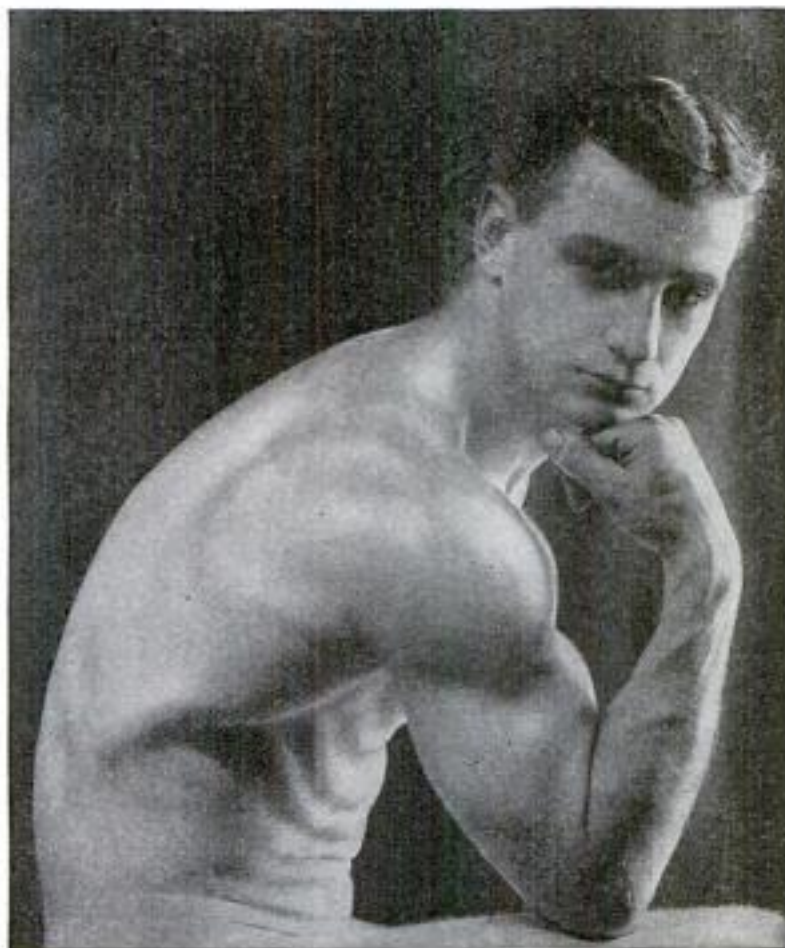

CHARLES MACMAHON

The Royal Road to Health and Strength

It explains *how* and *why* my pupils make such tremendous improvement in such a short time.

CHARLES MACMAHON

2109 N. Orianna St.

Studio D-1

PHILADELPHIA, PA.

DRAW CARTOONS

Cartoonists Trained by W. L. EVANS



MAKE MONEY

SOME of the cleverest cartoonists in America today are former students. They studied during their spare time and are now making good money. Cartoonist Evans' system of teaching is so simple, easy and practical that it is not hard to learn to draw originals. The school has a long established reputation and is recommended by well-known cartoonists because they know the students are handled right.



If you like to draw, send us a sample of your work, either a copy or an original. You may have more ability than you think. We will send you a portfolio of cartoons and full details about the school.

The Course is NOT EXPENSIVE

THE W. L. EVANS SCHOOL OF CARTOONING

821 Leader Bldg. CLEVELAND, OHIO



Electrical Course

In
Book
Form

Here is the quickest, easiest, cheapest way to learn electricity. Think of it! A complete electrical course in book form. No tiresome lessons with a lot of mathematics. Just plain everyday electrical facts—the very things and the only things you need know to hold down a good paying job. Written and simplified by 27 of the biggest men in the electrical field. 8 big books—4100 pages and 3300 pictures.

Electricity Means Success

—Good Pay and a Good Job. You can succeed in electricity. It's one of the best paying fields open to young men who know.



You do not have to give up your present position, just a few pleasant hours spent in the evenings on this subject, and success is yours.

FREE TRIAL!

Just mail the coupon—don't send a cent. We send books for a week's free use. Look them over yourself, and see how thoroughly and completely everything about electricity is explained in them.

American Technical Society
58th St. & Drexel Ave. Dept. E-919

American Technical Society, Dept. E-919 Chicago

Send me your 8-volume set of Electrical Books for a week's free use. I will either return the books in 7 days or remit \$2.00 and pay you \$3.00 each month until a total of \$20.80 is paid.

Name

Address

Employed by

Copy this coupon on larger sheet if more convenient

Business Needs Trained Executives



TRAINED MEN AND WOMEN EARN \$5,000 TO \$12,000 A YEAR

Men and women who have a business training—who are really business executives—name their own salaries. \$5,000 to \$10,000 a year and more is not uncommon. Big opportunities and money always open in business to the trained man and woman. A good business training leads to highest executive positions. Any person of average intelligence and common sense can now learn the secrets of business success through scientific coaching.

Trained men and women are **always** in demand. Don't let lack of training bar you from success. Learn at home in your spare time under the personal guidance of the Standard Education Society Business Expert.

Complete Business Course in One Year

The Standard Education Society guarantees to give you in its specially prepared home study business course, the valuable fundamentals and business training, including Business Administration, Secretarial Work, Bookkeeping, Shorthand and Typewriting. All of your training will be under the personal direction of a nationally known business expert. Only a few spare hours a week will fit you for a good position, a fine living and a handsome salary. Learn at home in your spare time the business principles and methods of most successful concerns in America. Low tuition fee—easy terms. Write for complete information and valuable free offer.

STANDARD EDUCATION SOCIETY

189 West Madison Street, Desk 12-5, CHICAGO, ILLINOIS



\$1400 to \$2600 a Year

Men, Boys, 18 or Over, Become

Railway Postal Clerks—

City Mail Carriers—

Post Office Clerks

SEND
COUPON
BELOW

FRANKLIN
INSTITUTE

Dept. D182, Rochester, N. Y.

Common education sufficient. Send coupon immediately.

This coupon, filled out as directed, entitles the sender to (1) free specimen examination questions; (2) a free copy of our book, "Government Positions and How to Get Them"; (3) free list of positions now obtainable; and (4) tell me also how I can get the position here checked.

COUPON

... Railway Postal Clerk (\$1600 to \$2300) ... City Mail Carrier (\$1400 to \$1800)
... Bookkeeper (\$1400 to \$1800) ... Rural Mail Carrier (\$1800 to \$2600)
... Post Office Clerk (\$1400 to \$1800) ... Customs Positions (\$1100 to \$2000)

Name

Address D182

Use it before you lose it. Write plainly.

DO YOU WANT TO BE— A garage or repair shop owner? A garage or repair manager?



FREE BUSINESS COURSE

A wonderful opportunity for you to learn how garages are conducted. Learn garage and repair shop system. Learn expense and overhead. Learn how much jobs cost and why—fit yourself to conduct your own business.



IF you are not earning at least \$50.00 a week—with \$75.00 and your own business in sight—this message is intended for you! There is an overwhelming demand for *big* auto men, the kind of a man who knows the financial as well as the mechanical end of his trade. To those men go the manager-ships. They are the men who eventually establish themselves in a business of their own. They are the men, who through their complete knowledge of system and costs can successfully compete with garages that are run on a guesswork basis.

FREE BUSINESS COURSE

The Stewart Automobile School—for 15 years acknowledged the leading school of the East, has installed the course you need to put you in the expert class. Find out about the big offer today. The automobile business is an open, big paying field. Interesting work and a fat pay envelope, go to make the men engaged in automotive work among the *most contented workers in the country*. Did you read of strikes in this field? No! Good working conditions and big money make labor troubles out of the question. Jobs that offer \$200.00 a month go begging because the ideal men to fill them are held down in small jobs paying \$25.00 or \$30.00 a week and a limited future. You can avoid this class.

How you can do it

There was a time when a man had to serve years as an apprentice in order to learn a business. He usually started by "sweeping out." But those days are gone. Now, all the information the apprentice got in years you can get in a few weeks, right here in New York. For 15 years Stewart instructors have been making automobile men. For 15 years the Stewart School has been recognized as the leading school by automobile companies all over the East.

Personal Instruction

The Stewart School men are not pushed thru and turned out as so many factory products. Each man is taught in the way he learns the quickest—and the best. **YOU STAY WITHOUT EXTRA COST UNTIL YOU SATISFY YOURSELF YOU HAVE LEARNED EVERY DETAIL.** Ten weeks is the minimum time required. Send for our free book and learn about our guaranty.

Pay as You Learn!

You can finish your course in 10 weeks of fascinating work. That means 10 weeks of practical work with tools spent among the pleasant and inspiring surroundings in New York. Find out about our easy payment plan. If you want to earn living expenses while learning our Employment Department will take care of you.

Decide Now

Make up your mind now to investigate the opportunities in the automobile business. *Learn about the Business Course offer!* Send the blank below and get our big **FREE BOOK**. You will be under no obligations. The book gives just the facts and figures you need. It shows just what chance you have in the automobile business and just how you can get in after 10 weeks in New York.

Send for Free Booklet Now

Where will you be 10 weeks from today? In the same old rut? Or will you be on your way toward a big job—a happy job and \$200 or more a month and a business of your own in view? Every day of delay is a day lost. With a newer, bigger future before you your time is precious—send the coupon in now.

STEWART AUTOMOBILE SCHOOL
225 W. 57th St., Dept. 1779, New York, N. Y.

Please send me your free book that describes your school and the opportunities in the Automobile Business. I am under no obligation.

Name

Address

City

State

LEARN Modern Barbering NEW EASY WAY

Earn \$50 to \$150 EACH WEEK



NO matter what you are now doing, no matter how much you earn, our amazing new system of training for the barbering profession enables you to step into this clean, pleasant, profitable business in a few short weeks. Start right in earning \$50 to \$150 a week.

J. E. McGregor, of New Orleans, writes: "I have never been out of a job since you sent me to the one from the Post Graduate department a year ago. I have saved up a nice bank account. I am glad I learned Modern Barbering with you."

F. Erbst, of Chicago, writes: "I own my own home! I have my own automobile! I am independent! Have made it all since graduating from your school five years ago."

What Moler System Means to You

Our national advertising educates the public to the safety, comfort and economy of Moler post graduate work. It makes you the sought-after barber in your locality. It keeps your chairs filled and turns profits into your pocket. You as graduate are a part of a national institution which assures steady, profitable business. Through no other method can you get this.

We Equip Your Shop on Easy Terms

If you own your own shop your success is assured. If you are a worker you are assured of steady employment.

Send for This
Free Book
Today

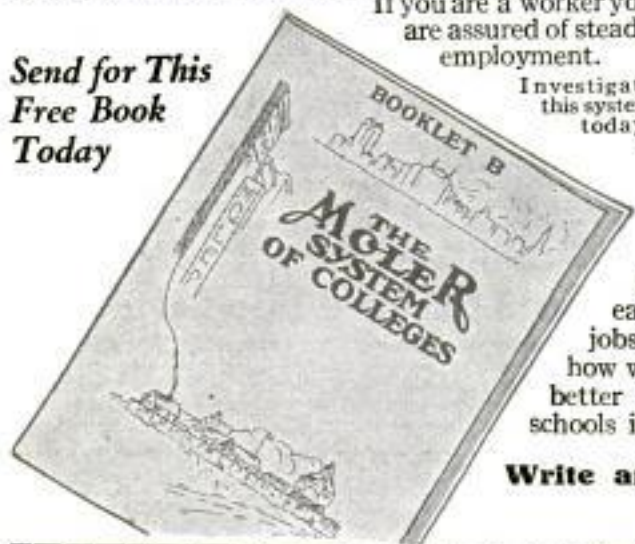

Investigate
this system
today.

We Train You to Be An Expert IN A FEW WEEKS

You want to get ahead—you want to make more money—big money. Our short, practical course gives you a complete training in modern barbering, including the electric hair cutter, the mechanical massage and scientific treatments. It also affords a study, if one desires, on hair and skin—it makes you an expert and expert barbers are always in demand.

Easy Work Always Busy BIG PAY

A trade that enables you to travel and see the world—one that pays in tips and commissions in addition to salaries. Moler System graduates are in great demand and have no trouble in securing good jobs.

Write for Free Book

Our catalog that we mail free tells how we enable you to earn while learning, how we put you into the best city jobs, how we equip your shop on easy payments. In fact, how we take you just as you are, make your life's work easier, better paying and more independent. We have 33 branch schools in leading cities. We have one near you.

Write anyone of the following addresses for our booklet B. Do it today.

MOLER SYSTEM OF COLLEGES

Address Nearest Branch →

Please send me without obligation on my part your Booklet B.

Name.....

Address.....

City..... State.....

The Moler System of Colleges

157 Third Ave. New York, N. Y.	215 Huron Rd. Cleveland, Ohio	23 N. Forsyth St. Atlanta, Ga.
105 S. Wells St. Chicago, Ill.	1045 Cass Ave. Detroit, Mich.	80 N. 2nd St. Memphis, Tenn.
810 N. 6th St. St. Louis, Mo.	1229 17th St. Denver, Colo.	910 Main St. Dallas, Texas
544 Main St. Kansas City, Mo.	110 S. 14th St. Omaha, Nebr.	712 Franklin Ave. Houston, Texas
206 E. 4th St. Cincinnati, Ohio	513 E. Water St. Milwaukee, Wis.	727 W. Commerce St., San Antonio, Texas
	1005 Canal St. New Orleans, La.	

New Training Plan In ELECTRICITY

Takes Only

20

WEEKS BY



S. V. Smith

President
S & H Engineering
Works

Mr. Smith is known as the "Electrical Wizard," not only because of his vast knowledge of Electricity, but also because he has been so successful in his training; that many of his students are holding some of the most important Electrical positions in America.

Amazing S & H Shop Type Method Prepare Quickly at Home for Better Jobs

Remarkable "Shop Type Home Training System" is the most complete, thorough and easily mastered Method ever devised. Trains you for the Higher Paying positions in Electricity.

Don't be satisfied to become an ordinary Electrician. Our remarkable new method enables you to *Aim Higher*, and *Get Higher*—it places the *Big Pay* jobs at the top of the profession at your disposal. It is different from all other courses.

A Master Course

This new system was designed by S. V. Smith, called by his friends the "Electrical Wizard" because of his ability to teach Electricity and because of the reputation and high positions attained by those whom he has taught.

This *Shop-Type Home Training System*—which makes you so efficient—is an exclusive feature of *S & H Training*.

It gives you all the theoretical knowledge of electrical principles that is taught in Technical Universities. That is something the ordinary Electrician *Never* gets.

But, in addition it gives you the *Practice* that a man gets *only* from doing practical work, which is something the College student does not get. The men at the head of big Electrical Plants—the men in the \$10,000 jobs, *Must* have *Both* the Theory and the Practice. *S & H Training* gives you *Both*.

If you are able to read and write ordinary English, we can train you to do house wiring, central station and power house operation, automotive and tractor electricity, electric welding, armature winding, motor and generator work, etc., so that when you are in charge of a plant you can tell every man in it what to do and how to do it.

Learn in Few Months

Because Mr. Smith has devised numerous short-cuts this *Extra* training takes no longer than the ordinary courses.

Free Outfit

To all who send coupon at once, Mr. Smith offers *Free*, a complete outfit of Electrical Apparatus, Instruments and Appliances for experimental and practical home shop work. By enrolling *now* you will be entitled to this outfit—but you must send coupon immediately.

Do this today. Get our big catalog giving information about this amazingly rapid and easy course. Read in it the letters from other students who have attained big success through *S & H Training*. This catalog will also explain the remarkable service rendered our students by the *S & H Employment Bureau*. This service is offered absolutely free.

Mail coupon now.

S. V. SMITH

S & H ELECTRICAL WORKS

Dept. 1-S, 1422 W. Monroe St., Chicago, Ill.

—Mail for FREE Offer—

Chief Engineer Smith,
S & H Electrical Works,
Dept. 1-S, 1422 W. Monroe St., Chicago, Ill.

Please send me catalog and full information about the remarkable S & H Course, your *Free Outfit*, your Employment Bureau, etc. This information is free and does not obligate me in any way whatsoever.

Name.....

Address.....

City..... State.....

Professor Harry S. Six, for 24 years head of music dept. of New York University, who personally teaches you. His new picture method enables you to play a real piece of music the first day.



You can play this Tenor Banjo Same Day You Get It! I'LL SHOW YOU HOW!

My New Picture Method

of teaching TENOR BANJO is so easy that you will play a real piece of music the first day. Pupils say, "Why didn't anyone think of such an easy way before? We never knew we could learn to play so quickly. Your course is wonderful." No knowledge of music needed.

I Play It for You First

This is the only course in existence that gives you free phonographic records of myself playing the piece you are learning. It's just as if you were getting the lessons from me in person. You learn to play by my quick and easy method, and then on the phonographic record I play it for you.

Be Popular

Remember that you get my personal attention all through your full course of 52 lessons. Every letter you get will be signed by me—Professor Harry Six—because it's my job to see that you learn to play right away. You will play right off with my method—next week you'll be in more advanced pieces—and in a short time you'll be playing Bee's Knees, Crying for You, You've Got to See Mama Every Night, and all the popular airs.

Popular Songs FREE

With each of the 52 lessons we give absolutely free a popular song, so you will know all the favorites.

Professional Full Size Tenor Banjo FREE!

For a limited time only to students who enroll in our conservatory we will give absolutely free \$18.00 full size professional tenor banjo. This is a big offer for people who love music and who have never been able to produce it. Send us your name and address on a post card for circular giving full particulars on just how Professor Six has been able to teach thousands to play—and how he can teach you so you will play from the first lesson on. Send the post card today, as Professor Six can give his personal attention to a limited number only, and you want him.

NEW YORK CONSERVATORY OF MUSIC
212 Fifth Avenue, Desk 1-D, New York

Try This on Your Hair 15 Days

Then let your mirror prove results. Write Today for FREE Trial Offer. Your hair need not thin out, nor need you be bald, for a way has been found to destroy the microbe that destroys the hair. This new and different method will prevent thinning out of the hair, dandruff, lifeless hair, baldness, gray hair, by strengthening and prolonging life of the hair for men and women. Send now before it is too late for the 15-days' free trial offer.
AYMES CO., 3932 N. Robey St., M-390 Chicago

Be an Expert Repairman

ON MOTORS AND GENERATORS

Repair and Maintenance Men in Big Demand

LEARN IN THREE MONTHS

Insure yourself permanent income and bigger opportunities—here at this Great Electrical

School you actually wind D. C. and A. C. armatures under expert instructors. Write today for

72-page illustrated Book. It's FREE.

SCHOOL OF ENGINEERING OF MILWAUKEE

P. M. 12, 415-17 Marshall St., MILWAUKEE, WISCONSIN



Why Miss Half the Fun in Life?



BE POPULAR—Learn to dance well! Arthur Murray, America's greatest dancing teacher, has invented a remarkable new easy method which enables anyone to learn all the newest dances at home—in a few hours—at very little cost! No music or partner needed. Success positively guaranteed! "90,000 learned dancing by mail."

FREE 5 DANCING LESSONS—

To prove you can learn easily and quickly, Arthur Murray will send you Five FREE lessons, including Fox Trot, Secret of Leading, and How to Gain Confidence. To pay cost of mailing, printing, etc., enclose 10c. Act NOW and be a good dancer soon.

Arthur Murray, Studio 933
290 Broadway New York



Eliminate the Electrician Everybody's Electrical Handbook

(new edition) tells how to safely do wiring for bells and lighting, also repair electrical appliances. 90 per cent of troubles in appliances can be fixed in a few minutes, yet you pay dollars to have it done. This is the most complete book on everything electrical in the home. Send No Money—Just your name and address, pay postman \$1.00 plus a few cents postage, or send a dollar bill with order. Money back if not satisfied. Circular Free.

WISNE BOOK CO., 388 EA Arcade Bldg., Cleveland, Ohio

EAT RAW FOOD HEALTH

Cooking destroys the Vitamines and Mineral Salts so vital to Health. MACERATED WHEAT IS A NATURAL FOOD. Prepared ready to eat. Banishes Constipation or Money Refunded. Full 2½ lb. Trial Pkg. \$1 Cash or Check. No Drugs or Medicine. Just Good Food.

BYRON TYLER, Est. 1899, 172 Gibraltar Bldg., KANSAS CITY, MO.

No Better Christmas Present for \$3.00

than a year's subscription to

Popular Mechanics Magazine
Containing 3600 Pictures and 3600 Articles

Much of it Interests Everybody

Most of it Interests Anybody

All of it Interests Somebody

Order through your Newsdealer or address the Publisher

POPULAR MECHANICS COMPANY

200 East Ontario Street, CHICAGO, ILL.

HEALTH

is the Greatest Joy of Life. Only the robust, vigorous and healthy can enjoy life to its fullest. The complaining, ailing, sickly ones are unhappy, discontented, dejected, failures.

For many years I have been making people well through Strongfortism. I have helped tens of thousands to become strong. No matter what ails you, write me fully about it, and I will prove to you I can help you.

The experience and research of a lifetime are contained in my wonderful FREE BOOK "Promotion and Conservation of Health, Strength and Mental Energy."

Send a ten cent piece (one dime) to cover postage.

LIONEL STRONGFORT

Physical and Health Specialist

1327 STRONGFORT INSTITUTE, Newark, N. J.

STRONGFORTISM



Lionel Strongfort
Perfect Man

There's Big Money For You In Radio

Our FREE BOOK, "Your Opportunity in Radio," opens up a big, broad avenue into a brand-new business field, alive and glowing with money-making opportunities and worthwhile achievements. Get this book! Read it! Profit by it!

CLIP the coupon at the bottom of this page and get your free copy of this fascinating book—a book that will quickly prove to you that there is big money for you in Radio, and show you just how to get it.

Radio is the big, new money-making field for alert, wide-awake men who are keen for business betterment and bigger bank accounts.

In the entire history of industry, there probably never has been a business development which compares with that of Radio. Within an amazingly short time it has jumped into the ranks of the world's largest and most profitable fields of endeavor.

The marvelously rapid expansion of Radio has opened up a multitude of avenues for personal advancement and profit-making. It has created opportunities never dreamed of in other fields. It offers you big money—an interesting occupation—quick advancement—a golden future in the world's fastest growing industry.

Send for this free book at once! Investigate immediately! Don't rely on anyone else! Learn for yourself about the big opportunities that exist for you in Radio!

What Big Men Say

Big men—men of vision—men of accomplishment—are quick to see the wonderful opportunities that exist in Radio for the active, aspiring man of today.

Austin C. Lescarbours, Managing Editor of *The Scientific American*, says: "Radio is distinctly the ambitious man's field, because he has an opportunity to mould it to his ideas. He can play an important role in Radio development. When I look over the unparalleled advance of a brief decade and a half, I hesitate to predict what the next decade may bring forth in Radio development. But I am positive of one thing and that is the REAL OPPORTUNITIES THAT EXIST FOR THE AMBITIOUS MAN ARE IN THE RADIO FIELD."

Ex-Postmaster General, Will Hays said: "Perhaps the biggest part in the future of the Postal Service will be played by Radio."

H. S. Gernsback, Editor *Radio News*, says: "There is perhaps no art that has before it so glorious a future as Radio. More things are being accomplished by Radio today than the boldest thinker could have imagined thirty years ago. Radio belongs to the present rising generation. There are so many fields that Radio touches that it is almost impossible to cite them all."

But there is no room here to go on quoting the opinions of the leaders in thought and action, as to the marvelous opportunities that exist for you in Radio. So, send for the free book which tells—in type and pictures—the whole story of

your big chance to attain a more interesting vocation—a bigger financial income—a happier business life.

What Others Are Doing

Men who are jumping into Radio today are climbing high on the Ladder of Achievement.

Edward J. Nally, who was a telegraph operator, has risen to the presidency of the largest Radio Corporation in the world.

William Dubilier got in on the ground floor of Radio and is today worth over a million dollars.

Edward H. Armstrong began experimenting as a Radio amateur, and recently sold some of his patents for several hundred thousand dollars.

David Sarnoff started at the foot of the ladder, but is now General Manager of the largest Radio company in America.

Elmer E. Bucher began at the bottom but is already recognized as an authority on Radio and its applications, through the many text-books he has written on the science.

And there is Grebe, Boucheron, Pannill, Finch and a myriad of others we could tell you about if we had more room on this page. But you can read about them all—and other successes—and your own opportunity for success—in our free book, which is now yours for the asking.

Get This Book Now

Right now is the time for you to find out all about the many big prizes that Radio is ready to throw into your lap.

Don't wait until tomorrow—next week—next month—next year. Only men of action attain the top rung of the Ladder of Success. The loiterers linger until too late and the chair-warmers cheat only themselves.

So, clip and mail the coupon now! For here is a new thing—a new business—which is growing so fast it can hardly keep up with itself—a business that offers you the biggest chance you ever had to make good and win out in a big way.

Do not neglect it! Act now—now while the Radio industry is getting ready to supplant every other means of communication—now while the big opportunities exist for clear-brained men of action.

Get into Radio now—on its upward swing—and it will lift you to higher levels of power and accomplishment than you ever before thought possible.

National Radio Institute, Dept. 15-M, Washington, D. C.

USE THIS COUPON

National Radio Institute, Dept. 15-M, Washington, D. C.

You may send me—without cost or obligation—a copy of your free book "Your Opportunity in Radio."

Name.....Age.....

Street.....

City.....State.....

This FREE Book



Points the Way

Make More Money Doing Work

Men Wanted—Mechanically Inclined



*"I am for Men,
not wage slaves"*

E. J. Sweeney

YOU want to make more money. You want to do the work you like. You hope to be independent, to be your own boss. Perhaps you want to travel and see the world. You want to get out of the rut. You want a job with a real future. Then learn about the opportunities that exist everywhere, at home, in your own town, on rural routes, state highways, cities, etc., offering every choice of climate and living conditions, of starting your own business as a garage or tire-service shop. Auto mechanics are needed everywhere, and men who want to travel

and see the world but don't want the responsibility of owning their own place find jobs at \$50 a week and up quicker than any other line of work.

Over sixty thousand men have proved this to be true, and over twenty thousand are running their own business. These are the interesting figures from the records of this famous and successful trade school, the Million Dollar Sweeney Auto School at Kansas City.

I Started With \$76.65

I started my own business 15 years ago. I had nothing but a family to support; lots of nerve; a determination to make good; two trained mechanical hands, and \$76.65 in cash. Today I own the Million Dollar Sweeney School. I made a success by teaching others to be successful. I am teaching the most practical, most profitable, easiest learned trade in the world. I am teaching white-collar boys from cities who want to get into overalls, and boys from the farm who want the bigger opportunities and advantages of city life. I am teaching coal miners, factory employees, unskilled laborers of all kinds, men who want to quit being wage slaves, whose jobs a strike or bad business or employer's whim can terminate without warning. Who want a chance to be independent, make real money, and own their own business. I refer you to sixty thousand men who found the way to success by sending for my catalog.

How to Be Sure of a Steady Job

Today LABOR is getting high wages. There is no lack of employment. But will the young man realize that history repeats itself? That to be safe he must have a skilled OCCUPATION in a permanent indus-

try? That to be safe he should be independent? He should plan to own his own business. Today any strong man willing to work can get good wages. Perhaps he does not realize that a JOB BY THE WEEK is a poor job, no matter what the pay is.

I want to urge ambitious men to **CHOOSE WORK SHIRTS** instead of **SILK SHIRTS**.

It is true that to **LEARN THE AUTOMOBILE BUSINESS** means you must make some sacrifice. You must spend some weeks and several hundred dollars in **LEARNING**. In being trained. During this period it looks like the fellow who is getting eight dollars a day in common labor job requiring no skill, training responsibility has the best of it. But what of the **DAYS TO COME?**

The Sweeney Trained men are ready to **HOLD GOOD PERMANENT JOBS**. To be partner or owner in a garage. To be independent. To be in business for himself. He is not working in a factory that may close down overnight, on a railroad where a strike may put him out of business, in a coal mine where labor troubles may send him to the bread line. He has **CAPITAL** in his head and hands.

Be Your Own Boss

Of the 60,000 Sweeney Graduates, I estimate that 20,000 of them own garages, tire shops, vulcanizing and service shops. It is easy to start in business for yourself. Then you don't have to bow down to some employer and do work you don't like. I say work for yourself, then you are not bothered by strikes and lock-outs or factories closing down. **OWN YOUR OWN BUSINESS**. Work for yourself with enthusiasm, not drudgery. It's the yearning of every young man to **BE HIS OWN BOSS**, and Sweeney makes it possible.

Sweeney trains men in 8 weeks in the Auto and Tractor Business, and you don't need previous experience.

The man who writes for my CATALOG has taken the first step towards his **OWN BUSINESS**. Towards Independence and Prosperity. It's just your own lack of energy and enterprise that's holding you back! Trust yourself! I will show you **HOW EASY** it is to be a man of standing and importance in your town.

A Billion Dollar Business

The **AUTOMOBILE BUSINESS** is America's greatest industry. It employs twice the capital of the National Banks in the United States. In 1922 people paid **ONE BILLION FOUR HUNDRED AND NINETY MILLION DOLLARS FOR TIRES**, and over **SEVEN HUNDRED MILLION DOLLARS** for parts and accessories. Yet this great business is just beginning. In ten years there will be over 23 million

Own Your Business—Travel—Be Independen-

You Like - Here's How to Succeed!

pleasure cars alone. That is about one for every family. Trained mechanics are in demand. Hundreds of thousands of men are needed not only as mechanics, but as salesmen, garage owners, tire repairers, dealers, demonstrators, chauffeurs, etc.

The smart man will QUIT his job and learn a SURE TRADE. He will BUILD A BUSINESS OF HIS OWN. He will be independent and not at the mercy of strikes, depressions, and circumstances beyond his control.

There was never a time when a man should consider his future and plan to put himself on a sure foundation more opportune than TODAY. Don't be a wage slave.

In thousands of localities there are opportunities for garages, repair shops, tire shops, sales agencies. Radio offers similar independent opportunities. Own your own shop. Stand on your own feet! How can you get into this great business?

What Others Have Done

There are opportunities everywhere. Other fellows with money are often looking for trained men to handle the mechanical end as partners.

Look at Clayton Eden's nice garage at Ainsworth, La. Clayton says: "We operate the leading garage. Have all the business we can do. Also handle Hudson, Essex, and Buick cars. Owe my present success to the wonderful training received at the Sweeney School."

Roy Atkinson sent me this letter from Everett, Mo. "Worked on a farm," says Roy. "At nineteen had only \$14.00. Got father to send me to the Sweeney School. Three days after I came home I fixed a neighbor's Ford car. That was my start. Today this garage is worth \$4,785.00. My business takes three men to handle. I never worked in any other garage. I used my Sweeney training. If you want to get that start, do as I did and go to the Sweeney School."

Look at John Boyer's garage at Milford, Illinois. John says: "Having a good business; busy all the time."

From far off Australia, S. A. Noller writes business is fine.

What these boys have done YOU can do. If you like mechanics, write me today for my big free catalog. Mail the Coupon today or post card will do.

What Is the Sweeney System?

The Sweeney System is the practical way—the only way to learn if you want to get into the Automobile business at the least possible expense of time and money.

It is easy—requires no previous education—no books—only 8 weeks' work. Our way of training is interesting in the extreme because it is so practical; no guess work to it. Just like a boy told me this morning. He said: "I really ought to go home and help the old man with his crop, but I never had so much fun and worked

as hard and learned more in my life." He said he could spend six months here and every day learn something new.

For Fathers and Mothers

I am the father of ten children. I surround the men in my school with the same good moral atmosphere and provide them the same opportunity and square deal I would like other people to give my children. I say to you, parents, help your children. Give the boy a chance. Investigate yourself the real opportunities for Success and Independence in the Auto Business. Don't make him a farmer because you have been one, or a wage slave because you may have been a worker for others. Give him a chance. Think of the Texas mother who saved up the butter and egg money, sent her boy here, and now sees him a successful business man. Or the Missouri father who helped his boy come here, and now is glad to be a partner in that boy's \$5,000.00 garage.

Get This Free Catalog

If interested in bettering your condition, simply send name today and get a free copy of my new illustrated 64-page catalog and a free copy of the interesting Sweeney News; also many pictures showing men at work and play in this world-famous school. I will also tell you about a special new offer I am making, and some interesting opportunities in this line of work. There is no cost, no obligation, no one will call on you, or bother you. No colored students accepted. Just send name today to

E. J. SWEENEY, President



Sweeney Auto & Electrical School
1260 Sweeney Bldg., Kansas City, Mo.

DEAR E. J. SWEENEY:

More money is just what I need. Please tell me, but without obligation, of opportunities in the Auto Business. Send me your FREE CATALOG.

Name.....

Street.....

City..... State.....

dent-See the World-Earn \$50. a Week & Up!



Play "JAZZ" on the Saxophone

Become a musician so quickly as to astound everyone. Learn by playing **real music**—instead of tiresome "exercises." You'll soon become the most popular person in your "set."

New Easy Method

is a revelation. Nothing else like it for thoroughness and rapidity. So simple that young and old find it easy to play with amazing skill. No "trick music"—but actual notes, learned quickly right in your own home.

FREE BOOK and Illustrated Folder

offers this wonderful musical opportunity. Send for them today before copies are exhausted. You'll be astounded, thrilled, fascinated, at this easy, rapid way to become a veritable **master** of your favorite instrument. Name below the instrument you are particularly interested in.

LEARN TO PLAY ANY INSTRUMENT	
Piano	Mandolin
Organ	Drums and Traps
Violin	Harmony and Composition
Banjo	Sight Singing
Clarinet	Ukulele
Flute	Piccolo
Harp	Trombone
Cornet	Saxophone
Cello	Valves and Speech Culture
Guitar	Automatic Finger Control

U. S. SCHOOL OF MUSIC, 712 Brunswick Building, NEW YORK CITY.
Send me your amazing free book "Music Lessons in Your Own Home." Also, Illustrated Folder. This does not put me under any obligation. (Please Write Plainly.)

NAME.....

ADDRESS.....

INSTRUMENT.....



Become A RAILWAY MAIL CLERK

Big Pay, Easy Hours, Pleasant Work

Uncle Sam pays Railway Mail Clerks \$1,600 to \$2,300 a year to travel all over the country FREE. Work is easy. Work only 6 days, then 6 days off. Full pay all the time. No strikes, lockouts, layoffs. Here's a great position you can keep, with good, steady pay and plenty of chances for promotion to positions paying up to \$4,500 a year. Let me train you to pass the U. S. Civil Service Examinations with high rating so you get this fine job quickest.

FREE BOOK TELLS HOW

Thousands holding Civil Service jobs today were successfully trained by me. I guarantee my training gets you an offer for position—or your money is refunded in full. Write for my BIG FREE BOOK today. Tells all about Civil Service positions. Examinations coming. Get ready now for job you want. Mail coupon or postal card at once.

Patterson Civil Service School Dept. 3812 ROCHESTER, N. Y.

PATTERSON CIVIL SERVICE SCHOOL, Dept. 3812, ROCHESTER, N. Y.
Send me, without charge, your FREE BOOK describing Railway Mail Clerk and other U. S. Government positions.

Name.....

Address.....

MASTER ELECTRICITY AT HOME

Send for my FREE Book—a STRAIGHT-FROM-THE-SHOULDER TALK about your future in the Electrical Field. It contains no misleading promises such as "EARN \$10,000 A YEAR" or "BECOME AN ELECTRICAL EXPERT IN A FEW MONTHS." You are far too intelligent to believe such rot. If you are seeking to better yourself, let me help you as I have helped thousands to reach their goal. My instructions are easily understood and right to the point. My book speaks volumes to any one who wants to be a success in the electrical field.

BUY SUCCESS WITH BURGESS TRAINING

Our close connection with International Association of Electrical Engineers gives you unusual chances. Experts everywhere endorsed this course as unqualified leader. All branches of electricity covered. Slide Rule and Slide Rule Course of 30 lessons and Electrical Hand Book given FREE if you ACT NOW. Write for our fully illustrated Book TODAY. New Radio Course Now Ready.



BURGESS ELECTRICAL SCHOOL
YORKE BURGESS, Superintendent
Dept. 12, 744 East 42nd St., Chicago, Ill.
Canadian Branch: 201A Crawford St., Toronto



Learn Auto and Tractor Business

Earn \$150 to \$400 a Month
Greater opportunities than ever for Rahe Trained Motor Mechanics. Learn here in Six to Eight Weeks.

Write today and let me "SHOW YOU HOW."
RAHE AUTO AND SCHOOL 1075 Locust St.
Kansas City, Mo.
(The Original and Only School Under the Personal Supervision of HENRY J. RAHE. Established 1907.)

LEARN RADIO

Here's your opportunity. Radio needs you. Win success in this fascinating field. Trained men in demand at highest salaries. Learn at home, in your spare time.

Be a Radio Expert

I will train you, quickly and easily, to design, construct, install, operate, repair, maintain, and sell all forms of Radio apparatus. My new methods are the most successful in existence. Learn to earn

\$1,800 to \$10,000 a Year

FREE Wonderful, home-construction, tube receiving set, of latest design. Write for "Radio Facts" free. Engineer Mohaupt.

American Electrical Association
Dept. A12 4513 Ravenswood Ave., Chicago

LEARN AUTOS AND TRACTORS



Wonderful opportunities constantly offered trained men—we train you thoroughly to start your own business, or to make good money as motor expert, driver, shop foreman, etc., and furnish you with a \$12.00 tool kit free of charge. This is the pioneer auto school. Over 7000 graduates making good. Catalog free.

CLEVELAND AUTOMOBILE SCHOOL, 1814 East 24th Street, Cleveland, Ohio

FREE FIRST LESSON RECORD

Learn to Play

Violin, Mandolin and Banjo-Mandolin quickly. No embarrassment. You learn to play or pay nothing. Play for money in two months.

Beautiful Instrument FREE

No charge for Instrument to one pupil in each locality. Few cents a week pays for lessons. Write for First Record—Sent without cost on 1 week's approval with complete details of Personal Instruction Record Course.

SCHNEIDER SCHOOL OF MUSIC
Dept. B-12, 238 Vermont St., Blue Island, Ill. (A suburb of Chicago)

ALL WOOL

Sport Model Overcoat!



Only
\$100
 DOWN
 6 Months to Pay
 Total Price \$24.95

This handsome, sport model overcoat is yours for less than half the usual price. We are giving you the advantage of our best buy this season. But you had better hurry and order now. These wonderful coats will not last long. We'll have to raise the price when the lot is gone. Only \$1.00 down! You have 6 months to pay! Just think, you get 6 months additional wear out of your coat while you are buying it. If you aren't satisfied in every way with this overcoat after you have tried it on and inspected it carefully, send it back. Your money will be cheerfully refunded.

This heavy, double-breasted, all-wool overcoat will give you dandy service. It is beautifully made of pure all-wool material in a warm, deep, rich cinnamon brown. The back of the material is an attractive plaid in harmonizing colors. Partly lined in high grade, durable material. Large collars, semi-raglan sleeves, full belt, roomy patch pockets and bound seam. Length 44 to 47 inches. Sizes 34 to 46 inches chest measure. Give chest measure taken over vest. Order by number 4689.

Order Today

Don't miss this wonderful chance to get your winter overcoat at this amazingly low price. If you aren't satisfied with this high quality overcoat at this remarkable low price, your money will be refunded. Our new catalog showing amazing values in boy's and men's suits and overcoats is just off the press. Send for it NOW.

Babson Bros., Dept. 13-59

19th Street and Marshall Blvd., Chicago, Ill.

Enclosed please find \$1.00. Send me the double-breasted, all-wool overcoat at the advertised price. If I am not satisfied when I receive the overcoat, I can return it and get my money back. If satisfied, I will pay \$4.00 after inspection and \$4.00 per month — Total \$24.95. Order by No. 4689. My measures are:—

Chest (measured over vest) Height Weight

Name

Address

City State

Age Occupation

Munroe Great Coat

LEARN CARTOONING

Successful cartoonists earn big salaries. Many of the most popular cartoonists of to-day learned to draw in their spare time, at home, through the Landon Course of Cartooning and now earn \$75 to \$200 a week.



The Landon Picture Chart Method of teaching ORIGINAL drawing makes cartooning easy to learn. Hundreds of sketches like the above explain every step in creating ORIGINAL heads, figures, animals, etc.

Write today for Sample Landon Picture Chart, long list of successful Landon students and full information showing possibilities for you. Please state your age. The LONDON SCHOOL, 738 National Building, CLEVELAND, OHIO

Results Prove Merit

In the leading publications and reviews which monthly reproduce the work of America's best cartoonists, you will constantly find the work of Landon students, including:

Dorman Smith of the N. E. A. Service.

Craig Fox of the Rochester Democrat and Chronicle.

Leo Thiele of the Sioux City Tribune.

Fred O. Seibel of the Knickerbocker Press of Albany.

Cartoonist Kuhn of the Indianapolis News—and others.

A constantly increasing number of Landon students are becoming nationally known as America's leading cartoonists.

NEW WAY to Learn FOREIGN LANGUAGES Easily!

Hundreds of words almost the same!
English. Interesting
French. Interessant
Spanish. Interesante
German. Interessant

You already know hundreds of foreign words without realizing it! You can talk and read French, Spanish or German in 8 to 12 WEEKS—right in your own home. Not a single English word in course, yet you read it easily by the wonderful

Pelman "At Sight" System
Our big free book gives you PROOF—you actually read AT SIGHT a page of the language you select. Write now, stating language wanted.

The Pelman Institute of America
Dept. 412 2575 Broadway, New York

Amazing
**BOOK
FREE**

Poultry Offers Big Money!



Make money from poultry; YOU CAN; we show you how. We can show you how to get most winter eggs, and how to hatch and brood strong, healthy chicks; how to make money from poultry. Mr. Harry M. Lamon, President of this Institution, is recognized as the Master Poultryman of the world, and ours is the only poultry correspondence course endorsed by leading agricultural colleges and universities.

Send Quick for New Free Book
Tells you all about the many opportunities for profit, whether you live in city, suburbs, town or country. This book is FREE. Send for your copy TODAY. Special offer now being made—ACT QUICK.

The National Poultry Institute
Dept. 312-A Washington, D. C.



"THERE'S MONEY IN IT"

AT HOME LEARN TELEGRAPHY AT HOME

MORSE AND WIRELESS

TEACH YOURSELF

In half usual time, at trifling cost, with the wonderful Automatic Transmitter, **THE OMNIGRAPH**. Sends unlimited Morse or Continental messages, at any speed, just as an expert operator would. Adopted by U. S. Government, and leading Universities, Colleges and Telegraph Schools. 3 Styles. Catalog free. **OMNIGRAPH MFG. CO., 16-22 Hudson St., NEW YORK**
If you own a Radio Phone Set—and don't know the code—you are missing most of the fun.

100 Genuine 10c Cigars \$6⁹⁵

Regular Retail 10c Cigar, Havana Filler, Wisconsin Binder and Sumatra Wrapper. These cigars are nationally known for their wonderful quality. Satisfaction guaranteed or money refunded. Order Today.
OWENSBORO TOBACCO CO., Dept. 130, OWENSBORO, KY.

Perfect Health Absolutely FREE through a Natural Law

Address **ALOIS P. SWOBODA**
1179 Berkeley Bldg. NEW YORK

BE A MARINE ENGINEER

Read how John Willadsen tripled his salary

"When I enrolled with the I. C. S. for the Marine Engineer's Course, I was earning small wages. I had only a common-school education and had tried to study engineering from other books, but could not understand half what I was reading about. One day I happened to see an I. C. S. advertisement and mailed the coupon. I was soon studying your course and had no sooner finished it than I received a Marine Engineer's license. Two years after enrolment I was earning three times as much as I made before enrolling with you."

If the International Correspondence Schools can triple the salaries of men like John Willadsen they can help you, too. There is not the

slightest doubt about it. Mark and mail the coupon to-day for Special Circular which tells how engineers, coal passers, firemen, water tenders, oilers and other employees of steam vessels can advance to Marine Engineers.

INTERNATIONAL CORRESPONDENCE SCHOOLS
Box 5363-D, Scranton, Penna.

Without cost or obligation, please send me a copy of your Special Circular which tells how I can prepare at home in spare time to secure a position as Marine Engineer.

Name.....

Street Address.....

City..... State.....

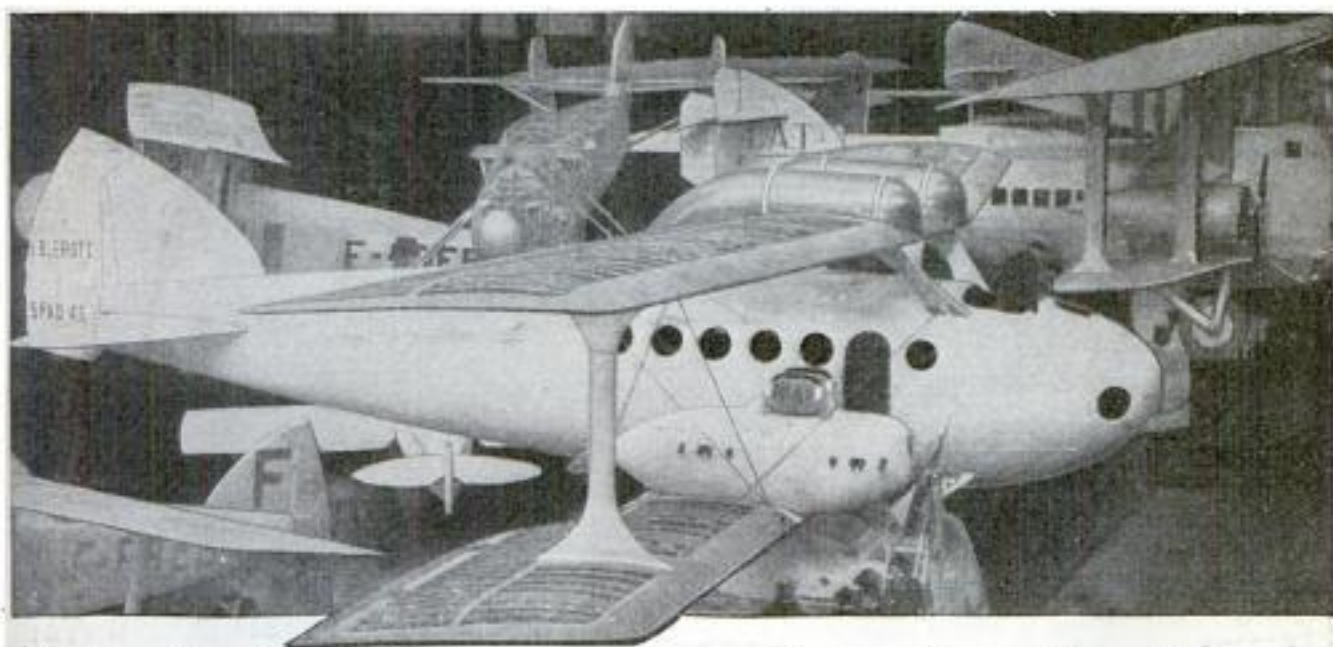

Quick Success in Aviation Fascinating—Daring—Big Paying

To young men of daring, no other field of work offers such a fascination, such high pay, nor such opportunities for quick success as the field of Aviation. As yet, aviation is practically in its infancy. NOW is the time to get in.

Amazing Opportunities in Airplane Industries

In the automobile industry and in the moving picture business hundreds of men got rich by getting in at the start. They made their success before others woke up. Today, these lines offer no greater opportunities than a hundred and one others. BUT AVIATION IS NEW. Get in while the opportunity and pay are big. All over the country there is a clamor for trained men. It is not a question of pay, but of getting capable men.

Here are Real Positions —\$50 to \$150 Per Week

Aeronautical Instructor, Aeronautical Engineer, Aeronautical Contractor, Airplane Repairman, Airplane Mechanic, Airplane Inspector, Airplane Salesman, Airplane Assembler, Airplane Builder.



View in an Airplane Factory

A Sure and Easy Way to Learn Aviation—at Home



A New Job—The Aerial Postman

The study of aviation is almost as fascinating as the actual work. Every lesson is full of interest. That is why it is easy to learn aviation. You do not have to make yourself study—it is like reading an in-

teresting book that tells you things you have always wanted to know. Only one hour each evening will give you the basic training in a surprisingly short time. You need only a common school education.

One of my students, James Powers, Pa., says, "I am indeed surprised that such a valuable Course can be had from such practical men for so little cost."



A New Seven-Passenger Airplane

Personal Instruction by Experienced Men

Men who have had actual experience give you personal attention. They select the lessons, lectures, blueprints and bulletins. They tell you things that are essential in everyday practice. Each lesson is easy to read and understand.

BIG BOOK FREE of Opportunities

Send coupon below for New Book, just out, "Opportunities in the Airplane Industry." It is interesting and instructive. It will show you many things you never knew before about aviation. Due to shortage of paper we could get only a limited supply of these books—send the coupon before they are all gone.

AMERICAN SCHOOL OF AVIATION
3601 Michigan Ave., Dept. 1199 Chicago, Ill.

AMERICAN SCHOOL OF AVIATION
3601 Michigan Ave., Dept. 1199 Chicago, Ill.

Without any obligation, send me your Free Book, "Opportunities in the Airplane Industry," also information about your Course in Practical Aeronautics.

Name.....

Street.....

City..... State.....

LUMINOUS PAINT

Make Your Watches, Clocks, Etc., Visible by Night

The very latest discovery in the scientific world, hitherto, practically unobtainable except at an exorbitant price, we have at last succeeded in producing this remarkable LUMINOUS PAINT, which, applied to the surface of any article, emits rays of white light, rendering it perfectly visible in the dark. THE DARKER THE NIGHT, THE MORE BRILLIANT IT SHINES. Quite simple to use. Anyone—you can do it. A little applied to the dial of your watch or clock will enable you to tell the time by night. You can coat the push buttons or switch plates of your electric lights, match boxes, and innumerable other articles; make your own Luminous Candles, Luminous Rosaries, etc. Small bottle, price 25c. Larger size, 50c and \$1 postpaid.

Serpent's Eggs

Box contains 12 eggs. When lit with a match, each one gradually hatches itself into a snake several feet long, which curls and twists about in a most life-like manner. Price per box, 10c postpaid, 3 for 25c.

Potmend

Mends Ironware. Agate-ware, kettles, pots, pans, boilers, etc. Also mends copper, aluminum, iron pipes, cracks in stoves, broken chimneys, porcelain, brick-work, tinware, crockery, woodwork, marble, etc. Comes in powder form, set with water and apply. HARDENS LIKE IRON. Mends a big hole or a small crack. PRICE 15c, 3 for 40c, postpaid.

Midget Bible

GREAT CURIOSITY. Smallest Bible in the World. Size of a postage stamp. 200 Pages. Said to bring good luck to the owner. A genuine work of art. Must be seen to be appreciated. Does good money selling them to friends, church societies, etc. PRICE 15c each, 3 for 40c, 12 for \$1.35, 100 for \$7.50.

STAGE MONEY

With a bunch of these bills, it is easy for each person of limited means to appear prosperous by flashing a roll of these bills at the proper time and peeling off a genuine bill or two from the outside of the roll, the effect created will be found to be all that can be desired. Prices, postpaid: 15 Bills 10c, 50 Bills 25c, 125 for 50c, or \$3.50 thousand.

Wonderful X-Ray Tube

A wonderful little instrument producing optical illusions both surprising and startling. With it you can see what is apparently the bones of your fingers, the lead in a lead pencil, the interior coating in a pipe seam, and many other similar illusions. A mystery that no one has been able to satisfactorily explain. Price 10c, 3 for 25c, 1 dozen 75c. Johnson Smith & Co.



Good Luck Ring

Quaint and Novel Design

A VERY striking and uncommon ring. Silver finish, skull and crossbones design, with two brilliant, flashing gems sparkling out of the eyes. Said by many to bring Good Luck to the wearer, hence its name, Good Luck RING. Very unique ring that you will take a pride in wearing. ONLY 25 CENTS.

Address orders for all goods on this page to

JOHNSON SMITH & CO.
Dept. 7
RACINE, WIS.

Our large catalog (356 Pages) of all the newest and best novelties, unobtainable elsewhere, free with every order.

The Dying Pig



The most laughable novelty yet produced. Made of rubber, and you have only to blow it up and stand the pig on his feet, when he begins to squeal as he slowly collapses and finally lies down and dies in the most natural manner. You can blow him up as often as desired, and each time he will go through the same performance to the great amusement and delight of your friends. Price, 15 cents; 3 for 40 cents; one dozen \$1.35, mailed.

Popular Watch Charms

ONLY 15c
3 for 40c; \$1.35 doz.

Very pretty little curiosities and decidedly novel. Fitted with Magnifying Lens that enlarges the pictures to a very surprising degree. In fact, it seems almost incredible that a clear picture could be possible in such small compass, and how sharp and distinct they show up when you look through. Come in assorted views—Astronomy, views of Panama Canal, Lord's Prayer in type, etc.

Mystic Skeleton

A jointed figure of a skeleton 14 in. in height, will dance to music and perform various gyrations and movements while the operator may be some distance from it. 10c pd.

NEW BOOK ON ROPE SPLICING

Useful Knots, Hitches, Splices, etc.

A most practical handbook giving complete and simple directions for making all the most useful knots, hitches, rigging, splices, etc. Over 100 illustrations. All about wire rope attachments, lashing, blocks, tackles, etc. 37 Heraldic Knots Illustrated. Of great value to mechanics, riggers, carpenters, boatmen. Price 20c ppd.

MAGIC FLUTE

Wonderfully Sweet Toned and Musical

The Magic Flute, or Harmonicon, is a unique and novel musical instrument that is played with nose and mouth combined. There is just a little knack in playing it which, when once acquired after a little practice will enable you to produce very sweet music that is somewhat like a flute. There are 12 keys and once you have mastered it you can play all kinds of music with facility and ease. When played as an accompaniment to a piano or any other musical instrument, the effect is as charming as it is surprising.

BLANK CARTRIDGE PISTOL

Protection against Burglars, Tramps & Dogs

Prices
50c
\$1.00



Post-paid

Well made and effective; modeled on latest type of Revolver; appearance alone is enough to scare a burglar. When loaded it may be as effective as a real revolver without danger to life. It takes standard 22 Cal. Blank Cartridges obtainable everywhere. Price 50c, superior quality, \$1.00 postpaid. Blank Cartridges, by express, 50c per 100. Johnson Smith & Co., Dept. 7, Racine, Wis.

DANCING BEAUTIES

Get a Kinemograph and see the picture move. France's latest sensation. A great surprise. Is worth twice what they cost. Are made of solid brass, highly nickled and very durable. Satisfactory, or your money back. 50c

Price... Johnson Smith & Co., Dept. 7, Racine, Wis.

BOYS! BOYS! BOYS!

THROW YOUR VOICE

Into a trunk, under the bed or anywhere. Lots of fun fooling the teacher, policeman or friends.

THE VENTRILLO
a little instrument, fits in the mouth out of sight, used with above for Bird Calls, etc. Anyone can use it.

Never Fails. A 32 page book on ventriloquism, the Ventrillo, ALL FOR 10 CENTS

1000 Silk Remnants

for patching Crazy Quilts, Sofa Cushions, Head Rests, Pin Pads etc. Large pieces, all colors and shades. Sure to delight you. For 10 Cents stamps, we send a large package and Book of quilt designs. 3 packages 25c. 1 pound makes a lovely large quilt. Price 15c postpaid. Our silk is the best. JOHNSON SMITH & CO., Dept. 7, RACINE, WIS.

LOOK 50c LOOK

Wonderful Instrument. Greatest thing yet. Nine articles in one. Everybody delighted with it. Odd, curious and interesting. Lots of pleasure as well as very useful. It is a double Microscope for examining the wonders of nature. It is also an Opera Glass, a Stereoscope, a Burning Lens, a Reading Glass, a Telescope, a Compass, a Pocket Mirror, and a Laryngoscope—for examining eye, ear, nose and throat. It is worth all the cost to locate even one painful cinder in the eye. Folds flat and fits the pocket. Something great—you need one. Don't miss it. Sent by mail, with 356 page Novelty Catalog. Only 50c or 3 for \$1.25

Resurrection Plant

One of the most wonderful plants known. Possesses the strange power of turning in a few minutes from an apparently lifeless, dry herb to a beautiful living fernlike plant of a dark green color. Simply place the plant in saucer of water, it will open up and start to grow in 30 minutes. When taken out it will dry up and go to sleep until placed in water again. Fine house plant—summer or winter. 10 cents each or 3 for 25c. AGENTS WANTED best paid. JOHNSON SMITH & CO., Dept. 7, RACINE, WIS.



We Guarantee You A JOB While You Learn And Place You When You Graduate

Erwin Greer
PRESIDENT

RECORD breaking automobile sales have created thousands of \$50 to \$125 per week jobs for trained automotive men. Hundreds of requests for such men come to our Free Employment Bureau. We need more men to qualify for these big money jobs. Greer Graduates are placed immediately.

THAT IS NOT ALL! We actually GUARANTEE to get you a job paying up to \$30 per week to help you while you learn. Only a small payment down on the course you select is necessary. Then you are set to climb. When you leave here you will take your place at the top. Let Greer help you. Inspect the methods that will make you a high paid man.

GREER TRAINED AUTOMOTIVE EXPERTS EARN \$50 TO \$125 PER WEEK

Day and Evening Classes on
Every Automotive Subject
Qualify You for Big Pay and
Help You Earn While You Learn

This magnificent new seven-story building—its 80,000 square feet of floor space filled with repair shops and modern shop equipment—is entirely devoted to training Greer Students.

Here in the big Greer Shops you get actual work on 4, 6, 8 and 12 cylinder engines. Electricity is thoroughly covered. All known Lighting, Starting, and Ignition units used. Special courses in Machine Shop, Batteries, Welding and Vulcanizing. Individual road lessons given. When you finish here you will know exactly what to do in any garage or automobile repair shop in the country.

BE EXPERT IN ALL THESE

Complete Greer Course includes Machine Shop Practice—Shop Management—Selling—Truck, Tractor and Automobile Repairing—Lighting—Starting—Vulcanizing—Driving—everything required to equip you for the highest paid automotive positions anywhere.

MAIL THE COUPON

It will bring you the big FREE BOOK "How to Succeed in the Automobile & Tractor Business." Also special Tuition Offer and complete information ABOUT JOBS. Mail it now!

We Pay Your Railroad Fare to Chicago

This special offering is made to fill the openings that now exist. Chicago is the place to train and opportunities for jobs are unlimited. Within ten blocks of Greer College are at least 40 large Automobile Sales Agencies. Throughout the city are approximately 5,000 Garages and Repair Shops. We will help you find a job and a home. Write us, and come to Chicago.

GREER COLLEGE

of Automotive Engineering

2062 So. Wabash Avenue, CHICAGO, ILL.



Many former Greer Students now own their own pieces of business. This means independence, no boss, and earnings that run from \$200 to \$5,000 per month.



Head Automotive Mechanic. Salaries average \$150 to \$200 per month or higher, depending upon character of shop.



The Greer-trained Truck and Tractor Repairman can have a steady job in any community. Pay averages \$40.00 to \$15.00 per day.



Automobile Salesmen make up to \$20,000 per year.

How to Succeed
in the
Automobile & Tractor
Business

ERWIN GREER, President
2062 So. Wabash Ave., Chicago, Ill.
Send me your Free Book "How to Succeed in the Automobile Business" and Special Tuition Offer.
Name.....
Address.....

PATENTS TRADE-MARKS AND COPYRIGHTS

SPECIAL OFFER FREE OPINION AS TO PATENTABLE NATURE

Before disclosing an invention, the inventor should write for our blank form, "Record of Invention." This should be signed and witnessed and if returned to us together with model or sketch and description of the invention, we will give our opinion as to its patentable nature.

Our Three Books Mailed FREE to Inventors

OUR ILLUSTRATED GUIDE BOOK

HOW TO OBTAIN A PATENT

Contains full instructions regarding Patents. Our Methods, Terms, and 100 Mechanical Movements illustrated and described; Articles on Patent Practice and Procedure, and Law Points for inventors.

Our Trade-Mark Book

Shows the value and necessity of trade-mark protection and gives information regarding Trade-Marks and unfair competition in trade.

Our Foreign Patent Book

We have direct agencies in all foreign countries and secure foreign patents in the shortest possible time and at the lowest cost.



**Prompt Attention
Reasonable Terms
Highest References**

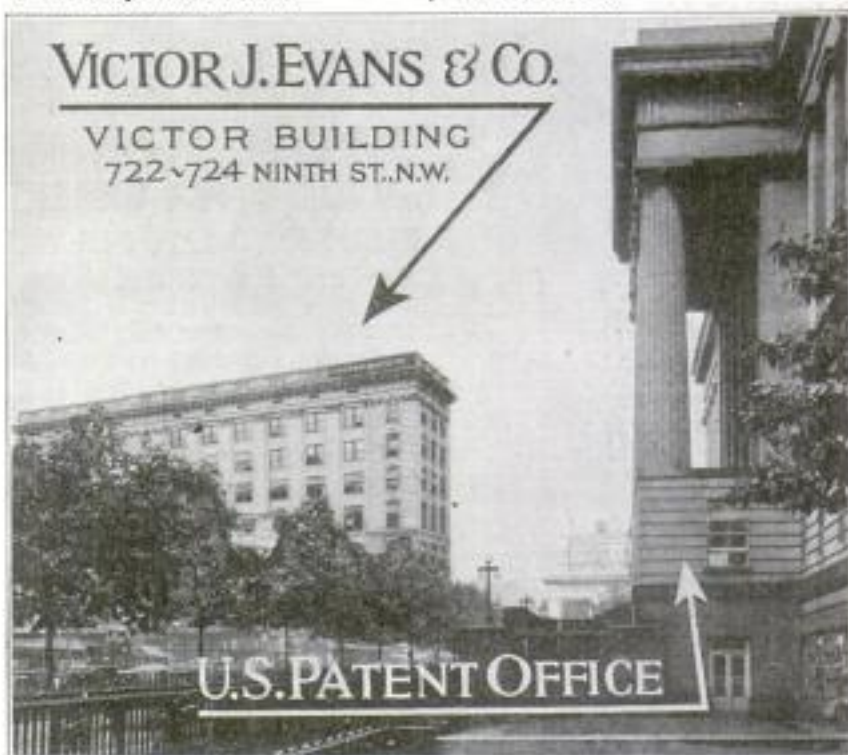

View from 9th and F Streets Corner of U. S. Patent Office Showing Location of Victor Building

FREE COUPON

VICTOR J. EVANS & CO., Patent Attorneys

MAIN OFFICES: 722-724 9th Street, N. W., WASHINGTON, D. C.

Gentlemen: Please send me FREE OF CHARGE your books as described above.

Name.....

Address.....

OUR ^{IN} PATENTS SERVICE

Our Branch Offices

In order to assist our clients in patent matters and give them the advantage of every convenience and facility, we have established branch offices in New York, Philadelphia, Pittsburgh, Chicago and San Francisco. These branch offices being located in the principal commercial cities of the United States, together with our main office located near the U. S. Patent Office in Washington, D. C., enables us to more promptly handle business of our clients, particularly as the branch offices are in constant touch with the main office, and fully equipped to handle patent and trade-mark business in all its branches. Our branch offices also enable us to assist our clients in any negotiations regarding the sale or leasing of their patent rights.

Specialization—Our Staff

The field of invention is so vast that it is impossible for any one man to become an expert in all classes of invention. Only those skilled in the class to which the invention relates are capable of rendering efficient service. For this reason we employ a number of patent lawyers and mechanical experts who have been selected for their special knowledge and ability in certain lines of invention. Each case is placed in charge of an expert in the class to which the invention relates.

The Value of Your Patent

Will depend upon the skill and care with which your case is prepared and prosecuted in the United States Patent Office. This work will receive the benefit of skill and experience required by long and successful practise. We spare neither time nor pains to secure the broadest possible patents that the invention will warrant. That every case intrusted to us receives our best efforts and that our work is done conscientiously, skillfully and thoroughly is evidenced by the many unsolicited letters that we receive from our clients. We will furnish upon request lists of clients in any state in the union for whom we have secured patents.

All Communications and Data Strictly Confidential. Interference and Infringement Suits Prosecuted.

..... **FREE COUPON**

VICTOR J. EVANS & CO.

Patent Attorneys
Main Offices: 722-724 9th Street, N. W.,
WASHINGTON, D. C.

Write today.—Just fill in your name and address below and send to nearest office and we will send you Free of charge our Patent Books.

Name

Address



Our New York Office
1007 Woolworth Bldg.



Our Philadelphia Office
714-15 Liberty Bldg.



Our Washington Office
Victor Building



Our Chicago Office
1114 Tacoma Building



Our Pittsburgh Office
514 Empire Building



Our San Francisco Office
1010 Hobart Building

PATENTS

Booklet Free

Highest References

Promptness Assured

Best Results

Send drawing or model for preliminary examination

ALL BUSINESS GIVEN PROMPT AND PROPER ATTENTION

WATSON E. COLEMAN, Patent Lawyer, 624 F St., Washington, D. C.

U.S. PATENTS



SEND FOR THIS FORM

**DON'T LOSE YOUR RIGHTS
TO PATENT PROTECTION**

Before disclosing your invention to anyone send for blank form "EVIDENCE OF CONCEPTION" to be signed and witnessed. A sample form together with printed instructions will show you just how to work up your evidence and establish the same before filing application for patent. As registered patent attorneys we represent hundreds of inventors all over the United States and Canada in the advancement of inventions. Our schedule of fees will be found reasonable. The form "Evidence of Conception," sample, instructions relating to obtaining of patents and schedule of fees sent upon request. Ask for them—a post card will do.

PATENTS AND TRADE MARKS

LANCASTER & ALLWINE

480 Ouray Bldg. Washington, D. C.
Originators of forms "Evidence of Conception."

PATENTS

C. L. PARKER
Formerly Member Examining
Corps, U. S. Patent Office
PATENT LAWYER
MCGILL BLDG.
WASHINGTON, D. C.

Patents, Trade Marks, Copyrights, Patent Litigation

Handbook for Inventors, "Protecting, Exploiting and Selling Inventions," sent free upon request.

PATENTS

Trade-Marks, Copyrights and Patent Litigation

Write for advice and instructions how to proceed, costs, etc. Hand Book with illustrations of 100 Mechanical Movements sent free on request.

ALBERT E. DIETERICH

Patent Lawyer and Solicitor

Successor to Fred G. Steierich & Co. 621 Ouray Bldg., Washington, D. C.



PATENTS

Send us sketch or model for patentability opinion and exact cost of patent. Our book "How to Obtain a Patent," Sent Free on request. It tells how to apply for Patents, Trade Marks, Foreign Patents, Copyrights, etc.; gives information on Patent Procedure; tells what every inventor should know. Thousands of Inventors, who are our clients, are our references.

Chandlee & Chandlee, 25 Years' Experience.
455 7th St. Washington, D. C.



GEARS ALL KINDS SMALL

The most accurate made and prices reasonable. We carry a complete line of gears in stock for immediate shipment. Can also quote on special gears of all kinds. Send us your inquiries.

WRITE FOR CATALOGUE.

CHICAGO STOCK GEAR WORKS
105-109 S. Jefferson St., CHICAGO

INVENTORS PROTECT YOUR IDEAS

Send for our Guide Book, **HOW TO GET A PATENT**, and Evidence of Invention Blank, sent Free on request. Tells our terms, methods, etc. Send model or sketch and description of your invention and we will give our opinion as to its patentable nature.

RANDOLPH & CO.
600 F St., N. W., WASHINGTON, D. C.

NAME

STREET

CITY.....STATE.....



EXPERIENCE **SERVICE**

CLARENCE A. O'BRIEN

PATENT ATTORNEY

REGISTERED IN UNITED STATES PATENT OFFICE
MEMBER OF THE BAR OF
SUPREME COURT OF UNITED STATES, COURT OF APPEALS DISTRICT OF COLUMBIA,
SUPREME COURT DISTRICT OF COLUMBIA, UNITED STATES COURT OF CLAIMS.
PRACTICE CONFINED TO PATENTS AND TRADE MARKS.



PATENTS

& TRADE MARKS

SCIENCE

INDUSTRY

ECONOMY

EFFICIENCY

INITIATIVE

PROTECT YOUR IDEAS

ANY NEW article, machine, design or improvement thereof, or any new combination of parts or improvements in any known article which increases its efficiency or usefulness, may be patented, if it involves invention.

IF YOU HAVE ANY NEW IDEAS

which you feel are useful, practical and novel, take prompt action to protect your rights. If you have invented any new machine, or new combination of parts of improvement, or any new design or process, SEND DRAWING, MODEL OR DESCRIPTION of it for information as to procedure to secure protection.

Write Today for Blank Form "Record of Invention"

USE THE COUPON attached, and immediately upon its receipt I shall send you this form to be returned to me with drawing, description or model of your idea; promptly upon receiving your idea I shall write you fully as to procedure and costs.

No Charge for Above Information

ALL COMMUNICATIONS are held in strict confidence. My personal, careful and thorough attention is given to each case. I offer you efficient, reliable and prompt service—based upon practical experience. **Highest references.**

Write Today for free book, "How to Obtain a Patent." This book will give you valuable information, and it may save you much time and effort. **Send for it, NOW.**

My practice is devoted **exclusively** to United States and Foreign Patents and Trade Marks. Write me freely, frankly and with full confidence; it is very probable that I can help you. **Write TODAY.**

Clarence A. O'Brien, Registered Patent Attorney
325 Security Savings & Commercial Bank Bldg., WASHINGTON, D. C.
Directly Across Street from U. S. Patent Office

CLARENCE A. O'BRIEN, Patent Attorney, 325 Security Savings & Com'l Bank Bldg., Directly Across Street from Patent Office, Washington, D. C.

Please send me your free booklet, "How to Obtain a Patent" and blank form, "Record of Invention," without any obligation on my part.

NAME.....

ADDRESS.....

(WRITE PLAINLY)



PATENTS

Seventy-six Years of Practice

THE firm of Munn & Company filed its first application for a patent in 1846, and for seventy-six years has endeavored to keep pace with the inventive genius of the United States.

An experience of many years is at your disposal. If you have an invention which you wish to patent, send your sketches or model together with a description of your device, explaining its operation, and you will receive prompt, courteous attention.

Write for our Handbook on PATENTS

A full and complete booklet on Patents, Designs, Trade-Marks, Foreign Patents, Copyrights, Labels and Patent Office Practice with an explanation about our methods, terms, etc.

All communications strictly confidential.

Keep in touch with the inventions of the world by reading

SCIENTIFIC AMERICAN

The MONTHLY MAGAZINE with a special appeal to every man of inventive genius. Recent rulings of the Patent Office, descriptions of the latest patented inventions, legislation and court decisions affecting patents, are noted in this authoritative publication.

MUNN & COMPANY

Patent Attorneys

672 Woolworth Building, New York City

Scientific American Building, Room 2
625 F Street, Washington, D. C.

Suite 801, Tower Building, Chicago, Ill.
601 Hobart Building, San Francisco, Cal.

Please Mention Popular Mechanics

PATENTS

To the Man with an Idea

I offer a comprehensive, experienced, efficient service for his prompt, legal protection and the development of his proposition.

Send sketch, or model and description, for advice as to cost, search through prior United States patents, etc. Preliminary advice gladly furnished without charge.

My experience and familiarity with various arts frequently enable me to accurately advise clients as to probable patentability before they go to any expense.

Booklet of valuable information and form for properly disclosing your idea free on request. Write today.

Richard B. Owen, Patent Lawyer
9-303 Owen Building, Washington, D. C.
2276-E Woolworth Bldg., New York City

Have You An Invention?

If so the WORLD PROGRESS will show you how to **PROTECT AND PROFIT FROM YOUR IDEAS**. Sample copy free. One year's subscription \$1.00. Send for free book,

"WHAT TO INVENT"

containing SUGGESTIONS TO INVENTORS as to Inventions Needed. We invite manufacturers to address us regarding inventions they want.

WORLD PROGRESS PUB. CO., Inc.
Room 203 Victor Bldg. WASHINGTON, D. C.

Are You Old at 40?



A very common cause of early old age is the disturbed condition of an important gland. Even big, strong men are not exempt from this serious irregularity. Our plainly written, interesting, educational

FREE BOOK

"Why Many Men Are Old at 40"

may bring a priceless message

to you. It tells of a sensible

way by which thousands have relieved this prostate

gland condition. It tells how sciatica, backaches, foot

pains, interrupted sleep, mental depression, etc., are so

often due to this gland. Sold for over five years upon a

money-back-if-not-satisfied plan. Do not confuse it with

massage, medication, violet rays, etc. No obligation.

Write today.

**The Electro
Thermal Co.**



2128 Main St.
Stuebenville
Ohio



Tighten Your Grip on a Trade

Be An Electrical Expert

At \$75 to \$200 a Week

Every up-to-date fellow knows what a future there is in electricity.

Big pay—fascinating work on land or sea—rapid advancement in a field where jobs are ten times more numerous than trained men to fill them, where \$75.00 a week is just a fair starter, where top notchers pull down ten thousand dollars or more a year—in a field, where any man if he wishes, can easily have a business of his own, have men working for him, be his own boss!

But what the average young man does NOT know, is what a simple, easy, A-B-C sort of a job it is to get started.

You Can Start Right Now!

Yes, you. You don't need a thing you don't already have! You can read. You can write. You can figure. You can think. And in your breast is the fire of ambition—the desire to get ahead! All right, that's all you need—we can help you just as you are—just as we have helped scores, yes, thousands of other two-fisted young fellows determined to get out of the rut and into the electric field—into work that will be pleasant—easy—and all in your home, during spare time.

Fascinating Home Study As You Hold Your Old Job

With the help we will give you, you can slip right into one of these big pay—he-man jobs and never lose a day's work. After a few weeks' start, you can earn enough in installation and electric repair jobs alone to more than pay for the Course and lay a foundation for an Electrical Contracting or Repair Shop Business of your own. When the proper time comes, we will tell you the easy way to go about doing it.

The Most Practical, Thorough and Condensed Electrical Course Ever Written

This is the only home study electrical course that gives you the combined practical and theoretical training you must have before you can be a successful electrician without which you cannot succeed—with which you cannot fail.

Written not by ONE man, with the narrow one-man viewpoint, but by 22 of the brainiest, most successful, electrical experts ever drawn from the field of practice and theory. Gives you the complete mastery of the subject—qualifies you as electrical expert to boss jobs—fits you right into the kind of a job you want—and does it in shortest time—at lowest cost—with the

Most Binding Guarantee of Results Ever Offered!

Satisfaction guaranteed or no sale! We not only SAY we can make you an electrical expert, we Guarantee it! If you are not absolutely satisfied when you have finished our Practical Electrical Course, we will refund every nickel you sent us.

FREE! Experimental Outfit Worth \$30 Find out all about our offer. Find out about the thousands who have taken this course in preference to all others and MADE GOOD. Find out about the Electric Library—four elegant volumes—worth \$25, but free. About the free Drafting Course worth another \$30. The free Experimental and Demonstration Outfit, including a real, not a make-shift Electric Motor, Wheatstone Bridge, etc.—the most scientific, high-grade and complete Experimental Outfit ever supplied with a Course in Electricity. Get all the facts without obligation, without expense! Just send the coupon!

American School

Dept. E-974

Drexel Ave. and 58th Street, Chicago

**FREE
Electrical
Coupon**

American School,
Dept. E-974, Chicago
Please rush all information relative to your Course in Electricity. This obligates me in no way whatever.

Name.....

Address.....



YOU CAN NOW LEARN HOW TO INVENT!

- How to develop your imagination
- How to develop your ideas
- How to get the facts you need for inventions
- How to keep legal records of ideas
- How to use scientific principles of mechanics
- How to avoid wasting time on impractical inventions
- How to apply for a patent
- How to organize a company
- How to protect your rights
- How to market a patent

and hundreds of other vitally important facts which EVERY successful inventor knows and uses. A remarkable new, and much needed course which can be studied in spare time, at home.

Make Your Ideas Pay You a Fortune

You can now learn how to train your mind along scientific inventive lines. No longer need you let your mind wander in unprofitable fields. You can learn how to think of worth-while ideas and make your ideas pay you money. The trouble with most people is that they do not know what to do with their ideas. Millions of dollars go to waste because of these undeveloped ideas. Now for the first time you can learn to harness your thoughts and make them work for you! One little invention, properly developed, may make you independent for life!

You Are Born an Inventor Develop your ability



Raymond F. Yates

Every man, woman, and child is born with creative imagination. Some develop this faculty to a greater degree than others, and those who develop it to the greatest extent are successful inventors. Invention is an orderly process of the mind, which combines two or more known facts to produce a new fact. Anyone who develops the right mental process can become an inventor. Every successful inventor has this type of mind, developed by constant experience over a period of perhaps many years. Heretofore those who succeeded in the field of invention had to discover all the principles themselves. But, now, just as any student of medicine, law, or engineering can take full advantage of all the recorded experience in these fields of study, so can YOU take the same kind of short cut to the habits of thought, and the methods of work required of successful inventors.

"Invention Is a Science and Should Be Taught as a Profession,"

Says Edison!

Every inventor realizes the hopelessness of groping in the dark for the habits of thought and methods of work required for successful invention. Trying to invent without knowing the fundamental requirements of invention is like trying to build a bridge without knowing engineering.

This is the first course in practical invention that has ever been devised. Now you can take Edison's advice and actually learn HOW TO INVENT—how to make invention a profession! In simple, easy-to-understand language, you are told how successful inventors work; you learn how to use the secrets of invention that convert a simple little idea into money.

Amazing Book On Inventive Science Free

Fortunes have been made by men who have thought of a "little" idea in a flash—the bottle top, the crimped hairpin, the thin lead automatic pencil, the snap fastener—earned fortunes, yet there are as many fortunes lost by inventors who did not know just what to do about their ideas. A wonderful book explaining this wonderful new course written by 14 practical inventors has been written and will be sent free to those genuinely interested. If you have ever had an idea for an invention, or if you would like to become a spare-time or professional inventor, and if you would like to know what to invent, send in your name at once on the coupon or a postal NOW! Only a limited number of these books are available for free distribution.

BUREAU OF INVENTIVE SCIENCE
Dept. 312, Wisner Bldg. ROCHESTER, N. Y.

Bureau of Inventive Science, 312 Wisner Bldg., Rochester, N. Y.
Please send me your free book "The Science of Invention."

Name.....
Address.....
City..... State.....

Can You

think of a simple, practical idea that will fill one of the many requests we have on file for new inventions? It may mean a fortune for you. Thousands of things are needed **right now**. Your brains can help. Send today for our great new book—

"Inventions and Trade-Marks, Their Protection and Exploitation" and learn more about making money from ideas than you ever knew before. It tells many things that are wanted, too.

A postal will do—
It is free

We Help Our Clients

without charge, to get the dollars out of their ideas—having facilities none others possess. Advice free. Don't delay—get the book at once.

American Industries, Inc.
200 Patent Dept.
WASHINGTON, D. C.

Patents
Advertised
For Sale Free
in Invention and
Manufacturing Supplement

Published for the man with an idea. Send for free sample copy. One year's subscription, 50c

PATENTS

As one of the oldest patent firms in America we give inventors at lowest consistent charge, a service noted for results, evidenced by many well known Patents of extraordinary value. Book, Patent-Sense, free. Lacey & Lacey, 645 F St., Wash., D.C. Estab. 1869.

PATENTS

REGISTERED PATENT ATTORNEY SINCE 1905
CHARLES W. LOVETT SECURITY BLDG LYNN MASS.
SEND FOR FREE BOOKLET

No Joke To Be Deaf



—Every Deaf Person Knows That

I make myself hear, after being deaf for 25 years, with my Artificial Ear Drums. I wear them day and night. They are perfectly comfortable. No one sees them. They stop head-noises. Write me and I will tell you a true story, how I became deaf and how I make you hear. Address

GEO. P. WAY, Artificial Ear Drum Co. (Inc.)
80 McKeeney Bldg., 2631 Woodward Ave., Detroit, Mich.

NO MORE BALD HEADS



WHEN our VACUUM CAP is used a few minutes daily. We accept no pay until you have tried the Cap 30 days and are satisfied. The Vacuum Cap is an appliance that draws the blood to the Hair Roots and starts a new healthy crop of hair. It stops Dandruff, stops the hair from falling out.

Bought by Doctors and men who know that it is the only reasonable HAIR GROWER known to science. No Drugs Used. Write for application blank, testimonials, and booklet on "HAIR," sent sealed in plain envelope, FREE.

THE MODERN VACUUM CAP CO.
Q 559 BARCLAY, DENVER, COLO.

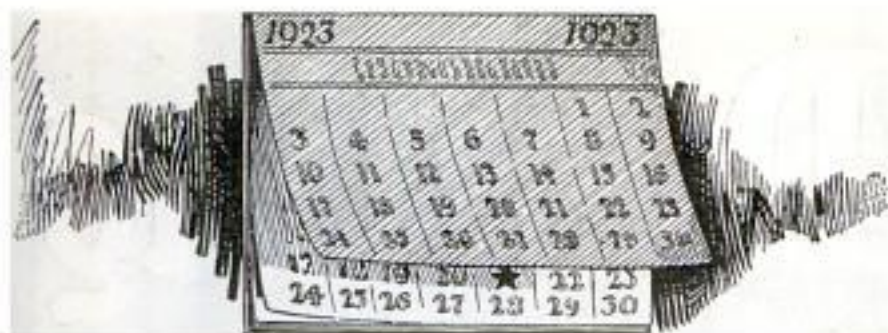

I Will Make You a High Priced Auto- Motive Electrical Expert in 50 days!

IMPORTANT NOTICE! This school is the only one in the country that limits each class to 20 men. That's one reason the training you get in 50 DAYS brings bigger money than many College Graduates can earn after 50 MONTHS of Study.

MANY Ambu Automotive Electrical Experts earn \$132 a week. And that isn't the top limit. Others operating for themselves charging for the actual VALUE they render, expert service, time saving, etc., do even better. Ellerd, for instance, writes that he averages \$1,000 a month. Ludlow \$175 a week. Get my free book which tells how they do it.

Big Jobs Now Open

The demand for Automotive Electrical Experts has always been far greater than the supply. Garage and Repair Shop owners can get plenty of \$40 a week mechanics. They can train mechanics in the shop, but electrical experts need study—training. That's why there is a shortage of men who understand the electrical part of a car. Yet 78% of auto troubles are in the electrical system. No wonder there is always plenty of big jobs for Ambu men. My free book tells about these jobs.

No Experience

You don't have to know about Automobiles or Electricity when you start to learn this delightful, big-pay profession. I supply you all the knowledge you need in 50 days. I train you to locate, instantly, any electrical trouble on any make or model of car and have the car running long before the average auto mechanic could find out what was wrong.

No grease; no heavy lifting, no hand labor. In fact, in some places, the Automotive Electrical Expert directs only—he has mechanics perform the labor under his supervision. See the facts and figures in my free book.

Amazing New Way to Train

When the government needed Auto-Electrical Experts for the war there was no time to waste. Men had to be trained 100% right and sent out almost overnight. The man who invented the 50-day method was the man to whom Uncle Sam went for help. Results were amazing. Never before had such a thing been accomplished by anyone. A complete practical thorough training in 50 days. So remarkable that after the war, and at a great cost, it was made available to Ambu students only.

Ambu has even improved on the original plan by not admitting more than 20 men to a class. No other school does this. The smaller the class the more you learn.

Come to Chicago or Train at Home

Hundreds of men who cannot come to Chicago have begged me repeatedly to give them Ambu training at home. And now for the first time you can receive the same world famous training you would get if you came to my great shops—right in your own home—during spare time. No need to give up your present job. I guarantee that my home training will satisfy you or I will refund your money.

GET FREE BOOK And Unusual Short Time Offer

This book tells what others are making and shows how thousands with no education or experience have learned this fascinating, big-pay profession in 50 days. If you can't come to Chicago, the book shows how you may make your \$132 a week and more just as those do who learn in Chicago. Also get my amazing temporary offer.

AMBU ENGINEERING INSTITUTE
Dept. 112, 2632 Prairie Avenue
CHICAGO, ILLINOIS

C. J. Buckwalter, Pres.
AMBU ENGINEERING INST.
Dept. 112, 2632 Prairie Ave., Chicago, Ill.

Please send me FREE Book and complete information about the big-pay, uncrowded field of Automotive Electricity. Explain also your remarkable short time offer. I am interested in

Home Study Course
 Resident Course at Chicago

Name.....
Address.....
City.....
State.....

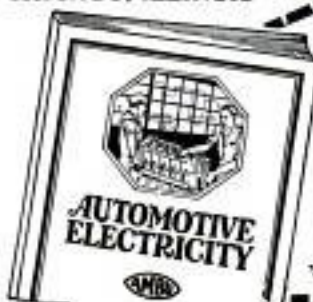

\$90 Drafting

To every student enrolling now I give an opportunity of getting a \$90 drafting course absolutely without cost to him. Send for full information today and learn all about this offer.

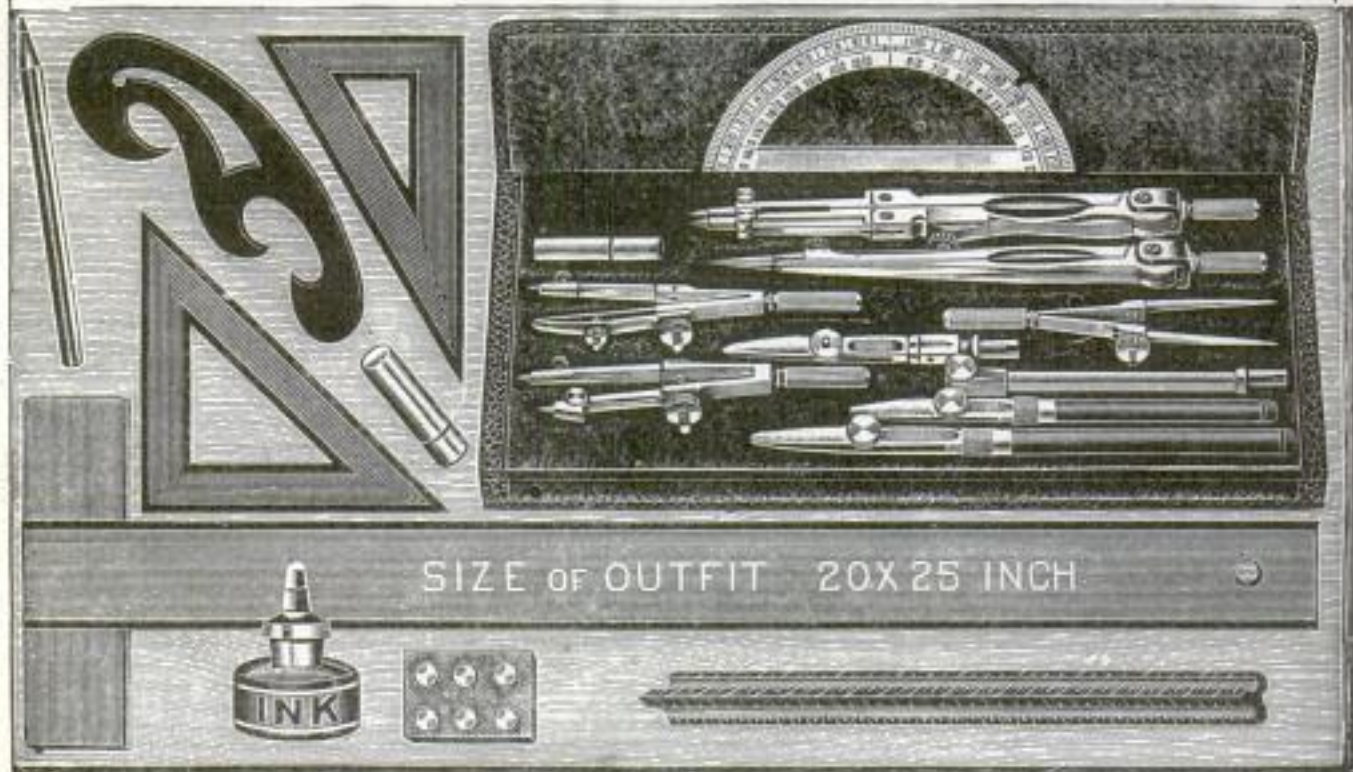

SIZE OF OUTFIT 20X25 INCH

Drawing Outfit Free!

To every student enrolling now I give an opportunity also of getting a regulation draftsman's outfit made up of the very same instruments which I use myself. The outfit contains everything necessary for the performance of your work in drafting. Every student gets this splendid set without cost. See illustration above.



Draftsman's Pocket Rule FREE!

To everyone who writes now for the offers which I am making, I will send this Ivorine pocket rule free. All you need to tell me is your age and that you are interested in becoming a draftsman. I want you to have this constant reminder of the great future which will be in store for you if you become a draftsman.

Course FREE



Drawing Table — FREE!

I am giving this practical folding Chief's Own drawing table to each of my students positively without cost. I am making this offer to get men everywhere interested in the great future which a draftsman has. More draftsmen are in demand to-day—right now—than ever before. It has been estimated that there are 6,000 calls for draftsmen every month. So, I want students to enroll early.

I Guarantee

To Train You Until You Are Placed
in a Position Paying Up to

\$250 and \$300 a Month!

I do this by a method no other man nor institution can imitate. I give you personal training at home by mail until you are actually placed in a position paying up to \$250 and \$300 a month. Write and I'll send you full particulars.



\$300 a Month Salary — — \$450 on the Side at Home!

That's the kind of money my drafting students make. Read what this one says:
"As a beginner I am doing fine. Am earning a salary of \$300 per month, besides I made over \$450 at home the last two months, drawing plans for private parties. The practical drafting training you gave me by mail put me where I am in less than six months' study. Thank you for all your personal interest and help you gave me so far."—(Signed) J. B. (Name and address upon request)

Send Coupon for FREE Book

Send coupon for my free book, "Successful Draftsmanship". Also full information as to how you can get a \$90 Draftsman's Course Free. Send the coupon now for the free book.

Chief Draftsman, Engineers' Equipment Co.
1951 Lawrence Ave., Div. 13-59, Chicago, Ill.

Chief Draftsman, Engineers' Equipment Co.
1951 Lawrence Ave., Div. 13-59, Chicago, Ill.

Without any obligation to me please mail your book "Successful Draftsmanship" and full particulars of your liberal "Personal Direction" offer to a few students. Also full information as to how I can get a \$90 Drafting Course Free.

Name

Address

Age

YOUR KNOWLEDGE OF MECHANICS

ought to "snap you into" many a novel and useful idea that could be given practical form as a

PRESSED METAL UTILITY

thereby adding to both your *bank account* and your *prestige*. One of America's great industries wants your aid in extending the basis of its public usefulness, and pays cash for ideas.

Its range of usefulness, economy and convenience to every man, woman and child, is so great that it has hardly begun to blaze the trail of its possibilities.

The Pressed Metal industry today totals about \$20,000,000 a year. If it could realize its full field of utility by a *wider public knowledge of its value* as a *Public Service*, it would crowd ten times that annual output.

Shoe-eyelets are Pressed Metal. Modern railway cars are Pressed Metal. Pencil-tips are Pressed Metal. Stew-pans, big auto-truck frames and little battery boxes are Pressed Metal. Telephone instruments and door-knobs are mostly Pressed Metal. What else can you think of that *ought to be* Pressed Metal?

Pressed Metal is *anything* that can be produced by *stamping* from sheets of steel, brass, aluminum, copper or any other useful metal. Take the brakes off your brain and

SELL US A PRACTICAL IDEA

of some new and useful way to utilize Pressed Metal *in Place of Other Materials*. The Pressed Metal Trade Extension Council will promptly *pay cash* for every acceptable suggestion approved by our Engineering Advisory Board.

Our purpose is serious and constructive and in the public interest. The membership of the undersigned Council includes many of the largest manufacturing concerns in the United States and their objects and plans are broad and businesslike.

We are releasing a surprising volume of *hidden genius* and *practical intelligence* now bottled up in thousands of ambitious workers.

The FREE Pressed Metal BOOKLET Tells HOW TO CAPITALIZE YOUR MECHANICAL TALENT

or inventive genius—or maybe just your "good old common-sense." It tells all the conditions and the amounts to be paid for the successful ideas, and also how to protect yourself against misappropriation of your creative thoughts by others. WRITE TODAY. (A post card will do, but please make it easily legible so it can be properly filed and acknowledged.) "Every day lost is lost forever." Address

PRESSED METAL TRADE COUNCIL

27 QUINCY STREET, SUITE 1701, CHICAGO



McGraw-Hill Home Study Courses

"Know your work as experts know it and get an experts pay"

These famous books will help you win a big-pay job in your chosen work

OVER 100,000 men are stepping ahead in their work with the aid of McGraw-Hill Home Study Courses. These courses enable a man to skip over the long years of hard work and low pay—they show him how to fit himself, easily and quickly, for bigger things in electricity, machine shop work, electrical maintenance and repair, and power plant engineering.

Practical subjects taught by practical men without the aid of correspondence instruction

EACH of these courses is a complete educator in itself. All the facts—the information you may wish to have about any particular subject is before you ready for instant use. There is a minimum of theory, and every line and every illustration will be found clear and understandable even by the beginner.

A lifetime of experience packed within these books

These courses contain more information than any one man could acquire in a whole lifetime of practice. The books have been written by men who are

The Croft Library of Practical Electricity

8 vol. 3000 pages—2100 illustrations.

40,000 sets of this great library are now in use—without a doubt the greatest sale ever attained by an electrical library. The books cover the entire field of electricity, from the fundamental principles to central station work—from the operation of electrical machinery to outdoor and indoor electrical illumination. \$19.50, payable \$1.50 in 10 days, and \$2 a month.

Machine Shop Practice

9 vol. 3978 pages—3608 illustrations.

This is the 1923 edition of this famous work—completely revised and brought up to date, with many new volumes added. The set is packed to the covers with the kind of information that every machinist, every apprentice, every toolmaker and shop foreman wants. \$19.50, payable \$1.50 in ten days, and \$2 a month.

Electrical Maintenance and Repair

5 vol. 1736 pages—1818 illustrations.

The only library of its kind. Contains the largest collection of practical methods for electrical repair and maintenance men ever put together. Covers wiring diagrams, armature winding, motor repair, connecting induction motors, electrical machinery and electrical methods of all kinds. \$14.00, payable \$2 in ten days, and \$2 a month.

Power Plant Practice

9 vol. 3978 pages—3778 illustrations.

Cost over \$80,000 to produce. The books cover everything that the power plant engineer needs to know to fill a big-pay position. Thousands of first-hand facts—thousands of specially-drawn illustrations. Practical from preface to index. \$19.50, payable \$1.50 in ten days, and \$2 a month.

acknowledged leaders in their field—men who have lived and worked with the very problems they write about. They are books by experts, and by studying them you, too, can become an expert and earn an expert's pay.

Only 7c a day for the course you select

Check on the coupon the course you wish to see and we will send it to you, all charges prepaid. No expense—no obligation. If you keep the books, pay for them on our easy terms. If they are not what you want, send them back to us at our expense.

FREE EXAMINATION COUPON

McGraw-Hill Book Company, Inc.,
370 Seventh Ave., New York

Send me for 10 days' Free Examination the library checked below. If satisfactory, I will send first payment in 10 days and the balance at the rate of \$2 a month until the full price has been paid.

- () Practical Electricity, 8 vol. \$19.50.
 () Machine Shop Practice, 9 vol. \$19.50.
 () Electrical Maintenance and Repair, 5 vol. \$14.00.
 () Power Plant Practice, 9 vol. \$19.50.

Signature.....

Residence Address.....

City and State.....

Your Employer.....

Your Occupation.....

PM-12-23

Mail this FREE Examination Coupon

AMPLION

The World's Standard Loud Speaker

You Never Tire of the Amplion

THE most striking thing about the Amplion is that its reproduction is never tiring. Its perfect rendition, absence of harshness gives you a thrill that is pleasing and refreshing.

No matter if it's voice or instrument, the charm is there. The message has lost nothing in its flight through space. It holds you and enthalls you just as if you were listening to the original.

The Amplion is made in several sizes to suit all occasions and pocket books from \$18 for the Junior model to \$66 for the Concert type

Ask your dealers to let you hear the Amplion. You owe it to yourself to hear the world's standard loud speaker before you buy.

Folder of styles and prices on request.

Patentees:
Alfred Graham & Company

Signal Electric Mfg. Co.

Sole U. S. Distributors Menominee, Mich.

BURNDIPT OF CANADA, Ltd.

Canadian Distributors
172 King Street, W.,
Toronto



*Amplion
Beauty
AR-15
\$46.00*



*Phonograph Unit
AR-35—\$24.00*



*Amplion
Dragon
AR-19
\$40.00*



*Amplion Junior
DeLuxe AR-45
\$26.00*



*Amplion Portable
AR-61—\$50.00*



*Amplion
Junior
AR-39
\$18.00*

The Supremacy of the AMPLION is the Supremacy of Actual Performance

Emk. Mrs. Frances E. Coleman,
3315 Montgail Av., Kansas City, Mo.
Clipping from Kansas City Star
9/23/23

Popular Mechanics Magazine

REGISTERED IN U. S. PATENT OFFICE

WRITTEN SO YOU CAN UNDERSTAND IT

Vol. 40

3705

DECEMBER, 1923

No. 6



“Pepping” Used Cars for Quick Sale to Unwary Buyers

THERE are more tricks in selling a used automobile than David Harum ever dreamed of when he was trading horses,” remarked the owner of a garage sadly to a man who had recently passed through his shop.

On the way the visitor had run across a friend lying beneath a battered specimen of a car. Beside him was a package of a widely known breakfast food and a smear of grease from the transmission case cover.

“Getting ready to feed?” he had asked.

“Nope,” was the answer. “Just trying to ‘dope’ up this old wreck until I can get rid of it.”

“But what are you going to do with the ‘oats’?”

“I’m putting them in to stop the noise of these gears until I can sell the ‘bus’.”

Then he went on to explain that chattering, whining, or generally noisy gears in the motor, transmission, or differential were one of the first signs of approaching senility in an automobile.

In comparatively new cars, the remedy,

of course, lies in refitting, but in the older models that are sold “azz-izz,” this would be too expensive, and so owners and unscrupulous dealers resort to wood fiber mixed with grease, ground cork similar to that in which grapes are packed, or even the heavy brands of breakfast food. The result is a few days of quiet operation until the foreign substance is packed outside the reach of the gear teeth, and then—more noise than ever.

Before manufacturing processes became as perfected as they are today, even the makers resorted to such subterfuges. Many years ago, a plant whose cars have long since disappeared from the highways had considerable trouble with noisy differentials. The fault was serious enough to stop sales, but the manufacturer had neither the time nor the money to make replacements after the cars had come through production. And yet, some way

8705



ceive even the expert eye, while cheap interliners hold it together for a few more miles. Piston slapping may be cured for a time by replacing the regular lubricant with steam cylinder oil (known as 600 W), which is about the consistency of molasses. And even the storage battery, when it is actually too weak to turn over the starter, can be brought back to a short life by adding strong acid to the electrolyte.

Then in demonstrating, seemingly marvelous changes may be wrought in the performance of a motor by the addition of a very small quantity of ether to the gasoline. Sometimes, also, moth balls are used for the same purpose, although there is considerable debate as to their efficiency.

But, after all, the main dependence of the salesman is upon the ignorance of his prospect and his own quick thinking. This is illustrated by the story of a prospect who demanded that the demonstrator drive up a hill that the latter knew the car would not make.

"Blank car will make it easily," the would-be purchaser announced.

"That's nothing," said the driver, "this car will even back up that hill," and to prove it, he

had to be found to meet the emergency.

Finally the head tester ordered a large pot of tar to be placed behind the factory. No one knew about it except members of the test crews, and they said nothing, but when they found a car with a noisy axle, they drove it behind the plant, poured a ladle of hot tar into the offending differential, and all noise miraculously vanished. Of course, the trouble came back, but probably not until the car had been safely sold and paid for.

This incident took place in the days when the motor car had hardly emerged from the experimental stage. Today, not even the smallest plant would countenance such a deception, and no reputable dealer or distributor would permit the "doping" of even a used car. Where tricks are practiced, they are the work of fly-by-night individuals who are seeking to make a quick profit on some old car they have picked up for a song.

In such cases, there are scores of ways of quickly rejuvenating a worn-out machine. Lampblack and turpentine will make old upholstery look like new for a few hours. Preparations that lend a deceptive luster to the body finish and top, although they result in their eventual destruction, are readily obtained.

Rubber paint helps the oldest tires to de-



Acid, Ground Cork, Moth Balls and Ether Being Used to Rejuvenate an "Azz-Izz"

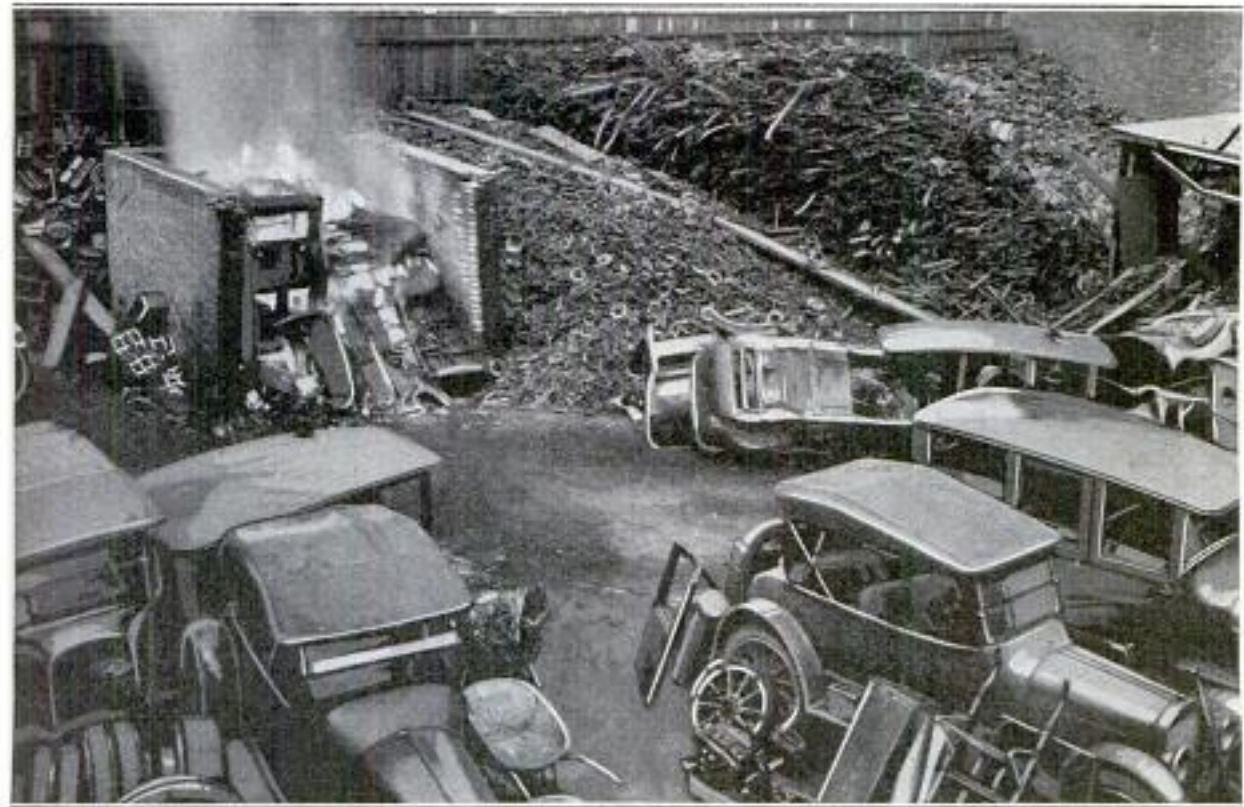

The Junk Heap, Where Automobiles Find Their Last Resting Place. Some of the Parts Being Salvaged and the Upholstery Burned, the Bodies Going to the Steel Furnace

turned the car around and mounted the grade in reverse.

As a result, the sale was instantly closed, the prospect not being sufficiently familiar with mechanics to know that the average reverse-gear ratio is so low that any car will almost back up the side of a wall.

Good or bad, however, there comes a time when every car is fit only for the junk heap. Usually, the body wears out first. Then the rivets in the frame loosen up and the transmission and differential gears become worn beyond hope of redemption.

Contrary to the general impression, the motor generally lives longer than the car and when its usefulness on the road is over, it often finds a place on the farm or in a motor boat. Also, many of the smaller parts are salvaged and resold by the junk dealer who dismembers the machine.

About the only material that is not put to some use is the upholstery and top fabric. To dispose of these in the quickest way, the bodies are ripped from the chassis, piled in an open-air furnace, and burned. The metal parts that remain are then sold and remelted by the steel mills. Copper, brass, and aluminum scrap also find a ready market and are made into various things.

After steadily rising from a product with an uncertain future some 25 years ago, the motor car commanded third place

in the rank of the nation's industrial products two years ago. In 1921, it was topped only by packing and petroleum products.

Today, according to the latest government census of manufacturers, the motor car leads them all. The number of vehicles produced in the United States this year will be between three and one-half and four million, according to official estimates.

Taking the National Automobile Chamber of Commerce's figures that the average value of a passenger car is \$750 and that of a truck \$1,500, the estimates conclude that the year's output will exceed three billion dollars in value.

On July 1 there were over 13 million passenger and truck motor vehicles in operation in this country—one to every nine inhabitants. That showed an increase in four years of 85 per cent in cars used.

As it is estimated that the life of a car is about five years, greater numbers of used cars are coming on the market each year.

☞ To warn miners of the presence of fire damp, a lamp has been invented in England that sounds a clear musical note when the atmosphere contains two per cent of this harmful gas. As the quantity of this vapor increases, the pitch and intensity of the instrument's tone rise in proportion, sounding an unmistakable alarm.

LINE GUIDE ON TYPEWRITERS IS RUN BY MOTOR

3646

Preventing eyestrain by placing notes to be copied directly in front of the typist, an electric motor-driven line guide for a



The Line Guide and Copyholder that is Operated by Electricity to Increase Typist's Speed

copyholder has increased the efficiency of stenographers. The invention was recently put on the market by an eastern man. Two buttons placed before the typewriter keyboard within easy reach of the thumbs are connected by wires with the motor. A slight touch on one raises the line guide, and pressure on the other lowers it.

Admission 3947

ROUND-THE-WORLD TRIP BY AIR TO START NEXT SPRING

Preparations are now being made by the British air force for a trip around the world next spring. The route will be by the way of France, Egypt, Mesopotamia, Persia, India, Burma, China, Japan, Kamchatka, the Aleutian Islands, Canada, New York, St. Johns, and a final lap across the Atlantic to England. If the weather conditions are favorable when the ship reaches the United States, the Atlantic Ocean will be crossed in a single hop, otherwise the plans are to go by the way of the Azores and Portugal. It is estimated that the total distance to be covered will be about 21,000 miles, which, at an average of 100 miles an hour, would occupy 10 days' flying time.

MAZE OF WALLS SLOW AUTOS AT RAILROAD CROSSING

3681

To reduce the possibilities of railroad-crossing accidents, a system of walls has been devised, which are so arranged that a motorist is forced to slow down to five miles an hour before passing over the tracks. While of sufficient height to prevent a machine from bouncing over them, the concrete abutments are low enough to give the driver a clear view ahead. As each car enters the passageway, it is compelled to fall in line. Thus the automobilist who may desire to go around those in front is checked by the barriers. In the center of the road there is a fencing, which provides a straight driveway after the machines have crossed the railroad.

FIRE FED BY ELECTRIC STOKER THAT PUTS ASHES IN CAN

3645

Furnaces equipped with an electric stoker, being made in an eastern city, can receive an even and constant supply of fuel and have the ashes removed and stored in a can without any other aid. By making use of the cheaper grades and sizes of coal, which are burned at a regular temperature, the apparatus saves considerable on the cost of heat. It is built to

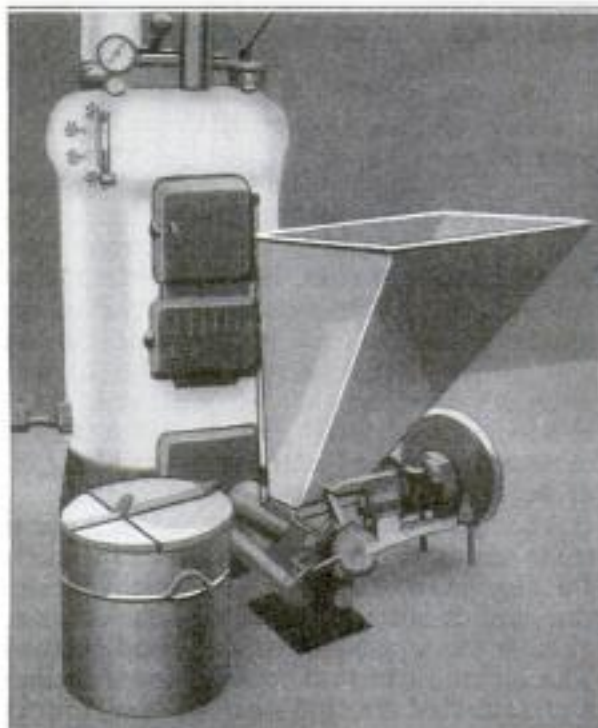

Automatic Electric Stoker That Feeds Fuel to Furnace and Stores Cinders in Ash Can

attach to any steam, hot-water, or hot-air furnace and operates by a motor that gets power from an ordinary light socket.

The Domestic Stoker Co., 101 Park Ave. New York City.

Detroit Free Press 10/1/23

RACE HORSE RIDES LIKE ROYALTY IN SPECIAL AUTO

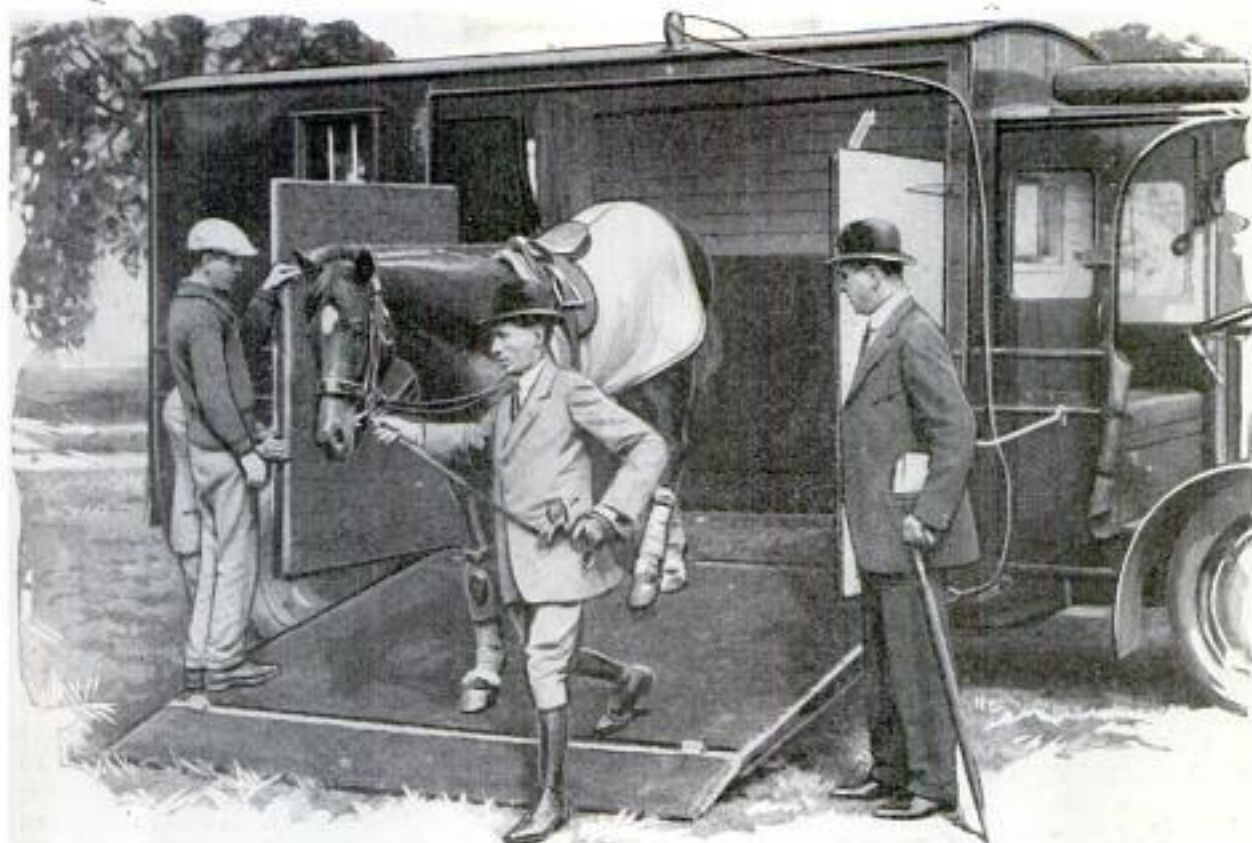

Papyrus, Winning Horse of the English Derby, Which Crossed Ocean to Meet Best American Three-Year-Old, Being Led Out of Padded Automobile that Carried It from Ship to Race Track

Papyrus, winning horse of the English Derby, which was brought to the United States recently to participate in a match race with America's best three-year-old, was conveyed from the ship to quarters at the race track in a padded automobile. This was but one of the many precautions

taken to prevent injury to the fleet animal. On the voyage it was closely attended by a veterinary who regulated its diet and watched over its health, and several trainers guarded the prized beast constantly night and day. Not once during the entire trip was the horse left alone.

ADS PRINTED ON SEALING TAPE AS IT IS UNWOUND

To reduce printing costs and save time, a holder for wrapping tape used instead of string is being made that prints a continuous series of advertisements on one side of the paper, wets the gum on the opposite surface, and cuts it into required lengths. There are no wearing parts to get out of order, and the inked rolls are instantly removable and interchangeable, permitting a merchant to substitute new designs and color combinations. Thus, attention can be called to special sales or



3721
 advertisements on one side of the paper, wets the gum on the opposite surface, and cuts it into required lengths. There are no wearing parts to

get out of order, and the inked rolls are instantly removable and interchangeable, permitting a merchant to substitute new designs and color combinations. Thus, attention can be called to special sales or

The Scott Corporation
 72 W. Washington
 Chicago

products. The ink is dried as the strip is pulled from the container. Sealing tape, besides making a neat package, and handled as easily as twine, is said to be much cheaper.

OPEN-AIR LIBRARY IN PARK LENDS VISITORS BOOKS

For the convenience of frequenters of a municipal park in Spain, a small open-air public library has been erected, which supplies them with reading matter free of charge. It is attended by a policeman, who, each morning and evening, opens and closes the shelves. Visitors help themselves to any volumes they desire, sit down on the benches under palm trees, and, after having enjoyed their reading, return the books. No receipt is demanded and no book has ever been stolen.

377-7-100
 Pontevedra
 Spain
 Copyrighted material

*Christie 356
 Station, Winnipeg,
 Canada.
 Alvin*



Magnets Have Proved Efficient for Removing Iron and Steel Filings that Become Mixed with the Fine Particles of Valuable Metals Gathered About Jewelry Plants



Floors of Factories Working in Valuable Metals Are Cleaned Daily by Powerful Vacuum Devices that Convey the Sweepings to Storage Tanks for Safe Keeping

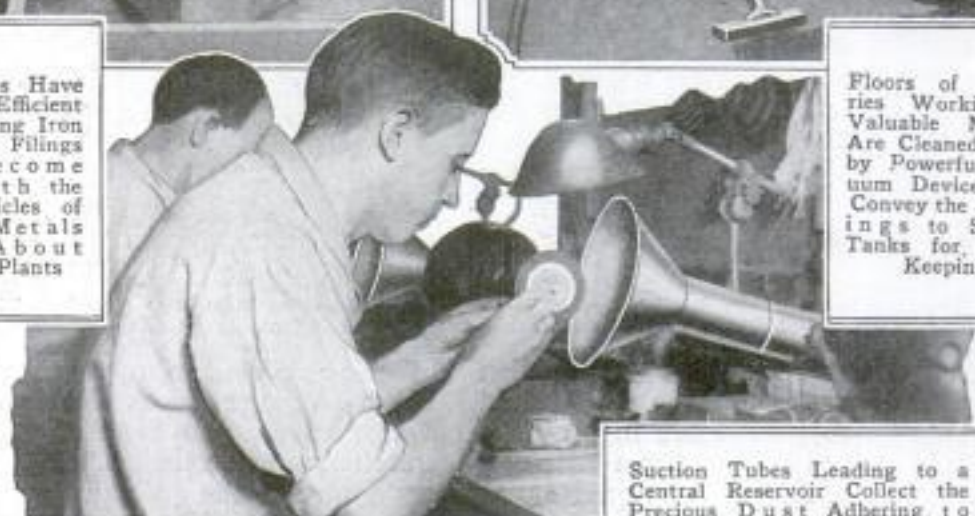

Suction Tubes Leading to a Central Reservoir Collect the Precious Dust Adhering to Whirling Polishing Wheels. Below: Through Felt Bags Waste Water that Has Picked Up Gold, Silver, and Platinum Dust, Is Strained for Its Treasure

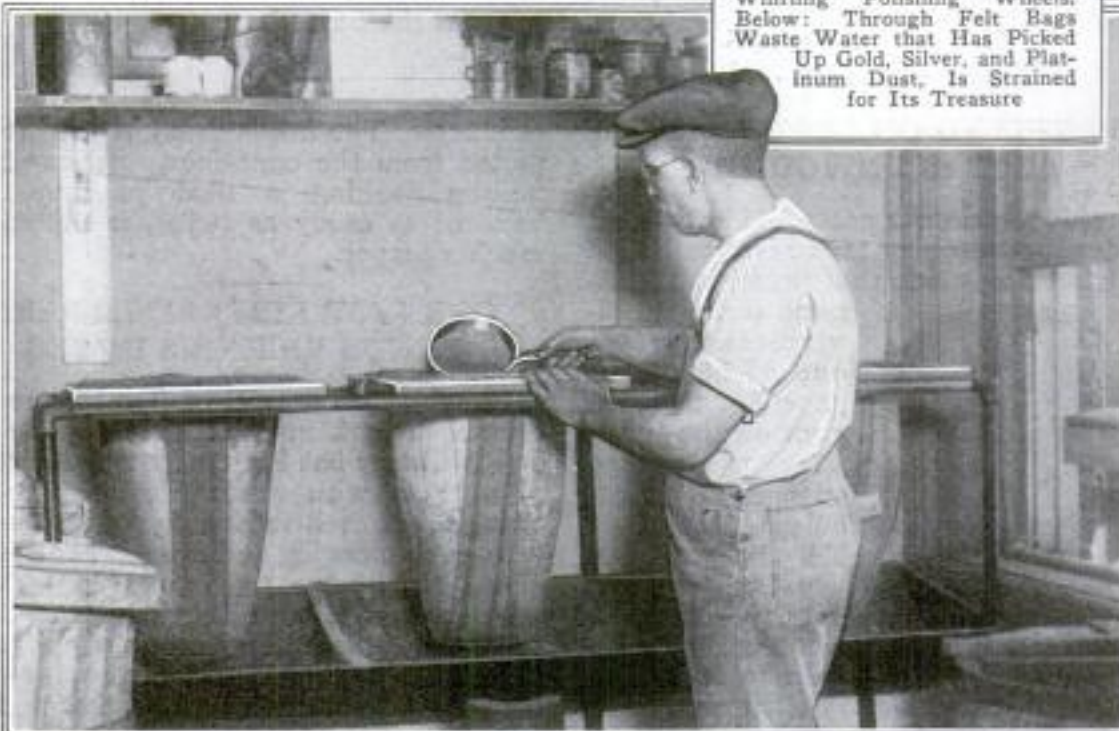

3384 Cml. Leon Harpole,
1725 W. Lake Ave. Chicago.

Mining Gold from Dust on Floors

Large

How a Youth's Idea Led to Recovery of Long-Spurned Wealth

OLD King Midas was immortalized in fable through a gift of the gods by virtue of which everything he touched, including his little daughter, turned to gold.

Just a humble youth employed in a modest jewelry manufacturing establishment had an idea and rented the yard at the rear of the shop where for years sweepings of the plant had been thoughtlessly thrown on the ground. He dug up the earth by wagon loads, treated it, and amassed a fortune in the platinum, gold, and silver with which it was richly laden.

Then the young man leased a vacant building that had been occupied by jewelers for many years. He tore up the floor and found its timbers a veritable mine of precious dust. Another deposit of the treasure had settled in the soil beneath, and his second fortune was reaped.

Soon after, jewelers began to install elaborate machinery to reclaim the fortunes in valuable metals which, before that time, had been recklessly trodden under foot. Suction plays an important role in this phase of the recovery. Behind each buffing and lapping

wheel, a tube is fixed, opening in a trumpetlike enlargement. Dust is drawn into



Melting Precious Dust from Sweepings

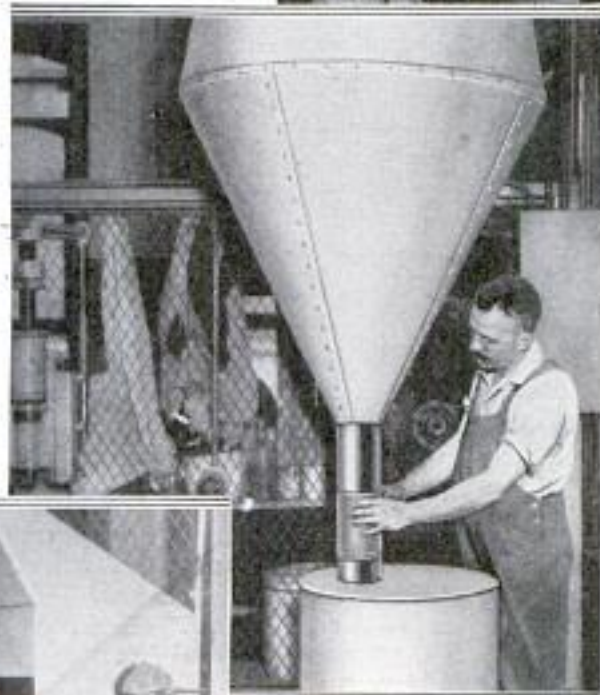

Tank Where Vacuum Cleaners Store Dirt

these and, thence, conveyed to a great metal drum. Jewelry from the polishing wheels is washed in a solution of hot water and ammonia which is carried off, passing through settling tanks, where gravity robs it of the

precious freight it has picked up, much after the fashion of the old-time placer mine.

The ablutions of the workmen provide another source of revenue. The metallic grime which they clean from their hands at the washbowls passes into basins beneath and is later recovered. Even the aprons they wear at their toil yield a precious toll, the water from the tub in which



Photos Copyright, Underwood & Underwood
Chemicals Are Often Used to Extract Gold from Dirt

Similar equipment made by
Solds with Bros. Smelting and Refining Co., 29 E. Madison, Chicago

Used by J. Mulheeny, 1358 State St. Chicago

they are laundered being saved for treatment. All this miry waste is collected at weekly intervals and strained through bags of felt.

While these processes are going on, the hand of economy is turned in another direction. The floors are cleaned by vacuum and all the dust is scrupulously stored in containers. But conservation does not yet reach its pinnacle. It is carried to its highest point in the employment of metal doormats at the entrances to the work-rooms to catch the particles of dust adhering to the shoes of the operators.

Metals recovered thus, from every nook

and cranny, are now ready for the next step. The gleanings from felt bag, floor, and polishing wheel are placed in a gas stove and heated to incandescence. The resulting mass is thrown into a cylindrical sieve which separates lumps from the pulverized dust. These lumps are crushed in a mortar and directly refined.

Roughly, a pound of the reclaimed dust is worth between \$24 and \$25, and its combined value mounts up swiftly through the weeks and months of daily operation. The yearly saving in one large jewelry-manufacturing plant reaches a total of several thousand dollars.

3692 LAKES-TO-GULF WATERWAY NEARS REALITY

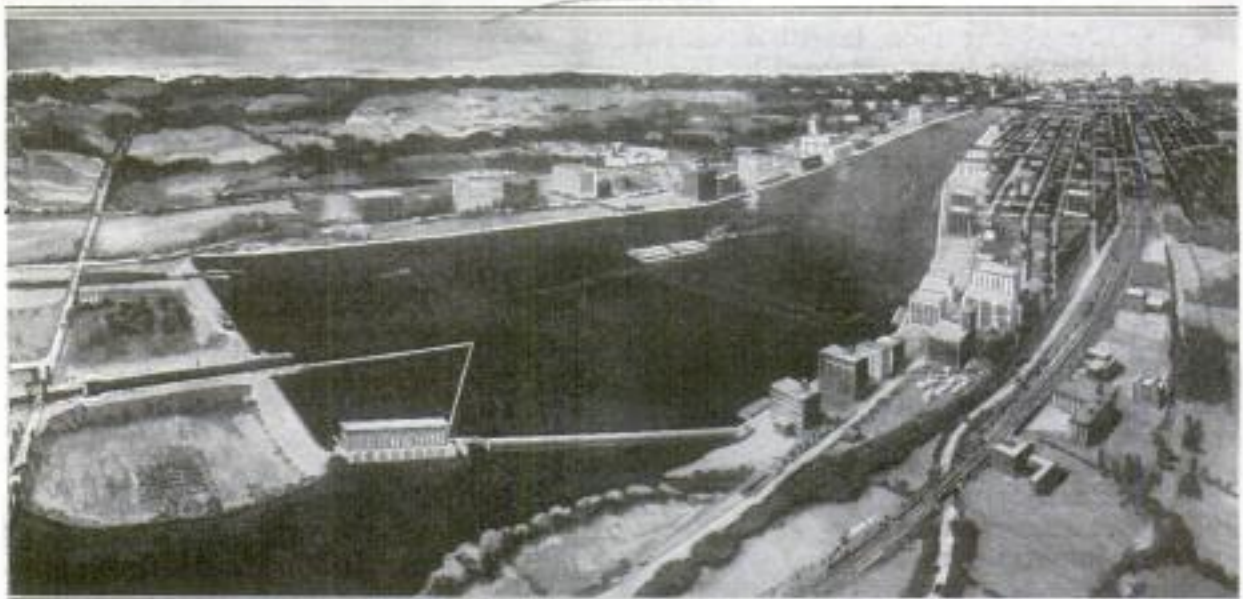

First of Illinois Waterway Locks Completed, Visualizing Dream of Early Explorers—an Unbroken Water Route from Great Lakes to Gulf of Mexico

With the recent completion of the huge locks at Marseilles, Ill., the first link in that state's \$20,000,000 waterway project has been forged and the dream of a century—a water route from the Great Lakes to the Gulf of Mexico—approaches reality. Four other similar structures, 600 feet long and 110 feet wide, are yet to be erected in the Desplaines and Illinois rivers between Lockport and Utica, a distance of 60 miles. Each will have a lockage of 9,000 tons, equal to 13 average freight-train loads, and together will develop a total of 75,000 electrical horsepower, estimated to create between \$1,000,000 and \$1,500,000 in revenue for the state. When these systems, including necessary dams and power plants, are in operation, accommodations will have been provided for 60,000,000 tons of freight traffic annually, and the neighboring ter-

ritory will have a direct water route to all parts of the world. As a result, engineers, affirm, exporting and importing costs will be lowered, while the saving on the carrying of coal alone to central and northern Illinois will approximate \$15,000,000 yearly.

3995 AUTOMATIC GEAR TO REPLACE CLUTCH IN AUTOS

In the invention in England of an automatic automobile gear, which dispenses with the clutch, gear box, and the usual type of rear-drive axle, certain engineers see the beginning of a new era in the industry that will be marked by many revolutionary changes in the vehicle's mechanism. The device is said to instantly adjust itself to loads and grades without attention from the driver.

George Constantine

Chicago Commerce 9/16/23 Association of Commerce

motor, Dec. 1923 Article in

RIFLE AS SAW, SMOKESTACK IS SNUFFER, FOR WELL FIRE

Shooting flames 75 feet into the air, a "wild" gas well, which threatened a Canadian field recently, was controlled and recapped by cutting its casing with a stream of steel-jacketed bullets from a high-powered rifle and then diverting the fire through an old smokestack, while workers plugged the pipes. For some reason, the ordinary capping failed and the resulting flow of gas became ignited, producing a blaze of peculiar shape. One end beat the ground, preventing a close approach, while the other hurtled into the air. The heat was so great that the pipe and its fittings became white-hot. The rifle was set up on a tripod some distance away and aimed at the casing. As a bullet penetrated the metal, a jet of burning gas spurting directly back at the gun. As the firing continued, the casing rim was completely separated and the flame rose like a torch. The smokestack was rigged up on a trolley strung between a derrick and a tree. By means of pulleys and guide wires its lower end was hauled over the blaze. Draft caused the gas to flow into it and burn at the top. When the casing cooled, the stack was swung into another position, cutting off the supply of gas at its head and putting out the flame at the peak of the improvised "snuffer."

WOOD PINS FOR GOLF TEES KEEP HANDS CLEAN

As a substitute for sand, spiked pieces of wood with cupped tops are being used as golf tees. They insure clean hands and clothes and a grip free from grit. There is no time wasted in preparing the small elevations, for these accessories can be stuck into the ground easily to a depth that will meet the requirements of the player. Their smooth surfaces offer little resistance to the white pellets. A dozen or more of them can be carried conveniently in any pocket. Painted red, they are not easily lost and can be used repeatedly.



*The Woods Mfg. Co.
18 E. 23rd St. New York*

CHILDREN AT PLAY "HOBBLED" FOR SAFETY

Safety-first methods of an English mother, unable to neglect housework to watch over her small children, consist of



Children Tied to Post Like Maypole Dancers to Keep Them Out of Harm's Way

tying them to a post in the yard by means of long tapes. While it gives them plenty of freedom, they are restrained from straying into a near-by highway frequented by automobiles. Like revelers in a maypole dance, the youngsters frolic at the end of their tethers while their parent performs her tasks without interruption or worry over their welfare.

WEEDS "TURNED INTO MUTTON" BY CHANCE DISCOVERY

Australian saltbush, that covers many million acres in northwestern United States, is being "turned into mutton" as the result of the chance discovery of a Washington ranch owner. He kept a flock on a pasture of this weed for an entire summer and found that they produced more and better wool and mutton than other animals in the neighborhood. Hitherto considered a nuisance, saltbush grows on arid and unfertilized land, where nothing else will thrive, and requires almost no attention after it is once well started. The value of the vegetation was first brought to the attention of the rancher when he saw some sheep feeding upon it greedily, while he was resting by the roadside.

Trading in dog skins is an important business in Mongolia and Manchuria.

recipies made by Wild State of Washington



Following the Earthquakes, the Horrors of Fire Confronted the Terrified Residents of Tokio When They Turned Back to See Their Homes a Ragged Mass of Wreckage

77 ide U oruit Kines St,
229 W. 43rd St,

New York City



Trail of Future Earthquakes Traced

Science Seeks to Map Path Tremors Will Take in Years to Come; American Cities Safe Because of Land Forms

FUTURE paths of earthquakes are being traced by scientists now studying the details of the upheaval that brought tragedy and ruin to a large section of Japan. This disaster, authorities say, culminated a series of volcanic eruptions and earth tremors that were in progress for the year previous in regions in and about the Pacific Ocean.

America, however, is safe, according to the observers, who call attention to the great depth of the mountainous land formations with an absence of

faults and ledges which are blamed for the slipping of earth strata. Investigations of quake zones seem to indicate that most of the disasters are confined to island and coast regions. Seldom do they extend to any great distances inland. It has also been pointed out that the zones of seismic disturbances largely center in the neighborhood of the equator, those nearest it being more active than the distant ones.

In their 12 months of performances the subterranean forces traveled over half the globe,

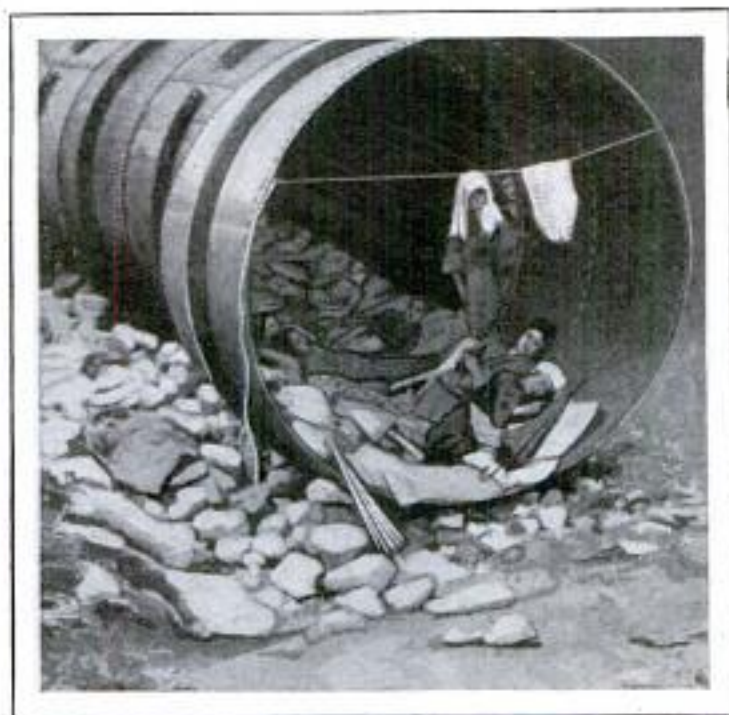

Sheltered Against Weather and Falling Embers from the Flames, These Refugees Occupied a Damaged Water Main



Modern Roadways Were Reduced to Bits by Yawning Gorges that Opened When the Ground Rose Up

moving like some gigantic burrowing monster. In their wake they left havoc spread by tidal waves and earthquakes, often breaking out in fierce blasts of volcanoes that disgorged rivers of white-hot lava and clouds of burning cinders. Chile felt this power in November of 1922, when three cities of that country were damaged and many lives lost. Hardly had the stricken area recovered from the blow when another shock struck it with equal loss.

From that time until the recent Japanese disaster it was a dull day for earthquakes when the recording instruments of the scientific observatories failed to register some evidence of uneasiness in the Pacific. On the Asiatic side disturbances were taking place daily. Some were so slight that they were not noted, or else so far away that the effects did not reach the delicate mechanisms.

In February of 1923, a series of intense shocks left a wide trail of ruin from the Society Islands in the South Seas to the Aleutian



Abandonment of the Old Method of Bamboo Construction Was Blamed for the Collapse of Many Buildings that Buried the Occupants Beneath Tons of Bricks and Timbers



Caught by the Inward Rush of Waters. Noon Crowds on the Docks at Yokohama Were Swept Up Like Dust, While Small Boats and Automobiles Crashed Against Building Walls Along the Shore

group far to the north. Destruction reached its height in the Hawaiian Islands, where a great wave swept inland, beaching ships, wrecking sea walls, and causing a number of deaths. In all, this mighty tremor shook an area 5,000 miles in length.

Two months later the American coasts were touched. Mexico felt shocks and a volcano in Ecuador caused terror in that country by casting up white-hot stones and ashes. A short time later the trail wound into southern Europe. Early in June, Mt. Vesuvius, that veteran of catastrophes in Italy, let loose with a blast that shook the countryside. Tremors of the earth accompanied its eruption, and while they caused considerable alarm, did little damage. In a few days it subsided, but as though contesting for the center of the stage, Mt. Etna, in Sicily, then broke forth, attaining such intensity that the inhabitants of near-by communities were sent fleeing for their lives.

With all these terrifying works of nature dotting our globe, the very danger they threaten seems to endear them to those living within their shadows. After the

crises are past and the terror is forgotten, new villages replace the ruined ones and other homes rise on the sites of the old ones. The people return to take up their interrupted peace until another grim trick of the earth forces them to flee the mysteries of nature's underground powers.

326 / _____
**AMBERGRIS, GOLD OF THE SEA,
 MAY HAVE CHEMICAL RIVAL**

Synthetic chemistry threatens the value of ambergris, a substance disgorged by diseased whales and which is used in manufacturing expensive perfumes. It has been more valuable than gold in the past and highly prized by chemists. Many sailors have won fortunes by picking up accumulations of this peculiar article found floating on the sea. An exceptionally large find was 926 pounds discovered off the coast of Australia that sold for 135 thousand dollars.

Gas production in the United States is reported to total 330,000,000,000 feet annually.

Handwritten notes:
 Kanua's City
 10/12/23
 62

The Champion Conservator Co
Des Moines, Iowa

CARBON PAPER ON TYPEWRITER ROLLS FROM FOLDING RACK

To eliminate waste of carbon paper, a folding rack which can be attached to a typewriter has been devised. It feeds the

3736

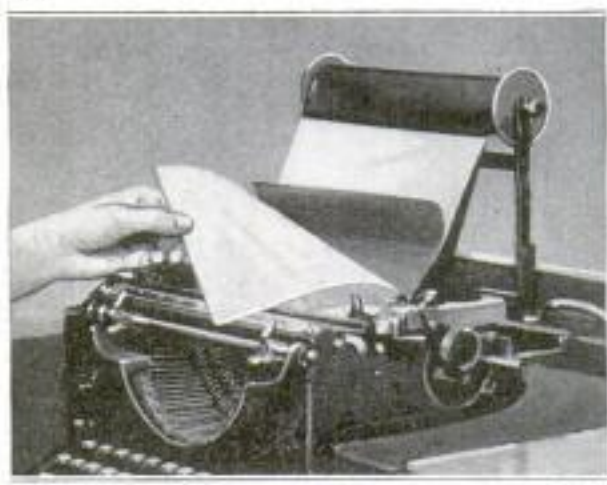

Carbon-Paper Reel on Typewriter Which Saves Much Stock and Time When Making Copies

tissue from a roll. With this device, it is claimed that great saving will result, because all of the coated surface is utilized instead of only a part, as is the case with sheets. As it is seldom necessary to touch the work, correspondence is kept free from blurs and finger marks. Placed in the typewriter between the letterhead and the copy sheet, the amount of carbon required is governed by the size of the letter. When the original and the copies have been removed from the machine, the carbon automatically returns to the reel. A cutter is provided to trim off worn parts, and hinges allow it to be folded against the typewriter for lowering into a desk.

CRADLE OF MANKIND MAY LIE BENEATH ASIATIC DESERT

What some scientists believe to be the birthplace of mankind has been discovered by an expedition in the dreary waste of the Gobi Desert in Asia. While fossils of the first men have not been unearthed, their tools and the bones of the woolly rhinoceros, which they hunted, were dug up by the explorers, who are planning a second trip to the site to search for remains of the first representatives of the human race. Stone implements of extreme age, spears and hammers that have lain for centuries partly buried by the drifting dunes, are included in the find. While the naturalists were excavating in this arid region, others opened up a mound in Honan, China, that had stood undisturbed since 900 B. C. It contained over

100 bronzes, some inlaid with precious stones and crusted with gold. This treasure is valued at \$500,000, not reckoning the scientific worth of the articles which bear information of an early age.

SQUARE CLOCK MARKS TIME BY SLIDING DOWN HOLDER

Its own weight causing it to slide slowly down two uprights that serve as a frame, a square clock being made needs no springs to keep it running. Raising the instrument to the top of the holder puts its works in motion which is communicated by gears toothed in notches on the metal standards. The drop requires 32 hours to complete, when the clock stops. Because its power does not vary, the timepiece is said to be more accurate than the spring-controlled types. Its position on the holder quickly tells the length of time it has run after each "winding."



Avonia, Clock Co, 215 W. Wabash St. Chicago

FISH EGGS SHIPPED IN ICE HATCHED IN GLASS TUBES

Glass tubes filled with water are used as incubators for trout eggs at hatcheries to which they are shipped packed in ice. In these crystal pipes, the young are reared and sheltered until large enough to be transferred to tanks. Thousands of the finny youngsters are born every year at several state institutions devoted to their



Water-Filled Glass Tube with Eggs of Trout that Were Shipped from Distance Packed in Ice

cultivation. When of sufficient size to take care of themselves, they are turned loose to stock streams, lakes, and rivers in various parts of the country.

International News
Not until they are 200 years old do mahogany trees reach their full height.

Wabash Tree Press
9/30/23

*Johns. Manville, d. mc.
1737 S. Michigan Ave.
Chicago*
POPULAR MECHANICS

ARTIFICIAL "WOOD" MAY SAVE SHRINKING TIMBER SUPPLY

In an attempt to save the rapidly dwindling lumber supply, experimenters have developed artificial "wood." It is a combination of asbestos and portland cement which will not rot or deteriorate under exposure to weather. In making this imitation lumber, the mineral is mixed with cement and other materials until the mass is as smooth as cream. Then it is poured into molds and pressed by a hydraulic machine into thin boards and sheets. The finished product can be sawed, drilled, shaped, painted, grained, and nailed like the natural article, and will not burn. It is now being fashioned in flat slabs which can be cut for window and house trim, roofs, partitions, and wall board. For building fireproof motion-picture projector booths, the new product is said to be ideal.

Illustration 3670

LIGHT CLAMPED TO A FINGER AIDS WORKER AT NIGHT

So the user may have free use of both hands, a small electric lamp, that can be worn on the finger or held secure to various objects by an adjustable clamp, is being made in Europe. It can be attached to the handle of a safety razor for shaving in the dark, to tools for working on an auto, on a clock for use at night, to a

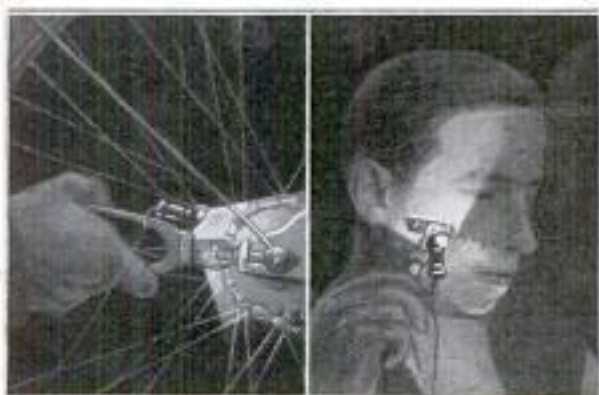

Light that Permits Free Use of Hands while Clamped to Finger or Some Object

music stand, and is serviceable in many other ways. So the weight will be slight and the length and width less than an inch, electricity is carried by wires to the bulb from a battery or house current through a transformer. Watchmen carry them, with the battery in the pocket.

Of the world's railroad mileage, 40 per cent is possessed by the United States.

Pendur Co. Leipzig, Germany

*Emb. Ernest Peterffy
376
New York City*

"CANNED SUNSHINE" FOR HEAT TO AID FUEL PROBLEM

"Canned sunshine" for heating purposes is the object of experiments being conducted by a Pacific-coast inventor. He

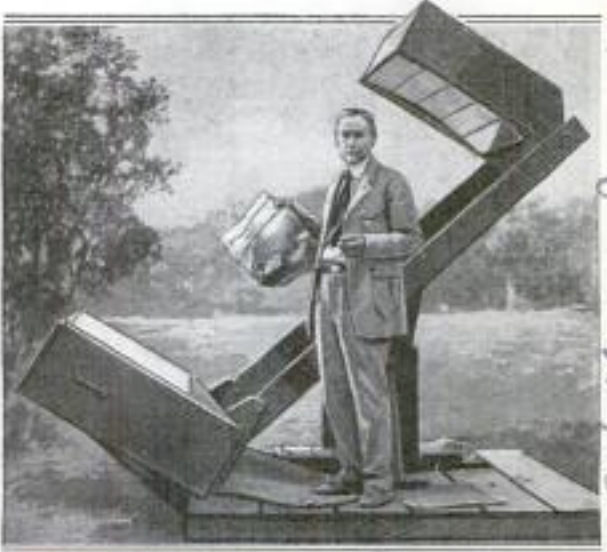

Harnessing Solar Rays to Make "Canned Sunshine" Which May Aid in Solving Fuel Problem

has developed heat from sunlight that will burn coal, melt lead, and generate a gas which he believes can be utilized for propelling power. This is accomplished by a series of mirrors that reflect the rays into a concentrator which produces a temperature of 2,800 degrees. By burning chemicals in this apparatus, cooling them, and then sealing the residue in air-tight containers, the expert expects to market an energy that can be used in many ways.

BEEES, COLOR-BLIND, MUST LEARN WAY BY EXPERIENCE

Bees are color-blind and they learn their way about by experience rather than by instinct, according to tests recently conducted by scientists. The experts show that to these honey-making insects, red and black look alike, orange and yellow are the same as green, and there is no difference in the appearance of blue, violet, and purple. However, they can see ultraviolet rays, which are invisible to the human eye. It was found that the guiding influence which takes them back home is nothing more than experience. It has been long known that bees locate hives quicker, the longer they have occupied them. During the experiments, some were put to sleep by ether, taken from a new hive, and moved 12 yards away. On the third day 30 per cent returned and 90 per cent had reached home on the eighth day.

*3744
Inventor: William Mosbey Thomas, was Angeleno Calif.*

*Kansas City Star
9/23/23*

RARE BIRDS GET FLIGHT SPACE IN LOFTY CAGE

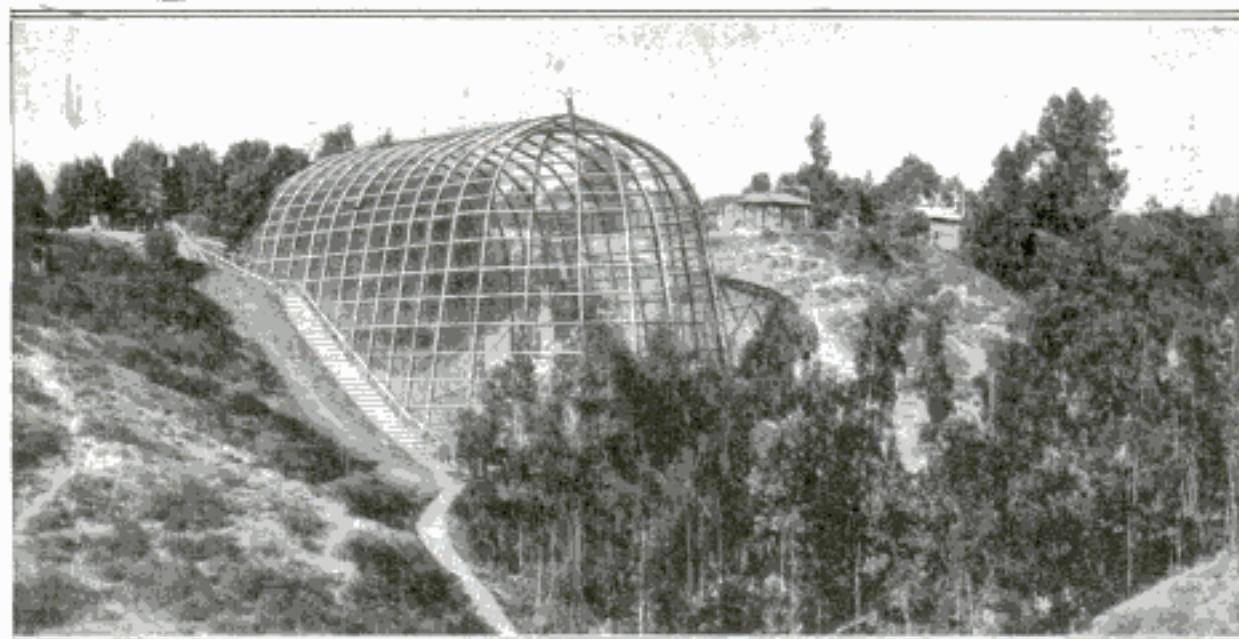

Gigantic Bird Cage that Permits Great Freedom of Flight for Its Feathered Inmates

Rare birds on exhibition in a Pacific-coast zoo can get needed exercise in the open air while inclosed in a gigantic outdoor cage, 85 feet high at its loftiest point. Within this structure, the winged creatures enjoy greater freedom than when

they are imprisoned in an indoor inclosure, since the range of flight is less restricted. For the convenience of visitors, a cement walk and stair surround the bird house. The aviary is expected to greatly prolong the lives of its inmates.

CROPS OF SUNSHINE AND CLOUD GIVE U. S. WEALTH

Just as population and wealth are concentrated in certain parts of the United States, so there are sunshine and cloudy centers, where these two kinds of weather mean dollars and cents to residents. Most of the former lie east of the Mississippi River, but the sunshine center of the country is situated in the extreme Southwest, near the mouth of the Colorado River. Yuma, Ariz., furnishes the dot on the map for the compass to draw a circle inclosing a region into which sunbeams pour almost ceaselessly during the daylight hours. Only 18 days in the average year can be called cloudy in this city, and in a roughly circular area extending about 100 miles from it in every direction. Considering both the length and number of days, this territory, embracing the southwestern part of the state, gets 85 per cent of all the sun's rays aimed at it in a year, while neighboring sections are only 5 per cent behind. Sunlight is capitalized here because it may be said to inclose the portion of the United States that sells its climate the year round to thousands of tourists and health-seekers. As the percentage of

fair days grows less with distance from this center, the rainfall becomes greater, so that agriculture may flourish without irrigation. Beyond the mouth of the Mississippi, the sunshine lines bend northward, taking in southern Florida, where this commodity of nature has a money value in the resorts. The clouds gather thickest in western Washington, near Puget Sound. Here half the days are cloudy and about 30 per cent partly so. About this little section is a much larger strip only slightly less marked by cloudiness. But there is a monetary compensation for this lack of sunshine, for heavy rainfall and snowfall, with the high mountains, give Washington a greater potential water power than any other state. There are two secondary "cloud grounds" in the East—one on the southeastern shore of Lake Ontario and the other in the upper peninsula of Michigan, where 75 per cent of the days are wholly or partly cloudy.

When he found that some animal had bitten through one of the eggs under a setting turkey hen, a southern man patched the hole with rubber from an auto inner tube. A lively turkey was born.

Smith & Remondway Co.
114 Cost St. Washington, D.C.
3647

GLASS IS CUT ON TWO SIDES TO REDUCE THE WASTE

Marking glass on both sides so that it may be broken easily, thus reducing the amount of waste from faulty operation, a glasscutter is being made that turns out circular as well as straight pieces. As the pressure is applied evenly to the sharp wheels by an arrangement of springs, the life of the instrument is said to be increased. A novice can readily manipulate it. By adjusting a single screw, thicknesses up to $\frac{3}{4}$ of an inch can be handled with ease. The apparatus shapes circles a foot and a half in diameter, while a gauge can be set at any desired length for straight cutting. With this machine, it is said, an operator can cut four times as much glass as he can by any other method.

PROCESS FOR GOLF BALLS GUARDED AS SECRET

Considerable secrecy is said to surround the manufacture of golf balls. Each maker has his own process which he takes great care is not revealed. In forming some of the little spheres powerful hydraulic presses are used to force them into shape and to exclude undesirable gases and air from the interiors. However, there is no standard machinery for the production of the article and every

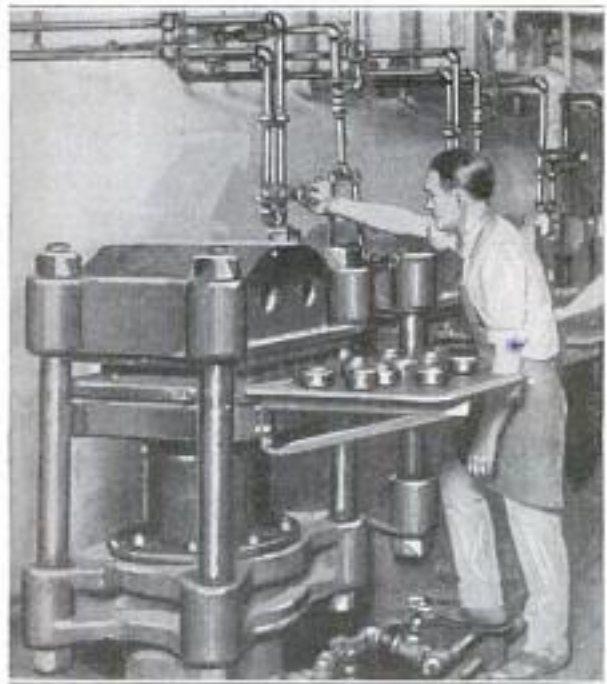

In Making Some Golf Balls Much Depends on the Expert Handling of These Hydraulic Presses

firm designs its own. Experts claim that through loss alone over thirteen million of the balls are consumed each year.

Underwood
205 W. Washington
Chicago

ELECTRICITY FROM WINDMILL TAKES PLACE OF COAL

To generate electricity cheaply without using coal, because of a fuel scarcity and its consequent high cost, a European in-

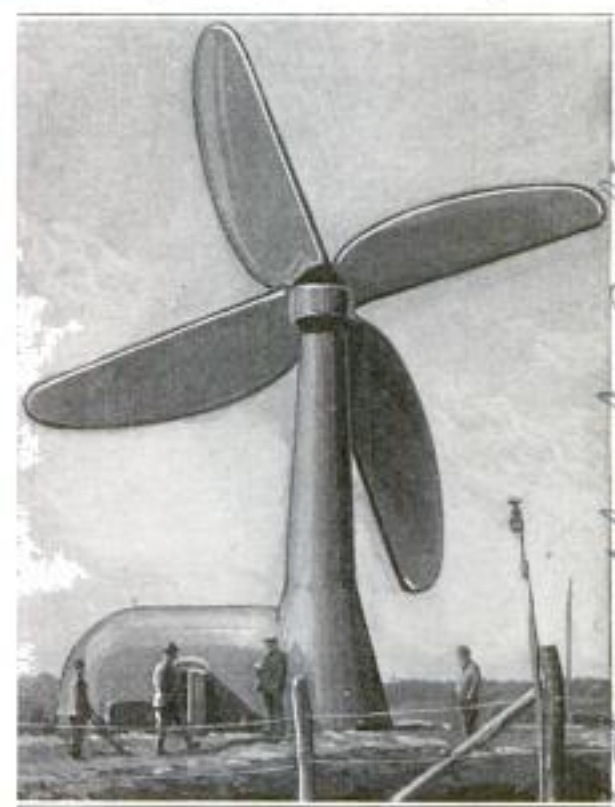

Windmill That Charges Storage Batteries Where Coal Is Too Costly to Make Electric Power

ventor has built a windmill that charges storage batteries. It is operating so successfully he is making eleven more. Mounted on a tower about 50 feet in height are big propellers that generate 40 horsepower in a moderate breeze and 70 in a strong wind. In a roundhouse on the ground, connected with the top by a shaft, are the generator and batteries.

DASH THROUGH FLAMES EASY IN FIREPROOF SUIT

Made of patented asbestos cloth, a life saving suit has been invented that is said to successfully resist heat and flames and to protect the wearer from injurious effects of smoke. With this garment, it is claimed a person can enter a burning building, walk through hot embers and blazes of fire, and return unharmed. Oxygen is supplied from a tank fastened inside the garb. In a recent test, the inventor carried documents from a flaming structure and, after it had collapsed, lay down in the glowing coals without apparent injury.

Photographisches Archiv
Berlin
Hauptstrasse 68
Postfach 12
Preussische
Inventor Carl A.
Ganceville
Albis

With Death at the Throttle in Mexico

Dynamite-Laden Trains Used to Spread Destruction During Years of Guerrilla Terrorism

By SIDNEY McNEILL SUTHERLAND



Chicago Tribune. Chicago

IT IS the ostensible purpose of a Mexican revolution, always proclaimed in flamboyant rhetoric and sometimes inspired by a sincerity born of self-hypnosis, ultimately to attain justice; the righting of some wrong. The real reason often is to be found in the sight of a sty at feeding time.

Mexico is composed of thirty states; and, since 1910, each of the thirty has, at sundry times, been hunting justice with a carbine. Guerrilla warfare became a pastime for the azotacalles. Insurrection is contagious; one commonwealth revolts and presently fifteen will be aflame at one time—each seeking a different brand of justice. And whether there is one general uprising against the president (and secretary of treasury), or whether there are fifty baby rebellions against local tyrants (and municipal exchequers), the hundreds of generales and the thousands of sublevados have agreed on three things:

First—Force the party in power out.

Second—Destroy the railroads.

Third—Down with the gringos.

The first means loot and release from work; the next, gratification of the strange Mexican obsession to wreck all real proof of Porfirio Diaz' superior mentality; and the last, the furnishing of a grito, or rallying cry, to keep the discordant

Editorial - 19 Feb

elements united behind their leader's ambitions and avarice.

In my rather extensive wanderings about Mexico in the wake of divers justice hunters, I have sometimes voiced a courteous comment on the wanton and utterly needless vandalism that wrecked the transportation systems of that country.

"General," I would say to whatever unlettered patriot I happened to be accompanying; "general, do you think it is necessary to blow up that bridge?"

"Señor, it is," the Napoleon of the West would reply, as he rolled a corn-husk cigarette. "By cutting the line at this point, I forestall pursuit. Having crossed this creek and destroyed the span, naturally our enemy cannot overtake us. This is tactics."

"True. But suppose we run into some more enemy down the road, and your excellency's profound knowledge of strategy should counsel retreat—"

"Señor!" he would thunder, twisting his mostacho and thumping his knuckles against his chest—"Señor, be assured that General Don Petronillo Rodriguez de la Corona y Carolampio never retreats!"

"Exactly. But if—"

"A temporary withdrawal, perhaps,



Gratification of the Desire to Wreck Everything United the Elements Behind Avaricious Leaders

whilst I rearrange the forces under my command and orient myself," he would interrupt again, transfixing me with a lowering stare. "But 'retreat!' The word is most odious to any Mexican officer, and especially offensive to the ears of one who to this hour, has never yielded a step in the presence of the enemies of justicia, fraterni-



Careening Around the Curve, the Runaway Dynamite Engine Struck the Train with a Deafening Roar. The Ground Heaved, Cars Were Splintered, and Soldiers Tossed in All Directions

dad, igualdad y constitucionalismo. If—and, mind you, I decline even to entertain the shameful thought—if I should decide momentarily to lead the foe into a trap by the sagacious feint of apparent retirement, we can abandon the train and gallop to the nearby sierra.”

“Well,” I would shrug my shoulders, “it seems a pity to tear up this line. It stops all passenger traffic, and it is the only means the poor peaceable noncombatant middle class can use to ship its grain and goats to market, or get the few things it requires from the larger cities. Everywhere I’ve been through out this country, general, I’ve seen the havoc wrought by the different armies; and every blow struck at the railroads is a heavy, may be an irreparable, blow at the recovery of this splendid land. To an outsider—and tendering the observation in the most disinterested and respectful manner—it does seem as if the revolutionists might spare the roads.”

But ever my advocacy of the poor rail-

ways fell on ears as deaf to common sense as they were unwashed.

I left Nuevo Laredo on May 15, 1920, having hastened to the border at the orders of a Chicago newspaper when we got word that President Carranza had fled from Mexico City a jump in advance of General Alvaro Obregon and his Sonora Yaquis. The road to Monterey, I was told by Colonel Borquez, in command of the Nuevo Laredo garrison, had been cut in a dozen places by his own men when they came north. But I might go south at dawn with the first repair train, he said. I did, and my camera tells something of the story.



Instead of Repairing Damaged Roadbeds, New Ones Were Built of Inferior Material Alongside Them

About ten miles out we stopped to pick up some ties. Presently, we came to a culvert which had been blown up to keep the Carranza troops in Monterey from following the rebels in their march on Nuevo Laredo. The laborers and their armed escort alighted and, after prolonged conversation and numerous cigarettes, went to work. It was decided not

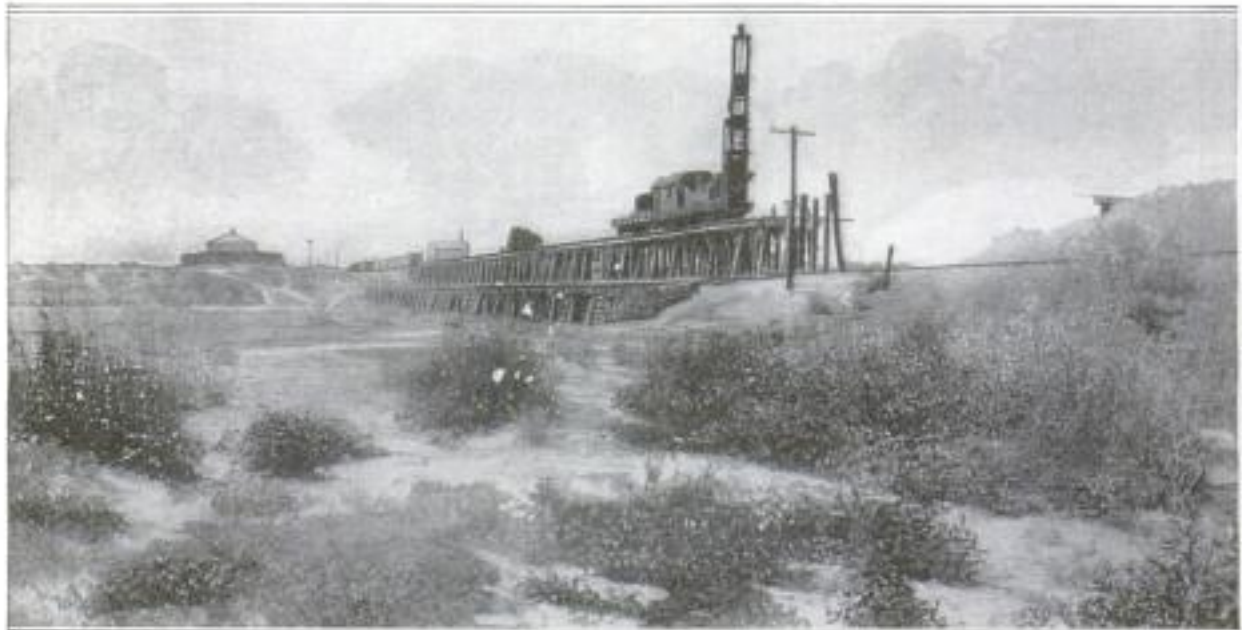

Great Bridges Built by Engineers of Forty Years Ago Were Wrecked and Forgotten. Temporary Structures to Replace Them Were Made Chiefly of Telegraph Poles and Railroad Ties

to attempt to refill the regular roadbed, but to build a temporary one alongside and lower than the old one. Long timbers were laid side by side and end to end and dirt piled up on them for about four feet. Ties were then laid from both ends to the actual rivulet bed, which had been left open for about 30 feet. There, piers were made of ties "cribbed" in log-cabin style. Timbers, 12 by 12 by 16 feet, were then placed on these ties, other sleepers were laid across, and the rails were put down, held to each tie by one

joint, the engine snorted furiously, the driving wheels spinning while the natives tossed shovelfuls of dirt on the rail, and the train crept slowly up



spike. The new roadbed was about 250 feet long, from where the engine waited to where the repaired track reached the old one.

When the engineer decided it would do, the train, consisting of the engine, oil tank car, three flat and two box cars, was started slowly. The untamped dirt settled, the ties creaked, the brakes whined, the Mexicans yelled all sorts of advice, and the train slid down the loose, yielding rails. Lurching from side to side and squeaking in each of its rusty

the incline. I snapped a picture while the train was sagging in the center, the engine and rear car several feet higher than the middle. Then the workers climbed aboard and we went on to the next burned bridge. It took us nearly three days to reach Monterey, the trip ordinarily requiring ten hours. A fearful mess they've made of the railroads in Mexico! Splendid roadbeds, built more than forty years ago by American and British engineers, have been allowed to crumble, grafting governments having refused to spend a peso for upkeep or repair; great steel bridges and tiny culverts have been dynamited; costly tunnels blown up; telegraph poles chopped down, crossarms that once hummed with fifty wires now carrying one; stations burned and replaced by box cars; rails pulled up, heated in the middle over a bonfire and bent double around poles or trees to make them useless; thousands of freight cars given to flames, their blackened skeletons filling the yards and sidings for miles; ancient engines have been patched and repatched for years by the natives, all the American employes having been chased out in

April of 1912; ties, unreplaced for thirteen years, have been cut in twain by the rusted rails, the outer ends either hanging by a shred, which constantly grows thinner as the release from the weight of passing trains jerks the spikes farther out, or lying in the weed-grown right of way, the steel resting only on the ground; passenger coaches filthy and insanitary, their windows broken and the varnish scaling off.

Ruin, desolation, and hopelessness everywhere mark the collapse of Mexico's railways, the consequence of Mexico's experiment in revolution.

From Monterrey to the capital the trip was normal, the damages having been repaired. At one place, where a branch line runs to the American Cuatro Ciénegas mining camp, they had no engine. I saw forty peons shoving a gondola piled with lumber up a rather steep grade. The gringos told me they had no idea when they would be allotted an engine, but that they could count definitely on the exact hour when the local tax collector would make his appearance.

Early in June, Carranza having been disposed of in the customary, bullet silencing manner, I went up to Escalon, Chihuahua, to join General Joaquin Amaro, a genuinely capable young officer, whose nondescript army of 5,000 soldiers was chasing the late Pancho Villa. He was kind enough to offer me quarters in his private car—later he gave it up and we moved into a box car—and as we passed Corralitos I told him the story of the famous engagement there in January, 1912, between General Gonzalez Salas, Madero's minister of war, and Pascual Orozco, who had revolted. I had gone north with Salas as representative of New York and Mexico City newspapers.

Orozco made his stand in the long

chain of low foothills which stretch east and west across the tracks, their summit about half a mile north of the tiny station and water tank. He probably had 2,500 well-armed cavalymen, who had concealed themselves behind the desert chaparral. They had several machine guns; and, straddling the road, were prepared to dispute the further progress of the government troops.

Salas halted his four trains, the first at Corralitos, the other three stretching for a mile and a half down the track; sent 1,000 men to the west to keep Orozco's thin right wing engaged; and deployed the remainder, 4,000 infantry and artillery, east of the tracks to dislodge the main body of rebels.

From Corralitos to a point about half a mile north, the tracks, slightly ascending to the higher ground, run straight; then they suddenly disappear around the

shoulder of a hill, reappear higher up about a mile farther on, continue in sight for a quarter of a mile, and then vanish into the plains beyond the foothills.

General Salas, some of his staff and I arose before daybreak, walked from his car at the rear of the last convoy to the first engine, under the water tower. From the cab we watched the battle commence on our right wing. The 3-inch guns opened the attack, sending their shrapnel above the heads of our men into the hills. The troops would run a few yards, drop behind a clump of cactus or mezquite, fire a few times, and advance a bit farther. On our left the soldiers merely kept the bandits back.

As the morning wore on, the wounded began to come in, either limping alone or carried by companions. Soon there were several hundred lying on the ground along the right of way in the shadow of the box cars. There they were min-

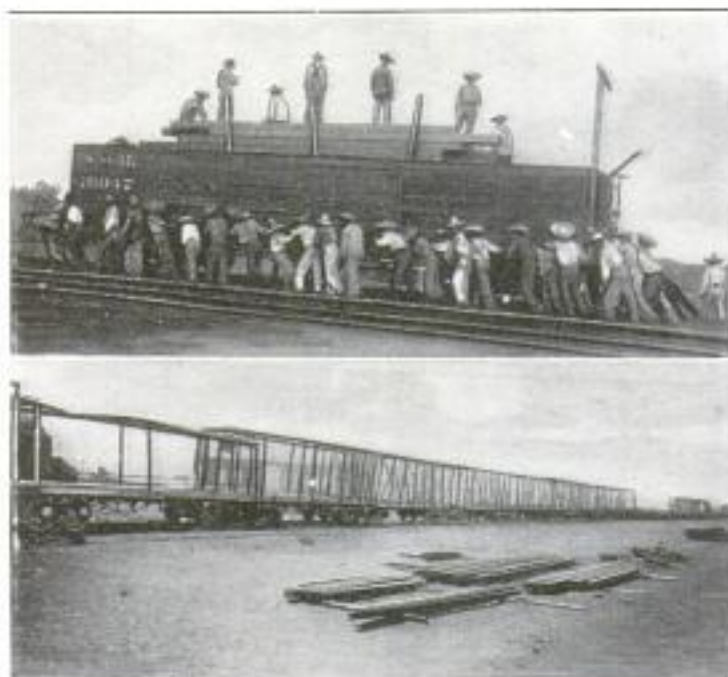

Blackened Remains of Fired Railway Coaches, and, Above, Peons Substituting for an Engine Moving Lumber Cars



istered to by their women and the doctors. By noon the government forces had almost reached the foot of the hills—the artillery was too much for the insurrectos. Presently, the orderlies brought our luncheon and a case of iced champagne. While we were dining, the Mexicans indulging in fervid compliments and congratulations, I happened to glance to the north; and what I saw caused me to let out a yell which so startled Salas that he dropped his bottle. The officers leaped to their feet and followed my finger with their eyes.

On the short stretch of track visible between the hills, was a locomotive running backward down the incline.

"*Dinamita!*" I shouted.

"*Locomotora ciega!*" they echoed my cry.

Each of us knew what it meant. Orozco had loaded an engine with dynamite, fired the fuses, and started it downhill with throttle wide open, crewless but manned by Death.

I don't know which of us reached the ground first, but I know who led the way to the nearest hills on our left!

When I reached a knoll about three hundred yards away, I threw myself prone behind it and looked back. The blind engine, its piston rods racing at full speed, careened around the curve and came down the tracks, its momentum increased by gravitation at every telegraph pole. From the forty box cars of the first train, women and children were leaping, screaming, and running about.

The runaway engine hit our locomotive with a deafening roar, the dynamite exploding at the moment of impact. The ground heaved, the first ten cars were splintered, dozens of wounded men and their women were torn to fragments, and

Every Blow Struck at the Railroads Was a Heavy Thrust at the Recovery of Mexico

a hole 50 feet by a hundred was blown four yards deep where the engines collided.

The battle became a panic. As far as we could see, soldiers arose, looked in our direction, and began running toward the three trains down the road. We were there to receive them!

In vain did Salas plead and storm and threaten. The horror-stricken men refused to turn and face the Orozquistas pouring out of the hills. The troops scrambled aboard in mad confusion, and the trains backed down the line to the base at Escalon, the rebels on horseback making a running fight of it as long as they could keep up.

And that evening, the minister of war, seated in the darkness, solved his problem as best he knew how, wiping out the disgrace with the 45-caliber bullet he sent crashing into his right temple.

*The Eschmann Service 32 Mission
Square, E., New York*

810

3556

POPULAR MECHANICS

INDIA'S WOODWORKERS SPURN SAWS AND LATHES

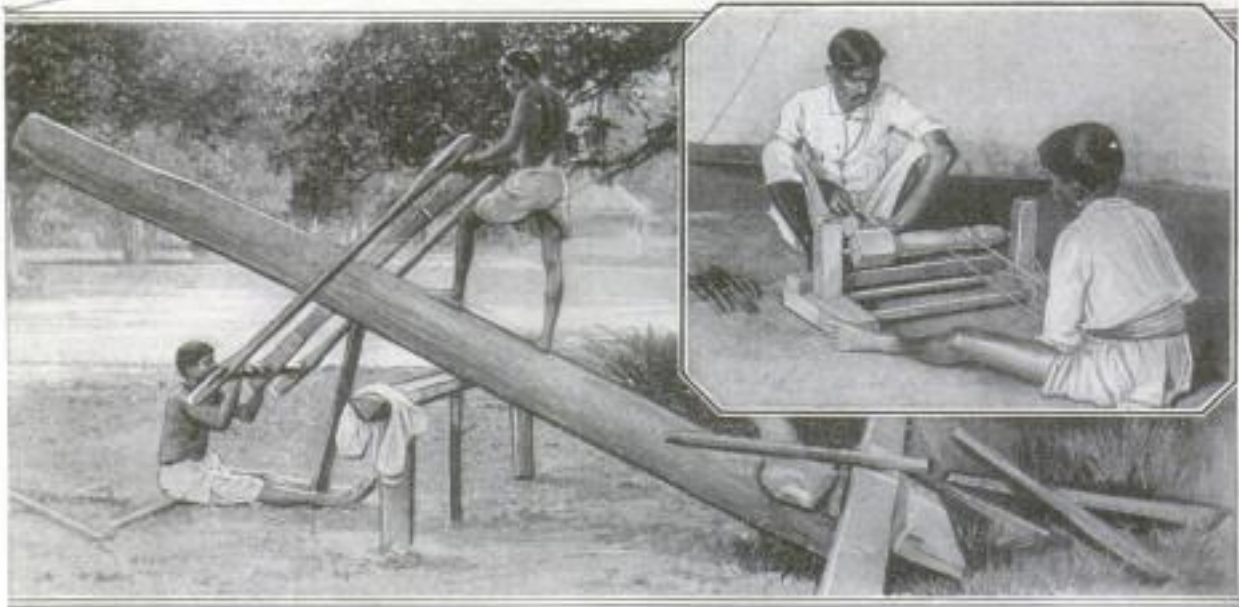

In India, Where Native Woodworkers Prefer Their Feet and Hands to the Most Modern Sawmill Machinery in Dressing Lumber for the Builder

With a labor market always flooded with cheap but skilled help, India can produce hand-dressed lumber at a cost below that of the machine-equipped sawmills of western countries. Methods that were employed long before the days of belt-driven wheels are still used. After the bark has been removed from a log, it is placed across a trestle and weighted

to raise one end. Two men then cut it into boards with a crude rip saw, one working from the ground and the other standing above. Wood turning is performed on a roughly made frame lathe held firmly by the feet of the squatting carpenter and his assistant, who rotates the piece by pulling on a cord looped around it.

COOKER ON RADIATOR OF AUTO PREPARES MEALS QUICKLY



of the motor provides sufficient heat to prepare a meal quickly.

ARTIFICIAL LUMBER OF HEMP TO CUT BUILDING COSTS

That experiments in the manufacture of artificial lumber will result in new building materials to supplement the diminishing forest product, is being predicted generally by western lumber interests. Government figures show that America's building program for this year calls for the expenditure of almost \$1,000,000,000 in excess of 1922. The homes needed today, averaged at \$5,000 each, amount to about \$8,000,000,000. To meet this demand, experiments have been made in an effort to produce "synthetic lumber" from logging wastes, which are ground, chemically treated, and pressed into boards. Another plan is to utilize the hemp left over from the manufacture of cordage products in making "boards" which could be sold at a 50-per-cent reduction. If successful, this would open a new market for a farm product from land either too poor for other crops or now lying idle as the result of the collapse of the rice-growing industry in the

*Chas. E. ...
East ...*

*Chas. Karl Wessel
California Engineer*

Copyrighted material

*Com. Frederick Kenney
Box 833, Salt Lake
City, Utah*

San Joaquin and Sacramento valleys. Hemp can be grown almost anywhere in the United States, but the high percentage of waste has heretofore limited its cultivation. Five acres of hemp, it is estimated, will produce enough waste to build a bungalow and furnish it with rugs and paint products. A native of China, the plant grows to great height, is a soil conservator, requires no expert cultivation, and yields sure returns.

GIANT HEMLOCK IS SANCTUARY TENEMENT FOR WILD BIRDS

Departing from their custom of nesting in separate trees, many heron, noted for their shyness, have built their homes in a giant hemlock tree close to the highway of a Canadian park, where a million automobiles pass yearly. As the park is a sanctuary, the birds are never disturbed. These feathered architects have so arranged the nests that none comes directly under others. In obtaining an unusual photograph of their skyscraper home, a photographer risked serious in-



Feathered Architects Who Have Turned Tree Beside Busy Highway into a Tenement

jury in climbing a near-by "king" of the forest. The picture showed 27 nests and 87 young.

*Com. Francis Stobie
Heriot Bay, B.C.,
Canada*

SOLID-GOLD RAIL FOR SPOT WHERE HARDING SPOKE

To commemorate the opening of a branch-line railroad in Utah, by the late President Harding, a solid-gold section



Bit of Golden Rail from Spot Where Harding Spoke Is Kept in Museum

of a rail, 9 inches long, was spiked into the tracks at the point where he stood in delivering his address. Left there for a period, under guard, it was later removed and placed in the museum at the state capitol. President Harding's train, which carried him to Seattle on his journey to Alaska and later bore his body from San Francisco to the nation's capitol, was the first to pass over this new route.

POTATO IS CUT INTO STRIPS WITH STROKE OF SLICER

In one stroke of a recently patented round, metal cutter, potatoes are sliced into many pieces of uniform shape for frying. It is made to speed up work and to eliminate use of the knife. Strips of metal form a network of squares which cut peeled potatoes when pressed down by two handles.



The average annual gasoline consumption for each passenger automobile in the United States is estimated at 360 gallons.

Sold by Peoples Gas Light & Coke Co., 123 S. Chicago

3535 Capt. Charles W. Douth
c/o Pennsylvania R.R.

10th floor Guaranty Bldg Phila

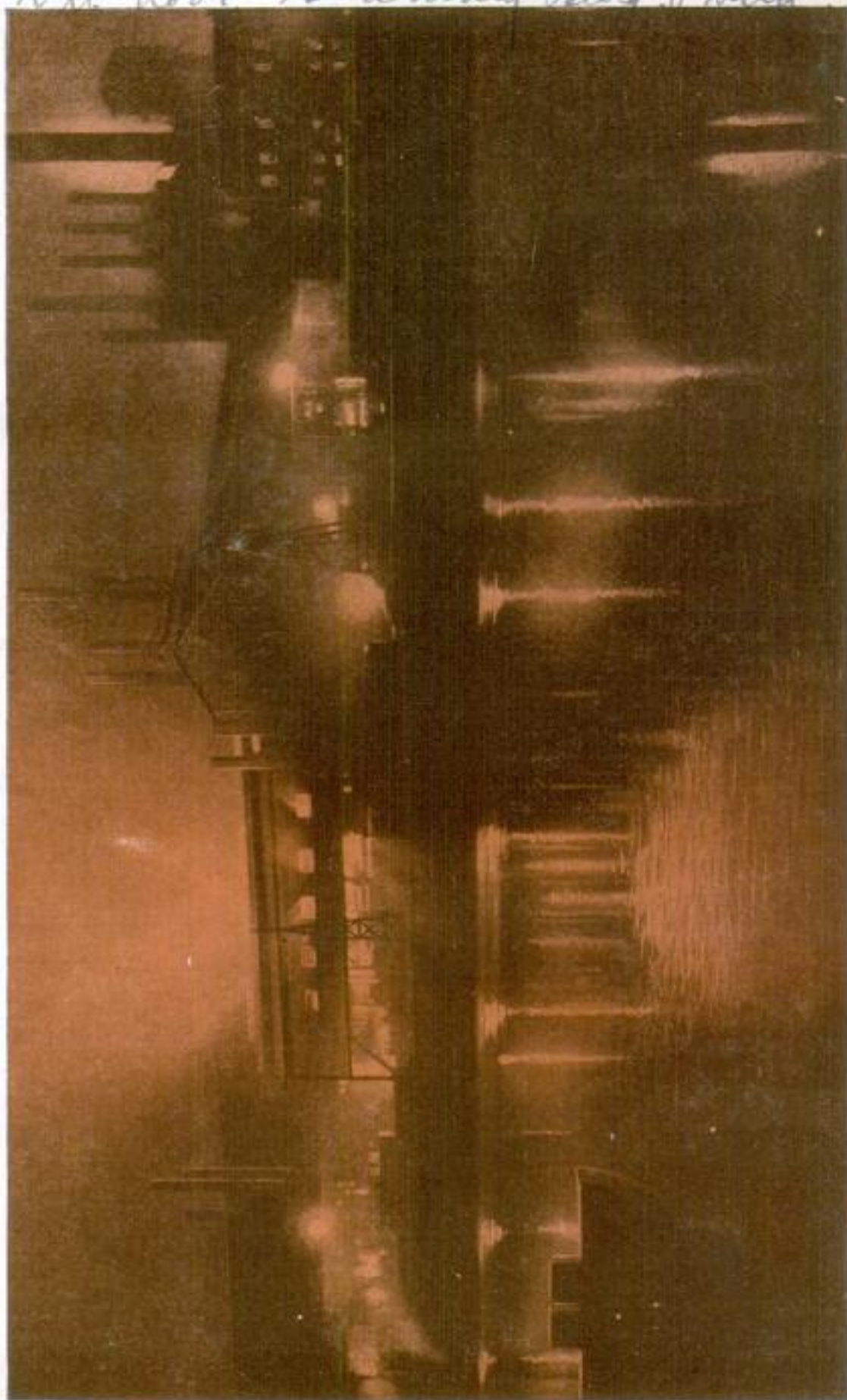

Volcanoes of Flame from Steel-Plant Furnaces Turn Nights into Days

Photo by Charles W. Douth

*Manito Chemical Co.,
1205 Lehman Bldg.,
Peoria, Ill. 843*

**STEEL-MILL GLARE UNDIMMED
BY THE EIGHT-HOUR DAY**

3535
With the eight-hour day being put into effect by steel companies all over the country, production has continued without a single break. Affecting some 60,000 workers, the change is being made gradually, but it is expected that it will be completed in less than two months. As many of the employes already were on this basis, the abolition of the 12-hour day has mainly affected furnace men and unskilled laborers. Introduction of the three-shift plan has had no visible effect in decreasing the output, although increases in prices have been forecast.

**ONE-MAN POWER PUMP USED
TO FIGHT FOREST FIRES**

3626
Mounted on a tripod like a camera, and but little larger, a portable one-man pump has been made to combat forest fires. Weighing less than 60 pounds, it can be carried easily, strapped over the shoulders like a knapsack. One leg of the tripod is a hollow iron pipe through which water is drawn when the machine is set up in the bed of a creek or pond. Using 50 feet of one-inch hose, it will throw a stream 81 feet from a $\frac{3}{8}$ -inch nozzle. By



Portable One-Man Pump, about the Size of a Camera, That Is Designed for Quick Operation

loosening four bolts, the engine can be lifted from the pump, the legs can be removed and the whole device dismantled.

*Chas. E. Ross, Wash.
State Supervisor of Forests
Olympia, Washington*

**PEAT BOGS FURNISH RIVAL
TO COAL AS POWER FUEL**

3637
Beds of peat believed to afford an almost inexhaustible source of fuel are being worked in the middle West to supply ma-



Where Peat Is Converted into Fuel That Can Be Used for Power Purposes

*Do not make
peat fuel.*

Underwood

terial that can be used as a substitute for coal. A process has been developed by which a high-pressure machine extracts the moisture and converts the combustible parts into dry and readily burned lumps. In preparing peat for market it is first screened and then graded for different purposes. It is said that it can be used in almost every case where good power fuels are required, with no ill effects on fire boxes or other sections of the boilers.

**STONE-AGE ART STUDIO FOUND
AMONG HIDDEN CAVERNS**

3695
While exploring the underground source of a small river in the south of France recently, an adventurer discovered numerous clay models of animals that existed in that country 25,000 years ago and which have been extinct in Europe for centuries. In the central chamber of a series of caves, the walls of which were decorated with rough mural paintings, was the headless figure of a bear cub, and near it, the skull of a full-grown beast, left as though the artist had been suddenly called from his task and never returned. Against the side of the cavern were two forms of tigers or lions, of which no prehistoric counterpart has ever been unearthed in that region. Like a number of other objects, they were covered by stalactites.

*Kansas City Star
9/18/12
Copyrighted material*

Emb. Ken Stone, Vice Pres.,
91 Beverly Ave.

Kansas City Times
8/2 1913

ACETYLENE TORCH LIKE PISTOL CONTROLLED BY TRIGGER

3546

Lightweight acetylene torches constructed along the lines of an automatic revolver are used in Europe for cutting

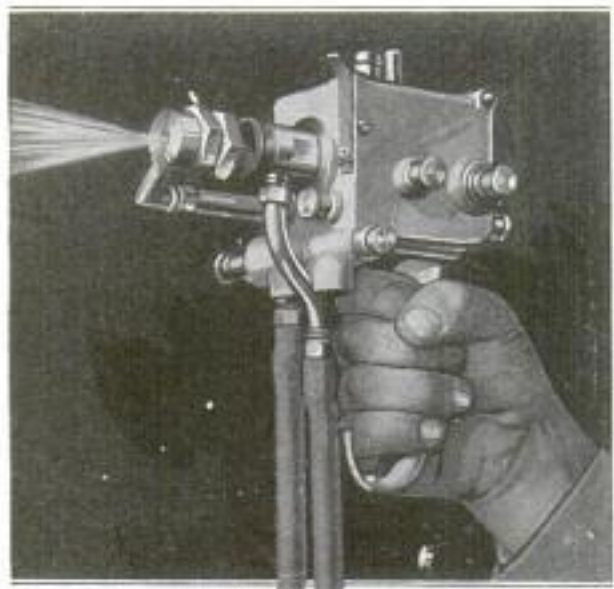

Acetylene Torch That Shoots Flame Resembling Revolver from a Nozzle

metal. The pistol grip permits a firm, steady control of the flame, which is turned on by pressing a trigger. Two tubes carry the air and gas to a chamber from where it passes to the nozzle. Owing to the ease with which it can be handled, the torch is a convenient aid in reaching corners and cutting steel beams formed into odd shapes.

TEAPOT SHAPED LIKE SQUARE HIDES SPOUT AND HANDLE

Stacking easily in dining-car pantries, a square teapot that conceals its spout and handle in its body has been designed for railroads.



Instead of the usual spout protruding from the bowl, there is an opening in one of the upper corners, while the handle is an indentation on the opposite edge. Minus projecting parts that are liable to be broken off, the utensil is said to have a longer life of service than the rounded models.

After oil has been extracted from castor beans, bricks are being made of the pulp.

GROWTH OF U. S. NAVY HALTS WITH BIG DREADNAUGHT

3480

Surpassing all other American warships of its class in size, gun power, speed, protection, and control, the "Colorado," recently completed, is the last battleship the government will build for some years, as stipulated by the international naval agreement. Eight 16-inch guns constitute its main battery. Twelve 5-inch guns are mounted for torpedo defense, and eight anti-aircraft rifles, a catapult for launching airplanes, and two torpedo tubes make up the remainder of its armament. The sea fighter is 624 feet long and can attain a speed of 21 knots an hour. As electric drive permits full use of its entire power either in forward or reverse motion, the ship can maneuver with great ease and rapidity. Gun-sighting and fire-control systems allow it to fire quicker than other warcraft, it is said. Heavy armor in protective belts is especially designed to resist airplane and submarine attacks. Oil is used for fuel.

LIGHT IN MAGNIFYING GLASS TURNS NIGHT INTO DAY

To permit the use of a magnifying glass in the dark, a small electric-light attachment has been devised in England. Mounted in a short wooden socket, the

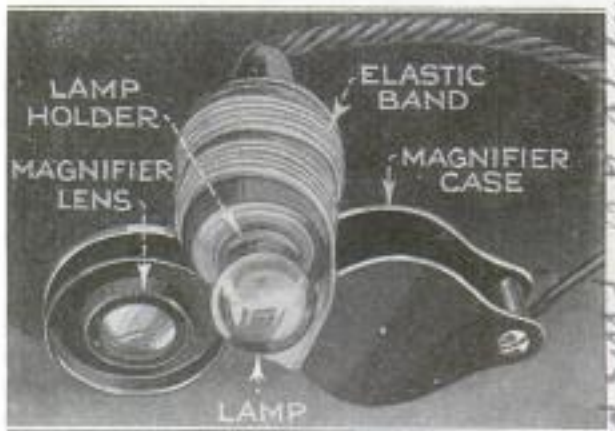

Light Magnifying Glass for Use of Scientists in Outdoor Night Work

lamp, an ordinary low-voltage bulb such as is supplied with pocket flashlights, is fastened to the magnifier by a rubber band. A short length of flexible cable leads to the battery. When placed in the pocket, the globe is protected by the conical shape of its holder and a thin brass tube that slips over it, being closed at the end by a cork stopper. It is of value to scientists in outdoor work.

German product

National
d sleeping
Co. no. do
Designed in
Water Proof
Railways, Montreal, Canada
Emb. C. A. Barron. in
129 Abbey Road

3400

OUR LATEST, PERHAPS LAST, WORD IN SEA WAR

Eight Such Guns on the "Colorado" Can Each Drop a Ton of Steel on an Enemy Ship 20 Miles Away



Powerful Electric Current Is Directed to Any Part of the Dreadnaught by the Mechanism of This Switchboard

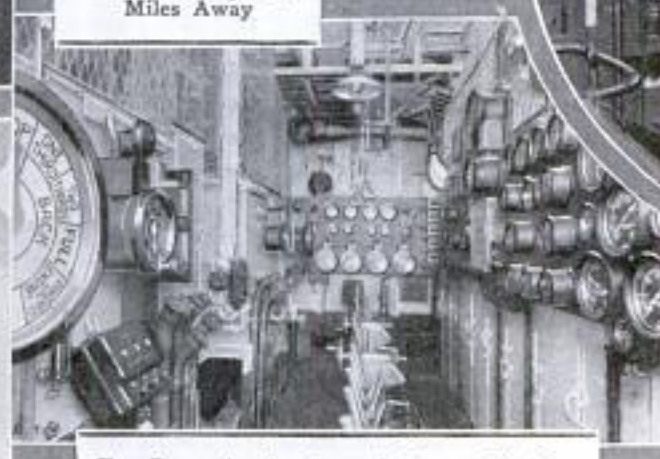

Far Down in the Control Room, Six Men Govern Every Movement of the Gigantic Machines on Orders from the Bridge

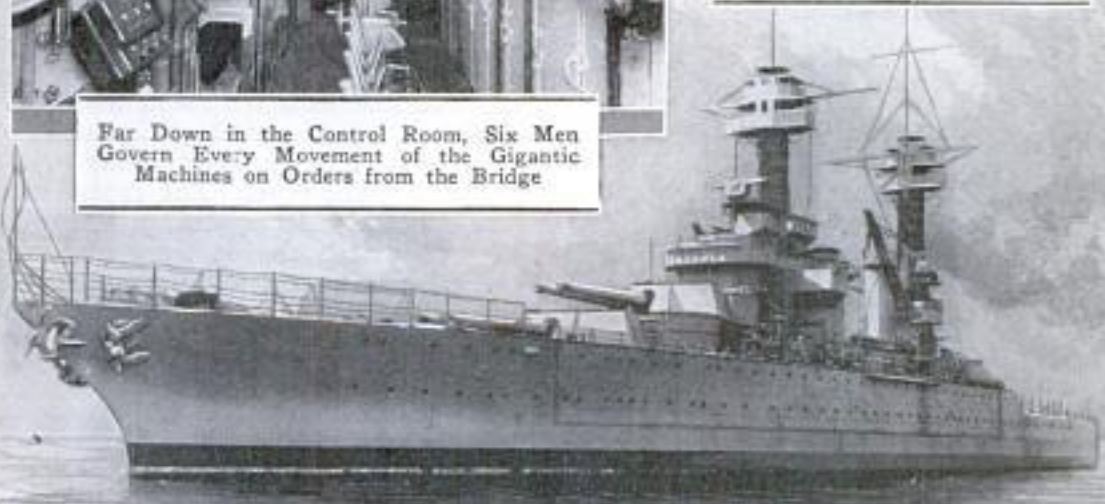

Armored Against Submarines and Air Bombs and Honeycombed with Water-Tight Compartments, the "Colorado" Must Be "Shot to Pieces" before It Can Be Sunk

Canada
LOGGING ELEPHANTS FOR CANADIAN FORESTS



Elephants Performing the Work of Men and Machines in Hauling Heavy Logs in Burma: Although They Appear Slow, Their Efficiency Has Been Proved

In British Columbia lumbermen are said to be considering the feasibility of introducing elephants to work in their logging camps, as they do in Burma. It has been shown that the elephants are more effi-

cient and actually cheaper to employ than machinery. They appear to be slow, but they are not. The only points that work against their use in Canada are the winters and the freightage of their hay.

LIGHT RAYS CURE FOR BURNS ONCE CONSIDERED FATAL

Light rays projected from a recently devised machine are being used to cure burns that formerly would have been considered fatal. Operated by electricity, the

it is said, aids nature in closing wounds and reconstructing tissue. Filtered through lenses, the healing rays may be either concentrated on one spot or diffused over the body.

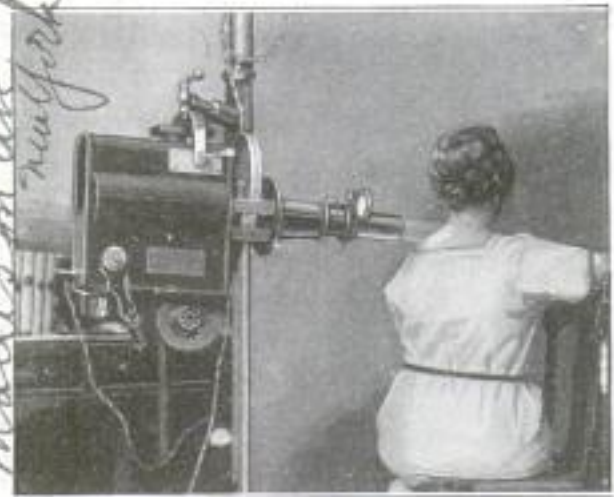

Light Rays from Electrical Machine Being Used to Cure Burns and Skin Disease

machine casts its brilliant beams in much the same manner as a magic lantern, to which it bears a resemblance. The light,

'GATOR ACTS AS A GO-DEVIL

Made fast to a wire and lowered down a manhole, a small alligator recently helped to open up a passageway in a clogged sewer pipe. The reptile made its way to the next opening, dragging the wire to which chains were afterward attached. It was a simple matter then to work the links back and forth and thus remove the obstruction.

CLOTH MADE FROM HEMP BARK

Weaving snow-white fabric from the bark of hemp is becoming an important industry in some sections of China. This cloth, called "hsiapu" by the natives and classified by foreigners as Chinese linen, is excellent in texture and is worn extensively. Compared with the finest silks and satins, the best quality of this grass product is quite expensive.

Letter recd.
Perfected by Uinshah
P. Shadiali, M. U.
17 Madison Ave
New York

*Always
help* 3532 *Com. Allen B. Child Dec 4 6 73
Kansas City, Mo.*

FRAME BUILT ON HULL TO RIGHT CAPSIZED SHIP

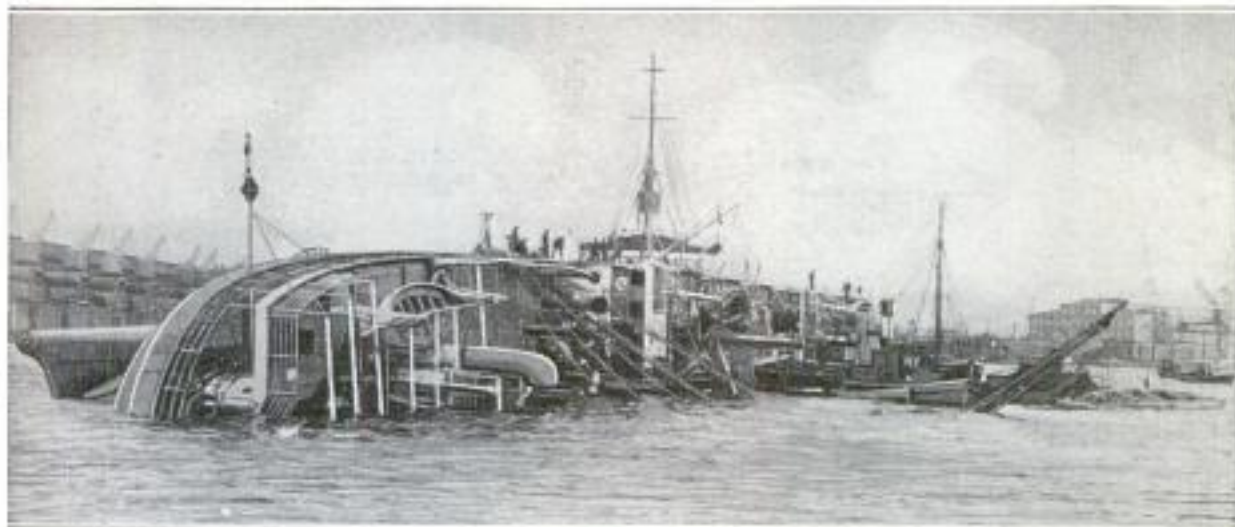

Capsized Ocean Liner That Was Raised and Floated after Cargo Was Removed, Loose Weight Shifted, and Holds Sealed to Prevent Entrance of More Water

To raise a large ocean liner that had toppled over in the harbor of Hamburg, Germany, recently, a heavy framework of steel girders was built on the exposed side of the hull. From the tops of this structure wire cables were carried to a battery of steam winches on shore. All loose objects on board were moved by divers to the shore side of the wreck, and a channel was dug in the floor of the bay close under

the steamer's bottom. One hour before high tide the engines of the winches were started, and aided by the rising waters, the great hulk slid into the channel and slowly swung into an upright position. The sticky mud held the craft firmly in the "pocket" until holds and compartments were cleared of water and ballast adjusted. In addition to the engines ashore, four large salvage craft and a floating crane lifted the ship from the outer side. During the raising two cables on the steel beams broke, but did not cause the vessel to drop back.



Twenty Winches and 132 Piles Driven into the Shore Served to Pull the Giant Hulk Upright. Above: Steel Structure on the Side of the Righted Hull

Inventor - John B. Callahan, Fort of Jacksonville
 848
 3584 *Water* POPULAR MECHANICS Florida

HYACINTHS "EATEN" BY BOAT TURNED INTO PAPER

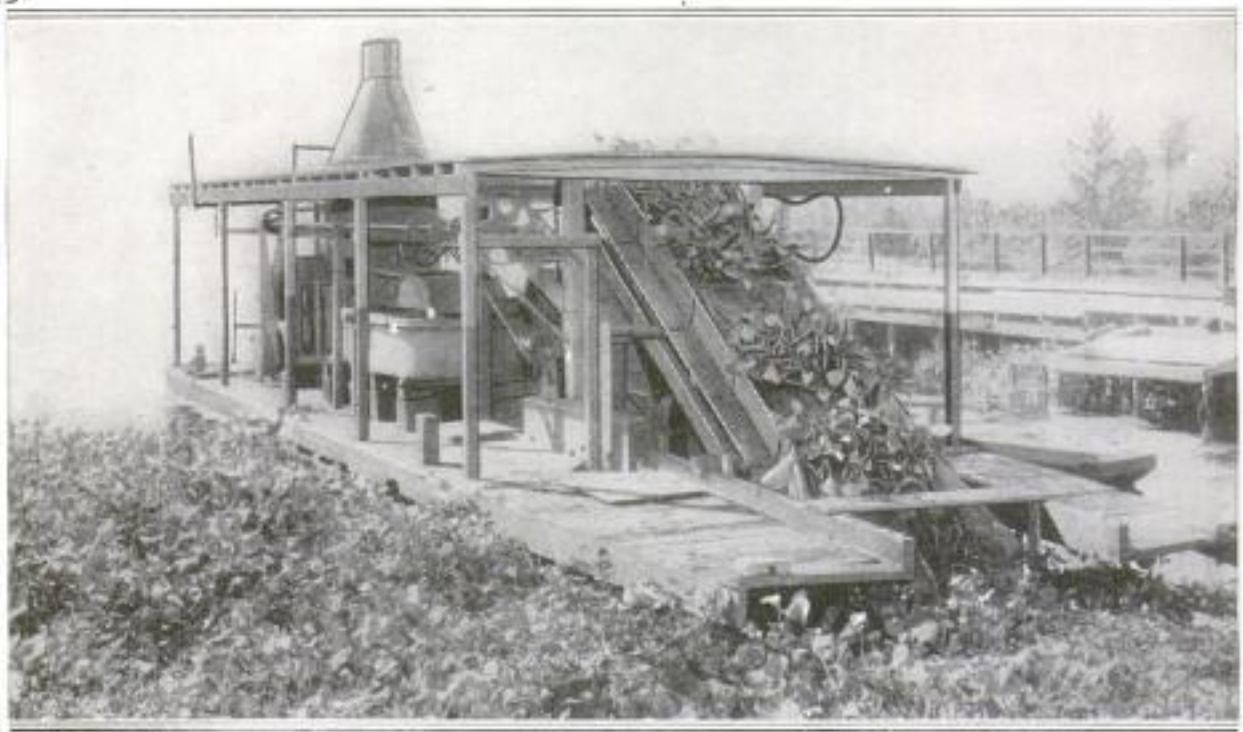

Queer, Self-Propelled Boat that Picks up Water Hyacinths on Rakes Attached to an Endless Chain and Reduces Them to Pulp Used for the Making of Paper

To destroy the water hyacinths that are a menace to navigation in the South, an inventor has designed a boat that not only removes the plants but reduces them to a pulp which is fireproof and may be made into wrapping paper or roofing material. Self-propelled, the ship forces its way into the thickets of the growths,

draws the weeds through an intake, chops them up, and produces the fiber product. Operated by only three men, the exterminator consumed 1,440 square yards of its fodder in six hours during a recent test. The plants are scraped from the bottom of the river by rakes attached to a chain conveyor.

"SPEAK GLOVE" ENABLES DEAF AND DUMB TO "TALK"

Deaf and dumb persons in Europe find it easy to converse with those who are not familiar with the sign language by wear-



Letters in Glove That Enable Deaf and Dumb Persons to Converse without Signs

ing a glove stamped with letters of the alphabet and the words "yes" and "no." Spelling out words by pointing to the characters, a conversation understandable to almost anyone can be carried on without the use of paper and pencil. The vowels and consonants are arranged on the thumb, fingers, and palm after the fashion of an American typewriter keyboard.

WATER POWER LIGHTS CITIES FOR FOUR HUNDRED MILES

Electricity made by water power in western mountains is being transmitted to cities almost 400 miles distant with little loss, causing engineers to believe that distance is no longer a barrier in transmitting current. Reservoirs will be built so water can be stored in flood season and released during droughts, they predict. A high-pressure, two-circuit transmission line, carrying 220,000 volts a long distance in the West, has been completed recently.

*International News Service
 306 W. Livingston
 11/11/13*

Copyrighted material

SECOND-STORY SIDEWALK MAY AID CHICAGO'S CROWDS

Elevated sidewalks in Chicago's downtown district are urged to relieve the ever-growing traffic congestion. Under the arrangement proposed, the roadway below would be given over entirely to vehicles and the parking of automobiles. It is pointed out that this step might create a system that would take care of all future problems, as the separation of pedestrians and vehicles would greatly increase the capacity of the ground level. The plan also includes passageways in alleys, which would give buildings much more advertising show-window frontage and leave the lower passageway free for trucking. By means of viaducts, heavy and light traffic already have been segregated in two streets that border the business section.

CLOTHES DRIER ON RADIATOR TO SAVE SPACE IN HOME

To hasten the drying of clothes after washing, a rack is being made that may be fastened to any-size radiator. Its several

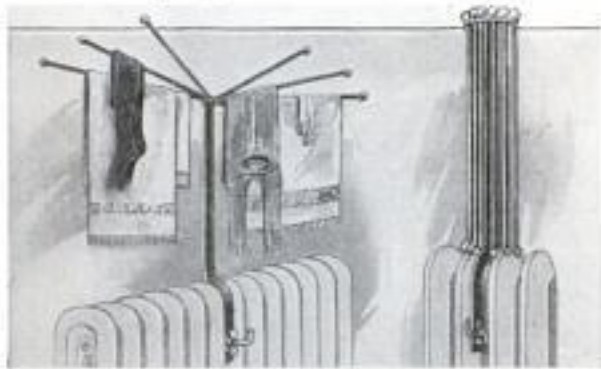

Clothes Drier that Fastens to Radiator; when not Needed It Can Be Folded Up for Storage

arms extend outward in fan shape. When the radiator is warm, circulation of the air insures a draft of heat passing over the materials. Moisture is carried off in a few minutes. The hanger eliminates the necessity of stringing a line in a room, thus saving space in crowded homes and small apartments. A rustproof coating on the rods prevents them from spotting the fabrics. The drier can be attached or removed by simply turning a screw, and may be folded up and stored away when not needed.

Unity Mfg. Co.,
224 N. Halsted, Chicago.

For the manufacture of baseball bats, a wood new to the industry is being imported from Cuba.

Chicago

GUIDE FOR LETTERING PEN GIVES SKILL TO NOVICE

To insure neatness and uniformity, a letter guide has been devised with which, it is said, skilled persons and amateurs can

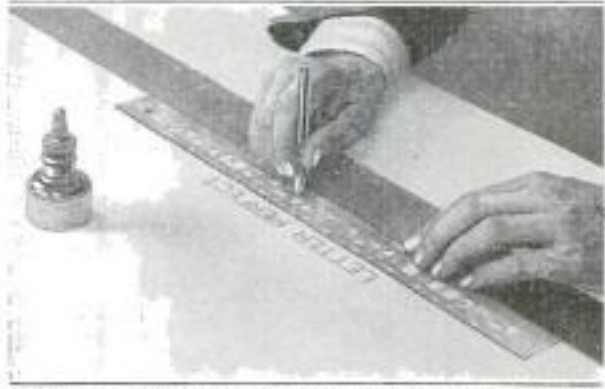

Aided by this Guide Amateur Letterers as Well as Skilled Craftsmen Produce Artistic Signs

mark maps, drawings, charts, and price cards equally well. Grooved on the under side, the instrument can be moved from one character to another without smearing the ink. While in use, a shift button that releases at a slight downward pressure, holds the device securely to the work. Some of the letters can be formed by a single stroke. Openings are cut in the transparent sheeting by means of which a specially designed pen is steered in forming the symbols and numerals.

TICKLESS WATCH MINUS HANDS TAKES TIME FROM SUN

Hands or gears are not required by a timepiece that takes its readings from the sun's position in the sky. The instrument will work anywhere within the confines of the United States, as it is adjusted for these latitudes. A sundial and a compass combine to indicate the correct hours of the day between 5 o'clock in the morning and 7 o'clock at night. The device can be carried in the vest pocket and possesses an accuracy that rivals many larger and much more complicated timekeepers.



No price

Wood-Elegance Instrument Co. New York
Marzani
154
Ansonia Clock Co. Randolph Chicago
215 N.

2.50



Far from the Propeller-Churned Lanes of the Ocean Liners, Sailors Believe There Exists a Mass of Seaweed in Which Ships of Many Ages Are Imprisoned

Kansas City Star 3575
8/31/23

Superstitions of Sea Defy Age of Reason

Sailors Still Firm in Belief in "Flying Dutchman" and the "Port of Missing Ships"

CLINGING to old beliefs in portents of good and bad luck, the sailors aboard the steamer "West Campgaw" recently attributed a hard battle with Atlantic storms to two young clergymen who were working their way to Europe as cattle men aboard the ship.

Both of the offending clerics, according to newspaper dispatches, were warned that singing hymns was just tempting the devils of the deep, but they persisted, and the result, the sailors said, was 48 hours of terrific battling against gales and fog in the region infested with icebergs.

Nevertheless, the chronicles of Davy Jones show that the preachers were fortunate in selecting the twentieth instead of the fourteenth century for their nautical adventure. In the early Middle Ages, the black robe of a churchman was regarded as an unfailing assurance of ill luck for the craft he sailed on. When subsequent behavior on the part of the winds and waves justified belief in the augury, the inoffensive offender was occasionally even thrown overboard.

"Superstitious as a sailor," is a phrase proverbial in the language of every country bordering on any of the seven seas. And while steel ships, radio, the Diesel engine, and scientific investigations have done much to eliminate beliefs which the forefathers of today's salt-water hearties held to the last man, stories of the "Flying Dutchman" and the Sargasso Sea are still to be heard wherever sailors gather.

Many a lookout will swear that in the still watches of the night he has actually beheld a great galleon, with all sails set and its crew, clad in medieval costumes, grouped about its decks, drift like a specter across the bows of some modern liner and then fade into the mist so close that even the musical chime of its ship's bell could be plainly heard across the waters. Others swear that they have beheld the "Port of Missing Ships," in the Sargasso Sea, where, it is believed, the vessels of many ages have become embedded in seaweed and drift in an endless circle far from the propeller-churned track of the liners.

So strong was the latter belief that an expedition was fitted out by Sir John Murray and the Norwegian government in

1910, which found the surface of the sea at the spot mentioned in the legends covered with patches of weeds, which, however, were not continuous, and could not have held any ship captive. Because of the vagaries of ocean currents, such masses of drifting vegetation have also been found in the solitary part of the Pacific, north of the Hawaiian Islands, near New Zealand, and along a belt of the southern ocean extending from the Falkland Islands, south of Africa and southwest of Australia.

Not all of the sailor man's beliefs are of such a harmless nature, however. As late

as 1867, the belief was prevalent that Finns possessed uncanny power. In that year, Carl Anderson, a Swedish sailor on the British vessel "Raby Castle," killed a mulatto deck-hand under the hallucination that he was a Finn and could draw blood from anything—even from the ship's foremast.

Even today a stormy petrel will cause a sailor unpleasant dreams and the sky will be scanned for sign of brewing mischief. Science declares that the petrel is an international super-



Copyright, W. W. Holkinson Film Corp.



Two of Nine United States Destroyers Wrecked During a Fog on the California Coast in the Greatest Peace-Time Disaster in the History of the American Navy

stition rather than a sound weather sign, but the sailor knows better, he declares. And he seldom can be argued out of his conviction that a school of dolphins or porpoises playing is an omen for the weatherwise. Their sport also means dirty weather.

In the olden days, credulity often rose from a lack of scientific knowledge, and training. Columbus' journal tells of seeing mermaids, but these, present-day knowledge asserts, were merely sea cows. Sailors still believe that sharks follow a ship on which a death is to occur. Their somewhat gruesome faith in the unerring instinct of the finny monster has no traceable beginning, but is deeply rooted in the minds of nautical folk.

For many years the Scandinavians have held a reputation for hardihood at sea, but two years ago a liner from the north came into New York harbor with most of the crew

wearing close-cropped hair. The captain admitted that during a two-days' howling tempest, the ship had literally lost way, rather than gained on its course, until the crew called to mind an old belief and insisted on hair-cutting—and the tempest died down before the barbering was completed.

Evidence of another strange superstition is to be found on ships crossing the equator in the weird services conducted to initiate passengers and members of the crews into the kingdom of Neptune. Then there still exists, despite the evidence of science, a belief in the existence of mermaids and sea serpents. The latter is attributed mainly to the antics of schools of dolphins that, seen at a distance as they leap from the waves, have the appearance of some great serpent writhing its way through the water in the sunshine.



Copyright, W. W. Hodgkinson Film Corp.
The "Charles W. Morgan," Said to Be the Oldest Square-Rigger Afloat

MOTORCYCLE ON SPEED TRACK LEAPS HUMAN HURDLE 3680

Whirling around a saucer-shaped track, a motorcyclist giving exhibition performances in Germany jumps his machine over a human hurdle. Three people lie side by side across the path of the racing cycle, which is thrown into the leap by the turned-up end of the track. Passing over the gap it lands on the flat continuation of the course at full speed. The track is a portable one of wood, built in sections.

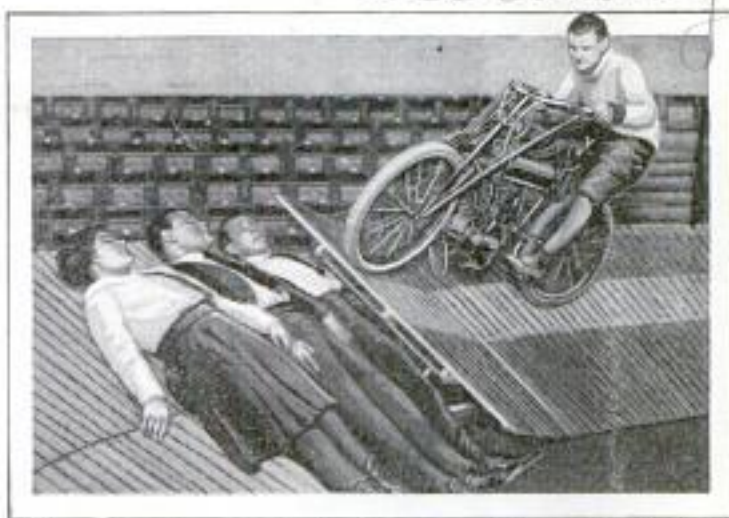

Motorcyclist about to Take the Leap over a Human Hurdle While Traveling at Full Speed

ELECTRIC ENGINE BURNS ASHES FOR ITS MOTIVE POWER 3778

Generating its own motive power by burning ashes from locomotive fire boxes, an electric railway engine is being experimented with in South Africa, which eliminates the need of central power stations, overhead charged wires, or "third" rails. Engineers believe that its perfection will result in great changes in suburban and branch-line transportation because of its

cheapness of operation. In a recent test run, a 30-ton car was driven at a speed approaching 20 miles an hour by energy manufactured by its refuse-burning plant. Electricity is created by heating the cinders and extracting a gas, which, after passing through a purifier, runs two internal-combustion engines operating a dynamo. It is estimated that a locomotive equipped with this system can travel 150 miles on five or six bags of cinders and 10 gallons of water.

Designed by - C. Lawson, Super. South African R.R. Durban, South Africa

THREE-IN-ONE LADDER AVOIDS ACCIDENTS, SAVES TIME

Folding in the center, a ladder is being made than can be used either in straight or step posi-

tion, and as a trestle. Extended or folded, the two sections are securely fastened in place by automatic locks on each side of the frame. As a stepladder, it is prevented from collapsing by a stout safety chain and will support two persons, one on each side. It has a wide base and there is no side sway.

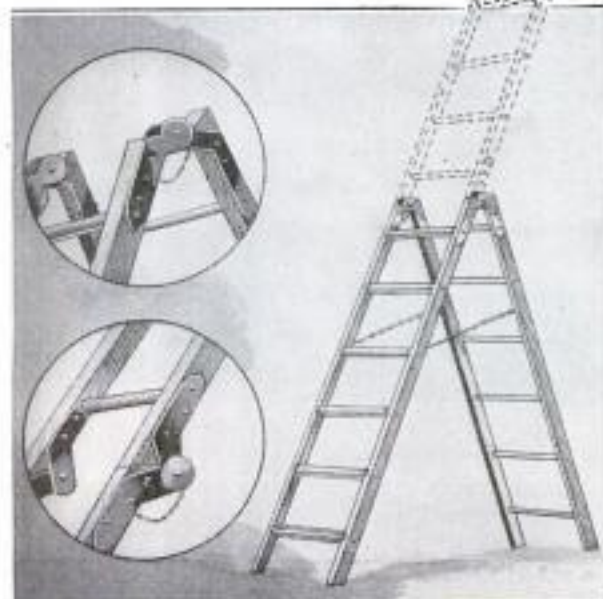

Ladder for Use in Either Straight or Step Position, or as a Trestle

WINGED TORPEDO TO BE ADDED TO U. S. COAST DEFENSE 3799

Although the tests have been shrouded in secrecy, it has become known that army and navy experts have been developing a winged death-dealer—an air torpedo that runs under its own power. Its stopping point can be accurately fixed, it is said, and its explosion timed. The device will not operate by radio control, though experiments have been made along that line. Use of the wireless was discarded, as it was feared that a torpedo so controlled, would also be sensitive to influences coming from other directions and might become a "boomerang" by being turned back upon its operators.

Labor Mfg. Co. Chicago Heights Ill.
Kansas City Star Copyrighted Material



Prophetic of a Near Future when Huge Airships Will Be as Common as Trains and Steamships Today, the ZR-1 Glides Serenely Above Busy Thoroughfares of American Cities

Mail
Air

*Pacific & Atlantic photos. etc.
25 Park Plaza*

LIGHTED AIRWAY OVER ATLANTIC IS PREDICTED

AS though painting the future, Paul Henderson, assistant postmaster-general, who conceived the idea of transcontinental air-mail service, sees a lighted airway over the Atlantic Ocean, along which will fly great, winged ships carrying mail between American ports and European cities.

This prediction was made following the flights of the United States Navy's giant dirigible, ZR-1, one of which took it half-way across the country and back to its station at Lakehurst, N. J.

The ZR-3, another big lighter-than-air ship, now being built for this government in Germany, is said to be larger and faster than the ZR-1. When completed it will be put into transatlantic service carrying mail between New York and London, according to government officials.

The plan for the illumined path across the seas includes a series of anchored docks, one every 400 miles, similar to landing fields. Aided by these, the airplane types of carrier can be utilized. The trip, one way, is not expected to take more than two days. The floats would be secured with heavy anchor chains and rest

on steel pontoons, elevated sufficiently above the water to avoid the highest waves.

The ZR-1 is 660 feet long, with a diameter of 78 feet. With its cabins, the height of the craft is 96 feet. Apartments for 30 passengers are provided in addition to those set aside for the crew. The ship can attain a speed of 70 miles an hour, and cover a distance of 400 miles without need of stop or landing.

For fuel, gasoline is used. The reservoirs have a capacity of 8,000 gallons. The great cigar-shaped cylinder incloses 20 bags filled with helium, a noninflammable gas.

With the introduction of the ZR-3 into the cross-seas service, the Pacific and Atlantic oceans can be brought into close touch with each other by air. Instead of the weeks that are sometimes

now necessary to transport mail matter from Europe to the western-coast cities, a period of but a few days will be required to make the trip by air-mail ship. It is believed that a regular 28-hour cross-country schedule will be installed in the air-mail service from New York, which, with two days needed for the ocean journey, will reduce the fastest time now being made.

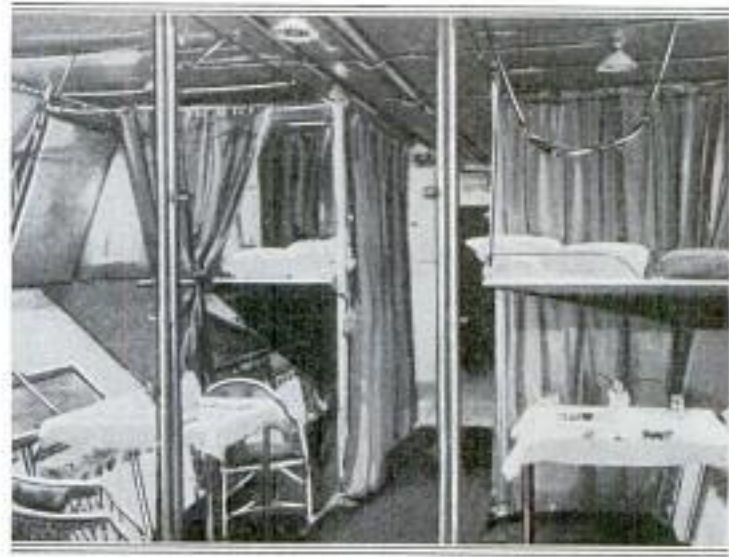

Interior of One of the Cabins that Provide Comfort for Passengers and Crews on Air Liners

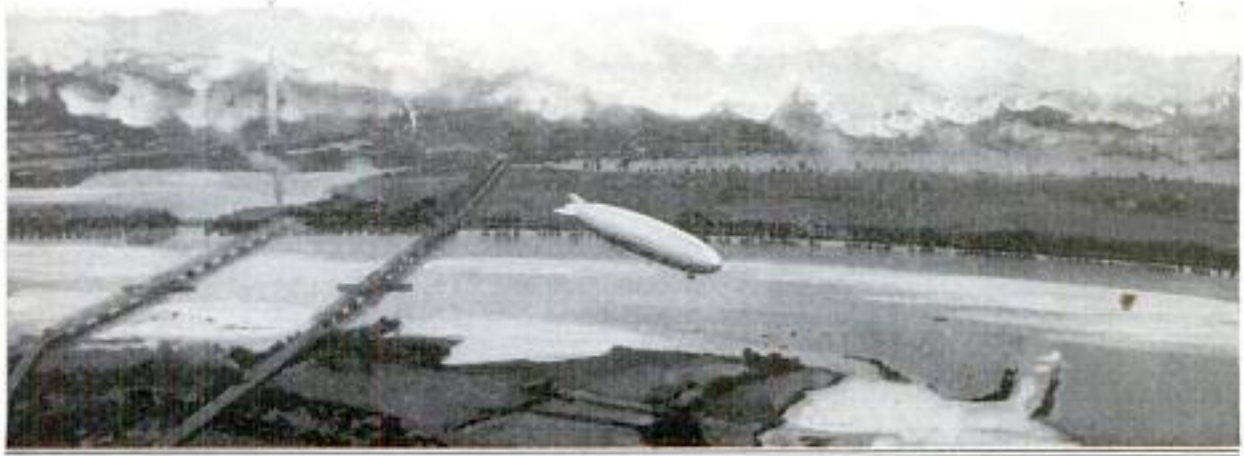

After Europe and America Have Been Linked by Air Routes, Attention Will Be Turned to Establishing Aerial Lanes Across the Pacific to China and Japan

3699 LEVIATHAN OF INLAND WATERS LAUNCHED

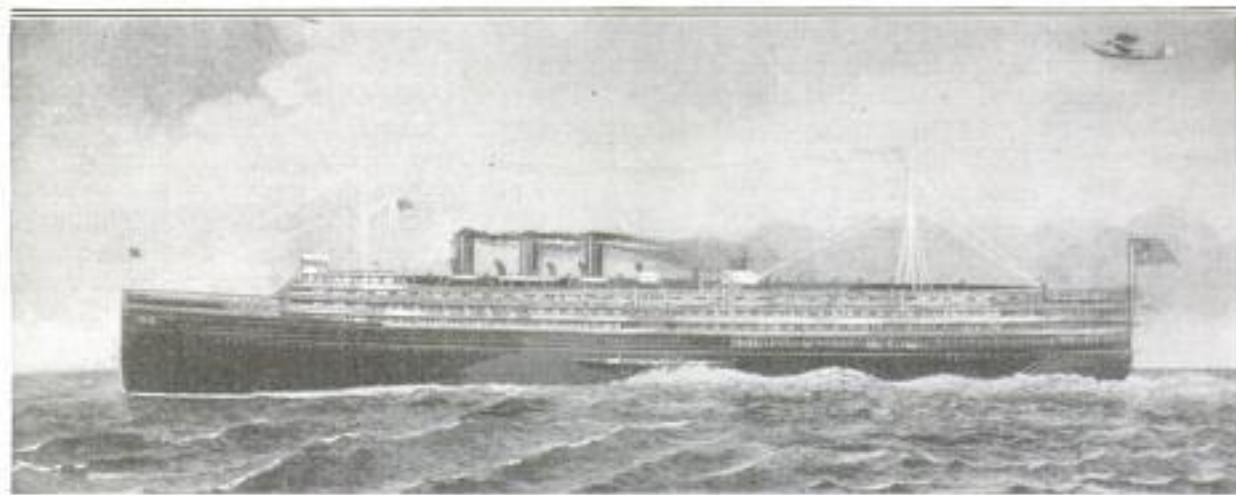

Largest Inland Water Vessel of Its Type, Believed to Be the First Big Passenger Steamer that Has Been Built for Great-Lakes Traffic Since the Great War

Launching of a leviathan of the Great Lakes, said to be the largest passenger steamship in the world for use on inland waters, took place recently at a lake port. It is the first big boat of its kind to be built for such service since 1917. Measuring nearly 550 feet from stem to stern and 100 feet amidships, it will have accommodations for about 1,200 passengers and a

Lake
crew of 300 men. After the christening ceremonies, the hull was towed to another point where the superstructure and the interior decorations will be finished. Its total cost is expected to reach more than \$3,500,000. Although lake craft is gradually assuming the lines of ocean steamers, many of the older types of construction are still employed by the builders.

3703 AIRSHIP METAL LIKE WILLOW, YET STRONG AS STEEL

Duralumin, an alloy of aluminum, which is used for airship girders, according to recently completed government tests is as strong as the best steel, yet only one-third as heavy. Weighing but 150 pounds

A support of this material, 16 feet long, such as were used in the framework of the giant dirigible, ZR-1, tips the scales at 5 1/3 pounds, yet, in the shape of a column, will hold a load many times its own weight. A piece the same size fashioned as a beam will sustain 125 pounds for each foot when the burden is evenly distributed. When first rolled, this product is very soft. After being heated to a temperature ranging from 897 to 914 degrees and immersed in water or oil, it increases in strength. As it cools, and is allowed to stand, it gains in toughness until at the end of a week it is said to be as strong as the highest grade of steel.



Test Showing Strength of Metal Used in Building Girders for Giant Airships

a cubic foot, as compared with 450 pounds for the same amount of structural steel, this metal can resist a stress of 27 1/2 tons, proving it to be one of the toughest known.

3749 TWO-DOLLAR NOTE IS DOOMED; VICTIM OF SUPERSTITION

Because of its unpopularity and the superstition attached to it, the two-dollar bill is said to be fast passing from circulation. Government officials admit this prejudice is general among all classes of people throughout the United States, except in New England, and even now are considering the advisability of discontinuing it. It has been omitted from the new designs for United States bank notes. The

New York Times 9/30/23

Empress Air Magazine, Building Green Building, New York

Underwood's News Photo Service.
 205 W. Washington
 Chicago 857

speed with which it circulates and becomes unfit for use is seen as an indication of its disfavor. Its life is less than six months, the shortest span of existence accorded to any form of paper currency. When it goes to the treasury for redemption, it is dirty, soiled, and unkempt. Frequently one corner is torn off. The bad-luck superstition which is responsible for much of the mutilation of these bills seems to be prevalent among those who risk their money in games of chance. Tearing off a corner is supposed to remove the "jinx." Even then the holder exchanges it as soon as possible or gets rid of it in some other manner.

3707

ELECTRIC FERRY, LIKE TROLLEY CAR, RUN BY "MOTORMAN"

Propelled by electricity, a ferryboat that has all of its machinery controlled from a switchboard panel has recently been put into operation in an eastern city. An engineer who acts as "motorman" manipulates all driving apparatus from this point under directions from the pilot above deck. In tests held to determine the time re-

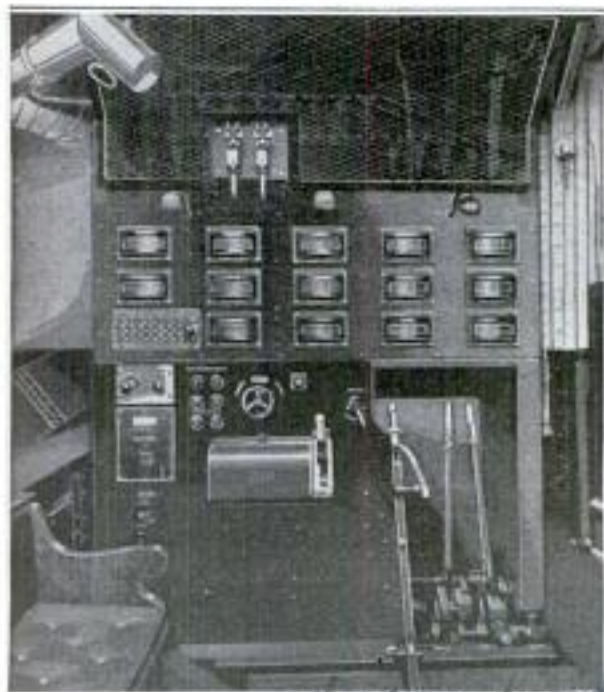

Control Panel of Electric Ferry from which All Propelling Machinery Is Manipulated by "Motorman"

quired to start and halt the craft, it was brought from full speed to a dead stop in 40 seconds.

☐ Mexico is reported to rank first in mineral wealth among the nations of the world equal to it in area.

PENCIL'S WEIGHT BENDS STEEL BAR, DETECTOR FINDS

Even a strong steel bar bends under a very slight weight, according to a test recently made by government experts



Copyright, Underwood & Underwood
 Proving that Weight of a Pencil Would Bend Steel Over Three Inches Thick

using an "interferometer." By this delicate instrument it was determined that a solid rod 3½ inches in diameter and 2 feet long, was pressed out of a straight line by laying an ordinary pencil on it. Although the depression was ever so small, this sensitive device detected the curve.

3748

RABBITS HERDED LIKE CATTLE ARE SLAUGHTERED IN PENS

Hunters in Kansas killed 4,000,000 jack-rabbits in the past year, according to estimates of state officials, in an attempt to free fields and orchards of these destructive pests. To encourage the warfare against them, the state pays a bounty of 10 cents a head. During the late fall and winter, thousands of them are slain in drives covering many miles. The rabbits are driven by men and boys, aided by dogs, into wire inclosures, where they are slaughtered. The usual practice is to remove the ears with which to collect the reward, and the carcasses are shipped to the larger cities and sold. Sometimes the fur is used for making hats and felt cloth. It is figured the average rabbit causes damage exceeding \$1 every year by girdling trees, and cutting roots of alfalfa, corn, and sugar cane.

Chicago Tribune
 7/30/23 material

Twenty Years Ago This Month as Seen

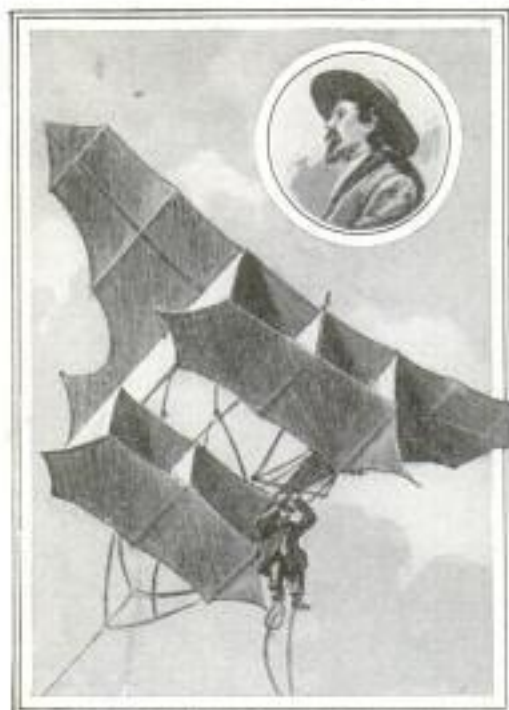

Kite That Crossed English Channel



London Fire Brigade in 1903

TWENTY years ago! Consider the world in 1903. It had few of the facilities for speed of transport and communication, for rapid quantity production, for convenience and comfort, that today are accepted as indispensable.

Automobiles were just appearing on city streets, the airplane was an object only of derision and jest, wireless telephony was scarcely more than a dream, and moving pictures had hardly emerged from the museums where they were first exhibited.

And yet, all of these things now seem c o m m o n p l a c e. They are wonderful only when an image is formed of a world without them.

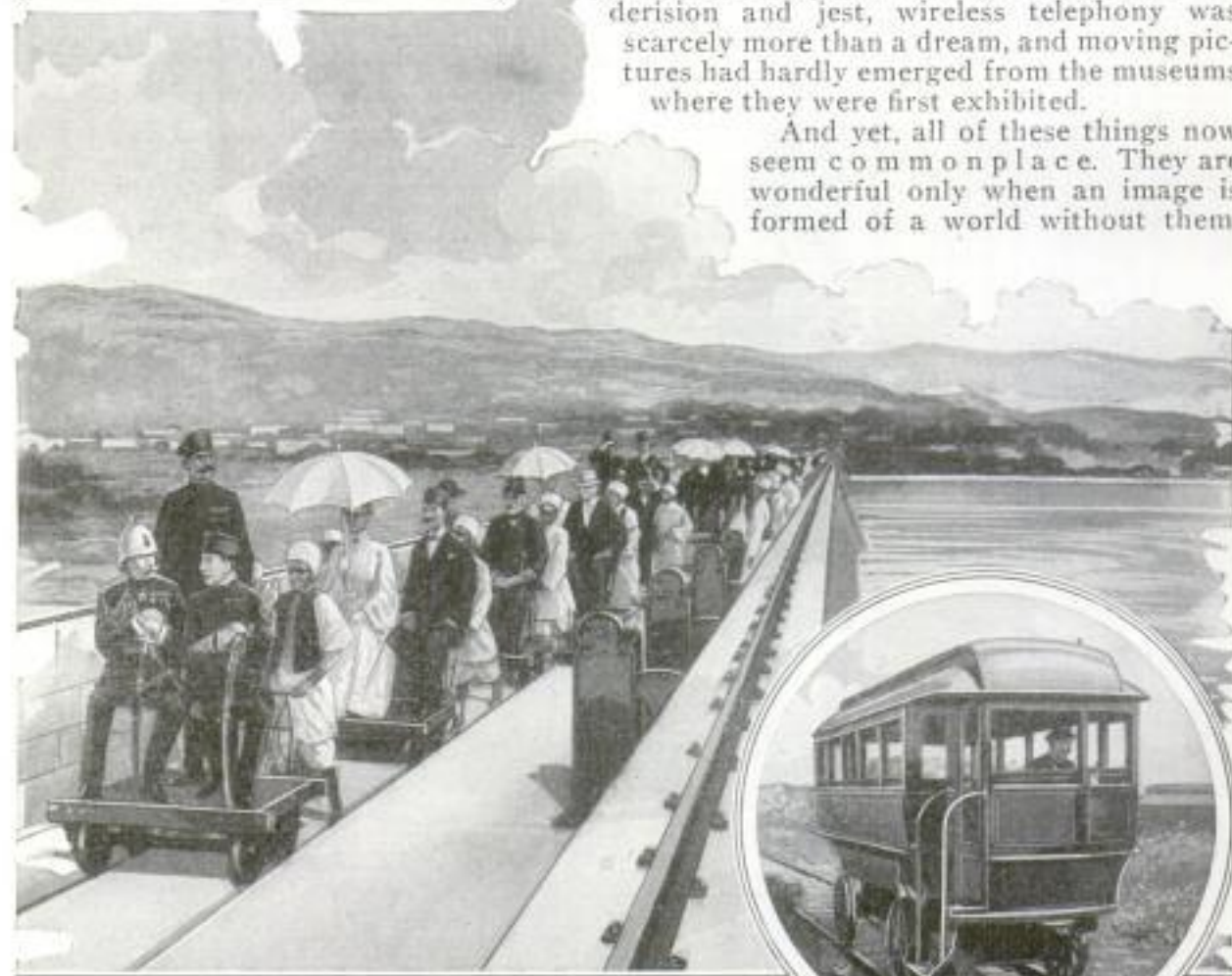

Opening of the Assuan Dam, and One of the First Railway Coaches Designed to Be Propelled by a Gasoline Motor

in the Columns of Popular Mechanics

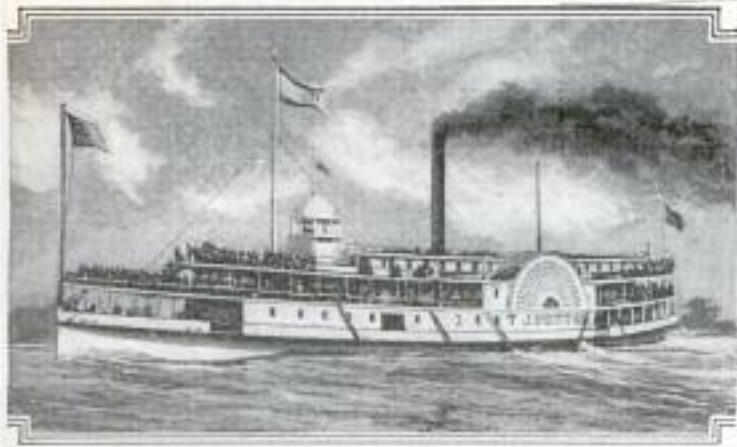

River Steamboat of Two Decades Ago

Nevertheless, the achievements of the past serve as the best guide to the future, according to Charles P. Steinmetz, one of the world's greatest engineers.

"What will our children's children think of the helpless human race in the year 1923?" he said recently. "I have no doubt that the transformation to be visualized a hundred years from now will be more complete than the most fanciful among us might conjecture.

"Electric power," he asserted, "will be at the service of everyone for every need. It will be as common as water is at present and distributed in much the same manner."



Early Type of Fire Extinguisher Operated by Electric Motor



Trackless Trolley That Preceded the Motor Bus, and Sand Dial Attached to Phone to Measure Time

**TYPEWRITER PAGES IN ROLLS
 SAVE TIME IN CHANGING**

3605

Paper, in rolls or in continuous lengths, fan-folded in a box, is automatically fed into a typewriter or billing machine, re-



Machine on Which Person Can Write 1,000 Pages without Inserting a New Sheet

cently invented, to save time formerly spent in placing and withdrawing sheets. As many as 1,000 pages can be written without renewing the paper supply. For making copies, the work is further speeded up by use of long carbons held by metal fingers at the back of the machine. Separating of copies is done by a slider, set in a rigid position and requiring no attention from the writer.

**EARTH'S INNER TURMOIL MOVES
 HIGH PEAKS OF SURFACE**

34762

California coast ranges are being forced northward and the Andes Mountains of South America are moving slowly eastward, in the opinion of a scientist studying the effects of the turmoil going on within the earth. The eastern part of Japan, he says, is being pushed westward. These changes, he believes, are results of tremendous pressure exerted from beneath the "Pacific deep." Both the recent Chilean earthquake and the Japanese catastrophe, according to him, were due to the progress of these shiftings and are the forerunners

of seismic disturbances equally as severe. While geologists have known that the Pacific coast peaks in the United States are marching toward the north, he asserted, the Chile disaster gave first definite proof that the Andes are sliding eastward. In both cases the movement is away from the ocean.

**GREYHOUND IS SPEED DEMON
 34738 OF ANIMAL KINGDOM**

Through a series of recently completed tests, the speediest animals are reported to have been determined as follows: the greyhound, race horse, prong-horned antelope, hare, Texas jackrabbit, common fox, coyote, foxhound, and gray wolf. The records were made by noting the number of bounds made by each animal in a given space of time, by means of a stop watch, and then measuring the length of the leap. The greyhound, it was ascertained, can travel a short distance at 35 miles an hour, about four miles an hour faster than the hare. None of those studied, however, can keep up their speed for any considerable distance, although the fox and wolf can beat either the greyhound or race horse in this respect.

Chicago Herald & Examiner 7/30/23

**WATER POURED IN FLASHLIGHT
 STARTS BATTERY ACTION**

3672

So the battery in a recently invented pocket flashlight will not deteriorate on a store shelf before being used, water to start the chemical action is not added

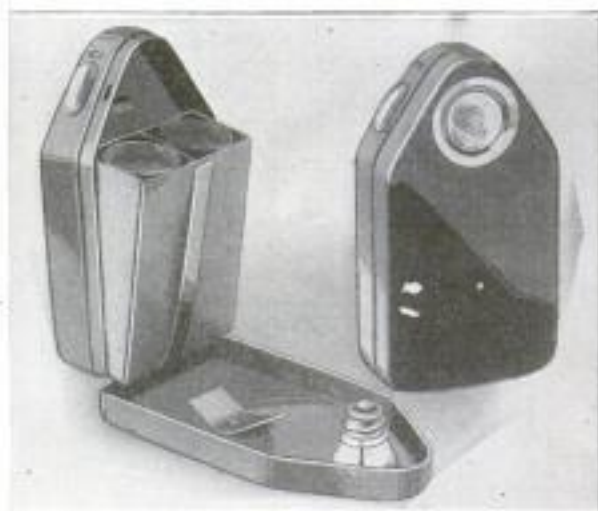

Flashlight with Battery That Becomes Active When Saturated with Necessary Amount of Water

until it is to be placed in service. The case is of a convenient shape that can be placed on end, while the bulb on the side gives a strong, white light.

*60
 5356
 (dealer)
 Chicago*

*Kanawha City Times
 10/18/23*

HORSES LEAP RIVER FORMING BARRIER IN RACE



Notable Photograph of Three Horses Taking Water Leap During International Steeplechase in Europe, where a Single Misstep Meant Disaster and Loss of the Race

Taxing the skill of their horses, jockeys at an international steeplechase held in Europe recently, jumped them over a hedge and across a river, said to be the longest water leap on any course in the world. Usually in such an event, if the

horse falls, he is either injured or does not finish because of the delay. In the contest, two horses left the ground, nose and nose, and passed over the water together. To the watchers they did not vary a fraction of an inch in the entire movement.

Apparatus described

RADIO RECEIVER HELD ON EAR WITHOUT HEAD BRIDLES

Fitting over the ear, a radio receiver is being made in Europe that does away with head bridles. It allows greater freedom of movement, yet is not uncomfortable, since its light weight is evenly distributed. As the ear is entirely inclosed in the device, with a cushion of air between it and the diaphragm, external noises are shut out, music and voices sound more natural, and the wearer can hear more distinctly. Sets of two are also being turned out.

AUTO WITH "WHEELS" LIKE EGGS PULLS LOADS OVER SNOW

For traveling over snow and ice, a motor-driven vehicle resembling an automobile has been made that has four revolving egg-shaped drums that grip the roadway with sets of spiral flanges. By rotating the two pairs of "wheels" at the sides in opposite directions, the car is prevented from slipping from its course. Steering is accomplished by means of bobsled runners extending in front. While its speed depends on the design and conditions under which it op-

erates, it has been run through deep snow at the rate of seven miles an hour, and over flat, icy surfaces is said to have made 23 miles in the same time. Primarily intended for winter service in logging and mining camps, it is also suited to other industries. During tests in a lumber tract the machine handled larger loads than teams could manage, and in one case started and moved four sleds of logs totaling in weight over 80 tons. In unpacked



Courtesy Engineering & Mining Journal
Egg-Shaped "Wheels" on Tractor for Use over Snow or Ice

snow it does not sink more than eight inches and leaves furrows that can be used by following horse-drawn vehicles.

*Benardi - Telephon G. 27
Wilmerdorf - Berlin Germany*

*11/16/22
1075 3*

Armstead Snow Motors, Inc., Detroit, Mich.

1897
Francis Herbert, Hermit
B. C. Canada



Wild Man of Borneo as He Is Today

Head Hunters Brave, Industrious, and Thrifty on Their Island Home

By FRANK BURNETT

IN Borneo the Sea Dyak best represents the "wild man" most persons have heard about, but few have seen, for the exhibit of the circus is not always a genuine savage of the Bornean wilderness.

Though a confirmed head hunter, the Sea Dyak is still a most genial character, and a good citizen, aside from his head-hunting habit. How this can be is, of course, entirely due to the different points of view prevailing upon certain matters in various parts of the world.

On his island home the Dyak is brave, not cruel, and never tortures his prisoners. He is kind and affectionate to his family, energetic, industrious, thrifty, exceedingly honest, and very hospitable. Though still a pagan, for there are practically no missionaries in his great territory, he is of good morals. He is very democratic, to such an extent that the chiefs have much less influence than those of other tribes in Borneo. Unlike so many native people, he is not vindictive and does not harbor a grievance. An idea of their quaint viewpoint is presented in the following story:

During my stay at Fort Kapit, far in the interior, on a recent visit, a young Dyak chief one evening walked into the living room where the commissioner and I were seated. He helped himself to tobacco, then sat down and talked for some time. When he finally left, I asked the commissioner what he wanted. "Oh, nothing very much," the commissioner replied with a smile; "he was merely inter-

ested in knowing how the work was proceeding in which he had been engaged in helping the government, a few months previously, some distance down the river. That is his quaint way of describing his term of imprisonment for what you would call murder in a civilized land, but which he considers a quite laudable action—depriving a Chinaman of his head."

Naturally, in such a land the taking of a head is not so severely punished as in civilized regions. To take certain human heads is part of the Dyak's way of life. That this is the correct thing is impressed upon him from earliest youth. Furthermore, no young man can get a wife until he has taken at least one head. "The more heads, the more influence," is the way of life among the Dyaks.

Stores of heads have always been the principal feature at Dyak feasts. Each chief would orate at great length over various heads selected from his pile, thus showing what a mighty warrior he was to have killed so many. He would also point out certain heads as belonging to famous men of enemy tribes. Due to the white government's campaign against head hunting, carried on vigorously for many years now, the number of heads taken has so greatly diminished that young chiefs are lacking in stock in trade.

To relieve the situation, and as the best means of keeping in check such outbreaks of killing, the white men ruling the land have adopted the plan of lending surrepti-



Sea Dyak in War Dress Made of Tiger-Cat Skin, and, at Right, a Human Head Recently Taken, Together with Other Ornaments



Native Village in the Wilds of Borneo Peopled by Famous "Wild Men" and Head Hunters

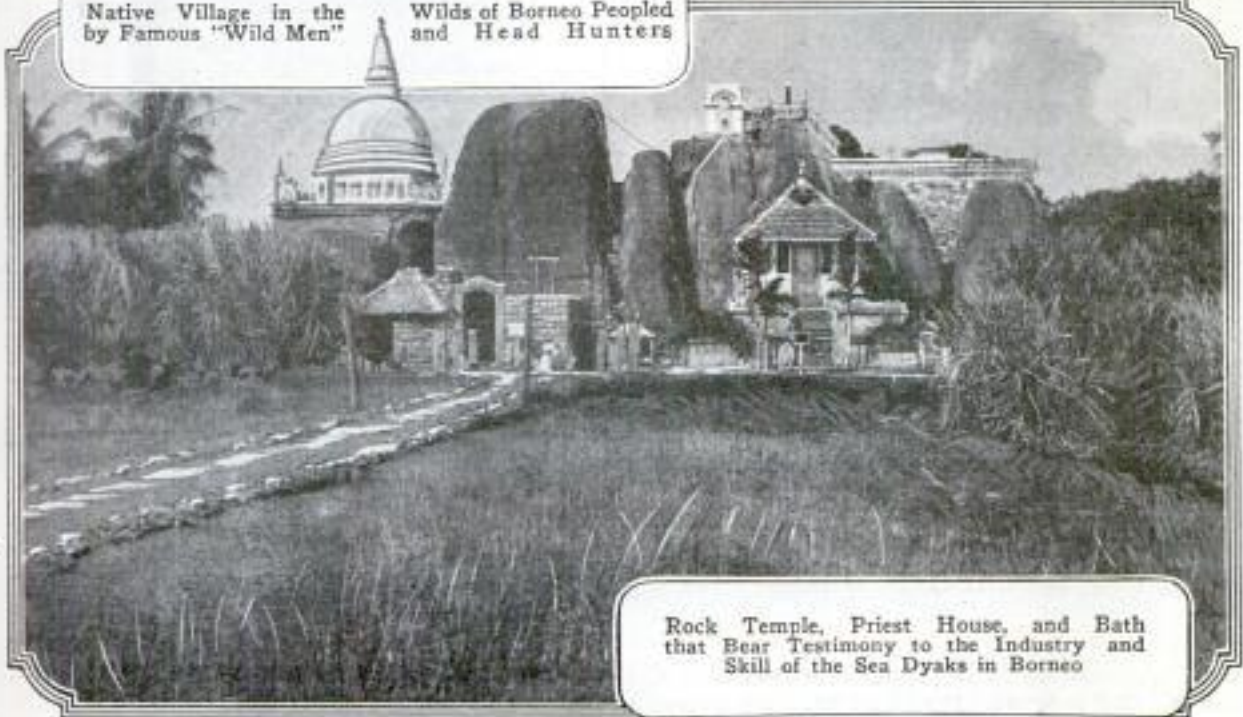

Rock Temple, Priest House, and Bath that Bear Testimony to the Industry and Skill of the Sea Dyaks in Borneo

tiously to various chiefs collections of heads now in the government's possession. As all heads look very much alike, once the flesh is gone, the chief can still pick out any one without fear of detection and ascribe it to So-and-So, famous chief of another tribe. In this way the government helps the natives save their face without breaking the white man's law.

The Dyak war dress is made of tiger-cat skin decorated with the feathers of the rhinoceros hornbill. From morning until night both men and women indulge in betel nut. As the Dyak women do as much paddling as the men, they have these

implements made of wood of a size to fit their strength and decorated with bone. The Dyaks are a musical race, and fond of dancing. The principal musical instrument is a compound of reeds fitted into a gourd bowl. When a number are played at once, a Scotchman listening might believe himself back at home, so like is the sound to that made by bagpipes.

This, very briefly, gives an idea of the Sea Dyak who, today in a century when civilization has reached a completeness never reached in any previous age, still lives primitively and fully deserves the name of "wild man of Borneo."

COAL YIELDS SMOKELESS FUEL, GASOLINE, AND CHEMICALS

Smokeless fuel, gasoline, and several chemicals have been obtained from soft coal by a distillation process recently in-

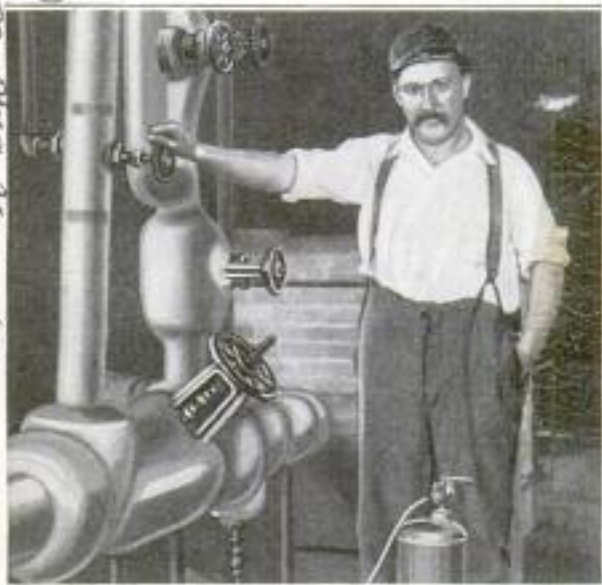

Valves Used in Distillation Process to Obtain Valuable By-Products from Coal

vented by a western engineer. While these substances are loosed from a single ton of coal, there remains 1,480 pounds of the original 2,000 that still possess high heating value. Although this residue, because it is free from smoke, may give the discovery its greatest fame, the possibility of extracting by-products—oils, greases, and bases for dyes—is said to be attracting industrial interest. In the process, domestic-size coal is poured into a retort, where superheated steam is forced through it. As this rises, it takes with it many different elements, which now are said to escape in smoke. From the top of the furnace, the vapor goes into a pipe, and thence travels into the first of a series

of separators. The tests showed that almost 20 gallons of gasoline can be extracted from each ton of coal.

IRON WEIGHT CAN'T BREAK GLASS FOR GOOGLES

To increase the safety of goggles, lenses stronger than any heretofore made have been developed by a large optical factory. The glass, while sufficiently clear to give the wearer unimpaired vision, is said to be tough enough to withstand the impact of a steel ball $1\frac{3}{8}$ inches in diameter dropped from a height of eight feet. Preceding types, it is said, failed to sustain blows of much lighter force. Because of the greatly improved efficiency of this product, it is said to offer the best protection for workers who are exposed to flying chips.

METAL FISH WITH A RUDDER MADE TO THRILL ANGLER

To provide the thrills of angling without tiresome waiting, a metal fish has been devised, shaped, and painted to resemble a real one. The line is attached to the top side of the device, so that it will glide from one side to another as it is pulled through the water. A straight or angular rudder also can be fitted to the tail, if desired. By extending the cord through the hole



at the base of the eyelet and affixing barb and bait, a small design can be used to attract fish, since a slight movement of the pole will cause the lure to jump up and down and wiggle sideways.

Handwritten notes on the left margin:
 D.M. J. J. Ferguson
 and Salt Lake City, Utah
 mfr. Utah By-product Co., Salt Lake City, Utah

Handwritten notes on the right margin:
 3770
 Rausch & Lomb, Rochester, N.Y.

Handwritten notes at the bottom:
 and W. Corbett,
 2213 Park St.
 Adrian Mich.
 Copyrighted material

3419 Emb. } Francis Diegel, Artist 1887, D.C.,
Canada
James Mc Intyre, Apartado,
370, Mexico
Cety Mexico



Sculptured Picture
Stories and Stone Sun
Calendars Bear Evidence of Learning That Rose High in
Ancient Empires of the Western Continents

Richard...
A. N. Murzaoff, Chicago

Secrets of Long-Lost Races Sought in Ruins of Once Mighty Empires

SEEKING the lost knowledge of the world's yesterdays, passed away with long-forgotten races, a dozen scientific expeditions are penetrating to the very outposts of civilization. Excavations that would swallow a city block have revealed the remains of ancient kingdoms that perished long before history began.

On the island of Ceylon, the skyscraper city of Anuradhapura, that flourished more than 2,000 years ago, has been uncovered by some of these explorers. A French engineer sounding the waters off Alexandria, Egypt, claims to have discovered an undersea construction that may prove to be an ancient harbor works built by the Pharaohs. Asiatic diggings promise still greater revelations.

Recently Ur, in Upper Egypt, gave up what is said to be the oldest temple yet found by modern civilization. Out of this city, Abraham, of the Bible, a highly civilized man, is said to have come. The deadly jungles of South America, the swamps of Patagonia, where is rumored to live a giant monster of the early ages, the sunburned wastes of Central America, once traversed by learned red men, all claim the efforts to solve the riddles of ancient existence.

Excavators, working in the Valley of Mexico, report that five different civilizations succeeded each other there. The oldest is believed to have flourished on plains 40 feet below the present surface. A race that rivaled the peoples of old Rome is claimed to have lived farther south. The zenith of their culture is placed between 300 and 600 A. D. With them, when they passed away, went secrets of

their vast treasure vaults and the sources of the almost eternal dyes of beautiful tapestries now seen hanging in museums thousands of years after they were made.

In villages bordering the wild and untrammelled forests of South America, strangers alien to the soil are often seen circulating among the superstitious chicle gatherers when they return from the fastnesses. They are the scouts of expeditions, alert for any yarn or rumor that might betray the location of ancient relics.

It was in such a section that the great sacred well of Chichen Itza was found in Yucatan. Victims once were dragged to it over a paved pathway, and cast alive with all their goods into its waters to drown as a tribute to fierce tribal gods. Most of the relics have been removed from its dreaded depths. In Palestine, two stone tablets have been dug up which authorities say furnish proof of the captivity of the Jews in Egypt.

Dark caverns, yawning pits, towering mounds, and bottomless morasses in the abandoned places of the world are all objects of the explorer's endless labors. But inspired by superstitious fear of their barbaric religions, the older peoples seem to have left little in view for the stranger of the future. Temples were ruthlessly destroyed, cities burned, and captives silenced, in attempts to guard their domains against the trespassing outsider. Precious metals worked into gorgeous designs, jewels, rare woods, and paintings that defy the expert eye of the modern chemist, all exist to tell of their creators, but none seem to reveal the secrets of the crafts that made them.

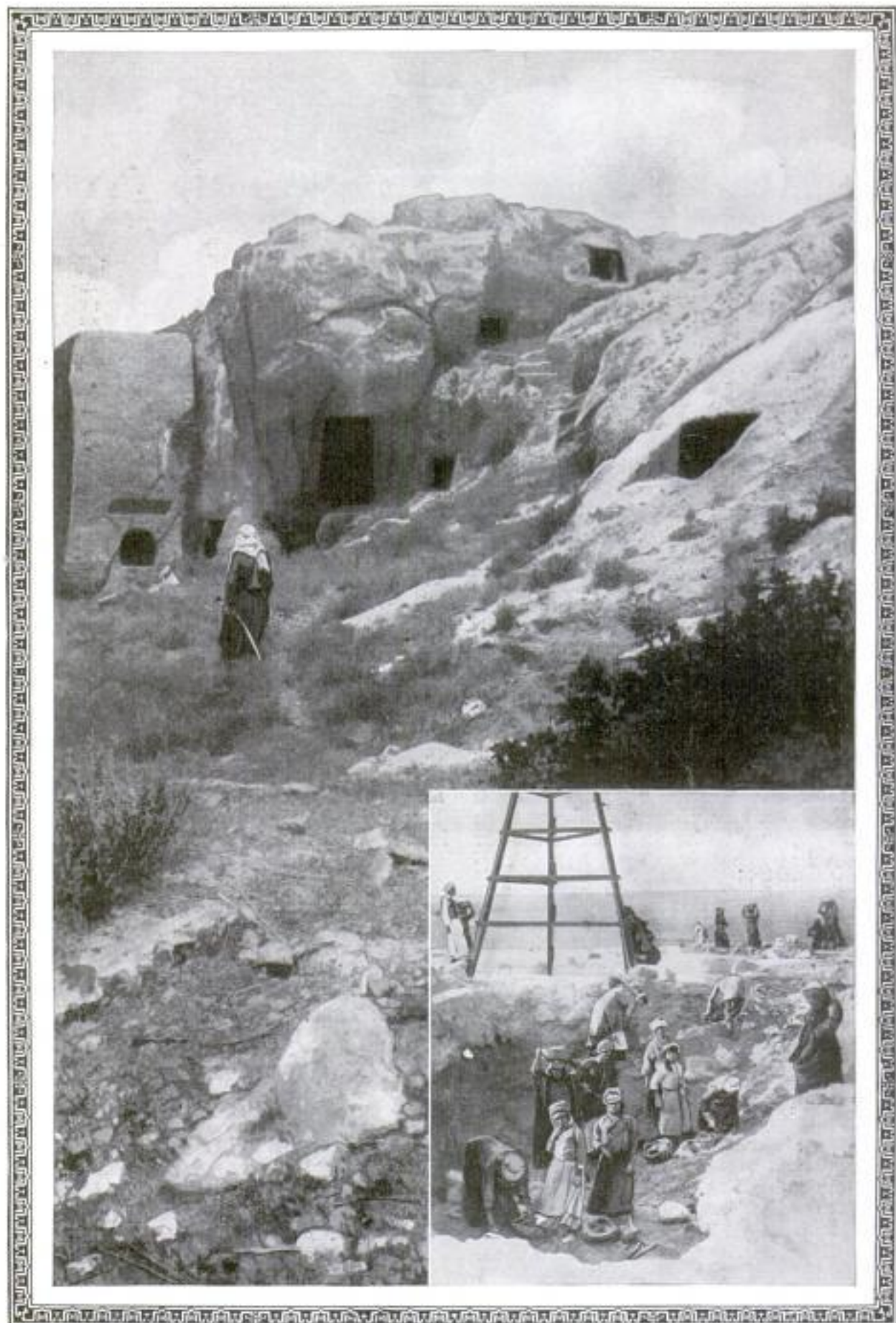

Copyright, Underwood & Underwood

Sand and Debris of the Ages Buried Abandoned Cities of Long Ago. In Penetrating Their Depths, Explorers Employ the Cheap Native Labor That is Always Close at Hand



Valleys Are Rified of Their Entombed Secrets and Gorges Are Ripped in the Sides of Mountains in Attempts to Unearth the Truth about the Forefathers of Modern Civilization

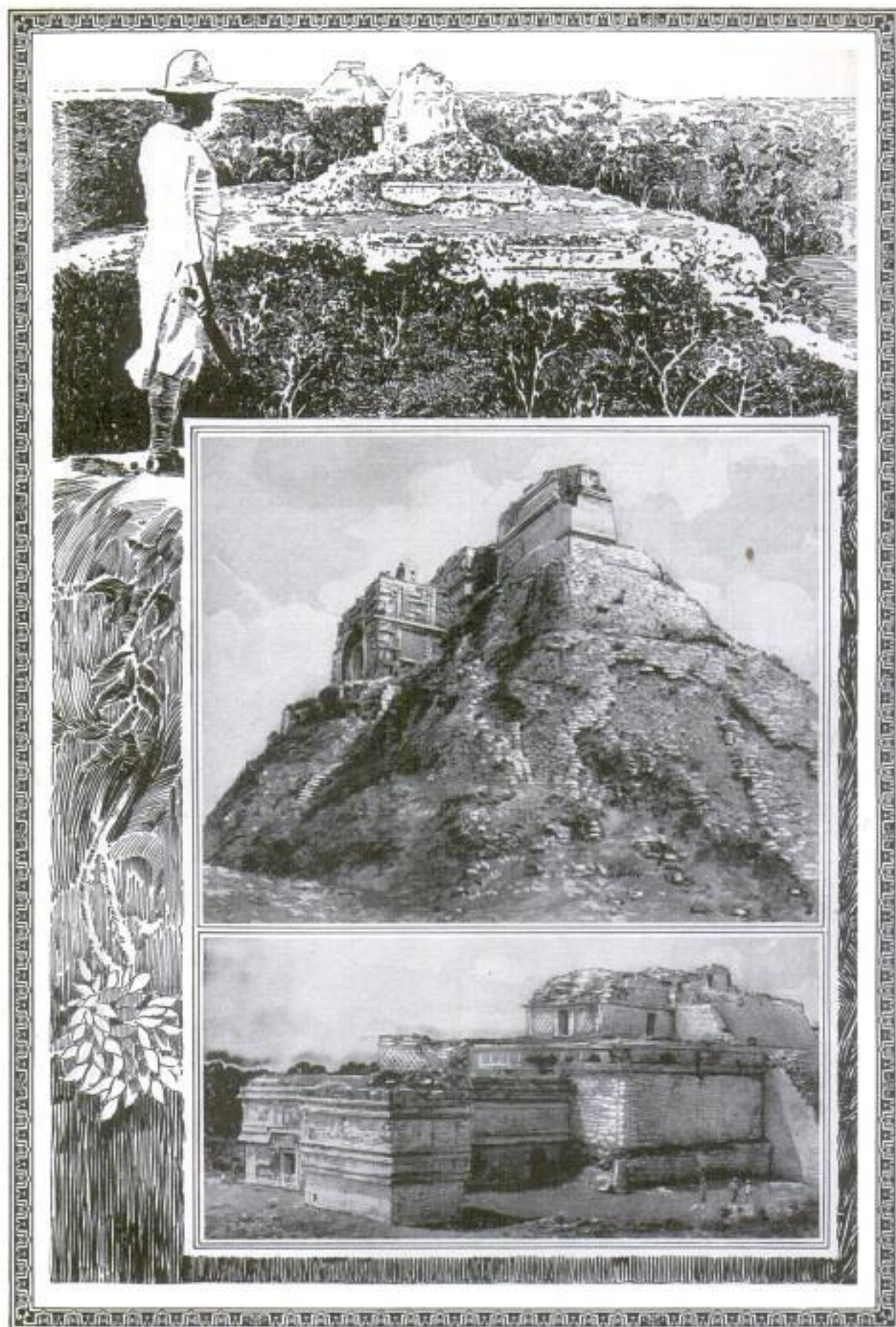

Dead Empires Are Disclosed Beneath Towering Mounds Which, Molded by the Hand of Time, Open under the Tireless Labors of Excavators Seeking Knowledge of Ancient Existences

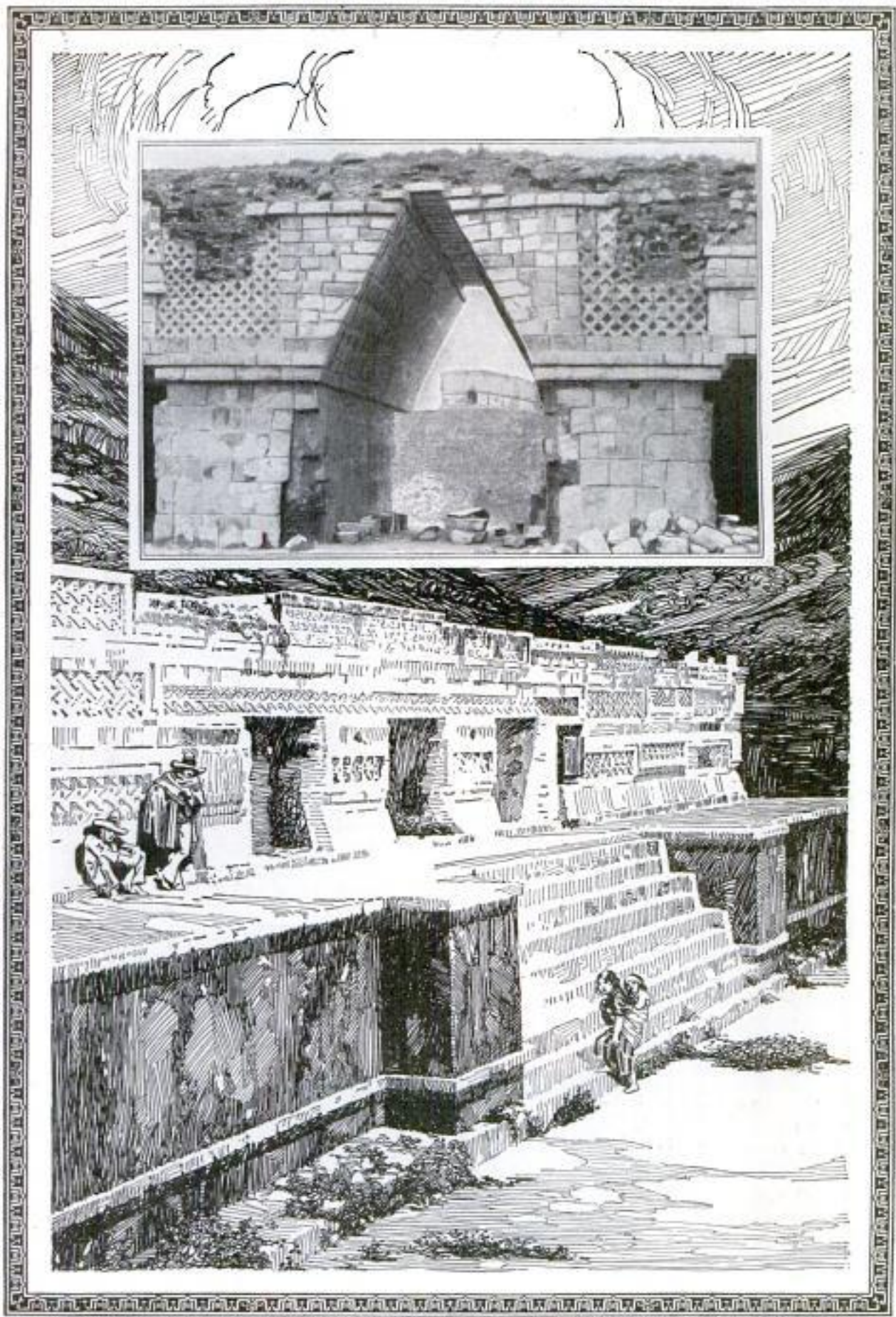

Sunburned Wastes of the Tropical Americas Covered Architectural Marvels Erected by Ancient Tribes Whose Culture and Attainments Rivalled Those of Old Egypt

National Safety Council

3,452

Play Safe! Twice as Many Persons Are Killed in Accidents as Die from Old Age

Carelessness Is Blamed in Nine Cases Out of Ten

166 N. Michigan Ave

ACCIDENTS, most of which are declared to be unnecessary and the result of carelessness, are costing the United States more than \$2,250,000,000 annually, according to figures just made public by the National Safety Council.

Pointing out that approximately 12 million persons are needlessly killed or injured every year, the report shows that the average individual is twice as likely to die of accident as from old age. In calling attention to this needless waste of human life, the following statistics were quoted:

One person out of every eight sustains an accident during the year.

Every five minutes some person is accidentally killed and 1,380 are injured each hour.

Five times as many persons are accidentally killed or injured every year as die from natural causes.

More people are kept from work by accidental injuries than are idle from lack of employment.

During the year 1922, there were 206 American citizens killed each day by accident. Of this daily number, 38 were automobile fatalities; 35 were caused by falls; 19 by drowning; 16 by burns; 9 by machinery; 5 by street cars, and the remainder by miscellaneous causes.

On the other hand, skeptical as the average person is regarding the safety of aviation, insurance companies—who employ hard-thinking, scientific minds for the investigation of risks on an essentially economic basis—have decided that aerial passengers and pilots are a good 1,000 to 1 chance. In Europe, under government supervision, the fatality ratio ranks as one death to every 400,000 miles of flying. An American company has carried 20,000 passengers 1,000,000 miles between Detroit and Cleveland without a mishap.

In seeking to safeguard the lives and health of their workers, the industrial establishments of the United States are declared to have done more than those of any other country. Machines have been designed to make accidents nearly impossible.

At the same time, because of the importance of the human factor, every effort has been made to educate the workers by means of pictures, movies, and striking texts telling them how to avoid danger.

While automobile accidents show a heavy increase, the figures prove that the number of men involved in motor-car disasters greatly exceeds the number of women. In Los Angeles the ratio for 10 months of 1922 was 96 to 4.

"After nine years of listening to complaints on traffic, I am firmly convinced that women are a great deal more careful drivers than men," says A. A. Carroll, superintendent of police of Grand Rapids, Mich. "They do not take the chances that men take; they do not drive as fast as men, and, as a rule, are more inclined to want to live up to the ordinances."

With national, state, and industrial leaders united in a country-wide campaign of prevention, "safety first" has become a national slogan and much has already been accomplished. More, however, remains to be done, as is shown by a comparison of the accident figures in the United States and England, where, in proportion to the population, the mortality is half what it is in America.

"War, pestilence, and famine may take their occasional toll of humanity, but I dare to look forward to the time when the fourth dread horseman, whose name is Accident, shall ride no more—when the crimson record of human carelessness shall have been bleached white," declared a director of the safety movement.

SAFETY IN THE HOME

WHILE much is heard about the hazards of industry and the perils of the street created by the automobile, it is rather startling to learn that a large percentage of the 75,272 accidental deaths in the United States last year occurred in the home.

Falls are responsible for a large percentage of household casualties.

Falls from shaky ladders and piano stools and other substitutes for ladders.

Falls down stairs because of defective steps or absence of handrails.

Falls on waxed floors or tripping over baby's kiddy car or stumbling over little Jimmy's ball bat carelessly left on the living-room floor.

Falls from balconies unprotected by strong railings.

Falls into uncovered cisterns.

By far the great majority of these accidents are attributed to carelessness and could have been prevented by foresight.

3452



THE FIRE DEMON KILLS! DESTROYS!

15,000 persons burned to death in one year! Countless thousands made homeless!

HELP PREVENT FIRES!

To Prevent Needless Sacrifice of Human Lives and Yearly Loss of Countless Millions of Dollars, Safety-First Posters Have Proved Their Value in Nation-Wide Campaign



Bins and Yards Like These are Safety's Friends

Neatness means fewer accidents—and a better looking place, too! Make your work-place a place to be proud of!



The result of trying to cut a small block on a big swing saw. The block got away from the unskilled man, tipped, jammed and broke the saw.

Don't operate a circular saw or any other machine unless you know how, and then only for the purpose for which it was made.



Dangerous reaching! It takes only a minute to re-set the ladder.



See What Happened!



This is what he should have done in the first place.

IT KEEPS THE SWEAT OFF YOUR GOGGLES



If you're bothered with sweat clouding your goggles in hot weather, wear a sweat pad like the one shown in this picture. It's made of absorbent cloth and is glued to the head. And—

SWEAT OR NO SWEAT--WEAR YOUR GOGGLES!

IT'S NEVER DONE BY SAFE WORKERS



Careful workmen do not leave tools where they may cause accidents. When this overhead pulley is started these tools may hit some one below.

Return All Tools to Their Proper Places at the End of Each Shift

A Fine Stunt For A Grown-up!



He shows the life counterpart the attitude of a fellow worker.

THE RESULT



Long pants don't make a man. Among other things it takes some common sense and a decent regard for the safety of others.

NOBODY

has ever been smart enough to think of a good excuse



for using a sledge with a loose handle.

THERE ISN'T ANY!

GOGGLES.
saved both
his eyes
on the
same day

**ARE YOU
WEARING
YOURS ?**

In Safeguarding the Lives of Their Workers with Every Device Known to Modern Science, American Manufacturers Have Done More than Those of Any Other Country

O.
N.
Ju.
Ameri.
Chicago
Ch

BLOW IT OUT WITH STEAM FIRST!

This gasoline tank had been drained but the gas had not been steamed out. When repairman brought torch close to filler hole the tank exploded.



This man is a safe worker. He always makes sure there is no gas in the tank before he applies torch or soldering tool. He is not the man who had the accident.

ONE MORE STEP



And he'll probably be a hospital case.

He should carry his load so he can see where he is going. Some one should have removed the nails, when the crate was opened.

**Such Thoughtlessness
CAUSES ACCIDENTS**

A TERRIBLE SQUEEZE!



Work From the Operating Side!

BE SAFE!

LOOK UP MAN!

See that weight
over your head?

Some one forgot to fasten the safety cable. If the bar breaks or if the weight comes loose it may drop on your head.

Always Be Sure the
Safety Cable Is
Fastened in Place



"Take Your Time! Better to Lose a Minute than to Lose Your Life," Is the Message Posters Carry to All Parts of the Country in Safety-First Campaign

LAW BREAKERS ARE ACCIDENT MAKERS

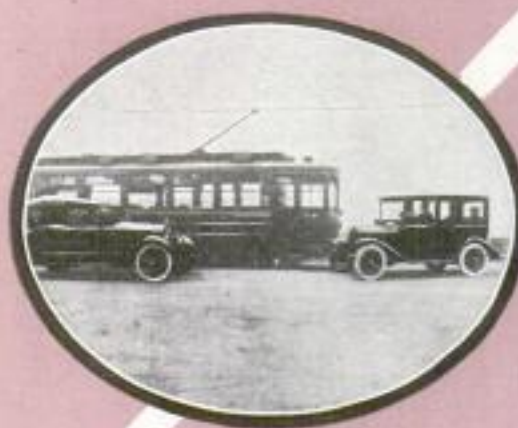

Passed Street Car
on Left Side



He Knew Better, but
Too Much Hurry

DRIVER AR-
RESTED AND
FINED



BIG REPAIR
BILLS TO
PAY

It's Not Enough To Know Traffic Laws-You Must Obey Them

Although Automobile Accidents Claim Thousands of Lives Every Year, a Greater Number of Fatalities Are Caused by Falls, Many of Which Take Place in the Home

HOW EASY TO PREVENT THEM!



Is There Any Good Excuse For Such Accidents?

IF HIS FOOT SHOULD HIT THE TRIGGER— YOU KNOW THE REST



Better take the bit out when you lay the air gun aside



He'll be at the Pearly Gates Next!

DO NOT STICK YOUR HEAD OVER GATES INTO ELEVATOR SHAFTWAYS

Ring the Bell and Wait!



YOU can buy parts after the accident, but the legs don't run, the fingers don't feel, the eyes don't see.

Another Poster, Carrying a Picture of Ben Franklin, Says: "What Is More Reasonable than an Honest Effort to Avoid an Accident in Your Work? Begin It Now!"

How the Moving-Picture Camera Lies

By Fibbing Scientifically and Artistically It Adds Last Touch of Realism to Screen

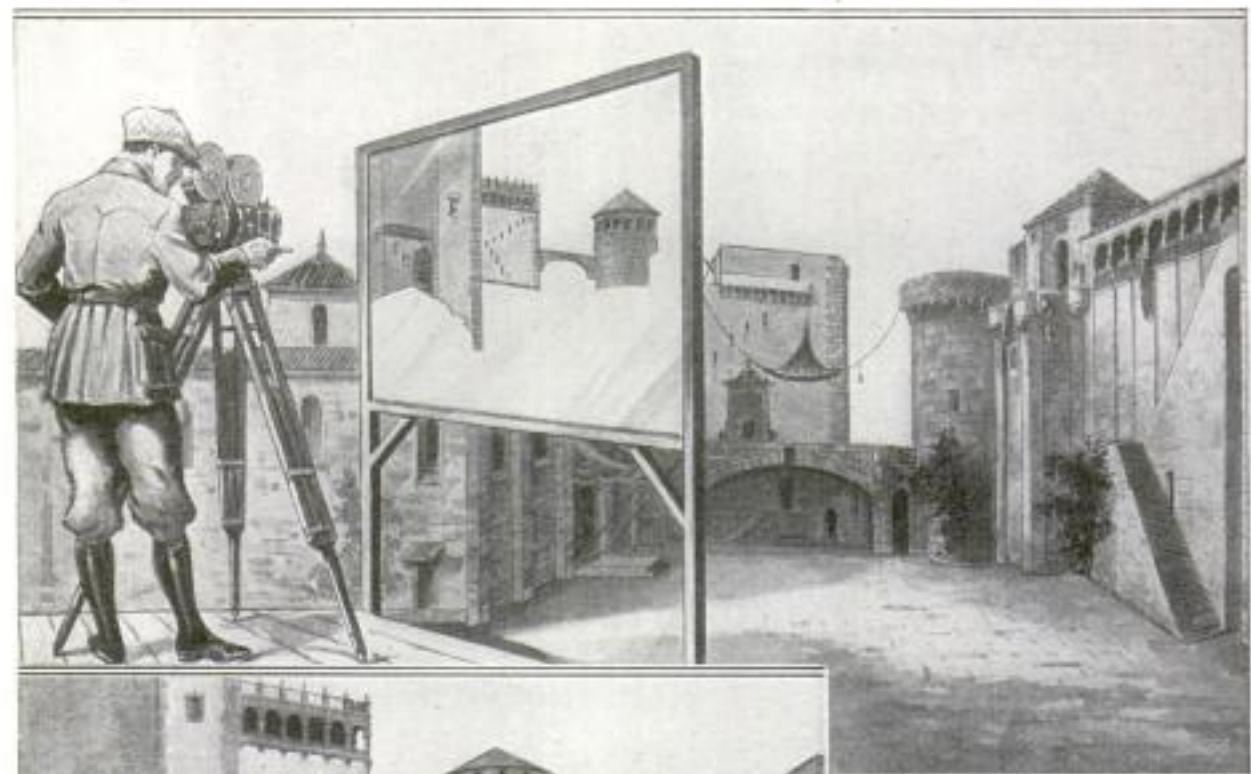

What the Director Sees Before He Shouts: "Action—Camera!"



But This Is How the Same "Set" Shown Above Looks When the Silent Drama Begins to Unwind on the Silver Screen

TH**ERE** was a time, not so very long ago, when the camera could not tell a lie, but that was before the coming of the movies. Today, by fibbing scientifically and artistically, it creates and maintains illusions that otherwise would be impossible because of the prohibitive expense.

Despite the fact that the settings now

being used are more enormous and costly than ever before, it remained for the photographer to add the last touch of realism to productions showing the towering battlements of a feudal castle, a colossal Egyptian temple and its majestic background, or the beautiful architecture of a French chateau.

So real are these made to appear on the screen that the spectator is amazed to learn that they are only painted on an ordinary pane of glass, no larger than the average window. And yet that is the case in most pictures, for it has become increasingly true, on the screen at least, that things are not what they seem, and producers have learned that illusion is more effective than the truth itself.

One of the greatest problems of the films has been to obtain accurate backgrounds without prohibitive expense. If



By Painting Glass and Photographing Through It, the Production of Wonderful Spires and Skies is Possible



the scene of a story were laid at Monte Carlo, it has been necessary either to transport the players and camera men to Monaco for views that would be before the audience only for a few minutes, or to construct sets at the studio that have cost more than \$500,000 in some instances.

Despite the vast sums expended, the latter method was inadequate, as it was impossible to reproduce the wonders of the Cathedral of Notre Dame, the Eiffel Tower, or the Arc de Triomphe. But, in the past two years the problem has been solved, and now Westminster Abbey, the House of Parliament, or the Tower of London may be made ready to photograph on an hour's notice. There is scarcely any building or scene in the world that cannot be duplicated.

This is accomplished by what is known in Hollywood as "glass work." Things that were never built and that did not exist except on a pane of glass in the strokes of an artist's brush, have been shown with startling reality on the silver screen, the result of a photographic trick

that, in the majority of cases, is invisible, even to the expert.

Ordinarily buildings or interiors intended for blending with glass paintings are constructed to the first story, or to a height that will permit the actors to move about. Then the roofs or towers are painted on a pane of glass about six feet square. This is placed in front of the camera, so that the painted portion exactly matches the remainder of the set.

The same method has been used effectively in filming clouds which are painted on the glass and then moved slowly in front of the lens, and also in providing marvelously realistic mountain backgrounds. In some cases two glasses are used, one stationary, to represent, say an island, and the other a wrecked ship drifting across it with the tide.

Another way of producing similar results is to use small models instead of placing glass paintings in front of the

camera lens. For instance, the lower parts of a building will be built on the "lot." Then the roof and towers are constructed in miniature, being placed a few feet from the camera in such a position that the lines of the "set" and model blend on the screen.

For exteriors, the miniatures have an advantage over glass, as the shadows exactly correspond to those of the actual settings. While this may seem a small detail, it is vital in the creation and maintenance of the perfect illusion demanded by the motion-picture "fan." Any slight inaccuracy is quickly detected and results in much criticism for the producer.

In a recent great spectacle, it was necessary to show the Cathedral of Notre Dame in Paris. To do this realistically, the massive front was built to a height just above the doors. Then the towers were constructed in miniature and placed in such a position a few feet from the camera that the lens caused them to blend with the lower setting. The result was so realistic as almost to defy detection.

Another method is "double exposure." In this, part of the film is masked by placing a black mat of proper design over the lens. Thus the light is prevented from reaching any portion desired during the exposure. After a reel is finished, it is rewound, put back in the camera and the part already exposed masked in the same manner.

Then a photograph is placed in the correct position to be photographed on the unexposed section of the film. The result is two pictures made on one strip of film each blending perfectly with the other.



Small Models Also Are Used in Obtaining Realistic Effects

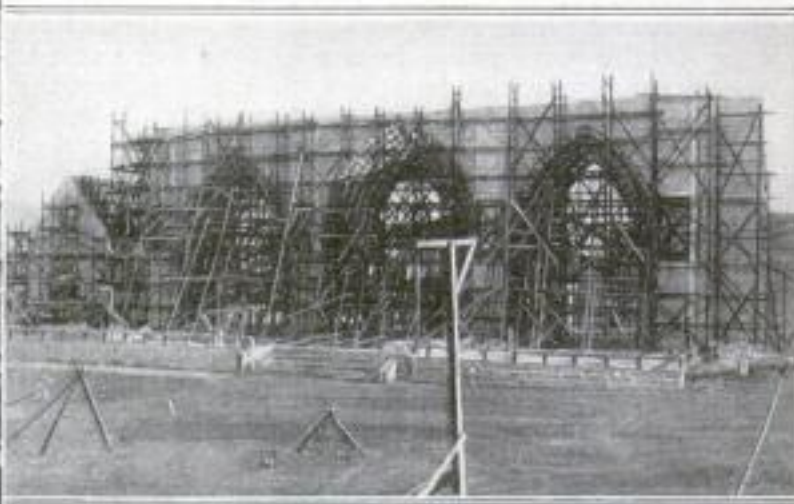

In the "Hunchback of Notre Dame": Right-Hand Picture Shows What Part of the Cathedral Was Built, the Rest Being a Miniature

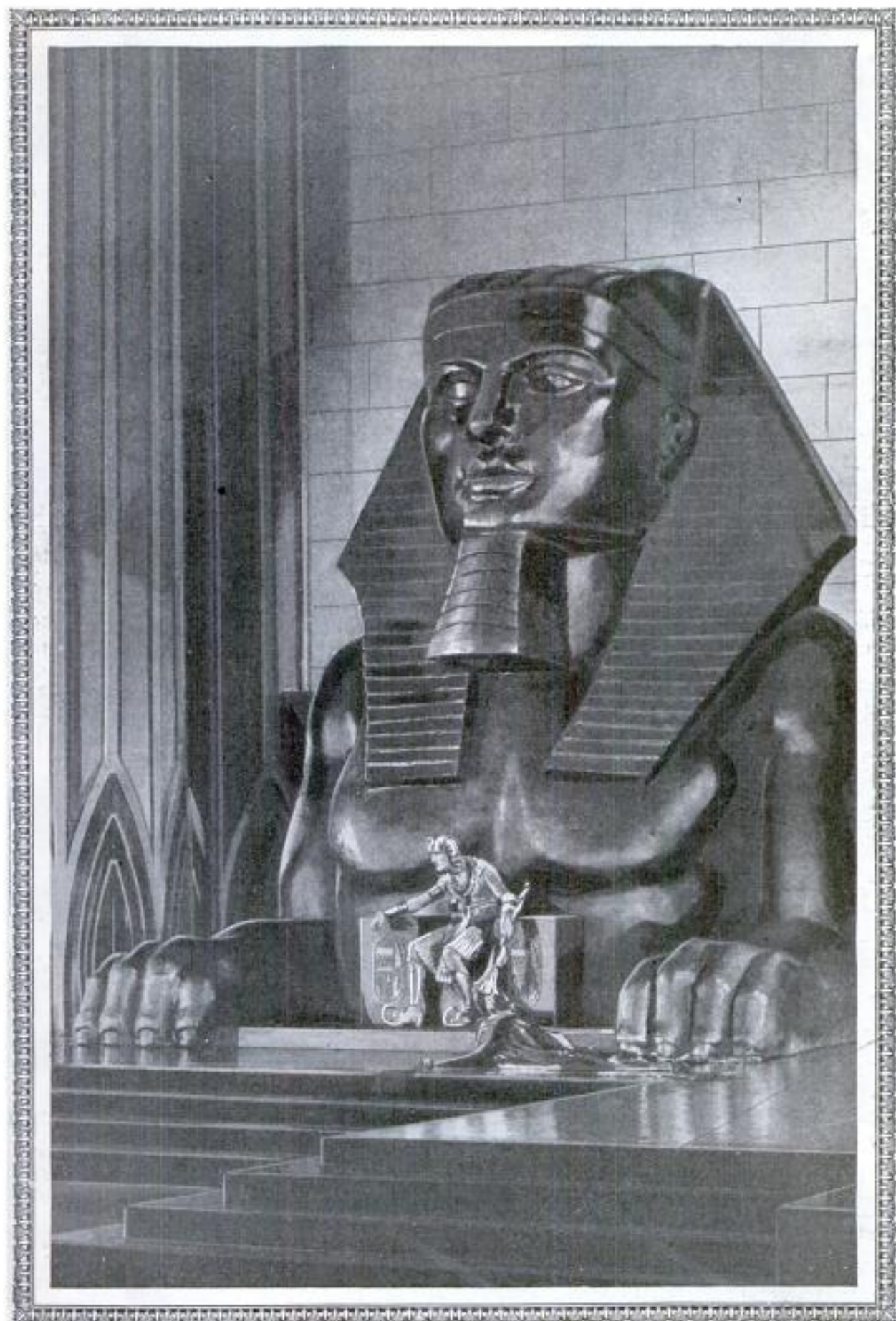

Although Many of the Marvelous Effects Obtained in the Movies Are the Results of Optical Illusions, Numerous Settings Are Real and of Mammoth Size

86 81

RACE THAT MADE BOOMERANGS PASSING AWAY



Survivors of Australian Natives, Originators of the Boomerang. Dressed in Festal and War Costumes

Natives of Australia, inventors of the boomerang, are fast becoming extinct. Numbering about 200,000 a century ago, less than 2,000 are to be found today. Like all passing races, these people for many years gradually have been discarding their ancient festal and war costumes. Recently a traveler persuaded some of the survivors to array themselves as did their

forefathers years ago, and pose for pictures. The blackfellows are of mysterious origin, yet the numerous researches made to disclose the secret of their ancestry seem to indicate that they descended from Caucasians. The men have been noted for their wonderful tracking abilities and some have been found to have a beastlike keenness of scent.

SCRUB BOARD FITS OVER HAND FOR USE OF TRAVELERS

Small scrub boards, that can be used in a bowl, are being made to save students,

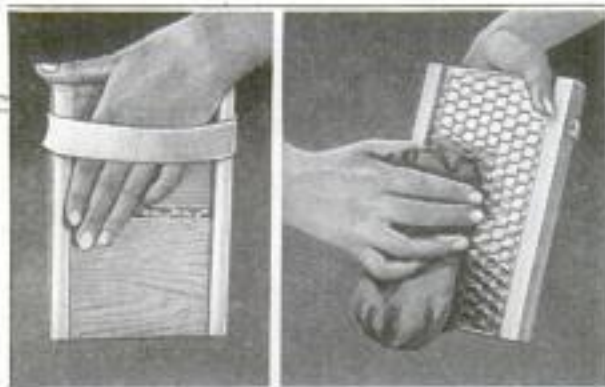

Small Scrub Board for Travelers and Tourists That Can Be Used in Washbowl

tourists, actors, and others from bending over a tub when they have only a few pieces to be washed. Held in the hand by a canvas handle across the back, they

are designed to accomplish the same work that a larger board does. The rubbing surface is of corrugated tin in a light wooden frame.

HOT WEATHER FORMS ICE IN COAL MINE

During the summer, ice is mined from a coal pit located in an eastern state. Cold air seeping through earth fissures in winter cools the rocks to a temperature far below freezing, but no ice forms because the atmosphere is too dry. At its depth the heat of summer cannot reach the vault. During warm months, the shaft becomes moist, and when coal was being dug there recently, it is said, the miners had to remove three or four carloads of ice every morning before they were able to get to their posts. As a result, the working was abandoned as a source of fuel, leaving it entirely free for use as a natural refrigerator.

Mr. Martin's Mercantile Co. 65 1/2 W. Lake, Chicago

caused this state 9/10/23

9/16/23

MUSICAL TONE ON TELEGRAPH IS FASTER THAN CLICKS

3654

Using the Morse code as a basis, an army officer has invented a system of transmitting messages by telegraph and radio. By making all signals of the same length but of varying intensity, it is said to result in a 165-per-cent increase in sending speed over the old method. An accuracy of receiving heretofore unknown also is attained, it is reported, while the likelihood of interference in wireless broadcasting and violent disturbances in the air are lessened. Instead of alternately turning on and shutting off the current, the words are formed by causing electricity to flow uninterrupted, like a continuous musical tone. A faint sound would represent a dot, a louder one a dash, and a greater vibration a space. Communications may be sent automatically by a transmitter of the perforated-paper roll type.

BALLOON TIRE ON AUTO WHEEL ABSORBS SHOCKS OF ROAD

3623

Decreasing the size of automobile wheels and fitting them with tires of large diameter makes their riding smoother, according to manufacturers who have made the experiment. With this type of tire there is no lost energy and there is less wear on the treads, it is claimed. Travel over rutty or bumpy roads becomes even and danger of skidding is greatly reduced. Lower air pressures are permitted and, in tests, it is reported that gasoline mileage

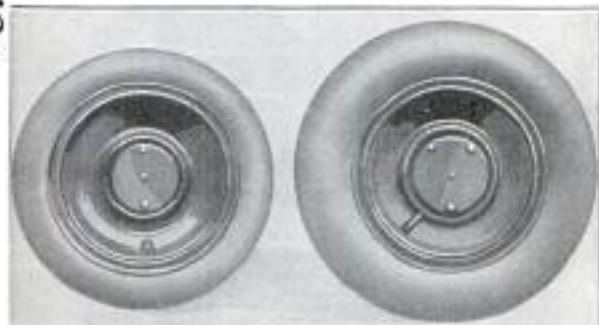

Greater Riding Comfort Is Claimed for Balloon-Tire Arrangement When Compared to the Ordinary Wheel

was increased three to five miles a gallon. An additional advantage is the ease with which sand and deep mud can be negotiated, even by heavy cars.

Experiments to develop a gas for killing earthworms that damage the greens of golf courses are being conducted by government experts.

BUILT-IN CLOTHES MANGLE FOLDS INTO CLOSET

3625

Folding into a closet space, a clothes mangle is being made that combines labor and space-saving features. Since it is



Clothes Mangle Built in Wall That Conserves Valuable Space as Well as Saving Labor

out of the compartment only while being used, the efficiency of a kitchen or laundry room is increased. Although weighing 300 pounds, it is so balanced on ball bearings that it can be lowered or raised with little effort. Specially adaptable to city flats where conservation of space is important, it is operated by electricity, and reduces hand labor to a minimum.

CONDOR, LARGEST FLYING BIRD, PASSING FROM LOFTY HOME

3655

In the clear, cold heights of the Sierras, the American condor, giant vulture of the air and the largest bird that flies, is making its last stand for existence. Although the huge creature still wings its almost solitary way over the lofty range, it is facing the necessity of hunting a new home. Not more than a century ago it held sway over the sky course from snowy Mount Hood on the north to San Jacinto on the south. This feathered giant nests only once every two years and lays but one egg in an inaccessible crag near the mountain top. After the youngster is hatched it remains for months a helpless chick wrapped in its soft natal down.

Mr. American Ironing Machine Co.
844 W. Adams.
Chicago

Yellow Cab Mfg Co.
5801 Dickens Ave.
Chicago

Kansas City Star
9/16/23

put me to work on this

Pacific + Atlantic Photos, Inc.

884

POPULAR MECHANICS

25 Park Place, New York

3412

FLOOD OF LIGHTS COVERS PRINCE'S PALACE

During religious ceremonies and state celebrations, the palace of the Maharajah of Mysore, in India, is lighted by thou-

sparkles like a jewel. So magnificent is the sight, that the palace is often referred to as "the most gorgeous abode in the

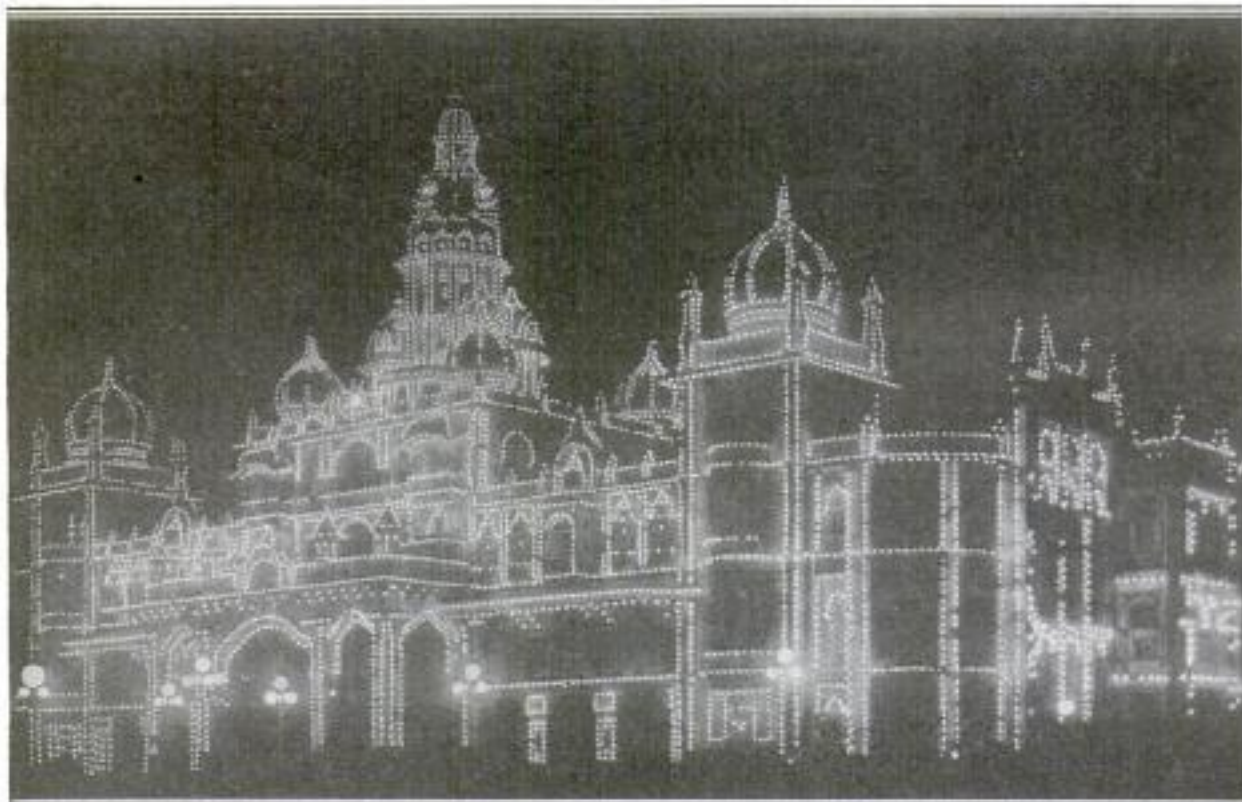

Palace of Maharajah of Mysore, Rich State of India, Set Aglow by Thousands of Incandescents During Religious Ceremony, Has Been Called "Most Gorgeous Abode in the Universe"

sands of electric bulbs, strung all over the massive structure. Against the dark background of night, the home of this native ruler, located in Madras, glows and

universe." Within the borders of Mysore are located the famous Kolar gold fields, worked by electricity generated by water power.

AUTOS "FLOAT" OVER BUMPS ON BLOCKS OF RUBBER

Shock insulators, that do away with shackle bolts and "float" the spring ends in cages between blocks of live rubber,

have been patented to make automobiles ride easier. Including the usual bushings, they replace many complicated parts. It is claimed they require little care and eliminate heaving and rolling on the roughest roads. The rubber blocks are said to retain their flexibility even after 200,000 miles of usage.

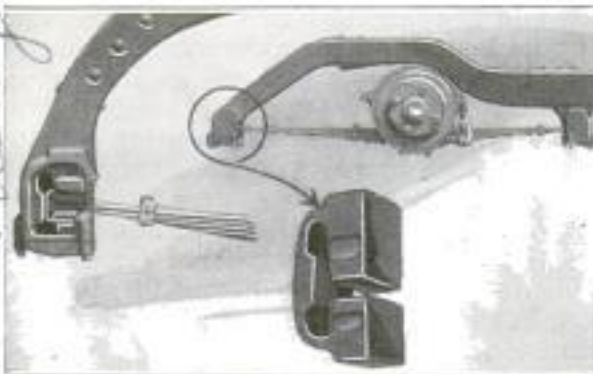

Shock Insulators, Showing How the Spring Ends Are Cushioned on Blocks of Live Rubber

RABBIT LIKE GHOST AND MOUSE WITH POUCH

Methods of exterminating pocket mice, creatures about three inches long that carry grain in pouches in their cheeks, and ghost jackrabbits, both known crop destroyers, are being sought by government experts. The mouse, one of the few pouched creatures on this continent, infests farms in the Northwest. The rabbit, found in Arizona, has white sides

Yellow Cab Mfg. Co.
5801 Lehigh Ave.
Chicago

Mr. Rubber Shock Insulator Co.,
#17 W. 60th New York.

Kansas City Star
9/16/21

Copyrighted material

H. Mc. Reese, Chemical Engineering
 100 West 42nd Street, New York
 U.S.A.

that are concealed when it crouches, but which alone are evident when it runs. Attempts are also being made to calculate the amount of forage eaten by prairie dogs in certain areas. A white-tailed squirrel, called the kaibab, whose range is limited to a plateau in northern Arizona, is also included in the survey. It is not found outside that territory, since it is cut off from all migrations by the great canyon to the south of its home and impassable deserts on all other sides.

WASTE "LIQUOR" OF PULP MILLS TO BE TURNED INTO FUEL

By a recently discovered chemical process, scientists report that it is now possible to utilize as fuel energy equal to many thousands of horsepower, some six billion gallons of sulphite waste "liquor" annually discharged into the rivers of the United States by numerous paper-pulp mills. The fluid, it is said, may be prepared for burning by being run through evaporators, which, by fermentation, change it to alcohol. An average American plant, it is estimated, discards enough of this liquid to supply 1,000 horsepower day and night. Swedish and German factories are now using a concentrated product of like refuse in the development of fuel. *3636*

INVISIBLE BELL WIRE HIDDEN UNDER PAPER ON WALLS



Thin, parallel strips of copper held between two felt paper tapes, $\frac{3}{8}$ of an inch wide and stuck together by glue, are being made to serve the purpose of invisible bell wire. Coming in coils of 100 yards, the material can be placed under wallpaper, on the ceiling under whitewash, or on the floor under the carpet. The fact that it cannot

be seen renders it suitable for secret wiring for burglar alarms.

Machinery for the new wireless station at Kashgar, Chinese Turkestan, was carried over 2,000 miles by camels.

General Electric Co., Ltd.
 London, England.
 Magnet House, Kingsway

MILLION SPENT DAILY FOR ICE IN UNITED STATES ALONE

Combined ice bills of residents of the United States approximate a million dollars a day, according to a recent announce-



Breaking Cakes of Ice Loose from Containers Immersed in the Brine Pool

ment. The latest available figures show that the factory value of the ice produced in one year, exclusive of that made by large establishments solely for their own use, approximated \$187,000,000. Although harvesting of the natural product has steadily decreased, it is calculated that about \$37,000,000 worth is still cut from streams, lakes, and rivers of the northern states. *international*

HANDLES ON FRUIT-JAR RINGS MAKE OPENING EASIER

So that the cover of a fruit jar may be easier to remove, rubber rings with sides that extend outside the metal top, are being made. Pulling these "ears" allows air to enter between the rubber and the cap, thus preventing any sticking, and eliminating the use of hot water to loosen the cap. Merely drawing out the sides is sufficient. If the ring is taken entirely off, the jar can be opened with but little effort.



Sold by
 Pearson Store, Chicago

Cupples Co.,
 740 N. West
 St. Louis, Mo.

Copyrighted material

UNCOVERING BRILLIANCY IN HEARTS OF DIAMONDS



Sorting and Weighing Raw Diamonds



Cutters Who Give Finish to Rough Stones



Searching for Flaws in Uncut Gems



Placing Steel Cutting Disk in Machine



Sawing Faulty Stones into Pieces



Pulverizing Useless Stones for Grinding Dust



Rubbing Diamonds Together for Shaping



Grinding Facets Against the Dust-Coated Disk

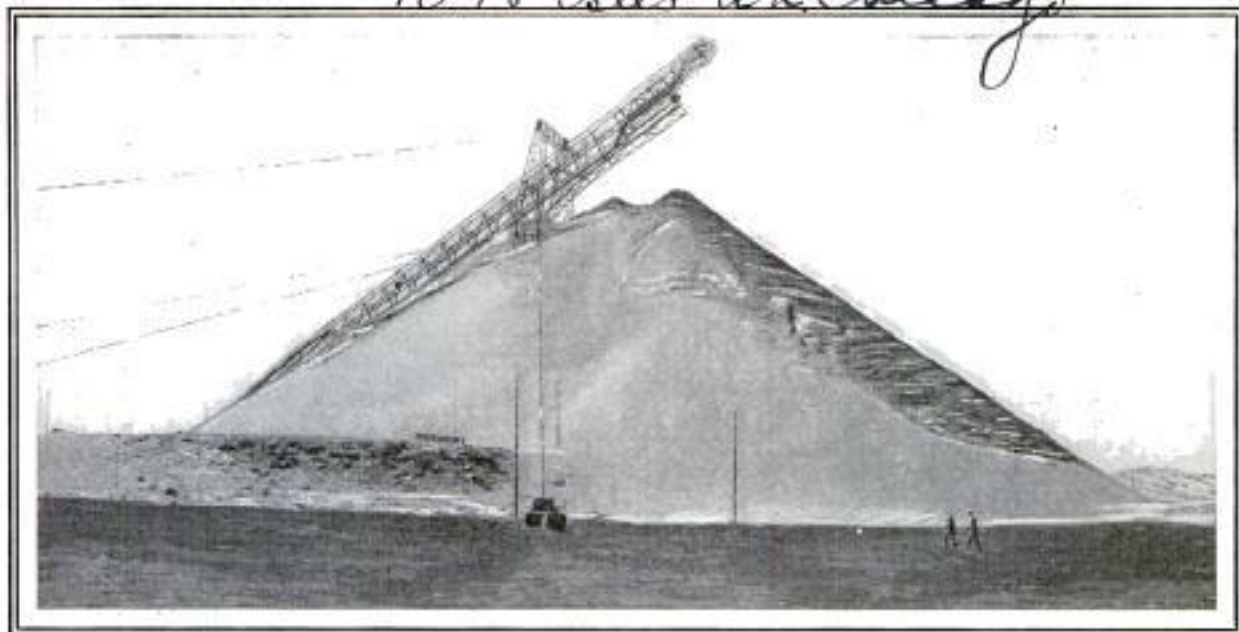

Dump Heap Near Diamond Mine Where the Cast-Off Dirt Is Piled after Giving Up Its Treasured Gems. Months of Exposure to Weather Crumble It for Careful Screening

Search for Diamonds Filled with Thrills

Lure of Sudden Wealth Results in "Rush" When Precious Stones Are Found in Any Part of the Country

JUST a short time ago, a famous diamond expert received a caller who exhibited a small, odd-shaped object which seemed to half hide a gleam and a glitter.

"Where did you get it?" the visitor was asked.

"Well, I'm a merchant, and a woman brought it in to me. She found it in the crop of a chicken. What is it?"

"Diamond."

Although the part of Illinois from which that chicken came never yielded another specimen of pure carbon, the fever spread all over the country. In one day, a dealer received three high-grade diamonds—one found in Wisconsin, another from California, and a third from Arkansas.

Diamond-hunting contains the greatest amount of adventure and pure luck of any known outdoor occupation. A diamond may be picked up by anyone, in practically any state in the union, and then, no one else may find a real gem in that locality again for years.

Almost the same thing is true with fresh-water pearls. A few years ago, a man placing a pump in the Fox River, just west of Chicago, found two pearl-carrying clams. Immediately he started clamming, and brought out more than a hundred pearls of varying qualities. His profits were over six hundred dollars.

At once that section became the Mecca of thousands of fortune hunters. Boys and men clammed it and combed it. It is doubtful, however, if the entire summer's operations along more than thirty miles of river yielded a thousand dollars' worth of pearls.

Another valuable stone often found in this country is the sapphire. Montana yields these stones regularly, and in many cases a month of sapphire prospecting there will produce handsome returns. There are, perhaps, 15 semi-precious stones often located in the United States, foremost of which are amethyst, agate, topaz, moonstone, opal, cat's-



Putting Diamond in Socket for Grinding: Insert, Cross-Shaped "Knot" in Gem

eye, garnet, aquamarine (beryl), and petrified wood.

Uncut, these stones have little value. Cut, four-fifths of their value lies in the work that has been put into them. The cutting has become an industry in itself in America. However, the real romance of stone-cutting is found in the story of the diamond. When an uncut, or rough, diamond comes to the cutter's bench, the gamble begins. How profitable his investment is, depends upon his buyer's ability to judge the type of stone. What results from a rough diamond, rests on how it breaks, how nearly flawless it is, whether it is "knotty," and what percentage of it must be wasted.

In cutting, the average diamond loses 42 per cent of its weight. When it loses more than 45 per cent the cutter's worries begin. Sometimes it will cut down to a third, or even a fourth. Add to this the fact that it takes as long as two months to split, shape, saw, and grind or polish the 58 facets of a "knotty" stone, and an idea of the cost of whittling these precious bits of carbon is obtained.

Diamonds are found free or in matrix—and when in matrix, are often combined with gold or iron. It is not at all unusual to see a matrix containing one or two diamonds and a couple of gold nuggets. Free diamonds, like gold nuggets, are found in "bearing" streams.

When the rough diamond comes to the

cutting bench, an expert there studies it to learn whether it is "two point" or "three point;" that is, to determine how it can best be cut. He searches for flaws and for the grain. Then he splits it to free the portion he wants. Next it is shaped. A gem is put into a lathe and another uncut stone is applied to it the same as a tool is put against something it is to shape, and rotated at great speed.

Then comes the sawing between thin disks of copper revolving at high speed. With soft stones, a diamond of, say a carat, can be sawed in from eight to twelve hours. But if that diamond contains a "knot," which is much the same formation as a knot in wood, the sawing may take weeks.

After the sawing comes the "polishing," or the putting on of the facets. The diamonds are fastened in a socket of tin and ground against revolving disks saturated with a solution of olive oil and diamond dust. This may take 40 hours, and when knots abound it might require 40 days. A large cutting establishment had a seven-carat Brazilian stone so hard that, after eight months of cutting and grinding, they were compelled to admit that it was too hard a nut for them to crack. It is still uncut.

And that's the reason why diamond-hunting and diamond-cutting are rich in the element of chance—and why the industry is one big gamble.

3624 ANGLING FOR HUMAN "FISHES" IS POPULAR WATER SPORT

Human-tarpon fishing, a game in which the angler, equipped with deep-sea tackle, tries to "land" a swimmer, is one of the latest water sports. In the contest, the line is tied in the ring of a special head-gear worn by the bather. At a given signal, the fisherman tries to reel in his catch. If the "fish" stays out of reach for 10 minutes, or breaks the line, the angler loses.

3715 BRUSH ON TYPEWRITER CLEANS ALL CHARACTERS AT ONCE

Attached permanently to a typewriter, a brush is being made that cleans all of the type in one operation, requiring only a slight pressure on its frame to move it over the surfaces. Shaped to conform with the arc of the character "bank," it is always ready for use and does not interfere with writing. The stiff bristles remove any dirt without soiling the fingers.

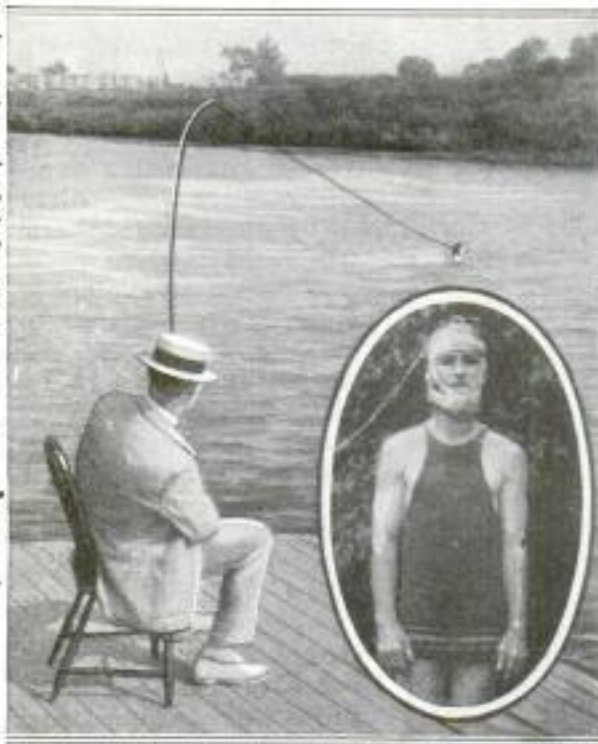

Angler, Playing the Game of Human-Tarpon Fishing, Trying to Reel in His Unwilling Catch

Emb. Walter V. Brennan, Clemens Mich
169 St. Nicholas St. N.Y.

Instants Sales Corp.
27 E. 22nd St.
New York.

3228 Cms. Miss Edna
 M. Colman, 5604
 14th St. N.W.

POPULAR MECHANICS

**FORESTS TURNED INTO STAMPS
 TO SUPPLY NATION'S NEEDS**

In a single year more than half a hundred acres of spruce trees, the only kind that produce the quality of pulp desired, are felled to supply the nation with postage stamps. According to the last count, 41,175 of these forest giants, covering 65 acres, were cut down for the year's postal script, which totaled 1,485,000 pounds, an amount sufficient for an issue of 4,150,000 seven-column, 20-page newspapers, or, if turned into lumber, building material could have been provided for 65 bungalows. If all the stamps used annually were placed in a single strip, they would make a ribbon of color 200,000 miles long and would wrap around the globe eight times. Arranged end to end, the usual sheets of 100 would form a brilliant sash 20,000 miles long, or, stacked one above the other, would build a shaft eight miles high. A single day's issue, valued at approximately \$1,000,000, is 50,000,000 and requires 3,000 pounds of paper, 2,200 pounds of ink, and 3,200 pounds of gum. There are 47 different varieties in 15 different shades.

**SAFETY ROOF ON MOTOR CARS
 PROTECTS RIDERS' HEADS**

To prevent passengers from bumping their heads against the top of inclosed automobiles when passing over bad roads, a safety roof has been designed. In building it, a hole is left over the rear seat. This is covered with bands of canvas webbing, which support the fabric cover. In the event of an accident where the rider is

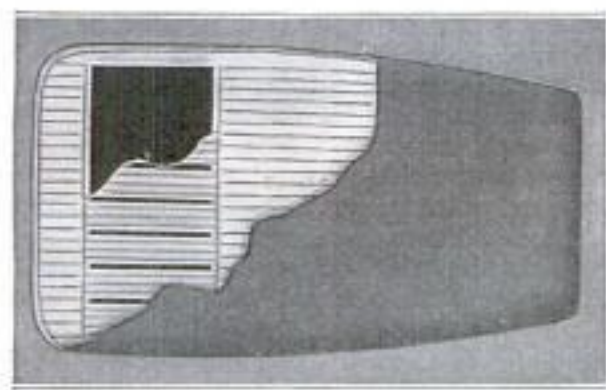

How Safety Roof for Inclosed Automobiles Is Constructed to Protect Heads of Passengers

thrown against the ceiling the webbing gives slightly, and, instead of the head striking the rigid cross member, the shock is broken by the soft top. This form of construction does not mar the appearance of the roof in any way.

Yellow Cab Mfg. Co.,
 5801 Dickens Ave.
 Chicago

Cms. C. A. Oldroyd,
 127, Abbey Road.
 889

**CANNED MUSIC SAVES BEGGAR
 FROM TURNING A CRANK**

Turning a crank of a hurdy-gurdy seemed too hard to an ingenious mendicant in Europe, so he purchased a phono-



Copyright, C. A. Oldroyd
 Phonograph Used by Beggar in Europe Instead of the Usual Hand Organ

graph. With this strapped over his shoulder and a selection of records hung from the other, the old man tours the streets to eke out a living, playing the tunes for alms. As the instrument needs only an occasional winding, he finds it much easier to operate than the more ancient, heavier hand organ.

**MONEY USELESS IN LABRADOR
 FISH SERVE AS COIN**

Fish are used as money along the Labrador coast where there are no stores, according to reports, and traders accept the finny exchange in payment for their wares. Currency is almost useless, for the residents prefer to be paid in food and clothing for their services. The last fishing season was unusually poor, because the schools of fish which have regularly furnished the chief means of livelihood to the natives, deserted the waters along those shores. In order to relieve the conditions, a paper mill that will give employment to many persons is being planned, and fishermen are raising goats to provide necessary food elements lacking in the usual diet of fish, white bread, and tea.

Perfumes were first employed only in religious services, and were consecrated to that use.

Philadelphia Public Ledger
 9/16/23

Cmt. Mrs. Frances B. Coleman,
 3315 Montgall Ave.
 3243
 Kansas City, Mo.

Pilots and Planes That Reached the Port of Missing Men

FOR centuries the sea has provided thrilling tales of adventure, yielding romance and treasure, the while it has taken its annual toll in men and ships. Today there is another element being conquered—the air. Like the ocean, it has now and again betrayed the men who put their faith in it.

Some have had adventure, others sheer tragedy, while many have left only mysteries. Wherever flying men gather, stories may be heard of those who have gone up into the clouds without being heard from again. Of late, the actual disappearance of airplanes has come to be attributed to pirates and bandits, bootleggers, rum smugglers, and ordinary thieves.

This is largely due to the growing perfection of the planes. In 1922 there were 89,435 flights by civilians in the United States, with only 70 accidents, and of these, seven were fatal. Over 5,000,000 miles have been covered by postal pilots with only one fatality, and 20,000 passengers have been carried by one commercial company without a single mishap. Every day, winter or summer, rain or shine, through snow, sleet, fog, wind, and storm, and over mountains, rivers, plains, and deserts, the ships of the air

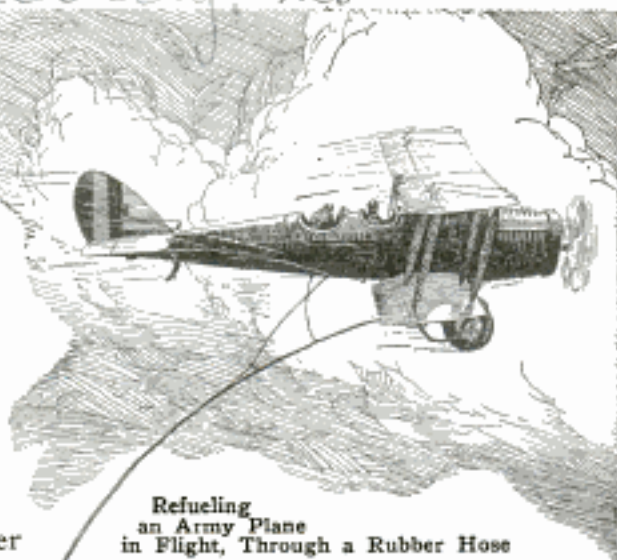
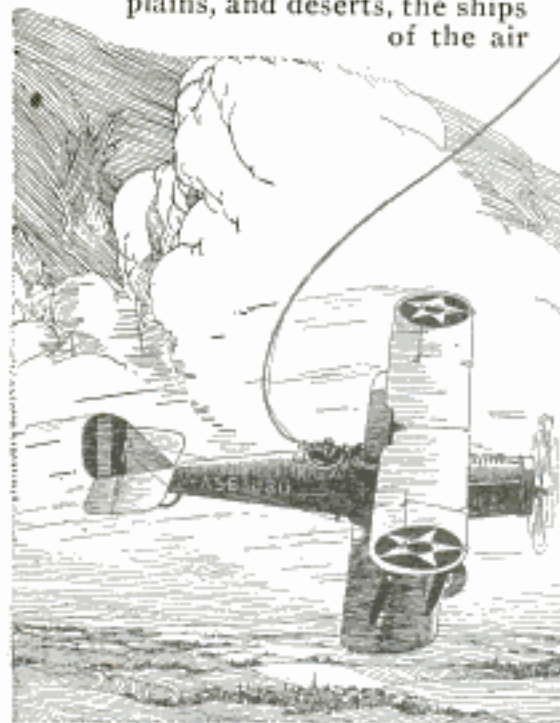

Refueling
an Army Plane
in Flight, Through a Rubber Hose

mail have flown on schedule time.

In the past four years, the postal aviators have demonstrated that flying through the air at a speed of 100 miles an hour is really safer than walking, for no man or group of men could walk the same distance without a few fatal accidents. Adventurous and resourceful, the air-mail pilots are a picked body of men, who have proved their endurance and courage in many tests.

While flying with mail from Salt Lake City to Cheyenne, Pilot Henry G. Boonstra lost his way and was compelled to make a landing in the snow. Although his ship was not "cracked," the snow was so deep that he could not resume his journey. After spreading his overalls out in the snow as a signal to other planes that he knew would search for him, he tied mail bags to his hands and knees to prevent his sinking into the drifts, and made his way to the lonely cabin of a rancher, where he was found four days later.

In crossing the mountains from San Francisco to Reno, the mail planes have a straight climb of about 15,000 feet, which they require about an hour and a half to make.

At one point there is a cliff over which the air flows like water over a falls.

When the ship strikes this current, it takes a sheer drop of 500 feet.

So strong is the wind here, that the westbound planes have never been able to fly over it, but take a path around the aerial

waterfall. In the operation of air-mail planes,

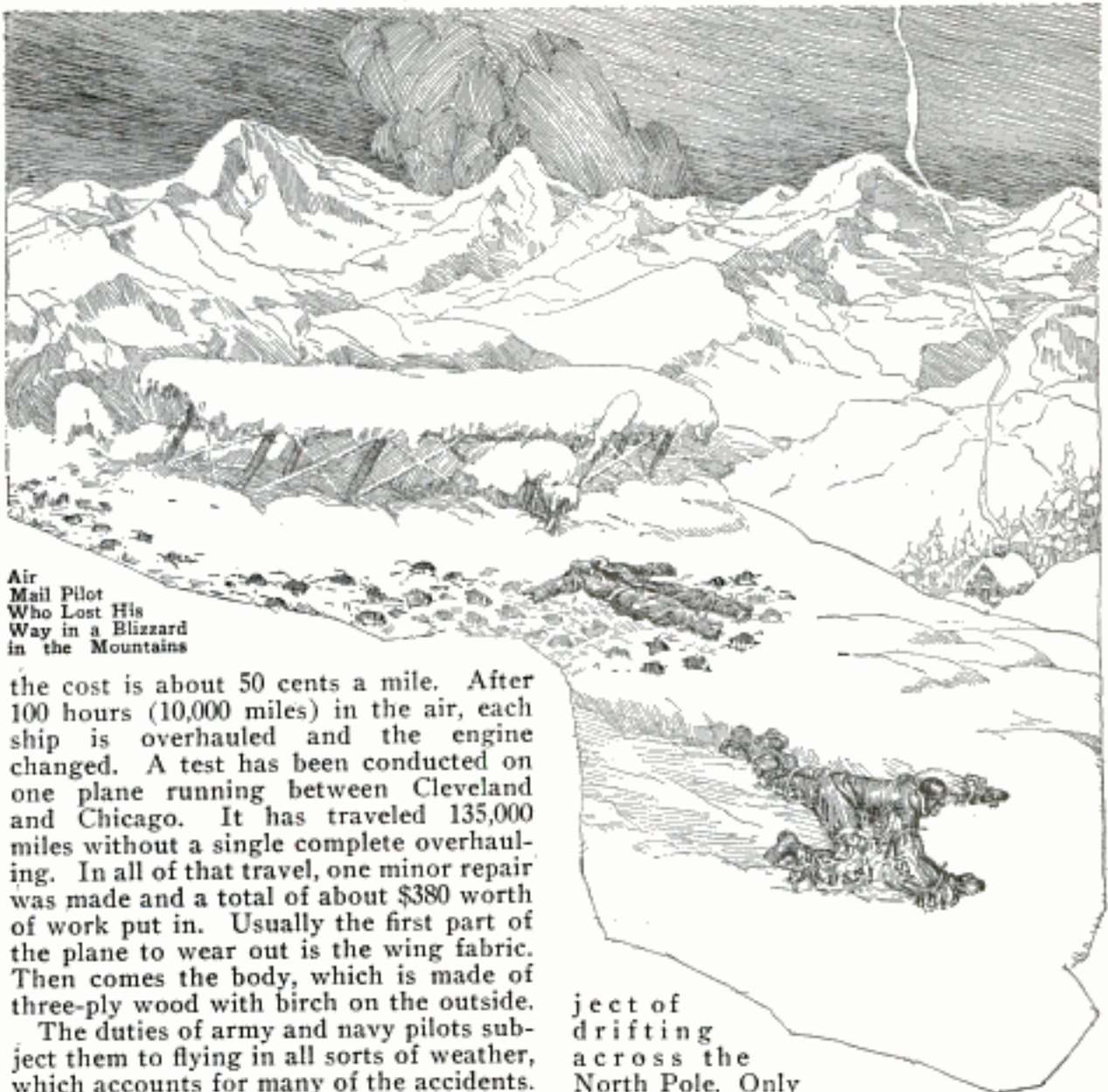

Air
Mail Pilot
Who Lost His
Way in a Blizzard
in the Mountains

the cost is about 50 cents a mile. After 100 hours (10,000 miles) in the air, each ship is overhauled and the engine changed. A test has been conducted on one plane running between Cleveland and Chicago. It has traveled 135,000 miles without a single complete overhauling. In all of that travel, one minor repair was made and a total of about \$380 worth of work put in. Usually the first part of the plane to wear out is the wing fabric. Then comes the body, which is made of three-ply wood with birch on the outside.

The duties of army and navy pilots subject them to flying in all sorts of weather, which accounts for many of the accidents. The greater number of crashes, however, are caused by the so-called gypsies, or aerial barnstormers, in flying over bad territory in machines which have not been kept in good repair. But, while each year witnesses fewer accidents, their supreme adventure has been the beginning and the end for many aerial voyagers. Of such was the disappearance of Capt. Mansell R. James, British airman, who on May 29, 1919, left Lee, Mass., continuing a flight between Boston and Atlantic City. No trace of him has ever been discovered, although the air forces of three governments (British, Canadian, and American) sought for him for some months.

Then there was the polar expedition of Prof. S. A. Andree, the Swedish scientist, and his two companions. Theirs was the first aerial disappearance of record, and one of the most striking. They set out in a free balloon in July, 1897, with the ob-

ject of drifting across the North Pole. Only one message reporting that "all's well" was received from them by carrier pigeon, and it is believed that they perished on top of one of the North Greenland glaciers.

Later, a naval balloon drifted out to sea from Pensacola, Fla., carrying a full complement of officers and men. They have not been seen since. Another disaster at sea took place during the London-Australia flight three years ago. Captains Howells and Henry Fraser flew safely from London to Taranto, Italy. They took off over the Mediterranean with the African coast as their objective. Several days later their wrecked plane was found off Corfu, only one body being recovered.

Of late, flying has become almost as common as any other means of transport for the persons engaged in it. But it was only two years ago that Lieut. Alexander Pierson, en route from El Paso to



Remarkable Night Photograph of Glacier Taken from Plane that Flew to Within 600 Miles of the North Pole

Florida, was lost in Mexico for eleven days. He rode out of the southern republic on a mule. His plane lay at the bottom of a deep canyon into which he glided when his motor stalled. His experience was relatively peaceful, however, to that of Lieut. Ross M. Hardendorf, one of the pilots of the Atlantic fleet, whose motor stalled 10,000 feet up off the coast of Cuba.

When it struck the water, it turned upside down, and the lieutenant climbed on top of it and was arranging his handkerchief on a wing strut as a distress signal when he was interrupted by a school of man-eating sharks. They charged him in droves, singly, and in pairs.

Night fell, and Hardendorf was confronted with the possibility of tearing his plane to pieces to defend himself. Morning brought the sun and a terrible thirst. After hours of labor, the aviator fashioned a makeshift evaporator from tubes and piping from the machine. With this he got about a quart of water. Late the next afternoon, he was rescued by another seaplane. With all

this his luck was better than that of the pilots of the three British seaplanes that disappeared off the Irish coast the same year. They were not found.

Details of hardship and adventure survive only with the victors in the struggle with the elements. Near Tabora, in the former German East Africa, are scattered parts of the largest of the British airplanes which set out in February, 1920, from Cairo to Cape Town. All came to grief in one way or another.

One machine with five passengers managed to fly southward for 2,628 miles. Rough winds and intense heat pursued them all the way. The glare of the sun on the desert sands made landings extremely difficult and dangerous. The engines leaked and overheated repeatedly. Finally, the party landed in a jungle on the banks of the Nile.

At one place, 40 miles from the nearest town, they were forced down in the long swamp grass. Elephants, hippopotami, and tigers gathered outside of the circle of light cast by their campfire, while all hands labored throughout the night to get away. Next day they came down for two days' delay. The heat evaporated the gasoline as soon as it was put in the feed tanks.

Once again in



Naval Plane that Attained a Speed of 238 Miles an Hour in Practice Flight

3490

art of the chemist has succeeded in imitating it with a fabric capable of being dyed and rendered as attractive to the eye as any coming from the silk makers of the East.

Where the worm eats and digests the green leaf of the mulberry and squeezes it out in delicate threads as a spider spins its web, the machine reduces vegetable matter, chiefly wood pulp, to a liquid condition and then strings it into thin filaments through microscopic spinnerets in much the same manner. The silkworms must first be killed in the cocoons as they lie in bowls of water, but the manufactured silk is wound directly on reels as it comes from the mechanism that creates it.

Neither silk can be told from the other without a careful chemical examination. Even the strongest microscope fails to find any characteristics by which the difference can be definitely identified. The research laboratory of the Laundryowner's National Association, after long experiments, found that by proper methods of handling, artificial silk can be laundered without any danger of impairing its ability to withstand the wear and tear that its older rival can weather with apparent safety.

Silk was first brought from the unknown East to European courts by way

of ships and caravans of Oriental merchants. Its rich sheen and soft caressing texture, combined with the depth and wealth of color it takes from dyes, and its jewellike play of light and glowing shadow, literally hypnotized the courtiers who were fortunate enough to gaze upon it.

With its introduction to the western world the Asiatics were called upon to increase the output. The result was that every available worker in the silk-growing countries was called upon to labor from dawn until sundown unwinding the glittering threads from the cocoons. Now, with the chemically made article equal in almost every respect to the natural filament, it is believed that this trade pressure has been greatly relieved.

The California cocoon products are rated as equal to some of the "extra classical Italian" grades, and a single cocoon unreels as much as 1,300 yards of silk. There the mortality loss of worms has thus far been inconsequential, while in non-irrigated sections of Asiatic countries such losses range from 30 to 40 per cent. The absence of rain during the worms' silk-making season is held to be advantageous for the industry, and the contrasting humidity of neighboring bay regions along the Pacific coast is said to be ideal for spinning and weaving.

3600
HUNTERS SNOWSHOE OVER MUD TO STALK SEA GAME

Skis and snowshoes are used by fishermen and hunters on the islands of the North Sea to enable them to walk over



Skis and Boards Being Used as Snowshoes to Walk over North Sea Mud

the wet and slippery mud that covers the ground most of the year. With these it is possible to travel miles over the soggy ground, inhabited by sea-dogs and water fowls, much of which otherwise would be

impassable. First the natives strapped big wood boards to their feet, but later it was found that the footgear used to traverse the snowdrifts was more efficient.

TURTLES AND ANGLEWORMS BECOME "FARM CROPS" 3656

Supplying turtles and fishworms to an eager market keeps two residents of a southern state busy, and provides for them a profitable source of income. In a large frame shack, which the owner calls his "terrapiin farm," thousands of the diamond backs are raised and sold for as much as \$100 a dozen. Angleworms by the wholesale are produced in a few square feet of earth, and the "breeder" is reported to have cleared \$20,000 in this unusual line of industry. He ships them to fishermen all over his state, and even to east-coast cities. To meet emergencies, 10 gallons of them are kept on hand at all times.

Persons living on rural routes are asked by the postmaster-general to paint their mail boxes white, with the name of the head of the family in black letters.

Kansas City Star
9/15/23

International Newsweek
326 W. Madison,
Chicago

910
8539

**PHOTOGRAPHIC GUNS OF NAVY
SHOOT AT SUN'S ECLIPSE**

In modern naval operations, the camera has come to figure almost as prominently as the torpedo and the 16-inch gun. From



Camera "Guns" of Navy
Used to Check Up Gunfire and in Making Maps

the impressions it records, shell fire and projectile velocity are partly determined, two most important factors in accurate gunfire. It also provides a means of obtaining authentic maps of territory during maneuvers. Both still and motion pictures are used. In the recent naval practice off the Atlantic coast, high-speed cameras caught the flights of bombs loosed from airplanes at targets floating on the sea. During the eclipse of the sun recently, a naval photographer ascended 15,000 feet in a plane to take pictures of the event with a special aerial camera, making, according to scientists, the first time such a feat has been attempted.

**FRYING BASKET FORMS CUP
OF SHREDDED POTATOES**

Shaped like birds' nests, small cups to serve vegetables and other foods are made

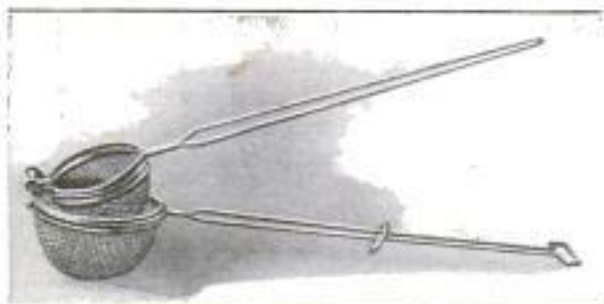

Double Fryer That Forms Shredded Potatoes into
Cups for Serving Other Foods and Vegetables

of potatoes with a double frying basket now on the market. After being peeled, washed, and cut into shoestring shape, they are put into a small wire container

that looks like a strainer. Into this a smaller basket presses, the two being held in place by a metal ring slipped over the handles. When fried crisp the shredded vegetable forms a cup that has the appearance of a bird's nest.

3485

**FIVE BILLION MATCHES DAILY
SUPPLY FOR WORLD'S NEEDS**

With the recent announcement that the world uses five billion matches every day, or about 2,000,000 million a year, attention is called to the fact that hand labor in these factories has been discarded for machines in order to meet the demand. Hauled from forests by trains, poplar, linden, and willow trees are cut into logs 16 to 36 inches in length, by power saws, and softened in boiling water. Run through veneering machines, these pieces are shaved into ribbons, as thick as a match and as wide as the logs. Each turns out splints for 10 to 17 million matches in 10 hours. These strips then travel through machinery that shapes them, and into another apparatus which dips the tips in the flame-producing compound. In all the process of manufacture only the packing is done by hand.

**ARMFUL OF "JUNK" FORMED
3598 INTO CARTOON FACE**

As a kind of initiation test, each student entering on the course at an art school in Germany is given an armful of rubbish and told to "make the best of it." Recently, one scholar carried out the instructions by forming his allotment of cast-off material into a queer face. On a piece of thin board he fastened a funnel for a nose, curled a spiral spring for eyes, and then bent its ends down for the outline of the head. Steel shavings served as hair, a sheet of perforated metal gave "color" to the cheeks, and an old stove brush took the place of the mouth. The background for the cartoon was furnished by a feather duster.



Copyrighted material
91- Seventh Ave.
New York

Sold by Peoples Loan Light
and Cash Co. 102 S. Michigan Ave
Chicago

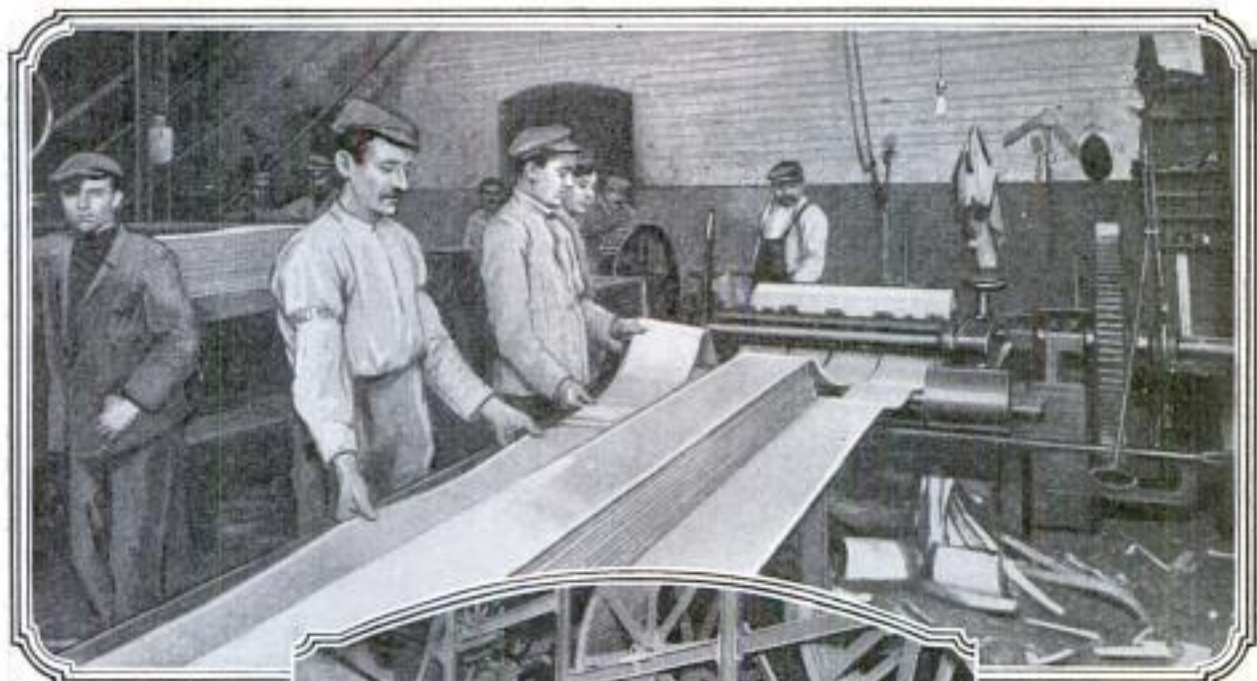

Above Are the Thin Flexible Ribbons of Match Wood Unwinding from the Log as It Turns Against a Knife That Presses Inward with Each Revolution. The Strips Then Go to the Stem Machine

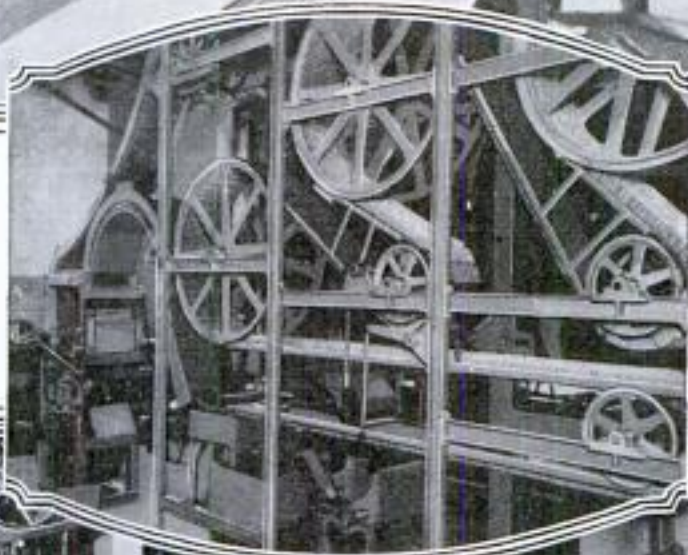

Left: Matches by the Million Stood on End and Firmly Gripped in a Conveyor Belt, Travel over Wide Pulley-like Wheels in Their Route Through the Mechanism Which Has Created Them

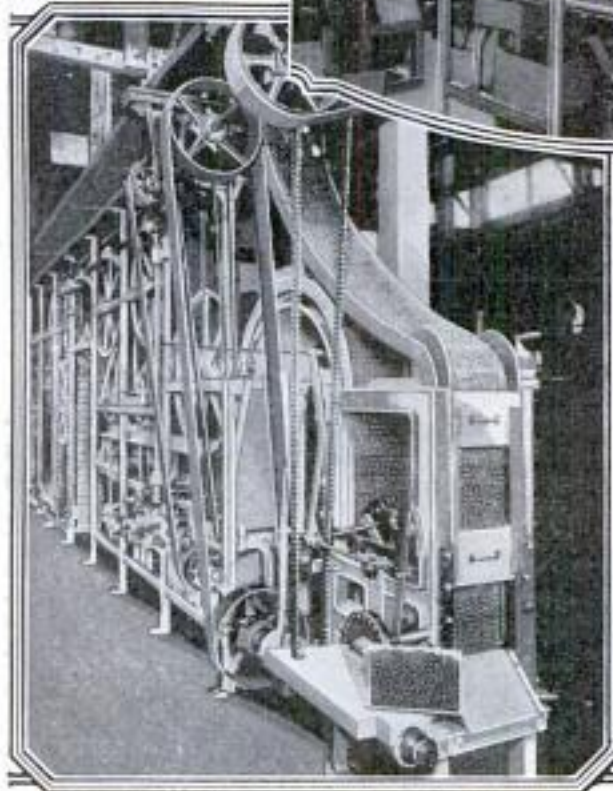

Left, Matches Passing from the Machine after Receiving Their Dips in the Composition That Gives Them the "Fire Heads": Right, Drying Racks and Ovens Where the Tips Are Hardened

Chicago

GLASS ROOF ON DEPOT LIKE FUTURIST PAINTING

Framed in high arches and narrow angles to get the best lighting effects and

drainage, part of the roof of a big rail-road depot in an eastern city looks like a creation of a futurist artist. Its appearance contrasts sharply with the rest of the building. Viewed from an airplane, or high point near the station, hundreds of square pieces of glass look as though they may have been juggled together in an effort to make them fit with each other within the space provided. The ridges of the arches are covered with saw-toothed frames into which the panes have been set.

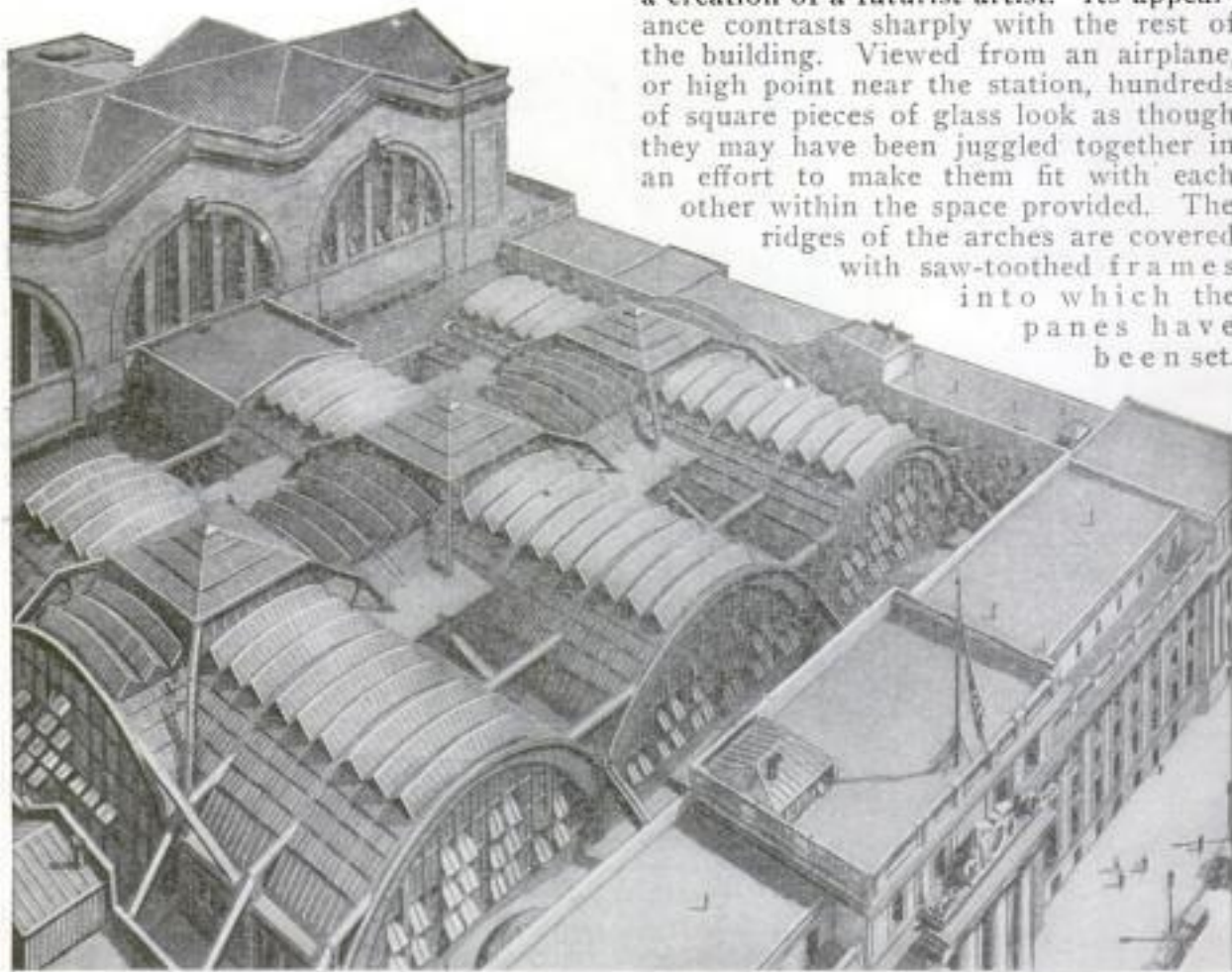

state

Copyright, Underwood & Underwood
Resembling a Cubist Painting, This Glass Roof over a Railroad Station Is Designed for Drainage as Well as to Transmit Light to the Interior of the Building

TROUSERS ARE KEPT IN SHAPE BY PRESSURE ON BOARDS

With only two levers to open and close, a press and stretcher has been patented that will keep from one to five pairs of trousers in good condition. Rapid in operation, the pressure can be varied by a simple adjustment. Also the boards need not be lifted off when it is desired to remove one of the garments.



More than 17,000 miles of wire are contained in the fire-alarm systems of Manhattan Island, New York.

WASTE AUTO OIL TO HELP SOLVE HEATING PROBLEM

Heating houses with waste oil periodically drawn from automobile crank cases may soon be a means of helping solve the fuel question, in the opinion of experts. Already garage owners in an eastern city are mixing this worn-out lubricant with fuel oil and burning it to heat their establishments. Experiments are now under way to determine the possibility of using this refuse in oil burners for dwellings. In one state alone, it is estimated fifteen million quarts of this substance, equivalent to 15,000 tons of coal, are thrown away yearly. Gasoline itself once was a left-over product, but with the coming of the auto its consumption increased until in 1922 more than sixty billion gallons were used in the United States alone.

Christian Science Monitor
9/11/23 Copyrighted material

The Cleveland Utility Co., Ltd.
8 Conduit St., Regent St., W. 1.

Kansas City Star
9/21/23

POPULAR

Western Electric News
Service, & information Dept.
463 West 913 St.,
New York City
Manufacture 3610

HAIR NETS SO FINE MACHINES CAN'T MAKE THEM 3676

Owing to the fine texture of human hair and the shortness of the strands, no machine has been invented that can knit delicate hair nets, so they must all be made by hand, says an eastern manufacturer. More than 95 per cent of the world's supply of this article is produced in the native homes of northern China, from where the hair is first shipped to the United States to be dyed and made sanitary by chemical process. It is then returned for knitting into nets. The strands are tied end to end to form one long string. This is wound on a shuttle which is worked round a bamboo stick or bodkin. The knots are fastened similar to those in fish nets and hammocks, and require skill created by years of practice. One net an hour is considered to be a good average for the ordinary worker.

LUNCH KIT, TIRE AND TOOL CARRIER ARE COMBINED 3649

Camp table, lunch kit, tool and tire carrier are combined in one automobile accessory patented by a western man. Just a little larger than an ordinary casing, a cylinder-shaped, all-metal case provides a waterproof space for the spares, and is divided into three compartments. A drawer, insulated with cork, serves as an

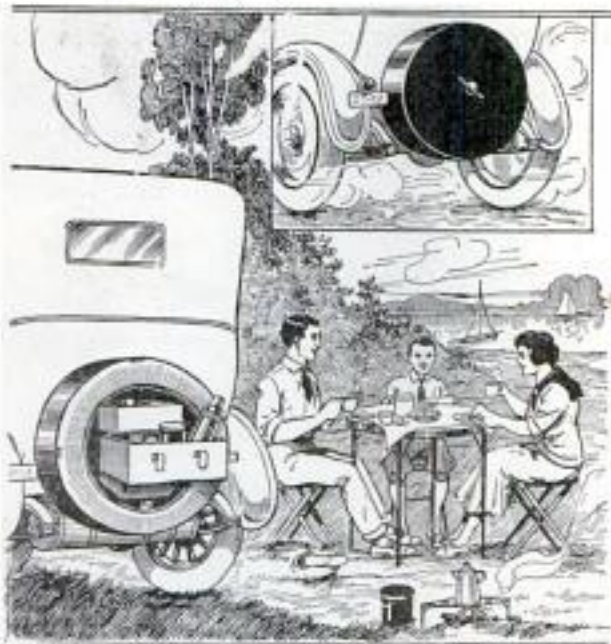

Combined Table, Lunch Kit, Tire and Tool Carrier That Is Weather and Dust Proof

ice chest for keeping food cool. A close-fitting cover keeps dust and rain from the contents, and also serves as a table top.

Chas. Esau & Sons
889 Alberta St.
Portland Ore.

GLASS PULLED OUT LIKE TAFFY FOR PHONE SIGNAL LIGHTS

Stretched and pulled like taffy, glass is formed into rods from which colored glass caps for telephone signal lamps are

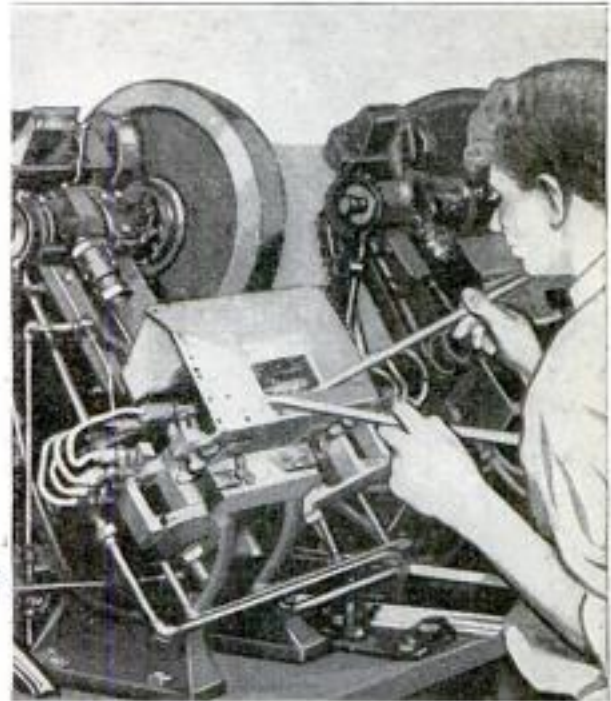

Copyright, Western Electric Co.
Feeding Heated Glass Rods into Press That Stamps Out Caps for Telephone Signal Lamps

stamped by punch presses from glowing rods. Red glass is made by dissolving a bit of gold in the "melt," green is produced by adding copper oxide, while opalescent contains bone ash. Set in brass rings, the different colored bull's-eyes tell the operators how to "put through" the calls.

VOLCANIC ASH KILLS DEER

Reindeers in the government's herd at Port Heiden, Alaska, have been killed by volcanic ash, erupted from a peak, that covered their feeding range to a depth of an inch and a half. Stirred by the hoofs of the animals, the debris caused acute lung and throat trouble and wore away the hair and skin from the lips, resulting in sickness and often death. The herders suffered also, but none of them died. An attempt to move the deer across the Alaska peninsula to a better forage ground was finally abandoned.

Write our Bureau of Information, if you wish to know who makes or sells any article described in this magazine. Send no postage; the service is free.



3612



Yuletide Candles Undergoing Inspection before Packing

SO great is the demand for Christmas candles, that the business of making them represents a year-round industry. More than one half of the entire product of the factories engaged in making them is said to be composed of these yuletide festival lights.

Candles are one of the earliest forms of illumination known to man. History shows that even in the time of Moses they were extensively used, being mentioned in connection with the required ritual of the temple. Among Greeks and Romans they were the natural outgrowth of the flambeaux or torches made of wood soaked in oil.

Those who make candles say that there are more of all kinds used now than there were in the colonial days, when the people had no other source of light. It once was an annual event in the rural districts to see the members of a family gathered together on the long winter evenings making tallow dips in a metal utensil.

Formerly made of beeswax or animal fats, these materials still enter into the composition of candles in varying degrees in the big factories which have relieved the household of their manufacture. Now, machinery is almost entirely employed to produce them, and to this step has been added a brilliancy of color which suggests an oriental gorgeousness.

Modern candles do not smoke as did those of the pioneer days, which required the constant application of snuffers. By drawing one strand of the wick tighter than the others, the candlemaker of today causes the wick to bend while it burns, coming into more direct contact with the air and consuming evenly.

The manufacture of the Christmas-tree candles begins the day after the holiday and continues throughout the year. These are made of wax which has first been colored. The twisted-rope effect is produced

Xmas Candles and How They Are Made with Machines By the Millions

by turning them through molds much in the way a screw is twisted into a piece of wood. They are then sorted and packed by a machine that drops the different colored ones into separate bins from where they slide down to an inspecting platform and are put up in cartons.

The yuletide candle is a large affair, about three and a half inches in diameter. The color is a beautiful red, effectively worked in holly and other holiday greens which are also of wax. According to the old custom these are to be lighted and left in the window to burn all night long on Christmas Eve. Modern usage also has given them a place on the mantelpiece and as part of table decorations for the Christmas feast.

Not all the candles made at the present time are used as decorations, however, as those in greatest demand are for miners. The men working in the depths of the pits where open lights are permitted, prefer the candle light as being better adapted to revealing the characteristic colors of the ores that bear precious metals.

Many candles also are manufactured in large quantities for other feasts and seasons observed throughout the civilized world, and as ornaments to the home.



"Banquet" Candles Get Their Brilliant Shades from Careful Dipping in Colored Wax

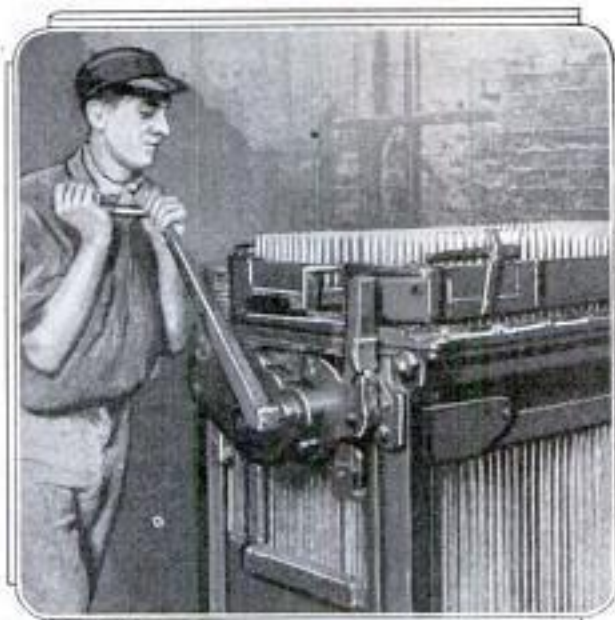

Each Rack of Candles Is Moved Upward and the Next "Set" Is Poured



Pouring Molten Wax into the Molding Machine



Better-Grade Candles Are Wiped Clean and Tested in the Boxing Room



Colors Are Automatically Separated and Delivered to the Packers



Washington, D.C.

FIRST TWELVE-INCH LENSES
MADE FROM U. S. GLASS

3487

Measuring 12 inches in diameter, the largest lenses ever made of U. S. optical glass have been completed by govern-



Big Lens Constructed by Government Scientists from Glass Made in the United States

ment scientists. Throughout the delicate process of grinding, an expert stood by the craftsmen to supervise the work, since even the slightest error in measurements is irreparable. Fashioning the lenses is done by curved instruments that scour emery across their surfaces. At first the grit is coarse, but, as the job progresses, finer quality is used, until the desired shape and thickness have been obtained. Polish, upon which clearness depends, is put on in the same way, and, on the more powerful lenses, it is so sensitive that the slightest finger touch will blur it. Although a lens may pass through the hands of several men before it is completed, it comes from the last as a perfect product, so skillful are the workers. Instruments that measure to a thousandth of an inch, or less, are used.

MARS TO APPROACH THE EARTH
CLOSE ENOUGH FOR STUDY

3694

On August 22, 1924, the planet Mars will be nearer the earth than at any time in the past 120 years, and closer, say scientists, than it will be again during the present century. Its expected approach has caused observers to prepare plans for making a study of it at short range. Throughout August and September of next year, this celestial neighbor will hang like a great lantern in the southern skies and,

Chicago Herald-Examiner 9/23/23

it is said, will rival Jupiter in brightness. In the opinion of one authority, little can be done regarding communication with possible inhabitants of the planet, although many believe that it shelters intelligent life. Another holds that the "canals" that traverse the sphere are neither water channels nor vegetation growing along such courses, but are plants springing from moist ground or banks of damp soil, since there is no known solid in the mineral world that darkens as these spots do and then fades out in sunlight.

ACROSS OCEAN SINGLE-HANDED
IN TEN-TON SAILBOAT

3662

Alone in a 30-foot, 10-ton racing cutter, a French adventurer recently crossed the Atlantic Ocean and part of the Mediterranean Sea, arriving in New York on the 142d day of his journey. He is said to have established a record for such a small craft. During his voyage, lasting a little more than four and one-half months, he met with three hurricanes, when huge seas threatened to swallow him and his boat, and was unconscious for 48 hours when he was stricken with fever. Near the end of his trip the supplies ran low and he was



Ten-Ton Boat, and Adventurer Who Crossed the Atlantic in It Single-Handed

forced to subsist for several days on a single cup of water. In all, he traversed 5,600 miles.

Alain J. Gerbault
International Tennis
Star of France

3663

Naval Air Station
at Pensacola Fla.

School

RADIO CODE IS TAUGHT TO SLEEPING STUDENTS

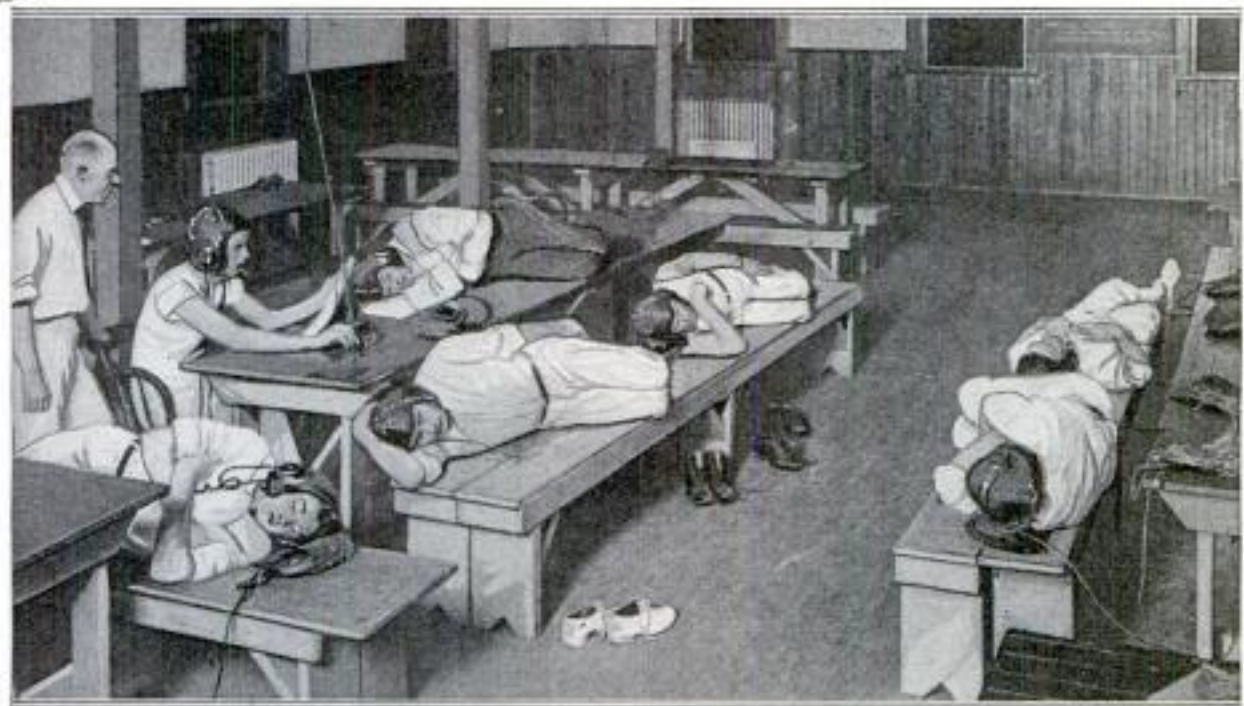

Sending Wireless Messages to Student-Operators at Naval Training Station While They Sleep: This Has Been Found an Aid in Teaching Them the Code

Sending wireless messages to novices while they sleep, to teach them how to send and receive, a method recently adopted at a naval air-training station, has proved a success, according to recent reports. Before dozing off, the students put a set of receivers over their ears.

An operator then broadcasts to them, usually at a rate faster than each is capable of copying. In their conscious hours, the amateurs can equal that speed, it is said, while some can even repeat from memory whole texts transmitted to them during their slumbers.

2724

HAIRCLOTH IS THING OF PAST

Gradual discarding of haircloth furniture has forced an eastern factory that manufactured this product to close down after 67 years of operation, according to reports. Formerly the company employed 400 persons, but in later years, with the change of customs, the demand for this fabric fell off until seven persons were able to keep the trade supplied. Now the plant is to be dismantled.

Christian Science Monitor 9/26/23

SUN'S RAYS MAKE ALARM CLOCK OF CANNON

3685

Sunlight is called upon to inform the residents of a community in southern Europe when high noon has arrived, by setting off the charge in a cannon. Fixed to the piece is a small lens that focuses the rays on the touchhole of the gun in such a way that they do not reach the powder until the sun's position is directly in line with a tiny opening. The supports of the "alarm" are arranged to adjust it

to the light beams at the same time every day of the year. Often the device fails to work because of cloudy skies that prevent

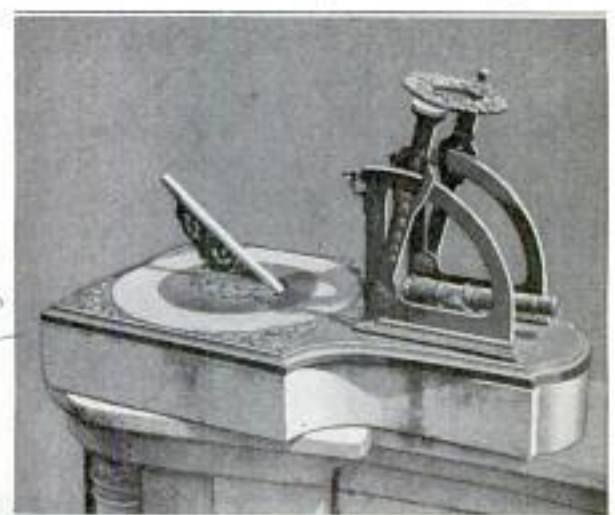

Cannon Automatically Fired at High Noon Each Day by Powerful Rays of Sun

sufficient heat from reaching it to ignite the explosive. The hours are indicated on a clocklike dial.

Wide World Photos
229 W. 43rd St
New York City
Copyrighted material

Behind the Scenes at the White House

Washington, D. C.
President's Home Guarded by Protective Devices, Including Fire
Escapes on Roof that Look Like Small Cannon

8571

MILLIONS of visitors from all parts of the world have made pilgrimages to the White House at Washington, but few of them have ever inspected any of its mechanical marvels.

Although neither lightning rods nor fire escapes are visible from the outside, they are there just the same, but in such strange forms that they would hardly be recognized, even if seen. The fire escapes, for example, look for all the world like miniature howitzers mounted on the roof of the executive mansion for the defense of the famous edifice. Weighing 200 pounds apiece and anchored from a balcony by means of extendable steel arms, the metal drums would never attract the attention of anyone hunting for steel ladders, safety ropes, or exit elevators. Pulling the chain at the bottom of the cylinders causes them to open and release an endless chain that fastens around the waist and then slowly lowers the load to the ground.

Science has also armored the White House against the dangers of lightning, approximately 2,500 feet of wire being strung across the chimneys and guard wall on the roof. The arrangement is

such that if any balls of fire are flung from the skies, the lightning wires deflect them into the ground. Then there is an attractive, screened, sleeping porch. This skyline bedchamber, however, is not for the use of the president. It is 18 feet square and was erected exclusively for White House attendants.

Another prominent accessory on the roof is known as the president's flagpole and is used wholly for the display of "Old Glory."

A mammoth lamp which is six feet high and two and one-half feet in diameter—a large man can stand erect within it, as he cleans the globe—is the faithful beacon which illuminates the main entrance to the mansion.

Migratory and native birds by the hundreds frequent the White House forest, consisting of more than 200 trees of about 65 different species. Birdhouses on poles as well as swinging shelters have been provided for feathered visitors. Even the comfort of the policemen who guard the president is well looked after. Cubbylike houses, heated electrically during the winter are provided at the entrances.

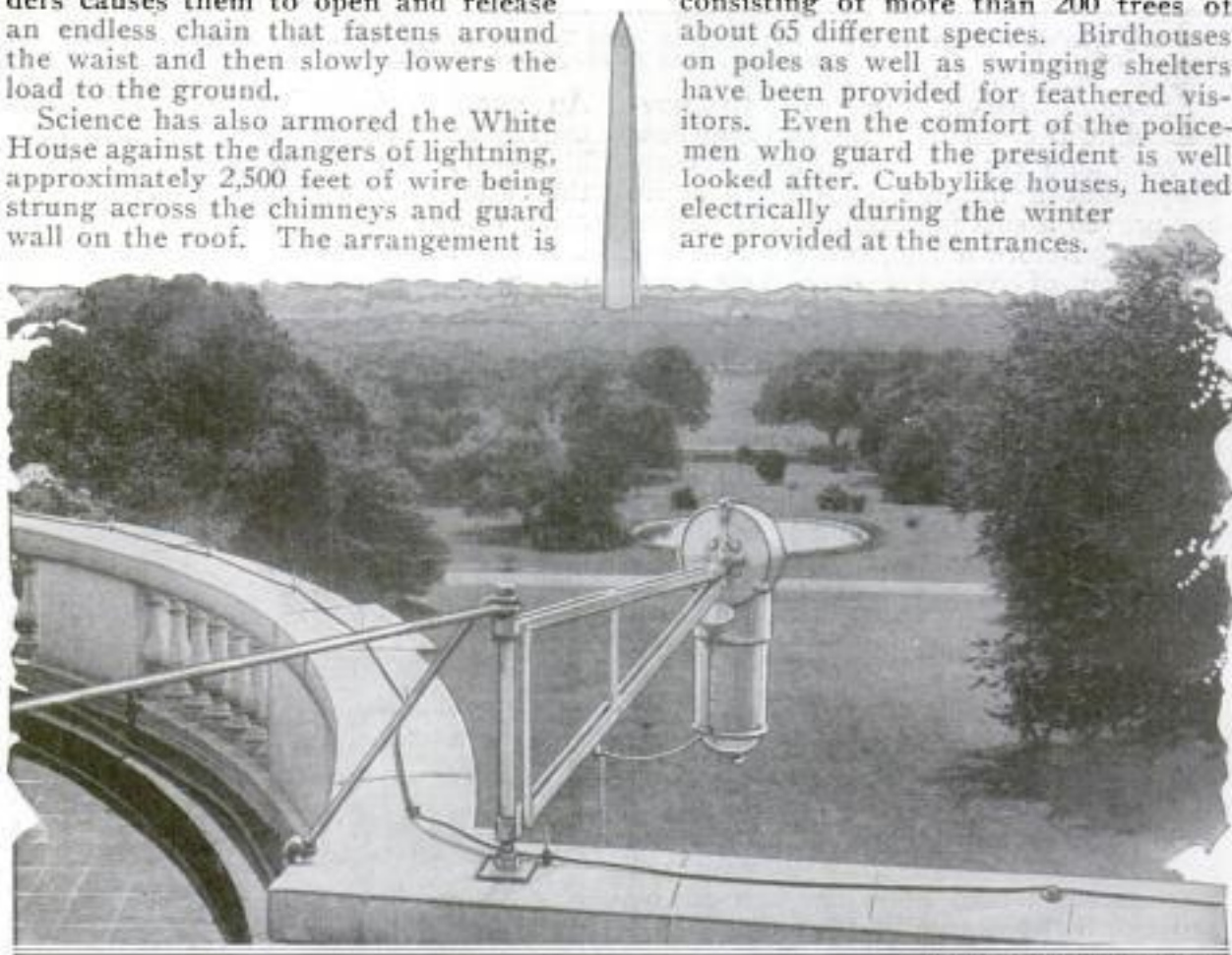

Copyright, National Photo Co.

Fire Escape on White House Roof that Can Lower Five Men to the Ground Simultaneously on Endless Chain, If Flames Should Threaten Executive Mansion

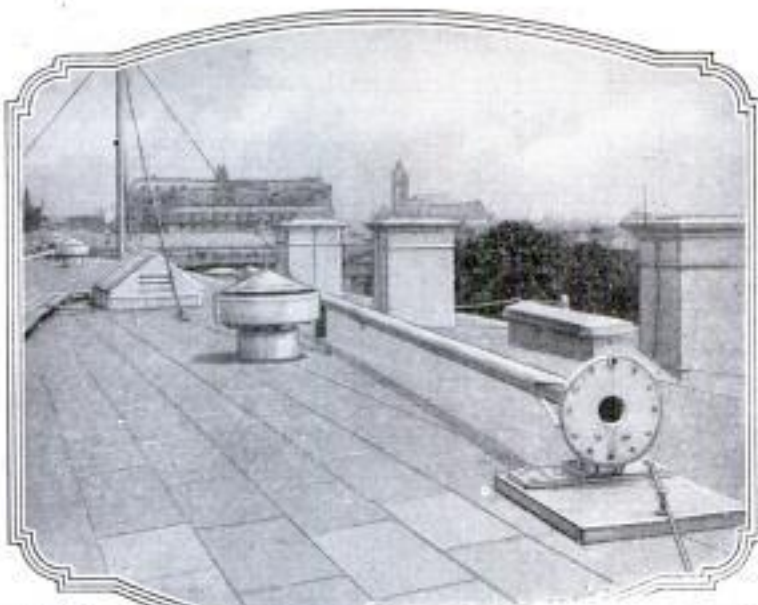

Portab'e, Hinged Flagpole Used on Special Occasions

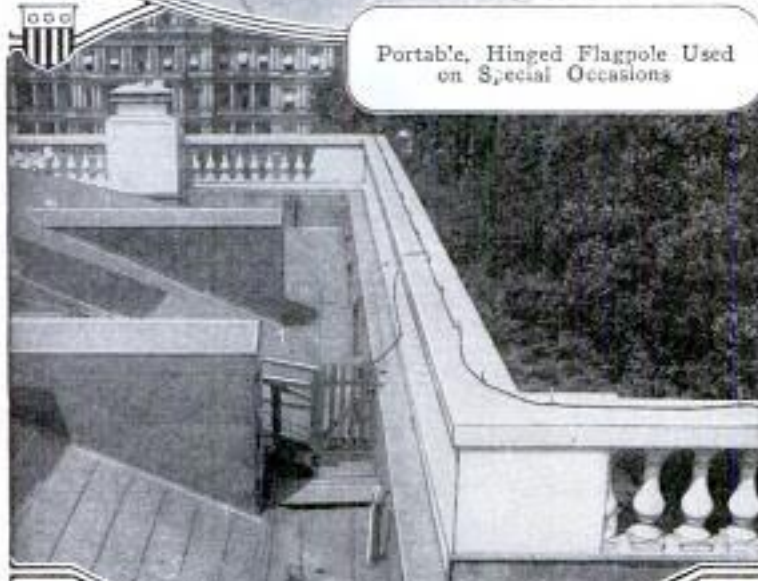

Mammoth Lamp, Suspended from Portico at Entrance to White House, in Which Large Man Can Stand Upright, and, at Left, Wires Which Are Strung Along Roof and Pass over Sides of Building to Guard Against Lightning

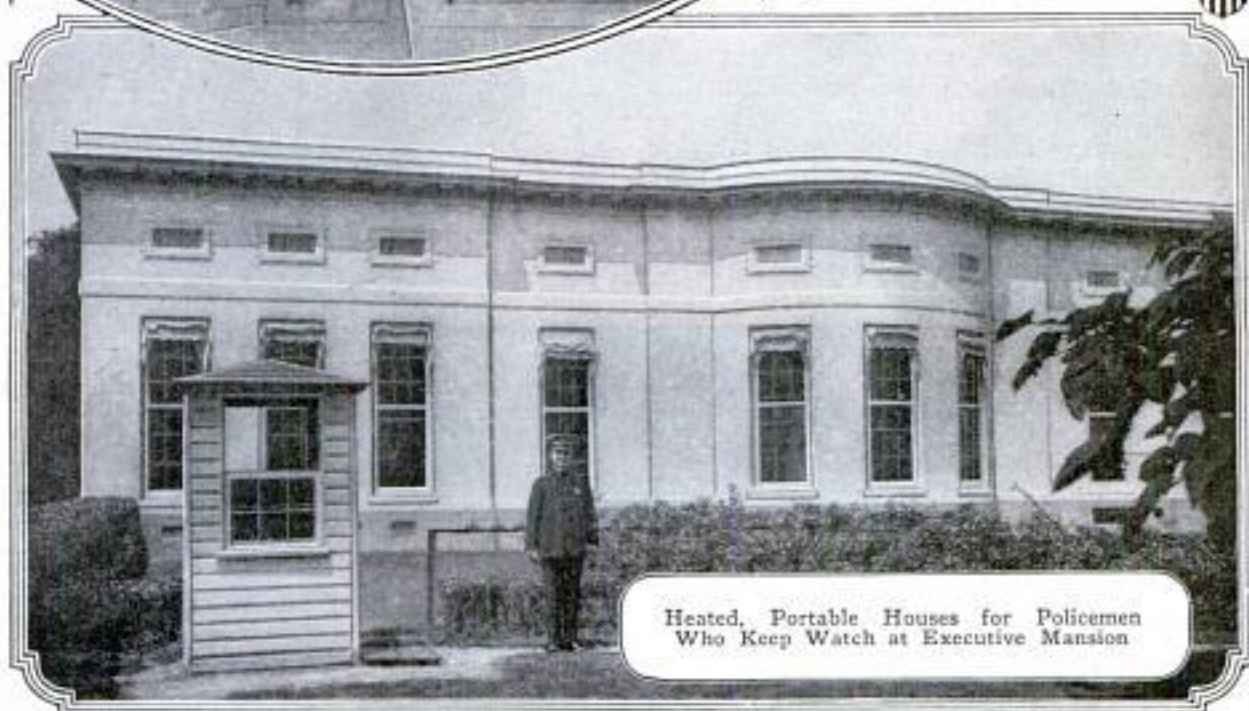

Heated, Portable Houses for Policemen Who Keep Watch at Executive Mansion

In the basement, however, is an old veteran of early-day mechanics—a huge extendable metal arm which could be swung in place above the open fire so that the pots and kettles in which the presidential dinners were cooked could be hung on it.

Two large marble troughs in another basement room, now used as a coal cellar, take us back to the days when this particular room was used as the White House dairy. The marble vats were used for cooling and storing the milk.

WHIRLING BRUSH AND VACUUM TAKE DIRT FROM CLOTH

Clothing and other fabrics can be cleaned by a renovator that has a vacuum



Clothing Renovator That Draws the Dirt from the Fabrics with Revolving Brushes and Vacuum

device to draw air through them while a revolving brush, protruding through the table top, agitates the surfaces. Spots are removed by another wheel of bristles that is moistened with a cleaning fluid contained in a tank within the machine. The dust is gathered in a chamber, from which it can be easily taken. Any kind of liquid may be used for the cleaning, as the device is practically all metal and is said to be proof against fire.

MODERN PALACE ON ROOF TOP RIVALS BABYLON'S GARDENS

Rivaling the wonders of ancient Babylon's hanging gardens, a million-dollar home, surrounded by grass-carpeted and ornamented grounds, studded with trees and shrubbery, has been erected on the roof of a New York skyscraper. Far above the din of traffic, this domicile reposes in a setting similar to that of a country villa. Three feet of earth has been found suffi-

cient to nourish 15-foot cypresses, vines, rosebushes, and lawns. Rustic benches, flagstone walks, fish pools, and birdhouses add touches of regal beauty to the "estate," which calls attention to the excavations of like works now progressing in Egypt. An exploring party there has unearthed the remains of a "sky garden" said to have been built by Pharaoh Mentuhotep III over a barren cliff of sand and stone near the Valley of Kings. High above the ruler's palace, landscape artists laid out a spacious courtyard. Slave gangs bored a series of holes, into which was dumped rich soil from the River Nile, and sycamore figs, a most imposing tree, were planted. Flowers from the lowlands and the tamarisk were cultivated, according to reports, which state that dried-up forms of these were found in the cavities made by the ancient gardeners.

LOCKED STAMP HOLDER STOPS THEFT AND SAVES TIME

To prevent loss, theft, or misuse of stamps, a container has been designed that issues the exact amount required for packages or letters when its keys are depressed. Holding any number of denominations, it

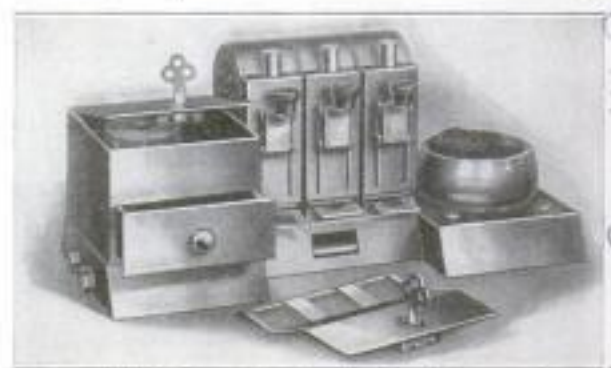

Automatic "Watchman" that Incloses Postage Stamps and Records Each Withdrawal on a Register

keeps them securely locked in coils, so that there is no confusion. Thus spoilage is reduced. The apparatus automatically records each selection, thereby providing a check on the number actually used.

More than 1,000 fur farms are located in Canada.

Handwritten notes in the left margin:
No. near City Star (Hypocrite Clean) Coats, Savannah, Ga. 7/23/23
0639
Engineering Sub Co.

Handwritten notes in the right margin:
3716
3708
W. J. McRay Co., 111 N. Parkers St., Chicago

**WOMEN OF WHITE AFRICANS
RULE TRIBAL HOMES** 3726

There exists in the remote Sahara Desert, among the mountain fastnesses of Hoggar, an Arab tribe whose female members have enjoyed privileges equal to those of the men folk for an unknown number of years. These people, called the Tuarega, while embracing most of the tenets of Mahomet, have disregarded the clauses referring to subjugation of women and permitting polygamy. They are purely monogamic. In this region the fair sex are absolutely independent, marrying according to their own wishes. Their authority as mistresses of the tents is not questioned and they do not wear veils. Inscriptions discovered by explorers indicate that their civilization dates from long ago, but nothing has been learned to credit legends which tell of cities built by these people. The male portion of the communities devote their time to martial exercises.

**WRIST WATCH WORN AS RING
OR HUNG ON NECKLACE** 3645

Worn as a ring, a lavalliere, or on the wrist, a tiny watch made by a middle-western jeweler serves three purposes. It can be changed quickly to suit the whim of the wearer. When worn on the wrist, the hinged ring part folds in two sections flat against the back of the watch, form-



Wrist Watch That Is Used as a Ring or Lavalliere to Suit Wearer's Fancy

ing eyelets through which ribbon passes. Another slight change is made if it is to be suspended on a lavalliere.

Lo S. Loeb, 358
Fifth Ave., New York.

**NAME PRINTED ON WRAPPERS
AS THE PAPER UNROLLS** 3604

As a means of advertising, shopkeepers are using a device that stamps a name or a design upon wrapping paper as it is

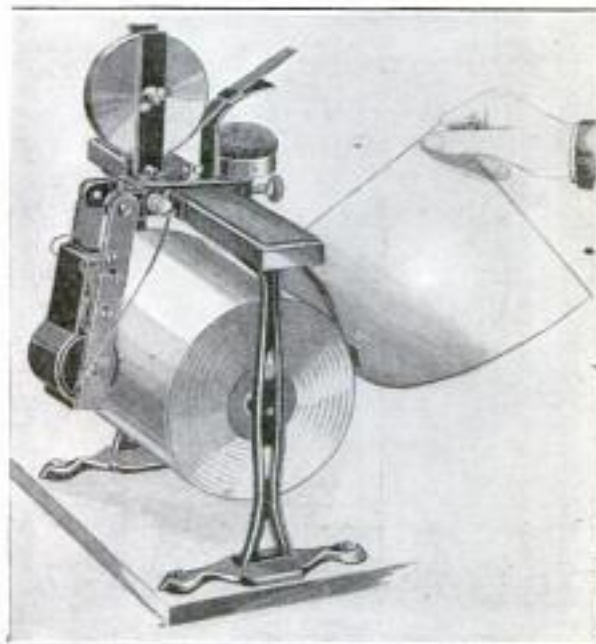

Revolving Stamp That Prints Ads on Wrapping Paper as It Unwinds from Roll

unwound from the roll. Thus storekeepers can save the cost of having their names put on at the factory, and can make up their own ads, changing the style and text as often as they wish. Different colors of ink can be employed also. Attached to the frame carrying the paper the printing attachment turns as the former revolves, leaving a neat, readable note on all sheets used. It requires little attention, and can be removed easily.

**COLOR CHANGE OF HYDRANGEA
BLOOM SOLVED BY TEST** 3690

Why hydrangea blooms change color in different localities, a mystery that baffled science for years, has been found through tests to be due to acid in the soil. Some varieties of the plant bear pink flowers one season and blue the next. Often opposite shades appear in those growing within a few feet of each other. Explorers found a species of the growth in China that had blue blossoms, but when these were reset in France they produced pink petals. In Holland, it was formerly rare to find blue ones, while in Germany they were either blue or some tint of red. It is said that with the recent discovery hydrangeas of any desired tint can be grown by simply treating the soil.

A. W. Old & Co., 27-29 Clark St., Chicago.

Chicago
The Scott Corporation
72 W. Washington
New Brunswick
Annual Experimental Station

3568
922

The Williams' Service, 32 Union Square, E.
New York City



While Civilization Was Still Young, the Apuan Alps Surrendered Their White, Marble Masses to the Glory of Art that Graced the Majesty of Old Roman Architecture



In Every Civilized Country Huge Blocks of Snow-White Carrara Marble May Be Seen Awaiting the Awakening Touch of the Sculptor's Tool to Carve Them into Expressions of Beauty

Mining Beauty in Mountain Peaks

More than Million Tons of Carrara Marble Produced Yearly in Apuan Alps of Italy

WITH the completion of a heroic statue of Adam and Eve, hewn by an eminent sculptor to grace the estate of a wealthy American, what is said to be the largest block of Carrara marble ever brought into this country found expression in one of the oldest, and perhaps the most influential of the arts.

Since Roman emperors opened the quarries more than 2,000 years ago, merchant princes of the Middle Ages, monarchs, and the modern world have fashioned their architectural dreams in "Carrara." Only in Tuscany, Italy, is it now to be found in great quantities. More than 1,000,000 tons yearly are being produced in the Apuan Alps, where there is a mountain of glistening stone 5,000 feet high. And despite the fact that centuries of building and art have drawn upon these snow-white deposits for their uncarved beauty, the supply is little more than touched.

Michael Angelo, whose sculptures are among the glories of the renaissance, worked in Carrara marble, Celleni used it, and, since before the birth of Christianity,

the quarries have been shipping the matchless stone to all parts of the earth. It is to be seen in the ruins of the Roman forum, at the still well-preserved Arch of Constantine, and beneath the great dome of St. Peter's Cathedral in Rome.

In most places where marble deposits occur, it has become split up in the earth and various substances have filtered into the cracks, giving rise to the colored veins which make it unfit for statuary use. For some mysterious reason the Carrara marbles have remained for the most part free from such disfiguring accidents. In this condition the ancients found them.

Through the neighboring towns surrounding the marble slopes of Carrara are the studios of nearly 2,000 sculptors. In their yards may be seen busts of Indian rajahs, half-finished pieces for merchants in far-off Japan, tombstones for Asia and South America, elephants, polar bears, and other figures from the animal kingdom.

Many methods of transportation are necessary to carry the workmen to the lofty quarries. Railroads, automobiles,



Planed and Polished to Mirrorlike Finish, "Carrara" Reflects Beauty of Ages in Modern Temples of Commerce.
Above: Hewn Centuries Ago, the Snowy Rocks Still Lie Amid Ancient Ruins

carriages, donkeys, are used, and an aerial railway suspended hundreds of feet above the earth, below, instant death, if anything should go wrong. The blocks, once they have been loosened, are lifted to rough wooden sleds, under which are soaped rollers, and dragged to the valley by ropes attached to posts. Where the slopes are not too steep, ox teams trudge downward with the huge rocks on creaking carts that leave deep furrows in the snowy dust. By railroad, they are then hauled to the sea, fifteen miles away, where

waiting ships carry the immaculate stones to foreign ports.

Seemingly inexhaustible, the quarries can yet be worked for ages. No one knows how far down in the earth the imperishable marble hills extend. Above the level, a majestic range of solid stone mountains rises, towering at points to a height of 5,000 feet from the sea—400 square miles of marble. By leaps and bounds the demand for Carrara marble has spread since first a Roman slave scratched the snowy bed with his iron pick.

**COLOR PICTURE SENT BY RADIO
"PAINTED" ON RECEIVER** *3711*

Colored pictures broadcast by wireless can be reproduced by means of a machine that breaks up the original into three primary shades, red, blue, and yellow. A record of each of these "primaries" is made and sent to the receiving device, where they are recorded on films. By combining the films in final printing the various tints of the subject are copied exactly as they appeared at the sending end. In the transmitter a sensitized cylinder is imprinted through a screen that separates the ground colors into dots.

Kansas City Star 9/13/23
**HAIR DRIER WITH SIX BLOWERS
SAVES SWIMMERS' TIME** *3714*

Six swimmers can dry their hair at once with a machine devised to save time for women bathers in a western natatorium. A half dozen individual tubes are provided, and each hose carries a large volume of air. Run by electricity, the apparatus combines heat with a blower. It is called upon to care for the needs of about 200 women a day and it is said to withstand the strain of constant operation better than other types.



Natatorium Hair Drier that Can Supply Warm Air from Six Blowers at the Same Time

*Com. John J. Bartie et al
P.O. # 2, Boulder, Colo.*

3603
**ELECTRIC HAMMER HAS ONE
MOVING PART**

Without a motor, gears, cranks, or rods, an electric hammer is being made for drilling and chipping. A hardened steel



Electric Hammer with Single Movable Part That Takes Less Current than Flatiron

head which goes back and forth in a bronze barrel is the only moving part. At the end is a winding of wire which becomes a temporary magnet, alternately as the current is received, first top and then bottom. This is done by taking advantage of the alteration of the current itself and requires no triggers or mechanical switches. It uses less electricity than a flatiron and is said to result in a 300-percent saving in labor costs. Because of its compactness, the device is of special benefit to contractors, sign manufacturers, steam fitters, plumbers, and elevator builders. The machine is said to bore a one-inch hole three inches deep in dense concrete in one minute.

National Electric Supply Co., Pittsburgh, Pa.

33 78 926
 408 Midland Trust Bldg,
 POPULAR MECHANICS
 St. Paul, Minn

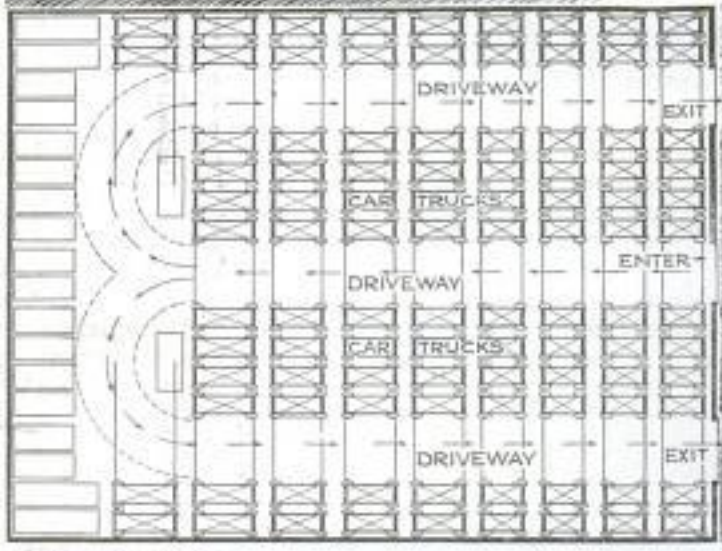
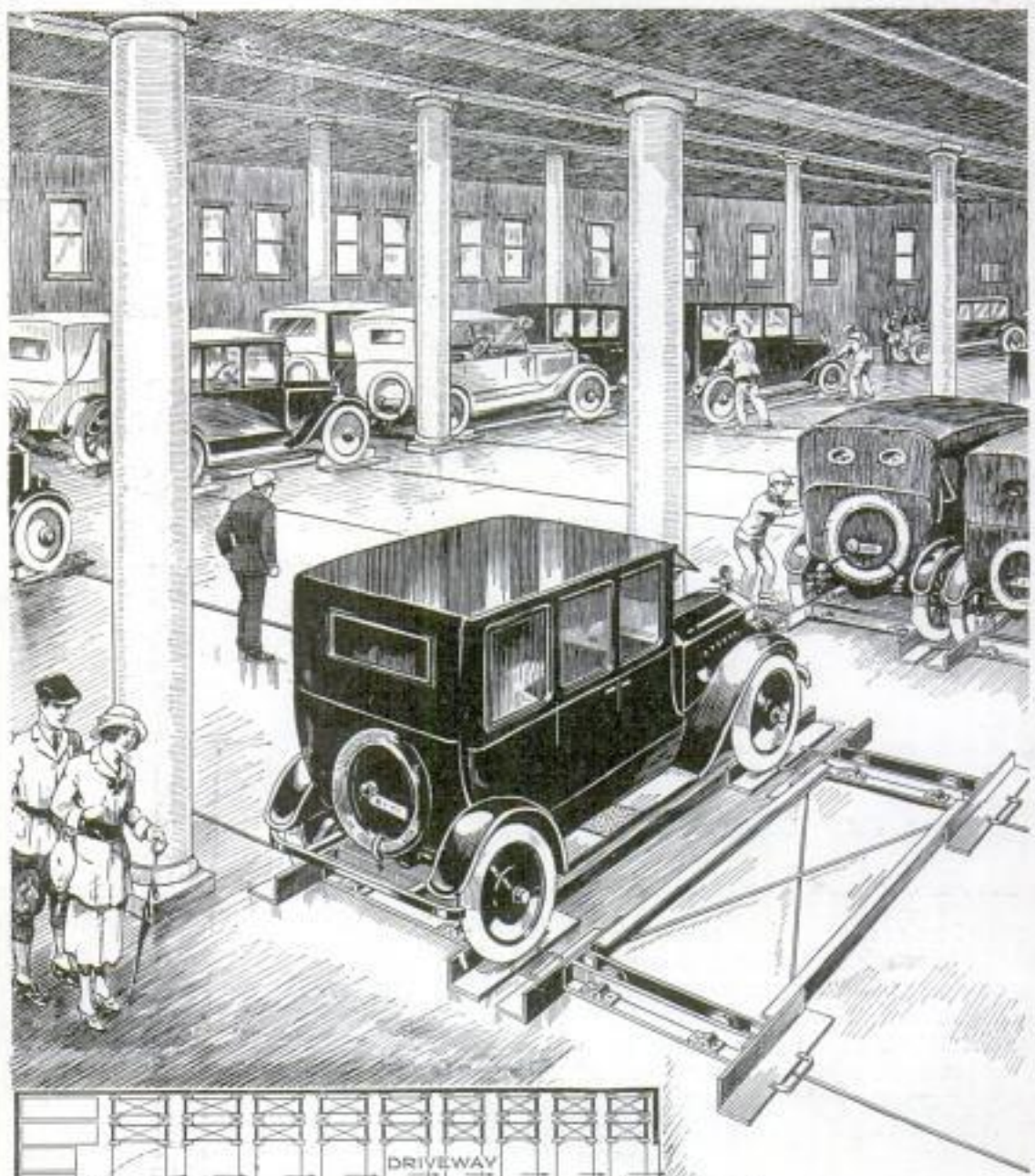

Storing Automobiles on Sliding Platforms in Garages, Where Space Is Saved and Danger of Damage from Scraping or Bumping Is Eliminated: Below, Floor Plan, Illustrating Operation of System

**AUTO STORED ON SLIDING SHELF
TO SAVE SPACE IN GARAGE** 378

Rolled from a driveway onto platforms that slide to their storage spaces on steel rails imbedded in the floor, automobiles can be parked in garages with great saving of room and little danger of damage from contact with posts, walls, or other cars, by the invention of a mid-western engineer. The system, it is said, permits a third more machines to be accommodated than by other methods. Any of the moving "shelves" can be pushed to the passageways for loading and returned to position in a few moments. Owing to the ease with which they can be moved, hand power alone is required. Attendants are also relieved of the trouble of manipulating cars to guide them into stalls of crowded garages.

**RHEOSTAT TO FIT ALL TUBES
FOR RADIO OUTFITS** 0673

To save radio fans the expense of buying a new rheostat when changing from one tube to another and to spare them the labor of removing the device from the panel, a middle-western man is making an instrument that will control any resistance, merely by inserting the correct



Radio Rheostat with Detachable Cartridge That Saves Replacing by Ability to Fit All Tubes

cartridge. This is clipped in without the slightest change to the bracket. Less than an inch in depth, it takes little space on the board. It can be used on the dry cell and is inexpensive. When a change is made from the low-resistance tube to a storage battery it does not require replacing.

Write our Bureau of Information, if you wish to know who makes or sells any article described in this magazine.

*Unity Mfg. Co.,
224 J St. Halsted,
Chicago*

**BEAUTY OF ROSES AT NIGHT IS
SHOWN BY LIGHTS** 3619

Tiny electric lights, concealed in the blossoms of artificial roses and other flowers, add a warm glow to the lifelike appear-



Artificial Flowers in the Blossoms of Which Tiny Electric Lights Are Concealed

ance of the bouquet. House current is used to illuminate the display, which is made entirely by hand from the fireproof muslin leaves to the varnished basket of skillfully created bark. Satin, silk, and plush also are used in making the foliage.

**SPIKES IN TOP OF PITCHER
SERVE AS CAN OPENER** 3609

By placing spikes in the lid of a pitcher now being made, in which a can of condensed milk fits, the need of an opener is done away with, as the tin is punctured when the cover is pressed down. After being put in the receptacle there is no need of touching the can again until its contents have been used. Covered on all sides by this holder, it is thus protected from insects and dirt. A single downward movement of the hand perforates the holes through which the milk flows freely, and there is no time wasted in hunting for some sharp instrument to perform this task. The device is nickel-plated metal.



*Artistic Flower & Foliage Co.,
1820 W. Grand Ave. Chicago*

*Mfr. - Brown's Creamwell
Co., 2635 Whittier Blvd.,
Los Angeles, Calif.
Price - \$1.50 to \$2.50*

*Dr. W. Nick Brown,
Island, Calif.*

Pacific & Atlantic Photos
250 Park Place

928

POPULAR MECHANICS

New York City

AIR TEST FOR PILOT ON GROUND TO PREVENT DEATH IN SKY

3613

To protect pilots of airplanes from disastrous accidents when striving for altitude records, rarefied air is fed to them

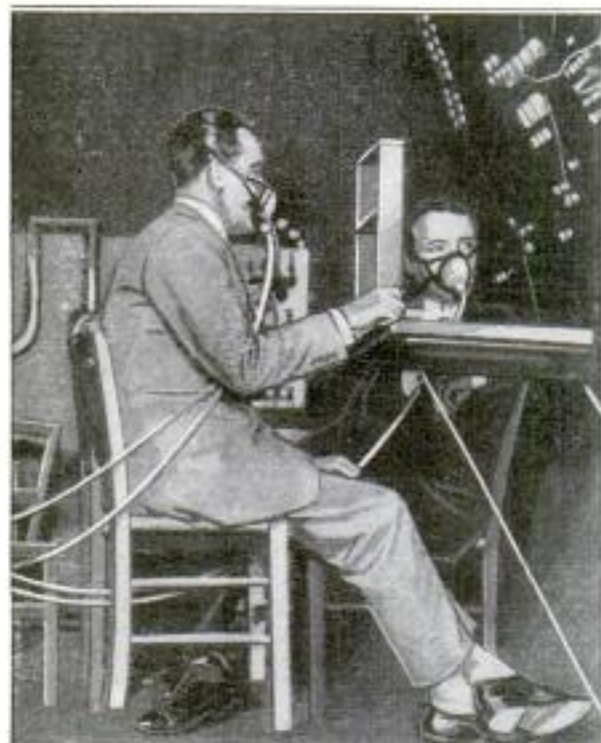

Copyright, Atlantic & Pacific Photos

Testing the Endurance of Airplane Pilots Before They Undertake Hazards of Altitude Flights

from a special apparatus prior to flights to determine whether they can endure the atmosphere thousands of feet above the surface of the earth. In the comfort and security of a warm room, instead of at the controls of a plane, pilots determine if their lungs and hearts can stand the strain of climbing miles into the sky. Physicians directing the tests accurately gauge the heights to which the subjects can mount without endangering their lives. At extremely high levels, life-sustaining oxygen is supplied from tanks. Heavy clothing also is needed to resist the low temperature. Some pilots, in past attempts to scale to dizzy heights, have returned to earth with their faces, hands, or feet frost-bitten and so exhausted physically that doctors had to attend them.

3615

OCCUPANT OF KING TUT'S TOMB ONLY "SHADOWY" PRETENDER

Science, to learn more of the life of ancient Egypt, will reopen King Tutankhamen's tomb and fully explore the innermost chambers, it was announced recently by one of the discoverers, who says that

the occupant of the imperial grave was not of royal blood and was but a "shadowy king" who claimed the throne through marriage. Less than one-fourth of the buried relics have been removed. To complete that task will require at least two years, he says. It is thought that when the sarcophagus is opened the body of the king will be found, jewel crowned and dressed in magnificent robes. An American member of the searching party states that the articles found in the tomb were products of arts in many respects superior to those of the present, and that only in the realms of electrical and mechanical discoveries and in the field of medicine has man advanced since the days of the Pharaohs.

WHISTLING AUTO-LOCK ALARM PREVENTS THEFT OF CAR

3640

To attract attention and at the same time prevent the theft of an automobile, a whistling lock has been patented that fits between the exhaust manifold and the muffler. Locking it shuts the pipe and turns on the whistling device. If a thief should try to start the motor, the first two or three explosions would result in a shrill alarm, after which the back pressure would stop the engine.



Letters rec'd.
10/16/23

COPPER PIPE FOUND IN EGYPT RELIC OF ANCIENT PLUMBER

That plumbers who plied their trade in Egypt more than 5,000 years ago employed copper in their work, is proved, according to authorities, by a pipe made of the red metal found at Giza near the tomb of an ancient king. A bronze bathtub was also discovered in Italy, where it had been buried by the eruption of Mt. Vesuvius in 76 A. D., and it will still hold water. The enduring qualities of alloys containing copper are also shown in a bronze figure of "The Flight of Time," known to date from the sixth century, and the famous snake column of Constantinople that has been exposed to the wear of elements since 479 A. D.

Edw. John Croce, St Joseph Mo.

Mo.

Waltham - The Piece

Anaconda Standard

Copyrighted material

9/22/23

9/23/23

These Articles Are for Everyday Use
But—
Can You Name Them?

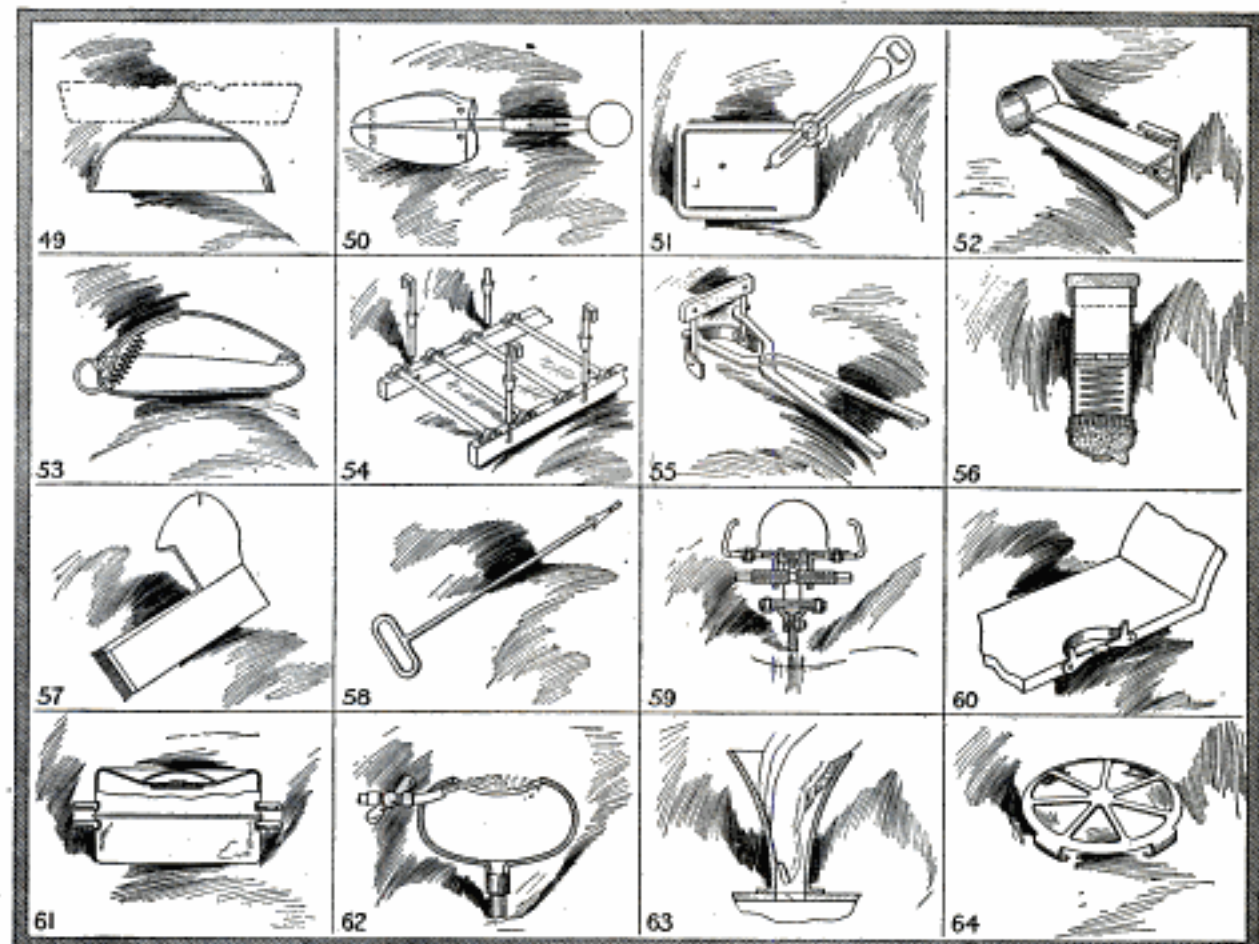

JUST to help you, the use for which the articles are intended is as follows:
No. 49, for personal cleanliness. No. 50, as part of wardrobe. No. 51, in the home. No. 52, by men. No. 53, for personal convenience. No. 54, on the farm. No. 55, on the farm. No. 56, in the office. No. 57, for cold weather. No. 58, in the home. No. 59, for sport. No. 60, about the home. No. 61, in the home. No. 62, for public use. No. 63, in a store. No. 64, for personal convenience.

Popular Mechanics Magazine offers no prizes for correct answers to these problems, but presents them for the interest it believes its readers will find in attempting to determine the nature of the various articles shown.

If you think you have the right answers you can find out by comparing them with the correct list which will appear in Popular Mechanics Magazine for January.

In November the following articles were shown. No. 33, fruit picker. No. 34, nail buffer. No. 35, nail set and holder. No. 36, tool to grain wood artificially. No. 37, safety razor. No. 38, teeth spreader. No. 39, wire clothespin. No. 40, eyeglass chain holder. No. 41, safety-valve for radiator. No. 42, hatpin guard. No. 43, knee-guard. No. 44, date stamp. No. 45, padlock. No. 46, churn. No. 47, holder for putting up electric-light bulbs and shades. No. 48, non-refillable bottle.

CARPET SAVES BALL PARK FROM FLYING HOOFS

To protect the diamond of an eastern ball park from the flying hoofs of the mounts of western riders who recently took part in a rodeo, the entire field was

covered with a mat containing 100,000 feet of coco fiber. Scores of workmen were kept busy for days laying the heavy carpet, huge electric sewing machines stitching the pieces together as they were stretched on the ground. As it costs thousands of dollars to get a major-league diamond in playing condition, this precaution against injury to the sod was demanded before the management would allow the stadium to be used for the meet.

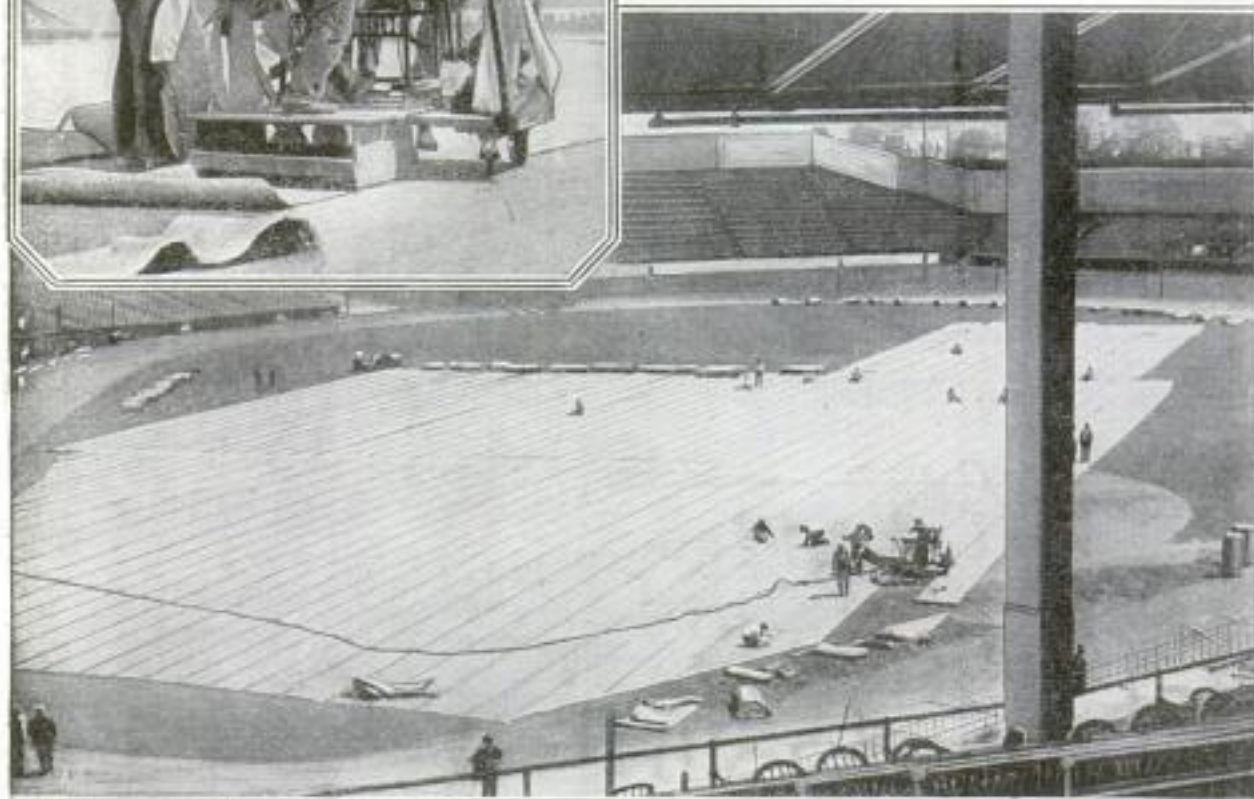

Stitching and Laying Great Coco-Fiber Carpet over Ball Park to Save Sod from the Hoofs of Horses During the Staging of a Western Rodeo

CHEESE WAS POPULAR TIDBIT AMONG EARLY PEOPLES

According to experts there are about 245 kinds of cheese made by as many different methods. One of the oldest forms of preserving milk as food, mention of it has been found among records dating back for centuries. The "belley" cheese, often referred to as "monk's head," is believed to have been first made by the monks of the canton of Berne, Switzerland, in the early part of the fifteenth century. "Brie," a cheese familiar to many in this country, has been made in France for hundreds of years. A curious fact surrounds the origin of "caciovallo," which means "horse cheese." For years no one could tell why it was so called,

but two explanations were recently offered. One is that it was first known in the region of Monte Cavallo; the other is that the imprint of a horse's head was stamped on each package as a trade-mark. "Isigny," supposed to be among the first American cheeses, was made about thirty years ago, while attempting to imitate the popular camembert. Another domestic brand, "jack," was known over a quarter of a century ago in California under the name of Monterey cheese. The green mold which appears in the aristocratic roquefort is produced by covering the whey with moldy bread crumbs when packing it for ripening in the caves where it gets its "age." In different parts of the world cheese is made from the milk of cows, goats, sheep, and horses.

Edw. J. ...
 The ... Washington ...

3424

3583
Times Picayune
9/9/23

POPULAR MECHANICS

SECRET RAY TO STOP PLANES
IS SEEN IN ACCIDENTS

That some secret means has been discovered for damaging airplanes in flight is the belief expressed by English scientists as the result of nearly 30 forced landings in central Europe recently. One theory is that wireless waves put the electrical parts of the machines out of action. Another is that rays are directed to vital points of the planes by reflectors, as it has been noticed that the accidents generally take place on clear days. In one instance, it is said, a pilot discovered a mysterious hole in the oil tank, and the solder on the piping had melted.

3520
MARATHON RUN OVER CRATER
OF OLD VOLCANO IN JAPAN

Testing the endurance of the stoutest contenders, a 25-mile marathon race held in Japan recently was run over the top of the volcanic mountain, Fujiyama. Beginning on one slope the course passed upward and across the old crater, from

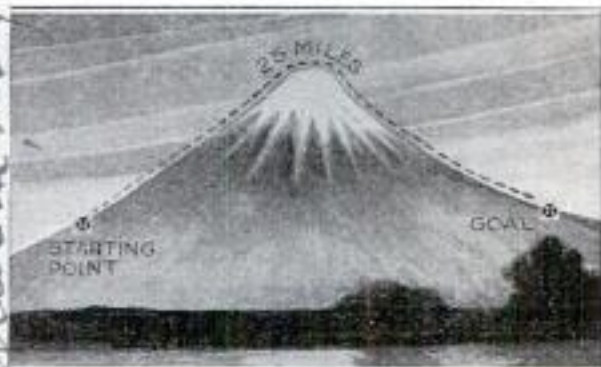

Course of Marathon Run, the Winner Covering the Distance in Four and a Half Hours

which steam still rises at times, and down the other side. As many difficulties were encountered in the descent to the goal as were experienced in climbing the first part of the way. Of 50 entrants, 25 failed to reach the "finish" marker at all. The winner covered the distance in slightly less than four and a half hours.

3586
FISH ARE USED FOR CANDLES

For lighting their dwellings in the long evenings of arctic winter, Siwash Indians are reported to use dried fish, called eulachons, shaped like smelts, which are so full of oil that, when dried, they burn nearly as well as sperm tapers. The natives also eat these fish and extract cooking oil from them.

Atlantic Photo
Berlin S.W. 1,
Königsplatz
930

3491
HORN TWICE SIZE OF PLAYER
—CARVED FROM TREE LIMB

In the Alps Mountains a horn 15 feet long, used to sound calls and signal blasts, has been carved from a single piece of



Crude Trumpet and Horn Carved from Tree Limb, Used by the Alpine Mountaineers

wood. It is said that it can be heard for miles through the valleys and gorges, and its echoes last for many minutes after it has been blown upon. Another instrument used by the Alpine mountaineer is a crude trumpet shaped somewhat like a flowerpot, which he sounds in the evening from a point of high ground. Its music is claimed to be a prayer that keeps illness and misfortune from the household of the herder.

3587
DROP IN RADIUM PRICE SEEN
AS RESULT OF DISCOVERY

What is described as probably the largest deposit of radium in the world is reported to have been found recently by an expedition to Russian Turkestan. As a result, in the opinion of scientists, the price of this precious metal may no longer be prohibitive and it may soon be a part of every hospital's equipment. The price dropped from \$110,000 to \$75,000 a gram last fall when it became known that extensive quantities of radium-bearing ores had been found in Belgian Kongo. Prior to that time most of it was extracted from corrotite ores in Colorado. Last July, it was estimated the world's supply was eight ounces, almost half of which had been manufactured in America from ore found in the West.

Only 7,000 shakata #10 welcome, by Tokyo, Japan
Only 7,000 shakata #10 welcome, by Tokyo, Japan
Only 7,000 shakata #10 welcome, by Tokyo, Japan

Times Picayune 9/9/23

Kansas City Star
9/8/23

Developed at Hay Fever
Clinic, to ensure Welfare

New York Times
9/8/23

932

POPULAR MECHANICS

HAY-FEVER CURE FROM WEED STARTS A NEW INDUSTRY

Following the discovery some time ago that a serum made from the pollen of certain plants was of benefit in relieving



COPYRIGHT, UNDERWOOD & UNDERWOOD

Collecting the Pollen of Ragweed Plants to Make Extract for Treatment of Hay-Fever Victims.

hay-fever victims, a new industry has grown up. Many persons now are employed in the cultivation of ragweed plants. These are covered by paper bags and when the pollen is shed, it is collected carefully and the extract made that is said to bring relief to the sufferers.

BRUSHES FOLDING INTO BACKS KEEP BRISTLES CLEAN

Brushes are being made with the bristles on loose bodies that can be reversed and folded into the backs to protect them against dust and damage. The handle and the case which forms the covering are in one piece. By raising one end of the brush, which is fastened to the frame by two pins sliding in grooves, it can be easily turned and replaced after using without detaching it

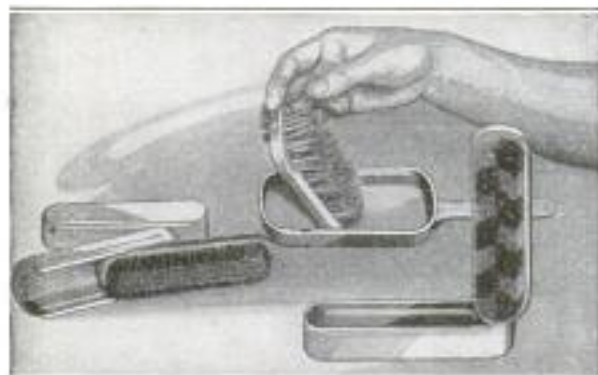

Toilet Brushes That Can Be Folded into Backs to Keep the Bristles Clean

from the case. The brushes are manufactured in several sizes for dressing-room and toilet purposes.

RELIGION AND CLIMATE CAUSE MARKET FOR RUBBERS

Religion as well as climate is responsible for the demand in Turkey and Persia for rubber overshoes, says a recent commercial report. Practices of the religious faiths require that the outer footgear be removed on entering a house of worship, and the rubber shoe replaces the heavy sandal or boot while the wearer is at prayer. Persians desire a lightweight rubber as their women folk wear them in place of slippers, preferring those lined with brightly colored felt. Palestine and Syria also come in for a share of the article. It is estimated that several hundred thousands of pairs were annually shipped to these countries prior to the Great War.

NONSPASH COLANDER CLEANS FRUIT WITHOUT SHAKING

Turning a stream of water to spray as it runs from a faucet through a cover, a colander being made thus prevents



splashing when cleaning fruits or vegetables. Guided by a funnel, the liquid strikes a perforated disk, which distributes it evenly over the contents, eliminating the necessity of handling, shaking, or tossing the foodstuffs to

rinse them. In addition, the kitchen device is adaptable to other uses, such as sterilizing small bottles, or for frying doughnuts and potatoes. Patents are pending on this utensil.

ICELANDERS TO OBTAIN POWER AND HEAT FROM GEYSERS

From a belt of geysers and hot springs within a mile of Reykjavik, the capital of Iceland, plans are being made to obtain water to heat the entire nation. According to preliminary outlines already prepared, the waters will be brought into the city in wooden pipes, connecting with all the buildings, thus eliminating, to a great

A H & J. G. all (Philadelphia)
1029 S. Athol St. Phila.
1107

3554
3545
Chicago
Mrs. G. W. Columbus
1107
Chicago
New York Times
9/8/23
Copyrighted material

Comd. George F. Paul
900 Ellsworth Bldg.
Chicago

60/123
933
Thiede & Linge A.-S. Bohnenkamp & Co. Bremen, Auf dem Bothenkamp 18
Germany.

extent, the use of coal for fuel. For many years, these gushers have been used by housewives as laundries and as a source of hot water. Bath and wash-houses surrounding the area are entirely heated from the steam supplied by nature.

A. S. Paul

RAILWAY TRACK MODEL SHOWS HOW TO AVOID WRECKS

3551

Railway track models mounted on long tables are being used in France to instruct signalmen and other employes how to solve many of the problems involving the safety of passengers. When not in use, the miniatures can be raised to the top of the cars in which they are transported about the country. All of the signals are in their regular positions on the stands and are operated by cord and lever control. On a single-track line, an electric arrangement makes it possible to announce with light and bell the approach of a train and to reproduce the

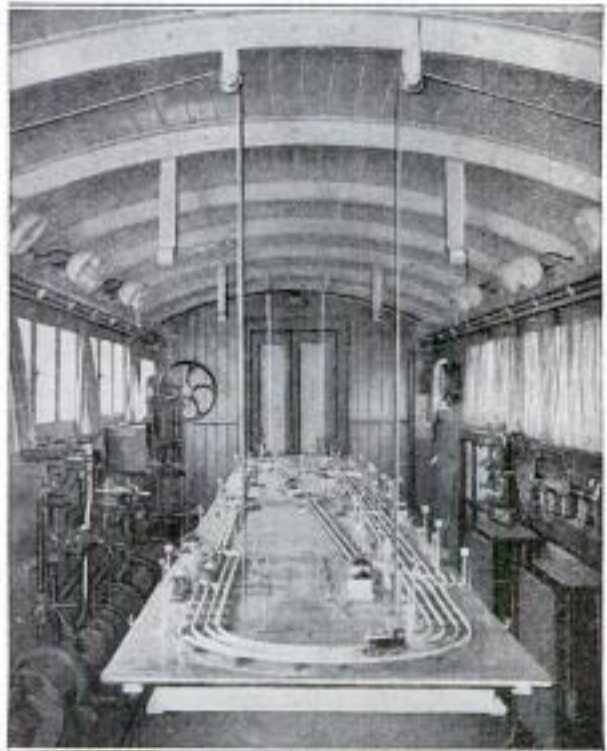

Model System of Railway Tracks and Signals Used in France to Instruct Trainmen

signals. Special training is given in protecting trains in case a warning fails to operate or of some service accident.

Within the last 20 years, from 1902 to 1922, the number of pupils enrolled in the public schools increased from 16,123,050 to 22,100,070, according to recent figures.

SCALE FOLDS AGAINST WALL WHEN NOT IN USE

3526

Folding up when not needed, a scale is being made in Europe that can be suspended from a hook in a wall, thus tak-



Folding Household Scales for Either Small or Large Packages Prevent Short Weights

ing up very little space. For use, its front beam is pulled down, its weights pushed back at each end, and the scale balanced by means of a screw. The heaviness of an object can then be determined by moving the numbered disks forward until the pan balances. It will accurately weigh articles up to 15 pounds. Bulky packages, such as fruit baskets and market bags, can be hung from a hook on the underside of the scale pan.

3599

STONE AGE ISLAND NATIVES PAINT SELVES YELLOW

Cut off from the outside world by walls of coral 300 feet high that form the shores of their island, natives of Rennell, one of the Solomon group, have advanced no higher in civilization than the Stone Age, according to a missionary who recently visited them. Possessing little iron, these islanders still use barbed wooden lances, and throw spears tipped with splints of human bone that break off in the wound. Good fighters and powerful wrestlers, they are peaceful despite their warlike appearance produced by yellow paint and tattooing. The only form of money is the teeth of flying foxes. In the interior of the island, once a gigantic atoll, there is a large lake connected to the sea only by fissures in the coral. The water is so salty that visitors cannot drink it, but the natives have become thoroughly accustomed to its taste.

New York Times
Copyrighted material
9/11/23

3/28

Prof. Wm. T. Learning French
1348 Essex Ave. Chicago



Hands Helping to Train Keen Brains

Toy Models Help to Solve Many Problems for the Engineer and Inventor

Miniature Ships, Airplanes, Motors, Houses, and Building Blocks
Are Found of Assistance in Visualizing Their Ideas

FIRST intended only to amuse children, toys, or miniatures, are now being used everywhere by engineers, architects, builders, and inventors to visualize their problems and to quickly test out their ideas.

So rapidly has the demand for these models increased that their construction has become a science in itself, resulting in the creation of a new industry that employs thousands of men throughout the country.

Realizing that the eye is many times quicker than the ear, schools also have turned to the use of what would have been considered mere playthings just a few years ago, in instructing both boys and girls.

In almost every branch of industry, models have proved of the greatest help. Just recently a noted automobile engineer, the head of a department employing a score of men, was found at his desk surrounded by bits of twisted paper, whittled sticks, shears, and glue pots.

"Building something for the children?" he was asked.

"Trying to solve this 'frame' problem," he answered, and went on to explain that the body of a motor car was the first part of the machine generally to wear out. "Squeaky doors and loosened panels are only a symptom—the result of a thing known as 'weave,'" he added.

Then he exhibited two pieces of heavy paper held parallel by four strips bent in the form of "L's"—like the bare frame of a car. Taking one side in each hand, he bent them back and forth. "That is what happens when a car goes over a

bump," he remarked, "and naturally the body can't stand the strain and loosens up."

Next he picked up a similar paper frame in which the sides were held together by round tubes of paper in the form of a letter "O." "Try to bend that," he said. This proved impossible without actually breaking it, and the engineer leaned back with a smile.

"It has taken us a good many years to think that out," he went on. "I could talk to you for a month on the many factors entering into the problem without making it clear, but by simply bending those bits of paper, you grasp it in an instant. It's a case of what the eye sees the mind believes.

"Eliminating all scientific formula, you realize that, while the amount of material in these two frames is equal, the change in design of the cross members from an 'L' form to the 'O' will eliminate a bending, or 'weave,' that cannot but be very destructive to the body of the car."

In Washington on almost any afternoon, a group of naval officers and engineers may be found gathered about a tank of water in one of the government buildings. Just above the surface, an electrically operated beam is towing several model boat hulls. In appearance, these little ships are similar to those with which children play in the parks. But this is serious business.

As the miniatures are pulled through the water, a scale registers the amount of pull, and from its readings, which indicate the amount of resistance that varies

With the Help of Their Hands, Students Being Trained Through Sense of Touch and Keeness of Vision to Solve Mechanical Problems

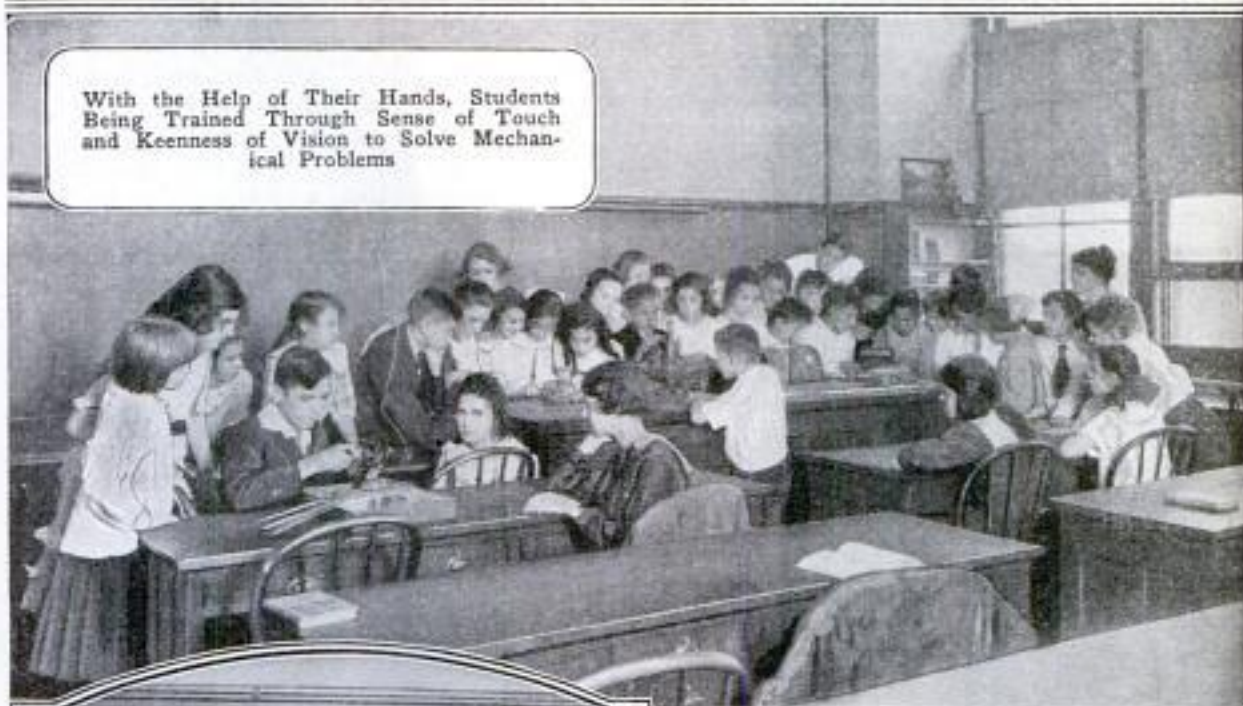

Turning Boys and Girls into Inventors by Stimulating Their Natural Curiosity

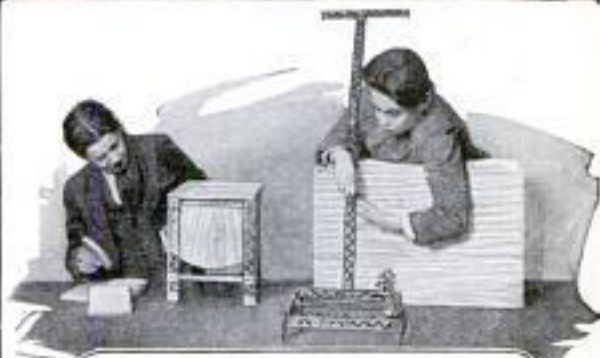

Working Models Give Insight into the Wonders of Science More Quickly than Textbooks

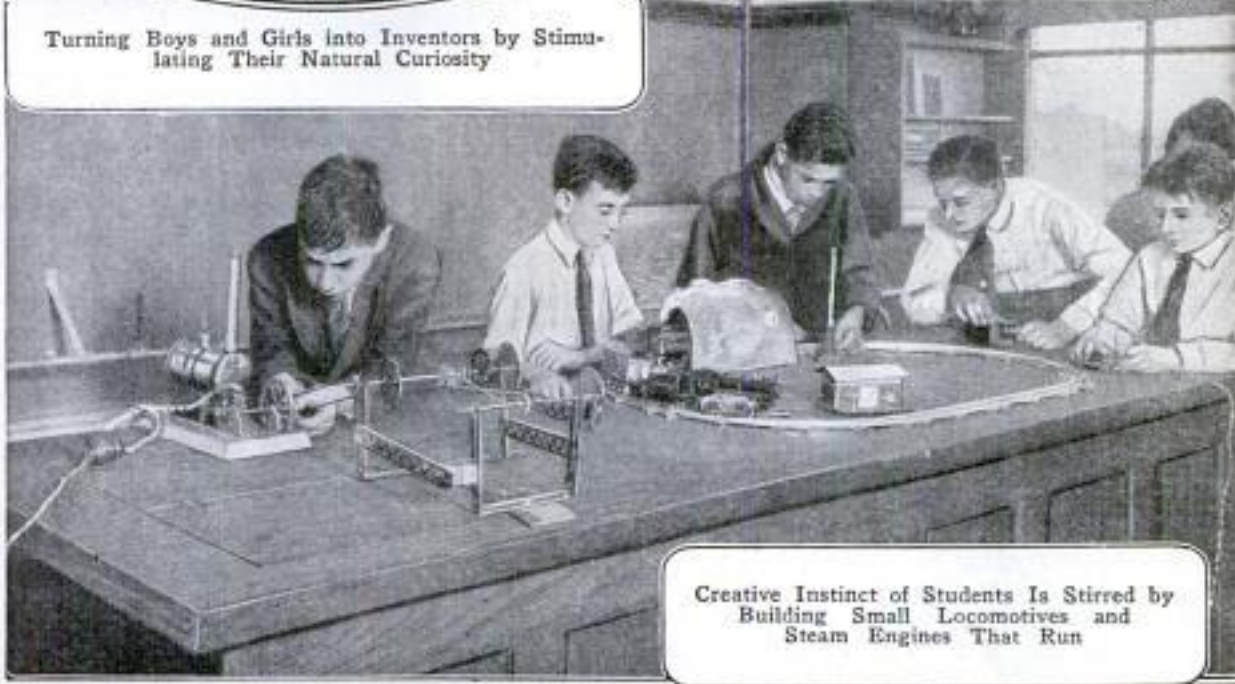

Creative Instinct of Students Is Stirred by Building Small Locomotives and Steam Engines That Run

with the lines, the proper shapes of Uncle Sam's warships are determined. Similar tests also are used by shipbuilding firms, and the model of today is often the great liner of tomorrow, every curve having been worked out during the experiments.

In another building, there is a great, horn-shaped instrument through which the air blows with cyclonic force. This is called a wind machine, and it is used in testing small airplanes. Without its aid in the study of wing positions, body shapes, and propeller designs, much of the progress recently made by aviation would have been impossible.

Another use to which the models have been put is in the selling of houses and machinery. Miniature bungalows, for instance, enable the home buyer to select the type best suited to his needs. Devices too heavy to carry, such as road-build-

programs have proved so successful. In one such classroom desks and tables are piled high with objects and exhibits. The "lesson" the teacher is "reviewing" is a windmill—and a homemade one, too. The textbooks are toys and mechanical contrivances the children have made themselves.

The science room in this school looks more like a laboratory than a schoolroom. It is equipped with long, black-topped tables. The walls are made into blackboards and the entire room is circled with a large gas pipe, from which burners project at every foot or two. Overhead is a perfect network of wires, with a score or more electric drops equipped with two or three-way sockets.

One end of the room is packed with tables and huge desks—all covered with various mechanical and electrical appara-

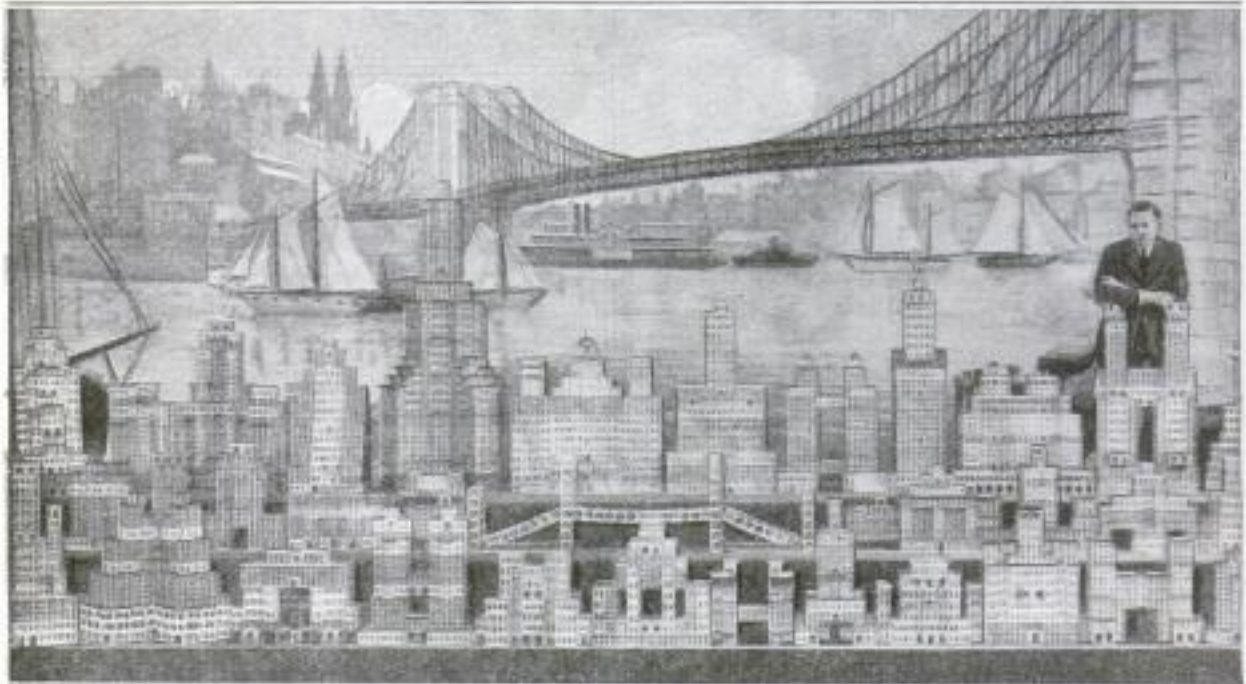

Copyright, Underwood & Underwood
Toys Built for Children Are Found Useful by Architects to Assist Them in Their Work and to Visualize Their Problems in the Construction of Skyscrapers

ing machines, may be reduced to the size of toys for the convenience of traveling salesmen. Blocks used by children have proved of the greatest help to architects in enabling them to visualize their designs and to study the effect of a finished structure.

One of America's greatest railway systems schools its employes in train dispatching and signal engineering through the use of toy electric trains. Working with the hands has been found to refresh the brain and to teach it to function systematically. That is why manual training and summer schools with physical

tus. Prominent among them is a table given over to steam engines, superintended at this moment by a girl with a very businesslike air. Four boys are working under her directions. Their problem, it seems, is to furnish power from three small steam engines to operate a perfect maze of mechanical contrivances on the next table.

"That class," said the teacher indicating the two tables and the dozen children watching the workers at them, is lost in the intricacies of traction. They have been experimenting with a caterpillar tank, and now they are at the steam engines.

Inventor and maker unknown.

*Emt. Edwin J. Farris
The Farragut
Washington, D.C.*

POPULAR MECHANICS

*Emt. J. Berenson
The Majestic Bldg
Chicago 937*

IRON FINGERS CRACK WALNUTS TOO SMALL FOR MARKET *3602*

Machines that can crack five tons of nuts in a day and keep 50 girls busy separating the meats from the shells are in operation in the West. Grading of English walnuts is no longer done by hand, but is performed by a vacuum device that picks the culls from the high-grade ones as they are carried along on an endless sieve belt. In another apparatus, the small nuts are cracked by a series of iron fingers on a cylinder so arranged that the shells are broken without injury to the meats. Still another contrivance salvages bits of nut-meats that are missed by the sorters. This little gleaner, it is claimed, saves \$50 a day.

Acad.

WINDOW LOCK LETS IN AIR BUT BARS OUT THIEF *3493*

Gripping a window casing with its corrugated jaws, a combination lock and sash holder, that operates automatically is being made to hold an open or shut window securely in place. Fastened to the outer edge of the frame, the device keeps the sash from rattling or falling and breaking the glass. A slight pressure upon two levers releases its grip, and it is sturdy

enough to sustain a large window and to foil a burglar.

HAND CRANK ON CORN POPPER DOES AWAY WITH SHAKING *3567*

Popping corn by turning a crank instead of shaking the kernels over a fire is made possible by a recent utensil for household use. The handle attached to the cover of a pan has two wings at the bottom which keep the contents in constant motion and so prevent burning. It is claimed that the device requires little heat and will pop corn on gas, kerosene, or wood stoves.



OIL BOOM IN WEST RECALLS MEMORY OF GOLD RUSH *3564*

Memories of the "days of '49" are recalled by the oil boom in southern California. With the opening of new fields,

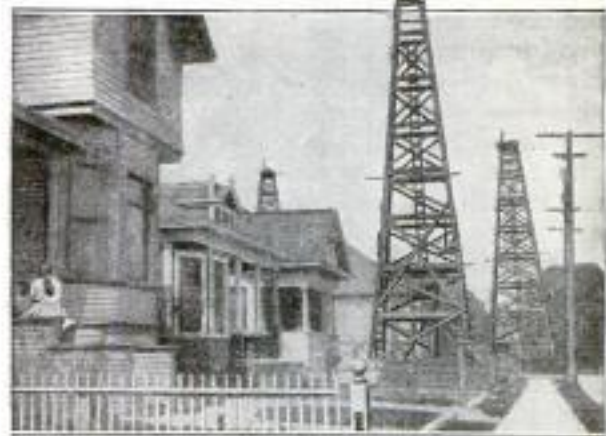

COPYRIGHT, KEYSTONE VIEW CO., INC.

Oil-Well Derricks in Front Yards Are One Result of Big Rush in Town of Southern California

and the bringing in of "gushers," work goes feverishly on night and day. Fortunes are won and lost between sunrise and dark. In several towns, the drillers have even invaded the residential sections and the sight of ugly derricks in front yards is not uncommon.

63 In Engine
TWO-MAN FIRE FIGHTER RUN BY SMALL GAS MOTOR

For fighting fires in rural districts, a small, motor-driven pumping apparatus has been made which can be attached to

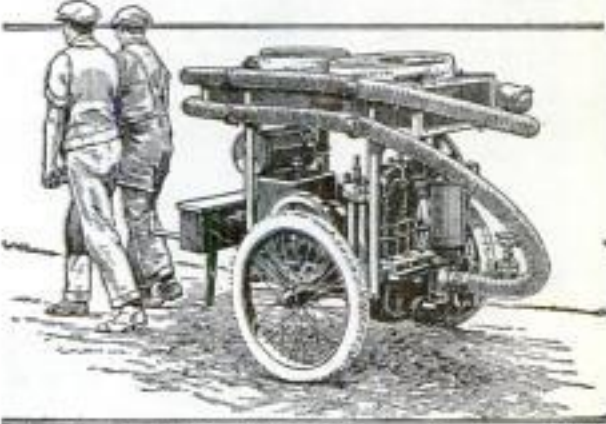

Fire Engine for Use in Small Towns, the Pump Being Operated by a Gasoline Motor

an automobile, motorcycle, or drawn by two men. It consists of a gas engine, pump, and hose mounted on two wheels. In operation, such an outfit will supply sufficient water for a one-half-inch fire nozzle under high pressure. Water may be drawn from any lake, creek, or well.

*Hart Sash Holder Co.,
Cincinnati, Mo.*

*Schramm, d.m.,
West Chester, Pa.*

*J. S. Keeze Machine Co.,
1029 S. Wabash - Chicago*

Chas. H. W. Broadbent,
Esro Farm Plantation,
 938 POPULAR MECHANICS
 74 *in* *Lihue, Kauai, I. H.*
 SUGAR-CANE PLANTER CUTS LABOR COSTS

Necessity is ever the mother of invention. It was the lean years in the sugar industry following the boom in 1920 that caused some of those responsible for sugar production in Hawaii to develop a planting machine that is being used with signal success.

The machine is still capable of much improvement, but even now it can plant 750 bags of seed in

nine hours, using only five men, where 30 men were formerly required. As it travels over the field, it opens two furrows, into

which the seed is dropped; a breaker plow attached to the rear opens up a large furrow between the rows for irrigation, and, at the same time, the seed is covered and the ground leveled.

The machine can also be used for planting potatoes.



Rear View of Cane-Planting Machine, Showing Seed in Furrows, and Breaker Plow

GEAR-SHAPER CUTTER GENERATES THREADS *76 m*

The application of the gear-shaper cutter to the generating of gear teeth, both of the plain spur and helical types, is now well known. A recent development, which is known as a thread generator,

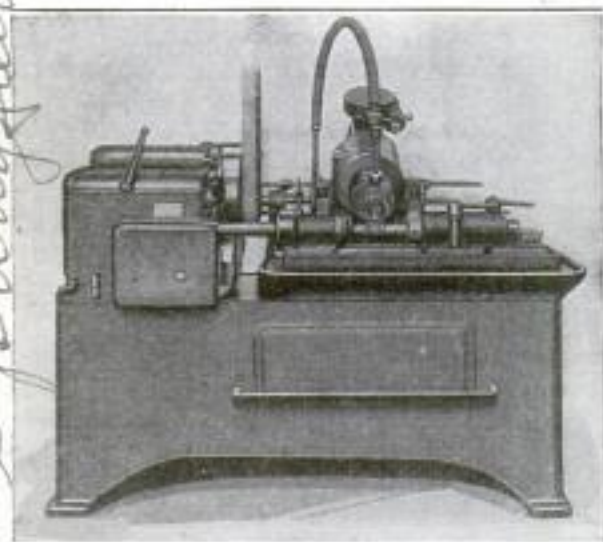

Generator for Producing Accurate Threads Such as Used on Taps and Worms

has still further increased the scope of this efficient tool, and it is now possible, by means of this cutter, to produce accurately generated thread shapes such as those used on taps and worms.

The thread generator has been so designed that modifications in work-holding fixtures as well as cutter heads enable it to handle a large variety of work. The

standard machine has a capacity of 12 inches maximum length of thread; 18 inches maximum center distance; 4 inches outside diameter; $\frac{5}{8}$ inch linear pitch; 23° helix angle, and $14\frac{1}{2}^\circ$ pressure angle.

When provided with standard equipment it will cut single, double, triple, and quadruple threads of from $\frac{1}{4}$ -inch linear pitch to $\frac{5}{8}$ -inch linear pitch, inclusive. By the use of special gearing in the cutter head, single-lead threads from $\frac{1}{20}$ -inch to $\frac{1}{4}$ -inch linear pitch may also be cut.

COMPACT FLEXIBLE COUPLING IS DURABLE AND QUIET *77*

Steel-faced leather liners cushion all shocks in a recently produced flexible coupling, and render it noiseless. The transmission element is a three-part housing "cinched" onto the coupling teeth, inclosing them in a grease-tight and dustproof pocket. The steel-faced liners engage the teeth, and, owing to the centrifugal force present when the shafts



are revolving, are kept well lubricated with the grease in the pocket. The flexibility of the coupling is obtained partly through the leather lining and partly by the ability of the housing to expand.

Fellows Gear Shaper Co., Springfield, Vt.

Chas. H. Clark
60 Island St. New York

Frederick A. Wagner Co., Inc.
381 St. Paul St.

POPULAR MECHANICS

**CENTER DRILL AND REAMER
HAS INSERTED BLADE** 66 m

Combining drill and center reamer in one, a centering tool for large shafts has recently made its appearance. The body or holder is made of mild steel, case-hardened, and the removable blade is of



tungsten steel. Only four sizes of blades are necessary to center shafts from 5/8 to 10 in. in diameter, and it is expected that the blades can be produced for the same cost as the drill used in the first operation at present. On large work three operations are usually necessary—drilling, reaming, and countersinking; with the new tool, these operations are done at once. The blade is located in the holder by two 30° beveled edges at the bottom and securely clamped by a hardened binding screw, insuring the perfect centering of the blade in the toolholder body.

**COMBINATION SQUARE HAS
UNUSUAL FEATURES** 44 m

Several interesting features are incorporated in a combination tool for machinists invented by an Omaha man. It

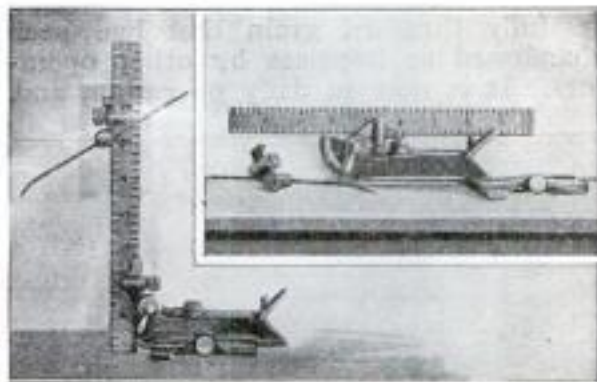

Left, Combination Tool in Use as Surface Gauge; Insert, Tool with Blade Folded

is fitted with the grooved sliding scale common in combination squares, but the head is pivoted on a graduated quadrant, so that it can be used as a protractor as well as a square. When the blade is folded against the head on one side, the V-end of the head is bisected by the blade, thus forming a center square for round stock. With the aid of a readily detachable base and an adjustable scribe, the tool is converted into a surface gauge capable of fine adjustment. Many laying-out operations can be shortened by the aid of this tool.

**MOTOR-DRIVEN SPADER
REPLACES PLOW** 60 m

A machine which, it is claimed, will do the work of five plows at once, has been perfected by a middle-western inventor,



A Motor-Driven Spading Machine That Will Do the Work of Five Plows

and was recently demonstrated at the Milwaukee County, Wis., agricultural grounds.

The implement consists of a number of forks attached to the rear of a tractor, and it spades, breaks, and pulverizes the land in the same fashion as the hand and foot-operated spade. The same tractor can pull a seeder attached to the motor spader, thus turning the soil and planting the crop at the same time.

**WISE PUNCH HAS POWERFUL
LEVERAGE** 57 m

While simple in design, and light in weight, a recently patented portable punch is capable of piercing 3/4-inch steel. The principle employed is that of the toggle lever, operated by simple gearing, and the design is such that the power applied is constantly increased as the punch is forced through the metal. The punch can be lowered or raised quickly without moving the gears, which are thus employed only when actually punching. The complete tool weighs only 65 pounds.

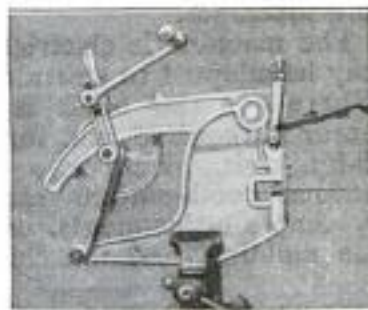

A measuring tape made of rustless steel has just been placed on the market.

Mrs. A. Kessler, 1514 Bryant St., New York
 E. E. Horn, Elm. Wis.
 W. A. Watasa, Wis.

E. Ahrlé, 1409 Jackson St.,
Omaha, Nebr.

Wielbeck-Hilger
Ltd., 106 Lafayette
New York

Allen Cunningham Inc. Out of business
 Machine Works
 940
 Seattle, Wash.
POPULAR MECHANICS

title

STONE-CUTTING MACHINE
EFFECTS ECONOMY 5/22

All work that can be done in lumber with a circular saw, channeling, tapering, recessing, and cutting at any angle, are some of the claims advanced for a new stone-cutting machine perfected by a western inventor. In addition, it is said

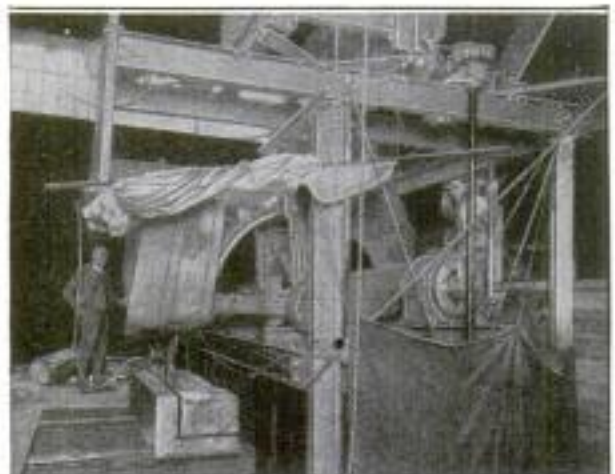

Cutting a Corner Block on a New Stone-Cutting Machine: Note the Accuracy of the Cuts

that 75 per cent of the hard work of preparing stone, and the usual loss of 30 per cent of stock are eliminated, and that the use of this machine permits the shop to be kept dustless, and sanitary.

A machine of this type has made remarkably low records for the cost of stone cutting, turning out the product at a cost of 10 cents per surface foot. In granite, the new machine, with one saw, cuts a total of 224 surface feet per day of 7 hours, with two men, thus equaling the work of five pneumatic surface-cutting machines.

The machine is electrically driven, but may be adapted to steam or water power. Where one saw blade is used, a 25-hp. motor is required, and for three blades a 75-hp. unit. With two or three saws, various combinations may be obtained by simple adjustments, one saw cutting, one molding, and the third grinding.

EXPERIMENTAL WORK AIDED BY LABORATORY STILL 1922

Many operations that are quite simple in the laboratory are found impracticable to carry out on a commercial scale, and, in many cases, mass operation materially affects the results obtained in industrial chemical processes. It is desirable, therefore, when investigating a new process, or experimenting with a view to modify

an old one, to use apparatus that will handle a larger quantity of material than the test tube or retort.

This is the purpose of a laboratory still recently placed on the market in England, which, with the aid of a few attachments, may be used for practically any distillation process now employed commercially. It is designed for working pressures up to 60 pounds per square inch, and is provided with a thermometer, pressure gauge, safety valve, and filler; it may also be fitted with a mechanical stirring device. The actual capacity of the still is 15 gallons, and it is thus not only adapted to research work, but may be used by manufacturers requiring but a small quantity of a particular product.

CENTRIFUGAL THRESHER
LATEST FOR FARMER 5/22

Centrifugal force is the principle utilized in the design of a new threshing machine, which, it is claimed, is lower in first cost and has less working parts than other threshers. In addition to these advantages, it is stated that the machine will thresh wet, damp, and sprouted grain, which cannot be handled with other machines, and that there is practically no cracking of grain or seeds. In a recent demonstration, the machine successfully threshed grain that had been abandoned as hopeless by other operators. It is now in daily operation, and,

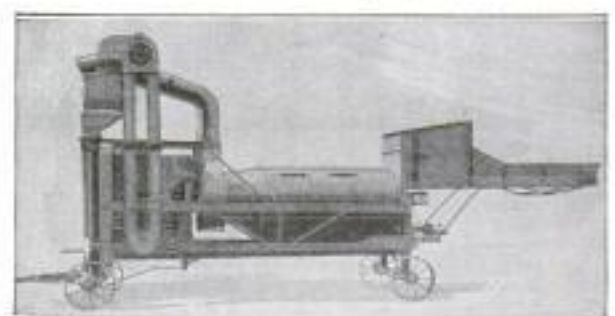

A Thresher That Operates on a Principle New in Threshing Machines

while working at only half its capacity, is capable of threshing 1,000 bu. of good wheat per day. A governor on the machine prevents it from operating except when it is running at the proper speed to do good work.

Almost any farm tractor will operate the machine, and it can be pulled through the field alongside of a header, and be operated by power from the tractor, thus eliminating the weight and expense of an extra engine.

And. H. J. Strong
 Wichita, Kans

John G. Hall
 1425 N. 51st St. Seattle Wash.

W. J. Fraser & Co. Ltd.
 Slagenham, Essex

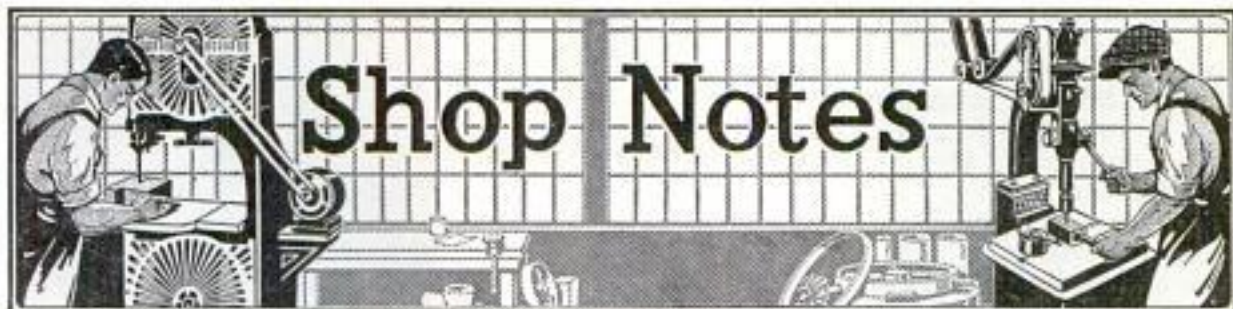

All Shop Notes published in 1922, in book form—Fifty Cents—from our Book Department.

Making a Bench Hacksaw

By J. V. ROMIG

THE bench hacksaw described in this article will prove a valuable addition to the small workshop; it is easily built from material obtainable everywhere, and the design is such that very little machine work is necessary.

The base is a piece of wrought-iron or steel plate, drilled and tapped for the

tened to a piece of cold-rolled steel with round-head screws, as shown, and spaced away from it with $\frac{1}{2}$ -in. washers or collars. This machine-steel slide works in a bearing arrangement made from angle brackets of brass screwed to a machine-steel bar, and this, in turn, is screwed to vertical slide members, made of flat stock,

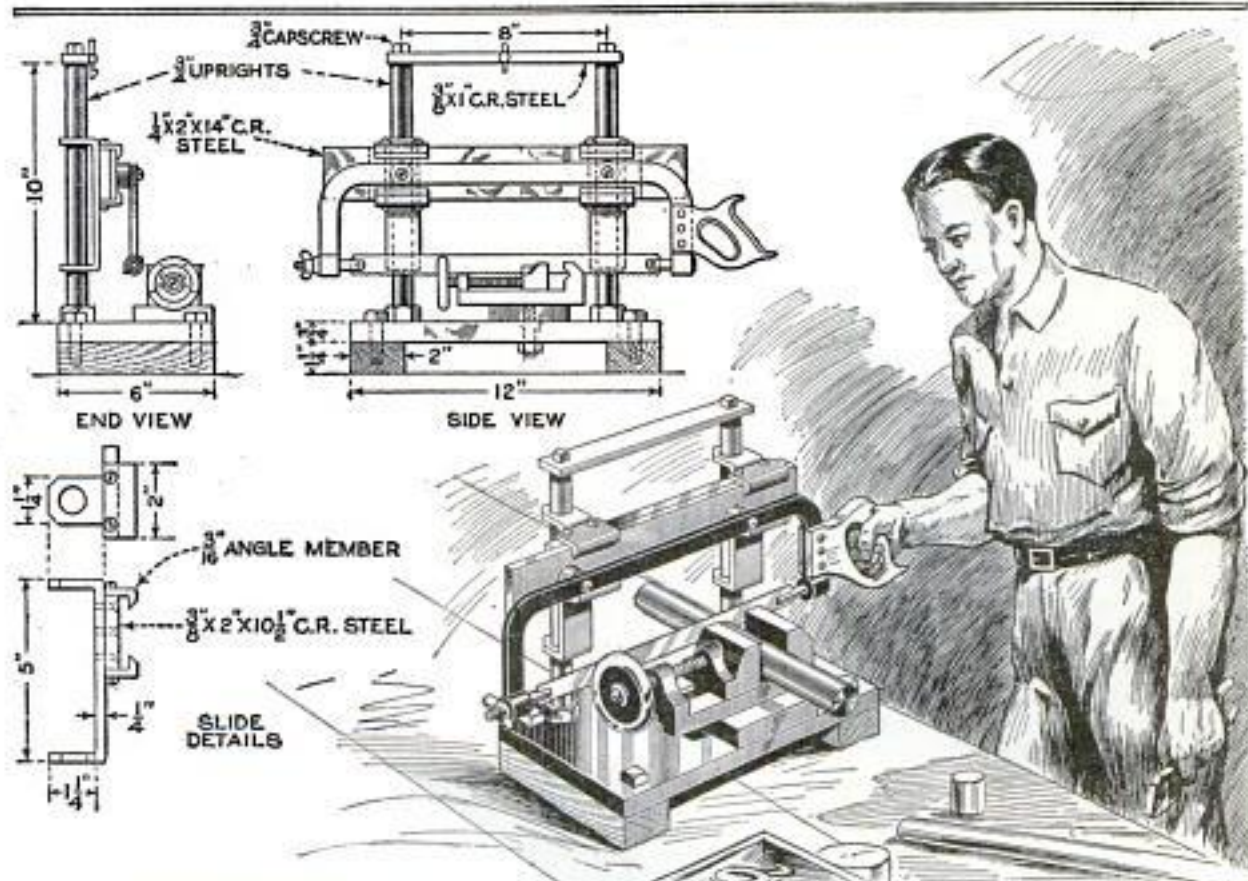

An Easily Made Bench Hacksaw That Will Prove Invaluable in the Small Workshop: No Castings Are Used and Little Machine Work Is Necessary

$\frac{3}{4}$ -in. standards, drilled for holding-down bolts, and slotted for the vise bolts. The standards are $\frac{3}{4}$ -in. cold-rolled steel, threaded at one end, and drilled and tapped for capscrews at the other.

The saw, which should be of the heaviest hand pattern obtainable, is fas-

bent, and drilled and reamed to fit the standards. They must be perfectly square with the standards, and should be a close, but free fit.

To the top of the standards is screwed a piece of flat stock, to stiffen them and hold them rigid. A latch is attached to

this bar, hooking over a pin on the back of the slide, to hold the saw in its highest position while the stock is placed in the vise for sawing. By mounting the base above the bench on two pieces of wood, the vise nut and nuts for clamp bolts are easily turned. The vise can be removed and work clamped to the base, when necessary.

A wooden handle of the carpenter's-

Centering Drill Rod Accurately

When machinists or toolmakers are required to make taps, reamers, counterbores, or similar tools out of drill rod, the centering must be done accurately.

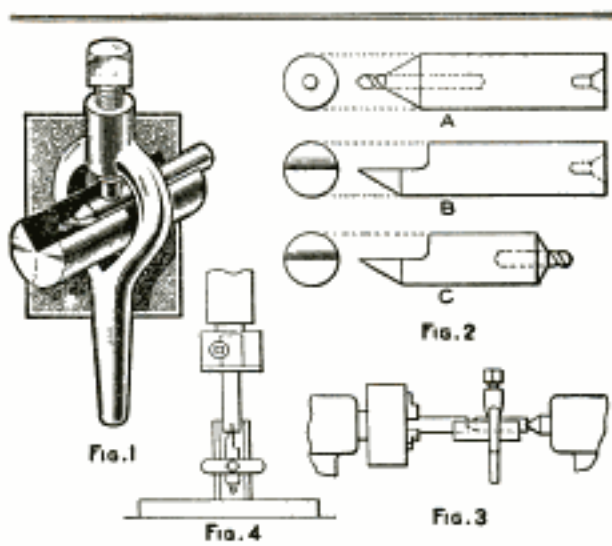

Simple Centering Tool for Use in Making Taps, Reamers, Counterbores, Etc., of Drill Rod

The simple toolholder illustrated has been found to give very good results. It consists of a round block, made from a length of steel rod, grooved as shown, finished smooth with a file or by grinding, casehardened, and used with the centering tools shown in Fig. 2.

The tools shown in details A and B of Fig. 2 are used when the centering is done on the lathe, tool A being used to drill the center hole and tool B to countersink it. Tool C is used on the drill press; it gives better results than the other tools in regard to speed, as there is no changing of centering tool, the block being turned upside down for countersinking. The length of this tool must be at least $\frac{3}{8}$ or $\frac{1}{2}$ in. shorter than the block, and its shank diameter the same as the diameter of the work. Tool A need not be shorter than the block, but its diameter must also be the same as the rod to be centered. The tool B should

saw type should be used on the hacksaw, as it will not tire the hand as the round type does.

The vise is of the type used on small drill presses, and can be purchased from the makers of such machines.

Much better and quicker work can be done with a tool of this type than with a handsaw, and blade breakage is greatly reduced.

be made from .005 to .02 in. smaller than the work, to allow a certain amount of pressure against the sides of the groove in the block. Fig. 1 shows one of the tools in position in the block, held in place by means of a lathe dog. Care should be taken that there are no burrs on the rod ends when centering, otherwise the work will not be true. Figs. 3 and 4 show the tool in position for use on a lathe and drill press.

Convenient Punch and Chisel Set

A variable-sized punch and chisel set takes up very little space in the tool kit and is much lighter in weight than a whole set of solid tools. It can readily be made by any mechanic. The holder

consists of two pieces, the handle and the tightening sleeve, which screws on the slitted end of the handle as shown, to clamp the tools in the holder. The handle is knurled to facilitate holding it, particularly when using small

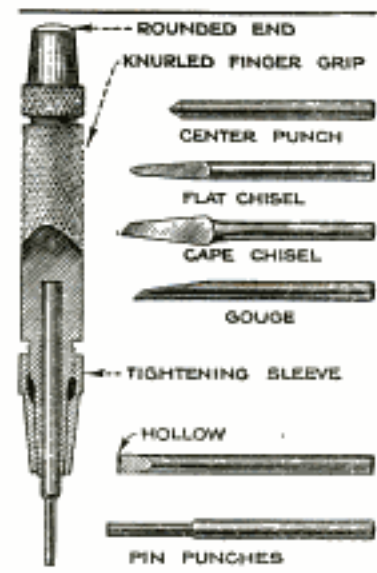

chisels in confined places and corners. As many separate tools can be made as desired, to suit the needs of the user. The pin punches are made of various diameters at the nose, each just a little smaller than the pin it is to drive. All points or working faces should be hollow or concave, which will prevent the spreading of the pin, due to upsetting. Center punches, pin punches, chisels, and gouges are made out of tool steel or drill

rod forged to shape, and ground after hardening and drawing the temper. The tools used for driving purposes should be made of tool steel, carefully hardened, and drawn to a dark-brown or purple color, which makes them tough, and lessens the danger of breaking them.

Safety Cut in Studs and Bolts

Studs and bolts used for attaching cylinder heads and plates on engines are frequently twisted off and the break often

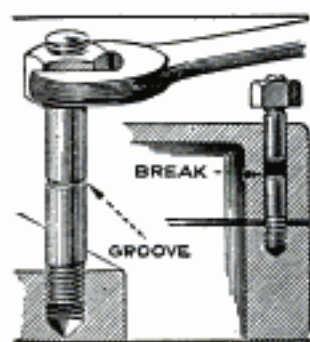

occurs inside of the hole, which makes it a difficult matter to remove the broken piece. This, however, can be prevented by making a V-cut, slightly deeper than the thread, around the stud or bolt above the surface, so

that, if it breaks at all, it will break off at the groove, and can then be easily removed with a small pipe wrench.

Machining Angle Plates on the Lathe

The machining of angle plates is usually done on the shaper or planer, but it can also be done on the lathe, when the former machines are not available. The angle plate is swung between the lathe centers as shown in the illustration, and it is then an easy matter to finish the faces. After the faces are finished, and have been tested for squareness, the sides are finished by mounting the angle plate with one edge against the faceplate, using washers or pieces of tin under each corner to true the plate perfectly square with the faceplate. The angle plate is then attached to the faceplate by clamps, resting on the brace.

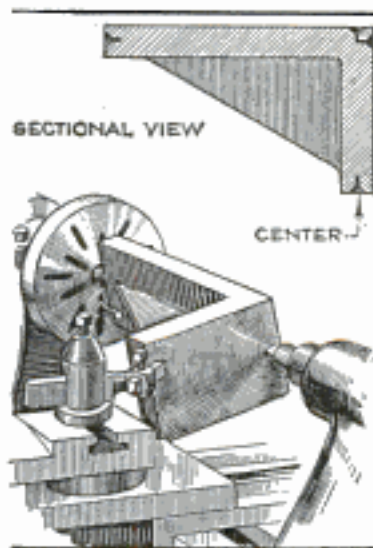

Holder for Drafting Scale and Triangles

The holder for drafting scale and triangles, shown in the illustration, was designed to meet conditions in a drafting room of a technical school, where

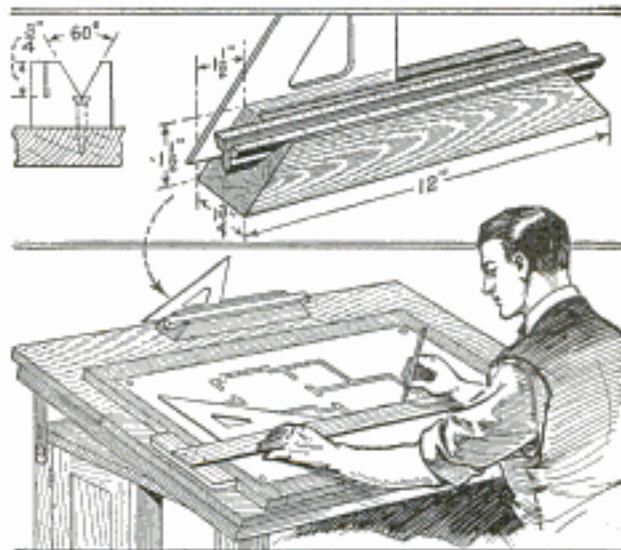

Holder for Drafting Scale and Triangles in a School-room Prevents "Losing" or Exchanging Them

four classes used the same instruments alternately. The holder eliminates the necessity of returning the rules and triangles to the instructor at the end of each class period, as these articles can be easily seen on the desks and checked up. Any interchanging of triangles between desks is prevented by stamping the desk number on each. The upper detail shows the size and shape of the holder, and the drawing below shows how it is mounted on the desk.—E. G. Asku, Sarnia, Can.

Mirror for Ironing Machine

On some types of ironing machines the work cannot be seen when it passes between the rollers, and the result is that it often comes out wrinkled. This trouble can be prevented by mounting a mirror on the frame of the machine as shown in the drawing, to enable the operator to look between the rollers. In case the work becomes doubled up or twisted, the machine is promptly shut off and reversed.

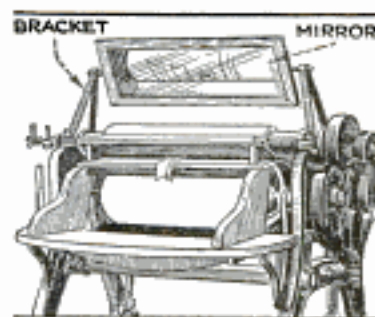

Storing Extension Lamp

An extension lamp with a 25-ft. cord is a very serviceable accessory for any motorist, but difficulty is usually en-

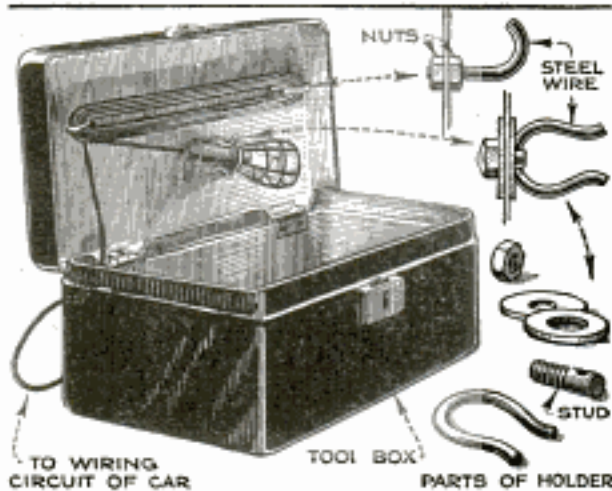

Auto Extension Lamp Conveniently Stored under the Tool-Box Lid to Avoid Damage from Tools

countered in handling the cord. Frequently it is placed in the tool box, but the objection to this, aside from the danger of tools cutting the cord, is that the tools must be removed when the cord is needed.

A much better place to store the cord is under the lid of the tool box, as shown in the drawing. The cord is wound on two hooks made from $\frac{1}{4}$ -in. rod, and the lamp is held by a spring holder, shown in the upper details. The cord is led through a hole drilled in the side of the box and is permanently connected with the wiring circuit of the car, so that the lamp is ready for use at all times.

Repairing a Cracked Jig

In repairing a cracked drill jig for a large marine-motor crankcase, it was found impossible to use clamps to pull it together and therefore the repair was ac-

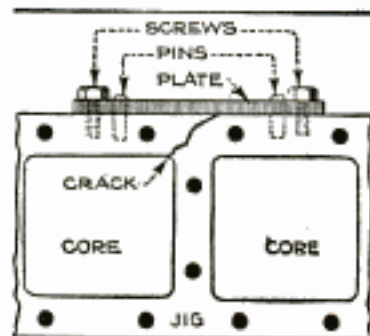

After obtaining a piece of cold-rolled steel, $\frac{3}{8}$ -in. thick, just as wide as the jig

the repair was accomplished in the following way: The crack was first cleaned thoroughly, which was done by flooding it with gasoline and blowing it out with compressed air.

was thick, and about 10 in. long, two screw holes were drilled near the ends and just inside of them two dowel-pin holes as shown. The surface of the jig was laid off and drilled to correspond, allowing $\frac{1}{16}$ in. additional space between the holes to allow for the crack. Holes were then drilled and tapped in the jig to correspond to the screw holes in the plate. The plate was heated until it had expanded so that its holes were directly in line with the holes in the jig, and the pins and screws then driven in. As the plate cooled, its shrinkage closed the crack so tightly that it could hardly be seen.

Preventing Waste of Compressed Air

In shops using compressed air to clean machinery, dies and molds, or manufactured articles, there is always a great tendency to waste the air. The $\frac{1}{16}$ -in. or $\frac{1}{8}$ -in. hole in the nozzle of the air "gun" looks too small to the average workman; he therefore tries to improve it by reaming it out to a larger size, and this, of course, allows a greater volume of air to escape. In a large eastern plant this

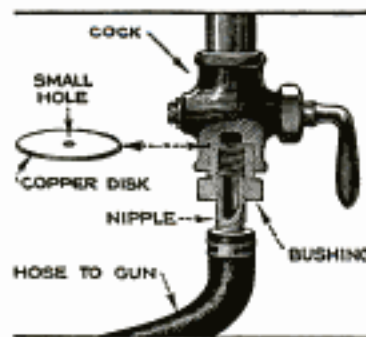

practice became very annoying and made it nearly impossible to keep up the air pressure, so that it was necessary to take preventive measures. All air pipes

to machines and benches were of $\frac{3}{8}$ -in. pipe, terminating in a regulation $\frac{3}{8}$ -in. cock, bushed down to $\frac{1}{8}$ in. A thin copper disk, with a $\frac{1}{16}$ -in. hole, drilled in the center, was placed between the bushing and the cock, at the bottom of the thread, as shown in the drawing. At 80 lb. pressure the plate allowed just enough air to pass to work the air gun properly. For the $\frac{1}{8}$ -in. size of gun, the disk is drilled with a $\frac{1}{8}$ -in. hole.

Another practice among a certain class of workmen is to blow their clothes with the compressed air, which is not only wasteful, but dangerous, as air at high pressure entering any openings of the body is liable to cause severe injuries. Furthermore, the dust on the clothes is not blown off but is blown through the clothes to the skin, defeating the very purpose of using the air.—A. S. Jamieson, Springfield, Mass.

Removing Paint from Tile

Spots and splashes of paint on tiled floors present a very unsightly effect and should therefore be removed. This can readily be done by washing with a solution of caustic soda, which will remove the paint without the necessity of using an after wash of acid to destroy the effects of the alkali, plain water only being required. If the tile is likely to stain with the soda, a rinse of diluted ammonia will remove the spots, and the ammonia can then be washed off with clean water.

Breaking Off Iron Plate

A favorite method of separating a piece of iron plate from the main stock is to chip a groove along a line drawn to the required shape, and afterward to break the piece off by wrenching it or striking it with a hammer. This, however, often results in bending the piece, which makes it necessary to flatten it out again before it can be used.

In one shop where a great deal of this kind of work was done, the method shown in the illustration was found to be very convenient and to save considerable time,

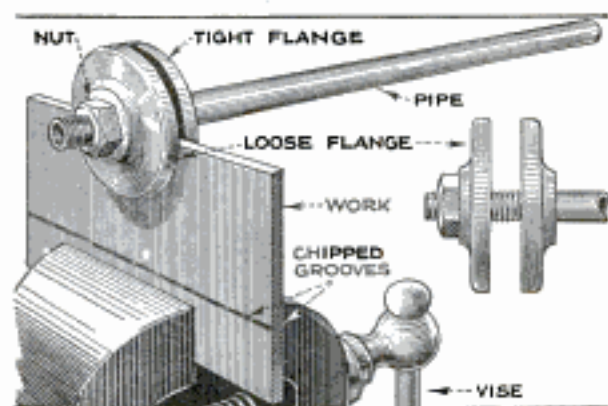

A Handy and Time-Saving Tool for Breaking Off Pieces of Iron Plate without Bending Them

as with it, plates could be broken off without bending. The tool consists of a length of iron pipe threaded at one end, two pipe flanges, and a nut. One flange is screwed on the threaded end until it is tight, and the other is screwed on until the work is gripped fairly closely, the nut then being used to lock it. With the plate securely gripped in the vise, pressure is applied to the handle as the tool is rolled along the edge of the plate.

☐ In making drawings, do not dimension from the rough edge of a casting, but from a finished surface.

Holder for Filling Coal Bags

In the larger cities where the houses are so close together that a coal chute cannot be used to discharge the coal



A Handy Stand That Saves Considerable Time When Filling Coal Bags

from the wagon into the basement, it is common practice to use heavy canvas bags, which are filled at the coal yards. To facilitate the work of filling the bags the holder shown in the illustration was devised. It is made of heavy lumber and has hooks under the chute to hold the bag while it is being filled.—E. M. Scott, Chicago, Ill.

Using a Broken Bit

An auger or bit with a broken or badly damaged screw is usually discarded; it can be made serviceable, however, in a very simple manner.

A short piece of tubing, equal in diameter to a smaller bit, is slipped over the broken or damaged screw point as shown, and filled with solder, any openings between the bottom of the tube and the bit being

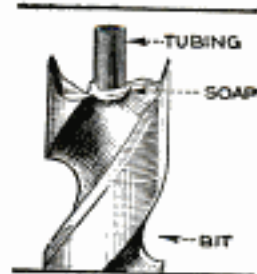

first filled with laundry soap. To use the tool, a hole is first drilled with the small bit the size of the tube, then the larger one can be used in the usual manner, without danger of running off, as the tube forms an excellent guide.

Casey Township High School -
Walter A. Newlin, Agriculture Teacher,
Keosauqua, Iowa.

Making a Clover-Seed Huller and Scarifier

James,
dava

BY IRA D. MULLINAX



HE machine for hulling and scarifying sweet-clover seed described in this article was made by the boys in an Illinois High School. The machine was designed by the farm crops and agricultural engineering sections of Iowa State College, patented, and given to the people, so that anyone is at liberty to make and use it. It is in use by seed companies and farmers for scratching the seed coats of clovers and alfalfa so that the seeds may absorb moisture readily, thereby increasing greatly the prospects of obtaining a good "stand" from costly seed.

The machine may be built at home by any farmer possessing a kit of carpenter's tools, and who has average skill in their use. Most of the material needed for constructing the huller may be obtained from the local lumber and hardware dealers, as may be seen from the bill of material at the end of the article. The machine shown in the photograph measures approximately 5 ft. long, 2 ft. wide, and 4 ft. high, but the relative dimensions may be varied to a considerable extent without impairing the efficiency of the machine.

The sweet-clover seed is poured into the feed hopper and runs downward through a gate into a chute leading into the open side of a blast fan. The fan is driven by a 1/4-hp. electric motor, although it can be belted to a countershaft mounted on the end of the huller, and driven by a gasoline engine or tractor, if necessary. The outlet of the fan is connected to the scarifying chamber or tube. The inner surface of the outer side of this tube is covered, from the point marked A, in the side view, to B, with emery cloth, sandpaper, or garnet paper.

The garnet paper, or whatever abrasive

is used, should not extend below point B, as it is not desirable that the seeds be thrown directly against this surface. As the seeds are delivered into the fan casing by the feed chute they are struck sharply and forcibly by the fan blades. They are then carried by the strong air-blast from the fan out through the throat and thrown against the hard, smooth surface of the lower end of the scarifying tube, and thence upward. When passing from B to A, the seeds are held in close contact with the rough surface of the garnet paper, and their hard coats are cracked, punctured, scratched, and otherwise softened, making it possible for them to absorb the ground moisture readily.

The seeds are delivered by the upper end of the scarifying tube into a compartment with a sloping tin-lined bottom, as indicated in the side and perspective views. In this compartment the force of the air is considerably reduced, and it makes its exit, carrying with it a portion of the chaff and waste. The seeds are stopped by an

adjustable baffle board, which causes them to fall to the floor and run into the chute that delivers them to a bag or measure. Behind the first baffle, a second is fitted; this may be a canvas curtain, as shown, or a board similar to the first.

When building the machine, good white pine, or its equivalent, free from knots and checks, should be used; this is easily worked, and makes a light machine, which can easily be handled. The legs, braces, and other parts of the frame are made of 2 by 4-in. stock, surfaced on four sides. The sides, ends, top, partitions, etc., should be of good boards, surfaced and matched so as to make tight-fitting joints. The seeds are small and often high-priced, hence cracks in boards and

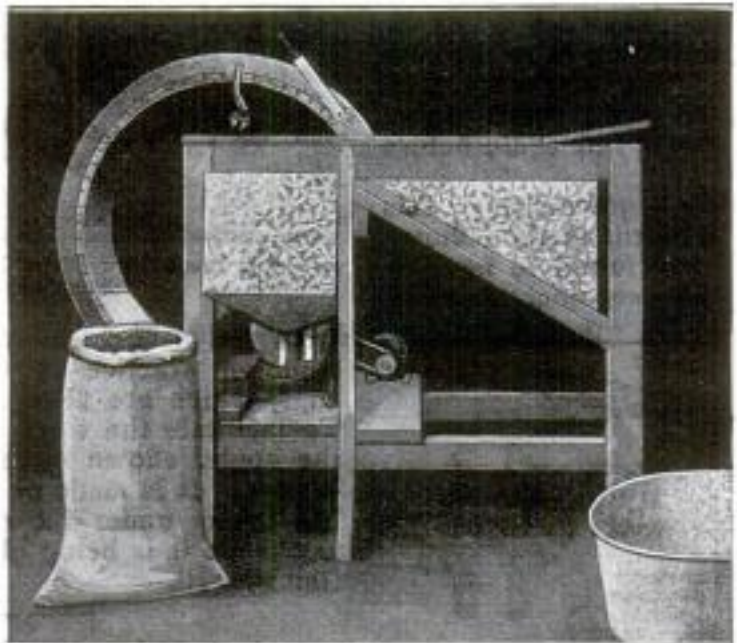

Hulling and Scarifying Machine Built by High-School Boys That Has Proved Profitable to Them and to Local Farmers

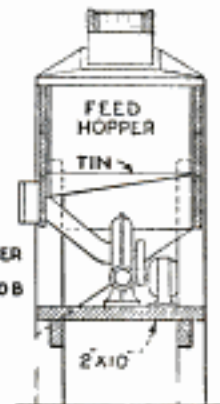
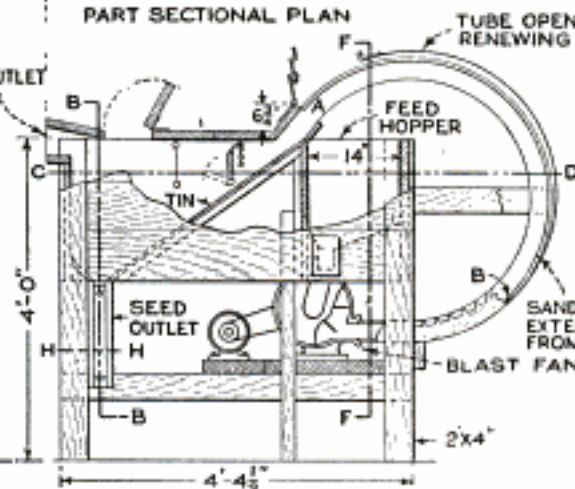
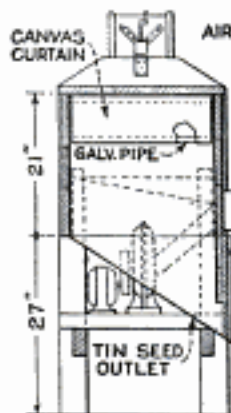
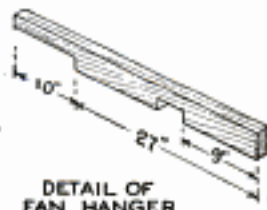
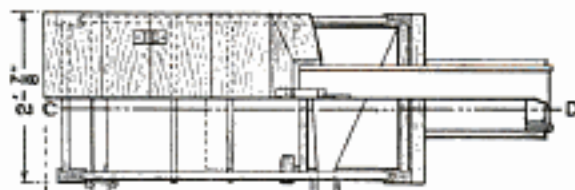

SECTION THROUGH B-B

SIDE VIEW

SECTION THROUGH F-F

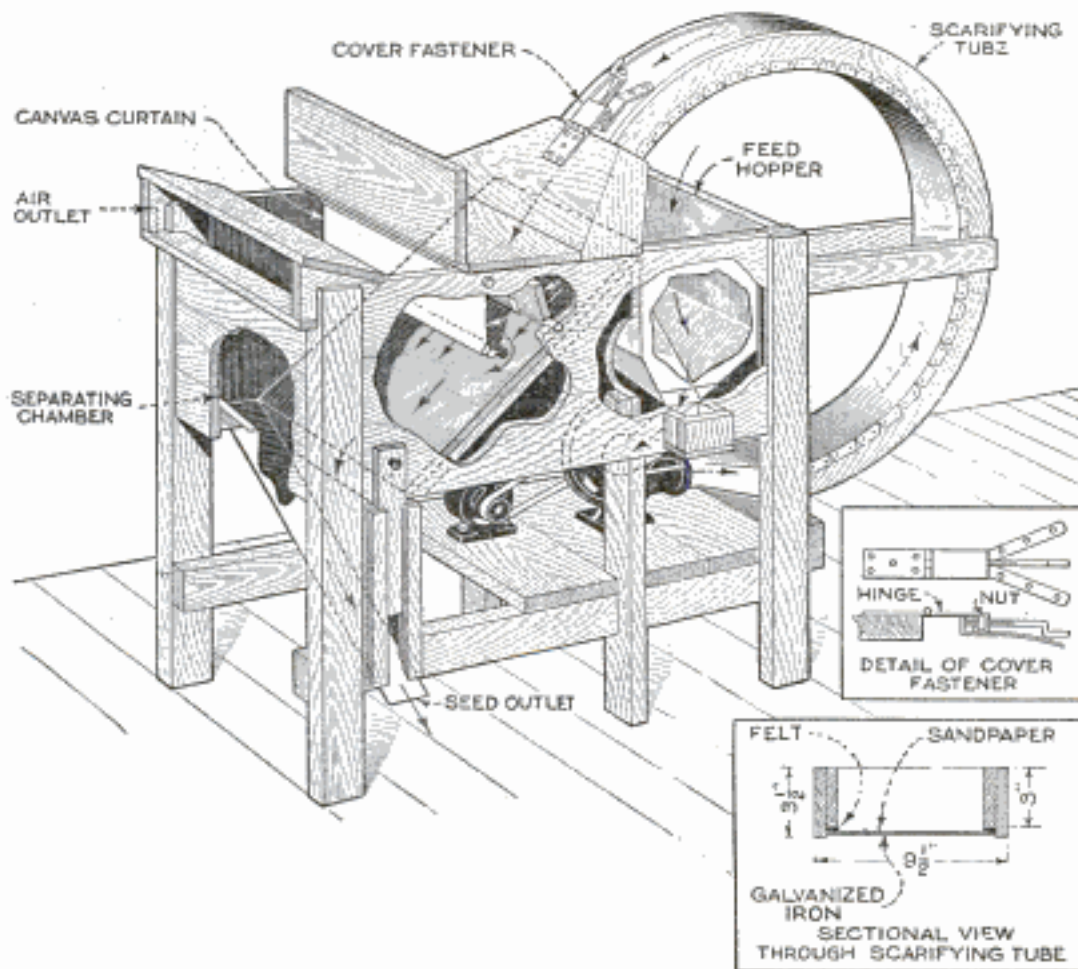

An Easily Built Machine That Will Hull Sweet-Clover Seed at the Rate of 10 to 12 Bushels an Hour: It Is Not Difficult to Operate and Will Pay for Itself in a Short Time

open joints may prove costly. The sides or panels are set into continuous mortises in the legs, as shown in section H-H, and glued and nailed in place. Strengthening all corners with metal braces is advisable, and the braces should be screwed to the wood. The baffle board is pivoted on long screws driven through the side panels into the lower ends of the board, and the upper end is adjusted by means of a chain hooked over a screw hook driven into the underside of the top. The board may be pivoted on a piece of pump rod running from side to side, if desired, simple tin straps bent around the rod and tacked to the board being used as bearings, as shown in the perspective view. The canvas curtain is of 6 to 10-oz. material, with a hem at top and bottom. The upper hem slips over a length of $\frac{3}{8}$ -in. iron rod, or pump rod, and the curtain is weighted with a length of galvanized-iron pipe, slipped into the lower hem. The size of this pipe depends upon the speed of the fan, and a little experimenting may be necessary in order to determine the proper weight.

The outer side of the scarifying tube is made of galvanized iron, cut and hinged about point B, and fastened at the top by a clamp made from a strap hinge, screw, and nut, as shown in the detail. The upper end of the galvanized iron is strengthened by a flat-iron spreader, riveted in place; the screw bears against the upturned end of this and draws the cover tightly around the tube frame, against the strip-felt packing shown in the tube detail.

The motor should be of a speed that will drive the blower at from 2,800 to 3,000

r.p.m., with the proper pulleys. The speed must be reduced for seeds that are softer than sweet-clover seed, or a portion of the abrasive may be removed from the scarifying tube, thus regulating the treatment so that only a small percentage of the seeds will be injured. With correct speeds and length of abrasive surface, not more than 2 per cent of the seeds will be broken. One application of garnet paper will usually treat 50 bu. or more.

The boys run their sweet-clover seed once through the machine to hull it, and then run it through a second time, when it is scarified. From one-half to four-fifths of the seed is hulled the first time, depending upon the quality and condition of the seed.

Students in the school have organized an agricultural club, which last year hulled and scarified 12,000 lb. of clean, salable seed for 25 farmers, some of the seed being sent 50 miles to the school. This year even more seed is being treated, and letters have been received from seven or eight states inquiring for prices on treated seed. The club has been charging local growers 1 cent per pound, on the basis of clean seed.

In 1922, ten times as much sweet clover was grown in this territory as in 1921, and this year the acreage will be greatly increased, a result much desired by agricultural research workers. The scarifier built by the boys has been a large factor in attaining this gratifying state of affairs, as it has provided the farmers with a service that they were unable to obtain elsewhere. Farmers in other communities can benefit greatly by following their example.

MATERIAL LIST

2 pieces 2 by 4 in. by 18 ft. white pine.	1 $\frac{3}{4}$ -hp. motor.
1 piece 1 by 4 in. by 12 ft. white pine.	1 pair 5-in. strap hinges.
3 pieces 2 by 10 in. by 2 ft. oak or birch.	1 piece $\frac{3}{4}$ by 2 by 8-in. wrought iron.
60 board ft. 6, 8, or 10-in. matched white pine.	1 large hasp.
2 sheets 28-gauge galvanized iron.	2 pulleys (size depending upon motor speed).
1 blast fan.	1 half-gal. can mixed paint.
	Nails, screws, bolts, felt, etc.

Refilling Barometers

Barometers that have developed air bubbles can be cleaned in the following way: Pour the mercury into a porcelain dish and cover it. Prepare a solution of 1 part of sulphuric acid and 20 parts of water. Pour the acid into the water slowly, with constant stirring, never the water into the acid. When the solution

has cooled, the barometer tube is washed with it, and then with clean water. Place the tube in a warm place to dry, with the open end up so that the vapor may pass off more easily. Next clean the mercury by forcing it through a piece of chamois skin, allowing the liquid to fall into a clean porcelain dish. This operation should be repeated several times.

To refill the tube, pour a small amount

of mercury into the widened end, holding the tube downward at an angle and tapping it lightly to force the mercury down to the closed end. Air bubbles that may be formed while pouring in the mercury are removed by tapping the tube with a stick of soft wood, holding the tube down slightly while doing so, and tapping with considerable care to avoid breaking the tube.

When the process has been completed, close the wide end of the tube with a cork or wadding. This sealing must not make the tube air-tight. If any mercury has been lost, add enough to make up for the deficiency, comparing the height of the mercury with that of another barometer of the same make.

Simple Screw Holder

Although there are a number of tools for starting screws in places that are nearly inaccessible, the tool shown in the

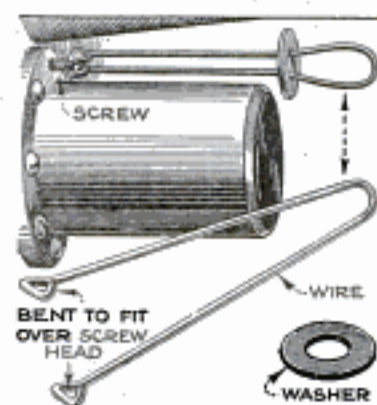

illustration would be hard to beat for simplicity, and can easily be made, in a few minutes, from a length of heavy galvanized wire and a washer. The wire is doubled as shown in the lower detail, the ends bent over to fit the screw head, and the washer slipped over the doubled end, after which this end is widened to prevent the washer from coming off again. In use the ends are slipped onto the screw head, and the washer moved down to clamp the screw.

Handy Gauge for Machinists



A great deal of time is wasted by machinists in using calipers and micrometers to measure small work approximately. A gauge made similar to the common wire gauge, as shown in the drawing, has been found to be a valuable tool, as with it measurements can be made in a fraction of the time otherwise consumed.

Crimping Tool for Pipe

Anyone who has attempted to join two lengths of galvanized-iron pipe, when the end of one length is not crimped, will appreciate the homemade crimping tool

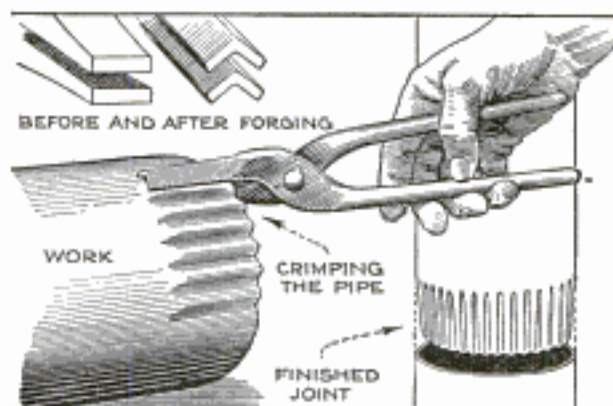

Homemade Pliers for Crimping Galvanized-Iron Pipe, Made from Ordinary Flat-Nosed Pliers

shown in the illustration. A pair of ordinary long-handled flat-nosed pliers was heated and the jaws forged to a V-shape, as shown in the detail. In use the crimper is simply pressed over the metal around the end of the pipe, which reduces the diameter, so that it can be pushed into the end of the other length of pipe.—G. A. Luers, Washington, D. C.

Guard for Mangle Rolls

After a laundry worker had caught her fingers between the rolls of an old-style mangle, the machine was equipped with a safety guard,

which made it impossible for similar accidents to occur. The guard consists of a length of $\frac{1}{2}$ -in. pipe supported at the end by a flat iron bracket screwed to the table as shown in the drawing. There is about $\frac{1}{4}$ -in. space between the pipe and the table so that the work can be fed in between the rollers, but the fingers of the operator cannot pass the guard.—A. C. Cole, Chicago, Ill.

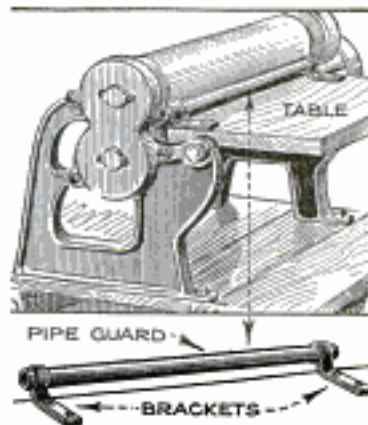

☐ If oxygen or acetylene valves become frozen, thaw them out with hot water.

Combination Punch, Shear, and Riveter

Punch, shear, and riveter for heavy-duty work are tools that should be found in every mechanic's shop, but the cost

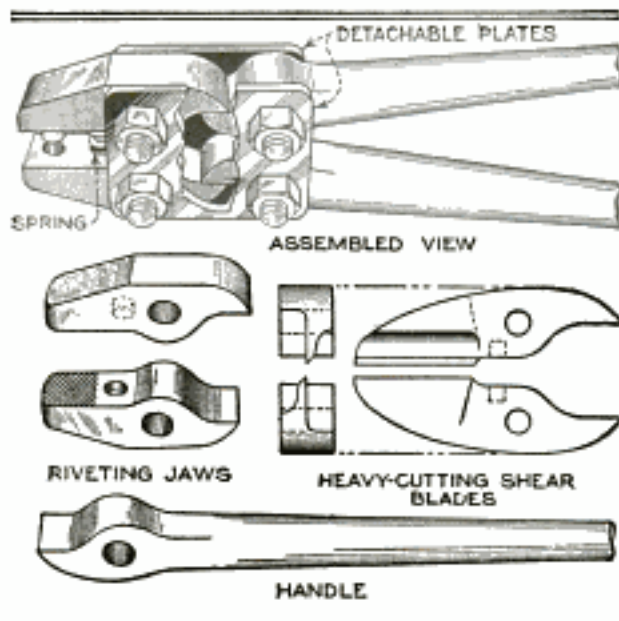

A Combination Punch, Shear, and Riveting Tool for Heavy Work That Can Be Made by Any Mechanic

of these makes a combination tool preferable. Such a tool is shown in the illustration. It consists of two handles and interchangeable shear blades, riveting and punching jaws, attached to the handles by means of two detachable plates and four heavy bolts as indicated in the upper figure, which shows the tool assembled. The handles and end members are made of square bar steel, which makes machining unnecessary except drilling, as the parts can be formed to shape by grinding. The side plates are made of ordinary steel plate. A small coil spring is provided between the jaws to facilitate using the tool. Several pairs of handles of various lengths should be provided to obtain different leverages.

Cementing Glass to Metal

For cementing glass to metal a mixture of sodium silicate and quartz meal, baking 12 to 24 hours to set hard, is recommended. If the color is unimportant a useful preparation may be obtained by soaking leather scrap glue in water, melting it by heat and then mixing it with 11 lb. of pitch, 4½ lb. of asphaltum and 4½ lb. of resin to each 1¾ lb. of glue solution. The mass may be loaded with powdered slate, etc., without losing its adhesive properties. An equally good

cement is prepared by dissolving equal parts of russian glue and shellac, and adding levigated chalk. Casein cement, for immediate use, is made by mixing fresh curd with one-fourth its weight of powdered chalk; while a second preparation, which will keep, consists of a solution of casein in ammonia, or of a solution of the same material in a 5-per-cent solution of caustic soda or borax, with the addition of a very small proportion of hexamethylene-tetramine. This cement is impervious to water.

Resin adhesives are also used, the "amber" cement employed by jewelers being composed of three parts of mastic and two to four parts of shellac, dissolved to a "sirup" in 90-per-cent alcohol.

Oiling Automobile Springs

Old crankcase oil can be used to advantage for lubricating automobile and motor-truck springs and other parts of the chassis, the work being quickly and thoroughly accomplished by means of a small hand sprayer of the kind used for spraying orchard trees. The nozzle is equipped with a quick-acting valve and with it a fine stream of oil can be thrown in almost a straight line for about 10 ft. This method of oiling is a time and labor saver for garages as well as for private owners.—G. C. Douglas, Raleigh, North Carolina.

An Easily Made Pin Setter

The drawing shows a handy tool for setting pins in places where the fingers cannot reach comfortably. The dimensions of the tool depend, of course, on the diameter and length of the pin to be driven in, the one illustrated being made of ⅜-in. round stock, bent to the shape shown, and drilled in the

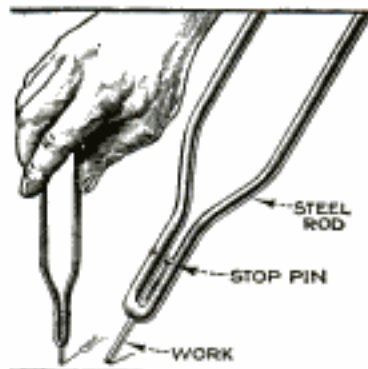

end to take a pin. It is also drilled through for a stop pin, which fits tightly in one side and loosely in the other. In use, a pin is slipped in the hole at the end, until it touches the stop pin. Then by grasping the holder in the hand as shown, the pin can be pushed in place.

A Novel Dairy Barn

Milking and feeding go together, and therefore provision should be made to milk and feed at the same time. A novel dairy barn, which is arranged to permit this, is shown in the drawing.

The hay manger is located above the heads of the cows so that they have to reach up a trifle to pull the hay out; the bottom has a row of $\frac{1}{2}$ -in. iron bars to allow this. A hay manger of this type has the advantage of containing enough hay to last the cows for a number of days. The trap door of the hay manger hangs outward on chains and can be pushed back into vertical position whenever necessary, as in cold or stormy weather.

The grain manger is of the ordinary type, except that it is much larger and also lower. Both mangers can be filled from the outside, from a wagon or truck, the surplus hay being temporarily stored on the roof, ready to be raked into the manger when needed.

Another interesting feature of this

dairy barn is the chain cow tie, which is an improvement on the stanchions usually used, as the cows have greater free-

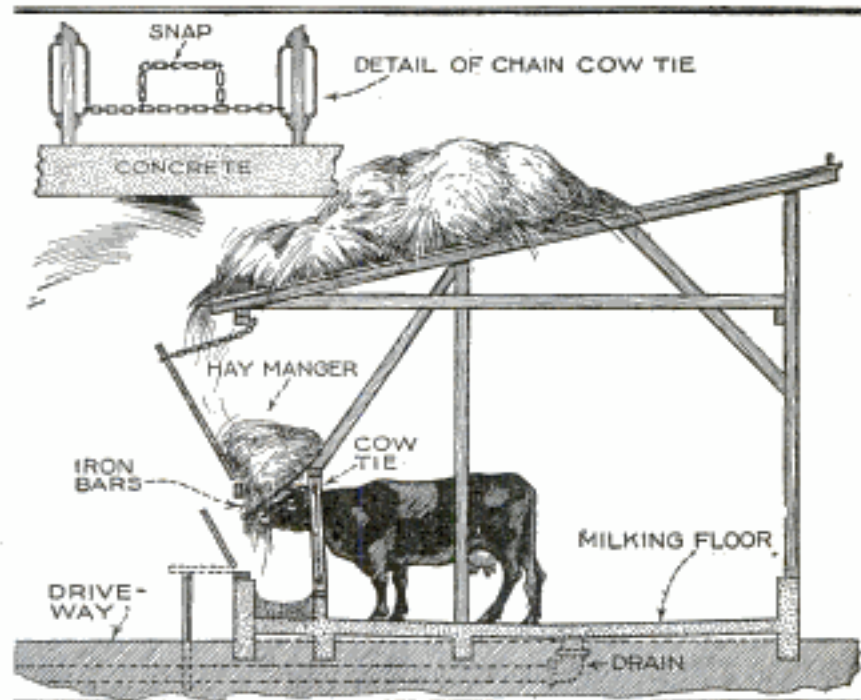

Novel Dairy Barn with a Self-Feeding Hay Manger and a Large Grain Manger: It Also Has Chain Cow Ties, and a Concrete Milking Floor

dom to move their heads around, the bars permitting the chain to be moved up and down, but preventing the cows from moving backward.—Herbert A. Shearer, Eagle Rock, Calif.

Removing a Counterbored Screw

Having occasion to remove a screw that was set in a counterbore about an inch deep, and that had become "frozen" in and began to break up when the screwdriver was forced, I hit upon the idea of soldering the tip of the screwdriver to the screw and found it successful. By playing the flame of a blowtorch on the screwdriver as illustrated, the screw and the tip of the screwdriver were heated sufficiently to cause a drop of solder to melt and bind both together.—John F. Diggins, Petersburg, Tenn.

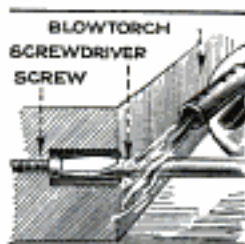

Ask the Bureau of Information where to obtain parts and materials mentioned in Shop Notes and Amateur Mechanics.

Lamps Indicate Blown Fuses

In places where fuses are often blown, it will be found convenient to shunt a carbon lamp around each fuse so that the lamp will burn when the fuse is blown. The lamps will not burn otherwise because the current can pass through the fuse much more easily than through the lamp, as the latter has a much greater resistance. The diagram plainly shows the method of connecting the carbon lamps.

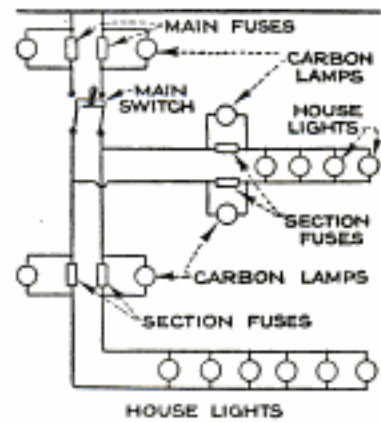

Handy Chute for Unloading Hogs



A Convenient Chute for Unloading Hogs from Wagons to the Pens at the Shipping Yards

The chute shown in the photo is in constant use for unloading hogs in a shipping yard at North Vernon, Ind. It pivots on the corner of a building, and the outside legs are fitted with small wheels, so that it can be pulled around easily. In use the chute is swung with one end against the back end of the wagon box, and the hogs driven through the chute into the pen. When not in use the chute is swung back against the building, closing the opening, and serving as part of the fence.—J. C. Allen, West Lafayette, Ind.

Bevel-Cutting Tool for Bar Stock

A handy and speedy tool for pointing, beveling, or turning radii on the ends of round stock, can easily be made and used on any type of lathe, combining in the

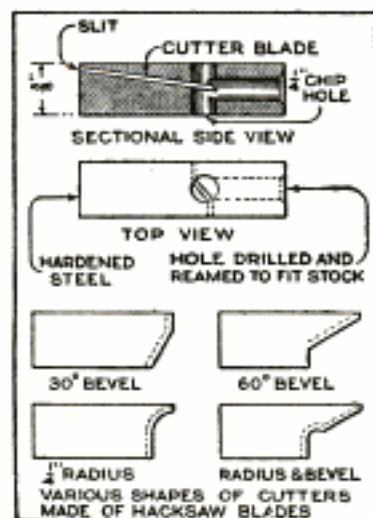

smallest possible amount of metal a tool holder and guide for the stock. The cutting tools are made from power-hacksaw blades that have been broken or worn out, the holder being made from tool steel, drilled and reamed

out to fit the stock being worked. A diagonal slit is then sawed with a hacksaw blade that has had the set of the teeth ground off to the thickness of the blade section. In use, the cutting edge of the tool is turned down, causing the chips to drop and prevent clogging. The inclination of the slot serves the double purpose of permitting an easy clamping action of the holder in the turret, and at the same time presenting the tool at an easy cutting angle. The holder should be hardened to prevent undue wear on the guide section.

Blades of various shapes for different classes of work are easily ground from pieces of power-hacksaw blades on a fine-grained wheel.

On speed-lathe work, it has been found best to hold the tool in the chuck of the headstock spindle and allow it to run continuously, holding the work in a drill chuck in the tailstock spindle.

Stand for Light Testing Work

White paper makes an excellent background for testing work by the light method. In the illustration a stand is



shown that was made especially for this purpose. This stand holds the paper so that it can be slid up and down to suit the operator, and also be turned around to any position to reflect the light. The base of the support is a slab of round stock, in the center of which is driven a length of $\frac{1}{8}$ -in. wire, sharpened at one end and bent over as shown, to eliminate

the chances of an accidental scratch. When using squares, center gauges, straightedges, or similar tools used for testing the shape of work this stand will be found to be of considerable assistance, as it does away with the necessity of setting the paper up against different objects to obtain the correct light.

☛ Steam rising from water at the boiling point has a pressure equal to the atmosphere, 14.7 lb. per square inch.

Drilling Fiber

A small shop order called for the drilling of a large number of soft fiber sheets. The holes were laid off and prick-punched in the usual way, but trouble arose during the drilling in that a ragged burr was formed on both sides of the holes and attempts to remove it merely resulted in a much worse looking hole.

To overcome the trouble, a fixture of the kind illustrated was attached to the drill press. It consists of a piece of flat iron, a collar, and two bushings, one threaded and the other plain. The plain bushing is a tight fit in the hole in the center of the drill-press table, and the threaded bushing screws into a tapped hole in the flat iron, which is bent to the shape shown, and clamped to the drill-press spindle by a collar and set-screw. Thus the entire surface of the table is clear of any obstruction and the work can be moved around as freely as if no fixture were used.

In operation, the flat-iron bracket is held about 1 in. above the surface of the work; then with the drill revolving in the hole of the threaded bushing, the spindle is brought down until the drill point enters the punch mark. The threaded bushing is then screwed down tightly on the work and the hole is drilled. With the work thus held tightly between the two bushings, a clean-cut hole can be drilled. The threaded bushing is turned back only a couple of

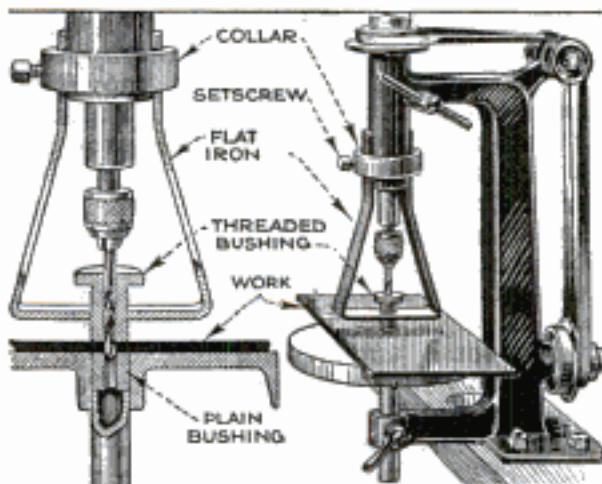

Fixture on the Drill Press for Drilling Holes Through Soft Fiber without Burrs

threads when changing the position of the work—just enough to allow the operator to see when the drill point enters the punch mark, so that operation of the device does not by any means slow up the work.

Roller for Handling Lumber

The roller support for handling lumber shown in the drawing is of considerable assistance in many places, as it can

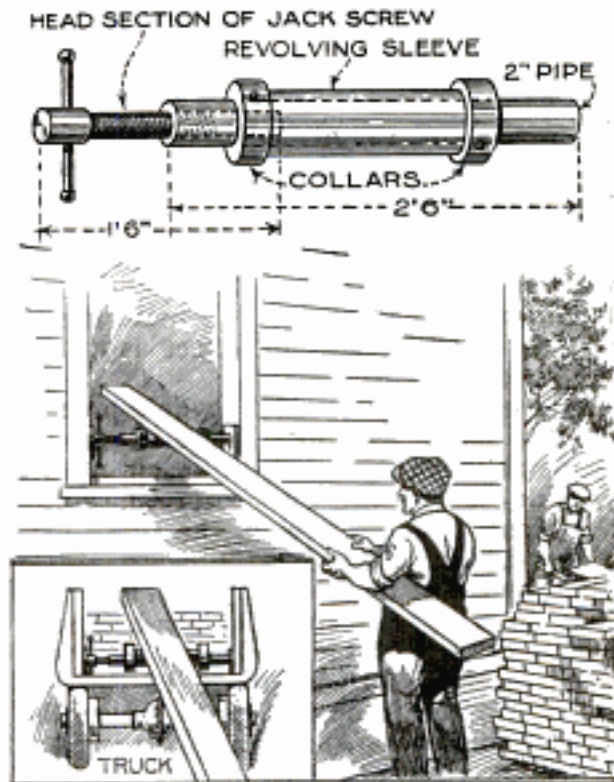

A Simple and Adjustable Roller Which Is of Great Assistance in Handling Lumber

be placed in a door, window, between girders and studdings, or on a truck. It has the advantages of being both simple and adjustable, and can be used without any stays or props.

The upper detail shows its construction and gives the dimensions. It consists of a jack fitted with a revolving sleeve on which the lumber is rolled. The jack is made of a screw, threading into a length of strong 2-in. pipe, and is fitted with a pipe cap and a handle for turning the screw. The revolving sleeve is a shorter length of pipe or steel tubing, and fits loosely between two collars tightened on the jack.

When a wooden post or brace is to be set on a smooth concrete floor, it often becomes a problem how to make it stand securely without the danger of slipping. If two or three $\frac{1}{2}$ -in. holes are chiseled in the concrete and nails driven into the bottom of the post, until about $\frac{1}{2}$ in. of the head end is exposed and in such a position that they will project into the holes in the concrete, the post will not slip.

CHIPPED-GLASS WORK

By J. S. HAGANS

MOST of us, at some time or another, have seen some examples of chipped-glass work, and wondered how the fanciful designs were made on the glass. The process is a simple one, although demanding just the right combination of temperature and materials, if the desired richness of effect is to be obtained.

A brief description of the whole process at this point will enable the reader to understand the purpose of each of the various steps in the work later on. First, the glass is roughened on the side to be chipped, then coated with thick, warm glue, and laid away to dry. When dry, it is put into a closed chamber and subjected to a fairly high degree of heat; when heated, the difference in the expansion of the glue and glass causes the former to chip off, bringing with it fragments of glass. The result is a pattern, of wonderful design, chipped into the surface of the glass.

It is absolutely necessary that the surface of the glass to be worked upon be roughened, to afford a "foothold" for the glue; smooth glass cannot be chipped, because the glue cannot obtain a grip, and flakes off without affecting the surface of the glass in the least. The quickest and most thorough way to roughen the glass is by means of the sandblast, as shown in Fig. 1. Sandblast apparatus of various forms, suitable for this work, was described on page 464 of the March, 1923, issue of this magazine. If compressed air is not available, or the amount of work is small, the glass may be roughened with sand and water, applied by means of a block, as shown in Fig. 2. This part of the work need not be done with any particular care, because scratches, unless very deep, will be obliterated in the finished work.

The next step is to apply the glue. A good grade of glue is soaked overnight, and melted in the morning to make a rather thick liquid. This is applied to the rough surface of the work with a broad brush, as in Fig. 3, so that every part of the surface is covered with a layer

of glue about $\frac{1}{16}$ in. thick. This done, the glass is laid away on a level surface and allowed to dry at room temperature. The consistency of the glue used must be found by test, but only the best glue obtainable should be used, and a thick solution applied to the work.

In some cases, the glue will begin to chip and fly off at room temperature, and the process can be expedited by playing the breeze from an electric fan over the sheet. If the glue dries out thoroughly without showing any signs of chipping, the process can be started by the application of heat. The glass is placed on edge in an oven, and the temperature run up as high as necessary to start the chipping, being careful, of course, to guard against fire through overheating. If the glass is too large for any oven available, a simple sheet-metal oven for containing the glass can be built to be set on a stove. It might be noted here that double-strength glass should be used in this process, as the lighter single-strength glass is apt to be broken by the tension created, especially in large sheets.

Assuming that the result has been satisfactory, the sheet now bears the appearance shown in Fig. 4, and is known as "single-process" chipped glass. If a finer pattern is desired, the "double process" can be used; this consists in applying another coat of glue to the glass, and treating exactly as before.

So far, the process is simple, and a solid-chipped sheet of glass is produced, such as might be used in an office door, or for some similar purpose. A little more care and work are necessary when an advertising sign, such as shown in Fig. 6, or any similar job, is to be made.

In the example shown, the letters and the scroll are chipped, the rest of the panel remaining clear; for this particular job, good plate glass should be used.

The glass is slightly warmed, and given a thin coating of beeswax; then, still keeping the glass warm, a sheet of lead foil, or even thin, tough brown paper, is rubbed down into close contact with the waxed surface of the glass. The design

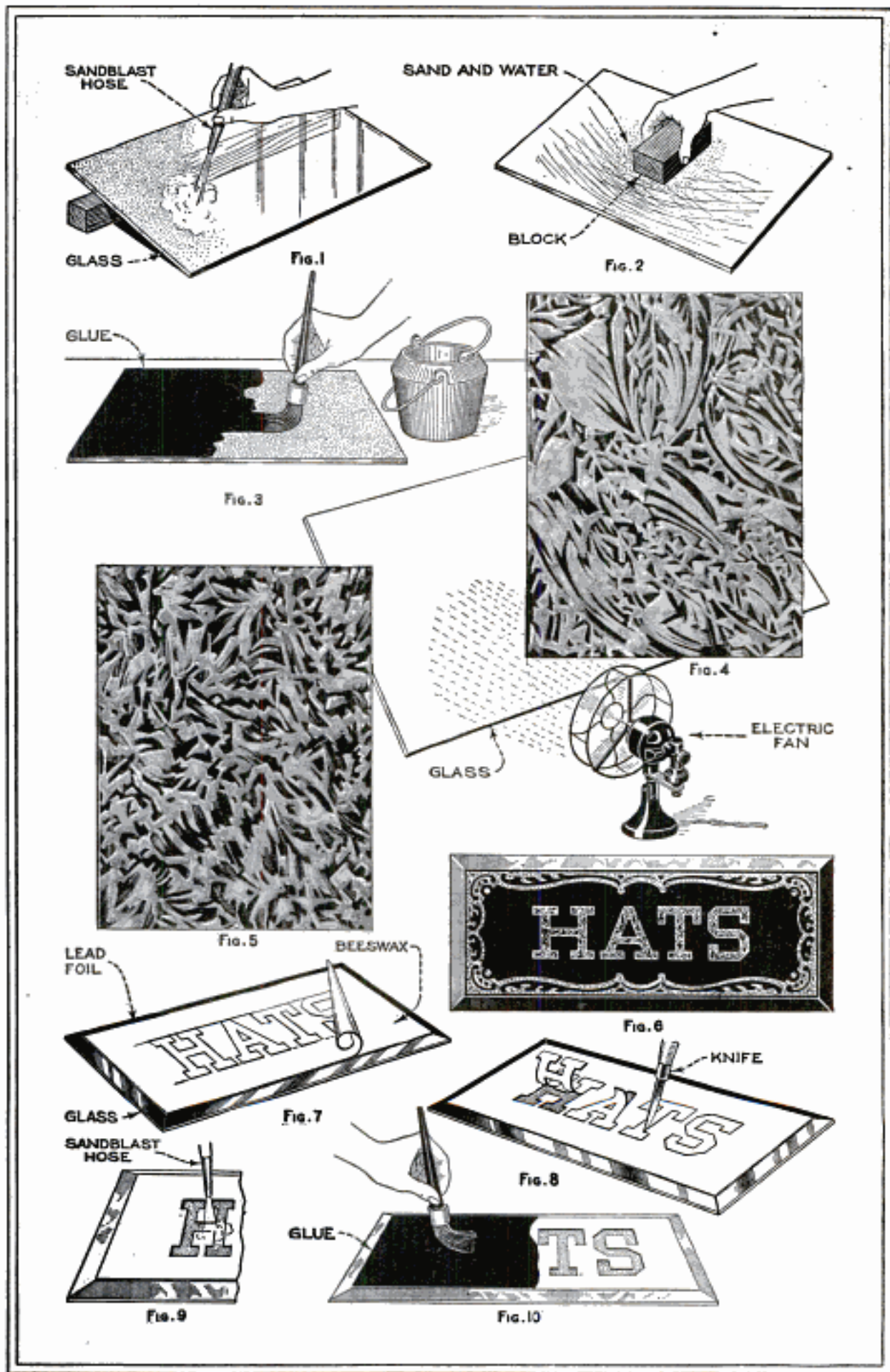

Various Steps in the Making of Chipped Glass, Both Simple Sheet and Ornamental Work: The Process Is Simple, and the Work May Be Done in a Small Shop

is then drawn on the foil, as shown in Fig. 7, and the outline gone over with a sharp knife. The foil covering the parts to be chipped is then stripped off as indicated in Fig. 8, and the work is sandblasted through the stencil, as in Fig. 9. Next, the work, with the stencil still in position, is coated with glue, Fig. 10, after which the remainder of the stencil is stripped off. From this point on the treatment is exactly the same as for the plain sheet.

Signs of this kind are usually backed with gold or silver leaf, to make the letters stand out to the best advantage, and they have an unusually rich and striking

appearance because of the refraction of the light striking the bright metal leaf through the rough surface of the glass.

The plain part of the glass can be coated on the back with some free-flowing paint that contrasts with the leaf; green and red are the colors usually chosen for this work.

Very fine results can be obtained by a combination of sandblasting, as described in the issue previously referred to, and chipping. This method requires two separate stencils, and the sandblasted part of the design is done first. This part is protected by the second stencil, which exposes only the parts to be chipped.

Stamping Tags Quickly and Neatly

A shipping clerk in a small factory, who had a large quantity of shipping tags to stamp with an ordinary rubber stamp, found the work quite tedious on

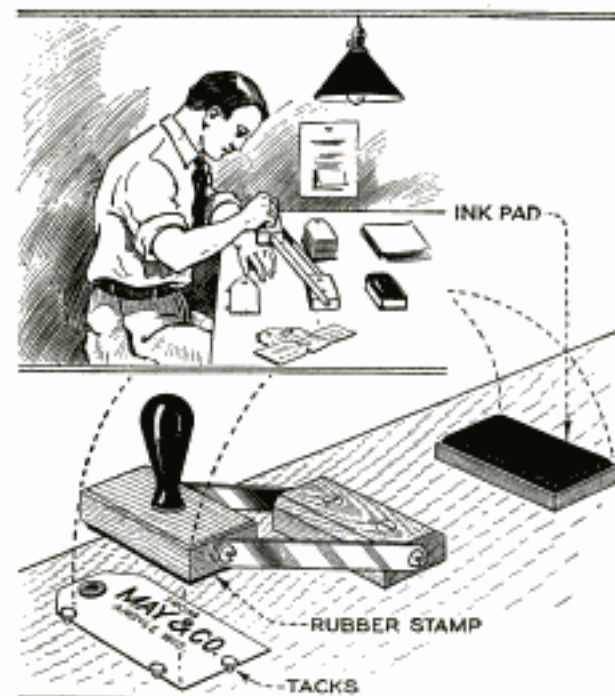

A Convenient and Time-Saving Attachment on a Bench Top for Stamping Large Quantities of Cards

account of the difficulty of holding each tag so that the printing could be stamped squarely on it. To simplify the work, he constructed the attachment shown in the drawing, and found that its use effected a considerable saving of time.

A small block, the same length as the stamp, was fastened on the bench top, and two 6-in. iron straps were drilled at the ends and screwed loosely to the block and to the stamp, so that it could be

swung back and forth from the ink pad at one side to the tag at the other side. Tacks, partly driven into the bench top, were used as stop pins to locate the tags quickly in the proper position for stamping.—G. E. Hendrickson, Argyle, Wis.

Adjustable Pinch Bar Pulls Gib Keys

The illustration shows an adjustable pinch bar for pulling gib keys. When using an ordinary puller it is necessary to put a block behind the head as soon as the key is pulled out a short distance, but, with the puller shown, the use of a block is eliminated. The attachment consists of a tapered piece, with teeth or serrations engaging with similar teeth on the back of the pinch bar. A sliding collar holds both parts together securely, and prevents either from moving when in use. The collar is slid toward the handle when the parts must be set for another "bite."

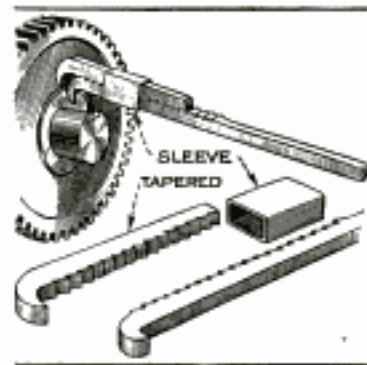

Pattern Color Denotes Material

A simple and practical method of indicating, for the information of the foundryman, the materials from which parts are to be made is to have the different materials indicated by the color of the patterns, a color chart being provided for reference. With this method it is possible to avoid mistakes and to

prevent the delay necessary to trace the pattern back to the original drawing. A color scheme of this kind, which was found to be of considerable assistance in a foundry, is as follows: Black for cast iron, gray for steel, yellow for brass, red for copper, and white for aluminum. The color used on the pattern was as close to the natural color of the metal as possible.

Improving Carpenters' Compasses

Carpenters are often annoyed by the loss of the screw that clamps the adjustable point of their compasses. A simple method of eliminating this trouble is as follows:



Just above the screw slot make two hacksaw cuts $\frac{1}{8}$ in. apart and $\frac{1}{8}$ in. deep, and another cut about $\frac{1}{8}$ in. from the end of the leg. Bend the cut portions downward and slip through these loops an 8-penny nail, from which the head has been removed, and with the point sharpened. On many forms of work an ordinary carpenter's pencil can be substituted for the round-pointed pencil, with the advantage that the lead does not wear so quickly.

Protector for Cadmium Sticks

In making storage-battery tests with the aid of cadmium, it is usually necessary to have a jar of water handy in which to immerse the cadmium, as it does not deteriorate as quickly in water as it does in air. Rather than carry a separate jar around with the voltmeter, it has been found convenient to attach a test tube to the side of the voltmeter as shown in the illustration. The cadmium stick is fitted with a rubber cork so that the water in the test tube will not be spilled while carrying the voltmeter around.—

J. B. Burnett, Vinita, Okla.

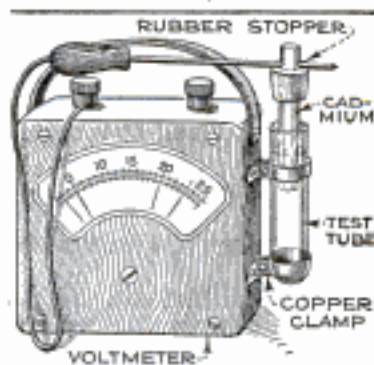

Guard over Door Prevents Danger from Icicles

Many instances have been recorded where workmen in factories have been injured by icicles falling from eaves over



Left, View Showing Absence of Icicles over Doorway; Right, Front View of V-Frame on Roof

doors that they were obliged to use frequently. At a factory in Three Rivers,

Mich., safety guards have been installed over all doors to various buildings throughout the plant, and have proved effective in preventing the formation of icicles of any size. The guard consists merely of two pieces of 4 by 4-in. timber, placed in the shape of an inverted V, and nailed to the roof directly over the entrance or door. A strip of roofing paper is nailed to the roof and against the upper side edge of the V-frame, forming a flashing to deflect the drippings to either side of the doorway. During warm weather, when there is no ice or snow, the guard serves as an eaves trough, deflecting the rain away from the doorway.

How to Clean Tools

To keep tools clean and bright rub a little mercurial ointment over them, which will form a moisture-resisting coating. Mercurial ointment is also known as blue butter. It is somewhat poisonous, so should be handled carefully. Another good mixture to keep tools from rusting is made by taking six parts of lard and one part of resin. Heat these together slowly until the resin is all melted. The mixture should be heated in the open air in case of fire, and benzine added in about the proportion of one pint of benzine to half a pound of the mixture. When cool, the mixture can be rubbed lightly over the bright-steel articles. Tools thus treated will resist the corrosive action even of salt water.

Pulling Stumps

In pulling stumps I find that a team and one or two long chains will do the work effectively if arranged correctly.

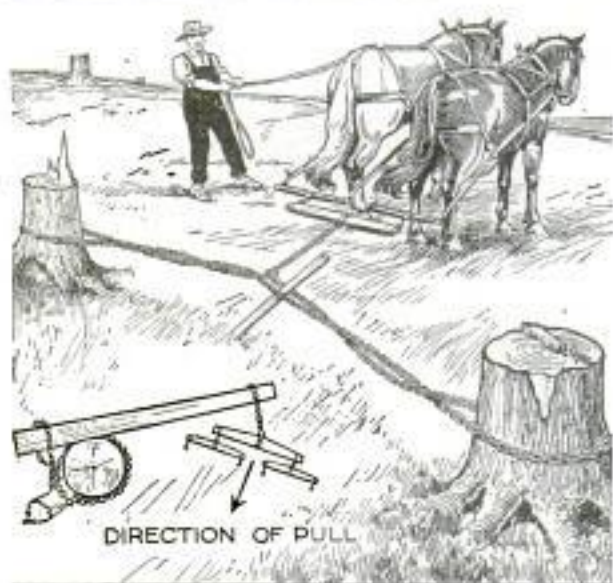

An Effective Method of Pulling Stumps by Means of a Heavy Chain and a Team of Horses

The greater the distance the stumps are apart, the easier they can be pulled.

When two stumps are situated close together, loop the chain around each stump and hook it. Twist it by means of a lever to get it as tight as possible, and hook the team on as shown. In case there is no other stump to hitch to, dig down so as to expose the main root, and, after fastening one end of the chain, wind it around the stump, and under the root, providing a loop large enough for a 10-in. pole. This pole should be about 20 ft. long and the team is hitched at one end as indicated in the left-hand detail.—E. R. Booth, Edwardsville, N. Y.

"Oxidizing" Copper and Brass

The antique finish so much admired in fixtures, hinges, trays, etc., known also as "oxidized" work, is produced on both copper and brass in exactly the same way. The process is cheap and simple. A strong solution of potash and lye, using about two tablespoons to a quart of water, is first made. A second solution consisting of about 2 oz. of sulphide of potash and two quarts of water, is then prepared. After fastening a short piece of wire to the article, to serve as a handle, the article is dipped into the first solution to remove all the grease and dirt. It is then rinsed in hot water and dipped into

the sulphide solution until it has a good, sharp-black color in the case of a copper article, and a grayish black in case of a brass article. It is again rinsed in hot water and hung up to dry. When thoroughly dry, it is buffed all over lightly on a soft cloth buffing wheel, then buffed so that the copper will show through in spots to produce the desired effect. A little practice will enable one to buff a piece so that it will look as well as if done by an expert.—E. R. Haan, Chicago, Illinois.

Trimming Spreader for Upholsterers

Automobile upholstery of the better grade is trimmed with tape that rolls back on itself, after tacking, to conceal the tacks. As it is rather difficult to hold the trimming flat while nailing, the spreading tool shown in the photograph has been found useful for this purpose.

A piece of galvanized iron about 4 in. long and 3 in. wide is cut to the shape shown in the lower right-hand detail. The narrow tongue is curved to form a handle and the tapering projections bent to form cones. In use the tape is fed into the large ends of the cones and is drawn out through the narrow ends, causing the edges to roll apart, thus exposing the

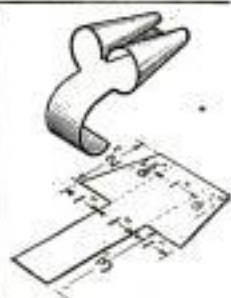

A Tool for Spreading the Trimming Tape Used on the Better Grades of Automobile Upholstery

center for tacking. The trimming closes again after the tool is drawn a few inches further.—Edwin M. Love, Alhambra, California.

Restoring Overexposed Blueprints

A simple method of restoring overexposed blueprints consists in taking the print from the washing-tank and laying it face upward, while still wet, on the table, then placing an unexposed dry piece of blueprint paper of the same size over the wet one, and rubbing it with a piece of cloth or with the hands. This brings the two surfaces into intimate con-

tact, and when separated, it will be found that the overexposed print is perfectly clear and of a rich blue color. The color obtained in this way is better than that obtained by the ordinary exposure and development, but there is, of course, the objection that a piece of blueprint paper is wasted for each print made.

Keeping Dirt from Boots When Excavating

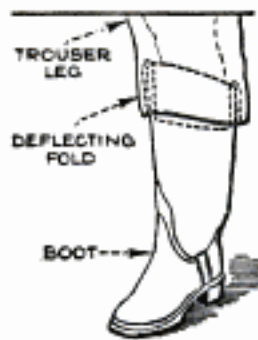

When excavating trenches, the worker's boots collect loose dirt and stones, which makes it very uncomfortable for him and makes it necessary to remove the boots frequently. This trouble may be prevented by folding the trouser leg over the boot so as to

overlap about 3 or 4 in. as shown. This lap prevents the passage of dirt into the boot.—Louis Schneider, Clinton, Mo.

Planing Deep Grooves

Every machinist and toolmaker knows what a tedious job it is to machine a deep rectangular groove in metals, particularly in brass or steel, with the ordinary tool holders on the planer or shaper. These tool holders carry the tool bit at an angle that gives the nose a positive rake, which is very good on plain work, but in grooving work, where a wide, square-nosed tool is used, it tends to dig in and break off. By reversing the tool holder—that is, by using it backwards—the bit is given a negative rake.

Of course, the bit must be re-ground so that the nose has a good cutting lip, and it will then do good work, taking a fairly heavy cut, and tending to spring away from the work, rather than to dig into it.—George A. Volz, Redford, Mich.

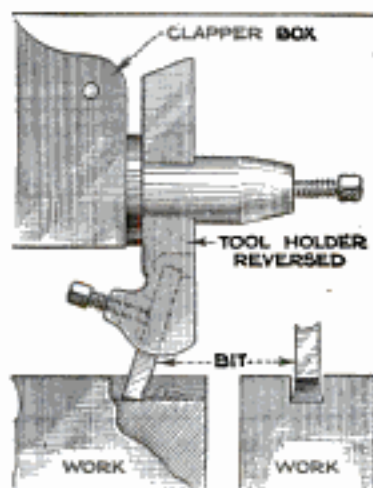

Useful Clamp for the Woodwork Bench

The drawing shows a simple home-made clamp that is of considerable usefulness to woodworkers. It consists of a wooden block, securely screwed to the

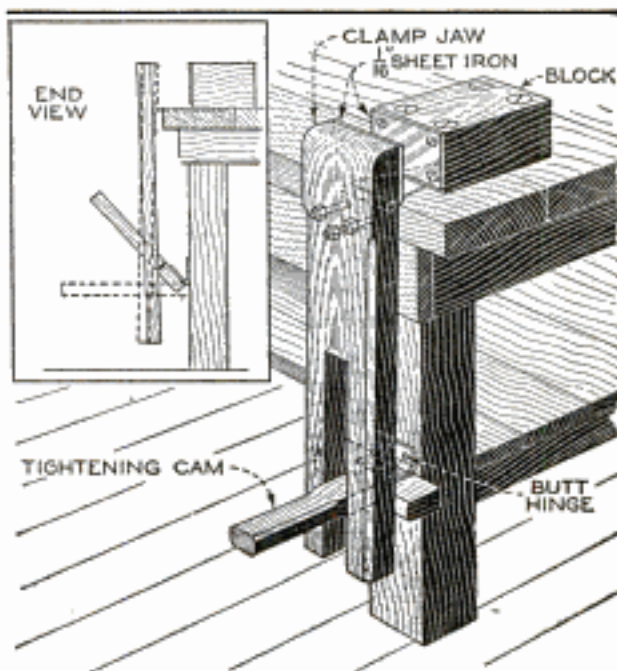

A Simple Foot-Operated Bench Clamp of Considerable Usefulness to the Woodworker

benchtop in the position shown, and faced on one side with $\frac{1}{16}$ -in. sheet iron. This forms the permanent jaw. A 2 by 4-in. lever, also faced at one end with sheet iron, and slotted at the other end as shown, is arranged to pivot on a strap hinge that is screwed to the benchtop and bolted to the lever at the point indicated. The upper end of the lever forms the movable jaw. The vise is tightened by means of a 2 by 4-in. cam, attached to the bench leg with a butt hinge, the narrow part of the cam fitting in the slot of the lever and extending outward about 6 in. so that it can be operated by the foot. Forcing the cam lever downward brings the vise jaws together, clamping the work between them. If the object is too small to be held between the jaws, one or two small wooden blocks are put between it and the jaws.

Cleaning an Oil-Soaked Belt

To clean an oil-soaked belt, coil the belt loosely in a box or tub and fill the box with whiting, being sure to get the whiting between the surfaces for the entire length. Let it remain thus overnight, and the whiting will absorb the oil and leave the belt clean.

A Lesson for Patternmakers

BY M. E. DUGGAN

WHEN I say that a pattern was molded in green sand, with a dry-sand core, and that the core was made without the aid of a corebox, the patternmaker who has had foundry training

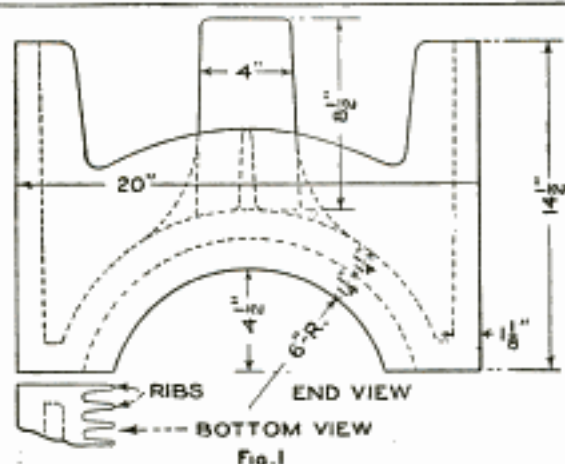

Piece That Was Cast in Green-Sand and Dry-Sand Core without Corebox

readily understands, but the patternmaker whose training was received in a shop far from the foundry looks at me with astonishment, and wonders how it was done. The young patternmaker will therefore appreciate a clear description of this detail of patternmaking and foundry practice.

The pattern selected for illustration was made by a worker who had a number of years' experience; he constructed it for green-sand molding, which, by the way, was impracticable in this case. When the casting was made, and the patternmaker was told that the job was done "in green-sand and dry-sand core" he thought that there was something wrong with the foundry, as he was positive that no corebox had been made for the job.

A side view of the work is shown in Fig. 1; it was made with ribs $\frac{3}{8}$ in. thick at the bottom, tapering to $\frac{1}{4}$ in. at the edge, and $1\frac{1}{4}$ in. deep. A section through the center is shown in Fig. 2. The pattern was molded with the ribs up; the piece could not be molded in green sand because the sand could not be made secure and would drop when the cope was being closed down on the drag, and the thin ridges of sand forming the spaces between the ribs would be "washed" away in the closing of the mold. For these reasons the molder decided to use a dry-sand core.

With the pattern inverted, core sand was rammed in between the ribs, the

pattern was then turned "right side up" on a core drying plate, and core sand filled in below and around it as indicated in Fig. 2; the pattern was then lifted from the sand core and the core baked.

Pieces of bent wire were imbedded in the core before baking, and, after baking, the sand above these wires was cut away to allow other wires to be passed under them. Then the core was taken to the molding floor and the core and pattern put back in the position shown in Fig. 2, except that a bottom or molding board was used instead of the iron core-drying plate. Drag flasks were then put in place and green sand filled in as shown, completing the drag.

The drag, with the pattern, core, and bottom board was then rolled over to receive the cope flask, in this case what is known as a "flat back"; this molding method makes it possible to use almost any flat cope flask.

When the rolling was done, the bottom board was removed, and the cope flask placed in position. Two wooden battens were placed across the cope flask, as

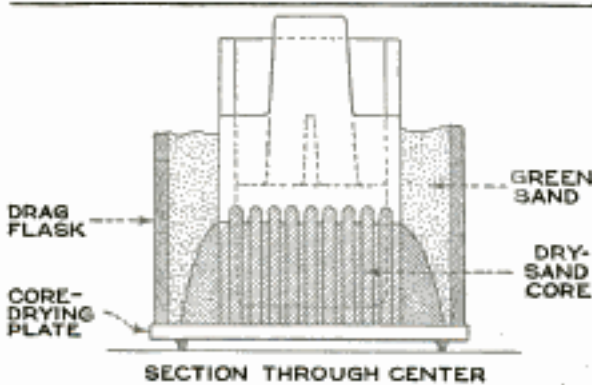

SECTION THROUGH CENTER

Fig. 2

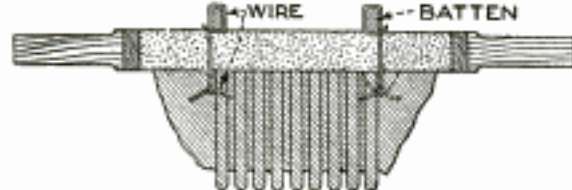

CORE SUSPENDED FROM COPE FLASK

Fig. 3

Above, Preparation of Drag; Below, Dry-Sand Core Forming Cope

shown in Fig. 3, and the core tightly drawn against the cope by means of wires passed under the wires in the core, and around the battens.

The cope, with the core attached, was then lifted, the pattern removed from the drag, the cope replaced and clamped, and the mold was ready for the iron.



A "Snow Box" for the Amateur Stage

BY L. B. ROBBINS

DEVICES intended to imitate the falling of snow upon the amateur stage are many and varied, but few are completely satisfactory. Either the fall of "snow" is limited by the small supply of

in the illustration, will serve to spread a snowfall over the visible portion of a small stage. Moreover, it holds a supply of material large enough to last, with judicious use, for many minutes, so that

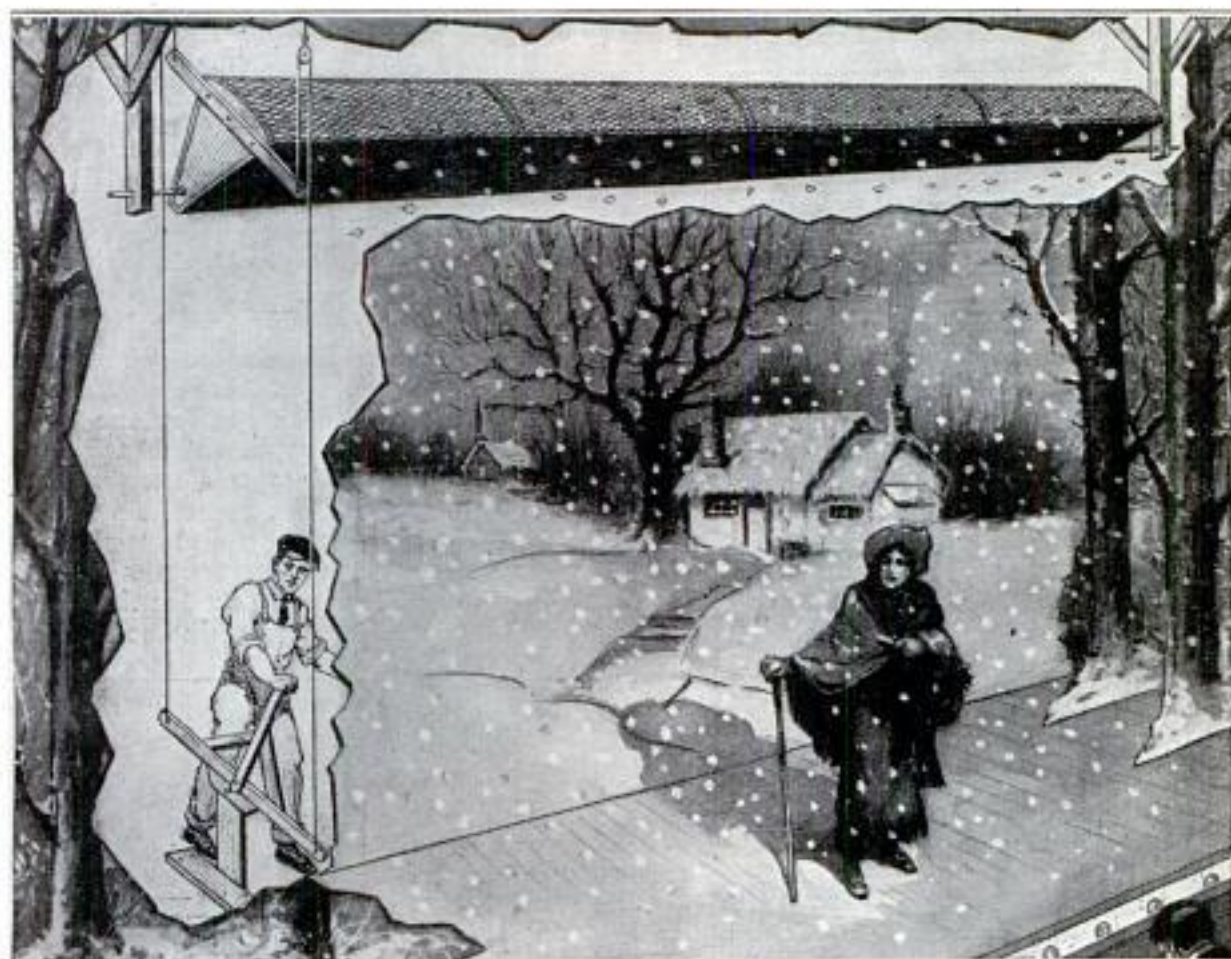

A Simple and Effective Attachment for the Amateur Stage for Giving the Effect of a Heavy Fall of Snow: The Box Holds a Large Supply of Paper, and Is Easy to Operate

the pieces of paper used to create the illusion, or the spread of the snowfall is far too small for the scenery required.

There is one device, however, that can be made by anyone handy with tools, and that has been in successful use on many professional stages for years, especially abroad. For the amateur's use this "snow box" has been simplified, and, as shown

a long scene can be staged without the snowfall abating in the least.

The necessary length of this snow box will, of course, depend upon the size of the stage, but for general use a 12-ft. box will be ample to cover any space not hidden by scenery, and should do for any small school, lodge, or society stage. The sides can be made of 12-ft. boards, 18 in.

wide, or several boards cleated together to make a side this width. The ends should be shaped to the segment of a circle, 18 in. along the sides, curved across the top edge, which measures 15 in. wide, and the point at the bottom cut off so that it measures about 2 in. wide. Nail the sides to these ends so that a box is formed as shown in the drawing.

Nail a 12-ft. length of 3-in. furring along the bottom, over the opening left by the bottom edges of the sides. Fit two or three barrel hoops in the top opening, curving them to correspond to the curve of the tops of the ends. These act as spreaders and serve to keep the screening which covers the top at the proper curve. This screening should be preferably 1-in. mesh chicken wire, tacked over the entire top opening of the box.

The box is then swung at each end by bolts run through the ends as shown. The ends of the bolts are run through holes in the ends of timbers placed over the stage well up and out of the way. Suspend the box horizontally in this man-

ner over the open part of the stage where the snow is to fall.

The box is operated by means of a tipping lever—a stick nailed across the top of one end. Cords fastened to each end of this lever pass up through pulleys attached to the ceiling and then down to the stage behind the wings, where they are fastened to a rocking lever made as shown in the drawing. Nothing elaborate is necessary for this lever, but it should be supplied with some sort of a handle so that it can be operated by a stage hand from a good vantage point.

When the box is filled with paper bits and then rocked from side to side some of these bits fall out and to the stage in imitation of real snow. An electric fan behind the wings at one end of the stage will blow the falling snow as though driven by a strong wind. If desired, a link from a large flywheel driven by an electric motor can be arranged to rock the snow box by power, so that the stage hands can attend to other duties during the "storm."

Zinc Makes Durable Chimney Caps

Brick chimneys are apt to break and become loose at the top, due to weathering, and the loose bricks are very dangerous, especially during high winds.

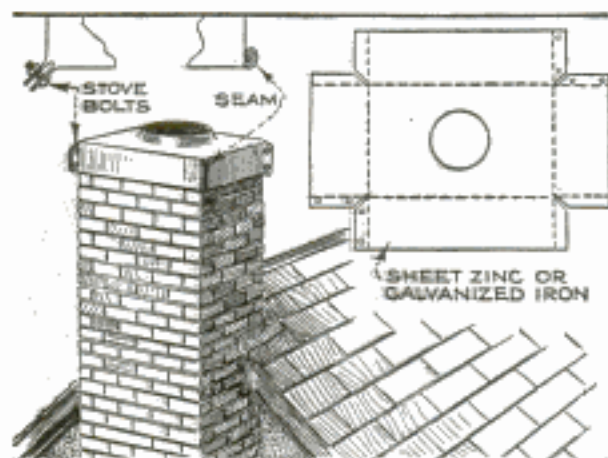

A Metal Cap for the Chimney Top Prevents the Bricks from Becoming Loose

This danger can easily be prevented by providing a cap made of sheet zinc, cut to the shape shown in the illustration and fitted on the chimney, brass bolts being used to tighten it. The edge of the circular hole is bent upward to shed water. The cap can be put on by anyone who can use tools such as tin snips and hammer. Heavy galvanized iron can be used for the cap, but zinc is more durable.

A U-Bolt Replacing Tool

When replacing U-bolts on the springs of an automobile, considerable difficulty is often experienced in getting the bolts in line with the holes in the bracket or fixture, because of the tendency of the bolt to spread apart. A great help in lining up these bolts is the simple tool illustrated. It consists of two lengths of iron rod, hinged together at one end; the other end of one rod is bent to fit in the bracket

hole, and a fork is forged on the end of the other. The forked rod is held against one side of the U-bolt, while the bent end is inserted in the hole of the bracket as shown.

With one leg of the U-bolt already located in position, it is an easy matter to force the other leg into place with a few light blows of a hammer on the hinged end of the tool.—Glen F. Stillwell, Collinsville, Ill.

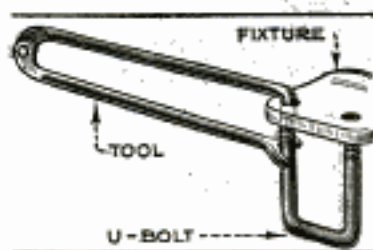

☐ A radiator hose usually begins to leak on the underside. By loosening the clamps and turning the hose around, so that the underside will be on top, it will serve twice as long.

Horseshoe Wrench for Oil Barrels

When one is in a hurry to fill an auto or tractor fuel tank, it is quite annoying to wait for the liquid to gurgle out of the faucet gradually, as is usually the case. Of course, if the upper cap is un-

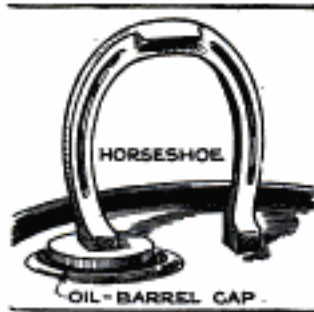

screwed so that air can enter, the flow is increased considerably, but unfortunately the caps of standard 50-gal. barrels are made round, with a square recess in the center, so that an ordinary wrench cannot

be used to unscrew them. A pipe wrench can be used on the outside, but a pipe wrench is not always at hand. A horseshoe has been found to be a very convenient tool for unscrewing the cap. One calk is inserted in the slot, as shown in the illustration, and the cap can then be loosened with a single twist.—G. E. Hendrickson, Argyle, Wis.

Heating Radiator Cools Engine

A farm gasoline engine, on which the water hopper had been broken by freezing, was not put out of service by this

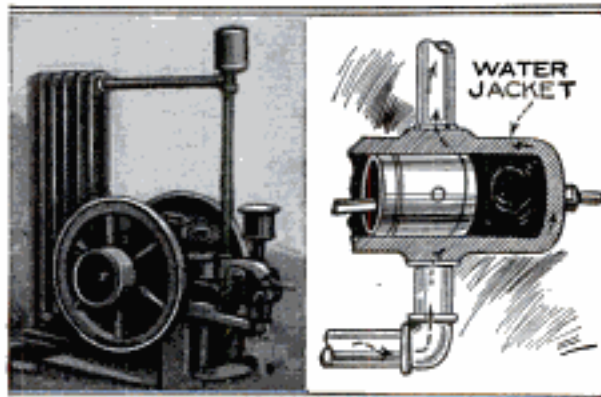

A Novel Cooling System for a Gasoline Engine Making Use of an Ordinary Heating Radiator

mishap, but was cooled by means of an ordinary heating radiator; this hookup, although novel, proved very efficient. The method of connecting the radiator to the water jacket is plainly shown in the photo and detail. A high radiator is best to use for this purpose, as there is a greater distance between the top and the bottom than there is in a small window radiator, and this induces a constant and steady circulation of water.—Dale R. Van Horn, Walton, Neb.

Six-Horse Evener for Plow

Farmers are often puzzled as to the proper method of making an evener to be used for six horses when plowing,

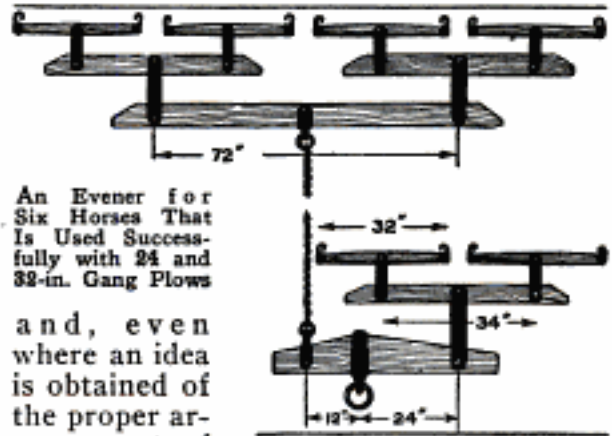

An Evener for Six Horses That Is Used Successfully with 24 and 32-in. Gang Plows

and, even where an idea is obtained of the proper arrangement of

the horses, the dimensions of the arms are still puzzling.

The illustration shows, in plan, an evener that has been used for years with success, on 24 and 32-in. gang plows. The four and two-horse eveners used are standard size, and the main-evener member is the same length as the standard three-horse evener. The right-hand lead and wheel horses walk in the furrow and guide the plow.

Kettle Holder on Faucet

The illustration shows a length of heavy galvanized wire, bent to form a holder that is attached to the kitchen faucet, so that steaming kettles may be hung on it to avoid burning the hands. The wire is bent to the shape shown in the detail and to a size determined by the faucet on which it is to be used. After it is fitted on the faucet a stovebolt is passed through the eyes formed in the wire, and is screwed up tightly.—Harold E. Benson, Boulder, Colo.

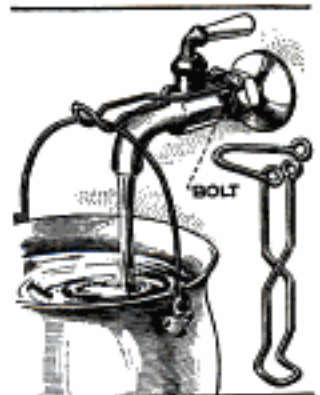

Never neglect attending to auto rear-axle noises; the rear axle is a very hard-worked piece of mechanism, and should therefore have the best of care. Have any noise investigated immediately.

Ice-Block Fence for Hockey Field

The photograph shows a hockey field inclosed with blocks of ice, which cost only one-third as much as a wooden fence

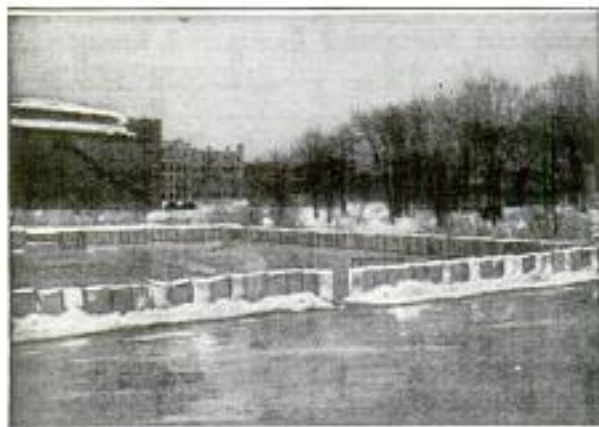

An Ice-Block Fence for a Hockey Field Is Just as Good as a Wooden Fence and Is Much Cheaper

for the same purpose. The blocks were about 20 in. thick, 40 in. long, and 22 in. wide. They were set on end, as shown, with the 22-in. sides lengthwise of the fence. Wet snow was packed between the blocks and the whole fence then sprinkled with water, which froze the blocks together. The section inclosed was then flooded, and this, upon freezing, also held the blocks together more securely. Slight thawing spells had little effect on the fence.—C. L. Meller, South Fargo, N. D.

Cleaning the Sink

There are numerous methods of cleaning sinks, but many of them are not effective. A simple method of doing the work effectively is shown in the illustration. The sink is half-filled with water, and a



wide 1-in. plank about 1 or 2 ft. long is laid on the water. Standing aside to avoid being splashed, the operator strikes the board a few hard taps with the hammer, with the

result that the pipe is cleared by the transmission of the blow through the water, which dislodges the obstruction. This method will always be found effective, provided the obstruction is not too large to be forced through the pipe.

Repairing Marble Clocks

Marble clocks are built up of a number of pieces of marble cemented together, and these are liable to fall apart when the clock is old. A simple and durable repair is to scrape off as much as possible of the old cement and use plaster of Paris, mixed with water to join the pieces together again. It may be necessary in some cases to drill a number of $\frac{1}{8}$ -in. holes in the edges of the pieces to anchor the cement securely, or to drill smaller holes, and bind the pieces with wire hooks in addition to the cement.

A Strong and Simple Bridge

The photograph shows a strong and simple footbridge used over a gully on a western golf course. It is made of two strong planks, one a little shorter than the other. A cleat, 10 in. wide, is nailed between them in the center, and a 6-in. cleat near each end. The ends of the short plank are securely nailed to the



A Strong and Simple Bridge Made from Two Planks, Used across a Gully on a Western Golf Course

underside of the larger one. The bridge, so constructed, will support a dead weight of 1,000 pounds.

Test for Sodium Carbonate

Many photographers make up their stock solution of sodium carbonate and sodium sulphite in similar bottles, and as the labels of these bottles become dirty or are torn off very easily, it is sometimes impossible to tell which solution a particular bottle contains. A good method of finding out is to pour a small quantity of either liquid into a measuring glass and add a small crystal of citric acid. If a constant stream of bubbles issues from the crystal until it is dissolved, the solution is sodium carbonate, but if there is no action, the solution is sodium sulphite.

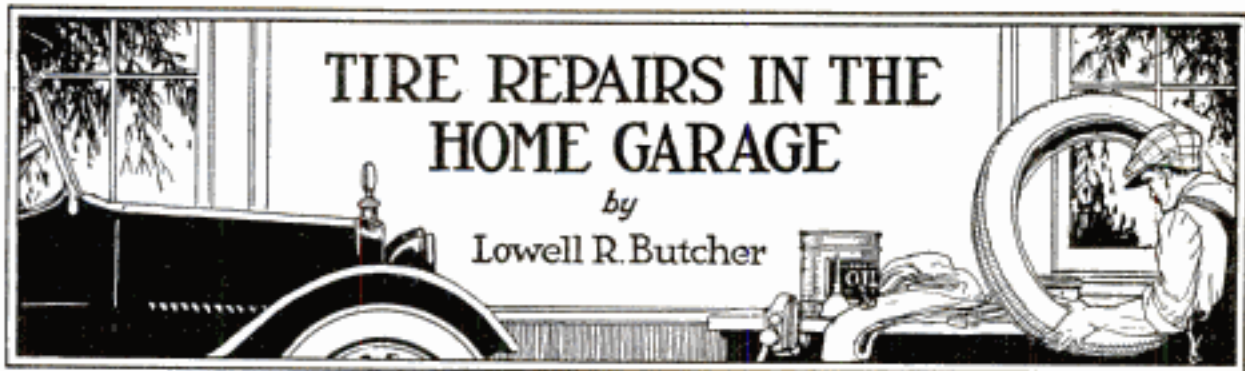

TIRE REPAIRS IN THE HOME GARAGE

by

Lowell R. Butcher

Part III—Inner Tube Repairs

THERE are few car owners who have not made repairs on inner tubes and it is equally true that there are but few drivers who have not had a tube repair fail on some particularly hot day. Many of the tube-repair failures can be avoided, for it is usually the workmanship that is at fault. A correctly applied patch will make the repaired section of the tube fully as strong as any other part.

Two methods of making tube repairs are in common use: the cold-patch repair, which needs no heat, and is often used for emergency repairs, and the repair by vulcanization, which requires heat to cure the patch. Many car owners prefer the vulcanized repair, holding that there is less chance of failure with this method.

The tire-repair shop makes use of heat from steam to vulcanize repairs, or, in some cases, the heat from an electric tube plate. While the car owner will have neither of these pieces of equipment, he can make vulcanized repairs fully as good as those turned out by any repair shop. A common type of vulcanizer, designed for the car owner's use, is shown in Fig. 1. This vulcanizer is especially convenient when making roadside repairs. The fuel is solid and is contained in a tiny pan the size of the patch. The patch is on the bottom of the pan. To make a tube repair with this vulcanizer, the pan is clamped over the damaged spot, the fuel lighted and in a few moments the repair is neatly vulcanized. This equipment does very well for the smaller tube repairs.

A small gasoline vulcanizer may be secured to make the larger repairs, although such equipment is not absolutely necessary. Almost every home affords an electric iron that can be used to cure the repair. With a little experience, a neat job of tube repairing can be turned out with the iron.

First, and the simplest of all repairs, is the puncture. Either the cold-patch method or the small tube vulcanizer may be used to make the repair. In either

case the tube must be well cleaned before any repair is attempted. Sandpaper the portion of the tube around the injury until all grease and dirt are removed and a "roughed" place is provided for the patch. If some high-test gasoline can be obtained, use a little of this to clean the injury. Clean water is better than the commercial grades of gasoline, which usually contain more or less kerosene and low-grade fuel.

If the small vulcanizer is to be used to make the repair, strip the protective linen covering from the patch and clamp the pan and patch over the injury. Prick up a corner of the fuel with a nail or pen-knife and light. Allow the vulcanizer to remain in place for at least five minutes after the fire has died out. After that, the tube can be dusted with mica or talc, replaced in the casing and inflated. No cement is required when making a repair with this equipment.

The cold patch will require cement for holding the patch into place. Apply two or three coats of this to both the patch and the tube, and allow each coat to dry partly before the succeeding one is applied. Cut a patch from the repair stock, allowing a liberal lap all around the injury; a round or oval patch is best as there are no corners to loosen. When the final coat of cement has dried until "tacky," press the patch into place and use a small C-clamp and block, as shown in Fig. 2, for applying pressure while the cement dries. Allow the patch to dry fifteen or twenty minutes before using the tube. Many failures of cold patches are due to using the tube before the cement has dried.

The tube damage will often be in the nature of several tiny holes in a group, or a puncture which is in the center of a chafed spot. In such cases, it is better to use one large patch to cover the group of holes or the entire chafed surface. A chafed spot in a tube indicates a weakened place and it will be only a matter of time until more repairing is needed

unless the entire surface is covered. Sometimes a portion of the tube is blown out or the tube is badly torn when a tire "blows." If the hole or tear is over $\frac{1}{2}$ in. long, it is best to reinforce the injury from the inside, as, if only an outside patch is used, there is apt to be a weak spot at the point of repair.

First of all, the hole should be trimmed so that the edges are smooth. Ragged edges on a hole are simply an encouragement for tears. Use sandpaper or emery cloth to clean and buff the inside and outside of the tube around the hole. Wash the injury with some high-test gasoline or some clean water. If the repair is to be vulcanized, the inside patch should be made from a material known as combination backing. This is a regular vulcanizing gum and has one side semi-cured to prevent the patch from sticking to the opposite side of the tube. Cut a patch from this large enough to lap the hole at least $\frac{1}{2}$ in. all around.

Regular vulcanizing cement must be used to make the repair. Apply three liberal coats to the inside of the tire and to the raw side of the patch. When the final coat of cement is almost dry, the patch should be inserted. Moisten the inside of the tube with high-test gasoline to prevent the patch from sticking until it can be centered. Place the patch over the hole, cemented side up, and force it in with a blunt stick as indicated in Fig. 3. Lifting up on the tube while the patch is pressed in will help to get it through. Center the patch carefully before the gasoline dries and inflate the tube slightly to smooth the patch into place.

Before the outside patch is applied, the hole must be plugged with a little gum. This plug should be cut from tube-repair stock to a shape that exactly fills the hole. Now cut the outside patch, making the corners round, and the lap around the edges of the hole slightly greater than that of the inside patch. Regular tube-repair stock is used for the outside patch. Cement as for the inside patch and press firmly into place, and the repair is ready for vulcanizing.

A piece of cloth or paper should be placed between the electric iron and the patch; "holland"—the protective cloth found around new repair materials—is excellent for this purpose. Place a smooth board under the tube, and clamp the electric iron down on the repair with a large C-clamp, as in Fig. 4. Some little experience in regulating the heat is necessary to get the best results. If the iron is heated to a sizzling heat and the cur-

rent turned off before the iron is clamped into place, there is usually enough heat retained in the iron to cure the repair. An undercured repair will be soft and retain the impression made when a pencil is pushed into the gum. Properly cured gum will spring back into shape after the pencil is removed. Overcured material will be hard, brittle, and lack the life of properly cured rubber.

The repair just outlined can be made by using the cold-patch method, but it is doubtful if the finished job will be as satisfactory. Regular cold-patch material is used instead of the vulcanizing gums and cold-patch cement instead of the vulcanizing cement.

It is a little difficult to repair an injury very close to the valve stem. This kind of a damage, or a torn valve-stem hole, is best repaired by shifting the valve to a new position, and patching the old hole. In shifting the valve stem, one should always push the valve stem inside the tube. Any effort to pull the bottom of the stem through the hole it is to occupy may result in tearing the tube.

The valve pad for the new position may be cemented into place with cold-patch cement or vulcanized, but the latter is to be preferred as the repair is more likely to be permanent. Select the new position for the valve and cut a small hole for the stem. Buff the tube around the hole with sandpaper and wash carefully. Cut an old valve pad from a worn-out tube and buff the bottom of this thoroughly. Cement both the tube and the bottom of the pad with three liberal coats of vulcanizing cement.

Cushion stock, a yellow vulcanizing gum, is used to bind the pad to the tube. Mark out the space to be occupied by the pad and cover this portion of the tube with cushion stock, $\frac{3}{16}$ in. thick. This is best applied in narrow strips. Continue to apply these until the entire space to be occupied by the pad is evenly covered, then press the pad into place and roll to press out any air bubbles. Fill the valve-stem hole with a chunk of inner tubing to prevent the hole from filling from the overflow of the gum during the cure. Slightly more heat may be required in this case, due to the fact that the raw gum is sandwiched between the pad and the tube. The electric iron is clamped down as before and the repair cured. After the vulcanizing is done, the valve stem may be pushed up through the hole and the valve assembly tightened into place. The hole formerly occupied by the stem is repaired in the usual manner.

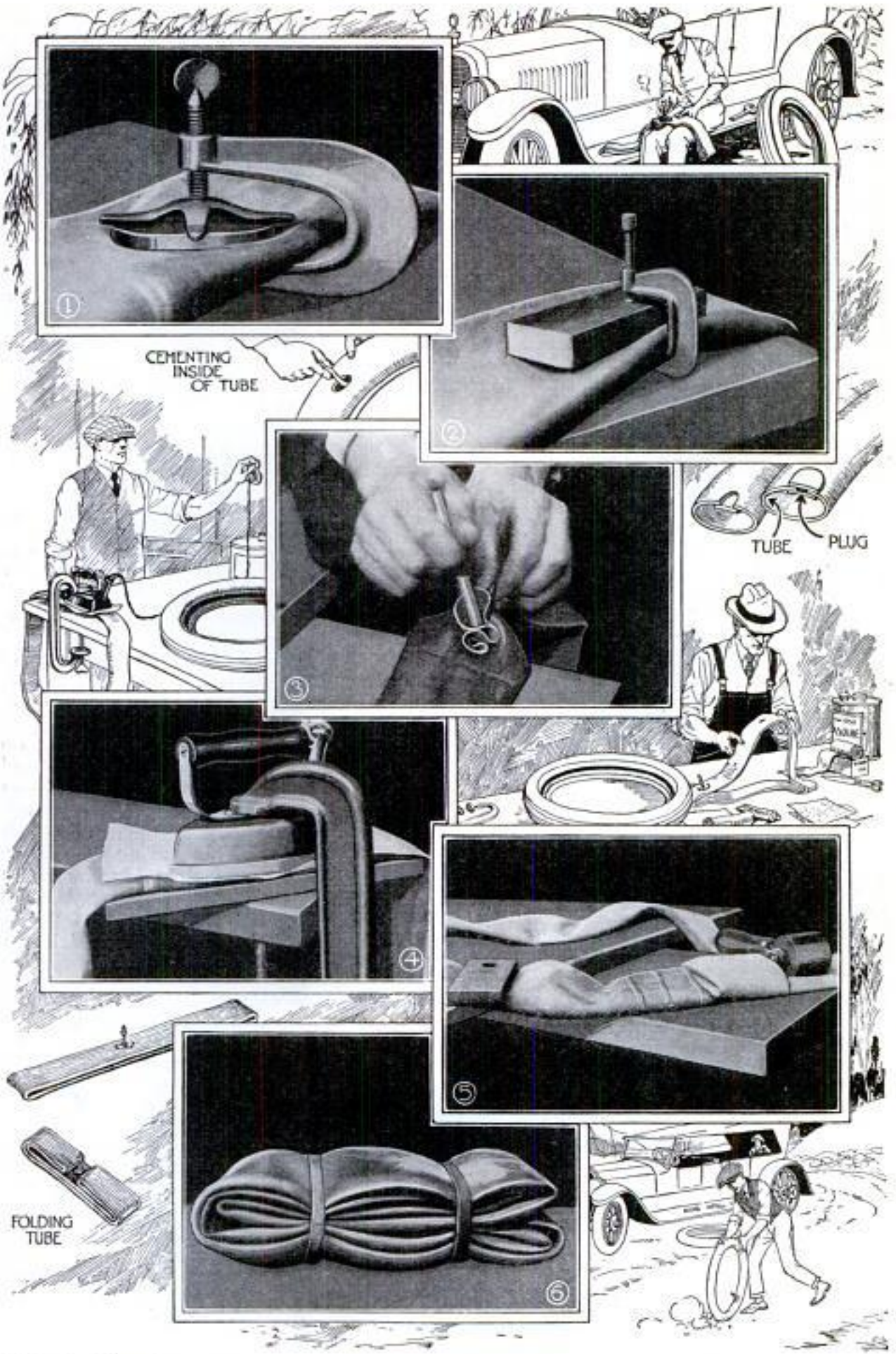

CEMENTING
INSIDE
OF TUBE

TUBE PLUG

FOLDING
TUBE

Methods of Repairing Injuries in Inner Tubes, from the Smallest Puncture to the Blowout Requiring the Splicing In of a New Section: This Work May All Be Done by the Car Owner

Bad blowouts or tears which extend part way across the tube may be so serious that they cannot be repaired by the usual methods. Sometimes what may seem to be an impossible repair may be made by cutting out the damaged section and splicing in another section of tubing the same length. This kind of repair necessitates two end splices, by far the hardest tube repair there is to make, and much care must be taken to keep the tube from being either shortened or lengthened during the splicing. The section cut out should be measured to give the dimensions for the replacement section. This section can be cut from another old tube of the same size as the damaged one. Cut the replacement section about 3 in. longer than the part cut out; this will allow for a lap of $1\frac{1}{2}$ in. at either end.

By trial, it will be found that the section to be spliced in is slightly larger or smaller in diameter than the tube. Make the splice so that the smaller diameter fits inside. Clean the splice ends by buffing them with sandpaper and wash with some high-test gasoline. If the part that is to fit outside is turned back, the buffing and cementing can be done more easily. Cement both the inside and the outside section of the lap with three coats of vulcanizing cement. Cut three strips of $\frac{1}{32}$ -in. thick cushion stock and arrange them around the inside end of the splice as shown in Fig. 5. Turn back the other section over this and roll the joint to press out any air bubbles or wrinkles.

Three "hitches" will be needed to cure the joint. Clamp down the heated electric iron on the splice and allow it to cure the splice from one side. Turn the tube one-third of the way around, and repeat the operation, and finally flatten the remaining third down and cure again. After the last cure is made the tube should be plunged into water to prevent the tube from sticking together on the inside. The second end splice is made exactly the same as the first, after checking the tube for length.

These ordinary repairs will take care of all common tube injuries.

No matter which method of repair is used, the success of the repair will depend upon the cleanliness with which the work is handled and the care taken in doing the work. Grease, oil, and dirt are fatal to repairs, and the first duty of the repairman should be to see that the injury is thoroughly cleaned.

The larger tube injuries are easy to find but tiny pin-hole punctures may be difficult to locate, especially if no water

is available in which to test the tube. If the repair is being made by the roadside, roll the partly inflated tube in the dust of the road, and a spurt of dust will be kicked up by the air from the puncture. The hole can sometimes be found by passing a moistened finger along the suspected part of the tube, when the air current from the hole will feel cool to the moistened finger. A particularly elusive puncture can be found by mounting the tube in a casing and inflating. Test the entire tire in a tank of water and mark the position of the leak on the casing. When the tube is removed, notice what portion of it was adjacent to the marked place on the casing.

Inner tubes become worthless if allowed to hang in the light and air for any length of time. If an extra tube is not carried in the car, it is best to fold it up and put it away in a dry and cool place. If an inner tube becomes dead and lifeless it can be restored, to some extent, by soaking in warm water.

The tube which is carried in the car should be folded and packed in a bag or wrapped in burlap. Boxes should be avoided, as they are apt to rub holes in the tube. A section from a large inner tube makes a very satisfactory bag for carrying the tube. The smaller tube can be folded and slipped inside the section from the large tube. The proper method of folding the tube is shown in the lower left-hand sketch, and the folded tube in Fig. 6. Needless to say, the inner tube should not be thrown in among the tools, where holes will be punched in it. Pack it carefully and put it where there will be no danger from shifting equipment.

All the tube repairs mentioned are so simple that they can be made without the aid of an expert tire man. The materials for the vulcanized repairs can be purchased at any tire shop, and only a small quantity of any should be purchased at a time. The age of the materials has nothing to do with their quality, but dirty materials will not make good repairs and a little stock will last the ordinary man a long time. If the materials get soiled or seem to lack life, freshen them up by washing with high-test gasoline.

A gasoline vulcanizer may be purchased if desired, to make the larger repairs but there is no need of going to this expense when such excellent results can be obtained with the electric iron. If the motorist wishes to make his emergency tube repairs by vulcanizing, the small solid-fuel vulcanizer makes a very compact repair outfit.

Drying Rack for Stove

The photo shows a simple drying rack, made of heavy galvanized wire, that can be attached to the stove in an instant, and removed as quickly. Each end of the wire is bent to a 4-in. loop and then bent at right angles to the front length.



The ends are then bent sharply upward for a length of 1 in., to slip between the door and the frame of the warming oven. Such a rack is of considerable usefulness when a few clothes must be dried in a short time.

Preventing Bell Contacts from Sparking

Where doorbells are operated from transformers, or directly from a d. c. house circuit through a resistance, there is usually heavy sparking at the contacts, and this rapidly burns away the points, making frequent renewals necessary. To eliminate this trouble, and make the bell

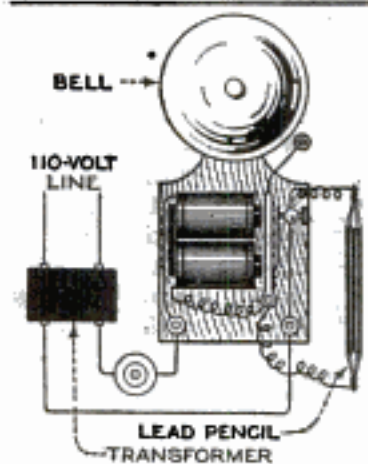

operate more steadily, a resistance should be connected across the contacts as shown in the illustration. A simple and effective resistance for this purpose is an ordinary lead pencil. The wood is cut off both ends of the pencil, and the wires twisted tightly around the bared ends of the lead. The wires are connected with the vibrating member and with the fixed contact. This resistance will pass the high-voltage current formed at the break, but will not shunt out the contacts and prevent the bell from ringing.

☐ Moths will rarely touch anything wrapped in newspapers, and winter clothes thus stored will be almost sure to escape damage.

Stretching Wire Fencing

A simple and efficient wire-fence stretcher is shown in the drawing. It consists of two lengths of 2 by 6-in. wood

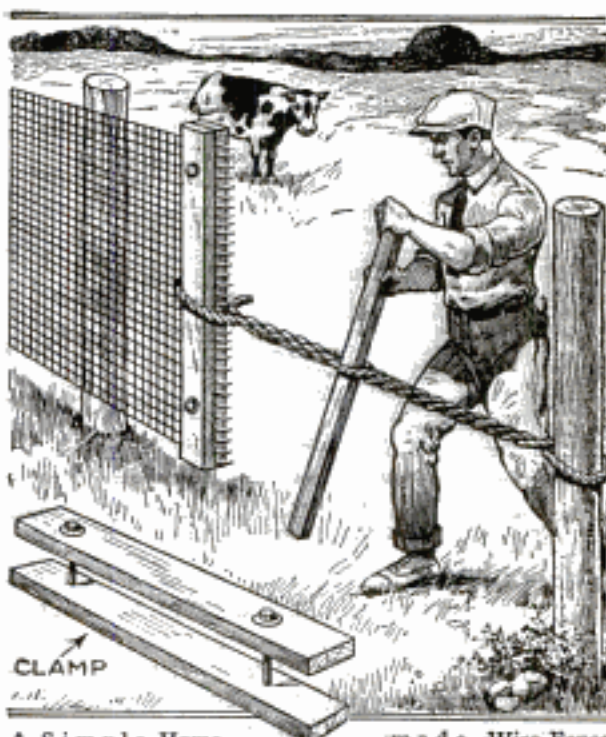

A Simple Home-made Wire-Fence Stretcher That Has Been Found Satisfactory

with two or three bolts passing through them so that they can be securely clamped to the end of the fencing as shown. A heavy rope is passed around both pieces, around a fence post, and tied. A stout stick is used to twist the rope, thus pulling the fence as tight as desired. The device can be made in a short time from material that can be found on every farm. —Geo. A. Luers, Washington, D. C.

Shaving the Lawn

Shaving the lawn with a safety razor seems ridiculous, but it has been done. Passing over the lawn with a lawnmower did not exterminate the numerous dandelions, so another method was necessary. Four razor blades were screwed to the narrow edge of a short length of lath, and a handle was attached as shown in the drawing. Using this simple tool the dandelions, including the buds, fell at the slightest touch. —Francis W. Lane, Villa Park, Ill.

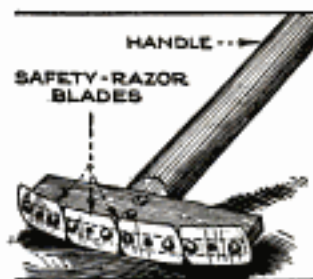

Exhaust-Gas Cook Stove for the Tourist

When equipped with a stove of the kind shown, the tourist does not have to worry about fuel for his stove, as his gasoline is also his fuel supply. The

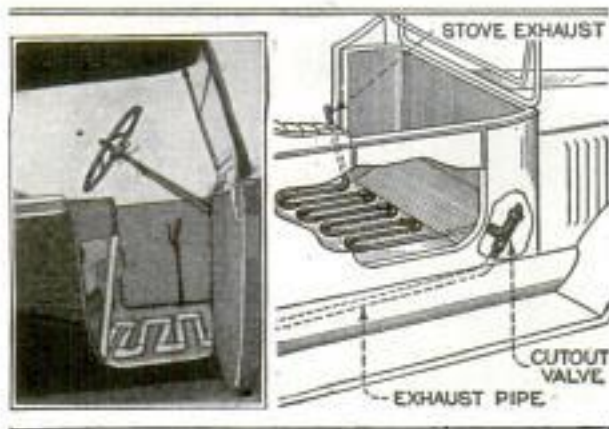

Camp Cooking Is Simplified by the Exhaust-Gas Cook Stove on the Floor of the Automobile

whole apparatus consists of pipe and fittings arranged so that it can be connected to the exhaust pipe of an automobile. The stove is made of several short lengths of pipe connected together by return elbows to form a hot plate. A cutout valve is inserted in the exhaust pipe at the point shown so that the stove can readily be attached and detached. It is, of course, necessary to provide a thick sheet of asbestos between the hot plate and the floorboards to prevent burning the latter. When the plate is not in use it is removed.—Curtis Clark, Waldo, Ark.

Tool Removes Milk-Can Covers

When the lid of a filled milk can is pressed down to prevent spilling the contents in transportation, a partial vacuum is created, which makes it extremely difficult to remove the cover again. To



overcome this difficulty a Wisconsin farmer made the simple tool shown in the illustration. It consists of an iron bar with two holes drilled as shown to receive bolts, which have their heads cut off and the shanks bent to form hooks. In use the tool is grasped at the two

ends and lowered so that the hooks engage with the handle of the cover. A quick twist and pull serves to loosen the most stubborn lids. This eliminates the use of mallets or hammers for removing the covers, a practice that damages thousands of covers every year.

Tightening Loose Watch Crystal

Watch crystals frequently become loose and cause a great deal of annoyance by constantly falling out. A simple and effective method of making them remain in place is to put a minute drop of glue at six or eight points in the groove. This can best be done with a toothpick or match stick. When the crystal is snapped back into place it will remain there indefinitely. Any glue that squeezes out on the glass can be removed very easily after it has dried.

Saving the Ties

The necktie kink shown in the illustration prevents neckties from stretching

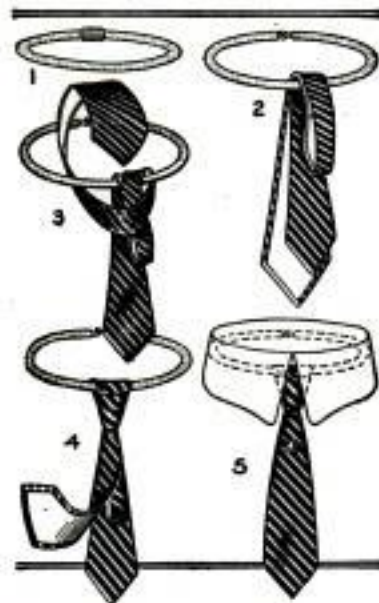

out of shape and from raveling, and eliminates the necessity of tying them every time they are worn. A permanent knot is tied on a flexible arm-band as shown in Figs. 2, 3, and 4, the band being cut in two at the point indicated, and the ends fitted with a hook and eye. The method of arranging the band under the collar is shown in Fig. 5.—Robert C. Knox, San Luis, Calif.

Repairing Narrow Curtain Lights

Broken celluloid curtain lights on a car can be readily and inexpensively replaced with ordinary kodak film, developed without being exposed. Cut the strip of film to the proper length and fasten it in place. As this film is thinner and more flexible than the celluloid used in curtains, it will not break so easily.

Storing Robe in Roadster

How to prevent the robe in my roadster from becoming soiled, was a problem that troubled me for a long time; it could not be kept clean on the rear deck, or on the floor of the compartment behind the seat, and it was impossible to keep it on the seat. I found, however, the use of a towel rail, screwed inside the compartment behind the seat, to be very satisfactory. It was large enough to accommodate the robe and also a sweater or coat, and prevented these from becoming soiled.—M. C. Johnstone, Madison, Wis.

Simple Negative Rack

The illustration shows a simple negative rack that can be made by anyone in a few minutes, from 4 pieces of wood and a number of nails. The back or base is about 4 in. wide and about 1 or 2 ft. long, and a hole is drilled at one end so that it can be hung on the wall. Two triangular-shaped blocks, about 4 in. high, are nailed on the baseboard and a length of 1-in. wood is nailed to these, as indicated. Small brass nails are driven into the base from the back, and are spaced about $\frac{3}{4}$ in. apart; the plates are set on the nails and rest against the front strip at an angle, as shown.—John H. Curtis, Philadelphia, Pa.



A Barbed-Wire Winder

The barbed-wire winder shown in the photograph can readily be made from material found on every farm, and it winds the wire on a spool just as neatly as is done in the factory. It consists of a frame made from pieces of wood of the dimensions shown in the illustration. Two V-shaped end supports are made of 2 by 4-in. lumber, the ends being spiked and bolted together. The supports are inverted and crosspieces are nailed on, the crosspieces being about 30 in. long. A strap-iron bearing is screwed on each support near the top as indicated in the end view, or if preferred, a $\frac{3}{4}$ -in. hole can be drilled through the ends of the V supports to serve as bearings instead

of the strap-iron pieces. A $\frac{3}{4}$ -in. pipe or rod is bent to the shape of a crank and a $\frac{1}{4}$ -in. hole is drilled through the crank, about 6 in. from the straight end, so that the spool can be securely attached. The



A Simple Homemade Barbed-Wire Winder Made from Material Available on Every Farm

spool consists of two pieces of 1 by 5 by 16-in. wood with a $\frac{3}{4}$ -in. hole drilled through the center, and two pieces of 1 by 5 by 20-in. wood, nailed across the first. The winding crank is pushed through the bearings of the frame and holes in the spool and a 6-in. spike or round piece of iron, held by ordinary fence staples, driven through one board of the spool, keeps the spool securely on the crank.

Keeping Wedges from Rebounding

Log-splitting wedges become smooth and polished after being used awhile, and this condition allows them to rebound very easily when driven in. The trouble can be eliminated by cutting a number of nicks in the sides of the wedge with a cold chisel, the nicks being driven in toward the point of the wedge. The edges of the nicks are slightly burred and this prevents the wedge from rebounding.

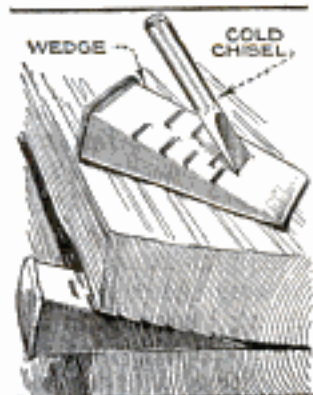

Stepladder Extension for Camera Tripod

In order to take pictures of objects too high for the reach of the ordinary tripod, an amateur photographer devised the combination stand shown in the photo.

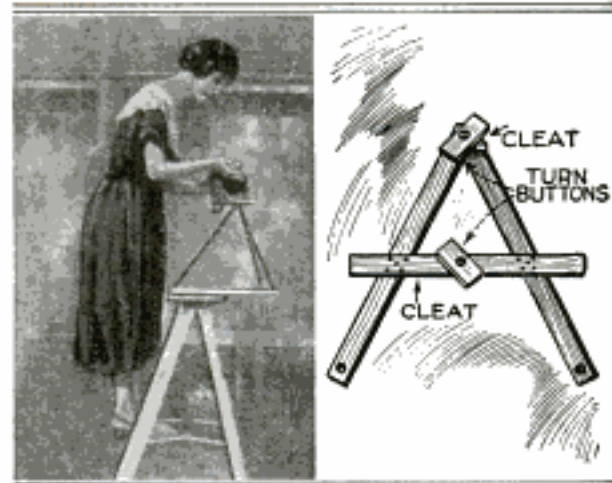

A Convenient Extension on the Top of a Stepladder Provides a Stable Base for the Camera Tripod

It consists of a wooden frame that can be attached to the top step of a stepladder so that the camera tripod can be conveniently mounted on it, enabling the photographer to look into the finder and locate his subject almost as easily as on the ground.

The frame is made by cutting two hardwood legs as shown in the detail, and nailing them together at one end, at an angle of 60°. Nail a small cleat over this joint, and parallel to it, at a distance equal to the width of the upper step of the stepladder, nail another cleat. Screw a heavy turn button to the center of each cleat so that the frame can be clamped securely to the stepladder. Bore small holes in the ends of the legs and at the joint to receive the points of the tripod legs, to prevent the tripod from slipping.

Two-Tone Photographs

Most amateur photographers are familiar with the sepia-toning process; the print is first immersed in the bleaching bath until the image is almost invisible and it is then transferred to the sulphiding solution, which restores the picture in sepia tone. However, few photographers have much use for the sepia-toning process, as it can be used only for a limited class of subjects.

A new process of toning photographs in two colors, sepia and black, produces an artistic effect and greatly increases the field of sepia-toning. The portions of the

photo that are to be toned sepia are painted with a double-strength bleaching solution, applied with a small camel's-hair water-color brush. The bleaching is accomplished much more easily by soaking the print in water and blotting it so as to leave it moist before applying the bleaching solution. Care must, of course, be taken to avoid getting any of the bleaching solution on the portion of the print that is to remain black. After bleaching, the print is immersed in the sulphiding solution. The portions of the print that have been bleached will be sepia and the rest of the photo remains black, giving a pleasing combination.

Objectionable backgrounds should be sepia-toned to make them less conspicuous, allowing the subject to remain black, but in cases where the subject is of a brownish color, it should be toned sepia to make it appear more natural, as black and white photos cannot do justice to a brownish subject.

Coupling for Spring Fan Belt

The illustration shows how a screen-door spring was used in an emergency as a fan belt on an automobile. The spring was stretched until the pitch of the coils was about $\frac{1}{8}$ in., in order to give it the necessary

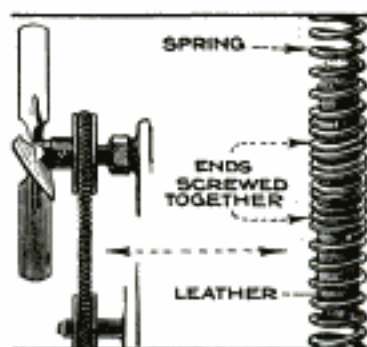

stiffness. The two ends were coupled by means of a 1½-in. length of round leather, with the ends slightly tapered to make an easy entry into the ends of the spring. This piece was screwed halfway into each end of the spring and the spring was twisted until the ends screwed into each other far enough to tighten the spring on the pulleys. The spring belt thus made was only intended as an emergency repair but was found to give better service than the regular V-belt.

When an ink bottle was accidentally upset on a carpet, a quantity of ordinary table salt was instantly applied to the spot; the ink was quickly absorbed by the salt, and when the latter was removed by means of the vacuum cleaner, the spot was scarcely visible.

Care of Radio Storage Batteries

By F. L. BRITTIN

ONE of the most necessary pieces of radio equipment—and the one that usually receives the least care—is the storage battery. The life of a storage battery can be prolonged to a remarkable extent by a little intelligent care, but most amateur operators, aside from the dyed-in-the-wool "hams," abuse their batteries

with a rubber bulb at the top, a nozzle at the bottom, and a weighted float inside, marked with graduations on the neck; the graduations usually run from 1.300 to 1.100, although the decimal point is often omitted on the scale figures. The method of using the instrument is as follows: Unscrew one of the filler caps

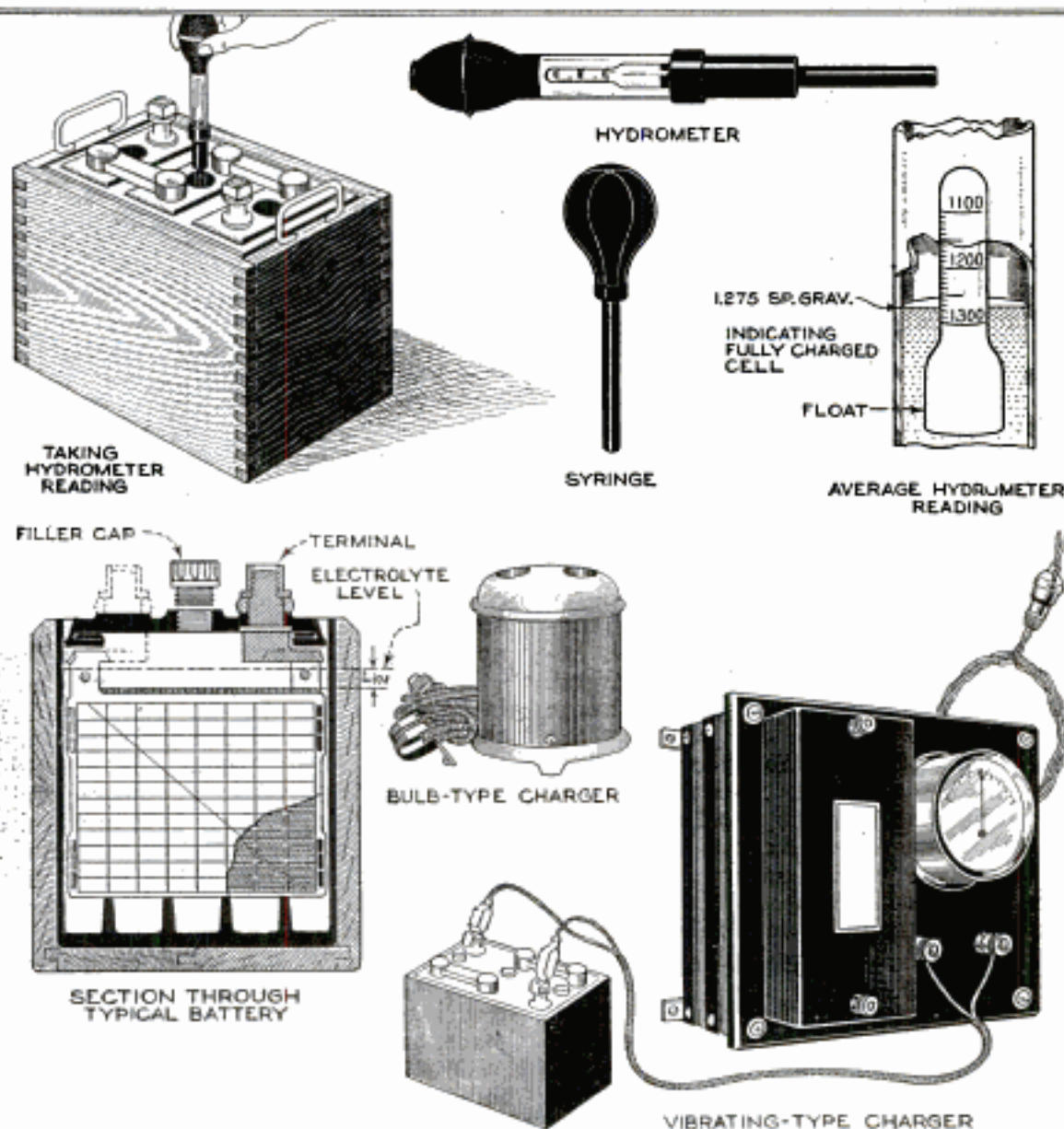

Various Instruments and Methods Used in Caring for the Radio Storage Battery: A Little Intelligent Care Will Prolong the Life of Any Battery, and the Time Is Well Spent

unmercifully, and then wonder why such an expensive piece of equipment does not stand up long.

Every owner of a storage battery should own a hydrometer, and use it every ten or fifteen days to determine the specific gravity of the electrolyte. This instrument consists of a glass tube or barrel,

on the battery and insert the nozzle of the hydrometer into the electrolyte. Compress and release the bulb at the top two or three times, and then withdraw the nozzle. The barrel of the hydrometer should now be about half full of electrolyte, and the float will ride in the liquid at a depth depending upon

the specific gravity. Hold the barrel vertically so that the float will not rest against either side of the tube, and, to prevent the electrolyte from running out, compress or bend the rubber nozzle tube. When the float is at rest, observe the point on the scale reached by the liquid level. It will be found that the gravity of a fully charged cell will vary, with the make of the battery, all the way from 1.275 up to 1.300, so the proper reading should be obtained from the maker when the battery is purchased. Also, an old battery will show a lower gravity than a new one, so that a reading of from 1.250 to 1.275 may indicate a full charge in a battery that has been in use for a considerable time.

The temperature of the electrolyte also affects the reading. The normal temperature at which readings should be taken is 70° F., and if the temperature is much below or above this point, a correction should be made. However, batteries used in the home are not much subject to extreme changes in temperature, so this point can be neglected.

Taking an average reading of 1.275 as indicating a fully charged battery, then a reading of 1.245 would indicate that the battery was three-fourths charged; 1.210 that it was half charged; 1.180 one-fourth charged; 1.150 fully charged. The reading should never be allowed to fall below 1.180 before the battery is recharged.

After the reading is taken, discharge the electrolyte into the cell, and test the other cells, one at a time. Never assume that because one cell indicates a full charge that the others are all right—test them all. Care must be taken not to spill the electrolyte on the battery top, and, if this is accidentally done, the liquid should be washed away with ammonia water or a solution of washing soda, afterward wiping the top dry.

Always return the liquid to the cell from which it was taken, as taking electrolyte from one cell and returning it to another will unbalance the electrolyte, and make future readings unreliable.

If the level of the liquid is below the tops of the plates, so that enough cannot be drawn to float the hydrometer, enough distilled water should be added to bring the liquid to the correct height. Before taking a reading under these conditions, however, the battery should have several hours' charge to mix the liquid thoroughly. Always wash out the hydrometer with distilled water after using, as the electrolyte will rot the rubber if allowed to remain in it.

The electrolyte must always be kept $\frac{1}{2}$ in. above the tops of the plates in the battery, and it will be necessary to add pure distilled water to each cell about once every two weeks to accomplish this. A special syringe is best for this purpose, and may be obtained at any battery station, but the hydrometer syringe may also be used. If one cell regularly requires more water than the others, a leak is indicated, and the cell should be replaced by a new one by a competent battery repairman. If the specific gravity in one cell is 50 to 75 points below the others, it indicates a short circuit, and this also demands the repairman's attention, as it will injure the battery seriously if neglected.

Under no circumstances should acid be added to the electrolyte, except by the repairman; use nothing but distilled water.

Several types of battery chargers are now on the market, and two of these are illustrated in the drawing. The vibrating type, while a little noisy, gives good service; the bulb type is comparatively quiet, and the author has used a charger of this kind for several years with good results. A double-pole, double-throw switch, placed under the operating table, is used to cut the charger in and out, and an overnight charge is all that is usually necessary to keep the battery "up."

Never overcharge the battery, as this is likely to buckle the plates and ruin the battery. When the battery is not in use for a long period, it should be drained and placed in dry storage at the battery station, or kept full, and a freshening charge given it once a month, to keep it in condition. Also, never keep a battery in any place where the temperature is likely to fall below zero.

Always remove the filler caps from the battery while charging; when the battery reaches full charge, gassing will take place, and the battery top will be covered with a fine deposit of electrolyte. Remove this with a cloth dipped in ammonia water, wipe dry, and replace the caps. It is a good idea to keep the terminals and connectors liberally covered with vaseline, as this prevents corrosion.

With proper care, a storage battery has been known to last five years, in very good condition, so that the time and trouble spent in caring for the battery will prove a paying investment.

¶Thin sheets of paper may be pasted together without wrinkling, by using air-drying rubber cement.

Cigar Box Used as Square

While building a gate I mislaid my square, which made it necessary to make use of some substitute. Finding a cigar box I tried to use it in the manner illustrated and found that it did the work

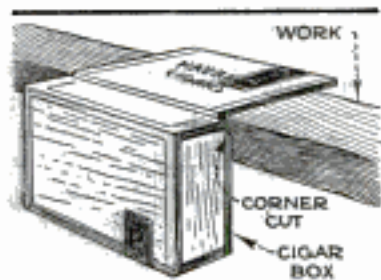

quite as well as a square, and was also just as handy. To test its accuracy, I used it to mark a continuous line around a piece of 2 by

4-in. wood, and found that the last line was perfectly in line with the first. The corner was cut as indicated so that the first line marked could plainly be seen when drawing the second.—Ben Frantzreb, Indianapolis, Ind.

Conveyor for Lifting Water up Incline

The drawing and photograph show a convenient method of conveying water up a steep incline, in order to eliminate hard climbing, which was otherwise necessary to obtain water from a point below the camp. The conveyor consists of a pail suspended a few feet below an inverted pulley, which runs on a wire suspended rigidly between a tree at the camp and a post driven into the ground near the water supply as shown. A long rope is connected to the pulley and is wound

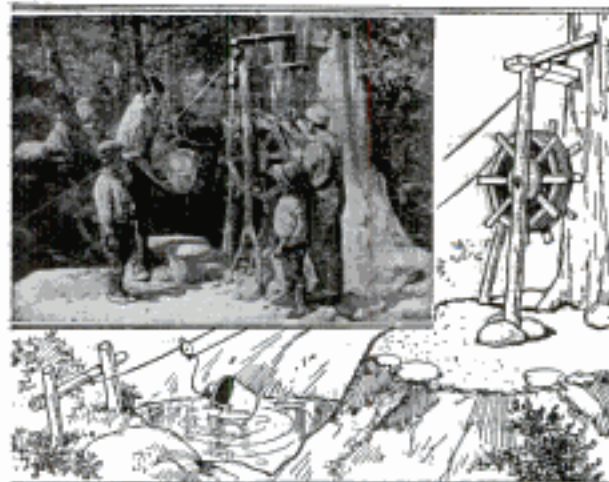

A Handy Conveyor for Lifting Water up Steep Inclines, That Saves Hard Climbing

on a large wooden drum, which is revolved to raise or lower the pail. When the pail is lowered it strikes the water and tips over, filling up immediately.

Concealed Counterweight for Cellar Door

The old-style trap doors covering the outside cellar stairs are rather unhandy to open, and for this reason counterweights, arranged as indicated in the

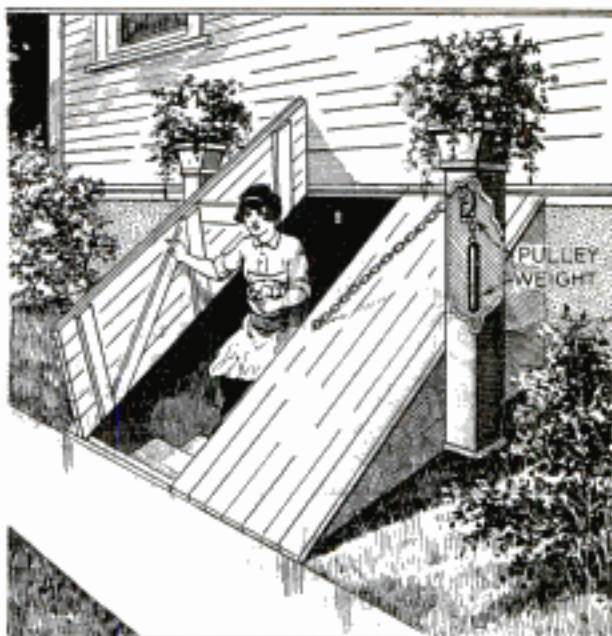

Counterweights Concealed in Ornamental Posts Aid in Opening Heavy Cellar Doors

drawing, have been found to be of considerable assistance. A hollow post made of $\frac{3}{4}$ -in. lumber, and set securely in the ground, is located on each side of the door. A pulley is fastened in one side for a chain to run over, one end of the chain being attached to the door, and the other end to a counterweight such as an old sash weight.

The appearance of the posts is greatly improved by mounting wooden flower boxes on top of them. The post and flower box are painted the same color as the house.—M. E. Duggan, Kenosha, Wisconsin.

Draft Shield for Carburetor

On many automobiles the carburetor is situated rather low on the side of the motor, right in the path of the air draft, which, during cold weather, cools the carburetor and prevents it from working properly. This trouble can be eliminated by providing a sheet-metal shield, large enough to close the space between the engine and the hood, and extending at least to the top of the motor. It is fastened under a manifold clamp, and its edges are rolled or bent over to prevent cutting the hands. Galvanized iron or brass is the best material to use for the shield.

Pulley Made of Pan Lids

A round-belt or V-pulley is often used in model and experimental work. As pulleys of the right diameters

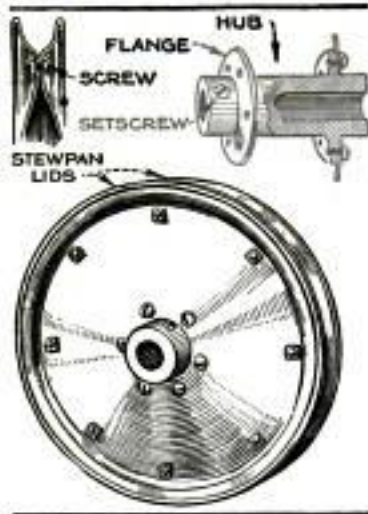

cannot always be purchased, the builder is often forced to make his own. A neat and strong pulley of large diameter can be made out of two stewpan lids, bolted together as shown in the drawing. The knobs are removed and the rivet hole is enlarged to slip

over a brass or steel hub, which can be keyed or screwed to the shaft. The center hole must, of course, be in the exact center of the lids. Six small screws are used to hold each lid to a hub flange, the flange being drilled and tapped to receive the screws. Stovebolts, as many as are necessary, are used to clamp the two lids firmly along the edge. Pulleys of this type are light and strong, besides being neat in appearance.

Simple Hanger for Portable Lamp

A convenient device for holding an extension cord at any point above the workbench or lathe is shown in the illustration. It consists of a length of heavy wire, stretched tightly over the bench, and a

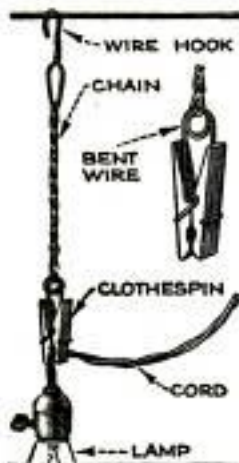

wire hook, fitted with a short chain and a spring clothespin as shown. The socket end of the extension cord is held by the clothespin, allowing the lamp to be hung at any desired height, and the hanger can be slid along the wire to the most convenient position for the worker. The wire on which the hanger slides is suspended between

two walls and is kept taut by means of a turnbuckle at one end. The clothespin is fitted with a wire hook, run through the center of the spring.

Spillways for Miniature Dams

On small concrete dams short lengths of pipe, with a cap on each end, make excellent spillways. They are, of course,

inserted through the form, and the concrete poured over them and the wire fencing used as reinforcement. The pipes should be of different

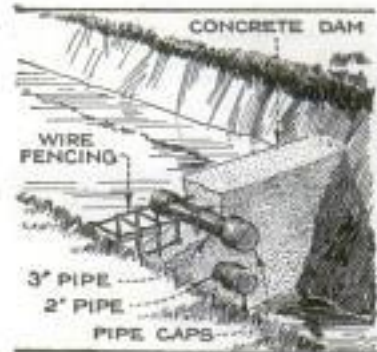

sizes, to allow variation in the rate of discharge, and they should be located one above the other as indicated, to make possible complete control of the height of the water behind the dam.

How to Make an Arrow Pistol

The arrow pistol shown in the photograph is a simple and entertaining device that can easily be made by anyone. A 14-in. length of pipe, or tubing, cut from the head of an old brass bedstead, forms the barrel. This is attached, with strips of tin, to a stock or grip, cut from a piece of wood, the top edge of which is grooved for the barrel. A strip of rubber, $\frac{1}{2}$ in. wide and 10 in. long, is cut from a discarded inner tube, and this is fastened to each side of the grip, by placing a square piece of tin over the ends, doubling the rubber twice, and fastening it with wood screws. The arrow can be made from any light wood, either tipped with feath-



A Novel Pistol for Shooting Arrows That Will Shoot Nearly 1,000 Feet with Considerable Accuracy

ers or not, as desired. The head should be pointed with a small nail, set into a hole drilled lengthwise in the wood. The mature stems of cat-tails, when cut to the proper length and tipped with shingle nails, form excellent arrows. Guns of the kind described have been found to shoot nearly 1,000 ft., with greater accuracy than a bow and arrow in the hands of a novice.

Making a Gear Tight

Considerable trouble was experienced with a large crank gear on a deep-well pump, as it came loose repeatedly, although it was retained in position by a setscrew clamping down a heavy key. To overcome the difficulty I mixed finely sifted cast-iron filings and common table salt with water into a creamlike mixture, poured it into the setscrew hole, then forced the setscrew down to the key. After pouring in so much of the mixture that it began to come out of every crevice, I put the setscrew down to stay and allowed the pump to stand idle for a few days. After being repaired in this way it has been in use continuously for over a year, and the gear is still tight.—E. B. Johnston, Canton, Ohio.

Baby Crib Made from Barrel

The latest contribution to a baby's ward in a hospital in Oakland, Calif., is a "barrel crib," which was devised to meet



the shortage of baby cribs. The barrel was sawed out as shown and was mounted on a simple wooden frame made of 1 by 4-in. material. The barrel was padded on the inside with a heavy

comforter, which was tacked on. The outside was rubbed down smooth with sandpaper, and given a liberal coat of white enamel, and a neat brass drawer handle was screwed to each end, so that the crib could be carried around conveniently. A number of these cribs have been made, and have given every satisfaction.—Miss Seline Hess, Oakland, Calif.

Straightening Gut Leaders

A gut fly or bait leader that has been coiled for any length of time is very hard to handle, as it kinks and jams easily, and is liable to crack when it is straightened out. To overcome this, take a piece of rubber about 3 in. square, from an old inner tube, and rub it briskly over the leader a few times; this will straighten it perfectly.—M. W. Meier, Seattle, Wash.

Portable Handrail for Porch Steps

Accidents on slippery porch steps, due to the formation of ice, can be avoided by the use of the portable steps and rails shown in the photo. The device is made



A Portable Step and Rail for the Porch Prevents Accidents Due to Slippery Steps

of wood and fits over the steps as indicated. The tread is cut from 1-in. boards, about 4 ft. long, so that two persons can pass side by side. The sidepieces are cut from 2-in. material, notched to fit the steps. The vertical pieces, supporting the rail, are made of 2 by 2-in. stuff, and are braced by triangular blocks cut from the sidepiece material. The particular advantage of this device is that it can be put away when the winter is over.

Making Tight Battery Connections

Storage batteries used on automobiles often have plain tapering terminals and this makes it unhandy to use them for radio purposes, as it is so difficult to attach wires to the terminals securely, in the absence

of heavy test clamps. A tight connection can, however, be made by cutting a small slot in the top of the terminal with a hacksaw as shown in the illustration, inserting

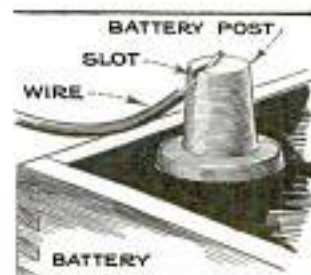

the bared end of the wire in the slot, and tamping the slot closed with a blunt-nosed tool. The small slot can hardly be noticed and will do no harm to the battery. This method of connecting is used in a battery station in preference to using clips, as these are soon ruined with battery acid and then make a poor contact, which has repeatedly caused the burning out of the rectifier bulb.

Tools Carried in Auto Door

Vacating the rear seat of an automobile so that tools can be obtained from under it, is very inconvenient to the passengers, especially during cold or rainy

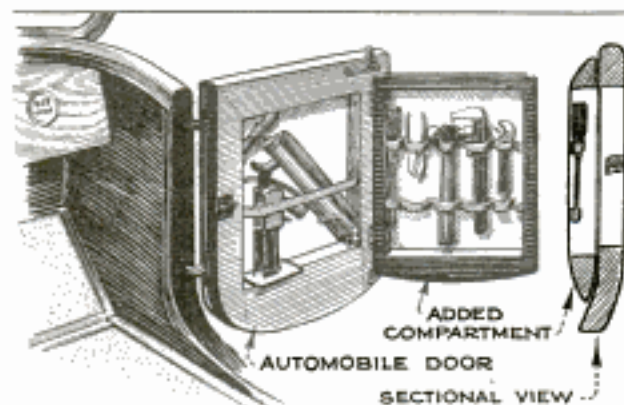

A Handy Automobile Tool Kit Incorporated with One of the Front Doors to Save Space

weather. A solution of this problem is to keep the tool kit elsewhere in the car, as for instance on the front door. The inside covering of the door is first removed and a frame, 2½ in. deep, covered with galvanized iron, is hinged to the door as indicated. The combined width of the door and of the additional compartment furnishes sufficient space for the jack, tire pump, and other tools. The tools are held in place by means of leather straps, arranged as shown, and a small catch is used to keep the compartment closed.

Testing Steel on Emery Wheels

Arguments often arise in the shops as to what particular type a certain piece of steel belongs. It is generally known that each kind produces a spark peculiarly its own, when touched on an emery wheel; but what these sparks are like, and to which kind of steel each belongs, is not

so easily remembered by everyone. The three most commonly used steels—machine, tool, and high-speed—can usually be recognized if the material is new, but if it is old, or has been used previously on other work, it is hard to judge just what it is without testing in some way. A

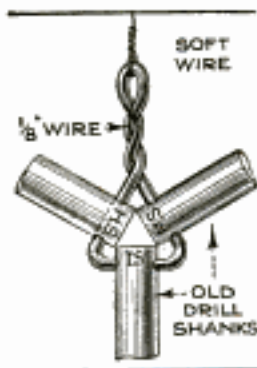

good practice, to avoid mistakes, is to keep samples of each at hand. The illustration shows a simple

method of doing this, which possesses the all-important feature of keeping the pieces together. Two old drill shanks, one of high speed, the other of tool steel, and a scrap piece of machine steel, have a 1/8-in. hole drilled through one end, and are stamped HS, TS, and MS respectively. The pieces are forced onto a 1/8-in. wire, which is then bent to a triangular shape to keep the pieces well apart, and twisted together, leaving a loop at the top. A length of soft wire is attached to this loop, the other end of the wire carrying a weight, and the whole thing fastened under the bench where the grinder stands, by two staples. In this manner it is kept out of the way when not in use. When it is desired to test a piece of steel the test pieces are pulled forward and touched on the wheel, while the piece to be tested is touched on the other side. In this way it is obvious to the most unskilled, by comparing the sparks, what kind of steel is being tested.

A Simple Lawn-Mower Repair

One of the signs of old age in a lawn mower is the failure of the knives to rotate when taking a heavy cut. Perhaps more lawn mowers are consigned to the scrap heap for this reason than for any other; yet the difficulty can be remedied very easily by a few minutes' work. Remove the wheels of the mower by unscrewing the center bolts, and lift off the spur gears that drive the knives. A 3-pawl ratchet, cast within the hub of the gear, acts on a sliding key running through the end of the knife shaft. As long as the faces of these pawls are nearly radial, they fit flat against the key when driving the knives; but when worn, as indicated in the upper detail of the drawing, they wedge the key down so that it ratchets in both directions, thus failing to rotate the knives.



The remedy is to dress the faces of the pawls. This can be done best by cutting straight through the front edges of the pawls, hub and all, with a hacksaw as shown, then chipping off the worn portion. The resulting cuts in the hub do not weaken it to any extent, as actual repairs made in this way have worked perfectly without any consequent breakage.

"American Flyer" Railroads and "Structo" Automobiles

Here's great news, boys and girls — this year we have made more "American Flyers" than ever before, so every Toy Store in your town can get a supply. We are also selling "Structo Autos" — you can buy them "Ready Built" or you can get them "Knocked Down" and put the parts together yourself. Remember, The American Flyer Company GUARANTEES all trains to be electrically and mechanically perfect. If any Toy Store hasn't got the "American Flyer" or "Structo" outfit that you want we will ship any of the trains, autos or equipment illustrated, post-paid on receipt of cash.



Stop for water



Water Tank
No. 2020
\$1.00

Made in America
American Flyer
The Train with the Movement — Registered U.S. Patent Office



Danger!

A full line of both electrically and mechanically operated "American Flyer" Miniature Railroads at the best Toy Stores. Take this Magazine to your Toy Store and ask to see these Trains and Autos.



No. 1221—Electric Engine, with headlight, 8 inches, 3 double-track cars, 6½ inches, 14 pieces of track; semaphore, station, tunnel; rheostat and track connection. Length of train, 31 inches. Price, delivered, \$11.00



No. 12

"STRUCTO" De Luxe Auto

Complete construction outfit—all parts ready to put together. Makes a car 16 in. long, as illustrated below. Price, delivered, \$10.00



No. 2—Mechanical Engine, with brake and piston rods 6½ inches, tender 4 inches, cars 5¼ inches; baggage car has sliding doors; 10 pieces of track; length of track, 103 inches; length of train, 24½ inches. Price, delivered, \$2.65



No. 44

"STRUCTO" Ready-Built Caterpillar Tractor

Complete as shown with disc harrow attached. Operated by a powerful motor. Works just like a real tractor. Measures 11 inches over all. Price, delivered, \$4.00



No. 13—Mechanical Engine, with brake and piston rods 7 inches, tender 4 inches, cars 5½ inches; baggage car has sliding doors; 12 pieces of track, 2 switches; length of track, 160 inches; length of train, 25 inches. Price, delivered, \$4.00

SEND TEN CENTS and we will mail you beautifully illustrated catalogs showing the full line of "American Flyer" trains and "Structo" Autos. We will also send free Horace Wade's famous story about "The Backyard Railroad" — how to build one and have loads of fun. You can operate a regular system of land transportation with "American Flyer" Trains and "Structo" Automobiles.

AMERICAN FLYER MFG. CO., 2233 South Halsted Street, Chicago, Illinois

Ask the Toy Store to show you this "American Flyer" Electric Train—the engine is an exact copy of the New York Central Electric Locomotive—the only electric engine that will reverse itself automatically whenever you want it to

No. 1207—Electric 12-Wheel Engine, with headlight and automatic reverse, mail car, 2 Pullmans, all electric lighted, 20 pieces of track; rheostat and connection; length of train, 48 inches, length of track, 202 inches. Price, delivered, \$27.00



Station—No. 100
\$2.50



Searcher Auto
No. 10
\$6.95

Station—End of Line
Take Structo Auto
for home



No. 12
Price
\$10.00

Transformer
No. 1250
\$3.75

Semaphore
No. 202—\$2.75



All clear! Go ahead!



Crossroads of Conversation

Could the telephone directory in the hands of each subscriber be revised from hour to hour, there would be no need for the information operator. But the directory cannot at one time list all subscribers. Even during its printing and binding, thousands of changes take place in the telephone community. New subscribers are added to the list. Old ones move their places of business or of residence.

Though their names are not listed on the directory, these subscribers must be connected by the highways of speech with all others in the community. To supplement the printed page, there must

be guides at the crossroads of conversation.

Such are the information operators, selected for their task because of quickness and accuracy, courtesy and intelligence. At their desks, connected with the switchboards in central offices, they relieve the regular operators from answering thousands of questions about telephone numbers that would otherwise impede the rendering of service. If they are asked for numbers already in the directory, service is retarded.

"Information" stands for the most complete utilization of telephone facilities.



"BELL SYSTEM"
AMERICAN TELEPHONE AND TELEGRAPH COMPANY
AND ASSOCIATED COMPANIES

One Policy, One System, Universal Service, and all directed toward Better Service



"Some present from Dad"

WHAT a wonderful thing it will be for any boy whose Dad makes it possible for him to take his first lesson on Christmas day on his very own

BUESCHER

True-Tone Saxophone

Every boy should play some musical instrument. Of all musical instruments, the Buescher Saxophone is the easiest to master. It is a boy's ideal instrument, one to which he takes naturally, for it fully satisfies that craving every boy has to personally produce music. It fascinates him, it tempts his ambition and brings out and develops his latent musical talent.

See How Easy It Is

With the aid of the first three lessons, which are sent free (upon request) with each new Saxophone, it is possible for your boy to learn to play the scale in an hour and in a few weeks be playing popular airs. If he wishes, he may join a band or orchestra in 90 days, or get up a neighborhood orchestra and have a lot of wholesome fun, besides earning some extra money from engagements.

Nothing can take the place of the Saxophone for home entertainment, church, lodge or school. Saxophone players are always in demand for dance or band work.

\$100 to \$250 weekly is not uncommon for musicians of ability to earn. Buescher True-Tone Instruments have helped to make famous Paul Whiteman, Tom Brown, Jascha Gurewicz and many others. Your boy might develop equal ability.

Free Trial, Easy Payments

You may order any Buescher Saxophone, Cornet, Trumpet, Trombone or other Band or Orchestral Instrument and try it six days in your own home. Easy terms of payment may be arranged if preferred. Mention the instrument interested in and a complete catalog will be mailed free.

Free Saxophone Book

It tells which saxophone takes violin, cello and bass parts and many other things you would like to know. Also illustrates first lesson. Send coupon for your free copy.



TOM BROWN
Director
Six Brown Brothers
Saxophone Sextet
Victor Records



BENNIE KRUEGER
Director Bennie Krueger
and His Orchestra
Brunswick Records



JASCHA GUREWICZ
Former Soloist
with Sousa's Band
Electric Records



BEN SELVIN
Director
Selvin's Orchestra
Acadian-Vocalion Records



DAN RUSSO
Director Dan Russo Orchestra
Brunswick Records

These Famous Saxophone Players

whose portraits are shown—use and recommend Buescher True-Tone Saxophones. Almost without exception, the great Professionals use Buescher Instruments exclusively. They are so flawless in scale, so perfect in tone and so accurate mechanically that more than 75 per cent of the popular Phonograph Records are played with them.

Buescher Band Instrument Co.
2537 Buescher Block, Elkhart, Ind.

Gentlemen:

I am interested in the instrument checked below:
Saxophone... Cornet... Trombone... Trumpet....
(Mention any other instrument interested in)

Name.....

Street Address.....

Town..... State.....

Buescher Band Instrument Company
Everything in Band and Orchestral Instruments
2537 Buescher Block Elkhart, Indiana

Diamonds for Christmas

\$1.00 Brings Your Choice



XA16—A fine quality, perfectly cut diamond, hexagon set in solid platinum ring with fancy pierced top and engraved shank. \$125.



XA17—Brilliant diamond set in this fancy, hexagon top, 18K white gold ring with fancy carved and pierced shank. \$90.



XA22—Artistically designed and executed, heart shaped lavalliere set with a blue white diamond. Delicately carved drop, 14k. gold chain. \$50.



XA18—Sweet's engagement ring set with a superior quality, perfectly cut diamond in 8 white gold prongs. 14K gold shank. \$100.



XA19—7 perfectly cut and matched diamonds expertly set in platinum to resemble one large solitaire. Fancy white gold prongs. 14K gold shank. \$48.50.



XA20—Sweet's fancy, massive ring of 18k. white gold set with a sparkling, blue white diamond. Engraved top, grooved shank. \$75.



XA21—Fine quality, sparkling diamond set in this square top, exquisitely carved and pierced solid platinum ring. \$90.



XA23—Perfectly cut diamond, hexagon, set in diamond-shaped genuine onyx ring. Fancy pierced white gold bezel shank. \$22.50.



XA24—Handsomely carved and pierced, 18k. white gold ring set with a fine, blue white diamond. \$65.



XA27—Gent's massive solitaire cluster, 7 perfectly cut and matched diamonds, expertly set in platinum to resemble one large diamond. 14k. carved and engraved shank. 18k. white gold top. \$67.50.



XA26—Popular, rectangular shaped wrist watch of 14k. white gold. 10 jeweled and expertly adjusted movement guarantee accuracy. Furnished with all grain ribbon and 14k. white gold fittings. Sapphire jewel crown. \$24.50.

10 MONTHS TO PAY

Just Think! ANY of these appropriate Xmas gifts will be sent you immediately upon receipt of only \$1. Our friendly credit terms enable you to buy worthwhile gifts at less than cash prices. \$1 at Sweet's does the work of \$5 elsewhere.

SEND ONLY \$1.00

and your choice will be immediately sent you for your examination. After you have convinced yourself that it is an exceptional value, keep it and pay only 1/3th of the price, 10 MONTHS NEXT YEAR TO PAY THE BALANCE!

NO DELAY—NO RED TAPE

Special Xmas Service insures prompt delivery. Satisfaction guaranteed or money refunded. Transactions strictly confidential.

EVERY DIAMOND GUARANTEED

All SWEET diamonds are perfect cut, blue white, superior quality gems. You are protected by the Guarantee Value Bond given with every diamond. 7 1/2% YEARLY INCREASE for exchange purposes guaranteed.

FREE: A postal brings the Sweet Diamond Book with over 3,000 appropriate Xmas gifts. Everything on our generous credit terms. Send for it TODAY to Dept. 63-T

FREE BOOK



XA25—Sweet's engagement ring set with a perfectly cut diamond in 8 white gold prongs. 14k. gold shank. \$75.

"THE HOUSE OF QUALITY"
CAPITAL \$1,000,000.

L.W. SWEET INC.

DEPT 63-T 1650-1660 BROADWAY, NEW YORK

Hello Boys!

ERECTOR

BUILDS

LOTS OF TOYS



GILBERT
Erector is the
only steel Con-
struction Toy
that builds
square Girders.

BOYS make wonderful models of bridges, cranes, derricks, wind-mills, skyscrapers, railroad signals, Ferris Wheels and machinery. Erector is not only the best fun in the world, but it is splendid training.

This famous Construction Toy will delight any boy this Christmas.

ERECTOR is the only actual structural steel toy. Every part is scientifically proportioned and correct in design. The boy who owns Erector or any other Gilbert Toy is made a member of Gilbert Engineering Institute for Boys, without cost. He can win valuable prizes, degrees and diplomas in this great Fraternity of American Boys.

THE A. C. GILBERT CO.
223 Blatchley Avenue
New Haven, Conn.



\$5

Gilbert
Erector No. 4

THE most popular set. In addition to hundreds of parts, it contains a sturdy Electric motor to operate cranes, draw-bridges and machinery models.

A. C. GILBERT CO.
223 Blatchley Ave., New Haven, Conn.

Send 10c today for Gilbert Year Book for 1924. Chock-full of interesting articles for boys, chemical experiments, athletic sports, tricks, useful items any boy can make, story of great engineering feats, etc., as well as a complete catalogue of the many Gilbert Toys.

Enclosed find 10c. Send me Gilbert Year Book for 1924.

Name

Address

City..... State.....

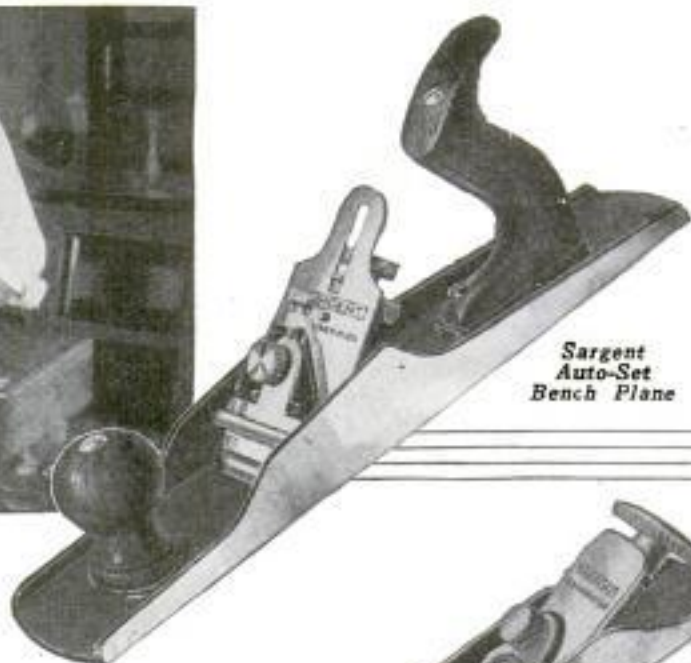

Sargent
Auto-Set
Bench Plane



Sargent
Steel Block
Plane



Sargent
Steel Pocket
Plane

A plane that measures up to your best workmanship

ABILITY to make things—and **TOOLS**, good tools, with which to make them! There's the unbeatable combination!

This Sargent Auto-Set Bench Plane is a *good, fleet* running mate for you. It is as light and keen as an all 'round plane could possibly be and is fully capable of meeting every demand you might make of it.

The auto-set feature alone saves considerable time and labor, permitting removal of the chromium steel cutter for whetting and its quick replacement without changing the original adjustment. The rigidly held blade cuts against or across the grain without the slightest chatter.

For small jobs and for the finishing touches to your craftsmanship you should have the Sargent Steel Pocket Plane and the Steel Block Plane. These are as expertly made as the Auto-Set Bench Plane and a delight to the most particular worker.

The Sargent Book of Planes is chock full of information. A post card will bring it. See these Sargent Planes at your hardware dealer's.

SARGENT & COMPANY

Hardware Manufacturers

49 Water Street

New Haven, Conn.

SARGENT

Tools & Hardware

\$2

X
M
A
S

G
I
F
T
S

Sent
for

\$2



L1—Five diamond in 18 K. white gold top, 14 K. green gold shank. \$22.50.



L2—Lady's seven diamond cluster resembles 2 ct. solitaire; 14 K. mounting. \$62.50



L3—Newest style elegant wrist watch of 14 K. white gold. High grade 15 jewel warranted movement. \$24.50.



L4—Diamonds & sapphire diamond cluster set in platinum; \$35.00.



L5—Three perfect cut diamonds set in 18 K. white gold. Top mounting 14 K. green gold. \$75.00.



L6—Diamonds & sapphire 14 K. ring. Two diamonds in center sapphire. \$50.00 each side.



L7—Gentleman's white gold ring diamond in center sapphire. \$50.00 each side.



L13—14 K. locket; diamond center, pearl drop; 14 K. neck chain. \$27.50



L10—18 K. sapphire ring with 5 diamonds. \$35.00.



L8—Lady's 7 diamond cluster ring in platinum; 18 K. white gold mounting. \$52.50.



L9—20 K. white gold ring, fine diamond set in 14 K. Karat cup. \$75.00.



L10—Lady's 18 K. white gold with fine diamonds in center; sapphires each side. \$65.00.



L11—Platinum four bar pin with perfect cut diamond. 14 K. pin. \$31.00.



L12—Lady's ring in 18 K. white gold platinum; fine diamond in center; 4 diamonds on sides. \$420.00.



L14—Lady's 18 K. white gold band engraved ring with two first quality diamonds. \$45.00.



L12—Lady's ring of 14 K. gold set with perfect cut blue white diamond. \$50.00.



L13—Lady's sapphire ring with fine diamond. 14 K. mounting. \$16.50.



L14—Platinum front eard pin set with perfect cut diamond. 14 K. pin. \$27.50.



L10—First quality blue white diamond set in lady's hand engraved ring of 18 Karat white gold. \$30.00.



L20—Diamond set platinum wrist watch. 14 K. white gold. High grade 15 jewel movement. Four blue white diamonds in platinum. Lifetime guarantee. \$42.50.

**\$2.00 Brings Your Choice
NO RED TAPE—NO DELAY**

Simply send \$2.00 and your choice goes to you charges paid. You have ten days in which to decide. Money back instantly if you are not satisfied as to the quality and value.

Ten Days' Free Trial

Send only \$2.00 and your choice goes to you in handsome gift box all charges paid. Guarantee Bond attesting to quality and value accompanies each shipment.

A Full Year to Pay

Simply send \$2.00 and receive your selection, all charges paid. After trial pay balance in 12 monthly payments. 10% discount for cash.

Free Royal Xmas Catalog

The most complete Catalog ever published of Diamonds, Watches, Jewelry, Silverware, Cameras, Ivory Toilet Sets, etc., sent FREE. Prices from \$5.00 to \$1000—quality the highest. Ten days' trial and a full year to pay on everything you order from our \$2,000,000 stock. Send for your copy today. Dept. 514



**ROYAL DIAMOND & WATCH CO.
170 Broadway - New York**



Eight thousand miles saved on every trip

It used to be 13,307 miles from New York to San Francisco by sea; it is now only 5,262.

The Panama Canal, which seemed such a heavy expense when it was built, is an immense national economy.

A greater economy because of the 1,500 General Electric motors which do its work—pulling the ships through, pumping water, opening and closing the locks—all at such a little cost.



To lighten human labor, shorten distance, and save money—these are the services of electricity. General Electric Company makes much of the apparatus by which electricity works, and stamps it with the monogram shown above.

GENERAL ELECTRIC

No. **185**Automatic
Drill—
"Mr. Punch."
Length, 10 in.No. **111**Automatic
Screw-Driver
Length,
extended, 18 in.

Give him a tool for Christmas

HERE are two of the best tools made—for handy men, for men who work with tools, for boys who build things.

Each is packed in a Special Gift Box—all ready to present on Christmas morning.

The Goodell-Pratt Automatic Drill, "Mr. Punch," bores holes—any size from $\frac{1}{16}$ to $\frac{1}{64}$ of an inch. In the handle are eight different size drill points. You get the one you want by turning the top cap. Fit the point into the chuck. Then you push and Mr. Punch twists. The hole is made in a jiffy.

The Goodell-Pratt No. 111 Automatic Screw-Driver also turns work into fun. You just push, and the screw sinks in. Three tool-steel blades—hardened, tempered and polished—are included.

Ask Your Hardware Dealer

These Goodell-Pratt Christmas Gifts are sold by hardware stores everywhere. If your dealer hasn't them, order direct from us. Price of each tool is \$2.50.

Mr. Punch says: "Do your Christmas Shopping at the hardware stores."

GODELL-PRATT COMPANY
GREENFIELD, MASS., U. S. A.

Toolsmiths

GODELL-PRATT

1500 GOOD TOOLS

Radio Catalogue Free—

**Write us
a post card—**

Address Dept. 6-R

and we will send you free this 52 page catalogue of radio sets and parts. It also contains explanation of radio terms, map and list of broadcasting stations and much radio information, including an explanation of successful hook-ups and circuits.

You will be amazed at the low prices Ward's quote. A complete tube set having a range of 500 miles and more, including tube, head set, batteries, and antenna equipment, as low as \$23.50.

This catalogue contains everything for the expert and amateur. Complete sets and every improved part for building sets, all the most up-to-date devices—at the lowest possible prices.

Headquarters for Radio

Montgomery Ward & Co. is headquarters for Radio, selling everything direct by mail without the usual "Radio-profits." Why pay higher prices? Ward quality is the best and the prices will often save you one-third. Everything sold under our Fifty Year Old Guarantee—Your Money Back if You Are Not Satisfied. Write today for your copy of this complete 52-page Radio Book.

Write to our house nearest you. Address Dept. 6-R

Chicago Kansas City St. Paul Portland, Ore. Ft. Worth

Montgomery Ward & Co.

The Oldest Mail Order House is Today the Most Progressive



Let DIAMONDS say Merry Xmas

642AD—18" indestructible quality Pearls of unusual sheen and lustre with White Gold clasp set with genuine Perfect cut diamond. **\$14.50**



643AD—Premier Diamond Ring, Blue-white Quality Diamond. **\$95.00**



644AD—Engraved Premier Diamond Ring, Blue-white Diamond. **\$37.50**



645AD—Green Gold Hexagon Platinum Top with Blue-white Diamond. **\$55.00**



651AD—Solid Platinum Trueheart Ring with exquisite Blue-white Perfect cut Diamonds. **\$118.50**



649AD—Cluster Ring, 7 Blue-white Diamonds set in Platinum. **\$73.50**



650AD—Green Gold Gypsy Cluster, 7 Blue-white Diamonds. **\$87.50**



647AD—Substantial Round Belcher Ring, Brilliant Blue-white Diamond. **\$80.00**



653AD—18 kt. White Gold Hexagon Ring, 7 Blue-white diamonds set in Platinum. **\$59.50**



654AD—Gent's Ring, finest quality Blue white Perfect cut Diamond. **\$110.00**



652AD—Popular 14kt. White Gold rectangular Wrist Watch, very much in demand, 15-jewel guaranteed imported nickel movement. Special Price **\$33.65**



646AD—Engraved Belcher Ring, Blue-white Perfect cut Diamond. **\$60.00**

NO MONEY DOWN

Any of the startling diamond values pictured here can be yours without risking a single penny. Each item is ideally suited for Christmas and will make a charming gift. No matter what you select, you pay **only a few cents a day**. Your selection sent on your simple request without a single penny down. If you don't agree that it is the **biggest bargain** you have ever seen, return it at our expense. If you keep it, pay at the rate of **only a few cents a day**.

YEARLY DIVIDENDS

You are guaranteed 8 per cent yearly increase in value on all diamond exchanges. Also 5 per cent bonus privilege.

MILLION DOLLAR BARGAIN BOOK FREE

Send coupon for your copy today to Dept. 1779. See these wonderful bargains for yourself under the Lyon Charge Account Plan.

J. M. LYON & CO.
2 - 4 MAIDEN LANE, NEW YORK
In Business Nearly 100 years

SEND FOR
MILLION
DOLLAR

BARGAIN
BOOK

FREE

J. M. LYON & CO.

2-4 Maiden Lane, Dept. 1779
New York, N. Y.

Please send me at once your big 128-page MILLION DOLLAR BARGAIN BOOK, showing thousands of America's greatest diamond and jewelry bargains.

Name

Address

City State

Stylish Moleskin Cloth Coat

\$1⁰⁰ Down

\$20.00 value
Special Price
\$13⁶⁵

Send only \$1 with coupon for this coat. Guaranteed rain proof and is also suitable for stylish top coat. Made from good weight moleskin cloth, a smooth, soft-finished material resembling chamois leather. Warm and comfortable in the coldest weather. Swagger double-breasted belted style with stylish plaided patch pockets. Adjustable strap on sleeve. Yoke back with inverted plait, giving the coat plenty of fullness. Collar can be converted into military style, buttoning close up to neck or worn as shown in illustration. Ventilated armholes. Ivory buttons. Backed with fancy plaid fast colored woven lining with extra coating of rubber between. All seams sewed, strapped and cemented. 45 inches long. Sizes 34 to 46. Rich Leather Brown shade.

Order by No. F-19.

Terms, \$1 with coupon, \$2.10 monthly.
Total price, \$13.65

6 Months to Pay

Buy the Elmer Richards way. You can always be well dressed and pay in small monthly sums, so small you will never miss the expense. Money back if not satisfied. No charge for credit. Don't miss this bargain. Supply limited at this special bargain price.

Elmer Richards Co.

Dept. 1779, West 35th Street, Chicago, Ill.

Enclose \$1. Send Moleskin
Cloth Coat No. F-19. Size.....

If I am not satisfied when I receive the coat I can return it and get my payment back with charges. Otherwise I will pay advertised terms, \$1 with coupon, \$2.10 monthly. Total price, \$13.65.

Name

Address

Post Office..... State.....



Rain
Proof

—
Plaid
Backed

No
C. O. D.
Charges
to Pay

Mail This
Coupon Today

Write for our
Monthly Bulletin of men's,
women's and
children's
clothing and
shoes.

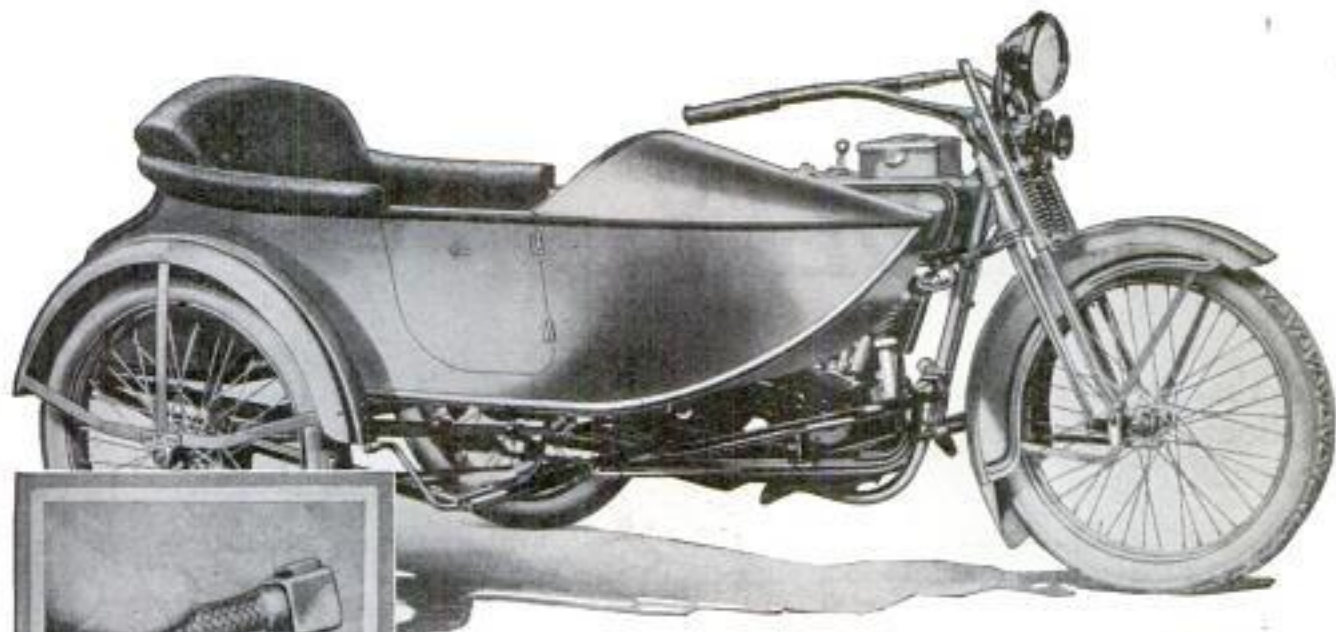

Money-making
sales opportuni-
ties in open ter-
ritories. Write
for particulars.



Easily Cared for!

A LEMITE lubrication—first on any motorcycle—makes the “weekly once-over” of the 1924 Harley-Davidson a clean, easy, five minutes job. This handy, thorough system is just another refinement—more evidence of the engineering that keeps the Harley-Davidson, year after year, the finest motorcycle ever built.

What a thrill you'll have when first you “open up” your '24! Speedier, peppier than ever (aluminum-alloy pistons); easier riding sidecar (49-inch, full-floating springs); handsomer than ever (olive green, maroon striped). Weaving swiftly to your work through highway or street traffic or into the country for skiing, skating, and other winter sports—why, man, a Harley-Davidson will bring you a new world of healthful recreation and economical service.

Take a free demonstration ride with your dealer. See for yourself how motorcycling beats auto-mobiling or waiting in the cold for street cars. Most dealers offer a Pay-as-You-Ride Plan that's interesting. Write us for free literature, showing 1924 models in actual color.

HARLEY-DAVIDSON MOTOR CO.
DEPT. P MILWAUKEE, WIS.

Harley-Davidson

The Motorcycle

Send me descriptive literature, in actual colors, showing the 1924 Harley-Davidsons and Sidecars.

Date _____

Name _____

Address _____

Choose your "mike" CAREFULLY

IF there's one tool in your kit that should be right in every detail it's the Micrometer.

Get a Starrett and you can't go wrong. Here are some of the features that help to explain the preference of two generations of machinists for these fine Micrometers.

EASILY READ—notice the large Barrel and the clear-cut distinct graduations.

SLEEVE ADJUSTMENT—a recognized triumph in tool design. Easier and more exact than the usual anvil adjustment.

IMPROVED RATCHET STOP—a wonderful aid to accurate gaging.

PERFECTED LOCKING DEVICE—a slight turn of the nut locks the spindle firmly.

Starrett design, workmanship and finish assure you of a Micrometer that is not easily sprung, is simple to adjust, and is good for years and years of reliably accurate service. You can't go wrong on a Starrett.

THE L. S. STARRETT CO.

The World's Greatest Toolmakers—Manufacturers of Hackaws Unexcelled
ATHOL, MASS.

USE STARRETT MICROMETERS

The Starrett Catalog will help you select the Micrometer best suited to your requirements. Mailed free—ask for No. 22 AP.



STARRETT MICROMETER No. 226

These calipers meet the demand for accurate gages at a low price. Supplied singly or in sets (combinations from 1 to 6 inches) as desired.



5869

Trade Mark Registered

WURLITZER

200 YEARS OF MUSICAL INSTRUMENT MAKING

Wurlitzer Saxophones

The most popular of all wind instruments. Improvements in fingering and special conical bore make Wurlitzer Saxophones the easiest to play and unusual for rich tone values. Blows and fingers so easily that playing is as simple as whistling a tune.

Wurlitzer Cornets

Needed for accurate pitch, and clear even tones in both soft and loud playing. Valve pistons individually ground to insure smooth, easy action and absence of leakage. Once "lipping" is mastered very little practice is required to play simple band music.

Wurlitzer Violins

The Wurlitzer collection of Old Violins is internationally famous. Wurlitzer modern violins are made by experts, and accurately patterned after Stradivarius, Guarnerius, and other famous models. We especially urge young people to take up the violin.

Any Musical Instrument

On Trial

WURLITZER will send you *any instrument* for a week's trial in your own home. No obligation to buy — no expense for the trial — you do not risk a penny. Wurlitzer instruments are known the world over for artistic quality and excellence of workmanship. Used by the greatest musicians, bands, and orchestras. The house of Wurlitzer has made the finest musical instruments for over 200 years.

Easy Payments

Payments are conveniently arranged in small monthly sums — a few cents a day will pay. All instruments to you at lowest factory prices. Special combination offers on complete musical outfits — velvet lined case, all accessories, self-instructor, etc. — everything you need at practically the cost of the instrument alone.

Send for New Illustrated Catalog!

The greatest musical catalog ever published! Over 3,000 articles — every known instrument described and illustrated — many of them shown in full colors. No matter where you live, you can buy Wurlitzer instruments direct by mail the same as at any of the 27 Wurlitzer stores.

Send the coupon today!

The Rudolph Wurlitzer Co., Dept. 1779

117 E. 4th St., Cincinnati — 329 So. Wabash Ave., Chicago
120 W. 42nd St., New York — 250 Stockton St., San Francisco

Send me your new catalog with illustrations in color and full description of every known musical instrument. Also tell me how I may have any instrument for free trial in my own home, and may pay for it in easy installments. No obligation.

Name _____

Address _____

(State instrument in which you are especially interested)

Copyright 1922,
The Rudolph Wurlitzer Co.

Wurlitzer Trombones

Tone remarkable for sonority and clearness, absolutely pure in all registers. Slides are drawn to a great hardness and perfect line, insuring easy action and perfect intonation.

Wurlitzer Stringed Instruments

Wurlitzer banjos, guitars, mandolins, ukeleles, etc. are made with particular attention to close fit at all joints, to give true vibration and full resonance. Stringed instruments are the easiest of all for beginners to "pick up" — some can become good players almost without effort.

Wurlitzer Trap Drum Outfits

Every conceivable drummer's trap is included in the Wurlitzer outfits — nothing is lacking. A sense of rhythm usually means that playing the trap drums will be almost instinctive.



The compact, convenient and complete Portable Typewriter. Sold by over 3,000 dealers and Remington branches everywhere. Easy payment terms if desired. Send for our illustrated "For You—For Everybody".

Address Department 12

We believe we make the best typewriter ribbon in the world—and its name is PARAGON

Remington Portable

Remington Typewriter Co., 374 Broadway, New York

21 Jewel Santa Fe Special

Sent
on

Approval

21 Perfect Jewels
Adjusted to Positions
Adjusted to Temperature
Adjusted to Isochronism
Adjusted to the Second
25 Year Gold Strata Case
Your choice of Dials (inc'ud-
ing Montgomery R. R. Dial)
New Thin Models. All sizes.

WHILE other watch dealers are raising their prices, asking you for larger monthly payments, and making payment terms harder for you to meet, we are offering you our new model Santa Fe Special, no advance in price, no money down, easier terms and smaller monthly payments. We realize the war is over and in order to double our business we **MUST** give you pre-war inducements, better prices, easier terms, and smaller payments.

Send No Money Without one penny of advance payment let us place in your hands to see, to examine, to inspect, to admire, to approve a real masterpiece in watch creation. Our determination to this year double our sales of the world famous Santa Fe Special and Bunn Special Watches prompts this matchless offer.

Santa Fe's "New Elite"

This Artistic dependable Ladies' Wrist Watch, fitted with genuine Illinois Springfield movement. A perfect timepiece. Beautiful 14 Karat *white or green solid gold* case. Many designs—Ask for New Watch Book showing New Elite case designs in color. Watch sent on approval and sold on payments.

Page 12 of Our Watch Book Is of Special Interest to You!

Ask for our Watch Book free—then select the watch you would like to see, either the famous Santa Fe Special or the 6 position Bunn Special, and let us explain our easy payment plan and send the watch, express prepaid, for you to examine. No money down. **REMEMBER**—No money down—easy payments buys a master timepiece—a 21 Jewel guaranteed for a lifetime at about half the price you pay for a similar watch of other makes. No money down. A wonderful offer.

SANTA FE WATCH COMPANY
Dept. C6, Thomas Bldg. TOPEKA, KANSAS
"Home of the Great Santa Fe Railway"

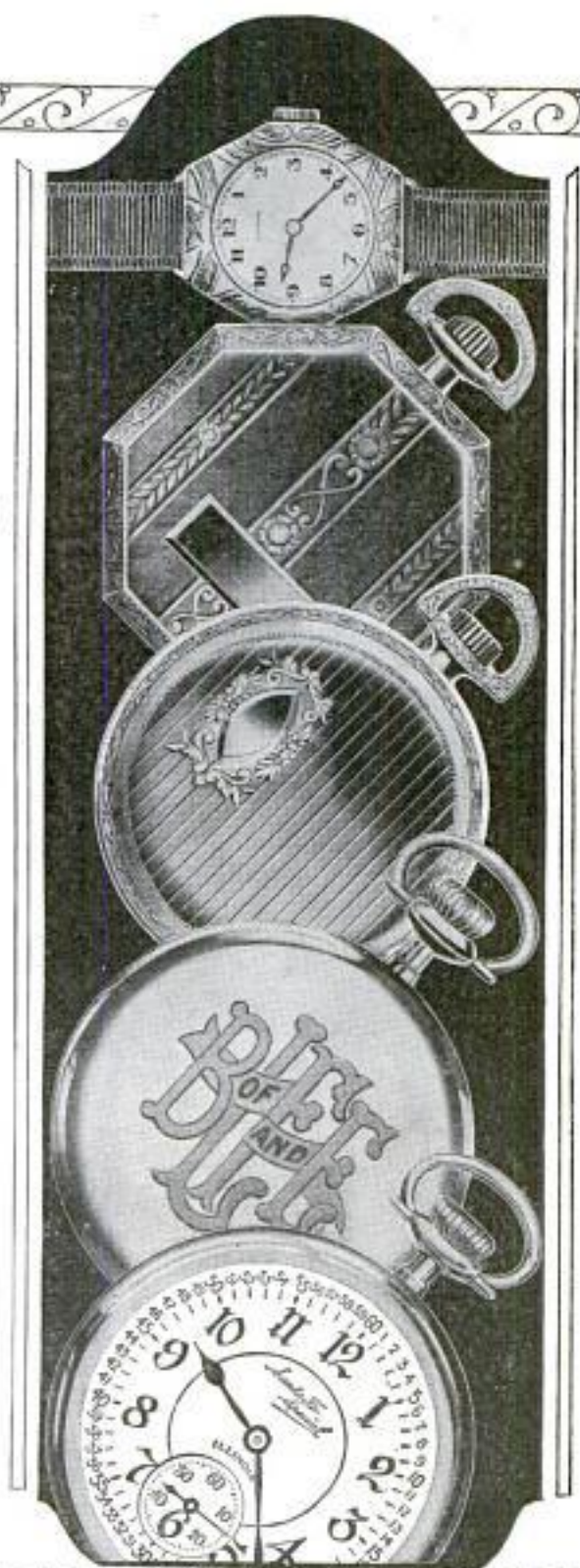

SANTA FE WATCH CO.
Dept. C6, Thomas Bldg., Topeka, Kans.

Please send prepaid and without obligation your Watch Book free, explaining your "No Money Down" Offer on this Santa Fe Special Watch.

Name.....

Address.....

State.....

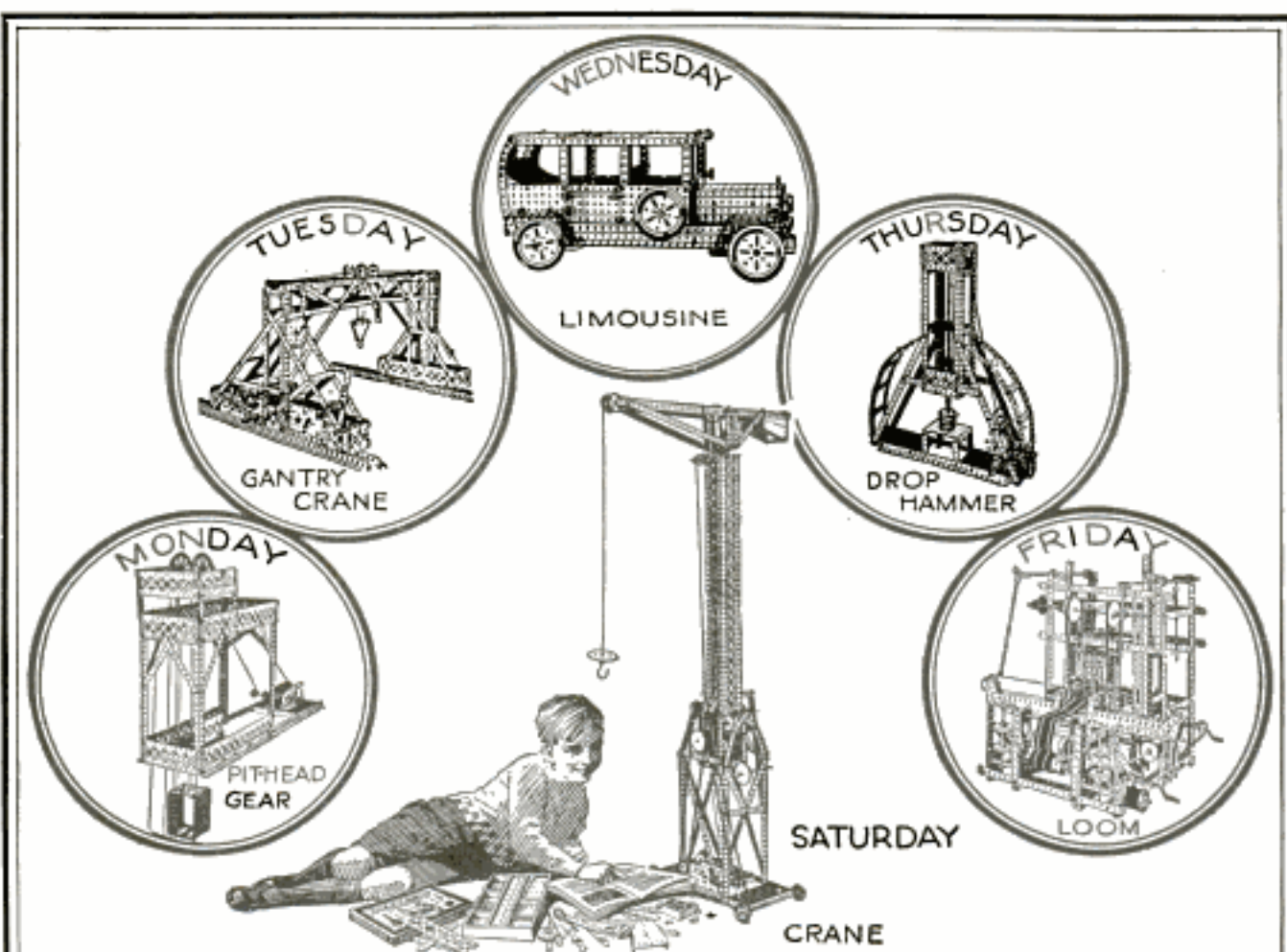

A New Toy every day!

A PERFECT crane one day, a splendid Electric loco the next—then a wonderful Pit-Head Gear, and so you go on every day for a year without once repeating a model. You do all this with the same interchangeable and unbreakable parts that always fit exactly where you want them and never get out of order.

Every part of Meccano is a real engineering piece—pulleys, gears, strips, girders, rods, couplings and cranks—all perfectly designed and accurately made.

Tell Dad You Want

MECCANO

Engineering for Boys



SEND FOR THIS NEW MECCANO BOOK

It describes Meccano and tells interesting things about model building. Every page a pleasure. Free, if you send names and addresses of yourself and three chums. Put No. 63 after your own name for reference.

Grand \$1250 Prize Contest Now Running
Ask your dealer for entry blanks or write us.

MECCANO PRICES

Outfit	Builds	Price
No. 00	40 models	\$1.00
No. 0	70 models	2.00
No. 1	106 models	3.00
No. 1X	with electric motor	5.00
No. 2	163 models	6.00
No. 2X	with electric motor	8.50
No. 3	207 models	9.00
	and up to	\$40.00

MECCANO COMPANY, INC. Division H-12 ELIZABETH, N. J.

In Canada: Meccano, Ltd., 11 Colborne St., Toronto



Gentlemen, this is my son

Just imagine that moment of glory—when you shall introduce that boy of yours to men of affairs—your boy, who so soon will step into the business swirl, to meet stiff competition, hard problems, dangerous temptations. To-day, your greatest joy is to “do something” for that boy of yours, and you ask: What Christmas gift will make him happiest—what will he appreciate most keenly—what will help him most?

You can answer that question right now—give him **THE AMERICAN BOY**, and his pride in the gift will equal your pride in him.

THE AMERICAN BOY knows that “boys will be boys”—and should be!—but it knows also that boys will be men. It attracts boys, fascinates them, and holds the eager interest of 500,000 of them by sheer merit which boys are quick to discover. It gives them information about vital things in life that they can get in no other way—shows the value of character and initiative as well as ingenuity; gives them a look-ahead and some preparation for the work-world that your boy will be stepping into almost before you know it.

Each and every story is written to let boys face a real boy-problem, and it teaches them how a regular fellow will meet and solve it. There is nothing

preachy about **THE AMERICAN BOY**. (How boys do hate preaching!) There is nothing namby-pamby or wishy-washy about it. Its articles are instructive, boy-building, man-building, and have an instant power to suggest all that is best and healthiest to a boy.

Your boy's feet are headed somewhere. What an opportunity you have, this Christmas season, to give him a friendly and trusted guide to walk with him while he gains the poise and stature of a man. Make him a present of a year's subscription to **THE AMERICAN BOY**.

Your boy needs **THE AMERICAN BOY**—to-day more than ever. It is a boy-building necessity! It is right that he should have it! Give it to him for Christmas. Subscribe to-day!

\$2.00 a year by mail. 20 cents a copy at news-stands. Subscribe for a year or leave a standing order at your news-dealer's.

The American Boy
The Lightest, Brightest, Best Magazine
for Boys in All the World

THE SPRAGUE PUBLISHING CO.
No. 861 American Bldg., Detroit, Mich.
Enclosed find \$2.00, for which send **THE AMERICAN BOY** for one year, beginning with the current issue, to

Name.....

Address.....

REGISTERED TRADE MARK

CHEMCRAFT

THE CHEMICAL OUTFIT

*Fred C. Luce,
Chief Chemist, at work
in his laboratory*



How to be a Boy Chemist!

Fred C. Luce tells all boys how to have fine sport with a dandy chemical club.

"CHEMICAL experimenting is the finest fun I ever tackled," said Fred in a recent letter. "If you want to do something new and different every day; something that will keep you busy and interested all the time—get a Chemcraft outfit and be a boy chemist. Then you can test the things you eat, wear and use every day; make ink, soap, dyes, and work hundreds of other wonderful experiments with your own laboratory, the same as I do. It'll be more sport than you ever had before. Sure, you can do a lot of funny, puzzling tricks, too, that will keep everybody guessing. I've got a dandy 'lab,' and it started with a Chemcraft outfit. When I got my outfit I started my own Chemistry Club under my own name and we have dandy times running shows and doing new experiments all the time. I'll tell any boy who wants real sport to get a Chemcraft outfit and be a Boy Chemist."

You can do the same as Fred. A CHEMCRAFT outfit makes you an amateur chemist and opens the way to days of fascinating fun. It also teaches you practical things about the most wonderful science there is today. Get a CHEMCRAFT outfit this

Christmas. Then you can join the Chemcraft Chemist Club, be the Chief Chemist of your own Local Chapter and get other boys in with you. You'll get the Club Magazine, too and can exchange letters with other

Club members everywhere. Select from these five fine outfits: No. 0, 75c;

No. 1, \$1.50; No. 2, \$2.50; No. 3, \$5.00; and No. 4, \$10.00. Each outfit is complete and contains a liberal assortment of harmless, non-explosive and non-poisonous chemicals, all necessary apparatus and a Manual of Instruction.

Be sure you get CHEMCRAFT because that is the original and best chemistry outfit; the one used in schools and colleges and endorsed by teachers and professors. CHEMCRAFT is sold wherever good toys are found. Ask for it by name—CHEMCRAFT. If you cannot get the outfit you want, we will fill your order direct upon receipt of price as above. West of Denver, Colo., and in Canada, these prices are 10% higher.

FREE TO BOYS!

Write at once and get a Free Copy of the Club Magazine; full of prize-winning stories written by boy chemists, and other Club news. It's free to boys who write at once.

THE PORTER CHEMICAL CO.

Porter Products Put Science at Your Service
115 Washington St., Hagerstown, Md.



*This boy has
Chemcraft
No. 3. Isn't
it a dandy
outfit?*

How three boys built a railroad

THREE boys sat disconsolately on the edge of the pond back of the old mill on the Jenkins' place. All week they had been building a railroad in the sand along the banks. They had leveled, and dug, and built up until they had the bed laid for a whole transportation system. There were grade crossings, and bridges and freight yards and even a tunnel. While along the edge of the pond Wally had built docks and ferry boat slips. But as Bob said, "What good is a railroad without any cars?"

"Why all the gloom, men?" said a pleasant voice behind them. The three boys looked up to see Mr. Jenkins, Bill's father.

Bill explained the lack of "rolling stock" for their railroad.

"Well!" said Mr. Jenkins, "Why don't you fellows chip in and get track and trains? In New York I've seen some beauties that operated by electricity. They were exact duplicates of the big ones that run on the Central."

"Chip in?" asked Wally, showing empty pockets, "Chip in what?"

"My golly!" said Mr. Jenkins. "Anybody'd think you fellows were cripples. When I was a boy, if I wanted anything bad enough, I just went out and earned the money and got it. I know Bob there could make some money if he'd saw that big pile of wood I saw yesterday out in the back of his Dad's place. Wally can pick the apples down in the orchard and I'll find something for Bill to do. Get busy and see what you can earn. And then I'll tell you what I'll do! I'll give you a dollar for every dollar you earn. How's that, fair enough?"

"O boy!" Bob cried.

"Let's see that orchard!" said Wally.

"Let's go!" shouted Bill, getting up in a hurry.

First meeting of the R. W. & W.

A MONTH later, the first meeting of the R. W. & W. Railroad (R—Robert, W—William, W—Walter) was held. Mr. Jenkins collected the money the boys had earned for the railroad.

Wally had seven dollars, Bill eight and Bob ten.

"That makes twenty-five dollars," announced Mr. Jenkins. "And now, as I said I would, I'll match your capital with the same amount." He took two new ten dollar bills and a five from his pocket and put them with the boys' money. "Total capital of the Railroad—fifty dollars."

"And now, gentlemen, if you three will meet me tomorrow morning early, we'll all go into New York on the eight o'clock and purchase 'rolling stock' for the railroad."

They buy "rolling stock"

WHAT a day those four had in the city!

Mr. Jenkins took the three boys down to the Ives Display Room in the Fifth Avenue Building at Madison Square.



On great tables, which ran all around the big display room, were complete railroad systems. Powerful electric engines, perfect models of their big brothers on the Central, thundered along with mail coaches and Pullmans. A freight engine rumbled by, pulling a long line of flat cars, tank cars, and cattle cars, and in the rear a caboose. The boys looked on wide eyed and noticed that each car was a *perfect model* of the real thing, even down to the monograms on the cars, which showed the cross of the Santa Fe, the seal of the N. Y. C. & H. R., the red and white circle of the Canadian Pacific.

There were semaphore signals, which showed red and green lights. Crossing signals that rang a warning bell as the Flyer approached. Trestle bridges, tunnels, freight and passenger stations, telegraph poles and street lights. In fact everything that you have ever seen in a big railroad.

There was a shriek from Wally.

"Oh boy! Look at these." He had found a big table on which were ocean liners, freight steamers, submarines, tug boats and racing yachts. "Gee! Couldn't we have some ships, too?"

"How about it, boys," suggested Mr. Jenkins, "couldn't we make Wally Captain of the Port and let him handle the ocean transportation?"

Everyone agreed to this and Wally, with the professional eye of a sea captain, picked out a liner, a tug boat for hauling freight, and a diving submarine for harbor defense.

The grand opening

A WEEK later, down behind the old mill, there was a scene of tense excitement. Lined up on the bank were Mr. and Mrs. Jenkins, Molly—Bill's little sister, Ambrose—the colored man who cut their lawns, and Rags, the dog. Bob knelt on the ground beside a switch. Wally fussed

with the mooring ropes of a liner which rode proudly beside her pier. Bill fastened an American flag to the halyards on a pole. All along the bank, ran the new railroad's tracks gleaming in the sun. The semaphore signals showed "Clear track ahead."

"Ready!" cried Bob.

"Ready!" answered Wally and Bill.

Rags barked. Mr. Jenkins waved his hat and Mrs. Jenkins her parasol. Ambrose clapped. Molly shrieked.

Then Bob turned the switch and out of the door of the old mill rolled the Flyer, headlight gleaming, parlor cars lighted. Along the bank it flew, round curves, through tunnels, over bridges. Then came a long freight loaded with lumber and gravel for "overseas." Down to the water front it went and there stopped alongside a pier.

"How about the R. W. & W.?" shouted Bob.

"Yea!" hollered Bill and Wally and Mr. Jenkins and Ambrose.

Suddenly little Molly began to cry as though her heart would break.

"Why, dear, what's the matter?" asked Mrs. Jenkins.

"I wish I was a boy," sobbed Molly.

And after all you couldn't blame her much—could you?

THE IVES MANUFACTURING CORP.

208 Holland Ave.,
Bridgeport, Conn.

I enclose 10c for which please send me your new smashing 28 page book that shows how to build an Ives Railroad. This book will also tell me about the Ives Fleet of Boats.

Name.....

Address.....

City..... State.....

On November 30th at 8:30 P.M. Mr. H. C. Ives will give radio talk "The Fun of Playing with Trains," Station W.E.A.F., wave length 492 meters.

Build This Transcontinental Receiver At Half the Usual Cost!

Ordinarily You
Would Pay From
\$125⁰⁰ to \$250⁰⁰



This Way You
Pay Only \$65⁰⁰



Erla synchronizing radio frequency reflex transformers provide unequalled magnification without distortion. Types, reflex 1, 2. List, \$5



Providing utmost sensitiveness with perfect stability, the Erla fixed crystal rectifier is uniquely adapted for reflex work. List, \$1

Dealers and Jobbers—No day passes that Erla does not increase your opportunities for sales and profits. Write for sample Erla Triplex receiving sets, in beautifully finished solid mahogany cabinets, at manufacturers cost, for demonstration to your trade

So simple and inexpensive to build is the Erla transcontinental Triplex receiver that every home can now enjoy the infinite pleasure and variety of nation-wide loud speaker reception.

Erla parts, complete even to the cabinet and panel, and Erla solderless connectors, make child's play of the work of assembly. Accurate, easily understood drawings guide every step.

Materials are reduced to a minimum through the employment of Erla synchronizing transformers, enabling vacuum tubes to do triple duty. Only three tubes are used, yet costliest multi-stage amplifiers are surpassed in range and volume.

Choice of broadcasting programs is exercised at will, so sharp and selective is the tuning. Yet controls are so few and simple as to be operated by any child. Especially remarkable is the purity and fidelity of reproduction, exceeding the finest phonograph.

For further information regarding Erla Triplex, as well as perfected Erla one and two-tube receivers, consult Erla Bulletin No. 14, obtainable gratis from leading radio dealers. Or write us direct, giving your dealer's name.

Electrical Research Laboratories
Dept J 2515 Michigan Avenue, Chicago

ERLA



The unique ability of Erla synchronizing audio transformers to reflex properly enables vacuum tubes to do triple duty. List \$5



Difficult, dangerous use of soldering irons is eliminated by Erla solderless connectors, saving time, temper and money. List, 5c ea.

Hand
Forged
Razor Steel
Blades, No. 57



Direct at Factory Prices

This \$2 KNIFE \$1.18 Postpaid
Hand Forged Razor Steel Blades
Handy shaped Blade makes this knife best for mechanics, sportsmen and farmers; light but strong; re-sharpened easily. Stag handle. German silver finish; blades file tested, hand forged from razor steel and warranted.

Sample \$1.18 3 for \$3.00 Postpaid.

Send for our 100-page List and "HOW TO USE A RAZOR" FREE

MAHER & GROSH CO., 106 A St., Toledo, Ohio

ONLY
\$ **3**
DOWN
and you
keep this
typewriter



DIRECT
to you
from our
Factory

Big Saving
In Price

Yes, we will ship you this Genuine Underwood

Rebuilt in our own factory just like new for
ONLY \$3 down—NOT ONE CENT MORE

Until you have tried the machine 10 full days at our expense



Our Factory

EVERY MACHINE is fully guaranteed. New parts wherever needed. New enamel, new nickel, new lettering, new platen, new key rings—a complete, perfect typewriter. Impossible to tell it from a brand new Underwood either in appearance, durability or quality of finished work.

An up-to-date machine with two-color ribbon, back spacer, stencil device, automatic ribbon reverse, tabulator, etc. In addition we furnish **FREE** waterproof cover and special Touch Typewriter Instruction Book. You can learn to operate this Underwood in one day.

Big Book FREE

Our big handsomely illustrated catalog will be sent **free** on request. It tells you all about the advantages of owning a **STANDARD SIZE UNDERWOOD**; how and why this machine will last for years, saving many dollars not only in the purchase price but in its operation.

Send in the coupon and let us send you this beautifully illustrated book **FREE** without any obligation whatever.

Shipman-Ward Mfg. Co.
"Typewriter Emporium"
2129 Shipman Bldg.
Montrose and Ravenswood Aves., Chicago

Write Right Now

and learn how it is possible for us to ship you this Underwood Typewriter upon our **free trial** plan and our direct-to-you **money saving methods**. Get the full details now—just sign the coupon and mail **today**. Get all the facts—then decide.

No Obligation

—to buy. You don't have to order. Just sign the coupon, send it to us and we will mail you our big catalog absolutely free.

Send the
Coupon
Today

10 Days' Free Trial

You have ten full days in which to try the typewriter before deciding whether you want to keep it. Give it every test—see for yourself—make the Underwood prove its worth to you. Don't take our word for it—put the Underwood before you and see if you don't think it the greatest typewriter bargain ever offered.

You will be amazed at the liberality of our offer, the beauty and all around excellence of our typewriters.

This is the genuine Underwood Typewriter. We offer you the same three models of the Underwood Typewriter being made and sold by the manufacturers today. **Standard 4-row single shift keyboard. Absolutely visible writing—the full line of typewriting is visible at all times.** All the improvements and attachments that any high grade typewriter ought to have.

Big Saving to You

Our plan of selling to you **direct** makes possible enormous savings, which are all for your benefit. **Send in the coupon and we will send you prepaid** our big catalog, including "A Trip Through Our Factory." This shows how the Shipman-Ward Rebuilt Underwood is the best that can be produced at our **Special Price**.

don't have to do a thing to get our big **Free** catalog and complete details of our amazing

FREE TRIAL COUPON

SHIPMAN-WARD MFG. CO.
2129 Shipman Bldg., Chicago

Please send me **FREE**, all charges fully prepaid, your **BIG NEW** catalog of **UNDERWOOD TYPEWRITERS** and complete details of your **FREE TRIAL Offer**.

It is understood that I am under no obligation whatever and that this is to be sent without one cent of cost to me.

Name.....
Street.....
City..... State.....

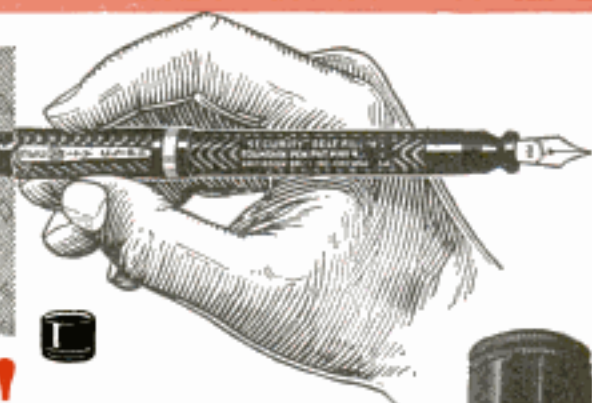

GET READY!

The Holiday Season Is Approaching!

50% of the Fountain Pens Sold Each Year Are Sold During the Months of November and December

A Large Percentage of These Will Be "SECURITIES"

THIS is the most wonderful opportunity for honest, live wire salesmen and saleswomen not only to make a clean up during the holiday season but also an exceptional opportunity to join an honest to goodness progressive organization and engage in a clean, profitable and permanent business, that had such a meteoric growth and phenomenal success in such a short period.

The Following Figures Tell The Story

Our sales for the first year—1922—amounted to 15,000 pens.

Sales up to the present have reached 150,000 pens and we are going to sell 150,000 more "SECURITIES" between now and the first of the year! And we have only started.

Our Goal for 1924 Is One Million (1,000,000) Securities

But we are not going to stop there either! Our aim is to make the "SECURITY" the leader in the field.

We have moved twice during the last ten months and are preparing to move again. This time however, not only to larger quarters, but to our own "SECURITY" building. **DO YOU KNOW WHY?**

BECAUSE THE "SECURITY" HAS MERITS, embodying novel, practical and patented features which combine a faultless, smooth-writing, even-flowing pen with a unique and perfect check protecting device equal to the most expensive check writer on the market and so convenient that it enables the owner to write and protect his checks any time, any place.

YOU DON'T HAVE TO SHAKE OR COAX THE "SECURITY" TO MAKE IT WRITE. It responds instantly the moment it touches the paper and will write, write and write without any LEAKS OR BLOTS, until the last drop of ink is out.

Seventeen years have been spent in developing this MASTER PEN by men, who for a decade, have been engaged in the fountain pen industry.

The sales possibilities of the "SECURITY" are unlimited. You don't have to look for prospects—they are around you everywhere.

Ambitious and energetic men and women who are anxious to better their condition, will find in the "SECURITY" a wonderful opportunity to realize their ideals.

You will make real friends of those to whom you sell "SECURITY" Pens because you give them honest merchandise with full value received.

The "SECURITY" is manufactured complete from end to end in our own daylight factory by experienced and contented employes, and is **THE ONLY FACTORY OF ITS KIND IN THE UNITED STATES OPERATED UNDER THE PROFIT SHARING PLAN.**

AGENTS—DISTRICT MANAGERS—QUALIFICATIONS

AGENTS—Honesty and a sincere desire to work. We have developed at considerable expense, a complete method of training which is worth real money to you. Write immediately for our interesting proposition.

DISTRICT MANAGERS—We select as District Managers, men from the ranks of our successful agents, who have shown exceptional sales records. **To you more qualified salesmen**, who have had sufficient experience in organizing and maintaining an efficient sales force, we have a mighty interesting proposition. Write us a letter, giving a brief history of yourself, your past experience, references and territory wanted.

TO AVOID LOSS OF TIME AND UNNECESSARY DELAYS ORDER A SECURITY TODAY before taking further action and send with your lettercheck or money order for style wanted. A cut-out pen for demonstrating purposes will be included free of charge. When you receive the pen, give it a fair trial. Then show it to your friends and some business men of your community. Its reception will more than surprise you. You will get orders without soliciting them. If on the other hand you don't find the "SECURITY" as represented, you may return it to us C. O. D. for full purchase price. **THIS IS A GO! WE MEAN BUSINESS.**

An unconditional FIVE YEAR written guarantee is furnished with each Pen.

PRICES
No. 300 . . . \$3.50 No. 600 . . . \$5.00
No. 400 . . . 4.00 *No. 800 . . . 7.00

Long and Short models.
*Giant Security made in a beautiful red and black (mottled) finish has an exceptionally large ink capacity.

PRICES IN CANADA
\$5.00—\$6.50—\$8.00—\$10.00

SECURITY PEN CORPORATION

DEPT. 120 P. M.

900-910 W. Jackson Blvd., Chicago, Ill. No. 300. \$3.50



Security Pen Corporation, Dept. 120 P. M.,
900-910 W. Jackson Blvd., Chicago, Ill.

Gentlemen: I am interested in your proposition from the standpoint of DISTRICT MANAGER AGENT. I wish to devote FULL TIME PART TIME. In the following territory. Explain in full.

Enclosed find check money order \$. . .
Send me one Security Pen No. . . . Long Short Medium
 Fine Stub Coarse in Flexible or Stiff Action.
Also DEMONSTRATING OUTFIT FREE.

Name

Address

City State

I Will Prove To You That You Can Make \$100 a Week



Yes, you can make \$100 a week. You can make \$5,000 a year and not work half as hard as you do now. You can do as well as H. T. Pearl, of Oklahoma, who made \$750 in one month. You can begin like R. L. Marshall, of New Jersey, who made \$80 in five hours. You don't have to wait. You don't have to invest any money. You don't have to take any course or do any studying. You can start right in next week. You can begin at once to make a really big income. The opportunity is waiting. The money is there for you to get. Do you want it? Then read this ad carefully and answer it, for this offer is meant for you.

700 Men and Women Wanted at Once

We are now ready to appoint 700 more Representatives in all parts of the country. You can be one of them, and by simply doing what we suggest you can make a net, clear, cold profit for yourself of anywhere from \$50 to \$100 a week with very little effort. Your first day will bring you big money. W. A. Webster, of Virginia, made \$6 in 1½ hours; Dennis Spear, of Kansas, cleared \$8.90 his first day; W. P. Stone, of Maine, made \$24 in 4½ hours. All without experience or training and you can do as well, or better.

Amazing Profits for Easy Work

We are the originators and manufacturers of Zanol Products—the nationally advertised line of pure food products, toilet preparations, soaps, perfumes, household and laundry necessities—over 350 different kinds. Four million dollars'

More Than a Million Dollars Made By Our Representatives in 8 Months

If you want your share of these big profits all you need do now is write. You won't believe how easy it is nor what wonderful profits you can make until you get started and the money begins to roll in.

We furnish all of our people with complete equipment for doing business. We furnish it free. We tell you in detail exactly what to do. We make it easy for you. We help you in every way to get started quick and to make big profits without waiting or delay.

You will be given the same proposition that has brought thousands of dollars in cash to E. S. Shelly, of Pennsylvania; Mrs. Nona Kerns, of Mississippi; Edgar Banville, of Massachusetts; and dozens of others. It has enabled G. C. Henry to make four times as much money as he ever did on a farm and G. A. Becker, of Iowa, to earn more than he did in 22 years in the grocery business.

Send No Money

Just send me your name and I will tell you how to get started. I will give you all the details. I

worth were bought last year but none of these products are sold in stores.

We sell direct from factory to customer. By this means we give greater values and lower prices than could be secured in stores. We have thousands and thousands of customers in every section of the United States. But instead of sending their orders direct to us we appoint a Representative in each locality through whom our customers send us their orders.

Exclusive Territory

We offer to assign you an exclusive territory and let you handle all our dealings with our customers in that territory. You will simply introduce our products and let the people know that you have become the Zanol Representative. The rest is easy. Our products are nationally advertised and well known in every locality. We have been in business for 16 years and have resources of more than a million dollars. The local man or woman who becomes our Representative is given complete instructions, full equipment and everything necessary for success.

will show you how you can make \$100 a week and even in your spare time \$8 to \$10 a day for a few hours' work. I will show you how you can have a permanent, profitable, honorable, pleasant and fascinating business that will bring in a bigger income than you ever thought possible. It is the one opportunity that you have been waiting for. It is your chance to get ahead. It means thousands of dollars to you. And you are not risking a penny. You are not agreeing to pay anything or do anything.

So mail the coupon. Don't wait until someone else gets in ahead of you. Don't delay until it is too late. Write now.

THE AMERICAN PRODUCTS CO.

Albert Mills
President and General Manager

Dept. 4873, Cincinnati, Ohio

Mail This NOW

Albert Mills, President,
The American Products Co.,
Dept. 4873, Cincinnati, Ohio

Please send me, without one cent of cost and without any obligation, complete details of your new plan by means of which I can make from \$50 to \$100 a week.

Name

Address

(Write plainly)

Your Profits Will Begin At Once

These records show you how our Representatives make large profits the first day. You can easily do as well.

\$16 Profit First Day

That's the record of Alysé Leblanc, of Massachusetts.

\$32 Profit in 8 Hours

is the result of the first day's work of Adolph Montoya, of New Mexico.

\$4 in One Evening

is pretty good pay for 2 hours' spare time. That is what Samuel Miles, of Arkansas, made his first day.

\$13 Profit First Afternoon

Jacob Myron, of Connecticut, started in the morning and cleared over \$13 before evening.

\$4 an Hour

was what Margaret La Roux, of Michigan, averaged her first afternoon.

\$40 in 24 Hours

was the result of the first work of B. Collander, of Massachusetts.

We Furnish An Automobile



We want you to realize that this is a high-grade proposition. We want to help you in every way to make large profits and we offer to provide a car without any expense to you whatever. Just write for our proposition. Mail the coupon for details of the plan that will give you this automobile without expense and from \$10 to \$30 a day in cash.



The Merriest Christmas of All—

Bright and early Christmas morning you and your boy will be running his Lionel Train, enjoying the "thrills" of the World's most fascinating and educational toy.

Lionel Trains and Miniature Railroad Equipment are exact reproductions of those used on America's leading railroad systems.

Lionel locomotives are powerful enough to haul a train of twenty or more cars around curves, through tunnels, over bridges and across switches.

The realistic Lionel equipment includes Crossing Gates that automatically lower as the train approaches and raise as it passes by. Electric Block Signals flash "Danger" and "Clear Track Ahead," while Electric Warning Signals ring at the crossings.

Lionel products have all the up-to-the-minute improvements in modern railroad design and construction. All Lionel Locomotives, Cars and Accessories are of steel construction and practically indestructible.

For 23 years Lionel Electric Trains have been electrically and mechanically perfect—fully guaranteed. They are attractively finished in rich enamels and baked like automobile bodies.

You can see Lionel Trains in operation at the best toy, hardware, electrical, sporting goods and department stores.

Complete Lionel Outfits sell from \$5.75 up.

Send for the new 48-page Lionel catalogue—a handsome book showing the complete line in colors. It's Free!

THE LIONEL CORPORATION
Dept. 14, 48-52 East 21st Street, New York City
"Standard of the World" Since 1900



LIONEL ELECTRIC TOY TRAINS

& Multivolt Transformers

NEW CHEAP FUEL

AGENTS Salesmen—Distributors

Here is the fastest selling agent's proposition ever known. Housewives all over America are eager to get this wonderful, simple invention which banishes forever the dirt and drudgery of coal and wood.

If you want to earn \$75 to \$150 a week as a part-time salesman or \$5,000 to \$12,000 a year as a district manager, write us at once. We still have some choice territory open. Now is the season for this nation-wide sensation. Write or wire for special sales plan and new low price offer.



For Cooking and Heating

Why Gas-Fire Is Better Than Coal or Wood

1 Because Gas-Fire is a scientific fuel made right in your own cook stove, range or furnace from the most efficient and cheapest fuel known—kerosene.

2 Because Gas-Fire creates a steady, non-carbon flame of intense heat from a vapor mixture of only 4% kerosene and 96% air. It is the only device that really makes a gas, and burns this gas as cleanly and silently as a city-gas stove.

3 Because Gas-Fire operates from three to four hours on one gallon of kerosene, making (according to U. S. Government tests) heat units equal to 500 feet of city gas, or 100 lbs. of the finest coal.

4 Because Gas-Fire, although scientific in principle, is extremely simple—with no mechanical parts to get out of order—no wicks to trim or replace—no chimney to clean daily—nothing to burn out or break.

5 Because Gas-Fire is equally efficient Summer and Winter. Its heat can be regulated to perfection for any and all cooking, baking or heating.

—Gives greater heat at less cost —Does away with coal and wood

An amazing new scientific fuel—that you make right in your own cook stove or heating range—ends forever the dirt and drudgery of coal and wood. This marvelous new invention, set into the fire box, converts any cook stove or range into a real gas stove—in one minute. All the heat you want for cooking and heating at the simple turn of a valve. No fire to build, no coal to buy, no wood to chop, no ashes to carry out or litter your floors and scatter dust over the whole house. No shivering in winter—no sweltering in summer.

Cheapest and Best Fuel Known

This wonderful invention, which gives far more heat than either coal or wood, burns a scientific gas composed of 96% air and 4% coal-oil (kerosene, the cheapest and hottest fuel known). The result is a steady, even, clean fire as hot or as low as you want.



for yourself what a wonderful labor and time saving device it really is.

Just Turn a Valve

Never before anything like this new device called the "Gas-Fire" Burner. A "Gas-Fire" actually

THE HEAT APPLIANCE CORP.
103-105 N. May Street CHICAGO, ILL.

makes your old stove a gas stove. Real gas burners—no wicks—no smoke or odor, for all the gas is consumed. A simple valve puts the heat at your control, and controlled heat is the secret of perfect cooking, baking, and roasting.

Fits Any Stove or Range

No holes to drill. No injury at all to your stove. Nothing to do but set this simple device into the fire-box and you have a wonderful new gas range. Lasts a lifetime. No mechanical or moving parts to break or get out of order. Absolutely safe.

Send for Free Book

Write quick! The "Gas-Fire" Burner is a nation-wide sensation. Thousands of housewives and home owners proclaim it the greatest invention of the age. Send for free book and special low introductory price offer. No obligation. Mail coupon now!

Gas-Fire
The Modern
Fuel

30 Days' Free Trial!

THE HEAT APPLIANCE CORP.,
103-105 N. May Street, Chicago, Ill.
Please send me free your beautifully illustrated and special 30 Day Free Trial Plan.

I am interested in a Gas-Fire Burner for a

- Cook Stove Heating Stove
 Check here if interested in unusual agent's proposition.

Name.....

Address.....

City.....State.....

ONLY \$2 DOWN

FAMOUS 21-JEWELLED ILLINOIS RAILROAD WATCH BUNN SPECIAL

\$5.50
A Month



PENN. TERMINAL

GRAND CENTRAL

We guarantee this watch to pass railroad inspection on any railroad in the United States.

The requirements for passing railroad inspection are so severe that only the very finest watches can pass them. This watch is adjusted to six positions, although railroad requirements call for only five. A full description of the movement will be given if desired. Better still, order it on trial.

GUARANTEED 25 YEARS

This famous Bunn Special movement is put in a 25 year gold filled case that will wear like solid gold for more than 25 years. We guarantee it against any defect in material or workmanship. These movements are built to give a lifetime of satisfactory service just as the two famous Terminals pictured above were built to last for generations.

30 DAYS' TRIAL: 10 MONTHS TO PAY

You can test this watch in your own pocket for 30 days with the distinct understanding that if you return the watch we will return every penny you paid. Order it now or write for any additional information desired. Get our big catalog.

STERLING DIAMOND & WATCH CO.

Established in 1879

63 Park Row Dept. 682 NEW YORK

STERLING DIAMOND & WATCH CO.,
63 Park Row, Dept. 682, New York.
Gentlemen: Please send the famous BUNN SPECIAL, 21 jewelled Illinois Watch, as described above, to me on 30 days free trial. I enclose \$2.00 deposit to show my good faith. If I am not satisfied and return the watch within 30 days, you will return my money. If I keep the watch I will pay you \$5.50 every month for ten months until the total price of \$57.50 is paid. Title to this watch remains with you until I have paid you in full. It is understood that you fully guarantee this watch to be as described. Please send your catalog.

YOUR NAME _____

LOCAL ADDRESS _____

CITY & STATE _____

Please Mention Popular Mechanics

CHARGE YOUR RADIO or AUTO BATTERY OVERNIGHT FOR A NICKEL



**GOLD SEAL
HOMCHARGER**
*The World's Most Popular
in Batteries-Chargers*

—silently and efficiently charges your radio or automobile battery overnight for a nickel. No stopping—no sticking—no fuss—no fun—no trouble. Self-polarizing—high charging rate—finished in rubbery and gold—approved by Underwriters. Price \$18.50 complete with ammeter (\$25.00 in Canada)—no extras to buy. At all good dealers.

LOOK FOR and INSIST ON the GOLD SEAL
WRITE FOR FREE BOOKLET AND LIST
OF BROADCASTING STATIONS
THE AUTOMATIC ELECTRICAL
DEVICES COMPANY

129 W. THIRD ST.
CINCINNATI

New Powerful Light "Gets More Eggs"

Patented 300 Candle Power Lantern equals safety, convenience, brilliancy of electricity at 1-10 cost. Hang it in the hen house night and morning. Gives soft, bright, white light—like daylight. Burns 96% air—4% fuel—gasoline or kerosene. Clean, odorless, positively safe. 20 times brighter than wick lantern on half the fuel. Lights with match—no wicks—no chimneys. Guaranteed.

Free Trial—30 days at our expense. Pays for itself in week or two. Send for money-saving introductory offer and big descriptive catalog giving valuable poultry facts. Free. Send your name today.

**Agents!—Make Big Money
Write for Free Outfit Offer**

THE AKRON LAMP CO.
2192 Lamp Building AKRON, OHIO



Build Your Own PHONOGRAPH

IT'S EASY WITH OUR HELP

A few hours' interesting work saves over half and gives you a machine to suit your ideas. We furnish motors, tone arms, case material, blue prints and full instructions. Plays any record. Make fine profit building phonographs for your friends.

Write today for our **FREE** Blue print offer.
GET YOUR RADIO SUPPLIES FROM US
Choraleon Phonograph & Radio Co.
1223 1st St., Elkhart, Ind.



SAVE
OVER
HALF

KIRK'S GOODS

Cal. 30

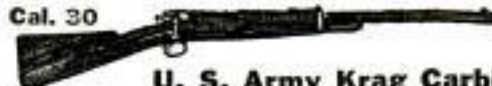

U. S. Army Krag Carbines

All carbines have the new model 1898 stocks. **\$15**
The barrels, actions and parts are either new or have been refinished by the Government, and are equal to new. Krag Sporting Rifles, \$14. Krag Rifles, \$12.50. Also Krag parts. Ammunition, 4c each.

HOME GUARD OLIVE DRAB OVERCOATS
Brand new. Like cut. All sizes. Weight, 5 to 7 lbs. Parcel Post. Extra. An excellent coat for dress or work. Send for Complete Catalog. **\$3.50**

W. STOKES KIRK 1627-PM North 10th St. PHILADELPHIA, PA.



The TOWN CRIER of TODAY



IN the quaint old villages and towns of long ago, when each community was a world unto itself, the Town Crier played an important part in the affairs of the day. With clanging bell and stentorian voice, he broadcast the news, perhaps weeks old, that occasionally drifted in from outside places.

Today news from all parts is immediately available right at your fireside. No matter how isolated your abode, Radio binds you to civilization. By a turn of the dial, the happenings, entertainments and amusements of the world are yours to command.

The Crosley Manufacturing Co. has done much toward bringing this new wonder within the reach of all and has made Radio a living, tangible thing—something to use in daily life, in business or pleasure.

Popularly priced, these famous receivers give perfect performance. Unsolicited letters are received daily from owners telling of satisfaction and new distance records.

Everyday tests prove to us that Crosley instruments are the most simple and efficient Radio receivers ever offered to the public, regardless of cost.

For Sale by Good Dealers Everywhere

Write for complete catalog. This fully describes the Crosley line of Radio parts and receivers which range in price from a 2 tube set at \$28 to a beautiful Console Model at \$150.



CROSLEY
Better - Cost Less
Radio Products

The Broadcasting Station WLW is maintained by the Crosley Manufacturing Co.

Crosley Manufacturing Co.

POWEL CROSLEY, Jr., President

1215 Alfred Street

Cincinnati, O.

CROSLEY

Model X-J
\$65



Crosley Model X-J, Price \$65

A 4 tube radio frequency set even better and with greater refinement of detail than the famous Crosley Model X, Price \$55. It combines one stage of Tuned Radio Frequency Amplification, a Detector, and two stages of Audio Frequency Amplification. A jack to plug in on three tubes for head phones, the four tubes being otherwise connected to loud speaker, new Crosley Multistat, universal rheostats for all makes of tubes for dry cells or storage batteries, new condenser with molded plates, filament switch and other refinements add to its performance and beauty.

Nowhere can a better receiver be purchased at any price.

Cost of necessary accessories from \$40 up. List prices on our equipment west of the Rockies 10% higher. In Canada add duty.

MAIL THIS COUPON TODAY

Crosley Manufacturing Co.,
1215 Alfred St., Cincinnati, O.
Gentlemen: Please mail me free of charge your complete catalog of Crosley instruments and parts together with booklet entitled "The Simplicity of Radio."

Name.....

Address.....



"Yankee" Tools in Christmas Boxes

YOU know how pleased you would be if you opened a rich holly box on Christmas morning and found the "YANKEE" tool that you had wanted so long.

Let Santa Claus know what you want, and choose for your friends from this "YANKEE" list, all ready now in Christmas boxes:

Ratchet Hand Drill No. 1530—only 10 $\frac{1}{4}$ in. long; weighs only 1 $\frac{3}{4}$ lbs. All five adjustments of No. 1555.

Ratchet Breast Drill No. 1555—Right-hand, left-hand and double ratchet movement, plain drill and gears locked. Two speeds. Holds drills up to $\frac{1}{2}$ in.

Automatic Push Drill No. 41—with magazine handle containing eight drill points.

Spiral Ratchet Screw-driver No. 30—with right- and left-hand ratchet movements and rigid; three bits.

"YANKEE" Tool Set No. 100—Solid oak case containing Spiral Ratchet Screw-driver No. 30 with chuck and 8 drill points; and Ratchet Screw-drivers No. 11 and No. 15, with finger-turn.

"YANKEE" Vise No. 1992—With swivel base. Removable from base, too, for holding work on machines.

See "YANKEE" Tools in Christmas boxes, at your hardware dealer's. "YANKEE" Tool Book sent free on request.



NORTH BROS. MFG. CO., Philadelphia, U. S. A.

"YANKEE" TOOLS

Make Better Mechanics

MAIL ORDER ADVERTISERS

Reach more than 500,000 thrifty families living in the cities, towns, villages and rural districts of the Central West, at only 50 cents an agate line. Forms close at 1 p. m. every Monday. Write for sample copy now.

JOSEPH A. GEIGER, 318 W. Madison St., CHICAGO, ILLINOIS



BUILD SHIP MODELS

Easy to build and sell. Pirate Ship—Early Dutch Ship—Santa Maria—Clipper. Complete plans, 35c each—3 for \$1.00—4 for \$1.30. MAAS & RICHTER, 422 Brumder Bldg., Milwaukee, Wis.



\$11⁵⁰
COMPLETE

Alfred's Ice King
The Skate for Pleasure

The Finest Tubular Skate and Shoe Made

Used by the World's Greatest Amateur and Professional Skaters. For Sale by All Good Dealers or Direct from Factory.

Factory and Salesroom

Dept. PM, 2846 W. North Ave., Chicago, Ill.

*Inspect it—
point by point*

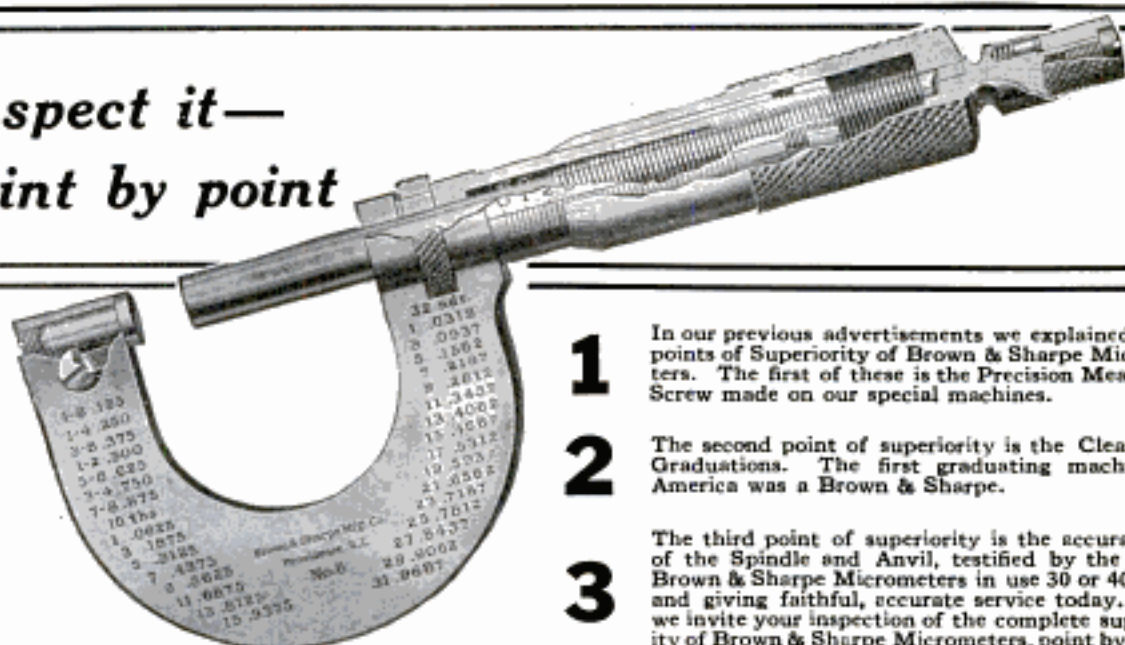

- 1** In our previous advertisements we explained three points of Superiority of Brown & Sharpe Micrometers. The first of these is the Precision Measuring Screw made on our special machines.
- 2** The second point of superiority is the Clean Cut Graduations. The first graduating machine in America was a Brown & Sharpe.
- 3** The third point of superiority is the accurate Fit of the Spindle and Anvil, testified by the many Brown & Sharpe Micrometers in use 30 or 40 years and giving faithful, accurate service today. Now we invite your inspection of the complete superiority of Brown & Sharpe Micrometers, point by point.

BROWN & SHARPE MICROMETER CALIPER No. 8

Brown & Sharpe Micrometers are made in the largest factory of its kind in the world, from the finest material, by skilled workmen. The highly accurate Micrometer Screw is made on our own special machines.

Improved Design is worked out from actual requirements in our large plant.

The Spindle fits the hub.

The Clamp Ring is a Brown & Sharpe Invention.

The Adjustments for wear are the best yet devised—although wear after many years of use is scarcely perceptible.

The Finish of the micrometer is distinguishing and in keeping with the superiority of the Tool.

The Standards we use are our own—and obtained from the Government Bureau of Standards.

Inspection is exacting—here experience is again a factor—we made the first micrometer in America.

The Brown & Sharpe Measuring Machine is our own product and measures to one-one hundred thousandth of an inch.

The Brown & Sharpe Micrometer measures accurately and wears long. Don't ask for a micrometer—demand Brown & Sharpe.

Our Small Tool Catalog describes the complete line of Brown & Sharpe Tools. You may want a copy of "The Micrometer" also—a little text book of valuable information. Write for them today.

BROWN & SHARPE MFG. CO., Providence, R. I., U.S.A.

BROWN & SHARPE TOOLS

30 Days' Free Trial

Select from 44 Styles, colors and sizes, famous **Ranger** bicycles. Delivered free on approval, express prepaid, at **Factory Prices**. You can easily save \$10 to \$20 on your bicycle.

12 Months to Pay on any **Ranger** if desired. Parents and girls can easily earn small monthly payments.

Tires best quality, at factory prices, express prepaid. Lamps, wheels and equipment, low prices. Send **No Money**, do business direct with makers.

Mead Cycle Company
Dept. 108 Chicago

Write today for free **Ranger** Catalog, factory prices and marvelous easy payment terms.



My Engine Will Do the Work of 6



Write now for the facts about this wonderful farm engine. Same engine gives 1½ to 6 H. P. Uses kerosene or gasoline. Portable, light, free from vibration, requires no anchorage. Easy starting—no cranking. Operates pump, 30-inch saw, 8-inch grinder, runs small silo filler, concrete mixer, spray rig, washer, churn, separator. Does all chores. All moving parts enclosed. Easy to operate.

Low Price—Free Trial Offer

Low factory price. Tremendous value. Thousands of satisfied users. Write at once for complete information and special free trial offer on this amazing engine.

EDWARDS MOTOR CO.
318 Main St., SPRINGFIELD, OHIO

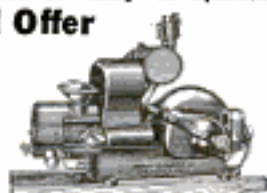

FASTEN IT WITH AN AJAX EYELET FASTENER

Binds Paper, Cardboard, Leather, Cloth. It Saves Time by Punching the hole, feeding the eyelet and clenching it in one operation. Order from your Stationer.

Machine Appliance Corp.
Dept. P. M. BROOKLYN, N. Y.



The biggest little woodworker ever built!

You'll want this sensational Parks combination wood worker right away for your shop; includes 8-inch rip and cross-cut saw, 4-inch jointer, band-saw, borer, shaper, sander, and universal motor. Only \$195 complete! Lathe attachment only \$15 extra. First-class Parks angle-steel construction, all joints electric-welded. Steel table-top. The newest thing in small shop equipment. Guaranteed 10 years.

Send for Bulletin C-8, describing this machine in detail.

Parks "Cabinet Shop Special"

\$195.00

as illustrated with motor I.o.b. Cincinnati.

THE PARKS BALL-BEARING MACHINE CO.

1500-1540 Knowlton St. CINCINNATI, OHIO

Canadian factory: 200 Notre Dame East, Montreal, Can.



PARKS

WOODWORKING MACHINES

MAKE MORE MONEY TORIT ACETYLENE TORCH NO. 13

For soldering, heating, melting, tempering, auto radiator repairing, battery repair work, and for all kinds of small jobs requiring a hot flame instantly. Usually pays for itself in a single day.

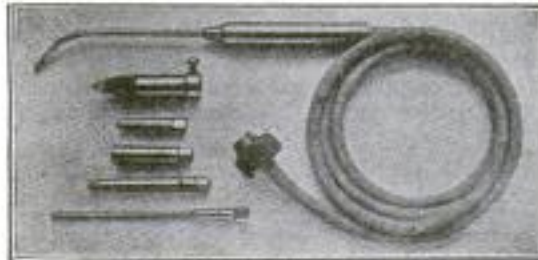

USES ACETYLENE GAS ONLY

Torch with 4 tips for different kinds of work, soldering copper, 5 ft. tubing and connection for auto-acetylene tank.....**\$7.50**
Order from your jobber. If he cannot supply you send your order to us.
St. Paul Welding & Mfg. Co., 177 W. 3rd St., St. Paul, Minn.

\$25 A DAY Clear Profit



—every day you work. Make \$5,000 to \$10,000 a year in the Floor Surfacing Business with the American "Universal" method. Work for yourself. Experience, special training or large investment unnecessary.

New Field; Big Profits

Better floors are demanded everywhere. American "Universal" electric machine, doing work of six men, assures BIG PROFITS in this new uncrowded field. Every floor,—old or new,—in town or city, is your prospect. Work easy to get. Profit possibilities unlimited. Positive guarantee and 5-day trial offer protects you. Write today for complete details.

AMERICAN FLOOR SURFACING MACHINE CO.
523 S. St. Clair St., TOLEDO, OHIO



\$2³⁵

CRESCENT KIT for Christmas

The ideal gift for the tool-user, 8 in. wrench, 6-in. pliers, Crescent T-type screw driver with 4-in. hardened, oil-tempered blade. Handle locks at right angles, to give extra turning power if desired. Crescent Kit is a favorite with car-owners. Fits side pocket. All three tools in rattle-proof case. Packed in attractive holiday box for gift purposes. Get it from hardware or accessory dealers.

CRESCENT TOOL COMPANY
Jamestown, N. Y.

10¢ A DAY and Up Bargain Prices

Celebrated Symphonola Phonographs. Genuine Mahogany, Walnut, or Oak. Portable and cabinet models, 10c a day and up pays. Plays any record. Write TODAY for Big FREE Book.

Larkin Co. Inc., Dept. S-1239
BUFFALO, N. Y. Peoria, Ill. Chicago, Ill.

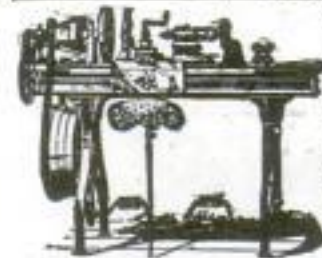

LATHES

9 to 18-inch Swing

List price \$165 and up according to size. When ready to buy send for Lathe Catalog and prices.

W. F. & John Barnes Co.
100 Ruby Street, ROCKFORD, ILL.



It is the well known quality of CRESCENT machines that justifies you in selecting one of them each time you have need for wood working machinery. The CRESCENT line is better than ever and will always give you satisfaction in every particular. Ask today for catalog of hand saws, saw tables, jointers, shapers, planers, borers, jointers and matchers, swing saws, disk grinders, cut off table, hollow chisel mortiser, variety wood worker, Universal wood workers.

THE CRESCENT MACHINE CO., 83 Columbia Street, Leontia, Ohio

New 1/4 H. P. 110 Volt Guaranteed Motors Complete with Cord, Plug and Pulley



60 cycle A. C. 1740 speed . . . \$13.00
60 cycle A. C. 1160 speed . . . 16.50
25 cycle A. C. 1450 speed . . . 16.50
Direct current 1740 speed . . . 17.25
Direct current 1160 speed . . . 19.75

HYRE ELECTRIC CO.
615M S. Dearborn St., Chicago, Ill.

Fix it with BERNARD PLIERS



There are
Dozens
of Places

on your car, motorcycle or bicycle where Bernards can nose in and grip and cut better than any other tool. Compound leverage, parallel jaws and outside cutting blades make Bernards the all around tool for men who appreciate the real thing. At good Hardware Stores.

Booklet "P" Free on Request.



BERNARD PLIERS

Wm. SCHOLLHORN CO.
NEW HAVEN, CONN.



PARALLEL JAWS

OUTSIDE CUTTER



TOOL CHESTS

for Machinists & Toolmakers

Every tool arranged in order. No up-to-date mechanic should be without one. A Gerstner Case costs no more than some tools, and will last a lifetime. Catalog free.

Gerstner Tools

717 Columbia Street DAYTON, OHIO

MYERS WONDERFUL SEWING AWL



Tools in
Handie

Have it when you need it. Don't stop work. A complete repair shop in itself. Sew anything heavy or light. Leather, Shoes, Harness, Automobile or Boggy Tops, Canvas, Belts, etc. Price to introduce, \$1.00 Postpaid. C. A. MYERS CO., 6339 Woodlawn Ave., CHICAGO, ILL.

MATHEMATICS

can be easily mastered with the Midget 5 in 1 Slide Rule. With this calculator you can instantly add, subtract, multiply and divide any combination of decimals, fractions, whole and mixed numbers. Also obtain all roots, powers, Logs, and Trig. Functions.

It is used at all colleges, 200 at Harvard, 200 at Cornell, etc. The Engine-Divided Scales are on white celluloid, mounted on aluminum and are grease and waterproof. Diameter 4 inches. Price with Instruction Book, \$1.50. Leather Case 50c extra. Catalogue Free. Your money back if you are not satisfied. GILSON SLIDE RULE CO., Niles, Mich.

BURN YOUR NAME ON TOOLS WITH ARKOGRAF

Protect your tools from theft. Write any name, engrave any design on metal with electricity like writing on paper with pen or pencil. Complete outfit \$2.50, prepaid anywhere. Interesting descriptive circular free. Write today. Agents Wanted. Arkograf Pen Company 481 East Couch St. Portland, Oregon



Write for
this
bulletin



16" x 6' Quick Change Gear \$466.00
16" x 6' Standard Change Gear \$406.00

FOR manufacturing, for the machine shop, for the general repair shop, SOUTH BEND LATHES meet the most exacting requirements. Every concern before buying a lathe should investigate this great lathe value.

"LATHE WORK SIMPLIFIED" contains 52 illustrations of up-to-date lathe operations that your mechanic should study, showing how to take hand work out of the shop, how to increase production.

SIZE	Standard	Quick Change
9" x 3' Lathe	\$211.00	\$241.00
11" x 4' Lathe	248.00	288.00
13" x 5' Lathe	304.00	354.00
15" x 6' Lathe	376.00	431.00
16" x 8' Lathe	438.00	498.00
18" x 10' Lathe	656.00	721.00

Over 30,000 users attest to the performance, accuracy and durability of SOUTH BEND LATHES. They are standardized, manufactured complete in large quantities and thus represent the greatest lathe value per dollar of cost. Write today for the Bulletin. Catalog No. 83 will also be sent you without obligation.

SOUTH BEND LATHE WORKS

555 E. Madison Street, South Bend, Indiana
New York Salesroom, 166 Centre Street

SOUTH BEND LATHES

South Bend Lathe Works, 555 E. Madison St., South Bend, Ind.
Gentlemen: Kindly send me without obligation, "Lathe Work Simplified," also Catalog No. 83.

Name

Street

City State

Concern

(If possible, attach coupon to your letterhead.)

Please Mention Popular Mechanics

Copyrighted material

ATKINS

METAL CUTTING SAWS



Use
Atkins
"Non-Breakable"
Hack Saw
Blades

Cut Hardest Metal Quicker and Easier

PUT an Atkins Non-Breakable Blade in your hack saw frame. It will saw the toughest metal faster and easier than ordinary blades, hold its cutting edge longer, and will not break. These blades are made of selected steel, and are hardened and tempered by an exclusive gas-and-oil process, which gives a hard, keen cutting edge and a tough, flexible body.

You can save time, money and effort by using Atkins Non-Breakable Hack Saw Blades. Prove it for yourself. Send ten cents and tell us what metal you want to cut, and we'll send you a sample blade that will out-cut and out-last any other.

Saws for Every Service

No matter what kind of wood or metal-cutting you do, there are Atkins Saws to save you time, labor and money. Ask for our free booklets on saws you're interested in.



Get This FREE Book on Saws

A 32-page book that's full of practical suggestions on metal-cutting, and general shop information. Every man who buys or uses saws will find it helpful. Just write your name and address on the margin of this page and mail it to us.

E. C. ATKINS & CO., Inc.
Dept. P Indianapolis, Ind.

Makers of "Silver Steel"
Saws and Tools

E.C. ATKINS & CO.
INDIANAPOLIS, IND.

Different from all others—the NEW BENJAMIN AIR RIFLE



Made on a different principle from all other Air-Rifles. The Benjamin is really a strong air-pump used to compress the air in the air chamber to any degree of power desired. From one to six strokes of the pump give all the force necessary. Each additional stroke gives increased power. The Benjamin works on the same principle as all air-drills and air-hammers—with this difference:

You control the shooting force as you desire. Look at this block of hardwood. It shows how Benjamin power is regulated as you wish.

You can't have accidents with a Benjamin. It's safe, always, because you control the power. The Benjamin never loses shooting force, and has no springs to get out of order or shake your aim. Write us for an interesting folder about this wonderful air-gun.

If your dealer does not handle mine, send direct to factory.

(PRICE \$5)
POSTPAID

BENJAMIN AIR-RIFLE & MFG.
CO., 315 N. Broadway, St. Louis, Mo.

Ask your
dealer for
demonstration.

Pacific-Coast
Representatives
THAYER &
DOWDY
Los Angeles
Calif., and
San Francisco
Calif.



Do Your PRINTING

Cards, circulars, labels, tags, book, menus, paper, Press, \$12. Larger \$35. Job Press \$150 up. Save money. Print for others. BIG PROFITS. All easy, rules sent. Write factory TODAY for press catalog, TYPE, cards, paper. THE PRESS CO. D-37, MERIDEN, CONN.

QUICK TO STICK—SOLD TO HOLD

AT ALL
5 AND 10
CENT
STORES

IRON GLUE

10¢-15¢
SIZES

MCCORMICK & CO., Baltimore



Dealers and Agents; Request
Attractive Proposition.

Adjusts Instantly to Any Length

Just slide it out. Gives exact inside or outside diameter. No folding. Accurate, strong, brass-trimmed. Any length 2 to 8 feet, 20¢ per lineal foot. If not at dealer's, sent postpaid.

Interlox

MASTER SLIDE RULE

MASTER RULE MFG. CO., Inc.
941-43 E. 136th St., N.Y. City

PILLIOD

Tool Cases Excel

Machinists, Tool Makers and Carpenters find them most satisfactory in construction, appearance, service and price. Immediate shipment.

Booklet describing 20 styles on request.
THE PILLIOD LUMBER CO.
Dept. 1 Swanton, Ohio



FREE To You

Book of Factory Bargains in Stoves, Ranges, Furnaces, Furniture, Refrigerators, Farm and Home Needs



Let me send you my new free catalog and show you how to make great savings at wholesale—direct from factory, at money saving prices. *Everything guaranteed—set in your home on*

30 DAYS' TRIAL—DON'T RISK A PENNY
Your money back without question or quibble. More than 500,000 satisfied customers.

Easy Terms—Write at Once
Just send name and address. A postal will do. **W. S. DEWING, "The Stove Man."**

Kalamazoo Stove Company
397 Rochester Ave., Kalamazoo, Mich.

A Kalamazoo Direct to You

AGENTS: \$12 A DAY
New Kant-Klog Coal Oil Burner

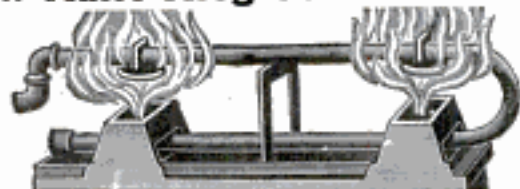

Most perfect burner ever invented. Can't clog up. Burns 85% air and 15% gas. Turns any coal or wood stove into a gas stove. Pays for itself in a short time. Cheaper than coal. Big seller. Popular price. Write for agency and territory.

PARKER MFG. CO., Burner 278, DAYTON, OHIO

\$11.85



KRAG SPORTER

caliber 30/40 with 22 inch barrel; five shot with military sight for 2000 yards. Weight 7 3/4 lbs. In fine order. Special price \$11.85. Ball Cartridges \$2.50 per 100. 372 page Military catalog 50 cents. Circular for 2 cent stamp. *Established 1865.*

FRANCIS BANNERMAN SONS, 501 Broadway, N. Y. CITY

MADE TO YOUR MEASURE

Suit \$14.95

NO EXTRA CHARGES *Postage Prepaid*

SEND NO MONEY We make this special offer to prove the wonderful value, style and fit of **Progress** tailoring. We will tailor to your special order one of these fine suits, send it to you postage prepaid and guarantee absolute satisfaction for only \$14.95. We have other equally striking bargains in the finest made-to-order suits at from \$14.95 up to \$39.50.

AGENTS WANTED—Earn \$20 to \$35 extra every week, taking orders from your friends and neighbors for our high-class tailoring. **NO EXPERIENCE NECESSARY.**

Big Sample Outfit FREE

Drop us a line today and we will send you absolutely free, our big assortment of woven samples, style book and special wholesale prices, on our made-to-measure suits.

THE PROGRESS TAILORING CO., Dept. Z-145, CHICAGO



The Embassy Phonograph



A disc machine which plays all makes of disc records.

\$1.00 After Trial

Most Beautiful Phonograph Outfit!

20 Selections FREE!
We include, without charge 10 double faced records—20 selections

An offer which removes all risk and doubt. Enables you to hear its wonderful tone and to inspect its beautiful design. Sent on free trial. You are the sole judge. If you like it, keep it, and send us only \$1.00 as first payment, after the free trial. Easy monthly payments after that.

Write for FREE Book! Send letter or post-card today asking for free book which gives you complete information about this unusual offer. This book is mailed free and prepaid. Write today.

F. K. Babson, 19th St. & Marshall Blvd. Desk 13-59, Chicago, Ill.

"Been on a vacation Bill?"

"No, Jim—I've stopped smoking. Gained six pounds in a week. You know how I used to smoke—a package of cigarettes and a cigar or two a day—it sure had some hold on me. But I'm cured—

took a scientific home tobacco treatment—fixed me up in two weeks.

"Wasn't hard on me at all—noticed improvement the first day—I feel like a new man. It didn't interfere with my work—didn't leave any druggish after-effects—the money I saved in the last two weeks has paid for the treatment alone.

"Why don't you take it! It has cured men like you and me for over forty years—it is a doctor's individual prescription that sure fixes you up. Just send the coupon for full information NOW. No obligation. All correspondence is strictly confidential."

LE



A Doctor's Prescription

The Keeley Institute, Dwight, Ill.

Please send me, without any obligation on my part, your free booklet which will tell me how to rid myself of the tobacco habit.

Name.....
Town.....
Street..... State..... P.M.-12



Ford Auto FREE!

We have a plan whereby our active workers can get a Ford without cost, in addition to their big cash earnings. Get the plan—quick!

"I have averaged \$7000

Per Year for Three Years—Have Made Over \$90 PROFIT in One Day"

That is the statement of Frank DePries, one of our live-wire representatives. Keeton of Mississippi made \$252 on his first sale. Vickers of Alabama made \$118 in one week. Conant quit a \$6,000 job to come with us.



DePRIES

AGENTS WANTED

We need more men like these, because the demand for our Super Fyr-Fyter is growing by leaps and bounds. Sells to garages, stores, factories, schools, homes, hotels, auto owners. Approved by the Underwriters. If you are willing to work and ambitious to make some real money, get our plan. You need no experience, as we train you without cost for the work. No great capital required. Good territory going fast. Better write us at once.

THE FYR-FYTER COMPANY

1730 Fyr-Fyter Bldg.,

Dayton, Ohio

Learn to Play **SAXOPHONE** EASY PAYMENTS

"C Melody" Artists' Model Saxophone

Boy, it's a WOW! As easy to play as one-finger tunes on a piano—easiest fingering, easiest blowing, richest TONE "Sax" ever! The choice of teachers and professionals all over the world. Now offered direct from factory at wholesale price, on small payments!



Complete Professional Outfit

\$1 DOWN

10 MONTHS TO PAY!

Thousands of happy young fellows have made their AX-PIERCE sax for itself in spare time earnings! Now at last you can be Everybody's Favorite—you can turn your saxophone playing into pleasure and profit!

FREE TRIAL—Consists of 28 days, self-instruction book, sheet music, reeds, strap, pearl keys, etc. \$1 reserves your Saxophone. Small first payment, then only \$5 a month!

Highest quality **PROFESSIONAL Saxophone** now within your reach. Write for catalog today! Dept. 1622, P. O. Box 503, Chicago.

CATALOG FREE!

BIG FREE BOOK BEAUTIFUL FURNISHINGS



The very things you need now. Latest styles. Factory-to-Family low prices. Save big money. Furnish a room or whole home. As little as \$3 down; a year or more to pay. Also Pianos, Players, Phonographs. Cut out this adv.—Write TODAY, for new Fall "Larkin Book of Better Homes".

Larkin Co Inc.

Dept. 1229
BUFFALO, N.Y. Peoria, Ill. Chicago, Ill.



DIVINE RED DEVIL Water Motors

Simple—strong—durable. Wonderful little workers for all sorts of household and shop uses. Thousands in use. For all light power purposes. Attaches to faucet.

Two sizes: 4"—\$4.25
6"—\$6.75

The higher the water pressure the more work they do.
Send today for catalogue.
Divine Water Motor Company
Utica, N. Y.

Art Corner Your Pictures-Album in an

where you can keep them safe and enjoy them always.

5 Styles **Engel** 5 Colors
"Art Corners" Colors

are on sale at Photo Supply and Album counters everywhere. They are the only Quick, Easy, Artistic, No Paste, No Fold way to mount Kodak Prints, Greeting and Souvenir Cards, Clippings, etc., on anything, anywhere. A dime brings 100 and samples to try. Write
ENGEL MFG. CO.
Dept. 22 4711 N. Clark Street, Chicago

Sell Shirts

Sell Madison "Better-Made" Shirts, Pajamas, and Nightshirts direct from our factory to wearer. Nationally advertised. Easy to sell. Exclusive patterns. Exceptional values. No experience or capital required. Large steady income assured. Entirely new proposition.
WRITE FOR FREE SAMPLES.
MADISON SHIRT CO., 603 B'way, N. Y. City

Build This Phonograph Yourself

TREMENDOUS SAVING IN COST

Easy, fascinating work with our **SIMPLIFIED PLANS**. We furnish blue prints, diagrams, motor, cabinet pieces, ready-built horn, etc. You don't need to be a cabinet maker. A few hours assembling and you will have a fine instrument at one-quarter the regular retail price. **AGENTS MAKE MONEY** making and selling these instruments. Write today for full details and our **FREE OFFER**. Address
LUPERL PHONOPARTS CO.
2648 W. Chicago Ave. Dept. 6 CHICAGO, ILLINOIS

"If I hadn't been all through it myself, I would n't have the assurance to tell you to 'cheer up.'"

ERICKSON.

The Beginning—(1892)

Those who wear them say:
ERICKSON LEGS are Wonderful because they do not chafe, overheat or draw end of stump.

If you have had a recent amputation send for new booklet on **TEST LEGS** for beginners.
E. H. ERICKSON CO.
38-A Washington Av. N.
MINNEAPOLIS MINN.

WINDOW SIGNS



AGENTS 500% PROFIT
Genuine Gold Leaf Letters
GUARANTEED TO NEVER TARNISH



For store fronts, office windows, Bank windows, Office Doors, Panels, Board Signs, Trucks, Automobiles and Glass Signs of all kinds. Anyone can put them on and make money right from the start without previous experience. All you have to do is to show your samples; the letters are very attractive and easy to sell. Letters costing 3½¢ sell for 25¢. One agent says: "Your Letters are the best thing I have seen in years; I have made \$125.00 the first week and still going strong." Paul Clark says: "Smallest day \$28.70." H. Gilder made \$835.00 in six weeks.

\$60 TO \$200 A WEEK

GENERAL AGENTS—It is easy to appoint sub-agents for this line. We pay you 20% cash commission on all orders we receive from local agents appointed by you anywhere. We allow you 50% discount on your own orders. You can sell to nearby trade or travel all over the country, as you please. Large demand for window lettering everywhere. Write today for free sample, full particulars and liberal offer to general agents.

Metallic Letter Co., 433-B N. Clark St., Chicago



Earn \$50 a day

Selling men's gas-mask

Goodyear Raincoats

\$1.90 each, in dozen or gross lots. Sample sent upon receipt of \$2.15. Agents wanted (Write for our 6 best sellers).

GOODYEAR RUBBER M'FG CO.
 Dept. A. 34 East 9th Street, New York City

FINE OLD VIOLINS

On Easy Payments
30 Days' Free Trial

allowed, no matter where you live. If not more than pleased with our values, return violin **AT OUR EXPENSE**—and no harm done. Ability to play the violin brings social and financial success. Get a violin with a rich, mellow tone and it will create within you a desire to master it.

FREE! MAGNIFICENT ALBUM-CATALOG

containing portraits of the world's greatest violinists since Paganini's time, a half-tone of "Stradivarius in his Workshop" and the romantic story of The King of Musical Instruments. A postal brings ad to you **FREE**—no obligations.

Old Violins Bought, Sold, Exchanged and Repaired

Send in your old violin by insured parcel post for examination. We may be able to make a very valuable instrument out of it at small cost. Many violins that were considered worthless brought high prices after they left our repair shop. No charge for estimates.

CREMONA VIOLIN SHOP

Forty-Third & Shields Ave., Dept. H-41, Chicago

DIAMONDS and other Xmas Gifts

Send No Money 10 Days' Free Trial On Credit

\$5 down—\$2 a month for any of these three rings



X36—Perfect cut blue white diamond, 1½k, white gold engraved and pierced ring..... **\$25.00**



X46—Handsome richly carved 1½k, white gold onyx ring set with perfect cut blue white diamond..... **\$25.00**



X32—Solid 1½k, white gold ring set with perfect cut blue white diamond..... **\$22.50**

\$10 down—\$1 a week for any of these six rings



X84—1½k, white gold perfect cut blue white quality diamond..... **\$50.00**



X76—1½k, white gold two perfect cut blue white diamonds one square sapphire **\$42.50**



X38—Seven blue white diamonds set in PLATINUM. Green gold 1½k ring..... **\$52.50**



X92—1½k, green gold ring 1½k, white gold top. Perfect cut blue white diamond..... **\$57.50**



X86—Two blue white perfect cut diamonds one sapphire 1½k, white gold ring..... **\$50.00**



X94—Artistic 1½k, white gold ring. Perfect cut blue white diamond. Rare beauty..... **\$48.50**

\$15 down—\$1.50 a week for any of these three rings



X20—1 white diamonds, PLATINUM set 1½k, white gold ring..... **\$77.50**



X90—Engagement ring, 1½k, yellow gold. Perfect cut blue white diamond **\$75.00**



X44—1½k, white gold ring. Perfect cut blue white diamond. **\$73.50**



X98—Solid 1½k, white gold case, Sapphire crown, Fancy dial. Adjusted 15 jewel movement. Guaranteed time-piece. Very dainty. **\$25** .. \$5 down—\$2 a month.

Send No Money

Buy on credit as others do. Simply send your name and address and we will send ring or watch you select. Only if satisfied make first payment down. If after 10 days' trial you are not satisfied, return to us and receive your money back immediately. You take no risk. Transactions confidential. Guarantee Bond with each purchase.

FREE Write for Xmas Catalog. Latest designs in quality jewelry at lowest prices and most liberal credit terms. Diamonds, watches, jewelry, every toilet set, etc. Prices \$10 to \$1000. Large and choice variety. Our prompt and efficient service has earned us thousands of satisfied customers. If you do not see what you want here, do not order your Xmas Gifts until you send for our catalog. Established 1850 Write Dept. E-26

BAER BROS. CO.
 6 MAIDEN LANE - NEW YORK

HERMAN'S SUPER SERVICE SHOES

For Men on Their Feet
All Day

Thousands of policemen, firemen, mailmen, motormen and conductors—who *must* have comfort as well as long wear—depend on No. 19 to keep their feet "on the job." Adopted by New York Police Department and many Police and Fire Departments throughout the country.

Let us send you our new **FREE** catalog and the name of nearest Herman dealer.

JOSEPH M. HERMAN
SHOE COMPANY
Dept. P
MILLS, MASS.



Style No. 19

LONG RANGE RIFLE

SINGLE shot hunting rifle of finest blue, case hardened steel, modelled after famous Springfield rifle. Bolt action, take-down model 36 inches over all. Shoots 22 calibre long, extra long and short cartridges. Special at \$6.25

22 CAL
\$6²⁵

Front and rear sights; automatic shell ejector.

PAY POSTMAN

ON DELIVERY plus postage.

Money back if Not Satisfied

CONSUMERS CO., Dept. 6-CB
1265 Broadway, New York

FREE

Send for free catalog of bargains in sporting goods.

Prophy-lac-tic Tooth Brush

Buescher-Grand TRUMPET

Especially easy to blow, with an improved bore and new proportions. With the mute in, it blows so softly and sweetly that it will not annoy anyone. A splendid home instrument.

The Buescher-Grand Cornet is exceptionally easy to blow, yet possesses a tone of wonderful volume. It is the same instrument with which the greatest cornetists of America have made their reputations.

Send today for Free Book, mentioning instrument in which you are interested.

BUESCHER BAND INSTRUMENT CO.
Makers of Everything in Band and Orchestra Instruments
2593 Buescher Block ELKHART, INDIANA



Be Sure Dad Gets You **PLANERT'S**



RACERS— That Make Records

Be sure Dad gets you the best skates made. They cost no more, but give lasting pleasure—are speeders on ice and safe because of quality. For 25 years Planert's Northlight Skates have held the reputation of being The "World's Best." You can't go wrong in selecting Planert's.

A Guaranteed Skate

These skates are used by Champions. Many records have been made on the ice, but Planert's Skates are made equally well for boys or girls and backed by our guarantee against defect in materials or workmanship. Accept no substitutes. Ask your dealer for Planert's. If he can't supply you, write us giving your dealer's name.

F. W. PLANERT & SONS
Builders of Tubular Skates for 25 Years
939-41 N. Robey St. Chicago, Illinois

PLANERT'S "NORTHLIGHTS" The World's Best Tubular Skates

FOR BOY MECHANICS

You will find thousands of uses for

Moore Push-Pins

Glass Heads—Steel Points
Moore Push-less Hangers
"The Hanger with the Twist"

To Hang Up Things
10c pkts. Sold everywhere.
In Canada 15c.

MOORE PUSH-PIN CO., Philadelphia, Pa.

SELF-FILLING INK PENCIL

"INDEPENDENT"

Guaranteed Improved Fountain Pen.
Eliminates fatigue. Promotes efficiency. Writes uniform.
A business necessity.

\$2 By Mail

Meets all requirements. Self-filling, non-leakable, safety cap. Attached clip. Smooth writing gold style point.

Your Name in Gold—25 Cents Extra

AGENTS WANTED

J. C. ULLRICH & CO., 161 Washington St., New York

Beautiful HOUSES \$900 and BUNGALOWS

CAN BE BUILT FOR AND UP
This and many others in my new book, Building Plans for Modern Homes, will save you hundreds of dollars. One of the most complete and comprehensive books of plans ever published by any architect. New edition just off the press. Nearly 500 floor plans and photographs of bungalows, Colonial houses, etc., costing from \$200 up; gives sizes and cost to build.

Sent postpaid for \$2.00



FREDERICK H. GOWING
ARCHITECT

161 Tremont St., BOSTON, MASS.

WHITE FLAME

BURNERS make your old kerosene lamps and lanterns give a brilliant white light better than electricity or gas. Doubles your light. Saves oil. NO MANTLE TO BREAK. Guaranteed Safe and Reliable. Delights every user. Send now for complete sample postpaid 50 cents, stamps or coin. 3 for \$1.25. Money Back if Not Satisfactory. Live Representatives Wanted. Exclusive Territory. WHITE FLAME LIGHT CO., 68 Clark Bldg., Grand Rapids, Mich.





Harris Homes Beautiful PERMANENT BUILT

Your Home Is Within YOUR Reach
When You Buy From Us!

A mighty organization of thirty great departments ready to serve you. Managed by expert material buyers, designers and practical builders. We have vast stocks bought at huge quantity price savings which are now at your command. Our sole aim and purpose is—

To help you get a home that will prove entirely satisfactory at a price that will mean a substantial saving in actual dollars of your money.

The combined efforts of these great departments in expertizing and testing materials and methods of construction have produced for you a GUARANTEED home, expert machine cut, banded and marked—the best word in building economy.

Not One Penny in Advance

So sure are we of the superior excellence of our material and our GUARANTEED Ready-Cut System that we will ship you any HARRIS HOME without the payment of one cent down. Our Plan Book explains our liberal terms fully.

FREE Plan Book

for you, contains our FREE PLAN OFFER and photographic reproductions, with floor plans and specifications of 100 beautiful homes. Write for full particulars now!

Our Specialties: Guaranteed Ready-Cut Houses, Plumbing, Heating, Lumber, Mill Work, "Presto-Up" Belt-Together Houses, Patios, Roofing, etc., etc., and Building Material of all kinds.

HARRIS BROTHERS CO.
Dept. PE-7, 1349 W. 35th St., Chicago

\$3 Cash Buys Typewriter



Balance Only \$5 Monthly

Save 35 to 60% on all standard makes—Underwood, Royal, Remington, etc. Every machine thoroughly rebuilt and GUARANTEED. Try five days at our expense before you buy.

WRITE at once for Free Descriptive Circular and Special Low Prices.

5 DAYS FREE TRIAL

WYNN TYPEWRITER EXCHANGE 11 Bellevue Bldg.
Kansas City, Mo.



NEW AUTOMATIC ADDER, \$3.50

Makes adding easy. It's accurate, quick, durable and easily operated. Capacity 8 columns. Saves time, brain work and errors. 75,000 pleased owners. Fully guaranteed. Price \$3.50 delivered. With metal operating bands, \$5.00 delivered. Agents wanted.

J. H. BASSETT & CO., Dept. 226, 1458 Hollywood Ave., Chicago, Ill.

HOME LOVERS' BARGAIN BOOK FREE

Showing Over 10,000 Furniture Bargains

All selections loaned free for a month. Take a year to pay if satisfied, paying little by little almost as you please.

SPIEGEL, MAY, STERN CO., 1188 W. 35th St., Chicago

We Pay \$8 a Day



Taking orders for New Serenola. Wonderful invention. Does more than machines costing many times its price. Easily carried with you anywhere. Built in just like a suitcase. Fully guaranteed.

EASY TO TAKE ORDERS

The fastest selling musical invention the world has ever known. No experience needed. Full or spare time. Pay you every day. We deliver and collect. Write or wire for terms and territory.

PERRY-LUDLOW CO., S-1648, Dayton, Ohio

21 Jewel ~ Extra thin STUDEBAKER The Insured Watch

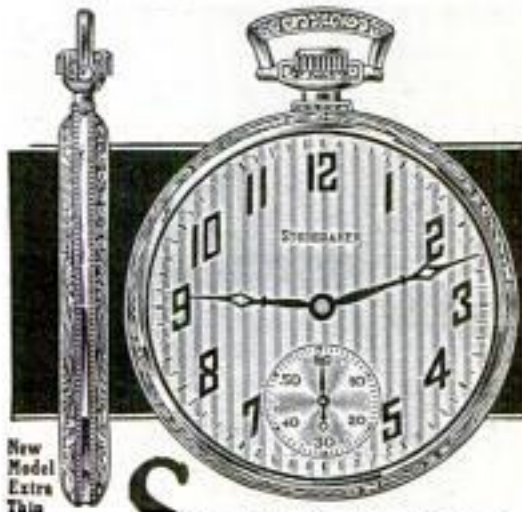

New Model Extra Thin

SENT FOR

\$1⁰⁰ DOWN!

Only \$1.00! The balance in easy monthly payments.

You get the famous Studebaker 21 Jewel Watch—insured for a lifetime; a choice of 54 new Art Beauty Cases; 8 adjustments, including heat, cold, isochronism and 5 positions—direct from the maker at lowest prices ever named on equal quality.

Write today for FREE BOOK of Advance Watch Styles.

Fine Chain FREE!

For a limited time we are giving away FREE with every Studebaker Watch a beautiful pattern Studebaker Watch Chain. Write now while offer lasts.

Mail Coupon for FREE Book of Advance Watch Styles

Send at once and get a copy of this book—FREE! See the newest, beautiful, advance styles in Studebaker Art Beauty Cases and Dials. Read how you can buy a 21 Jewel Studebaker Insured Watch direct from the maker—save big money—and pay for it on easy monthly payments.

Write! for our free book. It will post you on watch styles and watch values. Send coupon at once. Get Free chain offer today while it lasts.

Studebaker Watch Co.
Dept. 2212, South Bend, Ind.



STUDEBAKER WATCH CO.
Dept. 2212, South Bend, Indiana
Please send me your Free Book of Advanced Watch Styles and particulars of your \$1.00 down offer.

Name

Address

City State

BULLETIN

You, too, can
make \$150⁰⁰
weekly

This is Ed. Beck, N. Y. Joined my sales staff last spring. Averaged \$150 a week ever since. Sells FARM BULLETIN BOARDS in thousand lots. Often makes week's salary in single day! It's an entirely new idea; has no competition. Virgin field. Nothing exactly like it. Hale, Mass. cleaned up \$550 within sixty days. Hanson of Me. ran about \$125 weekly for the past three months. Wood, Ill., averages \$125 every seven days. Tozier, Ga., calls on big business houses and pockets from \$50 to \$260 on each order. Dozens, like Stead, of Ind. are averaging from \$60 to \$90 weekly. Sales really phenomenal. It's the new idea that takes. Roadside farm markets spreading like wildfire. Every farmer needs a specially constructed bulletin board that takes chalk marking. Box lids, shingles and improvised signs too crude. They are wild about FARM BULLETIN BOARDS. Gladly erect them in their front yards close to the roadside.

Ed Beck Writes:

"I have had some very good selling propositions in my day, but this FARM BULLETIN sales idea has them all beaten!"

No Bell Ringing. You Sell Only to Big Business Men!

Merchants, bankers, oil companies, battery men, auto agencies, etc.,—are quick to see the advertising possibilities of FARM BULLETIN BOARDS. They gladly buy hundreds of Boards with their advertising on the bottom and give them to farmers. Farmers erect them at once in full view of highway and chalk up offerings of produce, fruit eggs and dairy products. It creates good will among farmers. It also gives farm that distributes BULLETIN BOARDS free out-door publicity. Iowa Co. bought and gave away 3,000. Co-operative Milling Assn. distributed 5,000. A leading southern oil refinery handed out 5,000.

This is Your Big Opportunity!

I need 60 additional men right now! Get into my successful selling organization. No collections. No deliveries. I go the limit in helping my salesmen. Furnish them with free literature. Back their efforts with high-powered sales letters. Furnish free sketches and ideas to help land big contracts. This hearty team-work pays! Again I say, this is your big opportunity. Don't miss it. Drop me a line now—address C. R. Coppock, Sales Mgr.

National Advertising Service

P.O. Box 1216
LaGrange, Ind.

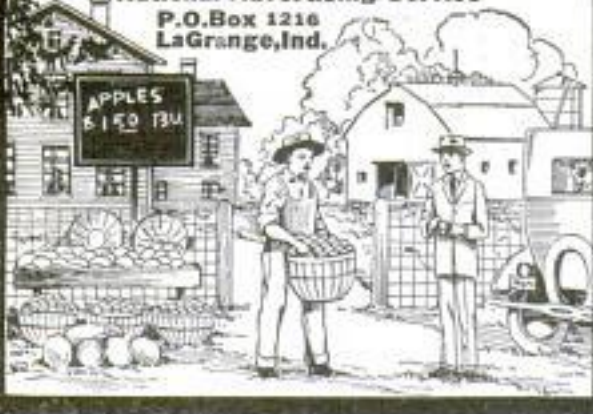

Please Mention Popular Mechanics



IT'S so easy to learn to play the famous KING saxophone! A few weeks' practice and you can play popular music—then join a band or orchestra and make good money playing for dances and other entertainments.

"KING" Band Instruments and Saxophones are easiest to play because they are built acoustically correct. Scientific design, finest skilled workmanship, careful supervision at each phase of construction make "KINGS" the most perfect instruments in the world. The tone quality is impossible to duplicate. Leading bands and orchestras insist upon "KINGS." Let us send you one for 10 days free trial.

Free Trial—Easy Payments

"KING" Band Instruments and Saxophones are fully described in beautifully illustrated circulars. Write today for complete information about our ten days free trial and our easy payment plan on any instrument. Ask for bargains in rebuilt instruments—old ones taken in trade.

THE H. N. WHITE COMPANY
5211-46 Superior Avenue, Cleveland, O.

TAILORING SALESMEN

We Pay You Salary and Commissions

Greatest money-making line in America. Made to measure suits, overcoats, one price, \$33.65, express prepaid, all wool, all wool linings, hand tailored, finest workmanship. No extra charges for style or oversize. Bigger advance commissions, weekly salary besides. Protected territory. Apply at once.

GREAT WESTERN TAILORING CO.

Dept. P. 837-841 W. Jackson Blvd. CHICAGO, ILL.

NEEDED IN EVERY SHOP

GIT HAND PASTE



Cleans Hands CLEAN of Grime Stains and Paint
10¢ at F.W. Woolworth Co., M'Crory and other stores

Diamonds Here at 60% of Market Price

Free Bulletin lists diamonds as low as \$60 per carat, also Gems of Finest Quality at higher per carat charges, but proportionately Low Bargain Prices. This 1-2 - 1-10 carat perfectly cut diamond a snugly fitting solitaire at \$38.50. This 75 year oldest trusted Diamond Bargain Firm is all the word needs money on diamonds. Thousands of unpaid loans and other bargains. Must sell NOW.

Why Pay Full Prices

Costs Nothing to See

Any Diamond sent for absolutely free examination at our risk. No obligation. No cost to you. Latest Listings—Unpaid Loans. Sent Free. Describes Diamond Bargains in Detail, & lists each loan value guaranteed. Explains unlimited exchange privileges. Write Today for your copy of Diamond Bargain List. Postal card will do.

Joe. De Roy & Sons, 1915 De Roy Building
Only Opposite Post Office Pittsburgh, Pa.



\$38.50
1/2 - 3/8 Ct.
Perfectly Cut



HEAT! THE NEW WAY

Amazing Invention Does Away With Coal and Wood

NOTE
SCIENTIFIC
APPLICATION
OF AIR TO FLAME

No Wood no Coal

Fits Any Stove

Twice the Heat at Half the Cost—On or Off with the Turn of a Valve.

Think of having instantly all the heat you want IN ANY STOVE without building fires; without kindling, ashes, dirt, or odors. Think of having—at the touch of a finger—a fire that is three times hotter than coal—or just enough to simmer a kettle. A fire that stays where you want it—high or low.

THREE TIMES HOTTER THAN COAL

Think of the wonderful cooking and baking you can do with such a fire, think of the better health and comfort the family will enjoy when you can keep every room in your home at just the heat you want, warm and cozy, day and night, in any weather. These are but a few of the advantages enjoyed by users of a remarkable new invention—

INSTANT-GAS—CHEAPER THAN COAL

A scientific combination of 96% superheated air and 4% kerosene (common coal oil)—the cheapest and safest fuel known. It is produced by an amazing invention which, in one minute, can be slipped into the fire-box of any coal or wood stove. All the convenience of gas at half the cost.

Start with the Turn of the Valve

Turn high or low to suit, heat your home, do your cooking and baking, and then stop with another turn of the valve. A child can operate it. Instant-Gas gives a clean, steady, dependable fire. No ups and downs to give the family influenza and pneumonia, no running out into the cold to fetch coal or wood, no fallen cakes or sodden biscuits from an unsteady oven. Saves cleaning bills, doctor bills, wall paper and curtains.

Works in Any Stove—Old or New

No holes to drill, no injury to stove. Installed in a few minutes, makes old stove work like new, and makes a new stove last twice as long. Lasts a lifetime. For many years the markets have been flooded with oil burning devices—but a scientific improvement in the application of oil burning principles makes the Instant-Gas Oil Burner the one great, outstanding success of its kind. Yet it costs

Do more than inferior out-of-date makes. Money-back guarantee gives you absolute protection.

TRY IT IN YOUR HOME FOR 30 DAYS FREE

Test the Instant-Gas for yourself, try it in your own stove at our risk for 30 days, see for yourself how much superior Instant-Gas is to any other fuel, how much money it saves, how easy it is to turn on and off, how much cleaning and scrubbing it saves, how much warmer you can keep your home, and how much better cooking and baking you can do. Join the hundreds of thousands of Instant-Gas users who have gained health and strength by cutting their work in half and doing away with the heavy, dirty, back-breaking coal and wood. Mail coupon today for 30 day trial offer and amazing new book "Scientific Oil Burning." No obligation. Special low introductory price to those who mail coupon at once. Mail yours today.

AGENTS Oil burning is the rage. People everywhere are turning to this remarkable new method of heating and cooking. \$60.00 a week sales plan for beginners and spare time workers. \$5,000.00 to \$10,000.00 a year easy for real producers, who can handle big territory. Write at once for details and be ready for big Fall and Winter sales.

INTERNATIONAL HEATING CO.

119 South 14th Street, Dept. 215, St. Louis, Mo.
Manufacturers of scientific heating equipment.

Mail this Coupon for Amazing Free Book

International Heating Co.,
119 South 14th Street, Dept. 215, St. Louis, Mo.

Without any obligation whatever to me, mail me, post paid, your Free Book entitled "Scientific Oil Burning," together with your special introductory price and 30 day trial offer to those who act at once.

Name.....
Address.....
City and State.....

If interested in making from \$60.00 to \$200.00 a week[]
as agent, like Lacey of Mass., mark X in this square.....



CAMERAS

Over a Hundred Styles and Sizes

Send for new illustrated catalog showing latest reduced prices. It's Free.

10 days' trial given

SENECA CAMERA MFG. COMPANY
300 Central Avenue Rochester, N. Y.

FOLDING SAWING MACHINES \$21.95

Fitted with Atkins Silver Steel Guaranteed Saw



9 cords in 10 hours by one man. It's the King of the woods. Catalog X115 free. First order gets agency. Established 1890.
FOLDING SAWING MACHINE CO., 1005 East 75th Street, CHICAGO, ILLINOIS

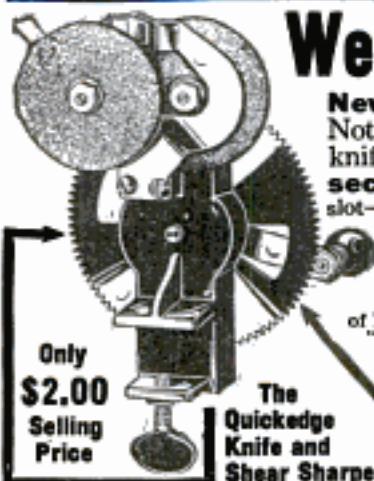

Only
\$2.00
Selling
Price

The
Quickedge
Knife and
Shear Sharpener

We Want Agents at \$50 to \$90 a Week

New Invention—Just out. Needed in every home every day. Patented. Nothing else like it. Low priced—**Sells on sight.** Sharpens any kitchen knife, paring knife, carving knife, bread knife, or shears and scissors in **ten seconds.** Mechanical masterpiece. A child can use it. Just put knife in slot—turn crank—sharpens both sides at once automatically. **We want representatives at once—men and women hustlers.** Get this position where **profits start first day.**

No Experience Necessary—200% Profit

Make as much money next week as these men are making now. J. C. Lewis, of Kansas, says: "I have sold one hundred sharpeners in four days." Hobart Kerr, of Md., writes: "The women can hardly wait till they get them." Herbert Cain, of Ky., sold nine after supper. At the end of the first day, J. W. Gordon, of Pa., writes: "I sold two dozen and I sold to every one I saw." Wm. G. Hall, of N. J., says: "I think it is great. I sold six in about one-half hour. The machine is a mighty fine proposition. I am a mechanic and I know what I am talking about." You can make this money. **WRITE TODAY. TERRITORY FREE.** Get busy at once.

QUICKEDGE SHARPENER CO., 112 Sharpener Bldg.
159 West Pearl St. Jackson, Mich.



Saw 15 Cords
a
Day
—Easy
!



"Men! Let Me Tell You About"
this New, Improved Power Saw!

New
Selling at
Very Low
Prices

HERE, folks is my new model OTTAWA Log Saw—my greatest achievement in over 20 years' experience in building machines to make farm work easier! It's a labor-saver that every farmer with wood or timber to cut needs right now! Easy to Make Money! Coal is now way up in price and wood in demand for fuel. Saw 15 cords a day. Just think, wood selling for only \$3 a cord would bring owner \$45!

own! I sell it Direct from my Factory—at a Low Factory Price! Makes 350 saw cuts a minute! Does the work of 10 good hired men. Fastest sawing, easiest moved, lightest weight, most powerful! Saws the human way.

SHIPPING POINTS

OTTAWA, KANSAS
Pittsburgh, Pa. San Francisco, Cal.
St. Paul, Minn. Memphis, Tenn.
Dallas, Texas Albany, N. Y.
Atlanta, Ga. Pueblo, Colo.
Indianapolis, Ind.
Portland, Ore.

OTTAWA "4 in 1" LOG SAW

1-Falls Trees 2-Saws Logs 3-Buzzes Up Branches 4-Does Belt Work

Try 30 Days. Try a whole month at your own work. You can pay cash, or I'll arrange Easy Terms to suit. And remember, every OTTAWA is backed by my 10-Yr. Guarantee. Send me a post card with your name and address for my new "Wood Sawing Encyclopedia," Big Special Offer and my Low Factory Prices. Right now's the time! Send today!

HARRY OVERMAN, Gen'l. Mgr.
OTTAWA MFG. CO.,
1742-0 Wood Street, OTTAWA, KANSAS
Room 1742-0 Magee Bldg., PITTSBURGH, PA.



Cuts Up Branches



Cuts Down Trees Level With the Ground

1000 SHOT
ALL STEEL
MAGAZINE
AIR RIFLE

WE GIVE
TO BOYS
WITHOUT COST

HAMILTON
22 CAL.
HUNTING
RIFLE

Choice of six guns (on four easy plans) for selling our Magic Healing

Way-o-lens at 25c box. We Trust You! Order Seven Boxes Today On Postal Card—we send promptly, prepaid. Easy to sell—used in every home. Return money as instructed, choosing your gun according to one of the plans shown in our Big Premium List. Also 200 other Gifts or Big Cash Commission if you prefer. If you are prompt, a special Free Gift. Waverly Co., 218 Tower Bldg., Monongahela, Pa.

It Will Pay You to Own a MONARCH Junior Lathe

Hundreds of things, of metal or wood, for the shop, auto and home can be made with a MONARCH Junior Lathe. This sturdy, small engine lathe, guaranteed to do work with 1/1000 of an inch accuracy, was especially designed for inventors, experimenters, and small shop owners. It is easy to learn to operate—even beginners can't jam it. Equipped with automatic safety devices.



\$245 9 in. lathe—2½ ft. bed—with bench legs.

SEND for Free Catalog of MONARCH lathes which are built up to 30" swing
THE MONARCH MACHINE TOOL CO.
400 Oak Street SIDNEY, OHIO



DIAMONDS

½ CARAT \$99.00

We are direct importers of perfectly cut, sparkling, brilliant, blue-white, genuine diamonds, which we now offer at only \$197.00 per carat from 1-8 carat to 3 carats. The former price was \$325.00 per carat. YOU SAVE 40 PER CENT.

30 DAYS FREE TRIAL

You can send cash with order, or we will send to your bank or express office for inspection before paying. If you can duplicate these diamonds for less than \$25.00 per carat, we will return your money. Guarantee Certificate Given.

WRITE FOR CATALOG

You should know the exact weight and quality of any diamond you buy. Our catalog tells you, and it brings a large jewelry store into your home. You save 40 per cent when you buy from us. \$1,000,000.00 back up our guarantee.

B. GUTTER & SONS ESTD. 1879

172 Nassau St., Dept. 1268, New York

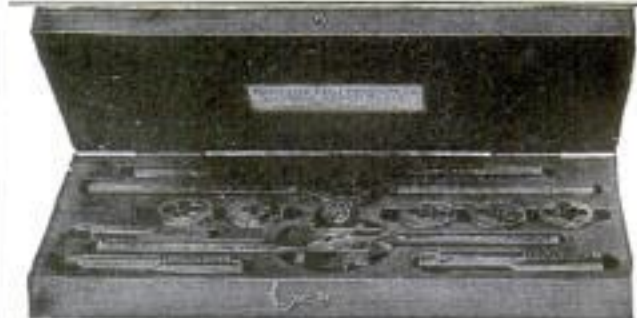

5 SIZE TAP AND DIE SET, ONLY \$3.00 FOR THE HOME—THE FARM—THE WORKSHOP
DIRECT FROM THE FACTORY TO YOU!

Our No. 12 Automobile Set furnished in our highly finished chestnut box contains 5 each taps and dies (1-4, 6-16, 3-8, 7-16 and 1-2"), in the S. A. E. thread, 1 die stock, and one tap and reamer wrench.
Our No. 11 Set is the same as No. 12 except that the thread is U. S. S. instead of S. A. E. You are purchasing a splendid set at a very low figure.
Send us your order at once and be one of our many satisfied customers.
Let us also send you one of our circulars illustrating our full line of Handy Tools.
WORCESTER STEEL PRODUCTS CO. Dept. A, 25 Union Street, Worcester, Mass., U. S. A.

"I Would Not Part With It for \$10,000"

So writes an enthusiastic, grateful customer. In like manner testify over 100,000 people who have worn it. Conserve your body and life first.

The Natural Body Brace

Overcomes WEAKNESS and ORGANIC AILMENTS of WOMEN and MEN. Develops an erect and graceful figure. Brings restful relief, comfort, energy and pep, ability to do things, health and strength. Does away with the strain and pain of standing and walking; replaces and supports misplaced internal organs; reduces enlarged abdomen; straightens and strengthens the back; corrects stooping shoulders; develops lungs, chest and bust; relieves backache, curvatures, nervousness, ruptures, constipation, after effects of Flu. Comfortable and easy to wear.



For Children Also

Costs You Nothing to Try It

Write today for illustrated book, free, with full information and measurement blank. Address

HOWARD C. RASH, Pres. Natural Body Brace Co.
223 Rash Building SALINA, KANSAS

20¢ A DAY PAYS for a Piano



Before you buy a Player-Piano or Piano, get our beautifully illustrated FREE Book showing popular models of famous sweet-toned Symphonies. Easy payments. Save \$100 or more. 25-year Guarantee. Write TODAY.

Larkin Co. Inc., Dept. P-1239
BUFFALO, N. Y. Peoria, Ill. Chicago, Ill.

DEAFNESS IS MISERY



I know because I was Deaf and had Head Noises for over 30 years. My invisible Antiseptic Ear Drums restored my hearing and stopped Head Noises, and will do it for you. They are Tiny Megaphones. Cannot be seen when worn. Effective when Deafness is caused by Catarrh or by Perforated, Partially or Wholly Destroyed Natural Drums. Easy to put in, easy to take out. Are "Unseen comforts." Inexpensive. Write for Booklet and my sworn statement of how I recovered my hearing.

A. O. LEONARD, Suite 226, 70 5th Avenue, New York City

QUIT TOBACCO OR SNUFF RUINING YOUR HEALTH WASTING YOUR MONEY

Harmless treatment quickly overcomes craving for pipes, cigarettes, pipe, chewing or snuff. Sent on trial. Costs \$1.00 if it cures, nothing if it fails. Used by over 400,000 people. Superba Co. H-2 Baltimore, Md.

30 DAYS FREE TRIAL \$10 Worth of Records FREE



Simply wonderful! The limit of value giving! Just think! A GENUINE DAVIS PHONOGRAPH on 30 Days' Free Trial, and on terms as low as

\$2 A MONTH

in case you decide to buy. Magnificent instruments in quartered oak or mahogany piano finished cases, equipped with the finest worm gear motors, rich toned machines— at less than half the standard price—and \$10 worth of records FREE.

Send No Money

Just a postal with your name and address. Only a limited number of machines are pressed on this extra-liberal offer. Better act quickly. This is a life-time opportunity. **DAVIS, 214 West 43rd St. Dept. G-41 CHICAGO**

Great New



Invention for seekers of Health Power Beauty

Elco Health Generators at last are ready for you! If you want more health—greater power to enjoy the pleasures and delights about you, or if more beauty is your desire—write! Ask for the book on these inventions which has just been prepared. It will be sent to you without cost. It tells you how Elco Health Generators aid you in leaving the lethargy and hopelessness of bad health and weakness behind forever. Re-vitalize yourself. Bring back energy. Be wholly alive. Write today!

10 Days Free Trial—Write for Free Book!



These great new inventions generate Violet Ray, Vibration, Electricity and Ozone—combined or separate **Free Trial**

They operate on the electric light in your home or on their own motive power at less than 50 cents per year. Elco Health Generators are positively the only instruments which can give you in one outfit Electricity, Violet Ray—Vibration and Ozone—the four greatest curative agents. Send the coupon below. Get the Free Book NOW!



For All These:

Paralysis	Catarrh
Pimples	Insomnia
Falling Hair	Skin Diseases
Headache	Hay Fever
Lumbago	Neuralgia
Nervousness	Deafness
Rheumatism	Pain
Sore Throat	Development
Asthma	Neuritis
Black Heads	Obesity

Mail Coupon for FREE Book!

Do not put this paper down without sending the coupon. Don't go on as you are with pains and with almost no life and energy. You owe it to yourself to be a better man or woman. You were put here to enjoy life—not just to drag through it. So do not rest another day until you have put your name on the coupon here. That will bring the whole story of these great new inventions. Do it today—now.



Lindstrom & Company

442-448 N. Wells Street, Dept. 13-59, Chicago, Ill.

Please send me your free book, "Health—Power—Beauty" and full information of your 10-day Free Trial Offer.

Name

Address

State Representatives Wanted

DIAMONDS ON CREDIT

WATCHES

BUY DIRECT FROM DIAMOND CUTTERS

\$100 \$75 \$50

7 Blue White Genuine Diamonds—Perfect Cut. Genuine Blue White Diamond—Perfect Cut. Blue White Genuine Diamonds—Perfect Cut.

SAVE 33 1-3% ON GENUINE DIAMONDS!!

Small Deposit—Small Weekly Payment

If you can duplicate any of our offerings at double our prices, we will refund your money.

No Red Tape—No Employer's Reference—Strictly Confidential



5 Genuine Blue White Diamonds—Perfect Cut—18 Kt. White Gold Wedding Ring . \$38.50

(15-J) 18 Kt.—Yellow or White Gold—Ladies Wrist Watch—Guaranteed Perfect Time Keeper . \$30.00



FREE TRIAL!!

Return your Purchase—After 30 Days Trial—if you are not Satisfied—We will Refund Deposit—and ask no questions.

Write for Catalogue—Dept. 1-B

JOS. ROSE & SON

"40 Years Diamond Cutters"

47-49 Maiden Lane—N. Y. C.

CAR OWNERS WANTED!

To use and introduce the greatest improvement in Inner Tubes since autos were invented. Air gauge in valve stem of every Tube shows at a glance through the Unbreakable Transparent Valve Cover amount of air in tires.



AIR-GAGE Heavy Duty Tubes

—sell on sight to almost every car owner because they save trouble, time, worry and expense. Add one-third to life of tires. Paul salesman makes big profits selling direct to car owners. Our million dollar factory can use 500 more salesmen at once. Experience not necessary. Our illustrated Free Book tells how the Paul Plan will start you in this big money-making business without capital. Write for Free Book Today. THE PAUL RUBBER CO., Dept. 25, Salisbury, N. C.

Roofing Book FREE

World's Best Roofing at Factory Price

Don't buy Roofing of any kind until you get our big Free Roofing Book, describing full line of Edwards Famous "Tightcote" Galvanized Roofings, Sidings and Ceilings, and our lowest factory prices. Then see for yourself how much we save you by selling direct and saving you all in-between dealers' profits.

EDWARDS "REO" Metal Shingles

Absolutely rust proof. By our patented "Tightcote" process, edges as well as sides of metal sheets are heavily coated with zinc—not a space the size of a pin point exposed to weather. Fire and lightning proof. Outlasts three ordinary roofs. Forever wind and weather proof. Needs no repairs—and all roofing expense. Patent INTERLOCKING DEVICE makes water tight seams—all nail heads covered—no chance for rust or leaks.



Wide variety of styles, all sizes of Portable Fireproof Metal Garages. Lowest prices ever made. Postal brings Big Garage Catalog free.

Write Today for free samples and proof that we can save you a lot of money on any kind of roofing, siding or ceiling you may need. Ask for Roofing Book No. 100.

THE EDWARDS MFG. CO., 1200-1250 Pike St., Cincinnati, O.

EDWARDS Galvanizing Test

Edwards "Tightcote" Galvanized Roofing can be bent, twisted or struck by lightning, and the galvanizing will not crack or flake. Bend it or hammer it—you can't loosen or scale the galvanizing. No other galvanized roofing can withstand this test.

Low Priced Garages

FREE Samples & Roofing Book

Delivered to You Free

for 30 days trial on approval. You can have your choice of 44 Styles, colors and sizes of the famous RANGER Bicycles. Express prepaid. Factory-to-Rider Prices save you \$10 to \$25 on your bicycle.

12 Months to Pay

If desired. Many boys and girls easily save the small monthly payments. Parents often advance first payment.

Tires

best quality, at factory prices, express prepaid. Lamps, wheels and equipment, low prices. Send No Money, do business direct with makers.

Mead Cycle Company Dept. 108 Chicago

Write today for free Ranger Catalog, factory prices and marvelously easy payment terms.



THE SHAW MOTOR ATTACHMENT Makes Your Bike Like a Motorcycle

A high grade 2 1/2 H. P. Motor attachment quickly clamped to any bike frame. Speed 4 to 40 miles an hour. 90 to 125 miles per gallon of gas.

Special Low Price Now! Write today for complete Description and Special Low Prices on SHAW Motor Attachments and the SHAW Complete Motorbicycles.

SHAW MFG. CO., Dept. 37, Galesburg, Kans.



MOTORCYCLES

RELIABLE STANDARD MAKES that you can DEPEND on.

Enjoy the glorious experience of going wherever you like—whenever you like. The price is within your means—35% to 50% less than others. These machines are slightly used, thoroughly overhauled or rebuilt. Send for catalogue.

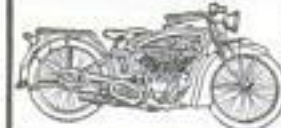

MYEROW BROS., 258 Columbus Ave., Boston, Mass.



EVINRUDE WILL

To insure delivery of a new SPORT TWIN, order from your dealer at once. Send for catalog.

EVINRUDE MOTOR CO., 307 Evinrude Bldg., Milwaukee, Wis.

BE OVERSOLD

FORDS run 34 Miles

on Gallon of Gasoline

Low Gear Seldom Used with Air Friction Carburetor



We guarantee all other cars nearly double present mileage, power and flexibility, make hills on high formerly difficult on low. Models for any car, truck, tractor, marine or stationary engine. Makes old cars better than new. See wonderful mileage guarantees for other cars.

Ford.....34 ml.	Reo.....24 ml.	Chevrolet.....32 ml.
Buick 4.....30 ml.	Chalmers.....23 ml.	Maxwell(25).....30 ml.
Buick 6.....24 ml.	Olds, 6.....23 ml.	Nash 6.....23 ml.
Hudson.....20 ml.	Paige 6.....20 ml.	Lincoln 8.....17 ml.
Hupp.....25 ml.	Oakland 6.....24 ml.	Stdbkr L.T. 6.....23 ml.
Dodge.....28 ml.	Overland 4.....32 ml.	Cole 8.....17 ml.

If your car is not mentioned here send name and model for particulars and our guarantee on it. **AGENTS WANTED.**

SENT ON 30 DAY'S FREE TRIAL

You can drive any car in heaviest traffic without shifting gears. Starts off on high in any weather without priming or heating—no jerking or choking. No more foul spark plugs or carbon in cylinders. No leaking of gas into crank case. Try it 30 days on our guarantee of money back if not entirely satisfied. No strings to our guarantee. **YOU ARE THE JUDGE.** Anyone who can handle a wrench can attach it. No boring of new holes or changing of operating mechanism. Write today.

AIR-FRICTION CARBURETOR CO.

157 Raymond Bldg.

Dayton, Ohio, U. S. A.

FORD RUNS 57 MILES ON GALLON OF GASOLINE

A new automatic and self-regulating device has been invented by John A. Stransky, 825 Fourth St., Pukwana, South Dakota, with which automobiles have made from 40 to 57 miles on a gallon of gasoline. It removes all carbon and prevents spark plug trouble and overheating. It can be installed by anyone in five minutes. Mr. Stransky wants agents and is willing to send a sample at his own risk. Write him today—Adv.

16,000 MILES without a Puncture



Wonderful invention. Insyde Tyres—Inner Armor for automobile tires. Positively prevent punctures and blowouts. Guaranteed to give double tire mileage, any tire—old or new.

Over 100,000 Satisfied Customers

Easily applied without tools. Just slip inside casing before replacing tube. Will not heat or pinch. Use over and over again. Old worn out casings will give 3 to 5,000 miles more service. Low priced. Agents wanted in every country.

American Accessories Co., B-1676, Cincinnati, O.

SEND for the INTERNATIONAL CATALOG

FOR
FORD
PRICES
FROM
\$27.85
UP.

Factory
to Con-
sumer
direct—
Pay only one profit.



Our net price list. Full line of auto bodies and accessories for Fords at Wholesale Prices

Save big money on bodies by buying direct from factory.

INTERNATIONAL BODY WORKS, Dept. 7, 914 W. Ohio Street, CHICAGO, ILL.

Custom-Made Tops Less Than Half Price



SEND NO MONEY

Instructions sent. You can attach them easily. Full complete tops with beveled plate glass, trunks, fasteners and welds. Free delivery 1,000 miles. For all sizes special prices on Maxwells, Overland Fords, Dodges and Chevrolts. Describe your car. Samples and money-saving Bulletins free.

Automobile Trunks for Running Board or Rear Platform.

High grade—low cost.

S-C PRODUCTS CO., 767 Nicholas Bldg., Toledo, O.

MOTORCYCLE BARGAINS

Save 25% to 65%

on Slightly used and Rebuilt Motorcycles, Side Cars, Johnson Motor Wheels, Evans Power Cycles, Bicycles. Send for Free Bargain Bulletin and Money Saving Message, listing hundreds of Bargains in used, rebuilt and new machines, supplies, accessories, etc.

AMERICAN MOTOR CYCLE CO.
Dept. 1222, 2047 W. Chicago Avenue, CHICAGO



Stevens "Visible Loading."
Retail price—including tax,
\$16.25. An accurate .22 Cal.
Repeater. You know when
it is loaded, and you know
when it is empty.



The tracks shown in the November issue were those of a fox.

Can you guess the tracks in this issue? Study them carefully and see if you can discover what animal has made these tracks. The answer will appear in a later issue.

Just look at these prices

As accurate as the day is long—accuracy that lasts, too—at prices amazingly low.

Look at the price of the Stevens *Little Scout*—only \$5.40. There's a rifle that can shoot straighter than any man or boy can hold. It's little but it does a man's work. You can count on *Little Scout* to pot pests or plug bull's-eyes. A wonderful rifle for the price.

Or think of the price of the Stevens *Visible Loading* repeating .22—where else can you get a repeater like that for \$16.25? That slide handle works like greased lightning. And it throws the bullet where you hold.

All through the Stevens line the same lasting accuracy and the same low prices—*Little Scout*, *Crack Shot*, *Marksman*, *Favorite*, or *Visible Loading*—you're getting real guns.

Ask at your dealer's or write direct for our interesting catalog.

J. STEVENS ARMS COMPANY

Department 548

Chicopee Falls, Mass.

Owned and Operated by the Savage Arms Corporation

Stevens

Secret Service



RADIATOR Neverleak is the only liquid that is guaranteed to *permanently* mend all leaks anywhere in cooling system, almost at once.

Simply pour Radiator Neverleak into the water in the radiator. There is no further bother or expense. Left in the radiator, it mends leaks as fast as they appear, and prevents rust and scale from forming.

Radiator Neverleak cannot injure or clog the cooling system in any way. Absolute satisfaction or money refunded.

Write for free "Secret Service" booklet.

BUFFALO SPECIALTY COMPANY
357 Ellcott Street BUFFALO, N. Y.



RADIATOR NEVERLEAK

FORD START HARD?

EASILY AND CHEAPLY FIXED WITH

C-A

(ADJUSTABLE CENTER)

BEARING CAP \$3.75



CORRECTS END-PLAY and sets magneto for full efficiency without removing motor from car. Saves battery on cars with starter, saves the arm on cars without. Installed in few minutes. Guaranteed for one year. Ask your dealer, or sent pre-paid on receipt of..... **\$3.75**

ADJUSTABLE BEARING CO., Dept. P, Brazil, Ind.

WANTED RAILWAY POSTAL CLERKS



\$1600 FIRST YEAR

Raise to \$2300

Travel—See the Country
MEN, BOYS—18 UP
LIFE JOB

Mail Coupon Today Sure

FRANKLIN INSTITUTE
Dept. 0209, Rochester, N. Y.

Five! Send me at once, free of charge, Sample Railway Mail Examination questions, list of other U. S. Government positions now obtainable and free book describing them.

Name.....

Address.....

SEND NO MONEY!

"A BUSINESS MAN'S WATCH"

SOLID GOLD EMBLEM GREEN GOLD SHELL CASE
ELGIN MOVEMENT 12 SIZE
THIN MODEL 25 Yrs. GUARANTEED CASE
\$25.00



FANCY SILVER DIAL

CAN BE HAD IN ALL EMBLEMS

Send Us Your Name and the Watch Will Be Sent for Inspection
Can Also Be Had in ENGRAVED or PLAIN BACK without EMBLEM

BUFFALO JEWELRY MFG. CO.

"THE MAIL ORDER HOUSE"

Dept. 1, Brisbane Bldg. BUFFALO, N. Y.

Car Owners Wanted



—To show and sell the greatest improvement in Spark Plugs since Gasoline Engines were invented. Unbreakable, translucent core shows at a glance just which cylinders are firing.

Beacon Lite Spark Plugs

You Can See Them Fire

Just lift the hood and look. See instantly which cylinders are "dead." No guessing. No testing. Cost no more than ordinary plugs. "Sure fire." Extra durable. Sold only by "Paul Men". Agents examining all engine records. Exclusive territory. Write quick.

THE PAUL RUBBER CO. (15)
25 Paul Park Salisbury, No. Car.

You Can Save \$35.00



\$4.45 and up

Parcels Post Paid

Recover your old auto top frame yourself. Custom tailor made to fit all makes and models of cars. Any person that can drive a car can put it on. Roof and quarters sewed together, with rear curtain, fasteners, welts and tacks complete. Give name, year and model number of your car and we will send you catalog with samples.

LIBERTY TOP & TIRE CO., Dept. E-7, Cincinnati, O.



AGENTS Make Big Money

Selling D-REX-U Safety Signal to automobile owners; complies with safety laws; guaranteed. Write today for wholesale price to agents and get territory quick. Big Winter Seller. Address Comstock-Bolton Co., Dept. K, 1925 E. 15th St., Kansas City, Mo.

Steady Work

in a fast growing business with Vanderpool Latest Improved Vulcanizer. Made in America.

Ask for Catalog

Vanderpool Co., Dept. 12P, Springfield, Ohio

F. H. DIBB, Agent for British Isles
26 Fairfield Rd. Winchester, England



SAVE MONEY
Get This Book

HANDY MAN BOOK

Install Your Own
PLUMBING & HEATING
NEW EASY WAY - SAVE HALF

25c
Reg. Price 50c

Brings you this big Plumbing and Heating Encyclopedia-Catalog. Write for your copy today without fail.

Guaranteed Heating Plants

Our Handy-Man Book shows how. Big 256-page well-bound encyclopedia of Plumbing and Heating Outfits, Systems, Supplies, Fixtures and Accessories—10,000 items—illustrated. Hundreds of floor plans, elevations, diagrams, trade secrets, money and trouble-saving hints, etc. "How to save coal in heating." "Easy repair methods." Every householder, contractor, farmer, mechanic, institution needs this book. Shows how to save wages, work and materials.



Hot Water Boiler

BIG HANDY MAN BOOK

Tells how we help you plan and install. From rough sketch or description we supply working plans and clear instructions. We loan the tools needed. Any handy man can install. This is the place to buy on money-back guaranty. Plumbing Outfits and Supplies; Water Systems; Hot-Air, Water or Steam Heating Plants; Radiators, Pipes, Boilers or Septic Disposal Tanks.

Send 25c for Yours Today

We have spared no effort or expense to complete this remarkable and instructive book. To keep from sending it broadcast to disinterested persons, we request a deposit of 25c, which will be refunded on your first order—or send for our FREE Bulletin. Write today and save half.



Pipeless Furnace

HARDIN-LAVIN CO.

50 Years
at 4547-57
Cottage Grove Ave.,
CHICAGO



Bathroom Outfit

AGENTS!

If you are making less than \$150 a week, better write for information about selling SAAL HEAVY OIL SYSTEMS.

H. G. SAAL CO., Dept. 901, 1500 Montrose Ave., CHICAGO

Make \$60 to \$100 A WEEK

New 300 Candle Power Lamp—Burns 96% Air

Introduce wonderful patented invention. Burns only 4% fuel—cheap kerosene or gasoline. Uses less than wick lamp. Greatest advancement in lighting of the age. Table lamps, wall lamps, hanging lamps, lanterns. Powerful, brilliant, soft, restful white light—like daylight. Brighter than a score of wick lamps. No Smoke—No Soot—No Odor.

FREE Outfit Offer Easy to earn big money. No experience—no capital required. Work all or spare time. Simply take orders. We deliver and collect—pay you big commission same day. Vivian of Minn. made \$400 in 39 days. Green of N. Y. made \$33 in one day. Hundreds making \$10 to \$40 a day. Get territory quick. Big season now on. Write today for free catalog and special agents offer.

The Akron Lamp Co., 2172 Lamp Bldg., Akron, O.

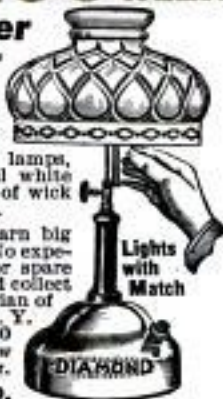

Lights with Match

DIAMOND

YES!

This is it

The Famous

YORK

"SAX"



sent to you on

free trial



Take advantage of this offer now. You can have the famous York Saxophone sent to you for 6 days' examination and trial. Convince yourself that this is the easiest instrument to play. Note particularly its fine, deep, mellow tone, and its quality. Observe the skill and perfection of workmanship. Keep the York Saxophone 6 days, and then if you are not completely satisfied send it back to us and it won't cost you a penny.

EASY PAYMENTS

If you decide to buy you can make small monthly payments while learning to play. We send you everything you need, including carrying case, and first lesson—FREE.

TAKE YOUR CHOICE

You can have any of the famous York band instruments sent to you on 6 days' free trial. Send the coupon below for our beautifully illustrated literature and pick any of the following instruments: Saxophones, Cornets, Clarinets, Baritones, Trombones, Drums.

Send This Coupon

Use the coupon below. Fill out with your name and address and mention instrument—or instruments—you are interested in, and we will send you at once full details of our Trial offer and Easy Payment Plan—also how to practice and how to learn to play.

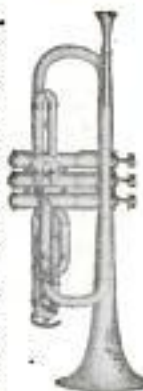

J. W. YORK & SONS

Dept. 221-L

Grand Rapids, Mich.

J. W. York & Sons, Dept. 221-L, Grand Rapids, Mich. Gentlemen: Kindly mail, without cost to me, your beautifully illustrated literature and details of your Free Trial and Easy Payment Offer.

Name.....

Address.....

Instrument.....

(Mention above the instrument most interested in)



"Red Devil" Rapid Boring Auger Bits
are 33 1/2% easier boring, have 10% greater
clearance, and bore with or against
the grain of any wood. Style 2400
—10/16 in., shown here, 75c.

Red Devil Tools

REG. U.S. PAT. OFF.

Inspire Good Work

THEY are so well designed and finished that you will admire them as much as you will like to work with them. They appeal to the man who loves good tools.

Not all tools are "Red Devils." Be sure the one you buy has the "Red Devil" trademark on it. There is a "Red Devil" for every purpose—just two shown below.

Combination Plier No. 999



For handling nuts, pipes, wire. Heavy enough for use as a hammer. Ideal for heavy work in general. Size 8 1/2-inch, \$1.00 a pair.

Hack Saw Blades No. 1239

Made of Tungsten steel. Designed for hard work and long wear—bite into the hardest metals. Style No. 1239, 10-inch, 75c a dozen.



The "Red Devil" Mechanic's tool booklet is a handy reference guide for users of good tools—it's yours for the asking.

SMITH & HEMENWAY CO., Inc.

Manufacturers of "Red Devil" Tools
260 Broadway New York, N. Y.

"Red Devil" Glass Cutters—the glassiers' standard tools of the world. "It's all in the wheel." Made in 40 styles. No. 024 shown here, 20c



Please Mention Popular Mechanics

For Pleasure or Profit

Every man has a hobby from which he derives either pleasure or profit—or both. Through a better job, more quickly, more easily done, the man whose hobby is working in wood or soft metals can get more pleasure and more profit from work done on a

Boice-Built Bench Machine

The Pony Bench Machine shown here combines six machines in one: saw, sander, drill, grinder, polisher and buffer. It saws 1 1/2" stock with ease, and does mitering, dadoing, tenoning, etc. Easily driven by 1/2 hp. or 3/4 hp. motor. Boice-Built machines are in use in thousands of shops, both industrial and private.

An Excellent Gift for Man or Boy

As a gift nothing could be more appreciated by the man or boy who likes to work with wood and soft metals. It will bring years of pleasure and profit to the recipient.

Sold on a Positive Guarantee

Every Boice-Built Machine is sold with a ten day trial money back guarantee.

The complete line of Boice-Built Bench Machines includes larger Bench Saws, Bench Band Saws, Bench Lathes, Bench Drills, Bench Jointers, and Motors. Write today for completely descriptive circular on any of these machines.

W. B. & J. E. Boice, Dept. P.M. 12, Toledo, Ohio



Boice
Pony Bench
Machine

Price without
Chuck
\$32.50

THE SCREWDRIVER THAT HOLDS THE SCREW

As Good as a Third Hand in Assembling anything from a Watch to an Automobile



Appeals Especially to Radio amateurs and professionals. A wonderful (patented) improvement. Jobbers, Dealers and Agents. Favorable discounts \$1.00 Postpaid THE COBURN TOOL CO., 114 Bedford St., Boston

MOTOR "PEPS"

A simple yet scientific device that prevents fouling of spark plugs and keeps motor free from carbon. Puts new life in old motors. Simply insert a "Pep" in cylinder in place of spark plug, and then insert spark plug in the "Pep."



Made in three sizes: 1/2", 3/4", metric
EVANS-LAWRIE COMPANY \$1 POSTPAID
782 Commonwealth Ave., Boston, Mass. Money back if not satisfied

"LYON" WINTER TOPS



ROADSTER
\$31.25
TOURING \$41.25
FOR
FORD and
CHEVROLETS

Late models. Warm, roomy and comfortable. Easily ventilated when desired. Don't envy others. Be comfortable yourself. Send for our "Special Fall Bulletin" containing also our full line of racing bodies.

AUTO TIRE SALES CO., Dept. P15
1346 S. Michigan Ave. CHICAGO Body Division



FANSTEEL
Balkite
PATENTS
APPLIED FOR *Battery Charger*

Noiseless and Indestructible

A new battery charger for Radio "A" (6 volt) batteries. Entirely noiseless. Has no moving parts, requires no attention or adjustment, and cannot get out of order. Simple and unfailing in action. Can be used while the radio set is in operation. A positive economical charger for home use. Can also be used to charge automobile batteries. Write for folder giving full description.

Dept. P3-Fansteel Products Co., Inc.
North Chicago, Illinois

LIGHTNING!

Will It Hit Your Aerial Next?
**Protect Your Radio,
Your Home, Your Life.**

COOK

Radio Protectors

What if lightning hits your aerial, or a wind or sleet storm brings your aerial into contact with a power-line circuit? **FIRE!** Not only destruction of your radio, but **FIRE!**

Approved by
Fire Underwriters

Only COOK Protectors give absolute protection. Approved by National Board of Underwriters. Both types made in dark brown porcelain with accurate air gap dischargers. The R-73 has, in addition, a fuse to protect receiving set from low potential currents and knife cut-out switch — being the acme of protection.

Ask your Dealer first or send money to

Cook Electric Company
2700 Southport Ave., Chicago, Ill.
Send postpaid in U. S. A.



Model R-73
Lightning Arrester
\$1.25



Model R-73 Lightning Protector Fuse and Knife Switch
\$2.50

*Radio Frequency —
Amplifying-Transformers*



United Radio
Frequency
Transformer and
Socket Combined

\$3.50



United Radio
Frequency
Transformer

\$2.50

Radio Frequency is becoming more and more popular. The New United Transformers have been designed to eliminate all capacity effects. The Unit Transformer is mounted in the base of the socket. This unit permits short leads — two or more units can be placed together.

Type R-1 is designed for either panel or table, or socket mounting.

Exceptional results can be obtained in any standard Radio Frequency. Reflex, Inverse Duplex, or Neutrodyne circuits.

Write for catalog of complete line of United Radio Products, and information on How to make a Power Amplifier from an Audio Transformer.

UNITED MANUFACTURING & DISTRIBUTING CO.
9706 Cottage Grove Ave., CHICAGO, ILL.
New York office: 50 Church Street, N. Y.
San Francisco: 709 Mission St., San Francisco, Cal.

Reliable
RADIO
Goods

Results are sure with RELIABLE goods

And it's easy to get such goods—anything you want in radio equipment. Big, complete stock—everything guaranteed; quick service; right prices. And you're sure it's reliable when it comes from Andrae. Get our complete catalog—free.

JULIUS ANDRAE & SONS CO., 115 Michigan St., Milwaukee, Wis.

ANDRAE *In Business Since 1860*

The Real Metal Solder in Paste Form

SOLDERALL

Introducing Our New
SOLDERALL BLOW TORCH
of Heavy Solid Brass

Indispensable in the Home, Garage and to the Electrician. For soldering Radio, House Wiring, Jewelry, Ignition, Kitchen Utensils, etc.



SOLDERALL CO. Dept. P Newark, N.J.

The first impression you get from looking at Pioneer Variocouplers and Variometers is that beyond doubt they are the most beautiful instruments yet devised.

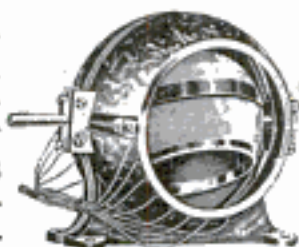

"Pioneer" Variocoupler
\$7.00

The beautiful Bakelite in a grained mahogany finish has a richness that has never been equalled before.

The heavy copper wire, covered with green silk, gives a contrast that makes the instrument irresistible and adds tremendously to the beauty of any set.

The mechanical parts are no less wonderful. The hardware of heavy bronze—the close-coupled rotor and stator—the positive contacts, all demonstrate the highest mechanical skill and attention to detail.

A special feature is the winding of the variocoupler on the inside of the shell—which is original and exclusive with Pioneer.

Pioneer Variocouplers \$7.00
Pioneer Variometers..... 6.50

Ask your dealer to show you these instruments. If he cannot supply you, write us, giving his name and address.

PIONEER RADIO
CORPORATION

104 Pioneer Ave. Galesburg, Ill.

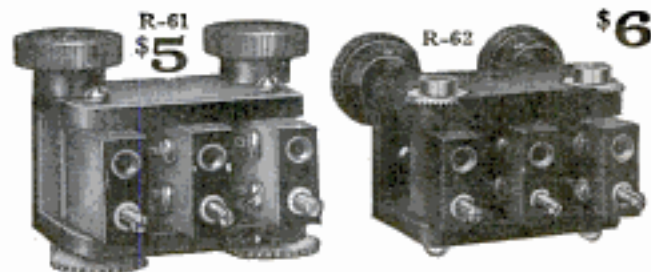

Get Selective Tuning With Branston Honeycomb Coils and New Mountings

Radio experts will tell you that sets using 3 Honeycomb Coils are best for selective tuning. Use Branston Coils and New Branston Bevel-Gear Front Panel or Rear Panel Mountings, with vernier adjustment. Mountings are substantially constructed of genuine Bakelite and are equipped with flexible leads.

Branston D. L. Honeycomb Coils Are "Standard of the World"

Insist on the genuine. Your dealer can purchase Branston Coils and Mountings, and a complete line of Branston Radio Apparatus from his distributor.

New Radio Manual Sent for 2c

Compiled by experts and includes five good Honeycomb Coil "Hook-ups" and complete catalog of famous Branston Radio Apparatus. Write today. Give us name of your radio dealer. If he can't supply you, write

CHAS. A. BRANSTON, Inc.
819 Main St. Buffalo, N. Y.

In Canada—Chas. A. Branston, Ltd.
Toronto, Ont.



BRANSTON
RADIO

FREE VACUUM TUBE RADIO SET

Can receive 100 miles and more.



RUSH your name to learn how you can get a Vacuum Tube Radio Set **ABSOLUTELY FREE**. Don't delay; write today for **FREE RADIO PLAN**.
HOME SUPPLY CO.
Dept. 11
121 Duane St., N. Y. C.

CHARGE YOUR RADIO or AUTO BATTERY OVERNIGHT FOR A NICKEL



GOLD SEAL HOMECHARGER
The World's Most Popular In Battery Charger

—silently and efficiently charges your radio or automobile battery over night for a nickel. No stopping—no sticking—no fuss—no loss—

no trouble. Self-polarizing—high charging rate—finished in mahogany and gold—approved by Underwriters. Price \$18.50 complete with ammeter (\$25.00 in Canada)—no extras to buy. At all good dealers.

LOOK FOR and INSIST ON the GOLD SEAL
WRITE FOR FREE BOOKLET AND LIST OF BROADCASTING STATIONS
THE AUTOMATIC ELECTRICAL DEVICES COMPANY
129 W. THIRD ST.
CINCINNATI

To You Men Who Are Handy

Handy men are handicapped without this superb torch. It is the most useful tool in the house. With its 20th century features it brings more advantages to your hands than steady torch users have with their old fashioned torches. And there's nothing to fear in the

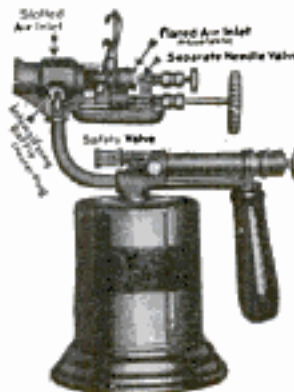

TURNER BLOTORCH

Safe as a Candle

It can't explode. Use it when or where you wish—with perfect safety. Use it in the shop, the garage; eleven exclusive improvements assure faster, better work. Use gasoline or kerosene. Troubleproof, leakproof, foolproof. Don't be without it another day. America's largest public utility companies prefer it to all others. Get it now—TODAY—from your dealer, or direct.

Great Turner production makes possible this unbelievably low price.

\$8.25
Postpaid

DEALERS: Write at once, volume sales assured.

THE TURNER BRASSWORKS
Industry Ave., SYCAMORE, ILL.

The World's Largest Exclusive Manufacturers of Blow Torches, Fire Pots and Brazers.

6 Months to pay for a RADIO Outfit

Your
Unlimited
Choice of Reliable Makes—Parts Too!

Here is the opportunity you have been looking for—you can now own the very best radio apparatus in the world without having to pay for your outfit all at one time. Our plan allows you to enjoy your radio and pay for it just as hundreds of thousands are paying for autos, pianos, furniture and talking machines. You are not limited as to choice. Pick out any reliable make and we will sell it to you on our deferred payment plan. If you want to build your own set we will sell you the necessary parts on the same plan.

Don't Send a Cent!

Full details of this plan are free. You will be amazed at the ease with which you can pay for the most expensive equipment on our terms. And when you buy from us you are sure of the best equipment. We cannot afford to recommend and sell any apparatus that our years of radio experience tell us is not up to standard—the best obtainable. Every radio fan should receive the IODAR SERVICE BULLETIN monthly. Send 25 cents in stamps or in coin and get on the mailing list. Be sure to write today for the *Iodar Plan*.

IODAR CORPORATION

116 S. Oak Park Ave. OAK PARK, ILL.

WEIGHS ONLY 8 OZ.

The Scientific

A 200,000th COMPANY stands squarely back of the guarantee on every Scientific headset

SEND NO MONEY!

20,000 TURNS EQUIVALENT TO 3,000 OHMS

Order Today by Postcard and Pay Postman on arrival

\$2.95

POST-PAID

LOUD SPEAKER UNIT 12¹/₂"

We Guarantee The Scientific Headset to be the greatest value on the market. Try it for five days. If not satisfactory send it back and your money will be refunded immediately. Circular on request. Dealers wanted.

THE SCIENTIFIC ELECTRIC WORKS
98 Brookline Ave. BOSTON, MASS.

THE TRINITY LOUD SPEAKER

The only device of its kind in the radio field.



TYPE B \$12.50

Study the illustration carefully and you will understand why it produces full, clear natural tones with perfect reproduction of all vocal and instrumental music. May be used with phonograph or built into your set.

TYPE A1, \$25.00
21" Fibra Horn

TRINITY RADIO CORPORATION
446 TREMONT ST., BOSTON, MASS.

Radio Bargains

For THIS MONTH

Hedgehog Transformer.....	\$3.15
Reflex Crystal.....	.89
Battery Test Clips (each).....	.05
199 Tube Adapter.....	.49
Licensed Neutrodyne Parts.....	19.98
Rheostats, 6, 25, 40 ohm.....	.69
Variocoupler or Variometer (180 degree) each.....	1.28
Erla Reflex Transformer.....	4.65
Murdock 2000 Ohm Phones.....	3.65
Jewel Lightning Arrester.....	.98
Cico Two-way Plug.....	.49
Cockaday Coil, each.....	1.89
Contact Points or Switch Stops per dozen.....	.10

SPECIAL PRICES ON TUBES, MAGNET WIRE, ETC.

Clip this List—Check Items You Want, Enclose with Money Order. Your order will be filled by return mail postage free. Satisfaction or Money Back.

FANS List of bargains FREE

RADIO BARGAINS

17 N. LA SALLE ST-CHICAGO

FREE—a book that tells how to get better results with radio tube sets. Address WILLARD STORAGE BATTERY COMPANY CLEVELAND, OHIO

"3,000 mile"

RADIO "B" BATTERY

DIRECT FROM FACTORY TO YOU

SHIPPED PREPAID

Greatest radio B battery on market. Absolutely fresh, full voltage, seamless cells, noiseless—will bring in Concerts **LOUDER** and **STRONGER!** Built correctly—full number of voltage taps—will work any tube or loud speaker. Real service **GUARANTEED**. Sold direct from our factories to you at lowest prices. Shipped prepaid to your door. **ORDER TODAY**. Send money order, check or pay C. O. D. Order by Number.

No. 622B—22¹/₂ volt variable—regularly \$2.25—our price **\$1.98**
 No. 622A—22¹/₂ volt variable—regularly \$3.00—our price **\$2.65**
 No. 645A—45 volt—8 taps—regularly \$6.00—our price **\$4.98**

AYRES BATTERY CORPORATION, Cincinnati, Ohio



'Read'em' Binding Posts

Simplify the most complicated radio hook-up

Tell at a glance whether it is Antenne, Ground, Fones, A or B battery, etc. Name neatly engraved for keeps on top of each post. (See illustration.)

KNOB'S CAN'T COME OFF

The irremovable knobs save time, trouble, and petty annoyances. "Read'em's" add to the appearance of any set. Don't be without them. Price 15c each. Set of ten, \$1.50. If your dealer can't supply you with "Read'em's" order direct. Look for the name "Read'em" on every post.

THE MARSHALL-GERKEN CO.
Dept. H, 27 N. Ontario St., Toledo, Ohio



Ace Type V ARMSTRONG REGENERATIVE RECEIVER

\$20

Licensed under Armstrong
U. S. Patent No. 1,111,149

HERE'S YOUR RADIO SET

Get ready for the long winter evenings—install this beautiful Ace Type V Armstrong Regenerative Radio Receiver in your home and enjoy the finest musical programs. The Ace V is a long range receiver and with it stations from coast to coast are heard clearly. An Ace two-step amplifier in connection with this set at \$20.00 makes use of loud speaker practical. Has Crosley Multistat which permits use of any tube. Send \$20.00 today and receive the highest value ever offered in a radio receiving set. Ask for "Simplicity of Radio"—it's free.

THE PRECISION EQUIPMENT CO.

Powel Crosley, Jr., Pres.

1215 Vandalla Ave. CINCINNATI, OHIO

F-F BATTERY CHARGER CHARGES AT HOME

RADIO "A" & "B" & AUTO STORAGE BATTERIES
Overnight For Few Cents From Any 110 VOLT, C.Lamp Socket
COMPLETE PORTABLE AUTOMATIC. No Skill Required.

Some Plug In Lamp Socket; Snap Clips On Battery Terminals
Turn Switch & Battery is Charged in Morning. Batteries Last
Longer. Charges Lasted Lifetime. 5 Types. POPULAR PRICES.

TYPE G charges 6 VOLT BATTERY At 6 AMPERES \$15

TYPE A charges 6 VOLT & up to 120 Volts Of B Bats. \$20

TYPE 16G charges 6 VOLT Battery At 12 AMPERES \$20

TYPE 1612 charges 12 VOLT Battery At 7 AMPERES \$20

TYPE 1620 is a COMBINATION of TYPES 16G & 1612 \$28

SHIPPING WEIGHTS COMPLETE 9, 12 & 16 lbs.

PURCHASE from DEALER, or Order CHARGER C. O. D.
10424 Beres Road

ORDER now, or WRITE for FREE CHARGER Bulletin 24
19424 Beres Road CLEVELAND, OHIO

How to Build the Cockaday Set

told complete (with diagrams) in our latest 1923-
24 handbook catalog. Send 15c (coin or stamps).

Mid-West Dealers: Make more

money handling better radio equipment. Write for our

special franchise on Mu-Rad Receivers.

Western Electric & General Radio Co. parts.

CHICAGO RADIO APPARATUS CO.

415 So. Dearborn St. Dept. PM-12 CHICAGO, ILL.

FREE Radio Text Book and Catalog

A Post Card Brings It

CONTAINS 75 VACUUM TUBE

300 ILLUS. 500 RADIO ARTICLES

ALL Armstrong Circuits: These important

circuits are explained clearly, all

values being given, leaving nothing

to puzzle you.

Also 75 full, clear diagrams, explanations

and instructions for all important vacuum

tube circuits, from the simplest to the

most advanced. How to make a wave-

trap—how to increase wave length of

set—aerial data—tube data—battery

data—reflex—regeneration—radio am-

plifiers—audio amplifiers—loud speakers

—tables of component parts, and endless

other radio subjects covered in simple,

understandable way.

The 75 diagrams in book form alone would cost

you \$5 to \$6. Get this all FREE. Send for it

right away. Offer limited.

RADIO SPECIALTY COMPANY, 98 E. Park Place, N. Y. City

New Invention



This is a new type blow torch. Absolutely different. No pump. No wick. No needle valve. It burns day in and day out without a trace of carbon. Very simple. Nothing to get out of order. Generates own pressure automatically. Makes intense heat. Perfect combustion. Shoots a long, livid blue flame. It's the

Downey Blow Torch

Weights only 35 ounces. Can be used in any position. Can be held at any angle. Won't leak. No soldered joints to melt. Fits into tool kit easily. Uses low grade gasoline. A bonanza for the plumber, painter, electrician, battery man, radio fan, mechanic, lineman or anyone who uses a torch. Wonderful for household use. Pressure can be generated within 15 seconds by laying torch on open flame. This not possible with any other torch. The DOWNEY TORCH also has self-generating device. Is always ready. Simply heat, turn valve and light. Frozen pipes instantly thawed. Convenient to use in inaccessible places. Radio fans are wild about the DOWNEY BLOW TORCH.

SOLD ON MONEY BACK GUARANTEE

The DOWNEY BLOW TORCH is absolutely guaranteed. Money back if not fully satisfied. Sent post paid upon receipt of price and your dealer's name. Price is low, only \$3.85. If you want full details of a real trouble-proof torch—one that has no bothersome pumps, no clogged needle valves, no charred wicks or carboned burners—clip the coupon now and get colored, illustrated, four page circular about the DOWNEY BLOW TORCH by return mail. Better still, mail coupon and P. O. money order for \$3.85 and order directly from this ad. You run no risk. Address

W. C. DOWNEY & COMPANY
P.O. Box 1205 Springfield, Ohio, U.S.A.

W. C. Downey & Company
P.O. Box 1205 Springfield, Ohio
Send me a DOWNEY BLOW TORCH as described and guaranteed in your ad.

Name

Address

My dealer's name is

Check here [....] if circular only is wanted.

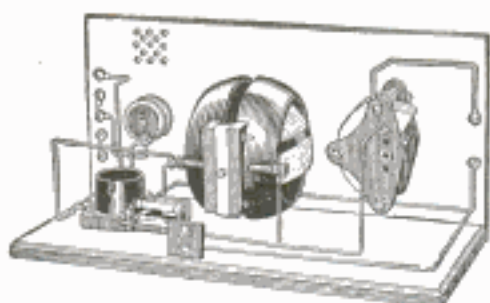

You Can BUILD YOUR OWN Radio

with the Overland Circuit and the easy non-technical instructions ANYONE can assemble their own Radio Receiver. No special tools needed. The Overland Circuit has proven this and has proven that it will

COVER A RADIUS OF 2000 MILES

which assures abundant radio entertainment regardless of where set is located.

Instruction Booklet and Complete parts for building the Overland Circuit Receiver as illustrated **\$11.50**
Instruction Booklet only; containing hook-up and wiring directions sent postpaid for 25c.

Address Mr. Berney

OVERLAND RADIO

& EQUIPMENT CORPORATION

108 WEST 40TH ST., NEW YORK, N.Y.

The Three Best RADIO Bargains

YOU can buy Murdock Standard Radio Apparatus from the best dealers throughout the country. If your nearest dealer cannot supply you send me money direct and your order will be promptly filled.



Murdock Headphones

Will give you better satisfaction than phones costing twice as much, and will last longer. New price, **\$4.00 and \$4.50**



Murdock Loudspeaker

Complete with Loudspeaker phone unit, Fibre non-vibrating horn, aluminum tone chamber and molded base. A most practical and satisfactory loudspeaker at a low price. **\$5.00**



New Murdock Plug Jack enables you to connect four pair of phones at one time. Every radio user needs this convenient plug. Only **\$1.00** Cord tip type.

\$1

WM. J. MURDOCK CO.

349 Washington Ave., CHELSEA, MASS.
Chicago San Francisco

MURDOCK RADIO

STANDARD SINCE 1904

Natural RE-PRODUCTION

Atlas AMPLITONE LOUD SPEAKER

LIST PRICE
Complete With Connecting Cord **\$25**

TRADE MARK

For Christmas give the radio enthusiast a perfect radio re-PRODUCER, the *Atlas Loud Speaker*. The patented "double diaphragm" responds uniformly to the full range of sound intensities. Adjustable to individual receiving conditions. A gift to an entire home. Hear the *Atlas Loud Speaker* at your dealer's. Write for Booklet W.

What have you accomplished with your Atlas Loud Speaker? Tell us about it.

MANUFACTURED BY
Multiple Electric Products Co., Inc.
Orange Street RADIO DIVISION NEWARK, N. J.



THE 1923 New OLIVER SPEEDSTER

Send for 1923 Oliver Catalog Showing New Standard three bank Keyboard.
The Oliver Typewriter Co., Dept. 1093, Chicago

CATALOG E19-100 PAGES FREE

LATEST REFLEX AND NEUTRO DYNE CIRCUITS
One of the largest complete stocks in the world.

DEALERS ALL OVER THE U.S.

Making big profits handling our supplies. 24-hour service. Goods shipped same day order received.

QUALITY AMERICAN RADIO SERVICE
WHOLESALE MFG. CO. DISTRIBUTORS
Dept. O, 6 W. 14th St. KANSAS CITY, MO.

ALL-AMERICAN

AMPLIFYING TRANSFORMERS
Radio and Audio Frequency

FREE! Book of tested hook-ups. Send 2c stamp for postage.

RAULAND MFG. CO. 200 N. Jefferson St., CHICAGO

Over 300,000 in SERVICE

STRENGTH Without Weight



Indian Scout

AN instant appeal to the fellow who wants plenty of power and speed without bulk.

An altogether *different* motorcycle—so light a youngster easily handles it, but sturdy enough for the biggest of big fellows.

And economical!—60 to 75 miles to the gallon of gas, 125 miles to the quart of oil. Low-built, graceful, compact—everything that you need for absolutely perfect, thoroughly dependable motorcycling.

Write Dept. P-12 for
descriptive folder.

Hendee Manufacturing Company
Springfield, Massachusetts

Ingersoll

Gifts for Every Member of the Family

THERE'S no gift like a watch, nothing used so much, consulted so often, carried so long.

The Ingersoll you give now will be ticking Christmas Greetings every day throughout the year.

NEW IMPROVED YANKEE The ideal watch for the every-day American.	\$2.00
YANKEE RADIOLITE Particularly valuable to motorists, sportsmen, nursing mothers, etc.	\$3.00
RADIOLITE TWO-IN-ONE The Yankee Radiolite in an ivory-like celluloid strand	\$3.25
ECLIPSE Smaller and thinner than the Yankee. Solid nickel case	\$3.00
ECLIPSE RADIOLITE Thin model. Tells time in the dark	\$4.00
JUNIOR Small size, thin model. The favorite watch of millions of men and boys	\$3.50
MIDGET For women, girls and small boys	\$3.50
MIDGET RADIOLITE The Midget plus the Radiolite dial	\$4.50
WRIST RADIOLITE The time's in sight, day and night—at a glance	\$4.50
WATERBURY A jeweled, 12-size watch that combines stam-ina with style	\$5.00
WATERBURY RADIOLITE A handsome watch with "silver" dial. Tells time in the dark	\$6.00
RELIANCE A fine 7-jeweled watch. Thin model. A thoroughbred in every detail. (In gold-filled case \$10.00)	\$7.00



A Wise Old Trapper

In the state of Ohio there lived a bunch of boys who had this trapping business down to a science. They each sent for separate price lists every year and then sent all their furs to the house giving the best quotations. After five years they decided they weren't so dreadfully wise because they didn't have enough profits to make their efforts worth while.

One day they met Tom McMillan driving a new car to town. Tom said he made the price of his swell outfit shipping pelts. He told how he got wise to those funny prices and found it was better to deal with Chas. Porter because he always knew in advance just what he was sure of getting. He said that Porter never offered \$5 for a \$3 pelt but he always paid the \$3 which he promised and sometimes just a little better. Chas. Porter now has five wise trappers in that section instead of one.

Don't Take a Chance with Your FURS

Send us your name and address. Get our Price Bulletins, Shipping Tags and full particulars. Do it right now. This means real dollars to you, so don't put it off. Write today.

Your furs mean real dollars to you. Why sell them to some fellow who offers you \$1.25 when you know blame well you are lucky to get fifty cents. Ask the wise trapper who knows. Once a Chas. Porter shipper and you will always be one. You know in advance that we give a square deal and every shipment brings sure money.

CHARLES S. PORTER, INC.
133 WEST 27th STREET NEW YORK



SQUAB BOOK FREE!

Squabs are selling at highest prices ever known. Greatest market for 25 years. Make money breeding them. No mixing feed, no night labor, no young to attend. Start small, grow big. Start now. Read how our customers sell squabs for \$12 a dozen. We have been established for 25 years. Better look into this. Let us send you, at no cost to you, our big, illustrated free book telling how to make money breeding squabs. Address

Plymouth Rock Squab Co., 634 HSt., Melrose Highlands, Mass.

FURS WAY UP!

Fur Crop On Every Farm

Send your name and address to Fouke Fur Co., St. Louis for FREE HELPS TO TRAPPERS. Learn the newest, best ways to trap; how to grade; how to prepare furs for most money. Get lowest prices on all supplies. Know the game laws, keep posted on the market all season. Get your name in at once... USE THE COUPON BELOW. For best profits and most complete satisfaction

Ship Your Furs Direct To

FOUKE

FOUKE FUR COMPANY

315 Fouke Building, St. Louis, Mo.
Send me new Fouke catalog of latest, best equipment, how to trap, how to grade, game laws, etc. Unexcelled price list service all season, all FREE.

Name _____

Town _____

State _____

R. F. D. _____

Box _____

TRAPPERS

Get **HONEST GRADING**
and **HONEST PRICES!**

Old timers will tell you McCullough & Tumbach pay every cent a skin is worth, based on honest grading by fur men who know the market. That's what you want! And we send cash the day your shipment is received. You want that, too! You want the service that has earned the trappers' confidence for McCullough & Tumbach during 30 years of business—

A Square Deal to Every Shipper

One shipment will prove what we say. Just send it!

FREE shipping tags; full fur information; price lists. Write for them now!

McCullough & Tumbach
148 N. Main St.
ST. LOUIS, MO.

FREE! ART PICTURES



of Ideal Chickens in Beautiful Natural Colors, 8x11 in., suitable for framing. Given only with Poultry Tribune—every issue. World's Great Poultry Paper. Check full of money-making ideas, articles, news by foremost poultry authorities. Pub. monthly, 80 to 100 pages. **SPECIAL OFFER:**

5 Big Trial Issues 25c
1 Year 50c; 3 Years \$1.00
Send stamps or coin today.

Poultry Tribune, Dept. 41, Mount Norris, Ill.

AN IDEAL GIFT
Only 50c Postpaid or C.O.D.

Pocket Identification Holder It is always necessary to have identification, license or fraternal receipt, or some valuable paper with you—attached to watch chain or key ring—it can't be lost! Weather proof! Handsomely nickel-plated. Order yours today—ask for circular of other items.

INSTITUTE MFG. CO., Dept. 201, 311 Main St., Worcester, Mass.

Pants Always Pressed

STAYPREST TROUSER PRESSER puts a real master-tailor crease in pants. Takes the bag out of knees and removes wrinkles. Easy to use—takes only a few seconds. Always a like-new press without delay or trouble. A real convenience. Saves many dollars in pressing bills, and trousers always look like just from the tailor. Makes them last longer. Saves nap of cloth which ironing ruins. Every man should have at least one or two.

Stay Prest
Made of selected hardwood, fabric covered, canvas lined. All metal parts heavily nickel plated. Fits any size trousers. Folds into small pack to fit handbag. Strong, but light. Has collapsible coat hanger. Lasts a lifetime. Thousands in use. Well dressed men have several in several presses well pressed. Sold through dealers, agents or direct by mail. Mailed postpaid on receipt of \$2.50, C.O.D. if desired.

FOUR PATENTS
Attractive, Useful Gift. Xmas Package if Desired. Satisfaction or money back. Order today. Best free.

The Getzoy-Jung Company
2112 G. & J. Bldg. Cincinnati, Ohio

TRAPPERS

It's **FREE** Send for it



Trapper Bill

SIGN and mail the coupon and we will send you "The Shubert Shipper" — FREE. This season especially you will have to keep accurately posted on market conditions and market prices if you want to get the most money for your furs. For your own protection—read "The Shubert Shipper" regularly and be posted on the fur market right up to the minute. "The Shubert Shipper" costs you nothing—but it will make you many dollars. It will put you in position to sell your furs at the highest market prices at all times—you will always know just what prices your furs should command. Isn't such information worth money to you? Just sign and mail the coupon below and a copy will come to you by next mail. **YOU NEED IT** Don't be without it.

A. B. SHUBERT INC.
25-27 W. Austin Ave. Chicago, U.S.A.

SIGN AND MAIL THIS COUPON TODAY

A. B. SHUBERT, Inc., 25-27 W. Austin Ave., Dept. 17, Chicago, U. S. A.
Without obligation send me "The Shubert Shipper" and keep me posted on Raw Fur Market conditions during the Fur Season of 1923-1924.

Name _____

(PLEASE PRINT NAME)

Post Office _____ R. F. D. _____ Box No. _____

County _____ State _____

©1923, A. B. S., Inc.



American Poultry Journal
OLDEST, LARGEST and BEST
4 MONTHS' TRIAL 25 cents

1 Yr. 75c. 2 YEARS \$1 5 Yrs. \$2

Averages over 100 pages per issue—tells how to feed, house and breed; how to secure high egg production; how to hatch and rear poultry successfully. Established 1874. Only 25 cents for 4 months. Stamps accepted.
American Poultry Journal, 14-523 Plymouth Ct., Chicago



RAISE BELGIAN HARES

New Zealand Reds — Flemish Giants — American Blues.
BIG PROFITS, WE PAY \$1.50 TO \$8 EACH.
Also Cavies, Mink, Skunk, Fox, Muskrat, Etc.
Easily raised anywhere. 32-page Catalog and Contract **FREE!**
Illustrated book "COMMON SENSE RABBIT RAISING," quarterly journal, and copy of America's leading small stock magazine, all for 30 cents. Address **Outdoor Enterprise Co., 1005 G. E. BLDG., KANSAS CITY, MO.**

PLANS for Poultry Houses!

All styles. 150 illustrations; secret of getting winter eggs, and copy of "The Full Egg Basket." Send 25 cents.
INLAND POULTRY JOURNAL, Dept. 74, Indianapolis, Ind.

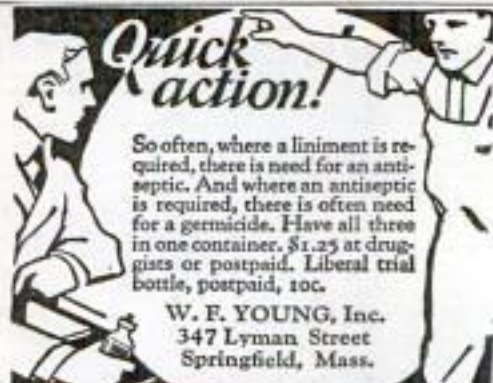

Quick action!

So often, where a liniment is required, there is need for an antiseptic. And where an antiseptic is required, there is often need for a germicide. Have all three in one container. \$1.25 at druggists or postpaid. Liberal trial bottle, postpaid, 10c.

W. F. YOUNG, Inc.
347 Lyman Street
Springfield, Mass.

Absorbine J
THE ANTISEPTIC LINIMENT

21-Jewel Watch



Most amazing value ever offered! Fully adjusted movement—reliable timekeeper. A high-grade watch, fully guaranteed—not to be confused with ordinary watches often offered at this price.

Guaranteed 25 Yrs.

Gold Filled Elgin Case

Latest style, 16-size, open face this model. Beautifully engraved edge and back. Genuine Gold Filled Elgin Napoleon case—guaranteed 25 years. Thousands of pleased users everywhere.

SEND NO MONEY

Just your request brings it. Pay postman on arrival only \$7.25. Money back if not satisfied.

WALTERS, YOUNG & CO.
Dept. W-130 Same Management Since 1882 Chicago



Get This Wonderful Ring. If You Can Tell It From a Genuine Diamond Send It Back

These amazing, beautiful CORODITE diamonds positively match genuine diamonds in every way—same blinding flash and dazzling play of living rainbow fire. They, alone, stand the diamond tests, including terrific acid test of direct comparison. Lifetime experts need all their experience to see any difference. Prove this yourself.

Wear a Corodite Diamond 7 DAYS FREE

Make this test. You risk nothing. Wear a genuine Corodite and a diamond side by side on the same finger for 7 days. If you or your friends can tell the difference, send it back; you won't be out a single penny. That's fair enough. If you keep the ring, price printed here is all you pay. No installments. Remember, Corodites alone have these same cutting and gemstone tests.

No. 1—Ladies' Solitaire 14K Gold B. Ring . . . \$2.84
 No. 4—Ladies' Hand-Carved Basket Setting, plat. finish . . . \$3.96
 No. 5—Ladies' Solitaire Bridal Blossom Engraved . . . \$3.54
 No. 7—Gents' Heavy Belcher 14K Gold B. Ring . . . \$3.68
 No. 8—Gents' Massive Hand-Carved Octagon Gypsy . . . \$4.28

Carat size gems. Beautiful mountings of most modern design. Choice of gold or latest white platinum finish. Unqualified 20-year guarantee. Hand-some art leather case free with each ring.

SEND NO MONEY Keep your money right at home. Just send name, address and number of ring wanted and size as shown by slip of paper, fitting and to enclose finger joint. Your ring will come by return mail. When ring arrives deposit amount shown above with postman. If you decide not to keep ring after 7 days' wear, send it back and your money will be immediately returned. Send today.

Good Profits for Demonstrator Agents



Elto
 3 H.P. Twin
 Outboard
 Motor



Exclusive territory for the ELTO—the only full 3 H. P. fast, light "twin!" Earn big money! Turn spot into profit! We'll send you a demonstrator at factory price. Or, if you cannot be

an active agent, but will help us find one in your territory, you can have the latest ELTO at factory price. This is open to only one buyer in new territory. Write at once for liberal offer.

ELTO OUTBOARD MOTOR COMPANY
 Manufacturers Home Building
 Dept. AA Milwaukee, Wisconsin

WHY PAY FOR COAL?



HEAT AT TWIST OF WRIST!

Burn free air in your present heater, range or furnace. Remarkable new device—NU-HEAT—causes one part coal oil (kerosene) to turn TWENTY TIMES its bulk of free air into intense gas for heating, cooking and baking. Installed in a jiffy. Heat at twist of wrist. Heats largest rooms in few minutes. No dirt,

ashes, or coal and wood drudgery. Better, cheaper, quicker. Absolutely safe. Ironclad guarantee. 30 days' free trial. Send post card for Free information. Mention if you have heater, range or furnace.

AGENTS

Make \$50 to \$200 a week. Full or spare time. Personal cooperation. Write quick for exclusive territory and free sample case offer.

WADE HILL MFG. COMPANY
 Dept. 240 ST. LOUIS, MO.

Clear-Tone FOR PIMPLES

Your skin can be quickly cleared of Pimples, Blackheads, Acne Eruptions on the face or body, Enlarged Pores, Oily or Shiny Skin. \$1,000.00 Cold Cash says I can clear your skin of the above blemishes. WRITE TODAY for my FREE Booklet—"A Clear-Tone Skin"—telling how I cured myself after being afflicted for fifteen years.

E.S. GIVENS, 129 Chemical Bldg., Kansas City, Mo.

THE FAMOUS GREEN AUTOMATIC



Grinds, hones and strops in one operation

A BIG MONEYMAKER THE FAMOUS GREEN AUTOMATIC

grinds, hones and strops all kinds of safety razor blades in one operation. If you now own a business of your own or have at least \$300 in capital to start an independent, profitable business of your own which will make you a handsome profit of from \$3.00 to \$5.00 per hour, then write us.

Wonderful Opportunities in the Sharpening Station Business

We make the latest models of machinery for sharpening safety razor blades (all makes), scissors, clippers, surgical instruments, carving knives, butcher knives, razors and all cutting instruments. Operating cost small. Wonderful advertising value for window installations. Estimated by operators as greater than cost. BEAR IN MIND—ALL MEN SHAVE. MOST MEN USE SAFETY RAZORS. UNLIMITED SERVICE OPPORTUNITY. If wide awake and progressive, write for full particulars and further information. Address

AMERICAN SHARPENING MACHINE COMPANY
 (Makers of sharpening and key cutting machinery)
 Dept. P. 12 KALAMAZOO, MICHIGAN

AMERICAN KEY CUTTER



Built for Custom Service. Cuts square, angular or curved slots. Accurate work guaranteed.

Flexible Flyer

"The sled that steers"

When you give your boy or girl a Flexible Flyer for Christmas, you give them health and wholesome outdoor fun for many years to come. You give a sled every boy and girl wants and knows by name. Strong, good-looking, graceful—sure, easy steering—grooved runners—the chosen sled of childhood.



Ask your dealer for free cardboard model showing how Flexible Flyer steers—or write us for it.

Look for this trade-mark on the sled you buy.



S. L. Allen & Co., Inc.
Dept. 39 Philadelphia

Fibre-Lite Limbs

Easy Payments—Do Nature's Work.
AGENTS WANTED who use Artificial Leg. GOOD PAY.
FREE Free Sample. DISCOUNT STUMP TO
WORMAN CO. 252-P. HENNEPIN AVE. MINNEAPOLIS, MINN.

TOBACCO OR SNUFF HABIT CURED OR NO PAY

Any form QUICKLY conquered. NO LONG WAITING.
Costs \$1.00 if it cures. HARMLESS. Sent on approval.
DR. C. M. SIMPSON, 325 W. 44th Street, CLEVELAND, O.

Taxidermy Book FREE!



Write today.

Stuff Beautiful Birds

Learn by mail to stuff and mount all kinds of birds, animals, fish and game heads, make rugs, tan skins. Mount your own specimens and make money preserving for others. Men, women and boys learn easily and quickly. Success guaranteed or no tuition. Write today for our wonderful FREE book. "How to Learn to Mount Birds and Animals." N. W. School of Taxidermy, 9779 Elwood Bldg., Omaha, Neb.

Deafness



Perfect hearing is now being restored in every condition of deafness or defective hearing from causes such as

Relaxed or Sunken Drums, Roaring or Hissing Sounds, Perforated, Partially Destroyed Drums, etc.

Wilson Common Sense Ear Drums

"Little Wireless Phones for the Ears"—require no medicine but effectively replace what is lacking or defective in the natural drums. They are simple devices, which the wearer easily fits into the ears where they are invisible. Soft, safe and comfortable to wear at all times.

Write today for our 168 page FREE book on DEAFNESS, giving you full particulars and plenty of testimonials.

WILSON EAR DRUM CO., Incorporated
334 Inter-Southern Building LOUISVILLE, KY.



Only \$5.00 a month and the machine is yours. **FREE TRIAL** This is absolutely the **EASY** most generous typewriter offer we ever made. Do **TERMS** not rent a machine when you can pay \$5.00 a month and own one. Think of it—Buying a perfect, late model highest grade \$105 Typewriter at a bargain price—at only \$5 a month.

The Famous L.C. Smith Silent Model No. 8

This is the famous L. C. Smith typewriter which has set the world's standard for quality and service for over twenty years. Perfect machines, Standard size, Keyboard of Standard Universal arrangement, 42 Keys, writing 84 characters—universally used in teaching the touch system. The entire line of writing completely visible at all times, has the decimal tabulator, the two color ribbon, with automatic reverse, the back spacer, ball bearing type bars, ball bearing carriage action, ball bearing shift action. Every late style feature and modern operating convenience. Comes to you with everything complete; tools, cover, operating book and instructions—nothing extra to buy. You cannot imagine the perfection of this beautiful typewriter until you have seen it. We do the most perfect and highest class job of rebuilding known to the industry. We have sold thousands of these perfect late style machines at this bargain price and every one of these satisfied customers had this splendid, strictly up-to-date machine on five days' free trial before deciding to buy it. We will send it to you F. O. B. Chicago for five days' free trial. It will sell itself, but if you are not satisfied that this is the greatest typewriter you ever saw, you can return it at our expense. You won't want to return it after trial, you cannot equal this wonderful value anywhere.

SEND NO MONEY Order Now—Before They're Gone

When the typewriter arrives deposit with the express agent \$6.20 and take the machine for five days' trial. If you are convinced that it is the best typewriter you ever saw keep it and after 30 days send us \$5.00 a month until our bargain price of \$66.20 is paid. All cash \$61.70, just a little more than half its original price. If you don't want it, return it to the express agent. He will return your \$6.20 deposit. We will pay the return express charges. This machine is guaranteed just as if you paid \$105.00 for it. It is standard. Over half a million people own and use these typewriters and think them the best ever manufactured. The supply at this price is limited; the price will probably be raised when next advertisement appears, so don't delay. Fill in the coupon today—the typewriter will be shipped promptly. There is no red tape. We employ no solicitors—no collectors—no chattel mortgage. It is simply understood that we retain title to the machine until full \$66.20 is paid. You can not lose—your deposit does not leave your home town unless you are satisfied. Get the coupon in the mails today—sure.

SMITH TYPEWRITER SALES CO.,
300-360 E. Grand Ave., Chicago, Ill.

Ship me the L. C. Smith Model No. 8, F. O. B. Chicago. I will pay you \$5.00 monthly as rent until the \$60.00 balance of the Special \$66.20 sale price is paid. The title to remain in you until fully paid for. It is understood that I have five days in which to examine and try the typewriter. If I choose not to keep it I will carefully repack it and return it to the express agent. It is understood that you give the standard guarantee.

Name.....

Street Address.....

City..... State.....

This Beautiful Coat **FREE!**



This Splendid Coat FREE!

The Goodyear Manufacturing Company is making an offer to send a handsome GOODYEAR RAIN-PROOFED coat to one person in each locality who will show and recommend it to friends.

It is a beauty, cut in the season's latest model, with all around belt, new semi-dent lapels, convertible collar and storm-tabbed sleeves. Guaranteed rain, dust and wind proof. A handsome topcoat, raincoat, motor coat and overcoat combined. Good all year around.

Big Pay for Spare Time

Just write your name and address on the coupon below and mail today. Send no money. Prove by your promptness that you are the one we seek. You must be quick.

SEND NO MONEY

When people see your wonderful sample All Weather Coat they will admire it, ask about it and want one like it. That is why we make this unparalleled offer. You can

make big money just taking these orders. Have all the money you want to spend. Don't lag behind and miss this great offer. Fill in the coupon and mail NOW!

THE GOODYEAR MANUFACTURING CO.
1740-R Goodyear Bldg. KANSAS CITY, MO.

GOODYEAR MANUFACTURING CO.,
1740-R Goodyear Bldg., Kansas City, Mo.

Without any obligation on my part please send me by return mail your FREE COAT and AGENCY OFFER.

Name

Address

City State

AMAZING AUTOMATIC WASHER!

Wonderful new invention—fits any wash boiler—washes clothes snow white in thirty minutes. Sells for less than one tenth the cost of old fashioned complicated electric machines. Most efficient washer known. Operates by heat from your own stove. Can be used anywhere. No moving parts—no electricity—no hand power or rubbing necessary. Absolutely guaranteed to give perfect satisfaction. Write today for 30 day Free Trial

AGENTS WANTED. offer, also special low price. Be the first in your territory to make big money with this remarkably easy seller. TORRENT WASHER CO., Sec. 6, 122 So. Michigan Ave., Chicago

Spencerian Personal Steel Pens

Getting right down to the point—Spencerian Personal Steel Pens are fashioned from finest quality steel into the longest-lasting, smoothest-writing pens that you can buy. Made by seven hand processes! That's why they've been the standard for more than fifty years. And remember there is an exact style for your particular handwriting.

No. 1—College, fine point, double elastic.



No. 28—Congressional, speedy and flexible.



No. 40—Medium point, all-round ability.



No. 42—Gold and dome pointed, smooth action.

SPENCERIAN PEN CO.
349 Broadway
New York

A dozen sample pens for a dime and our handwriting booklet, free

Buchstein's Fibre Limb

is soothing to your stump—strong, cool, neat, light. Easy payments. Braces for all deformities.

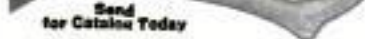

Send for Catalogue Today

D. BUCHSTEIN CO.
113 6th St. S., MINNEAPOLIS, MINN.

BIG REDUCTION

Gold Filled Case Guaranteed!
\$2.90 Beautifully engraved, gold-filled case. Open face with extra "seconds" hand dial. Most attractive design and splendid timekeeper. Stem wind and set. Guaranteed. A prompt order entitles you to this wonderful offer—a beautiful knife and chain free. Take advantage of it now.

FREE Knife and Chain

SERVICE WATCH COMPANY
Chicago, Illinois
P. O. Box 750L

Send \$10 FOR ONE OF THESE REG. VAL. \$85 to \$125 LYRADION RADIO CABINETS BEAUTIFUL

SPECIAL OFFER ONLY WHILE 200 LAST. READ DETAILS BELOW

Genuine "Lyradion" Radio Cabinets, in beautiful natural mahogany piano finish or dark Queen Anne oak, equipped with the famous natural tone non-vibrating Seabrook Loud Speaker Horn, wiring, aluminum adapter for Baldwin or other units, battery connectors, etc. A rare chance to obtain a loud speaker and a beautiful housing for your complete radio outfit at far below manufacturing cost. Holds your set, A and B batteries, and accessories all in one place, out of the way, yet easily accessible. Delights women folk who object to apparatus scattered on table. Permits everyone to hear and enjoy your radio. A handsome piece of furniture, too—harmonizes with any surroundings. Send only \$10. State finish desired. Cabinets will be shipped C. O. D. on approval. Pay balance plus expressage if acceptable. Otherwise return and receive back your \$10.00. Size A, 38 1/2 in. high (reg. price \$85), only \$31.50. Size B, 41 1/2 in. high (reg. price \$125), only \$35.75. **ACT!—ONLY 200 LEFT**

SHIPPED ON APPROVAL

HELLER-LOEB COMPANY, 143 W. Kinzie St., Chicago



Size A, Space for radio set, 20 1/2" high, 13 1/2" wide, 10" deep.

Size B, Space for radio set, 23 1/2" high, 14" wide, 10" deep.

"DETROIT" BELT LACING OUTFIT



Detroit Wire Hook belt lacing used by ten thousand big factories and many more small shops and farms. Laces belts perfectly for one cent an inch. It is very strong, flexible and easy to apply. Saves time, belts, power and money.



Complete outfit including lacing tool (used in an ordinary vise as shown) and assorted box of lacing (as shown) for every kind and thickness of belt. Outfit postpaid \$5.00. Assorted lacing \$1.50 per box. Post \$3.00. Money back if not entirely satisfied. Ask for folder.

Detroit Belt Lacer Co., Detroit, Mich.

Rings Bells Without Batteries

Avoid the annoyance of having bells out of order. At a nominal cost you can install this little device which will ring electric bells, buzzers, annunciators, electric heat regulators, door-openers, etc., from the same current that lights your home.

ONLY
\$2.00
Canada
\$3.00

Air-Way Bell Ringer Transformer

It connects direct to lighting-current, and eliminates forever the use of troublesome dry batteries. Does not use enough current to register on meter. Buy it from any electrical dealer, or we will send it anywhere postpaid upon receipt of price. Your money back if you are not satisfied.

JOBBERS, DEALERS, AGENTS—Write for selling proposition.
AIR-WAY ELECTRIC APPLIANCE CORPORATION
Toledo, Ohio

Sure Rupture Comfort

BE COMFORTABLE—Wear the Brooks Appliance, the modern scientific invention which gives rupture sufferers immediate relief. It has no obnoxious springs or pads. Automatic Air Cushions bind and draw together the broken parts. No salves or plasters. Durable. Cheap. Sent on trial to prove its worth. Never on sale in stores as every Appliance is made to order, the proper size and shape of Air Cushion depending on the nature of each case. Beware of imitations. Look for trademark bearing portrait and signature of C. E. Brooks which appears on every Appliance. None other genuine. Full information and booklet sent free in plain, sealed envelope.



MR. C. E. BROOKS

BROOKS APPLIANCE CO., 126J State St., Marshall, Mich.

21 Jewel Burlington



Adjusted to the Second
Adjusted to Temperature
Adjusted to Isochronism
Adjusted to Positions

21 Ruby and Sapphire Jewels
25 Year Gold Strata Case
Your Choice of Dials
(Including Montgomery R. R. Dial)
New Ideas in Thin Cases

Only \$1.00 Down

Only One Dollar Down will buy this masterpiece of watch manufacture. The balance you are allowed to pay in small, easy, monthly payments. The Burlington—a 21-Jewel Watch—is sold to you at a price much lower than that of other high-grade watches. Besides, you have the selection of the finest thin model designs and latest styles in watch cases. Don't delay! Write for the FREE Watch Book and our SPECIAL OFFER today.

Write *While This Special Offer Lasts*

Get the Burlington Watch Book by sending this coupon. Find out about this great special offer which is being made for only a limited time. You will know a great deal more about watch buying when you read this book. You will be able to "steer clear" of the over-priced watches which are no better. Remember, the Burlington is sent to you for only One Dollar down, balance in small monthly payments. Send the coupon for watch book and our special offer TODAY! Do not delay one minute!

Burlington Watch Company

Dept. 13-59 19th St. & Marshall Blvd., Chicago
Canadian Address: 62 Albert St., Winnipeg, Manitoba

Please send me (without obligations and prepaid) your free book on watches with full explanation of your \$1.00 down offer on the Burlington Watch.

Name _____

Address _____



Are You Reaching for the Truth?

I will tell you
FREE

Under which Zodiac Sign were you born? What are your opportunities in life, your future prospects, happiness in marriage, friends, enemies, success in all undertakings and many other vital questions as indicated by ASTROLOGY, the most ancient and interesting science of history?

Were you born under a lucky star? I will tell you free, the most interesting astrological interpretation of the Zodiac Sign you were born under.

Simply send me the exact date of your birth in your own handwriting. To cover cost of this notice and postage, **enclose twelve cents** in any form and your exact name and address. Your astrological interpretation will be written in plain language and sent to you securely sealed and postpaid. A great surprise awaits you!

**Do not fail to send Birthdate and to enclose 12c.
Print name and address to avoid delay in mailing.**

Write now — TODAY — to the

ASTA STUDIO, 309 Fifth Ave., Dept. 138, New York

MEN! You Take No Risk—
Watch Sent on
Money Back
GUARANTEE

Finest American Make Watch \$20
Value at amazing reduction. Excellent
timekeeper. Mechanically perfect.
Stem wind & set. Designed to give years
of service. Buy direct. Save over 50
per cent. Examine first.

25 yr. 14 Kt. Gold-Filled Case
Beautiful this vest model. Case stamped
25 yrs. Guaranteed Genuine 14 Kt.
Gold Filled. 7 Jewel fully adjusted movement.
Not an ordinary watch!

FREE—Beautiful Vest Chain
SEND NO MONEY—Your request brings
both. Elegant Chain absolutely free if
you hurry! Pay postman only \$1.00 on
arrival. Money back if not satisfied.

ACT AS OUR AGENT. Show watch to
friends. Secure five orders and get yours
free or cash commission.

ELITE JEWELRY HOUSE
306 S. Wabash Ave., Dept. 901
CHICAGO, ILL.



NEW LAMP BURNS 94% AIR

Beats Electric or Gas

A new oil lamp that gives an amazingly brilliant, soft, white light, even better than gas or electricity, has been tested by the U. S. Government and 35 leading universities and found to be superior to 10 ordinary oil lamps. It burns without odor, smoke or noise—no pumping up, is simple, clean, safe. Burns 94% air and 6% common kerosene (coal oil).

The inventor, H. E. Johnson, 609 W. Lake St., Chicago, Ill., is offering to send a lamp on 10 days' FREE trial, or even to give one FREE to the first user in each locality who will help him introduce it. Write him to-day for full particulars. Also ask him to explain how you can get the agency, and without experience or money make \$250 to \$500 per month.

This Palatial Florida Home

can be purchased at a very reasonable price. It is the finest estate in a community of 30,000 situated amid 5 acres of orange, grape fruit, sweet bay, palmetto and a large variety of semi-tropical trees and foliage. A water front of 400 feet, with entrance from a Boulevard, affording every modern convenience. House recently completed and never occupied. Has every modern improvement, large sun parlors, sleeping porches and 8 bath rooms. Inexhaustible supply of soft water, steam heat, high, light basement under entire house. Surf bathing all winter within 5 minutes' walk.

For full details, photographs and price address

OWNER,

200 E. Ontario St. CHICAGO, ILL.



New Kind of Light

—Brighter than 20 Ordinary Lamps

New Bright White Light For Every Home

Wonderful Invention

I have made it easy for every home to have bright, cheery, healthful light—in cities, villages and on farms—anywhere—at a price all can afford. No more need you put up with the dingy, smoky, foul-smelling oil wick lamps and lanterns. No more need you put up with the drudgery of cleaning and trimming greasy, dirty wicks and chimneys. For less cost than you would pay for a good oil lamp you can have an abundance of brilliant, white light—20 times brighter—for every room in the home or for outdoor chores.

Write Me Quickly

Let me send you complete particulars and information together with my amazing special introductory offer. My wonderful invention is the sensation of the age. Each Lamp and Lantern is a complete gas generating unit in itself—light in weight—easily carried, safe, convenient, easy to operate. Table Lamps, Hanging Lamps, Wall Lamps for every lighting purpose, also most durable, certain outdoor Lantern ever made. Wind-proof, storm-proof, bug-proof. Costs only half as much as wick lamps or lanterns to operate.



Mail
Coupon
Today

Lights
with
Match

300 Candle Power

—beats electricity or gas for economy, brightness and quality of light. Burns 96% Air—Only 4% cheap gasoline or kerosene (coal-oil). Produces a light bright as daylight. Soft, mellow, easy on the eyes.

Think of the difference. Ordinary wick lamps give 5 to 10 candle power of light. My invention gives 300 Candle Power.

Lights with match as quickly and easily as old-style lamp. Simple to operate and positively safe. Greatest advancement in home and farm lighting in a century. **30 Days Trial**

I want to put at least one of these Lamps or Lanterns in every home. I am making a sensational introductory offer to do it. I back it with my 30-day trial guarantee. You try it without a penny of risk. I take all the responsibility. The coupon, a letter or post card brings this offer and big attractive, descriptive catalog FREE, from which you can select any one of the many handsome designs. Be first in your locality to write and get this liberal money-saving introductory offer. Send your name and address today.

J. C. Steese, President
THE AKRON LAMP COMPANY
112 Lamp Building AKRON, OHIO

Special Offer Coupon

J. C. Steese, Pres., THE AKRON LAMP CO.,
112 Lamp Bldg., Akron, Ohio.

Send me without obligation your limited Special 30-Day-Trial Introductory Price Offer and Big Free Catalog of DIAMOND LAMPS and LANTERNS.

Name.....

Address.....

City.....State.....

If interested in Sales Agency, check here.

AGENTS

560 to \$100 A Week

If you want to earn big money, write me quickly for sales plan. No experience—no capital required. Exclusive territory. Big season now on. FREE outfit to workers. Check and send coupon for full details. Address me personally.

J. C. STEESE, President.

Agents Wanted

for the Best and Fastest-Selling Automobile Proposition on the market!

There are a few more openings in exclusive territories for live agents to handle **Airlox Airtight Puncture-Proof Tubes and Hughes Valve Caps**. These tubes, together with the caps, make a combination which renders them absolutely airtight and puncture-proof.

Experience is not necessary; we train you. If you are a man who wants to make some money, let us tell you how you can make a big success with **Airlox Airtight Puncture-Proof Tubes and Hughes Valve Caps**. Write today for information.

AIRLOX RUBBER COMPANY

2054 W. Jackson Boulevard, Chicago

MOVIES In Your Home



Our marvellous, practical **Movie Machines** sell as low as \$5.00—and what's more, we have wonderful films at lowest prices—with a new film rental service. **DON'T MISS THIS!**

Write NOW for Free Catalogue
PARAMOUNT MFG. COMPANY
Box 1371, Dept. M2, Boston, Mass., U.S.A.

**5 DAYS
FREE
TRIAL**

Send
No
Money



**"INVINCIBLE" Rebuilt GUARANTEED
STANDARD No. 10 Self Starter Model
REMINGTON \$43.75**

Try it in your own home or office before you pay a cent. Looks and writes like new. Has full 84 character keyboard, standard size type, back spacer, automatic ribbon reverse and all other late improvements. A real bargain. All standard makes. Deliveries from nearest of our 28 stores. Send TODAY or write for circular. Time payments at slightly higher price. Residual salaries waived.

AMERICAN WRITING MACHINE CO. Estab. 1880
Factory: 452-R Central Ave., Newark, N.J.



**\$25 A DAY
Selling Suits**

Fifth Ave.
New York
Custom
Tailors

want agents to sell advertised brand all wool tailored to measure suits and overcoats direct to wearer. Lowest prices, sell on sight. No capital or experience required. Big line, swatch samples free. Biggest commissions paid daily.

MONARCH TAILORING CO., 100 Fifth Ave., Dept. C-1, NEW YORK

MAKE YOUR **FORD INTO THIS SPORT CAR—SAVE \$50 to \$150 WITH Red-i-Kut Life-Size Patterns \$6.40**

famous **Red-i-Kut** life-size patterns and picture-instructions show you how you can easily convert your Ford into this **Fast, Saucy, Sport Car** as thousands have done, with easily obtained materials. No need to lay up the car. **LOOK AT WILFRED ENO'S PAL-ENO says, "I used material cut with steel and rivets for my Pal only \$11.50. It took me just 3 Sundays to build it and I was proud to put them on. He built that snappy sport car. I never cut any steel or did any woodwork before but now can't go wrong with Kuempel patterns." (Overland City) St. Louis, Mo. The "Pal" with pressed metal streamline rear.**

life-size patterns for each part of the body so you can't go wrong. picture instructions and **CONICAL DISK WHEEL PATTERNS** Only \$5.50 delivered. Order now while we can make good delivery, and really enjoy these wonderful days in your "Pal." Keen, Classy, Up-to-the-minute. You can build it. Over 11,000 in use. Don't hesitate. "Swing Le." Underling Irons, no frame cutting. **Kid, only \$7.50. Send 5c coin for new catalog of other distinctive sport body patterns from \$2.50 up.** —**REO's Steel, Spring-Lo, Irony, Jiffy, Yess and Geaux** Windshields. Order Right Now. **Kuempel Co., 43 Kuempel Bldg., Guttenberg, Iowa**



38-inch, Easy-riding seat

CLASS CLASS CLASS

Genuine KEYSTONE MOVIEGRAPH

(PATENTED)

SHOWS BIG SIZE MOVING PICTURES**Safe for the Home \$6.95** Non-Inflammable Safety Films
Reel of Charlie Chaplin—"The Kid"

The following reels are only a few in the film catalogue, that is furnished with the machine and are genuine, posed by the actors themselves. The film is the same size as used in the theatre.

- 1 Reel Charlie Chaplin in "Fun in the Bakeshop"
- 1 " Wm. S. Hart in "The New Sheriff"
- 1 " Tom Mix in "The Battle on Horseback"

Also Slides, Drawing Slides, Theatre

Tickets, etc., included. Every live boy should have at home or club a Keystone Moviegraph that shows pictures the same as in the movies with powerful French lenses and constructed along professional lines.

The electric cord is included for connecting to any lamp socket your electric bulb will fit. Can also be had for any Dry Cell Batteries for the home without electricity.

Nothing to get out of order. No complicated parts.

We have the largest comedy film service in the country for home machines.

Size of machine all set up

is 15"x9". Weight 3 lbs.

Send Money Order or check. Guaranteed to give good big pictures or your money back.

Reference American Trust Co., Boston, Mass.

Order your machine today in time for Christmas.

Machine and Reel of Film Complete for \$6.95



Price for Machine and Reel \$6.95 complete, prepaid. Genuine Keystone Moviegraph Patented 1919, 1920, 1921.

LIBBEY & NICHOLS

Jet Sales Co.

Dept. P, 230 State St., Boston, Mass.

READ ~ Write ~ Study ~ SHAVE ~ Work with**Adjusto-Lite**

A FARMERWARE PRODUCT

Reg. U. S. Pat. Off.

Clamps Everywhere

Projects a better, clearer, more direct light exactly where you need it—in home, office, store, studio, workshop. Solid brass; a quality product throughout. Clamp is felt-lined—can't scratch. 5-year guarantee. Complete with 8-ft. cord and 2-piece standard plug. For sale by live dealers everywhere.

If your dealer cannot supply you, order direct.

The Lamp with the CLAMP

Pat. U. S. A. Canada and Foreign Countries



S. W. FARBER, 141-151 S. Fifth St., Brooklyn, N. Y. Prices in U. S. A. and Canada: brass, \$5; bronze, nickel or white enamel finish, \$5.50. West of Miss. River 25c higher.

Big 3-Ft. Telescope Useful and Entertaining

(In Five Sections)

See people and objects miles away, on land or sea, as if they were close. Wonder Telescope gives new pleasures to home, farm, camp, travel, sport. See moon and stars as never before. Opens out over 3 feet long; measures 12 inches closed. Brass bound; has powerful lenses. Thousands please—"Could tell color of aeroplane 4 miles away."—Mrs. Yarbrough. "Saw Provincetown Light, 28 miles away, as clear as if in front of me."—Clyde Scribner.

SEND NO MONEY**SPECIAL OFFER!**
While they last

"I have been watching submarines 7 miles off the coast."—P. Grodz. "Can see childrens playing in school yard 6 miles away."—P. H. Hemington. "Read the numbers on freight cars mile away, see mountains on peaks."—A. C. Polster.

Because of a fortunate purchase from a large European manufacturer we can give you a big bargain. Be first in your neighborhood; entertain your friends. **Send no money; send only name and address for telescope complete by parcel post.** On arrival deposit with Postman only \$1.85 plus a few pennies postage. **Satisfaction guaranteed or money refunded. Order today while the supply lasts.****FERRY & CO., 75 W. Van Buren St. Dept. 1773 Chicago, Ill.**

"Wouldn't take \$10 for mine."—L. H. McKee. "See objects miles away that seem close at hand."—A. W. Stockholder. "I will always recommend the Wonder. I have two of them."—Anton Berka. "Well pleased with Wonder, send my son one for a birthday enclosed."—W. H. Baker. "More than pleased."—J. S. George. "Please send telescopes to two of my neighbors and 3 brothers and sisters, names enclosed."—James Hiding. "More than pleased, better than I expected."—Steve Bils. "Live a mile from town and have such pleasure seeing things that distances."—Mrs. C. M. Campbell.

1 1/2 HP \$43.45

Now, a more dependable, durable, powerful engine Direct from Factory at Low Price. 2 1/2, 3 1/2, 5 and 7 horse-power sizes also at a Big Saving.

OTTAWAEasiest Engine to Start. 30 Days' Trial! 10-Year Guarantee; Cash or Easy Terms. **FREE BOOK**—"How to Know Better Engines." Also Special Offer. Write today! **OTTAWA MANUFACTURING CO.** 831-Y King Street, OTTAWA, KANSAS. Desk 531-Y Mason Bldg., PITTSBURGH, PA.**AGENTS**

Hustlers Make \$25 a Day Selling the

PREMIER KNIFE AND SCISSORS SHARPENER

Every home, tailor shop, restaurant, meat-shop buys on minute's demonstration.

PREMIER MFG. COMPANY,

Dept. 29, Detroit, Mich.



Sharpens dullest knives, scissors, sickles, etc., quickly. Money back guarantee removes 90% of your sales resistance. Sent postpaid for 50c. Price to agents \$2 a Dozen. Price of sample refunded upon receipt of first order.

20 Monthly Brings Big Battery Charging Profits**EVERY SHOP** now can have big profits from 8-hour battery charging. Small cash payment puts HB Constant Potential Outfit in your shop. Your increased profits easily carry the small \$20 monthly terms, with good surplus business. Improved HB 8-hour service builds trade, beats competition. An HB saves you \$20 to \$115 over any other outfit on purchase price alone.**30 DAYS' TRIAL ON MONEY-BACK GUARANTEE**

Every HB outfit sold on 30 days' free trial with money-back guarantee. You run no risk. HB Constant Potential saves current, labor and rental batteries. HB Patented Voltage Regulating Winding absolutely eliminates recharging. HB construction permits output of one-third more batteries than any other outfit of similar rating. Write today. Start now for bigger profits.

HOBART BROS. CO., Box M-12, TROY, OHIO**Pays For Itself ~ Earns Big Profits**

Only \$14²⁴ DOWN



(WICO Magneto Equipped)

This WITTE Throtting Governor ENGINE Is sold DIRECT from FACTORY to YOU on 90 Days FREE Trial

Here's the engine that has revolutionized power on the farm—makes every job easy and cheap. Low priced—in all sizes, 2 to 25 H-P. Simple to operate and free from usual engine troubles. Over 100,000 WITTE Engines in use today.

Burns KEROSENE, GASOLINE, DISTILLATE or GAS

Delivers power far in excess of rating on the cheapest fuels. Built to burn any fuel—no attachments necessary. Practically no carbon and equipped with the famous WICO Magneto.

Write Today for my FREE BOOK Investigate this engine now. Write for my Big, Free, Illustrated Engine Book and details of amazing 90-Day FREE TRIAL Offer. No obligation. ED. H. WITTE, Pres.

WITTE ENGINE WORKS

1748 Oakland Avenue
KANSAS CITY, MO.

1748 Empire Building
PITTSBURGH, PA.

VITALIC Bicycle Tires

TRADE MARK REGISTERED

Tougher Than Elephant Hide



Tank Safety Blade Stropper FOR SKLETTE BLADES

Send \$2.75 Strop your own blades! We Pay Postage Imported Safety Razor Blade Stropper. Rollers move laterally from right to left. Perfect action! Perfect stropping! Keeps blades always sharp. **GUARANTEED.**

CHARLES KELLER CO.
116 Bedford St. Dept. 501 Boston, Mass.
Territory open to agents. Dealers write for quantity prices.

The Newest Simore Tool

"Lightning-Change"



\$2²⁵
Prepaid

Combination Knife and screwdriver—a keen steel knife blade, and two screwdriver blades in the handle. All blades selected and produced by gravity; the knife blade can never fold or turn and injure you; change blades in two seconds.

This combination Knife and screwdriver will be sent to you post prepaid for only \$2.25, check or money order. The only tool of its kind, an ideal Christmas gift for radio fans, carpenters, motorists, boy scouts, and for household use. Order today.

Dealers are invited to write for our proposition on this and other Simore tools.

THE SIMON & SKIDMORE MFG. CO.
Dept. 412 SANTA ANA, CALIFORNIA

\$100 Brings You Any of these Beautiful Xmas Gifts

Biggest Xmas offer ever made! Send a Dollar—mention gift desired. That's all! We ship at once! If satisfied pay 10% monthly. Otherwise return and we refund deposit. Rush your Dollar TO-DAY!



XX—24 inch Dale Pearls Diamond set white gold clasp \$18.50.



X2—14 Kt solid gold rectangular wristwatch 15 Jewel guaranteed movement \$24.



X3—Gents Tooth Ring Fine Blue-white Diamond \$35.

X1—Birthstone ring, white gold, any month \$12.



X4—Onyx Ring solid gold fine blue white diamond \$24.50.



X5—Solid gold Jap ring one fine diamond \$25.



X6—Genuine hand carved cameo, solid gold ring \$16.



X7—7 diamond cluster platinum set solid gold bolcher mounting \$52.50.



X8—Solid gold pendant and pearls one fine diamond \$23.



X9—Ladies fancy white gold diamond cluster platinum set \$48.50.



X10—Fancy white gold ladies ring 2 fine diamonds one blue sapphire \$57.50.



X11—Gents fine hand engraved reconstructed ruby \$16.



X12—Fancy pierced ladies white gold ring fine blue white diamond \$48.



X13—Ladies solitaire Engagement ring fine blue white diamond \$45.



BUY NOW! Pay As You Please

FREE CATALOG

Don't buy Xmas Gifts before you see the Big Bale Blue Book! 72 pages of America's Best Values in Diamonds, Watches, Jewelry, Pearls, Ivoryware, Silverware, Caskets and Thousands of other Gift Suggestions. Buy NOW! PAY-AS-YOU-PLEASE! Cash or YOUR OWN TERMS (within reason). Most liberal credit offer ever made! Send for Your FREE copy TO-DAY! Dept. P. C.

O.F. Bale & Co. EST. 1888
21-23 Maiden Lane New York

\$365⁷⁵ ONE DAY

Ira Shook of Flint Did That Amount of Business in One Day

--making and selling Popcorn Crispettes with this outfit. Profits about \$269. Bram bought first outfit Apr. 5, 1923 and 7 more outfits by Aug. 23, 1923. Iwata, Cal., bought one outfit, then 10 more within a year. Mrs. Lane of Pittsburg says, "Sold 8000 packages in one day (1923)". J. R. Bert, Ala., wrote, "Only thing I ever bought that equalled advertisement". J. M. Patillo, Ocala, writes, "Enclosed find draft to pay all my notes. Getting along fine. Crispettes all you claim and then some." John W. Colp, So. Car., writes, "Everything going lovely. Crispette wrappers lying all over town. It's a good old world after all." Kellog: \$700 ahead end of second week. Messner, of Baltimore, \$250 in one day. Baker sold 3,000 packages in one day. Perrin, \$380 in one day.



We Start You in Business

Furnish secret formulas, raw material, and equipment. Very little capital required; no experience needed.

Build a Business of Your Own

There is no limit to the sale of Crispettes. Everybody likes them. It's a delicious food confection made with or without sugar. Write me for facts about a business that will make you independent. Start now, in your own town.

Profits \$1,000 a Month Easily Possible

Send postal for illustrated book of facts. It contains enthusiastic letters from others—shows their places of business, tells how and when to start, and all information needed. Free. Write now!

LONG EAKINS COMPANY

1228 High Street

Springfield, Ohio



"Lighting Fixtures"

READY TO HANG

(Direct from Manufacturers)

Completely wired, including glassware. New designs. Send for catalogue No. 24. Send for DEALERS' proposition.

ERIE FIXTURE SUPPLY CO.

STA. A.

ERIE, PA.

Send No Money

Just write and say you want to try the

Regal Rebuilt Royal

The chance you've been waiting for! Famous late model, visible Royal Type-writer, perfectly rebuilt and fully guaranteed at sensational reduction in price! When it arrives use it 10 days FREE. If you like it, keep it while you pay for it at only a few cents a day. Otherwise return it and you will owe nothing. Equipped with two color ribbon, four rows standard key-board, automatic ribbon reverse, card holder, back spacer, tabulator and 30 patented time-saving features! Write now and save one third. Send letter or post card to

REGAL TYPEWRITER CO., Dept. 412, 359 BROADWAY, N. Y.



10 DAYS FREE TRIAL

Makes the Deaf Hear



Here is good news for the Deaf or people who are hard of hearing. Science has at last triumphed over deafness. Unless your Auditory Nerve is entirely destroyed, the Acousticon will enable you to hear as perfectly as anyone whose hearing is normal. Thousands who have been Deaf for years report most gratifying results—many say they can hear the slightest whisper and that their natural hearing has been greatly improved. We have testimonials from Governors, Bankers, Ministers, Lawyers and thousands of others. So great is our confidence that we invite every sufferer to

Try It 10 Days FREE

You are not asked to purchase this remarkable invention until you have tried it 10 days FREE, until you have proved to your entire satisfaction that it is what you need and want—until you are absolutely certain that it will enable you to hear all sounds clearly. Then, if you wish, you may keep and pay for it, otherwise return it and there will be no charge.

Send No Money

We ask for no deposit. We do not ship C. O. D. We send you this latest scientific invention entirely at our own risk and expense for 10 days FREE TRIAL. We don't ask you to pay first and then refund your money if you are not satisfied. We send you the Acousticon without cost or obligation. It must prove its own merits to your entire satisfaction. Unless you are amazed and delighted with it, you are not asked to purchase. When we say FREE TRIAL, we mean FREE TRIAL, so send name and address at once for descriptive literature, testimonials and FREE TRIAL request blank.

Dictograph Products Corporation

1307 Candler Bldg., 220 W. 42nd St., New York

1/8 H. P. Gasoline Engine \$24.50 COMPLETE

Castings \$7.50. 40 other styles and sizes. Gen. Cat. No. 22, 20c. Eng. Cat. supplement No. 23, 10c. Both postpaid for 30c stamps. (3 dimes preferred). Refunded first order.

MODERN ENGINE & SUPPLY CO.
334 Monadnock Bldg. CHICAGO, ILL.

AUTO SUPPLIES WHOLESALE 3000 BARGAINS

SEND FOR THIS CATALOG - it's FREE!

Everything you need in Auto Supplies at Amazingly LOW PRICES.

NEMCO BARGAIN SUPPLY HOUSE
33 to 49 No. Peoria St., Dept. P. CHICAGO, ILL.

A FLOOD OF LIGHT Burns 97% Air

GREAT 2 IN 1 LAMP

This great 2-in-1 (lamp and lantern) solves the lighting problem for millions who want a light brighter than gas or electricity. Requires no wiring or piping. Lights with matches. Smokeless, compact, handsomely nicked. Durable, economical—burns 97% air.

FREE To Introduce in new territory. Our Special introductory offer makes it possible to secure one Handy Lite free and a chance to make big profits from easy sales to your neighbors and friends.

Write for our Special Free lamp offer, our "Supreme Selling Secret" to agents.

Agents Wanted ENTERPRISE TOOL AND METAL WORKS, Dept. 312
2441-9 N. Western Ave. Chicago, Ill.



WEAR THIS MARVELOUS "RABON" RING 10 DAYS AT OUR EXPENSE YOU RISK NOTHING

and if your friends or even you yourself can tell it from a genuine diamond, send it back. "Rabon" diamonds look exactly like genuine, place a "Rabon" and a genuine diamond together, see if you can tell them apart. They have the same fiery blue white appearance as the genuine diamond, the same sparkling dazzling rainbow brilliancy and are actually alive with fire. "Rabon" diamonds almost defy the life time diamond expert. Neither science nor man has ever created anything more realistic. Give "Rabon" the same test you would a genuine diamond. Prove to yourself its amazing qualities.

No. 4 and 9 mounted in 14 karat gold shell. No. 2 mounted in 18 karat green gold shell. Nos. 1, 7 and 10 massive platinum effect, all 1 karat size, blue white absolutely perfect. No. 10 2 karat size.

Mountings are exact duplicates of latest style original genuine creations. Unconditionally guaranteed for twenty years.

SEND NO MONEY. Send size shown by slip of paper filling and to send around your finger. When ring arrives by return mail, deposit with the postman the amount shown here and if you are not more than delighted or decide not to keep it within 10 days, send it back, we guarantee to refund your money immediately. Remember you take no risk.

SPECIAL OFFER To introduce the amazing "Rabon" Diamond we will send absolutely free your choice of solid gold front cuff links or solid gold mounted scarf pin to those ordering two rings or more. This offer holds good for a limited time only.

THE RABON CO., 12 E. 22nd St., Dept. 28, New York



Let
Hartman
Feather
Your Nest

FREE Bargain Catalog!

Absolutely Free—this great 368-page book of amazing bargains in home furnishings, farm machinery, etc.—all on easy monthly terms and 30 days FREE TRIAL. Send postcard!

HARTMAN FURNITURE and CARPET CO., Dept. 5875, Chicago

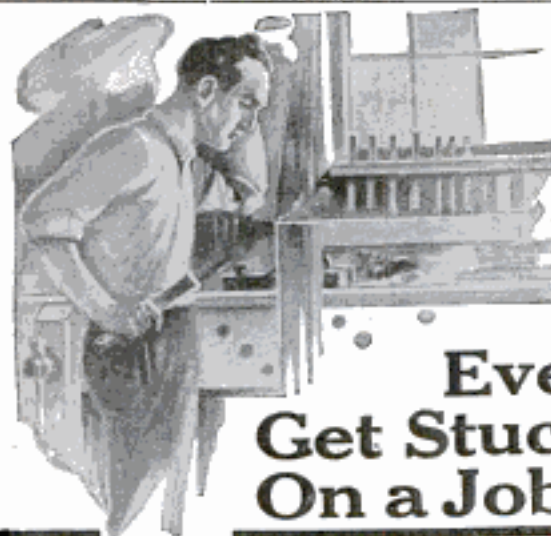

**Ever
Get Stuck
On a Job?**

SHOP NOTES FOR 1923

The latest volume of Popular Mechanics series of year books tells

544 Easy Ways to Do Hard Things

of daily use to every mechanic. Among the many useful articles are Shop Crane—Testing Motors—Power Hammer—Arbor Press—Air Compressor—Turret Lathe—Bench Punch—Concrete Mixer—Bench Grinder—Drag Saw—Concrete Tile.

224 Pages—436 Illustrations

Price 50 Cents, Postpaid

SHOP NOTES SET—comprising 14 of the volumes previously issued and including the latest or 1923 number—\$7.50 Prepaid.

Popular Mechanics Book Dept.
200 E. Ontario St. CHICAGO

**A Home and Income
For You in Sunny Florida**



**Be Independent—Own a Grapefruit and
Orange Grove—A Truck or Poultry
Farm. Increase Your Income**

**You Can Start a Grove Today Under
Our New Plan**

Develop a profit-earning fruit farm without leaving your present position—provide for your future. A small payment now and a few dollars invested each month.

A profit-producing fruit grove is a permanent investment and provides protection against old age.

**THE RIGHT LAND
IN THE RIGHT LOCATION AT
THE RIGHT PRICE**

We Have It—Any Size Farm

These splendid lands are suburban to Tampa, the metropolis of South Florida. Here you find the most healthful, the most delightful climate in North America. For ten years we have been right here helping develop Hillsboro—the banner agricultural County of Florida, and we are still here to serve you and to help you obtain the farm you want, on very easy payments extending over 2 or 3 years' time to suit.

Groves Developed for Non-Residents

If you want to remain in your present position for a few years we can develop a grapefruit and orange grove for you. When you are ready we will clear your land, furnish fruit trees, plant and care for your grove until you are ready to look after it.

**We Raise Our Own Guaranteed Citrus
Trees in Our Own Nurseries**

This insures every purchaser the best fruit trees that can be grown. This also insures a successful grove. We can save you money on planting and caring for your grove.

-\$300.00 to \$500.00 Per Acre Profit

This is not an unusual return for truck farmers in the Famous Tampa district. All kinds of vegetables can be grown. Big prices are paid for early potatoes. Winter cabbage, Bermuda onions, tomatoes, celery and dozens of other vegetables during the Winter and early Spring, when the north is covered with ice and snow. Strawberries, Melons and other small fruits, also yield large profits.

Write for Facts About Sunny Florida

IT COSTS YOU NOTHING TO LET US PROVE TO YOU that we have the land you want—in the location you want—at a price you can afford to pay and on the easiest terms you can imagine. Let us show you.

Fill out and mail us the coupon today and receive our large descriptive book FREE!

NORTH TAMPA LAND CO.

404 Zack Street

TAMPA, FLA.

Coupon for FREE Book on Florida

NORTH TAMPA LAND CO.

404 Zack St., TAMPA, FLA.

Please send me your large illustrated Book, "The Call of the Southland," on choice Citrus Fruit and Truck Farms suburban to Tampa, Florida, and information on how I can have a grove developed on the monthly payment plan. P.M. 12-23.

Name.....

St. No.....

City.....

State.....

Please Mention Popular Mechanics

FROST-RADIO

Ask Your Neighbor



No. 611 50c

Our new adapter
for UV-199 tubes

A genuine moulded bakelite adapter that converts standard base socket into one for C-299 or UV-199 tube. Highly polished. Phosphor bronze contacts and springs, nickel plated and buffed. See it at your dealers.

HERBERT H. FROST, Inc.
154 West Lake Street, CHICAGO, ILLINOIS
30 Church St., New York 10th and Grand, Kansas City, Mo.

SHINN AMPLITONE ANTENNA

No Receiving Set Is Better Than Its Antenna

Makes the little set work well and the big set work better. Amplitone Antenna gives 10 to 25% longer range to your set. It enables you to get distant states you never got before. Is equal to one stage of Radio or Audio Frequency in increasing strength of signals. Nothing to equal it for indoor antenna, in attic, in living room, etc. Tested and endorsed by leading radio men. 75 feet Amplitone antenna packed complete, ready to erect, with two antenna clips mailed on receipt of \$3.00. Cut out one stage of amplification and save the difference.

An Appropriate Xmas Gift

W. C. Shinn Mfg. Co., 14 East Jackson Boulevard, Chicago
Established in 1890

SHINN AMPLITONE ANTENNA

National Audio Frequency Transformers

The New 6 to 1 Ratio National Transformer is for use on the first stage of amplification. Its greater ratio means increased volume, but the tone qualities that characterize the 3½ to 1 ratio have been fully retained. Price of 6 to 1 ratio \$4.50 postpaid; of the 3½ to 1 ratio, \$4.00 postpaid. Dealers: Write for interesting sales proposition.

National Transformer Mfg. Co.
154 Whiting Street
Dept. 1210 Chicago, Ill.



World Radio
and
Auto Batteries
**SAVE YOU
50%**
WRITTEN 2 YR. GUARANTEE

World prices are possible because it costs the World Battery Company only one-half as much to sell World batteries. That is the reason we can spend just as much to build our batteries as any other big company. That is the reason we can stand behind every battery we put out with a written 2-year guarantee. You take no risk when you buy a World battery—service is certain.

COMPARE THESE PRICES

AUTO PRICES	RADIO PRICES
6 Volt, 11 Plate . . . \$12.25 Ford, Chev., Mitchell, Dup., Grant, Elgin, Voile, Saxon.	Special 2-Volt Storage Battery \$5.00 For W. D. 11 and W. D. 12 tubes. Will run 200 hours on one charge. Rechargeable.
6 Volt, 13 Plate . . . \$14.00 Overland, Buick, Rec., Paige, In- son, Nash, Stude., Dori.	Special 4-Volt Storage Battery \$8.00 For U. V. 199 tubes. Same features as 2-volt.
12 Volt, 7 Plate . . . \$17.00 Maxwell, Dodge, Regal, Frank., Scri- pps and Cross-Knight. Give your and model of car.	6-volt, 60 amp., . . . \$ 8.50 6-volt, 80 amp., . . . 10.00 6-volt, 100 amp., . . . 12.50 6-volt, 150 amp., . . . 14.50 6-volt, 180 amp., . . . 16.00

Send No Money We ship C.O.D. subject to inspection, or will allow 10% discount for cash with order. Shipment made same day order is received. Save 50% on your next battery and get better service and longer life. Written 2-yr. guarantee is your proof of satisfaction. Order NOW!

WORLD BATTERY CO., Dept. 6, 1219 S. Wabash Av., Chicago, Ill.



Howard Micrometer Adjustment Rheostats

Instant adjustment. Made from special heat resisting materials; operates with single knob; positive smooth contact. Micrometer adjustment.

Rheostats, 6½" — 25 or 40 Ohm, Plain, \$1.10; Micrometer, \$1.50
Power Rheostats, \$1.50
Potentiometers, 200 Ohm, \$1.50; 400 Ohm, \$2.00

Ask your dealer or write us. Complete catalog of Howard radio parts and book-let free on receipt of 2c for postage. Jobbers write for discounts.

HOWARD RADIO COMPANY 4244 N. Western Avenue
CHICAGO

SIGNAL Radio Cabinets

Made in 29 different stock sizes. Rich Mahogany finish, special sizes and shapes to order. Write for illustrated folder, also particulars of our Radio Table.
SIGNAL ELEC. MFG. CO. 1919 Broadway
Menominee, Mich.

Swing 4 in.; 11 in. between centers, 17 in. total length. Shipping weight 13 lbs. Bed of lathe is machined. Workmanship first-class. Equipped with wood turning chuck. Can be fitted with 3 in. face plate and drill chuck as special equipment. Order one today.



Price \$6.00 cash with order
Made also in larger sizes.

SYMPHER MFG. CO.
Dept. D TOLEDO, OHIO

Send for DEALERS Catalog

**HARRY ALTER'S
"POCKETBOOK"**
is a monthly net price catalog of Radio, Electrical and Lighting supplies. All good dealers should have a copy—get on our mailing list now. No obligation. Use your letterhead.



HARRY ALTER & CO.
WE SELL WHOLESALE ONLY
OGDEN BOUL. at CARROLL AV. CHICAGO

AGENTS Some Seller
At \$2⁰⁰
Looks Like \$5.00 Worth
Gives You \$1.10 Profit!



\$12 AN HOUR!

W. H. Marion, a beginner made 36 sales in three hours, first day, \$36 profit! How? Our representatives introduce our products with a first sale of beautiful combination sets of Toilet Articles, Soaps, etc. You sell at half store prices—no fancy talk—sell on sight. Make 20 to 30 sales a day with \$1.10 profit on each. Easy to average \$100 a week. Could you ask more while introducing line, establishing a permanent business for yourself? Another plan calls for no deliveries, no investment, no delays. You bank immediate profits. Also a plan with winning premium to each sale. Write quick for full details.

FORD FREE! No contest. Every producer gets a Ford Car absolutely free. Most amazing offer ever made. Don't waste a minute. Write TODAY for illustrated circulars explaining our Unique Plans including 30 other packages. ACT NOW.

E. M. DAVIS CO. Dept. 5612 Chicago

FREE 1000 Illustrations **ELECTRIC FIXTURE CATALOG!**

Write today for your copy. Save 50% direct from Manufacturer. No Middleman's Profit. OUR SPECIAL: 8 Room Electric Set, ready to hang, \$24.50—Other bargains.

UNITED LIGHTING FIXTURE CO.
280 Bowery Dept. 120 New York

Remington No. 10
Self-Starting \$38⁶⁵
30 Day Trial

Think of it—the most popular typewriter ever made—all late improvements—guaranteed 5 years—and you save at least \$60.

Biggest Value Ever Offered

—that's the comment we receive from thousands who have purchased from us. Guaranteed to have the same action, appearance and durability of a new machine.

Send Today—a postal will do—for details of our remarkable offer—or send \$38.65 NOW with the understanding that your money will be promptly refunded if you're not MORE than satisfied.

LINCOLN TYPEWRITER COMPANY
Dept. 135 298 Broadway, N. Y.

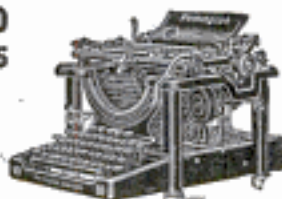

SPORT BODIES for FORD and CHEV. 490 at \$34.50 UP

Life-size paper patterns—You can build your own body at small cost.

We are manufacturers and our quantity production enables us to quote exceptional low prices. Our unique shipping methods save you 73% in FREIGHT CHARGES. Send at once for free particulars on Central Bodies. Our Book: "HOW TO BUILD A FORD RACER" sent anywhere on receipt of 25c in cash or stamps. WRITE TODAY!

Central Auto Supply Co. Dept. 120. Louisville, Ky.



UNDER SLUNG PARTS
Per Set \$6.75

Play This JAZZY SAX

**Without Practice
—No Lessons
Sweet Jazzy Tone**

Not a toy
—but a
REAL
musical
instrument

Weights over 3 lbs.
Beautiful, clear, ringing tones and delightful harmony.
No need to spend \$85 when you can own a Jazzy Sax.

**Supply Limited
Order Today**

Send NO MONEY

Just fill out the coupon below. When the Sax and 30 free songs arrive, pay the postman only \$5.98 plus a few pennies postage. Play Jazz right away. You don't risk a penny. *Satisfaction guaranteed or money refunded.* The supply is limited—so don't delay. **Mail the coupon today.**

Jazzy Sax Will Delight You, Too —

as it has thousands of others. "This is easy. I played tunes after fifteen minutes and am delighted."—V. D. Beatty, Chicago, Ill. "I find your Jazzy Sax is very easy to play."—Clara Lemke, Appleton, Wis. "A friend of mine got a Jazzy Sax and I just think it is a great instrument so I am writing to get one myself."—Wm. Ellis, Tiltonville, Ohio. You, too, will be amazed at the ease with which you can play it, at the wonderful jazzy harmony, at the unlimited opportunities for fun afforded you. Remember—you don't risk a penny. Satisfaction guaranteed or money back.

Send This Coupon Today

FERRY & CO., 75 W. Van Buren St., Dept. 1772, Chicago, Ill.

Please send me at once your Jazzy Sax and song book. On arrival I will deposit \$5.98 plus postage with the postman. If I am not satisfied I will return the instrument and you will refund my money.

Name.....

Address.....

City..... State.....



Any one can play this imported Jazzy Sax right away. No knowledge of music required, no lessons. Play by numbers instead of notes. Or play by music or ear if you wish. All directions and 30 songs free! Be popular at parties, dances, picnics, entertainments. Glistening polished brass all over, except nickel mouthpiece. Looks just like regular saxophone, the same size.

An Ideal Xmas Gift



FREE

140-page Book full of life-size ruled forms, each one completely filled in. The answer to problem of accounting and record keeping for any business or professional man.

Send for this Book today

John C. Moore Corporation
(Established 1839)
2103 Stone St., Rochester, N. Y.

MOORE'S LOOSE LEAF SYSTEMS
In Use In More Than
300,000 Offices

Not an Accessory, but
a Real Necessity for
Your Ford Car



The
Acme No-Draft Mat

Every Ford driver knows 'he discomfort that comes from the cold drafts of winter—the hot air of summer, the dust and gases that are constantly coming thru the pedal slots.

The Acme No-Draft Mat is the first device that absolutely prevents this discomfort. It has no equal. Made of best molded rubber—lined with sheep's wool—fits snugly around the pedals and brake lever. Attached by anyone in 10 minutes.

If your dealer can't supply you, send us your order direct.

\$1.75 Complete
P. P. Prepaid

Acme Sales Co. Dept. B. 1017 Euclid Avenue
CLEVELAND, OHIO

"HOMES OF DISTINCTION"



A BEAUTIFUL book of 68 pages, showing homes in Spanish, Italian, English, Swiss, and Modern style, in original colors, with floor plans and complete descriptions, costs, etc. Blue prints and specifications furnished for any design.

Price ONE DOLLAR postpaid
SCROGGS & EWING
Architects
610-P Lamar Bldg., Augusta, Georgia

FIERY DAZZLING CLUSTER PIN

9 Stones

LOOK PROSPEROUS! Surprise your friends, a real "look out," wear one of these wonder cluster stick pins of 14-kt. gold filled set with 9 genuine RADEX stones—Has all the sparkling and fiery brilliancy of genuine diamonds. Will deceive the most expert eye. FREE Safety Catch included. **SEND NO MONEY!**—When Pin arrives Pay Postman only \$2.00, pay the balance of \$1.00 a month for 4 months. Complete satisfaction guaranteed.

H. STILWIN CO., 263 Fifth Ave., New York

FREE-SAFETY CATCH

RADIO SET FREE!

Underslung
Fixtures

SPORT BODIES \$29.00 UP



Racing
Gears, Wheel Discs,
Hi-Speed Camshafts

4, 8 and 16 Overhead Valve
Heads, Sport Fenders for
Underslung and Standard
Fords.

With an order on a Ford Speed Body or other merchandise amounting to \$100, we will give Free a \$25.00 Standard DX Radio Set, regenerative type under Armstrong's U. S. Patent, solid mahogany case, vernier dial controls. This offer is only good for a limited time. Send in your order with \$25.00 deposit and radio set will be forwarded immediately, balance of \$75.00 on delivery of other merchandise. If you are not ready for body now, place your order for future delivery. Enjoy your winter evenings by bringing to your home operatic artists; best orchestras playing classical and dance music; direct sporting and business news; and when spring comes, you will already have a good start on your classy Ford speed car. Oh Boy! what a happy combination. Write immediately for body catalog and special Radio Offer. Radio sets for sale at \$25.
N. K. FORD SPEED & POWER EQUIP. MFRS., 250 W. 54th St., New York, 2nd Floor

18
INCHES
HIGH



\$2⁹⁵

Beautiful Electric Reading Lamp

Free Lamp Dolly
SEND NO MONEY

Order No. 325
Order today, when lamp arrives pay Postman our bargain price, \$2.95 plus postage.

Here is the prettiest, daintiest table lamp you ever saw. Has beautiful **Polychrome** gold and rich colored base, and highly artistic **Parchment** shade decorated in assorted handsome designs and colors. Complete with socket, plug and 7 ft. cord. Here is your opportunity to get a rich lamp that will **beautify your home** at only a small part of its regular price. **Don't Pass By This Bargain.** This lamp makes a fine gift. All who see it are delighted. **You Risk Nothing.** If you are not more than pleased your money will be promptly returned.

Send today.

EMPIRE LAMP CO.
20 E. Lake St., Dept. 190, Chicago



FOR
SIMPLIFIED
PIPE-
THREADING

OSTER

BULL-DOG DIE-STOCKS

cut leak-proof threads quickly and easily. There's no "unwinding" at the end of each cut. The dies open up and the tool lifts off.

Ask your supply house about the four other big Oster features which make pipe-threading easier—or write us for Bull Dog folder.

THE OSTER MFG. CO.

2100 E. 61st Place, Cleveland, Ohio

Our BUREAU OF INFORMATION will answer all questions regarding articles appearing in this magazine. Address Bureau of Information, Popular Mechanics Magazine, Chicago



"Push-Pull" Amplifying Transformers

for those who demand more than has heretofore been secured from audio frequency amplification. Supplied in sets of two.

Modern 10 to 1

has carved its own way to fame by performance in reflex circuits. Also preferred by many as the first stage of standard audio frequency amplifiers.

Modern 4 to 1

meets with a welcome wherever it goes. The many repeat orders attest to its all around efficiency. Write today for illustrated circulars and bulletins.

The Modern Electric Mfg. Co.
Dept. 612, Toledo, Ohio



RADIO FANS

Here's what you have been looking for—

A non-inductive potentiometer that will vary vacuum tube plate and grid potentials smoothly, accurately, and noiselessly without choking back the high frequency radio currents—enabling you to get stations that are now beyond the range of your set.

Contact with the pure graphite resistor is made by a brass disc which can be brought to bear upon the resistor at any point desired. This patented pressure contact prevents wear on the graphite strip, and eliminates all noises.

If your dealer cannot supply you, write for one today, enclosing money order, or ask for descriptive pamphlet.

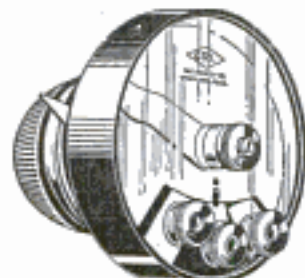

No. 110 (400 ohms) \$1.75
No. 111 (2000 ohms) 2.00
(Plus 10c for postage)

CENTRAL RADIO LABORATORIES
309 16th Street MILWAUKEE, WIS.

POTENTIOMETERS
— Non-Inductive —

\$348⁰⁰ MADE IN 28 DAYS



That's what L. J. Lenhart of Kansas City did with a Burch Popcorn Machine. Now he makes more. He says, "This popcorn business is a revelation to me. In the first 28 days profit from the Burch amounted to \$348.00, and patronage is steadily increasing."

Start at Once No Training Needed

If you can count money you can make a big success with a Burch from the very first day. It opens a marvelous opportunity for big, quick profits in a business that requires no experience and is wonderfully simple, pleasant and easy. Popcorn demand enormous. You take in money hand-over-fist. Locate anywhere. Specially good for owners moving picture shows. A year 'round business everywhere.

85% Profit On Every Dollar

Expenses are small, profits enormous. \$10 to \$50 a day on each machine. You can get good locations and operate several. Big successes made by many young men; over 50 profitable Burch operators in one city of 300,000 people. Big business men buying machines and having others run them. Guy Shriner writes, "The machine you sold me a year ago was the cause of my awakening to the money making possibilities in pop corn, and therefore the cause of my investment of \$14,000 for the pop corn concession in Kansas City's new Million Dollar Park, Fairyland."

BOY OR GIRL CAN OPERATE

So simple a child can run it. Light gas, press button and the Burch is busy making you regular income. Nothing to regulate. Nothing to get out of order. **Free Book** tells

FREE BOOK



how to make more money than you ever dreamed possible. Explains how to start in business, how to go about securing the Burch, the cheapest and best pop corn machine on the market, on easy payments right out of your profits. Tells why the Burch makes "the best pop corn you ever tasted," and how it pops faster and makes you money faster than any other. Write for it today, NOW.

BURCH SALES CO., 919 Baltimore Ave., KANSAS CITY, MO.

Send No Money for this General Utility Motor

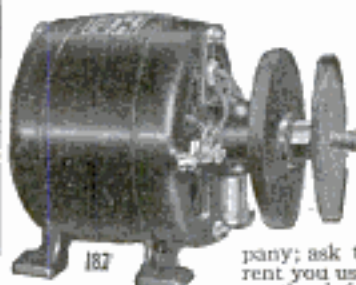

Completely equipped with Cord, Plug, Pulley, Grinding Wheel and Buffing Wheel. Can be used for cleaning and polishing silver, sharpening knives, operating sewing, washing or other household machines. Simply call up your electric light com-

pany; ask them what kind of current you use and its voltage. Send us the information, and we will ship you the proper motor.

Completely Equipped \$17.95

The price is only \$17.95 for 1/6 H. P., 32 and 110 Volt D. C. or 110 Volt A. C., 50 or 60 Cycle Motor.

SATISFACTION GUARANTEED
OR MONEY REFUNDED

PETER BROS. MFG. CO., Algonquin, Ill.

Morrison

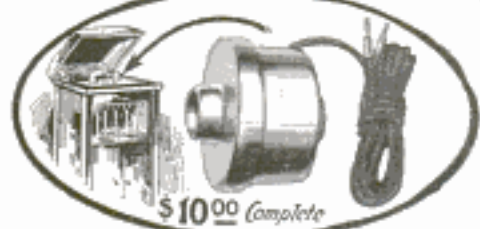

Loud Speaker

IF YOU ARE CRITICAL

Ask the man who is proud of his receiving set—who boasts of the wonderful reproduction from long distance stations—ask him what Loud Speaker he uses and he will say "Morrison." Today people want to hear their opera and their dance orchestra in clear, full tones entirely free of harsh noises.

Attach Morrison Loud Speaker to the tone arm of your **PHONOGRAPH** or use it with your **HORN**

and you will be proud to entertain your friends with a real radio concert. Tones adjusted soft or loud by a turn of a little dial—no other adjustment necessary.

Sold under an absolute money-back guarantee.

Order from your dealer or send direct to factory.

Complete with 5 foot cord

Nickel Plated Model

\$10.00

Gold Plated Model

\$15.00

Illustrated Catalog will be sent free on request.

Dealers Morrison Loud Speaker is Radio's most popular merchandising unit. We have a plan to help you sell that many of the best dealers in the country are finding quite profitable. Wire us today.

MORRISON LABORATORIES, INC.
337 Jefferson Ave., East DETROIT, MICH.

Manufacturer With National Distribution Wants More Local Representatives

The man we want is now employed, but finds it difficult to make both ends meet. He feels certain that there must be some way whereby he can better his condition. He may not be a salesman but he can talk convincingly on something he firmly believes in. He may not have much money but he is not broke.

The man we are looking for is mechanically inclined and willing to devote his spare time as a local manufacturer and representative for us—work that can be done at home which will pay a splendid profit and surely develop into a business which will justify giving it all his time.

The **OZARKA PLAN** will give such a man more money, more independence and a real opportunity to build up a permanent, profitable business of his own. It is fully described in a large illustrated book—a **FREE** copy is yours for the asking.

Unlike any book you ever read, the **OZARKA PLAN** is a true story of life, of men, of why they fail and how they succeed. It is founded on the principle that the world owes every man a good living, a home of his own and a surplus for a rainy day. This book proves the reason why some men are millionaires and why others, by the sweat of their brow, made them so.

In territory not now covered the right man is wanted—the **OZARKA PLAN** may be the turning point in your life, so in writing for the **OZARKA PLAN** book, tell us about yourself fully and give name of your county.

OZARKA INC.,

551 Washington Blvd. Chicago, Illinois

SWEATERS SAVE 20%-30%



Any Style or Design for Men, Women, Boys, Schools, Clubs, Teams

Order direct from mill. Save from 20% -30%. Pick any style, any color, size or design from our regular stock or special to order. Finest virgin wool and pure worsted only. Custom tailored workmanship of highest grade. Closely knit. Warm, soft, snug. Real beauties you will be proud to wear.

FINEST QUALITY AT BARGAIN PRICES



FREE Always holds shape. Most customers get from 3 to 5 years wear easily. Can endure severe wear and retain bright, fresh appearance. Biggest values in history. Workmanship guaranteed. Prices slashed. Unusual chance to save. Special offers to schools, clubs, teams. Write for free illustrated catalog.

AMERICAN KNITTING MILLS 1538 Clybourn Avenue Dept. 26 CHICAGO



\$4.00

High Grade **\$4.00**
Head Set

Radio Cabinets
Phonograph
Cabinets and Parts

LAKESIDE SUPPLY CO.
73 W. Van Buren St. Chicago, Ill.

Vacuum Tubes Repaired

SAVE AT LEAST 1/2 THE COST OF NEW
UV200 and UV201.....\$2.75 each
UV201-A, WD-11 and WD-12..... 3.50 each

GUARANTEED EQUAL TO NEW
Opportunity for boys to make big money by collecting tubes in quantities.

All tubes received and returned parcel post, C. O. D.
HARVARD RADIO LABORATORIES
200 & 204 Old Colony Ave., So. Boston, Mass.

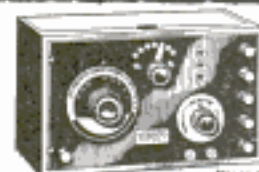

MIRACO
GETS 'EM FROM COAST TO COAST

Price Over **\$18.50**

At rock-bottom prices you get the efficiency of sets costing three times as much. Users tell us that Miraco Radio frequency receivers pick up stations from coast to coast. Operate either on dry cells or storage battery. Solid mahogany cabinets—finest workmanship throughout. Order direct or send for bulletin.

One tube outfit, \$18.50 Two tube outfit, \$29.50
Four tube outfit, \$54.50

Dealers-Agents—Write for proposition quickly—it's a winner.

THE MIDWEST RADIO COMPANY
807 Main Street Cincinnati, Ohio

BIG MONEY in Poultry

Send for this **FREE BOOK!** Amazing profits by applying Prof. Quisenberry's Methods. "Fellers and Sows in the Poultry Business"—96 pages of secrets—How to Get Winter Eggs, Save Feed, Cull Layers, Raise More Chicks, Make More Profit.

200 Eggs Per Hen!

Mrs. Wildt made \$2,000.00 with hens in twelve months. All simple and easy. The book is **FREE**. Write at once. If you enclose 25c we will send you 25 colored leg bands to mark your best layers. Mention breed of hens.

American Poultry School
Dept. 181 Kansas City, Mo.



FREE BOOK

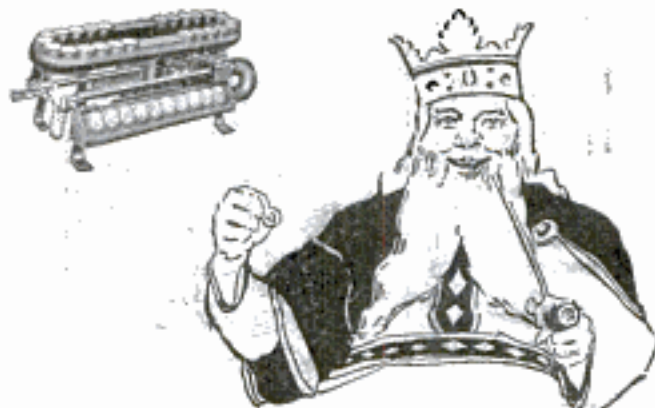

The Heir to King Coal

Oil solves the heating problem

Oil is heir! Oil is not only the present bone of contentment but it is the means of content to many a home where coal has become impossible to get, either on account of lack of supply or due to the high prices. Now King Oil is at your service for heating your house or cooking your meals!

This Wonderful Invention

converts any cook stove or heater into a real gas stove. Oxo-Gas made from kerosene and air is cheaper, cleaner and more efficient than coal. Send for catalog illustrating Oxo-Gas appliances for all purposes where coal is used. We have openings for General Sales Managers and distributors. Only those who can finance themselves considered.

GLORIA LIGHT COMPANY

135 North May Street

Chicago, Illinois

OXO-GAS

Cultivate Your musical Bump



**Ted
Lewis
Jazzical Clown
Plays a CONN**

Insist on a Conn and you'll learn to play quickly. For half a century Conn instruments of every kind for band and orchestra have been used and endorsed by the world's greatest artists because they are

- easier to play
- perfect in tone and tune
- most reliable in action
- perfectly balanced, beautifully finished.

More Conn saxophones are sold than any other make in the world. The great jazz kings and popular record makers prefer Conns for their exclusive features. Free Trial; Easy Payments. Write for details, mentioning instrument.

Conn drums of highest quality.

C. G. CONN, Ltd.
1231 Conn Bldg., Elkhart, Ind.

CONN

WORLD'S
LARGEST MANUFACTURERS
OF HIGH GRADE BAND AND
ORCHESTRA INSTRUMENTS



"I WAS AMAZED by the wonderful FARMING OPPORTUNITIES in Canada" —

Said the Editor of a Famous Farm Paper



**\$20.00
Per Acre
Average
Price**

"On my recent tour through Canada via the Canadian National Railways, with frequent stopovers and motor trips into the country, I was absolutely amazed by the farming opportunities I saw.

"Not only world-record grain production in quality and in bushels per acre, but prize-winning beef and dairy cattle, draft horses, sheep and poultry, huge potato crops, vegetables of all

kinds, as large and perfect as I have ever seen. "I was surprised, too, at the towns and cities, schools, agricultural schools, universities, grain elevators, stock yards, the many thousands of miles of railroads with frequent branch lines and many shipping points, the many good dirt and gravel roads."

WHY DON'T YOU TAKE ADVANTAGE OF THIS PROSPERITY OPPORTUNITY?

There are still good farms and millions of acres of fertile land to be had at very reasonable prices and terms. Others have gone to Canada on just such farm lands and with the same opportunities you'll find. They have prospered and gone ahead. Any man who investigates as this famous Editor did is equally strong in praising Canada's farm opportunities. It's not too late for you to share in the prosperity to come. Canada's 1923 wheat crop broke all previous records. One-fifth of the world's wheat supply is produced by just a few thousand Canadian Farmers!

GET FREE BOOK TODAY
Our FREE illustrated book tells what others have gained by going to Canada. Send the book. You'll be convinced there is a better chance for you. Send your name and address for the book now — today — before it is too late. Let us help you — our advice is free and without obligation.

EASY PAYMENTS

Low Prices—Low Taxes—Increasing Values
You can buy land unsurpassed for fertility along the lines of the Canadian National Railways for an average of \$20 an acre. Our booklet shows the yield per acre. Easy terms place it within reach of all. You make only a first small payment, usually 10% or less—the balance being spread over a term of years with low interest rates and small land tax. No tax at all on buildings, improvements, animals, machinery or personal property.

Special Excursion Rates

Reduced railway fares are in effect for landseekers and their effects to encourage inspection along the lines of the Canadian National Railways. Personally conducted excursions will also be arranged.

DeWITT FOSTER

Supt. of Resources, Canadian National Railways, Dept. 439, Marquette Bldg., Chicago, Ill.

DeWitt Foster,
Supt. of Resources, Canadian National Railways, Dept. 439, Marquette Bldg., Chicago, Ill.

Dear Sir:—Please send me your free illustrated book on Canada.

Name

Address

R. F. D. Town

State

CANADIAN NATIONAL RAILWAYS

Free latest BOOK on HEALTH and BEAUTY

VIOLET RAYS



Only \$1.00 DELIVERS now **to Your Home**

ONLY \$1.00 brings this complete, scientific Violet Rays outfit to you. Treat yourself and family at home, save delay, costly doctors and medicines. Thousands use Violet Rays at home to relieve pain and sickness. The identical outfits doctors have bought from us for years and with which they successfully treat many ailments.



QUICK RESULTS—No Medicine

Violet Rays work quickly, it's scientific, goes after the cause. That's why results are quick, permanent. Dr. Duncan, Kewanee, Ill., writes, "Violet Rays is the finest thing I ever used to relieve pain, treatments are so pleasant all my patients like it." Use it yourself at home, you save Doctor's bills.

BEAUTY AID

Brings natural, magnetic beauty of health, no dieting, exercise or drugs. FREE book tells in detail how high priced beauty specialists use it to improve scalp and skin.

EARN CASH

Men, women, without experience earn liberal profits in spare time showing Violet Rays to neighbors. Proves results first demonstration. Sells on sight. Get attractive offer and wholesale prices now.

SEND FOR FREE BOOK

Explains how Nikola Tesla discovered Violet Rays, how it works, why it heals. Tells what doctors and plain folks accomplish in conquering pain, disease and nervous trouble with Violet Rays.

Reveals Marvelous Scientific Discovery

Shows charts of human body, explains where pains start, how to banish them. Offered FREE for a limited time only, to introduce Violet Rays. Send for FREE copy.

Mail Coupon—Send No Money

VI-REX ELECTRIC COMPANY
326 West Madison St., Dept. 222, Chicago

Please send me without cost or obligation your free book describing your VI-REX Violet Ray outfit, and details of your \$1.00 offer.

Name _____

Address _____

City _____ State _____

NO.1 NO.2
\$2.63 \$3.25

NO.3 NO.4
\$5.90 \$4.98

WEAR SEVEN FREE DAYS

OUR MARVELOUS MEXICAN DIAMONDS

Have delighted thousands of customers for 18 years. They positively match genuine diamonds. Same perfect cut, same dazzling play of rainbow fire. Stand intense acid test of side by side comparison with genuine. Nubbed experts positively need their experience to detect any difference whatever. Perhaps the gems you admire on your closest friends are MEXICAN DIAMONDS and you never knew it. Test a MEXICAN DIAMOND FREE; you risk nothing. Wear it seven days side by side with a genuine diamond. If you see any difference, send it back; it won't cost you a cent.

HALF PRICE TO INTRODUCE

To introduce to new customers, we quote these prices which are all you pay and just half our catalog prices.

No. 1—Ladies 1 ct. Solitaire, fine 14k gold \$2.63
No. 2—Gents Heavy Touch Solider, 1 ct. gem, 14k gold \$3.25
No. 3—Ladies 3 Stone Duchesse Ring, fine platinum finish, two 1/8 ct. first water Mex. diamonds, one blue sapphire. 4.98
No. 4—Gents Ex. Heavy Gypsy ring, platinum finish, black inlay on sides; 1 3/8 ct. first water Mex. Diamond. 4.98

SEND NO MONEY Just send name, address and slip of paper that inserts around ring finger to show size. Say which ring you want. We ship promptly. On arrival, deposit price with postman. If you decide not to keep it, return in 7 days and we'll refund your money. Write TODAY. Agents wanted.

MEXICAN DIAMOND IMPORTING CO.
Dept. E1 LAS CRUCES, N. MEX.
Exclusive Controllers of Mexican Diamonds for 18 years.

If Every Boy

who Loves to Fish
and Camp, or is
fond of the Water,
will write to the

Izaak Walton League

537 Lake Shore Drive
CHICAGO

He will receive something
which cannot fail to interest
him. A postal card will do.

\$3 with the coupon

Brings This Typewriter



Try Before You Buy

5 Year Guarantee

10 DAYS TRIAL

**EASY TERMS
BIG SAVINGS**

ROYAL
STANDARD

**DIRECT FROM OUR
FACTORY TO YOU**

Think of it! Your opportunity to secure this late model Royal No. 10 for only \$3.00 down on the easiest terms ever offered. Simply send us the coupon and \$3.00 and we will ship this typewriter subject to your approval. You then pay only \$5.00 per month until our low direct from factory price, \$53.00, has been paid when the machine becomes your property. Why pay rent when you can buy on such easy terms, have the use of the machine while you pay—besides you save more than half. We give you the same guarantee as if you paid the original factory price, \$102.50. Our cash price is \$47.70.

Ten Days' Free Trial

Send us your order today. We will ship one of these wonderful machines on ten days' free trial without obligation to buy unless you are satisfied in every way that this is the greatest typewriter bargain ever offered. The Royal features the beautiful writing quality—Compare it with any other machine—and you will know why hundreds of thousands have been sold. You do not buy until you have tried it. Let us prove what we say, and if you are not thoroughly satisfied you may return it at our expense. We are positive you cannot equal this wonderful typewriter value anywhere.

Young Typewriter Co.

Dept. 210C, 654 W. Randolph St.
CHICAGO, ILL.

Every machine is completely RE-MANUFACTURED BY THE FAMOUS YOUNG PROCESS and fully guaranteed like new. All worn parts are replaced wherever a new part will make it a better machine. Completely re-enameled, re-nickelled—a perfect writing machine. You cannot tell it from a brand new Royal in appearance, service or workmanship. This beautiful typewriter comes to you with all the latest improvements such as two color ribbon, automatic ribbon reverse, backspacer, card writing attachment and forced alignment. Touch can be regulated by simple attachment, to suit you. Most complete visible writing, etc.

Send the Coupon Today

You will perhaps never have as great a typewriter opportunity. There are only a limited number of these typewriters at our low factory price so rush your order. Simply send us \$3 with the coupon and we will ship to you at once for full 10 days' free trial, or write us for our big free catalog of typewriter bargains all standard makes

Order Coupon

YOUNG TYPEWRITER CO.

654 W. Randolph

Dept. 210C Chicago

I am enclosing \$3.00. Ship me the Royal typewriter, F. O. B. Chicago, as described in this advertisement. Check here if you wish big free catalogue sent without obligation—now at once. On 10 days' trial. If I decide to keep it, I will pay you promptly \$5.00 monthly as rental for 10 months and the machine is mine. The title is to remain with you until all payments are made.

If I choose not to keep it, I will carefully re-pack it and return it at your expense.

Name.....

Street Address..... City.....

State..... Occupation.....

UNLIKE ALL OTHERS!

ONE TO SIX PUMP-STROKES COMPRESSES AIR TO ANY SHOOTING-FORCE DESIRED

Three Strokes for
Ordinary Shooting

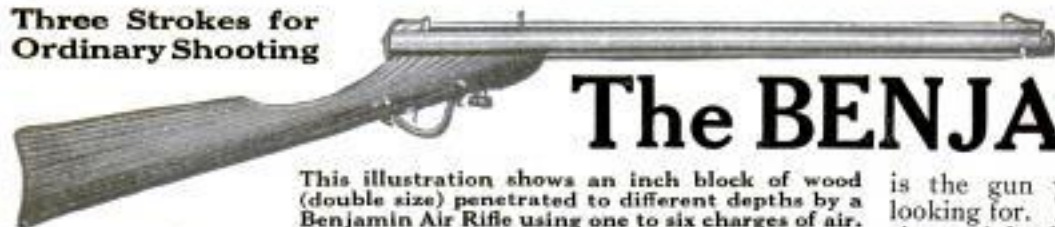

The BENJAMIN

This illustration shows an inch block of wood (double size) penetrated to different depths by a Benjamin Air Rifle using one to six charges of air.

This is a Feat No Other Air Rifle Can Duplicate

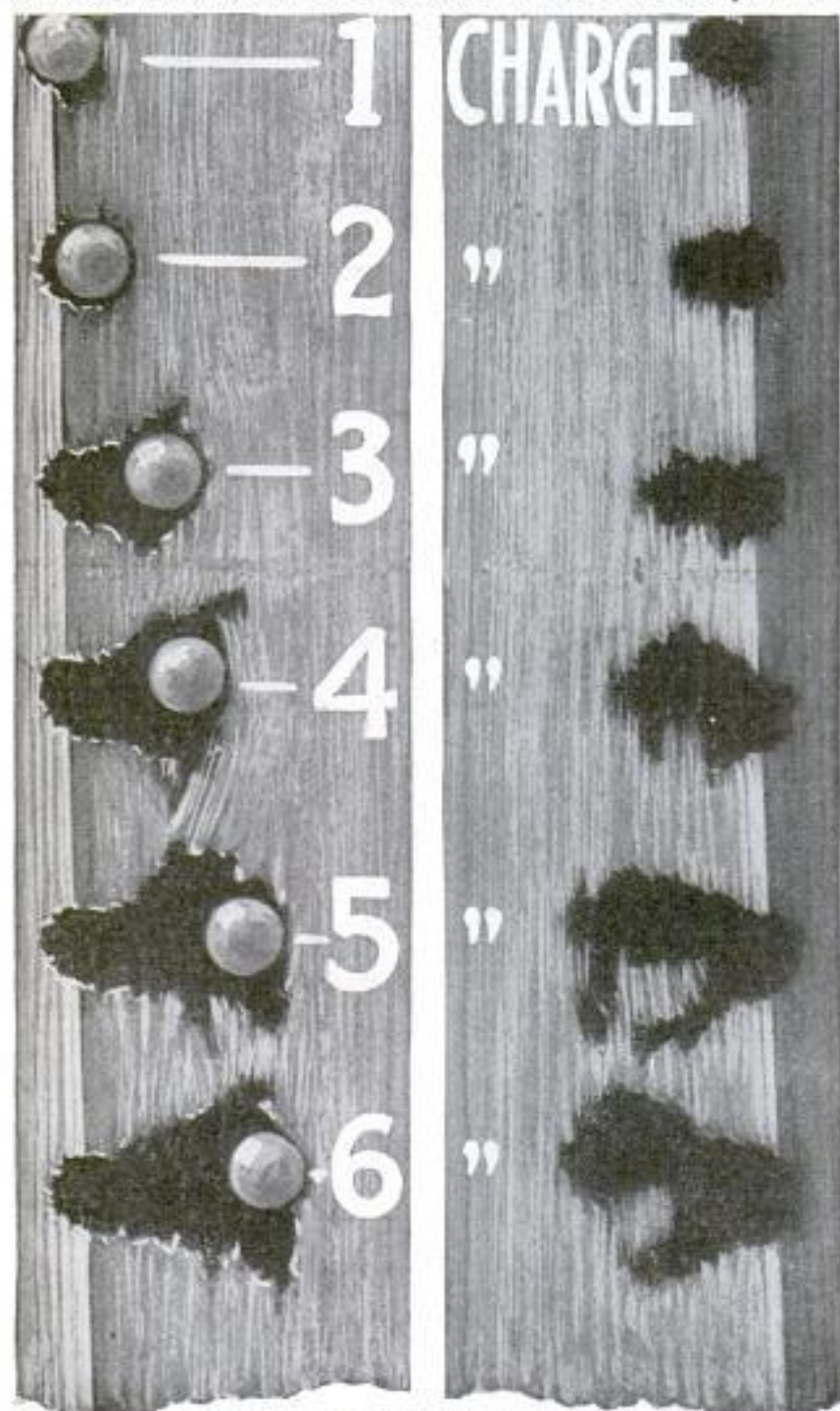

is the gun you have been looking for. For target practice and for hunting rabbits, squirrels, gophers, rats and frogs it has no equal. It is the most powerful, accurate and reliable compressed air rifle made. It has a far greater shooting range than any other. Imagine bringing down rabbits with an air rifle! You can do it with a Benjamin.

The BENJAMIN

is the ONLY PUMP GUN MADE using compressed air. SIMILAR TO AIR DRILLS AND HAMMERS. It does not lose shooting force after long use. The BENJAMIN is the only air rifle with the shooting force under the operator's control. It can be loaded to shoot weak or powerful as desired, from one to six strokes of the pump giving all the power wanted. It is absolutely safe; accidental discharge is impossible. Furthermore, after being charged with air, it is ready for instant use at any time after the shot is placed in the barrel.

The BENJAMIN

is mechanically perfect. It is the only air rifle not requiring frequent repairs, customary in all spring guns.

Price **\$5⁰⁰** Post-Paid

Write for descriptive folder giving full details of this wonderful air rifle.

BENJAMIN

AIR RIFLE & MFG. CO.

651 N. Broadway,
ST. LOUIS, MO., U. S. A.

Pacific Coast Representative
THAYER & BOWER
Los Angeles, Cal. & San Francisco, Cal.

Salesmen Make \$100^A DAY

With New Fuel!

Amazing Invention Does Away With Dirty Coal and Wood!



Think of the appeal you can make to every man and woman using coal! No more fires to build, bank or watch—no more worries about coal shortages, poor quality or high prices since this wonderful New invention. No wonder Oliver Salesmen pile up such amazing records. Bentley's \$215 profit in a single day, Ames's \$279.65 in one day, Slade's \$13,500 are only indications of what may be expected.

At last, the device that American Householders have wanted for years has been perfected—a real efficient Oil-Burner for stoves and furnaces at a low price. Oliver salesmen are riding in on the tremendous sweep of sales and profits. \$1,000 a month is not an uncommon thing. No wonder—think of what this wonderful device means to every person now operating a coal stove or furnace!

Cheap, Clean, Odorless

They do away forever with coal—ashes—dirt—dust—soot—smoke—building fires—cleaning furnaces—carrying ashes—uneven heat—cold rooms—frozen pipes and plumbers' bills—coal shortages—poor quality and exorbitant prices. Banished!

2 Times the Heat of Coal

These extraordinary comforts

and conveniences are only possible through the wonderful discovery by Mr. Oliver of a way to combine 95% air with 5% oil, the cheapest fuel there is. This forms a gas that burns with an intense, clean flame and gives 2 times the heat of coal.

58 Regional Managers To Get Established National Business

A national Distributing Organization has been made necessary by the enormous growth of Oliver sales. Millions of dollars of established business will be transferred to 58 Regional Managers. In the next few months every home in America will be reached by advertising telling the story of Oliver Furnace and Stove Burners. Selling Organizations or Big Caliber men looking for a position that will net from \$10,000 up to \$150,000 a year should write or wire immediately to Mr. Oliver personally (address below) for full details of this plan.

mission offer and tell you how you can get an exclusive territory. You must act quickly! Mail the coupon at once. Do not delay a single day. Live salesmen recognize this unequalled opportunity for big profits. Territories are being snatched up. Act quick. Mail coupon immediately.

Exclusive Territory Offer

You might as well be cashing in on the nation-wide sale of this invention. You might as well become an authorized Oliver agent, and have a steady money-making line as long as you live. This is one chance of a lifetime. You owe yourself this opportunity. The coupon below will tell you of the amazing features of the Oliver Burner. It will bring Mr. Oliver's liberal com-



Slips right into any furnace without change. 2 times the heat of coal. No motors, gas or electricity.

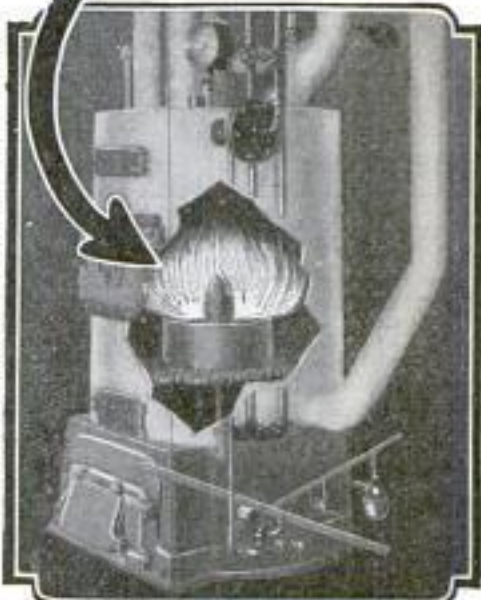

OLIVER OIL-GAS BURNER

OLIVER OIL-GAS BURNER CO.

2014-W Oliver Bldg., St. Louis, Mo.

Canadian Distributor: 2014-W Oliver Bldg., Toronto, Ont.



The Oliver burner makes any range, a gas stove—on and off at turn of valve—roast, or little heat as desired.

16 types, to fit any heater or cook stove

OLIVER OIL-GAS BURNER CO.

2014-W Oliver Bldg., St. Louis, Mo.

Send me immediately complete details of your offer to prospective Oliver representatives including your free book, "New Kind of Heat," and full details of Exclusive Territory Franchise Offer. I am interested in proposition checked below.

Name.....

Address.....

City..... State.....

Spare Time Work Full Time Work Regional Distributor

The Proper Finish Will Make Your Furniture Harmonize



Small odd pieces of modern furniture add greatly to the attractiveness of every home. You, yourself, can easily make them for your family. There is no particular trick to constructing porch swings, tables, telephone sets, etc.

The furniture, woodwork and floors of your home can be made to harmonize if a little taste is used in finishing them. You can easily refinish dingy, shabby, scratched wood. Our method involves practically no expense. All you need is a little time—a brush—and **JOHNSON'S WOOD DYE.**

Johnson's Wood Dye is very easy to apply—it goes on easily and quickly, without a lap or a streak. It penetrates deeply, bringing out the beauty of the grain without raising it—dries in 4 hours and does not rub off or smudge.



Johnson's Wood Dye

FREE-This Book on Home Beautifying

This Book tells how to finish wood in artistic stained and enameled effects. Gives practical suggestions on making your home artistic, cheery and inviting. Tells just what materials to use and how to apply them. Includes color card—gives covering capacities, etc. Use coupon below.



S. C. JOHNSON & SON, P. A. 12

RACINE, WIS. (Canadian Factory—Brantford)

Please send me free and postpaid your Instruction Book on Home Beautifying and Wood Finishing.

The best dealer in paints here is.....

MY NAME.....

MY ADDRESS.....

CITY & STATE.....

JOHNSON'S WOOD DYE has many uses, for both the artisan and amateur. *Architects and contractors* specify it for coloring woodwork and flooring in new buildings. *Painters and decorators* use it with equal satisfaction on new and old woodwork of all kinds. *Housewives* delight in it for doing over old furniture and for coloring reed and wicker baskets, etc.

JOHNSON'S WOOD DYE is made in fourteen standard shades—a few of which are:

129 Dark Mahogany	126 Light Oak
127 Brown Mahogany	123 Dark Oak
140 Early English	110 Bog Oak
131 Walnut	124 Golden Oak
	125 Mission Oak

All shades may be easily lightened, darkened or intermixed. Full directions on every label.

If you are building or remodeling you should have our book on Wood Finishing. It is chock full of valuable information. Tells just what materials to use and how to apply them. We will gladly send it free and postpaid. Use coupon at left.



The individualized Corona

a wonderful idea
in Christmas gifts

Use this list to select your Christmas Corona

If the vocation of the person to whom you will give Corona is not listed here, mail the coupon below.

Classification Keyboard Recommended

Advertising Men	XC-A
Architects	XC-Special
Authors	Standard Portable No. 20
Bankers	" "
Business Men	" "
Chemists	XC-Chemical
Children	No. 20
Doctors	Medical No. 19
Druggists	" "
Engineers	XC-Engineering
Farmers	No. 20
Housewives	" "
Insurance Men	" "
Lawyers	" "
Linguists	XC-Polyglot or any one of 50 languages
Ministers	No. 20
Playwrights	" "
Realtors	" "
Retailers	XC-A
Salesmen	XC-A or Special
Secretaries	No. 20
Scenario Writers	" "
Stenographers	XC-A
Students	No. 20 or Special
Teachers	No. 20 or XC-Polyglot

Note: All "XC" keyboards have 92 characters, with "dead keys" where required.

CLIP HERE

Corona Typewriter Co., Inc.,
108 Main St., Groton, N. Y.

Please tell me where I can see Corona.
I am interested in purchasing one for
the following kind of work:

.....

Name

Address

THE gift of a Corona will mean more this year than ever before. You can now select a Corona Keyboard which exactly suits the vocation of the one who is to receive it.

There is scarcely anyone who does not need a Corona nowadays. In business, in school, in the home, Corona is fast replacing the pen.

It's a satisfying gift to give, or to receive—wonderfully durable, light, compact, yet big in the work it does.

Corona has a 10-inch carriage, a two-color, automatically reversing ribbon, back spacer, margin release, platen release, paper release, self-spacing carriage return—everything you would expect in a heavy machine—yet it costs only half as much. Place your order today for one or more Coronas for Christmas. Your dealer will deliver the machines, specially packed in beautiful Christmas cartons, on whatever date you specify. If your phone book doesn't list "Corona," mail the coupon for the address of the nearest store.

CORONA TYPEWRITER CO., INC.
108 MAIN ST., GROTON, N. Y.

Corona is light and compact, yet it has the toughness and endurance of seasoned hickory. Its record for proved durability goes back over 17 years of continual service.

\$50 Ninety-Character
Models \$5 extra

