

NOVEMBER

25 CENTS

POPULAR MECHANICS

MAGAZINE

WITH WHICH IS INCORPORATED THE ILLUSTRATED WORLD

WRITTEN SO YOU CAN UNDERSTAND IT

REG'D. TRADE MARK. GREAT BRITAIN. No. 410426

REG. U. S. PAT. OFF.

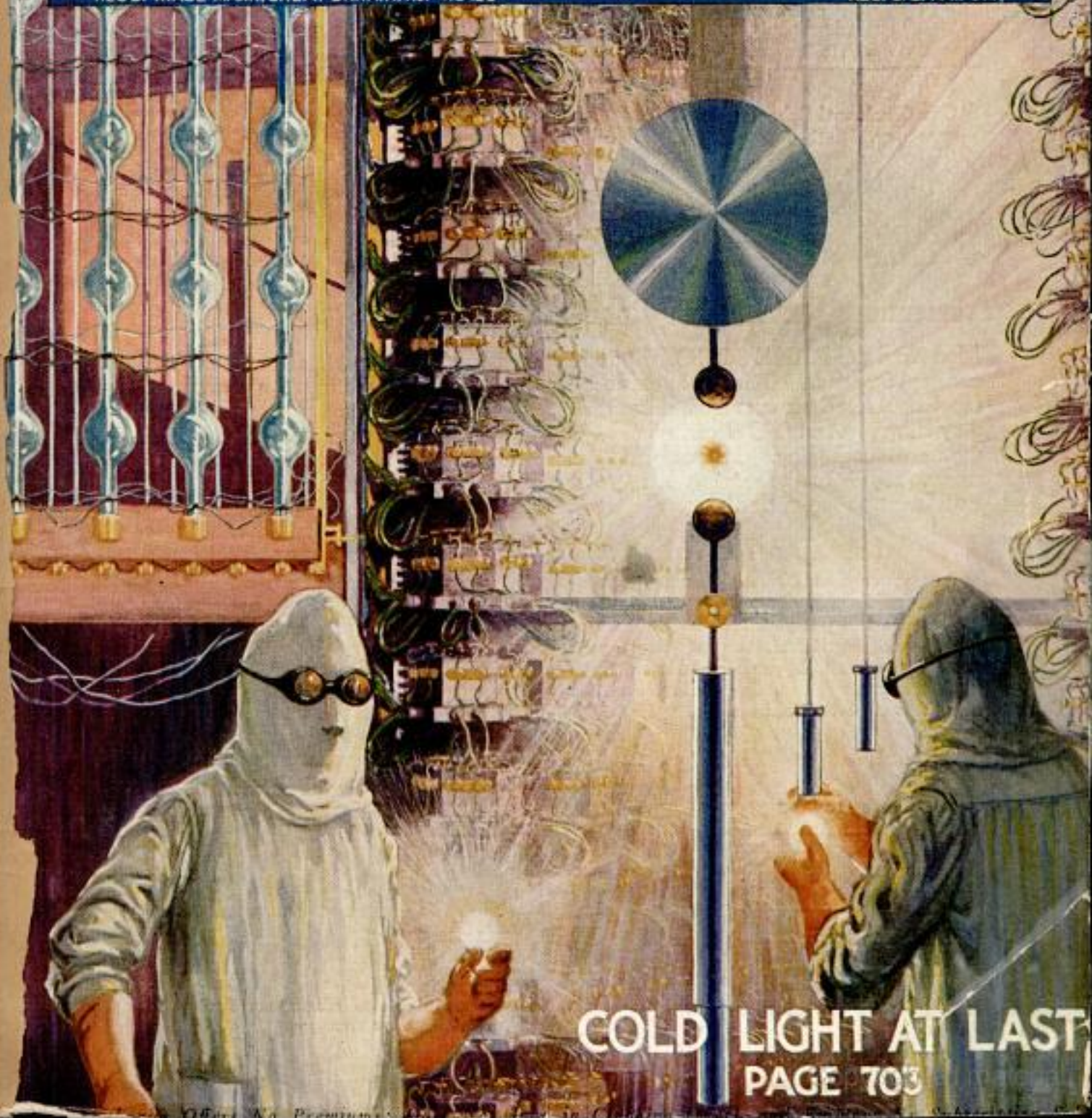

COLD LIGHT AT LAST
PAGE 703

Takes Only 50 Days to Get a Big Job

Automobile Tractor & Electrical Catalog **FREE**

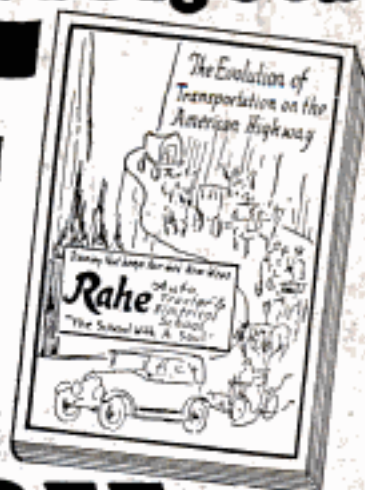

THESE MEN HAVE MADE GOOD

"My garage and Ford Agency is a big success. I owe it to Rahe training."—G. Smith, W. Alexandria, O.

"I got a fine job the day after I left school."—W. C. Wyatt, Mt. Sterling, Ky.

"I thank Rahe Training for a great job in the best garage in Lima."—Howard Metzger, Lima, Ohio

"Rahe Training was the best investment I ever made."—Colby Lord, Oakland, Maine

FREE ELECTRICAL COURSE

Our Cincinnati School



**We'll Pay
Your Railroad
Fare and
Board You**

Our Chicago School



Tremendous Demand For Rahe-Trained Men

Men from the RAHE SCHOOL are in constant demand. Millions of autos need repairs. RAHE experts have more than they can do. And YOU can succeed as they are succeeding. **No experience necessary—you learn with your hands—not from books.**

DECIDE NOW!

Make up your mind TODAY to make your future secure. Earn Big Pay. Fill out the coupon NOW. It will put your feet on the road to steady work at REAL wages. Here's your chance. Let us tell you all about what the RAHE course will mean in your life. Send the coupon to our school nearest you.

Think of a complete course in electricity FREE in connection with your automotive course! You can turn this knowledge into big money immediately. Don't hesitate; every day you wait is a day lost. Resolve today to make a success of yourself.

YOUR FUTURE

Your future is up to you. Will you remain chained to your job at a miserable wage, or will you be a high-salaried expert, owning your own auto and tractor garage and repair station? The world demands that you KNOW SOMETHING; the world has no place for the idler; the four-flusher.

Rahe-Trained Men Make Good.

Practical job training on "Live" motors under expert instructors in a Practical Auto, Tractor and Electrical School.

Desk 890

Send me your wonderful FREE CATALOG.

Name _____

Address _____

City or R. R. _____

(Rahe Schools have no facilities for colored students)

Rahe Auto Tractor & Electrical School

9th and Walnut
CINCINNATI, O.

4445 Grand Blvd.
CHICAGO, ILL.

Get this wonderful catalog and plant your feet on the road to sure success

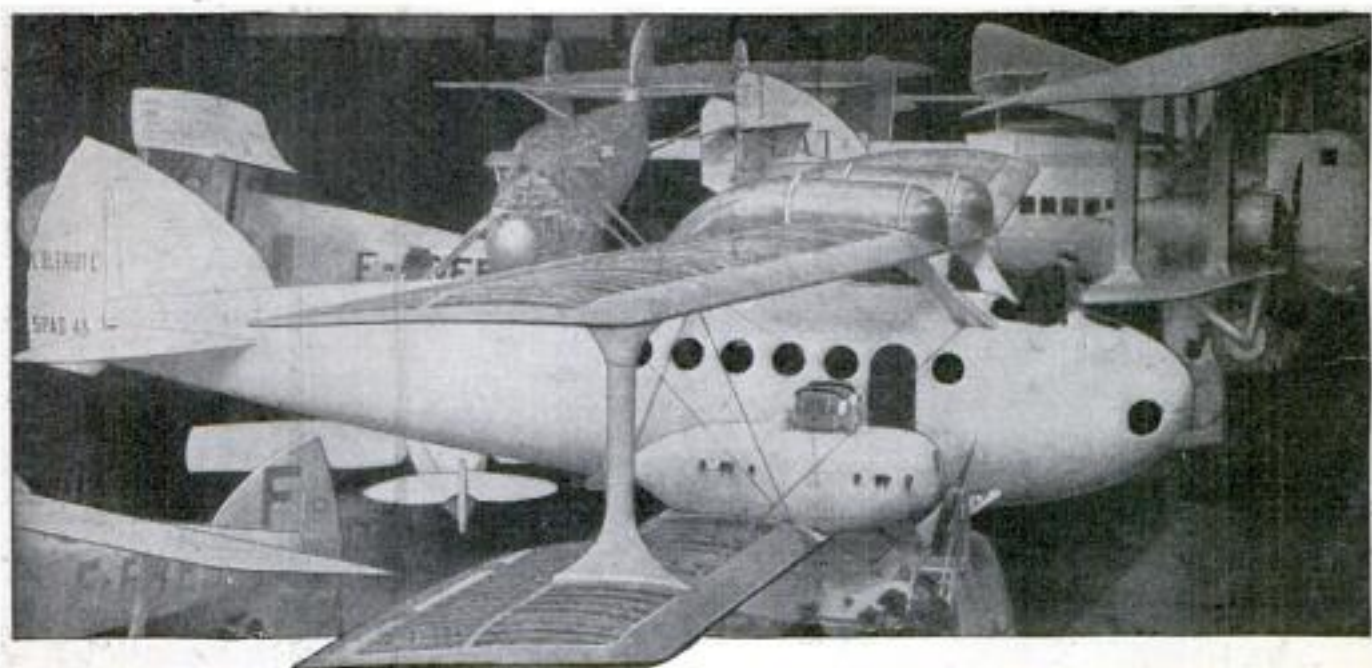

Quick Success in Aviation Fascinating—Daring—Big Paying

To young men of daring, no other field of work offers such a fascination, such high pay, nor such opportunities for quick success as the field of Aviation. As yet, aviation is practically in its infancy. NOW is the time to get in.

Amazing Opportunities in Airplane Industries

In the automobile industry and in the moving picture business hundreds of men got rich by getting in at the start. They made their success before others woke up. Today, these lines offer no greater opportunities than a hundred and one others. BUT AVIATION IS NEW. Get in while the opportunity and pay are big. All over the country there is a clamor for trained men. It is not a question of pay, but of getting capable men.

Here are Real Positions —\$50 to \$150 Per Week

Aeronautical Instructor, Aeronautical Engineer, Aeronautical Contractor, Airplane Repairman, Airplane Mechanician, Airplane Inspector, Airplane Salesman, Airplane Assembler, Airplane Builder.



View in an Airplane Factory

A Sure and Easy Way to Learn Aviation—at Home



A New Job—The Aerial Postman

The study of aviation is almost as fascinating as the actual work. Every lesson is full of interest. That is why it is easy to learn aviation. You do not have to make yourself study—it is like reading an in-

teresting book that tells you things you have always wanted to know. Only one hour each evening will give you the basic training in a surprisingly short time. You need only a common school education.

One of my students, James Powers, Pa., says, "I am indeed surprised that such a valuable Course can be had from such practical men for so little cost."



A New Seven-Passenger Airplane

Personal Instruction by Experienced Men

Men who have had actual experience give you personal attention. They select the lessons, lectures, blueprints and bulletins. They tell you things that are essential in everyday practice. Each lesson is easy to read and understand.

BIG BOOK FREE of Opportunities

Send coupon below for New Book, just out, "Opportunities in the Airplane Industry." It is interesting and instructive. It will show you many things you never knew before about aviation. Due to shortage of paper we could get only a limited supply of these books—send the coupon before they are all gone.

AMERICAN SCHOOL OF AVIATION
3601 Michigan Ave., Dept. 1198 Chicago, Ill.

AMERICAN SCHOOL OF AVIATION
3601 Michigan Ave., Dept. 1198, Chicago, Ill.

Without any obligation, send me your Free Book, "Opportunities in the Airplane Industry," also information about your Course in Practical Aeronautics.

Name.....

Street.....

City..... State.....

"CYPRESS lumber defies decay. You save repair bills."

CYPRESS

"THE WOOD ETERNAL"

Use Cypress; For What? Why?

FOR house, barn and garage construction,—i. e., roof, siding and all exterior trim, because it is the "wood eternal." It takes paint as kindly and holds to it more tenaciously than almost any other wood, and far better than most woods.

FOR the interior trim of a house or bungalow, including doors, because of the striking beauty of its grain. Its surface excels all other woods in producing effects with simple oils or stains, and it is the only wood on earth that will take the famous "Sugi" finish, in exact simulation of the much coveted Antique Japanese Driftwood.

FOR the interior trim of house or bungalow because its tendency to shrink, swell or warp is so slight. It "stays put" to beat all other woods, and cannot be too strongly endorsed for kitchen finish, and all furnishings thereof.

FOR door and window casing, and window sash, because it is so admirably adapted by nature to those trying places. No twisting or springing to break the glass. Great for "outside" doors—does not "come and go" with every change of weather.

FOR porches, and the floors of them, for porch steps, porch and lawn furniture, trellises, arbors and pergolas, because it is the one antiseptic wood; germs of decay can not find lodgment in imperishable Cypress, because of its impregnation with natural preservative elements, imperceptible but potent.

FOR the small or large conservatory, because it is the one recognized standard wood for greenhouse construction. Ninety per cent of all the greenhouses built by professionals are made of Cypress. Because they know. (Now you do.)

FOR all kinds of creamery construction, because Cypress is free from odor, taste or color as a container, and for the floor of the creamery nothing equals Cypress.

FOR fence posts, because they do not "rot off before they get well set in the ground." Nor for generations thereafter. No other wood approaches Cypress for endurance when set in the soil.

FOR the garden fence, because it lasts, and lasts, and lasts, and further, because Cypress fence boards are not full of peek-a-boo knot holes. And it takes paint. And "holds it, but lasts a long time without it." (U. S. Govt. Report.)

FOR floors in stable, garage, cellar or poultry house, because it is not affected by moisture, nor does it fill the ambient air with the "expensive smell" of rotting wood.

FOR water tanks, troughs, vats, laundry appliances and laundry furniture, because Cypress excels even metals for long life when exposed to alternate wet and dry influences, etc., etc. (Cypress is "some wood.")

When planning new improvements or repairs to old ones, just remember—"With Cypress you build but once"

Southern Cypress Manufacturers' Assn.

1219 Poydras Bldg., NEW ORLEANS, LA., or 1219 Graham Bldg., JACKSONVILLE, FLA.

INSIST ON TRADE-MARKED "TIDE-WATER" CYPRESS AT YOUR LOCAL LUMBER DEALER'S. IF HE HASN'T IT, LET US KNOW.



Papier mache Replaces Ice
in Fresh Fig Shipments 686

Popular Mechanics Magazine

200 E. Ontario Street, Chicago, U. S. A.

H. H. WINDSOR, Editor

London: Hachette & Co.,
16-17 King William Street, Charing Cross, W. C. 2

Paris: Hachette & Co.,
111 Rue Reaumur

Melbourne, Australia
The Australasian News Co.

ISSUED MONTHLY

SUBSCRIPTION:

SINGLE COPY, 25 CENTS

In United States and its possessions, also Canada, Cuba, and Mexico, per year, postpaid - \$3.00

To all other countries in the Postal Union - 3.50

All subscriptions are discontinued at expiration. Please examine the date printed on your wrapper.

Entered as Second Class Matter Sept. 15, 1908, at the Post Office at Chicago, Illinois, under Act of March 3rd, 1879.

Entered as Second Class Matter at the Post Office Department, Canada.

Published monthly by POPULAR MECHANICS CO.

Copyright, 1923, by H. H. Windsor. Copyright in Australia

Vol. 40

Contents for November, 1923

No. 5

Acetylene Jet Machine Cuts Intricate Shapes.....	778	Drier, Clothes, Folding, Heated by Gas or Fan....	756
Air, Brake Tank, Engine Crews in Tunnels to Get	757	Earthquakes—Their Causes and Results.....	681
Air Cushion in Disk Wheels Makes Riding Smoother	735	Elevator Truck, Air Space Made to Pay Rent with.	763
Air Mail, Night, with the United States.....	664	Engines, War, of Future to Be Electric.....	767
"Airplane" Scenes for Movies "Shot" from High		Ferris Wheels Popular in Nile Valley.....	759
Ladder.....	693	Firemen, Shield of Water Guards, from Flames....	708
Airplane Service Links Arctic to Outer World....	753	Fish Cleaner Prevents Scales from Flying.....	764
Airplanes with Radio Guide Fishing Boats to Prey	799	Fish Food, Bugs Drawn to Bright Lights Become..	735
Anchor for Bolts in Stone Gets Strength from Pull	753	Flasks, Heat Imprisoned in, Is Released at Touch.	689
Animals on Edenlike Isles Do Not Fear Man.....	747	Flint Knife, Surgeon of Prehistoric Age Worked	
Armless Persons, Grip for, Turns Pages of Books..	667	with.....	745
Arsenic Mines, Pests in Cotton Fields Boost....	693	Fog Bells, Lighthouse, Controlled by Weather....	775
Asiatic Paths, Further Adventures in, by Sven		Furnaces, Electric Steel, of Exceptional Efficiency	
Hedin.....	729	Installed in Italian Factory.....	776
Automobile Bumpers, Head-on Collisions Try		Gas Bombs, Deadly, Sought for Airplane Attacks..	736
Strength of.....	694	Girls Face Death in "Looping the Loop" Stunt....	775
Automobile Covers Made of Dust-Proof Paper.....	684	Glass, Unbreakable, Resists Heat and Acids.....	678
Automobile with Armored Turret Transports Bank		Gold Buried in Sunken Ship, Recovering.....	763
Funds.....	727	Golf Course, Model, in Office Building.....	693
Bamboo Made into Phonograph Needles.....	659	Golf on Ship's Deck Played with Spiked Clubs....	689
Birds, Flightless, Inhabit Antarctic Seas.....	748	Guns, Anti-Aircraft, Fired by Electricity.....	756
Blocks, Cinder, for Building, Pressed on Site of		Hacksaw with Pistol Grip Fits Many Blades.....	687
Work.....	688	Hogs Receive Shower Baths on Way to Market... 743	
Blowtorches on Turntable Solder Buttons.....	678	House, Garage with Sliding Doors Is Part of....	725
Boats, Round Motor, Bug Ball Played with.....	684	Hunting Million Year Old Game.....	739
Boiler, Steam, New, Carries Enormous Pressure..	778	Insect Actors, Mysteries of "Invisible" World	
Bookshop, Printing Art Turns World into Mighty.	724	Portrayed on Movie Screen by.....	713
Brick-Laying Machine Invented in England.....	747	Jelly Strainer, Holder for, Fits Rim of Drip Pan..	753
Bridge, Arch Added to, as Traffic Continues....	745	Jungle, Calico Money and Bicycle Help to Subdue.	688
Bridge, Bamboo, Spans River in Japan.....	764	Lake Miracle Waters Found in India.....	702
Brush, Wire Wheel, Cleans Like Sandpaper.....	766	Lamp of Ancient Asia, Stone, Found in Alaska....	742
Bullets, Homemade, Recall Frontier Days.....	752	Lamp, Photographers' Flash, Avoids Use of Loose	
Bus, Motor, Sight Seeing, Has Folding Top.....	769	Powder.....	769
Camera with Two Lenses Gives Depth to Motion		Lathes, Cone Headstock, Motor Drive.....	777
Pictures.....	736	Laws, Enacted, Thirteen Thousand, in Year....	770
Camping Outfit, Complete for Autoists.....	766	Leather, Eight Days to Tan, with Vacuum Process	687
Cannibals Hold to Ancient "Law".....	769	Leather Painted on Walls Used in Place of Paper..	757
Car Boarded While in Motion Aids Traffic.....	758	Light, Heatless, to Chain Almost Limitless Flow of	
Cattails Yield Food Products.....	701	Power.....	704
Chair, Folding, Cannot Tip.....	675	Lighter, Cigar, on Desk Heats from Hidden Battery	773
Chinese Language Set on Type Machines.....	762	Lights, Shade on, Guards Eyes.....	678
Church Steeple, Truck with Winch Pulls Down... 690		Lock to Secure Key in Door Is Burglar Proof....	724
Cigarette Case for Autoists.....	727	Ma Chang, Chinese Game, Popular in United States	673
Clock Stops Waste of Gas, Prevents Explosions... 773		Machine, Electric, First, for Stamping Seal of State	769
Code, Messages Recorded in, Explained by Type-		Mail Box, War Mine Is Now, on Pacific Liner... 775	
writer.....	701	Mail Boxes for Air Mail Put on Berlin Streets... 773	
Coin Press Makes Five Dimes a Second.....	659	Metals, Germs Killing, Found.....	701
Coins, Tragedies and Romances of World History		Mines, Old Gold, Reopened, to Supply German Need	753
Revealed by.....	716	Mirrors Coated with Gold.....	725
Columbus, Christopher, Body of, Moved to Final		Mistletoe Pest in South, Festive Twig Elsewhere..	676
Resting Place.....	768	Molasses, Low-Grade, Yields Fuel and Potash....	777
Commutator V-Slots, Motor Driven Tool Cuts... 777		Mortar, Ox Team and Stone Wheel Mix, for Hindu	679
Coolies Stand as They Row Ancient Craft.....	735	Mosquito War, Dynamite in, Clears Breeding Spot	694
Copper, Mountain of, Spans Ocean in Deep Sea		Mountains, Height of, Figured from Boiling Water.	671
Cable.....	670	Mushroom Garden in Abandoned Mine.....	747
Cork, Wood Substitute for, Found in South America	743	Nails, Lever Drives, into Spring Jaws.....	685
Cornstalk, Fossil Similar to, Mystifies Scientists.. 687		Needles, Phonograph, Thorns of Cactus Used for..	685
Cotton, Spain Finds Imported, Cheaper than		Newspaper Ads Reach Hut of Mongol Worker....	736
Domestic.....	762	Nut That Locks on Bolt Cannot Loosen Grip....	689
Criminal Minds, "Soul Searcher" Gets Truth from		Ocean, Ceaseless Vigil of Coast Guards to Keep,	
701		Free of Hidden Perils.....	681
Crop, Nation's, How Estimates Are Gathered and		Oil Spreader to Help Ships in Storm.....	701
Sent Out, by Robert H. Moulton.....	760	Oil Tanker, Ocean Keeps Tragic Secret of.....	770
Cutter, Weed, Saves Time and Labor for Railroad.. 775		Ore Stamped by Hand in Africa.....	771
Death Dealing Juggernaut's Toll Increasing.....	765	Paper to Clean Eyeglasses, Leather Folder for... 690	
Desk Cover, Flat Top, Rolls Out of Sight.....	770		

[Continued on Page 4]

This one



ZXYL-UZ2-987W

[Contents—Continued]

Pets, Fish as, Trained to Follow Owner About.....	675
Pie Crust Sealer Keeps Filler in While Baking.....	667
Pigeons, United States Training, to Fly at Night... 754	754
Pilgrims, "Juggernauts" Wheels Again Moved by..	697
Pipe, Machine Carves Bowl of, in One Operation..	763
Piston King Has Unusual Flexibility.....	776
Plant Disease, Fight Against, Increases Crop Harvests.....	675
Plant Diseases, Specialists Discover More.....	743
Plants, Increasing Growth of, by Aid of Electric Lights.....	763
Poles of Elastic Concrete Bend without Breaking... 685	685
Popular Mechanics Records of Twenty Years Ago..	669
Portraits; Woods Colored by Scorching "Paint" Mosaic.....	702
Possums, Newly Born Baby, Climb to Parent's Pouch.....	771
Poultry Feed, Fowls Reach, Through Slots in Package.....	702
"Pullman" of Highway Has Home Comforts.....	698
Rack, Dish Holding, in Pan Saves Time.....	757
Radio Phones in Hotel Halls.....	688
Radio Tones, Mica Clears, of Metallic Sound.....	773
Railroad Train Requires Single Track.....	749
Railways, Millions Spent by, to Meet Growing Needs 691	691
Rain Machine for Gardens.....	756
Raincoats, Grass Fiber, Worn by Mexicans.....	675
Rats Hitched to String Pull Wires Through Conduit 764	764
Roaster with a Glass Cover.....	670
Rotary Ore Mill, Gold Washed from Rocks by.....	754
Safeguarding Workers in Factories.....	760
Saw Attached to Tractor Saves Time and Labor.....	759
Saw, Meat, Electric, Regulated by Trigger.....	770
Saxophone Tone Rivalled by Sarrusophone.....	670
Sealer, Envelope, Has Water in Handle.....	736
Seaplanes at Anchor Get Fuel Through Air Pump.. 785	785
Seaweed Made into Food.....	725
Ship Lights, "Rules of the Road" Govern.....	745
Ships' Hulls Painted White to Keep Barnacles Away 773	773
Shoes Worn by Five Generations Still Good.....	725
Shredder, Food, Straight Teeth on.....	659
Signal Tower, Mirror in, "Sees" Around Curve... 697	697
Sirup, Extracting, from Sweet Potatoes.....	754
Snakes, Collecting for Zoo Is Thriving Business... 679	679
Snap Gauge and Micrometer, Tool Combines.....	776
Snowfalls, Rare, in Jerusalem Bring Threats of Floods.....	747
Sponges, Wet, Tied to Face, a Protection Against Dust.....	676
Stars, "Shooting," Shower of, Gather in Comet's Path.....	679
Statue, Indian, Cast in Concrete, Tree's Trunk Harbors.....	703
Statue, Solid Ivory, Rare.....	671
Steel, Old, Lives Again in Huge Skyscrapers.....	709
Streets, One Way for Chicago.....	678
Stump Pulling, Huge Machine Makes Play of.....	758
Submarine's Hull, Water in, Traps Men at Sea... 789	789
Sun's Eclipse, Motion Pictures Show.....	694
Tank in Anthill Keeps Water Cool.....	771
Tattooing, South Sea Islands Puts Taboo on.....	660
Teeth, Treatment of, Taught in Room of Hundred Chairs.....	688
Temple, World to View Wonders of Ancient.....	726
Toaster, Cone Shaped Knobs Spread Heat under.. 753	753
Tobacco, a King's Wrath, Whipping, and Death Failed to Halt Spread of.....	726
Tractors Tow Canal Barges and Fell Trees.....	687
Trap, Rat, Wound by Key Kills with Hammer.....	678
Treasure Mountain, Ghostly Legend Guards Peak of 667	667
Trees, Food, Crop of Future Predicted.....	670
"Tub," River Is, for Women of Madrid.....	674
Tuna, Fishhook Hung from Kite to Catch Giant.. 676	676
Vaporizer, Electric Bulb in, Gets Liquid Through Wick.....	669
Vases Made of War Shells Show Workers' Skill.. 768	768
Vise, Attachment Holds Round Stock in.....	778
Warships Go to Junk Yard.....	742
Washing Machine, Small, Has Folding Wringer.. 679	679
Water Spout, Giant, Shoots Up to Clouds.....	676
Weather, Bottle of Mystery Mixture Forecasts... 752	752
Weather, Rainy, Cedar Logs Floating in Lake Forecast.....	749
Wires, Insulators for Heavy, Screwed in Place by Hand.....	698
Wonders of World, Ancient, One Left of Seven... 660	660
Words, Chinese, Japan Bars from Schoolbooks... 685	685
Wrench, Thumb, Pressure on, Gives Grip to Jaws.. 749	749

SHOP NOTES

Accelerator, Automatic, for Sawing Outfit.....	794
Aluminum, Satin Finish.....	790
Aluminum, Working.....	788
Automobile Engine, Lifting Bar for.....	781
Babbitt Bearings, Long, Turning.....	795
Bench, Groove in, Prevents Parts from Rolling Off. 782	782
Blowtorch, Using on Windy Days.....	793
Castings, Small, Homemade Preheater for.....	788
Chart, Computing, for Spring Scales.....	795
Clamp for Soft Materials.....	793
Drawing Board, Portable, How to Make.....	781
Gauge, Alinement, for Lathe, How to Make.....	794
Grease Machine, High Pressure.....	791
Land Listed, How to Fill Furrows on.....	782
Lathe Faceplate, Holding Securely.....	796
Machine Vises, Supporting Irregular Work in Machines, Setting to Conserve Space.....	790
Mandrel, Keyed, Aids Production.....	781
Metals, Whitening Process for.....	780
Paint, Floor, Making Durable.....	790
Pipe, Iron, Leaks in, Cement for Closing.....	781
Rack Aids in Filing Forms.....	794
Rack for Handling Heavy Barrels.....	790
Rail, Handling on a Handcar.....	793
Refrigerating Machine, Homemade.....	783
Router, Homemade.....	796
Salt Box, Concrete, for Stock.....	779
Scale Beam, Illuminating the.....	780
Shingles, How to Make a Weatherproof Joint with Corrugated Iron Roofing.....	789
Taper-Turning Tool for Lathes.....	780
Trestles, "Ball Bearing".....	796
Tripods, How to Improve.....	787
Trough, Bench, Convenient, for Washing Machine Parts.....	789
Tumbling Barrel, Making an Effective.....	792
Valve, Relief, Prevents Water Hammer.....	782
Washbowl, Concrete, for Garage.....	795
Washers, Standard, Grinding.....	796
Wheelbarrow, Underslung, for Carrying Milk Cans 787	787

AMATEUR MECHANICS

Aerials, How to Erect.....	809
anchors for Small Boat Landing.....	810
Axle, Pull Floating, Emergency Repair for.....	807
Battery Charger, Building.....	811
Bloodstains, How to Remove.....	801
Boat Hulls, Painting.....	807
Bushings, Radio Panel, Made from Valve Stems... 809	809
Cabinet, Medicine, Making More Convenient... 802	802
Catch Garage Door, Simple.....	800
Clinker Remover.....	815
Floors, Concrete, Repairing for Dancing.....	810
Gas Tank Kink, Improvement on.....	802
Generator, Grounding, When Battery Is Removed.. 814	814
Gluing Clamp, Improvised.....	815
Graduate, Homemade.....	799
Gun, Damaged, Repairing.....	814
Hog Hanger, Handy.....	805
Incubator, Leveling.....	814
Motorcycle, Oiling, Transmission.....	806
Oil Feed, Automatic, for Automobile.....	808
Paper, How to Fireproof.....	815
Paper Rolls, Holder for.....	812
Plants, Water, Screen Facilitates Growth of.....	798
Rake, Leaf, Attachment for.....	801
Rat Trap, Novel.....	799
Roofing, Roll, Fastening Edges on.....	800
Rotary Harrow and Drag, Combining.....	792
Scoop, Yard, Homemade.....	801
Screws, Setting, into Hardwood.....	810
Starter Troubles.....	816
Steps, Retreading with Concrete.....	802
Stirrer, Milk, Simple Wind Power.....	800
Tire, Repairing in the Home Garage.....	803
Toolholder for Amateurs' Lathe.....	798
Typewriter, Portable, Stabilizing.....	814
Vacuum Tubes, Cushion for.....	802
Wampus, Walking, Making.....	797
Water, Fresh, for Farm Kitchen.....	815
Water, Locating Surface of, in Well.....	818
Waterwheel, for Driving Small Dynamo.....	807
Weather Strip, Homemade.....	808
Window Display, Novel.....	809
Wood Box, Swinging.....	816

DRAKE'S PRACTICAL MECHANICAL BOOKS

THEY WILL RAISE YOUR PAY—

ORDER ON 5-DAY TRIAL

The books listed below will perfect you in your chosen trade — pave the way to the big positions. Written in non-technical language—easy to read and understand. *Every book covers its subject completely. An entire course of instruction condensed into one volume.* Your choice sent postpaid — you benefit 5 days — money refunded in full if not entirely satisfactory. Order direct from this page.



Automobile Books

- Automobile Ignition, by ManlyLeatherette **\$2.00**
- Automobile Starting and Lighting, by Manly.....Leatherette **\$2.00**
- Brookes' Automobile Handbook.....Leatherette **\$2.00**
- Ford Motor Car, Truck and Tractor, by Manly.....Cloth **\$1.50**
- Starting and Lighting Troubles, Remedies and Repairs, by ManlyLeatherette **\$3.00**
- Automobile Battery, Care and Repair, by Manly.....Leatherette **\$2.00**
- Automobile Catechism and Repair Manual.....Leatherette **\$1.50**
- Tires and Vulcanizing, by TuffordCloth **\$2.00**
- Gas and Oil Engine Handbook.....Cloth **\$1.50**
- Automobile Upkeep and Care, by Manly.....Cloth **\$1.50**
- Motorcycle Handbook, by ManlyCloth **\$1.50**

Shop Practice Books

- Sheet Metal Workers' Manual.....Leatherette **\$2.00**
- Oxy-Acetylene Welding and CuttingCloth **\$1.25**
- Slide Rule and Logarithmic TablesLeatherette **\$2.00**
- Handbook for Millwrights.....Cloth **\$2.00**
- Modern Blacksmithing.....Cloth **\$1.25**
- Machine Shop Practice.....Cloth **\$2.00**

- Mechanical Drawing and Machine DesignCloth **\$2.00**
- Pattern Making.....Cloth **\$1.50**

Carpentry Books

- Cloth Binding
- Modern Carpentry, 2 vols.....\$3.00
- The Steel Square, 2 vols.....\$3.00
- Wooden Boat and Shipbuilding.....\$1.50
- Modern Estimator\$1.50
- Timber Framing\$2.00
- Builder's Architectural Drawing.....\$2.00
- Concretes\$1.50
- Practical Bungalows\$1.00
- Low Cost Homes.....\$1.00
- Roof Framing, by Van Gasbeek.....\$1.50
- Stair Building and Hand Railing\$1.50

Electrical Books

- Practical Applied Electricity....\$2.00
- Alternating Current\$1.50
- Electric Motor Control Systems.....\$1.50
- Wiring Diagrams and Descriptions\$1.50
- Electrical Tables and Data.....\$1.50
- Armature and Magnet Winding.....\$1.50
- Modern Electrical Construction.....\$1.50
- Modern Electric Illumination...\$1.50
- Electricians' Operating and Testing\$1.50
- Motion Picture Operation.....\$1.50
- Drake's Electrical Dictionary...\$1.50
- Electric Motors, D. & A.....\$1.50
- Electrical Measurements and Meter Testing\$1.50
- Drake's Telephone Handbook...\$1.50
- Easy Experiments.....Cloth **\$1.25**
- Wireless Telegraph and Telephone Handbook.....Cloth **\$1.25**
- Telegraphy Self-Taught...Cloth **\$1.25**

Steam Engineering

- Swingle's Handbook for Steam Engineers and Electricians.....Leatherette **\$4.00**
- Examination Questions and Answers for Marine and Stationary Engineers.....Leatherette **\$2.00**
- Steam Boilers.....Leatherette **\$2.00**
- Swingle's Catechism of Steam, Gas and Electrical EngineeringLeatherette **\$1.50**

Painting Books

- Scene Painting and Bulletin ArtCloth **\$4.00**
- A Show at Sho' Cards.....Cloth **\$4.00**
- Sign PaintingCloth **\$4.00**
- Strong's Book of Designs.....Leatherette **\$4.00**
- Strong's Art of Show Card WritingCloth **\$4.00**
- Signist's Alphabets.....Cloth **\$1.50**
- Modern Painter's Cyclopedia.....Cloth **\$2.00**
- Automobile Painting.....Cloth **\$1.50**
- Estimates, Costs and Profits, Painting and Decorating.....\$1.50
- New Hardwood Finishing.....Cloth **\$1.50**
- The Amateur Artist.....Cloth **\$1.50**
- New StencilsCloth **\$1.25**
- Chalk Talk and Crayon PresentationCloth **\$1.25**

Farm Books

- Farm Mechanics.....Cloth **\$1.25**
- Farm Buildings.....Cloth **\$1.25**
- Farm Engines.....Cloth **\$1.25**
- Traction Farming.....Cloth **\$1.50**

Business and Reference Books

- Better Business Letters.....Cloth **\$1.00**
- Better Business English.....Cloth **\$1.00**
- Better Advertising.....Cloth **\$1.00**
- Finger Prints Simplified.....Cloth **\$2.00**
- Practical Bricklaying.....Cloth **\$1.25**
- Practical Instruction for DetectivesCloth **\$1.00**
- Practical PlumbingCloth **\$1.50**
- Hot Water Heating.....Cloth **\$1.50**
- Elementary Chemistry.....Cloth **\$1.50**
- Courses in Civil Service.....Cloth **\$1.50**
- Cyclopedia of Recipes.....Cloth **\$1.50**
- American Star Speaker...Cloth **\$1.50**

Modern Languages

- By Prof. P. S. Allen, U. of Chicago
- French without a Teacher.....Cloth **\$1.25**
- Spanish without a Teacher.....Cloth **\$1.25**
- German without a Teacher.....Cloth **\$1.25**
- Everyday French.....\$1.25
- Everyday Spanish.....\$1.25

ORDER DIRECT FROM THIS PAGE—ON OUR MONEY-BACK PLAN

The books listed above are only a few of the many in our catalogue, which you will receive promptly after filling out and mailing us the attached coupon. For quick action order direct from this page—cross name of each book wanted and send in with price quoted. We prepay postage and send the books on our money-back plan.

FREDERICK J. DRAKE & CO.

PUBLISHERS

1008 Michigan Ave., Chicago

Drake Books Are For Sale at All Book Stores

FREDERICK J. DRAKE & CO.
1008 Michigan Avenue
Chicago, Ill.

GENTLEMEN:—Please send me free, postage paid, your illustrated catalogue which lists and describes over 100 Practical Mechanical Books for Home Study.

My name is

and my address

Mail Coupon For Free Catalogue
Your Guide to Home Study

St. Louis Man Discovers a New Kind of Heat!



B. M. OLIVER

Mr. B. M. Oliver of St. Louis has invented an amazing device which ends forever the days of woman's slavery to dirty, mussy coal and wood fires. It sets into the fire-box of any kind of heating stove, cook stove or furnace without changes and just turning a valve it gives any degree of heat from a tiny flame to a roaring inferno—

3 times the heat of coal if it is needed.

Mr. Oliver calls his invention the Oliver Oil-Gas Burner because it makes its own gas from 95% air and 5% oil (kerosene) the cheapest fuel there is. The wonderful story of a woman's freedom from building fires, carrying heavy scuttles, emptying ashes has spread so rapidly that already over 150,000 burners are being used by American housewives. Mr. Oliver wants every woman to have the use of his invention. If you will write to him at 2048-W Oliver Bldg., St. Louis, Mo., you will receive an attractive booklet FREE that tells all about it. Mr. Oliver is now making a Special Low Price Offer, to readers of this paper. He is also looking for good, live distributors and will tell you how to earn \$500 a month in full or spare time if you are interested and request his sales plans.

562 page RADIO BOOK only

Just Off the Press!

The greatest book on Radio ever written. Price only \$1. Filled with sound, practical, tested information for every radio fan, from beginner to hard-boiled owl. Written, compiled and edited by radio experts of national reputation. Filled with suggestions for getting more pleasure out of radio. Will save you from wasting money on things that won't work. Send \$1 to-day and get this 562-page I. C. S. Radio Handbook before you spend another cent on parts. Money back if not satisfied.



Mail the Coupon To-day

INTERNATIONAL CORRESPONDENCE SCHOOLS
Box 8858-D, Scranton, Penna.

I enclose One Dollar. Please send me—postpaid—the 562-page I. C. S. Radio Handbook. It is understood that if I am not entirely satisfied I may return this book within five days and you will refund my money.

Name.....

Address.....



Be Your Own MUSIC Teacher

Learn at Home

by wonderful print-and-picture method that teaches in half usual time. Far superior to private teachers. Simple as A, B, C—a child can master it. Your lessons consist of real selections instead of tiresome exercises. When you finish one of these delightfully easy lessons you've added a new "piece" to your list. You read real notes, too—no "numbers" or trick music. Method is so thorough that many of our 300,000 students are band and orchestra LEADERS.

Automatic Finger Control

Our own invention—Limbers, trains, and guides your fingers so that they fall into proper place almost automatically.

Play by NOTE
Piano, Organ,
Violin, Cornet,
Mandolin,
Harp, Cello,
Trombone,
Flute, Clarinet,
Piccolo, Saxo-
phone, Ukulele,
Guitar, Har-
mony and Com-
position, Banjo,
Tenor Banjo,
Voice and
Speech Cul-
ture, Drums
and Traps, Au-
tomatic Finger
Control, etc.

Free Book and Sample Lesson

show you how you may quickly become a fine player or singer through the U. S. School home study method. Write now, however, before free books and sample lessons are gone. Mention your favorite instrument or whether you prefer vocal music. Please write your name and address plainly. Address

U. S. SCHOOL OF MUSIC, 711 Brunswick Bldg., N. Y. C.

Learn Expert Auto Painting



There is Big Money in auto painting and refinishing. Our Home Study Course in Practical Auto Painting will enable you to do the finest work and earn big wages. Wonderful opportunity for new money-making business of your own.

FREE circular tells all about this big new business. Be first. Write quick.

CHICAGO COLLEGE OF AUTO PAINTING
Dept. 113, 140 S. Dearborn St., CHICAGO, U.S.A.

LEARN ENGINEERING

Courses, 3 months to 2 years practical-technical training under experts. Not a Trade School, but a practical technical college teaching electricity, steam, gas, auto-electric, armature winding, drafting, radio. Extensive laboratory and shop equipment. Degrees awarded. Day and night sessions. Enroll any time
1091 Indiana Avenue
FINLAY ENGINEERING COLLEGE KANSAS CITY, MO.

Don't Wear a Truss

BE COMFORTABLE—Wear the Brooks Appliance, the modern scientific invention which gives rupture sufferers immediate relief. It has no obnoxious springs or pads. Automatic Air Cushions bind and draw together the broken parts. No salves or plasters. Durable. Cheap. Sent on trial to prove its worth. Never on sale in stores as every Appliance is made to order, the proper size and shape of Air Cushion depending on the nature of each case. Beware of imitations. Look for trade-mark bearing portrait and signature of C. E. Brooks which appears on every Appliance. None other genuine. Full information and booklet sent free in plain, sealed envelope.



MR. C. E. BROOKS

BROOKS APPLIANCE CO.,

126-H State St., Marshall, Mich.

CARPENTERS

LET THIS NEW AUDEL SET SOLVE YOUR PROBLEMS

POCKET SIZE—
FLEXIBLE
COVERS—
3100 ILLUS-
TRATIONS
— 1600
PAGES

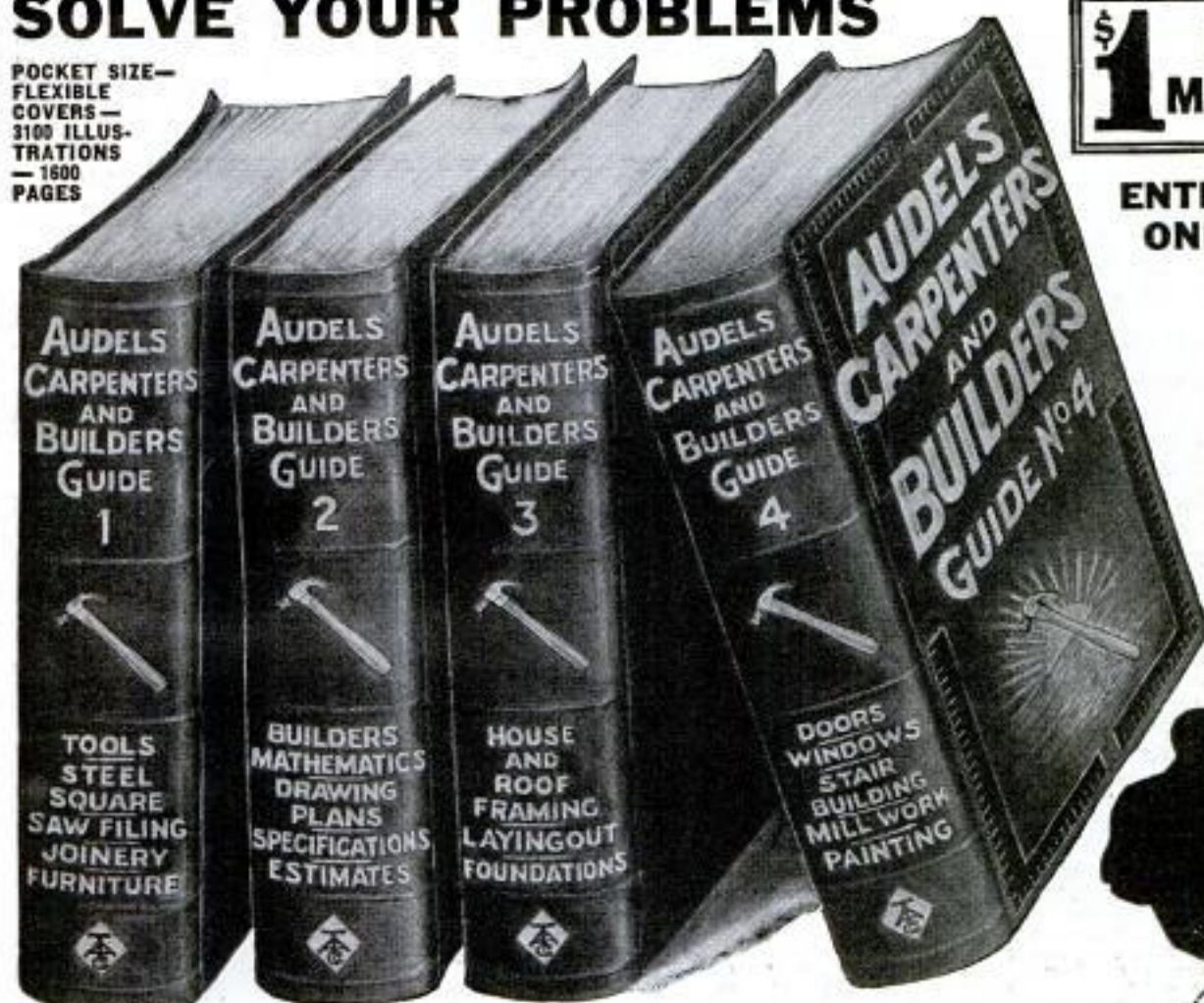

\$1 PER MONTH

ENTIRE SET ONLY \$6

JUST OUT!

Audel's Newest Set, Concise and up-to-date **FOUR Handy Volumes**

QUESTIONS AND ANSWERS—CLEAR ILLUSTRATIONS—SHORT CUTS THAT MAKE YOU A BETTER WORKMAN AND INCREASE YOUR PAY

Just available—Audel's Carpenters and Builders Guides—the short cut, professional information you want. A Guide that keeps you in close touch with your work and shows you how you may increase your earning power. No need to guess or take chances. Every day you have before you in this set, exact, practical, useful information to help you with your daily work.

HOW To Handle the Job That Puzzles YOU

There are thousands of examples of modern construction and building work—new methods, new ideas, proved efficiency plans, short cuts, time saving suggestions, new ways that cover the entire theory and practice of modern carpentry. Every point is easy to read and understand and clearly illustrated with sketches and forms. Inside Trade Informa-

tion for Carpenters, Builders, Joiners, Building Mechanics and all Woodworkers on—Care and Use of Tools—How to Use the Steel Square—File Saws—Make All Kinds of Joints—Draw and Read Plans—Write Specifications—Make Estimates—How to Frame Roofs and Houses—Lay Out Work—Put in Foundations—Full Instruction on In and Outside Building Work—Stair Building—Saw Mill Work—Practical Painting—Thousands of Short-Cuts that save time and money—Information usually obtained only by hard experience.

NO MONEY! MERELY SEND COUPON AND LOOK THE SET OVER AT AUDEL'S RISK

FREE

EXAMINATION

Not a cent to pay until you see the books. No obligation to buy unless you are satisfied. Fill in coupon in pencil. Send now—today—get this great help library for carpenters and builders.

THEO. AUDEL & CO., 72 5th Avenue, NEW YORK CITY

Send me for free examination **AUDEL'S CARPENTERS AND BUILDERS GUIDES** 4 numbers. If satisfactory I will send you \$1 within 5 days and mail \$1 monthly until \$6 is paid.

Name.....
Address.....
Occupation.....
Employed by.....
Reference.....

P. M. Nov. 23



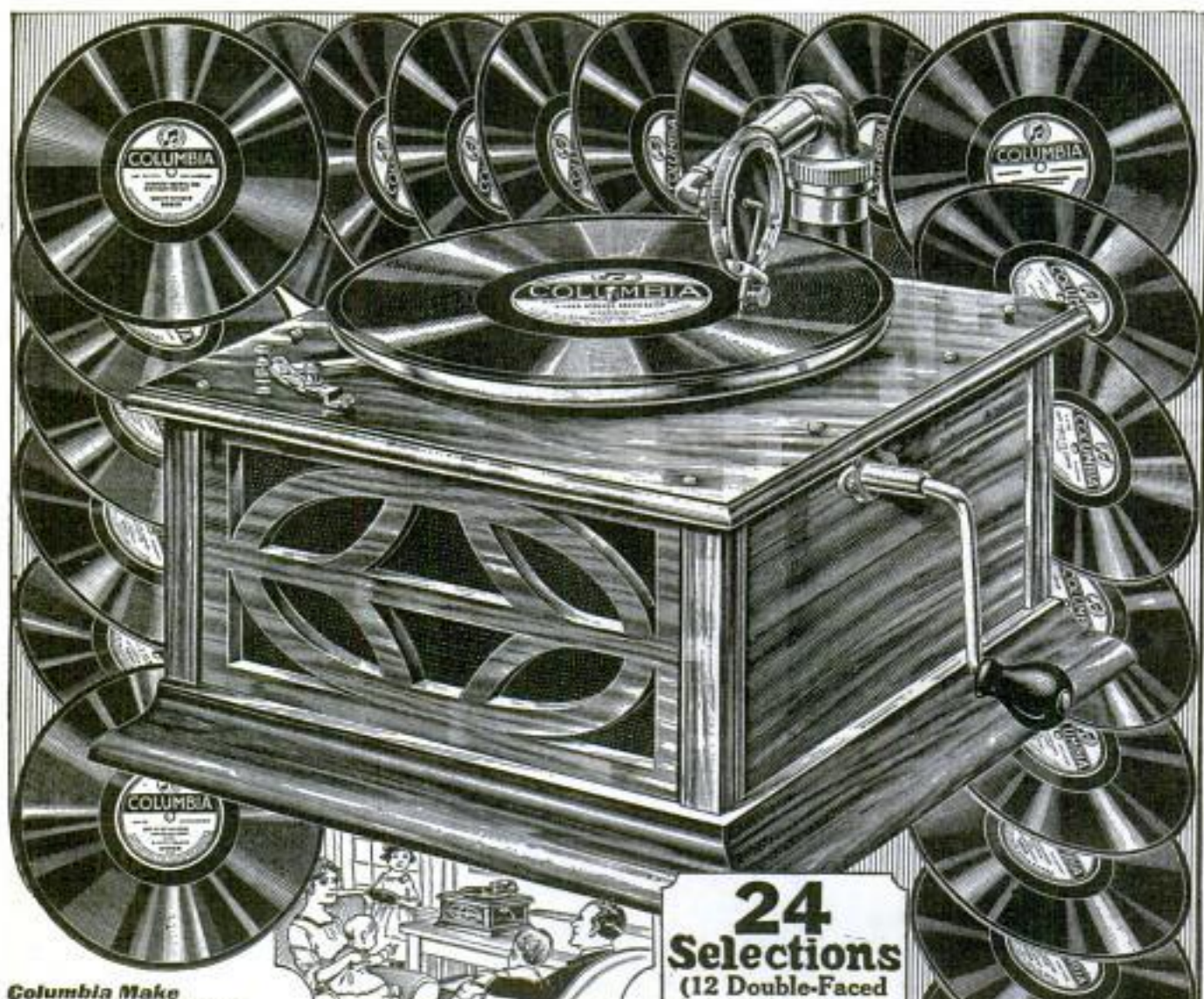

Columbia Make
Mahogany Finish

No Money Down

Coupon brings this wonderful standard size Phonograph with 12 Columbia Double-Faced Records (24 choice selections) absolutely FREE. Pay only \$3.95 and small transportation charges on arrival. Use outfit 30 days on Free Trial. If not satisfied, return Phonograph and all records and we refund your \$3.95 and pay transportation charges both ways. If you keep them, pay balance on the Phonograph a little every month. Take

Nearly a Year to Pay

This Phonograph is made by Columbia Graphophone Co. Has beautiful hardwood case in handsome mahogany finish. Front ornamented with fancy grill. Turn-table holds 10 or 12-inch records. Equipped with strong double spring motor. All metal parts nickel plated. Has speed regulator; stop-start lever.

Plays All Disc Records

And bear in mind, we send you twelve 10-inch double-faced records FREE with the Phonograph. This means 24 of our choice selections, including popular "hits" like—Song of Love, Sleepy Head, Jabberwocky, etc. Don't put off—no money now. Better send the coupon at once. If you have a phonograph get this one as a gift for a friend.

Order No. 269EEMA23. Bargain Price, \$29.95. Pay \$3.95 and small transportation charges on arrival. Balance \$3.50 monthly. The 12 Double-Faced Records (24 selections) are FREE.

HARTMAN Furniture & Carpet Co.
Dept. 5699 Chicago, Illinois
Copyright, 1923, Hartman's, Chicago



24 Selections
(12 Double-Faced
Columbia Records)
FREE
With This
Phonograph

FREE Bargain Catalog and FREE GIFTS

316 pages of bargains in Furniture, dishes, rugs, carpets, sewing machines, silverware, also farm machinery, etc.

—all sold on our easy monthly payments and on 30 days' free trial. Also explains Hartman's gift plan by which you receive many splendid articles such as glassware, silverware, tablecloths, napkins, etc., absolutely free with purchases. Send a postal for this big free bargain catalog today.

"Let Hartman Feather YOUR Nest"

Hartman Furniture & Carpet Co.
Dept. 5699 Chicago, Illinois

Send me the Mahogany Finished Phonograph No. 269EEMA23, Price \$29.95, and with it the 12 Double-Faced Columbia Records (24 selections) absolutely FREE. I will pay \$3.95 and small transportation charges when shipment arrives. It is understood that if I am satisfied I will send you \$3.50 monthly until the bargain price, \$29.95, is paid. This remains with you until final payment is made. If not satisfied after 30 days' free trial, I will return the Phonograph and all records, and you will refund my \$3.95 and pay transportation charges both ways.

Name..... Occupation.....

R. F. D., Box No. or Street and No.

Post Office..... State.....

(If your shipping point is different from your post office, fill in line below)

Send shipment to.....



“I Was At The End of My Rope”

“WE lived in a fairly comfortable home, but it was a terrific struggle to make both ends meet. I couldn't save a cent and I was deeper in debt than I dared confess to my wife.

“I hadn't had a decent raise in years, and there were nights—too many of them now—when I lay awake for hours wondering what we would do if I ever lost my position.

“For other men were getting ahead of me and I knew that I couldn't stand still. I either had to go up or down. And I was afraid it was going to be down!

“Then suddenly one night it came to me like a flash that the reason I wasn't getting anywhere was mainly because I had never made any definite effort to make myself more valuable to the firm.

“I knew my own little routine job, but that was all. I was just one of the force to my employers. There was really no reason why they should think of me when a better position was open.

“That night I made my decision. ‘If the I. C. S. can raise the salaries of other men,’ I said to myself, ‘it can raise mine. If it can help other men to win promotion and have happier, more prosperous homes, it can help me, too. To-night, right now, I'm going to send in that coupon and find out what the I. C. S. can do for me.’

“It was the best move I ever made. My employers heard about my studying and started to take an interest in me. Six months after I enrolled with the I. C. S. I received my first increase in salary. Within two years I was head of my department. And I'm going still higher.”

An International Correspondence Schools course will help you just as it helped this man whose letter is reproduced here. It will help you to have the happy home—the bigger salary—the comforts that you want for your wife and your family.

For spare-time study is that vital something which makes one man succeed where one hundred fail—that lifts a man out of the rut and makes him a trained worker instead of just a “hand.”

One hour a day, spent with the I. C. S. in the quiet of your own home, will prepare you for the position you want in the work you like best. Put it up to us to prove it!

MAIL THE COUPON TO-DAY

INTERNATIONAL CORRESPONDENCE SCHOOLS

Box 5552-D, Scranton, Penna.

Without cost or obligation, please tell me how I can qualify for the position or in the subject before which I have marked an X:

BUSINESS TRAINING COURSES

- | | |
|--|---|
| <input type="checkbox"/> Business Management | <input type="checkbox"/> Salesmanship |
| <input type="checkbox"/> Industrial Management | <input type="checkbox"/> Advertising |
| <input type="checkbox"/> Personnel Organization | <input type="checkbox"/> Better Letters |
| <input type="checkbox"/> Traffic Management | <input type="checkbox"/> Show Card Lettering |
| <input type="checkbox"/> Business Law | <input type="checkbox"/> Stenography and Typing |
| <input type="checkbox"/> Banking and Banking Law | <input type="checkbox"/> Business English |
| <input type="checkbox"/> Accountancy (including C.P.A.) | <input type="checkbox"/> Civil Service |
| <input type="checkbox"/> Cost Accounting | <input type="checkbox"/> Railway Mail Clerk |
| <input type="checkbox"/> Bookkeeping | <input type="checkbox"/> Common School Subjects |
| <input type="checkbox"/> Private Secretary | <input type="checkbox"/> High School Subjects |
| <input type="checkbox"/> Spanish <input type="checkbox"/> French | <input type="checkbox"/> Illustrating <input type="checkbox"/> Cartooning |

TECHNICAL AND INDUSTRIAL COURSES

- | | |
|---|--|
| <input type="checkbox"/> Electrical Engineering | <input type="checkbox"/> Architect |
| <input type="checkbox"/> Electric Lighting | <input type="checkbox"/> Blue Print Reading |
| <input type="checkbox"/> Mechanical Engineer | <input type="checkbox"/> Contractor and Builder |
| <input type="checkbox"/> Mechanical Draftsman | <input type="checkbox"/> Architectural Draftsman |
| <input type="checkbox"/> Machine Shop Practice | <input type="checkbox"/> Concrete Builder |
| <input type="checkbox"/> Railroad Positions | <input type="checkbox"/> Structural Engineer |
| <input type="checkbox"/> Gas Engine Operating | <input type="checkbox"/> Chemistry <input type="checkbox"/> Pharmacy |
| <input type="checkbox"/> Civil Engineer | <input type="checkbox"/> Automobile Work |
| <input type="checkbox"/> Surveying and Mapping | <input type="checkbox"/> Airplane Engines |
| <input type="checkbox"/> Metallurgy | <input type="checkbox"/> Navigation |
| <input type="checkbox"/> Steam Engineering | <input type="checkbox"/> Agriculture and Poultry |
| <input type="checkbox"/> Radio | <input type="checkbox"/> Mathematics |

Name.....
 Street.....
 Address..... 8-3-23
 City..... State.....

Occupation.....
 Persons residing in Canada should send this coupon to the International Correspondence Schools Canadian, Limited, Montreal, Canada.

I Can Train You For A \$3500 Hotel Job in 20 weeks



The Hotel Business offers wonderful opportunities to the trained man or woman! Now fourth largest industry in America. Hundreds of high-salaried executive positions now standing open—waiting for the trained worker. You can easily qualify for one of these big-paying jobs—in your spare time at home. No previous experience necessary.

I Guarantee to Teach You

in my 50-lesson home-study course on hotel work, all that the leading hotel experts know about the business—men making from \$5,000 to \$50,000 a year! My students are eagerly sought by the biggest and best hotels in the country. You won't have to look for a job. Big pay, fine living, free meals and apartment, fascinating work—these are only a few of the many advantages of hotel work.

Send for FREE Book

20 Years' Experience in 20 Weeks is what this wonderfully complete course gives you. Course prepared by Clifford Lewis, a hotel expert of national reputation. Endorsed by managers of such hotels as Biltmore, Waldorf-Astoria, Copley-Plaza, Commodore, etc. Interesting free book explains all. Send for it today.

LEWIS HOTEL TRAINING SCHOOLS

Founded 1914. The Original Hotel Training School

CLIFFORD LEWIS, President

Room 330

Washington, D. C.

The National Institute for Hotel, Restaurant and Tea Room Training

LEARN TO GET DOLLARS OUT OF WATCHES.

WATCH-REPAIRING, ENGRAVING, JEWELRY REPAIRING.



ENICAR

WRITE NOW.

TRADE

SCHOOL

530 W MONUMENT SQUARE,

RACINE, WIS.

BIG MONEY IN TAILORING

Agents Wanted Spare time will do. Big Pay. Easy work. No experience needed.

We furnish everything FREE. Only two sales a day gives you \$50.00 a week. You get your own clothes at manufacturing cost—about one-half retail prices.



WE FURNISH EVERYTHING

We supply you with the finest tailoring outfit, same as we give to our very best star salesmen—showing 200 big cloth samples, all the latest styles, and everything you need to start right in making money—from \$50 to \$150 a week.

YOUR SPARE TIME WILL DO

Even if you can give only a few hours a week, we'll take you, teach you and fit you out with the big outfit so that you can start right out making from \$3.00 to \$5.00 an hour. But don't delay. Fill out the coupon below and mail to us at once.

To L. E. ASHER, President

BANNER TAILORING CO. Dept. 116 CHICAGO, ILL.

Dear Sir:—Send me your special offer, all FREE.

Name.....

R. F. D..... Box..... St. & No.....

P. O..... State.....

Does your English Help or Hurt you?

Every time you speak or write you show just what you are. Mistakes in English reveal you as a person who lacks education and refinement. Lack of language power prevents you from presenting your thoughts in the strongest possible way. No matter what you do, real command of English will help you to your goal. Stop making mistakes in spelling, punctuation, pronunciation. Increase your vocabulary.

WONDERFUL INVENTION

Only 15 minutes a day with Sherwin Cody's New Invention—and you can actually SEE your English improve. It teaches by HABIT—makes it easier to do the RIGHT way. Wonderful self-correcting lessons include Spelling, Punctuation, Grammar, and Pronunciation.

SEND FOR FREE BOOK AND 15 MINUTE TEST

Lack of language power may easily be costing you thousands of dollars every year. See what Mr. Cody can do for you: it costs nothing to find out. Mail a postal card or letter this very minute for free book, "How to Speak and Write Masterly English," and the 15 Minute Test. It will prove a revelation to you. WRITE NOW. Address



Sherwin Cody School of English, 511 Searle Bldg., Rochester, N.Y.

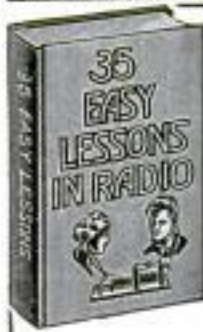

THIRTY-FIVE EASY LESSONS IN RADIO 50c

A systematic course of elementary principles written in a simple and concise lesson course, easily understood. Thousands have taken up Radio for entertainment and are operating their own amateur sets.

This book embodies all the principles and application of everyday radio for the home and in business. Paper cover.

Price postpaid 50c

SHREWSBURY PUBLISHING COMPANY

5311 West Lake Street

CHICAGO, ILL.

LEARN Penmanship

I Teach Penmanship by Mail

Small Cost. Spare Time. Write for my Free Book, "How to Become an Expert Penman." It contains specimens and tells how others became expert writers by the Tevis Method. Your name written on card if you enclose stamp. Write Today.

T. M. TEVIS, Box 25K, CHILLICOTHE, MO.

LEARN AUTOS AND TRACTORS



Wonderful opportunities constantly offered trained men—we train you thoroughly to start your own business, or to make good money as motor expert, driver, shop foreman, etc., and furnish you with a \$12.00 tool kit free of charge. This is the pioneer auto school. Over 7000 graduates making good. Catalog free.

CLEVELAND AUTOMOBILE SCHOOL, 1814 East 24th Street, Cleveland, Ohio

BECOME A RAILWAY MAIL CLERK

Examinations soon. \$1600 to \$2300 a year. No strikes or lockouts. Common education sufficient. No "pull" necessary. Mail coupon for catalog.

Patterson Civil Service School
Dept. 311, Rochester, N. Y.

Sirs:—Send me without charge your Catalog, describing this and other fine U. S. Government positions.

Dept. 311
Patterson Civil
Service School
Rochester,
N. Y.

Name.....

Address.....

See Here!

You can make
\$75 to \$200
a week!

**LEARN TO DO
ANY JOB!**



The Cooke-Trained Auto Expert gets the big money because no job is too difficult for him. The JOB-WAY of instruction has shown him how to find the trouble instantly and repair it quickly!

Be An Auto Expert

Keep your Job—stay at home—loan me part of your spare time and I'll make you an AUTO EXPERT quick! A liking for machinery all you need. As Directing Engineer of the big CHICAGO AUTO SHOPS I train you the "JOB-WAY"—no books or useless theories in my course. I show you the short-cuts, the inside methods acquired during my 20 years in training men.

! I Guarantee



**\$18.50 REPAIR
OUTFIT FREE!**

Learn with tools! And make the course pay for itself like hundreds of my students have done! Mail coupon and get this money-making outfit FREE!

to prepare you to go into business for yourself where you can become INDEPENDENT. I guarantee to train you until you can hold down any EXPERT'S job at TOP SALARY. I guarantee to make you an expert right in your own home—to give you the most practical instruction ever devised in every branch of Automotive Mechanics, Automotive Electricity, Battery, Ignition, Welding, Vulcanizing, etc. And I guarantee to refund your money if you are not satisfied.

**B. W. COOKE, Directing Engineer
CHICAGO AUTO SHOPS**

NOW YOU CAN LEARN AT HOME!

Get your share of the millions of dollars spent yearly for repairs on autos, trucks, tractors. Think of it! Now 15 million cars, trucks and tractors to keep going—15 million batteries to service—50 million tires to repair and replace—15 million electrical systems to maintain! Man alive!—where else can you find equal opportunities to make real money!

START NOW! Mail coupon today—get all

facts quick! My big free book tells you how you can get ready to cash in on the thousands of opportunities in the world's biggest business! Reduced prices and easy terms right now—\$18.50 repair outfit free right now—write me personally or mail coupon *immediately!*

B. W. COOKE, Directing Engineer



**Directing Engineer Cooke
CHICAGO AUTO SHOPS
Dept. 301, 1553 W. Madison St., Chicago, Ill.**

Please send me Free Book and complete information about your Home Study Course. I am mailing this promptly to secure FREE REPAIR OUTFIT and the reduced prices and special terms you offer now. Of course, I am not obligating myself in any way.

Name.....

St. No. or R.F.D.....

City.....

CHICAGO AUTO SHOPS
Dept. 301
1553 W. Madison St., CHICAGO, ILL.

Smashing Reduction!



Here's your chance to get the famous Marshall Stillman Boxing Course for the price of a good necktie. Six books clearly printed on fine paper, over 240-half tone illustrations. The most scientific method of teaching boxing ever devised. You should see all the letters we receive regarding the won-

BOXING, Jiu-Jitsu, Wrestling

Now
\$1.97

**Marshall Stillman Association,
Dept. 1223L, 42nd St. and Madison Ave., New York**

You may send me on approval the Marshall Stillman course. I will deposit 97 cents (plus actual postage) with the postman, with the understanding that if, after 10 days, I wish to return the course, I may do so and my money will be instantly refunded. If I keep the course I am simply to send you \$1 in final payment.

Name.....

Address.....

Canadian and foreign orders must be accompanied by cash (\$1.97 U. S. funds) subject to money back guarantee if not entirely satisfactory.

derful results obtained. Some subscribers have whipped men 30, 50 and 60 pounds heavier than themselves. Even professionals who have taken the course are enthusiastic.

Marshall Stillman teaches by association of ideas. You hold out your hand as though for a coin, lower your head like a goat butting, etc. Then you are led to similar movements in hitting, ducking, etc. You learn quickly and never forget. Soon you are feinting, ducking, sidestepping, blocking and hitting like a veteran.

FREE book included containing lives of 69 famous boxers with little known stories.

Also a book devoted to the wonderful art of Jiu Jitsu.

10-Day Trial—Send No Money

Simply mail the coupon. When you receive the course, deposit 97 cents plus actual postage. Try it out for 10 days. Then send us the small final payment of \$1, or return the course, and we'll send your deposit back.

LEARN SPANISH on your phonograph

Learn to speak Spanish as if you were living in Spain. Records fit any phonograph. New Conversational Method evolved in Europe and introduced in America by the I. C. S. School of Languages. Endorsed by the Spanish Embassy.

Write to-day for descriptive literature.

International Correspondence Schools, 5561-D, Scranton, Penna.



COLUMBIA SCHOOL OF DRAFTING

Specializing in training of professional Draftsmen—Mechanical, Architectural and others; personal instruction in spare time, at home by mail; complete course 3 to 9 months. Free Catalog. Address Dept. 2169, R. C. Claffin, Pres., 14th and T Sts., N. W., Wash., D. C.



How to Box 40c

By Terry McGovern, James J. Corbett, J. Gardner Smith, M.D., Arthur P. Keeley and Gus. E. Keeley.

How to Box to Win, How to Build Muscle, How to Punch the Bag and How to Stand, Walk or Run.

This interesting book written by experts is known also as "The Book of Health and Strength." It will greatly assist everyone in keeping fit, in putting them in condition to master a strenuous undertaking either physical or mental.

63 illustrations. Size 4 1/2 x 7 1/2 in. Paper copy, 126 pages
SHREWSBURY PUBLISHING CO.
5311 West Lake Street, CHICAGO, ILL.

BE A CARTOONIST

BIG PRICES PAID FOR DRAWINGS

Turn your talent into money. We can teach you drawing in your home during spare time. Well trained artists earn from \$40 to \$200 a week. Thousands of publishers and advertisers need the work of good artists. The MODERN METHOD is an easy way to learn to draw original pictures. Send three stamps for full particulars showing opportunities for you. State your age.

MODERN INSTITUTE OF ART, Dept. 11, 7 East 42nd Street, New York City



WANTED

RAILWAY POSTAL CLERKS

\$1600 to \$2300 Year

MEN — BOYS 18 UP.

MAIL COUPON IMMEDIATELY

Steady work. No layoffs. Paid Vacations

Common education sufficient:

TRAVEL — SEE THE COUNTRY



FRANKLIN INSTITUTE, Dept. C179, Rochester, N. Y.

Sirs: Send me without charge, (1) Sample Railway Postal Clerk Examination questions; (2) List of government jobs now obtainable; (3) Send free illustrated book, "How to Get Government Jobs."

Name.....

Address.....

AUDEL'S GUIDES ANSWER YOUR QUESTIONS IN A PRACTICAL WAY

YOUR FOREMAN WILL QUICKLY NOTICE THE SUPERIOR QUALITY OF YOUR WORK

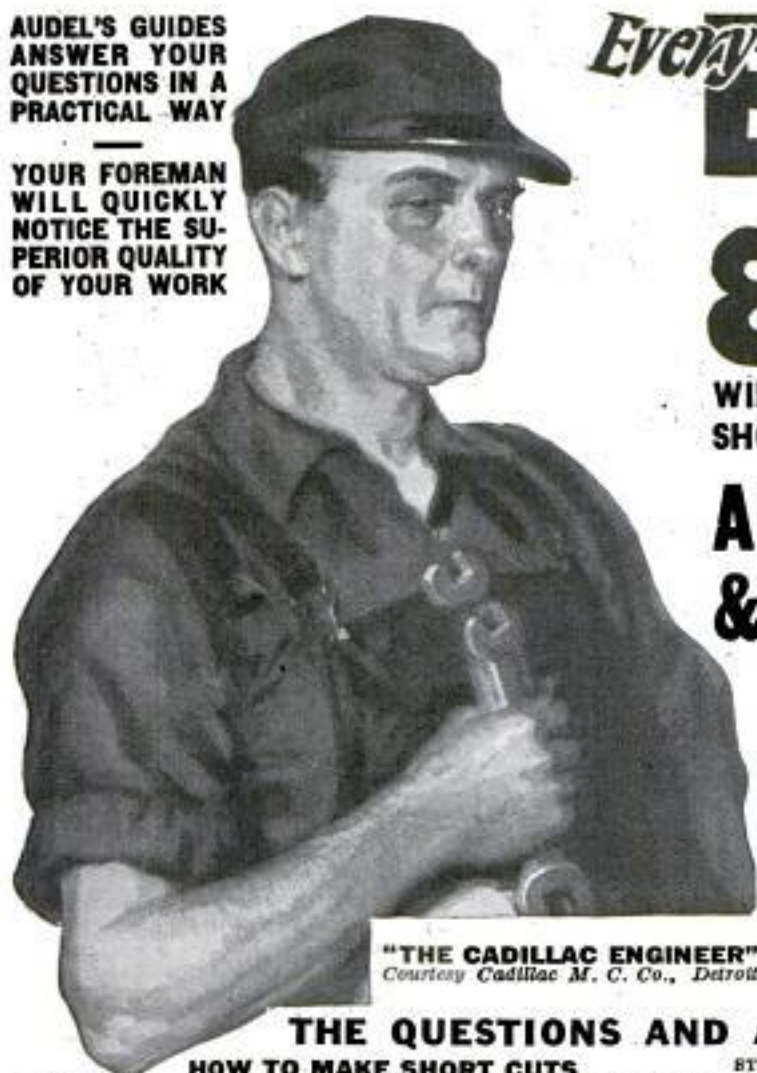

"THE CADILLAC ENGINEER"
Courtesy Cadillac M. C. Co., Detroit

Every ENGINEER & MECHANIC

WILL FIND PRACTICAL INFORMATION ON SHORT CUTS AND MODERN METHODS IN

AUDEL'S ENGINEERS & MECHANICS GUIDES

Every Engineer, Mechanic and Electrical Worker will welcome this new master set. It will answer your problems.

It will help you with your daily work.—A sure source of advancement and higher pay. Complete up-to-date information that is thoroughly and easily explained on every branch of modern engineering and electrical practice. **The entire set costs you only twelve dollars**—knowledge and instruction that has cost thousands of dollars and years of time—yours for \$12.00—\$1.00 a month.

THE QUESTIONS AND ANSWERS TEACH YOU QUICKLY

HOW TO MAKE SHORT CUTS

HOW TO HANDLE THE JOB THAT PUZZLES YOU

Study This Brief Table of Contents: Theory, Practice and Operation of ALL Steam Engines, Valve Motions—VALVE BETTING: complete information on All engines and pumps—COILLESS ENGINES and the Theory, Construction and Operation of all Steam Engines, including UNIFLOW and POPPET VALVE ENGINES, and LOCOMOBILES—Locomotive-Marine Engines; Turbines; Rotary Engines—the Indicator—Lubrication—PRACTICAL MANAGEMENT. How to use Indicator—GAS, GASOLINE, OIL, SEMI- and FULL DIERSEL ENGINES—Aeroplanes and Aviation—HOW TO SELECT AN ENGINE, working instructions, drawings on

STEAM ENGINE DESIGN, including rules and formulae. Theory and Construction of ALL Steam Boilers; Heat-Combustion; Fuel and Flue Gas Analysis—CO₂ readers—Characteristics of Boilers—Materials—Construction of all types of Boilers (THE LATEST PRACTICE.)—Boiler Construction—Mechanical Stokers—Oil Burners—Setting—Chimneys—Mechanical Drives—HOW TO SELECT A BOILER—Complete instructions and drawings on BOILER DESIGN based on A. S. M. E. BOILER CODE—OPERATION, including installation, FIRING; care and repair of Steam Boilers—Pipes, Fittings and Pipe Fitting—Heating and Ventilation—Refrigeration—Cooling Towers—Condensers—Distilling Apparatus—Elevators—Cranes and Hoisting Machinery—Ropes and Cables—Splicing—electric wiring in ALL branches; compendium of practical electrical engineering as an aid for engineers and electricians in obtaining a license—57 chapters—ready reference index, covering entire field of Modern Electricity.

AUDEL'S MASTER SET 8754 ILLUSTRATIONS 4750 PAGES—8 VOLUMES

POCKET SIZE—FLEXIBLE COVERS

TURN SPARE TIME INTO CASH BY STUDYING THE GUIDES.

Take a volume with you where ever you go. They can be easily slipped in and out of your coat pocket without damage. Study the questions and answers. In fifteen minutes a day study you will in a few weeks acquire information that will make you a more valuable man.



FREE EXAMINATION
Not a cent to pay until you see the books. No obligation to pay unless you are satisfied. Send coupon now—today and get this new master set for engineers.
Pay only \$1 a month.

THEO. AUDEL & CO., 72 Fifth Avenue, NEW YORK CITY
Please submit me for free examination AUDEL'S MASTER SET FOR ENGINEERS AND MECHANICS. Ship at once prepaid. Use 8 numbers, total cost \$12.00. If satisfactory, I agree to send you \$1 month until paid.

Name.....
Occupation.....
Employed by.....
Home Address.....
Reference.....

P.M. Nov. 23

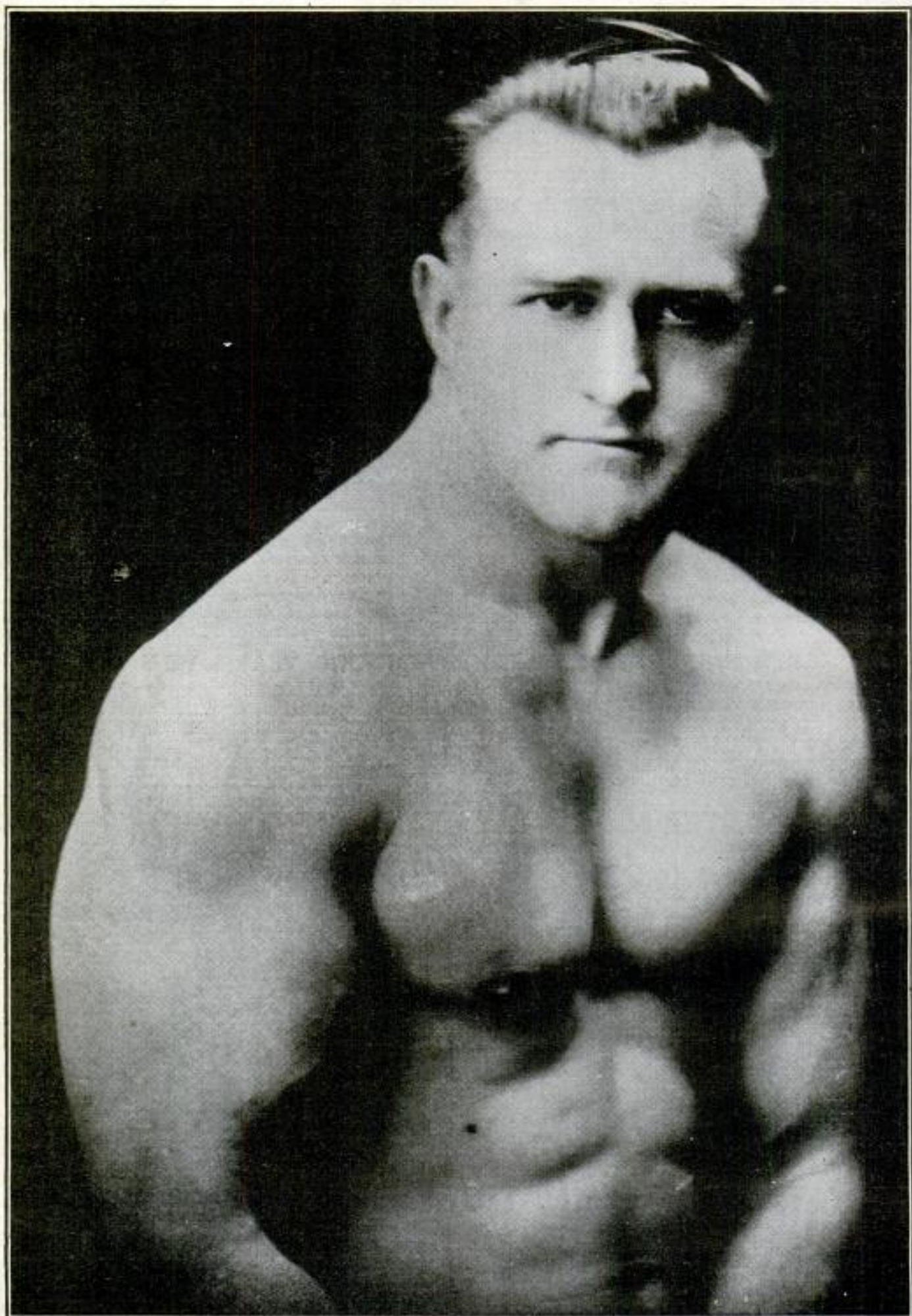

EARLE E. LIEDERMAN, *The Acme of Physical Perfection*

Call the Undertaker!

WHAT'S the use of living when you're only half alive? You get up in the morning and you don't have the pep of a jelly fish. Your work is a burden and life has ceased to give you a thrill. You don't seem to get anywhere and nobody cares whether you do or not. What's the use, fellows? Call the Undertaker, for you're dead and you don't know it.

A New Life

Stop! It's all wrong. There is another life right here before you. A *new* and a *better* one. A life that is full of *thrills* and *sunshine*. Every day opens *new worlds to conquer*, *new joys*, *new friends* and *lasting ones*. Come with me and let me guide you to it.

I have a system that knocks those gloom bugs higher than a kite. I'll put pep in your old backbone that will make you feel like a jack rabbit. I'll put a spring to your step and a flash to your eye so that your own friends won't know you.

Health and Strength

That's what you need and that's what you get. Come on now, pull in your belt and throw out your chest. Take a good deep breath of that pure air that's all about you. Give your heart a treat with some rich blood. You will feel so good you will think it's your birthday. Drop me a line and I'll show you how to do it. I'm going to put a chest on ~~your~~ ^{your} chest that will make your old ribs strain with the ~~land~~ ^{land} leg. I'm going to change those skinny arms ~~will~~ ^{will} have the ~~ours~~ ^{ours} to a real man's size. You ~~never~~ ^{never} thought ~~length~~ ^{length} and vitality to do things ~~Get~~ ^{Get} busy. I don't ~~possible~~ ^{possible}. Come on fellows! ~~antee~~ ^{antee} them. Are you with me? these things—I guarantee them. Are you with me? these things—I guarantee them.

Send For My New
64 Page Book—

"Muscular Development"

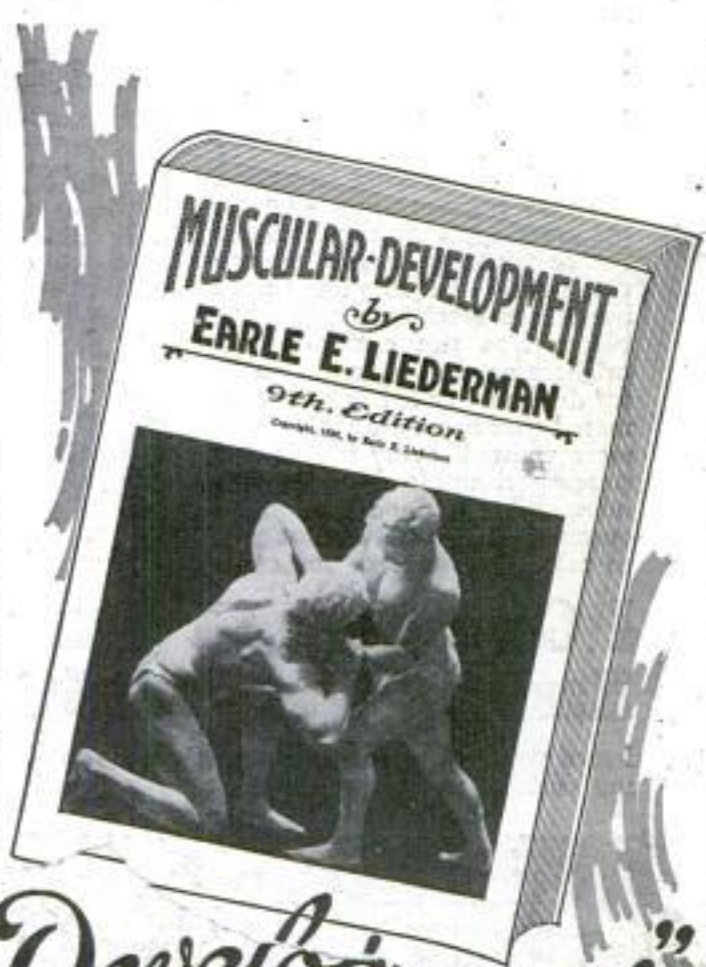

It contains forty-three full page photographs of myself and some of the many prize-winning pupils I have trained. Some of these came to me as pitiful weaklings, imploring me to help them. Look them over now and you will marvel at their present physiques. This book will prove an impetus and a real inspiration to you. It will thrill you through and through. All I ask is ten cents to cover the cost of wrapping and mailing and it is yours to keep. This will not obligate you at all, but for the sake of your future health and happiness, do not put it off. Send today—right now, before you turn this page.

EARLE E. LIEDERMAN
Dept. 2011, 305 Broadway, New York City

EARLE E. LIEDERMAN

Dept. 2011, 305 Broadway, New York City

Dear Sir:—I enclose herewith 10 cents for which you are to send me, without any obligation on my part whatever, a copy of your latest book, "Muscular Development." (Please write or print plainly.)

Name.....

Street.....

City..... State.....

EXTRA!

\$90 Drafting Course Free

Prepares You For a \$3000 to \$3600 a Year Position

This is a very extra special offer which I am making because I want to impress upon all men the great opportunity which lies before you now if you become draftsmen. For 25 years I have been Chief Draftsman and never before has the outlook been brighter or the demand greater for draftsmen. It has been estimated that there are 6000 draftsmen wanted every month for steady positions in clean, pleasant offices and with opportunities for quick advancement. I want men to take advantage of my offer.

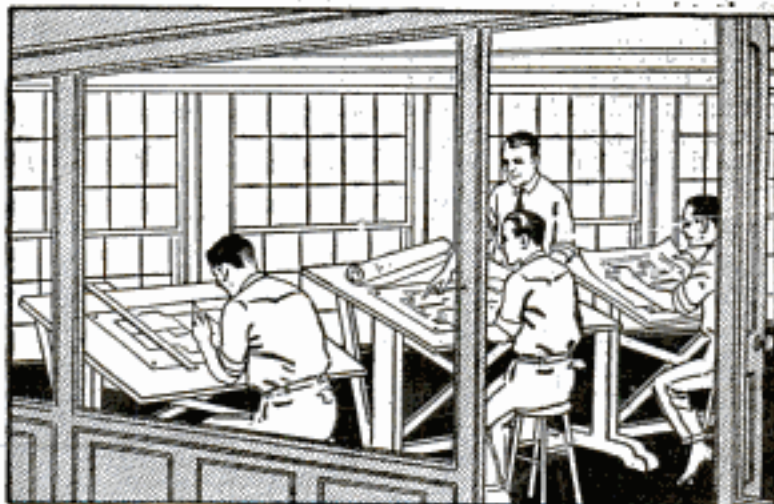

I Guarantee to Train You Until You Are Earning Up to \$250 and \$300 a Month

I give you real, practical drafting room training which enables you to become a skilled

draftsman in the shortest possible space of time. This is a close, personal working course and then before you are qualified to \$250 and \$300 a month. That is an offer I have been making for 20 years.



Send Free Coupon

It costs you nothing but a stamp to mail the free coupon for my book, "Successful Draftsmanship". Get it now. It tells you how I can afford to train you until you get your position. I urge your immediate action because I cannot, will not, and do not take all of the students who apply. Some will certainly be disappointed.

Chief Draftsman, Engineers Equipment Co.
1951 Lawrence Ave., Div. 13-58 Chicago, Ill.

Without any obligation whatever, please mail your book, "Successful Draftsmanship", and full particulars of your liberal "Personal Instruction" offer to few students.

Name _____

Address _____

Age _____

FREE Drafting Outfit

Above is pictured a handsomely finished drafting outfit which I send to you free as soon as you register as my student. These are regular drafting instruments—the very same that I use myself—and the outfit contains everything necessary for the performance of your work in drafting. Mail coupon, or send postcard or letter today.

Chief Draftsman, Engineers Equipment Co.
1951 Lawrence Ave., Div. 13-58 Chicago, Ill.

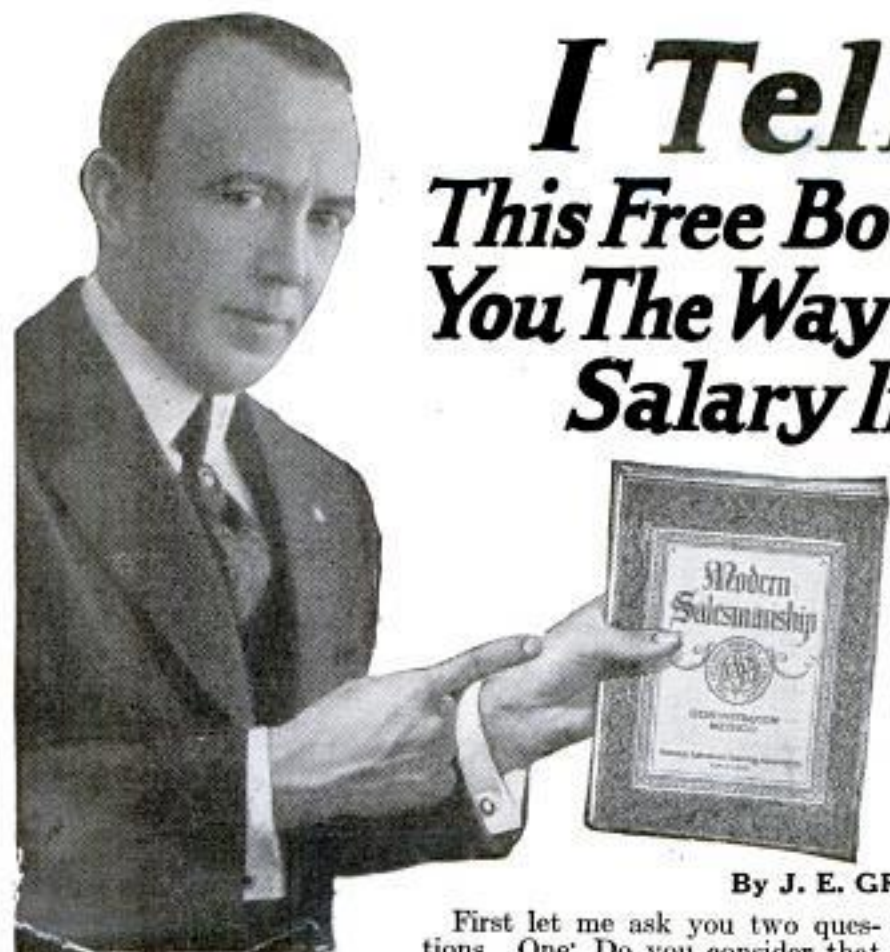

I Tell You This Free Book Will Show You The Way to Amazing Salary Increases

I only ask that you risk two cents on the strength of my word that the contents of this amazing book will show you the way to a prosperity that you never dreamed possible, in a fascinating field that you never thought of entering. This book is now free. Read my offer.

By J. E. GREENSLADE

READ!

\$9,000 First Year

Ellis Summer Cook, 20 E. Jackson Blvd., Chicago, left a \$25 a week job and last year made \$9,000!

\$100 a Month to \$100 a Week in Only 3 Months

H. D. Miller, another Chicago boy, was making \$100 a month as stenographer in July, 1922. In September, 3 months later, he was making \$100 a week as a salesman.

\$150 to \$500 a Month

W. P. Clenny, of Kansas City, Mo., stepped from a \$150 a month clerkship into a selling job at \$500 a month. He is making \$850 a month now.

\$6,500 a Year

M. V. Stephens, of Albany, Ky., was making \$25 a week. He took up this training and now makes five times that much.

Small Pay to Big Earnings

J. H. Cash, of Atlanta, Ga., exchanged his \$75 a month job for one which pays him \$500 a month. Now Sales Manager at \$10,000 a Year

O. H. Malroot, of Boston, Mass., stepped into a \$10,000 position as a SALES MANAGER—so thorough is this training. All these successes are due to this easy, fascinating and rapid way to master certain invincible secrets of selling.

EMPLOYERS

are invited to write to the Employment Dept. of the N. S. T. A. We can put you in touch with just the men you need. No charge for this service to you or our members. Employers are also cordially invited to request details about the N. S. T. A. Group Plan of Instruction for entire sales forces. Synopsis and charts sent without obligation.

First let me ask you two questions. One: Do you consider that you are as intelligent as the average mail-clerk, farmhand, office clerk, mechanic, or bookkeeper?

Second: If you suddenly found yourself with all the money you needed to spend, wearing the best clothes, living in the finest neighborhood, driving a good car and belonging to the best clubs—but having to make good in a job that paid \$10,000 a year, would it scare you? There are men to whom \$10,000 a year is so much that the idea of earning it themselves never occurs to them. They will always be in routine jobs at low pay. Their dreams will never come true. But yours will if you will absorb what I am going to tell you.

Now, in one quick step you can enter the field where opportunities in your favor are ten to one—the Selling field. You know that Salesmen top the list of moneymakers—that the salesman is his own boss—that his work is fascinating, interesting and highly profitable! But the thing you doubt is your own ability. All right, but you can become a first-class, money-making salesman in an amazingly easy way.

Proof That Salesmen Are Made—Not "Born"

The story of six men who once thought salesmen were "born," who did not believe they were "cut out for selling," is on this page.

Thousands of men like these six men who formerly thought salesmen were "born," are now enjoying magnificent earnings in the selling field. They were bookkeepers, mechanics, farmers, clerks—even doctors, lawyers and ministers—but in a few months after writing to the National Salesmen's Training Association they were out in the field selling—and making more money than they had ever hoped to make in their former vocations.

Sounds remarkable, doesn't it? Yet there is nothing remarkable about it. Salesmanship is governed by rules and laws. There is a certain way of saying and doing things, a certain way of approaching a prospect to get his undivided attention, certain ways to overcome objections, batter down

prejudice, overcome competition and make the prospect act.

Just as you learned the alphabet, so you can learn salesmanship. And through the NATIONAL DEMONSTRATION METHOD—an exclusive feature of the N. S. T. A. System of Salesmanship Training—you gain actual experience while studying.

It is one of the many reasons why N. S. T. A. members make good as salesmen right from the start.

A Lifetime of Selling Experience in a Few Weeks—Then Start

The N. S. T. A. System of Salesmanship Training and Employment Service will enable you to quickly step into the ranks of successful salesmen—will give you a big advantage over those who lack this training. It will enable you to jump from small pay to a real man's income.

Remarkable Book, "Modern Salesmanship" Sent Free

With my compliments I want to send you a most remarkable book, "Modern Salesmanship."

It will show you how you can easily become a master Salesman—a big moneymaker—how the N. S. T. A. System of Salesmanship Training will give you years of selling experience in a few weeks; how our FREE employment service will help select and secure a good selling position when you are qualified and ready. And it will give you success stories of former routine workers who are now earning amazing salaries as salesmen. Mail the coupon today. It may be the turning point in your life.

National Salesmen's Training Association
Dept. 12-S Chicago, Ill.

National Salesmen's Training Association
Dept. 12-S, Chicago, Ill.

I simply want to see the facts. Send me free your book, "Modern Salesmanship," and Proof that I can become a Master Salesman.

Name.....

Address.....

City.....State.....

Age.....Occupation.....

BOYS



Learn

Electricity

How would you like to earn two or three dollars every evening after school and prepare yourself for a fine big job at the same time? Here's the opportunity of a lifetime for you fellows who like Electricity. Begin right now to prepare yourself for a regular man's size job in this fascinating field. Your chances for a big success are simply wonderful—the pay is big (\$70 to \$200 a week) and advancement comes swift and sure.

I will Train You at Home

Look What This Boy Is Doing

"Although the School term is coming to a close, and I am pretty busy with my examinations, I manage to keep up with my electrical studies and work.

"I guess I forgot to tell you I am now in business for my self. As it all to you, in your Course, I, being under age, could not have secured my license in this town. But I got it, and now have all the work I can do, averaging \$20 to \$30 a week through spare time work.

"I went out on a job tonight after school, on which I made \$3 and brought home another on which I made \$2.50—\$5.50 for 4 hours' work and no material furnished by me."

ROGER SMITH,
1215 Chestnut St.,
Greenville, N. C.

With my easily learned, spare time Electrical Course I will train you at home like I have trained hundreds of other boys who are now big successful men. It will not interfere with your school work, and you can earn more than the small cost of the course doing odd electrical work in your spare time. The Course pays for itself. I will show you how to get this work and how to do it. Some of my best students make \$10 to \$15 a week this way.

Tools, Apparatus and Radio Course FREE

Send me the coupon below and I will tell you all about the big outfit of tools, apparatus and instruments and a new Radio Course that I am giving to my students for a limited time. I will send you my big interesting Electrical Book and a sample lesson, too—all Free. You will be tickled with the things I will send you Free. Mail the coupon right now.

L. L. COOKE, Chief Engineer
Chicago Engineering Works
Dept. A-18 CHICAGO

Use This "FREE OUTFIT" Coupon

L. L. COOKE, Chief Engineer,
Chicago Engineering Works,
Dept. A-18, 2150 Lawrence Ave., Chicago

Send me your Free Outfit Offer, your big Electrical Book, Sample Lesson and particulars of your Electrical Course and Free Radio Course. This will not obligate me in any way.

Name.....

Address.....

For use of boys 15 years old or more.

Please Mention Popular Mechanics

Make Money Taking PICTURES



Got \$100 for Flood Pictures

"I took pictures of a flood and sold them for \$100. I have been able to buy my house and lot from the sale of pictures."

C. M. COLE,
Washington.

\$97 in Two Days!

"I made \$97 in December. Went out two days last week on home portrait work and made \$97."

A. G. HUGHES,
Kentucky.

Tremendous, big-paying opportunities are open for ambitious men in Modern Photography. This is the picture age. Magazine and newspaper publishers buy thousands of photographs each year. Every manufacturer sends out high priced pictures of his products. Every home wants portraits. Photography is a business running into millions of dollars each year. And there is a great shortage of trained photographers.

EARN \$3,000 to \$10,000 a YEAR

Hundreds of men are earning big money and establishing their own businesses. Even during spare time, while training, you can make \$75 a week easily—no matter where you live!

Amazing New Easy Method

I show you, at home, how to do the kind of work turned out by the big studios in New York and Chicago! I show you how to make big money within 30 days! C. M. Cole bought a home with money he had made when only half way through his training. So well do I know what I can do for you that I guarantee under bond to return every cent of your tuition if you are not thoroughly satisfied.



Professional View Camera FREE!

Write at once for Free Camera Offer—I give you free, a splendid professional view camera. You will be astonished and delighted. This offer open for short time only—so act quick! Be satisfied.

INTERNATIONAL STUDIOS, Inc.
Dept. 1198, 3601 Michigan Ave., Chicago, U. S. A.

30 Days' Free Trial

Select from 44 Styles, colors and sizes, famous **Ranger** bicycles. Delivered free on approval, express prepaid, at **Factory Prices**. You can easily save \$10 to \$25 on your bicycle.

12 Months to Pay on any Ranger if desired. Parents and girls can easily earn small monthly payments.

Tires best quality, at factory prices, express prepaid. **Lamps, Leaks, wheels and equipment, low prices. Send No Money, do business direct with makers.**

Mead Cycle Company
Dept. 103 Chicago



Write today for free Ranger Catalog, factory prices and marvelous easy payment terms.



Wonderful, new device, guides your hand; corrects your writing in few days. Big improvement in three hours. No failures. **Complete outline FREE.** Write C. J. Ozment, D-34, St. Louis, Mo.

Be a Newspaper Artist!



Win Fortune and Fame. **MANUEL ROSENBERG COURSE IN NEWSPAPER ART** tells you how. 71 Lessons and 150 Illustrations. Drawing made easy. Complete instruction in layouts, lettering, illustration, cartooning and sketching. Ten years' experience as staff artist of important American dailies. Send \$5 or pay the postman C. O. D. Only 250 copies left. Order yours TODAY.

MANUEL ROSENBERG
Butler Building Cincinnati, O.

LEARN WATCH REPAIRING

Be a watchmaker—you can learn this profitable trade by correspondence in a few weeks in your own home by the DeSelms Chert System. After you complete the course you will know a watch from A to Z. You will know just what the matter is and how to repair one. When you graduate you will be a practical watchmaker and repairer and competent to fill any position. Postpone for our graduates. Ask for our Free Book. It explains our system and terms.

THE DeSELMS WATCH SCHOOL
23 Perry Street ATTICA, INDIANA





Get Expert Training in DRAFTING

Raise Your Income

Send for Free Trial Lesson

FREE

Drawing Outfit

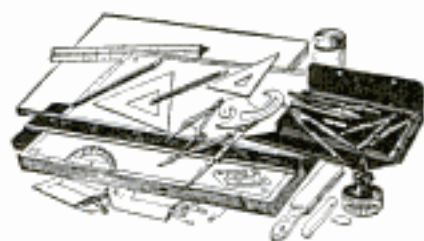

Students enrolled with Chicago Tech. for home study in Drafting receive this complete Drawing Outfit (retail price \$25.00) with no extra charge (or credit on fees if they have outfits). This is a regular full size outfit—same as used by practical draftsmen and engineers.

Send the Coupon

Mail the coupon and get the Free Trial Lesson—also catalogs and full information about the Chicago Tech. Method of teaching Drafting by mail. Find out about the opportunities that Drafting offers to ambitious men. No cost to you—no obligation. Send the coupon.

Become a skilled Draftsman and your future is settled. Your services will always be in demand by great organizations willing to pay top-notch salaries to men who can undertake important work and get it done. Never before such a call for men with practical knowledge of Drafting. Don't put in your time in hoping and wishing for better things or in working in a small pay job. Learn Drafting!

Chicago Tech. Will Train You by Mail

Right in your own home you can become a proficient, practical Draftsman. The Chicago Tech. experts will train you by mail, giving you the same thorough instruction you would get if you came to the College. Hold your present job and master Drafting in your spare time. Just a few hours a week is all you need to put in. No interference with your present work—and you put yourself years ahead of men without the ambition to get the specialized knowledge which means quick advancement and more money.

Salary increased 75% by Chicago Tech. training.

T. F. Anderson.

My income increased 92% since enrolling with Chicago Tech.

S. Patrick.

Have had my pay raised \$73.70 a week since I took the Chicago Tech. course.

S. Schrier.

Make Your Spare Hours Count for More Money

Chicago Tech. training gives you the experience of men who know what kind of training equips a man for quick advancement and a high salary. You get the kind of knowledge in Drafting that has the highest value measured by the pay check—and this simply by utilizing your spare time at home or by

To Employers:

Chicago Tech. men are practical. Write to us when you need Draftsmen.

attending the College (day or evening classes) in Chicago. No need to hesitate on account of cost. The fees are small and the terms easy.

FREE Trial Lesson

Just sign and mail the coupon and we will send this Trial Lesson which will show you how well prepared you are to take up Drafting. While other schools ask you to enroll and pay a fee before you receive instruction, we send you this free lesson first. Before you pay—before you even decide about enrolling, you test your ability and see just how we teach Drafting by mail. Send today—no money, only the coupon.

Chicago Technical College
1130 Chicago Tech. Building, CHICAGO, ILL.



CHICAGO TECHNICAL COLLEGE
1130 Chicago Tech. Bldg., Chicago, Ill.

Without cost or obligation on me please send instructive matter about opportunities in line I have marked with "X."

- Drafting.** (The Big Salary Course.) No experience necessary. Free Lesson sent now.
- Building Trade Course.** For men in the building lines.

Name.....

Address.....

Post Office.....

State.....

Novelty



Musical Instruments

Not toys—but high-grade practical instruments for Symphony or Jazz orchestras. Great for solo work at Club, Lodge or Legion gatherings or home entertainments. Anyone can play with a few simple lessons, furnished with each instrument.

Musical Pitch Fork Glassophone Jazz-O-Nette
Mando-Zi Harp Musical Saw Hohner Sax

Free Trial Try any of these instruments for 15 days. If not satisfied, if you can't learn to play it quickly and easily, return at our expense. Remarkably low prices. Easy Time Payments. Send today for new, illustrated catalog describing complete line.

MUSSEHL & WESTPHAL 481 S. Water Street
Pt. Atkinson, Wis.

Make \$10 a Night

Be a Drummer Professional drummers in demand everywhere and make big money. You can quickly and easily learn to play band, orchestra and dance music through my home study course. Write for particulars Today, NOW! Write for folder of special snare drum offer.

The Herman H. Rinne Correspondence School of Modern Drumming
3154 Park Ave. INDIANAPOLIS

MY 3 NEW INVENTIONS

Will Enable You to Quickly Learn **VIOLIN**

You have always longed to play the sweetest of all music—the Violin. Now with the aid of my 3 new inventions—mastery of the Violin is easily within your reach! My system of teaching by written and pictured instructions is far advanced over any other method! Endorsed by the foremost violinists of the country! I make it so simple and easy that

You Will Play a Complete Piece Your First Lesson

Just think of it!—you play real music at once! No boring, senseless—so long, dreary hours of practice. Under my instruction you will actually play a complete piece your very first lesson—and a new piece each succeeding lesson.

FREE VIOLIN OUTFIT

Most Complete Violin Outfit Ever Offered—furnished free to my students with the complete Conservatory course of 52 lessons. No extras to buy—everything is furnished. Outfit includes: splendid toned imported Violin, Bow, Extra Straps, Tuning Pipe, Mute, Rosin, handsome nickel-trimmed carrying case exactly as shown, and my 3 Remarkable Inventions.

Write Me Today

—and I will gladly tell you all about my 3 New Inventions and how I guarantee to teach you Violin quickly and thoroughly. Here is the opportunity you have waited for so write me RIGHT NOW.

Prof. A. Hincheliffe, First Hawaiian Conservatory of Music, Inc.
Dept. 70 Woolworth Bldg. 233 Broadway, New York

FREE
This \$20.00 Outfit



We Import
Our Violins Direct
From Europe

Learn to Write

I Teach by Mail

I can make a good penman of you at your home during spare time, no matter where you live or how poorly you now write. My simplified system is as shown thousands the way to good penmanship during the past twenty-five years—IT CAN and WILL do the same for YOU.

My beautifully illustrated 32-page Book

"How to Become a Good Penman" FREE!!

It contains many beautiful specimens of penmanship showing what others have accomplished by the Tamblin System, with testimonials and general information about our course. (Your name elegantly written on a card if you enclose stamp for postage.) Ladies taught successfully as men. Write Today. Address

F. W. TAMBLIN
418 Ridge Bldg. Kansas City, Mo., U. S. A.

MEN WANTED

Prepare as Firemen, Brakemen, Electric Motormen, and colored Train Porters. Hundreds put to work. No experience necessary. 500 more wanted. Name position you want.

RAILWAY INSTITUTE Dept. 35 Indianapolis, Ind.

Anyone CAN LEARN

No talent or experience necessary. Fascinating work. Pays big money. Complete instruction book tells about: Alphabets, Colors, How to Mix Prints, Show Cards, Window Board and Wall Signs, Ready made letters, Gilding, Tricks of the Trade, also gives 100 Alphabets and Designs. Book bound in inflexible list, leather-gold edges, and four ball bearing Show Card Pens. Sent postpaid \$3.00 (C.O.D. 10c ex.)

Applio Pub. Co., 57 Ross St., Dept. 50, N. Y. City

EARN MONEY IMMEDIATELY—WE FURNISH EQUIPMENT TO START!!

STUDY AT HOME

Directed by

The University of Chicago

Courses in English, History, Chemistry, Business, Education, Mathematics, Psychology, and 35 other subjects command credit toward a Bachelor degree. Begin any time. Address 15 Ellis Hall, University of Chicago, Ill.

\$25 A DAY Clear Profit

—every day you work. Make \$5,000 to \$10,000 a year in the Floor Surfacing Business with the American "Universal" method. Work for yourself. Experience, special training or large investment unnecessary.

New Field; Big Profits

Better floors are demanded everywhere. American "Universal" electric machine, doing work of six men, assures BIG PROFITS in this new uncrowded field. Every floor, —old or new, —in town or city, is your prospect. Work easy to get. Profit possibilities unlimited. Positive guarantee and 5-day trial offer protects you. Write today for complete details.

AMERICAN FLOOR SURFACING MACHINE CO.
523 S. St. Clair St., TOLEDO, OHIO

PRACTICAL ELECTRICITY SELF TAUGHT COMPLETE COURSE IN ELECTRICITY FOR FREE EXAMINATION

HAWKINS ELECTRICAL GUIDES

3500 PAGES—4700 PICTURES—\$1 A VOLUME—\$1 A MONTH—10 VOLUMES

OVER 5000
READERS
HAVE
OWNED
THIS
SET

Know the facts in Electricity. They mean more money and better position for you. Hawkins Guides tell you all you need to know about Electricity. Every important electrical subject covered so you can understand it. Easy to study and apply. A complete, practical working course, in 10 volumes. Books are pocket size; flexible covers. Order a set today to look over.

LEARN ALL ABOUT THESE IMPORTANT POINTS

Magnetism—Induction—Experiments—Dynamometers—Electric Machinery—Motors—Armatures—Armature Windings—Installing of Dynamometers—Electrical Instrument Testing—Practical Management of Dynamometers and Motors—Distribution Systems—Wiring—Wiring Diagrams—Sign & Flashers—Storage Batteries—

Principles of Alternating Currents and Alternators—Alternating Current Motors—Transformers—Converters—Rectifiers—Alternating Current Systems—Circuit Breakers—Measuring Instruments—Switchboards—Wiring—Power Stations—Installing—Telephone—Telegraph—Wireless—Bells—Lighting—Railways. Also many Modern Practical Applications of Electricity and Ready Reference Index of the ten numbers.

**USE FREE SHIPPED FREE
COUPON**

Not a cent to pay until you see the books. No obligation to buy unless you are satisfied. Read Coupon now—today—and get this great help library and see if it is not worth \$100.00 to you—you pay \$1.00 a month for ten months or return it.

NOW →

THEO. AUDEL & CO.,
72 Fifth Ave., New York City

Please submit me for free examination, HAWKINS ELECTRICAL GUIDE. (Price \$1 a number). Ship at once prepaid, the 10 numbers. If satisfactory, I agree to send you \$1 within seven days and to further mail you \$1.00 each month until paid.

Name.....
Occupation.....
Employed by.....
Home Address.....
Reference.....

PM Nov. '23.





DENTISTRY

MECHANICAL

**THE IDEAL VOCATION FOR MEN
WHO ARE MECHANICALLY INCLINED**

Dentistry needs more Mechanical Dentists. For men who like mechanical work, Mechanical Dentistry offers an exceptional opportunity to rise above a limited income into professional work with professional earnings.

TRAIN 3 MONTHS—THEN EARN \$35 TO \$125 A WEEK

The Dental Profession is constantly calling for graduates of the four great schools of this institution. Salaries from \$35 to \$45 a week to start, with advancement up to \$125 a week. Many positions are unfilled for weeks because of the great shortage and the demand.

ESTABLISH A BUSINESS OF YOUR OWN

Work with a Surgeon Dentist, in a Dental Laboratory, or establish a business of your own with unlimited earning possibilities. Dental experience or special education not required.

FREE 36-PAGE ILLUSTRATED CATALOG

Contains illustrations of students "Learning by Doing" actual practical work through individual instruction, day and evening sessions. Describes the great field and demand, and how you can "Earn While Learning." Investigate—Write today for Free Catalog No. 2.

BODEE DENTAL INSTITUTE

Founded 1892—No Correspondence Courses

NEW YORK
136 West 52d Street

PHILADELPHIA
1305 No. Broad Street

BUFFALO
1226 Main Street

BROOKLYN
15 Flatbush Avenue

LAW

BOOK FREE

Send for it today

Whether you are a corporation president or a clerk, capitalist or wage earner—whatever your ambition is—this book will be of vital interest to you—be of direct positive value. It tells you frankly about the amazing success of successful lawyers and law trained men in business. It proves conclusively how a law education will quickly fit you for a better position and bigger pay. It shows true stories of successful men in your spare time. It tells slayed for practically nothing. Three year course covers preparation for our examination. Degree of LL.B. conferred. Earn

\$5,000 to \$12,000 a Year as a lawyer or law trained man in business. Read at home—aided by reading course. Moneyback guarantee if not satisfied upon completion. Low fee, easy monthly terms. Includes complete up-to-date 12 volume library by the highest authorities. Send for free book now. No obligation to you whatever.

HAMILTON COLLEGE OF LAW
431 S. Dearborn St. Dept. 68
Chicago, Ill.

MUSIC LESSONS FREE

IN YOUR OWN HOME

You can read Music like this quickly

Piano, Organ, Violin, Mandolin, Guitar, Banjo, etc.
Beginners or advanced players. One lesson weekly. Illustrations make everything plain. Only expense about 20¢ per day to cover cost of postage and music used. Write for FREE booklet which explains everything in full.

AMERICAN SCHOOL OF MUSIC, 51 Lakeside Building, CHICAGO

LEARN WATCH REPAIRING



You can learn by our modern and original system of instruction every part of the Watch Repairing Trade at home as good or better than at a shop. You can earn money while learning and secure a well paying position or start in business after completing our course of instruction. Good watch repairers are always in demand and earn from \$30 to \$70 per week. For particulars apply to the Wisconsin School of Watch Repairing

166 Mason St., MILWAUKEE, WIS.

STAMMERERS

I can teach you to speak normally. Send for free booklet telling how. BOSTON STAMMERERS' INSTITUTE, FOUNDED 1897 Samuel A. Robbins, Director, 246 Huntington Ave., Boston 17, Mass.

"BECOME A LIGHTNING TRICK CARTOONIST"

MAKE MONEY CHALK TALKING. SEND \$1.00 FOR SNAPPY PROGRAM OF TRICK DRAWINGS WITH INSTRUCTIONS BY A PROFESSIONAL CARTOONIST. SATISFACTION GUARANTEED. CIRCULAR FREE. BALDA ART SERVICE, 61, OSHKOSH, WIS.



WANTED! Get \$1600 to \$2300 a Year

U.S. RAILWAY MAIL CLERKS

MEN—BOYS 18 OR OVER SHOULD MAIL COUPON IMMEDIATELY

Steady Work—No Layoffs—Paid Vacations
Travel—See the Country
Common Education Sufficient—Send Coupon Today—SURE

Franklin Institute, Dept. C180, Rochester, N. Y.
First: Send me, without charge, (1) sample Railway Mail Clerk Examination questions; (2) tell me how to get a U. S. Government job; (3) send list of places at which examinations will be held; (4) send copy of illustrated book, "How to Get Government Jobs."

Name.....
Address.....

These Books Helped 280,000 Men to Bigger Pay

Think of it, 280,000 men are getting Big Money because they own a set of these books. These men do not have to go to school—they need no special training—but, they got into the Big Pay Class with a set of these pay-raising reference books and the Free Consulting Membership. These books and the Membership are their Silent Partners—Always ready to help—Always at hand to advise. Every question is answered and every problem solved.

No matter what kind of work you are doing, don't you think you could learn something from twenty to thirty of the biggest experts in that line? The world's greatest experts have prepared these books to help men who want to advance into BETTER JOBS and BIGGER PAY. Each set is written in plain, every-day language that anyone can understand. There are no puzzling technical terms. They are written in a simple, understandable way that makes them doubly practical. You can put what they teach right to the test in your daily work—you can profit by them at once—you can refer to them dozens of times daily to solve some new problem—you can use their knowledge as a stepping stone to that better position you have had your eyes on for some time—and make them bring to your pockets that fatter pay envelope you have yearned for.

Reference Books That Make Happy Days of Pay Days. Select Your Own Line From This List for Week's Free Use

5 vols. Carpentry and Contracting—was \$37.50 now.....	\$19.80
12 vols. American Law and Practice (including free reading course and 250 page book of standard legal forms)—was \$97.50 now.....	49.80
8 vols. Applied Electricity—was \$60.00 now.....	29.80
6 vols. Auto Engineering—was \$45.00 now.....	21.80
9 vols. Civil Engineering—was \$67.50 now.....	34.80
8 vols. Business Management—was \$52.50 now.....	29.80
7 vols. Steam and Gas Engineering—was \$52.50 now.....	24.80
4 vols. Sanitation, Heating and Ventilating—was \$30.00 now.....	14.80
4 vols. Fire Prevention and Insurance—was \$30.00 now.....	14.80
6 vols. Modern Machine Shop Practice—was \$45.00 now.....	21.80
4 vols. Telephony and Telegraphy—was \$30.00 now.....	14.80
4 vols. Drawing—was \$30.00 now.....	14.80

Free Consulting Membership

A resident consulting staff of from 15 to 20 practical experts is waiting to solve for you any difficulty that you may have. A letter or a wire to American Technical Society will bring you an immediate answer and the solution to your problems. This advisory staff of practical men plus your working and reference library will enable you to handle successfully any job in your line. These men know all the latest methods and the newest and best ways of doing things. Let this pay-raising consulting staff be YOUR SILENT PARTNER. Use this service daily if necessary.

This Free Consulting Membership Offer Is Good for a Limited Time Only and Can Be Withdrawn Without Notice

Use Books Free for One Week—Send No Money

—just fill out the coupon. After you receive the full set of books, express collect, read them over and test them out for seven days. If you don't want them, send them back at our expense. If you decide they will do for you what they have done for more than 280,000 others, pay \$2.80 within one week and \$3 each month thereafter until the special price is paid. This amounts to only ten cents a day. Mail coupon NOW if you want a bigger, better job at higher wages.

Here's your opportunity, if you want to EARN MORE MONEY. Remember, we are taking all the chances—you pay NOTHING unless you are absolutely eager to after seeing the books. Isn't this about the fairest proposition you ever saw in print?

AMERICAN TECHNICAL SOCIETY

Dept. X-819

Chicago, U. S. A.

AMERICAN TECHNICAL SOCIETY, Dept. X-819 Chicago.

Please send me a set of..... for seven days' FREE EXAMINATION, shipping charges collect. I will examine these books thoroughly, and if satisfied, will send \$2.80 within seven days and \$3 a month until I have paid the special price of \$..... If I decide not to keep the books, I will return them within one week at your expense. It is understood that if I keep the books I am entitled to a FREE Consulting Membership in the Society.

Name.....

Address.....

Reference.....

(Please fill out all the lines, give local merchant, banker or employer as reference.)



"The Man Who Knows"

May we send you this inspiring booklet with our compliments? The coupon brings your copy



You will enjoy this interesting little book with its brief but significant stories of three of history's most striking characters. And then there is "A Little Story about You" from which you may get a suggestion of real importance in your career. An illuminating, profusely illustrated booklet is this—yours without cost or obligation.

What Is It Worth to You to Know?

When you face situations that call for facts—in the office, in the club, at a social gathering—what is it worth to you in influence and leadership, in dollars and cents, to meet these demands without hesitation? Success in life depends so largely upon your reserve of knowledge that you must have readily available such an infallible source of Knowledge as



THE NEW INTERNATIONAL ENCYCLOPEDIA

Newly Revised 1922 Edition

In the twenty-four volumes of this work, five hundred brilliant scholars have recorded all that the world has ever thought or done—all the knowledge gained since the beginning of time. Here is America's great question-answerer, at your service instantly—always, with the knowledge that brings success.



The Scholarship of a Hundred Universities

comes into your home with the New International Encyclopedia. Here at a moment's notice are the facts on almost any conceivable question. Get your copy of "The Man Who Knows" with its interesting story and its information about this great reference work.

Send This Coupon Now

DODD, MEAD & COMPANY
449 Fourth Ave.,
New York

Send me without cost or obligation a copy of "The Man Who Knows."

NAME.....
(Pop. Mech. 11-23)

ADDRESS.....

OCCUPATION.....

Please Mention Popular Mechanics

LEARN BY DOING

Every phase of all branches of

ELECTRICITY

Taught by Actual Practice

In America's foremost and oldest institution for trade training

No Books Used
Individual Instruction
Start Any Day

A SPECIAL and SEPARATE Course in Ignition, Auto Lighting and STARTER Systems. Write for FREE 64-page catalog.

THE
NEW YORK ELECTRICAL SCHOOL
44 West 17th Street, NEW YORK CITY

PIANO JAZZ

By Note or Ear. With or without music. Short Course. Adult beginners taught by mail. No teacher required. Self-instruction Course for Advanced Pianists. Learn 67 styles of Bass, 180 Syncopated Effects, Blue Harmony, Oriental, Chime, Movie and Cafe Jazz, Trick Endings, Clever Breaks, Space Fillers, Sax Slurs, Triple Bass, Wicked Harmony, Blue Obligato, and 247 other Subjects, including Ear Playing. 110 pages of REAL Jazz, 25,000 words. A Postal brings our FREE Special Offer.

Wortman Piano School, 259 Opera Theatre Bldg., Los Angeles, Cal.

STAMMER NO MORE

Kill the fear of stammering. Re-education the key. The widely famed Hatfield Method fully outlined in an accurate, dependable, worthwhile book—"HOW TO STOP STAMMERING." It has inspired thousands. Free copy today.

THE HATFIELD INSTITUTE, 109 N. Dearborn, Chicago, Ill.



THE BART CHALK-TALK

If you can draw a little, you can do the Bart Chalk-Talk. Send 4c in stamps for Chalk-Talk folder and complete catalog of art and Chalk-Talk Supplies.

Bart Supplies, Exlts Bldg., Minneapolis, Minn.

BE A TRAFFIC MAN

DEMAND INCREASING DAILY

With the energetic revival of business activities, the demand for men trained to handle transportation problems is greater than ever before. Our highly specialized course prepares you for this high salaried profession. Personal attention and practical experience—with successful Traffic Men. Special plan to help pay your tuition. Post graduate course FREE. Write today for full information.

INTERSTATE TRAFFIC SCHOOL
111 Traffic Bldg. Fort Wayne, Ind.



Is Your Time Worth \$50 an Hour?

FIFTY DOLLARS AN HOUR would be a mighty satisfactory price to receive for your time, wouldn't it? Yet, as a matter of fact, it may easily be within your power to invest a certain portion of your time in a way that, provided you are sincere and conscientious, will surely bring you that return—very possibly even more.

Sometime ago, an analysis of the relation of education to earning power—made by one of the largest philanthropic organizations in the country—demonstrated the fact that the average adult gets back in increased earnings the sum of thirty dollars for every hour spent in well directed study.

That certainly throws a new light on study habits, doesn't it? But read what follows.

This university trains men in their spare hours at home for specialized activities in the higher fields of business. Its resources of over seven and a half million dollars make possible the maintenance of staffs comprising many of the leading business specialists in the country.

It conducts its training by the LaSalle Problem Method—distinctive with this university—whereby the student gains not "book learning" but actual practice and experience, at every stage of his progress. He learns to do by *doing*. To all intents, from the moment he begins he is actually performing the work of the position he is training to fill.

Naturally you would expect the rewards to be higher for the man who trains this way than for the man who follows a less intensive—a less practical method.

The facts show that the gains *are* greater.

It is a matter of record—established by the facts in our files—files built out of the experience of the four hundred thousand men who have enrolled with LaSalle—that the time invested in the study of any highly specialized LaSalle course by the average member who *completes* that training, returns him in increased earnings not less than \$50 an hour.

Indeed, we have many reports showing that spare hours spent at home with LaSalle training have resulted in increased earnings which—when apportioned over the ordinary period of a

man's business activity—would show a return in excess of \$100 an hour.

Such reports are by no means unusual.

But it is safe for *any* man to expect—and with every prospect of realization—that with diligence and sincerity he can make the time he devotes to acquiring LaSalle training yield him returns at the rate of \$50 for each hour so invested.

LaSalle has no magic formula—no marvelous cure-all. All that it does—as witnessed by the progress-records of 400,000 men—is

to provide an effective way to help men help themselves.—Which is all the right man *needs*.

But that, as we see it, is a mighty big, a vitally important task, and we feel and realize the full necessity of living up to the tremendous obligation it carries—because it is our job as it is our privilege to serve one of the most sacred things in human life—ambition.

To the man who "doesn't care," LaSalle means nothing. But to the man who is looking for "the way," this institution has a message.

J. H. Hopkins
President
LaSalle Extension University

LaSalle Extension University

The Largest Business Training Institution in the World
Dept. 1164-R Chicago, Illinois

Upon request, the book "Ten Years' Promotion in One," and material completely descriptive of the course and service that interests you, will gladly be sent without cost or obligation. Indicate your choice by checking, and write below your name and address.

- | | |
|---|--|
| <input type="checkbox"/> Business Management | <input type="checkbox"/> Modern Business Correspondence and Practice |
| <input type="checkbox"/> Modern Salesmanship | <input type="checkbox"/> Modern Foremanship and Production Methods |
| <input type="checkbox"/> Higher Accountancy | <input type="checkbox"/> Personnel and Employment Management |
| <input type="checkbox"/> Law: Degree of LL. B. | <input type="checkbox"/> Expert Bookkeeping |
| <input type="checkbox"/> Traffic Management | <input type="checkbox"/> Business English |
| <input type="checkbox"/> Railway Station Management | <input type="checkbox"/> Commercial Spanish |
| <input type="checkbox"/> Commercial Law | <input type="checkbox"/> Effective Speaking |
| <input type="checkbox"/> Industrial Management Efficiency | <input type="checkbox"/> C. P. A. Coaching |
| <input type="checkbox"/> Banking and Finance | |

Name

Present Position

Address

He thought he could throw me—



Dear Tom: You know how Ted Brown has always been saying he could throw me with one hand tied behind him, if he wanted to. Well, yesterday, he grabbed hold of me and we had it out. Gee, I wish you'd been there. You know how much bigger Ted is than I. He thought he had me licked dead easy—

but



I wriggled around and got a hold on him that I'd learned from the Farmer Burns School of Wrestling. The next second — KERFLOP, and I had Mister Ted Brown on the ground, yelling for me to quit. It's a cinch to handle a fellow half as big again as you are if you know the secret holds. If I were you I'd write to Burns School for their free book about wrestling. So long—FRED.

Learn Wrestling Secrets from Worlds Champions Farmer Burns and Frank Gotch

Learn the marvelous holds, breaks, blocks and tricks that will enable you to handle big, strong men with ease. The renowned FARMER BURNS—"father of scientific wrestling"—and FRANK GOTCH the world's champion, have prepared a series of lessons in which they reveal the inside secrets of training that will make YOU, too, an expert wrestler. All the great secrets of self-defense and jui-jitsu illustrated by printed word and picture. The lessons teach you how to become a great athlete, and secret knowledge enabling you to throw boys and men larger and stronger than yourself.

Farmer Burns School
1778 Railway Exchange Bldg., Omaha, Neb.
Please send me at once, without obligation, your FREE illustrated booklet on Scientific Wrestling, Physical Culture, Self-Defense, and How to Win.

Name.....

Address.....

Age.....

Send for FREE Book

Our FREE ILLUSTRATED BOOK tells you all about the advantages in health, vigor and respect that being able to wrestle brings one. It tells you how to learn to become a skilled wrestler in your spare time. Brim full of interesting information about wrestling. Also lots of pictures. INVESTIGATE. Write today for this free book. No obligations. Tear out and mail coupon NOW!

Farmer Burns School 1778 Railway Exchange Bldg.
Omaha, Neb.

STAMMER

If you stammer attend no stammering school till you get my large FREE book entitled "STAMMERING, Its Origin and the Advanced Natural Method of Cure," bound in cloth and stamped in pure gold. Ask for special tuition rate and a FREE copy of "The Natural Speech Magazine." Largest, best equipped and most successful school in the world for the cure of stammering; stuttering, etc. No sing-song or time beat. Write today, The North-Western School, 2317 Grand Ave., Milwaukee, Wis.

WRITE JOKES

EARN FROM \$50 TO \$150 PER WEEK

writing jokes, epigrams and humorous stories for publications. Tremendous demand for material. Our short course in Humor Writing teaches you to write humorous material that sells. Learn in your spare time—earn in your spare time. Complete marketing plan and markets furnished.

Write for full particulars

AMERICAN INSTITUTE OF HUMOR
Office J, 414 Park Bldg., Cleveland, Ohio



WANTED—RAILWAY MAIL CLERKS

\$133 to \$192 a Month for Life

Every second week off with full pay — no "lay offs" because of strikes, poor business, etc.—sure pay—rapid advancement to higher positions. City and country residents stand same chance. Common sense education sufficient—no political influence.

**TRAVEL—SEE YOUR COUNTRY
DON'T DELAY—ACT AT ONCE**

Send Coupon today—sure. Every day's delay means so much less chance of appointment from the next examinations—so write at once.

FRANKLIN INSTITUTE, Dept. C178, ROCHESTER, N. Y.

Take the First Step for
a U. S. Government Job
Use Coupon Before You Lose It

COUPON

FRANKLIN INSTITUTE, Dept. C178, Rochester, N. Y.
Kindly send me, without any obligation whatever on my part and entirely free of charge, (1) A full description of the position checked below; (2) Sample examination questions; (3) Free copy of illustrated book "Government Positions and How to Get Them;" (4) A list of U. S. Government Jobs obtainable; (5) Tell me how to get the position here checked.

..... Railway Postal Clerk (\$1400 to \$2300) Customs Positions (\$1100 to \$2000)
..... Postoffice Clerk (\$1400 to \$1800) Internal Revenue (\$1100 to \$2000)
..... City Mail Carrier (\$1400 to \$1800) Rural Mail Carrier (\$1800 to \$2600)
..... Income Tax Auditors..... (\$2000 to \$3000)

Name.....

Learn to Mount Specimens like These

Write for
FREE
Taxidermy
Book!

Mount Birds, Animals and Fish Be a Taxidermist. Learn by Mail

You can now learn quickly, easily and thoroughly right in your own home by mail. Mount all kinds of game—birds, animals, game heads, fish, also taxskins and furs and make fine robes and rugs. Our wonderful course of 40 lessons teaches you all about taxidermy. The most interesting art you ever studied or can study. Here is the opportunity you have long wanted. Write for free book today. Men, women and boys—all love this wonderful art and all learn quickly. Of untold value to hunters and trappers. Business men, farmers and clerks, all take our lessons and are completely fascinated with this beautiful and easily learned art. If you do nothing else today, send for the free book and investigate.

Make Big Money!

Sell your mounted specimens (if you wish). Big demand and big prices. Mount for your sportsmen friends. The news soon travels that you are a taxidermist and the work pours in. Our students earn big extra money in spare time for guns, traps, books, radio, vacations, etc. One writes "have made over \$100.00 from taxidermy, in spare time, since I joined the school". The most profitable "side line" business in the world.

Learn Field Taxidermy Sportsmen and fishermen, you must know "field taxidermy" to properly care for specimens when you take them, if they are to be correctly mounted later. This is of great importance to all who take hunting and fishing trips. Completely taught in our lessons.

Be a Taxidermy Artist

We now reveal all secrets of taxidermy. We teach latest methods. You become a true artist. You can decorate your home, office or den with nature's finest art—actual game specimens, preserved exactly like life—not mere pictures, but the beautiful game itself. You can become a true taxidermy artist, using spare time only.

Sportsmen—Fishermen if you do not save your finest trophies you miss and lose more than half the pleasure and all the profit. Save your hard-earned elk, deer, wild cat, grouse, duck, bass or trout. All real sportsmen now insist on knowing taxidermy. We can teach you. Our school teaches taxidermy—nothing else, 20 years in business. 75000 graduates in every civilized country. Now is the time to start.

Write for FREE Book

Our beautifully illustrated Taxidermy Book tells you how to learn the art. Send the coupon at once and receive copy by return mail extremely interesting, and shows dozens of photos of mounted game specimens.

FREE This book is absolutely free. No obligation on your part whatever. If you hunt, fish or trap, you need this book. You cannot imagine how interesting and valuable it will be to you, so send right now. Don't delay or you may forget it. Clip the coupon this minute.

Free Book Coupon

Northwestern School of Taxidermy
1778 Elwood Bldg., Omaha, Neb.
Send me absolutely free your illustrated book, "How to Learn Taxidermy." No obligation.

Name

Address



"Be Wise"



High School Course in Two Years!

You Want to Earn Big Money!

And you will not be satisfied unless you earn steady promotion. But are you prepared for the job ahead of you? Do you measure up to the standard that insures success? For a more responsible position a fairly good education is necessary. To write a sensible business letter, to prepare estimates, to figure cost and to compute interest, you must have a certain amount of preparation. All this you must be able to do before you will earn promotion. Many business houses hire no men whose general knowledge is not equal to a high school course. Why? Because big business refuses to burden itself with men who are barred from promotion by the lack of elementary education.

Can You Qualify for a Better Position

We have a plan whereby you can. We can give you a complete but simplified high school course in two years, giving you all the essentials that form the foundation of practical business. It will prepare you to hold your own where competition is keen and exacting. Do not doubt your ability, but make up your mind to it and you will soon have the requirements that will bring you success and big money. YOU CAN DO IT.

Let us show you how to get on the road to success. It will not cost you a single working hour. Write today. It costs you nothing but a stamp.

American School

Dept. H874, Drexel Ave. and 58th St., Chicago

American School

Dept. H874, Drexel Ave. and 58th St., Chicago

Send me full information on the subject checked and how you will help me win success.

- | | |
|------------------------------|----------------------------|
| Architect | Lawyer |
| Building Contractor | Machine Shop Practice |
| Automobile Engineer | Photoplay Writer |
| Automobile Repairman | Mechanical Engineer |
| Civil Engineer | Shop Superintendent |
| Structural Engineer | Employment Manager |
| Business Manager | Steam Engineer |
| Cert. Public Accountant | Foremanship |
| Accountant and Auditor | Sanitary Engineer |
| Bookkeeper | Surveyor (& Mapping) |
| Draftsman and Designer | Telephone Engineer |
| Electrical Engineer | Telegraph Engineer |
| Electric Light & Power | High School Graduate |
| General Education | Fire Insurance Expert |
| Vocational Guidance | Wireless Radio |
| Business Law | Undecided |

Name.....

Address.....

Please Mention Popular Mechanics

WE TEACH COMMERCIAL ART

Meyer Both Company, the largest Commercial Art Organization in the World, offers you an unusual opportunity for practical training, based upon twenty-three years of success. This nationally known organization each year produces and sells to advertisers over 15,000 commercial drawings. Meyer Both instruction is the difference between successful fact and experimental theory. This well paid profession is equally open to men and women. Home study instruction.

Get Facts Before You Enroll in Any School

Ask the Advertising Manager of the leading newspapers in your city, anywhere in the United States, Canada, England or Australia about the Meyer Both Company—let them tell you about us. Write for our illustrated book telling about the success of our students—for one-half the cost of mailing—four cents in stamps.

MEYER BOTH COMPANY

Department of Art Instruction
Michigan Ave. at 20th St., Dept. 16, CHICAGO, ILL.

Note—To Art and Engraving Firms: Secure practical artists among our graduates. Write us.

ELECTRICAL ENGINEERING IN ONE YEAR men with training are in demand. For more than a quarter of a century this school has been training men of ambition and limited time, for the electrical industries. Condensed course in Electrical Engineering enables graduates to secure good positions and promotions. Theoretical and practical Electricity, Mathematics, Steam and Gas Engines, Mechanical Drawing. Students construct dynamos, install wiring and test electrical machinery. Course with diploma, complete.



Thoroughly equipped fireproof dormitories, dining hall, laboratories, shops. Over 3000 men trained. Write for catalog. 31st year begins Sept. 26, 1923.

BLISS ELECTRICAL SCHOOL

104 TAKOMA AVENUE, WASHINGTON, D. C.

BE A PIANO TECHNICIAN



Our Tune-a-Phone Guides You to Success

Tuning, Voicing, Regulating, Finishing and General Care of Pianos Taught in ONE Complete Course. 25 years of successful correspondence instruction makes our guarantee worth while. Knowledge of music NOT necessary. Write for FREE BOOKLET and the plan that saves you all risk in testing our method of teaching. NILES BRYANT SCHOOL, 24 Bryant Bldg., Augusta, Mich.

LAW High-Grade Instruction

By Correspondence
Prepares You for the Bar—Est. 1892

University Methods.

Standard Text-Books. Approved by Bench and Bar. Graduates practicing in every state. Send today for Free Catalog and Rules for Admission to the Bar.

Chicago School of Law
520 Reaper Block Chicago, Ill.



HOW TO BECOME A PROFESSIONAL PHOTOGRAPHER EARNING \$35 TO \$125 A WEEK



Three to six months' course. Motion Picture, Commercial, Portraiture. Practical instruction. Modern equipment. Ask for Catalog No. 49.

N. Y. INSTITUTE OF PHOTOGRAPHY
NEW YORK CHICAGO BROOKLYN
141 W. 36th St. 630 So. Wabash Ave. 505 State St.



MEN WANTED

This Don't Mean Any Kind of Men. It Means Trained Men



MEN WHO KNOW A TRADE. SKILLED MEN

What is the difference between trained men and untrained men today? Trained men are receiving from \$8 to \$15 per day, steady time. Untrained men are receiving from \$2.50 to \$5.00 per day and work wherever and whenever they can find employment.

One of our men recently qualified as an automotive engineer for a job paying from \$3,600.00 to \$5,000.00 per year, another for \$1.00 per hour, steady time as an electrical expert and so it goes.

There are all kinds of big paying jobs for you as well as thousands of others, if you will but wake up to what is waiting for you. Will you answer the call or are you satisfied with an unskilled, small pay job. Office men all over the country

are realizing the opportunities in the trades for them, are quitting their jobs and learning a trade.

Blame yourself if you do not take advantage of this opportunity. Write today, now, for our big, FREE catalogue, the most practical course of training at the lowest price. *Everything complete, practical and made so simple that any man can master it.* Night business course, night Radio course, Y. M. C. A. membership, Life Scholarship privileges. All for the one low fee.

"Teach Your Dollars to Have More Cents"

IOWA STATE AUTO TRACTOR SCHOOL

"The Best By Test"

739 Nebraska St.

Sioux City, Iowa

COUPON

IOWA STATE AUTO TRACTOR AND ELECTRICAL SCHOOL,
739 Nebraska St., Sioux City, Iowa

Please send me free your big 72 page illustrated book.

Name.....

Address.....

R. F. D.....

You Can Easily Learn to Play Any Music on the HAWAIIAN GUITAR

Just As Hawaiians Do—Native Instructors Teach You QUICKLY!

Here's Proof of our Remarkable Course

Buchanan, Va.,
First Hawaiian Conservatory of Music, Inc.

It has been two months since I have finished your course on the Hawaiian Guitar and I can play anything I wish. The course was all that could be desired and I am perfectly pleased with my playing ability since finishing your course.

Respectfully yours,
Louise E. Hammond

Koester School,
214 So. Franklin St.,
Chicago, Ill.

First Hawaiian Conservatory of Music, Inc.

I shall certainly be very glad to recommend your course whenever the chance is mine to do so. Mr. W. L. Johnson has not phoned me yet, and if he does not phone in a day or so, will write him. Am sending a letter to Miss Helen Slavik today which I think may help to secure her enrollment, and I shall be glad at any time to write a personal letter to anyone whom you may suggest.

Your former student,
W. L. Walker

In Half an Hour You Will Be Playing "ALOHA". Soon You Will Be Winning Praise Everywhere Playing "Stumbling", "Three O'Clock in the Morning", "Hot Lips" and ALL Popular Music as Well as the Beautiful Hawaiian Melodies

Here's the chance you've been waiting for—the opportunity to play popular music quickly on the most entrancing instrument of the age—the Hawaiian Guitar. No previous musical knowledge necessary.

ONLY FOUR MOTIONS TO LEARN

and these you acquire in a few minutes. No troublesome scales or runs, you begin to play harmonious chords immediately! We don't care if you never saw a note of music in your life, we guarantee to teach you to play just as the Hawaiians do!

We Furnish Everything—a Beautiful Hawaiian Guitar, Picks, etc., and 52 Pieces of Music FREE!

You have always wanted to play some instrument, so we have made it unusually easy for you by furnishing everything—a beautiful Hawaiian Guitar, complete Conservatory Course of instruction and 52 pieces of especially selected music.

No Other Course Teaches as Quickly and Easily

This is the only Conservatory Course where you get the personal instruction of Native Hawaiian Experts—Frank Ferrera, Walter Kolomoku, Lawrence Kalaluki and Carl Seville, famous the world over and the most noted makers of phonograph records, supervise your playing.

Mail Coupon for Details of FREE Offer

Don't wait another minute—clip, fill in and mail the coupon NOW and get full details of our remarkable offer to teach you how to play the Hawaiian Guitar just as the Hawaiians do.

Special Arrangements for Lessons if You Have Your Own Instrument

FREE

This \$15
Hawaiian
Guitar

You will be delighted with the fine tone of this splendid Hawaiian Guitar

First Hawaiian Conservatory of Music, Inc.,
Desk 48 - 213 Broadway (Woolworth Bldg.), New York.

Send me at once details about your 52 easy lessons and FREE Hawaiian Guitar offer!

Name.....

Address.....

Town..... State.....

Print name and address clearly.

Special Courses under famous Teachers. Tomorrow, Violin, Banjo, Ukulele and Ukelele. Fine Toned Instruments

FREE!



BE A RAILWAY TRAFFIC INSPECTOR

Earn Up to \$250 Per Month

"The Best Thing I Know Of"

—By H. M. LONG



"The S. B. T. I. Course in Railway Traffic Inspection is the best thing I know of and I have never been able to find words to praise it as I think it deserves to be praised.

"Railway Traffic Inspection is easy to learn if anyone who studies it has any grit at all. And the Course itself is easy, interesting, instructive, important and influential. The hours are not long and the pay is fair to begin with but soon becomes excellent if one only uses his head and maintains himself honestly.

"I want to say for the Standard Business Training Institute that its promises are carried out to the letter and even more. Furthermore, they are always willing to help a man after he has begun working, and for those who do not know, let me say that this means more than they can imagine."

POSITION GUARANTEED

Earn Up to \$250 Per Month, Expenses Paid

Prepare in three months' spare-time study at home for this fascinating profession. Many opportunities for advancement; many men are needed. Steady, pleasant outdoor work; travel or remain near home.

YOU TAKE NO RISK

After completing course if we do not get you a position paying at least \$110.00 a month and expenses, we refund your entire enrollment fee. Cost is moderate.

Send coupon today for full details.

Standard Business Training Institute
BUFFALO, N. Y.



Standard Business Training Institute,
BUFFALO, N. Y.

Send me, entirely free, Booklet No. D-63, giving full particulars about course in Railway Traffic Inspection.

Name

Street

City

Please Mention Popular Mechanics



Play PIANO By Ear

No matter how little you know about music, if you can just remember a tune, I teach you to play Jazz, Ragtime, Popular Songs **BY EAR, easily, quickly.** Beginners and even those who could not learn by the old fashioned method grasp the Niagara idea readily. Self-instruction—no teacher required. You learn many new styles of bass, syncopation—blues, fill-ins, breaks, trick endings, etc. Why spend years studying tiresome scales and finger exercises when I teach you to

Be a Master of JAZZ and RAGTIME Learn at Home in 90 Days

and play any tune you can remember, by ear—without notes. Original method, wonderful, easy. No do-re-mi—no scales—just a few simple rules, a little practice—results are amazing. Letters from hundreds of enthusiastic pupils and interesting book SENT FREE. No other course like it—fully protected by copyright. Simply write me name, address. State if you have ever taken piano lessons.

Ronald G. Wright, Director,
NIAGARA SCHOOL OF MUSIC
Department 595 Niagara Falls, N. Y.



Send for this Free Book

Rider Agents Wanted

Select from the 44 Styles, colors and sizes of Ranger Bicycles. Ride and exhibit sample Ranger and make money. Delivered free, express prepaid, on approval. Factory-to-Rider prices save \$10 to \$25.

12 Months to Pay on any Ranger if desired. Boys and girls easily save the small monthly payments. Parents often advance first payment, best quality, at factory prices, express prepaid. Tires, lamps, wheels and equipment, low prices. Send No Money, do business direct with makers.

Mead Cycle Company
Dept. 108 Chicago

Write today for free Ranger Catalog, factory prices and marvelous easy payment terms



LEARN WATCHMAKING

and become independent. Good-paying positions secured. Easy to learn. Send for FREE CATALOG.

ST. LOUIS WATCHMAKING SCHOOL, Dept. 5, ST. LOUIS, MO.

BE AN ARTIST

Comics, Cartoons, Commercial, Newspaper and Magazine Illustrating, Postal Crayon Portraits and Fishery. Our simple method quickly develops your talent in spare time. By Mail or Local Classes. Write for terms and list of successful Students. ASSOCIATED ART STUDIOS 87-B Flatiron Building, NEW YORK

PIMPLY SKIN made WELL

When a few applications of this wonder-working lotion has cleared faces of pimples,

FREE BOOK blackheads, acne eruptions on the face or body, barbers itch, eczema, enlarged pores, oily or shiny skin, you can realize why CLEAR-TONE has been tested and approved in over 100,000 Test Cases.

The simplicity of the treatment, and The Story of How I Cured Myself are all explained in my free booklet, "A Clear-Tone Skin." Write for your copy today and learn of the results gotten by thousands of men and women.

E. S. GIVERS, 128 Chemical Bldg., Kansas City, Mo.



Copyrighted material

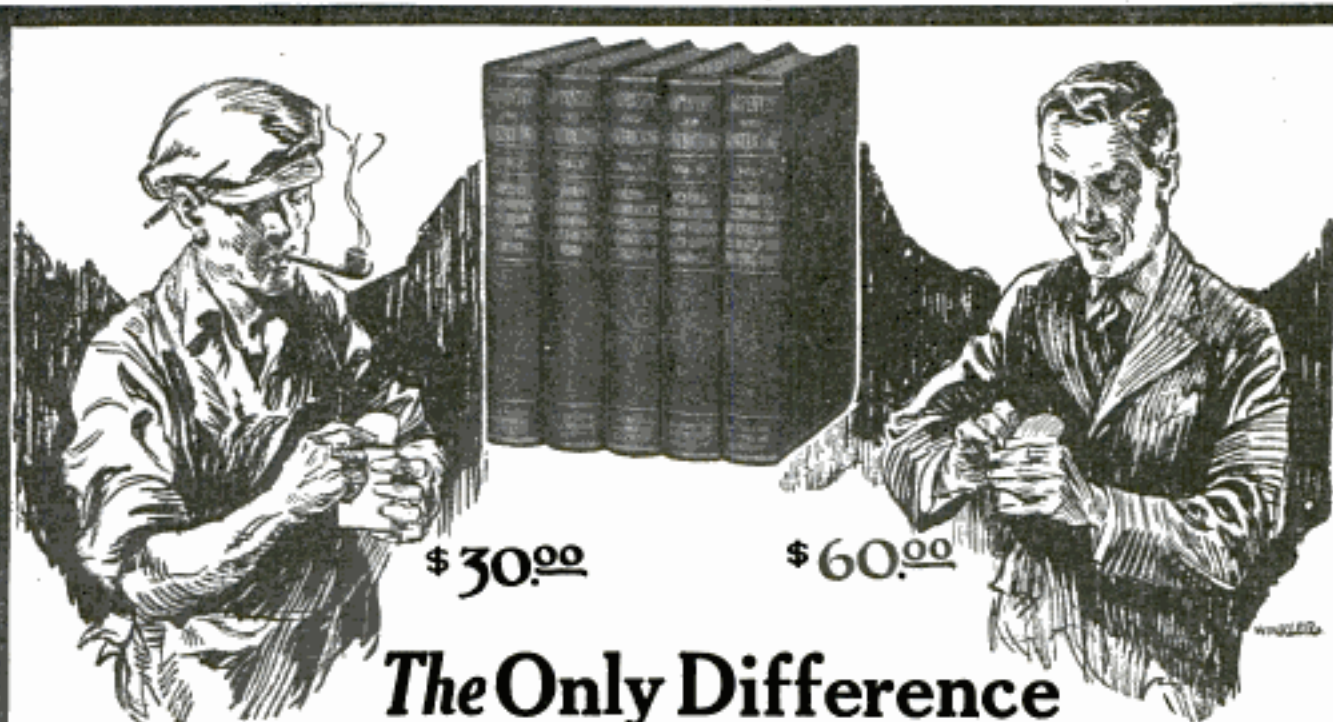

The Only Difference Between Them Is a Set of Books

One earns \$30 a week—the other \$60. A year ago they were equal in skill, and both got the same pay. But one stood still, while the other was ambitious to get a bigger, better job. He read our "Carpentry and Contracting" and it told him a thousand things he never knew before—

gave him ideas—better ways of doing things—enabled him to do jobs successfully—by so doing helped him to solve the problems that came up in his daily work. The big boss was quick to notice his progress. Today he has a better job and a man's size income. He is the boss himself.

FREE Consulting Membership

A resident consulting staff of 17 practical experts is waiting to solve for you any building or contracting troubles that you may have. A letter or a wire to the American Technical Society will bring you an immediate answer and the solution to your problems. This advisory staff of practical building men plus your library of Carpentry and Contracting will enable you to handle successfully any building job. These men know all the latest methods and the newest and best ways of doing things. Let this pay-raising consulting staff be YOUR SILENT PARTNER. Use this service daily if necessary.

This free consulting membership offer is good for a limited time only and can be withdrawn without notice

Free Examination 6 Months to Pay

Send the coupon for these pay-raising Carpentry and Contracting books TODAY. You will receive the whole set, by express collect, for a week's FREE examination and use. If you don't think they are worth twice the money, notify us to take them back at our expense. If you like them send us only \$2.80 in seven days and \$3 each month until \$19.80 is paid, or cash with order \$17.80. Remember, sending the coupon does not obligate you to buy.

**American
Technical Society**
Dept. G-819
Chicago, Illinois

With the big building boom sweeping across the country, there is a demand for more and better carpenters, plasterers, painters, masons, plumbers—every branch of the building trade is crying for good men at BIG WAGES. Now is the time for you to "cash in"—you can earn more if you learn more. Every man in the shop or on the job should have this set of

Carpentry and Contracting

Five big, wonderful volumes, bound in black flexible binding that will last a lifetime, 2138 pages of practical wisdom and more than 1,000 blue prints, plans, pictures and diagrams, prepared by 25 well-known experts.

Here are a few things this set of books will tell you:

Estimating	Blue Print Reading	Concrete Work
Drafting	Use of Steel Square	Stair Building
Drainage	Heating and Ventilating	Plumbing

Why not spend a little of your spare time at home fitting yourself for a much better job and a fatter pay envelope? Read this FREE trial offer and easy payment plan.

© A.T.S. 1923

AMERICAN TECHNICAL SOCIETY, Dept. G-819
Chicago, U. S. A.

Please send me a set of Carpentry and Contracting, for seven days' FREE EXAMINATION, shipping charges collect. I will examine these books thoroughly, and if satisfied, will send \$2.80 within seven days and \$3 a month until I have paid the special price of \$19.80. If I decide not to keep the books, I will return them within one week at your expense. It is understood that if I keep the books I am entitled to a FREE Consulting Membership in the Building division of the Society.

Name.....

Address.....

Reference.....

(Please fill out all lines, give local merchant, banker or employer as reference.)

Be a Certificated **Electrical Expert**

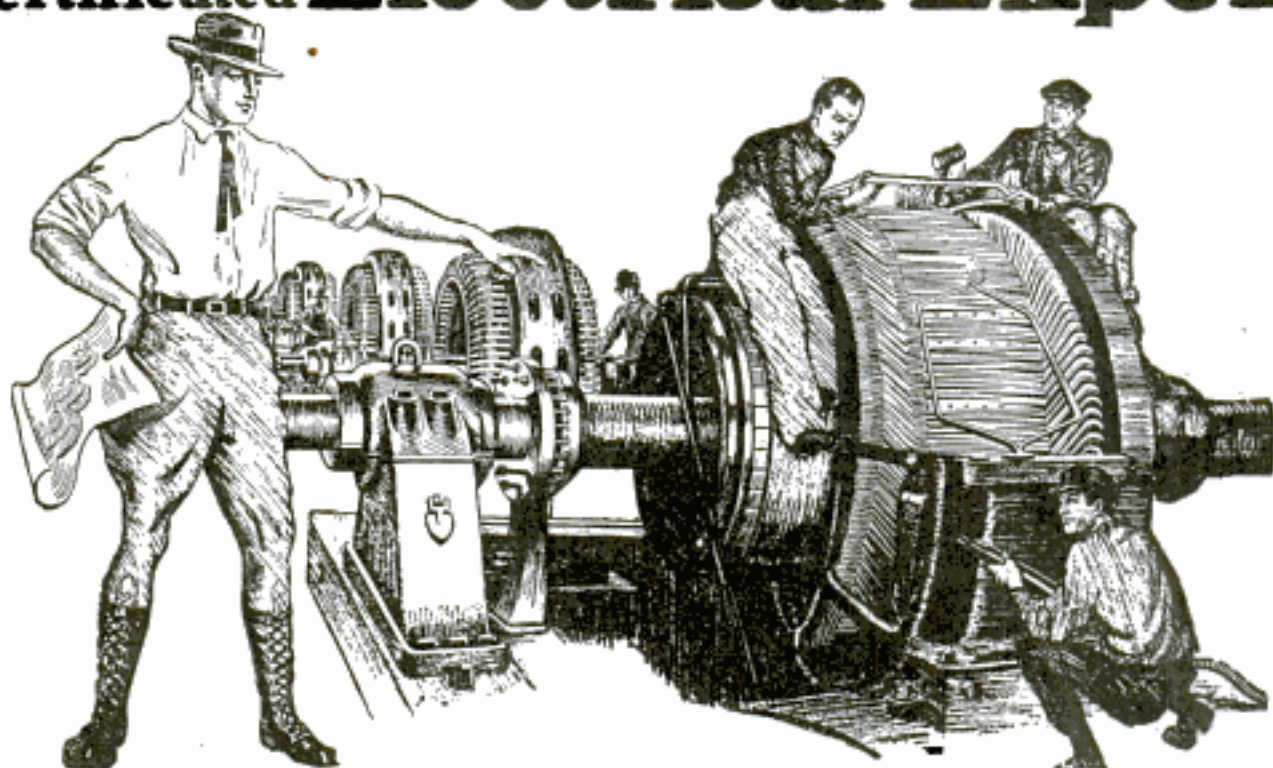

“Electrical Experts” Earn \$12 to \$30 a Day WHAT’S YOUR FUTURE?

Now you earn \$20 or \$30 or \$40 a week. In the same six days as an Electrical Expert you can make \$70 to \$200 a week and make it easier—not work half so hard. Why then remain in the small-pay game, in a line of work that offers no chance, no big promotion, no big income? Fit yourself for a “Bossing” job—

Be an “Electrical Expert!”

Today even ordinary Electricians—the “screw driver” kind—are making money—big money. But it’s the trained man—the man who knows the whys and wherefores of Electricity—the “Electrical Expert,”—who is picked to “boss” the ordinary Electricians—to boss the Big Jobs—the jobs that pay.

\$3,500 to \$10,000 a Year

Get in line for one of these “Big-Pay Jobs” by enrolling now for my easily-learned, quickly-grasped, right-up-to-the-minute, Spare-Time Home-Study Course in Practical Electricity.

Age or Lack of Experience No Draw-Back

You don’t have to be a High School graduate—it isn’t even necessary that you should have finished the grades. As Chief Engineer of the Chicago Engineering Works, I know exactly the kind of training you need, and I will give you that training. My Course in Electricity is the most simple, thorough, successful and practical in existence, and offers every man, regardless of age, education, or previous experience, the chance to become, in a few short months, an “Electrical Expert,” able to make from \$70 to \$200 a week.

Earn While You Learn

With me you do practical work—at once. In my first few lessons I show you how to make money doing Electrical work in your spare time. (Over half of my students are paying for their Course in this way.) I show you, also, how to get started in business for yourself, and then I help you to get started.

FREE—Electrical Working Outfit—FREE

To do spare time work you’ll need tools, etc. These I give you,—Free—a whole kit, including measuring instruments, a real electric motor (no toy), and other things—the greatest value ever given by any School.

Your Satisfaction Guaranteed by a Million Dollar Institution

I absolutely guarantee to return every penny paid me in tuition if, when you have finished my Course, you are not satisfied in every way with my instruction. And back of me, in my guarantee, stands the Chicago Engineering Works, a million dollar institution.

Nothing Like “Cooke” Training Anywhere

“Cooke” training is *different* because it’s the most practical and most successful. It’s *best* because it’s backed up by the greatest Service to students ever known. It’s this Service, plus “Cooke” training, that makes the “Cooke” trained man the “Big-Pay” man everywhere. Become a “Cooke” Trained Man yourself, and earn \$12 to \$30 a day—\$70 to \$200 a week—\$3500 to \$10,000 a year.

Investigate! Mail Coupon

Get the Vital Facts. Let me send you *free* my big new book on The Future of Electricity. Let me tell you more about the big demand for “Cooke” trained Electrical Experts. Sign and send me Coupon below.

L. L. COOKE, Chief Engineer

Chicago Engineering Works

INCORPORATED
Dept. 18, 2150 Lawrence Ave., CHICAGO, ILL.

L. L. COOKE, Chief Engineer, Chicago Engineering Works,
Dept. 18, 2150 Lawrence Ave., Chicago, Ill.

Dear Sir: Send me at once full particulars of your great Special Offer; also your Free booklet on “How to Become An Electrical Expert.” No obligation on my part.

Name.....

Address.....

Occupation..... Age.....

The “Cooke” Trained Man is the “Big Pay” Man

Classified Advertisements

WORLD'S BEST WANT AD MEDIUM

Advertisements in this section, 25 cents per word, each insertion, minimum 10 words, payable in advance. To be inserted under proper classification in December issue, copy should be in our office October 18th.

ADVERTISING AGENCIES

ADVERTISING. We sell Display in all publications at Publishers' rates and advise for your profit. What do you sell? Write, Capital Advertising Co., Inc., Munsey Bldg., Washington, D. C.

TO secure agents or salesmen or for selling farms and reaching investors, use classified (want) ads in largest newspapers and magazines. Price list No. 30 sent free. Anbram Advertising Agency, 20 W. Jackson Blvd., Chicago, Ill. The largest classified advertising agency in the U. S.

25 WORDS—355 Rural Weeklies, \$14.20. Ad-Meyer Agency, 4112-M Hartford, St. Louis.

FOR ADVERTISERS

ADVERTISE in 24 Big Sunday Newspapers, 24 words \$15.00. Catalog listing 1,000 leading Dailies, Weeklies, Magazines, 4c stamps. Union Advertising, Baltimore Bldg., Chicago.

28 WORDS 200 Newspapers and Magazines \$5. Beck Agency, 5406 Alaska, St. Louis.

SALES LETTERS

25 YEARS Direct Mail Experience writing letters, circulars, booklets, mapping out complete campaigns, producing \$50 to \$50,000 daily sales. Submit in detail your problems for free diagnosis. Ten years Sales Promotion Manager Larkin Co. James C. Johnson, 118A Woodbridge Ave., Buffalo.

AUTOMOBILE SUPPLIES

AUTOMOBILE owners, garagemen, mechanics, send for free copy America's popular motor magazine. Contains helpful, money-saving articles on repairing, overhauling, ignition, carburetors, batteries, etc. Automobile Digest, 507 Butler Bldg., Cincinnati.

WHY pay \$25.00 to \$200.00 repair bills? Buy "Automobile Repairing Made Easy" and do the job yourself. Every detail of every car fully handled. All owners, mechanics, chauffeurs, dealers need it. 1060 profusely illustrated pages. \$4.00 postpaid. Catalogue free. Wells and Edwards, P852 George, Chicago.

AUTOMOBILE parts, guaranteed new for all cars. Save money; get our wholesale prices on gears, shafts and bearings. State make of car, model and parts wanted. Parts shipped immediately from stock. We refund your money, including transportation charges, if not satisfied. Mechanics Gear Co., 3708 No. Halsted St., Chicago.

AUTOMOBILE Parts—Used parts for most any car at half factory list prices. Allen, Briscoe, Buick, Cadillac, Chalmers, Chevrolet, Dodge, Ford, Grant, Hudson, Hupmobile, Oakland, Overland, Oldsmobile, Reo, Studebaker and many others. Send list of parts wanted. Maxwell Bros., 4106 Olive St., St. Louis, Mo.

LIBERTY Air Compressors, for garages, tire-shops, filling stations, also paint spraying equipment. Air Compressor & Equipment Co., 1437 Carroll Avenue, Chicago, Ill. Distributors wanted.

TOURIST Auto Sleeping Beds—Camp Equipment. Vanderpool's, Springfield, Ohio.

IMPROVED Alloyum Pistons for all cars, saves oil and gas; light weight; get more speed and power; circular free. Egge, 7794 S. Main St., Los Angeles, Calif.

SINK-OR-SWIM Ball Hydrometers universally satisfactory. Agents extraordinarily successful. One Dollar. Chaslyn Company, 3845 Barenwood Avenue, Chicago.

RECHARGING Automobile Storage Batteries with Constant Potential 8-Hour Service Pays big Profits. Easy payments paid by increased earnings. Particulars free. Hobrosco, Troy, Ohio.

ONE Magneto Recharger, only, with Agency, \$35.00. Reliable, Utica, N. Y.

STANLEY Steamer Owners, a real boiler for your automobile. Vaporizers, superheaters, accessories. Everything for your steamer. "Doc" Payne, Denver, Colo.

TITAN A-C Spark Plugs, all sizes, each 35c. Kelly Lamp Works, Oak Park, Ill.

YOUR Motor will start hard the first cold morning unless you are prepared. Imperial primers start immediately, \$4.75. Water Thermostats heat your motor quickly—\$10.00. Both are necessities. Easily installed, 10% for cash with order. Rayfield, 3941 Washington Blvd., Chicago, Ill.

AGENTS, Easy Money. Interview motorists. Patented instrument every motor needs. It Saves Money Three Ways—guaranteed. Thousands "Sold." Glad Users Everywhere. Big demand at your door. Pleasant work. Permanent business of your own—employ sub-agents—\$75.00 weekly up, all or part time. Experience unnecessary. This is a high-class money-making proposition. Your opportunity for success. Whatever you do answer this ad quick. Wizard Mfg. Company, 453 Central Ave., Rochester, N. Y.

ALL Overhead-valve motors made noiseless by Lane Hocker Arm Silencer. Excellent for Buick, Durant, Chevrolet, etc. Spring takes up lost motion between valve stem and cam shaft. State year of car. Easily attached. Set mailed on receipt of \$2.50. Circular. Agents wanted. Consolidated Mfg. Co., 32 Union Square, New York.

AUTO parts—Save 25-90%. New gears, axles, bearings, springs, radiators, magnetos—4,000 models. Bankrupt supplies, retopping outfits. Brightman Auto Exchange, 321 Windsor Ave., Hartford, Conn. Largest in the East.

VALVE Fits all tires. Seal tight with lock nut. County distributors wanted. Stamps 25 cts. brings a sample. Duryea Co., Hackensack, N. J.

REPAIRING Ford Cars, Trucks and Tractors in the most proper and efficient way is explained in a new 229-page book by the former director of the Ford Motor Co. Service School. This information is otherwise unavailable outside of the Ford plant. Written more especially for the mechanic and repairman. Price \$2 postpaid. Popular Mechanics Book Dept., 266 E. Ontario St., Chicago.

COMPRESSOR, Automatic Air. \$35.00 brings it—balance terms. Particulars free. Hoharts, Troy, Ohio.

BYPRO—Motor Tonic. Increases Specific Gravity of Gasoline; prevents Carbon; increases Mileage; gives Greater Efficiency. Cannot injure Motor. 5-ounce can treats 125 gallons. \$1.00—postpaid. W. G. Duff, 62 North Harrison Ave., Belleue Branch, Pittsburgh, Pa.

BECOME real sales factor. Wide-awake distributors can connect with reputable manufacturer of Nationally advertised automobile products in building world's largest and most successful distributing organization. An opportunity to develop honest, aggressive effort into permanent and profitable business. Applicants must furnish unquestionable references. Robert Bowes, E. Ohio Street Office, Indianapolis.

AUTOMOBILES

AUTOMOBILE owners, garagemen, mechanics, send for free copy America's popular motor magazine. Contains helpful, money-saving articles on repairing, overhauling, ignition, carburetors, batteries, etc. Automobile Digest, 507 Butler Bldg., Cincinnati.

PATENTS—Write for our free illustrated Guide Book and Evidence of Conception Blank. Send model or sketch and description of your invention and we will give our opinion of its patentable nature. Highest references. Prompt service. Reasonable terms. Victor J. Evans & Co., 185 Ninth, Washington, D. C.

DYKE'S Automobile Encyclopedia, 13th edition, new, greater than ever, entirely rewritten and rearranged. Contains greatest array of automobile facts ever published in one volume. Separate books containing same information cost \$21. Over 1200 pages and 4100 illus. Cloth \$6. Flex. Amer. Morocco \$7.50 postpaid. Popular Mechanics Book Dept., 266 E. Ontario St., Chicago.

LEATHER Coats, U. S. Aviators, \$10 to \$15. Wonderfully warm. 28 H. P. airplane motors, new, \$100. Smith, 403 Goggan Bld., Houston, Texas.

PATENTS Procured. Send sketch or model today for examination, prompt report and advice. No charge for preliminary advice. Write for free Booklet and blank form on which to disclose your idea. Highest references. Promptness assured. Clarence A. O'Brien, Registered Patent Lawyer, 319 Security Bank Building, Directly across the street from Patent office, Washington, D. C.

FOR FORD OWNERS

FORDS Get 25-45 Miles with Reid's Automatic Vaporizer. Guaranteed. Send today. Price \$3.50. Agents wanted. R. A. Reid, 19 Berget Ave., Medford, Mass.

FORD Car Repair Book Sent Free. This complete and well illustrated valuable book explains in a simple way how to overcome Ford car troubles; Repairing, Economical Winter Driving, Cold Weather Car Starting, Equipment for Fall and Winter, Carving Piston Ring Troubles, Carburetor Adjustments and Repairs, Connecting Rods, Timers, Transmission Troubles, and Practically every phase of Ford car driving, repairing and equipment. Send 25c coin for three months' trial subscription and get the valuable repair book free. Ford Owner and Dealer Magazine, 523 Montgomery Bldg., Milwaukee, Wis.

AUTOMOBILE owners, garagemen, mechanics, send for free copy America's popular motor magazine. Contains helpful, money-saving articles on repairing, overhauling, ignition, carburetors, batteries, etc. Automobile Digest, 507 Butler Bldg., Cincinnati.

FORD Owners. Learn About Wonderful New Power Maker. Practically eliminates spark lever—stops misfiring—adds power and speed—saves gas and is waterproof. Price is low. Ask for booklet and learn about Free Trial Offer. A. B. M. Co., Box Z, Brightwood, Mass.

135 Miles on 3 1/2 gallons—34.84 miles per gallon for your Ford with a Nischan Gas Fertilizer. Attached in three minutes. Satisfaction guaranteed or money refunded. Sent post paid for \$1.00. Address: J. I. Nischan, 974 Fourth St., Louisville, Ky.

FORD fender braces have given absolute satisfaction wherever installed. Indispensable to motorists carrying loads on running-boards. Draws fenders up and locks them firmly in place, eliminates vibration. Installed in 4 minutes. Front brace \$1.50, front and rear \$2.75. State model of car when ordering. Swanson & Goodman, 1121 Washington Ave. South, Minneapolis.

FIREBUG Automatic Carbon Burner stops carbon-knocks instantly. Cleans motor in one minute. Guaranteed. Sample 25c. Write Accessories Manufacturers, 4536 South Xerxes, Minneapolis, Minn.

FORD owners, stop that ruinous chatter on your car. Install Bredar's Ball Shim. Price \$1.10. Write for information. Nic Bredar's Son Mfg. Co., Rock Island, Ill.

UNDERSLING with "RKO" Swing Lo Irons. See "Red-i-Kut" ad, page 175.

MOTORCYCLES, BICYCLES AND SUPPLIES

1920 HARLEY-DAVIDSONS, \$90; 1919, \$65; 1917, \$55; 1915, \$40. Guaranteed Money refunded if not satisfied. Circular free. Wisconsin Cycle Sales Co., 726 National Ave., Milwaukee, Wis.

USED parts for all motorcycles, cheap. State wants. Schuck Cycle Co., 1922 Westlake, Seattle, Wash.

WONDERFUL bargains in reconditioned motorcycles. Priced as low as \$35. Sidecars from \$25 up. Everyone expertly rebuilt and guaranteed in absolutely first-class condition. Don't delay. Send 2c for new big catalog showing 1923 bargains. Western Supplies Co., 539 Hayutin Bldg., Denver, Colo.

'19 INDIAN 3 Speed \$75.00. '20 Indian 3 Speed \$95.00. '21 Indian 3 Speed \$125.00. Howard A. French Company, Baltimore, Md., Washington, D. C.

SEND for big list of slightly used motorcycles on the easy payment plan. Howard Cycle Co., Trenton, N. J.

DON'T buy a Bicycle Motor Attachment until you get our new catalogue and prices. Also runs washers, pumps and shop machinery. Shaw Mfg. Co., Dept. 27, Galzburg, Kans.

USED Motorcycles fully guaranteed like new, \$25 to \$100. Motorcycle tires, \$3. Auto tires, \$3. Bicycle tires, \$1. Bicycles, \$5; tandem, \$10. Disk talking Machines, \$9. Records for all Talking Machines, 25c. Easy terms. Send stamps for catalogue, Deminger, Price Cutter, Rochester, N. Y.

LARGEST stock of new and used motorcycle parts and accessories in the world at your disposal via Uncle Sam's mail. Write for quotations, Motorcycle Parts Mfg. Co., 2030-35 Wabash Ave., Chicago, Ill.

MOTORCYCLES!! Rebuilt by factory trained mechanics! \$50 up. Write for illustrated folder, Jim Clark, 23rd and Fondulac, Milwaukee, Wis.

REBUILT Indian Motorcycles, The Bike Shop, Fostoria, Ohio.

MOTORCYCLE cylinders reground, fitted with new pistons and rings \$6.00. Guaranteed. Muncie Piston Co., Muncie, Ind.

INDIAN, Harley, Henderson Motorcycles, new and used, all in good running order \$35.00 and up. Harwood Automotive Co., Marion, Ind.

SEND for our Bargain Bulletin and Money Saving Message. It will save you money on Motorcycles, Side Cars, Motor Wheels, Repair Parts and Accessories. Some used parts at less than half. Cleveland and Ace Motorcycles our specialty. See our ad on page 139. American Motor Cycle Co., 2043-5-7 W. Chicago Ave., Chicago.

AVIATION

ONE Dollar for beautiful pair of sterling silver wings mounted on stick-pin or on bar-pin, with safety catch. Wear one to show your interest and connection with aviation. Clip this ad and mail with name and address to Wallace Aero Company, Davenport, Iowa, the oldest commercial aviation company in the middle west. Pay the postman.

"PLANS for Building Airplanes." Motorcycle engine monoplane, \$1. Ford motored Sportplane, \$2.50. "Knockdown Planes," \$100 up. Circular Free. Aviation Engineering Co., Lawrence, Kansas.

HEATH propellers represent the most efficient method of aerial drive. Each propeller individually designed for the particular work to be done, as laid out by America's oldest aeronautical engineers. Propeller catalog 4c. Heath Airplane Co., Chicago, Ill.

BIGGEST, best catalogue Model Aeroplanes, Parts and Supplies; 5c Postpaid. Ideal Aeroplane Co., 72 1/2 Green St., New York.

INVENTORS desiring patents should write for our Free Illustrated Guide Book and Evidence of Conception Blank. Send model or sketch for our opinion of its patentable nature. Highest references. Prompt service. Reasonable terms. Victor J. Evans & Co., 187 Ninth, Washington, D. C.

AIRPLANES, new or slightly used, \$200 to \$350. Motors, wings and propellers—Barrains. Leather Coats, \$10 up. Smith Machinery Co., 403 Goggan Bldg., Houston, Texas.

THE American School of Aviation announces a new correspondence course in Mechanics of Aviation. A thorough training in Practical Aeronautics. American School of Aviation, Dept. 186-B, 3601 Michigan Ave., Chicago, Ill.

SEND 10c for our latest aeronautical catalogue, listing a complete line of airplane goods at reduced prices. Ford or Motorcyle motored airplane catalog 4c each. Heath Airplane Co., Chicago, Ill.

WANTED—6 cyl. 45 H. P. Anzani Motor. E. J. Dunham, Hamburg, N. Y.

LEARN to Fly" in 15-30 days. Fall and Winter classes now enrolling. 6 hours flying course, \$164. Also pay as you learn course, 20 minute flying lessons, \$10 each. Ground Instruction included Free. 8 Weeks course for Airplane Builders, \$50. Complete planes for sale, \$350 up. Motors, \$100-\$200. Aviation Engineering Co., Lawrence, Kansas.

"AERODRIVE" Sled Blueprint 50c. Large blueprinted aeronautical supplies price list ten cents. Ostergaard Aircraft, 4269 North Narragansett, Chicago.

TEN lessons in the air, of twenty minutes each, will make you a pilot, by our advanced method of training. This together with our five week shop course at \$100.00 makes America's oldest aircraft factory the most popular flying school. Work after class hours guaranteed. Heath Airplane Co., Inc., Chicago, Ill.

THREE foot model aeroplane. Small cost. Circulars free. Aero Shop, 3050 Hurbit Ave., Detroit, Mich.

PATENTS Procured. Send sketch or model today for examination, prompt report and advice. No charge for preliminary advice. Write for free Booklet and blank form on which to disclose your idea. Highest references. Promptness assured. Clarence A. O'Brien, Registered Patent Lawyer, 309 Security Bank Building, Directly across the street from Patent Office, Washington, D. C.

WELDING

WELDING Encyclopedia—A complete instruction book on all welding processes; oxy-acetylene, electric arc, electric resistance and thermit. Welding of all weldable metals fully discussed, 326 pp., 375 illus. The accumulated experience of the welding brains of America is yours for \$5. Money back if not satisfied. Popular Mechanics Book Dept., 206 E. Ontario St., Chicago.

BOOKS AND PERIODICALS

"MASTER KEY" \$2.50. "Power of Will" \$3.00. Cowe's Free. Phipps, 1014 Belmont, Chicago.

"ESSENTIALS of Poetic Art." Endorsed by Educators. A book of valuable instructions and information that every song-writer and poet should read. Tells you the truth about your song and how to develop and dispose of it to best advantage. \$1.00 Money Order. East Side Book Concern, 1007 Commerce Building, St. Paul, Minn.

HYPNOTISM astounds, controls others. Wants gratified, 25 easy lessons \$1.10. "Mindreading" (Any distance), Wonderful, \$2.75. Popular Institute, N1014 Belmont, Chicago.

LEFAX—"Facts on Leaves." You make your own handbook, loose-leaf. From our complete list of Lefax data sheets you select only those that you actually need, then fill in your own notes or diagrams on extra blank sheets which come in 100 different styles. These in loose-leaf binder make up a book covering your individual needs. Send for complete information and price list to Popular Mechanics Book Dept., 206 E. Ontario St., Chicago.

BOOKS on Magic, card tricks, coin tricks, puzzles, each 10c. Geo. Fenner, Louisville, Ky.

FIRE-PROOF Homes. Directions for building good, substantial fire-proof homes at reasonable cost. Read de Linde's book on building. It may save you much costly labor and material and avoid mistakes. This book also contains directions for manufacturing Tombstones and Monuments from white cement. Price one dollar. Peter de Linde, Zion, Ill.

INDUSTRIAL Alcohol. Wright's book everybody wants. Full directions for making with drawings of necessary apparatus. \$2.50 postpaid. Spon & Chamberlain, 120 P. M. Liberty Street, New York, N. Y.

"LIGHTS, Colors, Tones and Nature's Finer Forces," covering Vibrations; Odde-Auras; Cold-lights; Radio; Inventions; 270 pages. Satisfaction guaranteed; \$2.00. Circulars Free. M. Stevens, Publisher, 242 Powell, San Francisco.

ELECTRICIANS' Examination book of questions and answers, with diagrams, symbols, tables, notes and formulas, for preparation for license. \$1.25. Address Reader Pub. Co., 296 Broadway, New York.

YOU should have our New Illustrated List of Practical Books. Free. Spon & Chamberlain, 120 P. M. Liberty Street, New York, N. Y.

SEND Today for free sample copy of Writer's Digest, America's greatest magazine for writers. Filled with practical articles by leading writers. Will help you write and sell stories, photo-plays, songs, etc. 603 Butler Bldg., Cincinnati.

TRADE, class, technical magazines. List free! Local agents wanted everywhere. Toepf Magazine Agency, Middletown, N. Y.

ALCOHOL Book. Legal. Copyrighted. Where To Buy 10,000 Things at Wholesale, etc. Particulars free. G. C. Shaver, Publisher, Oil City, Pa.

OUR valuable catalog of over 500 practical books arranged for easy reference under 80 different subject headings will be sent free on request. Popular Mechanics Book Dept., 206 E. Ontario St., Chicago.

NOVELTIES, CURIOS, ETC.

IMPORTED Japanese Weeders, dropped into water, expand five times original size, turning into fish, flowers, animals, babies. Pretty package twelve assorted, 15c. Six 50c. Thirteen \$1.00. Prepaid. Hootch Insurance Policy, latest Prohibition joke, free, each order. Heinemann, 7242 Pingree, Chicago.

MOON-O-LIGHT radium paint shines in darkness; 25c per bottle. Gray & Breyer Co., Dept. 10, 1463 St. Lawrence Ave., Bronx, New York.

TRICKS, magic cards, books, novelties, puzzles. Catalog free. Geo. Fenner, Louisville, Ky.

PICTURES AND POSTCARDS

12 ENGRAVED Beautifully designed Christmas Greeting Cards. Name embossed, \$1.00 Postpaid. Agents Wanted. Samples 10c. Sharrs Stationery, Edith Place, Oakland, Pittsburgh, Pa.

A DIFFERENT Club. Money-back guarantee. Members in every country. Send stamp for particulars. International Courier, 1710 Crilly Court, Chicago.

JOIN Live Postcard club; Membership list, including Catalog, 10c. Harvey Teeple, De-catur, Ind.

ADIRONDACKS: Fifteen scenic views and copy Postcard Tourist, 25c. De Roire, Geneva, N. Y.

JOIN the Old Reliable Card Club. Membership 10c. Riverside Club, Frederick, Md.

GAMES AND ENTERTAINMENTS

200 KINDS Iron, wood and wire puzzles. Leader and illustrated list 10c. Western Puzzle Works, St. Paul, Minn.

VENTRILQUISM taught almost anyone at home. Small cost. Send 2c stamp today for particulars and proof. George W. Smith, Room M-789, 125 N. Jefferson Ave., Peoria, Ill.

MAGIC TRICKS, BOOKS, AND JOKERS' NOVELTIES

MAGIC—Tricks, Books and Supplies. For Amateurs as well as the great professionals. Anyone can learn through our instructions. Feature Acts in Mind Reading, Spiritualism, Rope Ties, etc. Large illustrated Professional Catalog, 10c. Chicago Magic Co., 140 S. Dearborn St., Dept. B, Chicago, Ill.

ATTRACTIVE gift. Halloween and other special days. One dollar and postage. B. Mason, 22 Front Street, Binghamton, N. Y.

PLAYS, musical comedies and revues, minstrel music, blackface skits, vaudeville acts, monologs, dialogues, recitations, entertainments musical readings, stage handbooks, make-up goods. Big catalog free. T. S. Denton & Co., 623 So. Wabash, Dept. 11, Chicago.

EVERYTHING in Magic. Four Catalogs 15c. Gilmagic, Morgan Park, Ill.

MAGIC Trick Cards 25c Pack and Catalog, 10c. Hamilton, Barnes City, Iowa.

TRICKS, Puzzles, jokes, magical apparatus, plays, stage supplies, mind-reading, sensational escapes, 160-page illustrated professional catalog, 10c. Oaks Magical Co., Dept. 548, Oshkosh, Wis.

HERMAN'S Tricks with Cards, 50c; Howard Thurston's Card Tricks, 25c; Heller's Book of Magic, 50c—all three, Illustrated Books, \$1.00. Henry H. Collins, 197 Fulton Street, Brooklyn, N. Y.

470 TRICKS, Puzzles, Jokes and big catalog 10c. "Andco," 4047-P, North Whipple, Chicago.

STAMP COLLECTING

NEWFOUNDLAND Stamps sent on approval. Rev. Butler, St. Georges, Newfoundland.

202 DIFFERENT European, Lichtenstein, Azerbaijan, Danzig, Latvia, Slovakia, Ukraine, Lithuania, free with Mekeel's Stamp Weekly, Beverly, Mass.; three months 25c.

25 VARIETIES, fine, (catalogue \$2.50), 25c. McKeel, 1313 1/2 Railroad, Bellingham, Wash.

3 UNUSED sets, 100 different, hinges, gauge, 15c. Doering, Newton St., Marlboro, Mass.

FREE—Set Russian Occupation gauge, \$1. U. S. Stamp lists, etc., for 2c stamp and reference for approvals, 100 diff. U. S. 22c; 25 diff. Bulgaria 9c. Hawkeye Stamp Co., Cedar Rapids, 29, Iowa.

200 DIFFERENT stamps ten cent to approval applicants only. K. C. Stamp Co., Lee Bldg., Kansas City, Mo.

100 DIFFERENT with approvals, 6c. Co-operative Stamp Co., 845 Conway, St. Paul, Minn.

VARIETY Packets—1000 \$1.65; 555, 55c; 333, 33c; 223, 23c; 113, 13c. Lists Free. Emerson Shop, 635 Bower, Elkhart, Ind.

"MEKEEL'S sold stamps to your grandfather." Stamps for new and advanced collectors, sent on approval. 300 different stamps, mostly 19th Century, 50c. Mekeel Stamp Company, Bethlehem, Penn.

FREE—15 Unused Ukraine, to (50%) approval applicants only. Lampe, 423 West 42nd, New York.

FOREIGN Stamps—33 different, 2c. Ahwahnee Stamp Co., Ahwahnee, Calif.

STAMPS for Collectors. Honest prices paid for stamps. International, 2117 Regent Place, Brooklyn, N. Y.

PACKET for Reference and Stamp to Approval Applicants. Irving Crowley, 4638 Blaisdell, Minneapolis, Minn.

FREE Rare Stamps to approval applicants. Lawrence Brothers, Anamosa, Iowa.

STAMPS of all Countries Exchanged. Membership fee 25c. Willow Stamp Club, 2541 W. 124th Pl., Chicago, Ill.

SUPERFLUOUS Stamps Free, value 10c upward. Send postage for approval books. John W. Aymar, Asbury Park, N. J.

STAMPS, 50 varieties, Africa, Brazil, Peru, Cuba, Mexico, etc., 10c. 50 different U. S., 25c; 1,000 mixed, 40c; 1,000 hinges, 10c. List free. C. Stegman, 5948 Coto Brillante, St. Louis, Mo.

158 GENUINE Foreign Stamps. Mexico War Issues, Venezuela, Salvador and India Service, Guatemala, China, etc., only 10c. Finest approval sheets 50 to 60%. Agents Wanted. Big 72-p. Lists Free. We Buy Stamps. Estab. 20 years. Hussman Stamp Co., Dept. 54, St. Louis, Mo.

24 VARIETIES Cuban stamps, 10 cents. List of 6,000 low-priced stamps free. Address Chambers Stamp Co., 111P, Nassau St., New York City, N. Y.

STAMPS, 20 unused, all different, free. Postage 2c. Mention paper. Quaker Stamp Co., Toledo, O.

PACKET of 23 stamps, no two countries alike. Packet hinges. Set of \$1 and \$2 U. S. Rev., all for 5c. Mention paper. Miami Stamp Co., Toledo, Ohio.

20 UNUSED stamps free. All different. Postage, 2c. Fisk Stamps, Toledo, Ohio.

BEST one cent approvals in America. F. P. Hand, 1117 So. 60th St., Philadelphia, Pa.

FREE—set 7 Hungarian Peace Stamps with 100 different, 10c. Walter Oliver, 813 Richmond, Buffalo, N. Y.

COLLECTING Stamps? Start now. Bargains on Packets and Approvals. Schmidt & Wallace, 124 Glenn Ave., Fresno, Calif.

100 RARE and valuable foreign stamps, all different, and big catalog, 7c. Stanton, Niantic, Conn.

FREE, Dollar Stamp Free to applicants for my 60% approvals. Norman Shultz, Colorado Springs, Colo.

ABYSSINIAN stamps Free to approval applicants. 50% commission. Enclose 2c, 1,000 different stamps \$1.35. Ioor, 801 State Life, Indianapolis, Ind.

FREE—50 varieties to approval applicants sending 2c. Richard P. Lamprecht, Valparaiso, Ind.

ZAMBESIA, Zanzibar, Abyssinia, Herzegovina, Allenstein stamps, menagerie collection, hinges, 10c. Liberty, 3974 Arsenal, St. Louis, Mo.

STAMPS sent on approval at 70% discount. Reference required. Emory Benoit, Hanover, Pa.

FREE packet, Ukraine, Bulgaria, Turkey, etc., with request for 50% and 60% sheets; enclose 2c postage. George Flagg, 270 Wyoming Ave., Melrose, Mass.

SNAPS—200 different stamps, 10c; 60 different United States Stamps, 12c. With each order we give free our price list of sets, packets, albums, etc., and our pamphlet which tells "how to make a collection properly." Queen City Stamp Company, Room 35, 604 Race, Cincinnati, Ohio.

GERMAN Air Mail Set Free to applicants for my 1 cent to 15 cent net approvals; also high priced stamps at 50% discount. Reference Required. Chas. W. Schmidt, 3227 Benner St., Wisconsin, Philadelphia, Pa.

1,000 DIFFERENT \$1.50; 500, 60c; 300 25c; 150, 10c. Fred Onken, 630 79th Street, Brooklyn.

14 NICE Stamps Free to approval applicants. Postage and reference. Southwestern Stamps, Slaughter Bldg., Dallas, Texas.

\$3.00 FOR 12c!! 100 different Neurope, catalogue \$2.10; triangle stamp, Red Cross set, airplane set, perforation gauge, millimetre scale, fine wallet, 5 approval sheets, 250 hinges, scarce packet from Nyassa, Abyssinia, etc., price lists and approvals—all for 12c!! Atlanta Stamp Co., Box 532, Atlanta, Ga.

SET Austria, Bavaria, Bulgaria free for 2c Stamps. Poste Stamp Co., 5418 Sansom Street, Philadelphia, Pa.

STAMPS on approval 1/2c up. Free premium. Herbert Keigwin, Middletown, N. Y.

FREE Set, 14 varieties to all applicants for 1 and 2c approvals—more premiums later. Send 2c postage. Elmer, 59 Court St., Boston.

FREE! Loose Leaf Postage Stamp Album at rate of 8 pages each month given with subscription to monthly Journal. Send 2c stamp for prospectus. United Stamp Co., Marquette Bldg., Chicago, Ill.

FOREIGN Stamp Collection Sent Free. Cornish Company, Schenectady, N. Y.

FREE—200 different stamps to approval applicants sending 4 cents postage. H. W. Myers & Co., 1018 Florida St., Richmond, Calif.

LIBERIA, 1921, triangles, 5 varieties, 20c. Sets, singles on approval. S. Buffham, Lake Ave., Racine, Wis.

50% APPROVALS. Free premiums to new customers; references required. Gateway Stamp Company, Box 163, Stockton, Calif.

1000 DIFFERENT Stamps \$1.00. Approvals 60%; References. Martel, 1292 Cartier, Montreal, Canada.

118 DIFFERENT stamps from Latvia, White Russia, Danzig, one rare Hayti, Cat. \$1.00, 5 Port. Col., 5 French Col., etc. (with big bargain lists), all for 12c. To approval applicants only. G. P. Kunz, 2054 Boulevard, Jersey City, N. J.

FREE! World's smallest stamp. Approvals. Postage 2c. Cannon, 1418 Carey, Davenport, Iowa.

BARGAINS for new customers. 325 different stamps 25c, 540—50c, 1035—\$1.50. Hinges free. 53 unused 11c, 500—75c. W. Benno, 1531 N. California, Chicago, Ill.

50 DIFFERENT United States 10c; 10 Nyassa 1901 2c. Seidenberg, Merton, Wis.

NEW Airplane Stamp Unused—8c, green, issued by Uncle Sam; also 25 French Colonials for 20c. Jacob Fischer, 4239 Crystal St., Chicago.

RAYMOND STONE, Approvals, Better Grade. Reference, 562 W. 190th St., New York City.

ODD Moments—Odd Stamps. Approvals for postal. Odd Stamp Co., Sunset Heights, Asheville, N. C.

100 DIFFERENT Germany, including new 5000-mark stamp, 25c. Mogensen, 414 North 14th, Omaha, Neb.

FREE! 25 varieties French Colonials and 100 var. Foreign to applicants for Net Approvals. Reference required. A. M. McFadden, 3105 Ash Street, Mt. Banier, Md.

NYASSA Giraffes and packet of 52 different scarce stamps. Flume Triangle, large \$1.00 U. S. Rev., millimetre scale, perforation gauge and ruler for only 2c. To introduce our Sudden Service approvals. Pennell Stamp Company, Dept. P, Fullerton Bldg., St. Louis, Mo.

\$9 VALUE 15c. Packet of scarce stamps from South and Central America, including Cuba, Hayti, Salvador, Venezuela, Uruguay, having catalog value of over \$9.00. Price to new applicants for Fenway net approvals 15c. Fenway Stamp Co., Fenway Station, Boston, Mass.

BIG Variety Packet Foreign Stamps Free for 2c postage. Gray Stamp Company, Station E10, Toronto, Canada.

FREE 10 different unused stamps, sent to approval applicants at 60 2-3 to 70% discount. J. deJong, 516 West 162 Street, New York City.

DANZIG Free—Nice Set Danzig Stamps with Biggest Lists issued, 2c postage. Midland Stamp Co., Station E2, Toronto, Canada.

8 DIFFERENT French Guiana, beautiful pictorials, 15c. Allison, Angola, Ind.

105 CHINA, etc., stamp dictionary, list, 2c. Album (500 illustrations), 3c. Bullard, Sta. A, Boston.

206 DIFFERENT stamps, Liberia, Abyssinia, China, Japan, Peru, Egypt; lists and approvals only 12c. 500 different 50c. J. B. Musick, 4440 Natural Bridge, St. Louis, Mo.

100 DIFFERENT New Europe Free to approval applicants sending 2c return postage. Anvelink Co., 2410 Prairie St., Milwaukee, Wis.

500 ALL Different Stamps for 50c; 1,000 all different for \$1.50; 50 all different Iceland stamps for \$1.50; 20 all different Newfoundland for 30c; Liberia, 1906, 9 varieties for 50c. Price Lists Free on request. Alois Von Isakowitz, Monticello, New York.

FAMOUS Barney Google packet to approval applicants—only 10c. Sid. Desk 11b, 140 Langdon, Madison, Wis.

500 MIXED U. S. old and new 10c, 1000 hinges, 10c. Stamp Album 15c. 100 diff. Foreign 10c. Weatherby, Medina, Ohio.

1000 UNITED STATES and Foreign Postage Stamps mixed—for stamp collectors, 25 cents. C. W. Parker, 77 Kensington Heights, Meriden, Conn.

2,000 DIFFERENT Stamps \$5.65; 1,000 \$1.55; 500, 55c; 300, 25c; Michael, 5355 Calumet, Chicago.

FREE—Nyassa Set, also one set Neurope, for a request for my 1, 2 and 3c net approvals, also the higher-priced desirable stamps at 50% discount and better. You will find many good British Col. on my sheets and books. None better. Chas. T. Egner, 4821 Frankford Ave., Ph'd, Philadelphia, Pa.

FREE! Set Newfoundland to bonafide approval applicants. Penna Stamp Co., Manor, Pa.

FRENCH Colonies Free—Pretty Picture Set, Native Chiefs, Tigers, 2c postage. Empire Stamp Company, 342 Lippincott, Toronto, Canada.

FREE: 10 unused, 1 triangle. National Stamp Co., 25 Farmland Rd., Lowell, Mass.

RARE COINS

\$2 TO \$500 each paid for hundreds of Old Coins. Keep all Odd or Old Money. It may be very valuable. Send 10c for New Illustrated Coin Value Book, 4x6. Get posted. We pay cash. Address Clarke Coin Co., Ave. 2, Le Roy, N. Y.

CALIFORNIA gold, 3/4 size, 27c; 3/8 size, 53c; three-cent-piece and catalogue, 10c. Norman Shultz, Colorado Springs, Colo.

FIRST Coin with "In God We Trust," was the 2c piece, first coined in 1864. As a special offer, I'll send you a genuine 2c piece, and 50-page Illustrated Coin Catalog for Ten Cents. Send for this now and you'll send for more. B. Max Mehl, Numismatist, Mehl Bldg., Dept. P, Fort Worth, Texas. Largest Rare Coin Establishment in the United States.

NEW Price Lists and Wild Cat Bill; California Gold, 3/4 27c; 3/8 53c; Nickel 3c and 2c piece., A German and Austrian Bill. Albert Bonsall, Richmond, Ind.

CALIFORNIA gold, half 52c; quarter 27c; 1837 Jackson cent 15c. A. Wylie, Wheaton, Ill.

OLD Coins. Large Fall selling catalogue of coins for sale, free. Catalogue quoting prices paid for coins, 10c. William Hesslein, 101 A Tremont St., Boston, Mass.

100,000 GERMAN Marks, \$2.00. 1,000,000 Russian Rubles \$1.00. Craig Dare, 449 55th, Brooklyn, N. Y.

COINS, medals, paper-money, guns, Indian curios, stamps. Lists free. Nagy, 33 South 18th, Philadelphia.

CALIFORNIA gold, Half 52c, Quarter 27c, McKinley dollar \$3.50, Jackson cent 15c. A. Wylie, Wheaton, Ill.

40 OLD coins all different \$1.00. List free. Claude Denney, Box 315, Dallas, Texas.

OLD Coins Wanted. Will pay Fifty Dollars for nickel of 1913 with Liberty Head (not Buffalo). We pay cash premiums for all rare coins. Send 4c for large Coin Circular. May mean much profit to you. Numismatic Bank, Dept. H, Fort Worth, Texas.

FOR BOYS

BOYS and Girls Earn Xmas Money. Write for 50 sets American Christmas Seals. Sell for 10c a set. When sold, send us \$3.00 and keep \$2.00. Neubecker, Dept. 88, 961 East 23rd St., Brooklyn, N. Y.

BOOKS — "Ventriloquism," "Toymaker Book," "Boy Electrician," 10c each, all for 25c. G. Elsen, Bowling Green, Ohio.

MOUTH-ORGAN Instructor, 25c. Learn in one hour. G. Elsen, Bowling Green, Ohio.

MOVING Picture Machines Free. Aeroplane Balloon 30 inches long, 10c. Nite-Mall Order Supply, 609 27th, Denver, Colo.

CAMERAS AND PHOTO SUPPLIES

KODAK print colored free. In the October issue of Popular Mechanics, Classified Advertisements, we made an unusual offer. We repeat it again this month, although our artists have been kept more than busy. Read it over carefully. Act promptly. Send us a print to color for a model. Get busy on your snap-shots for holiday gifts, it's very easy. We offered a set of fifteen colors with full instructions, the world-famous Peerless (Japanese) Transparent colors, postpaid, for \$1.00 plus the coloring of a model print. Japanese Water Color Co., Peerless Building, Rochester, N. Y., U. S. A.

SEND us your favorite negative. We will make one 8x10 enlargement, beautifully hand colored, all for 65 cents. Established 17 years. Camera Shoppe, 24 Market St., San Francisco, Calif.

SPECIAL Trial Offer: Any size Kodak film developed for 5c; prints 3c each. Overnight service. Get a Free Auto. Ask for details. Roanoke Photo Finishing Co., 209 Bell Ave., Roanoke, Va.

FILMS developed, prints made, prompt service. Z. Koscielniak, 17214 Lamont, Detroit, Mich.

WE will print all your kodak views or portraits, make any size enlargements from films or photo, at extremely low prices, to introduce our work. Otto Hueser Co., 4336 No. Lincoln St., Chicago, Ill.

KODAK Films—Special trial offer; your next kodak film developed, 5c—prints, 2c each. Moser & Son, 1917 St. James Ave., Cincinnati.

MODERN Photography in all its branches now taught by mail. New Successful Method. Students earning \$300.00 while learning. Big Opportunity. Write for particulars and unusual offer open for short time. Dept. 3435 International Studios, Inc., 3601 Michigan Ave., Chicago.

BIG Money Saved on Photographic Lenses and Apparatus—goods exchanged; repairing done. Ralph J. Golsen, 1128 Argyle St., Chicago, Dept. P.

SUPERIOR quality finishing and enlarging. Trial offer: Any size 8 exposure roll developed and printed, 25 cents. 8x10 enlargement unmounted, 30 cents. Carthuff Photo Finishing Co., 2129 W. Van Buren St., Chicago, Ill.

JUST Published—Our new complete 128-page catalog and bargain book of new and used cameras and supplies. Our goods are guaranteed finest quality obtainable. We have thousands of satisfied customers. Write at once for this bargain bulletin, just hot from the press. Address Central Camera Co., 124 S. Wabash Ave., Dept. E 75, Chicago, Ill.

MOTION PICTURES

\$\$\$ FOR Ideas. Photoplay plots accepted any form; revised, criticized, copyrighted, marketed. Advice free. Universal Scenario Corporation, 206 Security Bldg., Santa Monica and Western, Hollywood, Calif.

MOVIE Film: For Home Use. Send \$5.00 Cash or Money Order and we will ship you postage prepaid, Big 1,000-foot Reel. Complete stories with best screen stars. Dramas—Comedies—Features—Westerns. Special—only while they last. Monarch Theatre Supply Co., Dept. P, 724 So. Wabash Av., Chicago.

MOVIE Films big reels \$3.00—100 feet postpaid \$1.00. Boy agents wanted. Home projector \$25. New Motor Driven Suit-case Projector \$75. Movie Electric Generator for Ford Auto \$100—New Gasoline Engine and Electric Generator and Motor Driven Projector \$250—Movie Camera \$50—with best lens. Ray, 326 25th Ave., New York.

BIG Money Nightly—Good assortment. Complete outfits, installation plan. Splendid Home Outfit \$25.00. Ralph J. Golsen, Dept. M, 1128 Argyle St., Chicago.

FILMS: Special Features—Comedies—Cartoons—Dramas and Serials. Lowest Prices. Bargain List Free. Monarch Theatre Supply Co., Dept. 81, Memphis, Tenn.

BARGAINS in used film and projectors. New miniature projectors \$4.50 to \$30.00. New Professional projectors \$180.00 to \$400.00. Werner Brothers, High Ridge, Mo.

BARGAIN lists, Machines, Films, Supplies. National Equipment Company, Duluth, Minn.

JUST in time to get in on the big money to be made! Bass will start you in the Motion Picture Making Business, enormous profits making Industrial Films, News Weeklies, etc. Catalogue and full information Free! The Cinema Handbook, 575 pages for \$3.00 postpaid. Bass Camera Company, 105 No. Dearborn St., Chicago, Ill.

AMERICA'S Greatest Fortunes made in the Motion Picture Business. We furnish Complete Theatre Equipment on easy payments. Openings everywhere. Catalog Free. Monarch Theatre Supply Co., Dept. F—724 South Wabash Ave., Chicago.

\$5.00 PROFIT nightly. Small capital starts you. No experience needed. Our machines are used and endorsed by government institutions. Catalog free. Atlas Moving Picture Company, 482 Morton Bldg., Chicago.

FREE to Writers—A wonderful little book of money-making hints, suggestions, ideas; the A B C of successful story and play writing. Absolutely Free. Just address Authors Press, Dept. 12, Auburn, New York.

ONLY \$98.00 starts you in this business. Wonderful opportunities for making fortunes. Details Free. Monarch Theatre Supply Co., Dept. 46, Memphis, Tenn.

REMARKABLE value; Light Weight Professional Motion Picture Projector, Mazda illuminated, with 1,000 feet of film, \$37.50. Send for photograph. De-Franco, Importers, 109 No. Dearborn St., Chicago, Ill.

MAKE money writing photoplays; details free to beginners. No correspondence course. Producers League, 230 Walworth, St. Louis.

VIC'S Movie Handwriter, 10c. Everybody delighted. Vic Hansen, Wallace, Idaho.

LEARN Photoplay Writing from John Emerson and Anita Loos. Free book and Profit Sharing Plan. Laird Extension Institute, 520 Laird Building, Minneapolis.

BE a Movie Operator. Short course. Positions secured. Box 38, Sioux Falls, So. Dak.

SCENERY TO RENT

SETTINGS for Opera, Plays, Minstrels. Plush drops. Address Amelia Grain, Philadelphia.

EDUCATIONAL AND INSTRUCTION

BE a Laboratory Expert. Earn \$300.00 to \$500.00 a month. Study Microbiology, Bacteriology, Laboratory Technology, Sanitation. Interesting Extension and Residential Courses. Diplomas and Degrees granted. 71-piece Urinalysis Outfit Free to students. Write for Free 48-page Prospectus Today. Int'l Physicians and Surgeons College of Microbiology, Room 935, 550 Garfield Ave., Chicago, Ill.

YOU can have a business profession of your own and earn big income in service fees. A new system of foot correction; readily learned by anyone at home in a few weeks. Easy terms for training; openings everywhere with all the trade you can attend to. No capital required or goods to buy. no agency or soliciting. Address Stephenson Laboratory, 1 Back Bay, Boston, Mass.

WRITE articles, stories, news, in spare time for newspapers and magazines. Big pay. Copyright book free. Press Syndicate, 552, St. Louis, Mo.

FREE. Touch Typewriting Course. Secretary, 1552 Broadway Avenue, Grand Rapids, Mich.

LEARN honest shoe repairing business in six weeks. It pays up to \$100.00 weekly. If you are handy with tools this is an exceptional opportunity. 120,000,000 pairs of shoes repaired monthly in United States; regardless of the size of the town or city a good living can always be made with this trade; as a business it can be entered with very small capital. Why work for others—send for the United States copyrighted course tonight. The cost is \$3.00 Postpaid complete in the United States. It can be obtained nowhere but direct through me. C. Bower, Box 1234, Seattle, Wash.

COMPLETE Law Course \$1.50. The "Vest Pocket Lawyer," 350 pages—Instructs fully on all law questions. A guide for everybody. Contains 112 assorted legal forms. Is used like a dictionary. Tells you "What to do" to avoid—trade acceptances—bills of sale—power of attorney, wills, deeds," etc. Endorsed by lawyers, bankers, businessmen. Saves thousands yearly. Order your copy Now. Send \$1.50 for a copy to Chas. W. Parker, 77 Kensington Heights, Meriden, Conn.

DOUBLE Entry Bookkeeping mastered in 60 hours with 8 keys; guaranteed; diplomas. Our graduates lead in bookkeeping, auditing, accountancy, balance sheets, and financial statements. International Bookkeeping Institute, Dept. 8, Springfield, Mo.

STUDY a Profession at the Distinctive University. We will make you an expert Bacteriologist, Chiropractor, Osteopath, Chiropractist quickly. National University, 2925 Michigan, Chicago.

ARTIFICIAL Marble, sanitary flooring instructions, ornamental casting, concrete plaster, papier-mache decorations, garden furniture, statuary, Rubber-moulds, Electrometallurgy, particulars and 200 illustrations free. Chris Mahler, Box 122, Huntington, N. Y.

JOURNALISM—Photoplays—Short Stories, Plot Chart and Copyright Book free to those wishing to enter above professions or to dispose of manuscripts on Commission. (The Service offered is given by Professional Authors and Editors of high standing.) Harvard Company, 431, San Francisco, Calif.

WORK for Yourself Writing Show Cards. Invest 1 hour daily and earn \$50.00 weekly in short time. Easily learned. Full particulars free. Birch Speedy Correspondence System, 980 Eddy St., San Francisco, Calif.

WRITE a better signature. Yours written six styles on cards. Send dime. Meub, Expert Penman, 2051 N. Lake, Pasadena, Calif.

WORLD-ROMIC System, Masterkey to All Languages. Primers, 23 languages, \$1.91 each language; English, French, German, Italian, Portuguese, Spanish. Pronunciation-Tables, 103 languages, 39c each language. Languages Publishing Company, 8 West 40th Street, New York.

SHORTHAND in 100 Hours. Most rapid readable system. Introductory booklet free. Manuscript Institute, Roanoke, Va.

USED books and educational matter bought, sold, exchanged. Bulletin free. Instruction Correspondence Exchange, 1909 Broadway, New York.

MECHANICAL Draughting. Are you studying draughting? Then it will pay you to write at once. Engineer, Box 204, Darby, Pa.

FENMANSHIP. Trial lesson 25c (silver). Price, 130 W. 104th, New York

SHORTHAND in three weeks; written with longhand characters; simple, speedy, legible. Teachers wanted. Dickinson, 406 McMillen Building, Kansas City, Mo.

USED books and educational matter bought, sold, exchanged. List 1,000 items free. Students' Exchange, 47-A West Forty-second Street, New York, N. Y.

USED educational matter, books, etc., sold, rented and exchanged. Big list free. Lee Mountain, Pisgah, Ala.

ROPP'S Calculator and Short-Cut Arithmetic shows the answer as quickly as a watch shows the time to all problems likely to occur in office, store, shop, bank, farm or factory. Price, pocket size, paper 35 cents; cloth 50 cents; leatherette \$1. Desk size, cloth, \$1.50 postpaid. Popular Mechanics Book Dept., 286 E. Ontario St., Chicago.

SHOW-CARD Writing, a pleasant profitable profession, quickly and easily learned by our new simple "Instructograph" method. No canvassing or soliciting. We show you how, no matter where you live. Full particulars and booklet free. American Show Card System, Limited, 203 Adams Building, Toronto, Canada.

"WHAT to Invent for Profit" free. Patent News-N, Washington, D. C.

TELEGRAPHY

TELEGRAPHY—Both Morse and Wireless—taught thoroughly and quickly. Tremendous demand. Big salaries. Wonderful opportunities. Expenses low; chance to earn part. School established fifty years. Catalog free. Dodge's Institute, H St., Valparaiso, Ind.

USED Omnigraphs for sale. John Percival, 2113 York, Des Moines, Iowa.

RADIO OUTFITS AND SUPPLIES

PURE Sheet Aluminum \$1.50 square foot. Electrical Specialty Company, Valparaiso, Ind.

RADIO Generators, 500 Volt, 100 Watt, \$28.50 each. Battery Chargers \$12.50. High Speed Motors, Motor-Generator Sets, all sizes. Motor Specialties Co., Crafton, Pa.

LOUD Speaking Crystal Set. Stations from over 1000 miles have been brought in easily. Music can be heard all over the room right from your own crystal set with the Steinmetz Amplifier, only \$8.50. Complete catalog at your dealers or Steinmetz Wireless Mfg. Co.; Eastend, Pittsburg, Pa. "Radio Library" most complete simplified radio publication, Nov 25c.

FREE—Complete price list Aitken Radio Co., 504 Superior St., Toledo, Ohio.

\$55.00 THREE tube sets \$40.00. Cut prices on tubes, \$6.00 Headphones \$4.00. Box 32, Station "R," New York.

YOU Don't Need Tubes to get out of town. If you want new stations on your crystal set Write Me Today. Mine works 400 to 1,000 miles without tubes or batteries! Thousands have bought my plans and now get results like mine. Changes often cost less than a dollar. Send self-addressed envelope for further information. Leon Lambert, 539A So. Volusia St., Wichita, Kansas.

RADIO Tubes repaired and exchanged; write for free circular. Radio, Box 43, Roseville Station, Newark, N. J.

TRADE SCHOOLS

EARN \$50 to \$75 per week tuning and repairing pianos. We teach you to be an expert. Chicago School of Piano Tuning, River Forest, Ill.

LET us place you in a position to earn from \$10 to \$25.00 per day. That's what our Students are doing all over the country. You can learn in a few weeks at low cost to be a Sign, Auto and Pictorial Painter—Decorator, Paperhanger, Showcard Writer, Grainger and Marbler. No books used; all practical work. Send for Free Catalog. Chicago Painting School, 148 West Austin Ave., Chicago

PAINT Automobiles. Trim Automobiles. Become a certified Electrician. We fit you for a big-money job. Make you an expert, able to step right into a position paying \$45 to \$100 per week. We secure you a job while training that more than returns tuition costs and expenses. Come to Detroit, the Automobile Hub; the World's wonder city. Write today. Standard Trade Schools, 416 Woodward Avenue, Detroit, Mich.

BUSINESS OPPORTUNITIES

REAL Estate Business of your own or position worth \$3,500? Our Graduates can choose. Training at home prepares you in short time and we aid you to make good. Bulletin free. Penn Realty School, 19th and Ellsworth, Philadelphia, Pa.

REST Island Silver Fox Farms, Inc., Largest in the World. Breeding stock unexcelled. Arthur Schleicher, Secretary and Manager, Ryan Hotel, St. Paul, Minn.

LEARN Mail Order Business. New system raise money. Taytexco, 28 School, Boston, Mass.

RAISE guinea pigs. Pay better than poultry or rabbits; easy to raise; little space required. We guarantee market. Particulars and booklet how to raise free. Cavies Distributing Co., 3102 Grand Ave., Kansas City, Mo.

DISTRIBUTORS for Champion Cross Spring Assembly for Dodge cars. Good clean-cut proposition; men with ability wishing to establish permanent business. Requires \$800.00 initial stock. Write us. Champion Auto Spring Company, St. Louis, Mo.

MONEY-MAKING opportunity; particulars free. Lemke, Box 572, Cincinnati, Ohio.

"GET into the Specialty Manufacturing Business" or "Why Work for Others?" may sound good to you, but you won't succeed in that business unless you possess formulas that are absolutely reliable, the same required by leading manufacturers supplying the Best. Don't be Bunked into buying a Collection of cheap "Formulas" and expect to succeed. Send today for my valuable literature and Formula Lists and Real Money-Makers in the Specialty Manufacturing Business. 26 years supplying the Best. Miller, Chemist, 805 De Leon St., Tampa, Fla.

MAKE Money at Home—making toys. We show you how. Send \$1 for complete working drawings and instructions. DeKalb Designing Co., Decatur, Ga.

STOP Flooding! Be Successful. Operate a Tire Repair Shop. Make big profits in any locality. We teach you and furnish complete equipments \$100.00 up. Book of Opportunity free. Haywood's, 1305 South Oakley Avenue, Chicago.

BE a Laboratory Expert. Earn \$500.00 to \$500.00 a month. Study Microbiology, Bacteriology, Laboratory Technology, Sanitation. Interesting Extension and Residential Courses. Diplomas and Degrees granted. 71-piece Urinals outfit Free to students. Write for Free 48-page Prospectus Today. Int'l Physicians and Surgeons College of Microbiology, Room 971, 550 Garfield Ave., Chicago, Ill.

GO into the Crispette business. Everybody likes Crispettes. You can make a lot of money. We start you. Write for facts. Long Eakins, 1959 High St., Springfield, Ohio.

ENTER a new business. Earn \$3,000 to \$6,000 yearly in professional fees making and fitting a foot specialty, openings everywhere, with all the trade you can attend to; easily learned by anyone at home in a few weeks, at small expense; no further capital required, no goods to buy, job hunting, soliciting or agency. Address Stephenson Laboratory, (1) Back Bay, Boston, Mass.

WE Start You in Business, furnishing everything; men and women, \$30.00 to \$100.00 weekly operating our "New System Specialty Candy Factories" anywhere. Opportunity lifetime; booklet free. W. Hillier Ragsdale, Drawer 4, East Orange, N. J.

EXCEPTIONAL Opportunity for Sales Manager capable of handling state distribution. Marvellous new Adding Machine. Retail \$15. Work equals \$350 machine. Tremendous possibilities. Unlimited profits. Write quick for details. Lightning Calculator Co., Dept. B., Grand Rapids, Mich.

BECOME a Landscape Architect. Dignified, exclusive profession not overrun with competition. Crowded with opportunities for money-making and big fees. \$5,000 to \$10,000 incomes attained by experts. Easy to master through our correspondence methods. Established 1916. Get information today. American Landscape School, 56-K, Newark, N. Y.

"SCHEMER Magazine," Alliance, Ohio, prints big profit schemes; one subscriber making \$25,000 from three; another \$10,000 from one. Try your luck. Year, only \$1.00; three months, 25c.

START a Real Estate Office of your own. Earn from \$3,500 upwards. Our course of 21 lessons tells you how. Booklet M, on application. Frederick Jenkins, Corlar Heights, Schenectady, N. Y.

WANTED—Ambitious men to work at home. New business. Local or mail order. Ordinary men made \$15-\$25 day. You can too. Interesting particulars; write Kraft, Box 896-P, M., San Francisco, Calif.

LEARN the collection business. Good income, quick results. Interesting booklet, "Skillful Collecting," free. National Collectors Assn., Long St., Newark, O.

EARN \$2,000 to \$20,000 yearly. You can be a Professional man in Bacteriology, Pharmacy, Osteopathy, Chiropody. Resident and Home courses. Begin now. National University of Sciences, 2923 Michigan, Chicago.

GET ahead of the other fellow Start a manufacturing business. Very little capital needed. Write for particulars. Universal Scientific Laboratories, Box 1871, Richmond, Va.

FREE Book—Start little mail order business anywhere; home employment evenings; beginner's working outfit furnished; 500 circulars, samples, things to sell; you deal direct with manufacturers; no stock to carry; instructive booklet free. Pier, 292-A, 74 Cortland St., New York.

TRUTH-Seeking Executives. Learn "Truths" about Unseen Business Leaks. Sheargreen's "Confidential Leak Finder" with Complete Copyrighted "Corrective Formula," \$8.75. Unfailing accuracy. Hundreds used. Thousands saved. "Simply Immense." "Big Money Maker." Standard Cost Finding Service, 305 East Henn., Minneapolis, Minn.

I HAVE over 100 stores paying \$5 monthly maintenance. You can do the same in your city. Only one person in each city chosen. Midnight Alarm System, 2965, Algonquin, Detroit, Mich.

HOW To—Become successful Circular Mailer.—Publish profitable Ad-Sheet.—Get free imprint circulars.—Free Advertising.—Reliable names almost free.—Make own printing press. All above plans and copy of "Ad-Lines"—America's Best Mailers Magazine, 10c. Greenhalph, Box 278, Indianapolis, Ind.

\$100.00 PER million population. Buys state manufacturing rights. Valuable patent. No competition. Enormous profits. Machinery unnecessary. Independence for life. Dr. Schmidt, Blanton, Fla.

WE Start You in Business. Easy money operating our business leads. No capital required. Manufacturer furnishes everything. Cherokee Sales Company, Department P. M., Danville, Va.

MARBLE mixing instructions, covering wood or cement flooring 1/4 inch thick, fireproof, waterproof, low cost, sanitary, all colors. Particulars, 200 illustrations free. Chris Mahler, Box 122, Huntington, N. Y.

SUBSTANTIAL Corporation manufacturing several articles under valuable patents can place several more General Sales Managers; open branch offices, manage salesmen. \$500.00 to \$1,000.00 necessary to finance agency. Expenses allowed to Chicago if you qualify. Mr. Inman, 9 South Clinton Street, Chicago, Ill.

WANTED County Distributors for World Fastest Selling Automobile Accessory. Write C. Benross Co., 381 East 144th Street, New York.

"HOW to Sell Patents" free. Patent News-H. W. Jones, D. C.

PUBLISH a Magazine of your own; Start mail order business and Advertising agency on \$1 capital. Sample magazine and plan, 10c. Harvey Teeple, Decatur, Ind.

PATENTS Procured; Trade Marks Registered—A comprehensive, experienced, prompt service for the protection and development of your ideas. Preliminary advice gladly furnished without charge. Booklet of information and form for disclosing idea free on request. Richard B. Owen, 39 Owen Bldg., Washington, D. C., or 2276-B Woolworth Bldg., New York.

PATENTS Procured Send sketch or model today for examination, prompt report and advice. No charge for preliminary advice. Write for free Booklet and blank form on which to disclose your idea. Highest references. Promptness assured. Clarence A. O'Brien, Registered Patent Lawyer, 309 Security Bank Building, Directly across the street from Patent office, Washington, D. C.

SUCCEED With Your Own Products—Formulas, Processes Different, dependable, guaranteed, Catalog free. B. Thaxly Co., Washington, D. C.

MAIL Order Business is your opportunity. Brenner's Famous Handbooks teach how to start small, grow big. Sell merchandise, service, ideas; enormous profits. Spare time to begin. Get complete set, 11 books, \$3.00, and be posted. Brenner, 335 Walnut, Philadelphia. Descriptive Catalog and big batch interesting mail order information, 25c. None free.

50 WEEK evenings—I made it. Mail Order business; booklet for stamp tells how. Sample and plan, 25c. Free 12 articles worth \$3. Alayne Scott, Coboes, N. Y.

DOLLARS yearly in your spare time. Indoors or outdoors. I'll show you how. Particulars free. PM Metz, 313 East 89th, New York.

BE your own boss. \$100.00 sufficient. Handle your own cash. Dept. M, Paul Kaye, 149 Broadway, New York.

LEARN Candy Making. Make big profits at home or in shop. Big demand for good candy. Easily, quickly learned through our correspondence course. Write today for booklet I-10. The Candy Institute, Sixty West Fiftieth Street, New York.

MANUFACTURE Ready-Made Gold Window Sign Letters. Unlimited Profits! We furnish complete instructions, accurate patterns. Absolutely no experience required. Wonderful Business Opportunity! Particulars, Wilttering, 3161 Abbott Court, Chicago.

SLOT Machines; Headquarters for Premium Machines, 1016 Germantown Ave., Philadelphia.

\$3,000 TO \$6,000 Yearly. Want it? Others are making it. Send check or money order today for our invaluable books "How to Sell Real Estate," \$3.00—and "How to Conduct Real Estate and Insurance Business," \$1.50. Absolute satisfaction guaranteed. Free catalogs. Realty Book Co., Dept. 52, Cleveland, Ohio.

SILVERING Mirrors! My exclusive French Tartaric method opens enormously profitable business. Booklet free. H. Barstow, 514 23d Street, Oakland, Calif.

MAIL Dealers—Real money maker. Literature free. Grant's, 1713 12th, Detroit, Mich.

BEFORE Starting in Business for yourself insure your success by letting us help you. Vital, comprehensive, practical, ideas, hints, points, and information by experts on buying, selling, merchandising, banking and advertising. A new business. Unusual service. Write for free booklet today. Western Bureau Business Research, Room 509 B, 315 Montgomery St., San Francisco.

1000 AUSTRIAN Kronen or Polish Marks 10c. 1,000,000 German Marks \$1.50. Also Banknotes of other countries. Dealers List free. George Grigolet, 20 Jackson, Chicago.

"WHAT to Invent for Profit" free. Patent News-C., Washington, D. C.

658 WAYS to Make Money—2,718 Formulas "Encyclopedia Business Opportunities," 3 volumes, \$1. Ideal Book Shop, 5501-PV, North Robey, Chicago.

START Collection Business. \$2500-\$5000 Yearly Possible. "Scientific Facts" Free. Box 327, Battle Creek, Mich.

ATTENTION! You can have a business of your own. Establish and operate New System Real Estate Business, brokerage and insurance agency in your community. Office at home. Earn \$5,000 year. Representatives wanted everywhere. Send stamp free booklet. Hayes Realty Association, Cincinnati, Ohio.

SIGN Painting Self-Taught. Samples, 5c stamps. Healy Sign Co., 21 Old Colony Ave., Wollaston, Mass.

EARN \$10 daily silvering mirrors, plating and refinishing metalware, autos, chandeliers, bedsteads, headlights. Outfits furnished. E. Dece Laboratories, 1133 Broadway, New York.

INCH Display Advertisement 161 Magazines Thrice \$15. Year \$50. Page \$100. Wood's Popular Services, Atlantic City, N. J.

I MADE \$50 a Week Home. French Broommaking. 15 years' experience; Free Booklet tells. Ashbrook, 67, Marengo, O.

BUSINESS Man to act as manager for new invention that is going big wherever introduced; not hard to make \$500 to \$800 month; no money investment necessary, but business experience essential; write today with references. Nelson J. Quinn, Sales Mgr., Toledo, O.

SIGNS, Banners and Cards easily painted with Letter Patterns. Write for free samples. John F. Rahn, A2433 Greenview Ave., Chicago.

MANUFACTURE Extracts and other necessities, 200% profit; we tell you how. Write White Manufacturing Drug Co., 1426 Laidlaw Ave., Cincinnati, O.

EARN \$150.00 Weekly—Start Automobile Repainting and Retrimming Shop. We teach you this Business at Home. Particulars Free. Automobile Finishing Co., Sheboygan, Wis.

CHEMISTRY

YOUR chemical problem solved and working process furnished Five Dollars. Write me. W. Stedman Richards, Consulting Chemist, address, Box 2402, Boston, Mass.

"POPULAR Chemistry," Experimenter's Monthly, Half-year, 50c. D. Wright Laboratory, Caldwell, N. J.

CHEMICAL Processes, Analysis, Research, Technical Information. Consulting Chemist, Madison, Maine.

PRODUCTS; formulas; duplicated, improved, cheapened, marketed. Ethical. Wm. Harding, 6334 Greenwood Ave., Chicago.

FORMULAS AND TRADE SECRETS

FORMULAS—Best that Chemical Science can devise. Not "Better Sort" Formulas, but Guaranteed Reliable processes in all lines. Stamp brings Valuable Literature and Latest Summer Sellers from an Analytical Chemist, Miller, Chemist, 807 De Leon, Tampa, Fla.

500 FORMULAS 25c; Luminous Paint—Resilvering Mirrors—Renewing Dry Batteries—Mechanics Soap—Gas Tonic—Carbon Remover—Puncture Plugger, 20c each. Entire collection 50c. Catalog Free. Ideal Book Shop, 5501-PC, North Robery, Chicago.

VALUABLE manufacturing secrets. Every one a money maker. Postpaid \$1.00. Your money back if not satisfied. S. Vignola, Ph. G., 135 Meadow St., Pittsburgh Pa.

5,000 RECIPES, \$1.25. Best formulas and processes for every business, trade or occupation are in "Youman's Guide." Many never before published. Worth \$1.25 each. 530 pages. Paper cover \$1.25. Cloth \$2.00 postpaid. Book catalog free. Wells and Edwards, X852 George, Chicago.

FORMULAS—Guaranteed. Catalog Free. Bestvall Laboratories, 4047-P, North Whipple, Chicago.

"BEATS ALL" Auto Cleaner and polish combine. One operation. Cleans anything. Formula, full directions \$1. Piant & Co., Waco, Tex., Ind.

FORMULAS and instructions for 10 fast selling articles, \$1. Start a business. Own it. Clarendon Co., Cold Brook, N. Y.

1,000,000 FORMULAS, 1,016 pages, \$2.50 Formulas Free if you order quick. Ideal Book Shop, 5501-PM, North Robery, Chicago.

ALUMINUM Bar solders instantly all metals by candle flame; use bar as soldering iron. Formula \$1.00. C. L. Ricketts, Box 181, Englewood, Colo.

20,000 FORMULAS, 557-page volume, \$1.50. Universal, 4047-P, North Whipple, Chicago.

NEW rouge formula a winner. Others, Circular free. Wm. Harding, Champaign, Ill.

500 FORMULAS; resilvering mirrors, valuable collection, 20c. Universal, 4047-P, North Whipple, Chicago.

500 VALUABLE Formulas 25c. Circular free. Harvey Teeple, Decatur, Ind.

10,000 SELECTED chemical, technological and practical recipes and processes, including hundreds of so-called trade secrets for every business, alphabetically arranged in one large volume of 800 pages. Price \$4 postpaid. Popular Mechanics Book Dept., 206 E. Ontario St., Chicago.

AGENTS WANTED

NO Dull Times Selling Food. The greatest, surest and safest business in the world today is selling Federal Pure Food Products, and here is your opportunity to get into this business. You can make \$3,000, \$5,000, \$10,000 or more per year—the only limit is your ability to take care of the business. People Must Eat, and our food products are the fastest selling, surest and quickest repeat order getters in the world. Sell on sight in every home where food is used. Repeat orders immediate and every week thereafter. We supply you with effective Free Advertising Matter. Free Samples and a Free Course in Salesmanship. We also have over 100 high-grade beautifully packaged Toilet Preparations. Your future will be a financial success. A Real Big Business All Your Own. Every New Customer adds a great deal to your weekly income. Your business once established has a market value just like a store and can be easily sold. The greatest money-making opportunity of your lifetime, because you risk absolutely nothing, as we guarantee your sales, and we will not let you fail. Remember! Guaranteed! Best products, biggest sellers, surest repeat orders. No capital or experience is required. We furnish capital and everything necessary for you to become a Federal Distributor. Exclusive territory will be given honest men or women who will write at once asking us to send our "Success Guaranteed" proposition. Address, Federal Pure Food Company, Dept. A, Chicago, Ill. Largest inventors of and packers of Pure Food specialties in the world. Reference, any bank, Dun or Bradstreet rating agency, Express or Railway Company in America.

NEVA-LOST Gas Tank Cap for Automobiles sells on sight; 100 per cent profit. Big opportunity for producers. State territory desired. Trinity Mfg. Co., Hartford, Conn.

"BIG Money in Emblem Goods, \$25.00 daily easy. Wall and Auto emblems; pins, buckles and leather goods sell on sight. Sales guaranteed. Get free sample and cash bonus plan. Kier Emblem Co., Dept. PM 11, Como Bldg., Chicago.

BIG Money—"Free Automobile"—Selling Klean-Rite Magic Washing Compound. Marvelous Discovery. Washes Clothes Without Rubbing. Guaranteed Non-Injurious. Beats everything. Women wild about it. "Free Samples Make Easy Sales." 300% Profit. Quick Repeater. Premium Plan Gets Big Business. Work full or spare time. "Beck, Illinois, Made \$98.00 in 2 days." Write quick. Bestever Products Co., 1941-K11, Irving Park, Chicago.

AGENTS—Our soap and toilet article plan is a wonder; get our free sample case offer. Ho-Ro-Co., 125 Locust, St. Louis.

THESE Advertisements of mine have appeared in Popular Mechanics for sixteen years. Hundreds of Successful Manufacturers today owe their success to my formulas and valuable information. Majority started with practically nothing. You can do the same—write today for my valuable literature relative to my Guaranteed Manufacturer's Formulas for making Non-Thermic Ice-Saving Cloths, Delicious Beverages for Home, Bottlers and Fountain sale. Pure Food Products, Non-Alcoholic Flavors, Launderite Washing Marvel, Zebest, greatest stain remover, Sta-Combed, Mireol Hair Curler, and latest Toilet specialties. Mexican Yucca Soap, Laundry Soaps, Flyno, Sensol, and all latest disinfectants. Amazon Tire Repair, Toy Rubber Balloons and all latest selling goods in all lines. Don't compare these with "junk" commonly offered. Analytical work carefully done. Highest references. Miller, Chemist, Tampa, Fla.

BIG Profits Selling New \$3.50 Automatic Adding Machine. Absolutely accurate. Fully guaranteed. Quick sales. Ten daily easy. No competition. Pocket size. Business people everywhere positive customers. Thousands being sold. Tremendous demand. Here's high-grade money-maker. Bassett Co., 1458-Y Hollywood Ave., Chicago.

MEN or Women Sell Our Men's Silk Neckties on Large or Small Scale Direct to Wearer. Big Opportunity for Christmas Trade. Box 450, Madison Sq. Station, New York, N. Y.

MEN'S Shirts. Easy to sell. Big demand everywhere. Make \$15.00 daily. Under-sell stores. Complete line. Exclusive patterns. Free samples. Chicago Shirt Manufacturers, 241 W. Van Buren, Factory, 113, Chicago.

MOST Wonderful Seller. 96c profit every dollar. No stock to carry. License unnecessary. Sample free. Mission Factory PM, 519 No. Halsted, Chicago, Ill.

AGENTS, sell shoes direct to ladies at home or at work. Fast selling line. Liberal pay. Splendid opportunity. Apply Now. Style-Arch Shoe Company, 503 Butler Bldg., Cincinnati, Ohio.

AGENTS Wanted (in U. S. only). Make your Christmas Money. Sell our exclusive line of engraved Xmas Cards. The very best in design, quality and price. Big commissions allowed. No money needed. Write for free samples and particulars at once, as no answers will be considered if received later than November 30th. Knight & Co., Box 278, Riverton, N. J.

AGENTS—Easy Money. Interview motorists. Patented instrument every motor needs. It Saves Money Three Ways. Guaranteed. Thousands "Sold." Glad Users Everywhere. Big demand at your door. Pleasant work. Permanent business of your own—employ sub-agents. \$75.00 weekly up, all or part time. Experience unnecessary. Your opportunity for success. Whatever you do answer this ad quick. Wizard Mfg. Co., 453 Central Ave., Rochester, N. Y.

PATENTS Procured. Send sketch or model today for examination, prompt report and advice. No charge for preliminary advice. Write for free Booklet and blank form on which to disclose your idea. Highest references. Promptness assured. Clarence A. O'Brien, Registered Patent Lawyer, 310 Security Bank Building. Directly across the street from Patent office, Washington, D. C.

FLORIST'S Plant Food. Prevents disease. Big profit. Six Formulas 25 cents. DeMuth, Camden, Mich.

AGENTS—Best seller: Jem Rubber Repair for tires and tubes; supercedes vulcanization at saving of over 800 per cent; put it on cold, vulcanizes itself in two minutes, and is guaranteed to last the life of the tire or tube. Sells to every auto owner and accessory dealer. For particulars how to make big money and free sample, address Amazon Rubber Co., Amazon Bldg., Philadelphia, Pa., Dept. 505.

FOUR \$7.50 Sales to Merchants Net you \$20.00 Daily. Sayers Systems, 2815 Sheffield, Chicago.

SELL Vic's Movie Handwriter. Big profit; everybody delighted. Sample 10c. Vic. Hansen, Wallace, Idaho.

AGENTS, Salesmen, Demonstrators, sell popular line food products and condiments direct to consumer, or to Drug Stores, etc.; popular 25c article on counter display card. Free samples. Write Stoner Mfg. Co., Forsyth Bldg., Atlanta, Ga.

AGENTS: \$75.00-\$100.00 weekly taking orders for popular price-smashing raincoats, \$3.98. Largest commission advanced. Prompt shipment. We collect. Free costs. Eagle Raincoat Co., 576 Mid City Bank Building, Chicago.

BIG Christmas Money. Man or woman to distribute samples, write orders for greatest household necessity and seller. 2 Red Stamps brings samples and particulars. Mitchell, I. 513 E. Federal St., Richmond, Va.

SUPERIOR Everlasting Writing Pad. Five dollars per hundred. Superior Manufacturing Co., Oakland, Calif.

RAPID Seller: Excellent side line for garage and repair shop trade; large profits. Colwell Machine Works, Norfolk, Neb.

WANTED—Sell Forman's distinctive cards and stationery. Congenial work; compensation liberal. Send 10c for outfit. X75, Plantsville, Conn.

DARN E-Z. Universal Fabric Patching Cement; sells to nearly everybody again and again; new uses command instant attention. Special selling system assures generous income. Dept. P. M., Darn E-Z Lab., Mutual Home Bldg., Dayton, Ohio.

AGENTS: Free sample Dr. Elliott's Vegetable Oil Soap—19 Full-sized packages right out of stock. Tea, Coffee, Extracts, Spices, Food Products, Laundry and Toilet Soap samples. Everything furnished. Send postal today. Department 61, Harley Company, Dayton, Ohio.

TO sell Thermostatic Automatic gasoline saver for Ford Cars. Retail price \$3.60—Agent's price, six or more, \$3.00 each. Chicago Tool & Engineering Co., 542 Washington Blvd., Chicago, Ill.

INSYDE Tyres inner armor for automobile tires. Prevent punctures and blowouts. Double tire mileage any tire. Tremendous demand. Big profits. Sample and details free. American Accessories Co., B-178, Cincinnati, Ohio.

WONDERFUL Invention—Eliminates all needles for phonographs. Saves time and annoyance. Preserves records. Lasts for years. 12,000,000 prospects. \$15.00 daily. Free sample to workers. Everplay, Desk 1223, McClurg Bldg., Chicago.

AGENTS, Salesmen, Demonstrators, you will have the devil's own time trying to find a better seller than "Zippe." If there was such a thing we'd have it. Splendid profit on 50c "Go Getter" repeat article that sells on ten second demonstration. Works While You Watch It. Demonstrates value, while others waste time making claims. New Discovery! Greatest Scientific Triumph of the age. It's the berries Haven't room to tell our story here. Write immediately. Karam-Smith Co., 611 Bozart St., Ft. Wayne, Ind.

AGENTS—\$15 a day—Easy, quick sales—Free Auto—Big weekly Bonus—\$1.50 premium Free to every customer. Simply show our Beautiful 7-Piece Solid Aluminum Handle Cutlery Set. Appeals instantly. We deliver and collect. Pay daily. New Era Mfg. Co., 803 Madison St., Dept. 21-T, Chicago.

AGENTS wanted to distribute Bleeco Washing Wonder. Big profits. Permanent business. Exclusive territory. Guaranteed sales. Sample, particulars free. Yonover, 1637-A 11 Roosevelt Rd., Chicago.

AGENTS. "Cleaning Up." Housewives everywhere talking about wonderful new invention—Perfection Pressure Cooker. Saves money, time, labor. Easy to sell. Write quick. Jubilee Mfg. Co., 23, Sta. C, Omaha, Nebr.

AGENTS—At last; big money maker; sample case free; contains 18 articles of pure food flavors, soaps, perfume, toilet goods, etc.; sell in every home; large profit on every sale; Edith Hunt made \$54 in one week; Dora Kraft made \$24 in spare time; Wm. Turner placed an order for \$100; Anna Lockray made \$4 an hour; Geo. Oates took order for \$72 in one week for flavors and perfumes; all big sellers; every woman buys; sells every day in the year; big repeat business; have a steady income; order your sample case today and make some real money and build up a big business. American Products Co., 9845 American Bldg., Cincinnati, O.

TAILORING Agents—We've got a wonderful line of tailor-made suits to sell at \$18 and up. Beautiful assortment of fabrics, \$10 to \$25 cheaper than retail. No experience needed. Our free suit offer is a wonder. Write American Woolen Mills Co., Dept. 1851, Chicago, Ill.

CHRISTMAS Greeting Cards—Make \$100.00 weekly. Spare time. Wholesale Prices. Manufacturer, 1235 Arch, Philadelphia, Pa.

AGENTS—Sell Geiger's Health Builder. Costs you 36 cents postpaid; sells for \$1. Money back if not pleased. Geiger Co., 6542 North Maplewood Ave., Chicago, Ill.

WANTED—Tailoring salesmen, make \$60 to \$125 per week. Biggest merchants in many towns have started with our lines. We are the largest made-to-measure tailoring house in the country, furnishing elaborate sample equipments, including 500 all wool fabrics and guaranteed absolute satisfaction, perfect fit, best workmanship, or no sales. Write me for line and all accessories to be sent free. Tell us all about yourself. Address G. H. Mitchell, Sales Manager, Box 483, Chicago, Ill.

WUNRUB, the Perfect Polish for automobiles and furniture, sells at sight. It's a Wonder. Exclusive territory, 100% profit, big repeat business. Send 25c for standard 50c can. Wunrub Company, 26 Bellevue Place, Chicago.

AGENTS Everywhere! Women's and children's guaranteed shoes direct to wearer. We deliver. A. P. Condon, Sales Manager, The Allen Shoe Co., 110 Summer St., Boston, Mass.

QUICK, steady profits for agents selling "Gem Polish"—the dustless cleaner for windows, mirrors and pictures. Details free. Sample 25 cents. Gem Polish Mfg. Co., 215 Marion Bldg., Indianapolis, Ind.

OUR Ex-Cel Luminous Crucifix "shines brilliantly in the dark." Sells on first demonstration. Big profits. Free Selling Talk with first order. W. C. Hannan Co., Dept. B, 57 E. 18th St., Chicago.

I'VE got it boys. A Silver Plating Solution that's a marvel. Just Completed. Original—New—Different. Surprising results. Wonderful seller. Repeater. Great money-maker. Big profit. Hurry. Write B. N. Hallgren, 6917 South Racine, Chicago.

AGENTS—Big Money. Fire extinguishers for automobiles. Retail (\$1.50). Send stamp for reply. F. & S. Extinguisher Co., 10th and Perry, Erie, Pa.

"HOW to Sell Patents" free. Patent News-O, Washington, D. C.

NEW patented articles. Nothing like it. No competition. Sells on sight. Can use men and women Agents, part or full time. No experience required. Write at Once, Dept. 51, Arden Products, 214 W. Kinzie, Chicago.

\$12 DAILY easy introducing Ladies' and Men's sweaters in silk, wool and artificial silk, 23 colors. Latest novelties. Going like wildfire. You simply show sample we furnish. Take orders. We deliver and collect. Your pay daily. Mac-O-Chee Mills Company, Form 11011, Cincinnati, Ohio.

EARN \$10 daily silvering mirrors, plating and refinishing metalware, auto, chandeliers, bedsteads, headlamps. Outfits furnished. E. Decle Laboratories, 1133 Broadway, New York.

AGENTS—"Perfo" Plates make cooking easier, less expensive. Sell to every house. Big profits. Write B. A. Seed, 73 Franklin Street, New York, for particulars.

MAN in each town to plate auto parts, reflectors, bathroom fixtures, refinish beds, mirrors, chandeliers; by new method. No capital or experience required. Simple plan of manufacturing at home starts you in big money-making business. Outfit furnished. Free particulars and proofs. Gun Metal Co., Ave. H, Decatur, Ill.

AGENTS. Write for free catalog. 300 sure sellers. House Dresses, Hosiery, Wearing Apparel, Household articles, Novelties, etc. Economy Sales Co., Dept. 270, Boston, Mass.

THE wonderful arch support and shoe preserver, for every shoe; unequalled for agents. S. P. M. Co., 359 Pearl St., New York.

LARGE Corporation wants a Service Man in every town to paste up its signs on store-keepers' windows. Excellent opportunity for reliable party. Steady work. No experience necessary. We also have attractive proposition for agents and salesmen. Guarantee Sign Service, 363 West Superior, Chicago.

AGENTS make \$10 daily—Big line guaranteed extracts, food products, perfumes, toilet goods, household necessities. No capital or experience needed. Free sample case and instructions. Write for amazing offer. Perkins Products Co., Desk 6, Hastings, Neb.

AGENTS—25c Sample Free. Empey, 9 Oak St., Charlestown, Mass.

\$50-\$200 A WEEK. Genuine Gold Letters for store windows. Easily applied. Free samples. Liberal offer to general agents. Metallic Letter Co., 438-D, North Clark, Chicago.

SALESMEN—Get into the tailoring game—one of the most profitable of all specialty selling fields. Experience not necessary. We show you how to take measures, teach you how to sell our line and supply you with everything necessary to go out and make from \$10.00 to \$20.00 a day from the very first day. Our selling outfit is the finest of its kind ever gotten together and shows more than 100 large cloth samples of finest woolsens. You do no delivering. You just write your orders. We do the rest. Your profits run big and you get them cash with order. If you want to get into this most profitable of all lines, write us quick. Address Dept. 691, Goodwear Chicago, Inc., 814 W. Adams St., Chicago.

SELL direct to consumer men's knitted ties in novelty pocket box. Good staple seller and big for Xmas. Costs \$6.00 per dozen. Retail \$1.00. Start now. Sample 50c. Address Manager, 407 Searle Building, Rochester, N. Y.

PATENTED Cigar Lighters with Glass Advertising Front. Also Electric Cigar Moisteners. Wonderful Sellers. No Competition. Big Steady Profits. Proof, Cuts, Sales Plan Free. Drake Mfg. Co., Dept. M, Milwaukee, Wis.

MAKE Big Money. Spare or full time. Everybody loves Popular Music. Few hours a day with unique plan builds cumulative income. Representatives cashing in. Reserve territory. Get particulars quick. Crocker-Steinkamp, Dept. C-11, Quincy, Ill.

AGENTS—Portraits, medallions, frames, luminous crucifixes, pearl paintings, pictures, sell easy, always, everywhere at big profit. Pan American, 1217A Monroe, Chicago, Ill.

AGENTS—Moss-Corn and Calicos Remover will build you a steady repeat business. Send today for pocket size trial outfit. The Moss Company, 165 Searle Building, Rochester, N. Y.

AGENTS: \$10 a week selling guaranteed hosiery for men, women and children. Must wear 12 months or replaced free. Write for sample outfit. Thomas Mfg. Co., Class 162, Dayton, Ohio.

AGENTS—Send for sworn proof of \$5 to \$15 daily—introducing New Style Guaranteed Hosiery—57 styles, 17 colors. No capital or experience required. Just write orders—we deliver and collect. Your pay daily; also monthly bonus. Free auto offer besides. Complete outfit furnished, all colors—grades—including silks—wools—leathers. Mac-O-Chee Mills Company, Desk 25611, Cincinnati, Ohio.

YOU can sell every merchant in town our changeable signs. Large profits; easy sales. Write for territory now. Changeable Sign Co., 581 East 102nd, Cleveland.

SHEEP Wool Moccasins, Polishers, Dust-ers Box 26, East Boston, Mass.

YOU can be your own boss with our Key-Check outfit. Good for \$5 a day stamping names on pocket key checks, fobs, etc. Sample check with your name and address, 20 cents. Pease Die Works, Dept. M, Winchester, N. H.

AGENTS: Big money Monogramming by Transfer Method. Catalog Showing Over 50 Styles and Particulars Free. Motorists' Accessories Co., Mansfield, Ohio.

SELLS Like Hot-Cakes; Big Profits; New Ironing Wax Pad and Asbestos Rest; Clamps Board; Perfumes Clothes; Outfit 10c. Yankee Mfg's, 580 Atlantic Ave., Brooklyn, N. Y.

AGENTS—Easy Money. Interview motorists—Patented instrument every motor needs. It Saves Money Three Ways. Guaranteed. Thousands "Sold." Glad Users Everywhere. Big demand at your door. Pleasant work. Permanent business of your own—employ sub-agents—\$75.00 weekly up, all or part time. Experience unnecessary. Your opportunity for success. Wizard Mfg. Company, 453 Central Ave., Rochester, N. Y.

AGENTS: Big returns, fast office sellers; particulars and samples free. One Dip Pen Co., 2 Daily Record, Baltimore, Md.

DELICIOUS Desserts—\$1.00 an hour selling Stuart's delicious desserts, pudding powders and pie fillers. Write for terms and free samples. C. H. Stuart & Co., 5867 B'way, Newark, New York.

AGENTS sell made to measure gabardines, whincords, \$14.50; reversible rain-coats; \$75-\$100 weekly. Outfit free. Standard Raincoat, Dept. 5, 129 West 17th St., New York.

AGENTS. Sell Rich Looking Imported 36x66 rugs, \$1.00 each. Carter sold 115 in 4 days, his profit \$57. You can do the same. Write for sample offer. Sample prepaid \$1.39 each. E. G. Condon, Importer, 77 Bedford St., Boston, Mass.

MEN and women agents. Sell Box Stationery and Xmas card sets with name and address. New big profits. Samples. Teaply Co., 15D, Somerville, N. J.

AGENTS—The Big Seller of the year is the Universal Jar Opener. Has many uses. Sells for 50c. Costs \$2.00 dozen prepaid. Sample 25c. We offer agents the largest line of steel and wire specialties on the market. General Products Company, 7 Oliver Street, Newark, N. J.

NEW Business. Re-Dye Bugs on the Floor. Fibertint applied with brushes. Nine colors, \$1.00 box dyes 9x12. Sample for small rug 10c. Agencies granted. Teaply Co., Inc., 15-A, Somerville, N. J.

BIG Money and Fast Sales. Every owner buys Gold Initials for his auto. You charge \$1.50; make \$1.35. Ten orders a day easy. Write for particulars and free samples. American Monogram Co., Dept. 40, East Orange, N. J.

START your own business as our sole agent, selling 100 famous home products. All or spare time. Dr. Blair Laboratories, Dept. 524, Lynchburg, Va.

REX India Fibre Broom; One of the biggest sellers on market. Outlasts five ordinary brooms—price no higher. 100% profit. Rex Fibre Products Company, 145-C New Jersey Ave., Brooklyn, New York.

AGENTS—\$4.25 Profit on every sale of Nibco Service Set. Needed in every home and building. Get particulars quick. A. A. Silver-Chamberlain Company, Clayton, N. J.

START and Operate Your Own Business and acquire financial independence. Openings everywhere. Either men or women. We furnish everything and show you how. Big explanatory book "The Open Door to Fortune" Free. Ask for it now. National Scientific Laboratories, 16A, Richmond, Va.

ANY man handy with paint brush or light tools can start new mechanical business on nearly nothing; needed everywhere; nearly all profit; experience not required. John Brace-land, 1457 So. Ninth, Philadelphia, Pa.

BIG Fast Profits for Agents. Repeater Six Fuse Plugs sell on sight wherever there is electricity. Do away with lightning troubles. Welcomed everywhere. Get details. Sample 25c. Moss-Schury Manufacturing Company, Inc., 10-A, Detroit, Mich.

PORTRAIT and Medallion Agents—Our Goods WILL Make You Big Profits; delivery guaranteed; prompt shipments; low prices; send for latest catalog. Adam J. Kroff & Co., 602 Blue Island Ave., Chicago.

EVERY home a prospect. Zenith Cleaner and Polish for Automobiles and Furniture. Agents make 100%. Sample 25 cents, refundable first order. Absolute repeater. Zenith Products Company, 202 Clay Ave., Rochester, N. Y.

VALUABLE Information I supply sells readily. 1000% profit. K. Home, 1957 Warren, Chicago.

GENERAL Distributors—Make \$100 to \$150 weekly as Distributor for World's Greatest Automobile Polish. Easily demonstrated, wonderful results, sure repeater. Sell to consumers, sub-agents, dealers. Big money-making proposition to hustlers. Write quickly for exclusive territory. The Armo Mfg. Co., N-130 Goodale, Columbus, Ohio.

AGENTS, both sexes, we manufacture and control new household article. Fast seller. Big profits. Exclusive territory. Write now. Connolly, 123 Liberty St., New York.

AGENTS: No matter what you are selling, you can make more money selling our finest made-to-measure clothes for men at sensationally low prices. We pay biggest profits and supply everything, including line of finest swatch samples in handy carrying case. Line shows big assortment of finest weave worsteds. Also ladies' man-tailored coats. Even if you've never sold before, we'll take you. But write at once. Don't delay. Lines are going fast. Address Dept. 285, Knickerbocker Tailoring Company, 131 South Peoria Street, Chicago.

AGENTS: New product no equal. 150% profit. 100% Repeater year round. Sells to everybody. Astounding results from first day. Surety Manufacturing Co., 26 W. Washington, Chicago.

AGENTS, I will show you how to sell \$100 a day with very little talking. Costs nothing to find how to make \$20 daily selling line so good people must buy. Men or women. Write me today. B. H. Hornig, President, The C. & D. Co., Grand Rapids, 41, Mich.

PORTRAITS, photo pillow tops, frames, sheet pictures, medallions, merchant's signs, water-proof and tea aprons, guaranteed hose, toilet requisites, luminous crucifixes; catalog. 50 specialties free. 30 days' credit. Jas. C. Bailey Co., Desk M 11, Chicago.

27,000 RECORDS guaranteed with one Everplay Phonograph Needle; new—different; cannot injure records; \$15.00 daily easy. Free sample to workers. Everplay, McClurg Bldg., Desk 116, Chicago.

AGENTS \$100 weekly selling fancy knitted ties. Sample 35 cents. Raymond's Mfg. Co., 31 East 132nd Street, New York.

DISTRIBUTORS wanted for the fastest selling shop tool on the market—the O'Brien Automobile Engine Support. Holds all detachable head motors while making repairs. Will pay for itself in time and labor saved in one week. Sells to repairmen and fleet owners for \$18.00 cash, \$20.00 on time. Write for details. Banner Accessory Mfg. Co., 2629 LaSalle St., St. Louis, Mo.

FORTUNE Maker—Thread-Cutting Thimble. Live wires only. Sample, 15c. Automobile Mfg. Co., 3753 Monticello, Chicago.

GOLD Leaf Sign Letters; make and sell; profits exceed 1,000%; immense demand; particulars free. Johnston Co., Quincy, Ill.

AGENTS—Distributors—make easily \$100 to \$200 a week. Be a "Pile-Rench Man." Get into a permanent business with growing profits. Sell marvelous Eifel-Flash Pile-Rench Tool Kit—Guaranteed to Do Tool Work better, quicker, and easier, than 60 pounds of best other tools costing \$50.00. Only kit that does all work around Home, Car, and Shop. Weighs 1½ Pounds. Sells quickly, when shown, at \$5.50. On market 3 years—thousands sold. Extra good for agents with cars. Fine side line—carry in pocket. State how you sell, territory wanted. The Flash Sales Corp., Dept. P, 4809 North Ashland Ave., Chicago.

AGENTS secure exclusive rights selling direct to consumers. High grade rubber necessities direct from manufacturer. Ohio Sales Mfg. Co., 1459 W. 6, Cleveland, O.

MAGICAL Necklace. "Shines in the Dark." Absolutely new. Be the first to sell this charming and captivating necklace. 100% to 400% profit. Send \$1.00 for sample and territory protection. W. G. Hasman Co., Dent, E. 57 E. 18th St., Chicago.

SUCCESS in Business and Personal Affairs! Read character by handwriting and features. Conlin System. Low price for entire course. Write, H. E. Conlin, Dept. B, 21 St. John's Place, Buffalo, N. Y.

MAKE \$25 to \$50 Week, representing Clows' Famous Philadelphia Hosiery, direct from mill—for men, women, children. Every pair guaranteed. Prices that win. Free book "How to Start" tells the story. George Clows Company, Desk 31, Philadelphia, Pa.

RUG Salesmen—Get next to the biggest seller of the year—Loomrite Felt Rugs. Sell at sight at \$2.50; cost \$15 dozen. Big, complete Rug Catalog, Free. Malsley-Payne Mfg. Co., 104-D Hanover St., Boston, Mass.

LIVE Agents make \$10 day selling Eureka Strainer and Splash Preventer for every water faucet. Takes on sight. Widely advertised and known. Get details today. A. B. Seed Filter Company, 73 Franklin, New York.

EARN big money fast applying gold initials to autos. Every owner buys—\$1.35 profit on \$1.50 sale—particulars and samples free. Write quick, Lithogram Co., Dept. 17, East Orange, N. J.

AGENTS—If you have formerly sold felt rugs, write for our new proposition concerning new goods. It's a winner. Newark Felt Rug Company, 27-C 16th Ave., Newark, N. J.

AGENTS, Mailorder Men, Beginners, Valuable Inside Information, 300% Profit. Nite Mail Order Supply Co., 609 27th, Denver, Colo.

UNBREAKABLE Combs, kind you can hit with hammer, saw wood with teeth, etc. Real money-makers for hustlers. Agency terms and convincing proof free. Oliver Gandy Co., Crisfield, Md.

THE Agent's Guide, Tells where to buy everything. Copy sent sealed for \$1.00. United Publishing Company, Box 74, Madison Square Station, New York.

AGENTS: Can start you in Mail Order Business Immediately. Been at it 17 years. Small Capital needed. Particulars stamp. Home Business Expert, Valdosta, Ga.

AGENTS: Where to buy 12,000 articles Wholesale. Actually worth \$50. Enclose stamp. Wholesale Supply Co., Valdosta, Ga.

EASY applied Transfer Lettering. Big Money proposition. Samples Free. Address Auto Monogram Supply, 14 Green St., Newark, N. J.

AGENTS, \$54 a week; travel by auto, install New Stone Converter in country homes. Wonderful invention. Cook and bake all year without coal or wood. No gas or electricity needed. We furnish the auto. Sample free. Thomas Mfg. Co., Class 2562, Dayton, Ohio.

WONDERFUL opportunity—establish permanent business. Most attractive line Toilet Requisites, entirely new. Be first in territory. Soaps, Extracts, Remedies, Jewelry. Big profits. Catalogue free. Van Ogden, Inc., 1923 Van Buren, Chicago.

SELF-THREADING Needles find sales in every home. Fine sideline, easy to carry. Big profits. Sample free. Prentice-Lee, 145 East 23rd St., New York.

AGENTS—Make big money selling Earl's "Cutwell" Imported Pocket Pencil Sharpener. Sample 15c prepaid. Sells on sight. B. G. Earl, 56 E. Randolph St., Chicago, Ill.

AGENTS—Earn \$75.00 to \$100.00 weekly selling "Sun Bright" Pure Aluminum guaranteed Cooking Utensils direct to housewife. Prices 25 to 50% lower than retail. Write today for particulars and state what territory you want. Hand Distributing Co., Inc., Direct Factory Rep., 35 So. Dearborn, St., Chicago, Ill.

AGENTS: make some real money selling our popular line of rubberized products. Catalog on request. Central Mail Order House, 223 Commercial St., Boston, Mass., Dept. M.

AGENTS. Free offer captivates customers. 20 first day—\$20.00 profit. 100 celebrated necessities. National Products Co., 855 Grand, St. Joseph, Mo.

BIG, Quick Money for agents, distributors, men and women everywhere; good for \$10-\$15 daily; everybody buys; rapid cash sales; repeat orders come fast; your opportunity for permanent business; samples, circulars furnished free. Send for facts without fail. Paul M. Smith, Kutzowen, Pa.

AUTOMATIC Kuff-Buttons, Wonderful Convenience, shirt and trouble saver. Sells like wildfire. Sales unlimited, direct to wearer. Sample pair \$1.00. Flexo Copm, Sheboygan, Wis.

RAINCOAT Agents. Get Our Prices. Sell made-to-measure raincoats. We deliver and collect. Outfits free. World Raincoat Co., 659 Morris Park Ave., New York.

AGENTS: Our line of Unique Diversified Products will make you big money. National Auto Accessories Mfg. Co., Saginaw, Mich.

AGENTS—Steady income. Large manufacturer of handkerchiefs and dress goods, etc., wishes representative in each locality. Factory to consumer. Big profits, honest goods. Credit given. Send for particulars. Freeport Mfg. Co., 59 Main St., Brooklyn, N. Y.

HANDKERCHIEFS, "Quality" line. Agents get bedrock factory prices. Write for the plan of this dependable business. Turnover Sales Company, 18-A East 17th St., New York.

EARN \$10 to \$25 a Day. Sell beautiful durable "Novo" Hosiery. Knitted Neckwear and Full-Cut Shirts. Direct Mill to Wearer. Complete family line, silks, sport-woods. Customer satisfaction defies competition. All or spare time. Investigate. Novo Mills, Dept. E, 3rd and Sedgley, Philadelphia, Pa.

CLARKE made \$18 an hour selling vest-pocket windshield cleaner needed by every autoist, motorman, engineer; one rub keeps glass clear 24 hours; 50,000 sold; amazing proposition free. Security Mfg. Co., Dept. 104, Toledo, Ohio.

AGENTS—Send for sample "Fretnet"—the washday wonder. Be convinced you can do a whirlwind business. You can clear at least \$20 to \$100 weekly, according to spare or whole time. You don't have to talk; if she doesn't buy at sight, leave sample; she will be looking for you long before you are able to make the rounds again. Samples furnished free. Premiums for your customers. Exclusive territory guaranteed to agents who can produce. Credits given. Don't call. P. M. Motter & Sons, 20 E. Jackson Blvd., Chicago.

GENUINE Gold Leaf Letters anyone can put on store windows. Guaranteed to never tarnish. Large profits. Enormous demand. Free samples. Write today. Metallic Letter Co., 438-A North Clark, Chicago.

RUMMAGE Sales make \$50,000 daily. We start you. Representatives wanted everywhere. "Wholesale Distributors," Dept. 92, 609 Division Street, Chicago.

POLMET—The polishing cloth approved by "Good Housekeeping" and "Modern Priscilla." Sells fast at 25c. Sample free. Gale & Co., Inc., 15 Edinboro St., Boston.

CALIFORNIA Rosebuds selling like hot cakes. Agents coining money; new stuff. Big profits. Catalog free. Mission Factory PM, 519 No. Halsted, Chicago, Ill.

AGENTS Wanted—Something New—Fire Fighter sells easily. Makes a spectacular demonstration; car owners, homes, factories, stores, practically buy on sight. Our men make \$10.00 to \$50.00 a day; exclusive territory. If you wish to establish a business of your own with unlimited possibilities for making big money, write us today. Fyr-Fyter Co., 103 Fyr-Fyter Bldg., Dayton, Ohio.

AMAZING auto necessity. Retail \$4.00. Your profit \$2.50. Territory going. Write Super, 1396 Fondulac, Milwaukee, Wis.

AGENTS Make Money; sell California Specialties. Sample 25c. W. Bedell, 789 So. 18th St., Newark, N. J.

AGENTS: C. T. A. prices lower than ever. Suits \$18.00, made to order, any size or style. Orders easy to get. Big profits. Agents' outfit free. Sample suit at cost. Write Chicago Tailors Ass'n, Dept. 418, Sta. C, Chicago.

AGENTS sell made to measure gaberdines, whipcords, \$14.50; reversible raincoats; \$75-\$100 weekly. Outfit free. Standard Raincoat, Dept. 5, 129 W. 17th St., New York.

SELL Something nine out of ten women will buy because it saves double its cost the day it is bought. 50c each. \$2.00 profit on \$3.00 sales. Premier Mfg. Company, Dept. 813, Detroit Mich.

PORTRAIT Agents—\$50,000 Profits I made canvassing. My valuable Free book explains all. Guaranteed Prints, Portraits, Frames, Photo-Pillow-tops, Sheet Pictures, shipped all over the world. Samples free. Picture Man Friedman, Dept. 8-H, 673 Madison, Chicago.

EASY, pleasant work for Mechanics, Shop Men, Clerks, during spare hours; will add many dollars to their salaries. Also want persons who can give full time. Big wages assured. Novelty Cutlery Co., 67 Bar St., Canton, Ohio.

SELL Madison "Better Made" Shirts direct from our factory to wearer. No capital or experience required. Easily sold. Big profits. Write for Free Samples. Madison Mills, 503 Broadway, New York.

AGENTS—W. F. Omels, a former brush salesman, made over \$5,000.00 during 1922 selling our \$1.50 kitchen specialty. He is now a district manager. We are offering you the same proposition—an opportunity as big as you want to make it. You can do what Omels did. Write today to M. H. Tyler Mfg. Co., Manager's Desk, Muncie, Ind.

AUTO owner tire agent wanted each locality to use and take orders for handmade Mellinger fabric and cord tires; guarantee bond 8,000 and 12,000 miles (no seconds); shipped prepaid on approval; get your tires free; no capital or experience required; make \$100 to \$300 weekly. Write for wholesale prices and sample kit. Address, Mellinger Tire Co., Dept. 100, Kansas City, Mo.

AT Last—World's Greatest Adding Machine. Almost human. Retail \$15; work equals \$300 machine. \$500 monthly easily made, demonstrating to stores, offices, garages, factories. Simple, easy; adds, subtracts, multiplies, divides automatically. Speedy, accurate, durable, handsome. Five year guarantee. Tremendous demand, amazing profits. Liberal trial offer. Protected territory. Write quick. Lightning Calculator Corp., Dept. F, Grand Rapids, Mich.

AGENTS—\$3 per hour and more! Sell Iron Board Covers, Rubber Aprons, Shopping Bags, Embroidered Aprons, Saton Coverall Dresses. Free Sample offer. American Hauling Company, Dept. P, 329 W. Monroe, Chicago.

AGENTS: Big profits. Best and cheapest window letters made. Easily applied. Dime brings five samples. Particulars free. Stalbrite Co., 1115 Second Ave., New York.

AGENTS—Clever Invention! Inkspoon makes every pen a fountain pen. Fast office seller; big profit, demand increasing everywhere. Exclusive territory offered. Sample free. H. Marul Company, Tribune Bldg., New York, N. Y.

EVERYBODY uses extracts. Sell Duo Double Strength Extracts. Complete line household necessities. Big repeaters. Write today. Duo Co., Dept. E1, Attica, N. Y.

AGENTS—Stamping names on Pocket Key Protectors; sample Check with your name and address, 25c. Stamping Outfits, Emblem Checks, Check Fobs, Name Plates. Hart Mfg. Co., Desk 2, 383 Degraw St., Brooklyn, N. Y.

IF you want good live agents—fellows who can get the business—ask me how others are doing it. I'll gladly render the necessary assistance. Geo. F. Baker, Mgr. Classified Advertising, Popular Mechanics Magazine, Chicago.

\$8.00 TO \$20.00 per day. A wonderful seller. Any man, woman, boy or girl can make big wages selling Crimp Grip Clothes Line Fasteners. It is a perfect rope holder and can be used for many purposes. Crimp Grips are a simple, time-saving device. They last a life time and will not rust; it holds the line tight, and saves time on wash days. Every buyer is a booster. Send 50c for Mounted Sample and one pair of Crimp Grip Clothes Line Fasteners. Write for particulars. Crimp Grip Company, Belvidere, Ill.

WE pay \$50 a week and expenses and give Ford auto for men to introduce poultry and stock compounds. Imperial Co., D-23, Parsons, Kan.

WANT Distributing Agents everywhere for Hanslick, the new original powdered hand soap. Removes grease, grime, ink, paint, and most anything from the hands without injury to the skin. Every mechanic and auto-owner, everybody who gets his hands dirty will be a customer. A great opportunity for a hustler to get in business for himself. Full information free. Send 10 cents, coin or stamps, for liberal sample can. Solar Products Company, 122 West Lake Street, Chicago.

AGENTS clear \$50.00 weekly selling Opaline Portraits. Expense money advanced. Credit given. Big line now ready. Samples and Catalog free. Consolidated Portrait Co., Desk 2, Chicago.

AGENTS—N-R-G Laundry Tablets, the old reliable moneymaker for live agents. Millions sold—used in many homes—sales waiting for you. Clothes washed spotlessly clean in 10 minutes without rubbing. Free samples. N-R-G Company, 732-A N. Franklin, Chicago.

SELL Necessities. Everybody needs and buys the "Business Guide." Bryant cleared \$800.00 in July. Send for sample. It's free. Nichols Co., Box 4-B, Naperville, Ill.

\$100 WEEKLY. Agents, Crew Managers. Absolutely new article selling big to housewives. No capital required. Commissions paid in advance. No collections. No delivery. Exclusive territory. Write quick. Pioneer Corp., 6301 Yale Ave., Chicago, Ill.

AGENTS make 500% profit handling Auto Monograms, New Pictures, Window Letters, Transfer Flags; Novelty Signs. Catalog Free. Write Hinton Co., Star City, Ind.

GET Our Free Sample Case—Toilet articles, perfumes and specialties. Wonderfully profitable. La Derma Co., Dept. A, St. Louis, Mo.

AGENTS—Good salary and commission selling "Ratskylil," new rat and mouse exterminator; ready for use; no bait required; non-poisonous; rodents die outside premises; no odor. Empire Specialties Co., 1549 N. Wells, Dept. 301, Chicago, Ill.

WANTED—Representatives to sell Automobile necessity. Kills headlight and sun glare. Write for sample. Dept. P, The Clark Products Co., Springfield, Ohio.

WE start You Without a Dollar. Soaps, Extracts, Perfumes, Toilet Goods. Experience unnecessary. Carnation Co., Dept. 201, St. Louis.

AGENTS make a dollar an hour. Sell Mendits, a patent patch for instantly mending leaks in all utensils. Sample package free. Collette Mfg. Co., Dept. 404-B, Amsterdam, N. Y.

AGENTS—Make big money selling the "Hatsaver," a waterproof cover which protects the hat from rain, snow and dust. Sample 25c. Weight one ounce. R. D. King, 312 South Dearborn St., Chicago.

AGENTS—Unusual opportunity \$2.70 profit on every \$4.50 sale; 30 sales daily easily made. Every home and office a live prospect. Re-orders. Write today for exclusive territory. Hoban, Receiver Holder Corporation, 520 West 41st, New York.

AGENTS: A sale in every home for our beautiful dress goods, silks and general yard goods. Quick sales! Big profits. Large book of nearly 1,000 handsome fabric samples furnished to agents. Write today. National Importing & Mfg. Co., Dept. 6X, 573 Broadway, New York, N. Y.

HIGH-GRADE SALESMEN WANTED

OFFICE Specialty—Costs 25c; sells \$1. Many buy hundreds. Big profits. Exclusive rights. Mfg., 3240 N. 13th St., Philadelphia.

RAPID Seller: Excellent side line for garage and repair shop trade, large profits. Utility Tools, Norfolk, Nebr.

SALESMEN and District Managers—Hundred Thousand Dollar Corporation wants capable salesmen to sell established, constantly used, repeating specialty to Hotels, Restaurants, Lodges, Dairies, Theatres, Garages, Schools, Hospitals, Institutions, etc. No dull seasons. Protected territories. Permanent, highly paid positions leading to District Managerships. Exceptional opportunity for live men with ability to organize District Sales Forces. Write at once, stating experience and territory desired. The Colorcraft Company, 1015 West 70th Street, Cleveland, Ohio.

\$4.00 PROFIT on Every \$5.00 sale. "Free Sample"—New Specialty. (Money Getter.) Every Storekeeper, Doctor, buys quickly. Experience unnecessary. Territories open. Box 596, Hartford, Conn.

SALESMEN—to sell X-Cell-All Master-lites, a commercial lighting unit, direct to stores, offices, etc. Permanent and profitable. Write X-Cell-All Co., Ltd., 19 S. Wells St., Chicago, Ill.

WORLD'S Fastest Selling Auto. Accessory County distributors wanted; write today. G. L. W. Spring Oiler Co., San Diego, Calif.

COLLECTIONS made where others fail. "Zim's Peerless"—once used, you'll stick forever. Retail, \$7.50. Creditors' Association, E-312 McKnight Bldg., Minneapolis, Minnesota.

1000 DOLLARS Monthly Proposition. Particulars Free. A. Davis, 1637 Roosevelt Road, Chicago.

SELL our advertising pencils. Big profits. Rose Pencil Co., 740 Hodapp, Dayton, Ohio.

\$3,000 AND more a year easy for capable salesmen selling Kit-Chin-Kits. Great, new idea. Tremendous sales possibilities. Get full particulars. Kit-Chin-Kit Corporation, A-1023, 6 West Randolph St., Chicago.

SALESMEN: If You Want \$6,000 This Year, write now. Strong line for retail stores. Nationally advertised; established concern. Liberal weekly advances to producers, George R. Williams, 1920 Euclid, Cleveland, Ohio, Dept. 200.

TAILORING Salesmen—Fastest selling line, suits, overcoats, made to measure—\$29.50—one price, all wool. Profits in advance. Biggest old reliable house. W. D. Smith & Co., established 1895, Chicago.

SALESMEN—Crew Managers. You will have the devil's own time trying to find a better seller than "Zippe." If there was such a thing we'd have it. Splendid profit on 50c "Go Getter" repeat article that sells on ten second demonstration. Works While You Watch It. Demonstrates value, while others waste time making claims. New Discovery! Greatest Scientific Triumph of the age. It's the berries. Haven't room to tell our story here. Write immediately. Karam-Smith Co., 6611 Bosan St., Fort Wayne, Ind.

SALESMEN, We pay larger commissions than any other Brush House in the country to men selling our line of Sanitary Twisted-in-wire Brushes. Sanitary Wire Grip Brush Co., 15 Mercer St., New York City.

MAKE \$120 Weekly in Spare Time. Sell what the public wants—long distance radio receiving sets. Two sales weekly pays \$120 profit. No big investment, no canvassing. Sharpe of Colorado made \$955 in one month. Representatives wanted at once. This plan is sweeping the country—write today before your county is gone. Ozarka, 802 Washington Blvd., Chicago.

SALESMEN—Become Independent. Own your business; experience unnecessary; selling our \$7,500 Accidental Death, \$50 Accident, \$25 Sick Weekly Benefits; \$12.50 yearly; other amounts proportionate. Guaranteed steady income from renewals. \$250,000 deposited Insurance Department. Registration Dept. A, Newark, N. J.

DISTRICT Managers! Are you making 290% on your sales? If not, get our proposition. High-grade line of Household Necessities. Write for territory and full particulars. Midwest Drug Co., 185 East Naghten St., Columbus, Ohio.

SALESMEN—Crew Managers to sell Kirby Telephone Pad Holders. Retail for 50c. No tools necessary to attach to telephone. With two places for pencil, a tearing edge and 4x5 pad, every office and home a prospect. Black enameled to match telephone. Big profit. Kirby Mfg. Co., 738 Middletown, Conn. "Prices guaranteed against a decline."

SALESMEN and Distributors for our Nationally Admitted line of Motorene Oils and Columbia Paints. We desire men of real ability who can establish a going business in their communities. This is an opportunity to establish a permanent business which will pay from \$2,000 to \$5,000 a year. Central Petroleum Company, Cleveland, Ohio.

BEST Seller: Jem Rubber Repair for tires and tubes; supersedes vulcanization at saving of over 80%; put it on cold, vulcanizes itself in two minutes, guaranteed to last life of tire or tube; sells to every auto owner and accessory dealer. Get particulars how to make big money and free sample. Amazon Rubber Co., Philadelphia, Pa., Dept. 510.

\$742 LAST month for Beck of Buffalo. Introducing latest advertising plan; nothing else like it; every merchant wants it; easy sales; no deliveries; no collections; specialty salesmen write quick for offer. National Adv. Service, P. O. Box 50, LaGrange, Ind.

BRUSH Salesmen, Dist. Mgrs. City and State. \$30-\$75 weekly. Get our 50-50 proposition. We train the inexperienced. Neway Brush Co., Hartford, Conn.

SALESMEN Wanted—We Have It: Something New; different, in demand; repeats; national adv., handled by all dealers; used by everybody; pays big comm. in advance; credits for reorders; samples easily carried in grip and may be carried as a side line or regular; a surprise waiting. World's Product Co., Spencer, Indiana, Dept. 25.

DISTRIBUTORS Wanted—Pay-Deo-Domes, unique deodorizer. Uniform, lasting, fragrant odor. Small, portable system. Low cost. Rapid seller. Appeals to all business people. Ideal work, no dull seasons. Manufactured by W. J. Howell, 1504 Turner St., Allentown, Pa.

CALIFORNIA Rosebuds selling like hot cakes. Agents coining money. Absolutely new. Big profits. Catalog free. Mission Factory 8P, 519 No. Halsted, Chicago, Ill.

LARGE Jewelry firm wants representatives. Sell high-grade jewelry direct. Full or spare time. Factory prices. Satisfaction guaranteed. Your generous profits in advance. Direct Jewelry Co., 16 Central Parkway, Cincinnati, O.

\$5 PROFIT selling \$7.50 necessity. Write for sample. Merchants Ass'n, Minneapolis, Minn.

A WONDERFUL Seller! Any man, woman, boy or girl can make big wages. Some agents make from \$8.00 to \$20.00 per day. Crimp Grip Clothes Line Fasteners are a simple, time-saving device for holding a rope—also used for many other purposes. It pays for itself quickly in time saved on wash days. No knots—it fastens and releases quickly. Every home a prospect. Every housewife who uses Crimp Grips—and there are thousands of them—is a booster. There is but one Crimp Grip. Write for particulars, or send 50c for one pair and a mounted sample, with full particulars to agents. Crimp Grip Company, Belvidere, Ill.

\$60-\$200 A WEEK. Genuine Gold Letters for store windows. Easily applied. Free samples. Liberal offer to general agents. Metallic Letter Co., 438-B North Clark, Chicago.

PHOTO medallion salesmen; Earn \$100 to \$200 every week selling P. & G. Photo medallions. No investment—free equipment. Guaranteed 4-day service—send for sales plan and free 1923 catalogue with 102 beautiful designs, including clock and religious medallions. Pudlin & Goldstein, 259 Bowery, Dept. A, New York.

SALESMEN Can make \$5.00 a day selling our Calendars, Pencils, Signs, Advertising Novelties, Yardsticks, Whistles, etc. Liberal terms. Sells entire year. Fine side line. Local and traveling agents. Model Calendar Co., Dept. 226, South Bend, Ind.

TRAVELING Salesmen calling on retail stores wanted by large manufacturer to sell wonderful line of business-boosting articles. Year round, fast selling, main or side line. If not earning \$150 weekly, address Elzasser Works, 222 Charles St., Rosville, N. Y.

WERE You Ever Offered a Grocery Store? Our Proposition is Better. You can handle Sugar, Flour, Canned Goods, Dried Fruit, Coffee and entire line of Groceries, as well as Paints, Roofing, and Automobile Oils, with no rent to pay; no money invested; take large orders from samples. Goods are guaranteed and proven quality. Selling experience not necessary. Steady, profitable work for "workers." Address Hitchcock-Hill Co., Dept. 200, Chicago, Ill. Reference: Any Bank or Express Co.

SALESMEN—Sideline pays five to ten dollars a day taking orders for Specially printed gummed advertising and Match Box Stickers. Write for proposition, samples, etc., today. Beardsley's Printery, Rock Island, Ill.

HELP WANTED

FIREMEN, Brakemen, Baggage-men, Sleeping car, train porters (colored). \$140-\$200. Experience unnecessary. 810 Railway Bureau, E. St. Louis, Ill.

U. S. GOVERNMENT positions. \$1400 to \$2500 year. Men 18 up. Become Railway Mail Clerks—City Mail Carriers—Post Office Clerks—Rural Carriers; Steady work. Life positions. Paid vacation. Influence unnecessary. Common education sufficient. Specimen examination questions and list positions obtainable—Free. Write immediately. Franklin Institute, Dept. C-3, Rochester, N. Y.

\$133-\$192 MONTHLY. Railway Postal Clerks. Sample questions, list positions, free. Chicago Civil Service College, A-51 Kesner Building, Chicago.

SMALL capital starts paying mail order business. Toilet specialties without competition. Proposition and particulars free. Glacier Laboratories, Inc., Springfield, Minn.

U. S. GOVERNMENT wants Railway Mail Clerks. Commence \$133 month. Steady positions. Travel—see the country. List positions free. Write immediately. Franklin Institute, Dept. C-20, Rochester, N. Y.

STORIES, poems, plays, etc., are wanted for publication. Good ideas bring big money. Submit manuscripts or write Literary Bureau, 522, Hannibal, Mo.

\$200 PROFIT Weekly, installing automatic advertising directories in hotels, etc.; the 12 advertising spaces sell quickly, illuminated information of train schedules, road maps, etc., appear on opaque glass. Get particulars and booklet. Sterling Service, Ocean View, Va.

\$5 TO \$15 daily easy—Introducing New Style Guaranteed Hosiery. Must wear or replaced free. No capital or experience required. Just show samples, write orders. Your pay in advance. We deliver and collect. Elegant outfit furnished. All colors—grades—including silks—wool—hathers. Mac-O-Chee Mills Company, Desk 29011, Cincinnati, Ohio.

RAILWAY Postal Clerks—Start \$133 month. Railroad pass; expenses paid; questions free. Columbus Institute, E-2, Columbus, Ohio.

BE a Finger Print Expert. Demand increasing. Write for special free offer. American Finger Print System, 1966 Broadway, New York.

WANTED. \$133 month. Men 18 up. Railway Mail Clerks. Write for list positions. Franklin Institute, Dept. C-20, Rochester, N. Y.

BE an Automotive Electrician. Best trade today. Be independent; earn good wages. We instruct by mail and personal attendance. Guarantee satisfaction. We place our graduates in good positions. Let us place you. Low price; easy terms. Johnson's Automotive Electrical School, Dept. B, 729 Broadway, Denver.

EARN \$110 to \$250 monthly, expenses paid as Railway Traffic Inspector. Position guaranteed after completion of 3 months' home study course or money refunded. Excellent opportunities. Write for Free Booklet CM-46, Stand. Business Training Inst., Buffalo, N. Y.

START Silvering Mirrors. Headlights, Tableware. Replate stoves, jewelry. Plans free. Clarence Sprinkle, Dept. 28, Marion, Ind.

\$35 WEEK. Men 15 up. Become Automobile experts. Learn while earning. Write Franklin Institute, Dept. C-401, Rochester, N. Y.

WANTED—Railway Mail Clerks. Free list of Government positions obtainable. Men and Women 17 to 45 years. Salary \$1600 to \$2600. Write today for booklet. Free list and sample lessons. United Business Tr. Ass'n, 2141 Dinan Bldg., Detroit, Mich.

MEN Wanted to Learn Motion Picture Operating, jobs guaranteed. Short Course, Box 38, Sioux Falls, So. Dak.

EARN \$10 daily silvering mirrors, plating and refinishing metalware, autos, chandeliers, bedsteads, headlights. Outfits furnished. E. Decie Laboratories, 1133 Broadway, New York.

GOVERNMENT positions, \$1,400-\$2,300 yearly. Many openings. 36-page information booklet free. Chicago Civil Service College, A41, Kesner Building, Chicago.

MEN—Boys—wanted—\$133 month. Railway Mail Clerks. Write immediately. Franklin Institute, Dept. C-20, Rochester, N. Y.

YOUNG Men Wanted at once. Become Draftsman and earn \$50 to \$100 a week. No experience required. Big demand; splendid opportunities; clean work. Learn in spare time at home. Send for our Free Book. Just out. No charge. Address: Department 2240, Chicago Tech., 118 E. 26th St., Chicago.

MAKE money writing Photo-plays; details free to beginners. No correspondence course. Producers' League, 230 Wainwright, St. Louis.

ALL men, women, boys, girls, 17 to 60, willing to accept Government Positions, \$117-\$190, traveling or stationary. Write Mr. Ozment, 101 St. Louis, Mo., immediately.

SILVERING Mirrors, French plate. Easily learned; immense profits. Plans free. Address, Wear Mirror Works, Excelsior Springs, Mo.

INVENTORS desiring to secure patents should write for our book "How to Get Your Patent," tells our terms and methods. Send sketch for our opinion of its patentable nature. Randolph & Co., Patent Attorneys, 620 P, Washington, D. C.

\$60-\$200 A WEEK. Genuine Gold Letters for store windows. Easily applied. Free samples. Liberal offer to general agents. Metallic Letter Co., 438-C, North Clark, Chicago.

WRITE articles, stories, news, in spare time for newspapers and magazines. Big pay. Copyrighted book free. Press Syndicate, 553, St. Louis, Mo.

OUR genuine gold window sign letters are an excellent money-making proposition for handy men. Slann Sign System, Bethune Ave. E., Detroit, Mich.

WANTED: Railway Mail Clerks—\$1,600 to \$2,300. Exams everywhere. Write today for full information. Patterson, Civil Service Expert, Box 4025, Rochester, N. Y.

WANTED—Men—Women, 18, up. \$95-\$192 month. Many Government jobs. List free. Write today. Franklin Institute, Dept. C-20, Rochester, N. Y.

ART AND ADVERTISING

CARTOONISTS—Improve your style by following the work of the greatest cartoonists found in the bound volume of Cartoons Magazine. Six volumes, each covering six months, July-December, 1917, to January-June, 1920, inclusive. 1200 cartoons, 900 pages to a volume, 7 by 9 1/2 in., 3 in. thick. New books, durable and attractive bindings. Sold separately at \$2 per vol. postpaid. Supply limited. Send at once. Popular Mechanics Book Dept., 296 E. Ontario St., Chicago.

MAILING LISTS

GUARANTEED accurate names, addresses, many classifications. Martineck, Corona, N. Y.

TYPEWRITERS AND SUPPLIES

UNDERWOOD Typewriters at far less than manufacturers' price; rebuilt, all worn parts replaced, guaranteed good as new. Cash. Installment payments. Write for Catalog 1518. Shipman-Ward Mfg. Co., estab. 1892, Montrose and Ravenswood Ave., Chicago, Ill.

TYPEWRITERS—All makes rebuilt, reconstructed and guaranteed ten years, \$15.00 up, shipped privilege 30 days' trial. Get our prices and agents' proposition. Typewriter Co., 2316 University Ave., New York City.

TYPEWRITER Bargains. All makes. Lowest Prices. Catalogue mailed on request. Henry Typewriter Co., 215 West 125th St., New York City.

TYPEWRITERS, all standard makes, \$10 up. Fully guaranteed. Free trial. Write for complete illustrated lists. Northwestern Typewriter Exchange, 320 West Goethe Street, Chicago.

TYPEWRITERS All Makes. Save one-half. Thoroughly rebuilt in our factory by the famous "Young Process." Fully guaranteed. Free trial. We handle all standard makes. Cash or sold on easy terms. Write for Catalog. Young Typewriter Co., Dept. 502A, Chicago, Ill.

ADDING MACHINES

NEW \$3.50 Automatic Adding Machine. Adds, Subtracts, Multiplies. Absolutely accurate. Capacity \$999,999.99. Fully guaranteed. 75,000 pleased users. Makes adding easy, positive, quick. Eliminates Mistakes. Saves Time. Postpaid \$3.50. Bassett Co., 1458-X, Hollywood Ave., Chicago.

FREE Trial. Marvelous new Adding Machine. Adds, Subtracts, Multiplies, Divides, automatically. Work equals \$350.00 machine. Price only \$15.00. Speedy, durable, handsome. Five-year guarantee. Used by largest corporations. Write today for catalog and free trial offer. Lightning Calculator Co., Dept. E, Grand Rapids, Mich.

DUPLICATORS AND DEVICES

YOU can make 50 to 100 copies of a letter, notice, etc., at a cost of three cents on a Hoyer Quality Duplicator. Write for free trial offer. The Hoyer Duplicator Co., 14 S. Wells St., Chicago, Ill.

"MODERN" Duplicators save Time, Labor, and Money. Gets business. Reproduces Typewritten or Panned Letters, Drawings, Lessons, Music, Menus, Bids, Notices, Specifications, Maps or anything in one or more colors. Prints Two per minute. Special Sale On 30 Days' Free Trial. \$2.25 up. Booklet Free. J. E. Durkin-Reeves Co., Pittsburgh, Pa.

STENCIL Duplicator—Hand Use—\$3. Larger \$4.50. On Approval. Prints Typewriting—Handwriting. Primos Specialty Co., 3-M, Primos, Pa.

PRINTING, ENGRAVING AND MULTIGRAPHING

500 ENVELOPES printed. \$1.75, postpaid. Womble Press, Bear Creek, N. C.

500 GUMMED Labels. Name and Address, 30c. Eastern Label Co., Clintonville, Conn.

QUALITY Printing! Reasonable Prices! Tell us your wants and let us quote our Money-Saving prices. Best Work. We print anything. Ernest Pantus, 525 South Dearborn Street, Chicago.

LETTERHEADS, Envelopes, Cards, \$2.75 1,000. Multigraphing. Superior Press, Weiss Building, Chicago.

PRINTING Outfits—Presses, type supplies, type novelties. Send stamp for catalogue. Model Press, York, Penna.

1,000 LETTERHEADS or Envelopes, \$3.00. Sent Prepaid. Samples Free. Monitor Press, Morrisville, Pa.

1,000 HAMMERMILL letterheads, envelopes, \$3.25; 2.50, \$1.25. Samples free. Troth Press, 98 Providence, Worcester, Mass.

EVERYTHING Printed. Samples free. Franklin Press, B-32, Milford, N. H.

GUMMED Labels! Rubber Stamps! Interesting Samples Free! Edward Harrison, "Printing," Baltimore.

JOB Printing. All Kinds—Cards to Catalogues. Quality work. Smith-Roberts Printing Co., Watseka, Ill.

GILT lettered Advertising-Pencils for you. Buy direct; save entire middleman's profit. Samples free (no agents.) Address S. Mustal & Co., 10-12 Lincoln St., Yonkers, N. Y.

1000 BOND letterheads \$3.00. Letters multigraphed \$2.50. Quick service. Williams, 3836 Clinton, Minneapolis, Minn.

WE print everything. Stationery, Booklets, Catalogs, Circulars, Samples. Commercial Press, Batavia, Ohio.

225 BOND letterheads, envelopes, bill heads, cards, \$1.25 each. Combination \$4.00. Economic Press, Leonia, N. J.

250 LETTERHEADS and 250 Envelopes printed and sent postpaid, \$2.65. Good white stock. Samples free. P. Donaldson, Printer, Kemp, Texas.

2,000 LETTERHEADS or Envelopes \$6.25 prepaid, 3rd zone. Samples Free. Quality Printshop, Marietta, Ohio.

250 BUSINESS Cards \$1.25—cash with order. Free delivery anywhere. Business Cards, Letter Heads, Envelopes, Bill Heads—printed by real printers—less than half regular prices. Send 10c for Type Book and Samples, including coupon to deduct 10c from \$2.00 order. The Campbell Company, 138 North Robey Street, Chicago. Established 1893.

250 LETTERHEADS, 250 white envelopes printed and mailed \$3.00. Samples printing free. Sunco, Mohawk, N. Y.

PRINTING and Binding. Book work, pamphlets, circulars, and all kinds of Commercial Printing. Rates reasonable. Prompt Mail Order Service. The Shenandoah Press, Dayton, Va.

150 LETTERHEADS and 150 Envelopes, printed and mailed, \$2.00. Race Printing Company, Hudson, N. Y.

150 EACH. Letterheads and Envelopes, \$1.50. Jacobus Service, Irvington, N. J.

1000 BUSINESS Cards, \$2.25. Samples. Rose Printing Co., 740 Hodapp, Dayton, Ohio.

FOR MEN

ARE you old at forty? See our advertisement on page 146 of this issue. The Electro Thermal Company, 2126 Main St., Steubenville, Ohio.

FOR SMOKERS

"BUTLER" Smoking stands. Ideal Xmas gift. Write for particulars. L. Martel, 496 Lincoln St., Marlboro, Mass.

CIGARS—Save 75%. Make your own—We teach you. Universal Cigar Co., 17 Liberty St., Grand Rapids, Mich.

SMOKERS! Attention! Something New! A beautiful picture appears on bowl of pipe after a few hours of smoking. Something wonderful. Sent postpaid 75c. Agents wanted. Martin Huizer, 1751 West 14th Place, Chicago, Ill.

SWEET Mild Havana type cigars, straight or belly shape, at \$1.00 per hundred delivered. Money refunded if after free trial of five cigars, you decide to return the balance. A. Ramirez & Co., P. O. Box 904, Tampa, Fla. (Established 1907).

BOATS AND LAUNCHES

ROWBOATS easily made. Blueprint, list free. Weesho-U Co., West Market, Detroit, Mich.

CHAMPION 35-mile speed boat building plans and directions, \$1.00. Send for free catalogue. The Rudder Publishing Co., 9 Murray St., New York City.

18 FT. ROWBOAT—easily made. Construction blueprint 30c. Weesho-U Co., West Market, Detroit.

RAZORS AND BLADES

GUARANTEED German Barber Razors. Goldbug Classics, each \$3.00. Boker's tree brand, Red Injun \$4.00. For wholesale prices write to H. Schatz, 2291 E. 55th St., Cleveland, O.

BLADES Resharpener 3c any make; Guaranteed Service. Standard Safety Razor Corp., Pittsburgh.

BLADES, resharpened, one edge 2c; double 3c. New York Edge Co., Glen Cove, N. Y.

DIAMONDS, WATCHES AND JEWELRY

WATCHMAKERS: Earn highest wages. Understand adjusting thoroughly. Circular free. Write Walter Kleinlein, Publisher, Waltham, Mass.

OPTICAL GOODS

SIX Power Binoculars, \$5.00. Famous Wollensak Binoculars, pocket size, light weight, excellent optical quality, fine illumination, handsome, durable finish. Complete with case, only \$5.25 postpaid. Money-back guarantee. Wollensak Optical Company, 17-19 Clinton Ave. N., Rochester, N. Y.

ANTIQUES, WAR RELICS AND INDIAN GOODS

FOR Dens: Relics collected from Europe's Battlefields. Firearms, helmets, medals, etc. Illustrated catalogue and sample War Photographs 25c. Lieut. Welsh, 2117 Regent Place, Brooklyn, N. Y.

SEND 5c for list Coins, Indian Relics, Firearms. F. E. Ellis, Webster Groves, Mo.

INDIAN Baskets, Blankets, Wampum Mats Wholesale. Catalogue. Gilham, Kelseyville, Calif.

PHONOGRAPHS AND RECORDS

BUILD your own Phonographs. We furnish everything. Write for catalog and free blueprint offer. American Phonograph Co., 3515 North Crawford, Chicago.

PERFECTION guaranteed phonograph motors, tonearms, cabinets and hardware, highest quality, lowest prices. Catalog free. Federal Supply Co., Indianapolis, Ind.

BUILD a genuine Choralion phonograph and save over half. Big profit building and selling. We furnish motors, tone-arms, full instructions and all necessary parts. Send for catalog and free blueprint offer. Choralion Phonograph & Radio Co., 1023 11th St., Elkhart, Ind.

SUPERIOR equipment at lowest price for building fine phonographs. Superior Phonographs Co., Erie, Pa.

BUILD Your Phonograph. Quality phonoparts. Quality Srenado motor and motors of other types. Electric Motors, tonearms, reproducers, amplifiers, case materials, accessories. Free blueprints and building instructions. Big saving. Wonderful results. Prompt delivery. Catalog mailed for ten cents. Hoosier Manufacturing & Supply Co., 313 Baldwin Block, Indianapolis, Ind.

MUSIC AND MUSICAL INSTRUMENTS

GENUINE Amber Violin varnish, 2 oz. \$2.00. Perin, Rushville, Ind.

WRITE Songs. Big money and reputation. Write for information. J. Gordon Pub. Co., 201 N. Hayne Ave., Chicago.

I WANT song poems. Casper Nathan, Garrick Theatre Building, Chicago.

VIOLINS—Deep, Mellow, Soulful—on credit. Easy terms for wonderful instrument. Get details today. Gustav F. Henning, 2424 Gaylord St., Denver, Colo.

"MUSIC Composed" to words. Bauer Bros., (formerly of Sousa's Band), Oshkosh, Wis.

COMPLETE, easy self-instructors—Harpmonics, Violin, Piano, Drum, Ocarina, Ukulele, Accordion, Saxophone 25c each. G. Elsea, Bowling Green, Ohio.

HAVE you any old player rolls or records you are tired of; we can use them. Write for circular. Standard Music Exchange, 30 E. Randolph St., Chicago.

FOR THE HOME

GRANDFATHER Clock works, \$5.00. Build your own case; Instructions free; make good profits selling your friends. Clock works with chimes for old or new cases. Write for full particulars. Clock Co., Ruffner St., Philadelphia.

MAKE your coal range an oil burner—guaranteed plans \$1.00; cooks, heats. Made for \$5.00. Agents send stamped envelope. McCormack Specialty Co., Guilford, Conn.

CANDY

NUTTIES—A Sweet That's Good to Eat. This delicious new Health Candy is made sweet by the pure fruit sugar of selected Raisins. Rich in mineral elements essential to health. Fine for Children. Pound and Half \$1.00 Postpaid. Sawyer Bros., R. 3, Portsmouth, Va.

PATENT ATTORNEYS

CANADIAN and foreign patents secured. Fine references. Reasonable rates. Prompt, personal service. The Ramsay Co., 273 Bank St., Ottawa, Canada.

PATENTS promptly procured. Personal, careful and efficient service. Highest references. Moderate fees. Send sketch or model for actual search and advice. George P. Kimmel, Master of Patent Law, 54-N, Loan and Trust Bldg., Washington, D. C.

EDWARD C. SASNETT, formerly a Principal Examiner, U. S. Patent Office, Personal Service. 516 McGill Bldg., Washington, D. C.

UNPATENTED Ideas can be sold. I tell you how and help you make the sale. Particulars free. Write W. H. Greene, Jenifer Building, Washington, D. C.

PATENTS—Before disclosing an invention the inventor should write for our blank form "Record of Invention." This should be signed, witnessed and returned to us together with model or sketch and description of the invention and we will give our opinion as to its patentable nature free. Our Three Books mailed Free to inventors. Our Illustrated Guide Book, "How to Obtain a Patent," contains full instructions regarding patents. "List of Patent Buyers" sent Free, contains unsolicited letters from manufacturers and others who are constantly writing us regarding the purchase or leasing of meritorious patents. Victor J. Evans & Co., 934 Ninth, Washington, D. C.

PATENTS, Booklet free. Highest references. Best results. Promptness assured. Send model or drawing for preliminary examination. Watson E. Coleman, Patent Lawyer, 624 F Street, Washington, D. C.

BEFORE or after filing application for patent on your invention it will pay you to read over my "Inventor's Advisor No. 3," free for asking. M. Labiner, Registered Patent Attorney, 3 Park Row, New York.

INVENTORS desiring patents, read the free treatise, "Reducing Inventions to Property Rights." Lester E. Barrett, 629 F Street, Washington, D. C.

INVENTORS should write us for our book, "How to Obtain a Patent," which clearly sets forth what may be patented and the necessary steps to protect an invention; it describes the procedure in patent office and tells about assignments, licenses and trade marks, and gives many useful facts about patents which every inventor should know; many persons well versed in patent matters have pronounced the book the best of its kind they have ever read; it is written so you can understand it; copy free upon request. Talbert & Talbert, Patent Lawyers, 481 McGill Bldg., Washington, D. C.

LACEY Patent Sense. See page 150.

INVENTORS: Send sketch or model of invention for opinion concerning patentable nature and exact cost of patent. Book "How to Obtain a Patent," sent free. Tells what every inventor should know. Established twenty-eight years. Highest references, prompt service, reasonable charges. Address Chandice & Chandice, 456 Seventh, Washington, D. C.

HERBERT JENNER, patent attorney and mechanical expert, 624 F Street, Washington, D. C. I report if patent obtainable and exact cost. Send for circular.

PATENTS Procured. Send sketch or model today for examination, prompt report and advice. No charge for preliminary advice. Write for free Booklet and blank form on which to disclose your idea. Highest references. Promptness assured. Clarence A. O'Brien, Registered Patent Lawyer, 309 Security Bank Building. Directly across the street from Patent office, Washington, D. C.

PATENTS. My fees in installments. Advice book free. Frank Fuller, Washington, D. C.

SEND sketch for search report. Get my latest book on Patents. H. L. Woodward, 714 9th St., Washington.

PATENTS and Trade-marks obtained. Prompt service. Write for our new book on patents. Established in 1889. D. Swift & Co., 369 7th St., Washington, D. C.

PATENTS Procured; Trade marks Registered—A comprehensive, experienced, prompt service for the protection and development of your ideas. Preliminary advice gladly furnished without charge. Booklet of information and form for disclosing idea free on request. Richard B. Owen, 30 Owen Bldg., Washington, D. C., or 2276-R Woolworth Bldg., New York.

MONROE MILLER, Ouray Building, Washington, D. C., patent attorney, mechanical and electrical expert. Best quality of work and results. Moderate charges.

INVENTORS—Send for form "Evidence of Conception" to be signed and witnessed. Form, fee schedule, information free. Lancaster and Albrine, 221 Ouray Bldg., Washington, D. C.

MILLIONS spent annually for ideas! Hundreds now wanted! Patent yours and profit! Write today for free books—tell how to protect yourself, how to invent, ideas wanted, how we help you sell, etc. American Industries, Inc., 500 Kresge Bldg., Washington, D. C.

H. F. LOWENSTEIN, Registered Patent Attorney, Technical expert, McLachlen Building, Washington, D. C.

INVENTORS: Record invention legally before disclosing to others. Our Invention-Record and Data Sheet shows how. Sent free and valuable information given on patent procedure, costs, etc. Report on patentability includes copies of patents nearest your idea. O'Connell & O'Connell, Jenifer Bldg., Washington, D. C.

"INVENTORS' Guide" free on request; gives valuable information and advice for all who have original ideas or improvements. Frank Ledermann, Registered Attorney and Engineer, 15-P Park Row, New York.

PATENTS, trade marks, copyrights. Prompt, personal, reliable service. Over 36 years' active practice. Write for terms. Book free. Address E. G. Siggers, N. U. Bldg., 918 F St., Washington, D. C.

FOR INVENTORS

PATENTS. If you have an invention which you wish to patent you can write fully and freely to Munn & Co. for advice in regard to the best way of obtaining protection. Please send sketches, or a model of your invention and a description of the device, explaining its operation. All communications are strictly confidential. Our vast practice, extending over a period of seventy-seven years, enables us in many cases to advise in regard to patentability without expense to the client. Our Handbook on Patents is sent free on request. This explains our methods, terms, etc. In regard to Patents, Trade Marks, Foreign Patents, etc. "Scientific American" contains Patent Office Notes, Decisions of Interest to Inventors and particulars of recently patented inventions. Munn & Co., Solicitors of Patents, 623 Woolworth Bldg., New York; Scientific American Bldg., Washington, D. C.; 801A Tower Bldg., Chicago, Ill.; Hobart Bldg., San Francisco, Calif.

INVENTORS—Send your ideas for manufacturing development in our modern sheet metal and angle-iron fabricating plant. These pertaining to dust collecting or ventilating preferred. Liberal payment for accepted inventions. Kirk & Blum Manufacturing Co., 2851 Spring Grove Ave., Cincinnati, O.

PATENTS. Write for free illustrated guide book. Send model or sketch and description for free opinion of its patentable nature. Highest references. Prompt attention. Reasonable terms. Victor J. Evans & Co., 157 Ninth, Washington, D. C.

UNPATENTED Ideas can be sold. I tell you how and help you make the sale. Particulars free. Write W. T. Greene, Jenifer Bldg., Washington, D. C.

INVENTORS' Educator: 900 Mechanical Movements, 50 Perpetual Motions. How to procure and sell patents. Mechanical Movements greatly assist inventors, suggest new ideas. Explains how to select an attorney and avoid Patent Sharks. Price \$1.50. Postage Free. Albert E. Dieterich, 621 Ouray Building, Washington, D. C.

GET your own patents. Application blanks, complete instructions \$1. Cutting Sons, Campbell, Cal.

HAVE You an Invention! If so, write for our free book, "How to Get Your Patent" tells our terms and methods. Send model or sketch for our opinion of its patentable nature. Randolph & Co., Dept. 144, Washington, D. C.

INVENTORS should write us for our book, "How to Obtain a Patent," which clearly sets forth what may be patented and the necessary steps to protect an invention; it describes the procedure in patent office and tells about assignments, licenses and trade marks, and gives many useful facts about patents which every inventor should know; many persons well versed in patent matters have pronounced the book the best of its kind they have ever read; it is written so you can understand it; copy free upon request. Talbert & Talbert, Patent Lawyers, 495 McGill Bldg., Washington, D. C.

MODEL Making and experimental work. Modern Shop; expert workmen. Manufacturing. Lamson Electrical & Mfg. Co., 625 W. Jackson, Chicago.

COMPLETE instructions for getting Patents. application blanks, sample drawing, all for \$1. Will Watt, Box 31, South Pasadena, Calif.

COMMERCIALIZE your ideas according to My Cooperative Plan. Booklet free. Ralph Burch, Patent Lawyer, Jenifer Building, Washington.

INVENTORS if you're not fully experienced on patent matters, better learn from one who is. My facts will prove valuable assistance. Adlard Plouffe, 38 South St., Woonsocket, R. I.

I SELL patents. Established in 1900. A service for the inventor that serves. Bankers, Lawyers, Patent Attorneys, Corporations, Mechanics, men in every walk of life, are my clients. Why not you, if you have a patent to sell? Charles A. Scott, 773 PM Garson Avenue, Rochester, N. Y.

REFRIGERATOR without drip pan or drain pipe Fountain Manicuring Instrument. Sponge filled Absorbent Pad. Writing board. Gift novelty. M. V. Bauer, 601 McLachlen Bldg., Washington, D. C.

PATENT Application Blanks free to inventors. Patent News-D, Washington, D. C.

PATENTS Procured; Trade Marks Registered—A comprehensive, experienced, prompt service for the protection and development of your ideas. Preliminary advice gladly furnished without charge. Booklet of information and form for disclosing idea free on request. Richard B. Owen, 30 Owen Bldg., Washington, D. C., or 2276-R Woolworth Bldg., New York.

PATENTS Procured. Send sketch or model today for examination, prompt report and advice. No charge for preliminary advice. Write for free Booklet and blank form on which to disclose your idea. Highest references. Promptness assured. Clarence A. O'Brien, Registered Patent Lawyer, 310 Security Bank Building, Directly across the street from Patent office, Washington, D. C.

PATENT Sense—"The book the inventor keeps." Free. See Lacey ad, page 150.

IF you have a practical, useful invention to sell (patented or patent pending), write us today. American Patents Corporation, Barrister Bldg., Washington, D. C.

TO sell your Patent. Write me; experienced handling, immediate action. Address Arthur S. Billings, Suite 401 Dekum Bldg., Portland, Ore.

INVENTION Magazine. Helpful advice. Send for circular. M. K. Burckett, 1430-M University Ave., New York City.

PATENTS FOR SALE

HAND Shoe-String Tipping Tool. Simple, inexpensive, and practical for home and factory use. Automobile Radiator Cover. Adjusts from top down instead of bottom up. Automobile Inside Top Hat and Luggage Carrier. Snaps on. Fits any car. Automobile Floor Board Clamps. Does away with screws, and noise, and danger of boards coming up, and does not interfere with removal of boards—specially adapted to Fords. Milk Bottle where ordinary cheap caps can be removed with fingers instead of fork, etc. Base Ball Players' Shoe Cleats. Locks onto sole of any ordinary shoes. Day-Old Chick Shipping Boxes. Can't smother them and does away with nailing wooden strips on top and sides. Cash or Part Cash and Royalty. Promoters or Manufacturers, whose rating will not stand Financial Investigation, need not bother us. Parks & Gee, Altoona, Pa. Inventors and Patentees.

PATENT on an Anti-Rattler and Anti-Draft Window Device; a five-cent-store article for which a very large demand has already been created by Woolworth's and other stores. For full particulars and very reasonable terms, Address Alex S. Peterson, Box 153, Boston, N. J.

IMPROVEMENT in Burglar Alarms—Electric underground device (Patented.) For immediate sale. R. J. Cutshall, 318 E. 4th St., Bicknell, Ind.

PATENT for Sale—Steering attachment for sleds; steers like Automobile. Willbur Rogers, 604 Tremont, Boston, Mass.

SASH Retainers—Best and simplest yet invented. Outright or royalty. Money-making proposition. Full particulars. Jacob Pittenger, Milburn, N. J.

INVENTION. Combination Plane Rabbit. Smooth and Block combined. Patent No. 1,448,775 for sale. Chas A. Trump, Derry, Westmoreland Co., R. F. D. No. 1, Box 37, Penna.

FOR Sale—Spark Plug Patent. P. V. Carpenter, Worth, N. C.

FOR Sale: Patent on Switch for Street Railways. Motorman throws switch while car is in motion. Chas. Strayer, 127 Leslie St., Johnstown, Pa.

FOR Sale: Patent on Concrete Mold. Makes all shapes and sizes with same mold. Patent granted 1916. Chas. Strayer, 127 Leslie St., Johnstown, Pa.

IMPROVED clothes dryer for rainy days. A necessity in every house. Outright or royalty. M. B. Hailiday, Walkill, N. Y.

YOU have a worth-while patent, haven't you. Why don't you tell our two million readers about it? Most of them are specially interested in patents and new inventions. Ask me to tell you how other inventors successfully sold their patents. Geo. F. Baker, Manager, Classified Advertising, Popular Mechanics Magazine, Chicago, Ill.

AUTOMATIC Oil and Sewage Separator. Kindle Separator Co., Pittman, N. J.

MY Patent for Sale. Adjustable valve reseating tool reseats from $\frac{1}{8}$ and $2\frac{1}{2}$ inch diameters. Face angle 30 to 60 degrees. Geo. Eard, Bradford, Ill.

DOUBLE Piston Gas Engine, Patent 1,461,948, 2-cycle, valveless, cylinder pre-compression. Stosk, 929 17th St., Denver, Colo.

ATTENTION, Patent Buyers: Have a very useful household invention. Improved meat softener will be used in every kitchen and will bring big money to manufacturer. Horace Robinson, Hotel St. Hyacinthe, St. Hyacinthe, Que.

INVENTOR will sell patent covering Removable-Noncorrosive metal tray for use on meat slicing machines—patent including gig for \$300.00 on account no time to attend to sale of trays. J. H. McLaughlin, 3285 Armitage Ave., Chicago, Ill.

U. S. PATENTS Nos. 1,397,112 and 1,358,197. "One-Raindrop" Window Closer. Make Offer. Phelps, 1810 Hart Lane, Phila.

FOR Sale—Spark plug patent No. 1,403,886, something new, self-cleaning. Everybody wants them. Outright or royalty. Monte Young, Box 63, Provo, Utah.

FOR Sale—Patent rights on locking hinges especially used for folding articles. Offers wanted. K. Gober, 325 Broadway, Oakland, Calif.

PATENT oil-cock wrench for Ford Cars. Eastern territory, Outright; royalty or exchange. Sample furnished. W. A. Calvin, 123 Steiner St., San Francisco, Calif.

FOLDING, Adjustable, Detached Grain Door for Railway Car. Solves the problem, saves half. Possibilities Unlimited. Billings, 155 Beach, Pontiac, Mich.

A BOON to automobile drivers. Improved foot-rest connected with accelerator. U. S. rights, cash or royalty. J. W. Lattimore, Box 291, Nogales, Ariz.

FOR sale or royalty, patent No. 1,431,298, new steel combination tailor measure; cost 6c, retail 50c. Sample sent upon request. Galassi, 1617 Voorhies Ave., Brooklyn, N. Y.

PATENTS For Sale: To sell, buy or obtain patents write Patent News-P, Washington, D. C.

DRAWING INSTRUMENTS AND DRAFTING SUPPLIES

DIRECT Importation. 10-piece Precision Mechanical Drafting Set in plush case. Finest German Silver. Special, each \$4.50. Photo free. De Franke, Importers, 109 N. Dearborn Street, Chicago, Ill.

SURVEYING INSTRUMENTS

NEW and used surveying instruments direct from factory. Satisfaction guaranteed or money refunded. Wisler, 619 Broadway, St. Louis.

MODELS AND MODEL SUPPLIES

WE make working models for inventors and do experimental work and carry a complete stock of brass gears and model supplies. Send for catalogue. The Pierce Model Works, Tinley Park, Ill.

INVENTORS—Write for our free illustrated guide book and Evidence of Conception Blank. Highest references. Prompt attention. Reasonable Terms. Victor J. Evans & Co., 165 Ninth, Washington, D. C.

DIES, Tools and General Manufacturing. Models, and Manufacturing of new inventions our specialty. Logan Machine Co., 222 S. Clinton St., Chicago, Ill.

MODEL Making Supplies—2 in.—4 in. diameter special thin brass tubing for Model Boilers, 10c—20c per inch. Machined ends, per pair, 2 in., 75c; 4 in., \$1.50. Miniature machine screws, 3-32 in. up. Finished Boiler Fittings. Catalogue 20c. Batho Mfg. Co., Dept. D, 5214 Woodland Ave., Philadelphia, Pa.

MODEL Making and experimental work; Modern Shop, expert workmen. Manufacturing. Lamson Electrical and Mfg. Co., 625 W. Jackson, Chicago.

PATENTS Procured. Send sketch or model today for examination, prompt report and advice. No charge for preliminary advice. Write for free Booklet and blank form on which to disclose your idea. Highest references. Promptness assured. Clarence A. O'Brien, Registered Patent Lawyer, 310 Security Bank Building, Directly across the street from Patent Office, Washington, D. C.

MODELS, Tools, Instruments, Brass, Aluminum Castings, and General Machine Work. Send sketch for estimate. Arthur Schmidt, 394 Canal Street, New York.

BEFORE you buy model engines, boilers, send stamp for our new illustrated list of machined castings, parts for boilers, boat fittings. Model Machine Shop Co., 417 East 71st St., New York City.

FOR MANUFACTURERS

SPECIAL labor saving machinery, Jigs and Fixtures and other production tools. Punches and Dies for all kinds of metal stampings. Gauges, manufacturing and machine work to order. Simplex Tool Company, Woonsocket, R. I.

WANTED—Metal Stamping and Model work taken on contract basis. We are ideally located and equipped to develop patents. Meyers Company, Box 326, Bedford, Ind.

IF you want dies and metal stampings write us. Lyons Machine Works, Lyons, Ia.

MANUFACTURING

WE make special machinery, tools and parts, models of all kinds. Write for our prices. Chicago Tool and Engineering Co., 542 Washington Blvd., Chicago, Ill.

SPRINGS made to order. Wright Bros., 5618 Huron St., Chicago.

EXPERIMENTS developed, dies, models and manufacturing machine designing. Estimates and information promptly given. Address Schroer Bros. Machine Works, 512 East 28th Street, Kansas City, Mo.

IRON, Brass, Aluminum Castings, Models, Patterns, Light Manufacturing. Welch Brothers Co., North Chicago, Ill.

WE will manufacture your invention if it is patented, of merit, and you want to be dealt with on the square by a reliable manufacturer—write complete details. Attention—General Manager, Standard Conveyor Company, North St. Paul, Minn.

LONG established manufacturer of auto accessories which are daily sold by practically all wholesale and retail accessory houses will consider manufacturing and distributing new automobile products, capable of equally wide sale through same channels. Patented articles preferred. Address Auto Accessory Manufacturer, 1512 North American Bldg., Chicago, Ill.

Special Offer

\$6-95Regular Value
\$10.00

All-Wool Heavy Jumbo Sweater Coat

Only

\$1.00 DOWN

Send only \$1.00 with the coupon. This heavy, pure virgin wool jumbo sweater comes on approval. Money back instantly if you ask for it. Don't be too late—order now.

Heavy Pure Wool

This is a splendid big sweater at a bargain price. Every fibre pure wool. Heavy rope stitch. Large fashioned shawl collar. Two large lined pockets. Close knitted wristlets. Ivory buttons to match. Made in big full size in rich fast colors. Nothing so practical for fall and winter wear. Sold by most stores for \$10.00, all spot cash.

Sizes 34 to 46. Colors: Dark Maroon or Navy Blue. Order by No. F-12. Send \$1.00 with coupon, \$1.00 monthly. Total price, \$6.95.

6 Months to Pay

Buy the Elmer Richards way, on credit, as thousands of well satisfied men are doing. Everything you need in clothing or shoes and you pay in monthly sums so small you will never miss them. Open a charge account with us. No charge for credit. One price only. Strictly dependable qualities. See this big sweater bargain on approval. Send coupon now.

← Send Coupon

Don't miss this. The supply is limited. You take no risk. We stand back of this sweater. Compare our prices with cash prices in retail stores. Money back if you say so. Send coupon now with \$1. Don't be too late; send coupon.

Elmer Richards Co.
Dept. 1778 West 35th Street, Chicago, Ill.

Write for our Free Bargain Catalog of men's, women's and children's clothing and shoes. Everything on small monthly payments.

Elmer Richards Co.
Dept. 1778 West 35th Street, Chicago, Ill.

I enclose \$1.00.
Send Heavy Wool Sweater F-12. Size.....Color.....
If I am not satisfied when I receive the sweater, I can return it and get my payment back with charges. Otherwise, I will pay the advertised terms, \$1.00 with coupon, \$1.00 monthly. Total price, \$6.95.

Name.....

Address.....State.....

Continued from Page 44

SCREWS, nuts, screw machine products, all metals. Autoscrew Works, 355 West Broadway—New York City.

SPECIAL labor saving machinery. Jigs and Fixtures and other production tools. Punches and Dies for all kinds of metal stampings. Gauges manufactured and machine work to order. Simplex Tool Company, Woonsocket, R. I.

PATTERNS, wood and metal. Models, tools and dies. Brass, bronze, aluminum and iron castings. Screw machine work, production work of all kinds. Write Modern Machine & Pattern Co., Terre Haute, Ind.

WIRE Goods, all kinds, made to order. Cooley Mfg. Co., 524-530 N. Western Ave., Chicago.

OUR factory will make your models, manufacture your articles as well as build your tools, dies and fixtures. Standard Die & Specialty Co., 817 W. Washington Blvd., Chicago, Ill.

WE Specialize on Dies Making, Stamping, Light Mfg. The Times Mfg., 410 Kimball St., Danville, Ill.

MACHINERY, TOOLS AND SUPPLIES

DIES—For manufacturing Toy Pop Guns. Cost \$3,600.00; yours for \$500.00 cash. Receiver—3609 Gratiot, Detroit, Mich.

CONCRETE Building Block Machines and Molds. Catalogue free. Concrete Machine Co., 303 South Third St., St. Louis, Mo.

ENGINES, MOTORS AND DYNAMOS

SMALL Gasoline, Steam Engines, Dynamos, Motors, Storage Batteries, etc., new and secondhand. Bargain Bulletin 135 free. Dynamic Manufacturing Co., First National Bank Bldg., Chicago.

LIGHTING Generators very special prices. One to 5 KW. Absolutely new. Easy terms. Wilhobart, Troy, Ohio.

GOVERNORS to control Auto Engines when used as stationary engines. Circulators. Candee-Smith Governor Co., Springfield, N. Y.

FOR SALE—General Electric Motors, 1/4 hp. \$16, 1/2 hp. \$39, 3/4 hp. \$52, one hp. \$60, for a. c. or d. c. current, or size, price upon request. Anthony Donato, 312 Front St., Schenectady, N. Y.

MOTORS—G. E. 1/4 hp. \$15.00—1/2 hp. \$32.50—1 hp. \$62.50. Generators 8v. 10 amp. \$15—32v. 500 watt \$30. Other sizes low prices. Motor Specialties Co., Crafton, Pa.

SMALL steam engine patterns, castings. Light machine work. Homer Boals, Sallenville, Ohio.

ELECTRICAL

LEARN How to wind D. C. Armatures. Engineering students will find in this book by W. E. Hennig a simplification of a difficult yet important subject. Mathematical and technical discussions have been avoided as far as possible. Contains all diagrams heretofore scattered in many books. 295 pp. Illus. in colors. Cloth binding. Price \$3.50 postpaid. Popular Mechanics Book Dept., 206 E. Ontario St., Chicago.

ELECTRICAL Experimenters—Here is the book you have been waiting for—"How to Make Things Electrical." 256 articles, 427 pages, 353 illustrations. Price \$2 postpaid. Popular Mechanics Book Dept., 206 E. Ontario St., Chicago.

FOR THE SHOP

THREADING cast iron made easy. Recipe \$1.00. Eward, Machinist, Bradford, Ill.

POPULAR Mechanics Shop Notes are published annually in book form; price 50 cents postpaid. The latest volume containing all notes in the magazine during 1922 is ready. Better send \$1 today for the two latest issues and get acquainted with these wonderful aids in your work. Back volumes are in great demand and we can supply 15 of them at 50c each. Altogether they make an encyclopedia of mechanical information that is priceless to the owner. Popular Mechanics Book Dept., 206 E. Ontario St., Chicago.

FOR MECHANICS

PATENTS—Write for our free illustrated guide book and Evidence of Conception Blank. Send model or sketch and description of the invention for our opinion of its patentable nature free. Highest references. Prompt attention. Reasonable terms. Victor J. Evans & Co., 184 Ninth, Washington, D. C.

YOU can't beat Lumite for cleaning and polishing all metals. Trial size 10c. Lumite Products Co., 409 Walnut, N. E., Canton, Ohio.

TOOLMAKERS, machinists. Ten only will make you tool designers and draftsmen in four months. Engineer, 86 Armory St., Springfield, Mass.

1,000,000 INDUSTRIAL Facts, Calculations, Receipts, Processes and Trade Secrets for every business are contained in the 1016-page book "Moore's Universal Assistant and Complete Mechanic," 500 Engravings, Cloth. Price \$2 postpaid. Popular Mechanics Book Dept., 206 E. Ontario St., Chicago.

BLACKSMITHS

BLACKSMITHS, Listen: Any Handy man can make more money doing hard jobs easy. Forging and welding solid, with Toy's Modern Methods of Blacksmithing. Hardening and tempering to a standard with colored tempering charts. All for one dollar. Samples Free. W. M. Toy, Sidney, O.

FOR SALE—MISCELLANEOUS

BUY—Exchange—Sell! Many of our readers have for sale or exchange the article you are looking for—and lots of them are looking for the very items you want to turn into cash. Get together! Let our two million readers know your wishes—they'll help you! Send your ad today to Geo. F. Baker, Manager Classified Advertising, Popular Mechanics Magazine, Chicago.

GASOLINE Lamps and Lanterns. Catalog Free. Little Wonder Light Co., Terre Haute, Ind.

ADDRESSOGRAPH, Letter Folders, Multigraphs, Envelope Sealers, Duplicators, less than half price. Guaranteed. Pruitt Co., 112-B N. La Salle, Chicago.

TOY patterns, Models, Machines and Tools. Charles Clouse, 3211 Fairfield Ave., Cincinnati, Ohio.

ALL sizes Printing Presses, Type and Materials. Make easy money printing for self and others. Watson, 160 Williams St., New York.

UNIVERSAL, Automatic Draft Operator, business, patent and stock of 100 completed machines. Invest small sum in ten-year established business with unlimited virgin field. Coxine, Carson Ave., Newburgh, N. Y.

ROOTS AND HERBS

GINSENG and other Plants for Medicine, Perfume, Dyes. How to gather. Address of Buyers Book 30c. O. Twitchell, Berlin, N. H.

WANTED—MISCELLANEOUS

WILL buy, sell and exchange for you anything you have in Jewelry, Diamonds, Pearls, Rubies, Gold, Platinum, Silver, Etc. Quick returns. Wiegand & Co., Irvington, N. J.

MAIL us your discarded Jewelry, Gold Crowns and Bridges, Watches, Diamonds, Silver, Platinum, and Old False Teeth. Money promptly mailed. Goods returned if offer refused. United States Smelting Works (The Old Reliable), Dept. 71, Chicago.

WANTED—Transit, Level, Drawing Instruments, and Correspondence Course in Civil Engineering. Rufe Cox, Hillsville, Va.

WANTED—Complete files of Popular Mechanics Magazine for the years 1902, 1903, 1904, and 1905. Must be in good condition. Will pay \$5.00 for full sets of each year. Address, Geo. F. Baker, Room 304, Popular Mechanics Bldg., 200 East Ontario, Chicago, Ill.

WANTED—Position as gentleman's valet in vicinity of New York or Chicago. If interested, write: Emil Kosabek, 17 Py. Lohenhaurg, Vienna, Austria. 39-10.

CASH sent immediately for old gold, silver, platinum, watches, diamonds, magneto points, unused postage stamps and other valuable articles. Merchandise returned if unsatisfactory. Busch Products, 144 Fifth Ave., New York.

WANTED—Copies of Popular Mechanics Magazine of September and October, 1922, in good condition. Will pay 25 cents per copy. Address, Room 311, Popular Mechanics Bldg., 300 East Ontario, Chicago, Ill.

REAL ESTATE, FARM AND ORCHARD LANDS

WANTED—I want farms for cash buyers. Describe and state price. R. A. McNew, 312 Wilkinson Bldg., Omaha, Neb.

SELL your property quickly for cash, no matter where located. Don't pay big commission. Particulars free. Real Estate Salesman Co., Desk B., Lincoln, Neb.

\$5.00 DOWN, \$5.00 monthly; 10 acres unimproved poultry, fruit, stock, woodland; \$100; Ozarks. Fishing, hunting, trapping. Alfred Zimmerman, 1800 N. Fifth, Kansas City, Kan.

FOR Sale—Three full sections in McKean County and two sections in Billings County, North Dakota. Each section contains land suitable for crops, balance for cattle. Each section has valuable deposits of lignite which some day will alone be worth many times the present value of the land. This part of the state is developing very rapidly with good schools within easy access. As owner cannot use this land himself, will sell one or more sections at a price which almost anyone can afford to pay. Address W., care Popular Mechanics, 200 East Ontario St., Chicago.

ATTENTION—"Get acquainted." Cash for your property. Farm, Hotel or Retail Store, no matter where located; confidential service. Hayes' Business Agency, Cincinnati, Ohio.

FLORIDA—near Tampa, lake frontage, deep spring water lake, splendid fishing, best quality grapefruit and orange lands, located on main paved highway leading into Tampa, one of fastest developing territories in Florida, values rapidly increasing. We are offering a limited amount of acreage. Landeck Lumber Company, American Building, Milwaukee, Wis.

STROUT'S Farm Catalog—Just Out! Save time and money by quickly finding just the farm you want. It's in new 160-page Illustrated book, money-making stock, dairy, poultry, grain, fruit farms. Hundreds, all kind, all prices, near cities and throughout many states. Copy free. Call or write today. Strout Farm Agency, 150P Nassau St., New York City.

WANT to hear from owner having farm for sale; give particulars and lowest price. John J. Black, Chippewa Falls, Wis.

BIG returns from Pecan, Orange and Fig Groves. Guaranteed care. Small monthly payments. Dept. M, Suburban Orchards Co., Biloxi, Miss.

DOGS

GUARANTEED Hunting Dogs—Coon, Mink, Opossum, Skunk, etc. Hounds or mixed breeds. Prices right. Catalog Ten Cents. Burrow, Pecahontas, Ark.

TRAINED Beagles, Foxhounds, Rabbit Dogs, Broken Coon Dogs, Trial, Setters. Geo. A. Brown, Lancaster, Pa. No. 5.

A-1 COON hounds only \$50.00; 10 Days' trial. Le Pelly Bros., Mena, Ark.

SCOTCH Collies. Beautiful puppies and grown dogs. Best possible breeding for work or show. Wonderfully intelligent companions for children or adults. Write Oak Run Collie Kennels, Boston, Ky.

SILVERBLACK Foxes \$300.00. Muskrats, Time Payments. Arthur Schumacher, Lockland, O.

COLLIES for Sale. Training Book 35c. Sunnybrae Kennels, Bloomington, Ill.

ST. BERNARD and Newfoundland puppies for sale. Excellent specimens, \$25.00 up. Ludwig Kennels, Greensburg, Ind.

POULTRY

PLANS for Poultry Houses. All styles, 150 illustrations; secret of getting winter eggs, and copy of "The Full Egg Basket." Send 25 cents. Inland Poultry Journal, Dept. 74, Indianapolis, Ind.

AMAZING BARGAIN!

3 1/2 x 5 Inches. Books Printed Uniformly; Bound in Heavy Card Cover Stock. At 5c Per Book We Are Establishing New Publishing Standards. Never Before Did the Sum of 5c Buy So Much Good Literature.

Price of World-Famous Pocket Series of 350 Titles Cut from 10c to 5c Per Book. This Is a Sensational Reduction! Size of Books Is a Sensational Reduction! Size of Books Is a Sensational Reduction!

5 Only
C
Per
Book

ORDER BY NUMBER TAKE YOUR PICK AT ONLY 5c PER BOOK ORDER BY NUMBER

- DRAMA**
- 295 Master Builder. Ibsen
90 Mikado. Gilbert
31 Pelléas and Melisande. Maeterlinck
316 Prometheus. Aeschylus
308 Stoops to Conquer. Goldsmith
134 Misanthrope. Moliere
16 Ghosts. Ibsen
80 Pillars of Society. Ibsen
46 Salome. Wilde
54 Importance of Being Earnest. Wilde
8 Lady Windermere's Fan. Wilde
131 Redemption. Tolstoy
99 Tartuffe. Moliere
240 The Tempest
241 Merry Wives Windsor
242 As You Like It
243 Twelfth Night
244 Much Ado Nothing
245 Measure for Measure
246 Hamlet
247 Macbeth
248 King Henry V
249 Julius Caesar
250 Romeo and Juliet
251 Midsummer Night's
252 Othello
253 King Henry VIII
254 Taming of Shrew
255 King Lear
256 Venus and Adonis
262 Comedy of Errors
264 King Richard III
267 Pericles
268 Merchant of Venice
- FICTION**
- 336 The Mark of the Beast. Kipling
333 Mulvaney Stories. Kipling
188 Adventures of Baron Munchausen
352 Short Stories. William Morris
332 The Man Who Was and Other Stories. Kipling
280 Happy Prince. Wilde
143 Time of Terror. Balzac
182 Daisy Miller. H. James
162 Rue Morgue. Poe
345 Clarimonde. Gautier
292 Fifi. De Maupassant
199 Tallow Ball. De Maupassant
6 De Maupassant's Stories
15 Balzac's Stories
344 Don Juan. Balzac
318 Christ in Flanders. Balzac
230 Pleace of Gold. Gautier
178 One of Cleopatra's Nights. Gautier
314 Short Stories. Daudet
58 Boeracello's Stories
45 Tolstoy's Short Stories
12 Poe's Tales of Mystery
290 The Gold Bug. Poe
145 Great Ghost Stories
21 Carmen. Mérimée
23 Great Sea Stories
319 Saint-Gerane. Dumas
38 Jekyll and Hyde
279 Will o' Mill. Stevenson
311 Lodging for Night. Stevenson
27 Last Days of Condemned Man. Hugo
151 Man Would Be King. Kipling
148 Strength of Strong. London
41 Xmas Carol. Dickens
57 Rip Van Winkle. Irving
100 Red Laugh. Andreyev
105 7 Hanged. Andreyev
102 Sherlock Holmes Tales
161 Country of Blind. Wells
85 Attack on Mill. Zola
156 Andersen's Fairy Tales
158 Alice in Wonderland
37 Dream of Bull. Morris
40 House & Brain. Lytton
72 Color of Life. Haldeman-Julius
198 Majesty of Justice. Anatole France
215 Miraculous Revenge. Shaw
- 24 The Kiss. Chekhov
285 Euphorion. Moore
219 Human Tragedy. France
196 The Marquis. Sand
239 26 Men and Girl. Gorki
29 Dreams. Schreiner
232 Three Strangers. Hardy
277 Man Without a Country
- HISTORY AND BIOGRAPHY**
- 340 Life of Jesus. Ernest Renan
183 Life of Jack London
269 Contemporary Portraits. Vol. 1. Frank Harris
270 Contemporary Portraits. Vol. 2. Frank Harris
271 Contemporary Portraits. Vol. 3. Frank Harris
272 Contemporary Portraits. Vol. 4. Frank Harris
328 Addison and His Times
312 Life of Sterne
324 Life of Lincoln
323 Life of Joan of Arc
339 Thoreau—the Man Who Escaped from Herd
126 History of Rome. Gies
128 Julius Caesar's Life
185 History of Printing
149 Historic Crimes. Finger
175 Science of History. Froude
104 Waterloo. Hugo
52 Voltaire. Hugo
125 War Speeches of Wilson
22 Tolstoy: Life and Works
142 Bismarck's Life
286 When Puritans Ruled
343 Life of Columbus
66 Crimes of Borgias. Dumas
287 Whistler—The Man and His Work
51 Life of Bruno
147 Cromwell and His Times
236 Heart Affairs Henry VIII
50 Paine's Common Sense
88 Vindication of Paine. Ingersoll
33 Brann: Sham Smasher
163 Life in Greece and Rome
214 Speeches of Lincoln
276 Speeches of Washington
144 Was Poe Immoral?
223 Essay on Swinburne
150 Lost Civilizations
227 Keats: The Man and His Work
170 Constantine and Beginnings of Christianity
201 Satan and the Saints
67 Church History
169 Voices from the Past
266 Life of Shakespeare
123 Life of Du Barry
139 Life of Dante
69 Life of Mary, Queen of Scots
5 Life of Johnson. Macaulay
174 Trial of William Penn
- HUMOR**
- 291 Jumping Frog. Twain
18 Idle Thoughts. Jerome
166 English As She Is Spoken. Twain
231 Humorous Sketches. Twain
205 Artemus Ward. His Book
187 Whistler's Humor
216 Wit of Helme. Eliot
20 Let's Laugh. Nasby
- LITERATURE**
- 355 Aucassin and Nicolette. Lang
278 Friendship, etc. Thoreau
195 Nature. Thoreau
220 England in Shakespeare's Time. Finger
194 Chestersfeld's Letters
63 Defense of Poetry. Shelley
97 Love Letters of King Henry VIII
3 Essays. Voltaire
28 Toleration. Voltaire
89 Love Letters of Genus
186 How I Wrote "The Raven." Poe
87 Love. Montaigne
48 Bacon's Essays
60 Emerson's Essays
84 Letters of Portuguese Nun
26 Going to Church. Shaw
135 Socialism for Millionaires. Shaw
61 Tolstoy's Essays
176 Four Essays. Ellis
75 Choice of Books. Carlyle
288 Chestersfeld and Rabelais. Sainte-Beuve
78 Prince of Peace. Bryan
86 On Reading. Brandes
95 Confessions of Opium Eater
177 Subjection of Women. Mill
17 Walking. Thoreau
70 Lamb's Essays
235 Essays. Chesterton
7 Liberal Education. Huxley
233 Literature and Art. Goethe
225 Condensation in Foreigners. Lowell
221 Women and Other Essays. Maeterlinck
10 Shelley. Thompson
289 Pepsy's Diary
299 Prose Nature Notes. Whitman
315 Pen, Pencil, Poison. Wilde
313 Decay of Lying. Wilde
36 Soul of Man. Wilde
293 Vilson. Stevenson
- MAXIMS AND EPIGRAMS**
- 77 What Great Men Have Said About Women
304 What Great Women Have Said About Men
179 Gems from Emerson
310 Wisdom of Thackeray
193 Wit and Wisdom of Charles Lamb
56 Wisdom of Ingersoll
106 Aphorisms. Sand
168 Epigrams. Wilde
59 Epigrams of Wit and Wisdom
35 Maxims. Rochefoucauld
154 Epigrams of Shaw
197 Witticisms. De Sevigne
180 Epigrams of Shaw
155 Maxims. Napoleon
181 Epigrams. Thoreau
228 Aphorisms. Huxley
113 Proverbs of England
114 Proverbs of France
115 Proverbs of Japan
116 Proverbs of China
117 Proverbs of Italy
118 Proverbs of Russia
119 Proverbs of Ireland
120 Proverbs of Spain
121 Proverbs of Arabia
348 Proverbs of Scotland
380 Proverbs of Yugoslavia
- PHILOSOPHY AND RELIGION**
- 338 A Guide to Emerson
218 Essence of the Talmud
11 Guide to Nietzsche. Hamblen
159 Guide to Plato. Durant
322 Buddhist Philosophy
347 Guide to Stoicism
124 Theory Reincarnation
157 Plato's Republic
62 Schopenhauer's Essays
94 Trial and Death of Socrates
65 Meditations of Aurelius
64 Eucken: Life and Philosophy
4 Age of Reason. Paine
55 Spencer: Life and Works
44 Aesop's Fables
165 Discovery of Future. Wells
96 Dialogues. Plato
325 Essence of Buddhism
103 Pocket Theology. Voltaire
132 Foundations of Religion
138 Studies in Pessimism. Schopenhauer
211 Idea of God in Nature. Mill
212 Life and Character. Goethe
200 Ignorant Philosopher. Voltaire
101 Thoughts of Pascal
210 Stole Philosophy. Murray
224 God: Known and Unknown. Butler
- 19 Nietzsche: Who He Was
204 Sun Worship. Tichenor
207 Olympian Gods. Tichenor
184 Primitive Beliefs
153 Chinese Philosophy of Life
30 What Life Means to Me. London
- POETRY**
- 351 Memories of Lincoln. Whitman
298 Today's Poetry
9 Great English Poems
283 Courtship of Miles Stan'ish
282 Rime of Ancient Mariner
317 L'Allegro. Milton
297 Poems. Southey
306 Shropshire Lad
284 Poems of Burns
1 Rubaiyat
73 Whitman's Poems
237 Prose Poems. Baudehise
2 Wilde's Ballad of Reading Jail
32 Poe's Poems
71 Poems of Evolution
46 Snow-Bound. Pied Piper
79 Enoch Arden
81 Lays of Ancient Rome
73 Vision of Sir Launfal
22 The Vampire. Kipling
- SCIENCE**
- 108 Introduction to Einstein. Hudgins
109 Great Men of Science
47 Animals of Ancient Seas. Fenton
74 Animals of Ancient Lands. Fenton
227 Ice Age. Finger
321 History of Evolution
217 Puzzle of Personality—Psycho-Analysis
90 Psycho-Analysis. Fielding
40 Biology and Spiritual Philosophy
275 Building of Earth
49 Evolution. Haeckel
42 Origin of Human Race
38 Reflection on Science. Huxley
202 Survival of Fittest. Tichenor
91 Evolution vs. Religion. Balmforth
33 Electricity Explained
92 Hypnotism Made Plain
53 Insects and Men
89 Eugenics. Ellis
- SERIES OF DEBATES**
- 30 Controversy. Ingersoll and Gladstone
43 Marriage and Divorce. Greeley and Owen
208 Debate on Birth Control. Mrs. Sanger and Russell
129 Rome or Reason. Ingersoll and Manning
122 Spiritualism. Doyle and McCabe
171 Has Life Any Meaning? Harris and Ward
206 Capitalism. Seligman and Nearing
234 McNeal-Sinclair Debate on Socialism
- MISCELLANEOUS**
- 342 Hints on News Reporting
326 Hints on Short Stories
192 Book of Synonyms
25 Rhyming Dictionary
78 How to Be an Orator
82 Faults in English
14 What Every Girl Should Know. Mrs. Sanger
91 Manhood: Facts of Life
83 Marriage. Besant
74 On Threshold of Sex
98 How to Love
172 Evolution of Love
203 Rights of Women. Ellis
209 Aspects Birth Control
93 How to Live 100 Years
167 Plutarch's Rules Health
320 Prince Machiavelli

We have an amazing bargain for those who order full sets of 350 volumes. At 10c per copy this set is worth \$35—our special price only \$16.90, which is less than 5c per volume. If you want full set shipped prepaid, add \$1.69, or \$18.59, for 350 books and carriage charges.

Please order by number instead of titles. For instance, if

you want "Carmen," simply write down "21." Remember the minimum quantity is 20 books—as many more as you like. Send money order, check (add 10c to personal checks for exchange), stamps or cash with all orders. If you want books shipped prepaid, enclose 10 per cent of the amount of your order in addition. Otherwise books will be sent express collect. Canada and foreign price 6 cents per book.

HALDEMAN-JULIUS COMPANY, Dept. S-20, GIRARD, KANSAS

Continued from Page 46

PERSONAL

TOBACCO, liquor and morphine habits can be overcome with the aid of Hill's Chloride of Gold Preparations. Liquor remedy can be given secretly. Particulars free. Ohio Chemical Works, Dept. 9, Westfield, N. Y.

TOBACCO or Snuff Habit cured or no pay. \$1.00 if cured. Remedy sent on trial. Superba Co., TP, Baltimore, Md.

ARE you bashful, self-conscious, easily embarrassed? These troubles overcome. Send dime for particulars. C. Veritas, 1400 Broadway, New York, N. Y.

TOBACCO Kills manly Vigor. Quit easily. Cigarettes, hawking, smoking, snuff conquered or no charge. Small sum if satisfactory. Stop craving; harmless. Full treatment on trial. Perkins Co., 34-A, Hastings, Neb.

UNUSUAL Horoscope—Six pages, consisting of extensive four-page Special Horoscope, Astro-Analysis, and two-page valuable guide giving daily and monthly advice covering entire year. Send 50c and birth date. Money returned if dissatisfied. Prof. Bolles, Box 5, Fordham Station, New York, N. Y.

ARE You Old at Forty? See our advertisement on page 146 of this issue. The Electro Thermal Company, 2126 Main Street, Steubenville, Ohio.

FREE—Stop using tobacco. We will give free information how to conquer habit easily and permanently. Results guaranteed. Anti-Tobacco League, Box K, Omaha, Neb.

YOUR greatest asset is Personality. Add to your stock. Success Tips and Self-Revealing chart 10c. Thomson Heywood, Dept. PM, Chronicle Bldg., San Francisco, Calif.

YOUR Horoscope—Business, Character Changes, Friends, Enemies. Send birth date and ten cents (stamps) for remarkable test reading. Zanya, 202-C, W. 105th St., New York City.

FREE—Information of a scientific nature that has brought happiness through perfect health to thousands. No charge; no obligation. Enclose stamp for reply. C. O. Wood & Co., Colorado Springs, Colo.

MISCELLANEOUS

CUTS anybody can make. Simple, cheap process, \$1. Specimens, particulars, 2c stamp. M. Day, Windfall, Ind.

STARTING a Company? Save expenses and taxes by organizing on the popular Common Law plan under a pure Declaration of Trust. No experience required to fill in Demaree Standard Forms, issue shares and begin doing business at once. Genuine Demaree Forms are nationally known, approved by attorneys and utilized by successful concerns throughout the United States. Send for large free pamphlet (C-53) containing valuable information that you may need. C. S. Demaree, legal blank publisher, 708 Walnut, Kansas City, Mo.

ARTIFICIAL Eyes, \$3. Booklet free. Denver Optic, 559 Barclay, Denver, Colo.

HOMEOPATHIC and Biochemic preparations sent postpaid to all parts of the world. Manual and booklets free. Halsey Bros. Co., 111 N. Wabash Ave., Chicago, Ill. Established 1855.

POCKET Maps. We will send you a reliable and comprehensive Rand-McNally indexed pocket map, tourists' and shippers' guide of any state in the Union, Canadian provinces, Alaska, Mexico or Central America, postpaid, upon receipt of 35 cents; also a splendid pocket reference map of practically any foreign country at 50 cents postpaid. Popular Mechanics Book Dept., 205 E. Ontario St., Chicago.

LOCKSMITHING, complete 500 tricks of the trade, new edition, many added features, \$1.50; money back if dissatisfied. H. Routson, 3405 Andover St., Oakland, Calif.

ART Metal Workers—You will find our book "Metal Work and Etching" a complete manual on making book ends, desk sets, pad corners, paper knives, letter openers, stationery racks, rocking blotters, desk calendars, arts and crafts jewelry, etc.; 96 pp. illus. Price 50 cents postpaid. Popular Mechanics Book Dept., 205 E. Ontario St., Chicago.

ARE You Old at Forty? See our advertisement on page 146 of this issue. The Electro Thermal Company, 2126 Main Street, Steubenville, Ohio.

IF You Are Different let us tell 'ow Better Jobs and Their Getting increase your pay. Newways Co., Box 161, New Brunswick, N. J.

RADIUS Scale.—Patent pending. Something new in scales. Finds the radius of an arc of a circle by simply placing the scale on curve and reading the radius. Scales graduated from a quarter inch radius up to a straight line. Accurate. Transparent-celloid. Indispensable to draftsmen. Price 50 cents postpaid. Kloster, P. O. Box 2848, Station 8, Philadelphia, Pa.

DRAWING Pencil Sharpener—Patent pending. Something new. Sharpens pencil with long point for draftsmen's use. Aluminum, with renewable razor steel blades. Price 50 cents postpaid. Kloster, P. O. Box 2848, Station 8, Philadelphia, Pa.

MONEY in Minerals. Many common minerals have market value. List 25c. Minerals identified, \$1.00. Mineralogist, Joplin, Mo.

MECHANICAL Amusement Wonders, Scientific Novelties, Home instructions, Art, Music, Catalogue. William Duke, Three Rivers, Michigan.

INCORPORATION in Arizona Completed in One Day. Any capitalization, least cost, greatest advantages. Transact business anywhere. Laws, by-laws and forms free. Standard Incorporating Co., Dept. 2, Phoenix, Arizona.

CONCRETE Handbook, for the Amateur. We have just published a book describing 173 ways of using concrete in the home, shop and on the farm, with full directions for doing these things yourself with ordinary tools. 138 illustrations. It is "written so you can understand it." Price 50 cents, postpaid. Popular Mechanics Book Dept., 205 E. Ontario St., Chicago.

SILVER Plate. Replates worn silverware. No electricity. Price 50c. Sample 10c. Delbridge Bros., 5178 Enright, St. Louis.

NEW KIND OF HEAT BURNS 95% AIR

Gives Three Times the Heat of Coal or Wood



Here's a new way to get as much or as little heat as you want—at the simple turn of a little valve.

A St. Louis inventor has discovered a wonderful new kind of heat that burns 95% air and yet gives three times the heat of coal or wood. What this means to the householder in these days of mounting coal prices can readily be seen. Besides the expense-saving there are also big labor-saving features. With this invention in the home there are no more fires to build, bank or watch—no more dirty, heavy coal to carry and lift—no more clouds of ashes to breathe or back-breaking scuttles to empty—no more heating problems—no more cold rooms in Winter—no more suffering from lack of quick fires in uncertain Fall and Spring—no more worries about coal shortages, poor quality or high prices.

No worry about heat when you can get 3 times the heat of coal by just turning a valve. No coal, wood, ashes.

This new kind of heat therefore has really ended the days of woman's

back-breaking servitude to a hot, mussy, stove or furnace! The wonderful invention of Mr. B. M. Oliver of St. Louis, in one minute, turns any coal or wood burner into a modern, up-to-date gas stove.

Mr. Oliver calls his invention the Oliver Improved Oil-Gas Burner, because it uses 95% air and only 5% coal oil (ordinary kerosene)—the cheapest fuel there is, turning them into an actual gas that burns with an intensely hot, clean flame. It is cleanly and also saves its cost in cleaning bills alone.

This invention can absolutely be depended upon to heat rooms in coldest Winter weather—it gives 3 times the heat of coal. But you needn't worry about the high price of coal. Install this amazing new kind of heat and you can snap your fingers at coal shortages, poor quality or high prices.

The Oliver Improved Oil-Gas Burner is made in sixteen different models to fit any kind of cook stove, heating stove or furnace. It doesn't change your stove and simply sets in a box. It is easily slipped in, in one minute—is absolutely safe and lasts a lifetime.

Just turn the valve and you have heat—as much or as little as you need. Physicians recommend the Oliver as a sure safeguard against colds, influenza, etc.

Now, once and for all time you can do away with household dirt and drudgery. End ashes, dirt, smoke, odor, chopping, shoveling, carrying, dirty heavy coal and wood. Mr. Oliver will be glad to send you immediately **FREE ATTRACTIVE BOOKLET**, "New Kind of Heat," telling all about this amazing new invention. Shows exactly how it works, how it is different from all other burners and tells how you can use it in your stove, 30 days, **FREE**. The famous Oliver Iron-Clad, Money-Back Guarantee protects you.

If you write at once you will be in time to receive Mr. Oliver's very low, introductory price offer. Get your Oliver installed immediately, before cold weather sets in.

OLIVER OIL-GAS BURNER CO.

Oldest and Largest Manufacturers of Oil-Gas Burners in the World
2014-K Oliver Building, ST. LOUIS, MO.

Mr. Oliver is anxious to obtain agents interested in filling the tremendous demands, all over the country for his new invention. Oliver agents earn as high as \$200 a month—\$25 a day spare time is easy. Exclusive territory. Big, all season seller. Write for Special Offer.



The ideal thing for this winter when coal prices are high and you want to save work, time and expense.

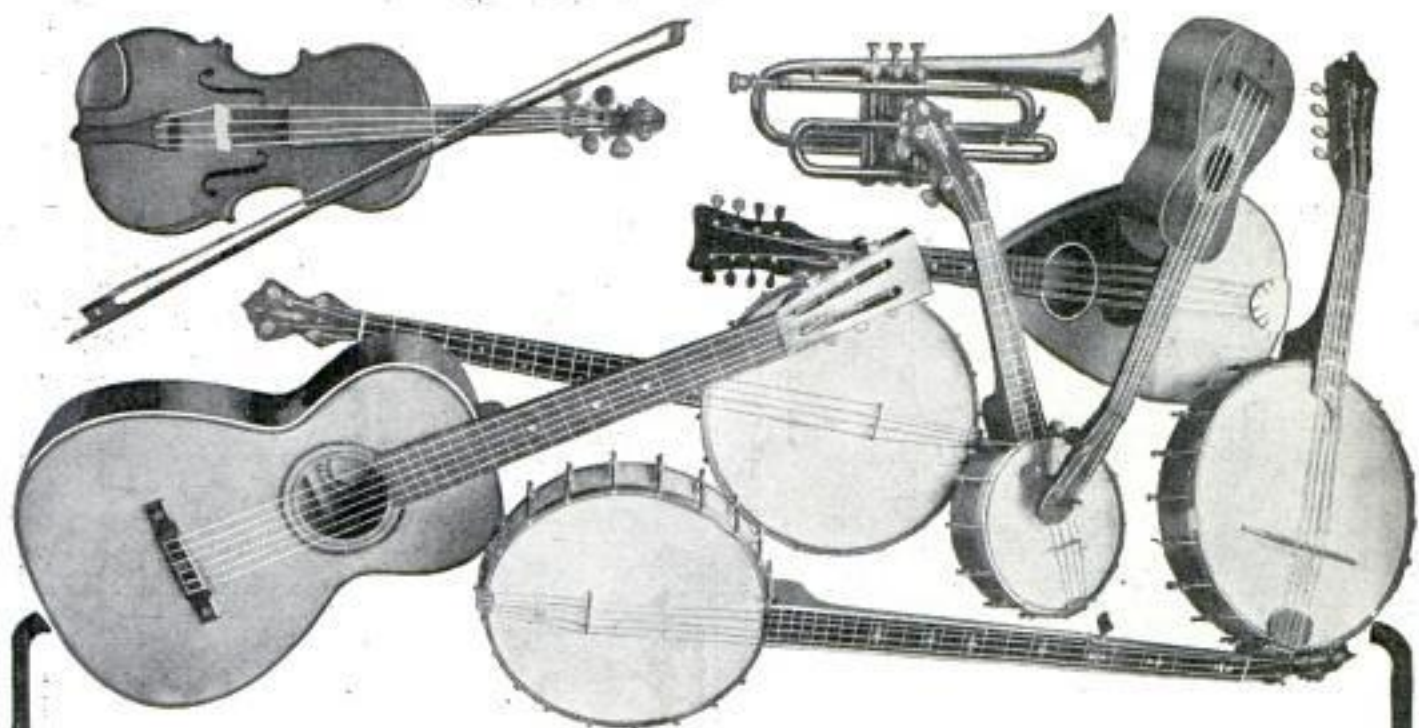

YOUR CHOICE \$
FREE 20

*Violin, Mandolin, Guitar,
Ukulele, Hawaiian Guitar,
Banjo, Banjo Mandolin,
Tenor Banjo, Cornet or
Banjo Ukulele*

Actually given away, absolutely free, to pupils in each locality. Last year we gave away thousands of high-grade musical instruments on this sensational offer, now repeated for YOUR benefit.

We have the most wonderful new system of teaching NOTE music by mail. Take your choice of any of these magnificent instruments absolutely free and learn to play by this easy to learn method. Can have you playing standard note music in 4 lessons. A very small charge for lessons—just a few cents a week—your only expense. Your success guaranteed. Pay nothing if you fail to learn; you take no risk. Complete outfit free with every instrument. Don't wait a minute, but mail the coupon NOW.

To Advertise Our Copyrighted Course

Our plan is, \$2.00 monthly for lessons. No charge for instrument. Ukulele and banjo ukulele given free with 20 lessons at 50c a lesson. Tenor banjo, banjo and Hawaiian Guitar given free with 32 lessons at 50c a lesson. Violin, mandolin, guitar and banjo mandolin given free with 56 lessons, 43½c a lesson. Lessons are mailed one each week. Fill out the coupon and enclose \$2.00 or, we will send instrument and complete outfit subject to examination at express office C. O. D. \$2.00 for first month's lessons, and you will get an instrument you will be proud to own. At end of one week if you are not delighted with instrument and lessons, send outfit back and we will refund your money.

Do not delay, but mail the coupon today, before it is too late. Be sure to state whether you want a free Violin, Mandolin, Guitar, Ukulele, Hawaiian Guitar, Banjo, Banjo Mandolin, Tenor Banjo. We guarantee any one of these instruments positively worth \$20 or more. For cornet, piano, organ and further information, write for booklet.

Slingerland's Correspondence School of Music
Department 2
Corner Orchard and Willow Sts., Chicago, Ill.

FREE INSTRUMENT COUPON

Slingerland's Correspondence School of Music
Department 2, Corner Orchard and Willow Streets
Chicago, Illinois

Please send me one..... free.
(Name of Instrument)

- Plan No. 1. I am enclosing \$2.00 for first month's lessons
 Plan No. 2. Send outfit and lesson C. O. D. \$2.00; but if I am not satisfied at end of one week's trial, I will return outfit and my \$2.00 is to be returned to me or, I will pay \$2.00 monthly until lessons are paid for.

Name.....
(Print or write plainly)

St. & Number.....

R. F. D.

City..... State.....



AMAZING OFFER!
 12 massive volumes — a complete LAW COURSE in book form — at a bare fraction of the usual cost! Sent for 7 days' FREE examination! No money down!

LEARN LAW

Read law in your spare time and become a lawyer or a law-trained man in business. Great opportunities for wealth, prestige and power awaits you in the profession of law. Equally great opportunities in being a legally trained man in business. Business firms and corporations are looking for the man who knows law, for law enters into every phase of business, into every single business transaction. Gain a knowledge of law and you can command an executive position—a position of responsibility at big pay! Why don't you learn law in your spare time? Here is a real chance to get a legal training at a bare fraction of the usual cost.

\$280 After Examination

Make these 12 large volumes your law school. They contain all the law. A complete text, the work of the highest authorities. Prepared especially for home study with quiz questions on every subject. Every subject in commercial and professional law covered. Every point made clear. No tiresome daily lessons.

Written in interesting, fascinating form. Never before so complete and thorough a law course as this. Never before so masterly a presentation of the law in easily learned form. Already several of the leading law schools have made application for the use of these volumes as class-room texts. Splendidly bound in law Buckram, with red and black labels and titles in gold. Only 482 sets to be sold at slashed price on this special introductory offer. Act quick to get in on this offer.

Send No Money

We'll ship the whole set right to your home or office for 7 days' free trial upon your simple request. If after the 7 days' free examination you are highly pleased and decide to keep them simply pay the small initial payment of \$2.80, and then only \$3.00 a month until the special reduced price of \$44.80 is paid. Regular price \$110. Think of it—a saving of \$65.20—and over a year to pay—only 75¢ a week. Act quick, as this cut price offer holds good only on 482 sets. So rush the coupon.

NOW!!

Mail the coupon now. Get the books for 7 days' trial. Decide for yourself whether you want to keep them or not.

\$5.00 required with order outside of United States.

The Johansen Corporation
 618A Manhattan Bldg., Chicago

Please send your 12-volume Home Study Course in Law for 7 days' examination, shipping charges collect. I will either send \$2.80 as initial payment and \$3 a month thereafter until \$44.80 is paid, or return the books within 7 days at your expense. (Special cash with order price \$39.80.)

Name

Address

Employed by Age

FREE! Reading Course

Act at once and we will include, extra and FREE, our Reading Course of 33 complete lectures in law, which will help you prepare for the bar examination. This with the books amounts to a complete course in law.



YOUNG MEN can now become perfect human Masterpieces with Tremendous Muscles—Old Men can have Perfect Health—Unlimited Vitality and a Perfect Body. You may now banish the fear

of approaching years without the use of Medicine, Drugs, Stimulants, or any artificial aid. **ANALYZE YOURSELF** and you will be shocked at the poison in your System. **PEOPLE DIE TOO YOUNG** because they do not give nature a chance externally, or internally. **DOCTORS CANNOT CURE YOU** unless nature assists them. **CONSTIPATION** often causes High Blood Pressure and some of our most fatal diseases.

KILL CONSTIPATION

or it will surely kill you. If you have that Tired Feeling—Poor Memory—Can't Sleep—Nervous Indigestion—Headache—Constipation—Weak Back—Thinness—Flat Chest—Round Shoulders—Short Windedness—Endurance—or a Drug Addict. Write us for our latest scientific improved way of treating by nature at home without Drugs. **THERE ARE FIVE HUNDRED MUSCLES** in your body. Give them a Chance. We can Increase the Muscle in your Arm one inch, and your chest two inches within Thirty Days—Then Watch them Grow. **WE CAN PUT MUSCLES ON YOU** that will be the envy of all your friends and make you afraid of no man. You will then pity the poor weakling and **WAKE UP FULL OF PEP**—With Eyes Sparkling—Brain Clear, and **BAT LIKE A KID**.

It is a crime not to be Physically Fit—Why be Just Average when you can Be Admired By Everyone? **NOW BLAME YOURSELF** if this message does not bring you Strength, Health and Happiness.

FREE Send name and address for Proof and Free Copy of Strength, Health and Happiness sent absolutely Free in Plain Cover.

UNITED STRENGTH INSTITUTE
 214 Dinan Building DETROIT, MICHIGAN

STOP USING A TRUSS

Do Away With Steel And Rubber Bands



Over 250,000 Now In Use

We have proved to hundreds of thousands of sufferers from hernia (rupture) that to obtain lasting relief and develop a natural process for betterment comes by wearing a Plapao-Pad. This patented mechanico-chemico device can do the same for you. The wearing of an improper support aggravates rather than improves the condition. The Plapao-Pad can and does aid the muscles in giving proper support, thereby rendering efficient aid to Nature in restoring strength to the weakened muscles. Being self-adhesive there is no slipping and shifting of pad with resultant irritation and chafing. Most comfortable to wear—no delay from work. Awarded Gold Medal at Rome and Grand Prix at Paris.

Send No Money. We will send you a trial of Plapao absolutely FREE, you pay nothing for this trial now or later. Write for it today, also full information. **PLAPAO LABORATORIES, Block 1427 St. Louis, Mo.**



Tighten Your Grip on a Trade

Be An Electrical Expert At \$75 to \$200 a Week

Every up-to-date fellow knows what a future there is in electricity.

Big pay—fascinating work on land or sea—rapid advancement in a field where jobs are ten times more numerous than trained men to fill them, where \$75.00 a week is just a fair starter, where top notchers pull down ten thousand dollars or more a year—in a field, where any man if he wishes, can easily have a business of his own, have men working for him, be his own boss!

But what the average young man does NOT know, is what a simple, easy, A-B-C sort of a job it is to get started.

You Can Start Right Now!

Yes, you. You don't need a thing you don't already have! You can read. You can write. You can figure. You can think. And in your breast is the fire of ambition—the desire to get ahead! All right, that's all you need—we can help you just as you are—just as we have helped scores, yes, thousands of other two-fisted young fellows determined to get out of the rut and into the electric field—into work that will be pleasant—easy—and all in your home, during spare time.

Fascinating Home Study As You Hold Your Old Job

With the help we will give you, you can slip right into one of these big pay—be-man jobs and never lose a day's work. After a few weeks' start, you can earn enough in installation and electric repair jobs alone to more than pay for the Course and lay a foundation for an Electrical Contracting or Repair Shop Business of your own. When the proper time comes, we will tell you the easy way to go about doing it.

The Most Practical, Thorough and Condensed Electrical Course Ever Written

This is the only home study electrical course that gives you the combined practical and theoretical training you must have before you can be a successful electrician without which you cannot succeed—with which you cannot fail.

Written not by ONE man, with the narrow one-man viewpoint, but by 22 of the brainiest, most successful, electrical experts ever drawn from the field of practice and theory. Gives you the complete mastery of the subject—qualifies you as electrical expert to boss jobs—fits you right into the kind of a job you want—and does it in shortest time—at lowest cost—with the

Most Binding Guarantee of Results Ever Offered!

Satisfaction guaranteed or no sale! We not only SAY we can make you an electrical expert, we Guarantee it! If you are not absolutely satisfied when you have finished our Practical Electrical Course, we will refund every nickel you sent us.

FREE! Experimental Outfit Worth \$30 Find out all about our
Drafting Course Worth Another \$30 offer. Find out about the
Big Electrical Library Worth \$25 thousands who have taken
this course in preference to
all others and MADE GOOD. Find out about the Electric Library—four elegant volumes—worth \$25,
but free. About the free Drafting Course worth another \$30. The free Experimental and Demon-
stration Outfit, including a real, not a make-shift Electric Motor, Wheatstone Bridge, etc.—the most
scientific, high-grade and complete Experimental Outfit ever supplied with a Course in Electricity.
Get all the facts without obligation, without expense! Just send the coupon!

American School

Dept. E-874

Drexel Ave. and 58th Street, Chicago

**FREE
Electrical
Coupon**

American School,
Dept. E-874, Chicago
Please rush all informa-
tion relative to your Course
in Electricity. This obligates
me in no way whatever.

Name.....

Address.....



Are You Reaching for the Truth?

I will tell you
FREE

Under which Zodiac Sign were you born? What are your opportunities in life, your future prospects, happiness in marriage, friends, enemies, success in all undertakings and many other vital questions as indicated by ASTROLOGY, the most ancient and interesting science of history?

Were you born under a lucky star? I will tell you free, the most interesting astrological interpretation of the Zodiac Sign you were born under.

Simply send me the exact date of your birth in your own handwriting. To cover cost of this notice and postage, enclose ten cents in any form and your exact name and address. Your astrological interpretation will be written in plain language and sent to you securely sealed and postpaid. A great surprise awaits you!

Do not fail to send Birthdate and to enclose 10c.
Print name and address to avoid delay in mailing.

Write now—TODAY—to the

ASTA STUDIO, 309 Fifth Ave., Dept. 138, New York



Eat Tyler's Macerated Wheat

(Tasty rawfood preparation)

for Rheumatism Stomach
and Intestinal troubles.
Amazing results guaran-
teed.—pamphlet free.

Byron Tyler (ESTB. 1899)

171 Gibraltar Bldg. Kansas City, Mo.

Be an Expert Repairman

ON MOTORS AND GENERATORS

Repair and Maintenance Men in Big Demand

LEARN IN THREE MONTHS

Insure yourself permanent income and bigger opportunities—here at this Great Electrical School you actually wind D. C. and A. C. armatures under expert instructors. Write today for 72-page illustrated book. It's FREE.

SCHOOL OF ENGINEERING OF MILWAUKEE

P. M. 11, 415-17 Marshall St., MILWAUKEE, WISCONSIN

Drive 100 Tacks and Save \$25

on your next Top or Seat re-covering. Fords \$5.20 to \$10. Chevrolets \$7.95 to \$15. All other car \$9.95 to \$23. Our Plate Glass Lights enhance the value of your car. Side Curtains \$5.95 up. Seat Covers \$2.00 to \$25. Quality and fit the best. Our instructions make it easy to apply. Send for samples. Our prices include delivery at your door. Eastern orders shipped from Ohio. Auto Equipment Co., 1055 So. Broadway, Los Angeles, Calif.

\$5.20 up
Delivered

SHOW CARD LETTERING

A pleasant, profitable profession, quickly and easily learned by our new, simple method. No canvassing or soliciting. We show you how, no matter where you live. Full Particulars and Booklet Free.

UNITED SHOW CARD STUDIOS, 214 Dinan Bldg., Detroit, Mich.

Learn Advertising

EARN \$40 TO \$150 A WEEK

I will teach you advertising by mail in your spare time at home. I assist you to earn money while learning. Hundreds of high-salaried executive positions now standing open—waiting for the trained advertising man or woman. Under my direction you can easily qualify for one of these big-paying jobs. No previous experience necessary. Interesting free booklet explains all. Send for it to-day.

G. B. CARPENTER, President
Gateway Bldg., Dept. A
KANSAS CITY, MO.

Carpenter School of Advertising

\$100.00 EARNED BY YOUNG ARTIST IN 2 DAYS

Well-trained artists earn splendid incomes. The Federal home-study course is a proven result-getter. If you like to draw, send 6¢ in stamps for 56-page book "Your Future."

FEDERAL SCHOOL OF COM'L DESIGNING
695 Federal Schools Building
Minneapolis, Minn.

COMMERCIAL ART

Big demand—large earnings for men and women who can qualify. A master course will be mapped out for you by our staff of practical commercial artists. Write for instructive 44-page book. No obligation.

Dept. 6, NATIONAL ACADEMY OF COM'L ART
230 East Ohio Street, CHICAGO

Minstrel Show Guide

350 End-men's Jokes, 26 Songs, 9 Complete Sketches, 8 Monologues, 4 Stump Speeches, besides Complete Instructions on stage and program arrangements, rehearsals and "make-up," from beginning to end. Price 10¢ postpaid.

J. C. DORN, 701 S. Dearborn Street, Dept. 35, CHICAGO, ILL.

TYPEWRITERS

\$50 buys a brand new Corona, the Personal Writing Machine. Latest model with many improved features. Write for free booklet No. 8.

Corona Typewriter Co., Inc.
GROTON, N. Y.

Look Here!



Are you ambitious—are you looking for the way to Success?
Do you want an easy, pleasant job?
Do you want to make from \$60 to \$100 a week?
Do you want to enjoy the luxuries of life?

Then Read My Offer!

I Guarantee

to train you right at home — to make you an EXPERT DRAFTSMAN quick! I guarantee to prepare you to hold down any big pay job in any Drafting Office and to refund every cent of your money if you are not satisfied with my training. I guarantee to give you my practical JOB-METHOD instruction until you are actually placed in a drafting position paying at least



**\$250 to \$300
A MONTH!**

I have recommended Drafting as a life-work to thousands of men during the past 20 years — I have seen them step into big-salaried positions immediately after completing my course — I have thousands of letters to prove that my "Job-Method" instruction has made these men **Successful Draftsmen** — and I offer you now the same opportunity to get into a business where there are always more jobs than Experts to fill them, where salaries are big, hours short, work pleasant.

BE AN Expert Draftsman!

Learn at HOME in your SPARE TIME!

Common schooling all you need. Learn in a few months. Important jobs everywhere — railroads, factories, builders, Cities, Counties, States, the U. S. Government, shipyards, automotive plants, architects and dozens of other lines all need Expert Draftsmen. Salaries range from \$60 to \$150 a week. Draftsmen are always in line for promotion as superintendents, managers and other official positions. Before any machine, building or product can be made, a Draftsman must draw the plans! He's the key-man of Industry. Executives depend on him. Not a wheel can turn without him.

FREE! \$19 Professional Drafting Outfit

The Coyne "Job-Method" teaches you Drafting with the same instruments and outfits you will use as an EXPERT when employed at a big salary. In order to help you START RIGHT NOW, we offer this \$19 Outfit FREE to every Coyne student. Coupon brings complete information. *Mail it immediately!*

2 Drafting Books Free!

Mail coupon today and take advantage of this opportunity.

**CHIEF DRAFTSMAN
COYNE SCHOOL OF DRAFTING**
Dept. 802—1-9 S. Ashland Ave.
CHICAGO, ILL.

**Chief Draftsman
COYNE SCHOOL OF DRAFTING**
1-9 S. Ashland Ave., Dept. 802, Chicago, Ill.

Without obligating me in any way, please send me your two books, "Drafting, the Foundation of Industry" and "Learn Drafting by the Job-Method" — all absolutely free. Also complete information of your rapid home-study Drafting course, free instruments and other features.

Name.....
St. No.....
City..... State.....

MAIL COUPON TO-DAY!

Mark and Mail This Coupon!

INTERNATIONAL CORRESPONDENCE SCHOOLS

Box 5553-D, Scranton, Penna.

Without cost or obligation on my part, please tell me how I can qualify for the position or in the subject before which I have marked an X:

BUSINESS TRAINING DEPARTMENT

- | | |
|---|---|
| <input type="checkbox"/> Business Management | <input type="checkbox"/> Salesmanship |
| <input type="checkbox"/> Industrial Management | <input type="checkbox"/> Advertising |
| <input type="checkbox"/> Personnel Organization | <input type="checkbox"/> Better Letters |
| <input type="checkbox"/> Traffic Management | <input type="checkbox"/> Foreign Trade |
| <input type="checkbox"/> Business Law | <input type="checkbox"/> Stenography and Typing |
| <input type="checkbox"/> Banking and Banking Law | <input type="checkbox"/> Business English |
| <input type="checkbox"/> Accountancy (Including C.P.A.) | <input type="checkbox"/> Civil Service |
| <input type="checkbox"/> Nicholson Cost Accounting | <input type="checkbox"/> Railway Mail Clerk |
| <input type="checkbox"/> Bookkeeping | <input type="checkbox"/> Common School Subjects |
| <input type="checkbox"/> Private Secretary | <input type="checkbox"/> High School Subjects |
| <input type="checkbox"/> Business Spanish | <input type="checkbox"/> French |
| | <input type="checkbox"/> Illustrating |

TECHNICAL AND INDUSTRIAL DEPARTMENT

- | | |
|---|--|
| <input type="checkbox"/> Electrical Engineering | <input type="checkbox"/> Architect |
| <input type="checkbox"/> Electric Lighting | <input type="checkbox"/> Blue Print Reading |
| <input type="checkbox"/> Mechanical Engineer | <input type="checkbox"/> Contractor and Builder |
| <input type="checkbox"/> Mechanical Draftsman | <input type="checkbox"/> Architectural Draftsman |
| <input type="checkbox"/> Machine Shop Practice | <input type="checkbox"/> Concrete Builder |
| <input type="checkbox"/> Railroad Positions | <input type="checkbox"/> Structural Engineer |
| <input type="checkbox"/> Gas Engine Operating | <input type="checkbox"/> Chemistry |
| <input type="checkbox"/> Civil Engineer | <input type="checkbox"/> Automobile Work |
| <input type="checkbox"/> Surveying and Mapping | <input type="checkbox"/> Pharmacy |
| <input type="checkbox"/> Metallurgy | <input type="checkbox"/> Airplane Engines |
| <input type="checkbox"/> Steam Engineering | <input type="checkbox"/> Agriculture and Poultry |
| | <input type="checkbox"/> Railroads |
| | <input type="checkbox"/> Mathematics |

Name.....
Street Address.....
City.....State.....

Occupation.....
Persons residing in Canada should send this coupon to the International Correspondence Schools Canadian, Limited, Montreal, Canada.



"The \$3700 Coupon"

"When I enrolled with the I. C. S., I was making \$25 a week. To-day I am earning \$5000 a year. That's a difference of \$3700 a year—all due to spare-time study. Do you wonder that I am glad I took up the I. C. S. course? It was the best investment I ever made."

Every mail brings letters from students of the International Correspondence Schools telling of advancement and larger salaries. The increases voluntarily reported in a single year totaled more than two million dollars. And there were thousands of increases not reported.

How much longer are you going to wait before taking the step that is bound to bring you more money?

The "\$3700 coupon" is printed above. It doesn't cost you a penny or obligate you in any way to cut it out and mail it to Scranton. Yet that one simple little act may be the means of changing your whole life. Mail the coupon to-day.

INTERNATIONAL CORRESPONDENCE SCHOOLS
Box 5553-D, Scranton, Penna.

Gibson Instruments

Mandolin, Mandola, Mando-Cello,
Guitar, Tenor-Banjo, Mandolin-
Banjo, Cello-Banjo, Guitar-
Banjo, Harp-Guitar,
Mando-Bass —



Easy to Play Easy to Pay

Select your Gibson now. You can soon be playing the music of the day. Your friends will be surprised and delightfully entertained. Let us help you organize a Gibson Orchestra in your community. You can increase your popularity, income and pleasure by playing for Concerts, Entertainments, Church Affairs, etc. A small down payment and then \$5 a month will soon pay for a Gibson and will furnish you with wholesome, year-'round entertainment. If you have an old instrument, we will make liberal allowance on a Gibson. Write for Free Book, Catalog, Free Trial Offer, information about Wm. Place, Jr. Book and instrument you prefer.

GIBSON MANDOLIN-GUITAR COMPANY
1591 Parsons Street
Kalamazoo, Mich., U. S. A.

Men and Women—17 to 45 Years

\$1600 to \$2600

Common Education Sufficient

Travel. See the country. No lay offs—lifetime job. Holidays with pay. Write today for free list of positions obtainable and information how to get a position.

UNITED BUSINESS TR. ASS'N

214 Dinan Bldg.

DETROIT, MICH.

MUSIC LESSONS FREE



IN YOUR
OWN
HOME

You can read Music like this quickly.
Piano, Organ, Violin, Mandolin, Guitar, Banjo, etc.
Beginners or advanced players. One lesson weekly. Illustrations make everything plain. Only expense about 2c per day to cover cost of postage and music used. Write for FREE booklet which evolves everything in full.

AMERICAN SCHOOL OF MUSIC, 50 Lakeside Building, CHICAGO

A THRILLING CAREER

Become a reporter and news writer at home. Practical New York newspaper men quickly teach you this fascinating, well paid work. Personal instruction in Reporting, Writing for Out-of-Town Papers, Spectacles, Publicity, Society, etc. You can earn \$100 to \$400 monthly, part or whole time. Men and Women. Write for free book now.

Metropolitan School of Journalism
Dept. 118, 30 E. 42nd St., New York

Become A Reporter! FREE BOOK Tells All

Be a DENTAL LABORATORY EXPERT

Earn \$65 to \$125 a week. Open your own Laboratory and make \$5000 to \$15000 a year. The new, unencumbered profession. Railroad fare to Chicago free this month. WRITE FOR FREE CATALOG and special offer.

McCARRIE SCHOOL OF MECHANICAL DENTISTRY
Dept. 201
34 W. Lake Street, CHICAGO

WEIRD MYSTO OUTFIT

The ORIGINAL weird Mysto Talisman Ring—wards off evil spirits, sickness, spells, etc., Ancient belief, brings success to wear in love, business, games, ALL Undertakings. Green gold solid, studded with Lucky Mysto Ruby and Emerald. 616 8th Street; ALSO the startling MYSTO WONDER, singing and mysterious instrument answers ALL questions. LOVE! Hate! Enemies? Marriages? Children? Money? Life? Luck? FREE with Outfit—Directions and Question Booklet—A DREAM BOOK—ALSO Free plan to make money. Pay on arrival \$1.97 Plus Postage. Mysto Co., 103 E. 125th St., Dept. 1010, N.Y.C.

Paul Briggs, Portland, Ore., National Graduate Who Now Earns \$4000 a Year as a Sales-Manager.

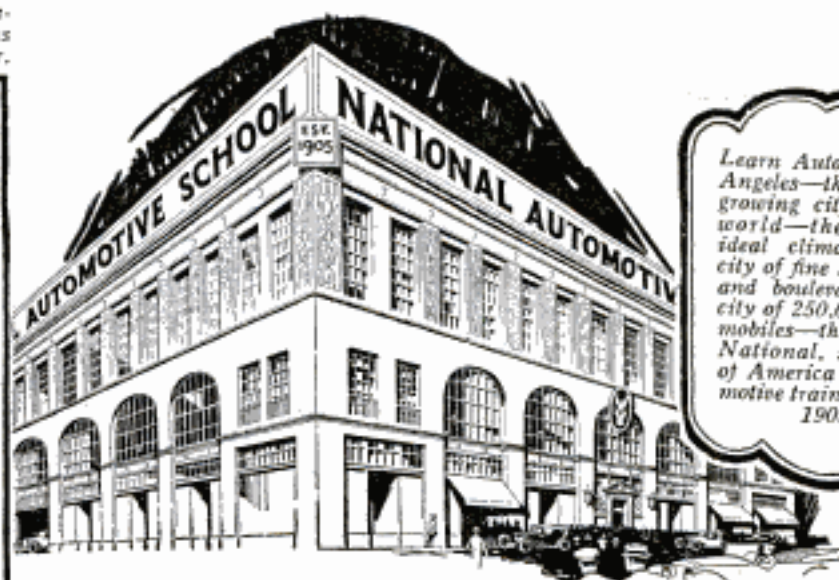

Learn Autos in Los Angeles—the fastest growing city in the world—the city of ideal climate—the city of fine highways and boulevards—the city of 250,000 automobiles—the home of National, standard of America for automotive training since 1905.

He Now Earns \$4000 a Year

National Automotive Training Enables Paul Briggs to Earn Three Times His Former Salary

How would you like to experience the same thrill of satisfaction that Paul Briggs enjoys? To know that now you had the knowledge, the power, the training that would always enable you to hold a big position and demand a big salary. To realize that you, too, might enjoy some of the luxuries of life; yes, and save money, too, to build a home and a business of your own.

You Have This Opportunity Today—If You Grasp It

Clip the coupon, as Paul Briggs did, and mail it now for "The Gateway of Golden Opportunity." This book, which will be mailed free to you, tells you in detail about National Automotive School, and why National is better equipped to qualify you as an automotive expert.

National Training Has Brought Success to Hundreds of Men

It's the quality of training that counts. Without National training Paul Briggs would never have been able to hold the position he now has. And he is not the exception. There are thousands of other men, who, through National Training, have increased their earning ability and started themselves on the road to fortune and success. Read some of their stories in "The Gateway to Golden Opportunity."

Now National Is Equipped to Give You Better Training Than Ever

A new National Automotive building, erected at a cost of over \$300,000, with equipment costing over \$200,000, offers you many special advantages not obtainable elsewhere. Experienced automotive experts are here to give you most thorough instruction.

Individual training in repair and construction work on all types of motors; learn ignition, starting and lighting systems; lathe work, vulcanizing practice and garage management. You learn by actual practice in National Automotive's big, practical training shops.

Send for Your Copy of "The Gateway of Golden Opportunity"

READ THIS LETTER!

September 19, 1922.

Robinson-Smith Co.,
Portland, Ore.

Dear Mr. Rosenkrantz:

At the beginning of my third year with this company, I want to thank you for the big part the school has played in helping me to a success in automobile work.

I am now Assistant Sales-Manager, and will make \$4000.00 this year, which is more than I would have made in three years at my former work as an accountant.

I consider your training was worth five years' ordinary shop experience to me in quick advancement.

Please give my best regards to all the instructors. Yours very truly,

PAUL BRIGGS.
P. S. My home address is 1285 Atlantic St., Portland.

This big, 84-page illustrated catalog will be sent FREE to you. It explains everything. National Automotive makes no free offers. The tuition fee is considerably lower than that of many other schools, but every dollar of it goes toward your training. In addition, California offers you an almost new field of amazing money-making opportunities. If you wish, we will secure a job for you to earn your room and board while learning. And we will help you find a big-pay auto job as soon as you qualify. Send for this catalog now. You owe it to

yourself to find out about National Automotive, and what National training will do for you. It may mean your future success and happiness.

National Automotive School,
Dept. 54, 4004 S. Figueroa, Los Angeles, Cal.

Please send me, absolutely free, your illustrated book about National Automotive.

Name.....

Street No.....

City..... State.....

NATIONAL AUTOMOTIVE SCHOOL, LOS ANGELES

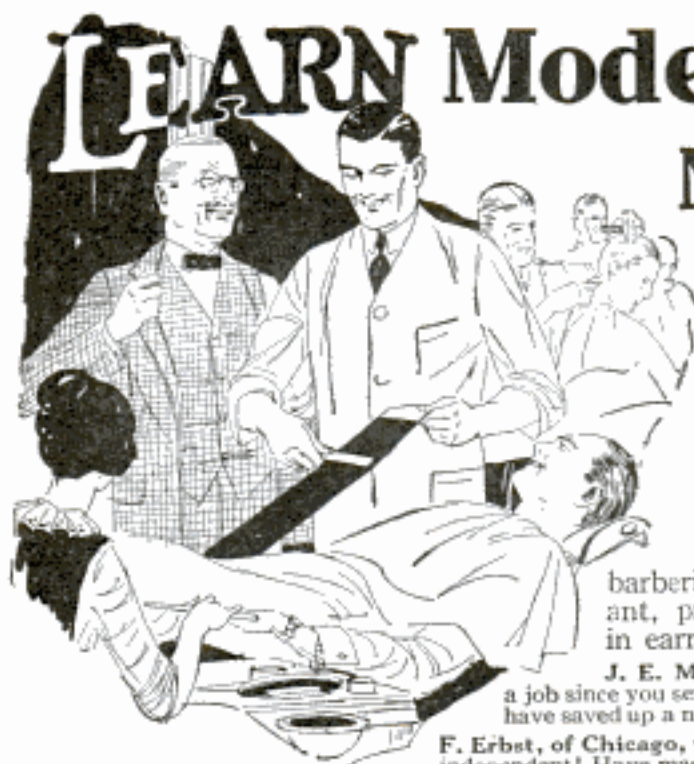

LEARN Modern Barbering NEW EASY WAY Earn \$50 to \$150 EACH WEEK

NO matter what you are now doing, no matter how much you earn, our amazing new system of training for the barbering profession enables you to step into this clean, pleasant, profitable business in a few short weeks. Start right in earning \$50 to \$150 a week.

J. E. McGregor, of New Orleans, writes: "I have never been out of a job since you sent me to the one from the Post Graduate department a year ago. I have saved up a nice bank account. I am glad I learned Modern Barbering with you."
F. Erbst, of Chicago, writes: "I own my own home! I have my own automobile! I am independent! Have made it all since graduating from your school five years ago."

What Moler System Means to You

Our national advertising educates the public to the safety, comfort and economy of Moler post graduate work. It makes you the sought-after barber in your locality. It keeps your chairs filled and turns profits into your pocket. You as graduate are a part of a national institution which assures steady, profitable business. Through no other method can you get this.

We Equip Your Shop on Easy Terms

If you own your own shop your success is assured. If you are a worker you are assured of steady employment.

Send for This
Free Book
Today

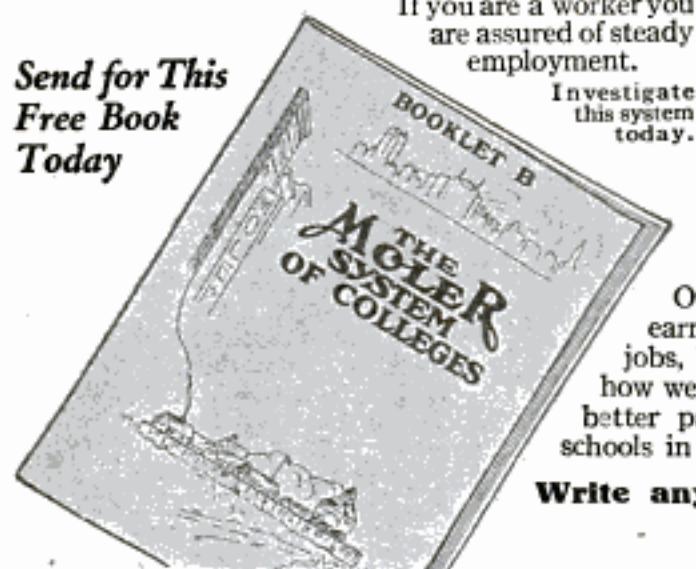

Investigate
this system
today.

MOLER SYSTEM OF COLLEGES

Address Nearest Branch →

Please send me without obligation on my part your Booklet B.

Name.....
Address.....
City.....State.....

We Train You to Be An Expert IN A FEW WEEKS

You want to get ahead—you want to make more money—big money. Our short, practical course gives you a complete training in modern barbering, including the electric hair cutter, the mechanical massage and scientific treatments. It also affords a study, if one desires, on hair and skin—it makes you an expert and expert barbers are always in demand.

Easy Work Always Busy BIG PAY

A trade that enables you to travel and see the world—one that pays in tips and commissions in addition to salaries. Moler System graduates are in great demand and have no trouble in securing good jobs.

Write for Free Book

Our catalog that we mail free tells how we enable you to earn while learning, how we put you into the best city jobs, how we equip your shop on easy payments. In fact, how we take you just as you are, make your life's work easier, better paying and more independent. We have 33 branch schools in leading cities. We have one near you.

Write anyone of the following addresses for our booklet B. Do it today.

The Moler System of Colleges

157 Third Ave. New York, N. Y.	1045 Cass Ave. Detroit, Mich.	80 N. 2nd St. Memphis, Tenn.
105 S. Wells St. Chicago, Ill.	1229 17th St. Denver, Colo.	910 Main St. Dallas, Texas
810 N. 6th St. St. Louis, Mo.	110 S. 14th St. Omaha, Nebr.	712 Franklin Ave. Houston, Texas
544 Main St. Kansas City, Mo.	513 E. Water St. Milwaukee, Wis.	727 W. Commerce St., San Antonio, Texas
206 E. 4th St. Cincinnati, Ohio	1005 Canal St. New Orleans, La.	
215 Huron Rd. Cleveland, Ohio	23 N. Forsyth St. Atlanta, Ga.	

FREE 1923 ATLAS WITH MAPS OF NEW EUROPE

To the readers of *Popular Mechanics* who take advantage of this offer now made in connection with
Webster's New International Dictionary

The Only Grand Prize

(Highest Award) given to dictionaries at the Panama-Pacific International Exposition was granted to Webster's New International and the Merriam Series for superiority of educational merit.

Words of Recent Interest

rotogravure, Flag Day, vitamin, fourth dimension, skidfin, Fascista, realtor, overhead, soviet, Blue Cross, camp-fire girl, Esthonia, Devil Dog, broadcast. These are but a few from the thousands of late words—all clearly defined in this Great Work.

"The Supreme Authority"

The Merriam Webster

A Complete Reference Library in Dictionary Form—with nearly 3000 pages and type matter equivalent to a 15-volume Encyclopedia, all in a single volume. India-Paper-Edition in Rich, Full Red Leather or Government Test Tan Buckram Binding, also Regular Edition in strong, Red Fabrikoïd, can now be secured by readers of *Popular Mechanics* on the following remarkably easy terms:

THE ENTIRE WORK (WITH COMPLETE 1923 ATLAS)

DELIVERED FOR \$1.00

and easy monthly payments thereafter (in United States and Canada)
 ON SUPERIOR INDIA PAPER

Reduced About ONE-HALF

In Thickness and Weight

India-Paper EDITION

Printed on thin, opaque, strong, superior India paper. It has an excellent printing surface, resulting in remarkably clear impressions of type and illustrations. What a satisfaction to own the new Merriam Webster in a form so light and so convenient to use! This edition is only about one-half the thickness and weight of the regular edition. Size 12 $\frac{3}{4}$ in. x 9 $\frac{3}{4}$ in. x 2 $\frac{3}{4}$ in. Weight 8 $\frac{1}{4}$ lbs.

Regular-Paper EDITION

Printed on strong book paper of the highest quality. Size 12 $\frac{3}{4}$ in. x 9 $\frac{3}{4}$ in. x 5 $\frac{1}{2}$ in. Weight 16 $\frac{1}{4}$ lbs. Both editions are printed from the same plates and indexed. Over 407,000 Vocabulary Terms, and, in addition, 12,000 Biographical Names, nearly 32,000 Geographical Subjects, besides thousands of other References. Nearly 3,000 Pages. Over 6,000 illustrations.



"To have this work in the home is like sending the whole family to college." The only dictionary with the New Divided Page, characterized as "A Stroke of Genius."

The Atlas

is the 1923 "New Reference Atlas of the World" containing 148 pages, with 96 pages of maps beautifully printed in colors, including changes brought about by the Great War. New Census Figures, Parcel-Post Guide, etc., all handsomely bound in red cloth, size 9 $\frac{3}{8}$ x 12 $\frac{3}{8}$.

To Those Who Mail This Coupon at Once!

G. & C. Merriam Co. Springfield, Mass.
 Home Office Dept. 8

(Publishers of Genuine Webster Dictionaries for Over 75 Years)

Please send me free of all obligation or expense, a copy of "Dictionary Wrinkles" containing an amusing "Test in Pronunciation" (with key) entitled "The Americanization of Carver"; also "125 interesting questions" with references to their answers, and striking "Facsimile Color-Plate" of the new binding. Please include specimen pages of India and Regular paper with terms of your free Atlas offer on Webster's New International Dictionary to *Popular Mechanics* readers.

Name.....

Address.....

HOW TO GET A POSITION WITH THE U. S. GOVERNMENT

THOUSANDS of appointments made yearly. Generous salaries, short hours, liberal vacations (as much as thirty days with pay in some branches of the service). Positions open now in Washington and in every other city in the country and in Alaska, Porto Rico, Hawaii and the Philippines.

Influence unnecessary. Common school education sufficient as groundwork for most appointments. All you need is special coaching. The International Correspondence Schools will prepare you right at home to pass your Civil Service examination with a high mark.

Mail the coupon today for 48-page FREE CIVIL SERVICE BOOKLET.

International Correspondence Schools

Box 5559-D, Scranton, Penna.

Without cost or obligation, please send me a copy of your 48-page CIVIL SERVICE BOOKLET, which tells how I can secure a position with the U. S. Government.

Name.....

Street Address.....

City..... State.....

You! can be a \$500 Auto Expert!



Automotive Mechanic



Automotive Electrician



Salesmen, Demonstrator



Garage Owner or Manager

"What Big-Pay Work Can I Learn Quickest?"



J. R. Bayston, Pres.
CHICAGO AUTOMOTIVE
INSTITUTE

Originator of the "Job-Way" System of Training

I give you this Tool Kit FREE and train you to use it



18 Piece Master Mechanics' Tool Kit FREE!

This Complete \$15.00 outfit doesn't cost you one penny! Full size, everything you need to do the "Jobs." 75 lessons, 150 Jobs, 12 lectures and many Free features in the C. A. I. course. And "Cigarette Money" pays for it!

"THE C. A. I. JOB-WAY TO BIGGER PAY!"

CHICAGO AUTOMOTIVE INSTITUTE
J. R. Bayston, Pres., Dept. 302, 536 So. Clark St., CHICAGO

LIKE machinery? Pay too small? Need more money? Then loan me an hour of your spare time a day! I'll guarantee to put you in the \$100.00 a week class quicker than you can learn any other big-pay work! **Don't quit your job! Stay home!** Thousands of men **no better than you** are making big salaries, holding down important jobs, earning enormous profits in their own business. I know how you can do the same, and I'll tell you how!

Learn Auto Repairing! Learn Automotive Electricity! Learn Vulcanizing, Welding, Battery!

My copyrighted "Job-Way" system teaches you in an hour what ordinarily takes a month to learn! The speed with which C. A. I. boys get ALL the work of the complete course has astonished educators everywhere! So simple a school-boy can understand it. Think of it! 13,000,000 autos to repair each year—13,000,000 batteries to service—13,000,000 ignition systems to keep going—65,000,000 tires to sell and repair—3,000,000 trucks to overhaul. Do you realize how hungry employers are for EXPERTS? Do you know what they're willing to pay for MASTER MECHANICS? Can you imagine the opportunities today to make big money in a business of your own?

Coupon Brings FREE BOOK and FREE LESSON!

I don't ask you to risk a penny. I know you can learn to earn \$3,000 to \$8,000 a year as an Automotive Master Mechanic. So I guarantee in writing to return every cent of your money if you don't think it's the most profitable investment you ever made. I want you to send for my free book, read the free lesson, find out about my wonderful "Job-Way" method. See why I offer the most complete Master Mechanics course for the least money, and on easiest payments. Mail Coupon or postal today!

MEN WANTED!

Thousands of big-pay jobs open right now, all over the U. S. Our Employment Service FREE to both students and graduates, reaches employees in every part of the Country. Look at this:

Master Mechanics	\$3,000 to \$8,000
Electrical Experts	- - \$3,600 up
Garage Manager	- - 3,000 up
Battery Expert	- - 2,400 up
Expert Welder	- - 2,400 up
Salesman	- - 3,000 up
Tractor Engineer	- - 2,400 up

My graduates earn money fast enough to go into business. Own your own Garage, Battery Station, Ignition Service, Repair or Welding plant.



Mail Coupon for
FREE BOOK!

Bigger-Pay Coupon!

J. R. Bayston, Pres.
Chicago Automotive Institute
Dept. 302, 536 So. Clark St., Chicago

Without a penny of expense or the slightest obligation, please send me Free Book about your rapid course in Automotive Master Mechanics, and Free Tool Kit offer. Explain your money back guarantee. I want to see a Free Lesson, too.

Name.....

Address.....

LEARN AT HOME THE C.A.I. JOB-WAY

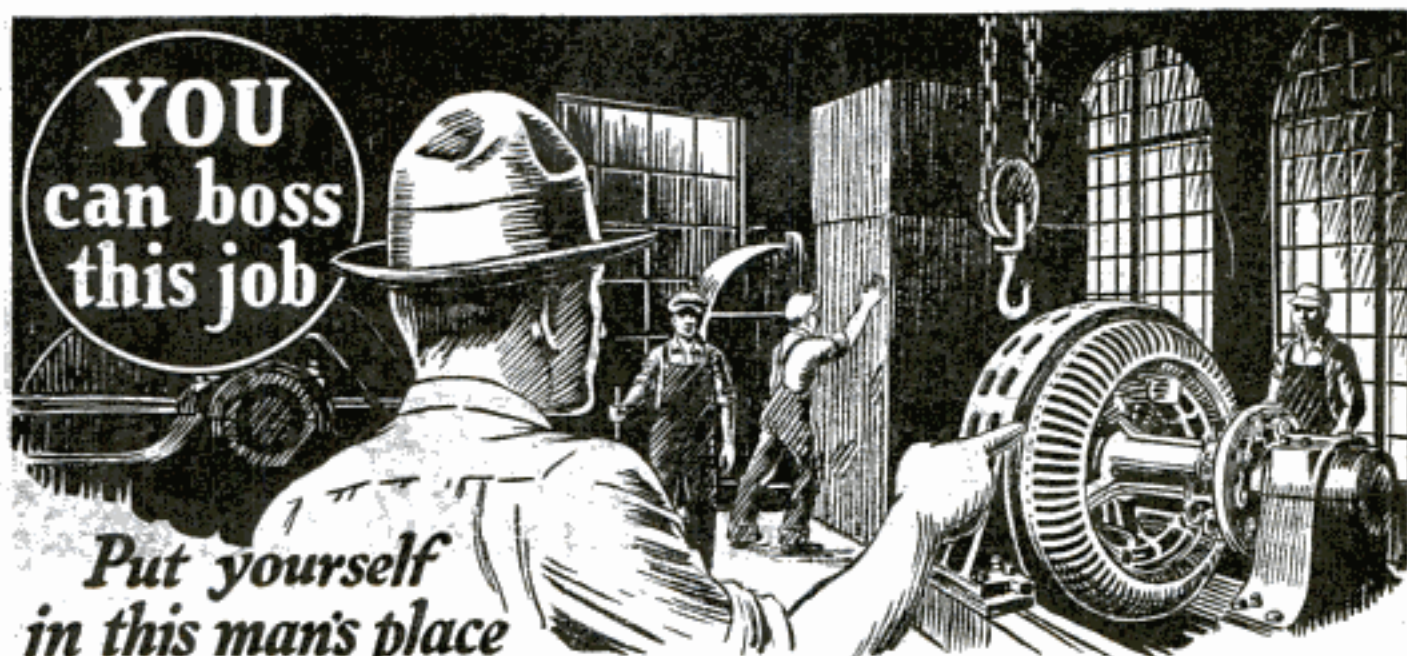

**YOU
can boss
this job**

*Put yourself
in this man's place*

**Earn \$75 to \$200 a week
as an Electrical Expert**

YOU can do it! Electricity is the biggest, fastest growing industry in the world today. Hundreds of millions of dollars being spent in development yearly! Millions of dollars to be paid for *trained brains*. A big, high-pay job waiting for you just the minute you are ready. Earnings of \$15 to \$35 and up per day by trained electrical experts are common.

Independence and Success for You in Electricity

Don't plod along on low pay, futureless work when the magical field of Electricity beckons you. We will train you quickly at home for big-pay electrical construction and service jobs and guarantee your success.

Thousands of men starting Electrical Contracting, Electrical Specialty, Radio or Automotive Electrical businesses "on a shoestring" are becoming wealthy. You can do it, too! We will help you do it. Resolve now to get in on the ground floor in the beginning of the great Electrical Age.

Send for Our Big 64-page Illustrated Book on Electricity

Learn all about the Associated Electrical Engineers—the most remarkable Electrical Training Organization on earth. Not a mere school, but a great National Organization of real Electrical Experts and Specialists. As a member of the Associated Electrical Engineers you will get the finest, most complete and easily mastered electrical training on earth right at home, in your spare time. And in addition we help you to "cash in." We show you how to make big money on the side while learning; how and where to find and hold the big money electrical jobs; how to establish your own electrical business without capital. We stand squarely behind you until you have made a **BIG SUCCESS**.

You Have Education Enough

You do not need a high school or college education to make a big success in Electricity by our **EXCLUSIVE** and **COPYRIGHTED** method. We start you right "off the ground" and build you up into the big-money class of Electrical Experts.

A Wonderful Experimental Outfit FREE

You start at once on practical work with our big **FREE** working outfit of electrical appliances, so you are not delayed in getting into actual money-getting work. A. E. E. Training includes complete courses in **RADIO** and **AUTOMOBILE ELECTRICITY**—the best to be had anywhere—given under the direction of

SPECIALISTS, who show you how to make big money in these limitless fields.

Backed by a Legal Guarantee of Satisfaction

You get back every penny of the small membership fee you pay if you are not thoroughly satisfied when you finish your training. We both must make good before it is a deal.

Mail the Coupon NOW

No matter what you are thinking of doing to increase your earning power and insure your success, **YOU OWE IT TO YOURSELF** to investigate the great Electrical Field and the **WONDERFUL MESSAGE WE HAVE FOR YOU**. Our big illustrated 64-page book on Electricity is **FREE!** Send for it **NOW**.

**Opportunity's
wide-open door**

Send for our 64-page book today

**ASSOCIATED
ELECTRICAL ENGINEERS**
Dept. A-1

537 South Dearborn Street
Chicago, Illinois

Without any obligation, please send me **FREE**, your 64-page book on Electricity and full details of how I can make big money as a member of the Associated Electrical Engineers.

Name _____

Address _____

Associated Electrical Engineers

Dept. A-1

537 S. Dearborn Street, Chicago

Now You Can Learn a Trade in 10 weeks in New York

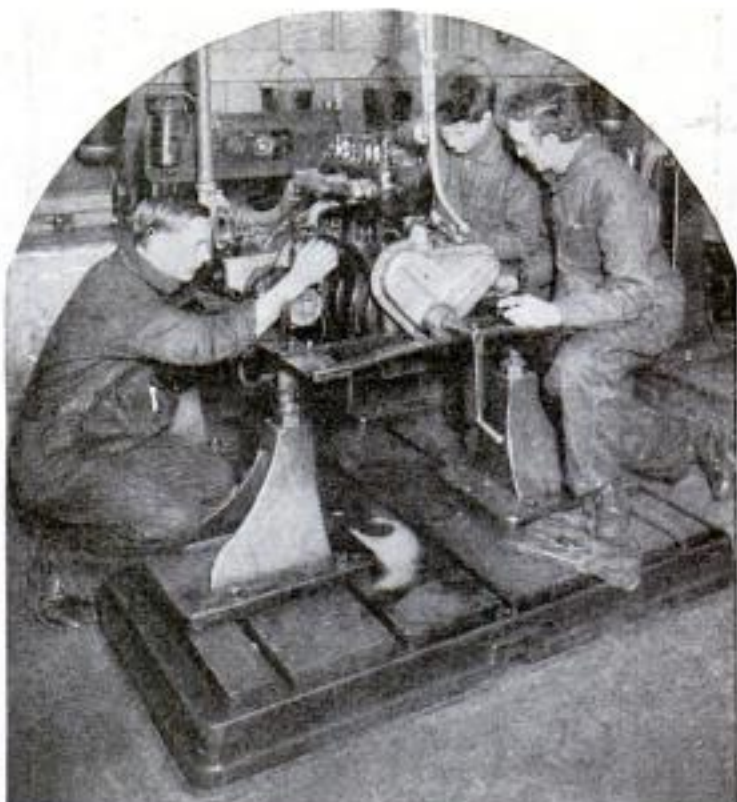

Are you making \$50 a week? Are you going to be making \$75 a week a year from now? If you aren't, or if you are not sure of your future, every word of this advertisement is meant for you. It points the way for you to realize your ambition. It shows the way to prosperity, to happiness and to independence. How? It shows you how you can get into the automobile business after 10 weeks of training and how you can become an expert with an expert's salary.

Learn the Automobile Trade

The automobile business is an open, a big paying and an interesting field. Men of experience are constantly needed and right now thousands of jobs paying upward of \$200 a month or more are going begging while the ideal men to fill them fool around with \$25 and \$30 a week jobs that offer a limited future! Those men are poorly paid, not because they have not the brains but simply because they lack the energy to ACT. The automobile repair man or electrician is sure of his job. He does not have to wait for promotion and advancement at the boss's whim—because the boss needs him more than he needs the boss.

How You Can Do It

There was a time when a man had to serve years as an apprentice in order to learn a business. He usually started by "sweeping out." But those days are gone. Now, all the information the apprentice got in years you can get in a few weeks, right here in New York. For 14 years Stewart instructions have been making automobile men. For 14 years the Stewart School has been recognized as the leading school by automobile companies all over the East.

Personal Instruction

At the Stewart School men are not pushed thru and turned out as so many factory products. Each man is taught in the way he learns the quickest—and the best. **YOU STAY WITHOUT EXTRA COST UNTIL YOU SATISFY YOURSELF YOU HAVE LEARNED EVERY DETAIL.** Ten weeks is the minimum time required. **SEND FOR OUR FREE BOOK AND LEARN ABOUT OUR GUARANTY.**

Pay As You Learn!

You can finish your course in about 10 weeks of fascinating work. That means ten weeks of practical work with tools spent among the pleasant and inspiring surroundings in New York. Find out about our easy payment plan. If you want to earn living expenses while learning our Employment Department will take care of you.

Decide Now

Make up your mind now to investigate the opportunities in the automobile business. Send the blank below and get our big **FREE BOOK.** You will be under no obligations. The book gives just the facts and figures you need. It shows just what chance you have in the automobile business and just how you can get in after 10 weeks in New York.

Send for Free Book Now

Where will you be 10 weeks from today? In the same old rut? Or will you be on your way toward a big job—a happy job and \$200 or more a month? Every day of delay is a day lost. With a newer, bigger future before you your time is precious—send the coupon in now.

STEWART AUTOMOBILE SCHOOL
225 W. 57th St., Dept. 1778, New York, N. Y.

Please send me your free book that describes your school and the opportunities in the Automobile Business. I am under no obligation.

Name.....

Address.....

City.....

State.....

"Give Us Men Who know Farm Marketing"

Get
this
book
FREE



Big Uncrowded Field of Opportunity Needs 50,000 Trained Men

There is a country-wide demand for MEN WHO KNOW FARM MARKETING. "Two jobs for every trained man" says a well known leader. Another emphatically asserts: "50,000 cooperative associations need more trained men than are available." Farm products are sold everywhere. If you have not found the job that suits you—investigate the wonderful possibilities of this new, uncrowded field.

Learn How To Sell Farm Products

Learn HOW TO SELL—WHERE TO SELL—and WHEN TO SELL, Grain, Live Stock, Fruits and Vegetables, Poultry and Eggs, and Dairy Products and you will assure yourself of a SUCCESSFUL FUTURE. You can cash in on a knowledge of marketing anywhere. You can live where you want to live.

Earn \$1,800 to \$15,000 a Year

Salaries range from \$1,800 to \$15,000 a year for men who know farm marketing. Cooperative shipping associations need trained organizers and managers. Executives in state departments of agriculture are looking for marketing specialists. Commercial enterprises want marketing agents. Become a specialist in the marketing of farm products and qualify for these high grade positions.

Experts Will Train You at Home

Our staff of nearly 100 authorities on farm marketing will give you inside plans and methods never before available. These experts will equip you for successful marketing work through The American Institute of Agriculture. They will help you to qualify for big salaries that trained MARKETING EXPERTS get. George Livingston, former chief of the United States Bureau of Markets is Director of this great educational institution. He will help you personally to win success through a SIMPLE, EASILY GRASPED HOME STUDY COURSE OF TRAINING

Start Now

Get into this new field now and assure yourself of a big successful future. Every day you postpone getting started means a loss in increased income. START NOW. Take your choice of one or all of our five complete marketing courses. Study at home. Resolve to make the most of this new field while it is still uncrowded.

Get "Profitable Marketing" FREE

Act now. Fill out the coupon. Get a copy of "Profitable Marketing" containing 64 fascinating pages and 76 high grade illustrations. It shows you how others are making money. It tells how you, too, can become an expert in the marketing of farm products and increase your income. No obligation on your part. Simply check the subjects which interest you and mail today.

THE AMERICAN INSTITUTE OF AGRICULTURE
Dept. 32P, 326 West Madison Street, Chicago

CLIP COUPON AND MAIL NOW

GEORGE LIVINGSTON, Director, The American Institute of Agriculture
Dept. 32P, 326 West Madison Street, Chicago, Illinois

Dear Sir:—Without obligation, please send me "Profitable Marketing" and full information about your farm marketing courses. I am especially interested in subjects checked.

Livestock Fruits and
 Grain Vegetables
 Dairy Poultry and
Products Eggs

Name _____
Street or R. F. D. _____
Town _____ State _____



GEORGE LIVINGSTON
Formerly Chief of U. S. Bureau
of Markets. Now Director of The
American Institute of Agriculture
in charge of home study
courses in farm marketing.

We Train You for These Big Pay Jobs

Manager Grain Elevator
Market Reporter
Manager Farmer's Shipping
Association
Commission Man
Broker
Government Marketing
Specialist
Organizer for Farm Cooper-
ative Association
Sales Manager
Track Buyer
Farm Business Manager
Marketing Agent for Cham-
ber of Commerce
County Marketing Agent
Institute Speaker
Live Stock Buyer
Marketing Specialist for
Railroad
Teacher of Farm Marketing
Bureau of Market Specialist



"I'm Going to Make More Money!"

"I'm tired working for a small salary. I know I have just as good a head on me as Fred Moore and Bob Roberts, for we used to work side by side. But they've gone far ahead of me.

"Why? Because they saw the value of special training, and I didn't.

"But I know better now. If the International Correspondence Schools can raise the salaries of men like Fred Moore and Bob Roberts, they can raise mine, too!

"If they have helped others to advance, they can help me. Today—right now—I'm going to send in this coupon and at least find out what the I. C. S. can do for me."

INTERNATIONAL CORRESPONDENCE SCHOOLS
Box 5556-D, Scranton, Penna.

Without cost or obligation, please tell me how I can qualify for the position or in the subject before which I have marked an X:

BUSINESS TRAINING COURSES

- | | |
|--|---|
| <input type="checkbox"/> Business Management | <input type="checkbox"/> Salesmanship |
| <input type="checkbox"/> Industrial Management | <input type="checkbox"/> Advertising |
| <input type="checkbox"/> Personnel Organization | <input type="checkbox"/> Better Letters |
| <input type="checkbox"/> Traffic Management | <input type="checkbox"/> Show Card Lettering |
| <input type="checkbox"/> Business Law | <input type="checkbox"/> Stenography and Typing |
| <input type="checkbox"/> Banking and Banking Law | <input type="checkbox"/> Business English |
| <input type="checkbox"/> Accountancy (including C.P.A.) | <input type="checkbox"/> Civil Service |
| <input type="checkbox"/> Cost Accounting | <input type="checkbox"/> Railway Mail Clerk |
| <input type="checkbox"/> Bookkeeping | <input type="checkbox"/> Common School Subjects |
| <input type="checkbox"/> Private Secretary | <input type="checkbox"/> High School Subjects |
| <input type="checkbox"/> Spanish <input type="checkbox"/> French | <input type="checkbox"/> Illustrating <input type="checkbox"/> Cartooning |

TECHNICAL AND INDUSTRIAL COURSES

- | | |
|---|--|
| <input type="checkbox"/> Electrical Engineering | <input type="checkbox"/> Architect |
| <input type="checkbox"/> Electric Lighting | <input type="checkbox"/> Blue Print Reading |
| <input type="checkbox"/> Mechanical Engineer | <input type="checkbox"/> Contractor and Builder |
| <input type="checkbox"/> Mechanical Draftsman | <input type="checkbox"/> Architectural Draftsman |
| <input type="checkbox"/> Machine Shop Practice | <input type="checkbox"/> Concrete Builder |
| <input type="checkbox"/> Railroad Positions | <input type="checkbox"/> Structural Engineer |
| <input type="checkbox"/> Gas Engine Operating | <input type="checkbox"/> Chemistry <input type="checkbox"/> Pharmacy |
| <input type="checkbox"/> Civil Engineer | <input type="checkbox"/> Automobile Work |
| <input type="checkbox"/> Surveying and Mapping | <input type="checkbox"/> Airplane Engines |
| <input type="checkbox"/> Metallurgy | <input type="checkbox"/> Navigation |
| <input type="checkbox"/> Steam Engineering | <input type="checkbox"/> Agriculture and Poultry |
| <input type="checkbox"/> Radio | <input type="checkbox"/> Mathematics |

Name.....
 Street.....
 Address.....
 City..... Date.....

Occupation.....
 Persons residing in Canada should send this coupon to the International Correspondence Schools Canadian, Limited, Montreal, Canada.

HIS PAY IS \$75 WEEK Trained in 8 Weeks I'LL SHOW YOU HOW

I made Ed Loss successful; I can train YOU for BIG PAY job. No previous experience necessary. My boys make \$2,000-\$10,000 year; many have own names over garage; why not you? I guarantee big pay knowledge of auto, tractor, aeroplane; you work with real tools on actual jobs in my big school repair shop. 12,000,000 motors need attention; only 38,000 garages; live chance for you! I'll pay your railroad fare from anywhere in U. S. Get my big FREE Catalog for sworn proof of success in 8 weeks. Write NOW to
Ohio State Practical Motors School
 D10-11 Cincinnati, Ohio



WANTED MEN AND WOMEN TO LEARN PHOTOGRAPHY!

Photographers and Photo-Engravers earn \$200 to \$500 a month. The field is uncrowded. Learn these profitable and fascinating professions. Taught by largest and best college of its kind in the world. Established over 30 years. Demand for our graduates far exceeds supply. Good positions secured. Tuition and living expenses low.

Get this FREE Book! Write today for free beautifully illustrated book describing wonderful opportunities in this field.
Illinois College of Photography, Box 4113, Effingham, Ill.

Be a Finger Print Expert! Learn SCOTLAND YARD METHODS

Big Pay, Enormous Rewards. We teach you how and arrange a connection for you as soon as you have finished our course. Send today for Free Booklet telling about **Scotland Yard**, and how to become **A Finger Print Expert.**

UNITED DETECTIVE TRAINING ASS'N
 214 Dinan Building Detroit, Michigan



BIG PROFITS

Agents wanted to sell boys' suits. Enormous demand and no competition. There are more than 100 boys in your locality every one of whom wears two or three suits a year. Boys wear out clothes quickly. Our method of selling boys' suits and overcoats direct from factory saves three profits—the jobber's—the salesman's and the store-keeper's. Every mother buys the minute she sees our low prices—20% to 50% less than retail stores.

NO COMPETITION—A CLEAR FIELD

We are the only firm in the country selling boys' suits and overcoats direct to the consumer through specialty salesmen. We sell regular \$12.50 boys' suits with two pairs of pants for \$8.45. You have no competition—sales are easy to make and your profit is 20%.

FULL TIME OR PART—EASY MONEY

Full time men make \$50.00 to \$75.00 a week—part time men \$25.00 to \$35.00. You get orders easy, and you get your profit the minute you make the sale. We deliver and collect. Handsome sample outfit—actual cloth samples—full illustrations—fits right in your pocket—no trouble to carry. Write quickly for full information—get exclusive territory.

Wright & Company, Dept. A103, Congress, Throop and Harrison Sts., CHICAGO

Agents Wanted

Fast Selling Line—No Competition—Big Profits

Sell Boys' Suits

22 Big Electrical Experts Prepared This Course

- C. C. Adams, B. S.
General Electric Company
- Morton Arendt, E. E.
Columbia University
- F. E. Austin, B. S., E. E.
Dartmouth College
- Winfield Dexter Bearce, B. S., E. E.
General Electric Company
- O. J. Bushnell
Commonwealth Edison Company
- Francis B. Crocker, E. M., Ph. D.
Formerly Vice-President, Crocker-Wheeler Electric Company, Atapara, New Jersey
- Louis Derr, S. B., A. M.
Mass. Institute of Technology
- William Esty, S. B., M. A.
Lehigh University
- W. H. Freedman, C. E., E. E.
University of Vermont
- H. B. Gear, A. B., M. E.
Commonwealth Edison Company
- Ward Harrison, M. E.
General Electric Company
- George J. Kirkgasser, E. E.
The Cutler-Hammer Mfg. Co.
- Robert A. Millikan, Ph.D., Sc.D.
California Institute of Technology
- John Mills, A. M.
Am. Telephone and Telegraph Co.
- David Penn Moreton, E. E.
Armour Institute of Technology
- Arthur N. Nelson
Commonwealth Edison Company
- Henry H. Norris, M. E.
Formerly Professor of Electrical Engineering, Cornell University
- Dana Pierce, B. A.
Underwriters' Laboratories, Inc.
- E. W. Seeger, M. E.
The Cutler-Hammer Mfg. Co.
- George E. Shoad, E. E.
University of Kansas
- H. M. Steller, B. E., M. S.
Western Electric Company
- A. G. Tarshull
Commonwealth Edison Company

This practical electrical training is prepared by not one man with a narrow one-man's viewpoint, but by 22 of the brainiest, most successful electrical experts ever drawn from Technical and Practical Sources.



American School

The American School is not a money-making corporation, but like resident schools and colleges, is chartered strictly as an "Educational Institution, not for profit."

More than 200 famous engineers and educators prepared the special instruction papers for our students.

For over a quarter of a century, Big Engineers, Educators and Business Men have recommended the American School. They know that our long experience as an educational institution guarantees better training at less cost than can be given by any school conducted for profit.



Be An Electrical Expert Earn \$75 to \$200 a Week

Big pay—fascinating work on land or sea—rapid advancement in a field where jobs are ten times more numerous than trained men to fill them, where \$75.00 a week is just a fair starter, where top notchers pull down ten thousand dollars or more a year—in a field, where any man, if he wishes, can easily have a business of his own, have men working for him, be his own boss! But what the average young man does NOT know, is what a simple, easy, A-B-C sort of a job it is to get started.

You Can Start Right Now!

Yes, you. You don't need a thing you don't already have! You can read. You can write. You can figure. You can think. And in your breast is the fire of ambition—the desire to get ahead! All right, that's all you need—we can help you just as you are—just as we have helped scores, yes, thousands of other two-fisted young fellows determined to get out of the rut and into the electrical field—into work that will be pleasant—easy—and all in your home, during spare time.

Fascinating Home Study As You Hold Your Old Job

With the help we will give you, you can slip right into one of these big pay—be-man jobs and never lose a day's work. After a few weeks' start, you can earn enough in installation and electric repair jobs alone to more than pay for the Course and lay a foundation for an Electrical Contracting or Repair Shop Business of your own. When the proper time comes, we will tell you the easy way to go about doing it.

The Most Practical, Thorough and Condensed Electrical Course Ever Written

Written not by one man, with the narrow one-man viewpoint, but by 22 of the brainiest, most successful, electrical experts ever drawn from the field of practice and theory. Gives you the complete mastery of the subject—qualifies you as electrical expert to boss jobs—fits you right into the kind of a job you want—and does it in shortest time—at lowest cost—with the

Most Binding Guarantee of Results Ever Offered!

Satisfaction guaranteed or no sale! We not only SAY we can make you an electrical expert, we Guarantee it! If you are not absolutely satisfied when you have finished our Practical Electrical Course, we will refund every nickel you sent us.

FREE! Experimental Outfit Worth \$30 Find out all about our offer.
Big Electrical Library Worth \$25 Find out about the thousands who have taken this course in preference to all others and MADE GOOD. Find out about the Electric Library—four elegant volumes—worth \$25—but free. The free Experimental and Demonstration Outfit, including a real, not a make-shift Electric Motor, Wheatstone Bridge, etc.—the most scientific, high-grade and complete Experimental Outfit ever supplied with a Course in Electricity. Get all the facts without obligation, without expense! Just send the coupon!

Electrical Works Division

American School, Dept. G874 Drexel Ave. and 58th St., Chicago
© A. S. 1923

ELECTRICAL WORKS DIVISION, AMERICAN SCHOOL,
Dept. G874, Drexel Ave. and 58th Street, Chicago

Send me full information about your Electrical Course and FREE your BIG NEW BOOK "Be a Power in Electricity." Or—
If you are interested in some other line we will send you full information and our free bulletin on any subject checked by you. This request puts you under no obligation.

- | | | |
|-------------------------------|-----------------------------|------------------------------|
| Architect | Machine Shop Practice | Foremanship |
| Carpenter and Contractor | Mechanical Engineer | High School Graduate |
| Auto Engineer | Draftsman and Designer | Accountant and Auditor |
| Auto Repairman | Steam Engineer | Bookkeeper |
| Civil Engineer | Wireless and Radio | Telephone and Telegraph |
| Structural Engineer | Expert | Engineer |

Name..... Address.....

LEARN CARTOONING

Successful cartoonists earn big salaries. Many of the most popular cartoonists of to-day learned to draw in their spare time, at home, through the Landon Course of Cartooning and now earn \$75 to \$200 a week.



The Landon Picture Chart Method of teaching ORIGINAL drawing makes cartooning easy to learn. Hundreds of sketches like the above explain every step in creating ORIGINAL heads, figures, animals, etc.

Write today for Sample Landon Picture Chart, long list of successful Landon students and full information showing possibilities for you. Please state your age. The LANDON SCHOOL, 738 National Building, CLEVELAND, OHIO

Results Prove Merit

In the leading publications and reviews which monthly reproduce the work of America's best cartoonists, you will constantly find the work of Landon students, including:

Dorman Smith of the N. E. A. Service.

Craig Fox of the Rochester Democrat and Chronicle.

Leo Thiele of the Sioux City Tribune.

Fred O. Seibel of the Knickerbocker Press of Albany.

Cartoonist Kuhn of the Indianapolis News—and others.

A constantly increasing number of Landon students are becoming nationally known as America's leading cartoonists.



**SHOP
WORK
with a**

CARNES ARTIFICIAL ARM

FOR nearly ten years a Carnes Artificial Arm has kept Mr. Pabhe Yasse of Lawrence, Kan., on the payroll as a draftsman and machinist at a good salary. Thousands of other mechanics, artisans, office workers, farmers and laborers owe their independence to this improved arm.

Life-Like in Action and Appearance

The Carnes Arm cannot be detected from the natural except by close inspection. Its user can dress himself, use knife, fork, pen, pencil and keys; pick up large or small objects, carry grips—in fact, do virtually everything that was possible before. He can bend the elbow of the Carnes Arm, bend and turn the wrist and open and close the fingers at will, even if the amputation is at the shoulder.

192-Page Book FREE. A book of 192 pages, profusely illustrated with photographs showing what can be done with this remarkable invention, will be sent free to any person interested. Send for it now.

CARNES ARTIFICIAL LIMB CO.,
208 Carnes Bldg., Kansas City, Mo.

SHOW-CARD WRITING

a pleasant, profitable profession easily and quickly learnt by our new, simple graphic block system. Artistic ability not necessary. We teach you how. Distance no object.

Full particulars and booklet free.

WILSON METHODS, LIMITED, Dept. 53-L, 64 East Richmond, TORONTO, CANADA

LEARN FRENCH AT HOME

New Conversational Method

evolved in Europe and introduced in America by the I. C. S. School of Languages. Records fit any phonograph. You can play them fast or slow—as often as you like. You will learn French as if you were living in France. Endorsed by French Embassy.

Write to-day for descriptive literature
INTERNATIONAL CORRESPONDENCE SCHOOLS
Box 5560-D, Scranton, Penna.

FREE FIRST RECORD

Learn to Play

Violin, Mandolin and Banjo-Mandolin quickly. No embarrassment. You learn to play or pay nothing. Play for money in two months.

Beautiful Instrument FREE

No charge for instrument to one pupil in each locality. Few cents a week pays for lessons. Write for First Record—Sent without cost on 1 week's approval with complete details of Personal Instruction Record Course.

SCHNEIDER SCHOOL OF MUSIC
Dept. B-11, 238 Vermont St., Blue Island, Ill. (A suburb of Chicago)

QUIT TOBACCO OR SNUFF RUINING YOUR HEALTH WASTING YOUR MONEY

Harmless treatment quickly overcomes craving for cigars, cigarettes, pipe, chewing or snuff. Sent on trial. Costs \$1.00 if it cures, nothing if it fails. Used by over 400,000 people. Superba Co. H-2 Baltimore, Md.

"THERE'S MONEY IN IT"

AT HOME LEARN TELEGRAPHY AT HOME MORSE AND WIRELESS

TEACH YOURSELF

in half usual time, at trifling cost, with the wonderful Automatic Transmitter, THE OMNIGRAPH. Sends unlimited Morse or Continental messages, at any speed, just as an expert operator would. Adopted by U. S. Government, and leading Universities, Colleges and Telegraph Schools. 3 Styles. Catalog free. OMNIGRAPH MFG. CO., 16-22 Hudson St., NEW YORK

If you own a Radio Phone Set—and don't know the code—you are missing most of the fun.

Men Wanted for Big Jobs

TO you men who have ambition we say "Come". Come to Chicago, the electrical center of the world. Come to the world's greatest electrical school.

Come and master electricity. Be an Electrical Expert. Get the actual experience in doing the things you must do in actual electrical work. You work on \$200,000.00 worth of equipment.

In the Great Shops of COYNE

you actually work on motors, generators, autos, batteries, radios, switchboards, power plants and hundreds of other electrical devices, the greatest outlay of any school in the world. When you finish Coyne after a course of only 3½ months you are a certificated electrical expert ready to take a big-paying electrical position or to go into business for yourself.

FREE Radio

To every student who enrolls now we will give **FREE** a complete course in radio.

**\$200
to \$600
a Month**

Big salaries are paid to Coyne-equipped men as power plant operators, electrical superintendents, telephone men, electrical construction experts, auto, truck or tractor electricians and battery and radio experts. Or going into business for yourself you can make from \$3,000 to \$20,000 a year, as other Coyne graduates are now doing.

Only 3½ Months!

Many students, even with no previous knowledge of electricity can complete this course in 3½ months (study longer if you wish.) Students step from Coyne to big-paying positions because Coyne training is so practical and thorough that big employers welcome the Coyne-trained man

Note We help students to secure part time jobs while studying and assist you to a position after graduation. We also furnish every student with a life scholarship which permits you to study as long as you like.

Write

Send this coupon now. Determine today that you are going to become a part of the world's greatest force—electricity. Assure your future by sending this coupon now. It brings you full information. Think of it—if you send the coupon today, you can be fully equipped for a fine paying electrical job in a few months. Send the coupon now before the special offer we are making is withdrawn.

COYNE
Electrical School

Endorsed by Electrical Industry

1300-1319 W. Harrison St., Dept. 13-58, Chicago, Ill.

Send Coupon At Once!

Coyne Electrical School, Dept. 13-58
1300-1310 W. Harrison St., Chicago

Gentlemen: Please send me free your big catalog and full information about your 3½ month's practical training and special offer.

Name.....

Address.....



\$100 a Week

"Wouldn't you like to earn that much, too?"

"I know you would, Bob—think what it would mean to us! It worries me to see you wasting the best years of your life when you could make them count for so much.

"Can't you see it, Bob? Don't you see that the reason men get ahead is because they train themselves to do some one thing just a little better than others?"

"If the International Correspondence Schools can raise the salaries of other men, they can raise yours. If they can help other men to win advancement and more money, they can help you, too. I am sure of it.

"Don't let another year slip by and leave you right where you are to-day. Let's at least find out how the I. C. S. can help you. Let's mark and mail this coupon right now!"

INTERNATIONAL CORRESPONDENCE SCHOOLS
Box 5557-D, Scranton, Penna.

Without cost or obligation, please tell me how I can qualify for the position or in the subject before which I have marked an X:

BUSINESS TRAINING COURSES

- | | |
|--|---|
| <input type="checkbox"/> Business Management | <input type="checkbox"/> Salesmanship |
| <input type="checkbox"/> Industrial Management | <input type="checkbox"/> Advertising |
| <input type="checkbox"/> Personnel Organization | <input type="checkbox"/> Better Letters |
| <input type="checkbox"/> Traffic Management | <input type="checkbox"/> Show Card Lettering |
| <input type="checkbox"/> Business Law | <input type="checkbox"/> Stenography and Typing |
| <input type="checkbox"/> Banking and Banking Law | <input type="checkbox"/> Business English |
| <input type="checkbox"/> Accountancy (including C.P.A.) | <input type="checkbox"/> Civil Service |
| <input type="checkbox"/> Cost Accounting | <input type="checkbox"/> Railway Mail Clerk |
| <input type="checkbox"/> Bookkeeping | <input type="checkbox"/> Common School Subjects |
| <input type="checkbox"/> Private Secretary | <input type="checkbox"/> High School Subjects |
| <input type="checkbox"/> Spanish <input type="checkbox"/> French | <input type="checkbox"/> Illustrating <input type="checkbox"/> Cartooning |

TECHNICAL AND INDUSTRIAL COURSES

- | | |
|---|--|
| <input type="checkbox"/> Electrical Engineering | <input type="checkbox"/> Architect |
| <input type="checkbox"/> Electric Lighting | <input type="checkbox"/> Blue Print Reading |
| <input type="checkbox"/> Mechanical Engineer | <input type="checkbox"/> Contractor and Builder |
| <input type="checkbox"/> Mechanical Draftsman | <input type="checkbox"/> Architectural Draftsman |
| <input type="checkbox"/> Machine Shop Practice | <input type="checkbox"/> Concrete Builder |
| <input type="checkbox"/> Railroad Positions | <input type="checkbox"/> Structural Engineer |
| <input type="checkbox"/> Gas Engine Operating | <input type="checkbox"/> Chemistry <input type="checkbox"/> Pharmacy |
| <input type="checkbox"/> Civil Engineer | <input type="checkbox"/> Automobile Work |
| <input type="checkbox"/> Surveying and Mapping | <input type="checkbox"/> Airplane Engines |
| <input type="checkbox"/> Metallurgy | <input type="checkbox"/> Navigation |
| <input type="checkbox"/> Steam Engineering | <input type="checkbox"/> Agriculture and Poultry |
| <input type="checkbox"/> Radio | <input type="checkbox"/> Mathematics |

Name.....
Street..... #3-23
Address.....

City..... State.....

Occupation.....

Persons residing in Canada should send this coupon to the International Correspondence Schools Canadian, Limited, Montreal, Canada.

Please Mention Popular Mechanics

DRAW CARTOONS

Cartoonists Trained by W. L. EVANS

MAKE MONEY

SOME of the cleverest cartoonists in America today are former students. They studied during their spare time and are now making good money. Cartoonist Evans' system of teaching is so simple, easy and practical that it is not hard to learn to draw originals. The school has a long established reputation and is recommended by well-known cartoonists because they know the students are handled right.

If you like to draw, send us a sample of your work, either a copy or an original. You may have more ability than you think. We will send you a portfolio of cartoons and full details about the school.

The Course is NOT EXPENSIVE

THE W. L. EVANS SCHOOL
OF CARTOONING

821 Leader Bldg. CLEVELAND, OHIO



"STAMMERING Its Cause and Cure"

You can be quickly cured if you stammer. Send 10 cents, coin or stamps, for 288 page cloth bound book on Stammering and Stuttering. It tells how I cured myself after Stammering and Stuttering for 20 years. BENJAMIN N. BOGUE
6903 Bogue Building, 1147 N. Ill. St. Indianapolis

You can easily learn to
play any music on the
TENOR BANJO

You Play a Piece of Real
Music Your First Lesson

Imagine the joy that will be yours when you surprise your friends with your wonderful playing of the TENOR BANJO. You will find it so amazingly easy to learn that you will thank your stars that you wrote us.

TENOR BANJO is the Most Popular Instrument of the Age

--and Prof. Barker's method of teaching is so simple and easy that you will quickly learn to play any and all of the popular dance hits just as you have heard them played by expert musicians --in dance orchestras, on the stage--everywhere.

No Previous Musical Knowledge Necessary -- Quick -- Easy -- Positive

Only 5 motions to acquire, and you learn them quickly; after that a short period of easy practice and long before you complete our Conservatory Course, you will be playing "Stomping," "Three O'Clock in the Morning," "Hot Lips" and other popular hits. We furnish free a handsomely finished \$15.00 Banjo, and all necessary equipment -- THERE ARE NO EXTRAS!

Be the Center of Interest Among Your Friends

Don't hesitate because you may not be able to read music -- simply write us on a post card -- "I am interested in your FREE TENOR BANJO Offer and course of 52 lessons." When you get our amazing offer, we know you will enroll at once. Rush Post Card to us today.

First Hawaiian Conservatory of Music, Inc.
Desk 60 233 Broadway, (Woolworth Bldg.)
New York City

Special courses under famous teachers: Hawaiian Guitar, Violin - Ukulele, Instrument Free



THIS
\$15.00
TENOR BANJO
FREE

STEADY JOBS at GOOD PAY

Earn \$50 to \$125 Per Week

Record-breaking automobile sales have created thousands of \$50 to \$125 per week jobs for men practically trained in automotive work. Hundreds of requests for such men—Greer Graduates—come to our free employment bureau. We have more jobs than we have men to fill them. YOU can be next in line if you will start right now. Eight short weeks at Greer College will equip you to step out and make big earnings for life.



Many former Greer Students now own their own places of business. This means independence, no boss, and earnings that run from \$300 to \$2,000 per month.

EARN WHILE YOU LEARN JOBS GUARANTEED

If you are in need of assistance we guarantee to place you at once in positions paying up to \$30 per week. Only a small payment down on the course selected is necessary. We have helped many men to an earning competence in this way. The instruction awaiting you will completely hold your interest. Here in the big Greer shops you get actual work on 4, 6, 8 and 12 cylinder engines. Electricity thoroughly covered. All known Lighting, Starting and Ignition units used. Special courses in Machine Shop, Batteries, Welding and Vulcanizing. Individual road lessons given.



Promotion to "Head Automotive Mechanic" is usually a question of but a short time for Greer-trained men. Salaries here average \$150 to \$500 per month.

You'll Be An Expert On All These

Complete Greer Course includes Machine Shop Practice—Shop Management—Selling—Truck, Tractor and Automobile Repairing—Lighting—Starting—Vulcanizing—Storage Batteries, Driving—everything required to equip you for the highest paid automotive positions anywhere.



The Greer-trained Truck and Tractor Repairman need never be looking for a steady job in any community. Pay average \$6.00 to \$15.00 per day, and higher.

We Pay Your Railroad Fare to Chicago

This special offering is made to fill the openings that now exist. Chicago is the place to train and opportunities for jobs are unlimited. Within ten blocks of Greer College are at least 41 large Automobile Sales Agencies. Throughout the city are approximately 5,000 Garages and Repair Shops. We will help you find a job and a home. Write us, and come to Chicago.

DAY AND EVENING CLASSES

Any job we get for you need not interfere with instruction. Day and Evening Classes are arranged to suit the convenience of every man who has the ambition to learn.

MAIL THE COUPON

It will bring you a big FREE BOOK, "How to Succeed in the Automobile & Tractor Business." It will also bring you special Tuition Offer and complete information about jobs. Mail it at once!



Automobile Salesmen make up to \$20,000 per year.



This magnificent new building—its 80,000 square feet of floor space filled with repair shops and modern shop equipment—is entirely devoted to training Greer Students. This is where you will prepare yourself for a lifetime of pleasant work at big pay.

GREER COLLEGE

of Automotive Engineering

2061 S. Wabash Ave.
CHICAGO, ILL.

**How to Succeed
in the
Automobile & Tractor
Business**

ERWIN GREER, President
2061 S. Wabash Ave., Chicago, Ill.
Send me your Free Book, "How to Succeed
in the Automobile Business," and Special
Tuition Offer.

Name.....
Address.....



\$2500 Reward for the Conviction of—

WHO murdered John Blake? The country was stunned by the crime mystery of the year. A rich reward was offered. There were clues a-plenty. Circumstantial evidence pointed to a dozen men. But the District Attorney didn't dare bring anyone of them to trial. Then the Finger Print Expert stepped in.

With feverish excitement the crowd in the courtroom listened. Judge, jury, attorneys and onlookers leaned forward in strained silence, eager to catch every word. The young Finger Print Expert in the witness chair was the center of attraction, as with calm assurance, he gave the evidence that convicted the murderer, and brought him the \$2500 reward.



T. G. Cooke,
President

I Can Make YOU a Finger Print Expert

I have trained hundreds of the men now prominent in the Profession. For instance, there's Harry Passno, Chief of the Iowa State Bureau. He had no previous experience—no college or high school education. He was just a country photographer. I trained him.

I can do the same for YOU. You may study right at home—in your spare time.

Right NOW is the time to start. More trained men are needed to fill the positions created almost daily. Salaries are high. Chances for big rewards are frequent. The Finger Print Expert is respected and deferred to by all. I am offering you a big opportunity. Will you take it?

Professional Finger Print Outfit—Free

A professional outfit, just like the Finger Print Expert uses in court, in the laboratory and at the scene of crime, is yours FREE with this famous course of training. Also a course in Secret Service Intelligence is FREE to you if you enroll early. Mail the coupon for my free book telling all about the exploits of finger print detectives and full information about this wonderful profession, and your opportunity as a Finger Print Expert.

T. G. COOKE, President

UNIVERSITY OF APPLIED SCIENCE
1920 Sunnyside Ave. Dept. 13-58 Chicago, Ill.

University of Applied Science,
1920 Sunnyside Avenue, Dept. 13-58, Chicago, Ill.

Gentlemen: Without any obligation whatever, send me your new, fully illustrated, FREE book on Finger Prints and your offer of a FREE course in Secret Service Intelligence and the Free Professional Finger Print outfit.

Name.....

Address.....

City and State..... Age.....

Please Mention Popular Mechanics

Stop Forgetting

Make Your Mind a File—Not a Pile

Let me show you how to make your mind as forget-proof as a card index file. When you wish to recall a name, place or date, must you grope in vain in a pile of miscellaneous knowledge? Summoned to give facts and figures does your mind become a blank? Be master of your mind's infinite resources—instead of a victim of its disordered details.

KNOWLEDGE IS POWER

and Memory Is the Basis of All Knowledge.

I HAVE HELPED THOUSANDS

The Dickson Method of Memory and Mental Training, perfected by 20 years experience, is recognized as the most thorough, efficient of its kind. Highly endorsed—easy to master. Give me 10 minutes a day and I will train your memory so you can classify ideas, names, faces, etc., and recall them instantly. Develop self-control, concentration; overcome bashfulness.

Perfect Your Memory and Command What Salary You Will

Send name and address and I will send you free, my interesting booklet, "How to Remember," and unique, copy-righted Memory Test; also tell you how to secure free of charge my \$3.00 book, "How to Speak in Public."

Prof. Henry Dickson, Principal
DICKSON MEMORY SCHOOL
Dept. 705-Y
Evanston, Ill.



Stop Forgetting

The Key to Success

LET THORNTON FISHER TEACH YOU CARTOONING

A Fascinating Profession For the past twelve years, THORNTON FISHER has become intimately known in millions of readers of New York World and other leading newspapers for characteristic cartoons on sport and political subjects. In the height of his fame he resigned to teach others his art. Study Cartooning, newspaper illustrating and comic drawing now, at home, under the teaching of this high paid artist. The most fascinating work in the fascinating newspaper business. Pays \$75 to \$250 a week. Send 5 cents today for portfolio of Fisher's work and his booklet.

THORNTON FISHER SCHOOL [Cartoon of Fisher drawn by himself]
Box 132, Times Bldg., NEW YORK CITY



Learn Watchwork, Jewelrywork and Engraving.

A fine trade commanding a good salary, and your services are always in demand. Address **Horological**, Dept. P, Bradley Institute, PEORIA, ILL., for our latest catalog.



FREE BOOK LEARN PIANO

This Interesting Free Book shows how you can become a skilled player of piano or organ at quarter usual cost. It shows why one lesson with an expert is worth a dozen other lessons. Dr. Quinn's famous Written Method includes all of the many important modern improvements in teaching music. Brings right to your home the great advantages of conservatory study. For the beginner or experienced players. Endorsed by great artists. Successful graduates everywhere. Scientific yet easy to understand. Fully illustrated. All music free. Diplomas granted. Write today for free book. Quinn Conservatory, Studio PM71, 598 Columbia Road, Boston 25, Mass.



PROF. CHARLES ATLAS
Twice pronounced the
World's MOST PERFECT
Man, receiving
two \$1000.00 FIRST
PRIZES.

Let the World's Most Perfect Man Show You the Way to Radiant Health and Energy

Be physically perfect—develop your power of will—overcome disease—Prof. Atlas will show you how. Send for new amazing 64-page book full of extraordinary living pictures of specimens of perfect manhood. Enclose 10 cents to cover wrapping and mailing charges. Grasp this opportunity of learning these rare secrets of becoming physically perfect. Do it now. Address

PROF. CHARLES ATLAS
96 Fifth Ave., Suite 214, N. Y. City

These Books FREE For One Week

Send no money—just fill out the coupon. After you receive the full set of books, express collect, read them over and test them out for seven days. If you don't want them, send them back at our expense. If you decide they will do for you what they have done for more than 100,000 others, pay \$2.80 within one week and \$3 each month thereafter until the special price of \$21.80 is paid. This amounts to only ten cents a day. Mail coupon NOW if you want a bigger, better job at higher wages.

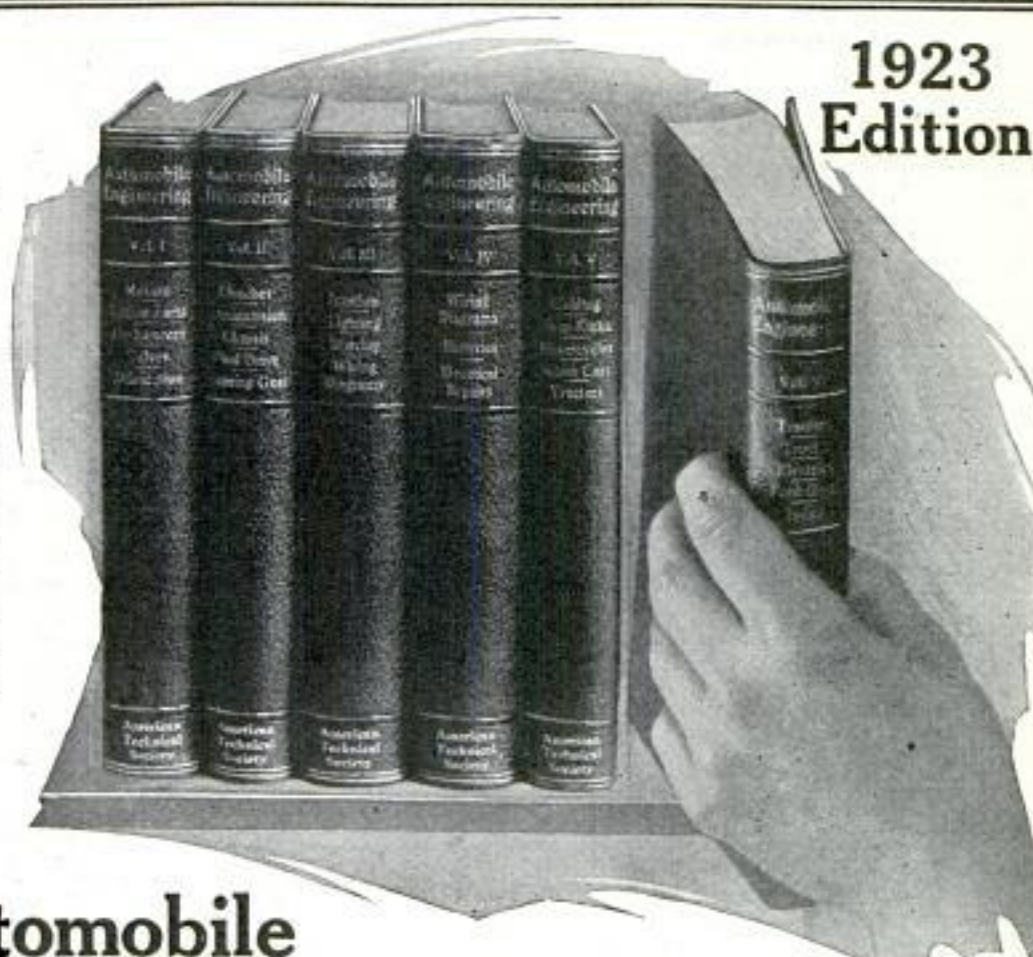

1923 Edition

All Automobile Engineering Facts at Your Fingers' Tips

Six Complete New Books for Study or Reference
Also Year's Consulting Membership in
American Technical Society—FREE

Here's the most practical set of books ever written on automobile engineering. Each book is brimful of information about the various phases of this work. 2,600 pages, 2,300 pictures and diagrams, 125 blue prints on every subject. Practical problems are solved in everyday language. They make automobile engineering as plain as day. Completely cross indexed for ready reference.

Know All About Automobiles and Earn Big Pay

These are just the books for the man who wants to know all about automobiles and fit himself for a big-paying job. They are interesting from start to finish and crammed with information. A little regular reading in them during spare hours will soon equip you for

the automobile business. Then after you get into the auto game, you'll still have them for reference.

Let These Books Solve Your Daily Problems

To the man now engaged as a mechanic or shop foreman, these books will give a world of help. They dig deep into the technical angles and theories and explain them in everyday words. If you have trouble on any point, you'll find the answer in these books. They are the work of fifteen auto experts who know from experience, the problems and difficulties of the shopman.

Repair Your Own Car

The car-owner will find these books extremely valuable as an aid in repairing his own car. Think of the heavy repair bills this will eliminate. Think of the money you can save.

© A.T.S. 1923

FREE Consulting Membership

A resident consulting staff of 18 practical experts is waiting to solve for you any auto, tractor or motorcycle troubles that you may have. A letter or a wire to the American Technical Society will bring you an immediate answer and the solution to your problems. This advisory staff of practical automobile men plus your library of Automobile Engineering will enable you to handle successfully any auto job. These men know all the latest methods and the newest and best ways of doing things. Let this pay-raising consulting staff be YOUR SILENT PARTNER. Use this service daily if necessary.

This free consulting membership offer is good for a limited time only and can be withdrawn without notice.

American Technical Society
Dept. A-819 Chicago, U. S. A.

AMERICAN TECHNICAL SOCIETY, Dept. A-819
Chicago, U. S. A.

Please send me a set of Automobile Engineering, for seven days' FREE EXAMINATION, shipping charges collect. I will examine these books thoroughly, and if satisfied, will send \$2.80 within seven days and \$3 a month until I have paid the special price of \$21.80. If I decide not to keep the books, I will return them within one week at your expense. It is understood that if I keep the books I am entitled to a FREE Consulting Membership in the Automotive Division of the Society.

Name.....

Address.....

Reference.....

(Please fill out all lines, give local merchant, banker or employer as reference.)

BE A HOTEL EXECUTIVE

**Earn \$2,500 to \$12,000 a Year
Quick Advancement**

You can have an attractive, big-paying position with one of America's leading hotels—at a salary to start with that means "good money" to the young man or woman, or "not too much sacrifice" for the maturer person looking for a life opportunity. There are almost unlimited oppor-

One of Famous Hotels
Employing S. B. T. I. Graduates



**HOTEL WOLVERINE
DETROIT, MICH.**

Senator Harold Van Orman, member of the Executive Council of the American Hotel Assn. and head of the Chain of Van Orman Hotels in the Middle West, in a letter to us, said: "You are doing a splendid work for the hotel fraternity and are to be congratulated upon your efforts."

Advised by Hotel Men

Big hotel men—whose names are recognized at once as authorities—advise S. B. T. I. training. They have endorsed it again and again by word and by letter. They recommend it to their own employees and to prospective students. Better still, they seek our graduates and students for service with their hotels, clubs, restaurants. They have more openings for S. B. T. I. trained men and women than we can fill. Mail the coupon at once to get the interesting details about your opportunities in the Hotel Business.

**STANDARD BUSINESS TRAINING INST.
CARLTON COURT BUFFALO, N. Y.**

Standard Business Training Inst.
Carlton Court, Buffalo, N. Y.

Send me free Booklet H-166 giving full information about the Hotel Operation and Management Course.

Name.....

Address.....

City.....State.....

Please Mention Popular Mechanics



Learn to Draw at Home

New Method Makes It Amazingly Easy

Trained artists earn from \$50 to over \$250 a week. Tremendous demand right now for good art work. Magazines, newspapers, advertisers, printing houses, etc.

Become an artist through wonderful new easy method—right at home in spare time. Learn Illustrating, Designing and Cartooning. Actual fun learning this way. Individual attention by mail from one of America's most famous artists. Learn to draw and earn big money.

Send for FREE BOOK

Just printed—a new book which describes the latest developments and wonderful opportunities in Commercial Art, and gives full details on this new easy method of learning to draw. Tells all about students—their successes—what they say—actual reproductions of their work—and how many earned big money even while learning. Write for this Free Book and details of special free offer. Mail post-card or letter now.

WASHINGTON SCHOOL OF ART

Room 3011, 1115-15th St. N. W., Washington, D. C.

MASTER ELECTRICITY AT HOME

A practical man will lead you to success. Write only if you are in earnest. Our FREE Book plainly tells how Burgess Home Training enables men and boys to get good jobs and hold them. Shows world-wide opportunities in electricity. Tells how fellows like you have stuck and studied until now they are on top. Write for your copy today. Romance of real success on every page.

PRACTICAL COURSE, EASILY APPLIED

No frills or feathers; no mystery; no bunk. Just honest, helpful instruction which any one can understand and follow. For the man high in the profession as well as for the beginner. All branches of electricity covered: Hydro-Electricity, Alternating Current, Motors, Power-Plant Practice, Slide Rule (30 additional lessons), Automotive Electricity, Electrical Drafting, Etc. We help you to position during and after instruction. The Course for you if you mean business. Write for Our Fully Illustrated Book Today. New Radio Course Now Ready.



BURGESS ELECTRICAL SCHOOL
YORKE BURGESS, Superintendent
Dept. 11, 744 East 42nd St., Chicago, Ill.
Canadian Branch: 201A Crawford St., Toronto



Why Miss Half the Fun in Life?

BE POPULAR—Learn to dance well! Arthur Murray, America's greatest dancing teacher, has invented a remarkable new easy method which enables anyone to learn all the newest dances at home—in a few hours—at very little cost! No music or partner needed. Success positively guaranteed! "90,000 learned dancing by mail."

FREE 5 DANCING LESSONS—To prove you can learn easily and quickly, Arthur Murray will send you five FREE lessons, including Fox Trot, Secret of Leading, and How to Gain Confidence. To pay cost of mailing, printing, etc., enclose 25c. Act NOW and be a good dancer soon.

**Arthur Murray, Studio 880
290 Broadway New York**

HEY, PILL-EATER! SNAP OUT OF IT!

Don't Be a Victim of Drugs and Dope



LIONEL STRONGFORT

Dr. Sargent of Harvard declared that "Strongfort is unquestionably the finest specimen of physical development ever seen."

STRONGFORTISM

Strongfortism is the science of buoyant, alive, vigorous health, developed after twenty-five years of physical and health teaching by me. I developed myself to be one of the strongest and healthiest men the world has ever known. Dr. Sargent of Harvard said of me: "Strongfort is unquestionably the finest specimen of physical development ever seen." I did this for myself through natural means—nature's own way. For twenty-five years I have been teaching others how to do the same thing for themselves; how to become physically able, without the use of pills, or dope, or drugs of any kind; without the use of fads or fancy methods or expensive contraptions; without interfering with your occupation; entirely in the privacy of your own room. My way is the scientific way, nature's own way—you follow my simple, sensible instructions, and you will build up your health and restore your vitality. I guarantee that I shall accomplish all that I undertake.

(Signed) Lionel Strongfort

You fellows with the tailor-made chests and the missing muscles—you fellows who are short winded and large waisted, flabby, weak and nervous—this message was written for you!

How much of a man are you? How do you stand out in a crowd of MEN? Have your vital forces gone to seed? Are you weak and sickly, run down and physically out of the swim? Have you an abused and neglected body that no longer has the stamina to withstand a weakling's ailments? Do you suffer with indigestion, catarrh, rheumatism, constipation, headaches and general debility and weakness? How can you expect to make headway in any calling if you're a physical wreck?

Banish Your Weakness! Be a Red-Blooded He-Man!

Get back your pep and energy, and add a dozen years to your life. Be a man your friends and associates can take pride in. *No one loves a weakling.* Don't go through life with one foot in the grave and the other in a doctor's office. Be a man—brace up, and let a real man make a man of YOU!

Strongfortism Will Remake You

Thousands of letters from those I have helped prove that the results following my confidential advice are simply astounding and that men are built-up and rehabilitated and rejuvenated as they never hoped to be—cured of serious afflictions, filled with pep, fired with desire and ambition and made to function as a real man should. *Even old age* has been stayed in its ravages on the human body.

I build men scientifically through an easily followed system—first removing troublesome ailments, then developing the muscles of arms, legs and chest as well as of the internal organs so that you have the groundwork always essential to perfect, continued good health. Each course is individual—for you and personal instructions given you. It is not a cut and dried general plan. Each case requires different treatment and my course is changed as your condition calls for it.

One Price to Pay

Remember, please, that you will know to the penny what my course for your trouble will cost you. There will be no dragging out of the treatment with constant payment for extras. The price is in all cases extremely moderate, and is stated *at the beginning*. We make it easy for anyone to take this wonderful course.

Send for My Free Book

I've devoted a lifetime to the study of the human body, and its care, and I've written the results of my experiences and research in a wonderfully interesting and instructive book, called "*Promotion and Conservation of Health, Strength and Mental Energy.*" It tells you in plain, frank, understandable English how you can make yourself over into a vigorous, clean, healthy specimen of manhood. Sit right down and write for it today.

LIONEL STRONGFORT

Physical and Health Specialist

1257 Strongfort Institute

Newark, N. J.

***** FREE CONSULTATION COUPON—ABSOLUTELY CONFIDENTIAL *****

Mr. Lionel Strongfort, Dept. 1257, Newark, N. J.—Please send me your book, "**PROMOTION AND CONSERVATION OF HEALTH, STRENGTH AND MENTAL ENERGY.**" for postage on which I enclose a 10c piece (one dime). Send me special information on subjects marked (X) below, as well as those I may write on extra line, without obligation.

.. Colds	.. Neuralgia	.. Torpid Liver	.. Female Disorders
.. Catarrh	.. Flat Chest	.. Indigestion	.. Stomach Disorders
.. Hay Fever	.. Insomnia	.. Nervousness	.. Pimples
.. Asthma	.. Bad Blood	.. Rheumatism	.. Blackheads
.. Obesity	.. Anemia	.. Gastritis	.. Lung Troubles
.. Headache	.. Debility	.. Heart Weakness	.. Weak Back
.. Thinness	.. Constipation	.. Poor Circulation	.. Drug Addiction
.. Lumbago	.. Biliousness	.. Despondency	.. Weakness (Specify)
.. Neuritis			

Mention Other Ailments Here: No matter what ails you write me fully about it and I shall prove to you that I can help you.

Name.....Age.....
 Occupation.....Street.....
 City.....State.....

The Menace of Wasted Years

Too many men think only of To-day.

When one is young and strong, some sort of a job is easy to get, and fairly easy to hold.

But along about 50 or 60—what then?

Age follows on the heels of youth—the back bends over—the legs soon weary—the man who lives by his hands alone falls lower and lower on the salary list.

Think of this old age problem, you young fellows of to-day, as you read over this magazine. Sit down quietly a little while and ask yourself this question—"What will I be doing at 50 or 60?"

Dependent on some relative for support? Waiting the coming day with dread? Knowing nothing of the joys of graceful old age?

Truly, it's a vital problem. And the only way to beat it is to train yourself while you are still young to do some one thing well—to be a *trained* man.

You can delay sending in this I. C. S. coupon to-day and to-morrow and next week or next year. But don't forget that the longer you wait the more you are going to lose. Time has never waited for any man, and it won't wait for you. Do it now!

INTERNATIONAL CORRESPONDENCE SCHOOLS Box 5554-D, Scranton, Penna.

Without cost or obligation, please tell me how I can qualify for the position or in the subject before which I have marked an X:

BUSINESS TRAINING COURSES

- | | |
|--|---|
| <input type="checkbox"/> Business Management | <input type="checkbox"/> Salesmanship |
| <input type="checkbox"/> Industrial Management | <input type="checkbox"/> Advertising |
| <input type="checkbox"/> Personnel Organization | <input type="checkbox"/> Better Letters |
| <input type="checkbox"/> Traffic Management | <input type="checkbox"/> Show Card Lettering |
| <input type="checkbox"/> Business Law | <input type="checkbox"/> Stenography and Typing |
| <input type="checkbox"/> Banking and Banking Law | <input type="checkbox"/> Business English |
| <input type="checkbox"/> Accountancy (including C.P.A.) | <input type="checkbox"/> Civil Service |
| <input type="checkbox"/> Cost Accounting | <input type="checkbox"/> Railway Mail Clerk |
| <input type="checkbox"/> Bookkeeping | <input type="checkbox"/> Common School Subjects |
| <input type="checkbox"/> Private Secretary | <input type="checkbox"/> High School Subjects |
| <input type="checkbox"/> Spanish <input type="checkbox"/> French | <input type="checkbox"/> Illustrating <input type="checkbox"/> Cartooning |

TECHNICAL AND INDUSTRIAL COURSES

- | | |
|---|--|
| <input type="checkbox"/> Electrical Engineering | <input type="checkbox"/> Architect |
| <input type="checkbox"/> Electric Lighting | <input type="checkbox"/> Blue Print Reading |
| <input type="checkbox"/> Mechanical Engineer | <input type="checkbox"/> Contractor and Builder |
| <input type="checkbox"/> Mechanical Draftsman | <input type="checkbox"/> Architectural Draftsman |
| <input type="checkbox"/> Machine Shop Practice | <input type="checkbox"/> Concrete Builder |
| <input type="checkbox"/> Railroad Positions | <input type="checkbox"/> Structural Engineer |
| <input type="checkbox"/> Gas Engine Operating | <input type="checkbox"/> Chemistry <input type="checkbox"/> Pharmacy |
| <input type="checkbox"/> Civil Engineer | <input type="checkbox"/> Automobile Work |
| <input type="checkbox"/> Surveying and Mapping | <input type="checkbox"/> Airplane Engines |
| <input type="checkbox"/> Metallurgy | <input type="checkbox"/> Navigation |
| <input type="checkbox"/> Steam Engineering | <input type="checkbox"/> Agriculture and Poultry |
| <input type="checkbox"/> Radio | <input type="checkbox"/> Mathematics |

Name.....
Street.....
Address.....

B-3-23

City.....State.....

Occupation.....

Persons residing in Canada should send this coupon to the International Correspondence Schools Canadian, Limited, Montreal, Canada.

Please Mention Popular Mechanics

Must Have More Auto Mechanics

**Positions Now Waiting—Free
Railroad Fare to Kansas City
for Training. Write Today**



"Few realize what a serious shortage of trained mechanics has been brought about by the rapid yearly increase of Automobiles, Trucks and Tractors," says Henry Rahe, who, during the past fifteen years has trained more than 40,000 Auto and Tractor Mechanics.

There are now 35,000 towns and communities without adequate repair shop facilities.

To help overcome this condition, Mr. Rahe is now offering not only special terms on his complete course of personal training, but will also allow your railroad fare to Kansas City for training. If you are mechanically inclined, and want one of these steady jobs at big pay now waiting, write today to Henry J. Rahe, President of the Rahe Auto and Tractor School, Dept. 1755, Kansas City, Mo., for full particulars and Free Carfare Offer. You will also receive a copy of his students' paper, the Pictorial School News, showing the vast equipment used in training. No colored applications.

LEARN WATCHMAKING AND ENGRAVING



Earn while learning. Most practical watch school. Individual instructions. Graduates in great demand. Book free. Chicago School of Watchmaking, Dept. 20, 6549 Lincoln Ave., Chicago

TELEGRAPHY

BOTH MORSE AND WIRELESS taught thoroughly. Big salaries; tremendous demand. Oldest, largest school. Endorsed by Telegraph, Railway, Wireless and Government officials. Expenses low—opportunities to earn large portion. Catalog free.

DODGE'S INSTITUTE, Jones Street, Valparaiso, Ind.

Money — Position — Power

can be yours. Thousands of men placed on Road to Success. Wonderful vocational chart enables you to find and take your rightful place in life. Why drift along in a rut? Write for inspiring free literature. Bolger Vocational Service, Inc., 158-G W. 45th St., N. Y.

MINSTRELS

Musical Comedies and Revues, with full instructions for staging. You can stage your own show with our books. Full line of plays, music, cross-fire, monologues, afterpieces, vaudeville acts and makeup. Catalogue Free.

T. S. DENISON & CO., 623 So. Wabash, Dept. 19, CHICAGO

13 WEEKS FOR
15 CENTS

The Pathfinder

SHOWS THE WAY THROUGH THE JUNGLE OF EVENTS

You've heard your neighbor praise the Pathfinder, the wonderful weekly news and story magazine with over half a million subscribers. Unbiased digest of national and world affairs. Check full of just the kind of reading you want. Fun, fashions, question box, books, health—entertainment and instruction for all. Exciting serial and short stories. Send 15c (coin or stamps) today for this big \$1 paper 13 weeks. Money back if not satisfied. **PATHFINDER, 552 Langdon Sta., Washington, D.C.**

Drawing Table Free!



Yes, this is exactly what I am doing. I am giving this drafting table free to you when you enroll as my student. I do this because I want you to have the right kind of Draftsman's Working Outfit — because I want to help ambitious men and boys get ahead. This is the kind you will use when you have completed my course and have become a regular draftsman.

Complete Drawing Outfit FREE

Besides the drafting table I also furnish free the \$25.00 set of regular working instruments shown here. You get both table and instruments free if you enroll at once. I will do everything possible to help you get ahead.

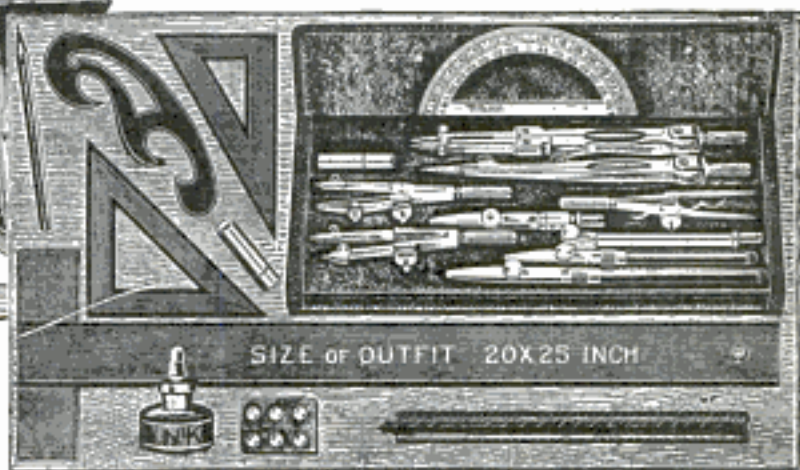

Also FREE \$90 Drafting Course

To my students enrolling now I give an opportunity of getting a \$90 drafting course absolutely without cost to them. This means you need not pay me for my personal instructions or for the complete working outfit.

**Salaries up to
\$250 and \$300 a Month**

Positions paying up to \$250 and \$300 a month which ought to be filled by skilled draftsmen are vacant everywhere. There are in every part of the country ambitious men, who with practical training and personal assistance will be qualified to fill the positions. I can now take and train a limited number of students, guarantee to train them by mail UNTIL placed in a permanent position at a salary up to \$250 and \$300 a month.



Here is the Rule you get FREE

To each young man stating his age when sending a sketch as shown in box at right, I am going to mail FREE AND PREPAID the Draftsman's Ivory Pocket Rule shown here.

Mail Coupon

Mail coupon at once for full information how you can get the table and working instruments Free, also how you can get the \$90 drafting course Free. Even if you don't send in a copy of the sketch send for this information.

Chief Draftsman, Engineers' Equipment Co.
1951 Lawrence Ave., Div. 93-58 Chicago, Ill.

Extra!!

Copy this Sketch
and Get Ivorine
Pocket Rule

To each young man of 16 years or older sending a sketch I will mail free prepaid the Draftsman's Ivorine Pocket Rule shown here. With it I will send you a 6 x 9 book on "Successful Draftsmanship."

There are no conditions requiring you to buy anything. You are under no obligations in sending in your sketch.



Chief Draftsman, Engineers' Equipment Co.
1951 Lawrence Ave., Div. 93-58, Chicago, Ill.

Without any obligation to me please mail your book "Successful Draftsmanship" and full particulars of your liberal "Personal Direction" offer to a few students. Also full information as to how I can get a \$90 Drafting Course Free.

Name

Address

Age

Learn Radio at Home

Earn \$50 to \$250 per week for fascinating, easy work; wonderful future in Radio. Thousands of new, big paying positions.



Easy to Learn at Home

You can easily and quickly become a "certified" radio expert through startling new method of National Radio Institute, one of the largest and oldest schools of radio in world. All instruction radio instruments loaned free. Employment service free to graduates.

Send for FREE BOOK "Your Opportunity in Radio"

Get full details of wonderful opportunities in Radio, of thousands of our successful graduates, and of remarkable, easy method of learning Radio at home to qualify for high paid positions in this tremendous new field. Mail postcard now for 44-page Free Book and Special Tuition Offer to those who enroll now.

NATIONAL RADIO INSTITUTE
Established 1914

Dept. 15-L, Washington, D. C.



Electrical Course

In
Book
Form

Here is the quickest, easiest, cheapest way to learn electricity. Think of it! A complete electrical course in book form. No tiresome lessons with a lot of mathematics. Just plain everyday electrical facts—the very things and the only things you need know to hold down a good paying job. Written and simplified by 27 of the biggest men in the electrical field. 8 big books—4100 pages and 3300 pictures.

Electricity Means Success

—Good Pay and a Good Job. You can succeed in electricity. It's one of the best paying fields open to young men who know.

You do not have to give up your present position, just a few pleasant hours spent in the evenings on this subject, and success is yours.

FREE TRIAL!

Just mail the coupon—don't send a cent. We send books for a week's free use. Look them over yourself, and see how thoroughly and completely everything about electricity is explained in them.

American Technical Society
58th St. & Drexel Ave. Dept. E-819

American Technical Society, Dept. E-819 Chicago

Send me your 8-volume set of Electrical Books for a week's free use. I will either return the books in 7 days or remit \$2.00 and pay you \$3.00 each month until a total of \$28.00 is paid.

Name.....

Address.....

Employed by.....

Copy this coupon on larger sheet if more convenient

Learn AUTO PAINTING

\$25 TO \$50
A DAY

and More

We want
800 men to
enroll for our
Fall and Winter
course to fill position
in the industry. Start
your course any time.

Experience not necessary. We
teach you Auto Painting
from A to Z in 8 to 10
weeks.

10,000,000 AUTOS
NEED PAINTING

Factories calling on us for men—you
can start a business or get a job painting
autos in any town or city—THE HIGHEST,
QUICKEST PAY in the industry.
START A BUSINESS without capital—all
you need to start business is a few brushes,
some paint and Our Training.

Get Free Book "MIXING PAINT
WITH BRANS"

Write for catalog and information. We have the
best instructors and equipment. You'll like the
course—Auto Factories endorse our methods and
employ our men. Detroit, the Center of the Auto
Industry is the place to learn auto painting.

DETROIT AUTO PAINTING SCHOOL
The Pioneer, the largest and best equipped school in U. S. A.
31 D.A.P.S. Bldg., 1471 Van Dyke Ave., Detroit, Mich.

DETROIT

DETROIT AUTO PAINTING SCHOOL

RAISE POULTRY FOR PROFIT

We teach you how. Easily learned at home. Our guaranteed methods make success certain—indorsed by leading Agricultural Colleges. Send TO-DAY for FREE BOOK—"How To Raise Poultry For Profit."



National Poultry Institute
Dept. 312 Washington, D. C.

POSITION GUARANTEED!

I
Want
You

The Finger Print Profession wants men immediately. Big pay, interesting work, no lay-offs or shut-downs. I will teach you quickly to become a trained Finger Print expert. I guarantee a position and back it up with a \$1,000 bank deposit. Write at once for full explanation and details about my free Secret Service course, free Secret Service reports and special low price. Offer is limited. Write at once. No obligation.

**U. S. SCHOOL OF FINGER PRINTS, Dept. 13-58,
7003 No. Clark Street, Chicago.**

FREE!

BE AN ARTIST

We can teach you
DRAWING in
your own home
during your
spare time.

Our 18
years of successful
teaching prove our
ability. 10 Courses in
Commercial and Illustrative
Drawing.

Teachers Normal and
Applied Art. Endorsed
by high art authorities.

Students trained by members of
our Faculty are filling high-salaried
positions. Artist's Outfit FREE to
Enrolled Students. Write today for Art Year
Book.

OUR
HANDSOME
ART
YEAR BOOK

is FREE TO YOU!

SCHOOL OF APPLIED ART

APPLIED ART BLDG. No. 2 BATTLE CREEK MICH.





Makes Sensational Advance in Teaching Electricity

The achievement of Chief Engineer Smith, of the S. & H. Electrical Works, Chicago, is a great step forward in fitting men for the big jobs in electricity. He has invented the Shop Type Training System, of teaching actual shop practice of electricity right in your own home. Mr. Smith is turning out expert electricians in an amazingly short time and by a brand new method that makes it the most fascinating study in the world.

Fits Men for \$3,000 to \$10,000 Jobs By New Plan of Home Training

IT is now made possible for an average man, regardless of education or experience, to be trained for the really big pay jobs in electricity. Everyone knows that a man must know shop methods to fill an electrical job. He must have the real practical experience such as our Shop Type System of Home Training gives him. At the end of this course he can be the confident, efficient electrical man—at home in the largest electrical plant. He is trained, experienced and fitted to step in where a man of authority and responsibility is needed, to direct others. No wonder the electrical men are uniting in praise of Mr. Smith's accomplishment. Electricity needs these Shop Type trained men and jobs are waiting that pay all the way from \$3,000 to \$10,000 a year and even higher.

Every Branch of Electricity

No matter what phase of electricity you want to learn or what field you expect to enter, you will find it in S. & H. Shop Practice of Home Study. You are taught all types of electrical work, such as house wiring (paying \$8.00 a day up), central and sub-station operating and maintenance (\$2,500 to \$10,000 a year), automobile and tractor starting, lighting and ignition (\$35.00 to \$85.00 per week), electrical jobs and battery station service (\$40.00 week to \$10,000 a year). You are taught



motor maintenance, armature winding, illuminating engineering and lighting construction. You are fitted to start right out and make good at any of these jobs. Best of all, you are fitted for the big pay jobs at the top of your profession.

Men Needed

You can easily realize why Mr. Smith has constant requests for men trained by this new method. An employment service has been developed to take care of this demand, and this service is given free to S. & H. graduates.

Never before has there been such an opportunity offered to get into the big pay field of electricity—that fascinating work that lifts men above the common rut, pays them big salaries, sends them to the most interesting parts of the world, gives them an unlimited opportunity for advancement and a place in the affairs of the world.

Mr. Smith has made it all so easy. You can easily qualify by spare time study in a few short months. Everything is so thoroughly explained and so wonderfully illustrated by original cuts, pictures, diagrams, plans and designs—and Mr. Smith's own personal supervision is so thorough—that you cannot help but grasp every step of the work. Mr. Smith is so anxious that every ambitious man, who really wants to learn electricity be given the opportunity that this course is offered at no advance in cost over the older methods.

Free Outfit

To all who send the coupon below at once Mr. Smith is now offering free a complete outfit of S. & H. Shop Type electrical apparatus, instruments and appliances for experimental and practical home shop work. By sending the coupon below you will be entitled to this offer—but you must send it immediately. You do not want to lose a day's time in taking this Shop Type Training and equipping yourself for electrical work, and when you enter this profession you cannot afford to be without the prestige and backing of the S.

& H. Electrical Works, where we actually do all the things which we teach you. Now is the time to act—don't take a chance to lose this big free offer. Get the information that will open a wonderful career to you. Mail the coupon now for big free book, "How to Get the Better Job in Electricity."

S. V. SMITH
S. & H. ELECTRICAL WORKS
Dept. N-1
1422 W. Monroe St.
Chicago, Ill.

How To Get
The Better
Job in
Electricity

FREE

S. & H. Electrical Works,
Dept. N-1, 1422 W. Monroe St.,
Chicago, Illinois.

Please send me free electrical book and full particulars of your course of Shop Type Training in practical electricity, and full details of your free offer to those who enroll now. I understand this is free of charge and does not obligate me in any way.

Name.....

Address.....

City.....State.....

DETROIT

The Auto Center is the Logical Place To

Training for
Head and
Hand

LEARN AUTO AND TRACTOR BUSINESS

Right now there are over thirteen million automobiles in use in the U. S. A. alone! Think of the repair work necessary on these millions of cars! 13,000,000 electrical systems to keep up, 10,000,000 batteries, 60,000,000 tires to be repaired or replaced. Think of the splendid opportunities for trained men. There is more repair work this year than ever before. Think of the wonderful opportunities to start a shop of your own. More battery repair shops are needed, more tire repair shops, more welding shops, more electric service stations. Production is still increasing and trained men are moving forward. Hundreds of men are now attending our School, preparing themselves for a greater future. Age, education or past experience make no difference if you want to get ahead. A few short weeks of M. S. A. S. factory endorsed training will qualify you.

UNLIMITED OPPORTUNITIES FOR TRAINED MEN

Be a Trained Farm Mechanic

Study automobiles, engines, trucks, tractors, farm lighting plants. Go back to the farm, trained to handle any kind of motor equipment. You get actual tractor operation and repair on our tractor farm. Charles Chambers, of Oakton, Ky., is farming 3000 acres of land. Says it would be impossible to farm without tractors and other motor equipment and that his M. S. A. S. training saves him many hundreds of dollars each season. Mr. Chambers is only one of hundreds of M. S. A. S. graduates making good on the farm. *Be a trained man—successful!*



DETROIT— The Auto Center

Come to Detroit and learn the business at the M. S. A. S. This is the Right Way to Get Started in the Auto and Tractor Business. If you get this right start you can go just as far in this business as you have a mind to—there's no limit to the success you can make. There are many advantages in coming to Detroit. You can visit the world's greatest automobile factories, learn their methods first hand. It is the fountain head of the automotive industry. The great factories help in your training at the M. S. A. S. Here you learn on finest equipment, new cars, all types of engines, all kinds of electrical systems. You are taught under factory-endorsed methods and by expert instructors. It all means greater opportunities and more certain success. Resolve to see Detroit and learn the auto and tractor business.

MONEY- BACK GUARANTEE

We guarantee to qualify you for a position as chauffeur, repair man, demonstrator, auto electrician, garage man, automobile dealer, tractor mechanic and operator, or farm lighting expert, paying from \$1500 to \$5000 a year or refund your money.

A. G. ZELLER, President

MICHIGAN STATE AUTOMOBILE SCHOOL

311 Auto Bldg., 3729 Woodward Avenue, DETROIT, MICH., U. S. A.



WE TEACH Autos, Trucks, Tractors, Tire Repairing, Brazing and Welding, Battery Repairing and Machine Shop work, by actual practice on the best equipment.

AUTO SCHOOL

Garages of this class—that
render dependable service,
are in demand



M. S. A. S. Training
fits you to conduct
a business
successfully

We are constantly receiving messages from our graduates telling of phenomenal success. Hundreds of them are conducting successful businesses of their own. We have many graduates in business who are making \$500.00 a month and more.

H. A. Bradley was working for \$12 a week. Says he didn't know a carburetor from a magneto. He trained at the M. S. A. S. and now has a garage business of his own at 7349 E. 55th St., Cleveland, paying a profit of over \$500 a month. **Ben W. Koehler**, 20 years old, M. S. A. S. graduate at Pulaski, Wis., has done \$93,810 worth of business in 6 months—profits \$10,000. **J. S. Steckel**, of Coplay, Pa., was working for small pay. He trained at the M. S. A. S., increased his income to approximately \$500 a month. Mr. Steckel also made a good record in the army, due to M. S. A. S. training.

Choose the branch of this great business that suits you best. A few weeks of M. S. A. S. training fits you to start a garage, electric service station, tire repair shop, battery repair station, or brazing and welding shop—or you can sell motor cars, trucks, and tractors. Very little capital is required to start a business. You can always get that when you know your business. The millions of cars that must be kept in repair have created thousands of business openings. There is

More REPAIR WORK Than Ever Before Become An Automotive Electrician

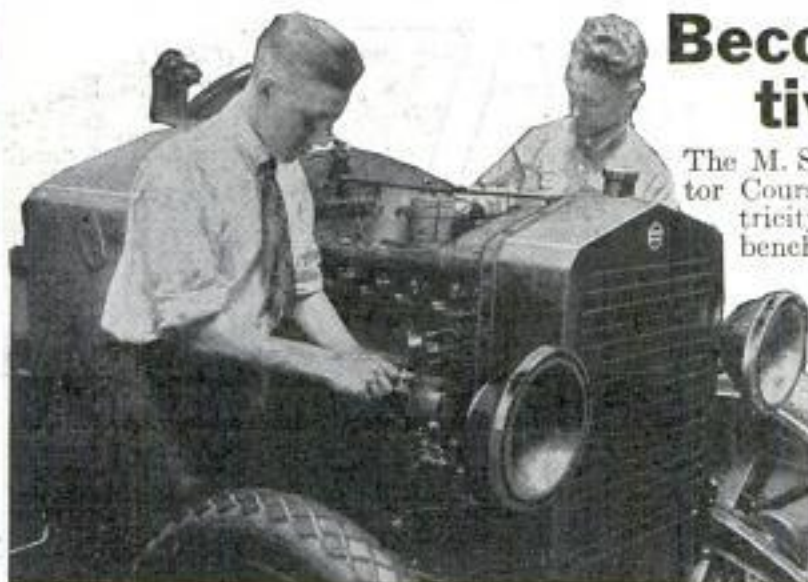

The M. S. A. S. Complete Automobile and Tractor Course includes training in automotive electricity from the ground up. You get actual bench work in the laboratory, tearing down, rebuilding, testing, starting motors, generators, magnetos. Every type of electrical system is here for you to work on. 75% of all motor car troubles are in the electrical end, and trained electric service men are always in demand.

Learn by Factory and
Dealer Endorsed
Methods

Packard Motor Car Co. says: "We have no hesitancy in recommending M. S. A. S. in every particular."

Dodge Brothers: "A diploma from this School would assist materially in getting employment from high class automobile dealers."

Thomas J. Doyle, Dodge Dealer, Detroit, says, "I keenly appreciate the great work you are doing for the industry by turning out trained men who can intelligently handle the difficult phases of motor car trouble."

Cadillac Motor Car Co., Detroit, says: "We believe you have the best and most complete school in the country."

Paige: "A certificate from the M. S. A. S. is a great help in getting a better position."

W. B. Deyo Co., big Ford Dealer, Detroit, says: "It is the class of fellows that are enrolled in your classes that make the best mechanics in the long run and it has been our experience in hiring these graduates that they are at all times energetic and working for the best interests of their employer."

Our 100-page CATALOG is FREE to you. Send the coupon for this book. 100 pages of information on the Auto industry, opportunities for you, Factory letters, Graduates' letters, etc. Get your free copy now. It is by far the most complete book of information we have ever issued.



Use
This
Coupon NOW

Michigan State Automobile School
311 Auto Bldg., Detroit, Mich.

Gentlemen: Without expense or obligation to me; please send your big catalog and tell me more about the opportunities for me in the automobile business.

Name.....

St. or R. F. D.....

City.....State.....

(Do you wish to start your M. S. A. S. training at Home or at our School in Detroit?.....) (What are you doing now?.....)

THE FACTORY



"\$60 More a Month!"

LAST night I came home with great news—a \$60 increase in salary! I took the money out of my pocket and asked Mary to count it. You should have seen her face light up when she found the extra \$60. I think she was even happier than I was, for it was the third increase in a year.

"Today I am manager of my department—earning more money than I ever thought it would be possible for me to make. I owe it all to the training I received from the International Correspondence Schools. That little coupon was the means of changing my whole life."

HOW much longer are you going to wait before taking the step that is bound to bring you more money? Isn't it better to start now than to wait for years and then realize what the delay has cost you?

One hour after supper each night spent with the I. C. S. in your own home will prepare you for the position you want in the work you like best.

Don't let another priceless hour go to waste! Without cost or obligation, let us prove that we can help you. Mark and mail this coupon.

INTERNATIONAL CORRESPONDENCE SCHOOLS Box 5555-D, Scranton, Penna.

Without cost or obligation, please tell me how I can qualify for the position or in the subject before which I have marked an X:

BUSINESS TRAINING COURSES

- | | |
|--|---|
| <input type="checkbox"/> Business Management | <input type="checkbox"/> Salesmanship |
| <input type="checkbox"/> Industrial Management | <input type="checkbox"/> Advertising |
| <input type="checkbox"/> Personnel Organization | <input type="checkbox"/> Better Letters |
| <input type="checkbox"/> Traffic Management | <input type="checkbox"/> Show Card Lettering |
| <input type="checkbox"/> Business Law | <input type="checkbox"/> Stenography and Typing |
| <input type="checkbox"/> Banking and Banking Law | <input type="checkbox"/> Business English |
| <input type="checkbox"/> Accountancy (including C.P.A.) | <input type="checkbox"/> Civil Service |
| <input type="checkbox"/> Cost Accounting | <input type="checkbox"/> Railway Mail Clerk |
| <input type="checkbox"/> Bookkeeping | <input type="checkbox"/> Common School Subjects |
| <input type="checkbox"/> Private Secretary | <input type="checkbox"/> High School Subjects |
| <input type="checkbox"/> Spanish <input type="checkbox"/> French | <input type="checkbox"/> Illustrating <input type="checkbox"/> Cartooning |

TECHNICAL AND INDUSTRIAL COURSES

- | | |
|---|--|
| <input type="checkbox"/> Electrical Engineering | <input type="checkbox"/> Architect |
| <input type="checkbox"/> Electric Lighting | <input type="checkbox"/> Blue Print Reading |
| <input type="checkbox"/> Mechanical Engineer | <input type="checkbox"/> Contractor and Builder |
| <input type="checkbox"/> Mechanical Draftsman | <input type="checkbox"/> Architectural Draftsman |
| <input type="checkbox"/> Machine Shop Practices | <input type="checkbox"/> Concrete Builder |
| <input type="checkbox"/> Railroad Positions | <input type="checkbox"/> Structural Engineer |
| <input type="checkbox"/> Gas Engine Operating | <input type="checkbox"/> Chemistry <input type="checkbox"/> Pharmacy |
| <input type="checkbox"/> Civil Engineer | <input type="checkbox"/> Automobile Work |
| <input type="checkbox"/> Surveying and Mapping | <input type="checkbox"/> Airplane Engines |
| <input type="checkbox"/> Metallurgy | <input type="checkbox"/> Navigation |
| <input type="checkbox"/> Steam Engineering | <input type="checkbox"/> Agriculture and Poultry |
| <input type="checkbox"/> Radio | <input type="checkbox"/> Mathematics |

Name.....
Street.....
Address..... 8-3-23
City..... State.....

Occupation.....
Persons residing in Canada should send this coupon to the International Correspondence Schools Canadian, Limited, Montreal, Canada.

Please Mention Popular Mechanics

Everybody Can Dance **NOW**

Learn In ONE HOUR at Home

There's now no need of being a wall-flower. In one hour—at home—by mail—I can make you an easy confident dancer—popular in any ballroom.

New Easy Method

No Partner Needed—No Embarrassment

Over 60,000 men and women have become popular dancers of Fox Trot, One-Step, Waltz and all latest up-to-the-minute society dance steps through my new **Foto-tell** and **Fono-tell** Method set to music. Amazingly easy—fascinating. No other course like it. I teach you perfect time and rhythm—the secret of good dancing. Your success guaranteed.

SENT FREE ON TRIAL —NO DEPOSIT

Convince yourself at my expense how amazingly easy it is to learn modern dancing with my new method. For a short time only, I'll send the first six lessons of my course (in plain wrapper), including 10 inch dance instruction record, free and prepaid for five days trial. See, test and prove this remarkable new method in your own home. Then, if not delighted at your success, simply return record and lessons within five days and you'll owe me nothing. Write quick before this unusual offer expires. Please mention make of phonograph you have.

WILLIAM CHANDLER PEAK, M. B.
Studio 35, 4601-4611 Broadway, Chicago, Illinois



LAW

STUDY AT HOME

Become a lawyer. Legally trained men win high positions and big success in business and public life. Greater opportunities now than ever before. Lawyers earn \$3,000 to \$10,000 Annually. We guide you step by step. You can train at home during spare time. Let us send you records and letters from LaSalle students admitted to the bar in various states. Degrees of LL.B. conferred. Thousands of successful students enrolled. Low cost, easy terms. We furnish all text material, including fourteen-volume Law Library. Get our valuable 120-page "Law Guide" and "Evidence" books FREE. Send for them—NOW.

LaSalle Extension University, Dept. 1164-L Chicago, Ill.

MAKE \$100 A DAY BE AN AUCTIONEER

18 yrs. one of the largest Auction Schools in the World. W. H. Adams, Utah, made \$20,000 second year after graduating. 1923 Annual Free. MISSOURI AUCTION SCHOOL, 818 Walnut St., Kansas City, Mo.



WANTED

RAILWAY POSTAL CLERKS \$1600 to \$2300 YEAR

Men—Boys 18 Up. Mail Coupon Immediately.
Steady Work. No Layoffs. Paid Vacations.
Common Education Sufficient.

TRAVEL—SEE THE COUNTRY

COUPON
FRANKLIN INSTITUTE, Dept. C182, Rochester, N. Y.

Sirs: Send me without charge, (1) Sample Railway Postal Clerk Examination questions; (2) List of government jobs now obtainable; (3) Send free illustrated book, "How to Get Government Jobs."

Name.....
Address.....



The Most Amazing Romance Ever Written

Come out of the humdrum of daily life into a marvelous new world—where you can lift your eyes and read the story of the heavens, see into the depths of earth and ocean, view the activities of invisible life, look back to the dawn of the human mind, watch man as he solves the thrilling mysteries of life and time and space. All this *The Outline of Science* offers you, for it is

*A Revelation of the Secrets of Science
The Free Book Tells You All About It*

*The Wonderful
Story of the Out-
line of Science*



In a Profusely Illustrated Booklet
FREE TO YOU

The interest in this epoch-making work has proved so intense that the publishers have prepared for free distribution a most interesting and strikingly illustrated brochure so that everyone may have the whole story of the most important publishing event in many years. With three plates in full color and over thirty half-tone pictures of scientific marvels, it shows how the four magnificent volumes of *The Outline of Science* describe the whole wonder-world of science. This fascinating booklet is yours free—send the coupon—no obligation and no expense.

The Whole Thrilling Story of Scientific Progress

is in *The Outline of Science*—The Romance of the Heavens—The Story of Evolution—Man's Rise from His Earliest Ancestry—The Development of Races—The Fight to Live—Seeing the Invisible—Marvels of the Insect World—The People of the Air—In the Depths of the Sea—The Kingdom of the Animals—Wonders of Plant Life—The Body Machine—The Science of the Mind—Miracles of Electricity—Man, the Flyer—The Amazing Wireless—The Story of Chemistry—and many more, all told in terms so simple that anyone can understand, with a magnificent collection of nearly 1,000 superb illustrations.

*The Coupon Brings Your Copy of the Free Booklet
With Its Interesting Story and Fascinating Pictures*

G. P. PUTNAM'S SONS Dept. 214, 2 W. 45th
Street, NEW YORK



G. P.
Putnam's
Sons, Dept.
214, 2 W. 45th
St., New York

Send me by mail, without
cost or obligation on my
part, the free booklet with
three color plates and over
thirty half-tone illustrations,
describing *The Outline of Sci-
ence*.

Name.....

Street and No.....

City and State.....

Occupation.....

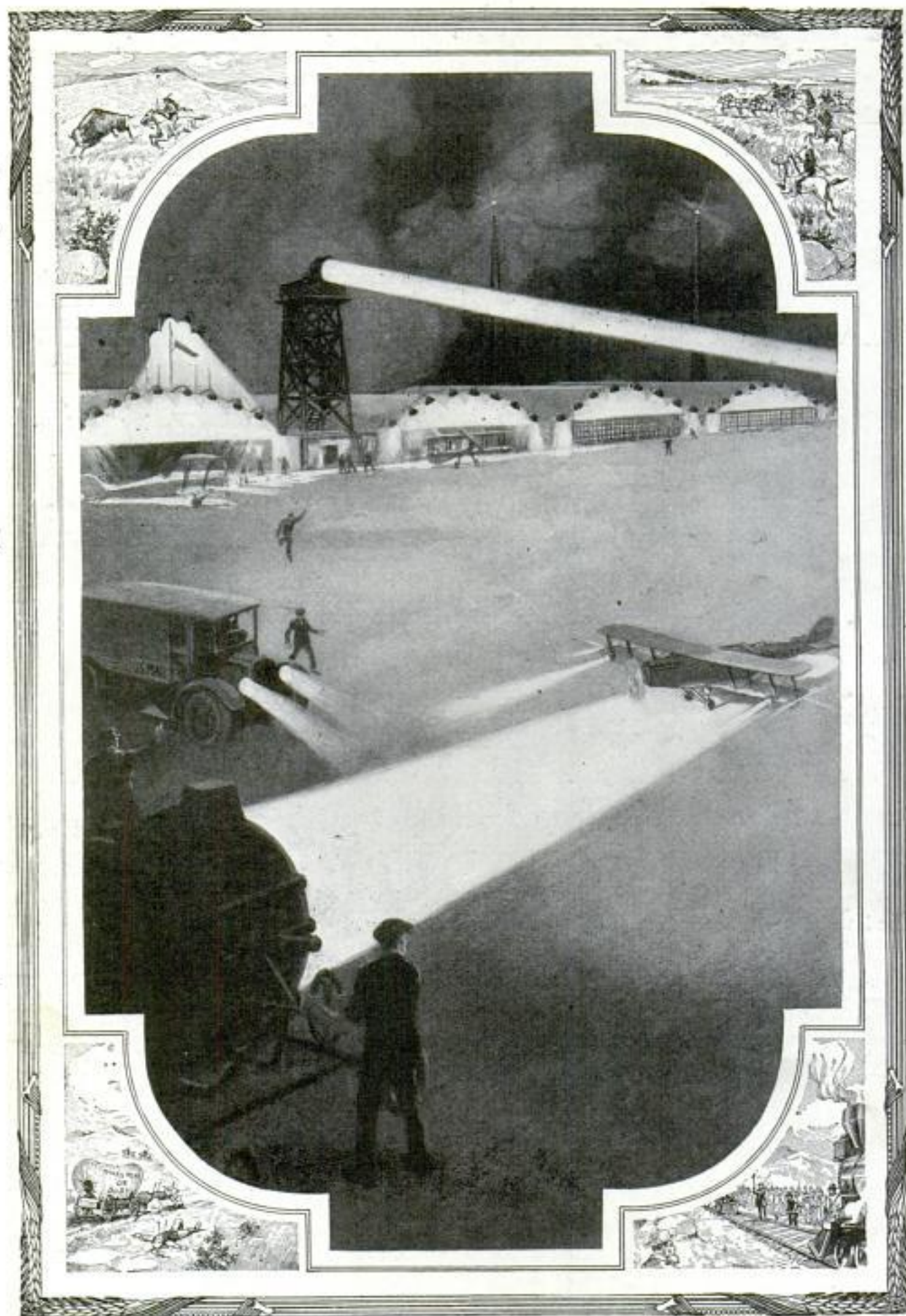

From the Explorers, Goldseekers, Stagecoach, and Pony Express, to the Night Air Mail Flying Down a Pathway of Light to Great Landing Fields

Blazing a Trail with the Night Air Mail Across Nation in Twenty-Six Hours

'Planes in Great Transcontinental Flights Between New York and San Francisco Mark New Era in the History of Aviation

IN whirring through 2,680 miles of space between the Pacific and Atlantic oceans in just a little more than 26 hours, United States Air Mail planes have not only opened up a new era in the history of aviation, but have narrowed the map of a continent beyond the utmost dreams of a scant generation ago.

From the foot of Lake Michigan to the southeast corner of Wyoming, a distance of about 885 miles, the flights were made at night, the pilots being guided across the cloud-flecked highways of the heavens by a gleaming row of giant beacons. More powerful than millions of candles, the pillars of light represented the first attempt to illuminate the airways for the use of man, in a shimmering ribbon winding like a gigantic glow-worm.

Although the weather conditions during the first flights were bad, the planes being delayed for several hours one night by a fog so thick that the pilots could scarcely see their propellers, not a single mishap marred the experiment, on which the eyes of the entire world were focused. Government officials announced afterwards that the four-day test was an

unqualified success. Favored by a strong westward wind, the first plane took off from Hempstead, N. Y., at 11:00 a.

m., the morning of the 21st of August, drifted southward over 247 miles of continuous mountains where there are not more than five fields available in case of forced landings, to Bellefonte, Pa. Well ahead of schedule, the mail was carried into Cleveland, over Bryan, Ohio, and on to Checkerboard field, just outside of Chicago,

shortly before dusk. Quickly the pouches were transferred to another waiting plane and packed away as closely as sardines in the long underbody whose sweeping curves of yellow birch glistened in the slight rain that had begun to fall. Listed as No. 207, the huge De Haviland measured 30 feet from the tip of its tail to the steel-shod propeller blades, a tireless rival to dispute the eagle's flight across mountain, plain, or valley.

Across the slender fuselage stretched two sets of silver wings, 42 feet, overall. Back of them, and just behind the mail compartment, was the pilot's cockpit with control lever, rudder bar, stabilizer wheel, spark and throttle adjust-

EVEN THE VISION OF GENIUS IS ECLIPSED BY FACT

WHEN, with the prophetic vision of genius, Kipling wrote "With the Night Mail," in 1909, he labeled it "A Story of 2000 A. D." But so rapid has been the progress of science and industry, that fact has far outstripped romance, and the feat which was only a dream 14 years ago is the reality of today, as proved in the recent night flights of the post-office airplanes when letters were carried between New York and San Francisco in just a little over 26 hours.—Editor's Note.

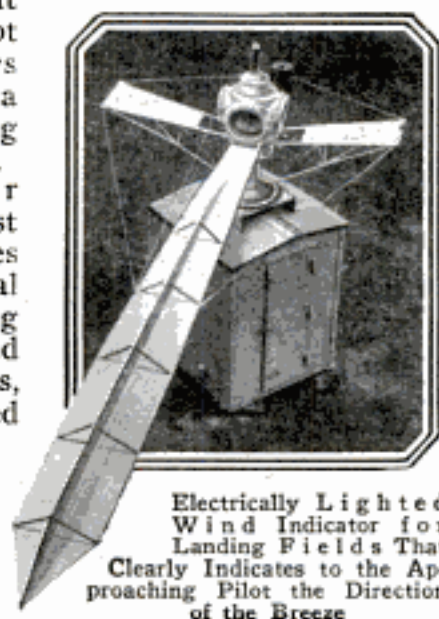

Electrically Lighted
Wind Indicator for
Landing Fields That
Clearly Indicates to the Ap-
proaching Pilot the Direction
of the Breeze

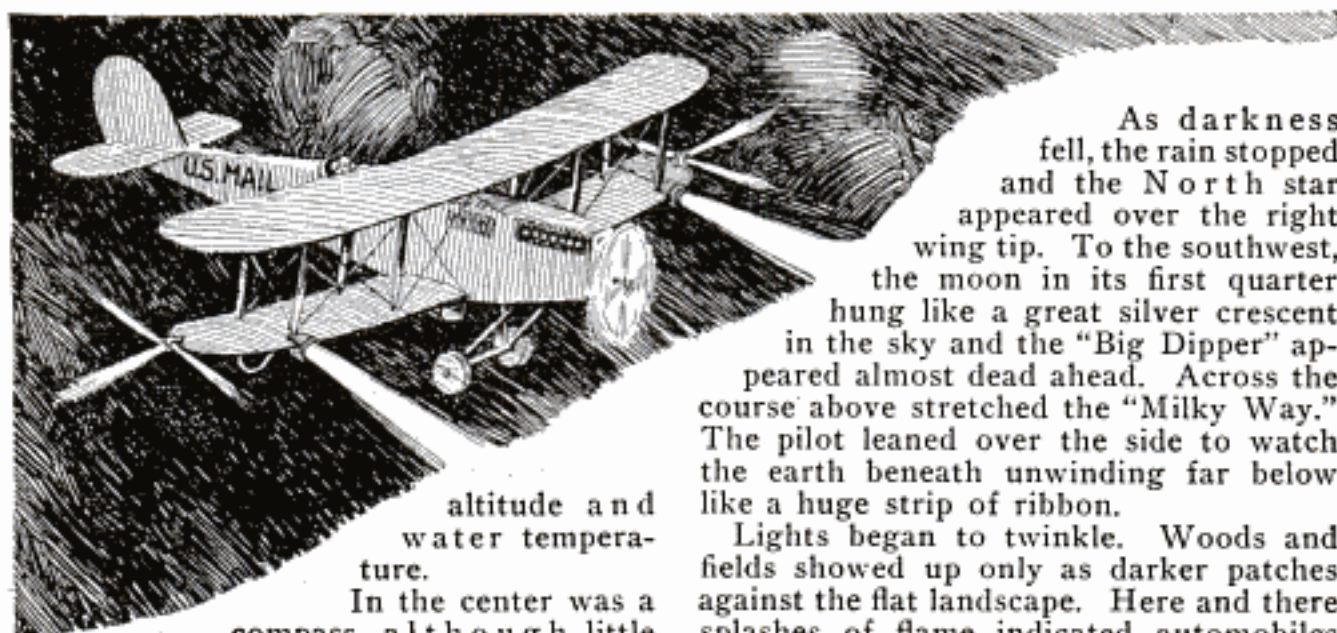

altitude and water temperature.

In the center was a compass, although little reliance was placed upon this for night flying, as its readings would only be of service during daylight where a clear view of the earth's surface would permit accurate calculations as to the "drift" of the ship.

As the last bag of mail was stowed away, the pilot took his place in the cockpit, khaki overalls covering his neatly pressed blue-serge suit, an aviator's helmet drawn over his head and a safety parachute strapped in a knapsack to his back.

"Ready—Off—Contact!" came the cry as a mechanic swung the propeller.

At the last word, the 400-horsepower Liberty motor awoke with a roar, but soon settled down to the steady drone as of a huge contented bee. Heading toward the east, the ship rolled down the field, rose in a gentle curve, circled overhead toward the setting sun then hidden behind the clouds.

Picked up and driven back with the force of bullets by the whirring propeller blades, the raindrops beat fiercely against the stanch body and taut wing fabric. Seated so low that a straight forward view was impossible without leaning over the side, the pilot was partly protected from the fury of the blast, as the rain was swept past him.

As darkness fell, the rain stopped and the North star appeared over the right wing tip. To the southwest, the moon in its first quarter hung like a great silver crescent in the sky and the "Big Dipper" appeared almost dead ahead. Across the course above stretched the "Milky Way." The pilot leaned over the side to watch the earth beneath unwinding far below like a huge strip of ribbon.

Lights began to twinkle. Woods and fields showed up only as darker patches against the flat landscape. Here and there splashes of flame indicated automobiles moving over roads like fireflies crawling along confetti streamers.

Until the stars wheeled into view, the plane had been sweeping along at the 1,000-foot level because of the low "ceiling" of clouds which would have obscured the view of the guiding beacons that marked the route on the ground—the same natural thoroughfare followed by immense herds of buffalo, by the Indians, explorers, goldseekers, stagecoach, pony express and, lastly, by the railway.

Ninety miles an hour—95—100—the dial indicated, and the wail of the wind through the rigging rose to a shrill shriek as the "207" began nosing upward toward the 1,500-foot level. Then the gale took hold of the ship and the pilot shivered in the icy blast.

Patches of light beneath indicated towns—McGirr, Franklin Grove, and Rock Falls. Twisting across the course, two branches of the Mississippi shone like mirrors in the moonlight. Then a revolving pillar of fire stabbed upward against a bit of fleecy mist.

"The Iowa City beacon," said the pilot, and circled until he caught the wind



direction from a floodlight turned on a white "sock"—a stocking, the foot cut off, streaming from a mast on the landing field. The pilot touched a lever and two powerful searchlights flared out from beneath the small red and green navigating lights on the wing tips.

Although the speed of the ship had been reduced from about 100 to approximately 65 miles an hour, it actually seemed to increase as the earth came into clear view. Sliding gently down as if on the beam of the 500,000,000 candlepower searchlight on the ground, the "207" came to a full stop and the roar of its mighty motor was stilled.

From waiting supply wagons 97 gallons of gasoline were pumped into its tanks and the last lap of its 400-mile trip to Omaha began. While snatching a drink of hot coffee at the field, the pilot explained that the engine ate up from 14 to 24 gallons of "gas" an hour and that a few extra gallons were carried for emergency use in a narrow copper tank built into the center of the upper wing surface.

As the lights of Iowa City faded into the distance the plane's nose was again headed along the row of small, 5,000 candlepower beacons set three miles apart on the ground. "Flickers," the pilots call them, because they blink on and off 150 times a minute. There are 273 of these on the 885-mile course.

Emergency landing fields every 25 miles are marked with larger lights of 5,000,000 candlepower, which rotate high in the heavens. These are visible for 45 miles, while the smaller ones can be seen easily at only about half that distance. The flyer was within range of at least three of these all the time, along the route.

At the main landing fields are huge, 500,000,000 candlepower searchlights whose rays were visible more than 127 miles on clear nights. Instead of being turned directly upward, their light is thrown just one degree above the horizon and revolves ten times a minute so as to strike a pilot, approaching from any direction, directly in the eyes.

Guided, protected, welcomed, and aided by these



COPYRIGHT, UNDERWOOD & UNDERWOOD

Airplane Taking on Mail

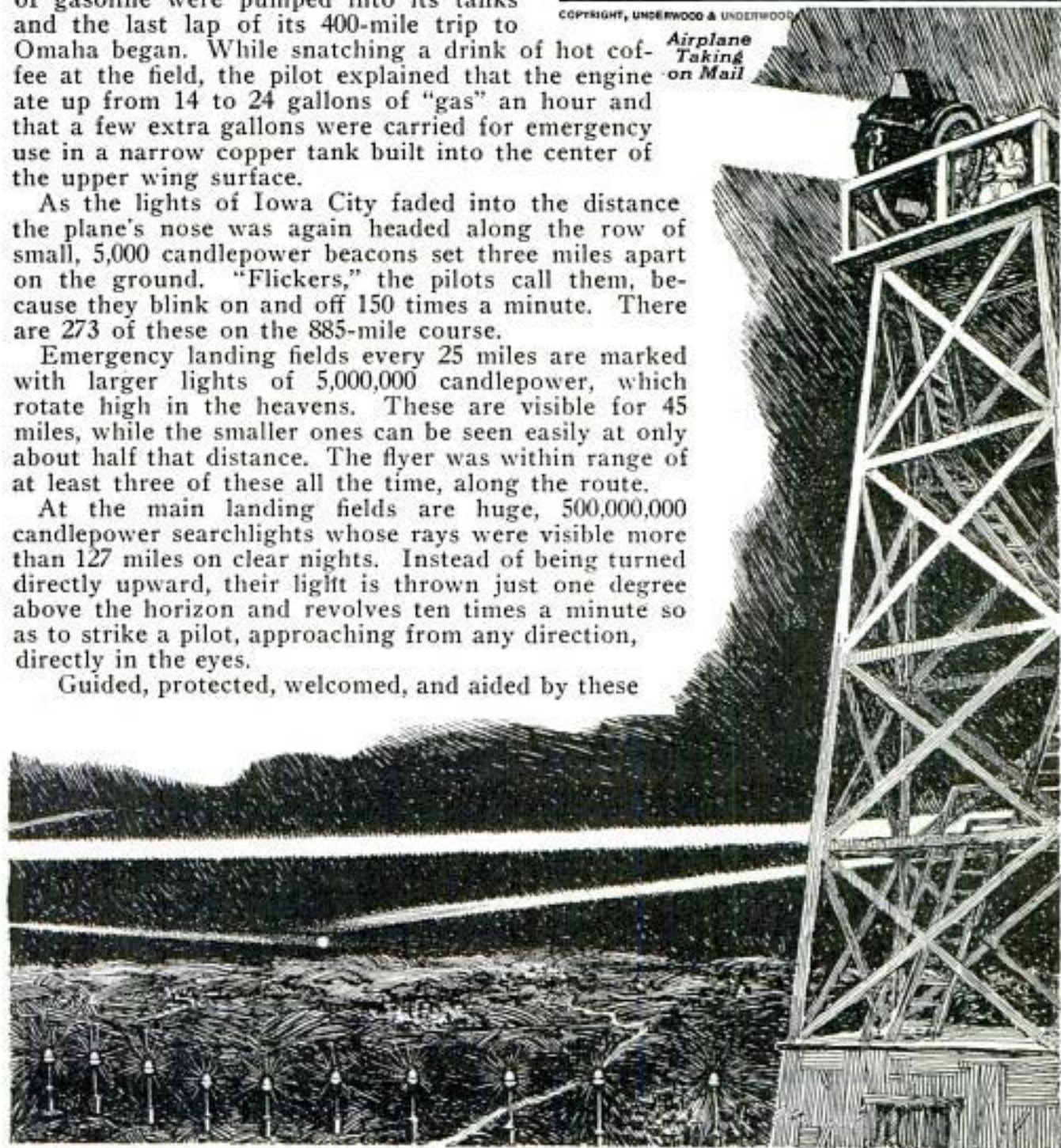



intently earthward and then consulted his chart.

"Montezuma light's not working," he noted, some derangement of its mechanism having stopped its flickering and turned it into a steady beacon.

Passing over Earham, asleep in the darkness below, a narrow pencil of blinding flame began crossing the horizon in front of the plane. This rapidly increased in size until it became an orange-red ball of fire that cast the shadows of the wings back against the body and dulled the stabbing blue flashes from the open exhaust ports of the motor.

Then, with a sudden dip caused by tricky air currents, the ship sped over the Missouri River, the lights of Omaha casting a red glare on a drifting blanket of clouds, and circled over the landing field where another plane was waiting to carry the mail westward to Cheyenne in Wyoming.

Anxious watchers below saw the ship first as two bright sparks of red and green, the navigating lights on its wings. Then came the roar of the engine's exhaust as it wheeled over the field and the flash of its landing lights as it slid easily to the earth.

In the meantime, the plane that had left San Francisco at 6:00 o'clock the same morning had encountered bad head winds in its 15,000-foot climb over the mountains to Reno, Nevada, and had left

lights, the "207" sped toward its goal at a speed of well over 100 miles an hour. Skimming along the 1,500-foot level again, at least three of the ground beacons were always within sight. At one point, the pilot looked

Salt Lake behind schedule. In crossing Sherman Pass in the Black Mountains, clouds, mist, and a gusty breeze further retarded its progress.

Just outside of Cheyenne there was a solid wall of blinding fog, the aviator's worst enemy and far more to be feared than rain, snow, or sleet. Once enveloped in the mist, all sense of direction is lost and the pilot does not know whether his craft has navigating room or whether it is driving toward destruction against a mountain or into a valley.

It was still daylight, although the sun had set, and the pilot flew around and over the fog bank covering the city in the vain hope of finding a rift that would permit a landing. A mile thick, the vapor

was as impenetrable as a stone wall and the plane finally returned to the nearest emergency landing

LIGHTING CLOUD-FLECKED PATH OF THE NIGHT AIR MAIL

IN a gleaming row, from the foot of Lake Michigan to the southeast corner of Wyoming, a distance of 885 miles, bright-burning beacons make a blazing highway across the heavens for the airplanes of the night mail.

If the illumination given off by the five 36-inch searchlights (rated at 500,000,000 candlepower each) and the smaller beacons placed approximately three miles apart, were merged in one mighty beam, it would be equivalent to the light of more than 2,520,145,000 candles.

As the ordinary electric bulb used in the home is rated at 32 candlepower, this gigantic, imaginary searchlight would be equal to nearly 750,000,000 such lamps.

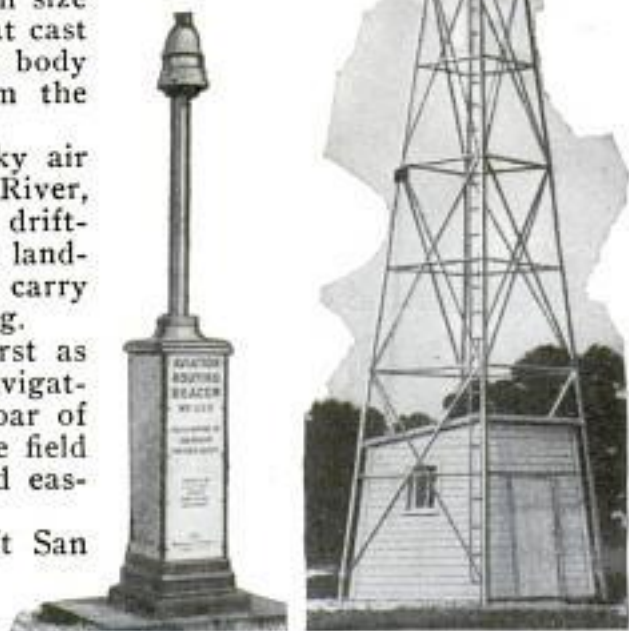

Three Types of Beacons Used to Light Way of Night Air Mail Planes Across Country

field for a fresh supply of gasoline. "I'll make it or 'crack' my ship," was the laconic message he sent to the temporary headquarters at Omaha.

When three efforts had failed, however, the plane waiting at Cheyenne was started eastward without the San Francisco mail. After it had penetrated the fog in its rush toward the rising sun, it found a star and beacon-lighted path.

"The air was so clear that I could see the jackrabbits hopping along the roads," declared the pilot afterwards.

About a hundred miles west of Omaha, the two ships passed in the night, one bound west and the other east. Only their navigating lights were visible to the pilots, both of whom saluted.

In commenting on the success of the flights, Harry S. New, Postmaster General, pointed out that the planes of the air mail have been operated 2,500,000 miles without a single fatality and that in 160,000 miles of flying in 16 weeks there

had not been even a forced landing.

"Most of the fatal or distressing accidents which are so regularly recorded in the public press," he said, "are due to the fact that insecure or worn-out machines are taken up by fliers who are not qualified, and to whom it is an outrage to intrust other human lives. There should be governmental inspection of ships.

"Another feature that must have attention is the question of right of way through the air. There is now none to say to the irresponsible fly-by-nighter who has acquired a cast-off plane that he may not take some venturesome aspirants for a nocturnal joy-ride over the lighted course of the post office, without the slightest idea of the elevation at which the mail pilot is to fly.

"National legislation governing the conditions under which planes may be flown, the quality and character of the machines and the qualifications of the pilot, is needed at once."

Keystone News Co.
12 South W. 35th St. New York
COIN PRESS MAKES FIVE DIMES EACH SECOND IT WORKS *359 7*

Three hundred ten-cent pieces are made each minute of its operation by a coin-stamping machine in use at the government mints. The silver is fed to the press in narrow strips the thickness of a dime. The trimming left after the dies have done their work passes out at the side, while the bright, new money is delivered to a table. A man wearing heavy leather mittens to protect his hands from the sharp edges and the heat left by the great pressure, places them in piles.

STRAIGHT TEETH ON SHREDDER PREVENT CLOGGING *3560*

So food will not clog, making it easier to clean, and eliminating waste, a heavy, durable grater is being made with straight

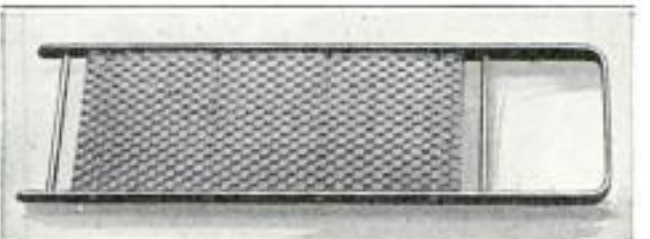

Two-Sided Grater That Is Made with Straight Prongs So It Cannot Become Clogged

prongs that allow vegetable particles to shake out readily. One side is for coarse grating and the other for fine cutting.

Peoples Gas Light & Coke Co., 122 S Michigan Ave. Chicago

3552
BAMBOO FORESTS ARE TURNED INTO PHONOGRAPH NEEDLES

Whole forests of bamboo are being cut down every year to supply the need for phonograph needles. Although it



Operator Turning Out 180 Bamboo Phonograph Needles a Minute from Long Strips of the Material

grows 40 feet in six weeks, this material requires two years before it is ready to be turned into music producers. After being felled, it is split into proper lengths. These go to machines that make 180 needles a minute which are chemically treated to toughen them. They are then polished in hardwood sawdust and wax.

Secret Process.

3552
Hall Mfg. Co., 35 W. Kenzie St. Chicago

Smith - Endicott Egg
141 Milk St.
660

3512 Boston Mass.

CHURCH STEEPLE PULLED DOWN BY TRUCK WITH WINCH

In wrecking a church in an eastern city, a motor truck, equipped with a capstan winch, was used to tear down a lofty spire. From the steeple, a heavy cable was

swung to the automobile, standing at a safe distance from the structure. With the winch revolving slowly under the power of the truck's

Spire of Church Being Pulled Down by Winch Operated by a Motor Truck on Ground Below



motor, the tower strained and cracked for three minutes, and then with a loud snap, parted from the superstructure and fell to the ground with a crash.

3547
ONE LEFT OF SEVEN ANCIENT WONDERS OF THE WORLD

All except one of the seven ancient wonders of the world have been destroyed, recent researches have determined. Even the colossal pyramid of Cheops, the only one of the famed group remaining to the present day, has not entirely escaped the forces of nature, for portions of it have been torn down by earth tremors. The second wonder, the walls of Babylon, was torn down by Xerxes.

The third, the statue of Zeus in the temple of Olympus, was destroyed by fire in 408 A. D. Diana's temple at Ephesus, constructed in the 4th century B. C., and fired by the Goths in 262 A. D., was the fourth wonder to perish. The fifth was the mausoleum at Halicarnassus, in Caria, which was demolished by an earthquake. The Colossus of Rhodes, built in 280 B. C., that straddled the island harbor, also was wrecked by an earth tremor. The lighthouse built by Ptolemy Philadelphus at Pharos about 247 B. C. was the seventh and, perhaps, was the forerunner of the modern skyscraper, since it was between 400 and 600 feet high. An earthquake toppled it over in 1382.

3553
TABOO NOW PUT ON TATTOOING IN SOUTH SEA ISLANDS

Tattooing in the South Sea Islands is dying out, according to explorers who returned from there recently. The new generation of islanders, it is said, frown upon the practice until now the marks of the tattooer's needle are to be found only on the bodies of old natives. Although the custom seemed to have begun to wane about 30 years ago, one old man was found whose entire body was covered with designs.

3546
PAPER TO CLEAN EYEGLASSES KEPT IN LEATHER FOLDER

For cleaning eyeglasses, neat packages of paper tissue have been made to fit in leather pocket folders. When closed, these resemble an ordinary notebook, and are smaller in size than a cigarette case. When the leaves have all been used, a new supply is easily fitted into the same

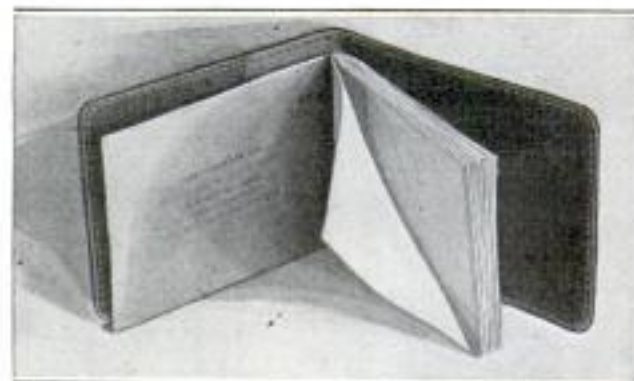

Leather Pocket Folder Filled with Paper Tissue for Cleaning Eyeglasses

container. The material is specially prepared for the purpose and, it is claimed, will not scratch the lenses.

Schulte Optical Co.,
108 N. State
Chicago

Indianapolis News
7/4/23



Earth Tremors That Have Long Terrorized Man Disclose Secrets of Nature

Noted Scientists, Engineers, and a Traveler Give Views on Causes and Effects of Shocks Such as Plunged Japan Into Chaos



What Is the Matter with Japan's Land Formation

By E. M. Newman, Travel Lecturer

ANOTHER earthquake, loss of life, great destruction of property. Not the first experience of this kind, but the worst. Why not give up and move away? This for the average man is but a natural question to ask, but where shall the Japanese go?

I have been in Japan eight or perhaps ten times. On two occasions I was compelled to run out of my hotel, as rocked by an earthquake, it swayed to and fro. Buildings creaked, groaned, and fell to the ground in heaps of debris. A hospital caught fire and many of the helpless were burned to death. A large section of Tokio was swept by flames.

On another occasion, Yokohama was visited by a tidal wave, which converted my room in the hotel into a swimming pool. An earthquake followed and several square miles of property was destroyed, thousands of people were rendered homeless, and millions of dollars were lost.

At one time, Japan was part of the mainland of Asia. Probably an

earthquake tore it from its moorings, the sea flowed through a rent in the earth, and Japan became an island. Of volcanic origin, it has been subject to frequent earthquakes, each taking its human toll and exacting from the people a frightful tax in the form of property loss.

Not everyone has sufficient money to build of steel and concrete, and after all is said and done, are such buildings any safer than ordinary wooden houses? Probably not. A one-story building constructed of wood and thatch, may withstand an earthquake better than one built

of stone or concrete. To build skyscrapers in a land where earthquakes are frequent would be folly.

This explains why such cities as Yokohama and Tokio are composed mainly of one-story buildings, which stretch for miles in every direction. Experience has taught the Japanese many things, but the problem of how to protect themselves from the devastation caused by earthquake, is still unsolved.

EDITOR'S NOTE

As Popular Mechanics Magazine goes to press with this issue, the Japanese people are hidden from the view of the world beneath a terrible pall of catastrophe.

Accurate reports as to the extent of the disaster, and as to scientific facts connected therewith, are not obtainable. From its many friends and correspondents in Nippon, nothing has been heard.

Believing, however, that the accompanying articles, written by acknowledged authorities, would prove of interest, they are presented with the explanation that when more is learned of the Japanese holocaust there might be additions or reservations to be made which, of course, would be impossible after the magazine has "gone to press."

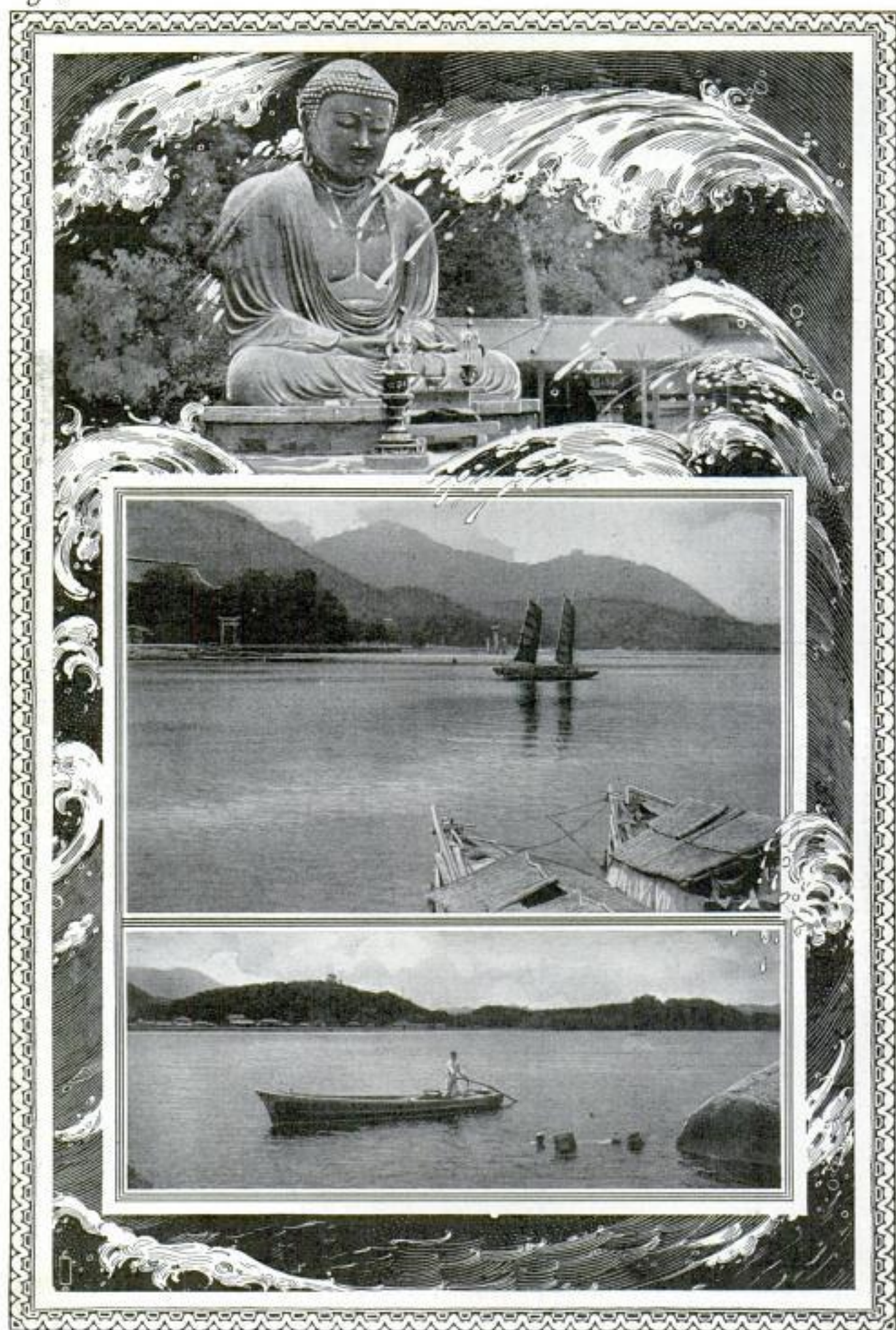

Quiet Bays and Peaceful Inlets Spilled Inland in Tidal Avalanches as the Sea's Bottom "Came Up." Above: Japan's Large "Buddha" Reported Thrown Down by the Rush of Water

There are many theories as to the cause of earthquakes. The one generally accepted is that they are due to faults in the earth's surface. In the readjustment, the crust rises and falls, at times breaking up and swallowing towns, lakes, and islands. Usually these phenomena take place in a volcanic region, indicating that so-called "faults" are mostly found where

nature's fires are near the earth's surface.

Japan in area is no larger than the states of Illinois and New York, but it has a population exceeding forty-seven million. A land teeming with human life, honeycombed with volcanoes, undermined by subterranean caverns in which seethe the mighty forces of nature. Is there a way to escape extermination?

— O O —

"Leak in the Floor of the Ocean Caused Japanese Quake"

By Capt. T. J. J. See, Professor of Mathematics, U. S. Navy

The basic cause of the earthquake which devastated Japan, as well as of other tremendously destructive earthquakes of history, is gradual leakage of the waters of the ocean through the earth's crust, bringing terrific upheavals when the water meets the hot lava in the interior.

Lying to the east of Japan is the "Tuscarora Deep," a pit in the Pacific (27,600 feet deep), the source of the greatest seismic disturbances which history records. Leakage from this

abyss into the depths of the earth is greater than it is anywhere else because of the tremendous pressure of the water. It is reported that this latest Japanese earthquake occupied six minutes of time, rather long duration for a heavy earthquake, and proving that the lava beneath the crust of the earth was adjusting itself from the sea toward the land. Further proof that the sea bottom was disturbed is found in the great tidal wave which followed the earthquake, and the broken cables, lying on the bed of the sea.

The earthquake is nature's method of building mountains, and, if there were no earthquakes, all our globe would be a dead level.

It is a well-established fact that the pressure at any point on the sea's bottom is great enough to throw a column of water as high as the sea is deep at that point. It is easy from this to see that the pressure at the bottom of the "Tuscarora Deep"—five miles below the surface of the ocean—would throw such a column of water

up to the highest clouds of our sky.

Pressure of this strength would force the water through the granite of the earth's crust, and thus cause the creation of untold forces of steam when the water hits the superheated lava of the earth's interior. Not only the main island of Hondo but the other bits of Japanese land have been so lifted up.

The Cordillera, or Andes Mountains, was similarly lifted up, and very deep water is still to be found along the Pacific coasts of both North and South America.



Insurance Policy in Operation in Japan, Providing in Many Cases Against Loss by Earthquakes

— O O —

Earthquakes Due to Creeping of the Earth's Crust

By Dr. A. C. Lawson, Professor of Geology at the University of California
(An Interview with H. H. Dunn)

Many people think that earthquakes are peculiar to some particular sections of the globe, but they are not. They are common the world over, and there probably is no fraction of the earth's surface that has not suffered from them. Now it has been found that certain points

on the earth's surface move in a rather mysterious manner. Mount Tamalpais, in California, moved 1.64 meters (approximately two yards) northward between 1854, when the latitude and longitude of the mountain were determined with great precision, and 1882, when its position was

3534

again learned. An observation station at Chaparral moved 2.06 meters in the 1906 earthquake.

These movements of the earth are not confined to the sudden and violent disturbance experienced at the time of an earthquake shock. The energy that was let loose in Japan, or that was released in San Francisco in 1906, had been stirred up in the earth's crust as an elastic compression. It seems probable that this energy was being stored by a slow accumulation of strain due to the application of some force, and that, when the strain reached the limit, things broke. It was the snapping at the time of the maximum possible strain that gave rise to the sudden shifting of the ground, and gave us the vibration that we recognized as an earthquake shock.

If the crust of the earth in any region is moving slowly to the north, as figures

and measurements indicate, certainly the force causing this movement is not applied at the surface.

The indications are that portions of the earth are in balance which sets up a disturbance, or undertow, of the deeper portions of the earth's crust toward the lighter portions. The process of erosion, the wearing down of mountains, is removing a load in an area where the mountains are and transferring it to a neighboring region. We are thereby disturbing what we call the "balance," and, if that disturbance be sufficiently great, then we must inevitably have a return flow from the region that is being loaded to the region that is being unloaded, and that return flow is very probably sufficient to bring about a drag effect on the brittle crust above it, and to apply to it a strain which can only be relieved by rupture, or slipping, giving rise to earthquakes.

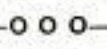

Nations Taking to Building in Steel to Defy Quakes of Earth

By James Baird (President, Geo. A. Fuller Co., Which Has Built \$50,000,000 Worth of Buildings in Tokio)

Private advices from our agents in Japan assure us that at least three of the large buildings we erected in Tokio withstood the terrible earthquake. We completed the last of these, which are respectively eight, seven, and eight stories high, in the fall of 1922, and a little more than a year ago they went through quite a severe quake and withstood the shock with practically no damage, except the

scaling off of a small amount of the tile used on the face of one of them.

Earthquakes do their damage on buildings that yield, because part of the building is thrown in one direction and part in another. Scientists, architects, and engineers have studied earthquake effects, and have decided on adopting many features to make the building rigid and resistant. In the first place,

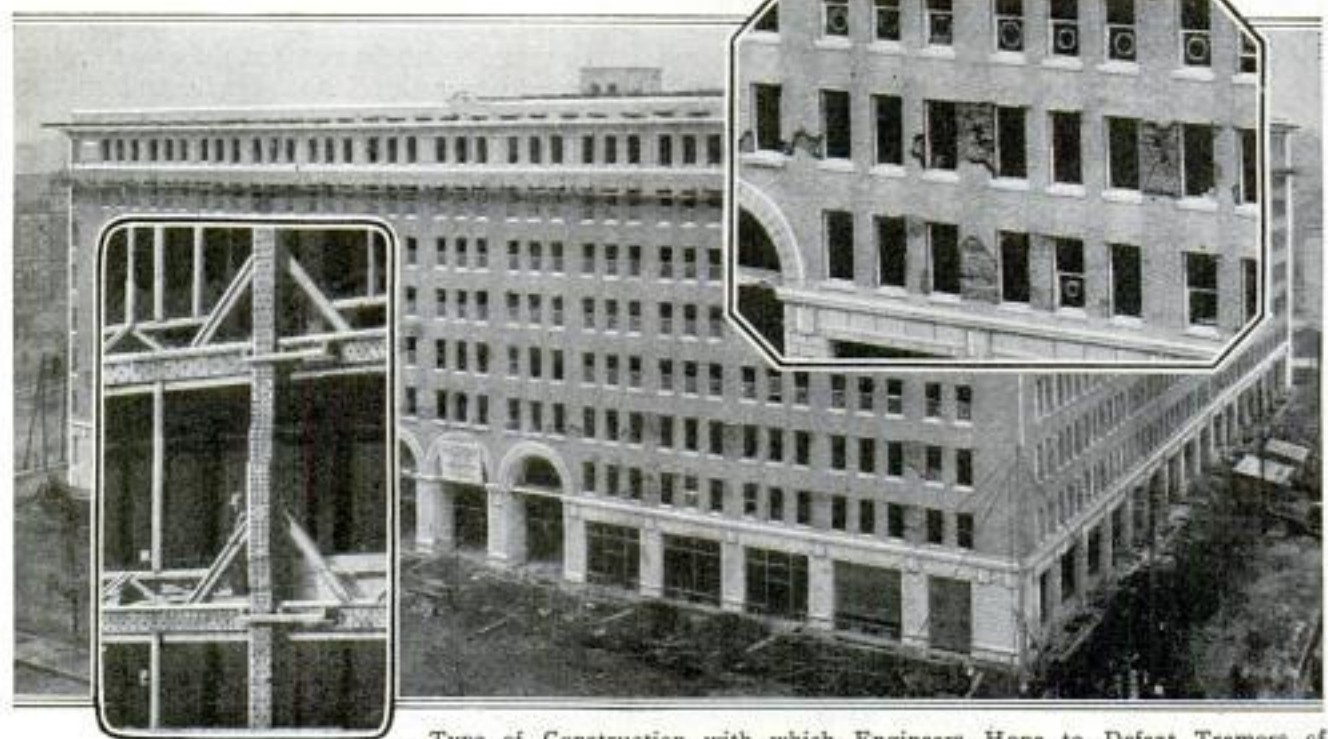

Type of Construction with which Engineers Hope to Defeat Tremors of "Quakes." Left: Heavily Riveted Steel Skeleton. Above: Close View of Finished Wall

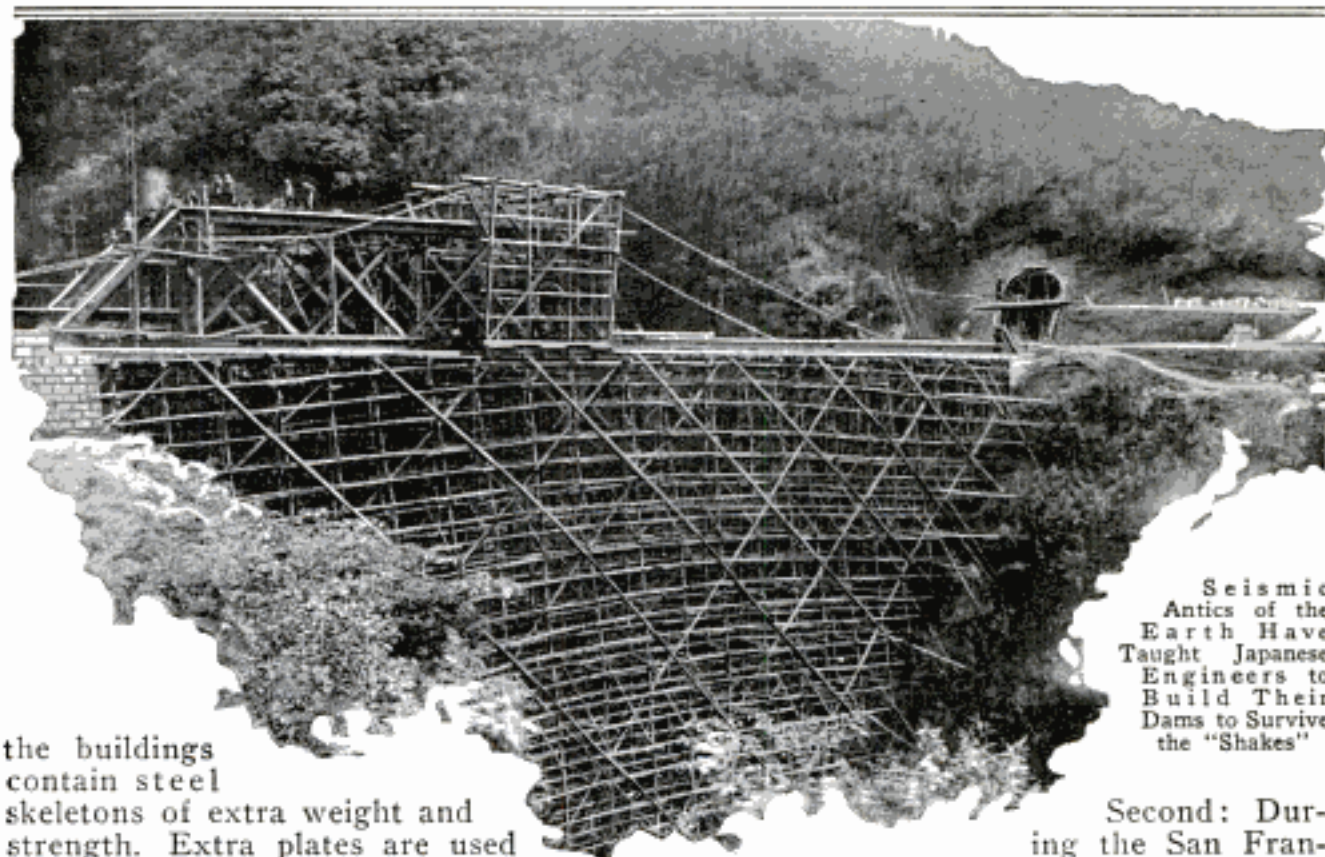

Seismic Antics of the Earth Have Taught Japanese Engineers to Build Their Dams to Survive the "Shakes"

the buildings contain steel skeletons of extra weight and strength. Extra plates are used to join steel beams on to the steel columns. Each floor level has very substantial steel braces extending from the columns to the floor beams, and at the roof line heavy plates are placed on the top of columns connected to the cross beams.

A very great number of rivets are used. There are perhaps three or four times as many rivets as in ordinary construction in this country. So it would seem that earthquake construction is very similar to what we call "wind bracing" in this country. The object is to stiffen the entire frame to resist choppy stresses.

Our confidence is based on various experiences and facts, of which we have knowledge, among them being the following:

First: During the great Baltimore disaster, fire, brick, and stone buildings crumbled and were practically flattened to the earth, but the steel structures, though they were gutted by fire, did not fall,

Second: During the San Francisco earthquake, substantial stone and brick buildings collapsed and were completely destroyed, but the steel-frame buildings survived with small damage.

Third: In wrecking steel structures it has been found practically impossible to tear the work apart or rupture it in any way, other than by cutting out all connecting rivets.

In the Baltimore fire, in a few cases, the fireproofing was broken from around columns, and the terrific heat melted the steel, but the beams were thereby put in tension, and although the floors sagged, yet there was no giving way, regardless of the fact that the weight from the six or eight floors above was left without support.

The various cables received by us from the institutions owning the buildings in Japan that were equipped with special steel skeletons, all indicate that they are quite safe and have come through practically unharmed.

— o o o —

Water-Proofing a City Against Earthquake Damage

By G. A. Elliott, (Chief Engineer, Spring Valley Water Company, of San Francisco)

The greatest damage done to cities by earthquakes arises from the conflagrations which almost always follow. In the earthquake of 1906, at San Francisco, it has been definitely determined that more

than 90 per cent of the property loss was caused by the fires occasioned by the breaking of gas mains and the firing of the gas by sparks from broken electrical connections.

3534
 San Francisco is considered by waterworks engineers to be one of the most difficult cities of its size in the United States to supply with water. When the earthquake hazard is added to the other considerations, the limits of the comparison may well be increased to the area of the world.

Situated, as it is, on the extreme tip of a peninsula which a number of earthquake faults cross, it is not hard to realize that all of the conduits carrying water to the city must of necessity be exposed to more or less interruption due to earthquakes. Another feature of importance is the fact that, to the south the neck of that tongue of land is cut almost across by marshy areas, which are subject to the same jellylike shaking.

The principal lesson learned in 1906 in San Francisco was that if waterworks structures are located in soft or filled ground, or near a fault which moves, it is practically impossible to so construct certain parts of them, such as pipe lines, in such manner as to guarantee absolutely against earthquake damage. Three precautions may be taken, in this and in other cities in earthquake areas, to insure the water supply against damage from seismic disturbances:

First, waterworks structures should be so located as to avoid known areas which are subject to excessive movement.

Second, the isolation of selected sections of the system by means of gate valves, placed at all points where pipes cross the boundaries of the ground subject to such seismic movement. This precaution is, of course, involved in the treatment of the local distributing system in each city.

Third, and perhaps most important, the carrying in storage within the city limits of a large quantity of water available for distribution. With sufficient stored water breaks in the conduits carrying the water would be relatively far less important than breaks in the distributing system.

It developed in the San Francisco quake that water was needed more for fire fighting than for any other purpose, and, following the reconstruction of the burned district, plans were made and a system constructed that embodies all the best features of water supply for fire purposes that have been in use anywhere. Many features of this system are designed to meet earthquake conditions, such as the locations of the reservoirs and pumping stations on solid foundations, the avoidance of filled ground in laying large feeders, gating of distributing mains in filled ground, duplication of pumping stations and sources of supply, and the use of special joints in connecting pipes designed to allow greater movement before rupture.

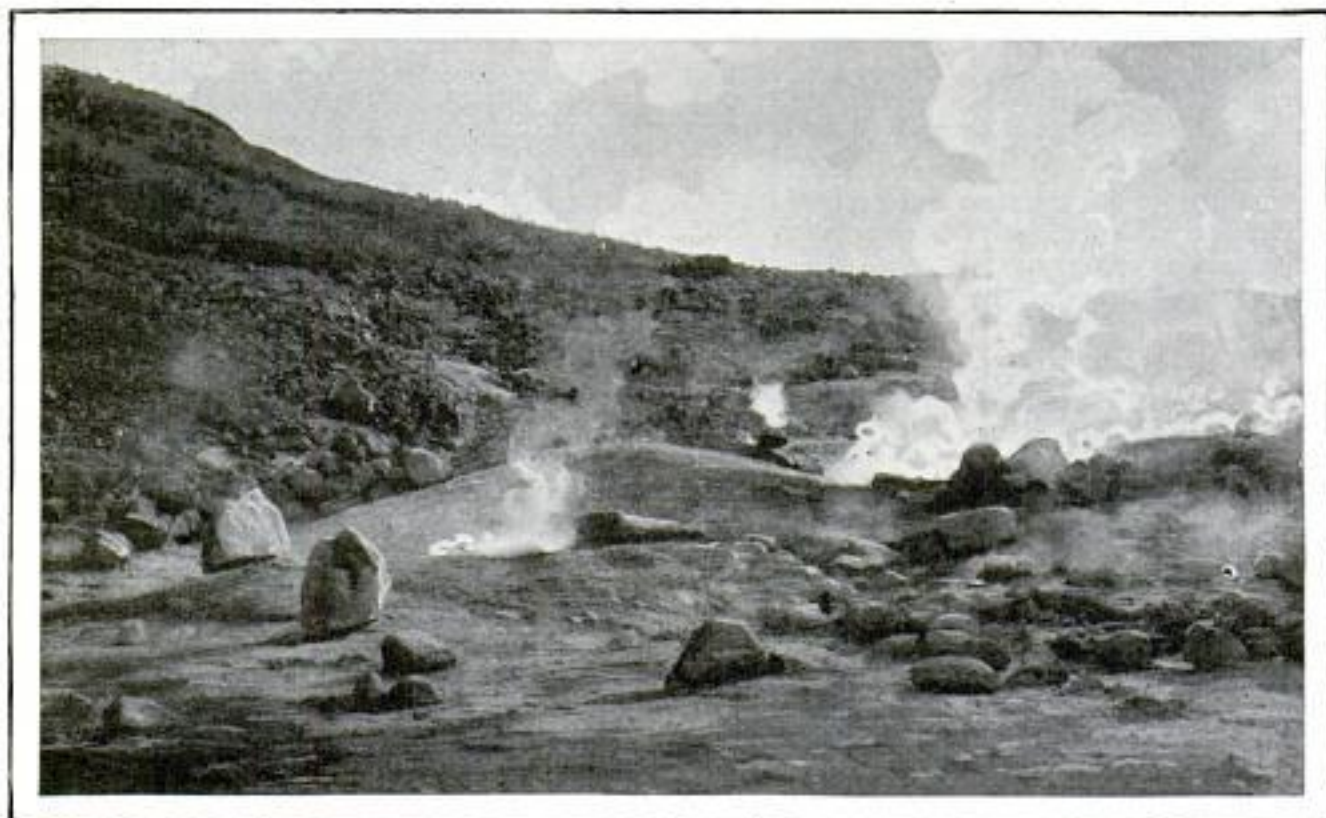

Like Phantom Fires, the Smouldering Cauldrons of Nature, Ignited Long Before the Dawn of Ages, Are Still Burning in the Threatening Craters of Many Volcanoes

9/4/23

GHOSTLY LEGEND GUARDS PEAK OF TREASURE MOUNTAIN

Warned by a legend handed down for several generations, mountaineers in the vicinity of Bread Tray Mountain, in the Ozarks, are said to avoid the neighborhood of its slopes. Reported to have once harbored a garrison of Spanish explorers who enslaved Indians to work a rich silver mine, it is seldom referred to by the tourist guides. Throughout that section are caves believed to have at one time sheltered the intrepid soldiers of Spain who left writings on the cavern walls. But the treasure mine supposed to have held them in that locality has never been discovered, as it is said the residents refrain from exploring the mountain top for fear of a band of phantom defenders which they have been told guards its secrets. These ghostly forms, tradition says, are the specters of the massacred garrison which died at the hands of the revolted slaves. Many exploring parties braving the dangers said to exist, failed to find any trace of the mine, but reported discoveries of relics and the remains of a fortress which bore evidence of the presence of the Spaniards several centuries ago.

Malena - very young, married, probably married big town.

SEALER FOR PIE CRUSTS KEEPS FILLER IN WHILE BAKING

To press the dough for pie crusts together and prevent the escape of juice into the oven while baking, a metal

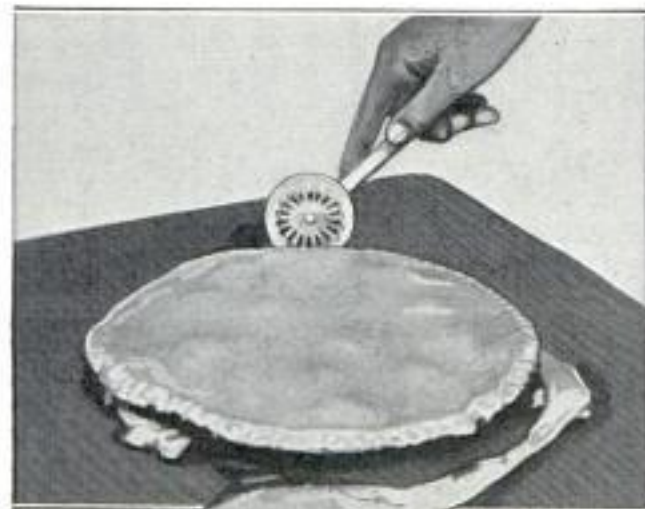

Metal Pie Marker That Trims and Joins the Crust and Prevents the Escape of Juice

marker has been made in the shape of a wheel with a handle. This is run around the edge of the crusts to mark the dough. As the wheel has a cutting edge, it trims the sides at the same time.

*Aunt Evelyn's Pie marker
Evelyn Simpson, 7 School St,
Waterville, Maine*

GRIP FOR ARMLESS PERSONS TURNS PAGES OF BOOKS

Armless persons may be assisted in turning pages of books and papers by an instrument recently made to be held at



Turning the Pages of a Magazine with a Mechanical "Finger" Designed to Aid Armless Persons

one end by the teeth. At the other end a rubber cap is pressed against the leaf, lifting it up and pushing it over. Two legs are provided on the device to keep it raised above flat surfaces so the operator will have no difficulty in seizing the handle in his mouth. A slight movement of the head is sufficient to operate this mechanical "finger."

EIGHT DAYS TO TAN LEATHER WITH VACUUM PROCESS

Great savings in time, labor, and power are claimed for a high vacuum tanning process recently announced by a Swedish inventor. Cylinders holding 400 hides are rotated by electric motors, the chemicals circulating in them constantly. A 60-per-cent reduction in the number of men employed is said to result from the use of the system.

☛The United States is a nation of ice-cream eaters. Last year it consumed four times as much as in 1914. In New York City 60,000,000 quarts are consumed in a year, an average of ten quarts for each resident.

*Albert Von
Horselles -
no address*

*A. F. Shipley, Christ's College
Lodge, Cambridge, England
Detroit Free Press
9/6/23*

3522

3557

3494

3556

3578

When the Automobile Was "New" as Seen

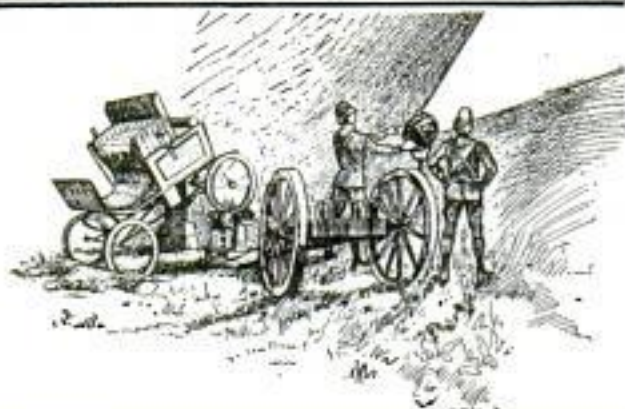

Automobile of Twenty Years Ago Being Used as the Tender of a Searchlight

SO rapid has been the development of automobile transportation that it is difficult to realize that 20 years ago the "one lunger" had scarcely ceased to be a curiosity on city streets.

In 1903 Popular Mechanics Magazine told of the first use of motor cars in war. This was during the Boer conflict, and the British put American, steam-driven vehicles into service to explode mines, run dynamos, operate searchlights and transport men and supplies.

Of one of these cars, it was said that it carried blankets, waterproof sheets for four men, planks for crossing ditches, tools, spare parts, telephones, a mile of wire, and a day's supply of gasoline. In addition, there was a trailer carrying a search light, projector, and dynamo.

In the same issue of the magazine there was an article on wireless telegraphy, declared to be "one of the latest and most important developments of science." "The most prominent worker in this field is Mr. G. Marconi, an Anglo-Italian," the article continued under a caption that read: "Mysteries of the Radio Unfolded."

Another wonder of that period was a locomotive without fire, water, or smoke,

that was hailed as the "Dream of Modern Traction." This was a large car, propelled by electric motors, the current being supplied by generators driven by gasoline engines. "It is generally accepted by railroad managers that the limit has been reached in steam locomotive construction," it was said in describing the new power plant, which was believed capable of drawing a 2,000 ton train across the continent, from New York to San Francisco, without stop, and at a speed of 100 miles an hour.

Although this vision of speed has now been more than realized, it was through the air and not over steel rails, as the airplane was then only an unrealized hope in the minds of inventors who were regarded as "cranks." It was not until some



An Artist's Conception, Twenty Years Ago, of "the Electric Farm of the Future"

time later that Professor John J. Montgomery, of Santa Clara College, California, made one of the earliest tests with gliders



During the Boer War Motor Vehicles First Proved Their Value in Military Service. American Steam-Driven Cars Being Used by the British to Transport Supplies and Run Dynamos

in Popular Mechanics Twenty Years Ago

which were released, after being raised aloft by a balloon. Of his first successful flight, it was written that the experiment was "the greatest and most daring feat ever attempted." "All that is now wanting," it was said afterwards, "for complete success is a power in the machine itself to rise from the earth."

With the transportation dream of two decades ago now realized in the flights of army and air mail planes across the continent, another hope still lies in the realm of romance—the "Electrical Farm of the Future." That was the heading on an article that declared that "it is not impossible that the time when the farmer shall conduct the whole of his operations by machinery and the application of scientific principles will proceed the millennium—a time when there will be no drouth, nor ruinous floods of rain; when the crops shall not fail, but will be forced to perfect maturity in less time than now

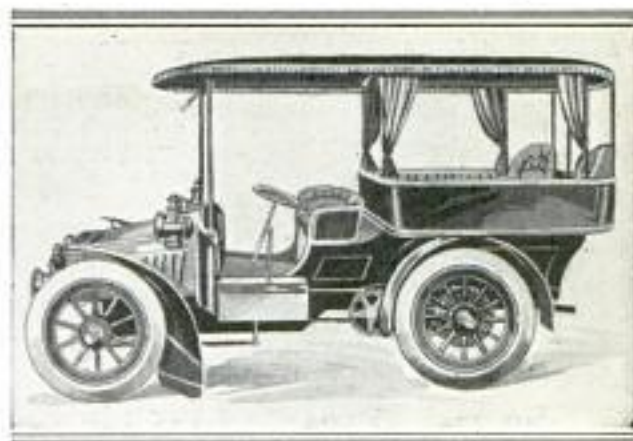

Rear-Entrance Machine That Was the Pride of Its Owner 'Way Back in 1902

nessed may be as cheap as water. The whole system will be under the control of one or two operators, and the farmer can tilt back his chair, elevate his feet and smoke and watch the grain grow. We predict that an American farmer will be the first to have a plant of this kind."

Although this dream of the artist and writer is still to be realized, it is interesting to note how much farm work now is being done by tractors and gas engines, the great irrigation projects in the West that abolish all fear of drouth and the harnessing of streams and waterfalls to provide cheap electricity in all parts of the country. Also, the number of hothouses and truck gardens where plants are grown in and out of season under glass is increasing each year.

In discussing "The Beginning of the Horseless Age," Popular Mechanics Magazine in 1902 said: "We have already crossed the threshold, but henceforth machinery will perform the heavy work now done by animal power."



Mine Being Exploded During Boer War by Electric Current Supplied by Dynamo Driven by Steam Automobile

is required by the natural process."

The article then dealt with a period when there would be "a huge forcing house run entirely by electricity, which, when all the streams and falls are har-

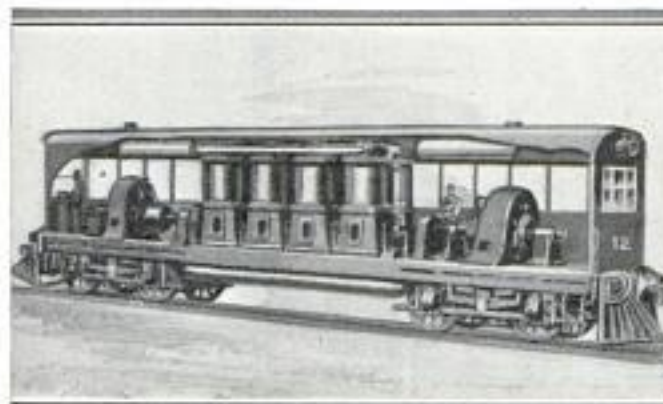

"Locomotive without Fire or Water," the Power Being Provided by Dynamos Driven by Gasoline Motors, and a "Balloon Farm" That Attracted Attention Two Decades Ago

Played by Sailor

P. A. Heudale

TONE OF SAXOPHONE RIVALED BY THE SARRUSSOPHONE

After years of supremacy in the field of "jazz," the saxophone now has a rival in what is known as the sar-



COPYRIGHT, UNDERWOOD & UNDERWOOD

Latest "Jazz" Dispensing Instrument Whose Notes Are Deeper than Those of Saxophone

russophone, coming into use in America. It is said to be deeper toned than any instrument now generally used in orchestras and to have lower bass notes than the bassoon. One has proved popular with the navy band in Washington. *W. C.*

MOUNTAIN OF COPPER SPANS OCEAN IN DEEP-SEA CABLE

Four million pounds of copper drawn into wire serve as the core of a deep-sea cable recently laid across the Atlantic Ocean. Reported to be the largest line spanning the sea, it transmits 600 words a minute in each direction at the same time. Delicate and dangerous work was involved in its laying, as the heavy strands had to be carried by the ship in three-mile lengths and spliced by skilled jointers as each piece was payed out. Special brass tape surrounds the joints to ward off a species of sea worm that bores into the hard rubber covering, creating openings that admit water and acid-laden sediments which corrode and eat into the soft wires. The line is tested every five minutes from a station at the shore end connected with the testing room aboard the steamer. If interruptions are found in the transmission, the wire is attached to a float and the ship goes back over the route to find the defective spot. Storms often arise while the work is going on, and the heavy waves toss the great weight of the cable as it comes from the reel with

New York Times 9/2/23

such force as to snap it, when it often sinks so deep that many days and weeks are required to recover the severed end. Cases are on record where icebergs dragging on the bottom of the sea have crushed and torn the strong lines. A repair ship actually had to tow one of the icy masses out of the cable zone in order to mend a break the great hulk had caused. Whales with their ponderous bodies, and even the sharp teeth of sharks, have been known to cut wires.

FOOD TREES CROP OF FUTURE, PREDICTED BY SCIENTIST

On the ideal farm of the future, according to an opinion recently expressed by a scientist, trees that produce food for both men and animals will be grown extensively. Among them, he believes, will be walnuts, hickories, pecans, almonds, chestnuts, hazelnuts, mulberries, and others known to the present-day farmer. In addition, there will be many developed through grafting and other processes. In the honey locust, with its large pods, he sees the possibility of growing beans on trees instead of climbing vines. This manner of producing foodstuffs, he says, has the advantage that crops can be gathered for a number of years without annual cultivation and replanting, while the trees can be placed far enough apart to permit of cultivation of grain and other products. An acre of nut trees, it has been estimated, should yield from \$100 to \$1,000 a year above expenses.

New York Times 9/8/23

ROASTER WITH GLASS COVER MAKES COOKING VISIBLE

Through the glass top of a roaster now being marketed, the housewife can watch the progress of cooking meat without lifting the cover, or exposing her hands to burning steam and the heat of the oven. Self-basting also, the utensil relieves the cook



from care and worries of overdone food, since she can tell at a glance when it is ready for removing. Made of aluminum and round in shape, the cooker has no corners in which grease can lodge.

Carl W. Newton Associates 9 S. Wabash Chicago

Annual Report

~~2293~~
2099

RARE SOLID-IVORY STATUE NOW IN AMERICA

Carved from a single piece of ivory, a rare statue of a Japanese mother and child, the work of the famous Godo, has reached America and is now in the private collection of M. Barrere Clawson. The figure was ordered by the British Museum, but when the war broke out in 1914, the order was countermanded, the statue finally being bought by an American, who later sold it to its present owner.

Earliest examples of ivory carving are believed to have been made by primitive cave dwellers of remote times. In China and Japan, the work of today has won an honored place in the history of art. During the 600 years that elapsed between the decline of the Roman empire and the Gothic revival of art, ivory sculpture recorded many of the changes in man's types which would otherwise have been lost to the modern world.

The ancients probably found that ivory was superior to bone for carving, because it requires no drying or other preparation for the tools of the craftsmen. Per-



haps the only exception to this is the large curved tusk of the hippopotamus, which is covered with a thin layer of enamel that is so hard it will strike fire when cut with a piece of steel. Before the carver can use its ivory center, the flint-like shell must be removed with acid or heating. If heat is used, the coating is scaled off, after it has been cracked by plunging suddenly into cold water.

With delicate strokes and quiet patience, the skilled ivory worker sometimes spends many months on one subject but in the end he has created a figure that is surprisingly lifelike. Ivory taken from the animals of Asia is softer and much easier to work with, compared to that found elsewhere. It is of a denser white and more porous in texture than the African product, but is apt to turn yellow sooner, and is harder to polish. No part of a piece of ivory is allowed to go to waste by the worker, who collects all trimmings and shavings for use in producing the smaller objects.

3393 New York Times 8/19/23

HEIGHT OF MOUNTAINS FIGURED FROM BOILING WATER

Although nearly 300 years old, the boiling-water test to determine altitudes is still the most accurate method known, despite the fact that barometers and delicate measuring instruments have been developed. For measuring heights by this method, a special instrument, called a hypsometer, has been invented. So compact that it can be carried easily on mountain-climbing expeditions, it has only one breakable part, the thermometer used for recording the temperature of the water, and is constructed so that it may be set up in snow or when high winds are blowing. Water boils at 212 degrees above zero at sea level, but, as the altitude

increases, the boiling point drops. On very high mountains, the liquid boils at temperatures so low that it is impossible to prepare a hot drink. Scientists found that on one of the world's loftiest summits when water came to a boil it was possible to put their hands into it without scalding them.

Short glides in the air were made as early as the reign of King Harold of England by a monk named Eilmer, who, after several successful flights, jumped from a lofty tower with wings strapped to his body. He glided for a furlong or more, when, striking a cross-air current, or "air pocket," he fell to the ground, breaking both legs. He attributed the accident to his neglect "to fit on a tail."

Emb. F. Scharlach, 3013 W. Maryland Blvd. Detroit, Mich.

CARVING MA CHANG PIECES FOR CHINA'S ROYAL GAME



Cutting the Bone into Small Slabs

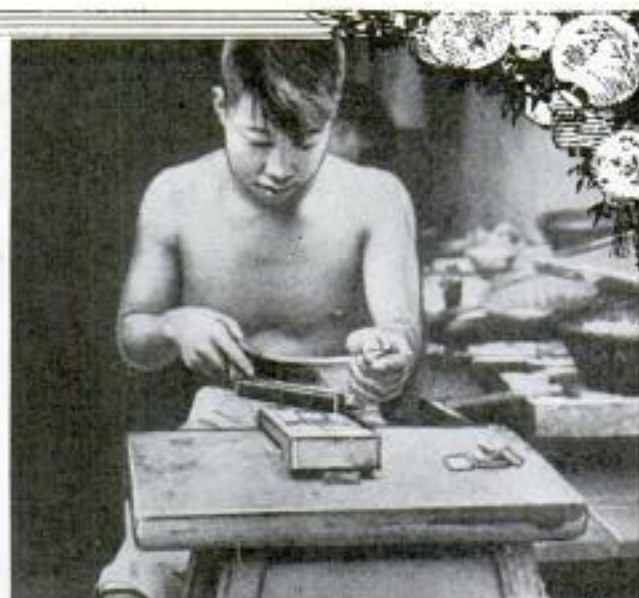

Planing the Surface by Scraping



Trimming the Edges of the "Tiles"



Fitting the Blocks with Bamboo Backs



Engraving the Designs and Figures

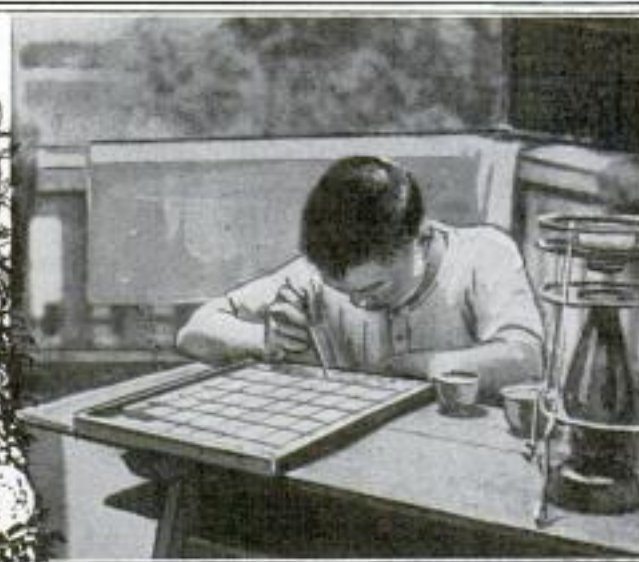

Applying Paints to the Carved Pieces

Chicago

A CHINESE GIFT TO AMERICA

OUT of China, still a rich storehouse of treasure and tradition, has come another oriental gift to the western world—the fascinating game, Ma Chang. Known under a score of other names throughout the celestial nation, the pastime has long been a means of entertainment among all classes of the natives since the days of Confucius. Even before the Roman empire the Chinese occupied themselves with the delights of the marvelous little ivory “tiles” and “sticks.” Whether among the coolies loitering about the water front of Hong-kong, or in the households and tea gardens of the mandarins, the game was played with the same enthusiasm and eagerness with which it has been received in the cities of Europe and America.

Created by the genius of a lowly fisherman, it has remained for 3,000 years a national fad of China. The story tells of one Sze, who lived on the shore of a large lake, wherein he daily let down his fishing nets from his small sampan and brought to the villagers a fair supply of the catch. Having dreams of great riches in the future, he profited and saved, and by and by other boats fell under his possession. But Sze had no crews with which to man them. The lake was rough and the seasickness which the storms caused the sailors was a dreaded malady. Evil spirits that hovered over the waters were said to make their victims ill as a penalty for the invasion. Not to be outdone

in his determination to build up a great fleet of fishing craft, the wily celestial hired his help from a distant inland country. Here again he was confronted with the terrors of seasickness, for the landsmen could not withstand the hardships of a rough voyage. They often became so ill that he had to put back to shore and await calm weather. Then Sze decided that, after all, it was only a matter of imagination. If he could but devise some way to occupy the minds of his weak-hearted hirelings, while waiting for the nets to fill, they would have no time to spend in thinking of the evils that might beset them. With the aid of his family and some neighbors to whom he complained, he invented a game so intricate and amusing that he was sure it would take all of the boatmen's attention to play it. He called it “Mah Diau.”



Building the "City Wall" in the Ancient and Honorable Game of Ma Chang



Ma Chang Sales Co. of Chicago, North American

Originally it was played with 108 pieces of cardboard, and according to the legend, the fishermen forgot all about the sickness, so absorbed did they become in the little signs and figures that made up the pastime.

Next it fell under the eye of an officer of the imperial army, who introduced it to his followers. Gamblers who invariably followed the armies added their efforts to its spread. One of them finding that there were insufficient cards to permit more than four persons to play, added more pieces. To those blocks representing the winds of the heavens, and the fiery dragons of the empire, he added "tiles" for the seasons of the year.

Richer enthusiasts called upon skilled bone carvers and ivory workers to produce elaborate sets in materials of their trades, with brightly enameled or inlaid characters. Shanghai today is filled with shops devoted to the business of trading

in the little carved slabs made by Ma Chang workers.

Because it was necessary to read the strange Chinese characters, westerners were slow to form the acquaintance of the game. The Chinese did not trouble to place it on the market or introduce it to their foreign visitors, so it was left to an enterprising young American who had lived for years in China and knew the game. By placing an English letter or figure on each block he succeeded in teaching its points to friends that he met in the foreign quarters of the large seaport cities. By this means its spread to Europe and America became rapid.

Today so popular is the game in this country that the Chinese are no longer able to supply the demand for sets. Accordingly a surprisingly large industry has grown up in a few months in the United States for the purpose of making outfits of Ma Chang.

3405 RIVER IS "TUB" FOR WOMEN OF MADRID

In strange contrast to many of their sisters of the western hemisphere, the women of Madrid, Spain, still follow primitive methods in washing clothes. When it is washday, instead of using washing machines, or other labor-saving appliances of the more up-to-date housewives, they rush from their homes early in the morning with the family garments bundled on their backs, to a shallow river

that runs through the city. Rivalry is keen among them for choice locations on the stream's gently sloping banks. Kneeling on boxes, with washboards that extend into the water, they perform their tasks. For many years this has been a custom that has remained virtually unchanged. On a pleasant day, both sides of the river are dotted with the figures of busy women.



Housewives of Madrid, Spain, Following a Custom of Their Ancestors, Betake Themselves on Washdays to the River, Where the Sloping Banks Provide a Public Laundry "Tub"

Newman Travel Talks
Tribune Bldg., Chicago

Detroit News
8/24/23

POPULAR MECHANICS

FIGHT AGAINST PLANT DISEASE INCREASES CROP HARVESTS

As a result of efforts of scientists to increase crop production by preventing various plant diseases, a type of wheat, so delicate that it was easily damaged by early frosts, increased its yield by having other grades of grain crossed with it. A little more than ten years ago pineapples growing in the Hawaiian Islands were weak, unhealthy plants owing to their inability to absorb enough iron for their needs from the soil. A solution of sulphate of iron is now regularly sprayed over the fields and the crops have been so aided that the output each year is worth about \$20,000,000. In a middle-western state fungus plagues threatened to utterly destroy cabbage growth, but by separating the healthy plants that were found in almost every field, a sturdy species was developed that resists the parasite and has swelled the yearly production.

The Buffington Co.,
FOLDING CHAIR CAN'T TIP;
HAS CUSHION SEAT

342 *Made in U.S.A.* 3432
New York

With a frame of metal and wood, and so built that a person can stand on the edge of the seat without tipping it, a folding chair on the market requires so little room when collapsed that six of them occupy only seven and a half inches of space. It is equipped with a cushion bottom, and can be folded or



opened up without noise. The corners are all smoothly rounded so that there is no danger of injury to clothing.

— 3459 —
GLASS THAT WILL NOT BREAK RESISTS HEAT AND ACIDS

Practically unbreakable glass is said to be made by a factory in Bohemia from a formula recently discovered. Resisting heat and chemical action, it is adaptable for cooking utensils and laboratory vessels that are subjected to high temperatures and destructive acids.

Detroit Free Press
8/26/23

James McIntyre
Apartado 376
Mexico City, Mexico
675
RAINCOATS OF GRASS FIBERS WORN BY MEXICANS

3375 In warm, damp parts of Mexico where sugar cane grows, the native harvesters



Mexican Indian Sugar-Cane Worker Wearing Rain-proof Coat of Native Grass

wear loosely fitting raincoats made of long grasses, to keep dry and cool. Though water is shed quickly, the loose weave of the garment permits air to circulate freely. The jackets are popular among the Indians, who form a great part of the field labor. They are found to be of help in warding off flies and other insect pests that plague the workers during the rainy seasons.

3474
FISH AS PETS, ARE TRAINED TO FOLLOW OWNER ABOUT

Making pets of some hundreds of fish that he keeps in aquariums in his home and office is the hobby of a western business man. One of the most interesting specimens is the striped gourami that cannot breathe under water but must come to the surface every few minutes to fill its gills with air. It is said that the fish are so familiar with their owner that they will follow him about as he moves around their tanks and refuse to be lured in any other direction by anyone else. The finny creatures, most of which are native to foreign lands, vary in size from a half inch to two inches.

U.S. Patent Office, Washington, D.C.

Detroit News
8/29/23

3445

WET SPONGES TIED TO FACES HELP AUTO RACERS BREATHE

As a protection against dust, drivers in a recent automobile race run on a dirt track, covered their mouths and noses



Auto Racers with Wet Sponges Tied to Faces to Prevent Breathing of Dust from Clay Track

with wet sponges tied about their heads with cords. Although suffocating clouds of pulverized clay, raised by the sweeping machines, hung over the track, and at times almost hid the cars from view, the pilots were enabled to supply clean air to their lungs through the makeshift guards.

MISTLETOE IS PEST IN SOUTH, FESTIVE TWIG ELSEWHERE

3378

While mistletoe generally is favored as a yuletide decoration, it is regarded as a pest in the Southwest, and for the past 12 years scientists have been studying a way to exterminate it. Government experts call the green sprig and its white berries, an "insidious and destructive disease," because it finally kills the trees.

Detroit News 8/15/23

FISHHOOK HUNG FROM KITE TO CATCH GIANT TUNA

3376

To catch tuna and swordfish, kites are being used on the west coast to carry the hooks and bait far from the boats. After they are sent up, the fishing line is attached to the kite string which drags it over the water. When a fish bites, the sportsman reels it in close enough for a companion to strike with a harpoon. As some of the catches weigh from 100 to 300 pounds, lively battles take place. Rules of a club formed by fishermen permit only the angler and spear thrower to kill or gaff the fish. In contests, shooting disqualifies the participant. To be eligible for membership a candidate must land a tuna weighing at least 100 pounds or a swordfish of more than 200 pounds, using heavy tackle.

GIANT WATER SPOUT SHOOTS 3408 UP TO CLOUDS

Believed to have been caused by a slight earth tremor, a huge water spout 100 feet wide recently rose out of the sea within two miles of the coast of England, near Brighton, and attained a height of 800 feet. Thousands of tons of water hurtled skyward, and, when the column broke, the din of the cascade that followed resembled the roaring of Niagara Falls.

Of thirteen plans for an underground moving pathway for Paris, France, five are being considered for tests. Of these, four work on the principle of parallel bands moving at graduated speeds. The fifth one slows down at each station.

Detroit Free Press 8/20/23

RAT TRAP WOUND BY KEY KILLS WITH HAMMER

3422

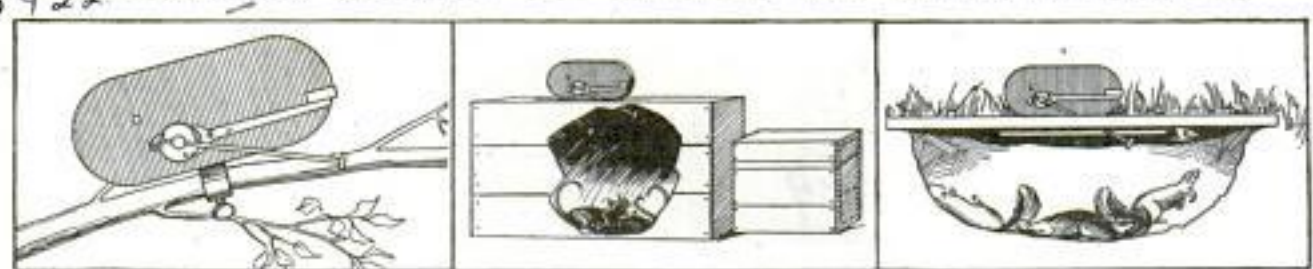

Self-Setting Rat Trap, Wound by Key, That Kills Rodents and Birds by Striking Them with Hammer as the Bait Prong is Disturbed by the Little Prowler

By hitting its victim on the head with a hammer, a self-setting animal trap, operated by a key-wound spring, kills rats and other rodents in buildings or fields. It is claimed that its sharp blow causes instant and painless death to the animal

which is struck when it touches the bait, the body falling into a space beneath. As there is no struggle or cry, other creatures are not frightened away. The snare may also be attached to tree limbs for destroying undesirable birds.

L. H. Beauchamp, 236 S. Electric Ave. Alhambra, Calif.

Vertical text on the right edge of the page, possibly a page number or reference.

33 76 The Tuna Club,
POPULAR MECHANICS
Santa Catalina Island, 677
Calif.



Anglers for Big-Game Fish along the West Coast Have Lately Devised a Scheme to Attach Kites to Their Lines So the Bait Will Be Skipped Along the Surface of the Water

Siemens-Schuckert-Werke.

678

POPULAR MECHANICS

BLOWTORCHES ON TURNTABLE SOLDER BUTTONS

8401

Berlin, Germany

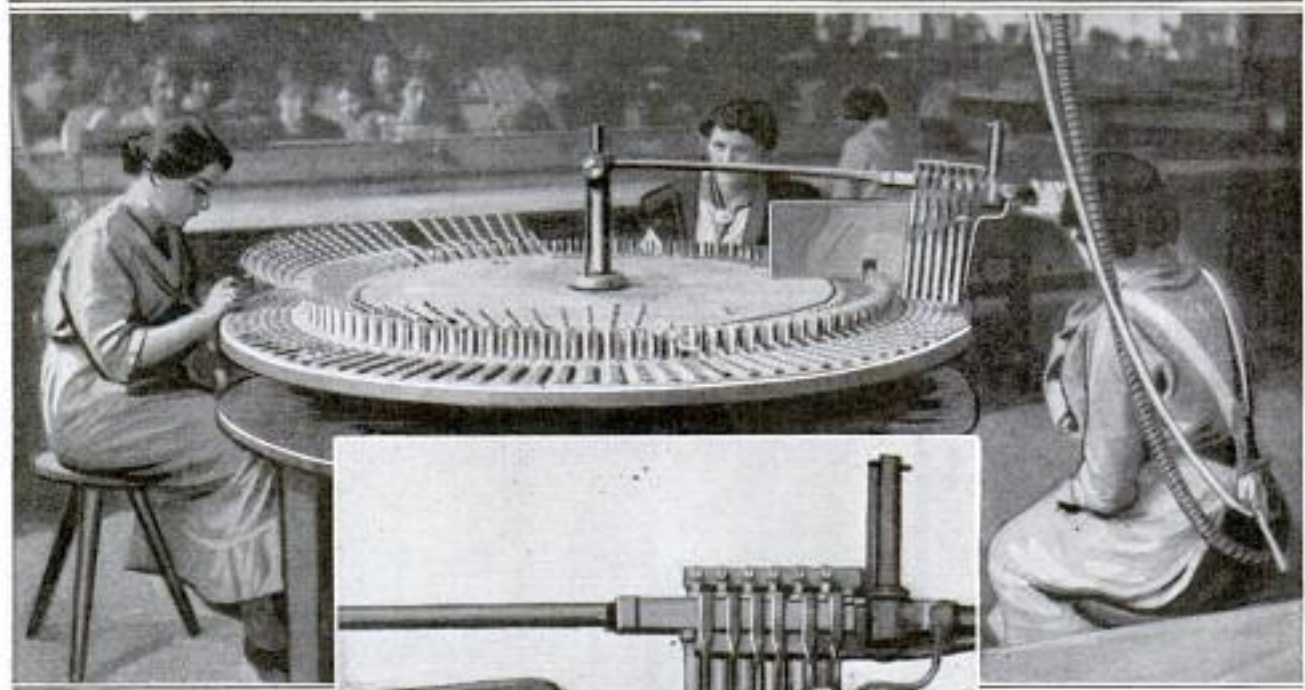

For soldering thread "eyes" to metal buttons, a machine has been invented in Europe. Around the grooved border of a revolving table the round metal pieces are placed, six in a row, while over each is suspended an arm carrying the same number of loops.

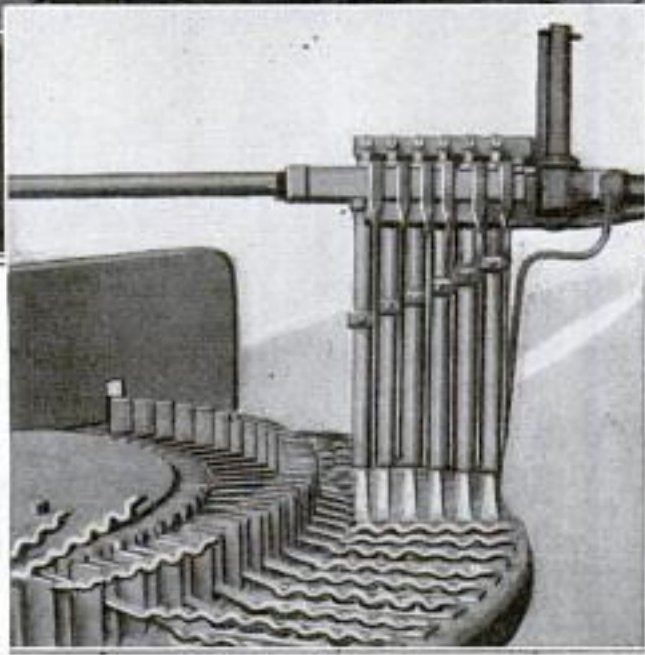

Above: Assembling Metal Buttons on Turntable.
Below: Torches Soldering Thread Loops

When these holders are pressed down to the plates, the six-flame blowtorch, mounted on a pivot is swung over them, melting the solder, thus connecting the loops to the buttons. As the table moves, the finished product is taken from the grooves.

33 50 SHADE ON LIGHT FOR AUTO OR HOME GUARDS EYES

For motorists, a shaded light is being made that may be attached to the car or used with a camping



Portable Electric Light for Use Around Automobile or in the Home

The Magnavox Co.,
2725 E. 14th St.,
Oakland, Calif.

outfit or in the home. Clamped to the spoke of a wheel or to the running board of an automobile while repairs are being made, the hood throws the beams on the work. It also may be attached to a bedpost or used as a table light. Although the bulb draws its current from the storage batteries of the automobile, it will supply illumination for all ordinary purposes.

ONE WAY STREETS FOR CITY

Convinced that Chicago's system of through streets is more or less ill-planned, a local transportation committee has recommended that a comprehensive survey be made of all the traffic thoroughfares. Its primary purpose will be the assignment of separate streets to motor trucks. The plan is expected to unravel Chicago's traffic tangle.

Card and data missing

Copyrighted material

Kansas City Star 8/19/23

Cml. Frances S. Coleman,
8315 Montgall Ave.

POPULAR MECHANICS

Kansas City Mo.

SHOWERS OF "SHOOTING" STARS
GATHER IN COMET'S PATH

3457
Showers of meteors that have been floating through space for ages return to earthly view at regular intervals. Large displays of these natural fireworks are visible every year for about a week during August. Their brilliant, flashing light is the result of the dust that forms them, and which has been left by comets, becoming heated by friction of the air, while traveling at great speeds. About every 33 years the earth runs into one of the denser clouds of meteors and is deluged with a shower of sparks, which generations ago caused terror among many people, who feared that they heralded the coming of the world's end. These bright little particles which are known as "shooting stars" weigh on an average less than a grain.

OX TEAM AND STONE WHEEL
MIX MORTAR FOR HINDU

3486
Reluctance of the people of India to give up old traditions is responsible for their time-honored way of mixing mortar. Two oxen hitched to a stone wheel that

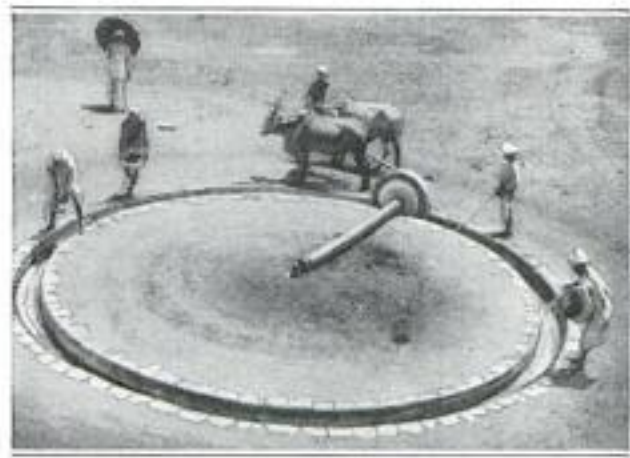

Fear of Evils of Modern Civilization Keep Crude, Traditional Methods Alive in India

travels in a circular ditch furnish the power that mixes lime, sand, and water as it is thrown into the pit by a crew of natives. The laborers move slowly around the trough behind the roller, stirring the mass so that it will have an even mixture.

Williams Service 32 Union Square, S. New York

(There was a decrease in the birth rate in the United States last year and an increase in the death rate, according to recent government figures. The number of births dropped from 24.3 in a 1,000 population in 1921 to 22.7 in 1922, and deaths increased from 11.7 to 11.9.

WASHER FOR KITCHENETTES
HAS FOLDING WRINGER

3438
Resembling a small steel cabinet in size and shape, an electric washing ma-



Little Space Is Needed for This Washer with Folding Wringer Designed for Small Homes

Price - \$100.00.
chine is being made for kitchenette apartments. Equipped with a folding wringer it occupies little more space than a chair, and its operation is said to be noiseless. When not in use all parts are concealed. After the contents have been washed, it may be rolled to any convenient location for the wringing.

COLLECTING SNAKES FOR ZOO
IS THRIVING BUSINESS

3462
Capturing rattlesnakes has become a profitable business for two eastern residents. One of them hunts the snakes, while the other supplies 200 frogs a week to feed the reptiles that are sold to a near-by city for exhibition in its parks. For live, healthy specimens, delivered, \$5 each is usually paid, but to those who carry their own purchases away, the hunter makes a reduction of \$2. After the buyer has received his snakes, he can arrange with the frog collector to furnish the live food supply.

Detroit News 8/24/23
Copyrighted material

Clements Mfg. Co., 601 Fulton St. Chicago

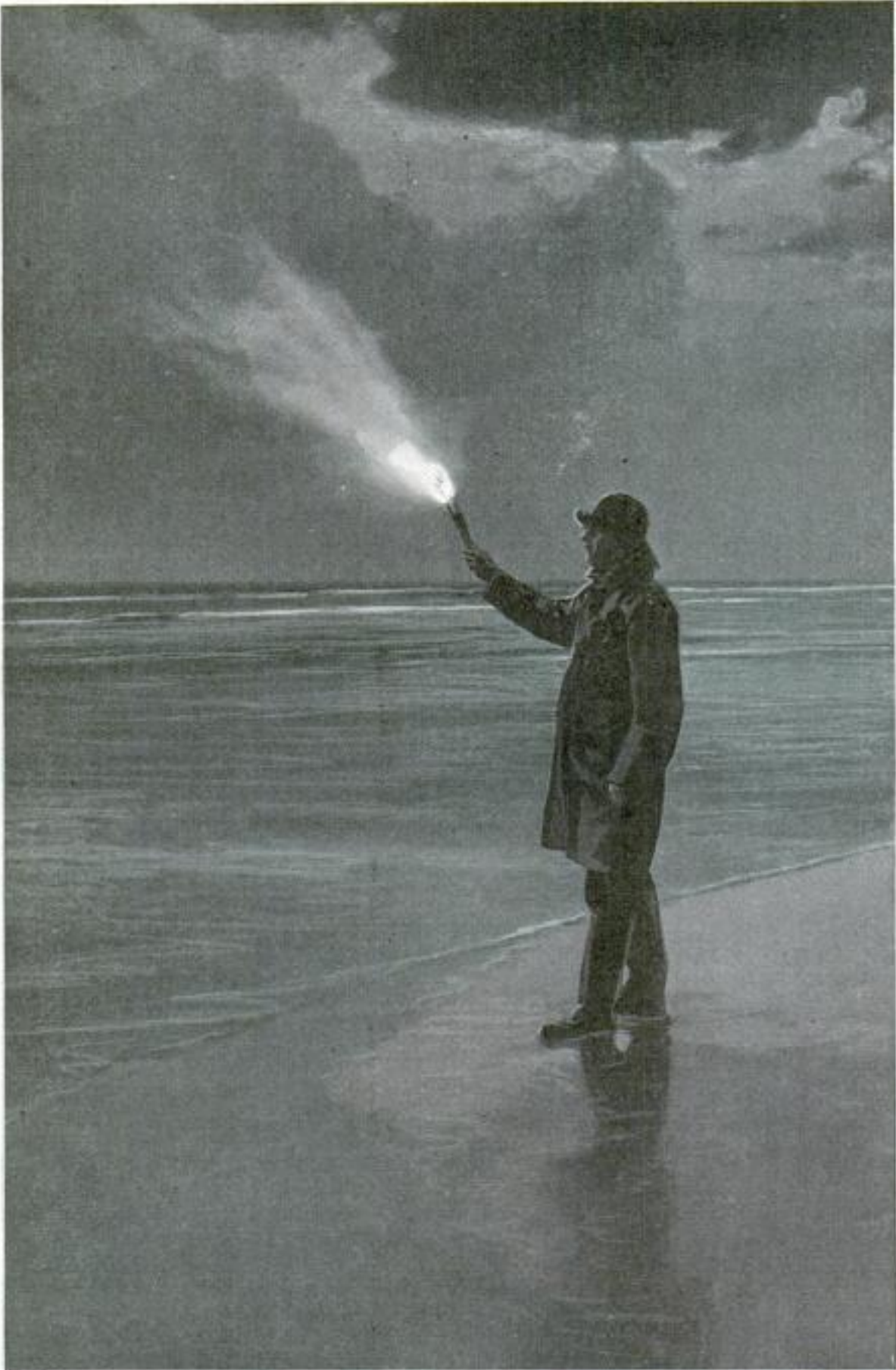

Surfman on Beach Patrol with Coston Signal, Warning an Approaching Vessel of the Danger of Sailing Too-Close to the Shore, and Helping It to Get Its Bearings

Com. Captain George Nightingale,
1442 Winnebago Ave. Chicago

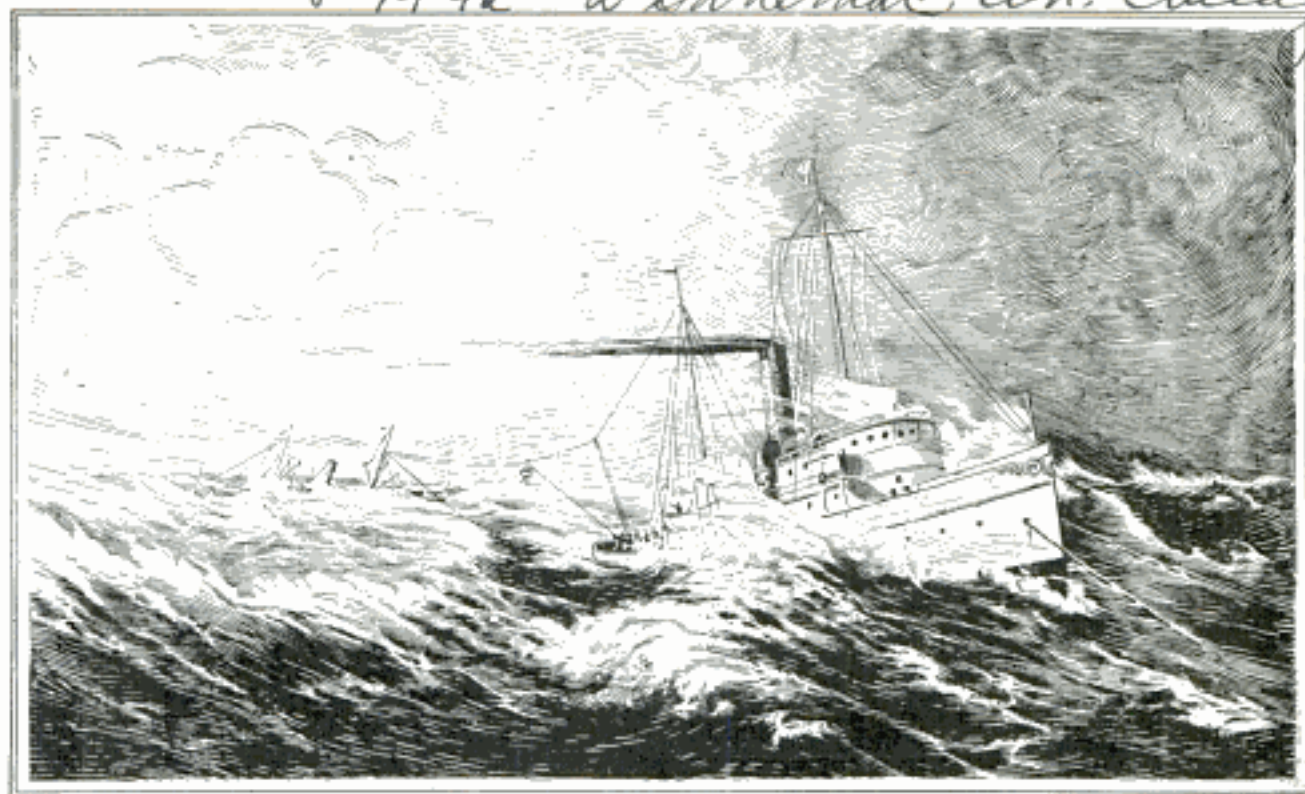

Fighting Icebergs and Derelicts in Battle to Rob the Sea of Hidden Perils

Ceaseless Vigil of Coast Guards Protects Lives of Passengers
and Crews by Keeping Liner Lanes Free of Obstructions

FIGHTING monster icebergs and drifting derelicts with long-range guns, undersea mines, and the famous depth bombs of war days, the United States coast guard has developed a successful method of destroying two of the greatest menaces to human life and shipping.

Keeping ceaseless vigil over the great transatlantic liner lanes, every obstruction to navigation, from a dead whale to a capsized schooner, dismasted ships, abandoned rowboats, and deadly torpedoes, is removed or sunk by explosives—an arduous and often a dangerous task.

Ever since a huge "berg" ripped open the hull of the "Titanic" on April 14, 1912, resulting in the death of 1,517 persons, the ocean highways have been constantly patrolled, ice warnings being sent out whenever danger threatens. In the winter months, when the peril is greatest despite the decrease in shipping, more than 30,000 miles of steamer lanes are under constant guard.

In battling huge icebergs with high explosives, great difficulty is encountered, as the floating mass is hard to approach in boats and offers no projections to which a bomb or mine can be attached.

To set foot upon it is virtually out of the question. One of the first bergs attacked projected about 200 feet above the sea level, seven-tenths of its mass being under water. Overhanging ledges rendered a near approach highly perilous.

After several efforts to attach the explosives had failed, a bit of lead, fastened to the end of a rope, was thrown over a wall of ice. It was found, however, that it was not heavy enough to counterbalance the weight of a mine, and the attacking party went to the opposite side of the berg. With "shoulder guns," several lines were shot over the hill of ice. Two oars and a sounding lead were fastened to the shot lines. Later the boat returned, picked up the projectile, and pulled in the lines until the oars held fast in a crevice on the other side. A bomb was lowered so that it would hang 30 feet under water, and fired.

For an instant the huge mass of ice seemed to lift itself from the sea, and then, with a splintering crash, fell back, breaking squarely in two. As the pieces soon melted, they disappeared in a short time and were erased from the charts where such menaces to navigation are noted.

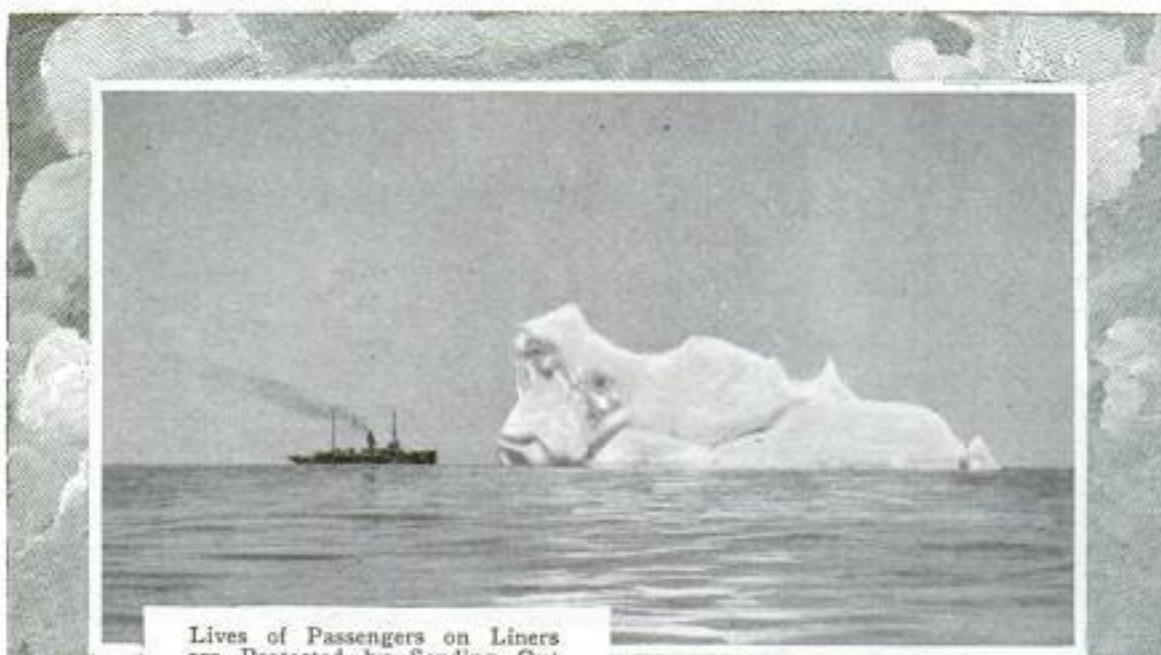

Lives of Passengers on Liners
are Protected by Sending Out
Warnings of Menacing Icebergs



Small Cannon Used to Shoot
Life Lines to Wrecked Ships
So Victims may be Removed

Constantly Called Upon to Risk Death, Members of the United States Coast Guard Keep Ceaseless Vigil on Land, Sea, and Lake, Awaiting the Cry for Aid

The line-throwing gun used is of small size and light weight, and can be fired like a rifle, from the shoulder. It is of .45-caliber and propels a strong cord for 100 yards, which, on being cast over a berg or wreck, can be tied to a rope, enabling the latter to be pulled across. Thus, a hawser strong enough to support a big mine or depth charge can be secured to the ice. A small cannon is also employed for the same purpose.

Destroying icebergs, however, is only one of the many functions of the coast guard, which was created in 1915, combining the then existing revenue-cutter and life-saving services. In general, it is a naval-military establishment, a fire-prevention brigade, and a mail, food, and medicine distribution bureau in one, all of these departments coöperating for the protection of life and property on the high seas and Great Lakes. During times of war, it is attached to either the naval or military forces at the order of the President.

In 1922, the organization's activities resulted in the saving of 2,954 lives and more than 14,000 persons were taken off of wrecks. During that year alone, 596 vessels were seized for violation of marine law, the fines paid amounting to \$135,990. Forty-eight derelicts and other obstructions were removed from the pathways of navigation and the actual value of vessels and cargoes benefited through these

removals amounted to more than 35 million dollars.

Although their work is little known to the general public, stories of the daring and heroism of the coast guards may be heard in any port. A thousand romances have been written about such things, but of them all there is hardly one that approaches the stark reality. To the city dweller they bring wonderment and the tribute of admiration that lies beneath the landsman's sense of superiority in his security. But to the men who know the sea, these are not things smacking of the marvelous—they are just a part of the 24-hour day's work.

Tossed about raging seas in cockleshell boats laden to the gunwales with men, no water save rain, a day's rations stretched out to five, heat that maddens, nights worse than the glaring days—and yet victory at last. These, together with other hardships that would try the stoutest hearts, are the lot of the coast guard. His reward is the often wordless gratitude of those he has rescued. Forgotten, save in the admiralty registers, his deeds show what man can endure and still live.

Entwined with their records are the stories of shipwrecked crews that have traveled thousands of miles in open boats, suffering the tortures of thirst and hunger, mutiny, typhoon, sirocco, and monsoon—names that call up the glint of sun on breaking waves and the sheen of plume-like palms.

In 1870, the "Saginaw," a small naval

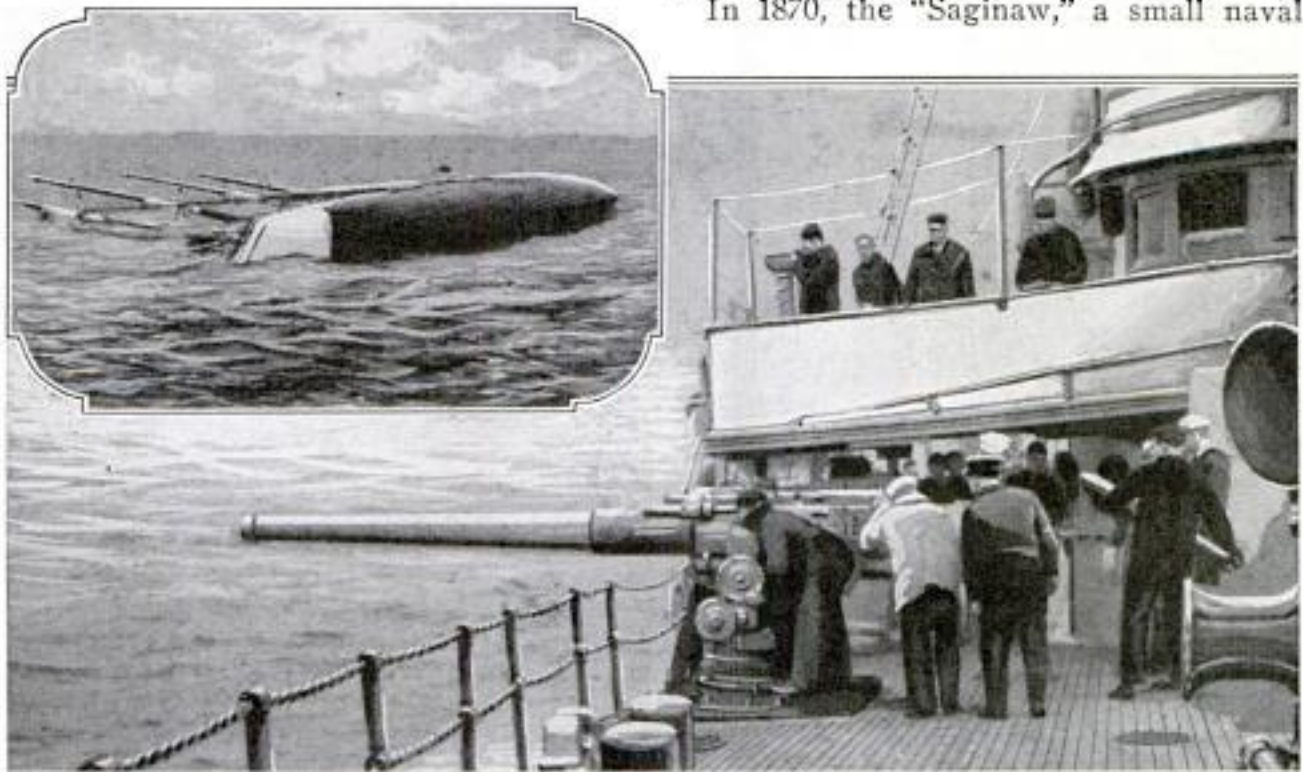

Drifting, Half-Concealed Derelicts, Known as One of the Most Dreaded Dangers of the Deep, are Sought Out and Destroyed with Guns, Mines, or Torpedoes

ship, went to Ocean Island, 1,700 miles beyond Hawaii, to look for castaways. The vessel struck a reef and all hands crawled to the sandbank, which is the island, a few feet high at the most. They faced starvation. Lieut. J. G. Talbot fitted up a whaleboat and, with four volunteers, departed in search of help. Navigation was difficult. There was food for five for 30 days—on quarter rations. All but one of the men, Halford, became ill. In 25 days the last of the provisions were gone. Three days later Halford knocked a booby bird on the head. It made five raw portions. A day or two later, he saw land astern. It had been passed in the night. The men were ill. Some were dying. The gig was leaking.

Then a storm broke and there was a cry of "Surf ahead!" A mistaken order from the dazed lieutenant, and the boat veered and was bowled over by the waves. Halford held fast and the boat rode clear and righted. He heard a groan. One other man had come through. Caught in an air pocket under the deck, he was insane. Halford got him through the surf, reached a footing, and collapsed. Hours later, he recovered, his feet still in the water, but his head on land. His one companion was dead.

Another Robinson Crusoe schooner was that built by the survivors of the "Hermes." Two British whalers, the "Hermes" and the "Pearl," were lost ten miles apart in 1822 on the reef that bears their names. A passing ship picked up the

survivors in a short time, but twelve stayed with James Robinson, who had started building a schooner. They took their chances—and arrived at Honolulu all but starved after ten weeks at sea.

In 1866 two Kanakas saw a small boat off the Hawaiian coast. They swam out, shook hands all round with the fifteen thin strangers aboard, and, still swimming, guided the boat through the breakers. The fifteen were the survivors of the clipper ship "Hornet," New York to San Francisco, which flared up like a match—a wooden ship filled with oil—a thousand miles at sea.

There had been three boats. Captain Josiah A. Mitchell took a mate, two passengers, and eleven seamen in the larger and towed the two smaller boats. Twenty-one days out he had to cut them adrift. Night came on and separation. The other two were never heard of again. There were flying fish for the big boat and booby birds, dolphins, a bonita, and a turtle, but before the Kanakas shook hands, on the 43d day, the survivors had gnawed the bare bones of a ham and had eaten the canvas wrapping.

Pitcairn Island, inhabited now by descendants of castaways, has annals that stand alone. In 1789 the crew of the British navy ship, "Bounty," mutinied near Tahiti, and the commander, Lieutenant Blight, was set adrift with eighteen men. Their 23-foot boat was so laden that a fair swell was a crisis, yet they covered 3,618 miles westward in 50 days.

WATER "BUG BALL" IS PLAYED WITH ROUND MOTOR BOATS

Built like a canoe, but round in shape and driven by a small motor, a queer-



Round Boat with an Outboard Motor, Built for Playing a New Water Game Known as "Bug Ball"

looking boat is being made for a new water sport—"bug ball." The object of the game is to push a large, air-inflated ball,

30 inches in diameter, across the goal line without touching it with the hands. The boats are capable of surprising speed. When going straight ahead, the back end, to which the motor is attached, goes down into the water slightly, while the front tips up, so that the strange craft acts like a hydroplane. They are very sensitive to steering and the slightest turn of the motor, or variation of the propeller, will change the direction.

PAPER BAGS FOR AUTOMOBILES KEEP OUT DUST AND DAMP

For covering automobiles in storage, during the winter season or at any other time, heavy bags of dust-proof paper are being marketed. Made in different sizes and shaped to fit all cars, the enveloping covers hang evenly to the floor, keep out dust, absorb moisture, and afford a measure of protection against insects which destroy cloth upholstery.

Beckley - Oakland Co.,
18th Michigan
Chicago

Johnson motor Co. d'ind.
3364
3354

Copyrighted material

No. 226, Aug. 20, 1923

POLES OF ELASTIC CONCRETE BEND WITHOUT BREAKING

Hollow, concrete poles, designed to carry electric transmission lines, are being made by a process that allows them to bend under heavy strains without breaking. The top of a 64-foot pole will swing 7 feet from its normal position and back again without injury. Laid in a horizontal mold, the steel skeleton of the pole is covered with concrete, and revolved 1,000 times a minute. The force drives the concrete against the sides, where it forms a shell over the framework. The finished product is kept in the mold for two days and then buried in damp sand for four weeks to season. This method of manufacture was developed in Europe.

No other information
LEVER DRIVES NAILS FED INTO SPRING JAWS

To make rapid nailing possible, a hand-operated device has been patented that removes the danger of smashed thumbs and fingers.

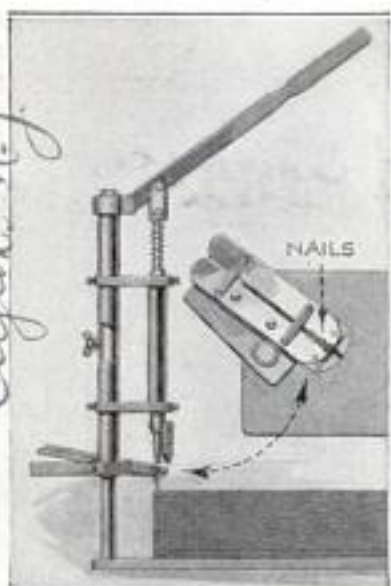

With each downward motion of its handle, a nail is driven home, another falling into position automatically when the lever is raised. Its capacity depends upon the speed with which it is manipulated. In shops or factories where boxes, door casings, and other easily handled articles are put together, it can be used to save time.

So numerous are the frauds practiced in the mails, that post-office officials are constantly alert to save the gullible from hundreds of thousands of dollars loss every year. Recently 21,000 letters, each thought to contain a dollar bill addressed to a fake company, were returned to the senders. To keep from the mails advertisements of "get rich quick" swindlers, the government issues fraud orders whenever dishonest schemes are detected.

THORNS OF CACTUS BECOME PHONOGRAPH NEEDLES

Thorns of the desert cactus weed are being used for phonograph needles after they have been dressed and sharpened



Above: Watering Cactus Plants in Back-Yard Garden. Below: Filing Thorns for Phonograph Needles

with a file. Besides producing a softer tone without scratching the records, they are said to last considerably longer than the metal article. One man who lives along the Pacific coast cultivates the plants in his back yard after they have been lifted from the desert soil. For many years this species was regarded as worthless, for, unlike many of its relatives, it is neither edible nor beautiful.

JAPAN BARS CHINESE WORDS FROM SCHOOLBOOKS

Chinese words to the number of 20,000 that slowly crept into the printed language of Japan, is said to be causing much concern among the teachers and officials of the latter country. Difficult to learn, they have hampered the education of the children in the public schools to such an extent that a society has formed to limit their use in textbooks. Reports say that the development of a Japanese typewriter has been made impossible by the great number of foreign signs and letters in general use that do not belong in the native alphabet. Not more than 2,000 of the characters will be permitted in future printing.

Emb. N. Sakata #19
Es-chome, Tada-yachi
Kojimachi-ku, Tokyo, Japan

d.m. Chas. Schmitt & Elfen, N.Y.

H. Leonard, Calif.

d.m.

3470

3349

3364

d no. James Pearson.

686

Box 32128

San Quentin, Calif.

3403

POPULAR MECHANICS

"FERRIS WHEEL" INKSTAND
CAN'T SPILL CONTENTS

Built like a Ferris wheel, an inkstand made by a California man prevents bottles of writing fluid which it holds from being knocked over or spilled while uncorked. Holders that keep them always

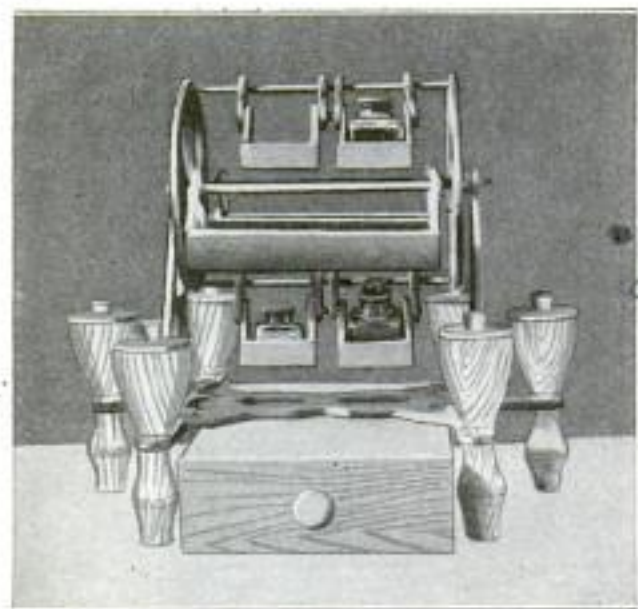

Holder for Ink Bottles and Desk Accessories That Operates Like a Ferris Wheel

in an upright position are fastened to a shaft that can be turned by a touch of the hand to bring the desired liquid with-

in reach. Containers for pencils and pens are also provided on the wheel, and six small cups for pins, paper clips, and other desk accessories, surround the stand.

PAPIER-MÂCHÉ REPLACES ICE
IN FRESH FIG SHIPMENTS

Papier-mâché, instead of ice, is being used to preserve shipments of fresh figs from the Pacific to the Atlantic coast. Containers of that material are in layer form, indented in the shape of the fruit so that each fig has an individual compartment. This method of shipping is expected to open unlimited markets, as it eliminates the cost of refrigeration.

d no. F. B. Scott, Los Angeles, Calif.

RADIO VIOLATIONS DETECTED
560 BY WIRELESS AUTO

Using a wireless-equipped automobile to detect any violations of the radio laws, is the method employed by the U. S. Bureau of Navigation, in the third and eighth districts of the radio service. The inspector of these districts and an assistant travel in the machine. These men regularly tour the middle Atlantic states in their car, which contains a complete receiving set, having masts mounted at the front and rear, between which is strung the antenna.

U. S. Dept. of Commerce, Bureau of Navigation

AFRICANS MAKE FISH-NET FRAME TO SAVE LABOR



As a Result of Ages of Experience, African Fishermen Fastened Cone-Shaped Nets on a Frame of Tree Trunks and Branches Built Across a Swift River

To save labor of catching fish by hand nets, natives in an isolated part of Africa have stretched a big frame of tree trunks and branches across a swiftly moving river. From the crosspieces at

the top, are hung large cone-shaped nets, which trap the fish. Ages of experience in fishing with various sorts of spears, hooks, and seines, resulted in this crudely built net.

Neuman Travel Talks, Tribune Bids, Chicago

copyrighted material

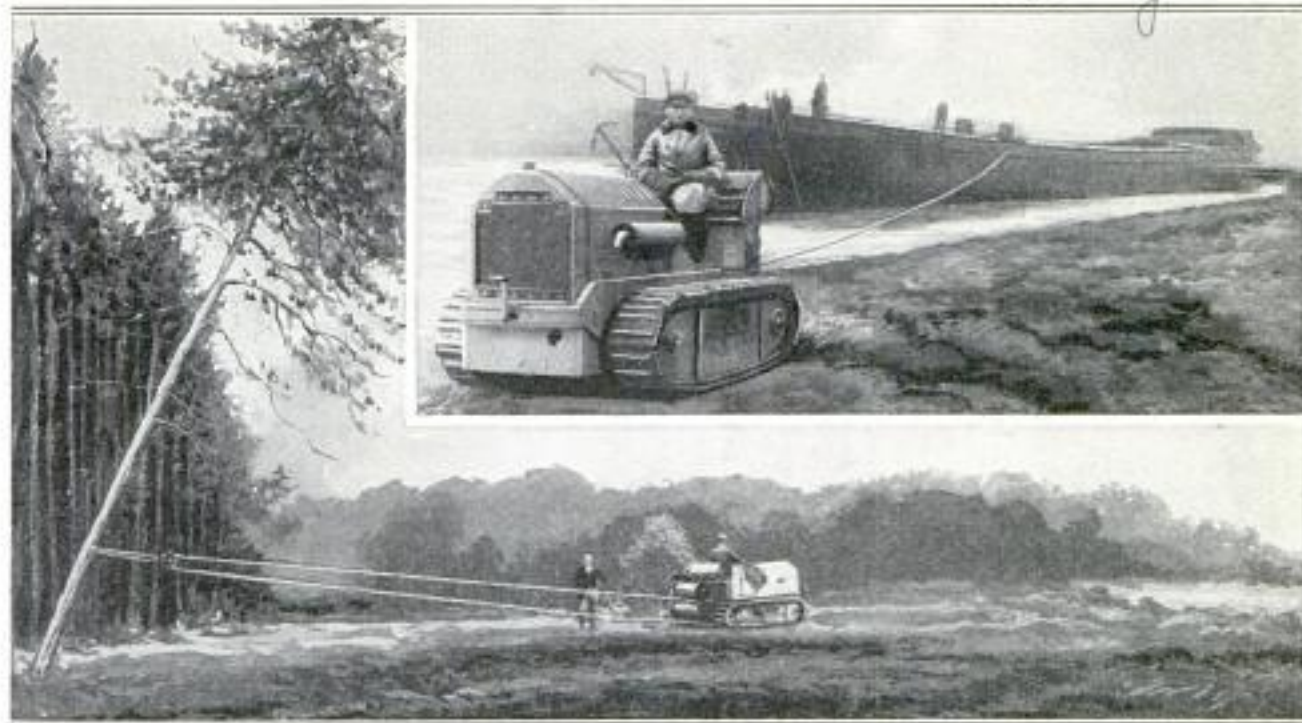

Above: Tractor Hauling Heavy Barge Through Canal, Performing a Task Requiring Several Horses.
 Below: Doing the Work of the Lumbermen in Felling Forests of Great Trees

TRACTORS TOW CANAL BARGES AND FELL GIANT TREES

In Europe the farm tractor is being put to work towing large ships and heavy barges through canals. Running along the banks it requires very little in the way of a towpath, as its caterpillar tread surmounts almost any obstruction. Many horses are released by this arrangement for work in other fields. Lumbermen have also called upon the tractor to pull down trees in the timber forests. It accomplishes in a few moments tasks that usually require the services of several men with saws and axes.

FOSSIL SIMILAR TO CORNSTALK MYSTIFIES SCIENTISTS

With the finding, in an Illinois coal mine, of a plant fossil resembling a cornstalk, previously accepted theories on the evolution of flowering plants are blasted, according to some botanists, and the mystery of their origin is pushed thousands of years farther back into the geological past. The strata from which the fossil was obtained were identified as belonging to the Paleozoic era, next to the oldest time division of geology, containing traces of long-extinct plant and animal life. Heretofore all reported specimens of land plants possessing highly organized structures, such as attributed to this recently discovered fossil, have been found in parts of the earth's crust formed during

the Mesozoic period, which came millions of years after the Paleozoic era. From these previous findings, botanists have assumed that flowering plants began to appear about the latter part of the age during which the coal-forming plants flourished. They had expected to discover more primitive growths in these strata, but the new find indicates that flowering plants had already gone through an exceedingly long process of development before the earliest period recorded in the fossil rocks.

HACKSAW WITH PISTOL GRIP FITS MANY BLADES

Designed to reduce fatigue, a hacksaw is being made with a handle shaped like a pistol grip. By sliding the frame forward or backward, many different sizes of blades can be fitted to it. Bolts that lock the saw in place are so arranged

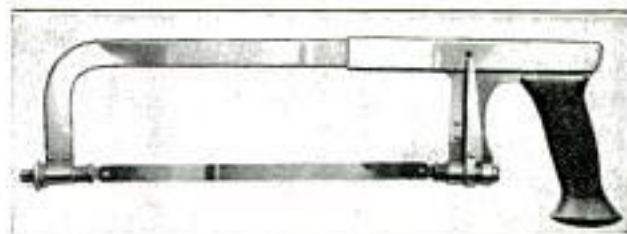

Hacksaw, Adjustable to Blades of Different Size, That Has Pistol-Grip Handle to Lessen Fatigue

that it can be turned sideways for horizontal cutting. Changes can be accomplished easily by a few simple adjustments.

Kansas City Star
 8/19/23

Albany Hardware Co.
 Specially Imported
 Albany, Wis.

688
 3465

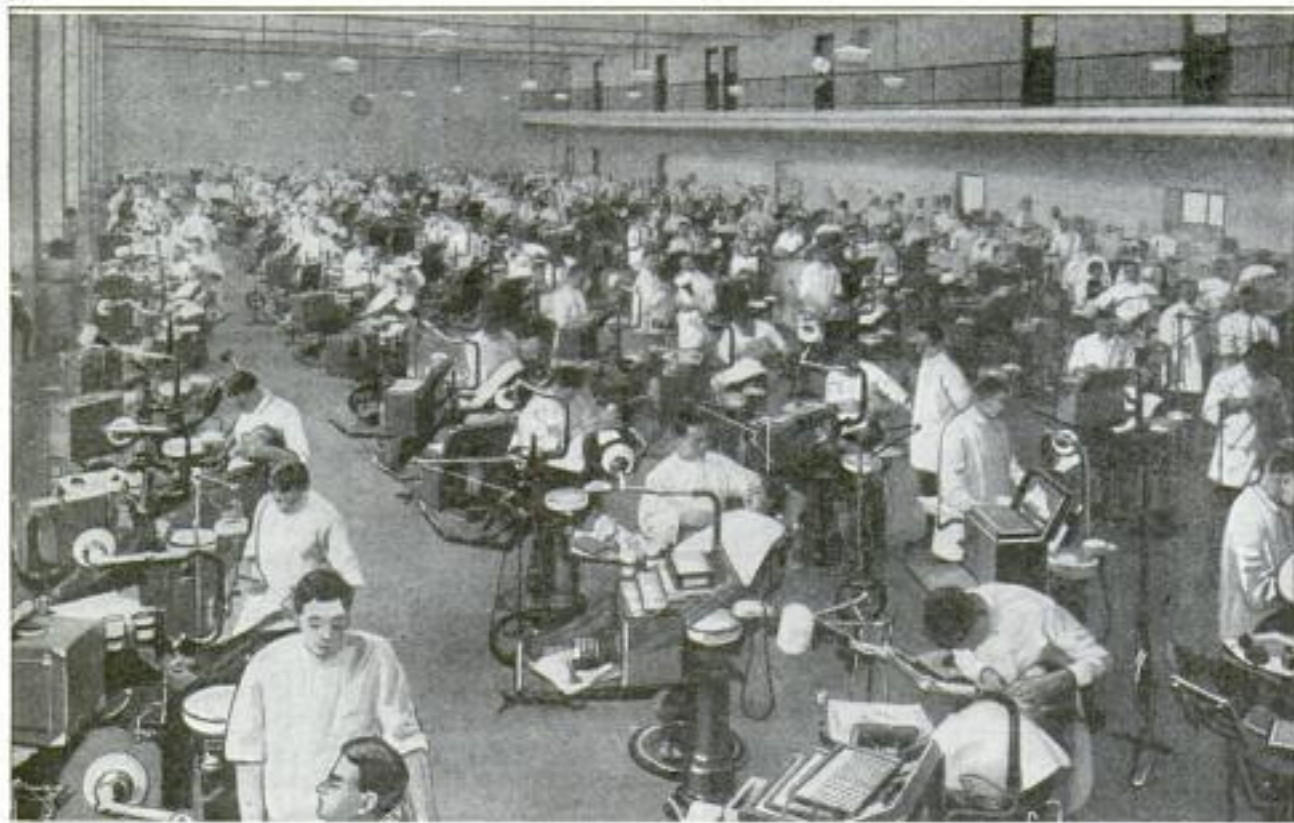

Treating Nearly Two Hundred Patients at One Time in the Laboratory of a Dental College So Students May Combine Actual Practice with Their Technical Training

**TREATMENT OF TEETH TAUGHT
 IN ROOM OF HUNDRED CHAIRS**

3465
 So that large classes of students in dentistry may receive practical training at the same time, a college in the middle West has furnished a laboratory with 152 completely equipped dentist chairs. Every instrument needed in ordinary practice of the profession is furnished each pupil, and all work together under the direction of a single instructor. Assistants to the dental teacher pass among the scholars inspecting the results of their efforts, and cautioning and advising them as to the proper methods.

**CALICO MONEY AND BICYCLE
 HELP TO SUBDU JUNGLE**

3524
 Plans to connect Katanga, in the Belgian Kongo, by rail with a West Africa port, tend to emphasize the extreme range of civilization in this mid-continent colony. White men, who first went there used bicycles on their journey, for the tsetse fly is a bar to domestic animals. Now a network of paved motor roads covers the region; yet, along these highways, travelers still build fires at night to ward off lions and savage natives, who chant, "white man, white man, we'll dance tomorrow with your head on the end of a spear." Bantu tribesmen do

business with calico money. They produce great quantities of rubber, coconuts, palm oil, sugar, and ivory, but the country's chief asset, perhaps, is its copper mines. Tin, iron, and coal are mined also, and gold is found in some sections.

3481
**CINDER BLOCKS FOR BUILDING
 PRESSED ON SITE OF WORK**

By a recently invented chemical process ordinary coal cinders are turned into bricks for building purposes. It is claimed that these blocks are cheaper than clay brick or tile and, in addition



Latest Form of Cinder Building Blocks Being Laid in a Model Cottage

Chas. Frank Cordery
 Copyrighted material

*maker - John P. Hallis - arr. New Rochelle, N.Y.
 10 Rand old*

Utah Press 9/14/23

The Scott Corp.
72 W. Washington,
Chicago

POPULAR MECHANICS

are nonconductors of heat, and cold. The press for making the bricks can be set up on the site of a building under construction and the blocks can be turned out ready for use within 24 hours after being molded.

HEAT IMPRISONED IN FLASKS IS RELEASED AT TOUCH

Metal flasks in which heat is stored are being made for use in homes and hospitals, and as foot warmers in automobiles. Richly nicked on alloy metal, they are filled with a harmless, odorless chemical compound that never has to be changed, and which is capable of absorbing and holding heat to be discharged by simply unscrewing a small knob stopper and replacing it. While the actual heat is bottled up, the outside of the container remains cool until the cork is removed for a few seconds and inserted again, when the outer surface becomes hot and remains so for several hours.

ELECTRIC BULB IN VAPORIZER GETS LIQUID THROUGH WICK

To insure an even and constant supply of medicated vapor for treatment of nose,

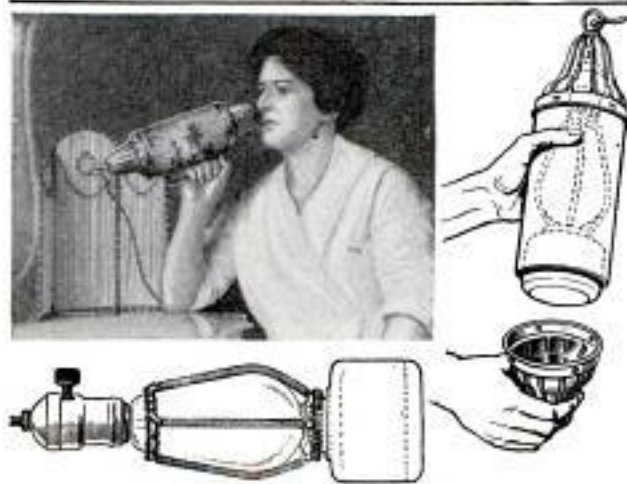

How Heat of Electric-Light Bulb Is Used to Provide Medicated Vapor

throat, and lung ailments, a western physician has invented an apparatus that by an electric light heats the medicine fed through a wick. The fluid is carried from a container to the lamp, where it vaporizes on the surface of the bulb. Filled with curative oils, the device can be placed in a water-soaked cylinder of gauze and by drawing from both sources mix the vapors together. By removing a plug the volume of healing steam can be increased.

International Newsreel

PRACTICE GOLF ON SHIP'S DECK PLAYED WITH SPIKED CLUBS

Spearing a ball with sharp prongs, a device that fits over the head of a golf club is being used by golfers aboard



Spikes Holding Ball to Head of Golf Club After Practice Drive on Shipboard

ocean liners for practicing the game. Instead of being knocked away by the impact of a "drive," the special soft sphere is held by the spikes. The attachment may also be used in large rooms without danger of sending the ball in flight. Thus, a player can perfect his strokes without going to the links. The cover is detached easily, and fastens firmly by clamps.

NUT THAT LOCKS ON BOLT CAN'T LOOSEN GRIP

Slotted through its side, a nut is being made designed to lock itself on a bolt. The two halves exert a pull on each other, binding it securely to the threads. Not requiring a washer, it often allows for a shorter bolt, resulting in a saving of material. Turned out in many different sizes, it can be used in the vital parts of automobiles and machinery, or employed in fastenings that are subject to great strains; also, it is not affected by excessive vibration.



The Radiator Co.,
240 Stockton St.
San Francisco.

Chapman Self-Locking Nut
Continental
Bldg. Baltimore, Md.

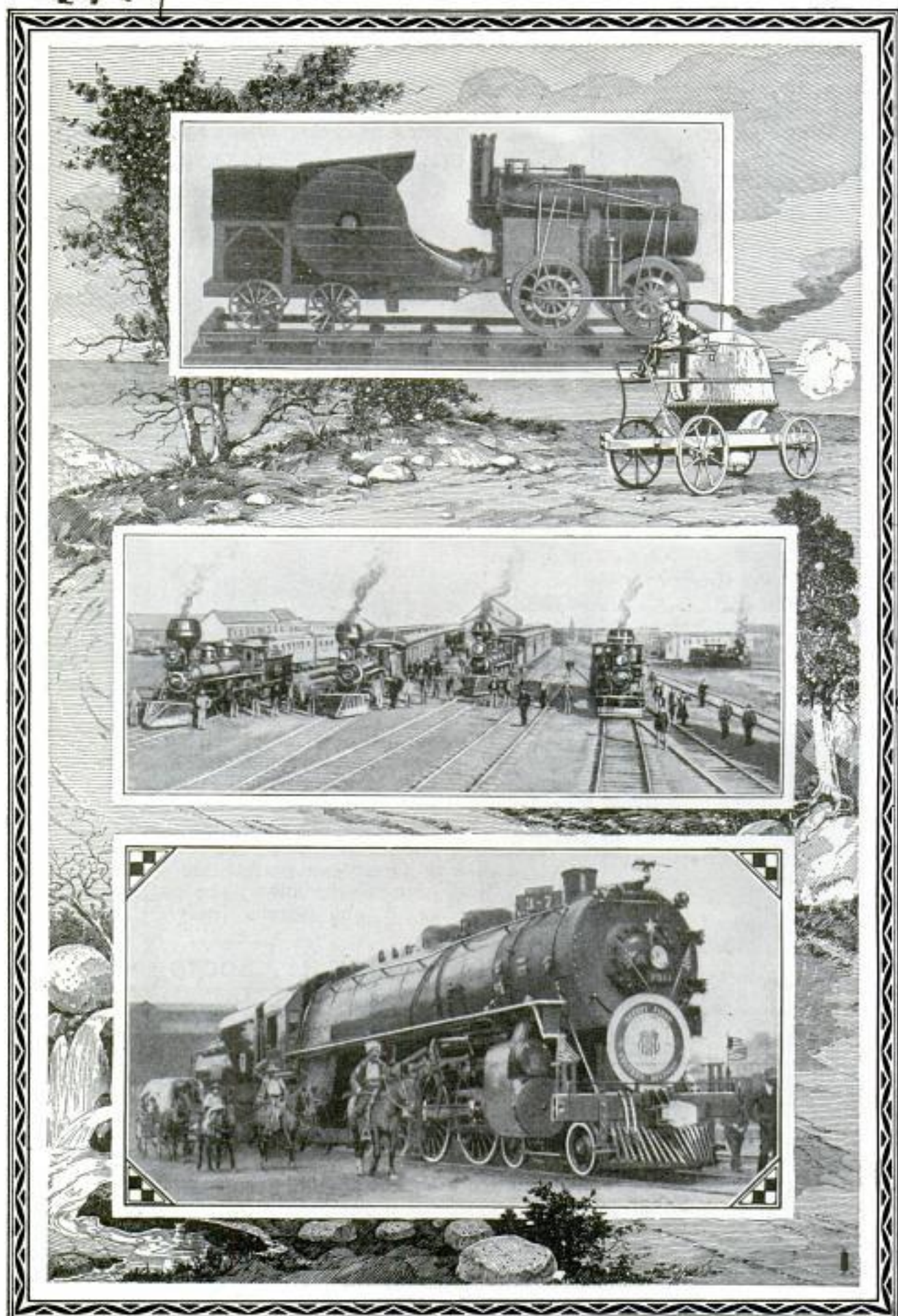

From the Midget Locomotive of 1827 to the Giant Mogul of Today, Showing, in Center, a Group of Transcontinental Trains at Ogden, Utah, in 1884

2829

Untold Millions Being Spent by Railways to Meet Nation's Needs

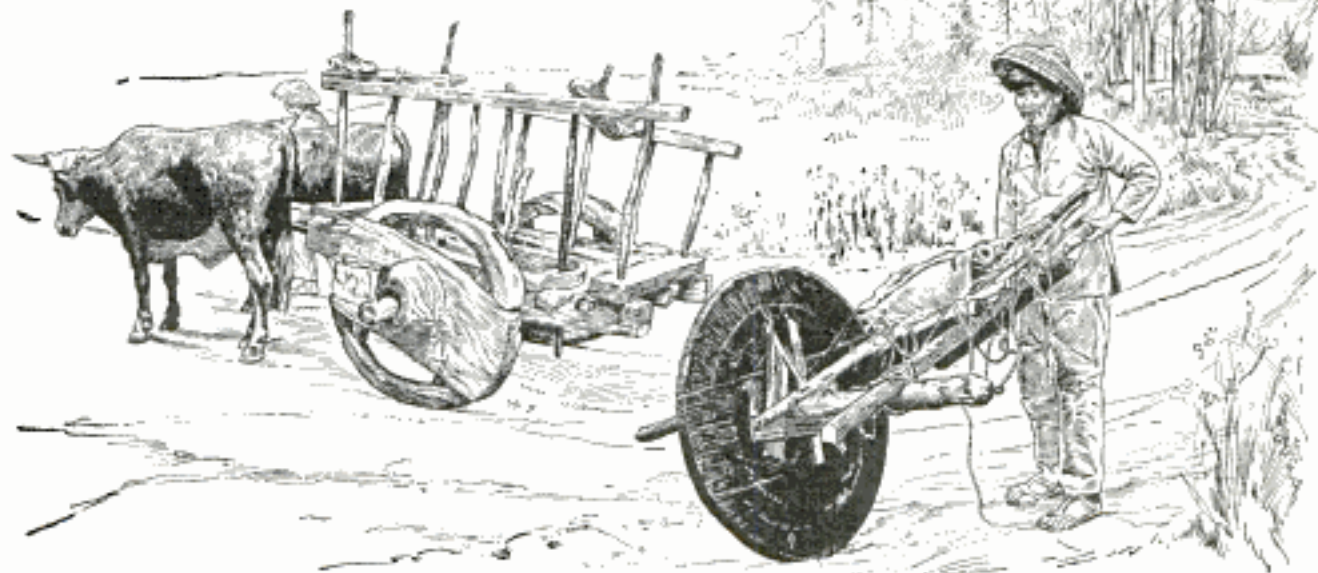

From the Primitive Wheelbarrow to the Oxcart

TO meet the growing needs of the nation's business, the railways of the United States, it is estimated, are spending approximately \$1,000,000,000 for improvements and new equipment. This is said to be the largest expenditure of the kind ever made in a single year.

In all parts of the country, terminal facilities are being enlarged, switches lengthened to accommodate trains of 100 cars instead of 50, new tracks laid, costly curves and grades eliminated, and freight capacity greatly increased.

According to one executive, the present difficulties of the roads are due not so much to lack of cars and motive power as to the need of second, third, and fourth tracks in the main arteries of transportation, and larger facilities. Untold millions are needed to correct the sharp curves and steep grades built in the days of the pioneer rail-
roaders.

It was less

than 100 years ago that Baltimore merchants built a road with rails of scrap iron and operated nearly a year with horsepower. As late as 1858, the people of New York held meetings and resolved that the railroads had no right to carry freight in competition with the Erie Canal. Within the lifetime of men now living it was proved by algebraic formula that no locomotive could possibly climb a grade under its own power.

Fifty years ago the attention of the country was held by the proposal to build a railroad over the Rocky Mountains. Following the natural thoroughfare used by immense herds of buffalo,

by the Indians, explorers, Mormons, gold-seekers, stage-coaches, and pony express, the march of the construction crews over the great divide did not begin until after the Civil War. And yet in 1860 the volume of vehicle traffic

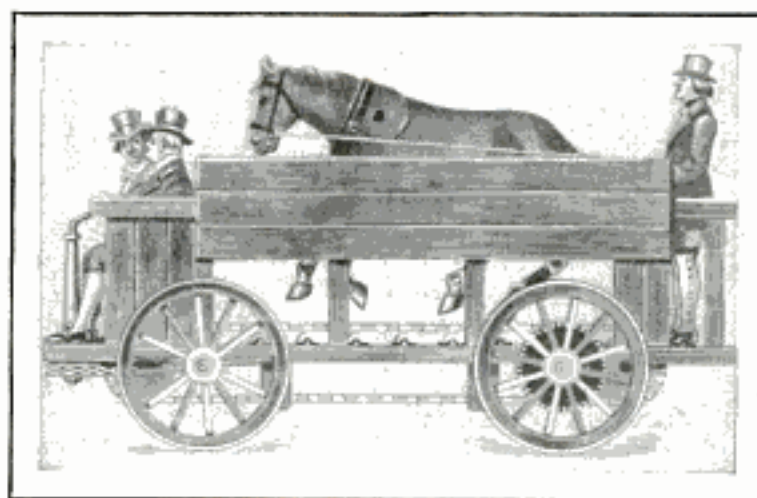

Putting the Cart Before the Horse in the First Treadmill Carriage

Cont. Harry Levy Service Corp
130 W. 46th, New York

Copyrighted material

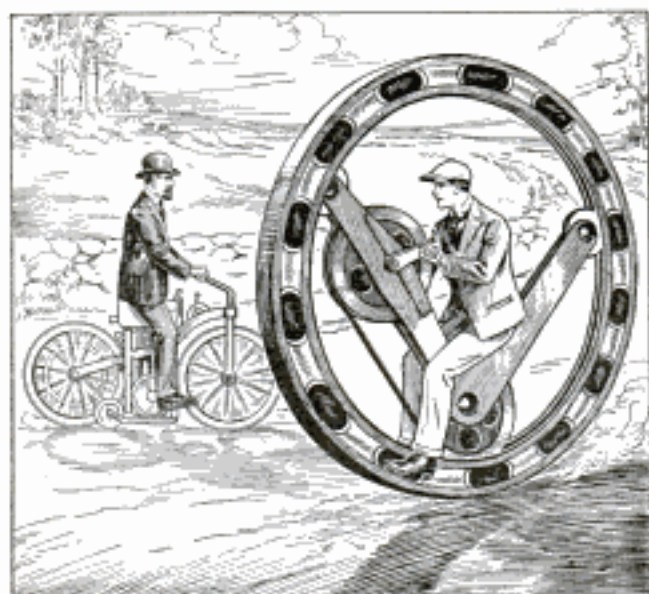

First Motorcycle and an Early Suggestion of a Bicycle Operated by Hand

along this route had grown to immense proportions, 500 freight wagons frequently passing Fort Kearney, Neb., in a day, and 888 westbound prairie schooners, drawn by 10,600 oxen, being counted between that post and Julesburg in 24 hours.

During 1861 Ben Holladay's famous stagecoach line was established, the journey from St. Joseph, Mo., to California requiring 18 days and costing more than \$225. Later, the pony express made the trip in ten days. With the opening of the first transcontinental railway, the journey to San Francisco from New York was cut down to about eight days, although now the trip may be made on fast trains in about 96 hours.

In some cities the streets are said to follow the old-time cow paths of the wilderness. This is literally true of the railroads, as the paths of the buffalo and deer led to the most accessible passes and, in many instances, determined the route taken by the surveyor's chain. Because of the constantly increasing demand for better and quicker transportation, the mistakes then made have now to be corrected.

Railroad profits are figured in fractions of a cent. The value of commodities constantly in transit is over \$1,500,000,000. If the average time could be reduced only one day a year, a saving of approximately

\$20,000,000 in interest charges alone would result. A half cent is a small sum in itself, but multiplied by the number of tons passing over a busy railroad every day, it shows why the roads are willing to spend millions in the reduction of curves and grades, and in speeding up travel generally.

Railways were not built "right" in the first place, owing to inadequate tools and lack of capital. It is said that the Chicago and Northwestern Railroad's first line was financed largely through the sale of potatoes and other contributed commodities. In those days it was cheaper to go around a hill than to go through it. Labor-saving devices were few. The wheeled scraper did not appear until 1877, when some one "put wheels on a dustpan and b'gosh, it ran," as a

contemporary remarks. Dynamite, an absolute essential of modern engineering, is a comparatively recent development.

Not so very long ago freight cars of 40,000 pounds were considered large. Now a capacity of 100,000 pounds is the standard. Larger and heavier locomotives have had to be made, 110-pound steel rails replaced those of 60 pounds, stronger bridges were necessary, and sidings had to be lengthened to care for longer trains. Ninety per cent of the sidings built prior to 1917 are now too short to take care of the larger freight trains.

At the present time the

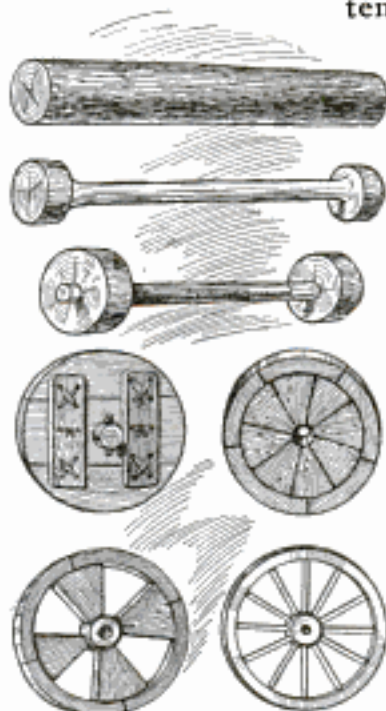

Evolution of the Wheel, and, Below, a Primitive Bicycle and Steam Automobile

New York Central is spending \$15,000,000 because the city of Albany stands 135 feet lower than the highlands beyond. To avoid climbing this grade, a new line

is being constructed to allow through-freight trains to go around it without passing through Albany at all. To give Detroit a direct line into the coal fields of Pennsylvania, \$20,000,000 is being expended. Meanwhile the Illinois Central is at work on an \$80,000,000 building program in and around Chicago.

All of these activities give only a faint idea of the progress of transportation since prehistoric man first developed the

wheel from a log, attached it to a crude axle, and then built a cart in which to carry his possessions. Today, grades so slight that the human eye can barely detect them are being leveled at a cost of millions of dollars. A cut of an inch and two-tenths in 100 feet cannot seemingly do much to relieve freight congestion, but such a reduction will allow 500 tons to be added to the weight of freight trains passing over the line.

PESTS IN COTTON FIELDS BOOST ARSENIC MINES

Arsenic mines in the West are kept busy by demands for their products coming from the cotton growers of the South. When the boll weevils invade a section of the fields, there are hurried preparations made in the surrounding country to repel the pest. One of the most effective weapons is calcium arsenate, gathered from the residue of gold ore. After the yellow metal is removed the arsenic is burned out of the crushed rock.

Detroit Free Press 9/4/23

"AIRPLANE" SCENES FOR MOVIES "SHOT" FROM HIGH LADDER

Some aerial motion-pictures taken from the ladder mounted raises the camera feet in the air, said to be as retaken from air of signals the di touch with the er, informing "shooting" the camera is back of the climbs to his diz way scenes are



scenes in a west- ture studio are top of a high on a truck that man 80 to 100 The pictures are alistic as those planes. By a set rector keeps in photograph- him when to start scenes. The heavy strapped to the operator as he zy perch. In this easily filmed.



Perched High on a Ladder, This Motion-Picture Photographer Gets "Airplane" Views

International Newsreel

MODEL GOLF COURSE IN OFFICE BUILDING FOR INDOOR GAMES

Modeled after an outdoor nine-hole course, a golf links has been built on the ground floor of a large office building in



Indoor Golfing Amid Bark-Covered Pillars Has All the Thrills of Outdoor Game

a Pacific-coast city. Sand-covered clay is substituted for grass, while the pillars of the structure are covered with huge strips of pine bark to represent trees. The walls are decorated with landscape scenes, and the ceiling, painted sky blue, is illuminated by electric lamps. One of the walls is covered by a picture of a clubhouse with a long framework veranda built in front of it where spectators, seated in wicker chairs, can watch the players. This indoor playground also has its hazards, such as hedges, a small, narrow tunnel, and bunkers of sand and clay. Nets are used to catch the drives.

Ships in East Prussia travel on dry land when going from Elbing, the seaport, to the lakes in the highlands. Special sluices have been built along the canal connecting the sea with those waterways. When a vessel has to "climb," it is loaded on wagons run over a double-track railway in the water.

3500

Emb. George S. Oliver, 104-17th Ave. Seattle 9/1/23

3396

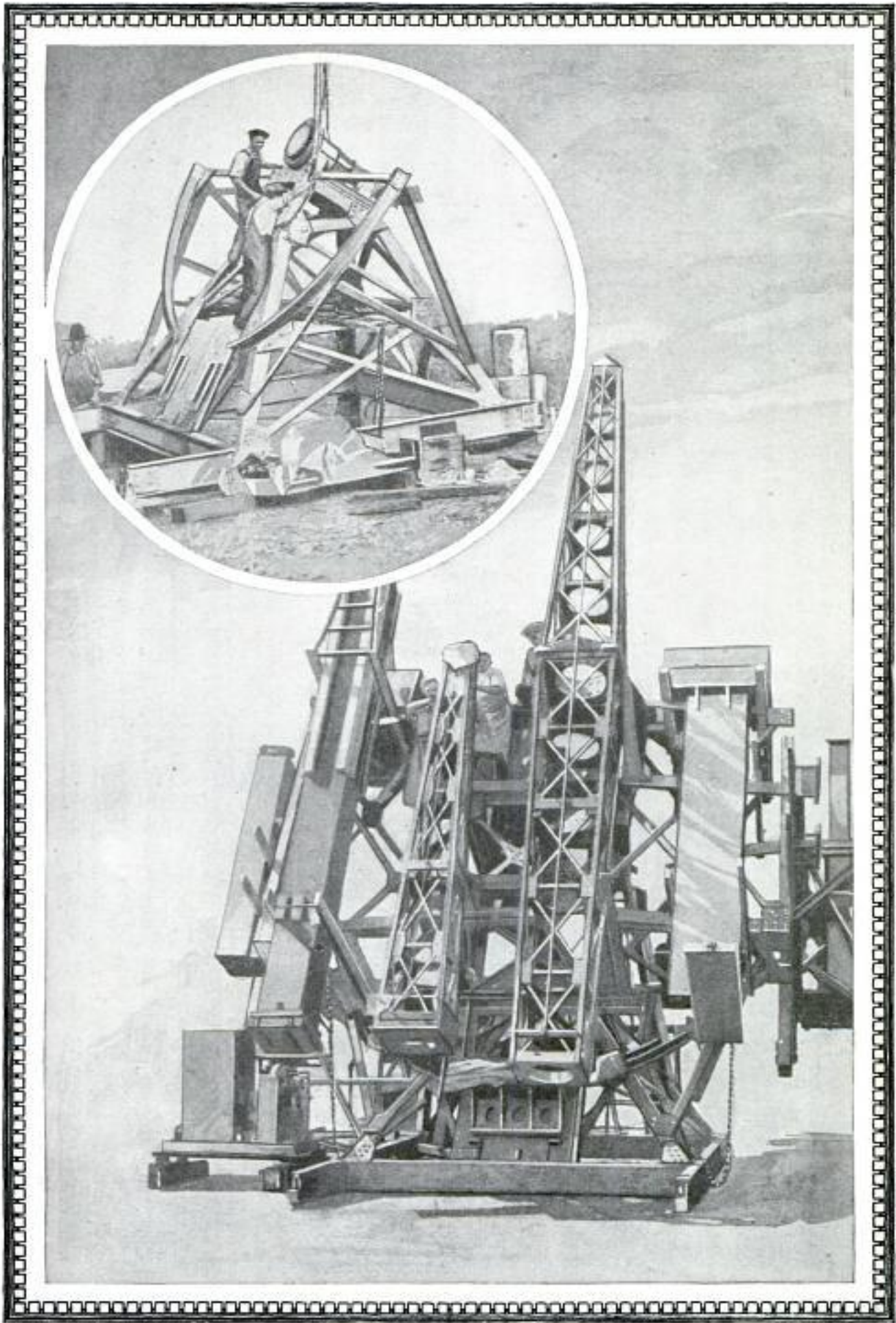

COPYRIGHT, UNDERWOOD & UNDERWOOD
In Attempting to Make a "Movie" Record of the Recent Total Eclipse of the Sun Seen in America Huge Telescopes and Masses of Complicated Apparatus Were Required

3205

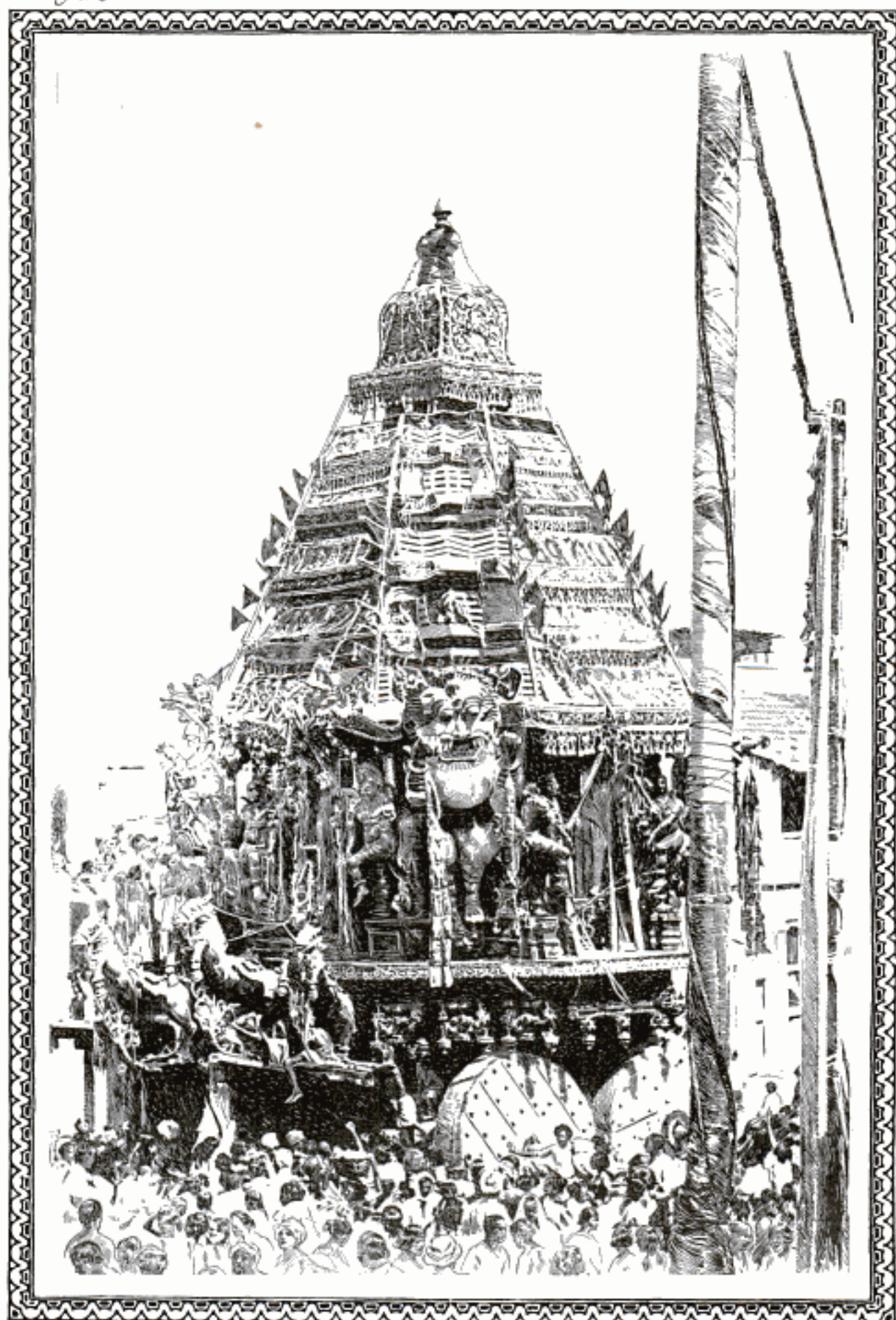

Eager Throng of Pilgrims Hauling "Car of Juggernaut" and Its Ornate Burden During Strange Ceremony That Has Been Solemnized for Centuries by a Certain Religious Sect in India

“JUGGERNAUT’S” WHEELS AGAIN MOVED BY PILGRIMS

Celebrated for centuries in India, the “Car Festival” of the Hindu god, Vishnu, attracts thousands of pilgrims each year. The ceremony derived its name from the huge car, 45 feet high, 35 feet square, and supported on 16 wooden wheels, 7 feet in diameter, on which the giant figure of the deity is moved through the streets. Often referred to as the “Juggernaut,” the vehicle is the center of many stories of natives being crushed to death under its massive wheels. The main temple where the image is stored for the greater part of the year is a colossal affair, 192 feet high, crowned with a mystic wheel. An immense inner in-

closure contains a number of small temples and shrines. It is divided into four principal rooms, the hall of offerings, the dancing hall, the audience chamber, and the shrine. Although the statue is hauled less than a mile, it takes several days to complete the trip, because of the deep sands along the route. Eager pilgrims vie with one another for the privilege of hauling at the ropes. The festival is the most important ceremony of the year, and elaborate services are held daily. The various images are dressed and redressed, and four meals a day served them. Special servants are assigned to the task of putting the idol, Vishnu, to bed.

International Newsreel

MIRROR IN SIGNAL TOWER “SEES” AROUND CURVE

As a safeguard against accidents, a huge mirror keeps silent vigil at a blind

hidden line by glancing at the mirror, placed on a level with his cage. This

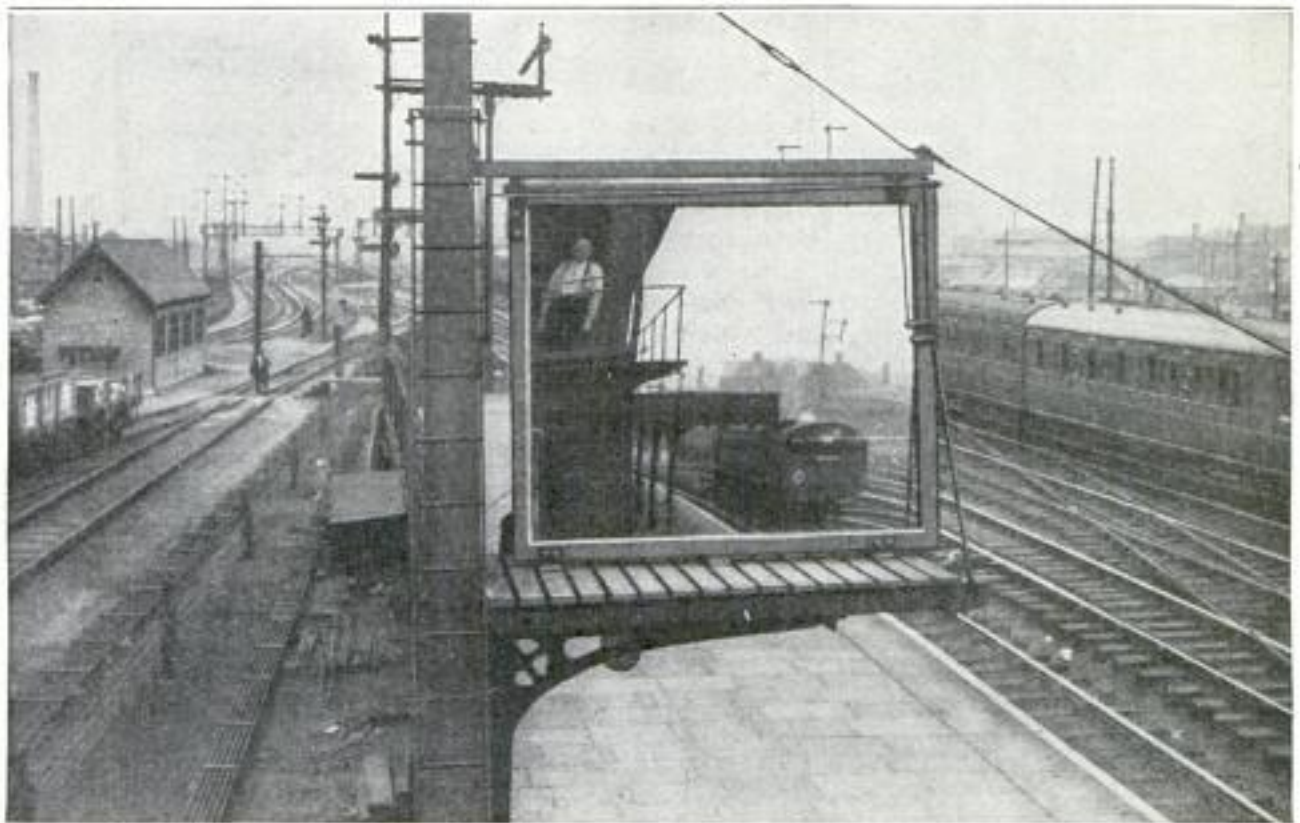

Mirror over Railway Tracks That Enables Signalman to “See” Around a Blind Curve, Adding to the Safety of Passengers on Approaching Trains Which Otherwise Would Be Hidden from View

curve on an English railroad, permitting the signalman to see oncoming trains otherwise hidden from his view. From his position in the tower, the operator, upon whose watchfulness and care depends the safety of many passengers and employes, can obtain a clear view of the

“third eye” is effective at night, too, since it reflects the rays from headlights of approaching locomotives.

By swimming the Dardanelles, six British soldiers have performed the feat for which the Greek god, Hero, was famed.

*Anureat Stratford Station
L. N. R. R., England*

Ride "Pullman"
"PULLMAN" OF HIGHWAY HAS COMFORTS OF HOME

3348
 All conveniences of a modern home, from the kitchen to the living room, are included in a specially designed touring automobile recently built for a wealthy manufacturer. Trimmed throughout in mahogany, with decorations to match, the forward part has four revolving arm chairs, which can be made into beds at night, or, by another attachment, converted into dining tables. The rear is

Current for light and heat is supplied by an electric generating machine, water is stored in a 40-gallon tank having an air-pump attachment and fastened under the chassis at the rear, while extra gasoline is carried in another receptacle underneath the car.

A radio set is installed back of the chauffeur's seat, while a speaking tube permits the occupants to talk to the driver.



De Luxe Automobile Coach Containing All the Comforts of a Yacht or of the Home, Including Revolving Arm Chairs, Electric Light, Kitchen, and a Radio Set

fitted as a kitchen, containing two oil stoves and an electric cooker, a folding table, a refrigerator equipped with an ice-making machine, cupboards for concealing the cooking utensils, and wash basin.

The interior is lighted by dome lamps and there are separate lighting fixtures for each chair. Roof ventilators provide fresh air, while two oscillating fans keep the car cool. Outside at the rear is an iron folding frame to carry light baggage.

3470

**INSULATORS FOR HEAVY WIRES
 SCREWED IN PLACE BY HAND**

Made of porcelain, an insulating knob for electric-transmission lines can be screwed in place without the use of tools

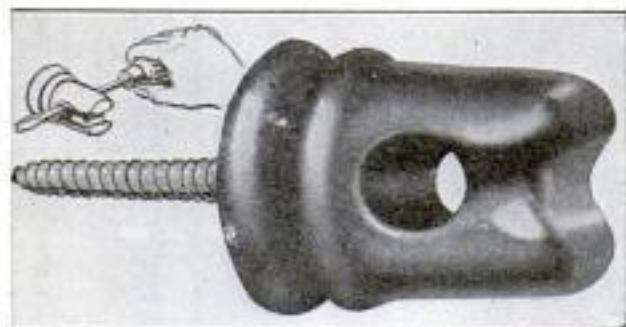

Insulator and How It May Be Screwed in Place with the Hands

or fasteners other than its own threaded pin. Inserting a screwdriver into a hole

gives a firm grip for turning, and it can be seated so close to a surface, that water cannot seep under the base. Strains up to 1,500 pounds can be put upon the holder without dislodging it from position.

**PAGE GUESTS BY RADIOPHONES
 PLACED IN HOTEL'S HALLS**

3475
 Guests of an eastern hotel will be paged by radio from the telephone operator's desk through loud-speaking microphones scattered through the halls and lobbies. At whatever point he might be, the visitor may hear the speaker's voice. All of the sounders will send forth the call at the same time. During the day and evening, concerts, lectures, and musical programs will be rendered through the radio and telephone systems for the benefit of those who live at the hostelry.

Lurham & Co. Inc.
 1936 Market St.
 Philadelphia Pa.

Build for W. J. Hadley, Fern Hall, 3348 Euclid Ave. Cleveland Ohio.
Line Material Co., South Milwaukee Wis.

~~3475~~ ~~Sturham & Co, Inc.~~
~~1936~~ Market St.
POPULAR MECHANICS
8348 Philadelphia Pa. 698

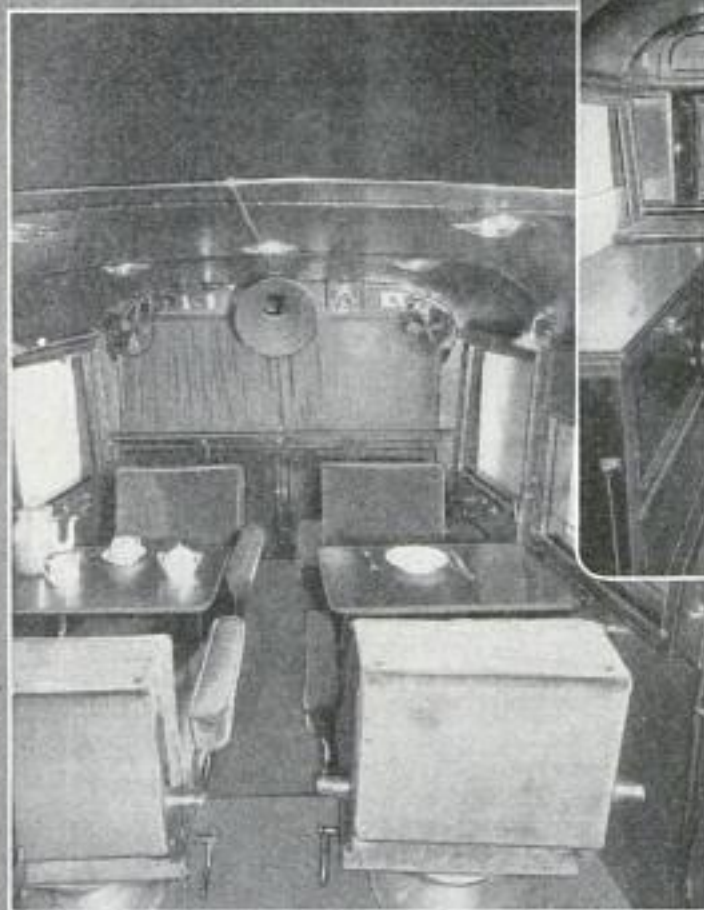

Luxurious Dining Room in Touring Automobile Where Meals May Be Served to Music Provided by the Radio Set in Top of Coach

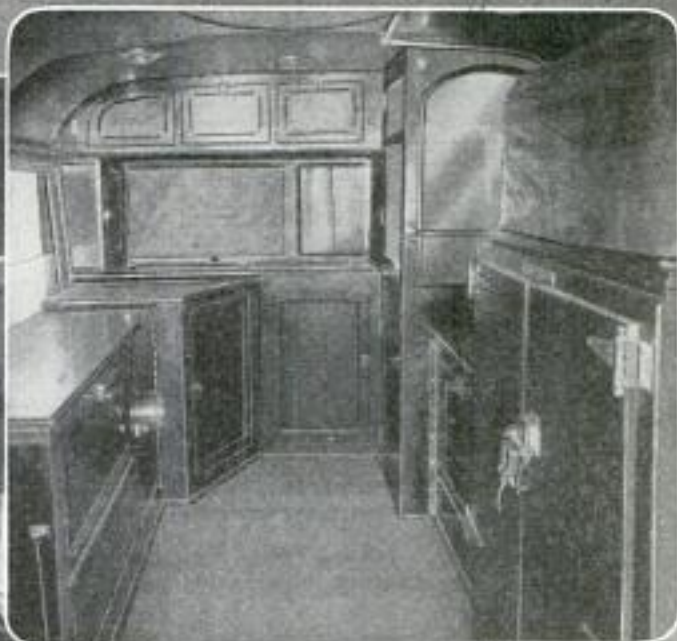

Compact Kitchen Compartment with Everything Needed to Turn Out Full-Course Dinner While Touring Comfortably Across the Country

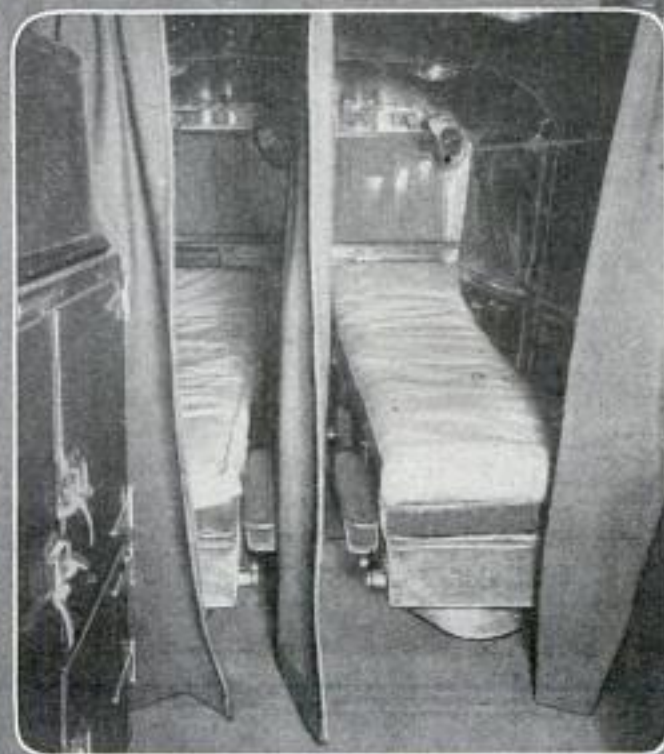

How Pullman Chairs Are Turned into Beds, and the Observation Compartment Lighted by Electricity and Cooled in Summer by Electric Fans: Broad Plate-Glass Windows Give an Unobstructed View of the Passing Scenery

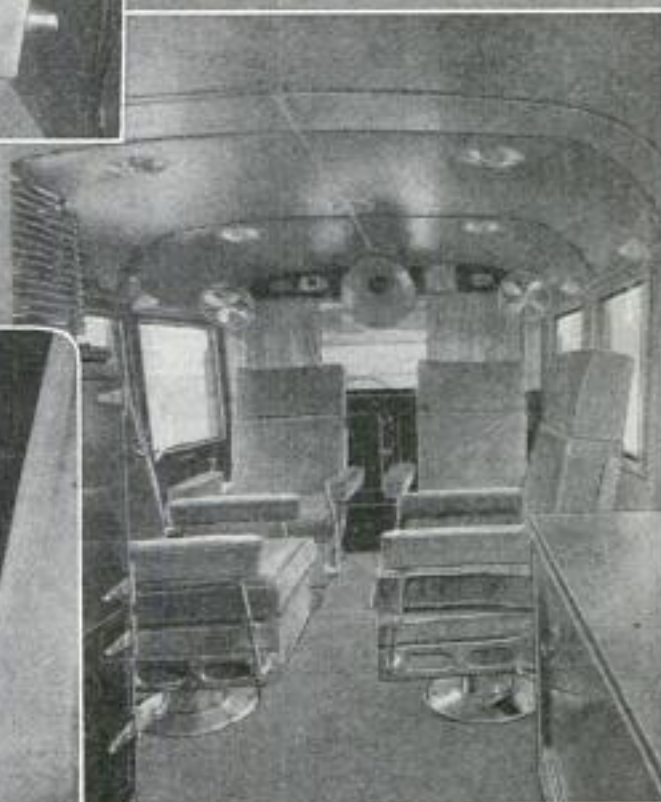



Preparing to "Pour Oil on Troubled Waters" to Aid Shipwreck Victims by Calming Sea

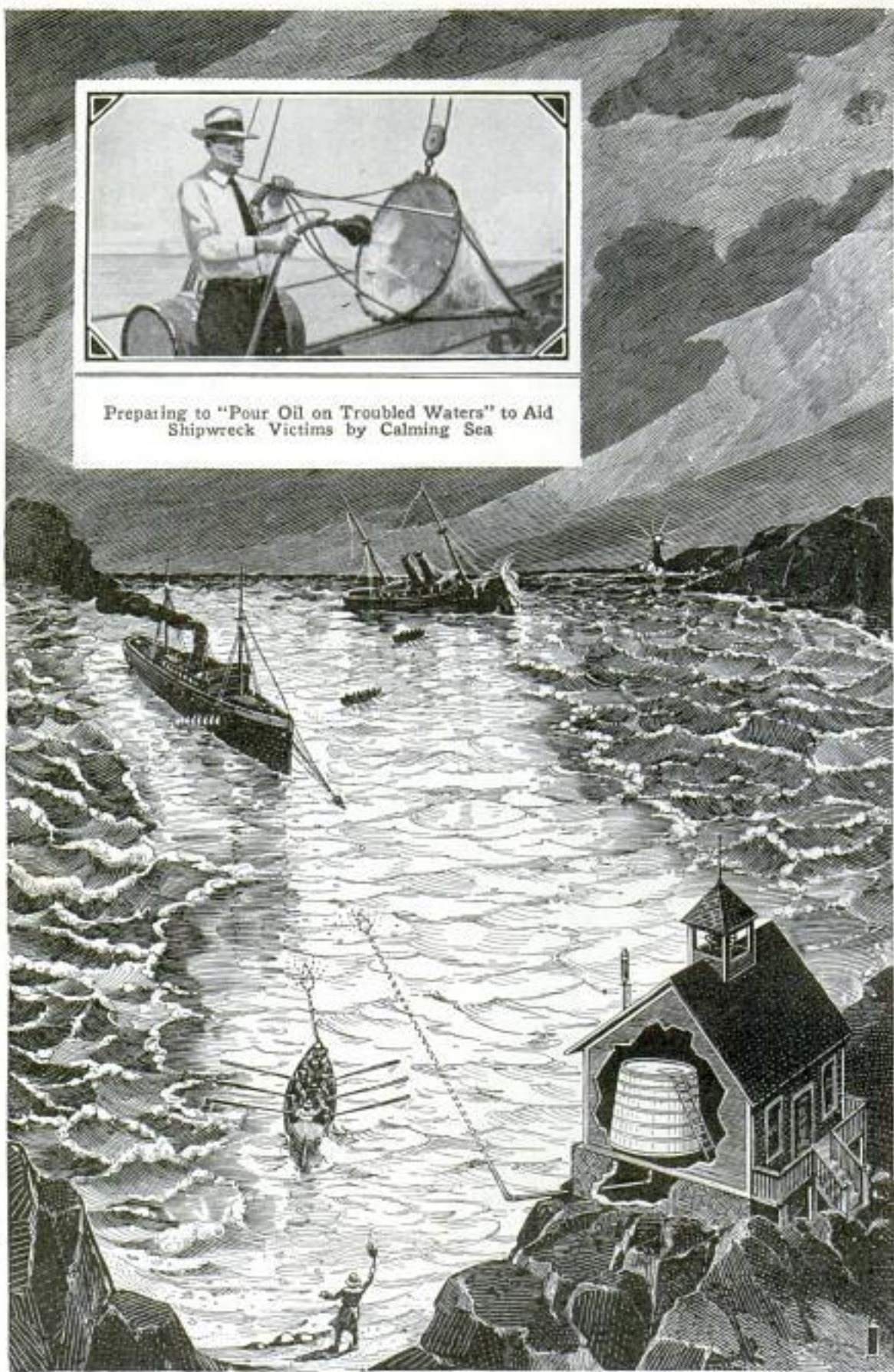

Oil Spreader Being Used from Ships and Shore to Subdue Breakers and Protect Passengers, Crews, Vessels, and Breakwaters: Pumped from a Tank, the Lubricant Is Sprayed Over a Wide Area

creator, Harry W. S. Toberg, Galveston, Tex. as.

Chicago Evening Post
9/6/23
701

POPULAR MECHANICS

3533 3468

Emb. Edison, I prize arrangement Washington D. C.

OIL SPREADER FOR ROUGH SEAS TO HELP SHIPS IN STORMS

To calm rough waters around ships caught in storms, a southern man has invented a spreader that sprays oil over a large area around the vessel. Pumped from a tank on deck, the fluid passes far out from the boat to umbrellalike devices of canvas that are set floating in the sea. It can be used for large or small craft, or from lifeboats while making their way through heavy waves in the event of disaster.

3527

METALS AFFECTED BY ACIDS FOUND TO KILL GERMS

That certain metals are capable of destroying any germs that come in contact with them has been proved by recent experiments. Among these are copper, brass, zinc, and silver. Observations made during the tests showed that those which kill microbes are most readily attacked by chemicals. Pure gold, freshly cleaned and polished, nickel, and platinum failed to harm the germs.

3467

MESSAGES RECORDED IN CODE EXPLAINED BY TYPEWRITER

For sending telegraph messages in a code so that they will be received in translated form, a British inventor has made an electrical device that connects two widely separated typewriters.

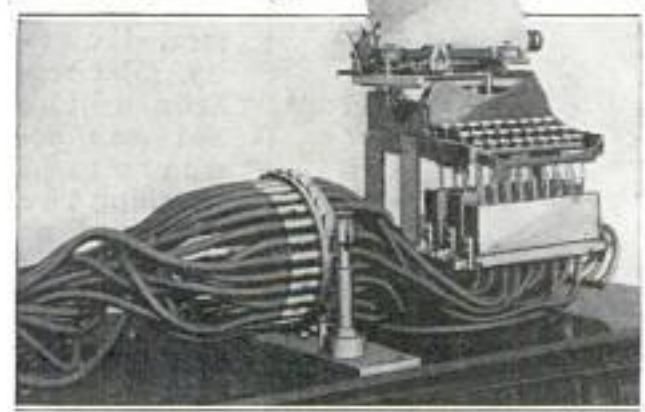

Typewriter Controlled by Coding Device That Sends Its Messages to Another Machine for Translation

An operator writes coded matter on one machine and it is immediately communicated to the other, which interprets the signs as fast as received through the attachment to its keys. Much of the time usually spent in decoding confidential information, it is said, can be saved by the apparatus.

International Show at exhibition of inventions at London.

"SOUL SEARCHER" GETS TRUTH FROM CRIMINAL MINDS

Persons suspected of crime may be betrayed or acquitted by a delicate instrument recently invented by a western uni-

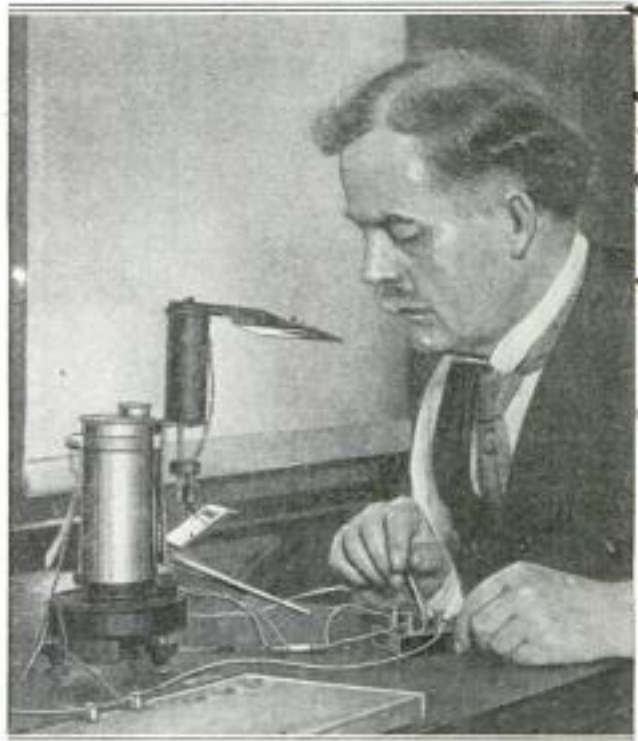

Watching Changes in Blood Pressure Registered by a Machine That Detects Truth in a Criminal

versity professor. By changes in blood pressure, it is intended to show the working of the subject's mind during the time lapsing between an examiner's question and the suspect's reply. The offender is asked to pronounce the first word that comes to his mind after the questioner has suggested one dealing with the supposed crime. If guilty, it is said that his blood force will register a high mark. Communication with the machine, which is called a capillary electrometer, is furnished through the finger tips of the person undergoing the test.

CAT-TAILS YIELD FLOUR, SILK, STARCH, AND ALSO SUGAR

From the cat-tails found in almost every swamp, scientists have succeeded in making both food and cloth. Roots of the weed produce starch and sugar, the pollen has been used as a flour to make bread, the brown spikes make an excellent substitute for silk, and the fluffy down is valuable for stuffing pillows. The plant was first discovered by the Iroquois Indians and, during the Great War, it was extensively used in central Europe.

Chicago Evening Post
9/6/23

Dr. Alexander Hervey, Calif. Criminology Dept. Univ. of California

Copyright material

Pietro Kostenko
Russia

Korn Bell Feed
mills
Omaha, Neb.

WOODS COLORED BY SCORCHING "PAINT" MOSAIC PORTRAITS

3486 With 87 pieces of wood, taken from 16 kinds of trees, a Russian artist creates portraits of famous men. To produce the

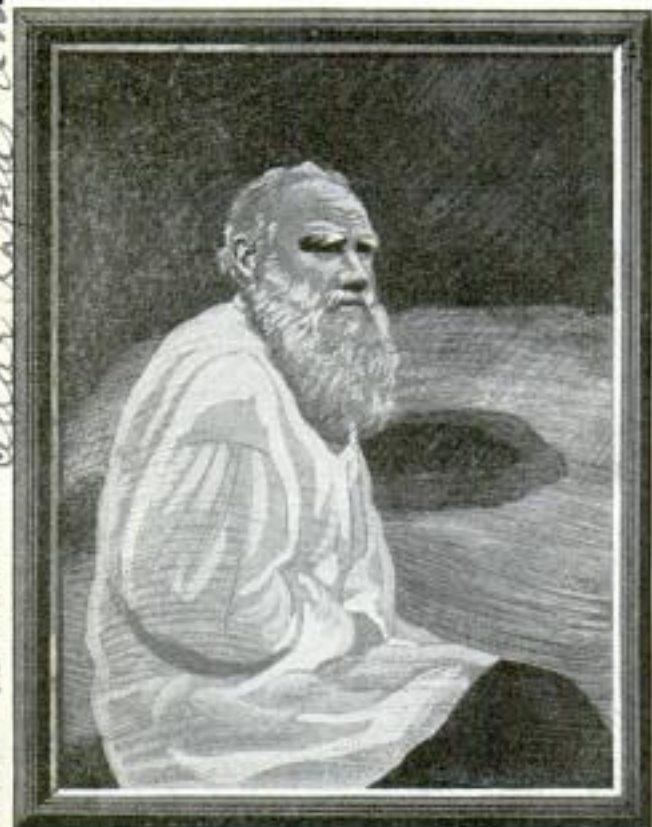

Mosaic Painting in Which Different Kinds of Wood Give Character to the Portrait

tones necessary to give "life" and color to the mosaic, the tiles, some of them as small as a needle, are placed so that their natural tints form the shaded lines of the subject. The grain of the woods and sections of knots are used to give character to the picture, while deeper shadings are produced by scorching the materials with hot irons or heated sand. A special rubbing process is employed to produce black.

LAKE OF MIRACLE WATERS FOUND IN INDIA

3519 In a village of Bengal, India, a small lake that has existed for many years has been found to possess marvelous healing powers, it is reported. Persons afflicted with almost incurable maladies are said to have been permanently cured by bathing in it. Only on a certain day of the week are the baths of benefit. During the other six days the curative properties are claimed to be absent. Thousands of natives gather in the town for "miracle day."

FOWLS REACH POULTRY FEED THROUGH SLOTS IN PACKAGE

3499 For marketing chicken feed, a middle-western company has devised a container that automatically supplies the foodstuff to the fowls. Shaped like a can, the receptacle has slots at its base which permit the feed to flow out as fast as needed. Thus, it is claimed, poultry can be fed more economically than by scattering grain in troughs or pouring it on the ground. The openings are covered by strong paper, to prevent the contents from leaking until the buyer is ready to use the package, when the cardboard may be cut through to allow the preparation to pass out.



TREE'S TRUNK HARBORS INDIAN STATUE CAST IN CONCRETE

3416 In replacing the decayed portion of a large tree trunk, tree surgeons working in the parks of a mid-western city



molded the figure of an Indian warrior on the surface of the cement with which they filled the treated cavity. The replica of the red man appears to be watching the distance from the shelter of the hollow trunk. It is thought that by thus adding ornamental statuary to the un-

sightly fillings that preserve the lives of blighted shade trees their beauty will not be marred and an attraction will be furnished visitors.

Using 113,540 pieces of wood, an eastern woodcarver recently completed a table that he started in 1915.

Emb. Frances Warren, 6098 Thurgate Lane

Emb. W. H. Dorned, 949 Lowry Ave. N.E.,
Munroe, Wis., Minn.

Emb. J. B. Raney, 11 Kasehatti,
Rose Lane Simla P. O., Calcutta,
India

Science Harnesses Atoms To Chariot of Light

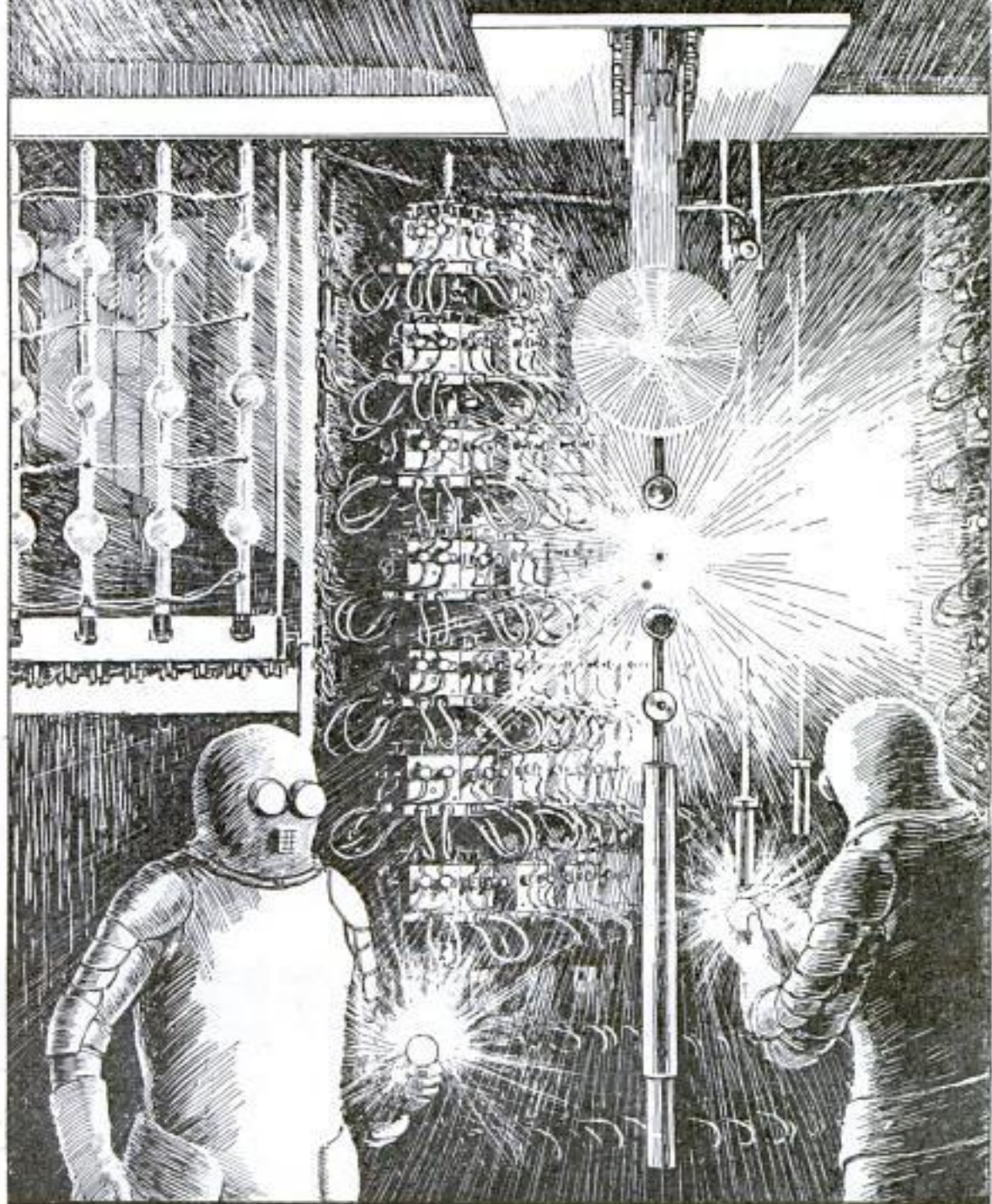

Electricity Being Drawn from the Air in Laboratory to Light Bulbs That Are Then Said to Continue to Give One Hundred Candlepower for Three Years without Recharging, or the Use of Batteries or Renewals of Any Kind

Heatless Light to Chain Almost Limitless Flow of Power for Mankind's Use

Tube Like Ordinary Electric Bulb Will Glow for Three Years by Putting Atomic Energy to Work, Is Claim

AFTER two years of experimenting to develop bottled, heatless light, an eastern inventor has announced discoveries that may result in the harnessing of almost limitless power for the use of mankind.

Surrounded by strange instruments in a modest little laboratory at Harrison, N. J., he says that he has succeeded in inventing a tube, not unlike the ordinary electric bulb, that will give 100 candle-power continuously for three years without connecting wires, batteries, or need of renewals. For years it has been known that a few pounds of matter contain more power than can be extracted from millions of tons of coal. Every bit of rock, piece of steel, or even a penny is a colossal reservoir of energy imprisoned by the force that guides the destinies of the universe. If it could be released and controlled, the use of steam, electricity, and coal would be rendered obsolete.

"I am of the opinion," Sir William Bragg, noted scientist, declared some time ago, "that this energy will supply our future needs. A thousand years may pass before we can

harness it, or tomorrow night may see us with the reins in our hands."

While the difficulties are tremendous, Sir Oliver Lodge remarked that there was just as much doubt at one time about the utilization of steam or electricity. "Is it to be supposed," he asked, "that there can be no fresh inventions, that all discoveries have been made?"

According to these scientists, all matter—steel, gold, wood, and gas—is composed of molecules. These are made up of atoms, which, in turn, are merely vast collections of electrons, all of them being in ceaseless motion.

While the atom is far too small to be seen, it is known that in a bubble of gas no larger than the letter "O" there are billions of them, and that the electron is more than a thousand times smaller than the tiniest atom. Electrons are constantly moving at a speed of from 10,000 to 160,000 miles a second, a rate sufficient to carry them around the world more than six times between the ticks of a clock. Over 1,340 barrels of powder would be required to move a rifle bullet as fast. In a copper cent, it is estimated, this

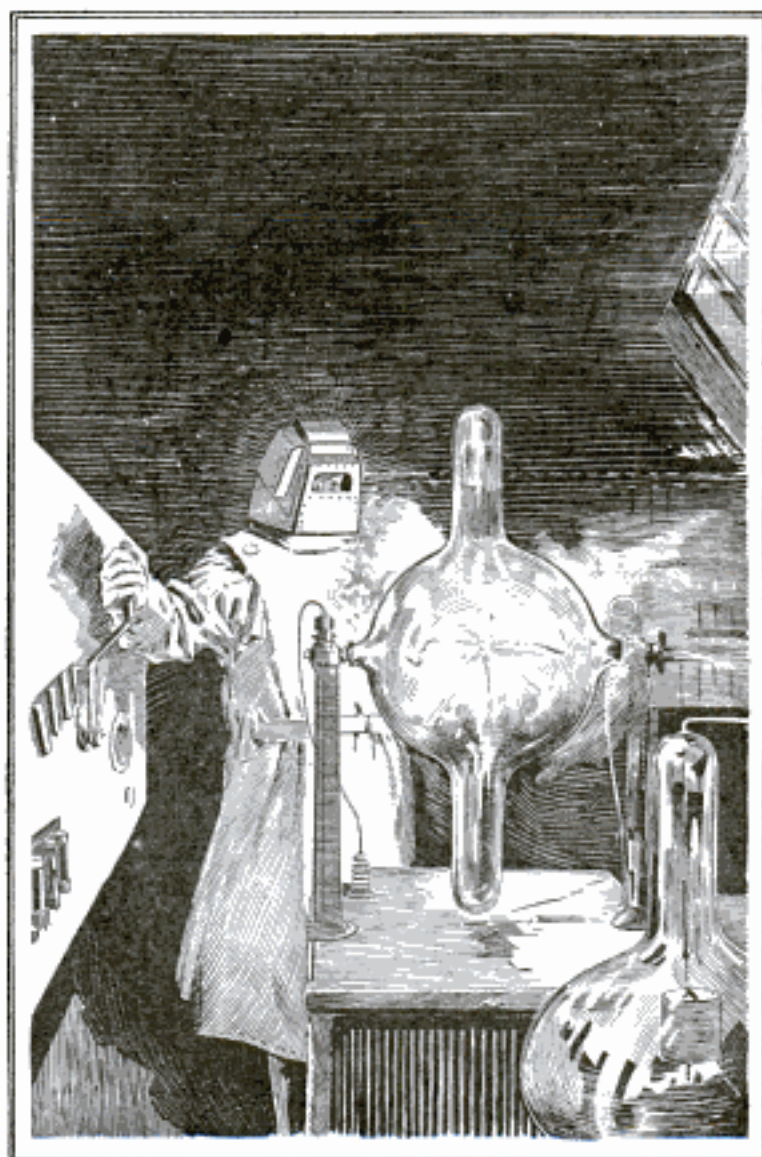

Most Terrific Heat Known, Estimated at 50,000 Degrees, Being Produced in Tests Seeking "Cold" Light

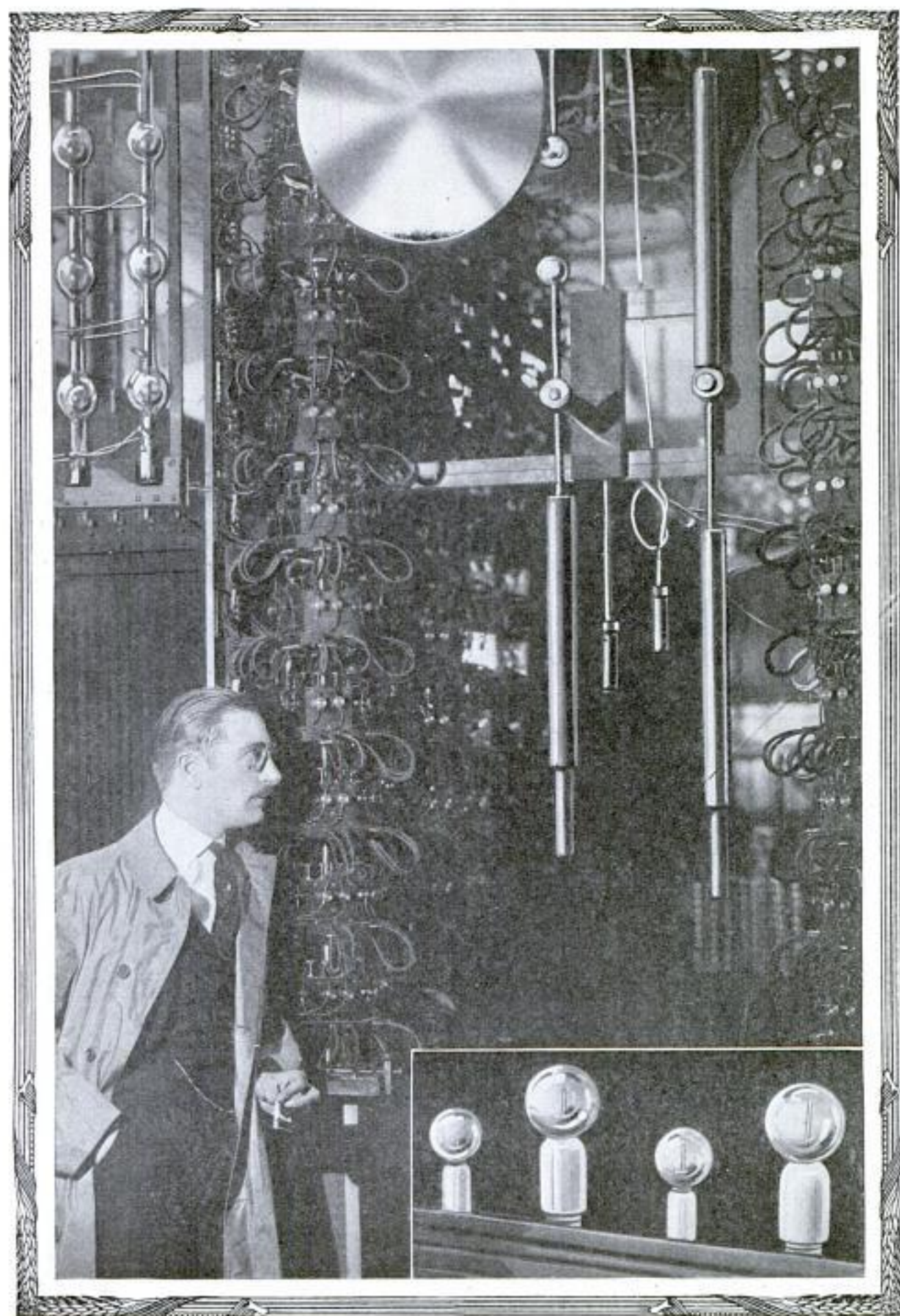

Inventor, "Cold" Light Bulbs, and Complicated Electrical Apparatus, Used in Setting Free Energy That May Provide World with Limitless Source of New Power

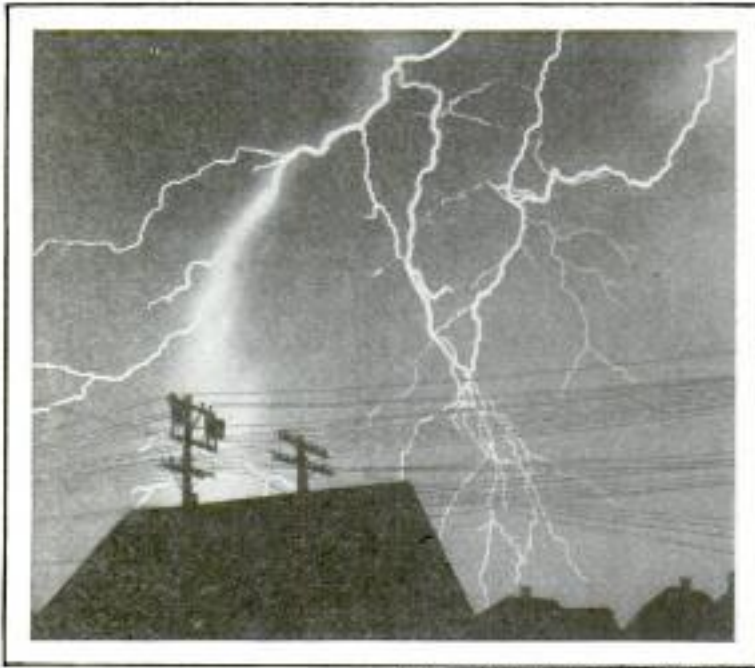

PHOTO COURTESY HI-VOLTAGE EQUIPMENT CO.

Symbol of Power Since Time Immemorial, Lightning Plays Queer Tricks with Telephone and Power Wires

energy, if it could be released, is equal to 80,000,000 horsepower, and the atomic force imprisoned in a hard-shelled crab is sufficient to blow up the largest skyscraper. The activity of the electrons can be stimulated in various ways, one being by the ultraviolet, or invisible, rays of the sun.

If most of this light was not absorbed in passing through the earth's atmosphere, metals would disintegrate under it and the present "steel civilization" would be impossible. By greatly increasing the movement of the atoms, massive buildings could be instantly dissolved into dust, and, if the rate of speed were made fast enough, a destructive explosion would result.

In his search for "cold" light, Juan J. Tomadelli first began experimenting with lightning, symbol of power since time immemorial. The voltage, or electrical pressure, of a bolt is estimated at about 50,000,000 volts. But as the flash is so quick that it is over in a one-thousandth part of a second, the energy involved is small, being estimated at 1.2 cents a bolt. During his tests, Mr. Tomadelli developed a 5,000,000-volt flash, a yard in diameter, which jumped a gap of 37 feet and was maintained for 31 seconds.

This was one step in his search for a force that would release the energy in the atom and at the same time control it. The jolt from the electricity, he says, started a series of "explosions" in the secret material composing the filaments of the lights. But, instead of occurring all at one time, the smash-ups are spread

over a period of years, according to the amount of substance used in the bulbs.

Ordinary electricity from the power house will not set this process in operation, according to the inventor. It requires current drawn from the air. This is not lightning and not the charge of the earth, but is said to have a sort of cousinly relationship with them. Special and highly complicated apparatus, some of which represents the most intricate and involved ever used for electrical experimentation, has been installed at the Harrison laboratory to capture and harness this current.

Outside the main building, a big metal disk has been set high in the air. It is said that the electricity is drawn from this through many heavily insulated wires to a magnetic revolving apparatus connected with metallic brushes.

In his experiments, Mr. Tomadelli said that he had made profound changes in the composition of the filaments inside the lights by rubbing the bulbs with green leaves. Also, he says, he was puffed up like a balloon and several pounds were added to his weight by the electrons that entered his system while experimenting in his laboratory.

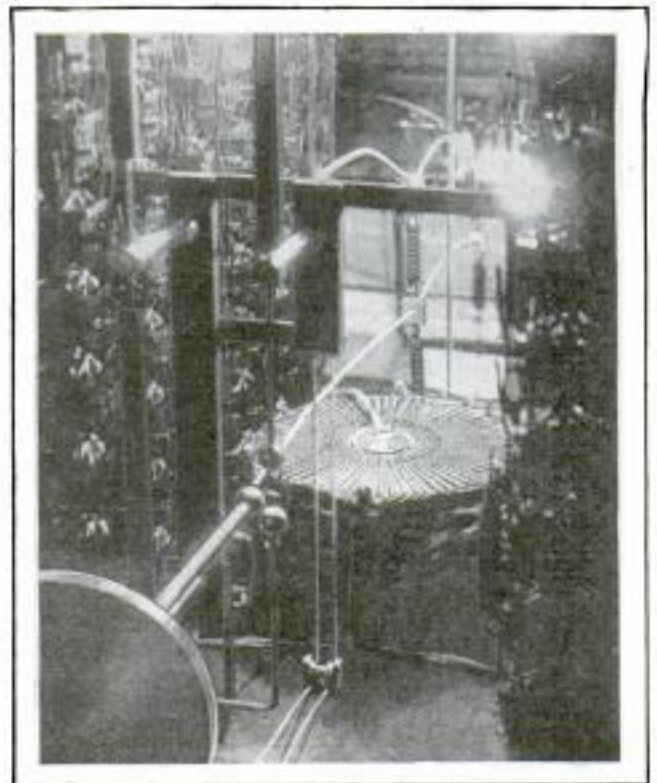

Blinding Flashes of Man-Made Lightning Used in Experiments to Solve Mystery of Life

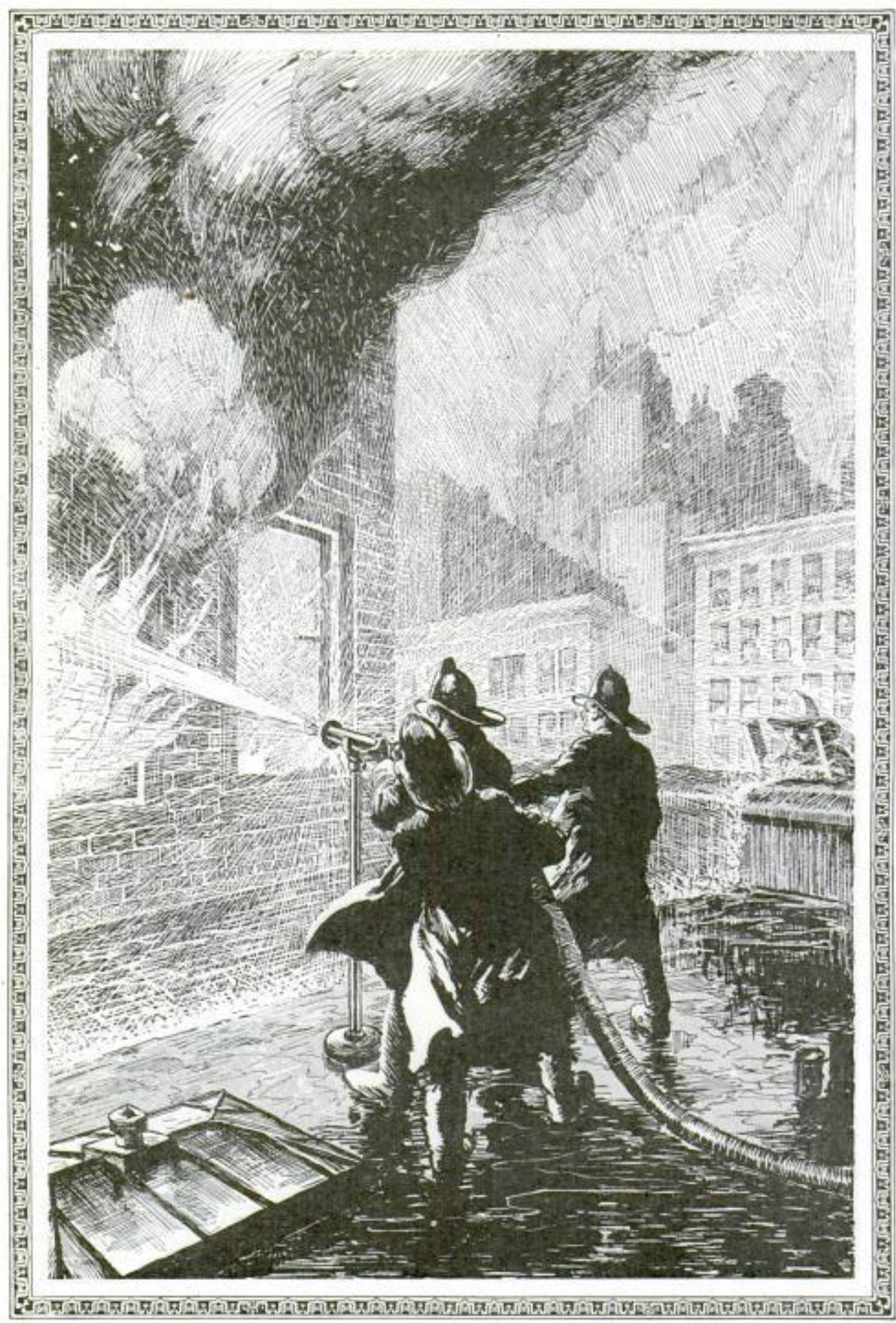

PHOTO COURTESY HI-VOLTAGE EQUIPMENT CO.

Although the Power of a Bolt of Lightning Is Estimated at 50,000,000 Volts, So Short Is Its Life That the Current Is Valued at only 1.2 Cents

3435

SHIELD OF WATER GUARDS FIREMEN FROM FLAMES



Screen of Water Sprayed at Right Angle by Hose Nozzle Protects Fire Fighters from Flames and Smoke and Permits Closer Approach to Blaze without Hampering Their Vision

Old Steel Lives Again in Huge Skyscrapers Built of Scrapped and Rusty Rails

Worn-Out Pathways of Commerce Not Allowed to Perish When Work Is Done, But Are Re-Rolled for Further Service

FROM the pathways of commerce to the towering skyscraper is the romantic progress of the steel rail, for, when its usefulness is ended, it does not perish, but is re-rolled for still another life of constructive purpose.

In the year 1830 there were but 23 miles of railway in the United States. Forty-three years later the rails of steel had carried civilization to the Mississippi and beyond, but the great Northwest was still an unsettled wilderness.

Today more than 300,000 miles of track carry mankind into every corner of the land. Along great railway systems have grown towns and villages, the centers of vast agricultural and industrial communities, dependent on the connecting roads for their every necessity.

From the flat strap-iron bolted to wooden beams of the early days, the steel rail of the present has been developed. To meet the constantly increasing requirements of weight, speed, and volume of traffic, its quality has been perfected by all the skill and genius of one of the nation's greatest industries.

Over it flows a gigantic commerce. Fruits of California and the South find rapid passage to the gateways of the North. Live stock of the prairies flows unceasingly to the central packing centers. Meat for a nation's need

emerges and is distributed in refrigerator cars, defying time and climate. In peace and war, the certainty of the steel rail has made national unity and progress possible.

But there is a step farther, a magical change, of equal romantic interest. When its usefulness is gone, the rail does not perish utterly, but, in a new form, lives again for still another life of constructive purpose. Re-rolled, it returns in skyscrapers to the cities, and in agricultural implements to the fields that it has opened to man.

Reborn from the rails, sturdy teeth of harrows open the soil for planting. Rolled into tubes, it serves dairy communities in the fittings of sanitary barns. In lofty windmills the rejuvenated rails lift their circling arms to catch the power of wind, pumping water to quench the thirst of land and beast.

Throughout the nation the reinforcing bars of rail-steel knit to rigidity huge, concrete structures. In every section of the country, for every need of rest and labor, in new and changed form, the scrapped rails still carry on long after their work in the service of transportation has ended.

At the re-rolling mills, the worn rails are piled high in the storage yards. Inherently as sound as the first day they were



Seething Volcano of Flame and Smoke That Marks the Birth of Steel in a Modern Bessemer Converter

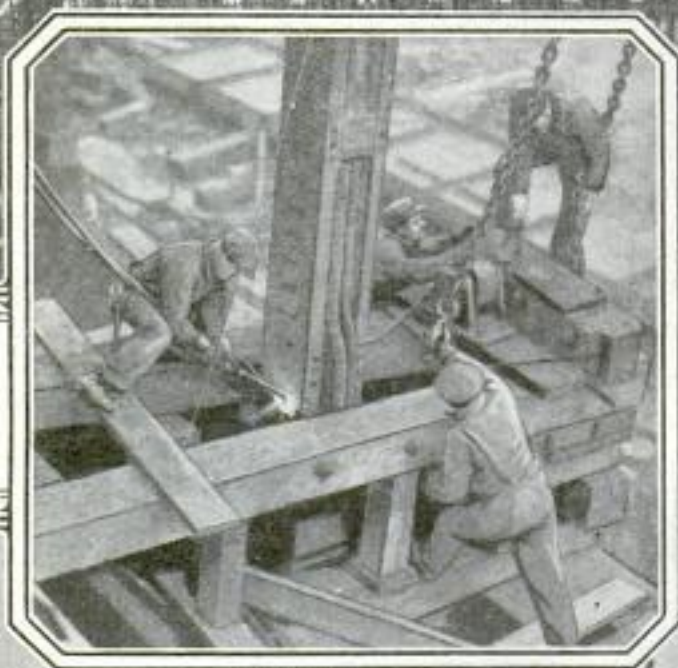
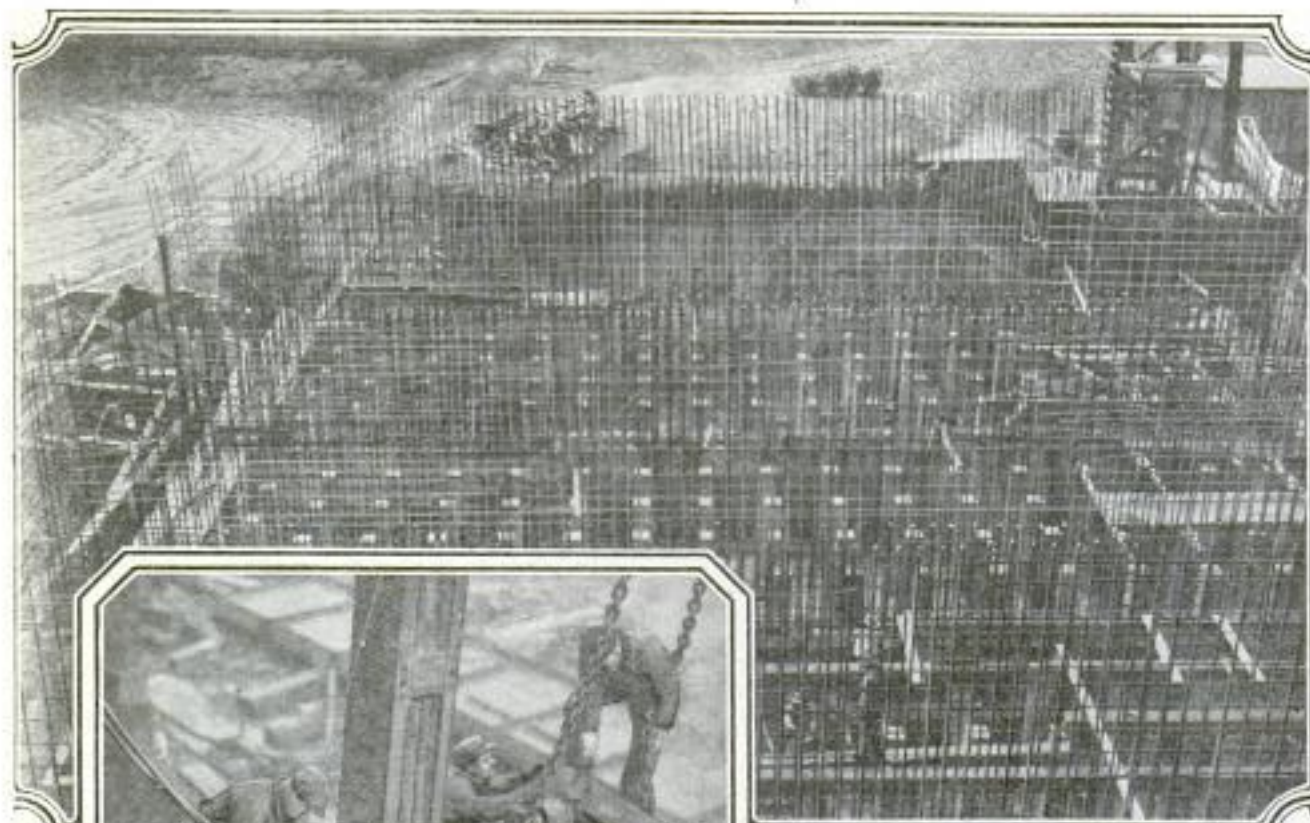

Skeleton of Steel Which Will Knit Together the Concrete Walls of a Mighty Skyscraper; and, at Left, the Acetylene Torch That Cuts Through Metal as Easily as a Saw Goes Through Wood

PHOTO AT LEFT, COPYRIGHT, UNDERWOOD & UNDERWOOD

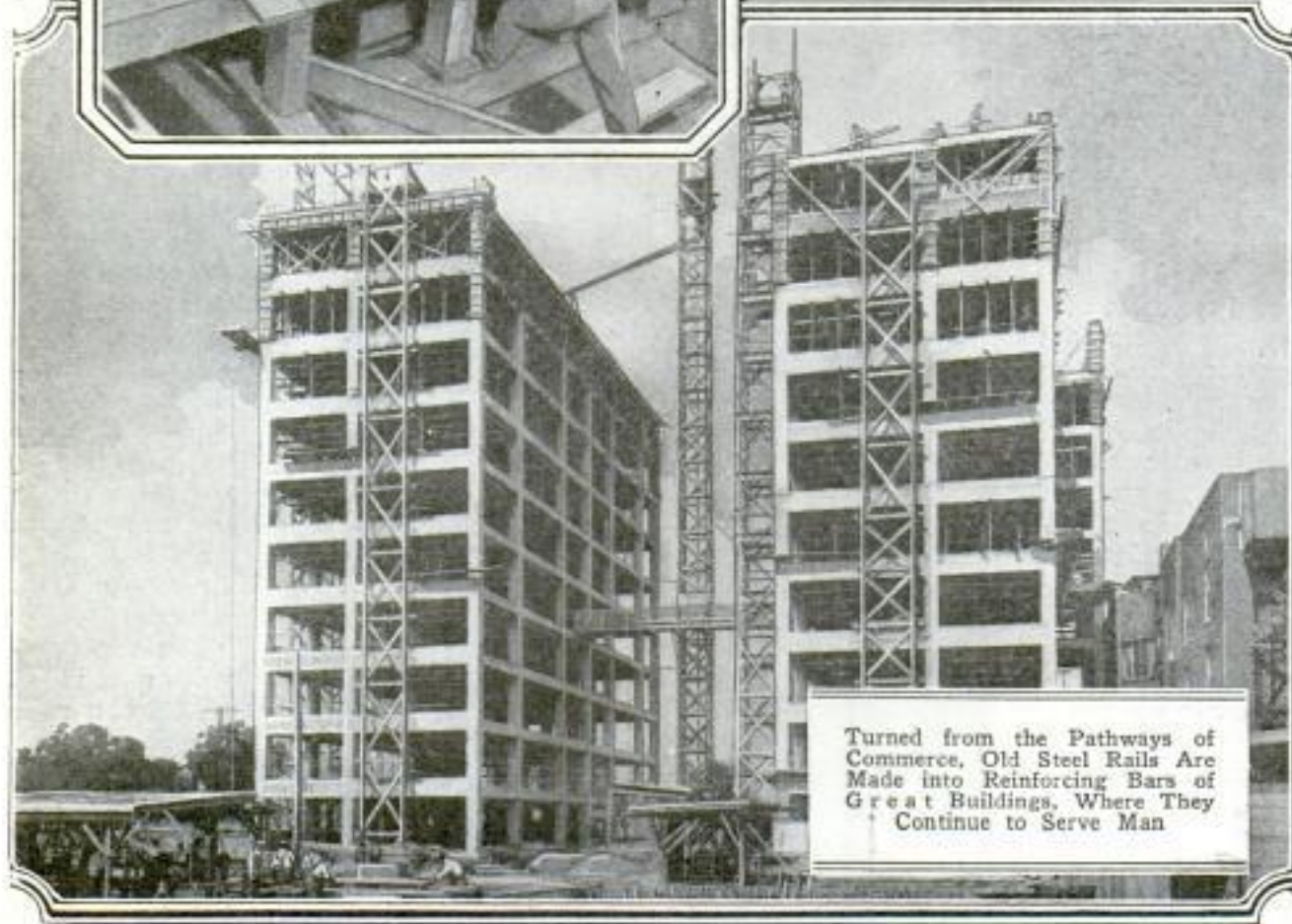

Turned from the Pathways of Commerce, Old Steel Rails Are Made into Reinforcing Bars of Great Buildings, Where They Continue to Serve Man

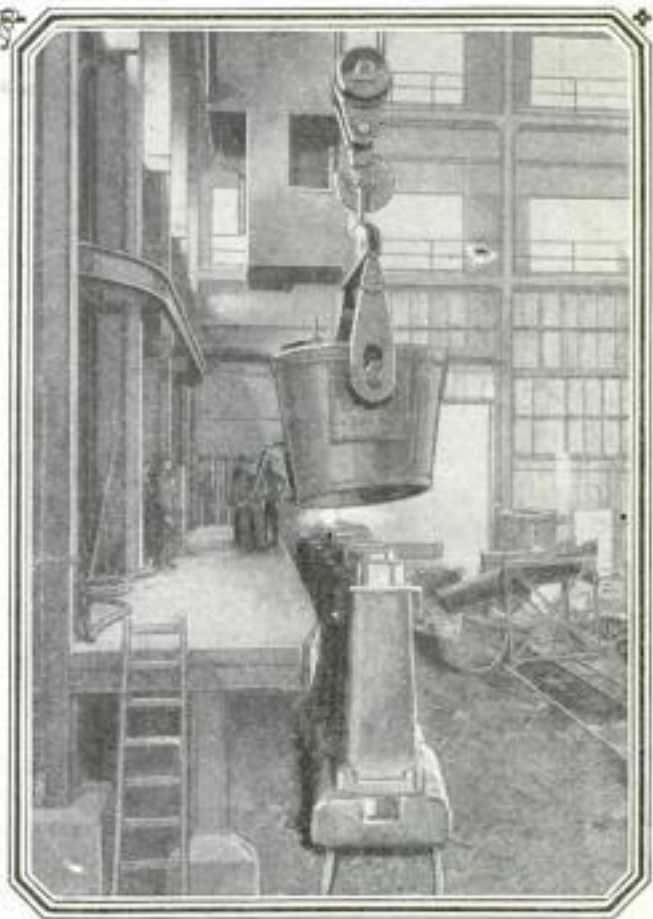

COPYRIGHT, UNDERWOOD & UNDERWOOD

On the Right a "Crab Bucket," Swinging from a Powerful Traveling Crane Is Discharging Iron Ore into Constantly Moving Conveyors Leading to Roaring Blast Furnaces and, Left, Pouring Molten Steel into Ingot Molds Amid Showers of Sputtering Sparks

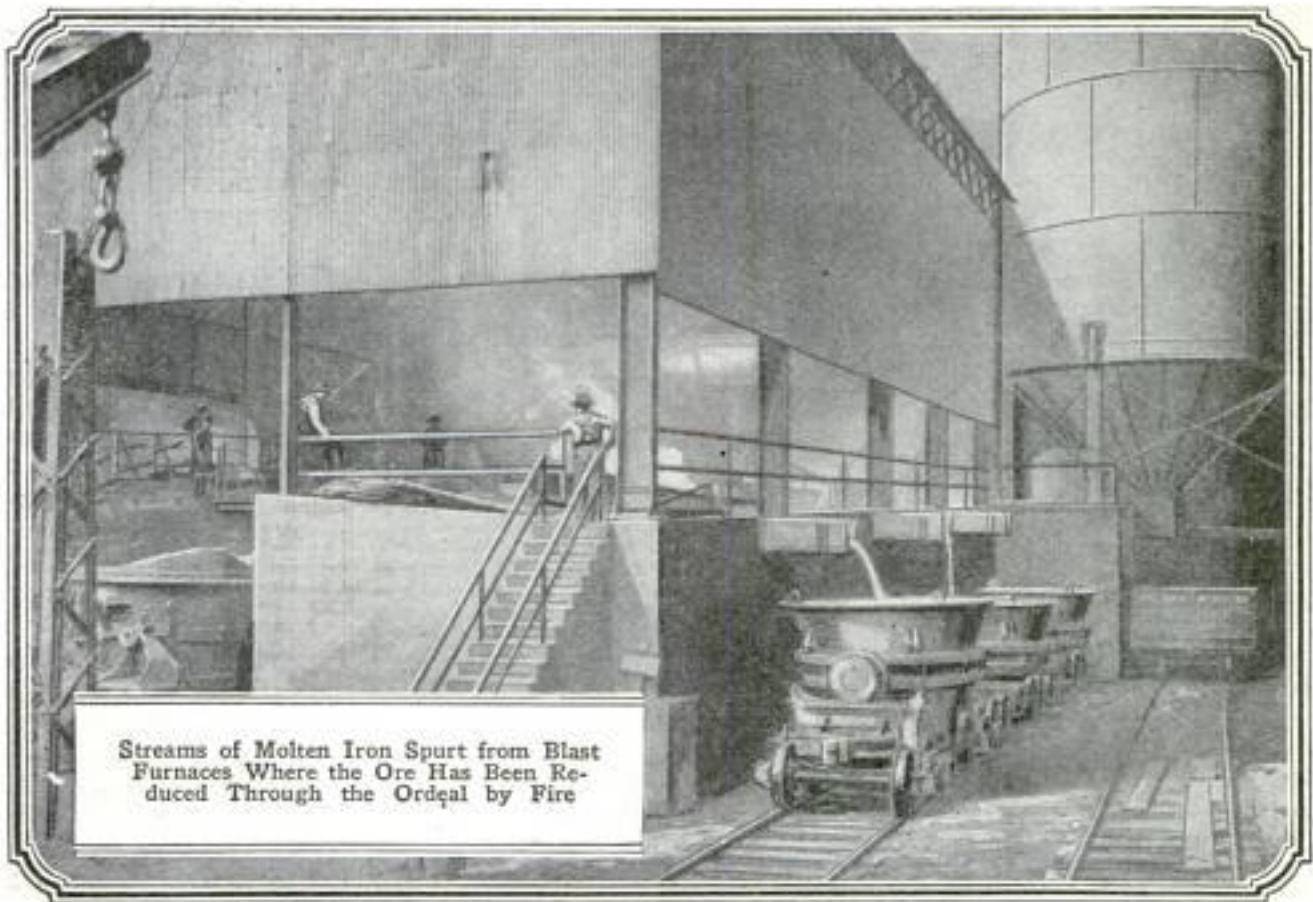

Streams of Molten Iron Spurt from Blast Furnaces Where the Ore Has Been Reduced Through the Ordeal by Fire

spiked to the ties, they are there only because of surface wear, of the grind of steel against steel. Broken into uniform lengths, with every section that might contain a flaw removed, the rails pass to the furnaces. It is the ordeal by fire. Under the terrific blasts of powdered coal or oil and air, the dingy ribbons of rust gleam incandescent as they pass slowly into the flame. Through the half-shut door of the furnace, the interior seems to glow with the brilliant white-yellow light. Heat atoms of fuel dance like snowflakes driven by a blizzard gale. And, in this purification of fire, the rails shimmer white hot.

With a clank of machinery and a blast of heat, a heated rail is discharged from the furnace and travels down the runway to the slitting roll. There is a crash as it enters and emerges beyond, cut into three twisting, gleaming yellow ribbons by the revolving blades. Workmen with huge tongs seize the ends and turn them back and they appear again like twisting, orange worms, writhing in sinuous curves over the smooth floor. Again they are snatched up and looped back for passage through

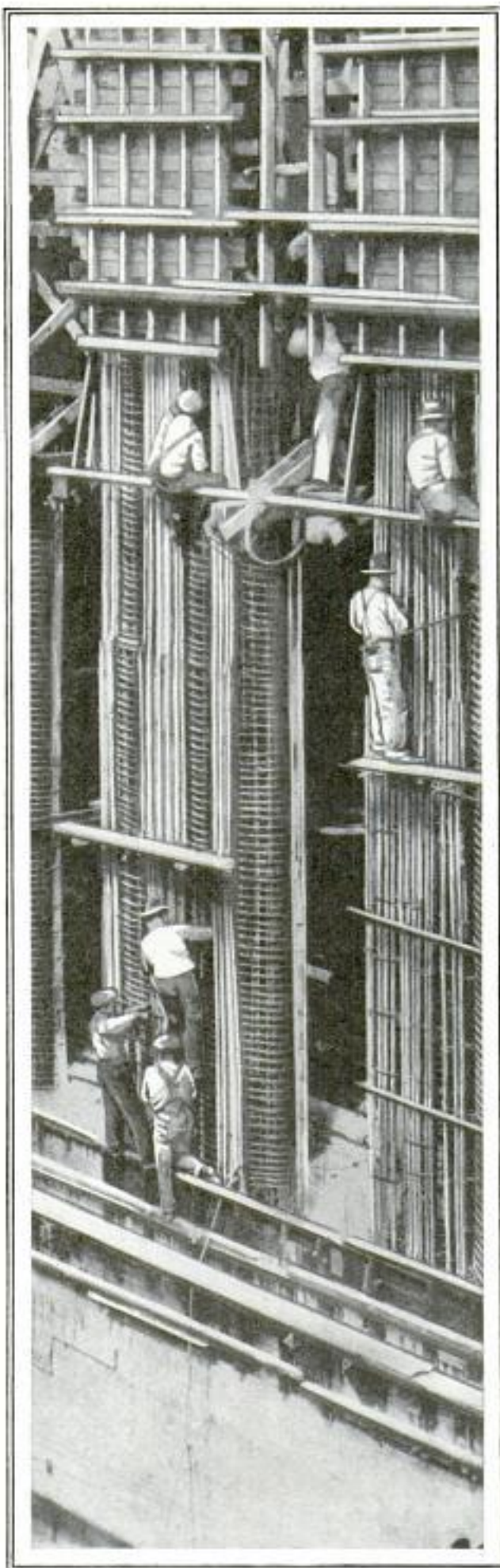

the roll stand. Returning finally from between the massive shapers, they have taken on new forms as light rails, angle bars, reinforcing beams, and other required models.

Down through the long building the glowing metal stretches in the gloom. Bright saffron is it, as it comes from the stands. Then, in the cool air, the saffron deepens to cherry red. A deeper blood color suffuses it, and finally the blue gray of cooling steel. The process, save for cutting into lengths, is completed. The re-rolled rails are ready for a new life of usefulness.

Steel, within the past few years, has become one of the most common products entering into everyday use. Without its wonderful strength, compared with its light bulk, many of the most important projects would fail of realization.

In one year there was dug from the great Lake Superior mines and shipped by steamers down the lakes, about 50,000,000 tons of iron ore, which was melted into more than 25,000,000 tons of pig iron. To convert this raw material required 38,500,000 tons of coal made into coke, and 6,096,000 tons of mined limestone.

Mysteries of "Invisible" World Are Portrayed on Movie Screen by Insect Actors

Dramas and Comedies Enacted in Drop of Water, Heart of Blossom,
or Beam of Sunlight, Are Magnified Thousands of Times

Louis H. Tolhurst

OPENING the marvels and mysteries of a new world to view on the motion-picture screen is the result of the discoveries and inventions of a western scientist after many years of tireless effort. As the result of his inventions, the "monsters" and "mammoths" to be found in a puddle of drainage, a square inch of earth, the heart of a blossom, a drop of water, or basking and disporting in a beam of sunlight, are revealed as clearly as the tragedies and comedies presented by any human actors.

Magnified thousands of times, a fly may be seen enjoying a promenade after its noonday meal, leaving a poisoned trail behind it—a squirming, colony of deadly germs, sufficient in number to supply more than one for every man, woman, and child in the state of New York.

What swiftly follows is one of the nameless dramas of the insect world, for the fly is led into the webby house of Mr. Spider, who crouches in a corner, his eight eyes gleaming, his huge jaws

opening, and his legs gathered for a rush that will be more like a flight than a run. On the screen, he appears so monstrous as to belong in the realm of fables—too frightful to be believed and, therefore, perhaps, grotesque.

Hopelessly enmeshed in the cordage of the web, the intruder is permanently prevented from further unhealthy wandering. Likewise with the moths. They, too, fall victims to the spider, who otherwise is so timid a being as to scurry away

as rapidly as possible at the approach of man, and can hardly be forced under any circumstances to strike back at him. It is said that there is but one species in the United States whose bite is to be dreaded even as much as the sting of a bee.

In a film recently completed, the curious habits and instincts of bees have been registered from the tiny egg to the hatched larva, and, thence, through the cocoon stage. The workers, queens, and honey-bearers, together with the lazy drone and the industrious mason, are

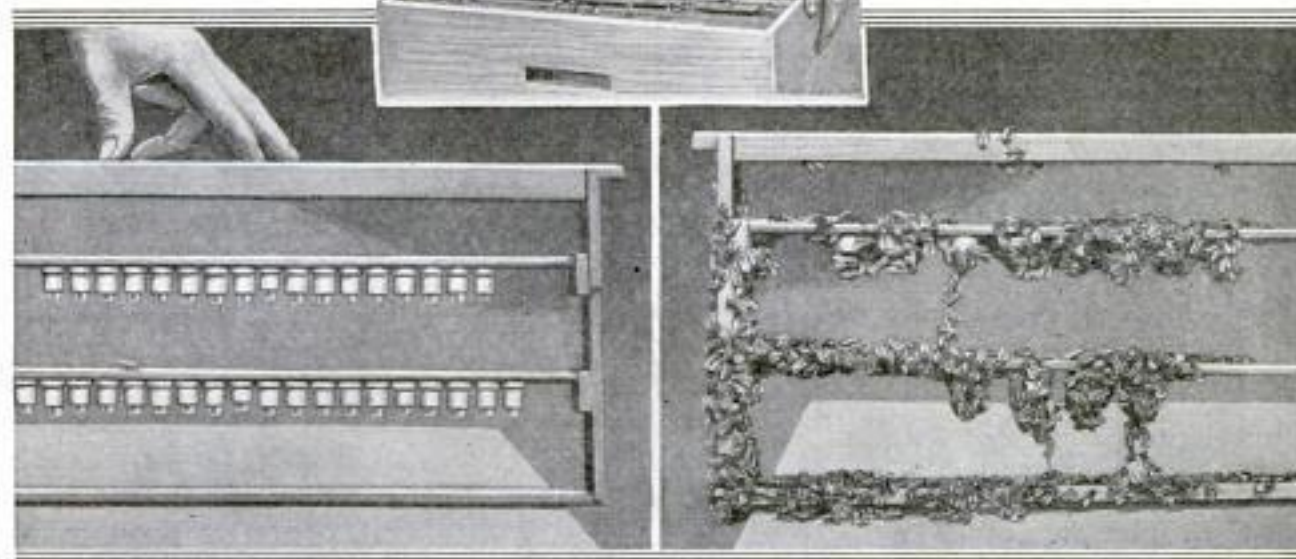
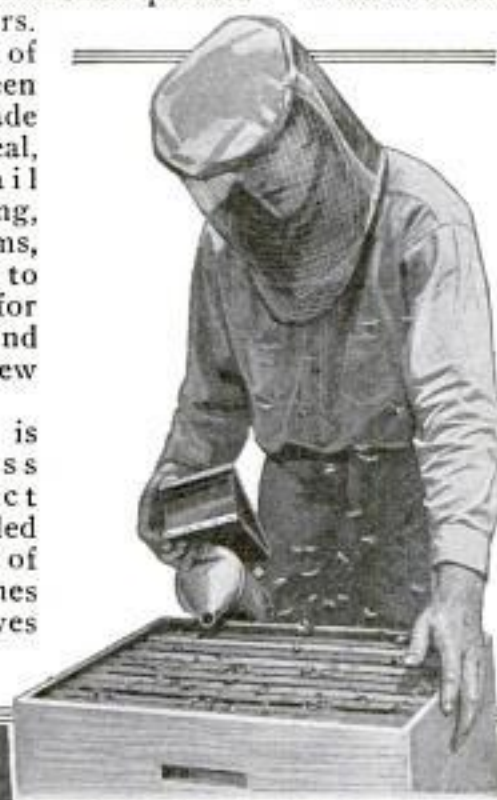

Above: Beekeepers Work with Slow, Quiet Motion to Prevent Disturbance in Hives. Left: Man-Made Cells That Induce Bees to Cultivate Queens. Right: Beginning Hive for the Queen



*Furry Head
of the Industrious Bee*

shown in their natural surroundings with all the freedom of original movement and untrammelled liberty. Louis H. Tolhurst, the inventor, takes a drop of water containing a variety of germs, and places it on a piece of perfectly clear glass. Then another thin piece of glass is placed on top, and the two clamped together as tightly as possible without breaking them. This "slide" is put under a high-powered microscope and the specially made motion-picture camera set to work. On the screen, the result is as though a pond of water existed between the plates of glass, while swimming to and fro, like fish in a bowl, are thousands of queer, living things.

While these experimenters have long struggled with the microscope as an aid to the motion-picture art, they have encountered many perplexing difficulties. The fierce heat of the brilliant lights required for photographing

*Sting and
Poison Sac of the
Honey Worker*



*Folding
Tongue
of the
Bee*



*Queer Profile of the
Busy Red Ant*

either killed the tiny victims of man's curiosity, or affected them so as to render the screen result imperfect or valueless.

To make these latest pictures possible, strong lights have been devised that are almost entirely divested of heat—so "cool" indeed, that the spider crouching in his net, ready to pounce upon the entangled fly, is not disturbed in his ungentle occupation, nor bothered by his knowledge of an intruding witness to his brigand efforts.

Another obstacle lay in obtaining correct focus. In ordinary motion photography, the normal number of exposures a second is 16, resulting in that number of distinct and separate pictures registered on the sensitive film. These, when developed and run through a projecting machine, give the illusion of actual motion.

But to catch the fleeting movement of microscopic life greatly magnified and record it faithfully for study and laboratory work, as many as

32 exposures must be made a second, so that every act may be registered—or as nearly so as is possible for human hands and ingenuity. As the shutter operates twice as fast as that of the ordinary camera, the instant of opening is so brief that unless the lighting be exceedingly bright, the image will not be registered at all, even on the most sensitive film.

By bringing the great insect world closer to both the scientist and the people, it is expected that these "movies" will result in the greatest benefit to mankind. With a more perfect understanding of the spider, for instance, it will be realized that he is a much-maligned friend of the human race—a sturdy sword bearer and executioner of enemies of the peace, dignity, and health of man, and he will not be ruthlessly destroyed just because he is ugly.

It also will be realized that the insects generally do not live to themselves alone, and that they often show what would seem to be the most pronounced evidences of intelligence. Mutual help is practiced extensively among them and cooperation reaches a high level.

"If we knew no other facts from animal life than what we know about ants," says one scientist, "we might safely conclude that mutual aid and individual action are two factors far more important than greedy rivalry."

Close-Up of the Spider's Ugly Deep-Set Head



As the Watchful Spider Appears Through the Microscope

This is exemplified by two sayings of the French. One is that the astronomer, who deals with the telescope, lives in a small world, while the scientist who handles the microscope dwells in a majestic, mighty universe. The other is that all animosities are but the result of imperfect understandings.

With a clearer comprehension of the insect world, many of the present prejudices against some of its dwellers would vanish, it is contended by the inventor of this new type of movies.

Vicious Jaws That End the Victim of the Web

Emb. A. N. Merzoff, c/o International
Newsreel Corp., 326 W. Madison
Tragedies and Romances of World History
Chicago
3/10 * Revealed by Coins of All Nations

Rise and Fall of Dynasties That Have Long Since Vanished, and the
Overthrow of Rulers Are Depicted by Money Tokens

IN searching for new metals to defy counterfeiters, scientists have turned their attention to the study of the money tokens of every age and nation.

From the golden, beautifully wrought coins of the Greeks and Romans, thin, cuplike waiers of the Byzantines, Louis d'ors of France, and doubloons of the Spanish Main, to the shinplasters and promises to pay of the early United States, the course of history has been traced.

Silver and golden bits from ancient Athens, fanciful things, sculptured with the heads of gods and goddesses, or with the symbols of some almost forgotten city, seem rare indeed, but they made them as they are turned out today, with a steel die, in issues of thousands at a time, and there were millions in circulation, for the Greeks never degenerated into paper.

More prosaic and less imaginative, the Romans impressed their coins with the heads of proconsuls and of emperors oftener than with gods. Modern-looking pieces, easy to handle, their money seems far less quaint than the coin of Elizabeth's time. Among the early English tokens is the "Rose Noble" of Edward

III—Edward rolling along across a wiggly ocean in a little boat, crown awry, scepter slanted over his shoulder, an obvious lack of leg, and under the boat in the middle of the ocean, the rose of Lancaster. And then there is the great 5-guinea piece of "Queen Bess," on which the august monarch sits, her heavy crown well to the back of her head. It is thin and wide, this coin, so thin that people used to clip off the gold about the edge with the scissors until a little row of dots was put about the rim.

Bright pieces, the Louis d'ors of France, are marked on one side with 24 livres and on the other with the head of Louis XVI. "By the Grace of God, King of France and of Navarre." Then, when Louis had been shorn of some of his royal power by the assembly, just "King of the French." Later the revolution put an end to livres, to Louis d'ors, with all other signs of nobility, and instituted the franc. Napoleon, the first consul, later the emperor, next left his mark on the coins of his day, the gold pieces of his brothers, Louis, king of Holland, of Joseph in Spain, Jerome in Naples and Westphalia, and of Marie Louise, grand duchess of Parma, changing from



Where Calico Is Money and Ivory Will Buy Every Necessity of Life, a Native Trader in the Heart of Africa

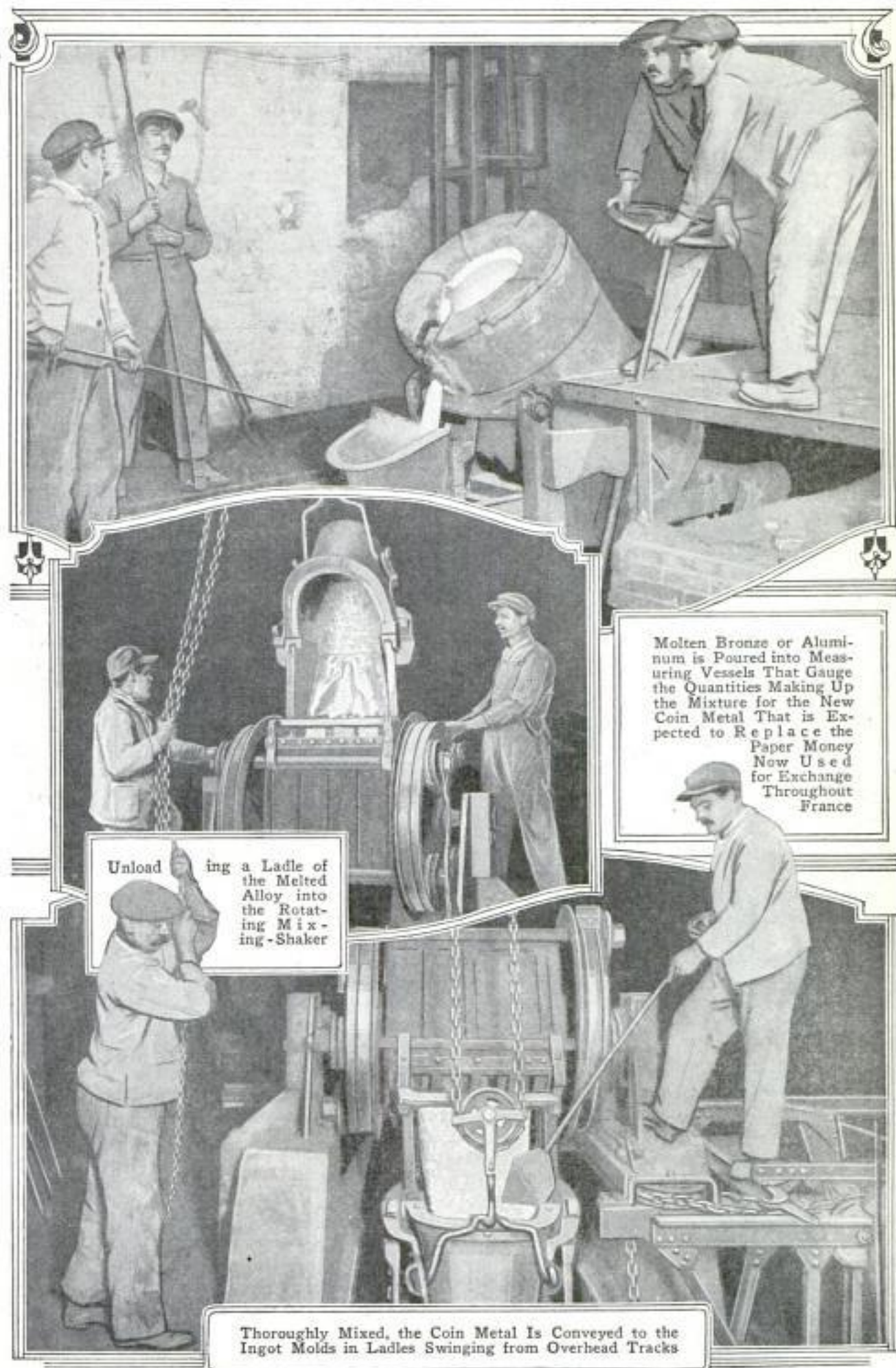

Molten Bronze or Aluminum is Poured into Measuring Vessels That Gauge the Quantities Making Up the Mixture for the New Coin Metal That is Expected to Replace the Paper Money Now Used for Exchange Throughout France

Unloading a Ladle of the Melted Alloy into the Rotating Mixing-Shaker

Thoroughly Mixed, the Coin Metal Is Conveyed to the Ingot Molds in Ladles Swinging from Overhead Tracks

the ancient pieces to those called "napoleons," after the conqueror.

In the wake of the revolutions that followed the passing of the tragic figure of "the man of destiny" from the stage of history, sprang up many young republics, all with coins of their own. There was the Venetian republic, the Roman, the Neopolitan, the Principality of Lucca, and a dozen others. Among the tokens of this time—pathetic relic of vanished splendor—is the Louis d'or of Louis XVI with the arms of the republic of Berne stamped ruthlessly into the waving curls of the wig of that fat, genial monarch, in an age when it was "down with wigs and up with democracy."

With the coins of about 1800, of Napoleon in France and of the third George in England, they began to look like the modern, machine-made article and lose the quaintness, the uneven edge of the older sovereigns. German pieces in the middle ages were marked in thalers by the hundred-and-one towns and principalities into which that country was divided until the empire united them in 1870 and established the mark as a unit. Pictures of the monarchs were conspicuously absent on these, which had pretty designs of the cities themselves.

In the United States there have been many hundreds of paper notes and substitutes. In grandfather's day they used shinplasters; incased stamps in isinglass and tin; towns made 5-cent notes. Stores of New York made stamp inclosures as advertisements. At one time colonial New York issued thin sheets of engraved paper worth "5 shillings and 4 pence." A dollar in those days was the Spanish milled coin which was well-nigh the only money token in the colonies. It was good because it was gold. The paper money was good because of the integrity of James de Peyster, Robert Livingston, Peter Schuyler, Oliver de Lancey, and other colonial notables.

Paper issued in New York was scorned in Massachusetts, whose people demanded Spanish dollars or English gold. They had their own mint, where were coined the "Pine Tree," "Oak Tree," and the "Good Samaritan" shillings. There also were the notes of the Republic of Texas, which was independent for four years, and of the Confederate States. Farther west were the woodpecker scalps, used for 50 cents by the settlers among the Indians, or the great eight-sided gold plug, used in the gold days in California.

Satirical money, issued in the days of

Andrew Jackson, who was trying to smash the United States Bank, controlled by private individuals, shows the figure of Jackson with the words, "My Experiment, My Currency, My Glory." In addition there were pennies issued by "Tom Cullen, Seller of Liquors," and even "J. J. Diehl, Undertaker."

During all ages, too, there have been counterfeiters. In one recent exhibit were coins from the days of the ancient Greeks down to the work of the modern swindlers. How could the Greek who carefully molded the coin with core of copper, cleverly plastered with silver, have known that after 2,000 years some one would dig it up and find bits of the silver corroded off and copper showing underneath?

Besides the precious metals, many others have been used in the making of money. Following years of tests, French experts recently found a way to mix aluminum and bronze which cannot be readily imitated by experts. This secret had been lost for 60 years because its discoverer died without revealing the formula.

In the United States, one of the most interesting contrivances found in the mints, is a machine that weighs coins of all denominations. Formerly each of these pieces was weighed by hand. Those that were too heavy were reduced with a file. Those that were too light were put aside to be sent again to the melting pot.

The weighing machines now used each have ten balances, which are set at the required weight of the coins that are to be tested. Each machine weighs ten coins at a time. If any be too light, the scale beam moves up and the coin is dropped into a chute that carries it to the "lights." If it is too heavy, it falls into another chute that leads to the "heavies."

There is some slight "tolerance" in the matter of weight. For example, the gold double eagle should weigh just 516 grains, but a coin of this denomination may weigh as little as 515½ grains, or as much as 516½ grains and still be passed as "good."

The standard fineness of all gold and silver coins is 900. If the gold deviates by only one-thousandth from this, it is rejected. In silver coins a variation of three one-thousandths is permitted. The so-called five-cent nickel is really only 25 per cent nickel and the rest is copper. One-cent pieces are 95 per cent copper and five per cent tin and zinc.



Accurate Glass - Inclosed Devices Equip the Rooms Where Coins are Weighed on Delicate, Automatic Scales as Rapidly as Men can Feed the Pieces into Electrically Operated Machines. When Rejected, They are Placed in Stacks Labeled "Lights" and "Heavies"



Blank Metal Slugs are Weighed, Hundreds at a Time. Those Passing the Test are Sent to a Stamping Room to be Formed into Coins



Making a Final Count of the Coins and Inspecting Each One Before It Goes into Circulation



Golden
Tobacco Leaves
on Way to Cutters

When a King's Wrath, Whipping, and Death Failed to Halt Tobacco's Spread

Formerly Known as the "Miraculous Herb," the Crop in the United States Alone Is Now Valued at Over \$300,000,000

WITH the value of the tobacco produced yearly in the United States alone estimated at more than \$300,000,000, attention has been called to the almost miraculous rapidity with which its use has spread over the world.

When Christopher Columbus, Americus Vesputius, Cortez, and other celebrated navigators of the fifteenth century first reached the American continents, they carried back reports that they had seen people who carried lighted firebrands of certain herbs and perfumed themselves with smoke.

When the plant was first brought to

Europe in 1558 by Francisco Fernandes, a physician who had been sent by Philip II, of Spain, to investigate the products of Mexico, it was supposed to possess

wonderful healing powers and was named "herba panacea." "Divine tobacco" it was called by Spencer, and "our holy herb nicotine," by Sir William Lilly.

In France, the adoption of tobacco in the form of snuff came about during the reign of Catherine de Medici. This queen was troubled constantly with headaches, and when her ambassador to Portugal, Jean Nicot, reported that the Portuguese were

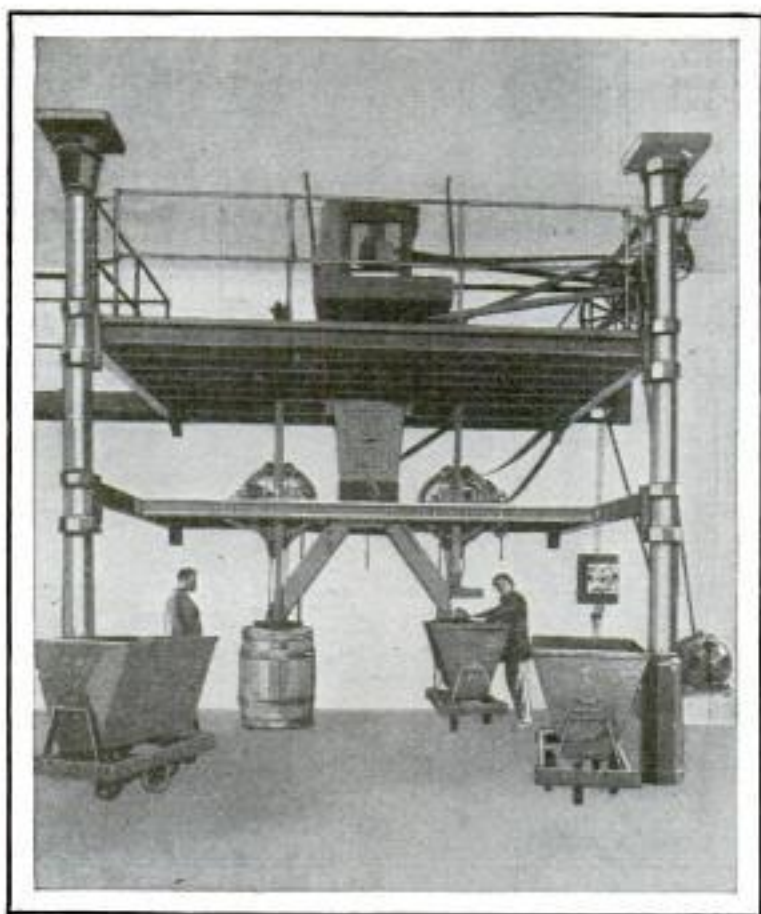

Loading Shredded Herb for Sorting

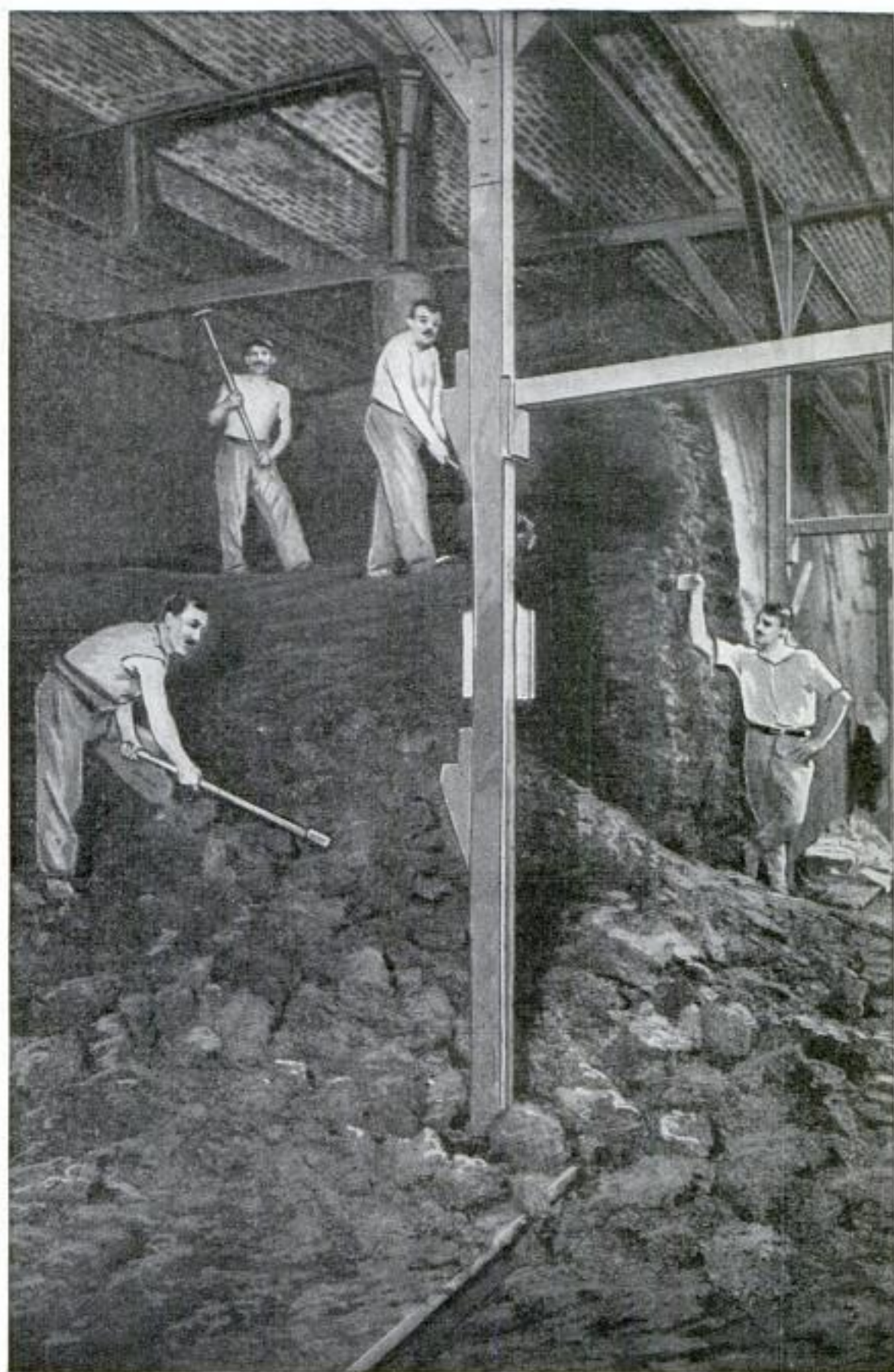

Taking Down Piles of Tobacco That Has Fermented in Huge Storage Rooms Where the Air Is Heavily Charged with Vapors Harmful to the Workers

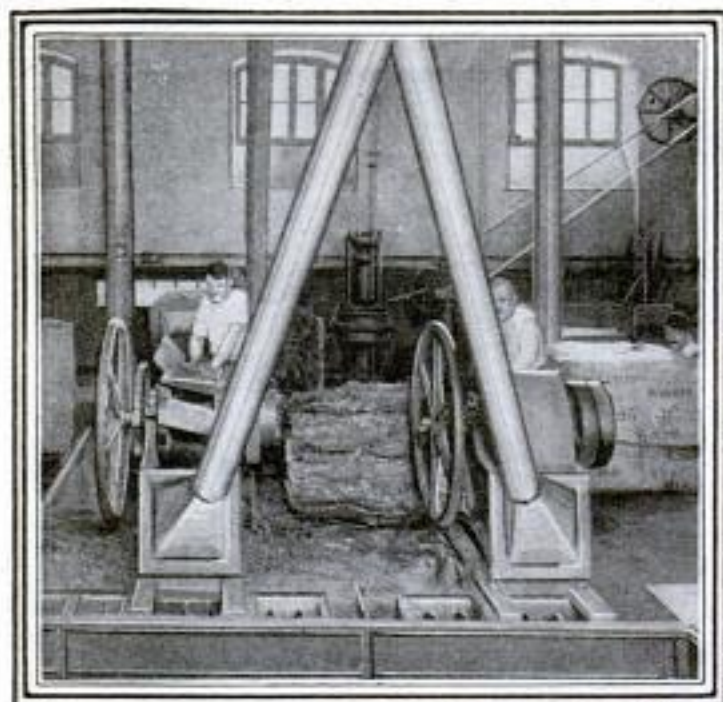

Whirring Knives on Steel Drums Cut the Tobacco Leaves into Pieces, While Long Flues Carry Away the Dust to Prevent Injury to the Workers' Health

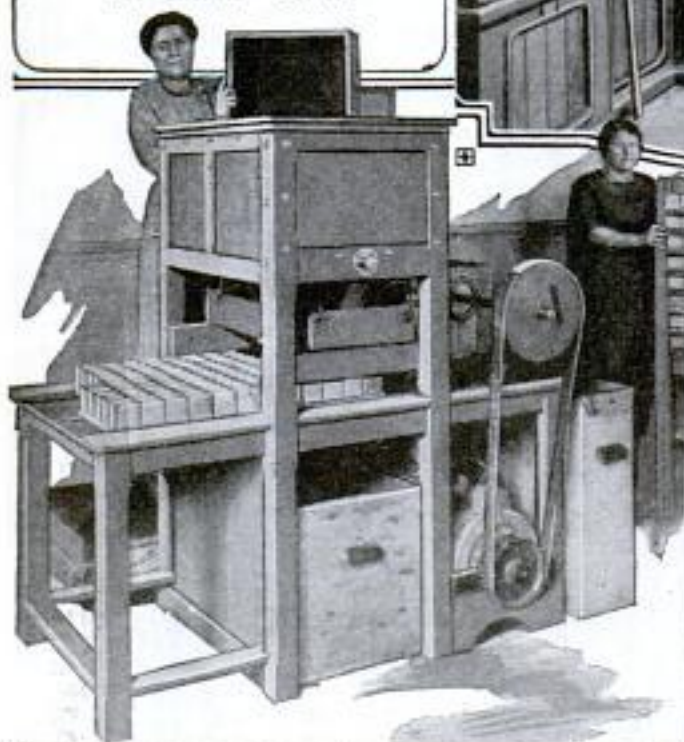

Heavy Powdering Machines Reduce the Dried Leaves to Six Grades of Fineness to Meet the Needs of Users of Snuff, for Which a Big Demand Still Exists in Europe



From the Time It Is Picked until It Reaches the User, Tobacco Is Put Through Many Processes. At the Right Is Shown the Chambers in Which It Is Aged for One or Two Months, and, Above, Snuff Being Packed in the Boxes in Which It Is Sold

using tobacco as a cure for the malady, she ordered him to bring her some. The cure proved a good one, and, because the queen used it, all her court adopted snuff. The name "Nicotine" is derived from the name of the French ambassador.

After a great many years the manufacture and sale of tobacco in France became a government monopoly, and so it is today. Tobacco is now grown in thirty-two departments of France by private growers, but the state maintains a constant supervision, fixes the price and decides as to the grades. During the growth of the plant, government inspectors keep a rather close watch and make reports on its progress, much as the crop reports are handled in the United States. At the time of harvest the growers assemble their tobacco in packets of 25 or 50 leaves. A number of these are bundled together in the form of balls, and in this shape they are sent to the government factories. There they are put through the process of manufacture into snuff, chewing and pipe tobacco, as well as products suitable for the making of cigarettes and cigars.

Snuff was formerly used in large quantities in the United States, the habit arising from the custom in European countries, which was brought over to the New World by the early settlers. Fashion has now decreed that the use of snuff is a custom not admired in public, and the practice in the United States is largely confined to more recent arrivals in America and old-fashioned people. In France, however, where this form of tobacco is called "tabac a priser," it is still in wide

use. The manner of making snuff is quite intricate and laborious. Recently, labor-saving machinery has been invented, which greatly simplifies the process and which holds great interest for the mechanical mind.

The balls of tobacco, having arrived at the manufacturing plant, are first taken to the cutting room. A most intricate machine has been devised to cut them into fine shreds. In the main cutter, a moving drum, with many sharp blades, pulls the tobacco leaves along under a number of other blades attached above the drum, which move up and down, and thus literally chop up the leaves. Having passed through the cutter, the tobacco is deposited on a moving belt and conveyed to a reservoir, which is kept filled to a constant level with salty water. An idea of the care that must be taken in all operations that are involved in the manufacture of good tobacco, is gained when it is noted that the amount of salt in the water in this reservoir is determined to the fraction of an ounce, for if the mixture is not just right the tobacco will be spoiled.

After remaining in this vat for some time, a chain of buckets is set in motion which scoops up the tobacco from the vat and carries it to the storage room. In this vast chamber the wet and partly cut-up leaves are piled as high as the ceiling, where the mass remains to ferment. For four and a half months this fermentation is allowed to continue, accomplished by the working of germs. Again, great care must be taken, that the tobacco not only be kept from spoiling, but



Packing the Tobacco Ready for Shipment

that spontaneous combustion does not take place and a fire result. The room is kept quite warm. This is necessary, because the work of the germs in this vegetable material produces heat. This becomes greater day by day, the hottest point being in the center of the mass. If the room is chilly, this heat would be prevented from escaping, and it would soon reach the point where the leaves would catch fire. The principal object of allowing the tobacco to ferment is to permit the germs to release the carbonic acid and ammonia, which is part of the plant. This would be harmful if left in the tobacco, for it would be drawn into the lungs of the smoker. There are other acids produced, such as citric and acetic. The piles of tobacco are tested after ten or twelve days with thermometers, this work being done by men who are forced to labor in a hot atmosphere which is saturated with irritating vapors, that have a harmful effect on their health.

When the fermentation has gone as far as necessary, the piles of tobacco are torn down with picks and put into sacks to be carried to the powdering room. Here, in a great chamber, are a number of monumental machines. Some perform chopping operations, others mix different grades together, some bake the tobacco to dry it out, and others grade

it. Following these operations the tobacco is placed in huge magazines, maintained at a certain temperature and degree of moisture, for one or two months. A number of other processes are gone through, and eventually the snuff reaches the salesroom in appropriate boxes.

The entire process takes eighteen months, and during this time the services of machinists, bacteriologists, botanists, and other scientists are required to constantly watch the material in its various stages. The French government has not only exercised great care in the manufacture, but has extended its experiments into the question of containers for the finished product. A number of years have been spent in perfecting the snuffboxes, which must be, among other things, waterproof and incapable of allowing dangerous fumes or germs to get at the contents.

During the 17th century the indulgence in tobacco spread with marvelous rapidity throughout all nations, and that in the face of the most resolute opposition, including the "counterblaste" of a great monarch, penal enactments of the most severe description, the lash, excommunication, and capital punishment.

Nevertheless, the success of tobacco was not impaired, and day by day its use has grown, up to the present.

LOCK TO SECURE KEY IN DOOR IS BURGLAR SAFEGUARD

Inserted in a keyhole under the key, a device is being marketed that is intended to make a door-lock burglar proof. Fastened by a chain and screw to the door jam, the instrument prevents the key from being turned or pushed out of the lock from the outside, securing the bolt so that it cannot be "jimmied." When the door is open

or unfastened, the key can be attached to the instrument to prevent its being lost. The device is installed easily without the use of any tools and is enameled as a protection from rust.

PRINTING ART TURNS WORLD INTO MIGHTY BOOKSHOP

Since the invention of printing, it is estimated that 60 million books have been turned from the world's presses, while the amount of labor, time, paper, and ink consumed in their making is regarded as incalculable. On the average 200,000 volumes are published each year. In the last century over eight and a half million books appeared. The three largest libraries in existence are the British Museum Library, with four million volumes; the Bibliotheque Nationale, Paris, with three million; and the Congressional Library at Washington with two and a half million.

There are 170,000,000 cells in the lungs of an ordinary adult.

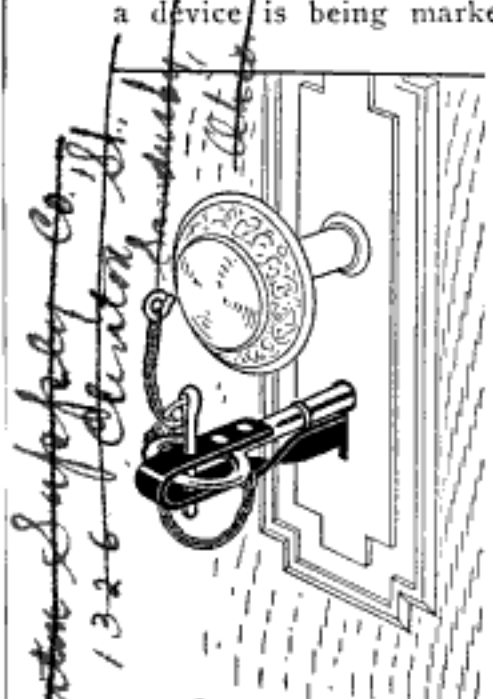

*Clinton Safety Co. 181
1326 Canton St.
Cleveland, Ohio*

*Keylock Co., 5713 Euclid Ave.
Cleveland, Ohio*

*9/21/23
Kansas City Times*

*Plan. American Place Brixh Association
1727 Brixh Ave
Life Bldg
Chicago*

*International Park of Commonwealth
Edison Exhibition*

3449

POPULAR MECHANICS

725

GARAGE WITH SLIDING DOORS IS PART OF HOME

In a model electric home erected for exhibition recently, the garage was built at the side of the house opposite an artistic sun parlor so that it would act as an ornament to the surroundings. Its

large sliding doors are so arranged that when closed they resemble a row of windows that appear as part of the home. Flower boxes, vines, and other trimmings were added to conceal the true purpose of the garage and to blend it with the rest of the house. An electric attachment makes it possible to open the doors from the seat of an automobile standing near them. Lights can be turned on from the house.

The Garage at the Left Has Sliding Doors That, When Closed, Resemble a Row of Neat Windows in a Concrete Wall



*Garage door - Street - Amer
Washington - Recording Co. 4101 Bannockburn*

English method.

MIRRORS COATED WITH GOLD RIVAL THOSE OF SILVER

Through recent tests, gold has been proved more efficient than silver as a coating for light reflectors. For almost 700 years silver has been used for that purpose. In the latest searchlights, copper reflectors coated with pure gold are being employed. These have been found to reflect more light than those covered with silver, since the former throw off a higher percentage of red and yellow rays. It is also claimed that fine color distinctions can be made more easily with the former. *Edison Jarrett*

SEAWEED IS MADE INTO FOOD

In Lower California great quantities of seaweed are being treated and reduced to a very clear and nearly tasteless food gelatin. It grows at varying depths, from one to ten fathoms, in the ocean and is gathered by divers. First dried in the sun, the weed is then boiled and exposed to a freezing temperature. When the water is evaporated, a high-quality vegetable jelly is left.

*Carruel Lighton Hope
Ensenada, Mexico*

WORN BY FIVE GENERATIONS, SHOES ARE STILL GOOD

Claims to the title of the longest wearing baby shoes, are made for a pair 150 years old. Made of heavy leather, with thick soles, clumsy in comparison with the baby's footwear of today, they have been handed down in a family ever since



Baby Shoes



That Have Been Worn by Five Generations

they were bought in Scotland in 1770. Although many children have used them, they show little marks of wear and promise many more years of usefulness.

Clinton National

WORLD TO VIEW WONDERS OF ANCIENT TEMPLE

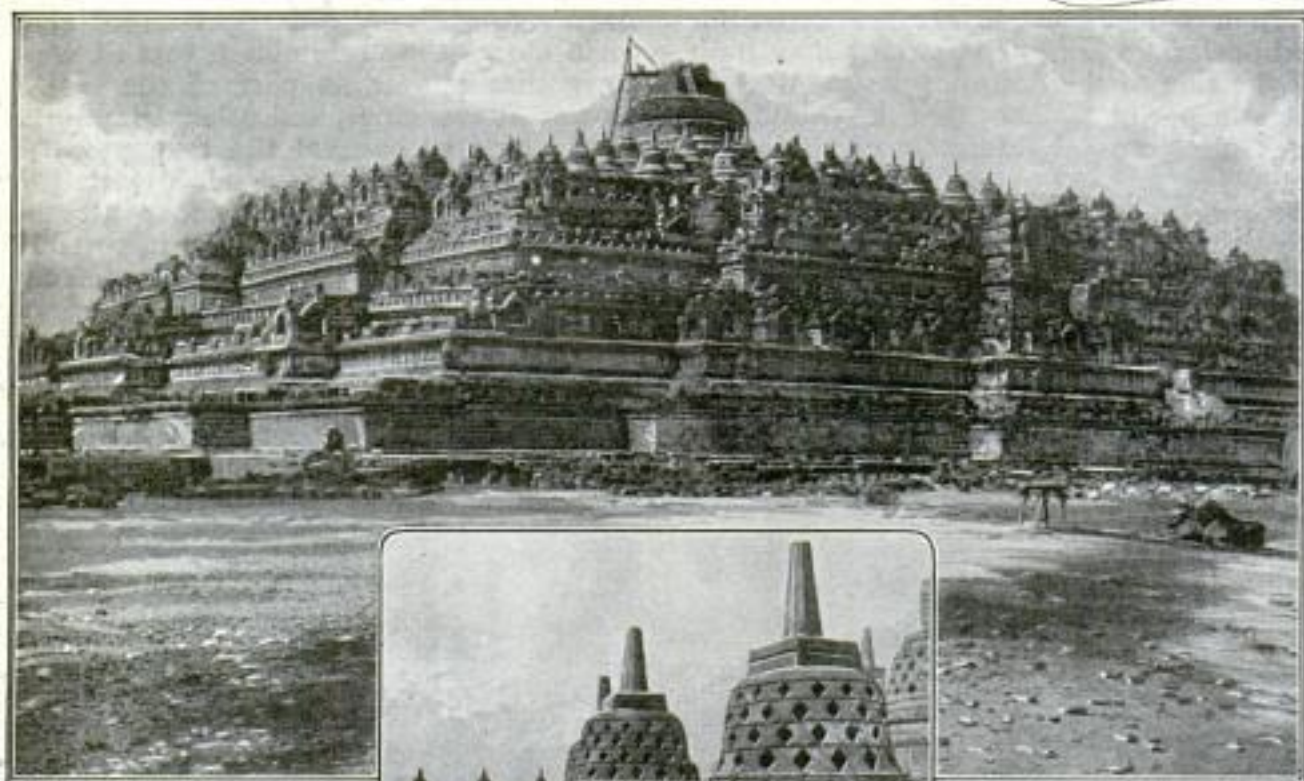

COPYRIGHT, FRANK BURNETT

One of the Greatest Temples of the Ancients,
a Buddhist Shrine in Java

MONSTROUS and magnificent is Boro-Budur, an old Buddhist shrine in central Java, said to be among the greatest of ancient temples. Believed to have required more labor to build than was used on the great Pyramids of Egypt, yet, it is a curious fact that this edifice has been overlooked by the majority of world travelers. This may be changed, however, with the opening of a proposed airplane service throughout the Malay archipelago, which will make the temple accessible, and attractive, to tourists.

Begun in the seventh century to hold some of the supposed ashes of Buddha brought by missionaries from India, the temple is notable for its beauty. The ashes were originally divided among eight towns, but later King Osaka, of India, had them taken from the tombs and redivided into 84,000 parcels, which were distributed over the Asiatic countries by missionaries.

Nearing completion in the 15th cen-

of the sword. It was then left to the encroaching jungle. Trees and shrubbery surrounded it. Lava dust from the many volcanoes on the islands gathered upon it and filled its galleries. Earthquakes cracked some of its walls. Yet, despite all this, it was in a fairly good state of preservation when it was discovered in 1814 by Sir Stamford Raffles, then in charge of the island for the British government. He

at once began the work of restoring it, which was continued by the Dutch when they took possession of that territory at the close of the Napoleonic wars.

Built in the midst of a vast plain it is an artificial, many-sided mound, made up of a series of galleries, cupolas, and spires,

topped by an enormous dome 52 feet in diameter, and surrounded by wide terraces. Formerly, a square parapet of



COPYRIGHT, FRANK BURNETT

Magnificent Temple Carvings Hidden in Wilderness
for Hundreds of Years

heavy stone enclosed the plain. In each of the four sides was an opening leading to a flight of steps protected by smiling lions of stone, which still remain grinning sardonically after 1,200 years. From the plain, similar stairs go up to irregularly shaped galleries, and on to the great circular one surrounding the dome. The terraces are well drained by carved gargoyles representing mythical monsters, the water being carried off through their mouths.

At each angle in the galleries sits a Buddha in a niche covered by a cupola. The figures, almost nude, are seated on lotus



COPYRIGHT, FRANK BURNETT

Carvings That Have Defied Time to Bear Witness to the Skill of Long Forgotten Race



COPYRIGHT, FRANK BURNETT

Although Cracked by Earthquakes, Walls of Old Temple Still Lure the Traveler

leaves. The entire wall space is covered with carvings having some bearing on the story of Buddha's life. Every incident of his existence from the time he left his lotus-leaf throne and came to earth, until he attained Nirvana, the spiritual haven of the Buddhist religion, is wonderfully pictured in carved stone. Near the top, rise three circular terraces, one above the other, and upon these, 72 bell-shaped shrines made of latticed stone, each of which has a slender spire. In every one sits a statue of Buddha faced toward the great central dome.

3482

CIGARETTE CASE FOR MOTORISTS KEEPS "SMOKES" HANDY 3353

For convenience of auto drivers, a neat nickel-plated cigarette case is being made

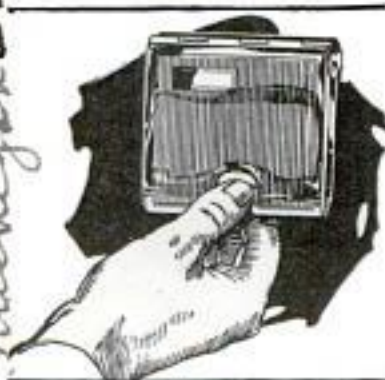

for attaching to the instrument board of the car or at the side of the rear compartment. "Smokes" are withdrawn from an opening in the bottom. When one is taken, another automatically drops into place, ready for the fingers. To refill the container, the front is raised after unfastening a catch with the thumb.

To improve London's position as an ocean port, work has been started at Tilbury on what is said will be the largest dock in the world when completed. It is to have a water area 6,550 feet long and 750 feet wide, with an entrance lock 1,150 feet in length and 130 feet in width.

AUTO WITH ARMORED TURRET TRANSPORTS BANK FUNDS

Covered with armor steel a quarter of an inch thick, an automobile, specially built to resist the attacks of payroll robbers, is being used by a western bank for transporting money. Weighing 5,000 pounds, the car is said to be bullet-proof and impregnable to onslaughts of bandits. Guns are carried for defense, and loopholes permit the occupants to fire in any direction. From a turret at the rear, a

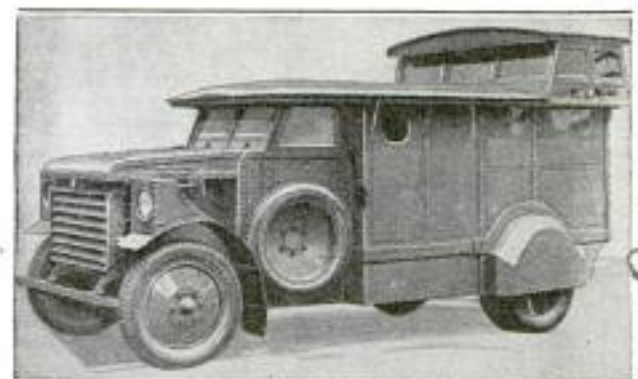

Armored Automobile with Turret Used to Carry Bank Funds and Eliminate Danger of Bandits

guard, who has an unobstructed view on all sides, can control the movements of the automobile.

Banner Tire Co. 1356 E. Michigan Ave. Chicago

Hollman Commercial & Trust Co. Los Angeles, Calif. & Irving Branch.



Explorer, Disguised as Native for Journey Through Mysterious Tibet to Lhasa, Is Victim of Night Attack and of Thieves and Is Finally Turned Back by Death Threats

Further Adventures In Asiatic Paths

BY SVEN HEDIN, *Stockholm Sweden*

Sven Anders Hedin, noted authority on those little-known lands, Tibet, Turkestan, Mongolia, and central Asia in general, has spent a great part of his life—he is now 58 years of age—in exploring these strange lands. These journeys, performed at times amid extraordinary hardships and always at the immediate risk of lingering and terrible death at the hands of savages or by starvation, have won for him high honors and a world-wide reputation and fame. A noted scientist, a daring adventurer, a fluent writer—he is author of numerous valuable and weighty books. Doctor Hedin is an honorary or active member of nearly every scientific society in the world; is a member of the nobility of Sweden, to which he was raised in recognition of his work by the king; is the bearer of honorary degrees from most of the famous universities of the civilized world; is the personal friend of potentates and rulers, and is now on his way to Asia for another daring journey through the wild interior where he has found strange buried cities, grotesque and terrible customs, and where he has several times been forced to travel long distances on foot without water or food.—Editor's Note.

ONCE I rode on horseback with two servants and some packhorses from the interior of Persia over Mount Elburs to the coast of the Caspian Sea. We were to camp in the midst of the mountains, in a small town. But when I learned that its caravan Sarai was notorious for its poisonous bedbugs, I decided to sleep in a garden outside the village. This was surrounded by a very low brick wall. I took my supper, which consisted of bread, milk, tea, honey, and apples. What was left was loaded in a box, and I wrapped myself in my blankets and fell asleep. My men had already gone into the village.

At dead of night I was awakened by a rattling and scratching sound around the boxes. Something pulled and tore at the straps. I sprang up and perceived half a dozen jackals disappearing between the poplar trees, but soon they came back. I struck at them with the horsewhip and pelted them with the remaining apples, but they became accustomed to my way of fighting, and their boldness increased. I had to keep watching constantly.

The jackals must not be looked down upon. In 1882 not less than 359 human beings were killed in Bengal by these minor animals of prey.

I felt as if the night would never come to an end. At last the dawn appeared and with a feeling of relief I saw the last one of the enemies with-

draw over the garden wall. Then finally I could enjoy a few hours' rest.

A singular trail is the one which goes through Baluchistan, from Seistan to Nushki, between Persia and India. This can hardly be called a road. It is a trail through nothing but desert, hard and excellent to ride. The traveler passes by rocks eaten through by the sun, and past sand dunes over arid furrows, which sometimes are filled to their very edges by torrential rains. Time and again there are seen sand spouts—yellow pillars formed by cyclones, sweeping over the barren ground like spirits of the infernal regions.

Here the traveler is transported by "jambaz," a noble race of quick-footed dromedaries. Long-continued breeding of the Baluchis has imparted to these animals their extraordinary running qualities. Ordinarily the natives use double saddles with one placed in front, the other behind the hump of the dromedary. When

I rode this way, however, I wanted to be alone with the racer. He ran with a frightful speed! The rider must be quite immune from seasickness. You are swayed from right to left and thrown forward and backward. You imagine that you are flying over the country.

Along the way, there are, in very wide distances from each other, station houses erected by the Indian government. The travelers may rest, drink, bathe, dine in them, let the dromedaries

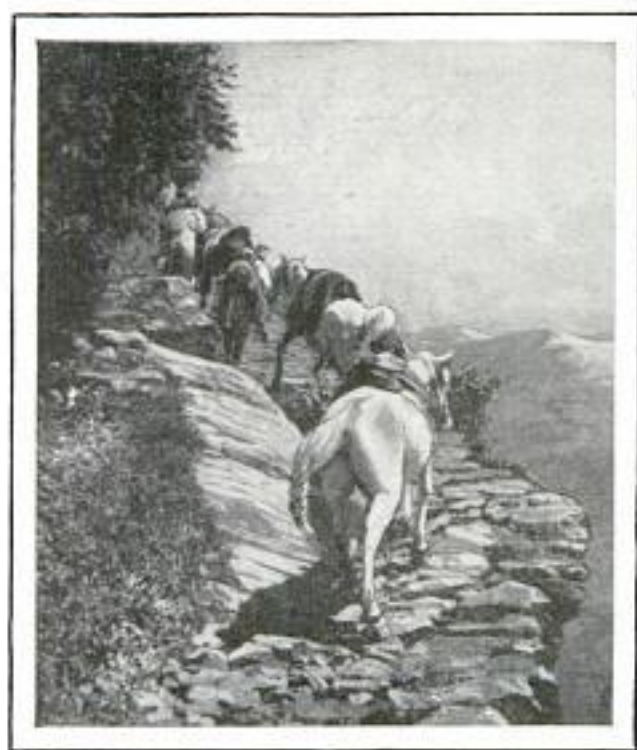

Even Sure-Footed Pack Animals Find Trails Hazardous

rest, and then continue their journey. Baluchis are always there acting as watchmen. They are looking out over the road to be at hand and aid the travelers. Some "jambaz" dromedaries must almost be forced to stop. They like to run, and would go on even over the next stretch of road as far as the next station house if they were not held back.

A few noxious minor animals against which the traveler must be on his guard, not only in Baluchistan but also in Persia and Central Asia, are the scorpions and the black shaggy spiders called tarantulas. Both are poisonous. I have often found scorpions under my bed or pillow, but have always escaped being stung. In Turkestan, the natives are positive in claiming that the scorpion, when in a desperate situation, will commit suicide, but I do not believe this. I was told that if he was inclosed in a ring of glowing coal, he would set his sting in his own back, thus causing his death. However, when I once made such an attempt, the scorpion toured several times around the coal ring and then placed himself in the center in a watchful position.

When, on my first large journey in Asia thirty years ago, I came from Moscow by the way of Samara to Orenburg, before starting out for Tashkent through the Kirghiz steppe. No other course was open for me but to buy in Orenburg a "tarantass," which is a clumsy vehicle on four low wheels, and then drive southeast on the postroad along the eastern shore of Lake Aral. The way was 1,200 miles long; it took 19 days. Horses were exchanged

every 18 miles, on an average. The station houses were in charge of Russian peasants, but the drivers were Kirghiz. When the road was hard and even, a troika was enough to pull the "tarantass," but when we reached passages that were soft and heavy with sand or mud, there was hitched on a "chetvorka" or "piatorka," that is, a four- or five-horse team. Through the sand dunes on the eastern

shore of Lake Aral, no horses succeeded at all in pulling my heavily laden wagon, so it was necessary to hitch three camels in front of the "tarantass." A glorious sight indeed it was to behold the tall animals, carrying between their humps the Kirghiz riders, and the Kimming with their broomstick legs over the light sand, which was dashing like water around their broad feet.

It was at the end of October and early in November, 1917, when I made this journey. In the northerly part of the desert, snow was lying. During the snow storm, when the road disappeared without any trace being left, the telegraph poles were a valuable guide. But the Kirghiz reported that during severe winter storms and impenetrable snowfalls, even drivers well accustomed to the road might lose

the way in the short distance between two telegraph poles. The only thing they could do then was to stop and wait until the storm had passed. In clear weather, on the contrary, it would never happen that they drove the wrong way, not even during the night. I often had occasion to wonder at their incredible instinct for localities and their phenomenally sharp eyesight. My coachman, for instance,



Descending into Tibet after Crossing the Lipu Lekh Pass Between Snow-Capped Mountain Peaks

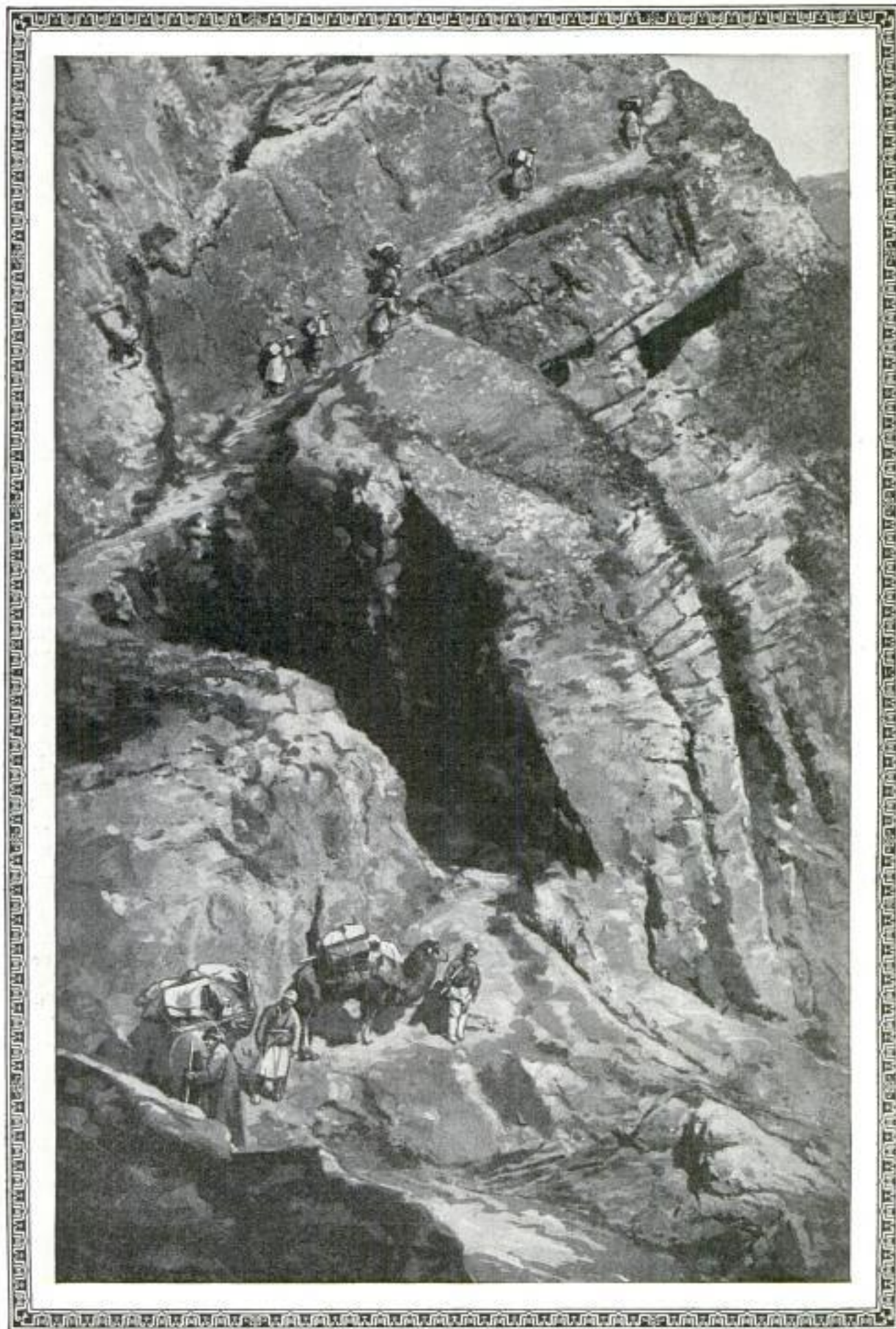

When Nature Has Endowed Animals with Ability to Pass over Trails of the Centuries, Why Should the Sons of the Heather Build Roads, the Natives Ask



Over Trails too Rough and Steep for Animals, Men Act as Beasts of Burden

could point at the way and say that a wagon was visible at the southern horizon. He could distinguish whether it was coming to meet us or was going in our own direction; whether it was a "tarantass," a "telega," or some other kind of vehicle, by how many horses it was driven, and what color they were. His eye was thus a finer instrument than my field glass, for even with it I could discover nothing, or merely a small black speck that appeared to move.

A few years later, the Russians built the Samara-Orenburg Railroad through the entire steppe as far as Tashkent, and the old drive lost all its poetry and significance. To call it old is, indeed, stretching the word a little, when we look at such a matter from the Asiatic point of view. The fact is that this drive did not exist in 1865, when General Cherniaieff marched on Tashkent with his detachment of 600 Cossacks.

In April, 1897, while approaching the end of the same great journey, I made a drive of the same kind through a tract of deserts and steppes, situated 2,500 miles farther to the east.

This journey carried me across the Gobi desert from Kalgan to Kiakhta on the Russian border, south of Lake Kaikal. The length of the way was the same as in the Kirghiz steppe, 1,200 miles. The Siberian Railroad had at that time been completed only as far as Kamsk, hence I used Russian sleighs to drive the entire way from Kiakhta over the Baikal ice, and also over Irkutsk to Kamsk.

But the drive through Gobi belongs to

my most picturesque remembrances. The Mongol way of transporting a wagon with horses is likely to be unequaled anywhere on earth. The wagon is a tiny Chinese cart, "mapu," without springs; it affords room for one passenger. There is no bench or seat; the inmate has to sit on hay, blankets, and cushions. The horses are not hitched in front of the wagon, and the space between the shafts is vacant, but at the end of the shafts there is a long crossbeam, which two mounted Mongol horsemen lay across their knees. At the ends of the beam, soft ropes are bound, whose free ends are strung around their bodies by a couple of other horsemen.

When everything is ready, the riding whips crack and the horsemen start galloping over the steppe. The distance between the stations is from 15 to 20 miles, hence the horses will get tired. Other horsemen, who are following along the sides of the wagon, will then speed forth and take over the beam or rope without any stopping of the gallop.

The stretch of land which I covered in this doubtful pastime equals the distance from Chicago to the southernmost point of Florida but the contrast between the two routes is strange, indeed.

Everything is so widely different in Asia; then why not also the "roads"? The Asiatics have no idea of road construction. In steppes and deserts they have their camels, in mountainous districts their mules and yaks. As long as the Creator has endowed these animals

3450

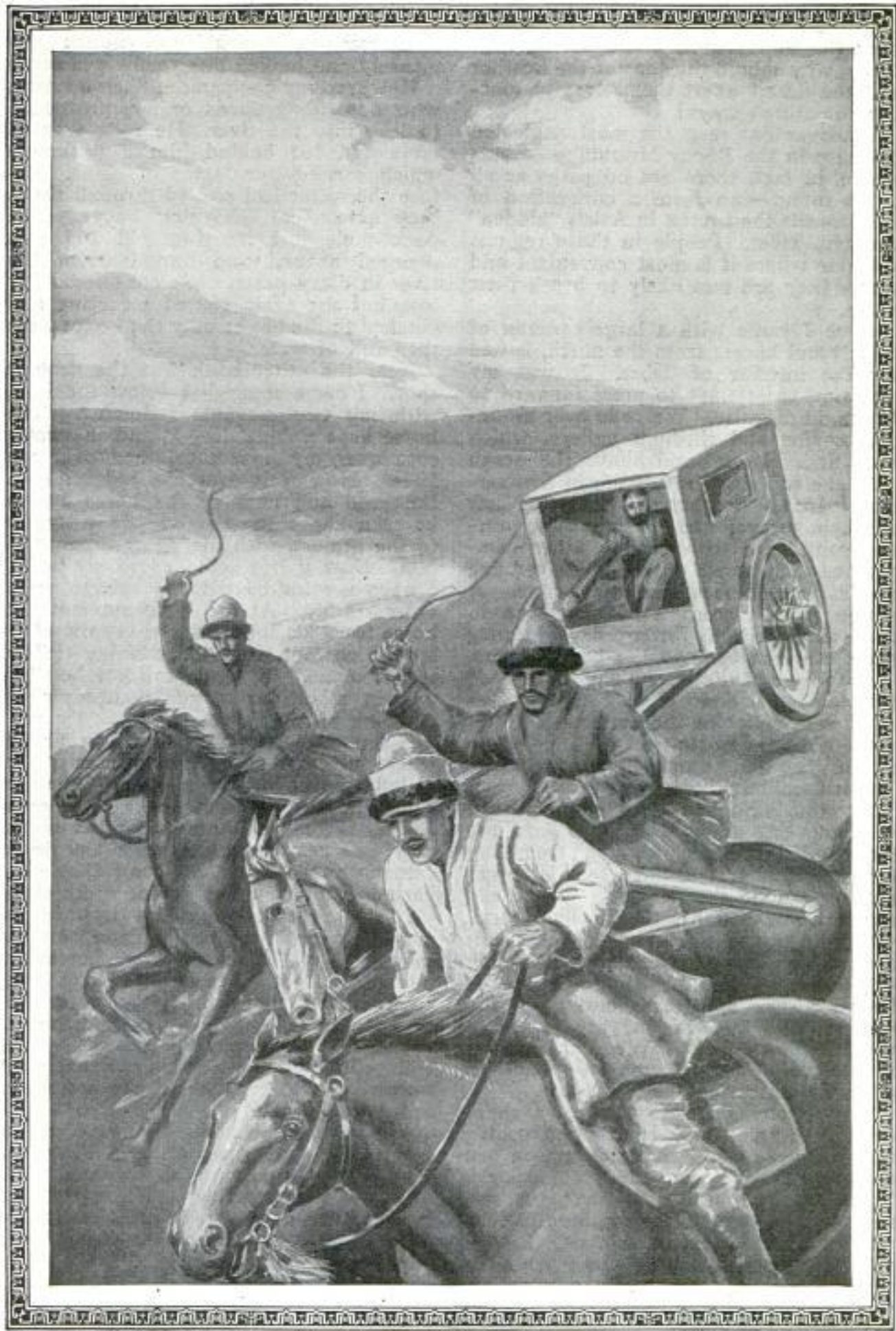

Strange Vehicle in Which Explorer Was Forced to Ride over Uncharted Wastes of Asia on His Way to "the Seat of the Gods," the Citadel of the Grand Lama

with the ability to pass along just safely over the unimproved paths of the centuries, why should the sons of the heather and the desert exert themselves to ameliorate nature's ways?

Whoever has seen the most neglected passages in the Rocky Mountains—tracts where, in fact, there are no paths at all to be found—can form a conception of what awaits the tourist in Asia's "hidden" country, Tibet. People in those regions will ride where it is most convenient and where they are less likely to break their necks.

Once I came with a large caravan of camels and horses from the north, bound for the interior of Tibet. It was my intention to attempt to press forward to Lhasa, in disguise. We rode over mountain chains and through valleys, which were at a higher level above the ocean than the top of Mont Blanc in Switzerland. In an uninhabited district I left the main caravan and continued the journey southward without any other companions than two Mongols. We had five mules, four horses, and two dogs. A native from eastern Turkestan was to come along with us for two days' journey and then turn back to the headquarters.

At the end of the second day we camped between two lakes. Here I finished disguising myself. In the evening a storm gathered in the north, and we huddled up in our little tent at an early hour to sleep. Toward midnight the man from east Turkestan, who had been charged with watching our animals, sneaked into the tent and whispered with a trembling voice: "Robbers! I have seen a figure moving around the horses!" We rushed out with our men into the howling storm, with the moon shedding a pale light around us. We were too late. Straining our eyes, we could distinguish at the border of the hills three horsemen who were driving two of our horses before them in hasty flight. We sent a bullet after them, but the shot only had the effect of increasing their speed.

The following nights we kept a sharp eye on the animals, and nothing alarming turned up. But now the rainy season had commenced, and the man from eastern Turkestan had been sent back. It was necessary for we remaining three to take turns at watching the animals. I shall never forget the dreary nights when I for three hours had to sit in the rain that was pouring down, with my eyes fixed on these mules and horses. In the meantime, the incessant rain kept on swelling all watercourses. The worst came when

our path was threatened by a river, called Sachutsangpo, which had swollen immensely and looked like yellow pea soup.

However, my companion, Shereb Lama, who was riding ahead of me, proceeded to leap into the river. He rode a small mule and led behind him a packmule which carried our boxes of skins. Before the water had soaked through them, they acted like lifesaving buoys. The pack mule lost her foothold and was dragged around and hurled down the river in dizzy haste. We considered her lost, but she again gained a footing and climbed to the bank; only the boxes were then full of water.

Near the other bank was the deepest spot. I came somewhat below the ford, with my two servants following. The horse kept sinking deeper, and the water rose over my boot tops, then over my knees. Now it is over the saddle; only the head and neck of the horse are to be seen above the floods! He struggles to the utmost, with the water tugging at him. Now it has come up to my waist. I open my fur coat, to be able to swim more readily. At the same moment the horse loses his foothold and is torn away by the current, with me clinging tightly to his mane. He again touches bottom, and in a furious struggle succeeds in climbing up the shore.

A few days later we camped in a spot where we could count twelve tents in the distance. In the dawn, three Tibetans came to our tent and spoke to Shereb Lama. From yak hunters farther north they had heard about a large European caravan approaching, and now they suspected that one of us was a white man.

In the night they lighted a ring of fires around our tent, to keep us from running away. Next morning the horsemen poured in from different directions. We counted 53 of them closely drawn up and riding around our tent on the soaked ground. They brandished their swords and yelled at us. It was clear that they wanted to frighten us, but we preserved a defiant attitude.

For several days we thus were, so to speak, the prisoners of the Tibetans. Finally the governor of the province, Kamba Bombo, arrived. He started an investigation and announced his decision: "If you take another step toward Lhasa, your throats will be cut."

Against an enemy so superior in number we had to give up the thought of resistance. We turned back north and after many vicissitudes arrived again at the headquarters.

Tribune Bldg. Quay 3321

COOLIES STAND AS THEY ROW ANCIENT CRAFT

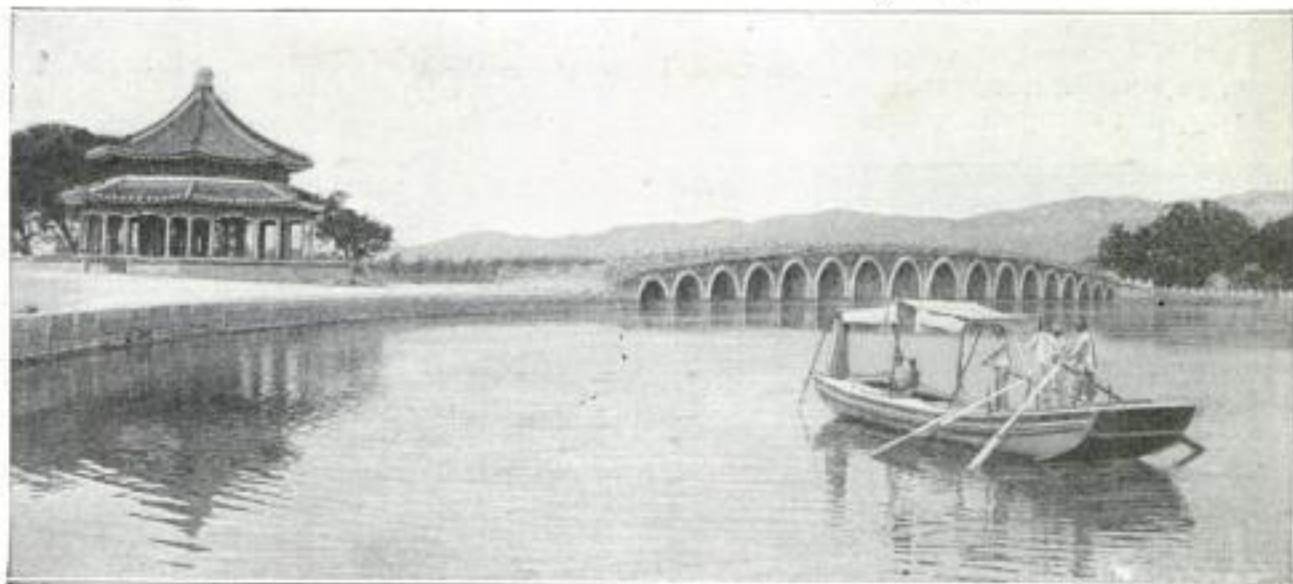

Ancient River Boat Used in China, Propelled by Coolies Who Stand at Their Oars: The Low Price of Native Labor Has Prevented the Adoption of Gasoline Motors

River boats of ancient days, long, flat, crudely made craft, propelled by men who stand as they row, still ply quiet waters of China. For a traveler to go 1,500 miles on such a barge, taking months to reach an inland point, is not an uncommon event. Often this is quicker and less expensive than a land

route, which might be rough and perilous. The cabin, the only place of comfort, is covered with a canopy of cloth. On the deck near the stern, coolies work the primitive oars made of long poles attached to flat boards. There is no rudder. Steering is done by the rowers or, in shallow water, by a long, heavy pole.

BUGS DRAWN TO BRIGHT LIGHTS BECOME FOOD FOR FISHES

Feeding fish by electric light is an experiment being tried at a hatchery in a mid-western state. It was discovered that an incandescent bulb at the edge of one of the ponds for young channel catfish attracted various night-flying bugs and that the fishes caught them whenever they ventured close to the water. More lights were strung around the tanks and now the finny creatures are furnished with thousands of insects that swarm about the bright rays on summer nights.

SEAPLANES AT ANCHOR GET FUEL THROUGH AIR PUMP

Refueling seaplanes while they are at anchor in the water has been accomplished by United States marines stationed on an island in the Pacific. By pumping air into an opening in the gasoline drum the liquid is forced out through another hole and carried by a hose to the tank of the flier. Formerly it required a half hour to empty one barrel of fuel into the aircraft's reservoir, but now only seven minutes are needed.

AIR CUSHION IN DISK WHEELS MAKES RIDING SMOOTHER

Forming a double air cushion, and thus increasing the resistance to road shocks, steel-disk automobile wheels have been invented by an Englishman that are claimed to make riding easier and lessen the wear on tires. By extending the inner tubes, shaped like a figure eight, into circular hollow spaces around the wheels, the air capacity of the tires is practically doubled. This, it is said, makes possible the use of lighter material. Casings can be removed for repairs without displacing the inner tubes.

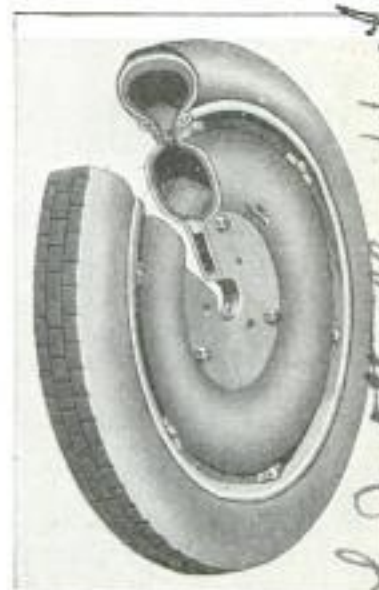

England
L. H. Stoll, High Road,
Leeds, England
C.M.

3388
New York City Star 8/16/3
3418
Emb. S. R. Winters
District National
Bank Bldg
Washington D.C.

340 MODERN STORE "ADS" REACH HUT OF MONGOL WORKER

Carried by some traveler in his wanderings, an English newspaper recently found its way into Mongolia, where modern cus-



NEUMAN TRAVEL TALKS
Clothed in European Garments, This Mongolian Weaver Still Follows Ancient Methods of Her Art

toms have only begun to find favor with the inhabitants, and there fell into the hands of a native weaver. Unaware that its pages displayed household-furniture advertisements, perhaps offering for sale some product of her own art or that of her coworkers, the Mongolian woman used it as a protecting wrapper for the strands of yarn from which she made cloth. A few years ago, the printed pages would probably have been the object of excited comment in the village, but now newspapers are accepted as part of the white man's presence. Mongolia, once the home of savage, warlike tribes, is becoming modernized, as is indicated by the garb of the workers, many of whom wear European clothing. Despite this, the processes of weaving developed by the race's early ancestors long before civilization appeared in the western world, have undergone little change.

With a staff of eight assistants and many internationally famous scholars, a midwest college professor has undertaken a 10-year task of compiling a dictionary of the Babylonian-Assyrian language, dead for 2,000 years. When completed there will be more than 200,000 different word forms and 30,000 words, it is estimated.

3280 DEADLY GAS BOMBS SOUGHT FOR AIRPLANE ATTACKS

With the development of aerial torpedoes powerful enough to sink or disable the largest warship, army and navy engineers have turned their attention to gas bombs for airplane attacks. Chemicals have been successfully used for throwing up smoke screens to hide maneuvers on land and sea, and efforts are being made to find some compound that will produce temporary unconsciousness without giving any warning of its presence by taste or smell. It is now believed possible that some compound will be found which will enable large areas of a battle field to be blocked off and rendered unusable for days, the chemical converting whole districts into a permanently infected "No-Man's Land."

3402 CAMERA WITH TWO LENSES GIVES DEPTH TO MOVIES

Motion pictures with a natural appearance of depth as well as width and height have been created by a middle-western inventor, who recently demonstrated his discovery. He has developed films, cameras, projection machines, and screens that apply the theory of the stereopticon to the reproduction of scenes. It is claimed that the eyes will not be strained, nor the three-dimension effect be spoiled, by sitting to one side or close to the screen, which is about four times the size of those now used. The camera, much larger than the standard, has two lenses and takes two pictures, one on top of the other.

3362 WATER FOR ENVELOPE SEALER SUPPLIED FROM ITS HANDLE



For sealing envelopes, a device, that feeds moisture from its hollow handle, stores sufficient water for 1,000 operations. Sealing at the rate of 60 per minute,

this small apparatus moistens the glue and closes the flap at the same time. It is sanitary and nonleaking, and all parts are made of brass.

The Consolidated Co.,
100 Boylston St.
Boston, Mass.

Chicago
Argyle St. Chicago
Hilton Co., 1345 Argyle St. Chicago
Edsall Redaway

SEA CRAFT BECOMES TARGET FOR AIR WARRIOR

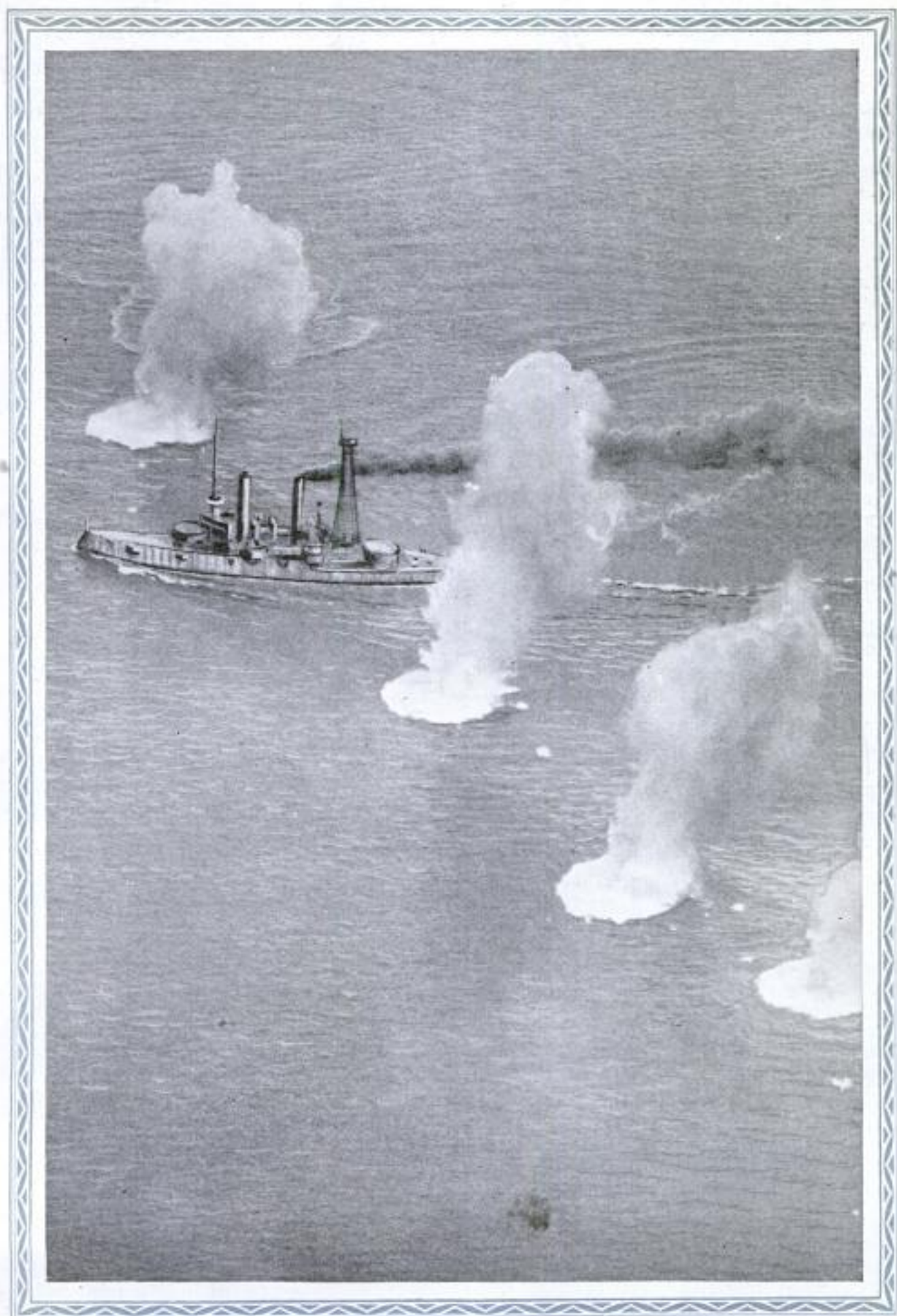

Warship Fleeing from Airplane, the Course of the Latter being Marked by Geysers Thrown Up by Its Bombs, Which Are Powerful Enough to Sink or Disable the Vessel

CELEBRATE BIRTH OF PASCAL, THREE CENTURIES AGO

3290

This year marks the 300th anniversary of the birth of Blaise Pascal, famous French religious philosopher and mathematician, and is the occasion of numerous services in his honor. He died in 1662, and is chiefly noted for his geometrical calculations. Although it is not widely known, he also invented a famous device to perform

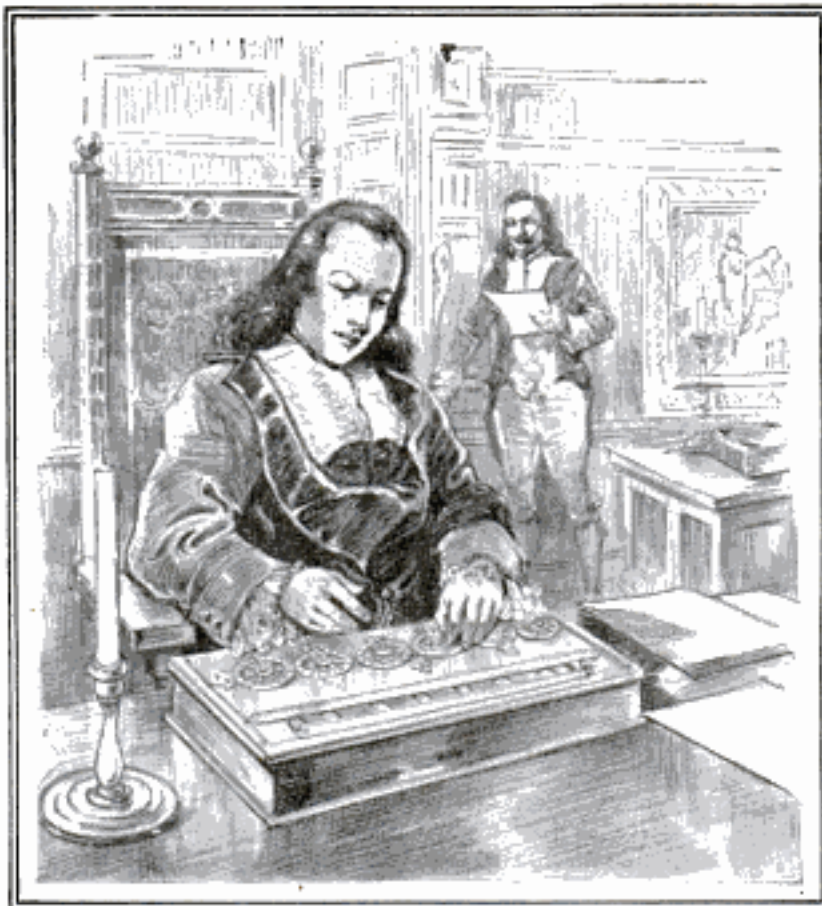

arithmetic problems. He made the first one about the year 1642 to simplify accounting for his father. Later, he turned out several similar devices, one of which is displayed in a French museum. It is a rectangular box with a series of numbered wheels, and works sums in addition or subtraction, the results appearing in slots at the top.

Air Motors Supercharged
AIR MOTORS SUPERCHARGED TO REACH HIGH LEVELS

3409

Flights 50,000 feet or more above the earth, where the atmosphere is so thin pilots cannot live unless equipped with oxygen tanks and bundled in warm clothing, are predicted as the result of the recent development of a supercharger for airplane engines. Plans are being made with a motor which, experts believe, will carry to undreamed-of altitudes. The flier taking this journey will be supplied with appliances to protect him from the intense cold, and special oxygen tanks will be provided with safeguards against explosion and freezing of tubes through which the gas is breathed.

WINDS CARRY SAND OF SAHARA ACROSS SEA TO ALPS

In a recent storm, sand from the Sahara Desert is believed to have been blown across the Mediterranean Sea and beyond the Alps Mountains, finally settling in Switzerland. At first, it was thought that the dust came from a volcanic eruption, but scientists disproved the theory. In the past, storms of the

desert caused dust falls in southern Italy, but this is held to be the only time in many years where the sand appeared so far north. Twenty years ago, after severe weather disturbances in northern Africa, it was found in Denmark.

FORTUNE IN STAMPS PROVED FORGERIES BY EXPERTS

3426

After a lengthy legal battle, 43 stamps composing a collection of rare "Hawaiian numerals" valued at more than \$200,000, recently were declared to be forgeries. By comparison with real "missionaries," an expert showed that certain characters were too artistically drawn, and finally that the stamps were produced by photogravure, and not by printing, as were the genuine articles. First printed in 1851, the stamps later became known as "missionaries," because the Christian teachers in Hawaii pasted them on their letters to friends and relatives in New England and California. Originally the imitation group was bought for \$65,000. Later the purchaser sold part of it to a millionaire collector for \$75,000. There are said to be not more than ten of the real ones now in existence.

Photo. Pub. Ledger 8/19/23

*Emb. Edmund Tarrone
 The Harriet,
 Washington, D.C.*

*Emb. Milton Carlson
 306 International
 Bank Bldg.*

Field Museum of
Natural History Chicago

Secrets of World's ^{Fossils} Youth Revealed by Million-Year-Old Game

HUNTING million-year-old game is the sport of scientists who journey to the remotest outposts of civilization in pursuit of the horned giants, flying dragons, hairy mammoths, and other weird inhabitants of the world when it was young.

Although the saber-toothed tiger can no longer bite, and the huge dinosaurs with three-horned skulls and armored collars of bone protecting their necks, have long since fallen under rock and vanished from the surface of the earth, the quest is as full of thrills as any journey to the wilds of today.

From fragments of bone buried deep in rock formations of North and South America have been pieced together the romantic story of prehistoric times. Long before the coming of man, the crust of the earth was elevated into continents, depressed into ocean troughs, and the land was buckled up into mountain ranges and folded in gentler hills and valleys.

Worn by air and water, many of the high places had been borne away by rivers and seas, to be laid down again elsewhere as deposits which eventually formed sandstones, mudstones, and similar rocks. Much of the material of the original crust has thus been broken down and worked up again many times over, so that in places this layer, it is estimated, is 67 miles deep.

When the sediments were accumulating, the remains of plants, birds, and animals living on the earth at the time were

buried. These form the fossils by the aid of which scientists now read the story of the past. The skeletons, when found, are not always real, but are composed of silica from nature's own laboratory. This is the result of the action of underground streams of water, which, when they touched the bones of dead beasts, snatched up an atom of the lime of which they were composed and in its place deposited a bit of silica. It was, naturally, a slow process, but, after a period of





Scientists Uncovering Fossils of Million-Year-Old Beasts That Roamed the World When It Was Young, but Which have Long Since Vanished, and, at Right, "Bones" being Brought Back to Civilization for Study After being Wrapped in Plaster-of-Paris Bandages for Protection



Prehistoric Giants and Dragons being Restored to Shapes They Assumed in Life for Museum Exhibit. Any Missing Parts are Molded from Plaster

PHOTOGRAPHS COURTESY FIELD MUSEUM, CHICAGO

30,000,000 to 40,000,000 years, it was fairly complete, until now the "bones" are exact reproductions in silica.

This chemical action is one of the methods used to determine the age of the sea, since all of its salt was dissolved out of the rocks after rain began to fall on the earth. Dividing the total amount of saline matter by what is contributed every year in modern times, it is estimated that the oceans are about 100,000,000 years old. But as the present rate of salt accumulation is probably much greater than it was during prehistoric periods, this figure may be far too low.

From the rock records, scientists also have drawn a picture of the appearance of the earth in those early ages. There were no trees of the types we see now, they say, but there were forests of club mosses and horsetails which grew to gigantic sizes compared with their pigmy representatives of today. In these forests the joint-footed invaders of the dry land ran riot in the form of centipedes, spiders, scorpions, and other insects, and on these and the herbage the strange beasts of the time fed. The climate was mild and very much like a long summer.

Although most of the earth's inhabitants were then reptiles, the little animals and the toothed birds were storing up the intelligence and strength to replace the creeping things when the slow change of vegetation and climate permitted. And so, after endless years, the marshes gave way to meadows and the browsing brutes to the larger-brained animals. On the more fertile lands also, an opportunity was offered

for a richer evolution of insects and birds, the climate became less moist, and the grazing herds extended their range.

Flying bats, climbers in trees, like sloths and squirrels, quickly moving hooped animals, burrowers like the moles, and shore-frequenting seals, took the place of the reptiles. Due to the climatic changes, it was a more strenuous period, with exacting rivalry among the creatures—a time of great unrest. Many migrations took place from hot lands to cold and the weaker stocks began to vanish as old land bridges were broken and new ones made. With the coming of the ice age, many types, like the mammoth, the woolly

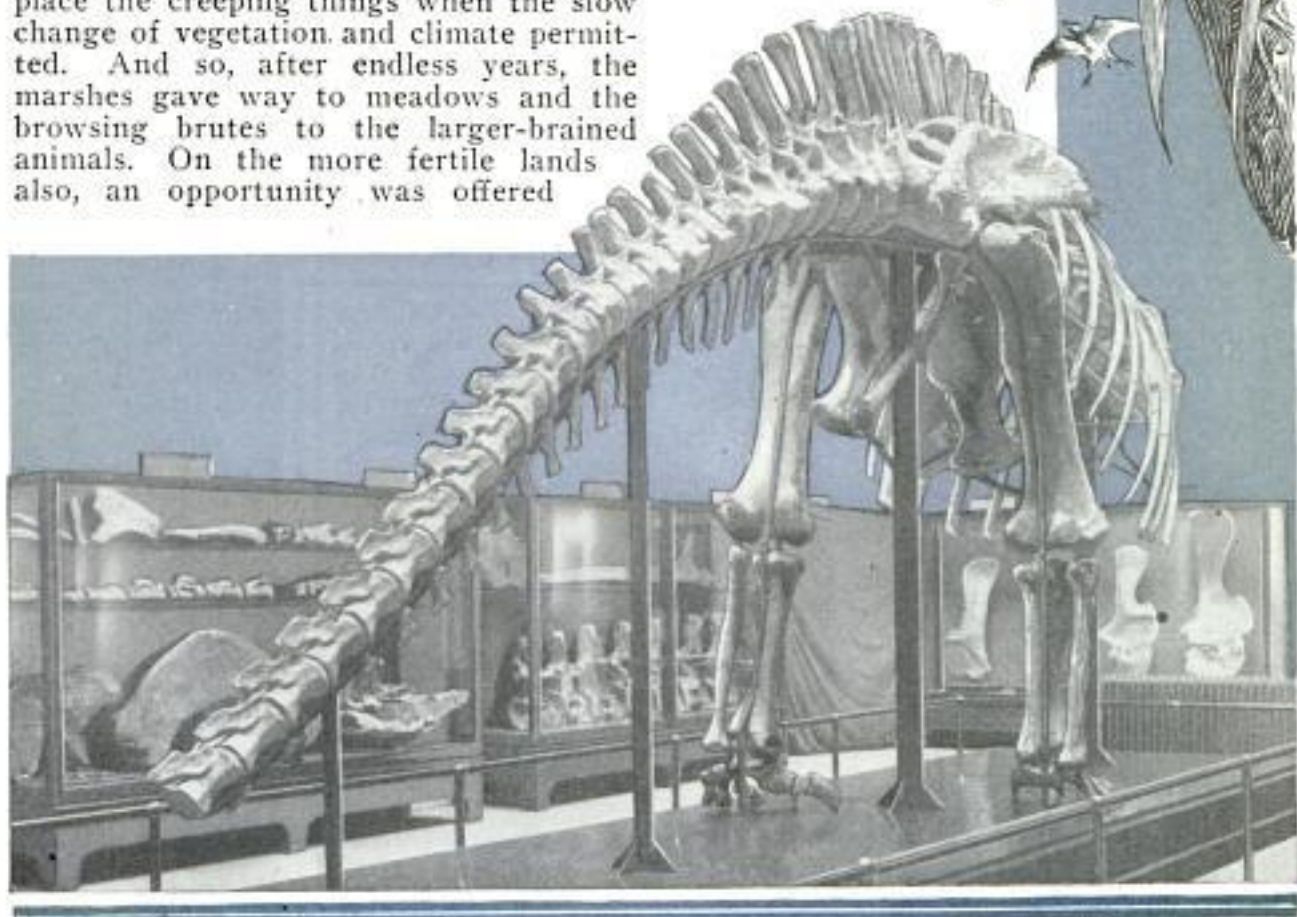

rhinoceros, the saber-toothed tiger, the cave lion and the cave bear, became extinct. As one scientist described it:

"The lands began to bloom with more and more flowering plants and grand hardwood forests, the atmosphere is scented with sweet odors, a vast crowd of new kinds of insects appear, and the places of the once dominant reptiles of the lands and seas are taken by the mammals. Out of these struggles there rises a greater intelligence, seen in nearly all the mammal stocks, but particularly in one, the monkey-ape-man. Brute man appears on the scene with the introduction of the last glacial climate, a most trying time for all things endowed with life, and finally there results the dominance of reasoning man over all of his brute associates."

To locate the fossils of this period, members of the scientific expeditions must be possessed of keen eyes. A stray "bone," a strange projection from a rock, meaningless to the average person, are sometimes their only clues. Wherever the sea has washed away the cliffs, or rivers or floods have dug deep into the earth's crust, there the hunters will seek diligently for their long-dead prey. Once found, the remains are treated with even more care than was bestowed on the modern furniture of King Tut's tomb. The most elaborate precautions are taken to excavate the skeleton, and the rock immediately incasing it, intact. When the bones are scattered, a wide and labori-

ous search is made for the missing parts. Any crumbling bits are soaked in a solution of gum arabic. The ancient bones, and the rocks in which they are bedded, are then swathed in plaster-of-paris bandages for safe transportation. This often includes hauling for long distances across wild and roadless country—an extremely difficult task, as these antediluvian monsters count their weights, plus bedding, not in pounds, but in tons.

Arrived at the museum workshops, the plaster coverings are taken off and each separate bone subjected to a most careful scrutiny. The bedrock is removed by means of specially designed chisels driven by compressed air, and the skeleton is then laid out to show whether any of the smaller parts are missing. If so, a restoration of the piece is made in plaster of a different color from the rest of the fossil. Then the whole is mounted on a steel framework to which the bones are fastened, or wired together in the position the animal is supposed to have assumed in the dim ages of the world's dawn. This is difficult, as no one knows, for instance, in what graceful attitude a dinosaur squatted at ease in a prehistoric swamp, or what figure it cut when out for its evening stroll. Its footmarks on some lonely promenade, it is true, are still to be found, but the fleshy parts disappeared shortly after its death, and it is only by a close study of the bones that the position it carried itself in can be determined.

STONE LAMP OF ANCIENT ASIA FOUND IN ALASKA ³⁴⁰⁷

Believed to have been made by the Mongolians of Asia several thousands of years ago, a queer stone lamp was recently found in Alaska. Shaped much like a shallow bowl, it has a small figure of a squatting god sitting near the rim, which may



have aided in gripping the lamp when carried about. Students interested in the study of early tribes inhabiting North America, believe it was brought by Asiatic tribes said to have visited this continent long before white men arrived. Whether they used ships or traveled over connecting land has never been determined.

PEACE COMES FOR WARSHIPS, GO TO JUNK YARD ³⁴¹⁰

As a sacrifice at the altar of peace, the United States has ordered the junking of eight great vessels of war, six of which have proudly carried the Stars and Stripes through the seven seas. Three of the monsters, scrapped in accordance with the terms of the recent disarmament treaty, have never had salt water wash against their prows. They are the "Constitution" and the "United States," whose construction was halted months ago, and the superdreadnaught "Washington," which has been lying in the wet basin of a shipyard for more than a year, waiting its call to doom. The other five are the "Louisiana," the "Minnesota," the "Michigan," the "New Hampshire," and the "South Carolina," the latter being perhaps the only one to go to the end with colors flying. It probably will be used in tests for underwater and deck attacks.

Philadelphia Public Ledger 8/19/23

326 W. Madison Chicago

WOOD SUBSTITUTE FOR CORK FOUND IN SOUTH AMERICA

34/14 Extremely light in weight, wood of the balsa tree has recently been imported from South America to be used as a sub-



Balsa-Wood Log Balanced by a Piece of Other Timber One-Tenth Its Size

On account of its exceptional buoyancy, it is quite popular among the coast peoples of Brazil and Peru, who employ it in the construction of rafts and small boats to which it has given the name of "balsa." A log of the wood weighs but a small fraction of an equal amount of most any other lumber. While the tropical forests hold what is said to be an unlimited supply of hardwoods, experts assert that the fate of the world's lumber supply rests in the softwoods of the northern hemisphere, which are being rapidly used up. More than three-fourths of the world's lumber is supplied from these timber lands, but whether the forests will be able to meet the demands of the future depends upon the steps taken to replant them. Only 80 per cent of spruce, pine, and other soft timbers cut annually, is being replaced by growth. In one year, it is estimated that 56 billion cubic feet of timber are used for lumber and firewood, the latter equalling in heating value one-fifth of the world's coal consumption.

New York City American Balsa Co., 50 E. 42nd St.

SPECIAL

OX WITH EIGHT LEGS STUDIED BY JAPANESE SCIENTISTS

Man, disease, experts, complet plant s1 growing, ington, those of, with rhis, grow bec, while the, ington win, tens. A, nese ca, Missouri, goni. T, month ago, yellow dat, county osors. How, Jersey, Per, h, cording to, just about, ne to get, caused, ka, om the owners hand, and already returned it back.

HOGS RECEIVE SHOWER BATHS WHILE ON WAY TO MARKET

Along the tracks of railroads carrying cattle to market, standpipes have been erected so that carloads of hogs may be given shower baths during hot weather. Livestock, crowded closely together in cars, must be watered at frequent inter-



GIVING A COOLING SHOWER BATH TO CARLOAD OF HOGS ON THEIR WAY TO MARKET

vals. This precaution not only cools the cars but keeps the animals from losing weight. An entire trainload of hogs or cattle can be sprayed in considerably less time than when ordinary hose is used.



Ships of the Sea Employ a Universal Language of Lights to Inform Neighboring Craft of Their Size and Type, and Direction of Travel During Fog or Darkness

8/4/23
"RULE OF THE ROAD" AT SEA
GOVERNS SHIP LIGHTS ³³⁴⁴

Ships that pass in the night talk to each other in the silent language of sea lights understood by every seasoned sailor. In darkness or in hazy fog, sailing masters are directed through neighboring shipping by the positions of colored lights in the rigging of the other craft. Where there is no other control over sea traffic, the "rules of the road" are based on signal beacons, and seldom violated. Power-driven ships must give way to sailing vessels which are identified in the darkness by their port and starboard lamps. From the arrangement of the lights, the craft's course is readily noted.

SURGEON OF PREHISTORIC AGE
WORKED WITH FLINT KNIFE ³⁴⁶¹

Showing evidence of an attempt at surgery, during an age when man's sharpest instrument was the flint knife, a skull of a prehistoric man has been found in New Mexico, which had been trepanned. An oval section two inches long and an inch wide had been removed from the frontal bone. Although the operation was neatly done, the bone did not heal, and it is believed that the patient died soon after. The skull is that of a short-headed man. A race having such a characteristic lived in the San Juan valley long before the Cliff Dwellers took up their residence in that section.

3394
ARCH ADDED TO BRIDGE AS TRAFFIC CONTINUES

While railroad traffic flowed uninterrupted, a steel arch was placed beneath a suspension bridge over the Niagara Gorge, transforming it into an altogether different type of structure. Faced with

could be properly strengthened at a saving, and without rerouting trains or delaying them to any extent. Huge traveling cranes, large enough to permit the passage of locomotives and cars, carried

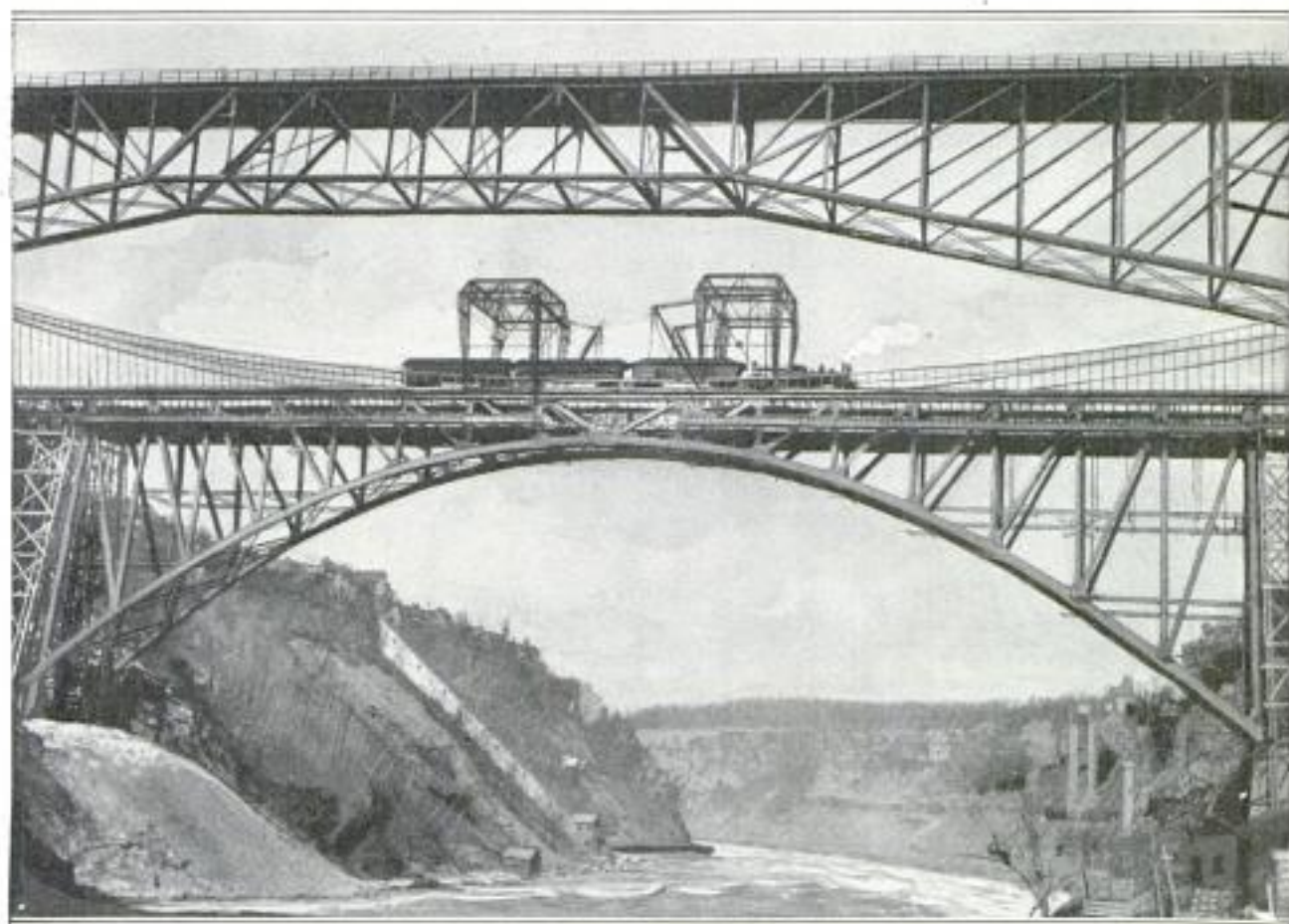

Suspension Bridge over Niagara Gorge. That, by Singular Engineering Skill, was Strengthened by the Addition of a Steel Arch without Interruption or Delays to Traffic

the necessity of erecting a new crossing at considerable expense, experts worked out this novel plan whereby the bridge

the heavy steel girders out to position, where workmen, perched high above the gorge, riveted them in place.

Com. Arvin E. Dunlap
Niagara Falls, N.Y.



NEWMAN TRAVEL TALKS

In Jerusalem, Men and Women Alike Help to Rid the Narrow Streets of the Heaps of Snow That Banks Against Walls and Piles High on the Roofs of Houses

Located at
Arlington, N.J. 747

**RARE SNOWFALLS IN HOLY CITY
BRING THREATS OF FLOODS**

In Jerusalem, where snow falls rarely, it is looked upon by the residents as something little less than disaster. In a climate that seldom grows colder than six degrees below freezing, the Holy City does not often experience freezing temperatures, but to allow the snow to lie in the narrow streets and on the roofs of houses, until it melts, would cause overflow of the drainage system. To prevent this, the watchful inhabitants, armed with shovels and scrapers, and all kinds of baskets and buckets, quickly convey it to hillsides and vacant lands where the dry ground soaks it up.

3325

**ANIMALS ON EDENLIKE ISLES
DO NOT FEAR MAN**

3433

On the Galapagos Islands, 600 miles off the coast of Ecuador, a party of scientists recently found animals that have long been extinct in other parts of the world. As there are no human inhabitants except members of a penal colony, the creatures have never been hunted or disturbed, and are as tame as their domesticated relatives. Left to themselves for ages, they have not followed the lines of development noted elsewhere. Reptiles are still in the majority, many of them heretofore unknown. Among the strange specimens are lizards four feet long and turtles that bite like dogs. So fearless are they, that birds permitted the explorers to lift them from their nest to obtain their eggs, penguins stood quietly while being captured, and a mother sea lion, without even a struggle, surrendered her young for examination. Small wild dogs, thought to be descendants of pets brought by the buccaneers of the Spanish Main, were seen running about.

**BRICK-LAYING MACHINE SETS
PACE FOR WORKMEN**

3400

Laying bricks at the rate of 500 to 600 an hour is said to be possible with a machine recently invented in England. Operated by one man, the apparatus adjusts the bricks in proper position and presses them firmly in their beds of mortar just as skillfully as workmen. Although the contrivance performs speedily and automatically, two workers must spread the mortar and place the bricks before it is set in motion. As the work progresses, the machine moves upward.

Ans. J. H. Knight
Barfield, England.

**MUSHROOM GARDEN IN MINE
PRODUCE ABUNDANT CROPS**

Far below the earth's surface, in the dark shafts of an abandoned copper mine

3374



Harvesting Daily Crop of Mushrooms in Dark Shaft of an Abandoned Mine

untouched by the sun's rays, an eastern miner has established a mushroom garden that is a profitable source of income. Nourished by the finely pulverized soil of these unlighted caverns, the plants grow with such speed that daily crops are harvested. The plot needs no care whatever, and the nearly constant temperature of the pits favors rapid growth. Raising mushrooms in cellars has been a practice of gardeners for a long time, since the

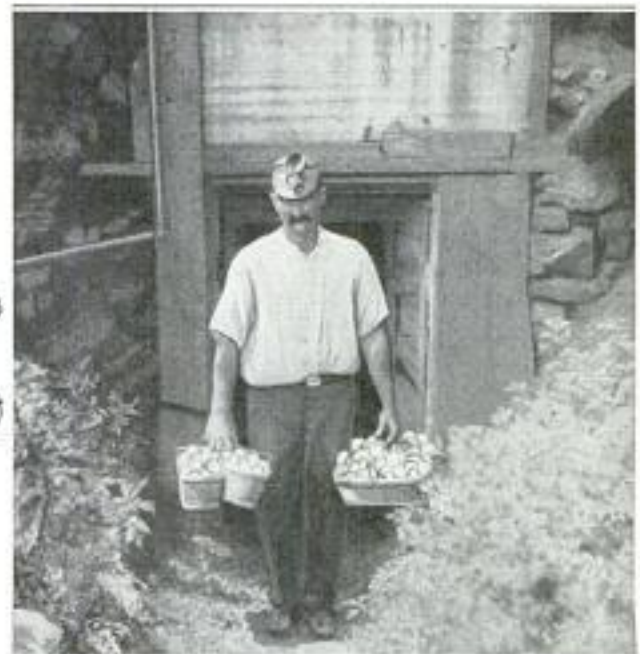

One Day's Yield of Highly Prized Vegetable Brought from Underground Garden Ready for Market

condition of the air below the level of the ground seems to be suitable to them.

2351

FLIGHTLESS BIRDS INHABIT ANTARCTIC SEAS

Keepers of the bird section in the London Zoo are proud of a rookery of trained males fight among themselves, the vic-



Thousands of Penguins, Flightless Seabirds of the Antarctic Region, Gathered on the Desolate, Ice-Covered Shores of an Island Far to the South, During the Breeding Season.

penguins, which have been a source of much delight to the large crowds of visitors that view them. The little colony of polar birds is a favorite center of attraction for youngsters, and the antics of the group never fail to arouse interest. These flightless seabirds live only south of the equator. In the breeding season great flocks of them gather on the rock-strewn coasts of desolate islands



These Plump Penguins at the London Zoo Were Photographed While Waiting for Their Dinner

tors mating with the females when the warfare has so taxed the strength of the weaker birds that they respond only feebly to the urge to battle. Young penguins are born blind and fed by their parents for a long time before taking to the water. Then, suddenly, the flocks, as one bird, rise to their feet, walk down to the sea, and swim away, not to return until the next mating season.

Tribune Bldg Chicago

TRAIN LIKE PACKSADDLE RIDES SINGLE RAIL

3404



Passengers Enter the Coaches from Both Sides of This Monorail Train in Operation in Ireland. Several Classes of Accommodations Are Available as on the Standard Railroads

Similar in appearance to a packsaddle are the coaches of a train that requires but a single rail, in operation on a railroad in Ireland. Each coach consists of two cars, hanging, one on each side of the "trucks" that travel on a track suspended above the ground on a truss-

work. The locomotive that hauls the train is also balanced on the one rail which seems to run through its center. Regular compartments are formed by dividing the coaches. Station platforms are brought much nearer the steps by this arrangement.

Ballyvaughan Railroad, runs to a resort on Western Coast of Ireland.

THUMB PRESSURE ON WRENCH GIVES GRIP TO JAWS

3434

Pressure of the thumb on the smooth jaw of a wrench recently marketed, firmly holds objects, regardless of shape, while

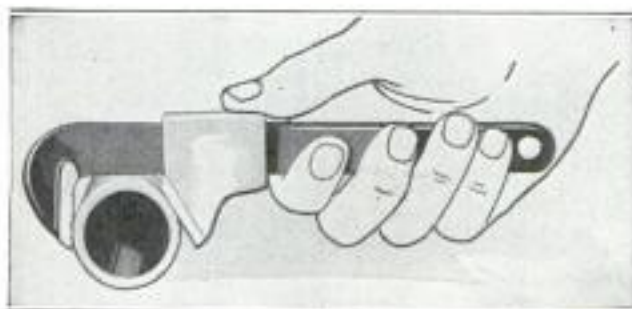

Wrench Made to Take Grip by Exerting Pressure of Thumb Against Movable Smooth Jaw

being turned or twisted. Whether against a wall or along a floor, a pipe or nut can be moved with a ratchetlike motion, by applying pressure in one direction, and

Albany Hardware Specialty Mfg. Co. Albany, N.Y.

releasing it as the handle is drawn back for each grip. The adjustable part of the tool slides on the stem and forces the work against teeth in the head.

3411

CEDAR LOGS FLOATING IN LAKE FORECAST RAINY WEATHER

Floating cedar logs in a small lake have been the "weather prophet" for residents of a northern Michigan city for 15 years. In all that time, observers say, their "forecaster" has never failed. Awaiting the great saws of the city's lumber mills, huge rafts of the timber lie close inshore, but about 14 hours before a rain, it is said the mass breaks apart and single logs move slowly out to the center of the lake. There is no current in the water and the movements occur on windy or calm days prior to a storm. When fair weather appears they gather again packed closely at the water's edge.

Detroit News

8/20/23 Copyrighted material

PARISIAN MACHINE MAKERS SOLVE PROBLEMS

3246 Cont. A. N. Mergaoff & Co. International
 Newsreel Corp. 826 N. Madison Chicago

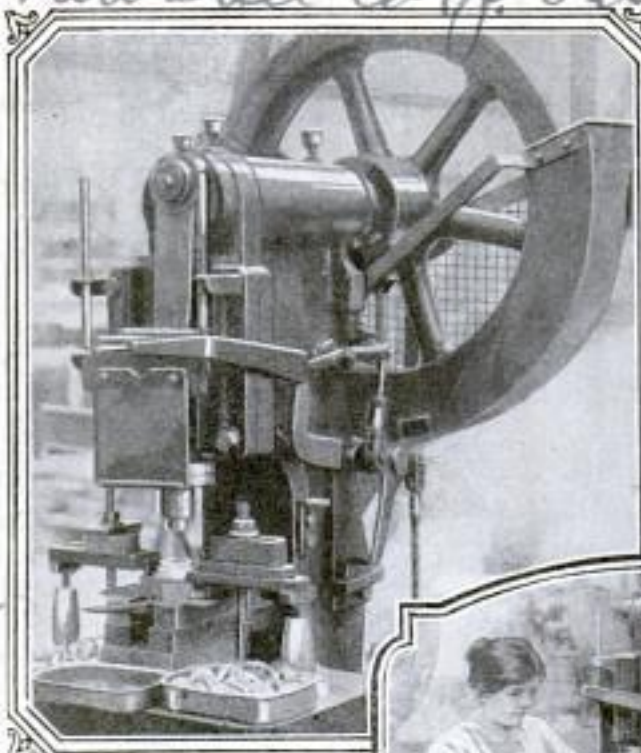

One of the Safeguards Adopted in Switzerland to Protect Workers is Seen Above. When a Pedal is Pressed, the Punch Comes Down Only Once. As It Goes Up, It Lifts the Shield That Prevents Injury to the Operator's Fingers

Why Protective Devices are Needed, Especially for Direct-Feed Presses, is Shown Above. Here the Operator must Feed with His Hand and Then Press Down the Pedal with His Foot. He Also must Remove the Finished Pieces

Where Keeness of Eye and Quickness of Motion were Previously Required to Protect Arms and Hands of Women Employees, Automatic Devices Which Assure Safety under Practically All Conditions have Increased Efficiency by Removing Fear

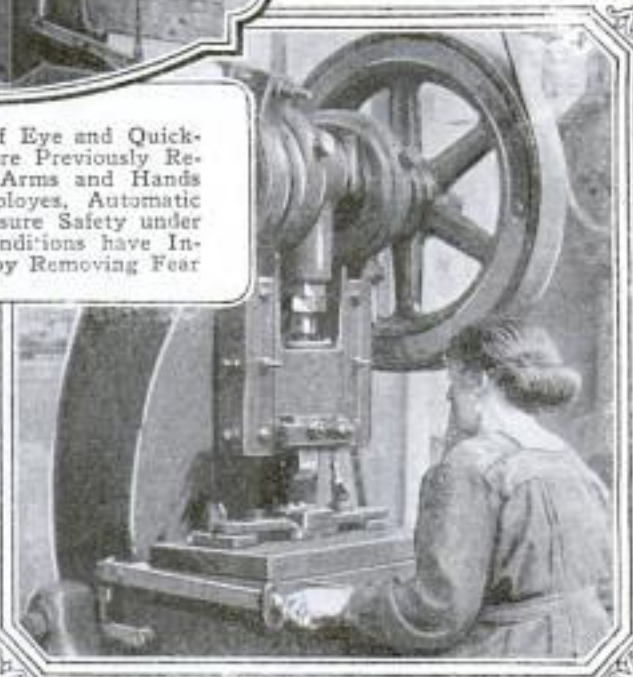

To Prevent Injury to Workers in Machine Shops, Engineers in France have United in Designing New Safeguards Against Accidents, Which Occur Frequently When Operators are Required to Feed Presses and Punches with Unprotected Hands, Regardless of How Expert or Careful They may Be. As a Result, There have Been Many Inventions for Handling the Work Automatically. So That the Attendants can Keep Their Fingers Out of the Danger Zone, Separate Attachments have been Built for Each Unit, Protecting Workers, Reducing Costs, and Increasing Efficiency

FOR SAFEGUARDING WORKERS IN FACTORIES

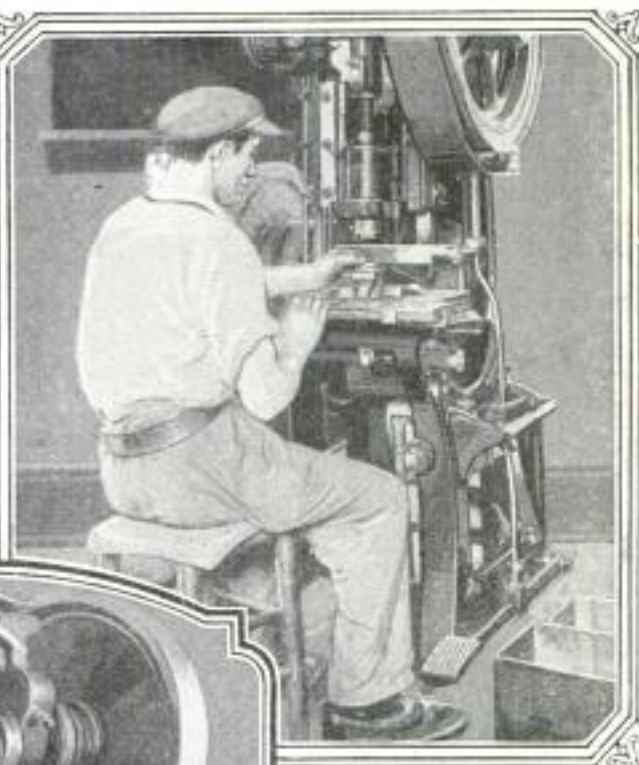
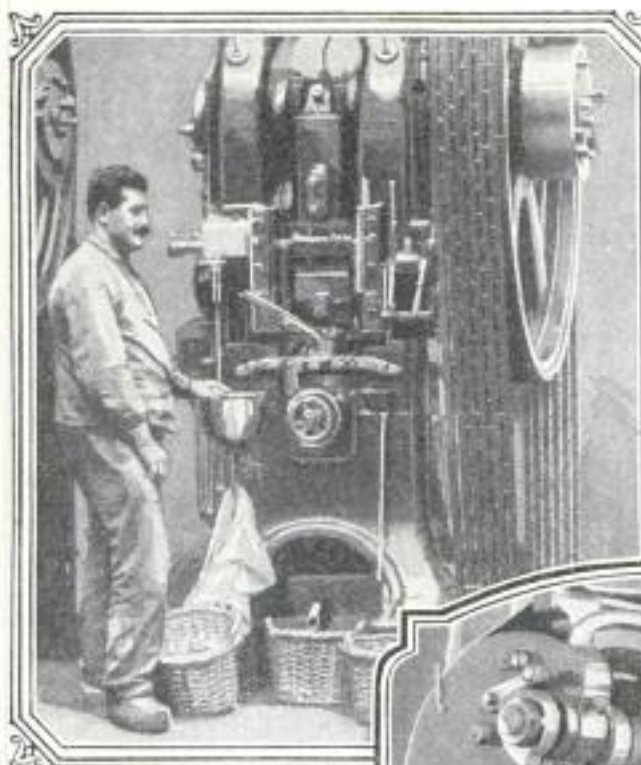

Stamping Machines in Mints That Formerly were Operated by Hand, the Blank Coins being Fed into Them by the Attendants at Considerable Risk: Now the Coins are Stacked in a Copper Cup and Placed under the Die with a Pair of Long Tongs

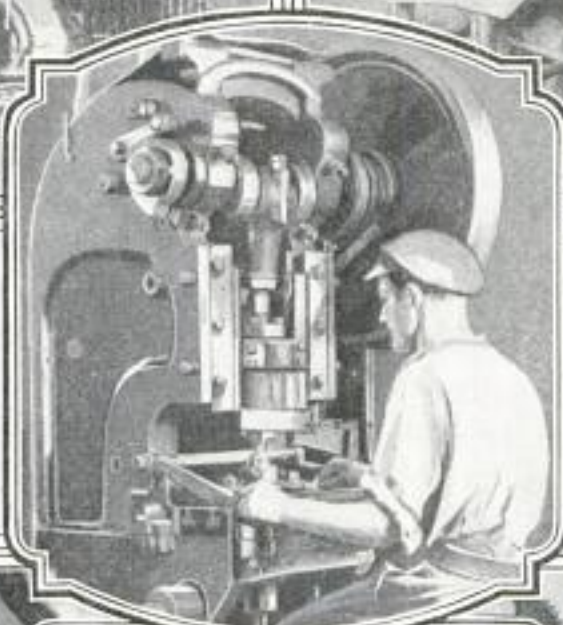

One of the Most Simple and Practical Devices for the Protection of Machine-Shop Toolers Is the Invention of a Worker in a French Plant. It can be Adapted to All Kinds of Presses with Only Slight Modification, and is Widely Used Abroad



Coupling to Protect Worker That can be Attached to Presses Operated Either by Hand or Foot: When the Material is Placed under the Punch, a Lever Prevents the Ram from Dropping until It is Released by the Workman

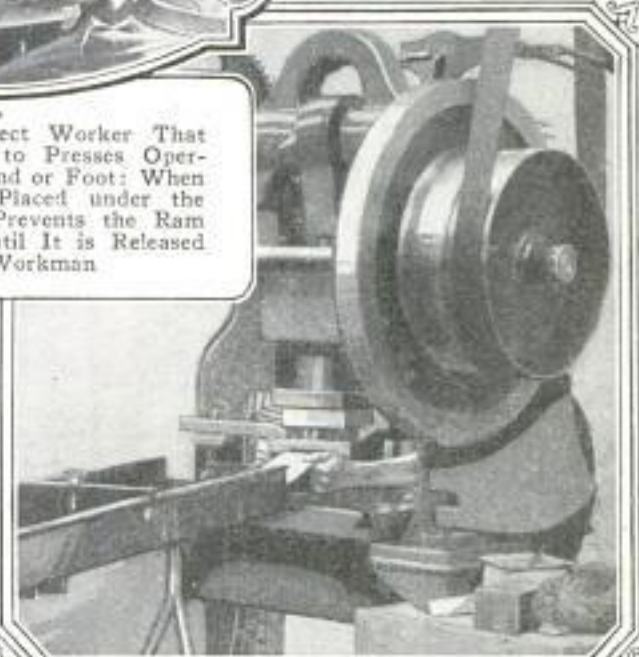

Danger Contrasted with Safety: In the Punch Press Shown at the Left, the Operator's Hands Are Entirely Outside the Danger Zone, Since the Die is Protected and Covered by Fixed Steel Blocks. The Picture at the Right Shows the Hazardous Position in Which the Worker's Arm has to be Placed in Holding a Sheet of Material to be Cut into Small Sizes. Protective Devices on This Press, However, Enable It to be Fed Automatically Now, a Sliding Board Pushing the Material Directly under the Cutter, Which is Covered So That the Hands of the Worker are Kept Out of Danger

Emt. Robert S. Pond
Larva Mont.

3368 BULLETS MADE IN HOME RECALL FRONTIER DAYS

As in the days of the old frontiersmen, when muzzle-loading rifle, powder horn, and shot bag hung beside the cabin door within easy reach for emergencies, and the bullet mold had an important place among the kitchen utensils, hunters and

may be in keeping with that of the empty shell. A bullet is first cut out of alloy by hand, and then a gauge fitted over it from which a mold, or "cherry," is made. In this the leaden missiles are cast. They are then run through a machine that

Reloading tools of Modern-Pond Co. Frederick of Wilmington, Del.

Anacapa Standard 8/26/23

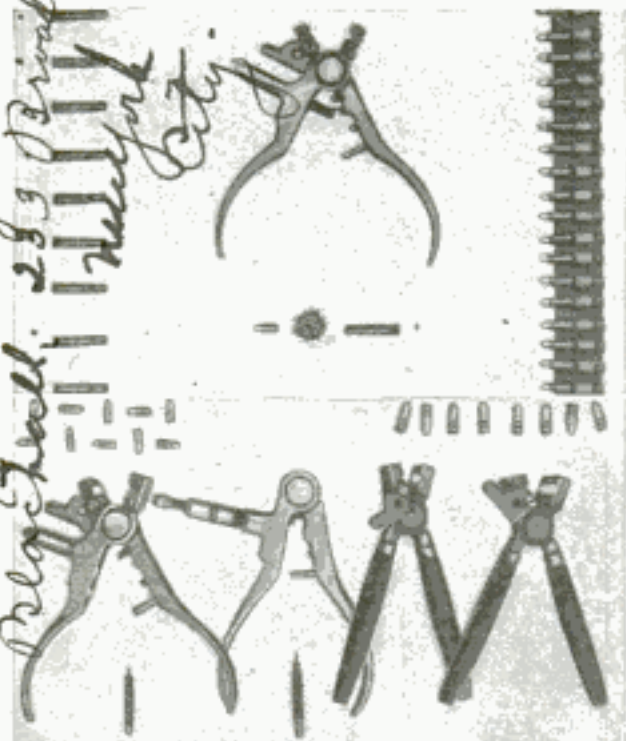

Above: Empty Shells, Crimping Tool, and Finished Bullets. Below: Bullet Molds, Reloading Tools, and Cap Extractors

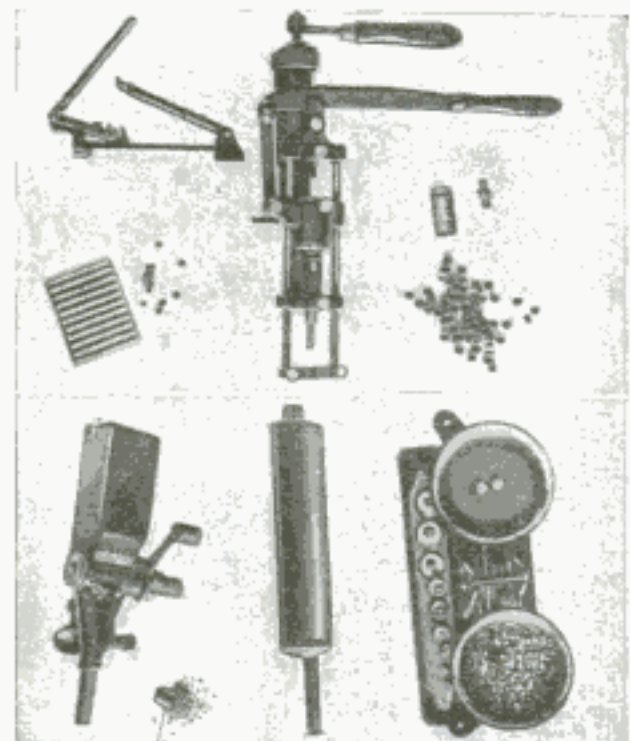

Above: Cap Seater, Bullet Greaser, Primers, and Gas Checks. Below: Powder Measures and Scales for Weighing Charge

those who do target shooting can now supply much of their own ammunition. This is possible by refilling old shells with hand tools that can be used in the home. Molds, cutting devices, and cap seaters are provided, making it possible to renew any cartridge for small arms. Apparently a simple thing, the casting of the ball requires great care in order that the size

forms a gas check at the base, and at the same time fills the grooves with lubricant. Powder measured in tiny dippers is placed in the shell after the old cap has been removed and a new one inserted. Following this the bullet is put into place and the cartridge "crimped" in the reloading tool, where the mouth of the shell is squeezed into the ball.

BOTTLE OF MYSTERY MIXTURE FORECASTS WEATHER 3478

Known to be at least three centuries old, a bottle filled with what appears to be a mixture of red sand and yellow liquid, and said to be a never-failing weather prophet, is attracting the attention of French scientists. Owned by an aged Brittany farmer, whose family has handed it down from father to son for ten generations, the prophecies of this "forecaster" are so highly regarded by peasants for miles around that they will not start harvesting until the bottle has been consulted. When rain is imminent, the solid

particles gather in round clusters. White flakes appear when snow is near, and if hail is on the way, it is said the entire mixture becomes cloudy and thick. A similar bottle possessed by the man's grandfather is claimed to have burst with a loud explosion 40 years ago, when a hailstorm was followed by a snowfall that turned into a light drizzle, but its contents were not examined by experts.

Having wound 25 miles of string into a ball almost half his height, a 77-year-old man now lays claim to the title of world's champion string-winder.

Detroit Free Press
9/2/23

Ackerman Johnson Co.
625 W Jackson Blvd.
Chicago
753

POPULAR MECHANICS

**OLD GOLD PITS ARE REOPENED
TO SUPPLY GERMAN NEED** *3509*

In dire need of gold to stabilize her finances, Germany has turned to the re-opening of mines closed for many years. One of the principal fields now being worked is in the Waldeck region. Back in 1586 prospectors gave up the idea of finding sufficient precious metal in this region, but now it is yielding as much as 40 grams to the ton. Spurred by hope, the miners are rewarded with an occasional valuable nugget.

**HOLDER FOR JELLY STRAINER
FITS RIM OF DRIP PAN** *3454*

Equipped with hook-shaped legs made to fit pots and pans of various sizes by



clamping to their rims, a jelly-bag holder supports the strainer firmly in place while dripping. The cloth, which is fastened securely to the upper part of the frame by its four corners, can be removed

quickly. The device folds into a flat package for storing.

**CONE-SHAPED KNOBS SPREAD
HEAT UNDER TOASTER** *3379*

With cone-shaped projections on the base, that serve to distribute heat evenly through the flat wire-netted top, a toaster is being made that is less than a foot in diameter. It is large enough for four



Toaster with Disappearing Handle and Cone-Shaped Knobs to Distribute Heat over the Bottom

slices of an ordinary loaf of bread, and when the loop wire handle is pushed in for storing away, takes little space.

The Washburn Co.,
Andrew's Division
Rockford Ill.

**ANCHOR FOR BOLTS IN STONE
GETS STRENGTH FROM PULL** *3421*

Getting most of its strength from expansion caused by the pull of the load put upon it, an anchor for fastening bolts

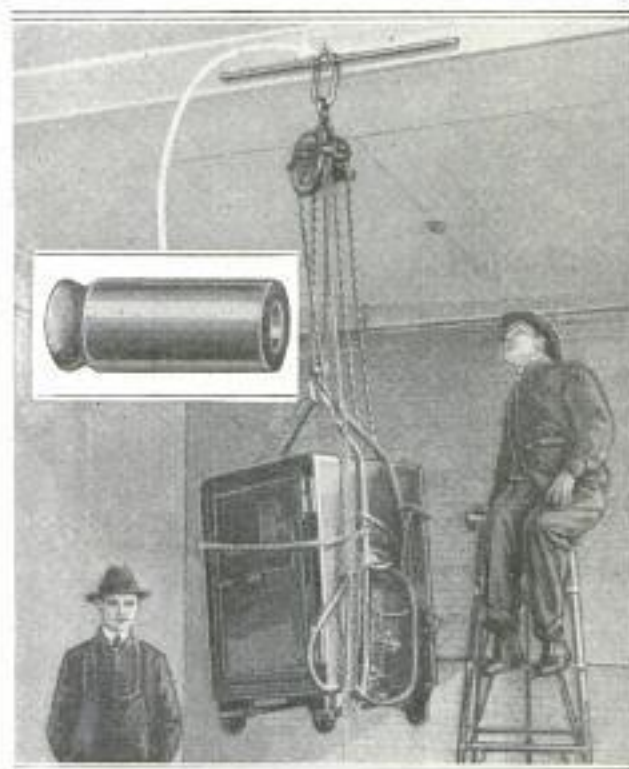

Bolt That Gains Strength from Pull, Being Used in Lifting Heavy Safe

in stone or concrete spreads by pressing a brass, cone-shaped wedge threaded for the screw, into a lead cylinder as the burden draws on it. The compression in the hole thus becomes tighter, and the metal is forced into the tiny pits and grains caused by the drill in making the opening. A special tool is furnished for setting the anchor in position, a few taps of a hammer being enough to tighten it.

**AIR SERVICE LINKS ARCTIC
TO THE OUTER WORLD** *3508*

To keep the workers on a waterpower project in touch with the outer world, the Swedish government began the first arctic air service, using two planes. In two years, 721 passengers were carried, together with great quantities of supplies. Before the air line was opened, about 500 or 600 workers were almost isolated from the outside world, the overland journey back to civilization requiring at least two days under the most favorable conditions. The time taken for the round trip by airplane is only about two hours.

Christian Science
Monitor 9/2/23
Copyrighted material

Pacific + Atlantic Photos
25 Park Place

Cml. Norman E
Mc Loudy 1717 St
Paul St
Baltimore Md

754

New York

POPULAR MECHANICS
U. S. TRAINING PIGEONS TO FLY
3042 AT NIGHT

GOLD WASHED FROM ROCK BY ROTARY ORE MILL 3447

Removing practically all of the gold from ore-laden rock, a rotary washing mill made by a western inventor re-



Rotary Washing Mill for Extracting Gold from Metal Bearing Rock without Requiring Outside Labor

cently completed tests to learn its capacity. Extraction of the precious metal is done by the machine without the aid of any outside labor. The mineral bearing quartz is put into the mill where the ore is separated and washed out of the crushed stone. After the operation it is claimed that no part of the gold is left to be thrown on the dump.

SIRUP FROM SWEET POTATOES SERVES TABLE OR COOK 3504

After several years' labor, government experts announce the production of a sirup from sweet potatoes that can be used for table or cooking purposes. Although it may not prove acceptable for general baking because of its dark color, it is said to be valuable in the preparation of gingersnaps and cookies and in the making of candies, such as taffies and caramels. While the cost of extracting the sirup is placed at 64 cents a gallon, based on the results obtained at the small test station, the federal chemists believe that this figure can be lowered by quantity manufacture.

☉Cairo, Egypt, now has more newspapers than any other city of its size in the world.

In teaching pigeons to fly at night, army officers claim to be developing a necessary factor in national defense and the maintenance of communications when other methods fail.

A band of night fliers in the Canal Zone has been trained with remarkable success, the birds, released at any point in the region, finding their way home on the darkest nights as speedily as in daylight. Unaffected by weather conditions, the pigeons make flights through thick haze and heavy tropical rains to a loft having its interior illuminated by electric lights.

"These birds were put to a useful purpose recently," said an officer, "when a small army vessel was in distress 40 miles at sea. Soon after dusk a pair of night-flying pigeons was released with messages asking for aid. In two hours, the birds were at the home loft, and relief was on its way."

In another instance, a tug carrying army officers and their families was not heard from for two days after it had started on a trip, causing great uneasiness among friends ashore. Its radio apparatus failing to work, some pigeons that were on board were liberated with reports of the craft's location, which were received by the post early the morning following.

Homing pigeons, it is said, fly with remarkable speed, often covering distances of 300 miles in a single night, where weather conditions are at best. To protect its eyes during flight, nature has equipped the pigeon with a kind of transparent lid that it closes at will. That memory and sense of direction are among its strongest faculties, is shown by the fact that even when carried long distances in covered baskets, these birds will immediately strike for home when released in the darkness.

During the late war, Great Britain alone, is said to have used more than 80,000 pigeons, whose life-saving value was demonstrated in rescues of wrecked aviators, and relief of troops isolated from the main armies, through receipt of messages carried by these feathered creatures.

Many ships and aircraft are now being equipped with pigeons before they start upon their trips, to be used as a means of communicating with their stations in the event that mishaps make wireless messages impossible to send.

Unable to locate maker or inventor.

Dept. of Agriculture, Washington, D.C.



OFFICIAL PHOTOGRAPH, U. S. NAVY

Pigeons being Trained by the United States Navy to Fly at Night So That They may Carry Messages, Regardless of Weather Conditions, When Other Means of Communication Fail

Pacific + Atlantic Photos
25 Park Place
New York

756

POPULAR MECHANICS

3446

ANTI-AIRCRAFT GUNS FIRED BY ELECTRICITY

In recent tests of anti-aircraft guns, the government mounted four of the great tubes in a straight line on a concrete base, and equipped the firing mechanisms with electric control. After they

ward one point and struck so near together that a wide area was affected by the explosions. As the guns come out of recoil the empty shells are automatically thrown out of the breech, and the

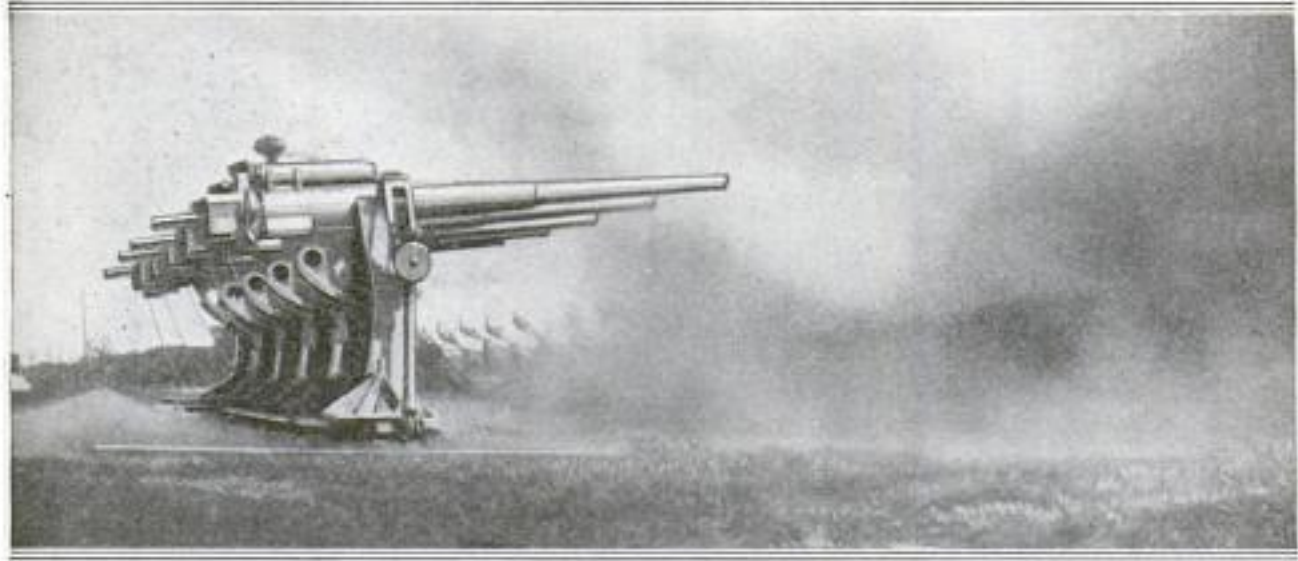

Battery of Anti-Aircraft Guns Being Set Off by Push of Distant Button, All of the Projectiles Traveling Toward One Point: The Shells Are Automatically Ejected

had been properly aimed for the trial, a slight touch on a push button, located at a distance, set them off at the same time. All of the projectiles traveled to-

ward one point and struck so near together that a wide area was affected by the explosions. As the guns come out of recoil the empty shells are automatically thrown out of the breech, and the

FOLDING CLOTHES DRIER GETS HEAT FROM GAS AND FAN

Using gas for heat and an electric fan for ventilation, a clothes drier that can be folded up when not in use, has been

patented, to conserve space. It provides sufficient room for a number of pieces suspended on sash cord so that the hot air may circulate freely, removing the moisture within a short time and eliminating the use of stretching clotheslines.

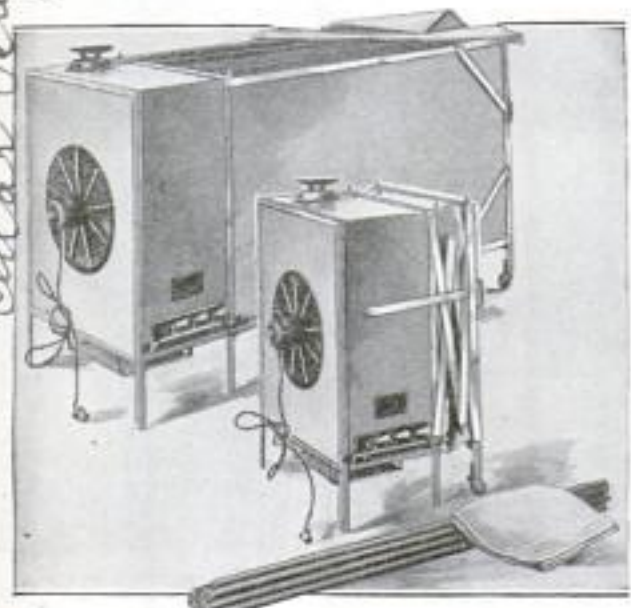

Clothes Drier, Using Gas for Heat and Fan for Ventilation, Open and Folded

RAIN MACHINE FOR GARDENS SPRINKLES LARGE AREAS

To create showers of varying intensity over many acres, a novel system of irrigation has been devised by a French inventor. The downpour may be changed from a slight drizzle to a cloudburst at will. Every square foot of area is covered by the artificial showers, the fall being controlled by a single valve. Simple in design, a long steel girder serves as a runway for the arm that distributes the water. To irrigate an area of fifteen acres, a runway is built some 300 feet in length. The sprinkling device consists of two metal arms, which roll up and down the runway, extending at right angles. The water is sprayed from a series of jets along the arms which move back and forth across the entire field.

E.W. Richard Co. Rapids, Iowa
Cedar Rapids, Iowa

Edmond Colliard - address unknown

New York Times
9/2/23

**WAR-ENGINES OF FUTURE
TO BE ELECTRIC**

3499

Electricity is to be a strong factor in future wars according to statements made by British experts who see in the discoveries of science a terrible power of destruction from mysterious waves of electric current sent through the air from hidden sources. Motors of airplanes and seacraft will be halted by special waves of wireless broadcast for thousands of miles, and even infantry and cavalry might be thrown into confusion or utterly destroyed by strong jets of water charged with electricity and mixed with acids. Machine guns and monster naval cannon, it is said, may be noiseless, and the projectiles will be "fired" by electric force. Sound made by electrically operated instruments will roar out over the battle fields with such a racket as to wreck the minds of opposing armies that dare to remain within hearing. Heat generated wirelessly will shoot out unseen over wide areas, destroying property and life without warning.

**DISH-HOLDING RACK IN PAN
SAVES TIME IN KITCHEN**

3352

To save time and labor in the kitchen and make dishwashing easier, a large pan containing a wire rack to hold china and cooking utensils while being rinsed with hot water, is being made. At one end is a receptacle to hold cutlery. After the



Pan with Wire Rack That Holds Dishes for Rinsing and Drying. Saves Much Time in Kitchen

dishes are washed, they may be stacked upright in the drier and hot water poured over them, which quickly drains off.

Just a tiny particle of dust, hardly as large as a pinhead, is blamed for a recent railroad wreck in Europe. The engineer of an express train, it is said, was temporarily blinded when dirt lodged in his eye and he failed to see stop signals.

The Washburn Co. and
Wire & Iron Works
Newford, Del.

**PAINTED LEATHER ON WALLS
TAKES PLACE OF PAPER**

3471

Making leather paintings to replace wall paper is a recently established industry in Europe. The completed work



Thin Leather Covered with Painted and Waterproofed Designs Made to Replace Wall Paper

is covered with a waterproofing preparation, so that the painting can be cleaned by washing. The designs are made of a special paint put on by ordinary camel's-hair brushes. Linen daubs are used for spreading ground colors over the greater areas.

**ENGINE CREWS IN TUNNELS
TO GET BRAKE-TANK AIR**

3425

Fresh air from tanks of the brake system, supplied to locomotive crews through a tube with a rubber funnel, is regarded by government experts as the best way to protect them from hot, choking smoke and damp, gas-laden air that often fill the tunnels through which they must pass. Poisonous fumes from hot exhaust of the engines are claimed to be sources of danger and the causes of many accidents. Tests held under conditions similar to those met with in tunnels have indicated that the men might be completely overcome in 20 minutes if a locomotive should become stalled.

Copyright
8/21/23

3159 *Bissell Stump Harvester Co.,
Fort Meyers, Florida*
HUGE MACHINE MAKES PLAY OF STUMP PULLING

machines



and burning. By means of a drum mounted on each side, the machine can pull from two directions at the same time, thus automatically bracing itself, while handling more work. In a day, according to reports, it clears four times as much land as one man can in a year.

Acres of wild lands in Florida, rendered worthless by thousands of stumps of giant pines, are being made suitable for farming by a powerful tractor that not only pulls the stumps out of the ground, but bores holes in them to take charges of explosive for splitting

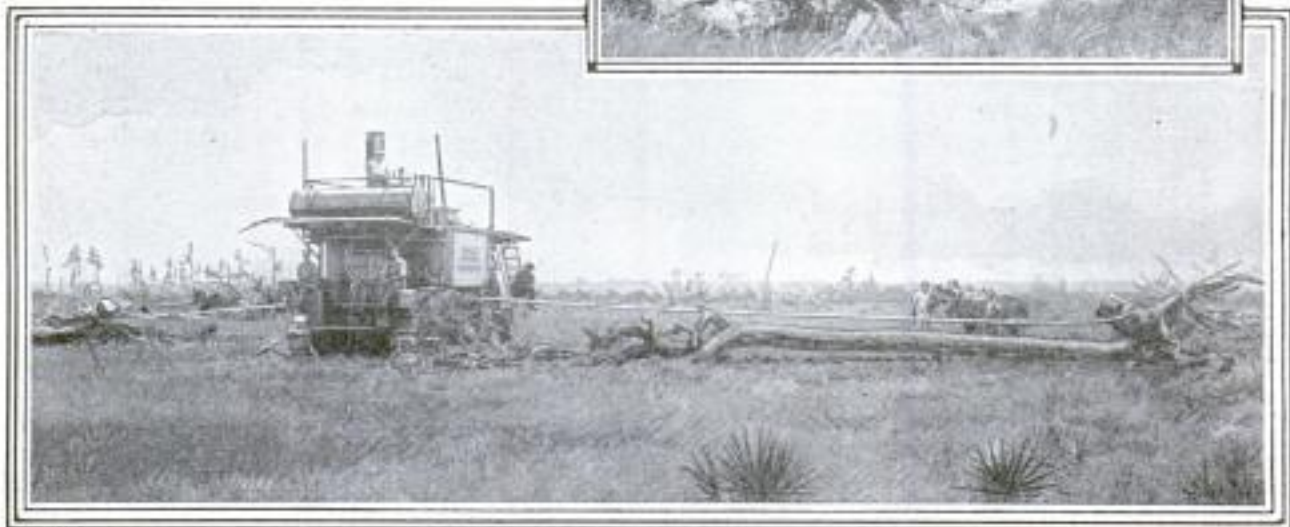

FERRIS WHEELS POPULAR IN NILE VALLEY

In the sunburned valley of the Nile in Egypt, Ferris wheels are a popular form of amusement among grown-ups and chil-

dren alike. Although made entirely of wood and propelled by hand, they are similar to the apparatus seen in American resorts, although they are hardly more than three times the height of a man. The first Ferris wheel was erected in the United States in 1893 for the Columbian Exposition.

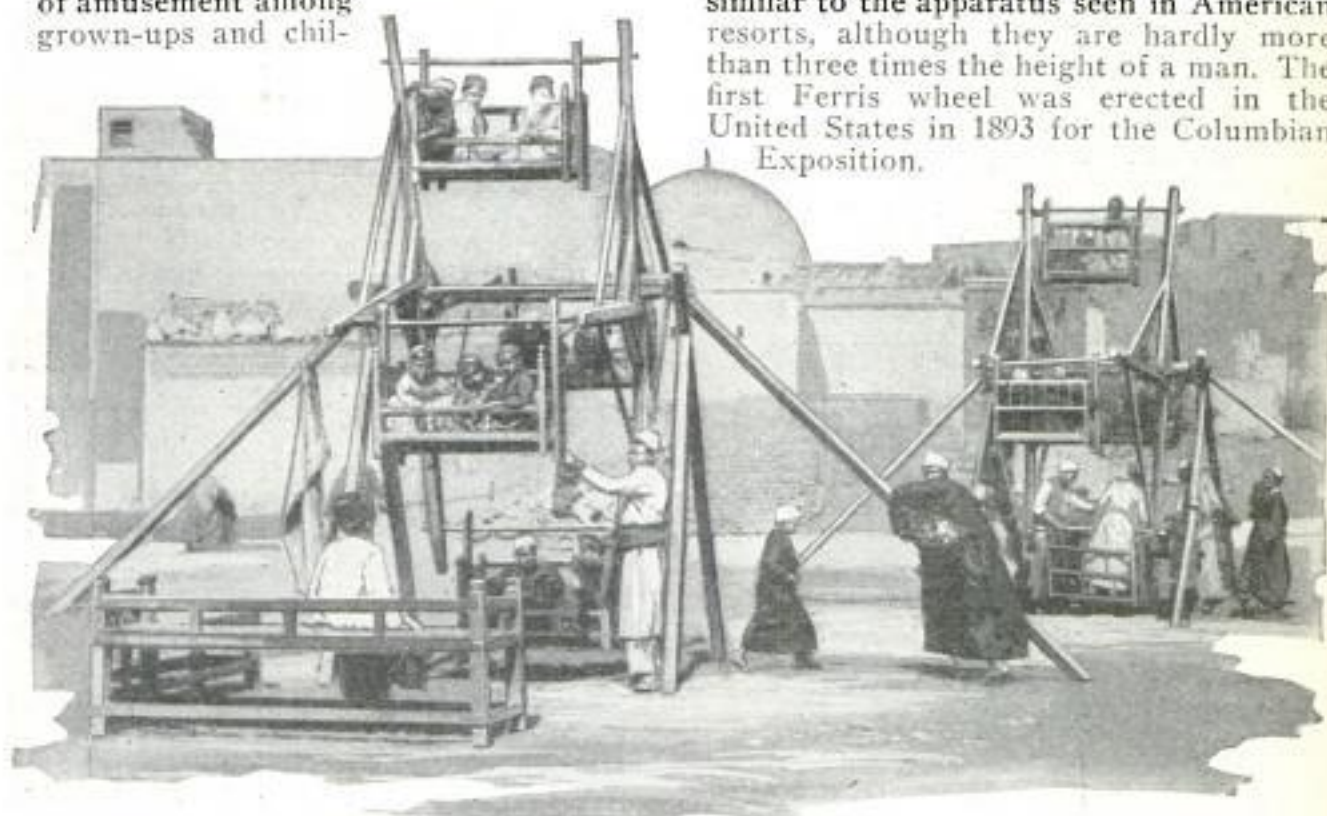

COPYRIGHT, UNDERWOOD & UNDERWOOD

In Egypt Crude Wooden Models of the Modern Ferris Wheels That Grace American Parks Are Operated by Hand but Attract Many Amusement Seekers from Among Both Young and Old

WATER IN SUBMARINE'S HULL TRAPS MEN AT SEA 3464

With their only avenue of escape blocked by 57 tons of water, the crew of a giant United States submarine recently was rescued after being 14 hours beneath the ice and water. Within the shadow of the arctic circle, where the craft was cruising, the ice laden waves tore off the sea valves. Tons of water rushed in so fast that all, except three men on deck, were trapped in the compartments. The submersible sank to the bottom, 102 feet below, her stern resting on the ocean floor with her nose above the sea. Ships summoned to the scene attached lines to the submarine's bow, divers cut a hole in the hull for the air pumps, and the boat was floated out.

SAW ATTACHED TO TRACTOR SAVES HAULING LOGS 3415

Much of the hard labor of wood-cutting is eliminated by attaching a saw frame to a tractor, so the farmer can ride

to the wood lot, instead of hauling heavy logs to a centrally located pile for cutting. The saw frame can be fastened by castings on the upper and lower sides of the radiator. Wood to be sawed is placed on

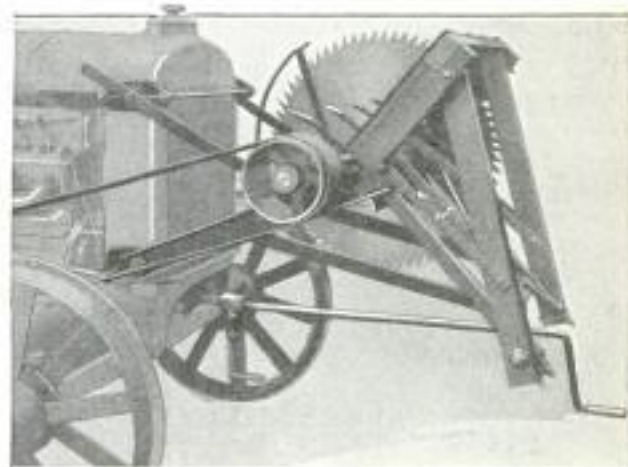

Attached to a Tractor the Saw can be Moved About, Saving Labor of Hauling Logs

steel strips that carry all the strain. The tractor can be prepared for moving in less than a minute.

Stover Mfg. & Engine Co., Freeport, N. Y. Copyrighted material

Phila delphia Public Ledger

How Nation's Crop Estimates Are Gathered and Sent Out to Waiting Millions

Army of Two Hundred Thousand Persons Used in Gathering Information of Vital Interest to Producers and Consumers

BY ROBERT H. MOULTON, *Room 2,
Board of Trade, Chicago*

"READY—Get set—Go!"

As the words ring out, there comes the rush of feet over a tiled floor, the clatter of telegraph instruments, and the latest crop bulletins are clicking over the wires to the four quarters of the United States.

Every month this drama is enacted in the corridor of the staid, old Agricultural Building in Washington. It is a twenty-yard dash by newspaper correspondents from a table on which the copies of the report are placed face down, to the nearest and quickest means of outside communication.

The reason for it is the government's determination to play absolutely fair, to see that the report is released to all interested parties simultaneously, and that no biased information is put out before the fixed time. No matter on what day the estimates are issued, the hour is exactly the same—2:15 o'clock, eastern time, to the second, as the western grain exchanges are then closed.

If the reports reached the traders during the midst of a session, they might create unwarranted changes in prices, it is felt. Naturally, the quotations often are affected, but coming after the close of a session, there is ample time to consider the figures before the boards reopen the next day. Farmers also are keenly interested, as the estimates may indicate whether the wheat, corn, or oats crop of the country will be large or small, and, consequently, whether they will be able to market their crops at a high or low price.

Indeed, the information is of interest to almost everyone. Ignorance of crop conditions is said to encourage speculation, which, while benefiting the consumer not at all, injures business, and often prevents the farmer from obtaining just prices for his products. If there were no tabulation by the government, and speculators, by misleading reports, should depress the price of cotton a single cent a pound, the growers might lose \$60,000,000 or more. On the other hand, if the price was improperly raised, manufacturers and allied interests would be harmfully affected in a proportionate degree and retail prices would suffer.

To the railway companies, it is important to know the probable size of crops in order that they may be enabled to provide the number of cars required. Merchants in small towns and manufacturers also are vitally affected, for, if

the crop outlook is good, they know that they can order or produce liberal amounts of goods to be handled by them several months later.

As issued by the government, the reports are, to a considerable extent, a composite of thousands of individual estimates. In the central office of the government bureau, there are about 135 employes, the majority of whom are clerks, computers, and trained statisticians experienced in handling and interpreting agricultural facts. In addition there are 42 salaried field agents, each of whom is required to travel over his state systematically during the crop season, and to personally inspect crops, interview



Dramatic Race Enacted Monthly by Newspaper Men Here Seen Waiting Word to Dash to the Telegraph with Crop Reports

GOVERNMENT REPORTS									
TOTAL PRODUCTION			CONSUMPTION				RESERVE		
OCT. 1917	SEPT. 1917	(000)	1917	1916	1915	1914	1913	1912	1911
102,000	71,624	WHEAT	100	100	100	100	100	100	100
110,000	70,000	SPRING WHEAT	100	100	100	100	100	100	100
120,000	70,000	FALL WHEAT	100	100	100	100	100	100	100
130,000	70,000	BARLEY	100	100	100	100	100	100	100
140,000	70,000	RYE	100	100	100	100	100	100	100
150,000	70,000	FLAX	100	100	100	100	100	100	100
160,000	70,000	OTHER	100	100	100	100	100	100	100

SEE FRONT, OCT. 1, 1917 P. 7.



In Every Seething Grain "Pit," Where a Change of a Single Cent in Prices Means Fortunes Won or Lost, the Traders Watch the Government's Estimates as an Almost Certain Guide in Handling Their Deals

From the Moment the Crops Burst Through the Soil, an Army of Government Investigators Watch the Slow Development of the Plants to Obtain Accurate Estimates of the Final Yield



Only after the Shrill Whine of the Threshing Machines, That Rises in Kansas and Ends in a Mighty Symphony on the Canadian Border, Has Ended, and the Harvest Is Complete, Does the Government Issue Its Last Figures on the Total Yield



When the Yellow Harvest Moon Looks Down on the Completed Results of the Farmers' Labor, Statisticians Complete the Figures Which Are So Vital to the Agricultural and Business Interests of the Country in Forecasting the Future Range of Prices

farmers, representatives of commercial houses, elevators, buying and selling agencies, and state and local authorities.

In all, there are approximately 200,000 volunteer correspondents, including 50,000 individual farmers. When the returns are all in, they are sorted by states and districts, the totals being tabulated on sheets which are identified by number only, so that the work of adding up and averaging the figures is purely mechanical and there can be no possibility of a "leak." Later the crop-reporting board is called into session and the figures placed in its possession. From this moment until the report is issued, it is impossible for anyone but the secretary or acting secretary of agriculture to enter the room, and even he cannot leave until the estimate is given to the press. Guards are stationed at the locked doors leading into the bureau, and all telephone and telegraph wires are disconnected, the switchboards being locked and the key retained by the chairman of the board, who is also locked in.

During the meeting the members of the board figure out crop conditions, yield and acreage, from the reports or

estimates sent in by field agents, county correspondents, and township representatives. the thousands of reports from the two latter sources having previously been reduced to percentages. Thus the members may be confronted, for instance, with the condition of winter wheat in Kansas at a certain time, somewhat like this: Field agent, 94; county correspondent, 91; township representative, 93. After taking into consideration weather conditions and reports from adjoining states, an average of the three estimates is then made.

Farmers benefit both directly and indirectly by the reports. What they learn from them about the condition and prospect helps them in their business, and, in addition, this knowledge is highly advantageous to the individual agriculturist. The more certainty there is as to the supply and demand, the less hazard of speculation—to the benefit, in the long run, of both producer and consumer.

The first work of gathering crop statistics in this country began in 1863. At present, this branch of the government costs about \$250,000 a year.

3429

SPAIN FINDS IMPORTED COTTON CHEAPER THAN NATIVE BRAND

Though the Spanish government encourages cotton-raising among native planters, irrigation and wages are so

the country, but the industry died out. Buyers from the mills meet the ships bearing the raw material at the wharves and set up strenuous arguments concerning weights and prices. Each bale must be tested on the scales and inspected by the purchaser before he closes the sale.

LANGUAGE OF CHINESE SET ON TYPE MACHINES

3458

As a result of the formation of a system of 40 characters, Chinese language is being set on type-casting machines and reproduced in print. Until recently little was known of the script, but it is now taught in native schools under control of the government and foreign missionaries. To each of the symbols have been assigned syllabic sounds that are identified by small dots and strokes. While the written words remained the same through the centuries, the spoken language has undergone many changes. Often the inhabitants of one province in China cannot understand the speech of those residing in other sections.



Weighing Cotton on Spanish Dock. Where Each Bale Undergoes a Rigid Inspection by the Purchaser

costly as to make the imported article cheaper. At one time cotton was extensively grown in the southern section of

(Cows only four feet high, the smallest in the world, are to be found in the South Sea Islands.

The Williams Service, 33 Union Square, New York City

Mergenthaler Linotype Co. 290 Myerson St. Brooklyn, N.Y.

**"DIVINING ROD" FINDS GOLD
BURIED IN SUNKEN SHIP**

3451

Whet.
as ir
ship
diver
left
of iron
hand
contact
carats
admira.

Divers have recovered practically all of \$30,000,000 in gold bullion and \$5,000,000 in silver coins carried by the liner "Laurentic," sunk off the Irish coast in 1917 by a German submarine. With spearlike instruments, that showed the presence of precious metals, connected to dials on the ships above them, they prodded through the wreckage. A needle on the scale indicated the kind of metal the rod touched. More than 2,100 bars of bullion have been taken from the hulk, each valued at from \$5,000 to \$10,000. Monster dogfish and other denizens of the deep hampered the work by vicious attacks on the men, which the divers repelled with long knives. Each undersea worker received one-thirty-second of the amount he salvaged.

3420

**WHIRLING WHEEL OF BLADES
DOES PIPE CARVER'S WORK**

Turning out a completed bowl for a tobacco pipe in one operation, a machine invented by a western man carves the bowl, bores the hole in the stem, and polishes the finished article. Blocks of wood



Above: Knife Wheel for Carving Pipes. Below: Right, Machined Bowl, and, Left, Hand-Chipped Article

are placed against the grinding wheel of 14 blades, that revolves 1,400 times a minute. Without being touched by hand, various sizes and shapes can be made by adjusting the cutting edges. By the old method, the bowl is chipped by hand tools, in a turning lathe, and the stem is hollowed out in a separate operation and the surface smoothed for the gloss.

Friend Electric Co.
625 W. Jackson

**AIR SPACE MADE TO PAY RENT
WITH TRUCK ELEVATOR**

3284

To utilize waste space in factories or warehouses, a truck has been patented that is equipped with a platform which

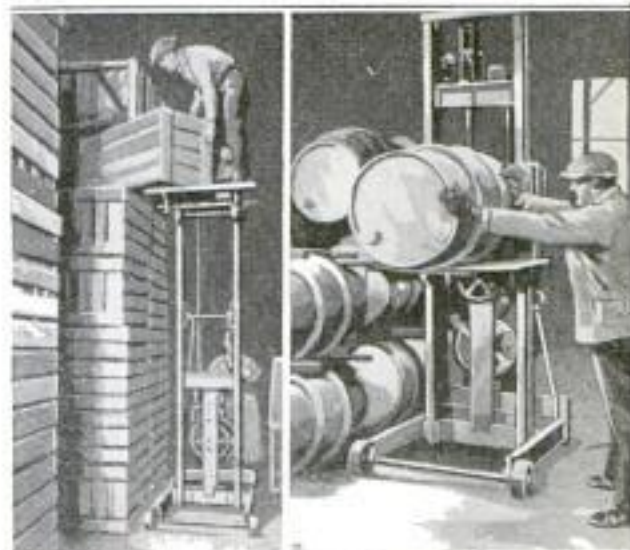

Two Men, Using Portable Elevator, Performing a Task That Ordinarily Requires Several Workers

may be raised or lowered by hand. The device stacks barrels, boxes, or bales in out-of-the-way, overhead places, where it would be extremely difficult for men to work. For instance, in a low-studded basement, one man using the apparatus can pile boxes to the ceiling, a task that otherwise would require several workers and take much longer. It also can be used as a permanent elevator between two floors, as a lift for handling bulky and heavy pieces of steel weighing a half ton or more, or as a ladder for hanging and cleaning motors and shafting, installing lights, or for any purpose where an elevation of medium height is necessary.

**GROWTH OF PLANTS INCREASED
BY ELECTRIC LIGHTS**

With the aid of electric lights, larger and better crops of vegetables can be produced, recent experiments have indicated. In one test, five incandescents were arranged over a bed of lettuce and lighted each day for 6 hours, beginning at dusk. After 12 days, the illuminated plants had two and a half times as many fresh leaves as those exposed only to the sun's rays. The forced heads also developed in two weeks—one-half the time required by the others—and were firmer and heavier. Thus, with the use of electricity, it is said two crops can be raised in the time required for one under ordinary conditions.

Blvd
Chicago

Lewis Shepard Co., 566 E. Third St., Boston, Mass.

Emt. N. Sakata #10, Geochome, Tidamachi
 Kojimachi-Ku. Tokyo, Japan.

764

POPULAR MECHANICS

3395

BRIDGE BUILT OF BAMBOO SPANS RIVER IN JAPAN

More than 100 feet in length, a bridge, made entirely of bamboo, spans a Japanese river. Long poles notched and

ing to sprout and are prepared and eaten like asparagus. They are also salted and served with rice, and prepared as pickles,

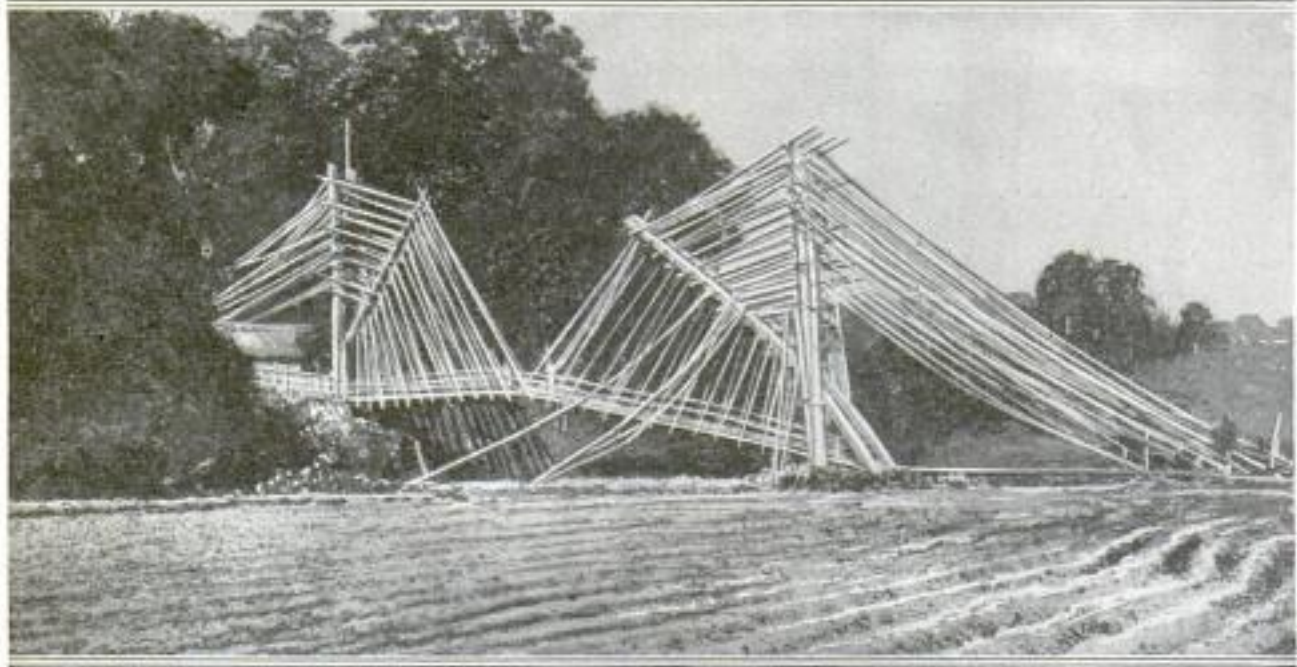

Built Entirely of Bamboo Poles Fastened Together with Leather Thongs and Metal Straps, This Suspension Bridge over a Wide River in Japan Carries Traffic without Much Need of Repair

strapped together with rawhide or metal, make a strong, light structure that can be built in a short time. In the orient, the bamboo tree is regarded as one of nature's most precious gifts to man. The young shoots are cut off when just start-

or candied in sugar. Joints of large stems are used as water buckets, and smaller ones as bottles. Houses are frequently built entirely of the wood. Masts of boats, furniture, and many other valuable products are also made of bamboo.

FISH CLEANER ROLLS SCALES UNDER TOOTHED BLADES

For cleaning fish, a scraper has been designed to roll the scales from under its blades instead of throwing them into

RATS HITCHED TO STRING PULL WIRES THROUGH CONDUIT

Four large rats are reported to have been trained by a foreman of an eastern construction company to draw wires through conduit pipes. They are said to perform tasks that usually were accomplished slowly and often with great difficulty by a system of jointed rods and pulleys. The owner of the little animals first taught them to crawl through stovepipes in answer to his whistle, always rewarding them with bits of cheese. Later he tried them in underground pipes, tying strings to their tails, to which were attached thin wires. Heavy cables are fastened to the wires and hauled through long stretches of tiling after the rodents have done their work.



Scraper for Cleaning Fish That Prevents the Scales from Flying into the Air

the air. Instead of being arranged in straight rows, the teeth of this tool are staggered and flattened at the points to prevent cutting into the meat. The task can be accomplished in a fraction of the time that it takes with a knife. As there are no sharp edges, the possibility of scratching the fingers is eliminated.

That New York City and its suburbs will have a population of 29,000,000 in A. D. 2000 is a prediction of an official city-plan committee.

E. W. R. Co. Inc. 1000
 3453
 Frederick Md.

Edw. J. Payne
 c/o The Washington, D.C.

Auto
Accidents

3277

DEATH-DEALING JUGGERNAUT'S TOLL INCREASING

With more than 12,000 deaths reported in the past year as a result of motor-car accidents, the constantly increasing list of tragedies has resulted in a nation-wide search for preventive measures. Speeding, joy-riding, dangerous curves, grade crossings, and collisions claimed the greatest number of victims, although defects in steering apparatus and carelessness were blamed in many cases.

When its steering gear failed to work, the car shown in the top picture leaped off the road and plunged through a wooded ravine, carrying its occupants to what seemed certain death over a precipice, but it was caught and held in a high wire fence.

What happens when a machine speeding at 60 miles an hour in the early morning hours strikes a truck, is seen below. Of the passengers, one was killed and six seriously injured. "Just another

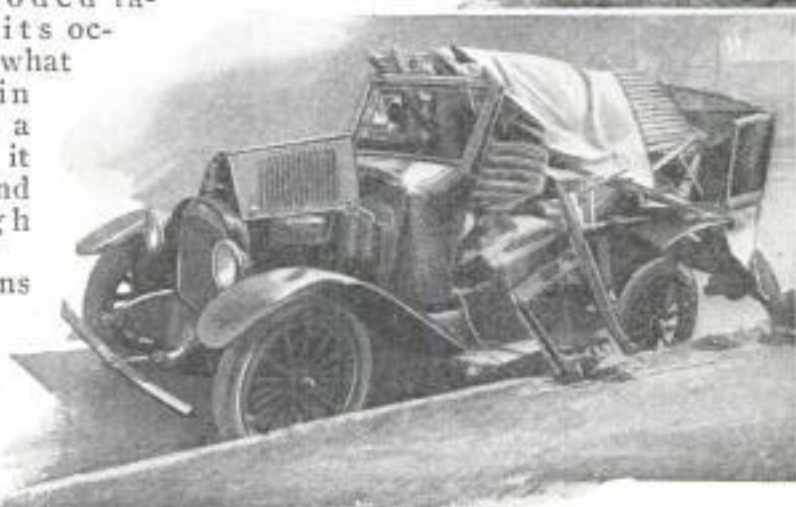

case of joy-riding," the police reported after a lengthy investigation.

Blinded by the headlights of an approaching car, the

driver of the machine shown in the third picture from the top, plunged from the narrow road at a curve. Although the automobile, which was going at an excessive rate of speed, was wrecked, the passengers escaped injury.

That some accidents are unavoidable, is proved by the bottom picture. Here an empty train missed the switch points at a station, and crashed into a motor car containing four persons, only one of whom managed to jump in time. Although a heavy coach completely covered the auto, none of the other occupants was injured.

As a result of these and the many other accidents taking place daily in all parts of the country, the regulation of automobile traffic has become stricter, and the examination of applicants for drivers' licenses is more severe than ever before.

Wilder Mfg Co, 211 Pacific St
 Brooklyn, N.Y.

766

POPULAR MECHANICS

CAMPING OUTFIT FOR AUTO RUNNING BOARD



Complete Camping Outfit, Light in Weight and Strongly Built, for Autoists, That Folds into Case on the Running Board of Car When Not in Use

For storing campers' equipment, a trunklike chest, light in weight but strongly built, is being made that is carried on the running board of the automobile. In its numerous compartments are dishes, forks and knives, folding chairs, and a small gasoline stove. When

set up, an inner section pulls outward and becomes a table top, supported on collapsible legs. So closely packed are the various utensils that the case holds enough for a party of several persons. Containers for uncooked food are provided.

WIRE-BRUSH WHEEL CLEANS LIKE SANDPAPER

For cleaning flat surfaces, a rotating brush with wire bristles, operated by a small electric motor, is being made. It

ally employed. Gripped in the hand like a saw, the instrument can be handled easily. Run by a specially adapted motor, using power from a lamp socket, it cleans quickly and thoroughly.

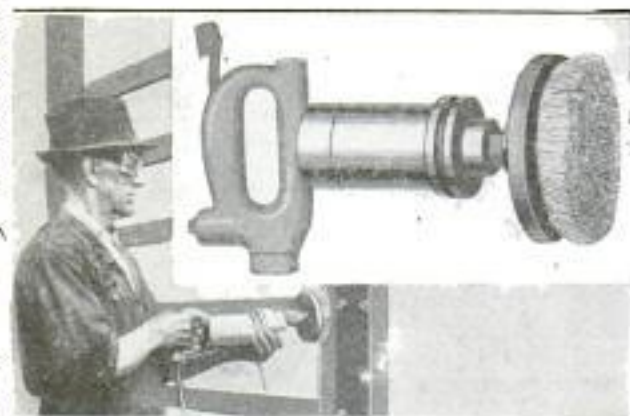

Wire-Brush Wheel Attached to Electric Motor for Cleaning Flat Surfaces

is for such uses as removing rust and paint from steel and iron, scouring stone or cement, scraping varnish from wood, and other tasks where sandpaper is usu-

AIRPLANES WITH RADIO GUIDE FISHING BOATS TO PREY

Encouraged by the government, owners of French fishing schooners are equipping their craft with wireless to assist them in locating and marketing the catches. Fishermen are guided to the regions where fish are plentiful by naval aviators scouting the sea in planes fitted with radio. By the same means home-bound trawlers keep in touch with the markets and steer clear of ports where the need for fish has been oversupplied. Thus, the skippers are aided in finding buyers at the highest prices. Messages exchanged with brokers ashore are followed by advance sales to dealers, and often fish caught thousands of miles away are sold before taken from the water.

New York Times
 9/12/23

J. W. Parson Co., Nicetown Lane & D. St., Phila.

Copyrighted material

These Articles Are for Everyday Use
But—
Can You Name Them?

3674

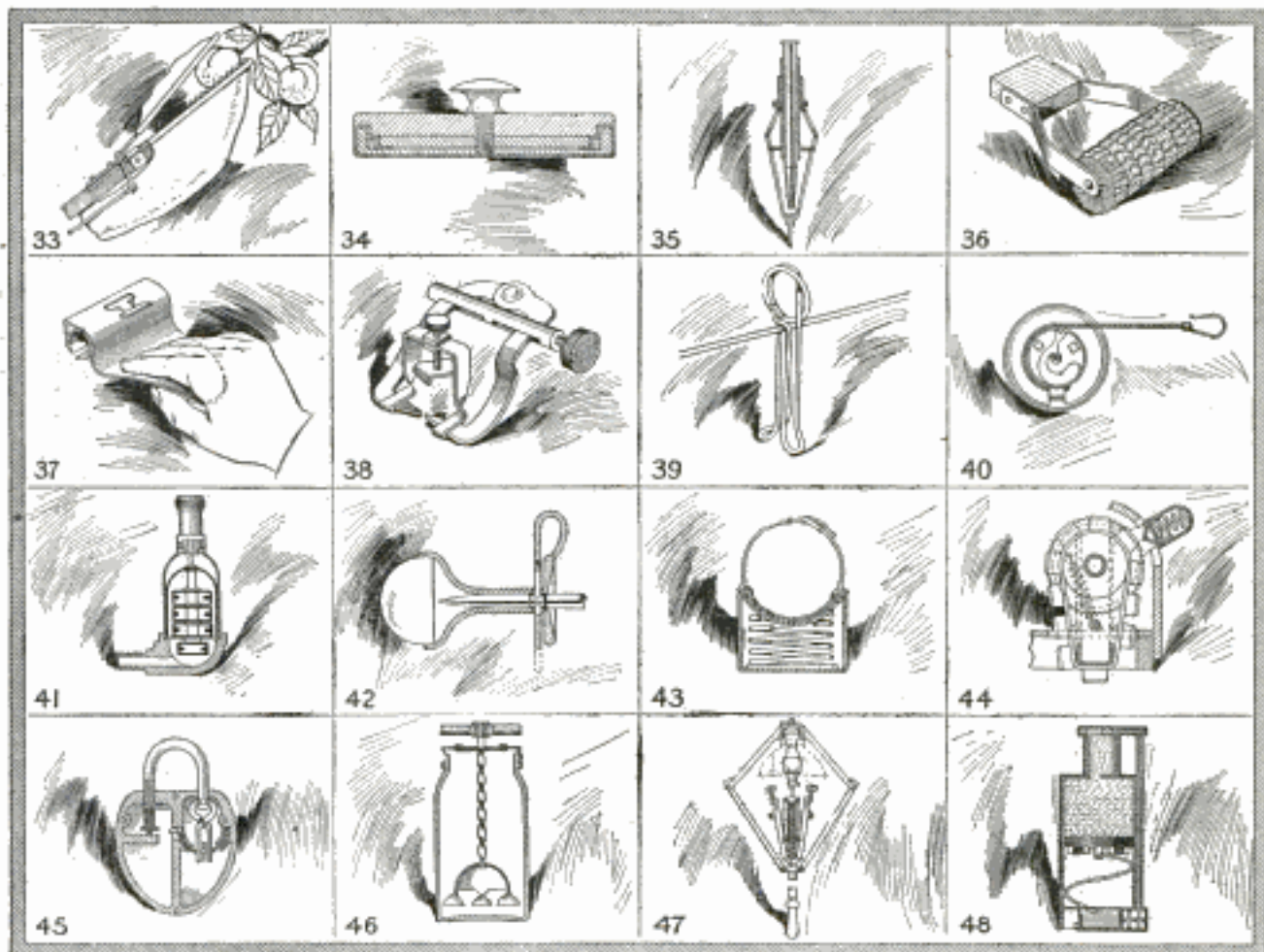

JUST to help you, the use for which the articles are intended is as follows:

No. 33 on the farm. No. 34 by women. No. 35 in a trade or in the workshop. No. 36 in a trade. No. 37 by men. No. 38 in a profession for painful work. No. 39 by the housewife. No. 40 by anybody. No. 41 in the home. No. 42 by women. No. 43 for men at work and in sport. No. 44 in the office. No. 45 anywhere for protection. No. 46 in the home. No. 47 in buildings and homes. No. 48 for business purposes.

Popular Mechanics Magazine offers no prizes for correct answers to these problems, but presents them for the interest it believes its readers will find in attempting to determine the nature of the various articles shown.

If you think you have the right answers you can find out by comparing them with the correct list which will appear in Popular Mechanics Magazine for December.

In October the following articles were shown. No. 17, can opener. No. 18, holder for baby's bottle. No. 19, pipe. No. 20, stand for rural mail box. No. 21, tumbler washer. No. 22, animal trap. No. 23, fly-paper and holder. No. 24, burglar alarm (tampering with doors releases water on sleeper). No. 25, cover for child's crib. No. 26, cigarette saver. No. 27, metal fence post. No. 28, match scratcher. No. 29, lemon squeezer. No. 30, wing-clip to prevent fowl's flying. No. 31, fish bait. No. 32, hair cutter.

3328

3328 VASES MADE OF WAR SHELLS SHOW WORKERS' SKILL

From big brass shells left by troops in the Holy Land, during the late war, skilled workers in brass create beauti-



Skilled Brass Workers with Objects of Art Made by Engraving Discarded Cartridge Shells

fully carved vases, goblets, and other ornaments. All work in this ancient craft is done by hand in a rude wooden vise. With sharp knives, the designs are drawn and the shells are cut to desired forms without the use of machinery. Though the metal takes a glossy polish, it tarnishes easily when exposed to the air. The bright surface is preserved by a bath of nitric acid, followed by a coating of varnish. It is believed that natives of this region acquired their craftsmanship from India, where it is an old and honored art.

CARS BOARDED WHILE MOVING TO AID TRAFFIC 3360

Perpetual motion in transportation, in so far as possible, is the aim of an experimental railroad built in England, that keeps cars moving even while discharging and loading passengers. Although only 300 yards long, with "up" and "down" tracks about 6 feet apart from center to center, this "never stop" road is estimated as capable of carrying 18,000 persons an hour in each direction. To permit patrons to leave or enter with ease, the cars are slowed down to 1 1/2 or 3 miles an hour while passing platforms. The train may be speeded up to 24 miles an hour between stations. The coaches are propelled and their speed controlled by endless screwlike spiral tubes laid between the rails of each track, in which an arm from the underside of each vehicle engages. This produces an interesting condition. While at a platform, the

cars are practically in contact with one another, but as the first coach moves out it runs away from the second, the latter leaves the third, and so on. Yet at the next loading point, since the lead coaches are slowed down first, they are once more in close formation. Each car is equipped with rubber-tired, flangeless wheels.

3327 BODY OF COLUMBUS IS MOVED TO FINAL RESTING PLACE

After having been moved three times during the four centuries since his death, the body of Christopher Columbus, discoverer of America, is at last in its final resting place in Seville Cathedral, Spain. Here every year thousands of travelers pay their respects to the Spanish admiral. After his death, the body was taken from Valladolid to a monastery at Seville, where the bones of his son, Diego, the second admiral, were also laid. Thirty-six years later the remains were trans-



NEWMAN TRAVEL TALKS Tomb in Seville, Spain, Where Body of Columbus Rests After having been Moved Three Times

ported across the Atlantic to the Cathedral of San Domingo. When that island was ceded to the French in 1795, the relics were re-exhumed and transferred to the Cathedral of Havana. Later they were returned to Seville, where they rest in a tomb.

Esquimo dogs of the arctic region are capable of hauling a sled over 20 to 40 miles of snow and ice in a single day.

The Engineer 7/27/23

Newman Travel Talks Tribune City Chicago

9101

SIGHT-SEEING MOTOR BUS WITH FOLDING TOP

To give passengers the enjoyment of touring in an open bus and yet provide for protection in case of a sudden shower, an English body builder has designed a motor-bus body with a folding top and drop windows. When the top is folded it occupies only a small space along the center of the bus, and the side windows drop out of sight in the sides of the body. When closed, the body insures complete protection from bad weather. The car is transformed from an open to a closed model in a few minutes. Since the roof occupies little space when not in use, the bus is convenient for sight-seeing, as it affords the occupants a view on all sides. Seats unfold for emergencies.

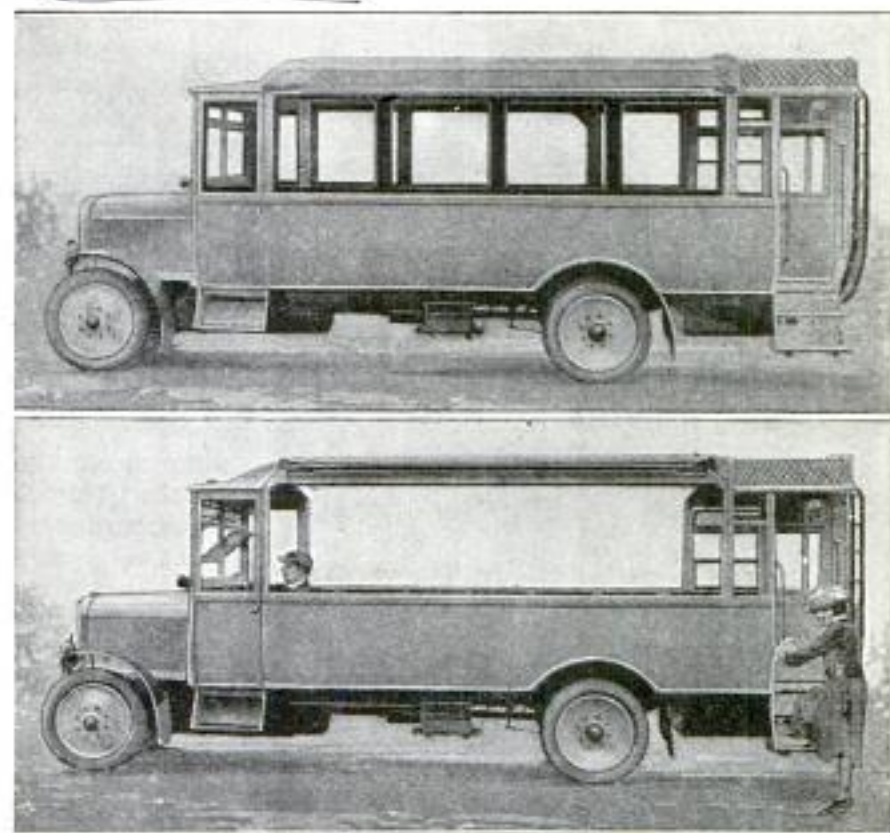

In Good Weather the Top of This Bus can be Folded into a Small Space in the Center, While the Windows are Dropped into the Sides

CANNIBALS HOLD TO EARLY "LAW" 3357

Many natives of the Solomon Islands, noted for their cannibalism and ferocity, are firm believers in the ancient "law"—"an eye for an eye and a tooth for a tooth." Recently three savages from the Malaita Island, the home of an exceedingly wild tribe, who were working on plantations, were killed by white men. Their relatives, to avenge their death, started on a hunt for the heads of three Europeans and, in an attempt to obtain the first, attacked and severely wounded a French captain employed in recruiting.

MACHINE FOR STAMPING SEAL OF STATE SAVES LABOR 3844

What is believed to be the first electrically operated machine made for affixing the seal of a state or any of its departments to documents is now being used by Arizona. Owing to a recently enacted law, the work was so increased that one man had to be assigned to the duty of stamping the official seal on all papers that passed through his hands. Now a touch of a button makes 500 impressions in an hour.

H. W. Wilson, Pres.
Phoenix, Ariz.

PHOTO FLASH LAMP AVOIDS USE OF LOOSE POWDER 3291

With a small metal lamp, shaped like a cigarette case, a flash for making photographs in the dark is obtained without

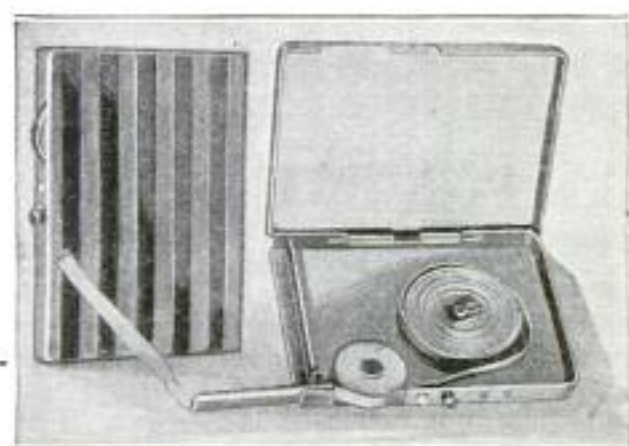

Photographer's Flash Lamp, Size of Cigarette Case, That Does Away with Handling of Powder

handling powder. A narrow strip of magnesium, which pulls out of the case like a wick, provides an intense flare, equaling that of the flash gun. Ignited by a match, the duration of the light is set by the length of the strip that is pulled out of the case.

Hugo Epstein, 212 W. Monroe, Chicago
Dealer.

R. H. Allwork
169 W. 152nd St.

Kansas City Star

8/18/23

POPULAR MECHANICS

COVER FOR FLAT-TOP DESK
ROLLS UP OUT OF SIGHT

OCEAN KEEPS TRAGIC SECRET
OF LONG-LOST OIL TANKER

33 45 Features of both flat and roll-top office desks are combined in office furniture recently patented by an eastern inventor.

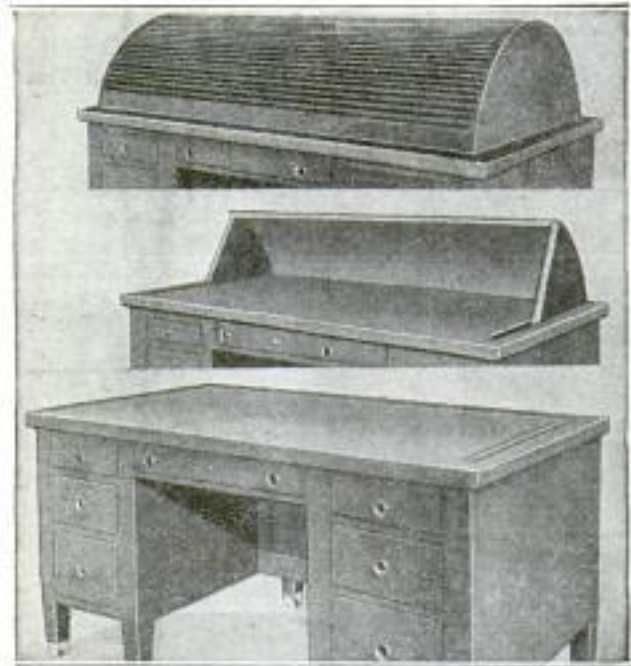

Flat-Top Office Desk Fitted with Roll Cover That Folds into Concealed Receptacle

Similar in appearance to a stenographer's table, it is fitted with a semicircular cover that extends over its upper surface, thus preventing the loss of important papers or letters. Only a slight tug is needed to draw it from a concealed receptacle at the rear, where it is kept while the desk is in service. A lock holds it firmly in a slot at the front when closed.

THIRTEEN THOUSAND LAWS
ARE ENACTED IN YEAR

Although there is said to be no exact record of the number of laws on the statute books of the nation, experts have calculated that in one year, 13,000 of 40,000 bills presented in the legislatures of 35 states, were passed at a cost of about \$900 each. Congress handles from 10,000 to 20,000 bills each session, and, it is estimated, passed 930 before its last adjournment. Estimators figure that there are between 50,000 and 100,000 state and federal laws.

More than 59,000,000 farmers, with their families, till the soil of China. The figures were given after a survey by a United States government bureau.

Disappearing in the Broadway of the Atlantic Ocean, extending from the eastern end of the Panama Canal toward New York City, the 7,000-ton oil tanker, "Swiftstar," added to maritime history another incident of mystery. Loaded with 77,000 barrels of oil and manned by a crew of 28 officers and men, it recently left Los Angeles bound for a Massachusetts port. It was last heard from when entering the sea lane along the east coast, but no vessel sighted it there, and no word came from its wireless. In those same waters the collier, "Cyclops," vanished some time ago as completely as if a giant monster of the deep had stretched forth a huge hand and pulled the craft beneath the water. Evidence that disaster befell the "Swiftstar" was found by a schooner captain after several electric storms. The sea all about was littered with splintered wood, a floating chest yielded the charred, unidentified body of a man, and for miles the surface was covered with a heavy film of oil.

MEAT SAW DRIVEN BY MOTOR
CONTROLLED BY TRIGGER

For cutting meat and bones in butcher shops or packing houses, an electrically driven bandsaw, operating on a frame

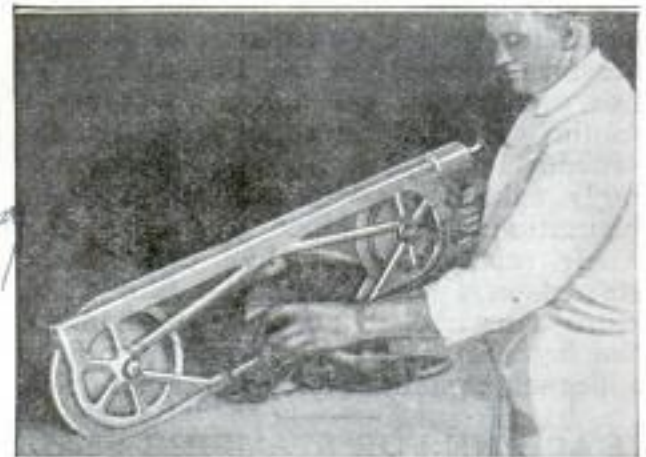

Electrically Operated Saw, Weighing Less than 14 Pounds, Cuts Meat or Bones Rapidly

resembling that of the ordinary hand tool, has been invented by a western man. Power is supplied to the device by a flexible shaft, or directly, by a motor. Its speed is regulated by a trigger on the handle. Light in weight, it can be handled with ease, performing the work quickly. By twisting the blade, the apparatus has been made small and compact without lessening its strength.

Kansas City Times
8/14/23

Copyright material
1116 E. Mill
Portland, Ore.

3326

Newman Travel Tales
Tribune Bldg.
Chicago

POPULAR MECHANICS

TANK IN AN ANTHILL KEEPS WATER COOL

To keep water cool, a concrete tank has been built into the side of a large ant-hill in a South African village. There

is no conduit system in the place, the water being obtained from galvanized-iron or concrete reservoirs.

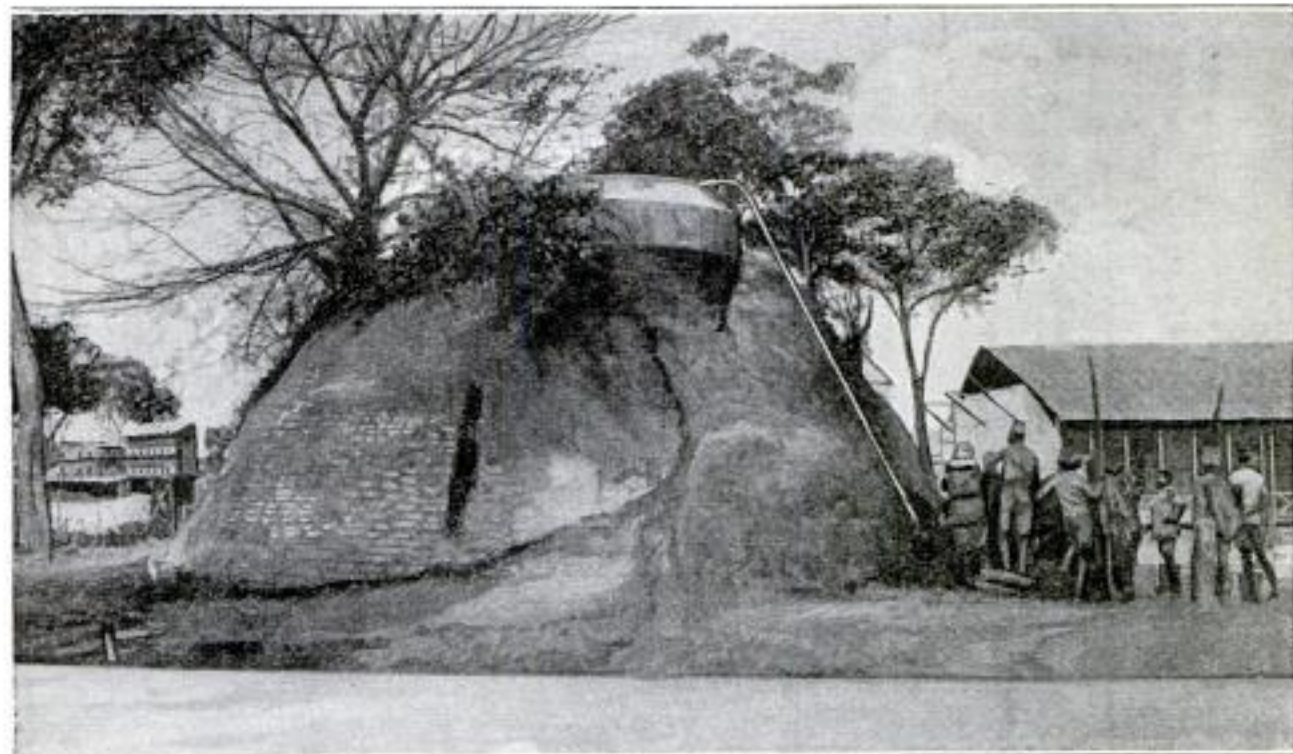

Water Tank Built in Ant Hill in South African Village Where There Is No Conduit System

NEWLY BORN BABY POSSUMS CLIMB TO PARENT'S POUCH

3390

Newly born opossums crawl unaided into their mother's pouch, which serves as an "incubator" during their first two-months' growth, scientists have determined. Many theories had been held by old woodsmen and nature students to explain how the little ones get there. Some believed that the young were born in the bag, while others thought they were placed there by the parent. Recently, the birth of a litter of 18 was witnessed. Guided by instinct, the small creatures climbed "hand over hand" into the haven of food and shelter.

mountains and woods, each one operated by two men. Across the crotch at the top of a dead tree, a long pole is balanced. From each end a heavy weight hangs by a chain, and below are metal



NEWMAN TRAVEL TALKS
Natives in African Wilderness Stamp Ore with Weights Raised and Lowered by Hand

ORE STILL STAMPED BY HAND IN AFRICAN WILDERNESS

3322

While steam and electricity have long been harnessed to operate huge machines for crushing ore, there are places in South Africa where the stamping of rock into powder still is done by the primitive method of raising and dropping weights by hand. Many of such crude mills are to be seen along the railroads, in the

troughs into which the rocks are put. With a seesaw motion of the beam, the weights are pulled up and down.

International Newsreel Corp

3269 326 W. Madison, Chicago

772

POPULAR MECHANICS

ELECTRIFICATION BRINGS NEW ERA TO AUSTRIA

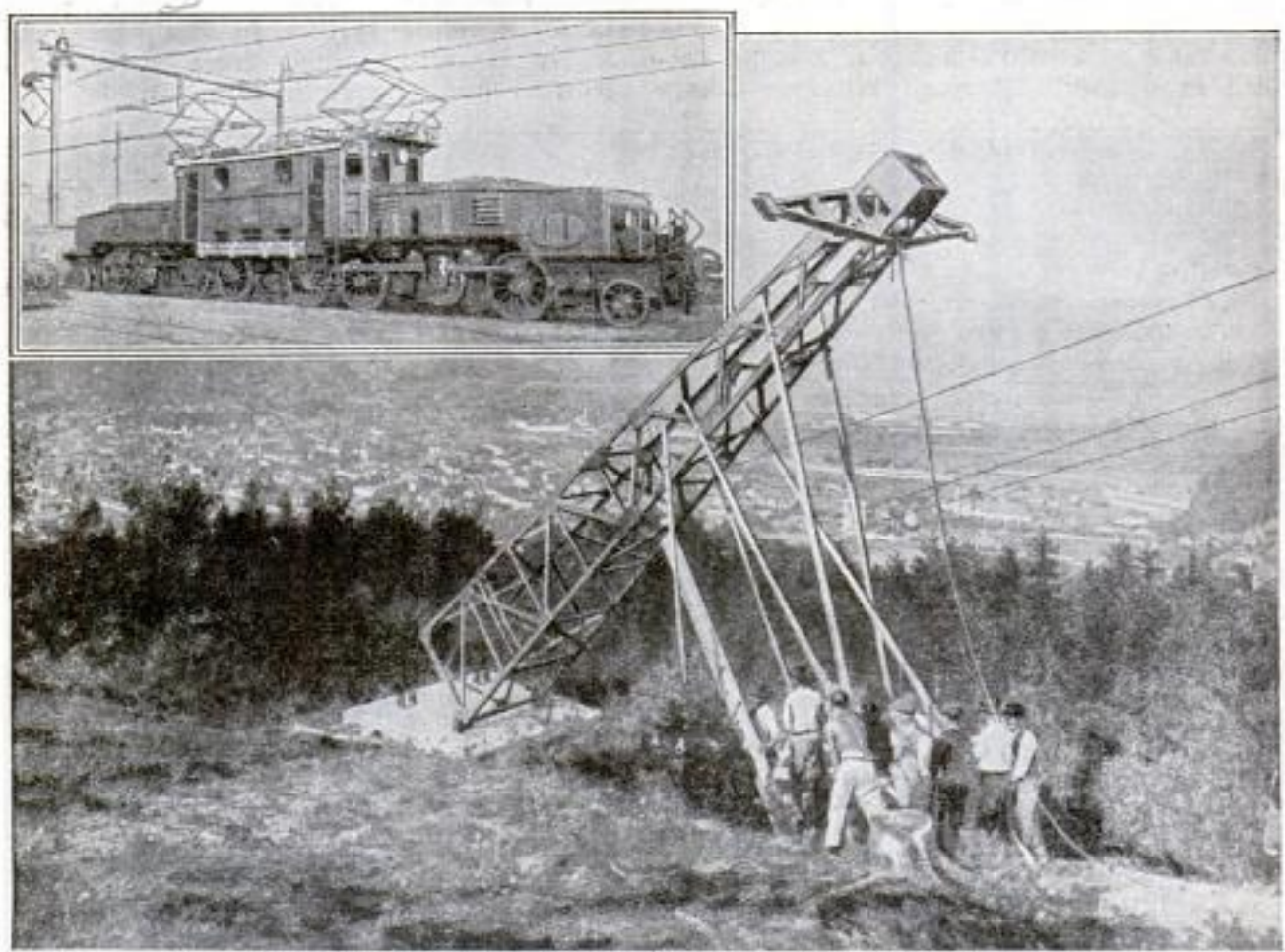

Workmen Placing Heavy Steel Transmission Pole on Concrete Base Set on Steep Mountain Side: Above, One of Giant Electric Locomotives Used in Express Service

Electrification of all lines of the Austrian state railways, regarded as marking an epoch in transportation in Europe, is meeting with success. Already one road, the Innsbruck-Telfis, has been changed from steam to electric power. It runs through the picturesque, yet exceedingly rugged, region of the Austrian Alps in Tyrol, where engineers solved many difficult problems in providing steel trans-

mission poles for the heavy-power wires. In some instances, the supports were erected on bases of concrete laid on the steep slopes of the towering peaks. On one section of the Arlberg system, now, a huge electric locomotive is pulling express trains, while others are being operated in the passenger service. It is said some time will elapse before all the systems are completely electrified.

TUNING FORK UNLOCKS SAFE WITHOUT COMBINATION

Lacking both a time lock and combination, a safe that opens to the vibrations of a tuning fork has been perfected by an English electrical expert. Attached to the tumblers of the concealed lock are electromagnets connected with a series of dry batteries, and a scale over which is stretched a steel wire. Set to the note of the tuning fork, this wire vibrates and causes electric currents that drop the bolts when the instrument is struck and touched to the top of the safe. As no two tuning forks have exactly the same

pitch, none but the one fitted to the vault can open it. Either banjo or violin strings may be used. They can be fixed to respond to the throbbings of other tuning forks, permitting the owner to change the "combination" when desired.

Smoking of meats may now be done in homes or meat markets in a galvanized-iron smoker that cools smoke passing through a long pipe entering the bottom of a chamber. Safe and fireproof, the smokehouse may be connected to any chimney, or moved about and used for storing the cured provisions. Space is provided for three to five dressed hogs.

Performed by Thomas Parker, an English electrical expert.

Chas. W. Ser. Engle,
Mess. Vogt & Masolle

International

Berlin Germany

POPULAR MECHANICS

MICA CLEARS RADIO TONES
OF METALLIC SOUNDS

2993

Using mica instead of metal disks to transform the sound waves and electric impulses in a radio has resulted in producing a clear tone, free from any metallic sound, in transmitting the voice, violin, piano, horn, flute, and even an entire orchestra. Tests recently conducted in Europe showed that with the mica plate high or deep sounds from any source were distinctly heard in all parts of a big hall and that there was no buzzing vibration so often present in a telephone or radio. Wire and radio have proved equally good for transmitting the current.

Three-watt power, the amount in a small flashlight, was used to give a concert in a hall to 3,000 persons, in all cases the sounds being clear and entirely free from metallic vibration. It is believed that these experiments will be helpful in improving other instruments transmitting musical sounds.

3359

CIGAR LIGHTER ON DESK HEATS
FROM HIDDEN BATTERY

Heated by electricity, a cigar lighter that requires no more space than a pocket tray, has been invented by a western man.



Light is obtained by touching a small push button that turns current into a coil set in a frame mounted on a metal base. A battery, which supplies it, can be kept out of the way under the desk or in a drawer. Models are also

made for attachment to the instrument board of automobiles.

CLOCK STOPS WASTE OF GAS,
PREVENTS EXPLOSIONS

3382

By setting a small clock, that can be attached to any coil or tank water-heater, it will shut off the gas when the contents have been heated. No matches are needed, when this control is used, for the timer lights the burner from a pilot flame. Saving steps and fuel, it also prevents accidents that might happen if the gas continued to burn after the water boils. The device also can be used on any other gas-fired appliances to cut off the fuel supply at required intervals.

LETTER BOXES FOR AIR MAIL
PUT ON BERLIN STREETS

3206

Boxes for mail intended for the air routes have been introduced in Germany. A number of them have been put on



One of Berlin's Letter Boxes Installed to Aid Patrons

the principal streets of Berlin to keep step with the growing popularity of the aerial service. The contents are collected shortly before the departure of each plane. Formerly, those who desired to send mail by airplane were forced to carry it to the post office.

WHITE PAINT ON SHIP'S BOTTOM
KEEPS BARNACLES AWAY

3392

Ships' hulls are being painted white, because recent tests have shown that this color is least attractive to barnacles, shelled animals that attach themselves to objects in the sea. Heretofore it has been thought that because red could easily be mixed with various poisons, one of them was sure to kill off the pest, but experience did not confirm the belief. Government men noticed that more barnacles were found on red-bottomed ships than on those of other colors. Tests were made by lowering glass plates painted red, yellow, green, and white, into the water, where they remained for three months. When taken up, the red plate was swarming with the creatures; the green had a large number, a few crusts were on the yellow, and only three were attached to the white glass.

The name, President Harding, has been suggested for a new geyser that has erupted in Yellowstone National Park.

Sold by Western Specialty Co.
690 Hollam St.
San Francisco, Calif.

New York James 8/19/23

Sentinel Mfg. Co.
New Haven, Conn.



Ready for the Plunge Down the Incline Which Catapults the Two Cars into Space:
One Machine Somersaults in the Air, the Other Leaps under It. Insert, Land-
ing, a Vital Danger Point, Where Miscalculation may Mean Death

GIRLS FACE DEATH IN "LOOPING THE LOOP" STUNT 3271

In automobiles traveling at a speed of 130 miles an hour down a steep incline, two girls perform leaps and somersaults in the air for the amusement of patrons of an eastern park. Crouching low, and gripping handholds, the riders keep themselves from being hurled out, as the cars are released and rush down the grooved track almost together. At the bottom they are catapulted into space by the curved end of the runway. While one "loops the loop" three times, the other, barely escaping the revolving car, dives underneath it to a landing platform, equipped with springs to absorb the shock as the machines drop on it and roll to the ground.

LABOR OF EIGHTY MEN SAVED BY RAILROAD WEED CUTTER 3372

Labor of about 80 men is saved by a motor plow recently made by a western railroad to cut the weeds and level the ballast along its right of way. One machine, built by fitting ordinary farm disks to a section hand's motor car, saves the railroad \$240 daily, it is estimated. Three men clear 24 miles of track with this mower in a day. A cutter, costing a few hundred dollars, saves almost \$100,000 a year in wages formerly paid track gangs working with picks and hoes. The plows are constantly in operation, eliminating fire hazard, preventing decay of

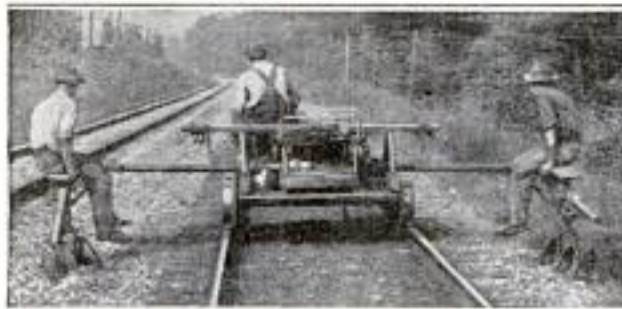

COPYRIGHT, UNDERWOOD & UNDERWOOD
Plows Attached to Railroad Motor Car That Save \$240 a Day, Cutting Weeds and Leveling Ballast

ties, and improving appearances by uprooting grass and weeds. Digging through the rocky surface, they maintain a solid roadbed by permitting thorough drainage.

☛Rivaling Jack's beanstalk, a corn plant on an Indiana farm during a period of extremely hot weather was reported to have grown 13 inches in five days.

WAR MINE IS NOW MAIL BOX ON BIG PACIFIC LINER

What was once a deadly mine, planted in the North Sea during the World War, is now being used in the peaceful mission of carrying



Mail Box on Pacific Liner That was Made from Deadly Mine

rying mail on a Pacific Ocean liner. The steel sphere is an object of great interest to the passengers. On one side may be seen an indentation that is probably evidence of the narrow escape of some unidentified ship during the conflict. The letter slot is cut through one of the plates that leads to the firing mechanism, where acids were held in glass tubes, ready to bring about an explosion when broken by the impact of a vessel. It is supported on a heavy iron framework bolted in position. 3363

FOG BELLS FOR LIGHTHOUSES CONTROLLED BY WEATHER

Lighthouses without attendants have been equipped with automatic fog bells that ring at regular intervals during damp or thick weather. A delicate instrument, called a "hair hygrometer," affected by moisture in the air, expands when damp atmosphere surrounds strands of hair by which it is controlled, causing the bell to ring. Dry air contracts it, and stops the ringing. Occasionally the device is deceived by clear air which has taken up moisture, but its mistakes are always on the side of safety.

Cont. Edwin Jarvis
The Paragon, Washington
20 26

PISTON RING HAS UNUSUAL FLEXIBILITY

Absolute conformity to the cylinder wall, whether the latter is perfectly round, or egg-shaped through long wear, is one of the claims, and a just one, advanced for

and with less liability of leakage or oil pumping. The principle of construction is a clever one, and imparts to the cast iron a flexibility akin to that of tempered spring steel, as a complete ring can be twisted into the form of a figure 8 without distortion. There is no gap in the rings, as they are cast in ring form and the subsequent machining leaves them in the form of complete circles.

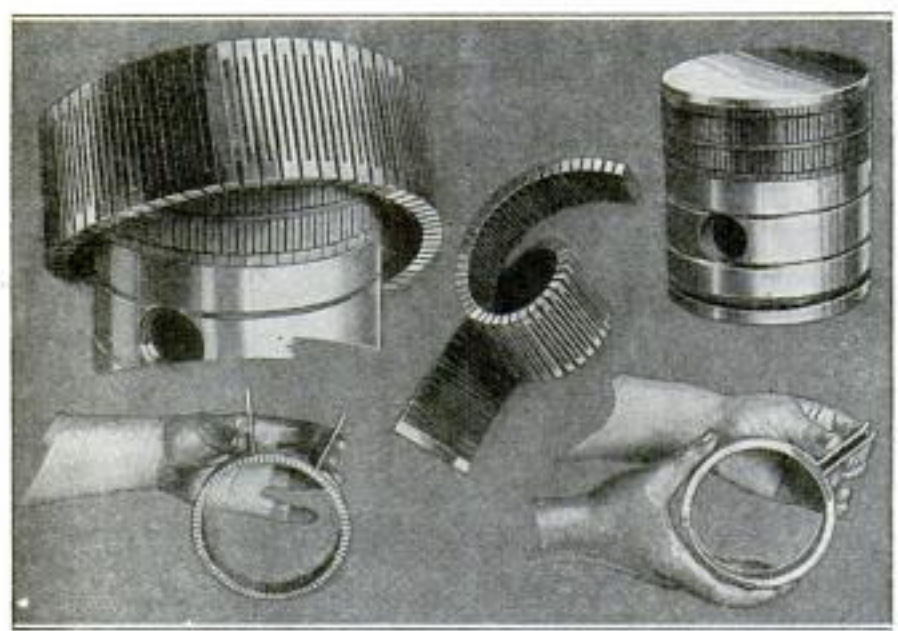

Upper Left, Close-Up of Ring; Upper Right, Ring on Piston; Center, Broken Ring, Twisted; Below, Ring Before and After Compression

The principle may be used not only for piston rings, but also for expansion reamers, cast-iron liners for aluminum cylinders, bearings, and complete pistons.

The use of the idea in connection with aluminum cylinders is especially interesting, as the difference in expansion between the aluminum and iron is perfectly

an unusual piston ring now in course of development.

One of the new rings will take the place of three or four of the present type,

counteracted. When the piston idea is fully developed, it will cause a revolution in gasoline-engine practice, as piston-ring troubles will be banished for good.

TOOL COMBINES SNAP GAUGE AND MICROMETER

Combining the functions of the micrometer and limit snap gauge, an automatic instrument forms part of a new system for controlling production to specified precision. The size of a reference standard is transferred to the product without any intermediate means, such as the snap gauge. The instrument has an operating range of .05 inch, an adjustable range of 1/2 inch, and an interchangeable tolerance

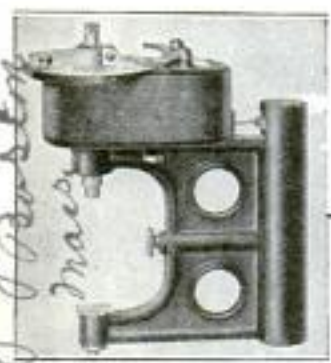

plate. The spindle is automatically centered on the work, released, set to a definite pressure, and locked to retain the reading as it is withdrawn. It follows up successive reductions, but is set back by hand for each piece. For production use,

the tool is set to read zero at the finish size; it then reads directly on its dial the amount that the work must be reduced, and the reading is retained. No skill or training is required in the use of the instrument, and its adoption will greatly extend the field for employment of special-machine operators of common ability.

ELECTRIC STEEL FURNACES OF HIGH EFFICIENCY

Electric steel furnaces of exceptional efficiency have recently been installed in an Italian automobile factory. As demonstrated by tests extending over a long period, these furnaces insure considerably higher outputs and a reduction of electrical losses, as well as in consumption of electrodes, a saving of deoxidizing agents, and less strain on the lad masonry.

The three electrodes rest with the whole armature on a special bridge, at right angles to the bath, as usual, but each electrode with its controlling mech-

Designed by Messrs. Pennington

Microgauge Co. Dept 112.6, 52 M

Lewisburg, Holland.

anism, including the motor, can be withdrawn as a unit and changed in half an hour, even during operation. A water-cooled casing, connected with the door frame, enables the furnace to stand up to 150 tappings without interruption. The successful and economical operation of the furnaces is due mainly to the special cooling and tightening arrangement adopted for the electrodes. The absence of any flames around the electrodes prevents any combustion of the latter at the point of admission.

Special transformers are used, with two voltage stages; the first, of 130 volts, is used to melt the solid charge, while the second, of only 75 volts, is sufficient to refine the bath and to raise it to a casting temperature of 1,750° C. (3,182° F.). Four large furnaces, each of 15 to 20 tons capacity, and two of 3 to 6 tons capacity have been installed.

24)u
**MOTOR-DRIVEN TOOL CUTS
 COMMUTATOR V-SLOTS**

Commutator slotting has been generally adopted, with the exception of a few industries, such as coal mining and foundry work, where short circuits occurred with the U-shaped slots produced by motor-driven slotting machines and other tools. A new machine, which cuts V-shaped slots, eliminates this objection, as the shape of the slot, with the centrifugal force exerted when the commutator is running, keeps it clean under all conditions.

The milling cutter is driven by an electric motor with a nearly constant speed, or may be driven by any electric drill rated at 1/4 inch or larger. One end of the handle is hollow and carries compressed air, which is deflected to the edge of the



Motor-Driven Tool That Cuts V-Slots in Commutators Quickly and Cleanly

cutter and blows the mica away, enabling the operator to see the work clearly at all times. The tool is furnished with a micrometer adjustment to enable the cutter to be set in the exact center of the mica, and with an adjustable guide to regulate the depth of cut.

20)u
**MOTOR DRIVE FOR CONE-
 HEADSTOCK LATHES**

To meet the demand for motor-driven lathes, a motor drive has been devised that can be attached directly to the com-

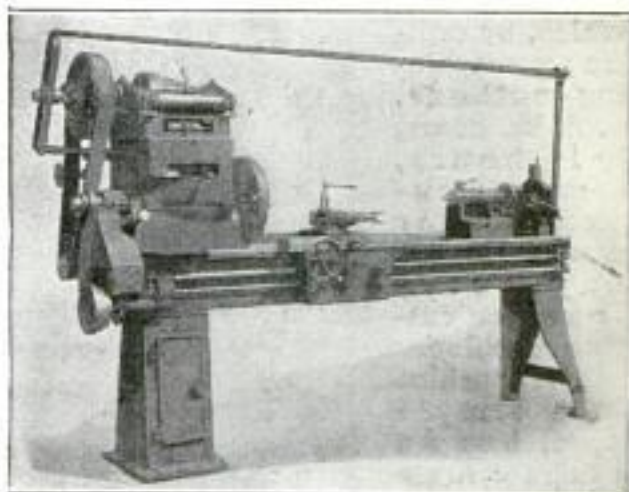

A Belt-Driven Lathe Converted to Motor Drive by Means of a Self-Contained Attachment

mon cone-headstock lathe. The arrangement can be attached with very little machine work, aside from the drilling and tapping of a few holes.

The countershaft unit is bolted directly over the cone pulley of the lathe, and is provided with a clutch so that the motor can be engaged and disengaged at will; the countershaft cone pulley may be adjusted so as to tighten the cone belt. The motor is placed on a bracket mounted on the rear of the lathe.

38)u
**LOW-GRADE MOLASSES YIELDS
 FUEL AND POTASH**

Low-grade or "blackstrap" molasses, at present regarded purely as waste, may be treated so as not only to yield a liquid fuel of commercial value, but also potash. Patents on the process have recently been granted to Dr. Paul G. Hildebrand, of Swarthmore College, Pa. It is claimed that from each ton of molasses is obtained a quantity of liquid fuel equivalent in heating value to 1 ton of coal, and, as a by-product, 150 pounds of potash.

The importance of this will be seen when it is realized that Cuba alone produces 1,000,000 gallons of blackstrap molasses yearly, which, when treated, would yield fuel equal to 4,000 tons of coal, and 600,000 pounds of potash. In Cuba, and all other Latin-American sugar-producing countries, fuel for power purposes, as well as potash for fertilizer, must now be imported, so the new process holds vast possibilities for them.

Isodrey Engineering Works.
Boundary Road,
POPULAR MECHANICS
39 M Westbury Ave, Wood Green, London
ACETYLENE-JET MACHINE CUTS INTRICATE SHAPES *Eng.*

778
 Cutting a plate in 8 minutes, where formerly a day was required for the job, and shaping turbine diaphragms, which, by ordinary machining methods, took 160 hours, in 1½ hours, are commonplace jobs for a new English oxyacetylene-jet cutting machine.

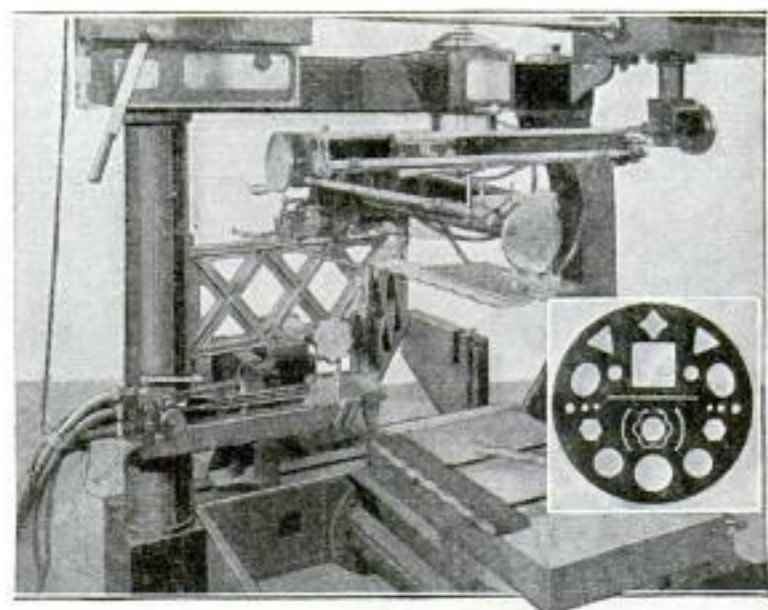

An Oxyacetylene-Jet Machine That Handles an Immense Variety of Work: Insert, Plate Showing a Few of the Patterns Cut

The machine is a simple one, but an immense variety of work can be handled on it; cuts may be made at any angle to the axis of the machine, and holes of any radius up to the length of the jet arm may also be cut, at speeds ranging from ½ to 20 in. per minute. Due to the constant feed, the machine

produces an exceptionally good finish on the work; the character of the jet employed also aids in this, as it does not melt the edges of the cut.

Templates may be used with the machine to reproduce intricate parts, and, as a demonstration of what the machine can do in this respect, gearing has been produced with but a few thousandths of an inch left on the teeth for finish; gears

of 2-in. circular pitch mesh together and run properly, 16 teeth being cut in 16 minutes, from ½-in. plate. Cuts as small as ⅓ in. wide have been made with the machine.

Benson Engineering Co., London, Eng.

NEW STEAM BOILER CARRIES ENORMOUS PRESSURE

If the claims made for a steam boiler now in course of erection in England are fulfilled, a revolution in steam generation will be constituted. The pressure to be carried is 3,200 lb.—enormous in comparison with the 150 to 200-lb. pressure normally used. In some instances steam is generated at 350-lb. gauge pressure, but this has been considered a high pressure heretofore.

High pressures mean increased efficiency in a steam boiler, and the need for increased efficiency is evident when it is realized that even at 200-lb. pressure, and with a high superheat, approximately 60 per cent of the heat value of the coal is wasted.

The principle underlying the design of the new boiler is the generation of steam at the "critical point," where no latent heat is required, and where the whole mass of water at 706° F. is suddenly and bodily converted into steam, without any priming troubles whatever. After passing through the boiler, the steam will be superheated to about 785° F., and then

throttled down to 1,500-lb. pressure to drive a 400-kw. turbine. The steam will then pass, at 200-lb. pressure, to another turbine, which will furnish another 600 kilowatts. The plant is expected to be in operation before the end of the year.

ATTACHMENT HOLDS ROUND STOCK IN VISE

Where the purchase of a regular pipe vise is not advisable, an attachment that makes any vise suitable for pipe or other round stock will be found exceedingly useful. The attachment consists of a pair of auxiliary jaws, joined by a strip of spring steel, which keeps them together while

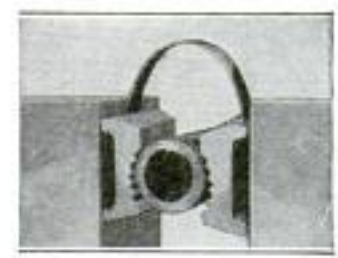

permitting them to follow the jaws of the vise. This tool will be found useful not only by the mechanic, but by the tinkerer around the home, who can convert his plain vise into a reliable pipe vise at a moment's notice.

Elgin, Ill. Co., Don mfg. Co.

Credited at: English Electric Co., Rugby, Eng. Elgin, Ill. Copyrighted material



All Shop Notes published in 1922, in book form—Fifty Cents—from our Book Department.

A Practical Salt Box for Stock

BY J. R. KOONTZ

TO have healthy live stock one must see that they have plenty of salt at all times. To feed salt to hogs, cattle, and sheep, and, at the same time to keep it clean and from being trampled into dirt, has been a problem for many stock raisers and farmers. If placed in a wooden box it is no time until the box is upset,

larger inside than the regular salt block, and deep enough so that about three-quarters of the block is below the edge of the box. The boxes are easily made, and cost only about 25 cents each.

First wet some sand, and from this form a block or core the same size the hole is to be in the block; saw four boards

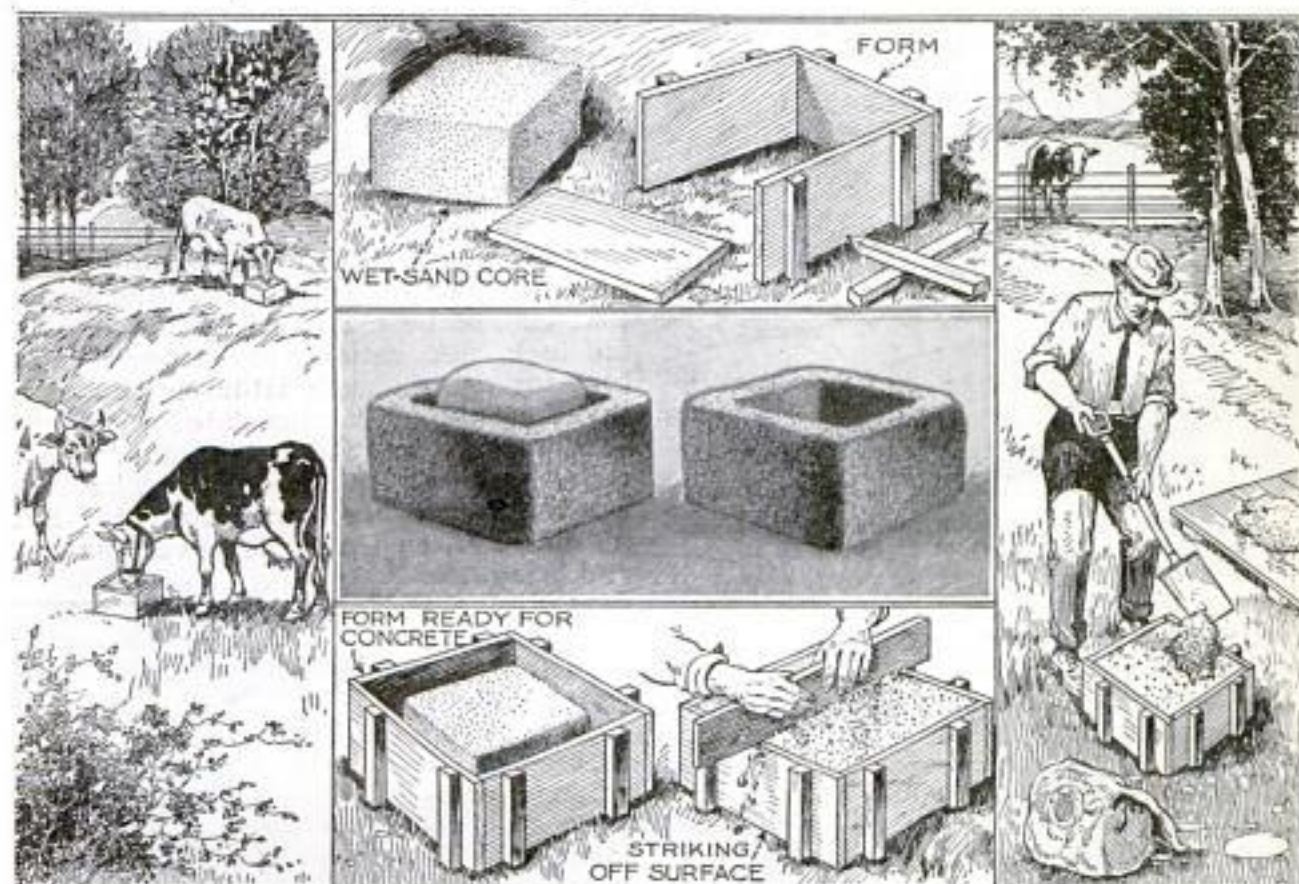

Concrete Salt Boxes are Easily Made with Improvised Forms, and will Prove of Great Help to the Stock Raiser, as They cannot be Upset and will Last for Years

and besides, a wooden box does not last long under the rough usage it receives.

Salt boxes made of concrete are the answer to the problem. They cannot be broken, and are heavy enough to prevent the stock from upsetting them, so that the salt will remain in place until it is all used up.

The boxes should be made a little

about 10 in. wide, and long enough so that, when assembled around the core as shown in the illustration, there will be a space of 3 in. between each board and the core. The boards should also extend 3 in. above the core. Place the boards around the core, driving stakes into the ground to hold them as shown; do not nail the boards, as the stakes are quite

sufficient to hold them firmly, and they can be taken apart easily.

Fill the space around the core with concrete mixed in the proportion of 1 part cement to 3 of clean, sharp sand, prodding the concrete down well with an iron rod to insure its filling all corners

of the form. When the concrete has set, remove the form boards, turn the box over, and dig out the sand.

Place the box in a cool spot, and keep it wet for about a week, when it can be placed in service with the assurance that it will last for years.

Illuminating the Scale Beam

The difficulty in properly adjusting the weight on the beam of a scale in a small

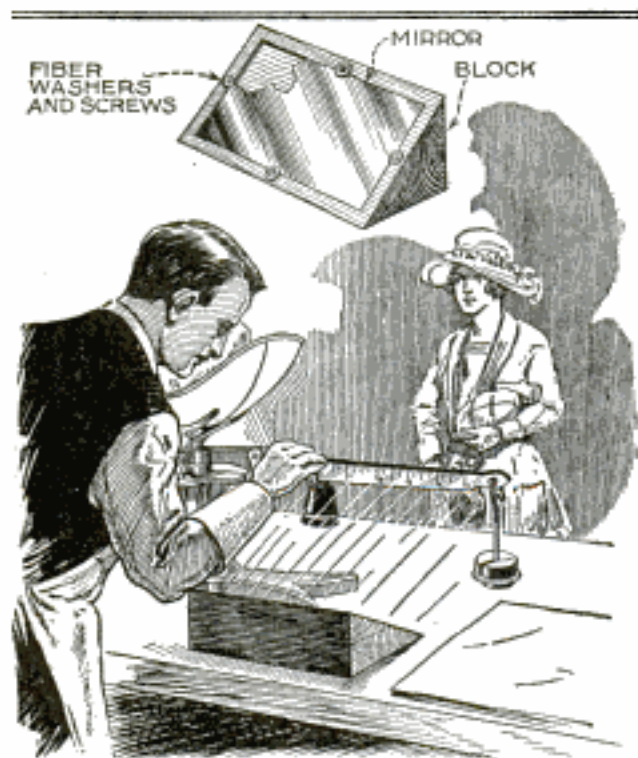

The Dark Side of a Scale Beam Illuminated by Means of a Mirror Reflecting Light on It

store, due to insufficient light, was remedied by providing a mirror set in the position shown, to reflect the light on the scale beam, the mirror being mounted on a triangular block. The light from the window opposite the scale was reflected so that the graduations could be seen distinctly, and at night the store lights were similarly reflected on the beam. The use of an electric light was first suggested but the mirror was found to serve the purpose just as well, and without the cost of burning an extra light.

Simple Whitening Process for Metals

A simple and inexpensive method of whitening small copper or brass articles, such as hooks and eyes, pins, buttons, etc., in quantities, is to immerse the articles in a solution made as follows: 2 oz. of fine silver in grain form are dissolved in

a little nitric acid, and this solution mixed in 1 gal. of distilled water, after which a strong solution of salt and water is added, which will precipitate the silver in the form of chloride. This precipitate is washed thoroughly to remove all traces of acid, and the last rinse water should be tested with blue litmus paper to make sure that all the acid is removed. The chloride of silver thus formed is next mixed with an equal amount of cream of tartar (potassium bitartrate) and sufficient water to form a mass of the consistency of cream. After the articles are thoroughly cleaned, they are immersed and stirred until sufficiently white, when they are rinsed in hot water and shaken up in sawdust to dry.

Taper-Turning Tool

When a lathe has no compound slide, there is some difficulty in turning tapers that cannot be machined by moving the tailstock. A satisfactory taper-turning tool for use on such lathes is shown in the illustration. It consists of a straight, solid tool ground flat on the end, with a roller attached as indicated. The stud carrying the roller is cut away for half its diameter, so that it fits over the tool and brings the

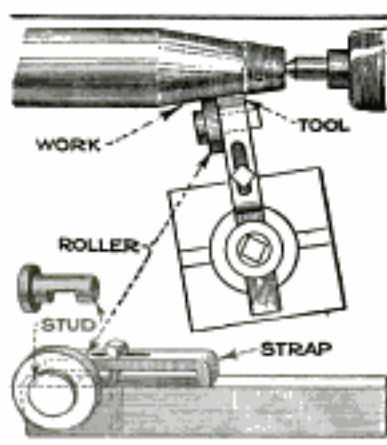

center of the roller in line with the edge of the tool. A slotted heel strap and screw complete the attachment. In use, the work is first roughed out, and the tool is then set at the correct angle to turn the required taper. Starting at the large end, the tool is fed in to cut the full width of its face. Then it is moved forward a distance about equal to its width, and it is again fed in until the roller touches the part already finished, and so on to the end of the taper.

Cement for Closing Leaks in Iron Pipe

The following formula is good for making a cement for closing leaks in iron pipe: 5 lb. of coarsely powdered iron borings, 2 oz. of powdered sal ammoniac, 1 oz. of sulphur, and enough water to make a paste of a thick consistency. By leaving the sulphur out the cement will set more firmly, but will require a longer time. The cement is tamped tightly into the leak.

Keyed Mandrel Aids Production

The speed of production and accuracy of work can often be improved greatly by a little thought applied to the arrangement of machining operations. For example, the gear blank shown in the drawing was formerly chucked, faced on one side, and bored and reamed, then forced on a plain mandrel, or expansion mandrel and turned all over; after this, the blank was keyseated and the teeth cut. When

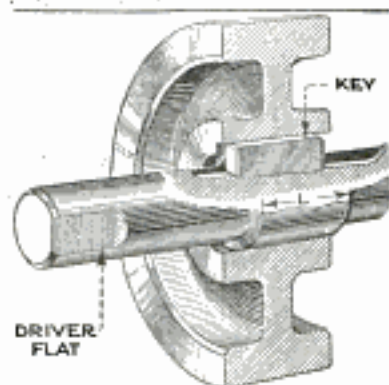

turning in this manner, it was necessary to take light cuts, to prevent the blank from slipping on the arbor. When the operations were rearranged, keyseating followed the boring and reaming; the blank was then placed on the mandrel shown, and tightened by means of the taper key. This drew the bottom of the bore against the mandrel in exactly the same way as it would be drawn on its own shaft, and, in addition to permitting heavy roughing cuts to be taken, insured accuracy in the circumference. The top half of the mandrel was drawfiled to permit easy entry into the bore, and the key used had a taper of $\frac{1}{4}$ in. per foot.

The gears turned and cut on these mandrels were much quieter than those previously made, as any possibility of eccentricity in the teeth was avoided.

When a one-piece rim is sprung, and will not go together when using a block and jack or a rim-mounting tool, put it on the wheel, tighten up the lugs, and hammer it. Many badly sprung rims can be very easily mounted in this way.

Lifting Bar for Auto Engine

Automobile engines are easily carried by means of the three-arm lifting bar shown in the drawing. It consists of

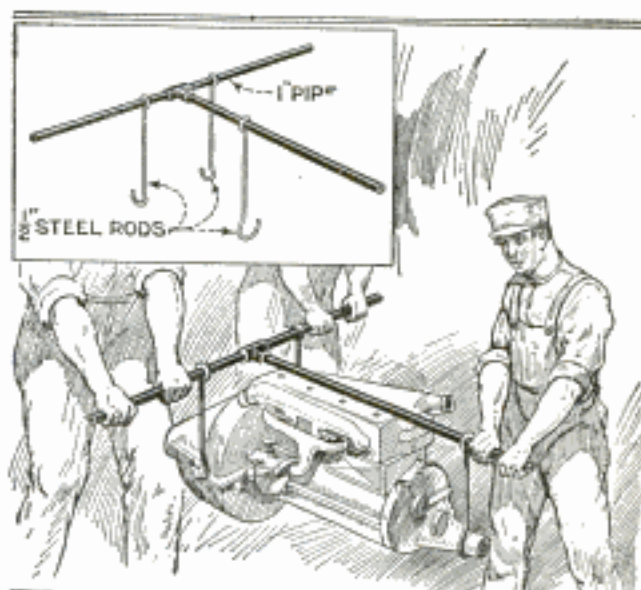

A Handy Lifting Bar with Which Automobile Engines can Easily be Lifted and Carried

three lengths of pipe screwed into a tee, and three hooks, made of $\frac{1}{2}$ -in. steel rods about 1 ft. long. The hooks are attached to the front end of the crankshaft and to the two rear engine brackets. Three men can readily lift the engine and carry it, as the lifting bar distributes the weight and keeps the workmen away from each other, thus preventing interference.

Portable Drawing Board

The illustration shows a drawing board that is very convenient for traveling, as it can readily be put into a suitcase. It consists of two smooth boards each 10 by 23 in. in dimensions, and two removable wooden strips that are slightly tapered in their length and are beveled on their edges to fit snugly into dovetailed grooves cut across the back of the boards. These strips hold the two parts of the drawing board together when pushed tightly into the grooves, no nails or glue being required to hold them.

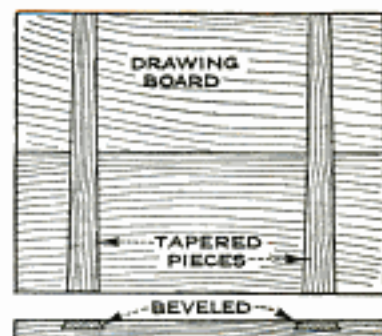

Stanley Dusdieker, Cedar Rapids, Ia.

Groove in Bench Prevents Parts from Rolling Off

The usual method of preventing small parts from rolling off a workbench is to nail a strip of wood on the bench top,

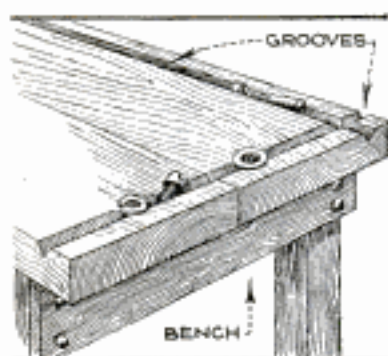

near the edges. However, it is not always desirable to have such a strip on the bench, as it often proves to be a hindrance in working, and therefore a V-shaped

groove cut along the edges as shown in the illustration has been found much more satisfactory. The groove is about 1 in. wide and about 2 in. from the edge of the bench top. It takes only a few minutes to cut the groove by means of a carpenter's grooving plane.

Supporting Irregular Work in Machine Vises

Ordinary parallels are not of much use as supports for irregular work held in machine vises, unless the surface of the work touching them is flat. Very often a job can be done more conveniently by using an adjustable support of the type shown in the drawing. This support consists of a length of round rod, forming a slide bar, on which two short lengths of tubing are fitted, the latter being drilled crosswise and threaded inside to receive the work-support screws. The support screws are countersunk, as

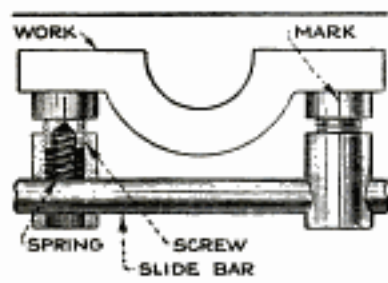

shown, to receive the ends of small coil springs, which keep the parts together, prevent the screws from turning too easily, and hold the tube pieces in the position set. After assembly, both screws are turned down close to the tube, and while in this position, a mark is cut on each screw head as shown.

Many kinds of work can be supported by machine vises fitted with this adjustable support, the tube pieces being moved in or out to avoid irregularities in

the form. The screws are used to suit work of various heights by turning them equally, using the marks as guides. By making the slide bar long enough, work extending beyond the vise jaws can be supported by means of a thin parallel resting on the vise bottom.—Harry Moore, Montreal, Can.

Filling Listed Furrows

The practice of listing out the soil was formerly confined to corn planting only, but has now become one of the principal methods of crop production, especially in dry territories. The ridges and furrows made by listing must be leveled down again and various implements have been made to do this. Of these a simple and effective one, which can readily be made on the farm, is shown in the illustration. The crosspieces, which are made of 2 by 10-in. material, should be long enough to cross five ridges from center to center. Lengths of 2 by 6-in. hard pine are attached edgewise to the

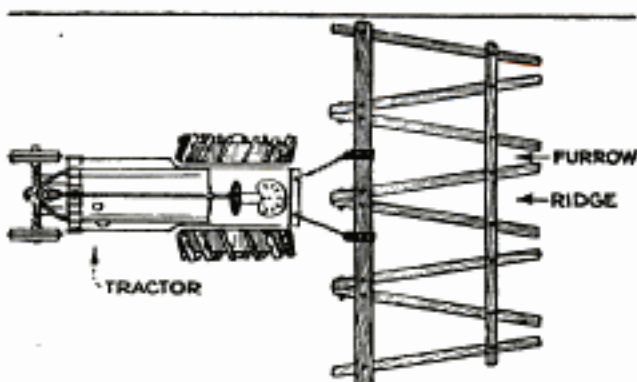

An Easily Made and Effective Drag for Leveling the Ridges and Filling the Furrows on Listed Land

crosspieces with nails and bolts in the position shown, so that the points where two adjacent pieces come together at the front will be located over the center of a ridge. The weight necessary to use on the implement depends on the hardness of the soil. In leveling the field, it is best to cover the surface twice, by half overlapping at each round. This leaves one furrow for the tractor wheel to run in, making it self-guiding, while the other wheel runs in the partly filled furrow. In this way four rows are covered at once, and at each round two rows are finished.—G. G. McVicker, North Bend, Neb.

☛ A little kerosene added to enamel will make it easier to apply. Stir in, very thoroughly, about one tablespoonful to the gallon of enamel.

A Homemade Refrigerating Machine

By JOHN GORRELL

THE household refrigerating machine described in this article has been in successful operation for some time, and, although a vast amount of time and experiment was necessary before the machine would work well, the problems have all been solved, and the reader who builds one is assured of a satisfactory machine.

A brief outline of the principle of operation is essential, in order that the builder may construct and operate the machine intelligently. In Fig. 1 is seen a condenser that contains a liquid gas under pressure, an expansion valve, cooling coils in the ice chamber, and a motor-driven compressor. If, when the compressor is running, the expansion valve is opened slightly, some of the liquid passes into the cooling coils, where the pressure is greatly reduced. The liquid now boils or evaporates rapidly, at a low temperature, and, in

doing so, absorbs a certain amount of heat from the pipes and the surrounding air. As the gas boils off the liquid, it is drawn into the compressor, compressed and passed into the condenser, where it is robbed of the heat of compression, and liquefies again,

ready to go through the cycle once more, as long as the compressor is running. Sulphur dioxide is the gas used in this case.

The compressor is the most important part of the system; it is the one that costs most in time and money, wherein the greatest trouble is encountered, and that must receive the best care and workmanship. The compressor must hold the gas both when in operation and when idle, hence the difficulty. It is not possible to buy a small compressor on the market that will satisfy the requirements, as none is gastight. It is possible, of course, to build a special compressor, but this is very expensive. It is also possible to make an ordinary air compressor gastight, but a good job is almost impossible, and would cost too much.

The only successful method for the ex-

perimenter is to inclose the whole compressor, and provide an oil-sealed, oil-displacement stuffing box. Fig. 4 shows the pattern for the compressor-inclosing tank or casing; this is quite large enough for a 1 $\frac{5}{8}$ by 2-in. vertical garage air compressor, which is the type used; a larger compressor is not advisable.

The lumber used for the pattern is $\frac{1}{2}$ by 16-in. material, and about 8 ft. will be required, both sides to be planed. The pattern may be fairly roughly made, and still serve the requirements, but care should be taken to allow $\frac{1}{2}$ in. of draft. The flange is $\frac{5}{8}$ -in. thick, to allow for machining. The inside corners should be filleted, and the pattern sandpapered smooth all over and shellacked. While the shellac is drying, the top cover can be made. This cover is shown in Fig. 5: it is simply a flat piece of material, cut

to dimensions, and with an extra piece nailed to it where the shaft of the compressor comes through. This piece is also filleted. Don't forget that the casting will be about $\frac{1}{8}$ in. per foot smaller than the pattern; use a shrink rule if possible.

The casting is made in gray iron, and will cost about \$7.00. The flange and part of the plain side of the cover are planed true and smooth, and the compressor may then be placed in the casing and holes marked for the bolts to hold it in place. After drilling, the compressor is shimmed up until the shaft is at right angles with the machined flange, then bolted in place, using leather washers and gaskets, well covered with a paste made of litharge and glycerin, under the nuts and washers.

On the right-hand side of the casing two holes are drilled and tapped for gauge-glass fittings, and care should be taken to get these in line, or it will be difficult to fit the glass without breaking. If a street elbow is used in each hole, any mistakes can be easily corrected. There is a hole drilled and tapped for $\frac{3}{8}$ -in. pipe on either side of the casting, as

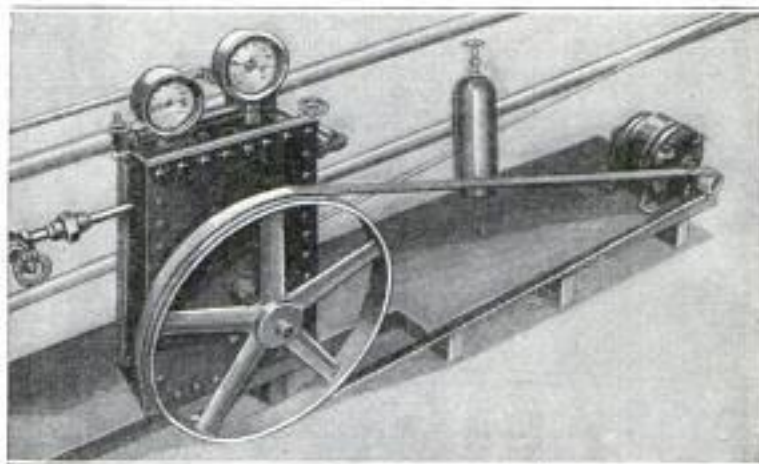

Photo Showing Compressor and Condenser Installed in Basement; The Ice Box Is on the Third Floor

shown in Fig. 6. The right-hand one merely leads inside the casing, and is the intake. That on the right is the outlet, and is fitted with a tee; the pipes leaving the casing have a long thread, so that a leather washer, coated with paste, can be tightened against the casting on each side with locknuts.

Two gauges are needed; one reads to 100 lb. per sq. in., and is used on the high-pressure side; the other reads to 100 lb., and also to 30-in. vacuum.

Careful measurements will show where the shaft will pass through the cover plate. At this point, a hole is bored and tapped for a 2-in. pipe. The stuffing box, which may be of iron or brass, is then made as in Fig. 7, the outside being threaded 8 threads per inch to fit the casting. A ring and nut are also made to the dimensions given, and the stuffing box screwed home, and packed with a good $\frac{1}{4}$ -in. graphite packing.

When the compressor is in the box, the cover bolted on, using a good gasket material for the joint, and all joints tight, the casing is filled with enough paraffin oil to bring the level 1 in. higher than the shaft.

The compressor should have an 18-in. pulley, and the motor a $2\frac{1}{2}$ -in.; a 1-in. belt is used,

and the motor should not be placed too near the compressor. A $\frac{1}{4}$ -hp. motor, operating at 1,750 r.p.m. is satisfactory, unless of the split-phase type, in which case a larger one will be found necessary to make the machine self-starting.

The condenser shown in Fig. 1 has been found to answer all requirements. It consists merely of two 10-ft. lengths of $1\frac{1}{2}$ -in. galvanized-iron pipe, connected by two elbows and a 12-in. nipple. If space is available, it would be desirable to make the pipes 15 ft. long, especially if the box is very large, or more than 50 ft. from the condenser. All threads in the condenser should be coated with plenty of the litharge and glycerin paste, and the joints made up at once. This paste should not be used more than half an hour after it is made, even should it still appear fairly soft, and must not be softened with glycerin, when once hard.

To insure proper drainage of the liquid the pipes should slant 10° or more as shown. Notice that the fittings do not form pockets that retain the liquid. If space is limited the condenser may be made of shorter lengths, but using more of them, and keeping the cooling surface the same.

The condenser may be placed anywhere, but the basement is usually a good place, as the temperature there is lower than anywhere else. In the installation shown in the photo, the compressor and condenser are in the basement and the ice box on the third floor.

As there is a liquid under high pressure on one side, and a gas under low pressure on the other, the expansion valve must be capable of fine adjustment. A good $\frac{1}{4}$ -in. or $\frac{3}{8}$ -in. brass needle valve will serve the purpose, or a regular expansion valve may be obtained. It should be connected so that the liquid will pass up against and around the point when leaving the condenser. If this is done, there will be less chance of the gas leaking around the stem. When installing or making adjustments, the point must never be screwed down too hard on the seat, as both are easily ruined. The author

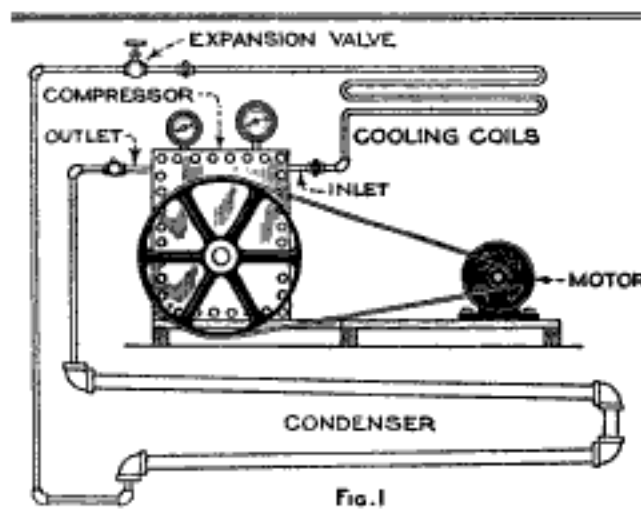

Diagram to Illustrate the Action of the Homemade Refrigerating Plant

has found it advisable to place an ordinary steam valve, with a composition seat, between the condenser and the needle valve, about 6 in. from the latter. This makes it unnecessary to touch the expansion valve except to adjust it, as the steam valve can be closed when there is any reason for shutting off the liquid.

As refrigeration starts on the low-pressure or suction side of the expansion valve, this valve is best placed just inside the chamber that holds the refrigerating coil. This coil is made of from 30 to 50 ft. of lead pipe, of $\frac{1}{2}$ -in. inside diameter. The pipe can be placed in any desired manner, but a vertical helix, 10 to 15 in. in diameter, with the adjacent turns held slightly apart, has been found satisfactory. The needle valve is placed at the top and the suction pipe consequently goes at the bottom. This is known as the "downfeed" method, and prevents

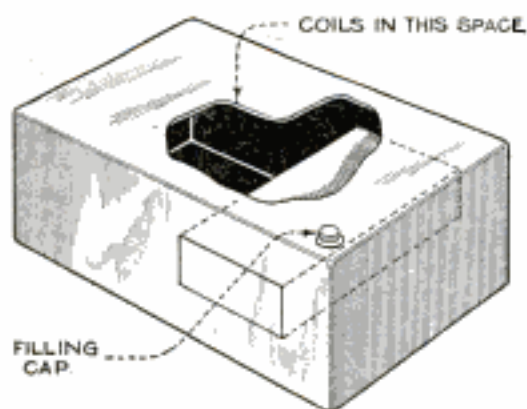

Fig. 2

BRINE TANK WITH FREEZING COMPARTMENT

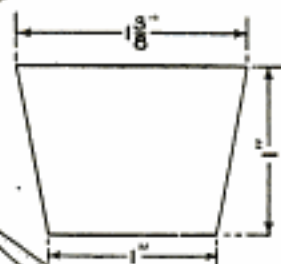
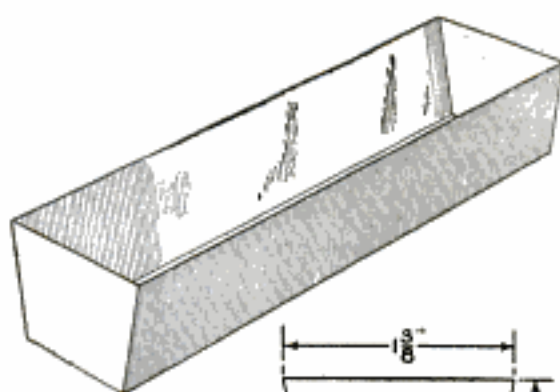

Fig. 3

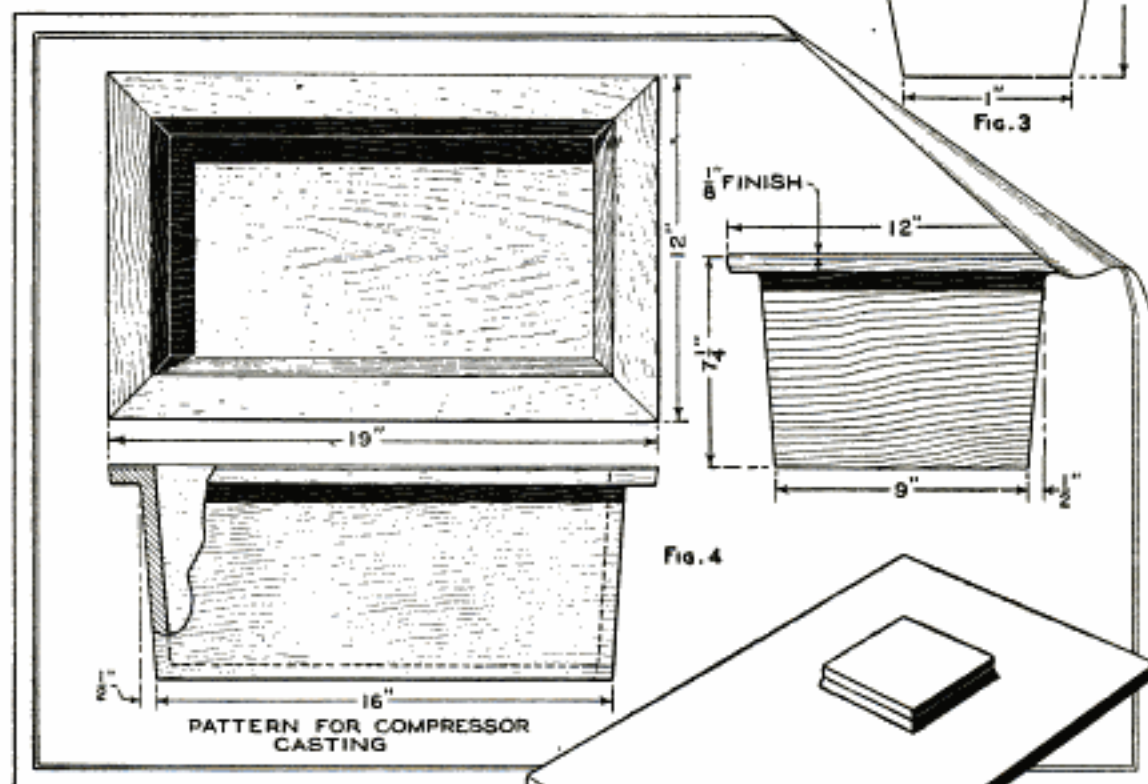

Fig. 4

PATTERN FOR COMPRESSOR CASTING

COMPRESSOR-TANK COVER, 12" X 19"

Fig. 5

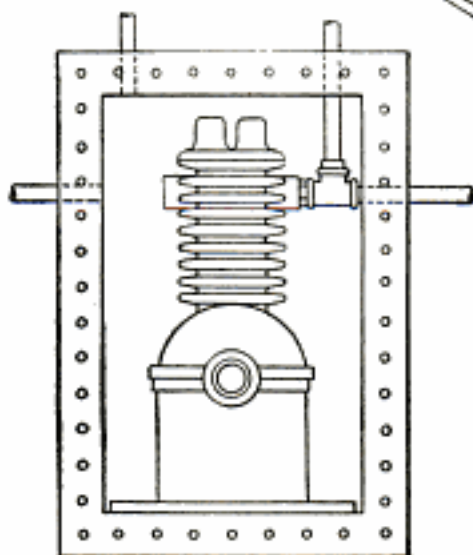
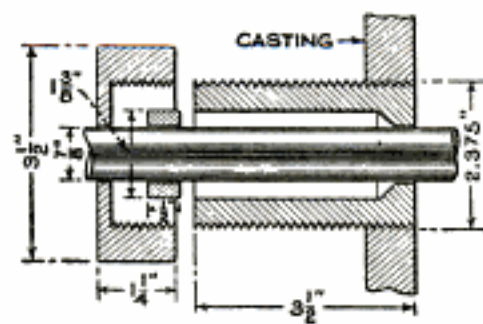

Fig. 6



CROSS SECTION OF STUFFING-BOX ASSEMBLY

Fig. 7

Figures 2 and 3, Brine Tank and Water Tray; Figures 4 and 5, Pattern for Compressor Tank or Casing and Tank Cover; Figure 6, Assembly of Compressor in Casing; Figure 7, Method of Making Stuffing Box

flooding of the system. On each end of the pipe a $\frac{1}{4}$ -in. galvanized nipple is placed, by simply screwing it into the pipe, and allowing the nipple to cut its own threads. When into the pipe about $1\frac{1}{2}$ in., nipple and pipe should be soldered together. On each nipple a union is placed; ordinary gasket unions are unsuitable, and only those known to the trade as railroad unions can be used. These have an iron projection that fits into a brass recess, and a gastight joint is

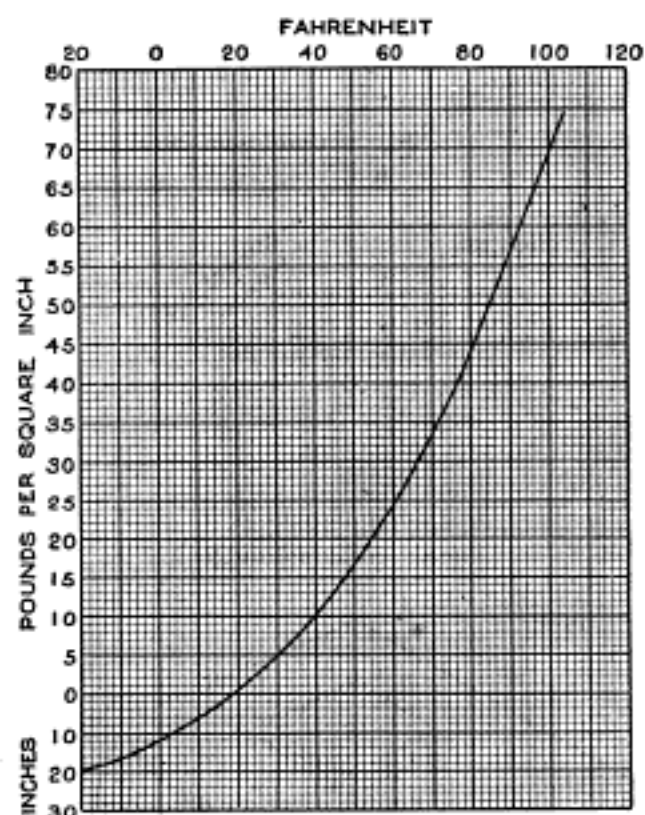

Graph Showing Relation between Pressure in Casing and Temperature in Ice Chamber

easily obtained by simply tightening the union firmly.

There has always been discussion as to whether the direct system of refrigeration, or the indirect, is the better. The former is the one described above, and the latter is the same, except that the cooling coils are placed in brine. The brine is cooled by the coils, and, in turn, cools the air in the ice chamber.

The direct system takes up less space, weighs less, costs less to install, and is easier to build. On the other hand, it does not keep the ice box at nearly as even a temperature, starts and stops frequently, requires thermostatic control, and is not completely satisfactory, as, when the machine is not running, the ice and snow on the coils melt, and the water is objectionable, and finally, if for any reason the machine stops work, the temperature in the ice box rises rapidly.

The brine system occupies more space, is heavier, adds about \$12.00 to the cost, and is supposed to be a few per cent less efficient than the direct. However, it requires little attention, starts and stops but once or twice a day, does not require a thermostat, and the brine acts as a reservoir of cold. If the electricity were off, or it were impossible to operate the machine, the brine would probably keep the contents of the box from spoiling for a day or more; so, for our purposes, the indirect system is the better.

The brine tank is made of heavy galvanized sheet iron, and fits inside the ice chamber, with a space of 3 in. between it and the walls. The lead pipe is placed within it, the ends being brought through holes drilled to receive them. A small opening is made at the top of the tank and fitted with a screw cover, for filling with brine. The brine is made by dissolving calcium chloride, which can be obtained from any ice plant or chemical-supply house, in water.

Enough clean, soft water is used almost to fill the tank; the water is boiled, and then the calcium is mixed with it in the proportion of 3.3 lb. to the gallon, if the calcium is anhydrous (water free), or 4.2 lb. to the gallon if the calcium contains water. A scum will come to the top; this is removed, and the brine allowed to cool before pouring into the tank. Do not use salt brine, as it will eat the galvanized-iron tank.

If it is desired to freeze water for table use, a rectangular tube is soldered horizontally through the tank, as in Fig. 2. The back end is closed, and a small door made for the front. If sherbets, ices, etc., are not to be frozen, a number of shelves can be put in this space, to carry the water trays shown in Fig. 2. When the water freezes in these trays it is forced up and does not burst them, as it would if the sides were straight. The length of the trays is optional and partitions may be soldered across them, to make the ice in small cubes. When frozen, the trays are inverted, and hot water poured over the bottom, loosening the ice.

The sulphur dioxide can be purchased in 6-lb. cylinders for about \$5.00, and in many cases the cylinder can be returned for refilling. The gas is admitted through a valve, tee, and nipple placed on the suction side, near the compressor, after the air has been driven out of the system as completely as possible. When all the gas has been drawn from the cylinder by

running the compressor, the valve is closed, and the system is charged, as the compressor has placed the gas in the condenser. With the compressor still running, the expansion valve is opened until the pressure in the casing is about zero. By adjusting the expansion valve to keep this pressure constant, the temperature in the brine tank will become about 14° above 0° F. The accompanying graph will give enough information to enable the user to regulate the temperature of the brine tank.

When the machine is idle, and the expansion valve left open, the pressure in the casing will be the same as that in the condenser. There will be very little oil displacement if the stuffing box is properly made, and all that is necessary to

restart is to turn on the motor. If the machine is run several hours a day, to run the temperature well down, there is no need for any thermostatic control.

If all the work has been carefully done, the machine will operate with complete success, and give much better service than ice. The food chamber will be drier, and thus the possibility of molding and spoiling is lessened. The cost of operation is dependent upon the cost of power, size of motor, insulating qualities of the box, and the difference in temperature between the ice box and the outside air.

The only attention required is the oiling of the motor, replacing of oil in the casing, and occasional recharging. A material list, exclusive of pipe, fittings, oil, belting, etc., is given below.

MATERIAL LIST

Condenser	\$ 6.00 to \$12.00	Compressor	\$25.00 to \$35.00
Lead pipe	4.00 to 8.00	Gauges	3.00 up
Brine tank	6.00 to 8.00	Castings	5.00 to 7.50
Calcium chloride, per lb.04 to .10	Machining castings	15.00 to 30.00
Expansion valve	2.00 to 4.00	Motor	18.00 to 30.00
Steam valve	1.00 to 1.50	Gauge glass	1.50 to 2.00

Improving Tripods

The tripods used by contractors, surveyors, and photographers can be greatly improved, and the risk of slipping almost eliminated by the application of the idea shown in the drawing. This consists in nothing more than bending the metal points at the end of the legs toward the center so that the weight of the tripod and instrument

will push the points down vertically instead of outwardly. This will effectively prevent the tendency to slip, which is more pronounced when the legs are spread far apart.

Underslung Wheelbarrow for Carrying Milk Cans

Anyone who has tried to carry a large filled milk can or to push it in an ordinary wheelbarrow, will appreciate the usefulness of the underslung wheelbarrow shown in the drawing.

The frame of an ordinary wheelbarrow is used, but the regular body is removed. A platform is suspended under the frame, by means of flat brackets, so that it comes to within a few inches of the ground.

The rear brackets are made in two pieces, and slotted as indicated, so that the plat-

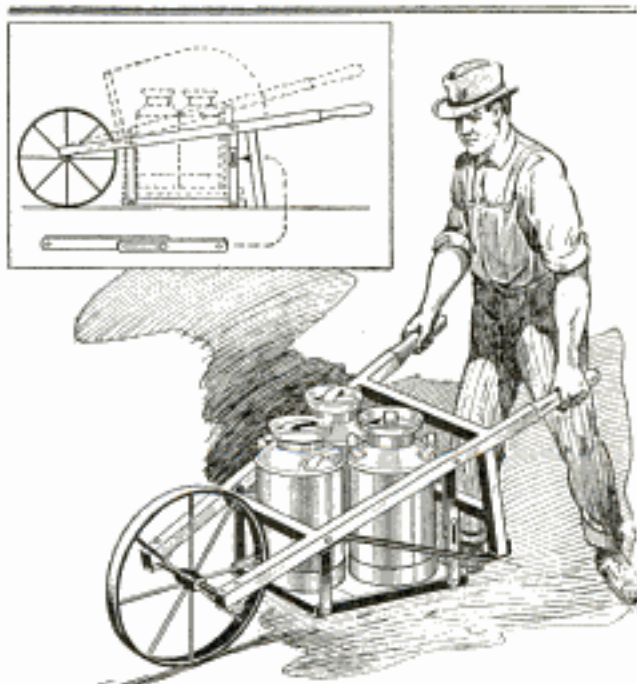

An Underslung Wheelbarrow That Enables Filled Milk Cans to be Transported Easily

form can be adjusted to suit the height of the user. The platform itself is made of 1-in. boards held on each side by lengths of angle iron. The center of gravity is so low that the load can be easily balanced to prevent spilling.

Homemade Preheater for Small Castings

The efficient furnace shown in the drawing was built to enable small shock-absorber parts to be preheated quickly for welding.

A 15-in. length of 3½-in. iron pipe is

pipe forming the mixing chamber, and a tip made from ½-in. pipe, swaged down at one end to ⅛-in. opening. To permit proper adjustment of the tip relative to the mixing chamber, the tip is attached to the latter by means of three heavy-wire supports, welded to chamber and tip; these support the tip central with the chamber, and at the proper distance from the end.

As the castings fitted rather closely within the 3½-in. pipe, a metal troughlike flue, 1¾ in. wide by 11½ in. long, was welded under the pipe, after vent holes had been cut in the latter to allow the heat to reach the parts, as illustrated, and a pair of legs, made of heavy rod, welded on.

A stop is filled in the lower end of the elbow, and a trigger provided to lift the end of the castings over the stop when it is desired to remove them.

In practice, the parts are fed into the top of the preheater and the burner lit. While the lowest casting is quickly raised to the desired temperature, those above are gradually warmed by the heat supplied through the flue, so that, as quickly as one part is welded another is heated ready for welding.

While this particular design is especially suitable for the parts treated, a modification of shape would allow it to be adapted to many varieties of work; moreover, it is also useful as an annealing furnace.—E. M. Love, Alhambra, Calif.

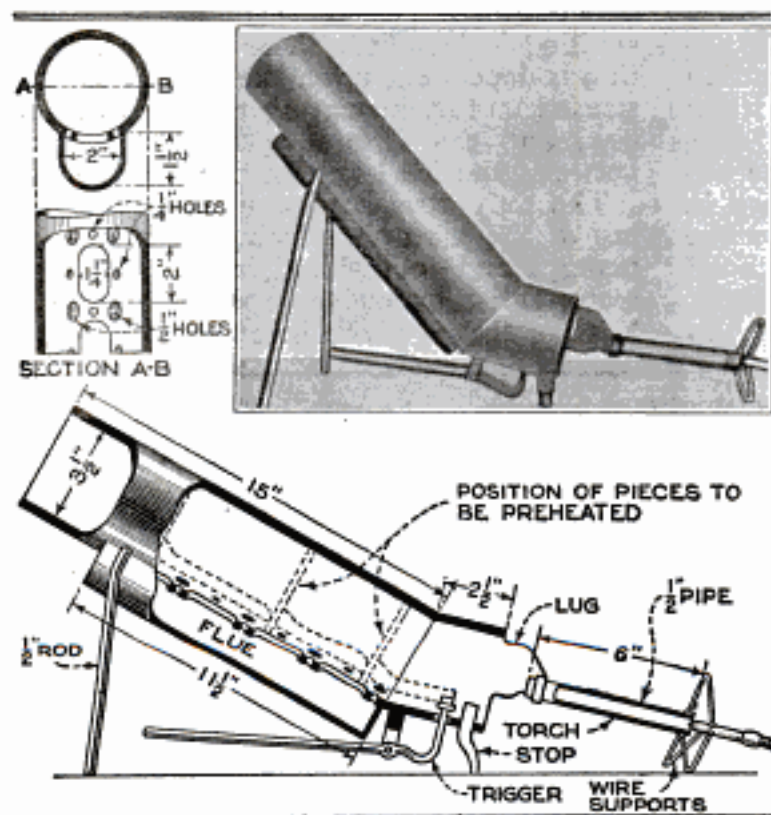

A Preheating Furnace for Small Parts That Is Easy to Make and Efficient in Operation

cut at one end at a slight angle, and a short piece welded on to form an elbow. At one side of the short piece, near the top, a lug is formed, to which the burner is attached by means of a ring. The burner consists of a 6-in. length of ½-in.

Working Aluminum

Apart from its light weight, which is, roughly speaking, about one-third that of copper, brass, or steel, aluminum possesses an outstanding property in its resistance to chemical action; practically the only substances that attack it appreciably are caustic alkalis, the halogens, and certain salts of mercury. Exposed to moisture, it oxidizes very gradually and regularly, and the thin film of oxide, when formed, protects the surface from further oxidation. This film is the cause of the comparative immunity of the metal from attack by chemicals, and explains why it can be used for the manufacture and storage of highly corrosive liquids, such

as concentrated nitric acid. Like many other metals it is hardened by cold working and softened by annealing. It is usually supplied in five different grades of temper, and the correct temper to be used in any particular case depends on the amount of work which will be done upon it, and the degree of hardness required in the final product. Hardening under working does not take place with the same rapidity as with brass, and if the finished article is to be dead-hard, it is generally necessary to start with a medium temper, unless the final shape is very complicated. The softest tempers are used for deep press drawing, but medium-soft or even medium-hard tempers give the best results for shallow stamping. A similar

range of temper is used for spinning, and for a spun cup with a diameter not less than two-thirds of the depth, a medium-soft temper gives an excellent finished hardness. Dead-soft tempers are, however, often used for deep spinning. Intermediate annealing is rarely needed, and even in drawing a very deep shell, annealing is unnecessary, unless more than six or seven redrawing operations are needed. Another method of working to which aluminum lends itself, is that in which flat sheets are worked up into the desired shapes by heating, with a mallet upon a leather sandbag. In this way contours which are impossible in steel, or can be obtained only by making a number of shaped sections and welding them together, are readily formed in one piece. For jointing aluminum sheets four methods are available—seaming, riveting, soldering, and welding, and many different surface finishes can be obtained by polishing, frosting, burnishing, scratch-brushing, plating, coloring by chemical action, and the application of paint or enamel.

Joining Shingles to Corrugated-Iron Roofing

It is seemingly a difficult matter to make a weatherproof joint when shingles and corrugated-iron roofing meet. However, the work is more simple than it appears. Lengths of valley tin are forced under the shingles and over the metal roof, the tin being securely nailed under

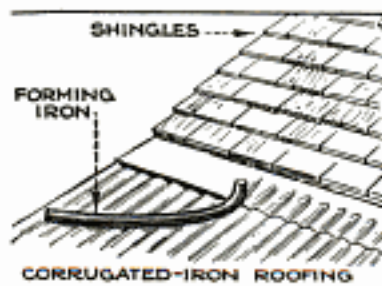

the shingles to the roof boards. Then by means of an iron forming iron the portion of tin extending over the metal roofing is pounded down into the grooves, the forming iron being placed on the tin and blows applied with a common hammer. If desirable the tin can also be sweated on the metal roofing, thus making it impossible for water to enter the seam. The best results are obtained with roofing having narrow corrugations. The forming iron is made from a length of iron bar that fits snugly in the corrugations; one end is bent upward as shown in the drawing and the remainder is slightly curved, so that it may be grasped without the knuckles being bruised while hammering. —Louis Schneider, Clinton, Mo.

Bench Trough for Washing Automobile Parts

A practical method of washing automobile parts is shown in the drawing. A large 5-gal. bread or dish pan is inserted

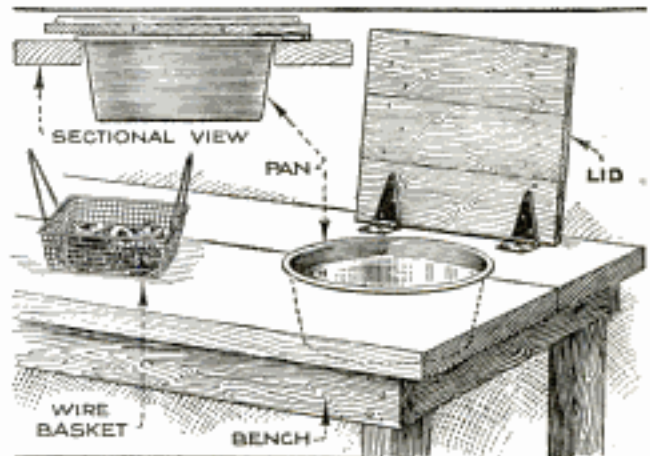

Convenient Bench Trough for Washing Automobile Parts, Which are Held in a Wire Basket

in a circular hole cut in the top of the workbench. The pan is not fastened down, but is simply held by its rim, which rests on the edge of the opening. A wire basket that fits in the pan nicely is used to hold the parts to be cleaned; two wire handles are provided on the basket so that it can be lowered into or raised from the pan. A wooden lid, hinged to the bench top and closing over the pan, is also desirable to prevent tools from falling into the liquid.

Relief Valve Prevents Water Hammer

A simple method of making a relief valve to prevent water hammer in pipes is shown in the drawing. The side outlet of a tee is turned down and threaded to fit the length of $\frac{3}{4}$ -in. pipe that forms the body of the valve, and a seat is turned in the outlet for the poppet valve, which is made of hard brass.

In the lower end of the pipe, a $\frac{3}{4}$ -in. plug is fitted; this is drilled for the valve stem, and with four $\frac{1}{8}$ -in. holes. The thread in the lower end is cut twice as long as the plug, so that the $\frac{3}{16}$ -in. brass-wire spring that holds the valve on its seat may be compressed to provide the necessary pressure. The valve can be set to release at any pressure, and practically eliminates water hammer.

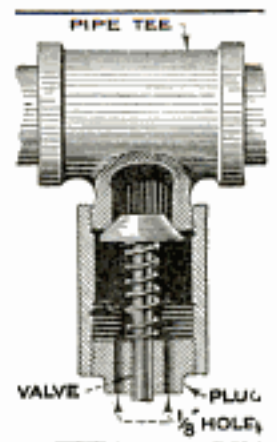

Rack for Handling Heavy Barrels

The rack illustrated has been found to be a time and labor-saving device for moving heavy barrels and casks. It is made of 1-in. pipe and fittings, with the

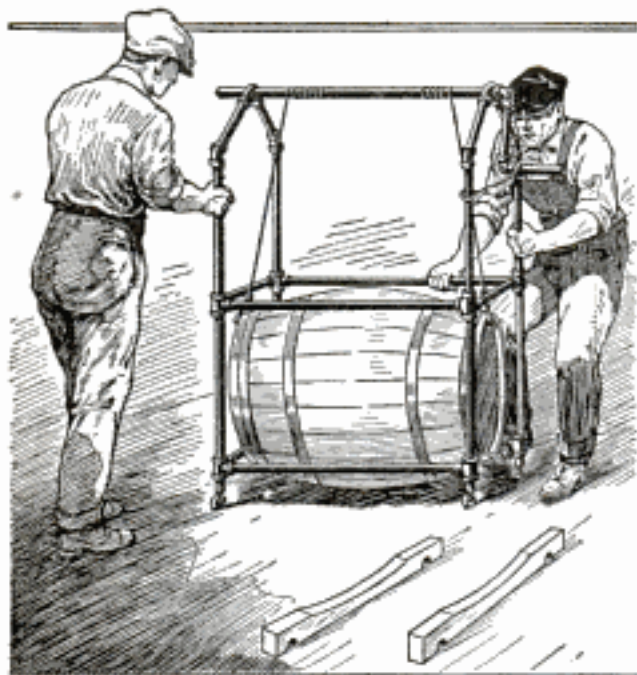

A Time and Labor-Saving Device for Conveniently Handling Heavy Barrels and Casks

exception of the windlass, which is made of $\frac{3}{4}$ -in. pipe. Two stout ropes are suspended from the windlass as shown, hooks being provided at the lower ends to engage with the barrel. By revolving the crank the ropes wind on the windlass, which raises the barrel a few inches above the floor, permitting it to be moved to any desired location, this being facilitated by casters that are provided under the legs of the rack. A short rope or chain with a ring at the end is fastened to the frame, to keep the crank from unwinding when under the strain of the load.—G. E. Hendrickson, Argyle, Wis.

Satin-Finishing Aluminum

To satin-finish aluminum, buff the article if necessary in order to obtain a good surface, and clean off the grease in benzine. Then dip it in a scalding solution of hot potash, not too strong, until the surface is dull and white. Rinse in cold water and soak for 5 or 6 minutes in a 5-per-cent solution of hydrofluoric acid to soften the surface. Then rinse again and dip into a mixture of equal parts of nitric acid and sulphuric acid to remove the discoloration. After this rinse again in cold water and in clean hot water; dirty water will leave stains on

the surface. Dry the article in sawdust of good quality and which is free from pitch or gum. Boxwood or birch sawdust should be used if possible. Care must be taken not to touch the aluminum at this stage with the bare hands, as this makes stains.

The frosting is accomplished with a fine, soft, steel-wire scratchbrush, about 6 in. in diameter, and running 2,500 revolutions per minute. New brushes should be broken in on coarse work or by running them against a file.

A Durable Floor Paint

A durable floor paint is made by adding a quantity of cement to the paint, and using benzine instead of turpentine, with some raw oil and driers. Never use boiled oil in a floor paint. Yellow ochre is very good to use for a base, as it is harder than lead. Zinc is also added in sufficient quantities to make the paint full bodied.

Setting Machines to Conserve Space

In order to conserve space without setting a number of bar-stock machines obliquely as is common practice, one concern has placed them at right angles to the wall and between the windows, the heads being next to the wall so that the operator gets the best possible light. This

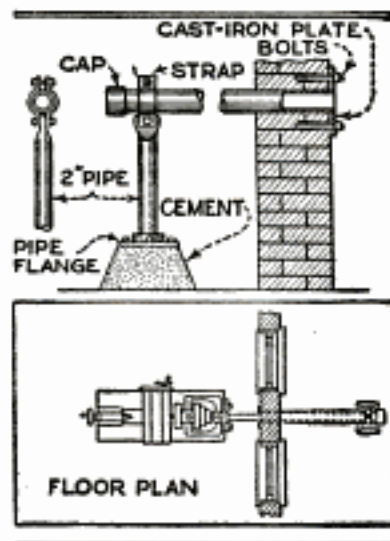

was accomplished by drilling the factory wall and supporting suitable lengths of pipe on standards on the outside; the pipes contained the bar stock, which was loaded through the headstocks from the inside. The pipes projected outside into space that would otherwise not be used. The same idea could be adapted to similar machines on an upper floor by supporting the pipes on the outside of the building by knee braces or suitable brackets. Aside from the economy of space effected, the shafts that drive the machines all run at right angles.

projected outside into space that would otherwise not be used. The same idea could be adapted to similar machines on an upper floor by supporting the pipes on the outside of the building by knee braces or suitable brackets. Aside from the economy of space effected, the shafts that drive the machines all run at right angles.

A High-Pressure Grease Machine

By J. C. DE PUE

THE object of this device is to supply grease, under a pressure of several thousand pounds per square inch, to all grease connections on an automobile, by means of a flexible hose equipped with various adapters.

The drawing clearly shows the various parts, and their relation to each other. It will be noted that no detailed dimensions are given; this is because the original machine was constructed from odd pieces of material found around the shop, and machined to fit each other, and so no record was made of individual sizes.

A 30-in. piece of 6-in. pipe, threaded at both ends, and two caps to fit, were obtained for the outer cylinder or container. One cap was screwed firmly on the lower end, and the cylinder mounted on the three-wheeled truck shown, by means of a clamping band, three braces, and three studs. The bottom cap was drilled and tapped for the threaded inner ends of the studs; the outer ends are also threaded, and extend through the truck-frame members, where they are fastened by the nuts that also hold the lower ends of the braces. The upper ends

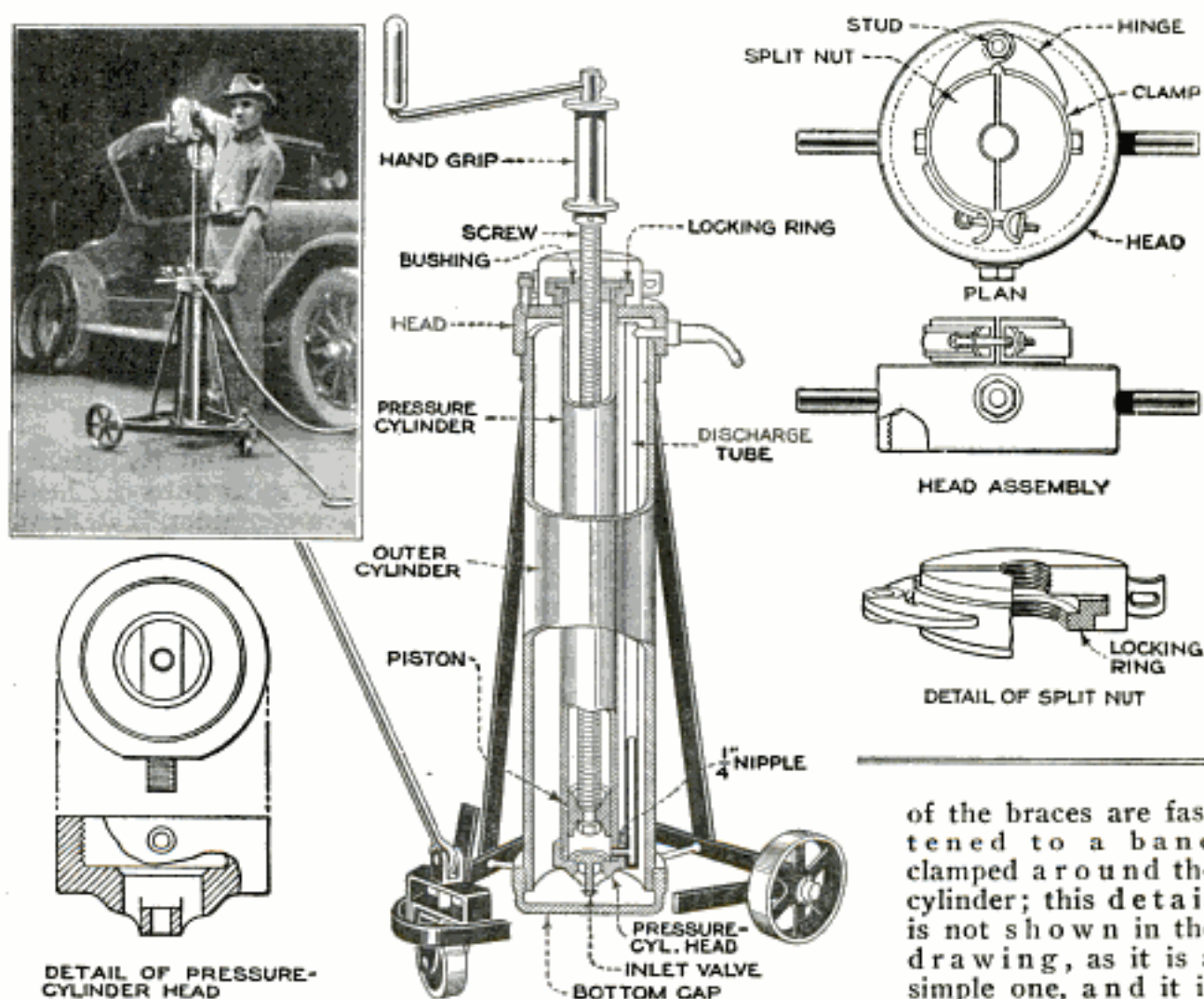

DETAIL OF PRESSURE-CYLINDER HEAD

A Homemade Grease Machine for the Garage and Service Station: Insert, Filling the Pressure Cylinder with Grease

However, in the following description, approximate dimensions of the more important parts will be given, so that anyone wishing to duplicate the machine will have no difficulty in securing the necessary material; and in laying out the work to suit the shop facilities.

was one formerly used to carry oil barrels, but one can be made from flat iron.

The upper cap was then turned smooth on the outside, and bored out and threaded for the pressure cylinder, also drilled and tapped for the outlet for the hose connection, handles, and hinge stud.

For the pressure cylinder, a piece of brass tubing was used; this had an inside diameter of 2 in., a wall thickness of $\frac{3}{16}$ in., and was cut long enough to extend from $\frac{1}{2}$ in. above the top cap to within $1\frac{1}{2}$ in. of the bottom of the outer cylinder. The tube was threaded $\frac{3}{4}$ in. at each end, 14 threads per inch, one end being screwed into the upper cap. A locking ring was turned from a piece of bushing bronze, and threaded to fit the pressure cylinder; this locks the cylinder to the head, and has a flange that fits the split nut, thus when the nut is closed it is locked directly to the cylinder. The bushing for the upper end of the cylinder, which guides the screw, was also made of bronze, and is a push fit in the cylinder; it has a small flange that acts as a stop, the locking ring being machined out to clear it.

The screw was made of 1-in. cold-rolled steel, and, except for a length of 7 in. at the upper end, was threaded 8 threads per inch; the lower end was turned down to $\frac{3}{4}$ -in. diameter and threaded to fit the nut that holds the piston. The piston was also turned from a piece of cold-rolled steel, and made a good sliding fit in the cylinder, without rings or packing of any kind. The bore of the cylinder being true and smooth, the piston was found to work with practically no leakage, and, after six months' continuous use, scarcely allows enough grease to leak past to lubricate the screw.

The pressure-cylinder head was made of bronze; after being turned to size it was bored and threaded to fit the cylinder, then bored for the valve seat, inlet opening, and valve stem; two segment-shaped pieces were next cut out with a hacksaw, leaving an inlet opening on each side of the valve-stem guide. This part was then screwed onto the cylinder, and the outlet opening drilled through both head and cylinder, tapped, and fitted with a $\frac{1}{4}$ -in. nipple for connection to the discharge tube. The latter is a length of extra-heavy steel tubing, welded shut at each end, and drilled and tapped about 1 in. from the lower end for the $\frac{1}{4}$ -in. nipple; at the upper end it is tapped to fit a $\frac{9}{16}$ -in. S. A. E. cap screw; this forms the hose connection, and is drilled through and tapped $\frac{1}{8}$ -in. pipe-thread size to fit the hose. The hose, being a standard part of a well-known lubricating system, was purchased locally, and three adapters, to enable the machine to be used on other systems, were made to fit the outlet end of the hose.

The split nut was made from a piece

of brass, bored out to fit the locking ring and threaded to fit the screw; the clamping band, of flat iron, was then bent around it, and fastened in place with two $\frac{3}{8}$ -in. cap screws. The two halves of the ring were then welded in place on the band, after which the nut was sawed in two, placed in position on the head, and secured by means of the hinge stud. The drawing shows clearly the method used to clamp the halves of the nut together; there are only two operating positions, locked on the screw, and wide open.

The photograph gives a good idea of the method of filling the pressure cylinder. The split nut is opened to clear the screw and the screw drawn upward, filling the cylinder with grease through the inlet valve; which, by the way, is merely a large auto-engine valve. When the top of the stroke is reached the split nut is locked on the screw, and the screw turned down by means of the crank; the downward pressure closes the inlet valve and forces the grease out through the hose.

With the old method, using a small hand compressor, it required about $\frac{3}{4}$ hour to fill all the grease connections on a car, and more than this on a car fitted with spring covers. With this machine, the job can be done in 15 minutes, and done more thoroughly.

The pressure cylinder and its mechanism can be adapted to fit onto the head of a standard grease container, if desired, thus dispensing with the outer cylinder, and eliminating even the short time required to fill it.

This machine has been in constant use in a shop employing 20 men, and, to date, has handled over 500 lb. of grease, without any attention other than refilling, except for the replacement of one hose, which was broken from excessive pressure. A test gauge was attached, and it was found that a slight turn of the crank developed a pressure of 4,000 lb. per sq. in., and, as the hose is guaranteed only to stand 2,000 lb., it was necessary to caution the men to "go easy on the hard ones." With this reasonable precaution no further trouble has been experienced.

The total cost of the material purchased was \$12.00, the remainder being picked up around the shop; about \$20.00 covered the labor cost, as the machine was made in spare time. It will be noted that considerable bronze was used in the construction; cast iron could just as readily have been used, but, as the bronze was on hand, it was cheaper to use it than to hunt for cast iron.

Carrying a Rail on Handcar

A long iron rail is by no means an easy thing to handle, especially on a handcar. The work of transporting one is best accomplished by attaching the rail to the handcar in an underslung fashion, the rail being suspended from the handcar by means of two rail tongs, fastened to the rail and to the handcar. This method can only be used where there are no switches as there is not sufficient clearance between a switch and the rail to permit the latter to pass over it. Three men can easily do the work, one acting as a counterweight to balance the handcar while the other two are lifting the rail.—Willard A. Francis, Bowerston, Ohio.

Clamp for Soft Materials

The illustration shows a serviceable clamp for cutting by hand soft materials such as leather and felt. It consists of a length of round steel rod, bent to the shape shown and held on a board by

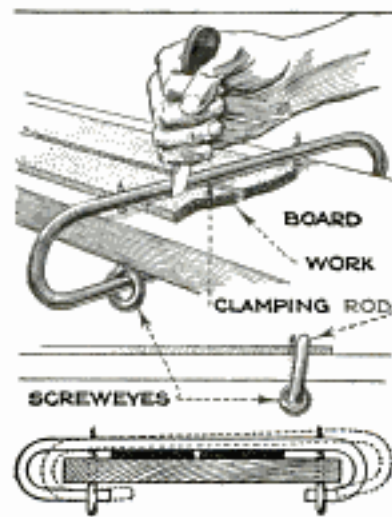

means of screweyes. The distance between the ends of the rod and between the screweyes is such that the clamp can be released from the screweyes by pulling it to one side as indicated by the dotted lines. By using long screweyes the ends will protrude above the board and will support the clamping rod when the knife is pressed against it. The screweyes may be turned to adjust the clamp to various thicknesses of material.

Auto-Driven Tumbling Barrel

A satisfactory tumbling barrel for cleaning and shining up auto and machine parts can be made by attaching a small wooden box to the rear wheel of an automobile. The box should have a hinged cover at one end and be provided with an additional board that projects about an inch beyond the ends. The box is clamped to the spokes between two

adapter blocks and two steel plates, both faced with leather to prevent marring the spokes. Two 1/2-in. bolts at each end hold the box securely on the spokes.

In use the wheel is jacked up from the

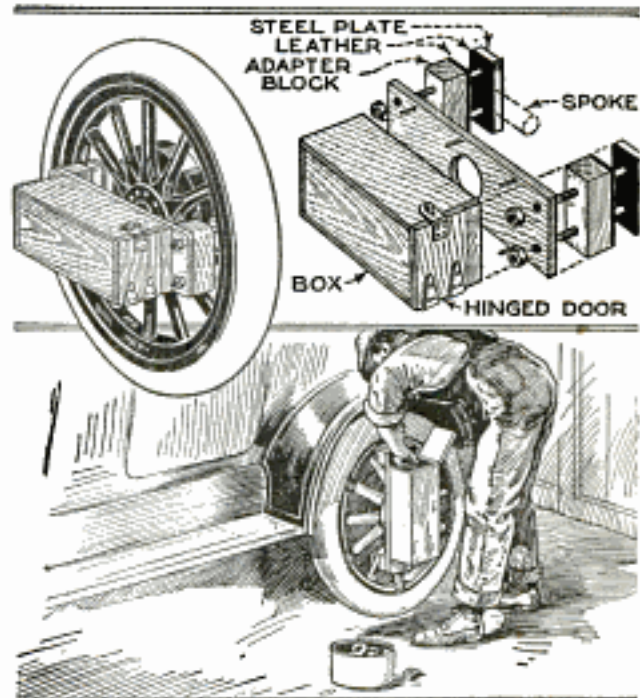

A Small Box Attached to the Rear Wheel of an Automobile Makes an Effective Tumbling Barrel

floor and run at a very slow speed. The box, when loaded, can easily be emptied by simply turning the wheel. For cleaning parts or for rolling small castings, shot or sand can be used as an abrasive, and for polishing, sawdust or scraps of leather will do the work.

Using Blowtorch on Windy Days

On windy days considerable difficulty is encountered in using a blowtorch, as the wind keeps the head too cool to make a blue flame.

To prevent this an effective windshield can be made from an ordinary tin can, cut out as shown, and slipped over the head of the torch. This shield is also of assistance in preheating the torch as it concentrates the flame around the head.—Andrew Fischer, Jr., Chicago Illinois.

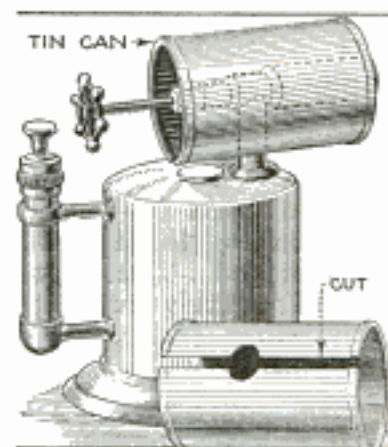

Automatic Accelerator for Sawing Outfit

On circular saws it is often necessary to speed up the engine in order to cut heavy wood, but it is, of course, not

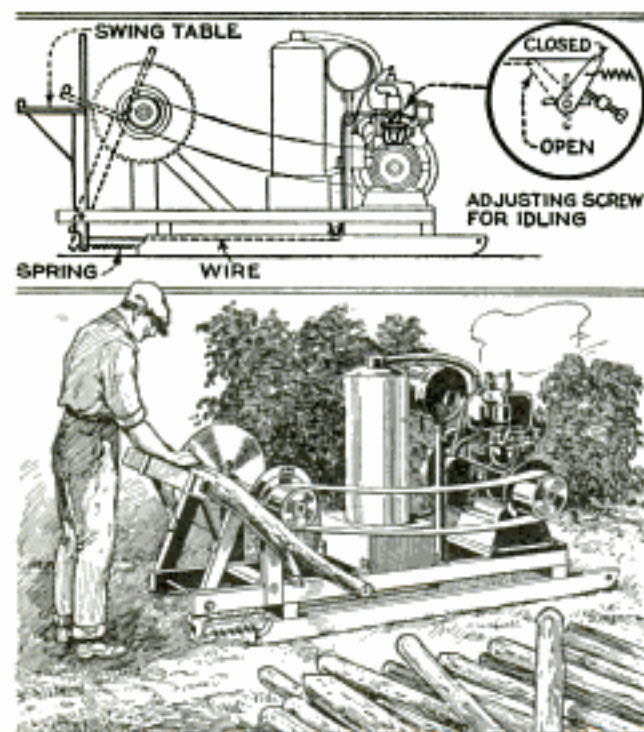

Automatic Accelerator Which Speeds Up the Engine When the Table is Moved toward the Saw

necessary to have the engine running so fast while no wood is being cut. To take care of the speed variation, an automatic accelerator can be improvised to work in connection with the swing table; when the latter is swung forward the speed of the engine is increased considerably, and when brought back again the engine will idle down. The accelerator consists of a length of flexible wire, one end of which is attached to the leg of the swing table and the other end to the arm of the throttle valve on the carburetor. A large coil spring is connected to the leg of the swing table and the end of the skid so that the table will be pulled back as soon as pressure against it is released. A small coil spring is also used to pull the throttle valve back to the closed position when the wire is released. The throttle valve is not closed entirely but kept open a trifle by the idling screw.—C. M. Wilcox, Torrington, Conn.

When melting scrap gold, the jeweler always examines it carefully to make sure that no iron, steel, or solder, or other foreign material is mixed with it. Do not use filings, or the joints of articles, but save these for the refiner.

Rack Aids in Filing Forms

Railroad and insurance offices, and many other places where a great deal of classification of printed forms is necessary in preparation for permanent filing, will find the device illustrated of considerable value.

A heavy wooden block, of any suitable size, is provided with four iron rods, properly spaced to suit the forms, as shown. An iron or heavy wooden block, with the corners cut out to clear the rods, and provided with a handle, completes the fixture. When the forms have been sorted and arranged in their proper piles, they are placed in the rack at right angles to each other, with the assurance that they will not be upset, or blown away.

Any individual pile can be removed in an instant, and a piece of colored cardboard inserted in its place, to keep the piles from becoming mixed.

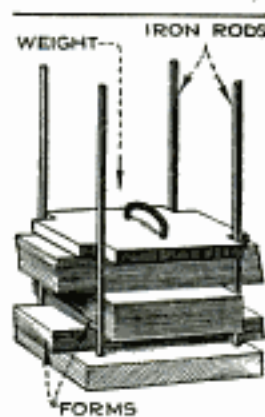

Alinement Gauge for Lathe

A useful gauge for centering work strapped to the saddle of a lathe is shown in the drawing, and can be made without much trouble. The usual method of measuring from the center is tedious, to say the least, but with a gauge of this type all parts of the bore can be measured quite easily.

The cylindrical part is bored out to fit the tailstock spindle, slotted at the front to the width of the caliper arms, and drilled and tapped for the knurled tightening screw, as shown in the lower detail. The caliper arms are made as indicated and drilled to make a neat fit on the small diameter of the tightening screw. A light spring between the two arms completes the instrument.

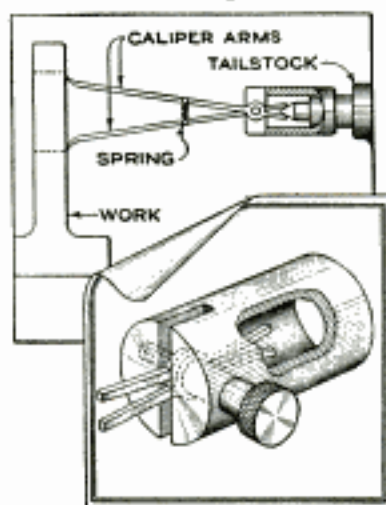

To use the gauge, with a casting on the lathe saddle, the hollow cylindrical part is slipped over the tailstock spindle, with the tightening screw loose. The cylindrical sleeve is pushed back against the tailstock center, which causes the ends of the caliper arms to slide up on the center. The opposite ends of the arms are set by this means to the required diameter of the hole, and the screw is tightened. The gauge can then be revolved by hand around the tailstock spindle, showing at once when the work has been correctly set up.

Concrete Washbowl for Garage

The drawing shows a concrete washbowl for use in garages. The bowl is built in a corner, as shown, so that it will not take any floor space. A number of holes are made in the wall at the point where the bowl is to be made, so that the concrete will be anchored securely. A wooden form is made as shown in the right-hand detail, two holes being drilled in it for the two pipes that are brought through the bowl as indicated; one of these is the water pipe, and is fitted at the top with two elbows, a nipple, and a valve; the other pipe is the drain pipe, which runs under the floor to the sewer. An ordinary tin wash pan is used as a form for the bowl. Several coats of heavy oil paint and two coats of white enamel

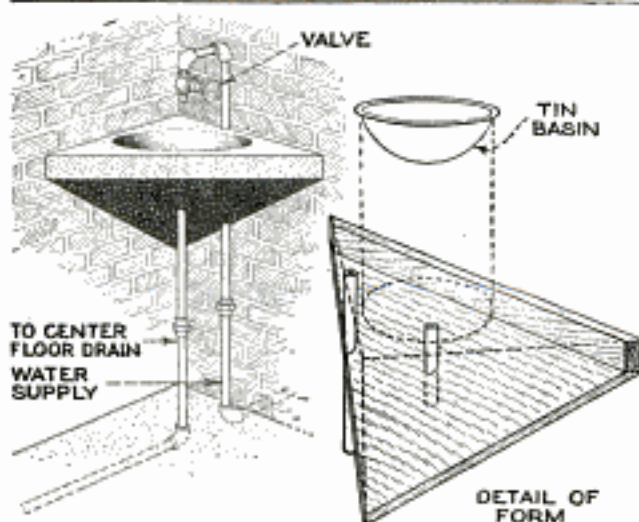

A Concrete Washbowl for the Garage can be Readily Made and does Not Take Any Floor Space

are applied to the inside and top of the bowl, to waterproof it and make it smooth.

☐ After a rain, do not put the auto top down until it is thoroughly dry.

Computing Chart for Spring Scales

A handy and helpful attachment for a spring scale is a computing chart of the kind shown in the illustration. It is made of tin, painted white and screwed to the

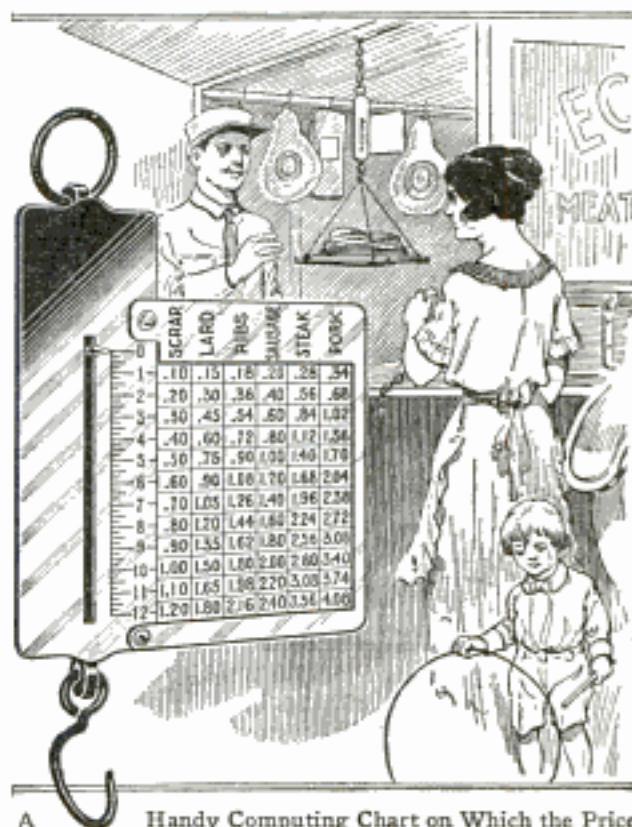

A Handy Computing Chart on Which the Price of Any Number of Pounds can be Seen at a Glance

face of the scale. Lines are ruled across the tin horizontally in line with the pound graduations, and columns are ruled vertically under various articles listed. The number of columns, of course, varies considerably in different cases, the butcher's chart showing various kinds of meat, the poultry dealer's chart chickens, ducks, geese, etc., and the junk dealer's chart iron, brass, copper, lead, etc. It is a good idea to prepare several blank charts so that a new one can be filled out at once when prices change. The chart shows at once the price of any number of pounds of each article, up to the capacity of the scale.

Turning Long Babbitt Bearings

In making some long babbitt bearings difficulty was experienced in holding the babbitt in the lathe securely and turning it. However, this trouble was overcome by filling a piece of pipe with babbitt, placing the pipe in the lathe and turning the pipe and babbitt at the same time. This made it easy to turn as well as to hold it firmly in the chuck.

Grinding Washers

Standard washers are often too big on their outside diameters for some particular job, and must therefore be ground down to the required size. When quantities of washers have to be ground in this way, the work can be done quickly by using a holder of the kind shown in

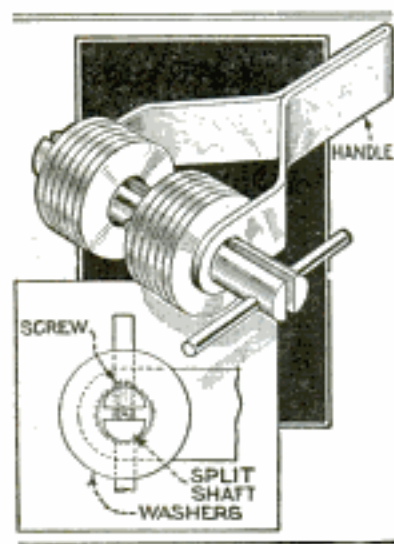

the drawing. It consists of a short shaft and a handle. The shaft is split lengthwise as shown and drilled at one end for a pin, which must fit tightly in one piece of the split shaft and loosely in the other. The latter piece is drilled and tapped in the center for a headless screw. The holder is used by turning the screw back a little and slipping the washers on, six on each side of the screw. When the screw is tightened the shaft binds all the washers but not the handle, as the holes in it are slightly larger. To grind the washers the handle is held by the left hand on the tool rest of the emery wheel while the washers are turned around by the pin on the end of the shaft.

Holding Lathe Faceplate Securely

It is often desirable to reverse the lathe, especially when threading, but there is al-

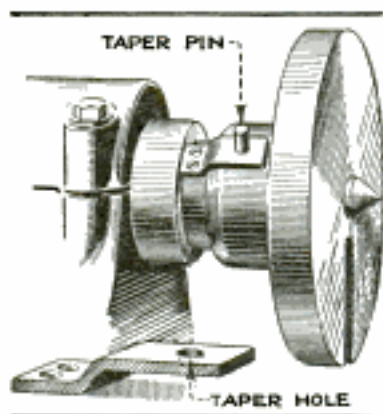

ways present the danger of having the faceplate fly off. The illustration shows a simple way of eliminating this danger. Fasten a small cold-rolled steel strap to the lathe spindle with two small screws, as indicated. Drill a hole through the other end of the strap, and into the hub of the faceplate, and ream this out to fit a heavy taper pin.

"Ball-Bearing" Trestles

To facilitate the sliding of sheet metal over a wooden trestle, where the material is being fed into or taken away from a punch press or other machine, groove the top of the trestle to receive steel balls $\frac{1}{2}$ in. or larger in diameter. The groove should be so deep that only about a third of each ball bearing projects above the surface. The balls themselves do not revolve, but their smooth surface, which comes in contact with the material, allows it to pass over with very little friction.—W. E. Rausch, Milan, Mich.

A Homemade Router

A router can be purchased in tool stores, but many workers, both amateur and professional, prefer to make their own. The one shown in the drawing is simple and easy to make, and answers the purpose perfectly. The block is made of beech or maple, the latter being the easier obtained, and it is usually desirable to have three sizes: 1 by $2\frac{1}{4}$ by 4 in., as in the drawing, $1\frac{1}{8}$ by 3 by 6 in., and

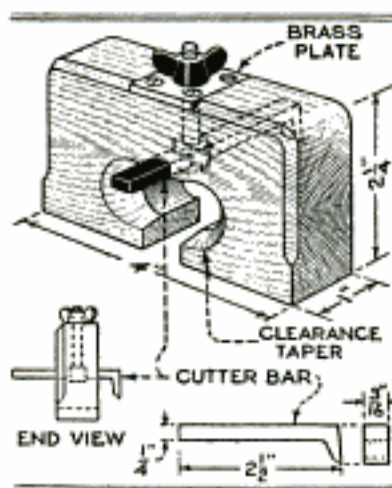

$1\frac{1}{4}$ by $3\frac{1}{2}$ by 8 in. A throat is cut out of the block, so that the worker can see the work, tapered to prevent clogging, and recessed to fit the cutter bar. Three sizes of these are used, to suit the various blocks: $\frac{3}{16}$ by $\frac{1}{4}$ in., $\frac{1}{4}$ by $\frac{1}{2}$ in., and $\frac{1}{4}$ by $\frac{3}{4}$ in., bent and ground as shown, and made a sliding fit in the block. The block is also drilled and counterbored to receive the shank and head of the clamping bolt, which can be made from a length of brass bar, or a brass casting, and provided with a wingnut. Below the wingnut, a brass plate is countersunk and screwed to the block; if desired, a plain washer can be used, but the brass plate makes the better job.—M. E. Dugan, Kenosha, Wis.

☛ If any difficulty is experienced in obtaining materials mentioned in these pages, write to the Bureau of Information.



The "Walking Wampus"

BY L. BOCHIER

THE toy shown in the illustration will please any child. When placed at the top of an inclined board, it will walk down in a comical manner without any assistance from springs or any other mechanical parts. The secret of the action lies in the placing of the pivot point for the legs. The pivot must be a little ahead of and a little above the center of gravity of the body. When this pivot is located

on the stock according to the dimensions given, the centers for the curves are quickly located and the toy is easily laid out.

The legs of the toy are made from $\frac{1}{4}$ -in. material, finished on both sides. It is important that the curve of the feet be laid out carefully. Two legs will be needed, one for each side of the toy. A band saw is convenient when cutting

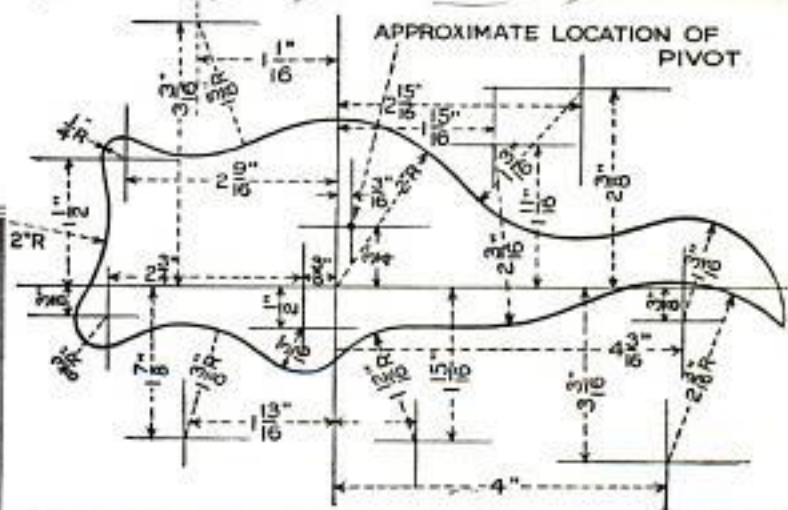
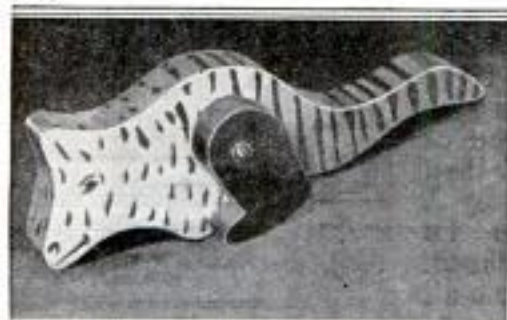
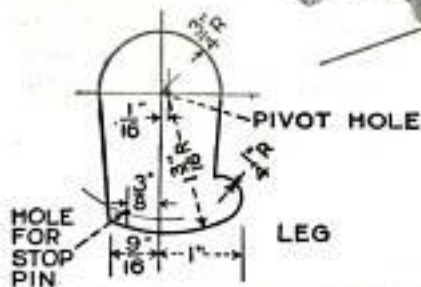

A Weird Toy That will Delight the Youngsters: It Walks down an Inclined Board without the Aid of Springs, Gears, or Other Mechanical Parts

correctly, the body falls forward on the legs, then tips forward slightly, allowing the legs to swing ahead again, and repeats the action until the bottom of the incline is reached.

The construction of the toy is made clear by the drawing. Material 1 in. thick, finished on both sides, is used for the body. If the center lines are drawn

out the body and legs, although a scroll or even a keyhole saw will do.

The holes in the legs should be large enough to be a loose fit on the wood screws used to fasten the legs to the body. A thin washer is placed between each of the legs and the body to reduce friction. An ordinary finishing nail or a piece of stiff wire will serve as the stop

pin that joins the legs; this pin keeps the legs moving in unison, and prevents them from swinging too far forward or back.

Before the pivot holes in the body are marked out, it is a good plan to find the center of gravity of the body. The legs must be pivoted in correct relation to the center of gravity or the toy will not move. The approximate position for the pivot point is shown in the drawing. This should be checked, however, as a knot or a dense place in the wood used for the body may locate the point dif-

ferently. The center of gravity of the body can be found by swinging the body between two uprights having nail points that clamp at right angles to the body. With a few trials a point can be found where the body will balance no matter in what position it is placed. The pivot for the legs should be a little above and ahead of this.

The color of the paint can be chosen according to the taste of the maker. The toy shown in the photograph has a yellow body striped with black, and red legs.

Screen Facilitates Growth of Water Plants

In a fish pool where it was desired to grow water plants, seed was first thrown into the water; some of it sank to the gravel bottom, but the remainder was

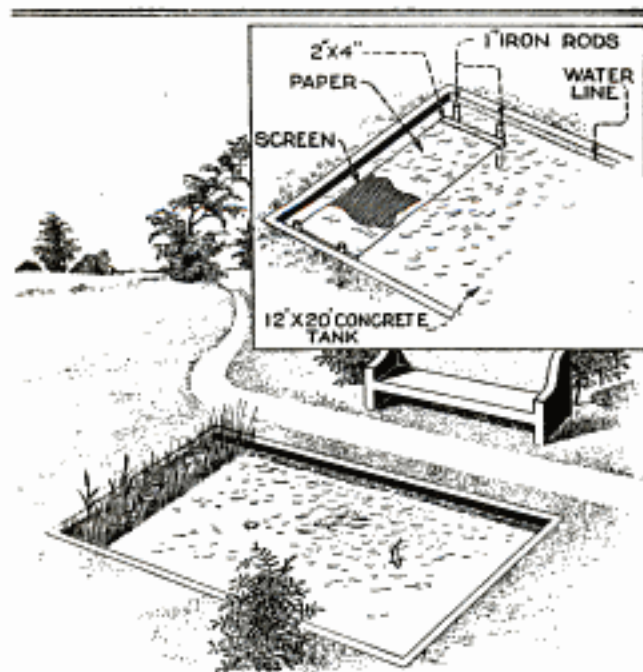

Method of Growing Water Plants in a Fish Pool by Means of a Screen

eaten by the fishes, who evidently thought that the seed was intended for them.

To prevent this, the method of growing the plants shown in the drawing was used. Four 1-in. iron rods were driven into the pond at one end, in the position indicated. A strip of copper screen with a $\frac{3}{16}$ -in. mesh, was cut to length and fastened at both ends to short lengths of 2 by 4-in. wood, which were attached to the posts by means of iron loops. Cleats fastened to the posts, about 6 in. below the water level, kept the arrangement from sinking to the bottom. It was found later that it was best to paint the screen. Thin coarse paper was laid on

the screen and the seeds sprinkled on the paper, then the screen was lowered into the water and attached to the posts. In a short time the seeds sprouted and the roots pushed through the paper and down into the water. The hanging roots provided a splendid cover for the protection and propagation of the fish, yet the screen held the plants securely anchored. The screen was well hidden from view by the plants.—Dale R. Van Horn, Walton, Neb.

Toolholder for Amateurs' Lathe

The usual amateurs' bench lathe employs solid forged tools, and, while the amateur realizes the superior advantages of a toolholder using square tool bits, he is usually unable to purchase a toolholder to suit the lathe, and doubts his ability to make one. The main difficulty in making a toolholder—the broaching of the square hole—is eliminated in the practical toolholder shown in the drawing. The bits used are

$\frac{3}{16}$ in. square by $2\frac{1}{2}$ in. long, and the body of the tool is made of a piece of cold-rolled steel, $\frac{1}{2}$ by 1 by $\frac{3}{4}$ in. in size. A $\frac{1}{8}$ -in. hole, about $2\frac{5}{8}$ in. deep,

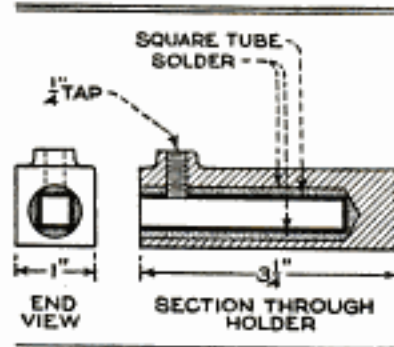

was drilled along the bar from one end, a little off center, as shown, and the bar shaped to size, leaving a boss for the tool-clamp screw, as shown. A small square tube was then made, with an inside measurement of a little over $\frac{3}{16}$ in., and 3 in. long, using a piece of square-steel rod as a form, the outside of the tube was cleaned and tinned, and the tube filled with damp dirt, to prevent it from filling with solder. The inside of the hole was

tinned by heating the holder and placing solder and flux in the hole. Enough solder was used so that when the tube was dropped in the solder overflowed. When the solder was hot, the tube was dropped in and turned to position, and the holder then cooled off with water.

The dirt was then dug out, and the hole for the $\frac{1}{4}$ -in. clamp screw drilled and tapped.

Right and left-hand holders can be made in the same way, except that the hole for the tube will run right through, and must be plugged at one end when filling with solder. The width will depend upon the toolpost, but the holder should not be much below $\frac{1}{2}$ in. wide, as then smaller than $\frac{3}{16}$ -in. bits must be used.—Leon Francia, Los Angeles, Calif.

A Novel Rat Trap

The novel rat or mouse trap illustrated has been found very effective in catching rats, which are attracted by the bait fixed on the trip board and also by the mirror behind the trip board. The mirror makes

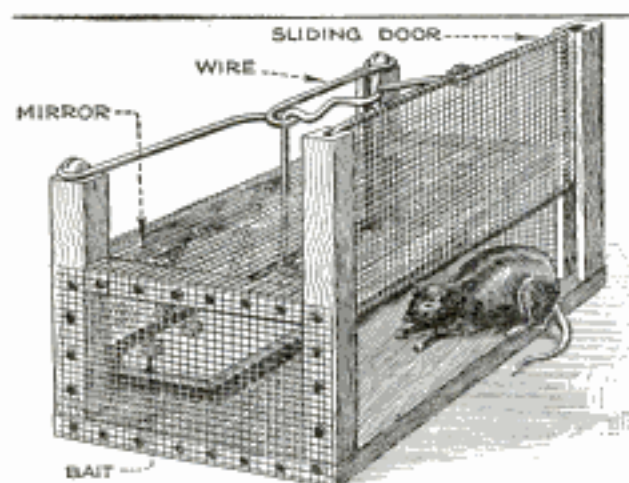

Rat Trap That has been Found Effective: A Touch on the Trip Board Causes the Door to Drop

it seem as if another rat is also stealing upon the bait, with the result that the rat will not be hasty to retreat but usually plays or fights with his image in the mirror. A light touch on the trip board dislodges the wire supporting the gate, which drops down, trapping the rat. The trap is made of wood, $\frac{1}{8}$ -in. wire mesh, and No. 12 galvanized wire. The construction is obvious from the drawing. The gate should be a sliding fit between two end posts, which are grooved to hold it. The wire mesh is tacked to the wooden braces and soldered to the wire gate. The only disadvantage of this trap is that it has to be set after every rat is caught.—E. K. Wehry, Cedar Rapids, Ia.

Combination Rotary Harrow and Drag

The combination rotary harrow and drag shown in the drawing and used for pulverizing clods can be made in a

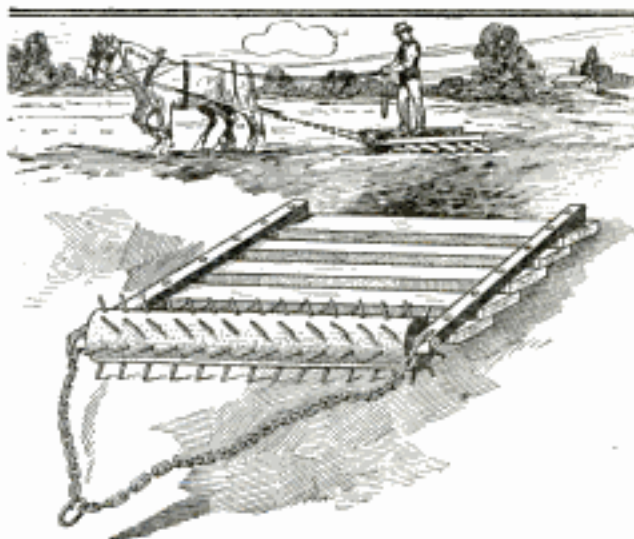

A Combination Rotary Harrow and Drag That Is Very Effective in Pulverizing Clods

short time from material available on every farm. It consists of five 6-ft. lengths of 2 by 10-in. lumber, nailed or bolted to two 2 by 4-in. endpieces, and a 6-ft. wooden roller, attached to the front so that it will revolve when the drag is pulled over the ground. Rows of teeth, made from heavy spikes, are then driven in so that they project about 4 in., and the heads cut off and the teeth sharpened. Two $\frac{3}{4}$ -in. bolts, driven into each end of the roller, serve as journals, and turn in bearing holes in the 2 by 4-in. endpieces. The drag may be weighted down with stones, or if desired an old mower seat may be attached to it.—J. T. Garver, Huntington, Tenn.

Homemade Graduates

In the workshop of the amateur photographer, electrician, or experimenter, occasion often arises for the use of several glass graduates. As few workers are equipped with more than one, it will be found convenient to use ordinary tumblers or fruit jars as substitutes, the graduations being marked with rubber bands cut from a discarded inner tube. The upper edges of the bands are set at the water lines.

It is, of course, necessary to keep the jars in a place where they will be out of reach of meddlers who might move the bands; under ordinary working conditions, there is very little danger of them being moved.

Garage-Door Catch

The garage-door catch shown in the drawing is used on garage doors to prevent the doors from swinging back

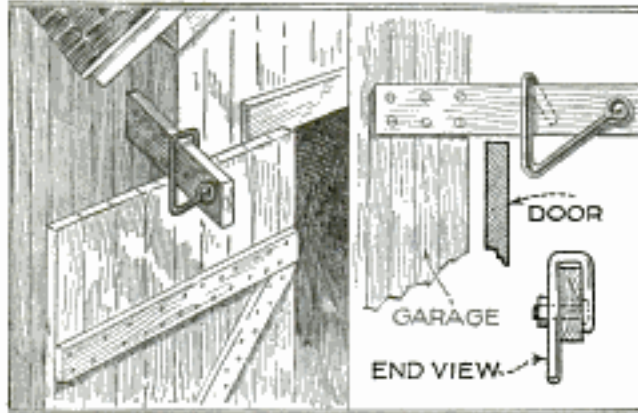

Garage-Door Catch to Prevent the Door from Swinging against the Car While Driving In

against the car while driving it into or out of the garage. The arrangement is unusually simple in that only one piece of iron rod, bent to the shape shown, and pivoted to a wooden bracket, forms the complete catch. The wooden bracket is screwed to the side of the garage and a bolt on the end of the bracket is used as a pivot for the catch.

Fastening Edges on Roll Roofing

When laying heavy roofing paper over the edge of a roof, it is usually found to be difficult to turn the material over and fasten it neatly without tearing. By hinging two hardwood strips together, a fixture is obtained that will prove of great assistance. The upper strip is made a little longer than the lower, to allow room for the two clamps required to hold it to the roof. One or both ends of the

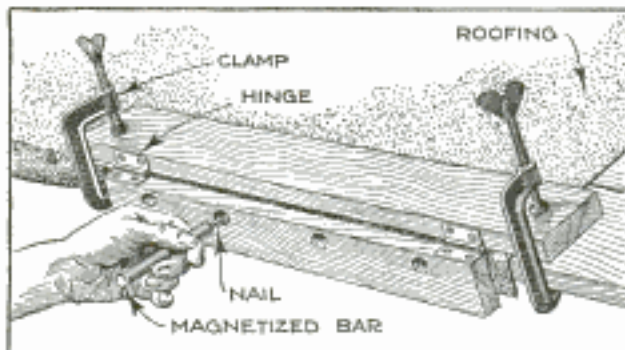

A Good Method of Fastening the Edges of Prepared Roofing

other piece are curved to prevent tearing the roofing by making a sharp crease in it when the edge is folded over.

The longer strip being clamped in place

at one end of the roof, the hinged piece is bent down, assisted by the hammer where necessary. It is well to get a few roofing nails in place before removing the fixture; this is accomplished by having a few holes drilled through the short piece, large enough for the big-headed nails to go through. A round, magnetized bar of hard steel will set the nails in place through the hole, and a few taps of the hammer will send them home. The rest of the nails can be driven after the fixture has been removed.

Simple Wind-Power Milk Stirrer

To keep milk sweet, especially during warm weather, it is necessary to remove the animal heat as soon as possible, and this can be accomplished only by thorough stirring. When done by hand this simple chore becomes rather tiresome, and therefore a wind-driven stirring device, of the kind illustrated, which will

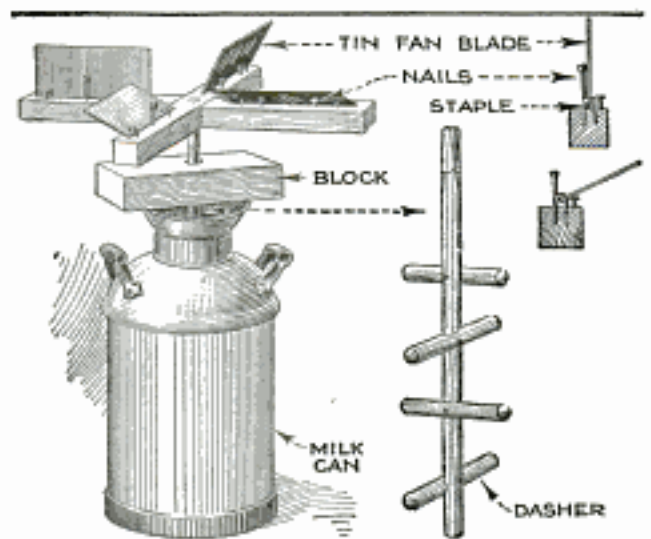

A Simple Milk Stirrer Driven by Wind Power for Removing Animal Heat from Milk

serve the purpose equally well, will be found useful.

The device consists of a vertical wooden shaft, fitted with two short crosspieces, on which blades are mounted to catch the wind. The crosspieces holding the blades are made of 2-in. material and the blades themselves are merely pieces of tin, obtained by removing the ends of tin cans and flattening the cylindrical portions. Staples are used as hinges for the blades to swing on; nails are driven into the crosspieces on both sides of each blade; a nail on one side is partly driven in to hold the blade in the vertical position when the wind catches it, and two nails, on the other side, driven in almost entirely, hold the

blades at an angle to permit the wind to catch it. The short crosspieces forming the dasher or stirring element are made of round wood, nailed or screwed to the shaft. A 4 by 4-in. block, with a hole drilled through it to serve as a bearing for the shaft, is placed on the milk can as indicated, to hold the stirring device in position.

In the slightest wind each blade of the wheel, as it catches the breeze, swings upward to an erect position, where it is held by the nail. Here it remains until it has revolved a quarter turn, when the reverse side is presented, causing it to fall back until a similar action of the other blades brings it into the wind again.

—G. E. Hendrickson, Argyle, Wis.

Attachment for Leaf Rake

When using leaf rakes constant difficulty is experienced, as the leaves and grass quickly accumulate between the teeth and must then be pulled out by hand. An attachment that eliminates this trouble is shown in the illustration. It consists of a length of heavy galvanized wire, bent to the shape shown in the lower detail and attached to the top of the rake with thin sheet-metal clamps.

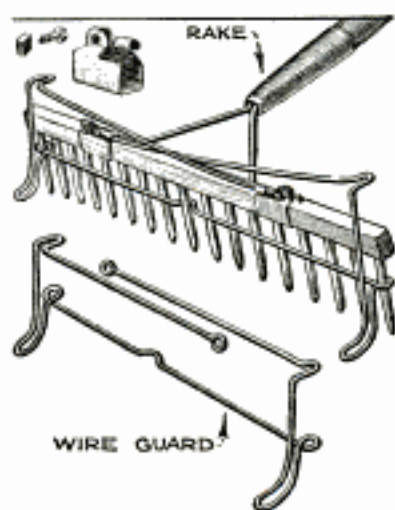

Of course, there are so many different types of rakes that the exact method of attaching this guard will vary, but the principle is the same in all cases. In its normal position the guard runs across the teeth near their ends, and is bent to form an eye at each end to fit the outer teeth. While using the rake, the guard moves up. This gives the leaves a chance to get on the teeth, but as soon as the rake is lifted from the ground, the guard pushes the leaves off. The guard does not add much to the weight of the rake and there is no necessity for removing it. The use of the guard also eliminates the "digging in" and tearing of grass roots experienced in raking, as the rake rides smoothly on the "feet" of the guard, and the rake teeth barely touch the ground.

Yard Scoop Saves Labor

A scoop of the kind shown in the drawing has been found useful for leveling small plots of ground and also as a substitute for a wheelbarrow. It consists of

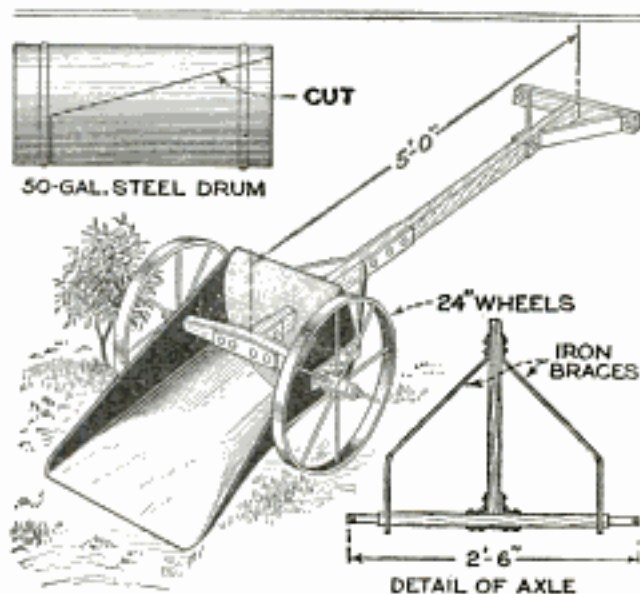

A Homemade Scoop for Leveling Uneven Plots of Ground and Carrying Heavy Loads

part of a 50-gal. steel drum, cut as indicated in the upper detail, and with the lower edge flared out to present an even digging edge. This part is then mounted on a wooden or iron axle; two wheels, about 24 in. in diameter, taken from an old farm implement, are mounted on the axle. A 5-ft. handle is also attached to the axle at right angles to it, the handle passing through the end of the scoop and being supported by two iron braces, bent to the shape indicated, and bolted to the side of the scoop. A crosspiece is provided on the end of the handle so that one or two persons can push it. The edge of the scoop should be sharpened to lessen the pressure required in scraping hard ground. As the edge of the scoop is only a few inches above the ground, the handle does not need to be tilted very high to make the scoop dig.

Removing Bloodstains

Many methods of removing bloodstains from linen and other cloth leave a dark spot on the material, especially if the stain is large. A method that will not do this is to soak the cloth in cold water for 24 hours and then wash it for 30 minutes in soap and suds, to which a small amount of soda has been added. Then the cloth is washed a few minutes in warm, but not hot, water.

Making the Medicine Cabinet More Convenient

Medicine cabinets are usually found too small to permit an orderly arrangement of the numerous bottles, vials, and other

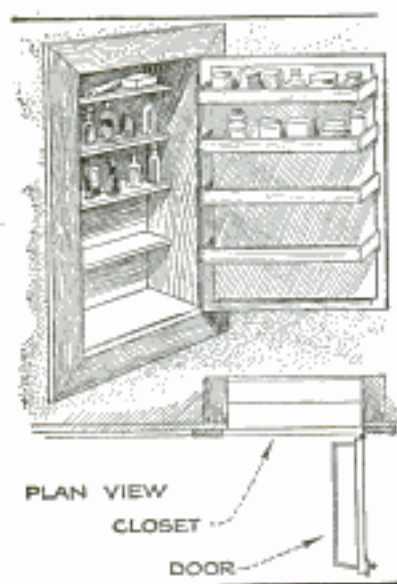

containers, kept in them and therefore additional space is necessary. This can easily be provided by building a few narrow shelves on the inside of the door as shown in the illustration, most cabinets of this type having the shelves set

back far enough to permit this. It may be necessary, in some cases, to provide a heavier door as well as heavier hinges to take care of the additional weight. One end of the shelves on the door must be cut off at an angle as shown in the plan view so that the door can be closed. A rail around the edge of each shelf is also necessary as opening and closing the door moves the bottles.

Cushions for Vacuum Tubes

It is an excellent idea to mount a vacuum tube on a shock-absorbing base in order to prevent interference from vibration, which is especially noticeable in the $1\frac{1}{2}$ -volt dry-cell tubes. Talking close to the set causes the grids to vibrate, which gives a ringing sound in the phones or loud speaker. To prevent this springs and rubber-band supports have

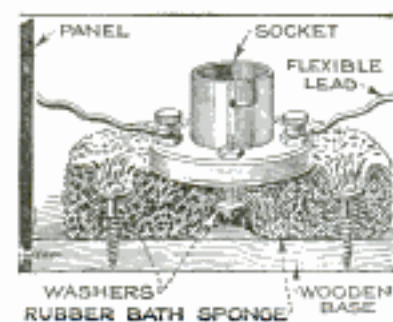

been tried out in factory-built sets, but neither has been found as successful as a rubber-sponge cushion.

The socket is attached to the sponge and the sponge to the wooden base by means of screws, which are fitted with

large washers to prevent the heads from tearing through the rubber. Heavy wire should not be used to connect to the socket terminals, as this will transmit vibrations to the tube; it is preferable to use common lampcord. When inserting or removing a tube, the socket should be held with one hand to prevent tearing the sponge.

Improvement on Gas-Tank Kink

The scheme of soldering a tire valve into the gas-tank cap, on an auto with a gravity-feed system, so that a tire pump may be used to provide pressure to get the car up a hill, is well known. Of course, the vent hole in the cap must be plugged when using pressure, and taken out again for gravity feed. An improvement on this scheme is to solder two valve stems in the cap, one containing a valve core and fitted with a dust cap, the other to serve as the vent. When necessary to use pressure, the cap of the stem containing the valve core is removed so that the pump can be attached, and the cap screwed on the other valve stem, to seal the vent.

Retreading Steps with Concrete

Wooden steps that are used continuously wear down soon and must then be replaced. A good method of renewing the steps is to retread them with concrete, which involves little work, as the

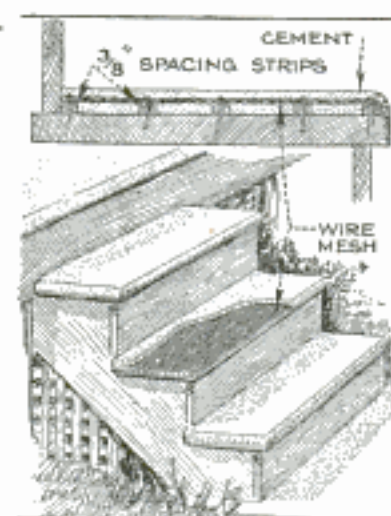

old steps need not be torn off, providing they are sound. Thin wooden strips are first nailed on the steps and a double layer of wire mesh is stapled over this to reinforce the cement. Almost any kind of meshed wire will do

except fly screen or similar screen, which is too light. The layer of cement should be about $\frac{3}{4}$ -in. thick and the mixture should consist of half sand and half cement. It is, of course, necessary to provide forms along the edges of the steps.—G. A. Luers, Washington, D. C.

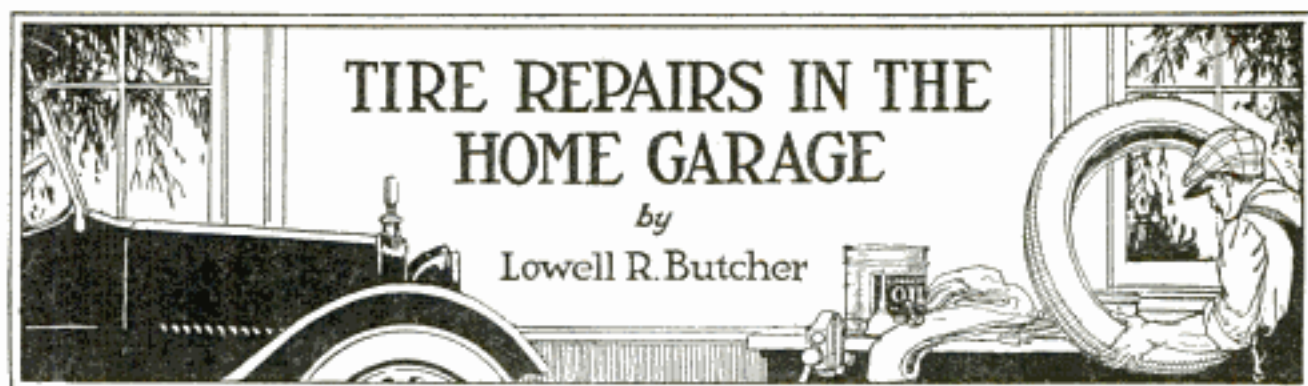

Part II—Casing Repairs

WHILE some of the more serious tire damages must be taken to the tire shop for repair, there are many simple repairs that the car owner can make. Most of the bad blowouts are caused by neglecting some simple injury that could have been repaired in the home garage. Trips to the tire shop and the purchase of new tires will be less frequent if the owner will learn to make a few simple repairs—and will make these when needed.

The most simple repair to make, and the one most often required is the tread patch. This repair is the same whether the carcass of the tire is of ordinary fabric, cord-fabric, or cable cords. The repair is used on tires the treads of which have been damaged by bruises or cuts. These minor injuries may not seem serious, but their neglect will cause other and more serious troubles. The patch is used to fill in the broken place on the tread and seal up the carcass against dirt and moisture.

Such damages usually extend only to the carcass of the tire. If many plies of the tire are damaged, it is best to take the tire to a competent repairman and have a section repair made. Broken plies make a hinge section at the point of the damage, and internal rubbing and friction take place, no matter how well the tread is sealed up.

All broken or injured gum must be removed from the injury before any attempt is made to build up the tread patch. Remove all separated or broken tread down to the breaker strip. A sharp knife or an old razor blade will be needed for cutting out the damaged gum, as shown in Fig. 1. The instrument must be kept sharp and will cut much better if it is dipped in water from time to time. The cut-down portion of the tread will be circular in shape, and the sides of the hole should be beveled off at an angle. Wash the injured spot with high-test gasoline to remove all dirt and grease, use a coarse file or a rasp to buff and roughen the injury, and finish the

work with some coarse sandpaper. Roughing the tread allows the tread patch to get a better grip on the tire.

Regular vulcanizing cement is used in making the tread patch. Apply this in three coats, allowing each coat to dry before the next is applied. As this cement consists for the most part of raw rubber it is almost impossible to apply too much. After the last coat has dried until it is "tacky" to the touch, the injury is ready to be rebuilt up with new gum.

Cushion stock and tread gum will be needed to build up the patch. The cushion stock is applied first in a thin layer that completely covers the injured spot, and laps at least $\frac{1}{2}$ in. all around the cut-down portion, as in Fig. 2. Use a sharp prod or screwdriver to work down the gum evenly over the injury, and roll the gum well with a tire roller before applying the tread stock. This prodding and rolling drives out any air bubbles that might be lurking under the gum, and is quite necessary, as the repair may fail if good contact is not secured at all points.

Wash off the repair with high-test gasoline to remove any dirt or grease that may have been rubbed on while working down the gum, then use the tread stock to build up the hole until the center of the repair is slightly higher than the surrounding tire. This operation is shown in Fig. 3. This will allow the gum to flow down evenly during the vulcanizing. Work down the tread gum with a prod, and roll before curing.

An electric or gasoline-heated patch vulcanizer may be used to cure the repair, but fully as good results can be obtained by using the electric iron. Shape a block to fit the inside of the tire by rounding the corners of a chunk of wood. The top of the block must be flat as the tire will have to be flattened out for the cure. Spread a piece of holland—the protective wrapping for repair materials—over the patched spot, and clamp down

the electric iron. A large C-clamp will serve to hold the iron tightly against the patch, as shown in Fig. 4. It is important that the iron be held tightly during the cure; if it is not, the gum may bulge at the point of contact, and make an unsightly repair.

The length of time required for cure will depend somewhat on the kind of gum used, and the depth of the repair. If the patch is shallow, enough heat may be retained in the hot iron without using current when the iron is clamped in place. More often, the repair will require more heat than can be supplied in this way, and the current will need to be turned on for a little while. The exact length of time for the cure is best determined by experiment. A piece of new gum may be used as a test piece and the exact heat and the length of time required to complete the cure found by making several tests. Properly cured gums will be full of life and elasticity.

If the fabric of the tire is bruised or partly broken, the tire should be reinforced from the inside. An inside shoe, firmly cemented into place, is used for this purpose. Prepared shoes may be purchased, but the car owner can easily make serviceable shoes from the carcasses of old tires. A tire slightly larger than the one for which the shoe is intended should be chosen. The shoe should extend from toe to toe of the bead and consequently cannot be made from a tire of the same size.

An inside shoe is usually made of three plies, cut down to the shape shown in Fig. 5. Its length will depend upon the length of the injury it is to cover but the ends of the shoe will be cut down or "stepped down" as shown in the illustration regardless of the length of the boot. Two plies of the shoe reach from toe to toe of the tire, but the third ply—the one that goes next to the inside of the tire—ends $\frac{3}{4}$ in. from each toe. In other words, this third ply lacks $1\frac{1}{2}$ in. of being as wide as the other two plies. The second ply is stepped down so that it is 1 in. shorter at each end than the first ply, the third ply is $\frac{3}{4}$ in. shorter at each end than the second ply. The large ply of the tire is always placed so that it is on the outside and the stepped-down layers of the shoe fit against the inside surface of the casing.

If all the plies of the shoe were ended at one point, there would be some danger of a hinge point at the ends of the shoe, and the sharp bumps which would be formed might injure the inner tube. The

gradual ending, or the stepping-down, prevents these sharp edges at the ends.

Ordinary vulcanizing cement is best to fasten the shoe into place. In spite of the fact that there is no equipment in the home garage to apply heat for vulcanizing the shoe into place, the heat from the tire in operation on the road will gradually cure the shoe to the carcass of the tire. In applying the shoe to the inside of the tire, start at the toe of one bead and fasten one edge of the shoe. Work across the tire, pressing down the center of the shoe first and working out from the center to each end. Placing the shoe in this way will do much to eliminate the chance of wrinkles and will insure good contact at all points. With a little practice, one can tell by touch whether the shoe is fitted snugly. A couple of wooden stretchers, used as shown in Fig. 6, should be made to keep the tire spread during the operations described.

If the tread patch is to be used in connection with an inside repair, apply the shoe before curing the patch. Some of the heat from the vulcanization of the tread patch will help to cure the shoe into place. Three coats of vulcanizing cement are used on both the inside of the tire and on the shoe. The tire and shoe must be thoroughly cleaned and washed before the cementing is done; a block of sandpaper and a wire brush are best for doing this. The application of the cement should be extremely liberal, as fabric will soak up a much larger amount of the cement than will the tread of the tire.

The inside shoe is often used without the tread patch, when the injury is confined to the inside of the tire. Sometimes stone bruises will break one or two plies on the inside of the tire and yet not break the tread or sidewall. Chafed spots on the inside of the tire may also be covered with an inside boot. These damages may not seem serious, but are apt to cause much tube trouble until they are repaired.

Reliners are really large inside shoes that extend all the way around on the inside of the tire. They give protection to the tube and are a welcome reinforcement to a weakened casing. Some tire men hold that the reliner does not add to the life of the tire, and such is certainly the case if the reliner is applied improperly. There are many times when the use of a reliner is justified, however, and will add many additional miles of service to the tire. A fairly good tire,

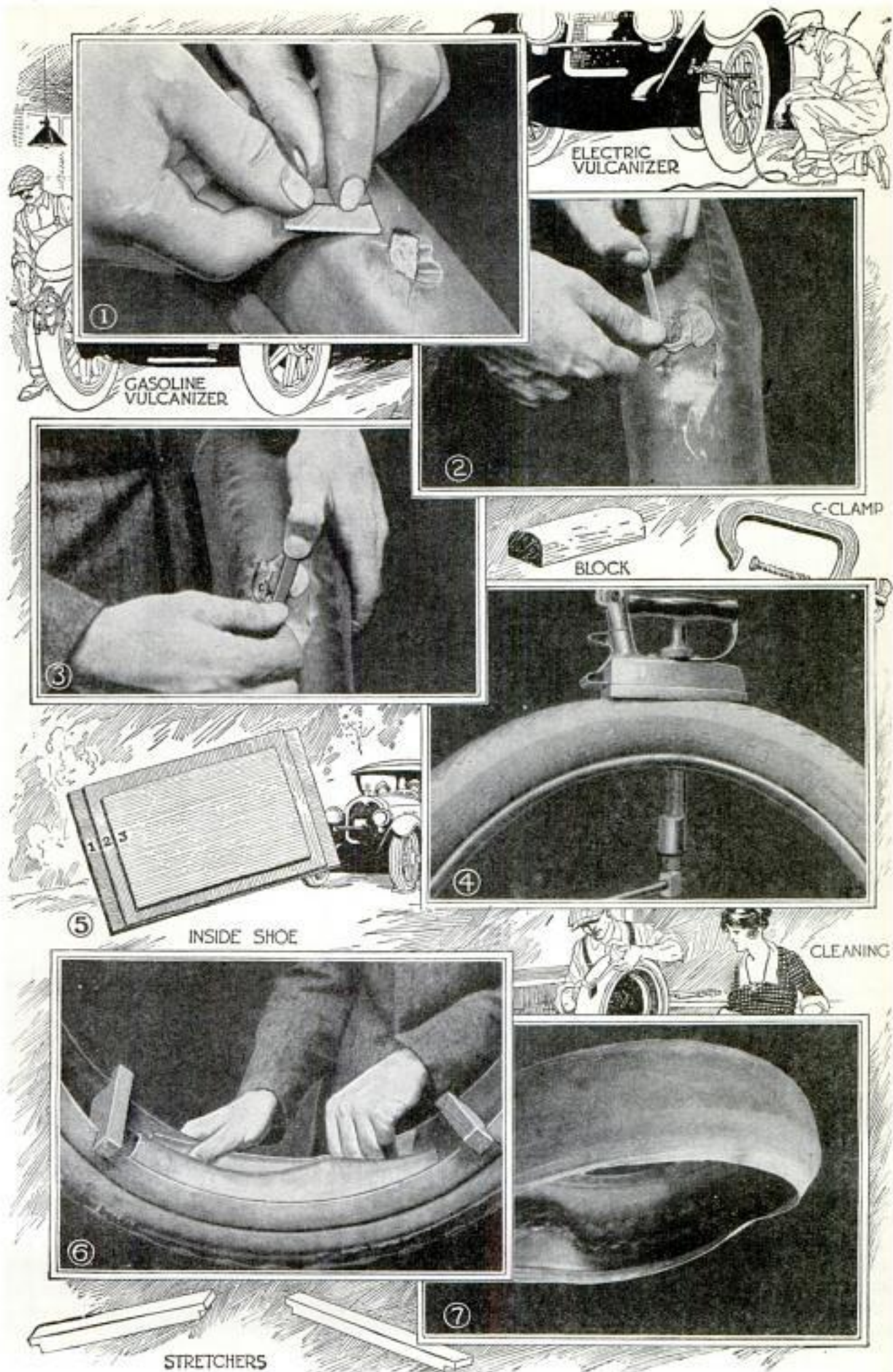

Various Steps in Repairing the Minor Injuries in Tire Casings That may Easily be Repaired If Attended to in Time, But Often Ruin a Tire Beyond Hope of Repair When Neglected

whose carcass has been broken or cracked by abuse, justifies the use of a reliner. The reliner will protect the tube and give strength to the carcass of the tire, but, whenever used, the reliner should be cemented firmly into place.

This type of inside reinforcement may be purchased ready for use, or be made from an old casing. If it is to be made from an old tire, the casing selected for that purpose should have a fairly sound carcass, as broken plies in the reliner will cause much trouble. Like the tire selected for making inside boots, the tire for making the reliner will be somewhat larger than the tire in which the reinforcement is to be used. Reliners are usually made from three plies, with the under ply stepped down so that it fails to reach the bead by $\frac{3}{4}$ in. on each side. The ends of the plies should also be stepped down so that no two end at the same point.

Both the inside of the tire and the reliner are well cleaned and liberally cemented before the reliner is applied. If the casing is light, it may be turned inside out, as in Fig. 7, while the reliner is applied. Heavier tires must have the reliners applied without turning. Prop the tire open with short stretchers, and work in the reliner in a manner similar to the way the boot was applied. The narrow ply of the reliner should go next to the inner surface of the casing.

Before the cement has had time to dry, mount the tire on a rim and inflate to the proper pressure. The pressure of the tube on the reliner will help to smooth out any wrinkles and make good contact at all points. It is a good plan to powder the inside of the tire with soapstone before the tube is placed. This will prevent the tube from sticking to any cement which may have overrun the reliner.

In cutting down an old tire for a re-

liner, the tread and sidewalls are removed first. Cut along the junction of the tread and sidewall with a sharp knife. The cut should be deep enough to extend down to the carcass of the tire yet not deep enough to injure it. An old razor blade makes an excellent instrument for cutting down the tire. After making the cuts around the tire, cut across the tread and sidewall to make a starting place for removing the rubber. Pry up one end of the tread and sidewall with a sharp screwdriver and remove the rubber in three strips. The screwdriver may be needed to loosen the rubber as it is stripped back. If the rubber sticks so tightly that it cannot be removed by this method, it can be cut from the tire in small strips.

After the rubber has been removed, the bead cover is taken off. If the end of this cannot be found, a starting place is made by cutting across the cover. The cover is pried loose with a screwdriver and stripped from the tire. Following the bead channel closely, cut the beads from the carcass. If the carcass is to be used for inside boots, cut it into sections of the proper length and step down the plies as explained before. When the material is wanted for a reliner, all plies but three are removed, and the inside ply cut down to the proper width. It is best not to cut the reliner to length until it has been measured and fitted to the tire in which it is to be used.

These simple repairs will handle the most common tire injuries. One should not hesitate to consult a tire man if the repair is beyond the equipment of the home garage, as a few dollars spent at the tire shop may save the price of a new casing. These more serious injuries will be much less frequent, however, if the minor damages are repaired as soon as discovered.

Oiling Motorcycle Transmission

As no appreciable amount of oil is consumed in the gear box of a motorcycle it has to be refilled so seldom that one is liable to forget all about it. On motorcycles equipped with a hand pump this danger can easily be overcome by providing an oil pipe from the pump to the gear box so that the oil can be pumped into the latter in the same way that it is pumped into the crankcase, the same oil being used for both purposes. The additional pipe, which is a length of copper tubing of the kind commonly

used for this purpose, is attached by soldering a T or Y-fitting in the pipe leading to the crankcase. A shut-off valve must, of course, be provided in both lines so that when oil is wanted in either crankcase or gear box, the flow of oil in the opposite pipe can be shut off. The tubing leading to the gear box should be bent to an S-shape so that it will not be affected by a slight change in the position of the gear box, which must be moved forward or backward occasionally to adjust the driving chain of the motorcycle.—George Wallace, Dallas Center, Ia.

Waterwheel for Running Small Dynamo

By using a light waterwheel of the type illustrated, where sufficient water current is available for turning it, the energy of the flowing water can be transformed and used for practical purposes.

The waterwheel can be made by attaching a number of tin cans, of suitable size, on the felloe of a discarded buggy wheel, and fastening the wheel, together with a pulley, on a shaft, that is supported by a wooden frame. The pulleys on the waterwheel and dynamo must be so proportioned in size that it will be possible to revolve the armature at its rated r. p. m., in order to obtain the voltage and amperage that the dynamo is capable of producing.

By concentrating the water current in a narrow channel, as shown, a greater force will be exerted on the waterwheel.

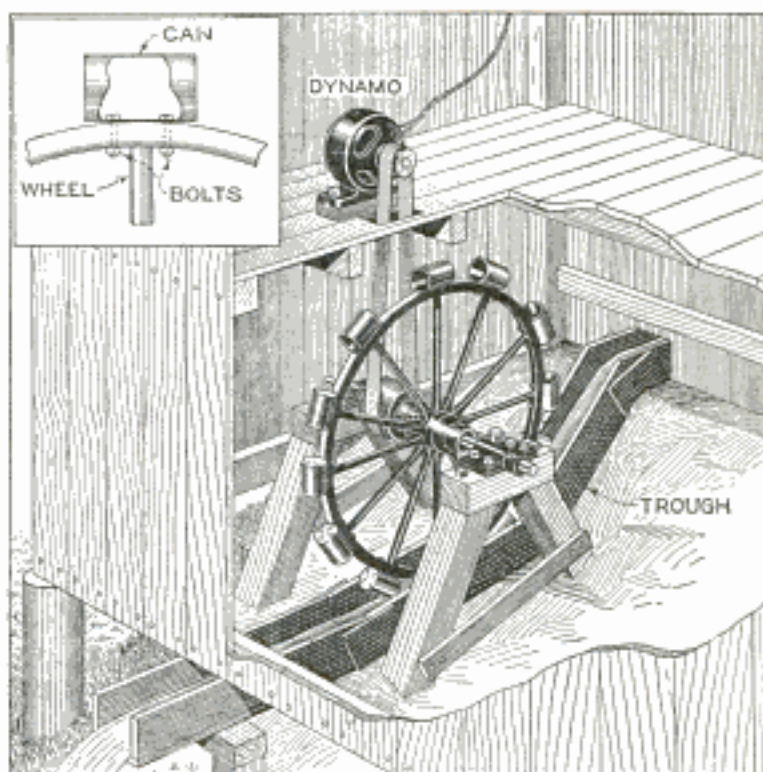

A Simple Waterwheel That can be Easily Made for the Purpose of Driving a Small Dynamo

Emergency Repair for Full-Floating Axle

The drawing shows a method used in an emergency to hold the wheel and axle of an auto in position, when the retaining nut on the full-floating axle came off. The weight of the car, resting on the outdrawn axle, forced the end of the housing out of round, which prevented the replacement of the nut, and therefore the arrangement shown was assembled from parts picked up at the nearest farm,

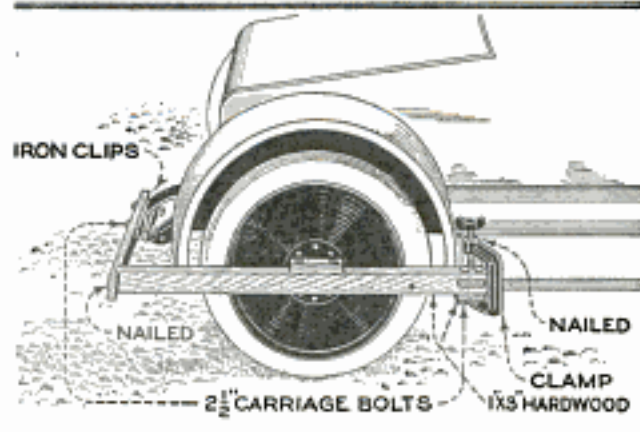

Emergency Repair for Full-Floating Axle That Permits the Car to be Driven to the Repair Shop

and in the toolbox. It consisted of a length of 1 by 3-in. hardwood, bolted to a strip

nailed and clamped to the running board, and attached to a second strip, which was bolted to the rear spring as indicated. This arrangement kept the shaft in place, and allowed the car to be driven for 40 miles, until permanent repairs could be effected.—J. F. Ware, Dayton, Ohio.

Painting Boat Hulls

The hulls of small boats are usually painted white but do not remain white very long owing to the dirt in the water, which coats the paint. This can, however, be prevented by using a paint consisting of white lead and turpentine instead of white lead and oil. White lead, which contains about 10 per cent of oil, is thoroughly mixed up with turpentine and is allowed to stand overnight to permit the lead to settle; the turpentine absorbs about half of the oil contained in the white lead. It is then poured off, the residue mixed with fresh turpentine, and the boat painted with it. As this paint dries quickly, several coats can be applied in a short time, thus building up a thick coat. As this paint lacks the necessary binding material, it washes off slowly, exposing a fresh surface of paint, and as it has no affinity for water, it does not become water-soaked. It does not blister or chip off, but gradually wastes away.

Automatic Oil Feed for Auto

This automatic oil feed, while illustrated and described as applied to a light car, may be used on any engine where

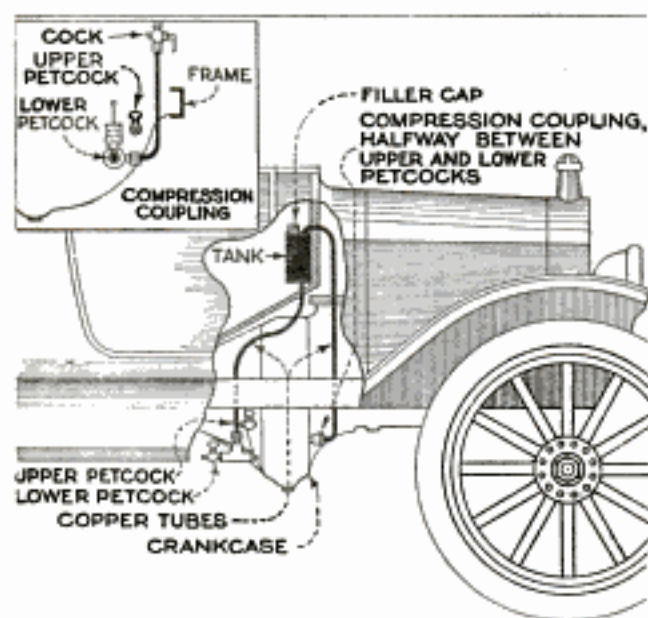

A Simple and Efficient Automatic Oiling System for the Light Car

the oil level must be kept at a predetermined height.

A hole is drilled into the crankcase at about $\frac{1}{4}$ in. below the point at which the oil level is to be held; this is tapped $\frac{1}{8}$ in. pipe size, and a compression coupling for $\frac{3}{16}$ -in. outside-diameter copper tubing screwed in firmly. The lower petcock is removed, and screwed into a $\frac{1}{8}$ -in. tee, which is connected to the crankcase with a nipple; a compression coupling is then screwed into the side outlet of the tee.

A tank of about 1 gal. capacity, made of sheet iron, and with all joints brazed, is then strapped to the dash; this tank may be a gallon oil can, but the constant vibration will chafe holes in it after about six months use, so it is better to use a specially made tank; in any event, the tank must be provided with a screw cap, fitted with a gasket, so that it will be airtight. The tubes are then soldered or brazed to the tank as shown in the drawing, and the tank filled with oil.

The oil will flow out of the tank, into the crankcase, until the oil level reaches the upper tube opening. When it covers the tube no more air can get up to the tank, and the oil ceases to flow. As soon as sufficient oil has been used to uncover the end of the upper tube again, a bubble of air passes up the tube, and a corresponding quantity of oil comes down the other tube. This continues automatically

until the oil in the tank is used up. The system may be improved by the addition of a float gauge, which may be purchased anywhere; when the gauge shows the least drop in height, it indicates that the tank is empty. A shutoff cock, of the compression-coupling type, can also be fitted in the oil line.

This system has been in use for over a year, and I would not be without it, as it eliminates much of the time spent in "oiling up."—John A. Blaker, West Auburn, Mass.

Ingenious Weather Strip

The drawing shows an effective weather strip that prevents cold air from entering under the door. It consists of two wooden slats, one screwed to the bottom of the door and the other loosely connected to the first with metal links and flat springs as indicated. A rubber strip is tacked to the lower slat. When the door is opened the springs force the lower slat to the position shown in the upper detail, the action of the spring being shown in the insert. Closing the door brings the one end of the lower slat against the door jamb, on the hinge side,

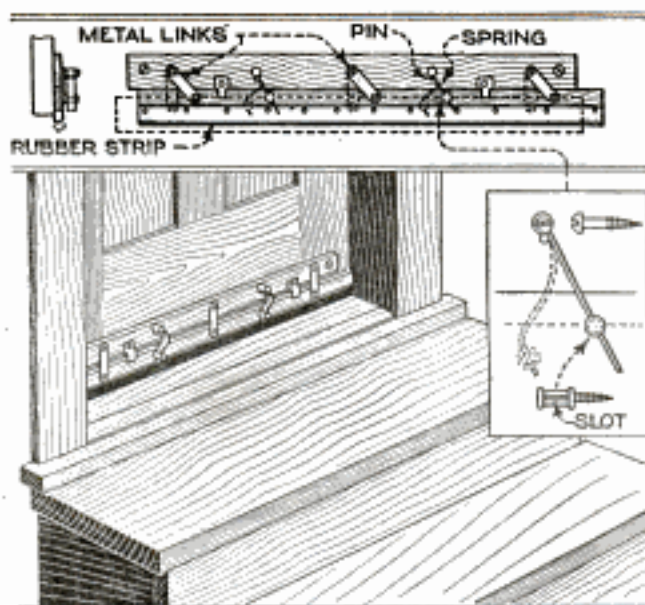

A Weather Strip That Effectively Prevents the Entrance of Cold Air under the Door

and this forces the lower slat tightly against the floor, effectively preventing all drafts.—D. M. Halliday, Chesley, Can.

It is a difficult matter to catch a moth with the hands as it flies through the air. However, if the hands are moistened, the moth can easily be caught, as the nearness of a wet surface seems to have a paralyzing effect on its wings.

Radio-Panel Bushings from Valve Stems

It has been found that excellent bushings for use on radio panels can be easily made from the valve stems of discarded inner tubes. Any length bushing, up to 1 in., may be made by cutting off the large end of the stem and drilling out the small hole to the desired size.—H. M. Flint, Strathmore, Calif.

Novel Window Display

A clever window display, which attracted considerable notice, and caused much comment, was used by a Chicago furniture dealer to advertise a line of refrigerators. The display consisted of

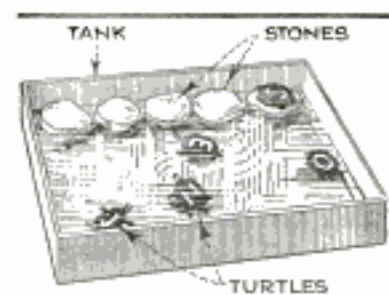

a tank containing water, some flat stones with the tops level with the surface of the water, and an equal number of turtles with letters

painted on their upper shells as shown in the drawing. A prize was offered for the person who discovered the turtles all on the stones at the same time in the proper position to spell the name of the refrigerator. In the drawing, the letters constitute the word "Jones."

Erecting Aerials

A simple method of erecting supports for aerials, when height is not a great consideration, is to nail lengths of 2 by 2-in. wood to the roof as shown in the drawing. The supports are fastened on opposite sides of the roof, and are located over rafters, so that the spikes can be driven into these. The distance between the upper ends of the supports should be about 16 to 24 in.

Ordinary porcelain insulators, which can be procured from any electrical store, are screwed to the ends of the supports and the aerial is attached to these. Care must, of course, be taken to have the aerial wires stretched as rigidly as possible so that they will not touch the roof.

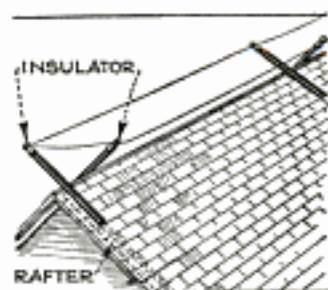

Handy Hog Hanger

Farmers and others who butcher hogs outdoors will appreciate the usefulness of the hog hanger shown in the drawing; with this hanger it is an easy task for



A Hog Hanger That can Easily be Operated by One Man without Any Assistance

one man to hoist a hog without any assistance. The post stands about 6 ft. above the ground and must be at least 6 in. in diameter; it should be set about 2 ft. in the ground as it must support heavy loads. A 2 by 4-in. crossbar is pivoted on the top so that it can readily be swung around to different positions, the pivot being a 1/2-in. bolt, driven into the top of the post. Two other 2 by 4-in. crosspieces are attached to the post about a foot below the top, and are arranged at right angles to each other. They are fitted into slots sawed into the side of the post and are securely fastened in place with large spikes. A 1-in. iron or steel crank is made to fit in either of two holes, drilled through the post at right angles to each other as shown. In use, the upper crossbar is brought directly above one of the lower crosspieces, and a rope loop is passed over the ends to support the upper one when a hog is pulled up. This is accomplished by means of the crank, a pulley attached to the upper bar, and a length of stout rope. The rope is provided with a hook which engages with the sharp pin that is pushed through the hog's "heels." Turning the crank lifts the hog up to the position where the pin can be slipped over the lower crosspiece, on which the hog is hung.—Robert H. Neill, Ottawa, Ohio.

Anchors for Small Boat Landing

The drawing shows a novel method of using cement blocks to anchor a small boat landing. The blocks are made in

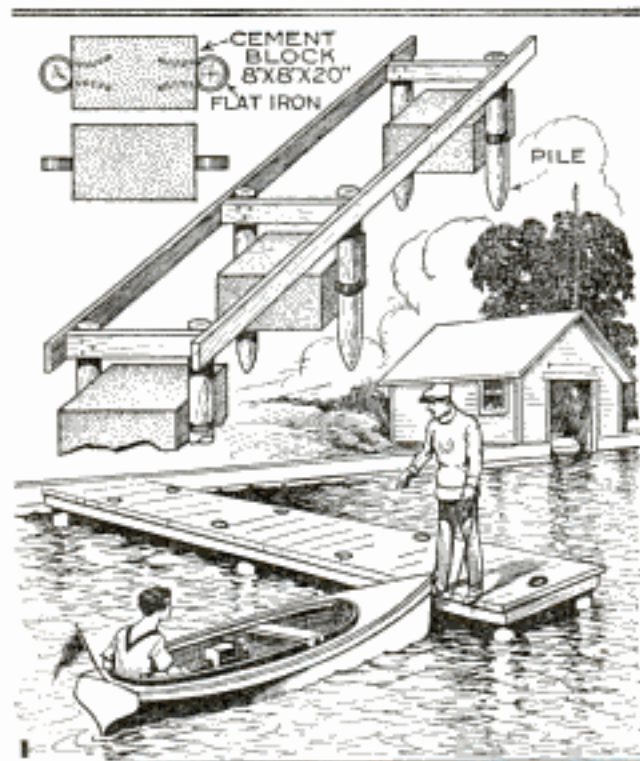

Cement Blocks Used to Anchor Small Boat Landing: They are Located between the Piles

a rectangular shape and of a size depending on the width of the landing. A block 8 by 8 by 20 in. in dimensions was found to be a convenient size. Lengths of $\frac{1}{2}$ -in. flat iron are set into the ends of the blocks, while the cement is soft, the exposed portion of each piece being rounded to form a ring that fits the pile loosely.

In setting up the framework of the landing, the piles on one side are first driven in. The rings at one end of the blocks are placed over the piles and the blocks are lowered down to the bottom. The blocks are then shifted to the correct position and the other piles located in the rings and driven down about 2 ft. Crosspieces, nailed to the piles at their upper ends, and two long 2 by 12-in. timbers, nailed along them as shown, form the framework upon which 2-in. lumber is nailed to form a walk.—M. E. Duggan, Kenosha, Wis.

When the paste pot or mucilage bottle is empty and some adhesive is needed for pasting papers, photos, and similar items, condensed milk can be used as a substitute. Spread it thinly over the surface to be pasted and it will hold well.

Preparing Concrete Floors for Dancing

The simplest and cheapest way to prepare a concrete floor for dancing is to treat it with liquid soap. The soap should be worked up into a lather and rubbed into the floor by means of a scrubbing brush. After this an occasional application of powdered soap will keep it in good condition. It will be necessary to apply several coats of liquid soap if the floor is rough and porous. Liquid soap is prepared by boiling a large quantity of soap in a small proportion of water.

A mixture of paraffin and turpentine can also be used. The paraffin is mixed in turpentine, just as much paraffin being used as can be absorbed by the turpentine. Only enough of the mixture should be applied to the floor to thoroughly fill the pores of the concrete, as an excessive amount will leave a sticky film on the surface. After the mixture has been allowed to dry, the surface should be treated with paraffin, applied in the same manner as to any wooden floor.

A third method is to treat the floor with heated wax, driven into the pores of the floor by means of a device similar to a blowtorch. The permanence of this treatment depends on the penetration of the wax, and this in turn depends on the temperature of the concrete. If possible the concrete should be heated just before the wax is applied. The surface is maintained by the application of powdered wax in the usual manner.

Setting Screws into Hardwood

It is frequently necessary to drive screws into hardwood or composition panels, and unless proper precautions are taken, the panels are easily cracked. Of course, it is common practice to drill a hole before driving the screw in, but this does not always prevent cracking, and it is therefore much better to tap the hole by means of a screw ground down for this purpose as shown.

Such an improvised tap cuts a good thread that allows the following screw to be driven in easily, and provides a good "grip" from which the screw will not pull out.

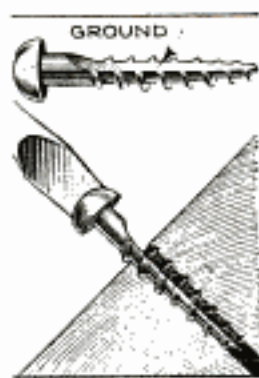

can be obtained from General Electric Co., Schenectady, N.Y.
Building a Battery Charger
Jungar Bulb *Westinghouse Electric*
 BY F. L. BRITTON *Emp. Co., East Pittsburgh Pa.*

THE type of battery charger using a rectifier bulb is to be preferred to either the noisy vibrator type or the chemical rectifier. While there has been some trouble in purchasing this type, anyone

for about \$7.50, not counting time. The instrument consists of a wood base, a socket, the rectifying bulb, and a two-voltage transformer. The bulb is the most expensive part of the instrument,

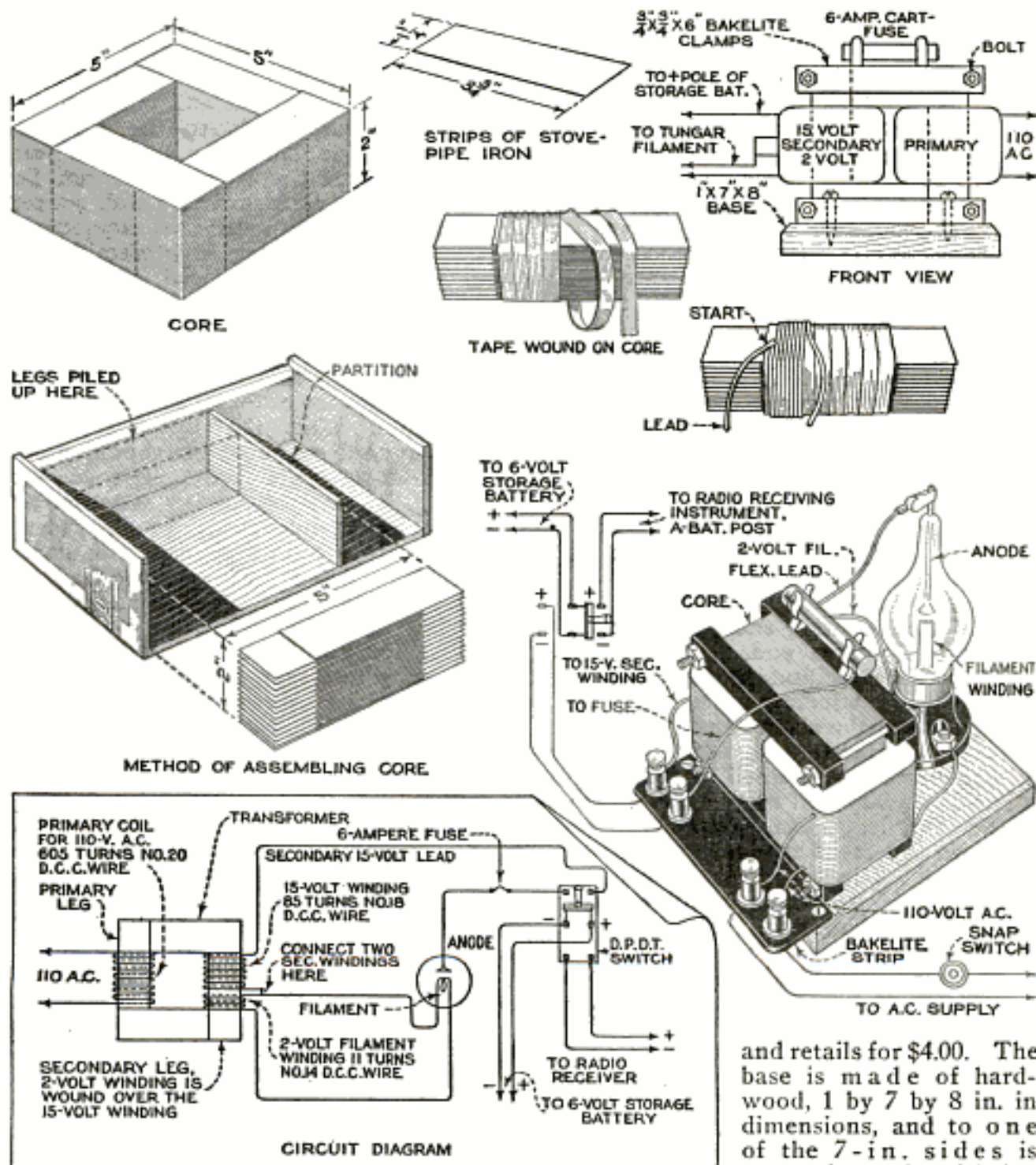

A Home Charger for the Radio Battery That Anyone can Make, and That will Save Many Trips to the Nearest Battery-Charging Station

who wishes to go to a little trouble can build his own at a considerable saving, as the commercial rectifier sells at from \$18.00 to \$35.00, while one can be made

The transformer is wound to furnish 2 volts for lighting the filament of the bulb, in addition to the 15 volts to be rectified for the battery. The secondary has

and retails for \$4.00. The base is made of hardwood, 1 by 7 by 8 in. in dimensions, and to one of the 7-in. sides is screwed a strip of bakelite to carry the binding posts necessary.

Therefore two windings, one carrying 10 amp. at 2 volts, the other 2 amp. at 15 volts. As silicon steel is rather difficult for the amateur to obtain, the core laminations are made of black stovepipe iron, of such a thickness that the laminations will pile up 58 to the inch, allowing for the shellac used in binding. The iron is cut into $1\frac{1}{4}$ by $3\frac{3}{4}$ -in. strips, and piled to make a hollow square, 5 in. on a side, the ends of alternate strips being overlapped $1\frac{1}{4}$ in. When all the strips have been cut so that there are no ragged ends overlapping the square, and it looks neat and regular, tear off one side and the lid of an old cigar box, then nail a partition across it so as to make a compartment 5 in. long. Pile the strips for one leg of the core in this compartment, shoving alternate strips to opposite ends; this will keep the ends even and square. As each strip is laid in, coat it with shellac, and when the pile is 2 in. high, place a wooden block on it and clamp until dry. When dry, remove the leg and bind it with friction tape; two legs are made in this manner, one for the primary and one for the secondary. Now wind the primary coil on one leg; this coil consists of 605 turns of No. 20 d.c.c. wire. Leave a long starting end on the coil, and bind it down under the first layer of turns, to hold it firmly. Coat each layer, as it is wound, with shellac; if desired, two wooden spool ends may be made for the leg, to facilitate winding the coil evenly. After winding, place the coil in an oven, and bake slowly and thoroughly. Take care to leave plenty of wire at the start and finish of the coil for leads.

The secondary coil may now be wound on the other leg, which should be wrapped with two layers of tape and one of empire cloth. Wind on the 15-volt winding first; this consists of 85 turns of No. 18 d.c.c. wire, and the 2-volt winding, 11 turns of No. 14 d.c.c. wire, is wound over it. Shellac each layer as it is wound and leave long ends for connections. Shellac the whole coil thoroughly, then bake until completely dry.

Stand the two legs on end, and insert the side strips or laminations on one end, then reverse and fill in the other end. Coat the entire assembly with shellac, and allow it to dry. The top and bottom ends of the core should be clamped to prevent the transformer from humming. To do this, use either regular iron transformer clamps, obtainable from electrical supply houses at 25 cents each, or use bakelite strips and long screws, as shown in the drawing. These strips are $\frac{3}{4}$ by

$\frac{3}{4}$ by $6\frac{1}{2}$ in. in size, and the lower ones, in addition to being bolted to the transformer, are screwed to the base to support the transformer. One of the top strips also serves as a support for a 6-amp. cartridge fuse, which is placed in series with the fahnestock-clip anode terminal at the top of the tube, and the negative battery clip. Join the secondary coils, as indicated in the wiring diagram, by a soldered connection, and tape and shellac the joint. Screw or bolt the tube socket in position and connect the 2-volt secondary leads to the filament terminals. The 110-volt a.c. supply for the primary of the transformer can be connected with lampcord to a wall socket if desired, but the method of connecting shown in the drawing is preferable, as the battery can be placed on charge merely by throwing the switch.

To operate, see that the bulb is in the proper position, then connect the clip attached to the flexible lead from the fuse to the anode terminal at the top of the bulb. When the 110-volt a.c. current is turned on the bulb should glow with a bluish-white light. The 15-volt winding is now supplying alternating current, which is rectified by the tube; the resulting pulsating direct current charges the 6-volt radio or auto battery at the correct rate. As this method of charging is rather slow, it is recommended for radio rather than for auto batteries, where time is important.

For charging the ordinary 6-volt, 60-amp. hour radio battery, an overnight charge about every week or ten days will keep the battery "up" for average use, however, do not leave this to guesswork, use a hydrometer, and keep the electrolyte as near 1.280 sp. g. as possible; never let it fall below 1.175 before charging, if possible to avoid it. The cost of operation, for the average radio battery, is about 15 cents for each charge. The tubes are rugged, the one the author uses has been in operation for two years.

If the bulb does not glow when the current is turned on, disconnect the end of the 15-volt winding, where it is connected to the 2-volt coil, and connect it to the other end, that is, reverse the 2-volt connections. If it still refuses to glow, it may be necessary to add one or two more turns to the 2-volt winding, or five or six turns to the 15-volt winding, as the characteristics of the tubes vary a little. When the instrument has been found satisfactory, tape the coils to complete it. Do not place the charger in a box, away from the air.

Soldering a Broken File

A thin round file that had been broken in two was repaired satisfactorily by soldering, much to my surprise, ordinary solder, chloride-of-zinc flux, and an alcohol lamp being used in the process. I first tinned the broken ends and then heated them just enough to melt the solder. The ends were dipped in solder and were then held together until the solder had set. During the entire process I took great care not to heat the parts more than necessary to melt the solder, and as a result, found that the temper of the file was not injured except at the joint. The repaired file was found to be almost as strong as it was originally.—Wm. J. Edmonds, Rutland, Vt.

Sewing a Split Paddle

A split blade of a paddle or oar can be satisfactorily repaired by the simple process of sewing up the split with copper or brass wire. As a rule such a crack does not extend into the thick part of the blade and therefore the main consideration is to hold the edges of the crack securely together. To do this, punch or drill a series of small holes all along the crack, on both sides, about $\frac{1}{4}$ in.

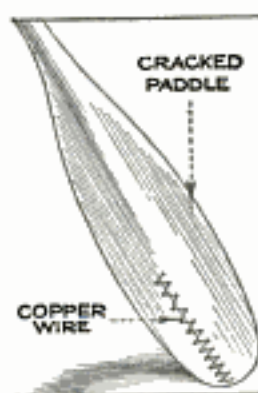

from the crack and $\frac{1}{2}$ in. apart. The holes should be staggered, those on one side coming halfway between those on the other side. Clamp or bind the blade so that the crack will be tightly closed, and then sew it together by passing the wire through the holes, beginning at the point farthest from the tip of the blade. When the tip has been reached, work back again, using the same holes. Finish off by twisting the two ends and fastening them down with a copper tack or a small brass screw. Use about No. 20 wire, and pull it tight at every stitch, taking care, however, not to break it at the sharp bends. As for the durability of such a repair, an oar repaired in this way has been used for an entire season without having any trouble at the seam. There are, of course, cases where this plan will not work, but in the majority of cases, where the edges are not broken apart on a long taper or bevel, the repair will be effective and permanent.

Simple Pump Filter

The old custom of tying a small cloth sack around the pump spout to filter the water is not recommended, as it is insanitary and unhandy. A much better filter and one that can readily be made is shown in the drawing; it consists of a tin-can lid, two rubber washers, a piece of copper screen, and a length of spring wire.

The inside of the lid is cut out equal to the diameter of the inside of the spout. The washers and screen are cut to fit inside of the lid. Ears are

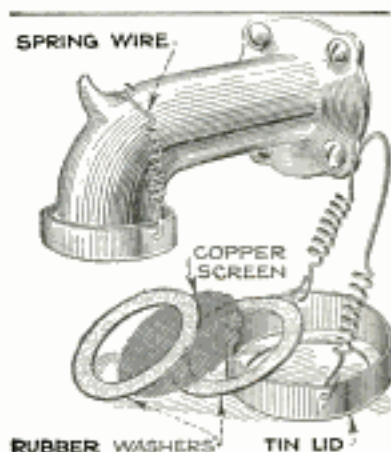

formed opposite each other in the side of the lid, and holes are punched in the ears to receive the ends of the spring wire, which is twisted to form a coil spring. A short section of the spring in the center and at each end is pulled open and straightened, and the ends are turned over to form hooks, which are brought through the holes in the lid.—J. V. Romig, Allentown, Pa.

formed opposite each other in the side of the lid, and holes are punched in the ears to receive the ends of the spring wire, which is twisted to form a coil spring. A short section of the spring in the center and at each end is pulled open and straightened, and the ends are turned over to form hooks, which are brought through the holes in the lid.—J. V. Romig, Allentown, Pa.

Convenient Mounting for Electric Fan

By mounting an electric fan on a camera tripod as shown in the photograph, the fan can be placed wherever desired, and can be adjusted to any desirable height. A circular wooden top is made for the tripod and is bolted to it by means of the screw on the tripod head.



On small fans that have only one speed, a lamp connected in series will cause the fan to run slower if desired.—K. H. Hamilton, Chicago, Ill.

Holder for Paper Rolls

An inexpensive and substantial holder for rolls of wrapping paper may be made from a short length of conduit, as shown in the drawing. Each end of the conduit

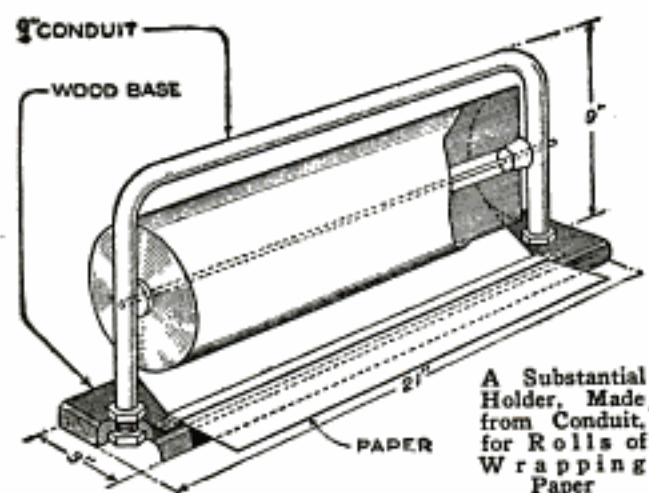

is bent at right angles at the proper points, and the ends are threaded for the nuts that hold it securely to the wooden base. A $\frac{1}{4}$ -in. or $\frac{3}{8}$ -in. hole is drilled in the center of each leg to accommodate a rod for supporting the roll. The rod is a trifle longer than the outside width of the holder, and is provided with a head on one end, and a thread and wing-nut on the other. The paper cutter that is attached to the base is made of light flat iron bent to the shape indicated, and fastened at the ends of the base with wood screws.—J. C. Bush, Duluth, Minn.

Grounding Generator When Battery Is Removed

When a storage battery is removed from an automobile for charging or repair, and the engine is run on the auxiliary magneto,

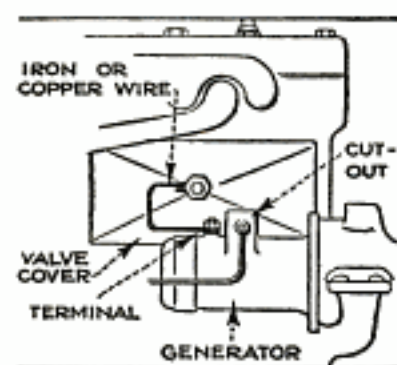

the generator should be grounded to prevent it from being damaged. To make a ground for the generator is an easy matter, as any piece of wire, insulated or not, can be used, this wire being connected to the terminal of the generator and to one of the nuts holding the valve covers in place, as shown in the illustration.

When a storage battery is removed from an automobile for charging or repair, and the engine is run on the auxiliary magneto, the generator should be grounded to prevent it from being damaged. To make a ground for the generator is an easy matter, as any piece of wire,

Stabilizing a Portable Typewriter

The main feature of several portable typewriters consists of an arrangement for folding the platen over the keyboard. When these typewriters are operated at high speed the platen is not very stable and consequently the letters are not printed evenly. This objectionable feature can be overcome by placing heavy rubber bands around the side arms so as to keep them together solidly. They can readily be removed when the machine is folded.—Charles I. Reid, New York City.

Leveling the Incubator

When an incubator is located in the cellar or basement it is usually necessary to lay small blocks under the legs to make it stand level, but it often happens that these blocks are accidentally dislodged, causing the incubator to tilt, and this not only shuts off the circulation of

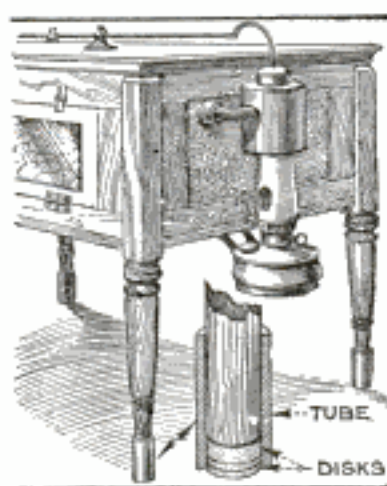

the water, but sometimes jars the eggs, which is very harmful for the setting. To overcome this trouble it is a good idea to place short lengths of tubing or pipe over the legs as shown, these pieces being free to slide up or

down. Circular disks of wood and cardboard, cut to fit inside the pipe, are placed under the legs. When the proper height is secured for each leg, the pieces of pipe are slipped down over the disks and this eliminates all danger of dislodging them, even though the incubator is moved over the floor.

Repairing a Damaged Gun

While on a hunting trip I had the misfortune to strike my gun on a rock, which made a deep dent in one barrel and also bent both barrels slightly. The dent was easily taken out by driving a hardwood rod, which was rasped down to the inside diameter of the barrel through the barrel several times. This nearly pressed out the dent. Then I forced a brass rod, fitting the barrel close-

ly, through in the same way, which completely took out the dent. To straighten the barrels I calipered both ends and center and drilled a hole in each of three blocks to correspond to the measurements taken. Then I sawed these blocks in half and placed the barrels in a carpenter's vise, placing the two blocks that fitted the ends between the barrels and the bench, and the other block between the barrels and the movable jaw of the vise. The end blocks were, of course, planed down so that the distance between the bottom of the groove and the side was equal to the thickness of the stationary jaw of the vise. By carefully screwing the vise down, I straightened the barrels out successfully.—Lewis B. Rogers, Downers Grove, Ill.

A Clinker Remover

The usual method of removing clinkers from a fire is a tedious job, but it is greatly facilitated by using the tool illustrated, made especially for this purpose.

It consists of two iron rods, one 1 in. and one $\frac{1}{4}$ in. in diameter, both about 5 ft. long. On the end of each rod a hook is shaped to the form shown, so that the clinker can easily be grasped between them. Two or three rings are welded to the $\frac{1}{4}$ -in. rod so that it can slide on

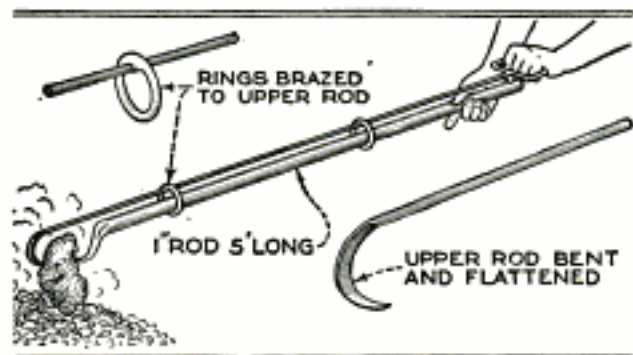

A Handy Tool, Made from Two Iron Rods, Facilitates the Removal of Clinkers from Fires

the larger rod. A handle is formed at one end of the smaller rod for convenience.

Fireproofing Paper

Paper can be made fireproof by immersing it in a strong solution of alum and water until the paper is saturated, and then permitting it to dry. Paper money can be fireproofed in this way. The paper is tested by holding it over the flame of a candle or match; if it ignites, the alum solution is not strong enough.

Fresh Water for the Farm Kitchen

Usually the fresh water pumped by the windmill goes to a reservoir outdoors, and from there to the kitchen, and there-

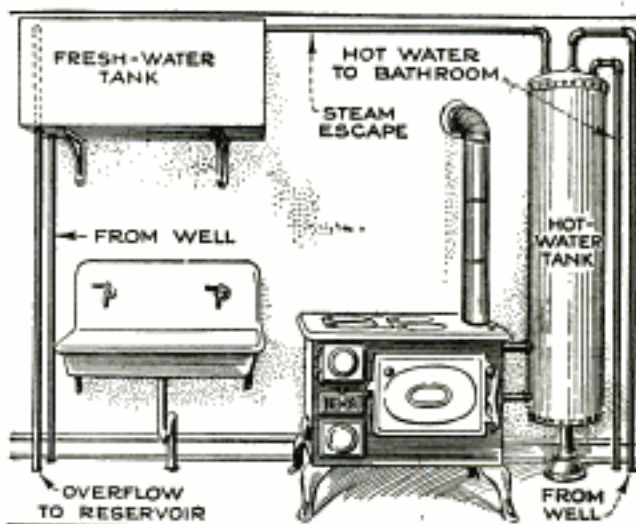

Fresh Well Water is Pumped into Tank in the Kitchen and from There to the Reservoir

fore the fresh water is not directly available in the kitchen. The drawing shows a system that first brings the freshly pumped well water into a tank located in the kitchen and from this tank, through an overflow, to the reservoir in the yard.

Improvised Gluing Clamp

A gluing clamp that is similar to a sawhorse in appearance and combines the advantages of both, has been found very useful for woodworkers. It consists of two rails of 1 by 3-in. material, about 6 ft. long, notched on the underside, and supported by two legs at each end. A vise screw is securely fastened at one end and a heavy block of wood, which serves as a movable jaw, fits the rails as shown.

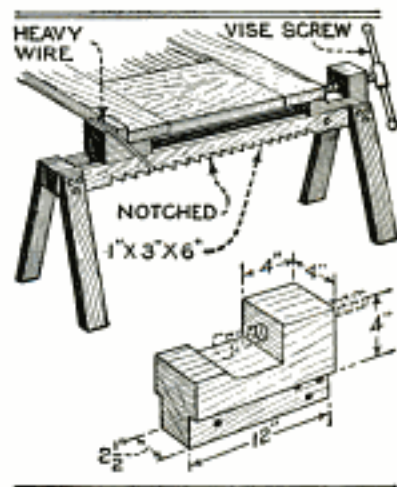

A groove is cut across the top and a heavy rod, bent to a rectangular shape, and with the ends securely twisted or welded together, is used to lock the block on the rails at any desired point. Woodwork of almost any size can be accommodated by such a clamp.

A Swinging Wood Box

When building a small hunting lodge, a Missouri man who remembered his youthful antipathy toward carrying wood,

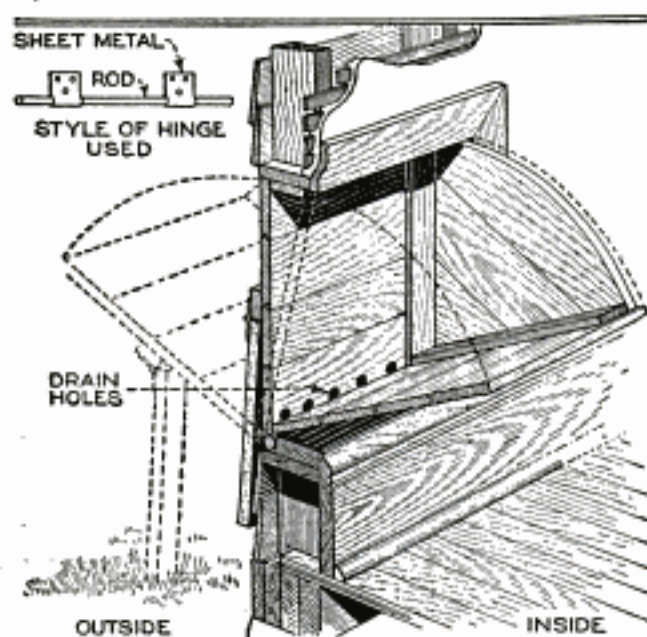

A Swinging Wood Box That can be Filled on the Outside of the House and Emptied Inside

installed in the wall a swinging wood box, which could be swung outward to be filled and then swung back inside again to its position next to the fireplace. It is built to resemble a feed trough, and, when viewed from one end, has the appearance of a 55° sector of a circle. It is pivoted on the bottom on a bar hinge, made as shown in the left-hand detail, and can be swung inward or outward freely. When it is in its normal position inside the house, the outer side of the box forms part of the exterior wall; and when swung outward for filling, the other side closes the opening in the wall and prevents cold air from entering. When swung outward the box is supported by a 2 by 4-in. leg, hinging on a cleat nailed on the outside. The top edge of the inner side comes against a cleat that is nailed on the top side of the opening. The box is naturally held in its inward position by gravity, but if desired, it can be fastened securely by an ordinary lock, attached to the wall above; and sliding into a keeper on the side of the box.—Ward L. Schrantz, Carthage, Mo.

☛An excellent holder for the back saw, when it is not in use, can be made from two clothespins, the heads of which are sharpened and set into holes drilled in the workbench. The saw fits between the upturned prongs.

Starter Troubles

Before blaming the starting motor or switch when the starter refuses to operate and the battery is known to be in good shape and fully charged, or nearly so, examine all terminals carefully, taking them off, cleaning thoroughly with a file or sandpaper, and scraping the battery-post clamps inside and out. Very often there is nothing wrong except dirty or corroded terminals, and cleaning will remove the trouble at once. Keep the battery posts and clamps clean and covered with vaseline to prevent corrosion, and be especially careful about the ground connections, which in many cars collect dirt, and rust or corrode.

It is also good practice to examine the starting-motor cables occasionally, and to renew them if the insulation is badly frayed or there are broken strands.

Locating Surface of Water in Well

A simple and accurate method of locating the surface of water in a well is shown in the illustration. A length of ordinary lampcord is connected at one end to a bell and dry cell, two or more dry cells being necessary if the lampcord is quite long. At the other end of the lampcord is connected an automatic switch, which operates upon striking water. The switch consists of a short length of $\frac{5}{8}$ -in. pipe with a wooden plug

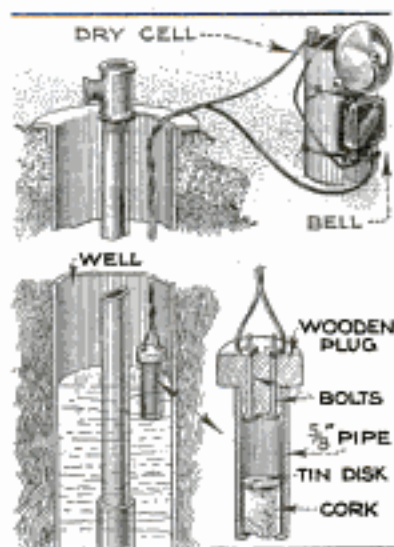

screwed into one end, and a cork, with a tin disk tacked on top, inserted at the other end, the lower edge of the pipe being hammered over to keep the cork from falling out. Two small-diameter brass bolts are passed through the wooden plug and the ends of the lampcord connected to them. The bolts are connected with each other electrically as soon as the cork rises in the pipe and pushes the tin disk against their heads, which closes the circuit and rings the bell, indicating that the surface of the water has been reached.

Ives Toys

MAKE HAPPY BOYS

TRAINS AND ACCESSORIES

**CUT THIS OUT WITH
THE IVES MANUFACTURING
CORPORATION**

207 Holland Ave., Bridgeport, Conn.



Gentlemen: I would like to know how to build a model railroad. I enclose ten cents for which please send me your new, smashing 28-page book (thirteen beautiful pages in full colors) showing Ives Locomotives and cars, Ives fleet of Power Boats and Model Yachts. It will tell me all about the different electric and mechanical locomotives; parlor-cars, buffet-cars, mail-cars, freight-cars, flat-cars, semaphore signals, tunnels, stations, etc.

Name.....

Address.....

City..... State.....

THE train illustrated below consists of a locomotive, Buffet-Car, Parlor-Car and Observation-Car and 8 pieces of curved and 4 pieces of straight track (2 Gauge, $2\frac{1}{4}$ " from center to center), one terminal section, control switch and connecting wire.

This is a wonderful set to start railroading with. Go to your dealer today and ask to see Ives Train No. 701. If he can't supply you, send us \$25.00 and we ship direct to you.

*"Side-track that freight!
Here comes the express!"*





Multiplying Man-power

To the man with pick and shovel the digging of holes for telephone poles is a slow and arduous task. Under favorable soil conditions three to five holes are for him an average day's work. Under adverse conditions perhaps he can account for only one. When the hole is dug, eight or ten men are required to raise the pole with pikes.

But the hole-borer with derrick attached, operated by only three men, can erect as many as eighty poles in a day—releasing for other telephone work upwards of forty men.

Hundreds of devices to quicken

telephone construction, to increase its safety to the employee, and to effect economies are being utilized in the Bell System. Experiments are constantly being made to find the better and the shorter way to do a given job. Each tool invented for the industry must be developed to perfection.

In the aggregate these devices to multiply man-power mean an enormous yearly saving of time, labor and money throughout the whole Bell System. Without them telephone service would be rendered neither as promptly, as efficiently nor as economically as it is to-day.

"BELL SYSTEM"

AMERICAN TELEPHONE AND TELEGRAPH COMPANY
AND ASSOCIATED COMPANIES

One Policy, One System, Universal Service, and all directed toward Better Service



ERECTOR

The famous construction toy

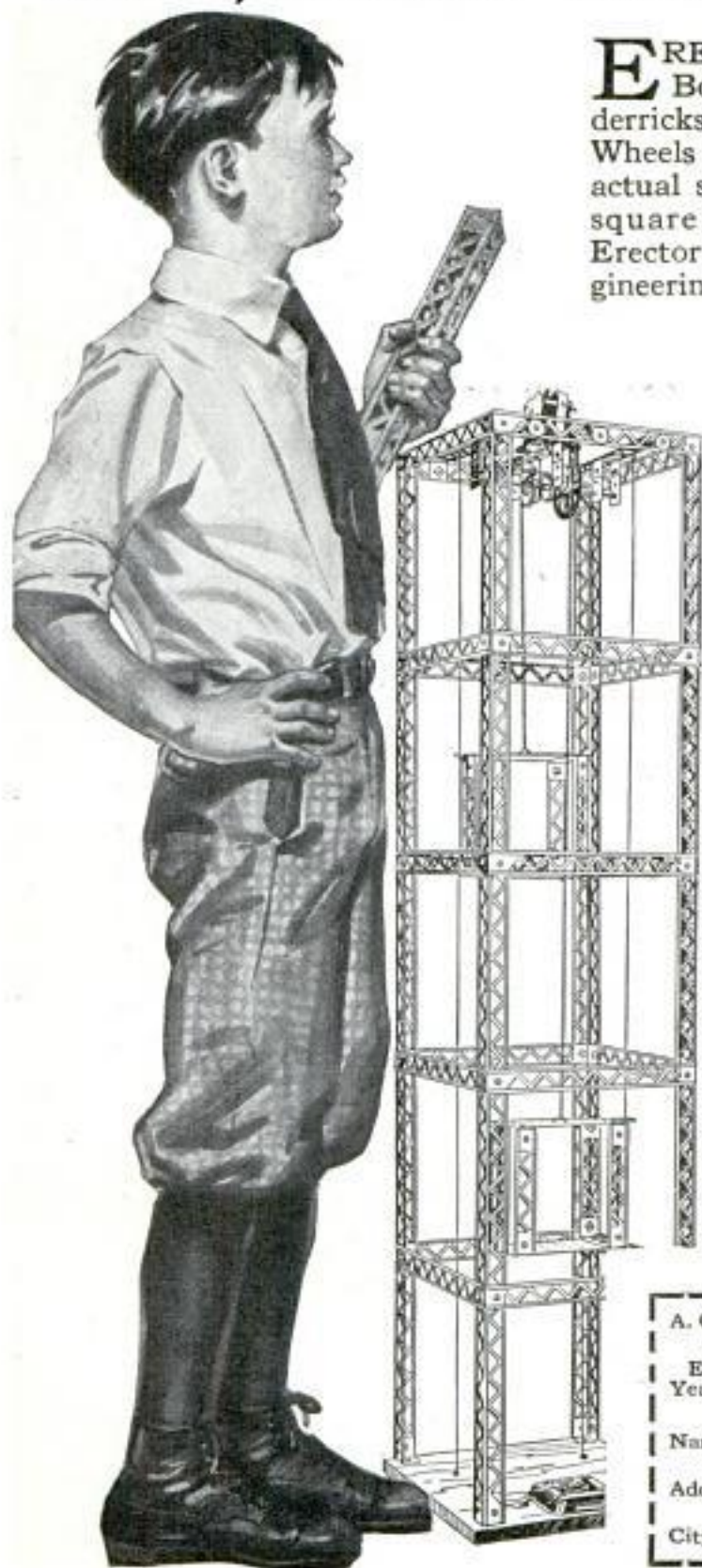

ERECTOR is the best fun in the world. Boys make wonderful bridges, cranes, derricks, windmills, railroad signals, Ferris Wheels and machinery. Erector is the only actual structural steel toy with four sided square columns. Every boy owning Erector is made a member of Gilbert Engineering Institute for Boys without cost.

In addition to the many designs shown in the manual accompanying each set, he can win diplomas, honors and awards with original models.

THE A. C. GILBERT CO.
New Haven, Conn.



*Gilbert
Erector
No. 4*

\$5

THE most popular set. It contains hundreds of parts and is also equipped with a sturdy electric motor to operate cranes, draw bridges and machinery models.

SEND 10 cents to-day for Gilbert Year Book for 1924. Chock full of interesting articles for boys, chemical experiments, athletic sports, tricks, useful articles any boy can make, story of great engineering feats, etc. etc., as well as a complete catalogue of Gilbert Toys.

A. C. GILBERT COMPANY

213 Blatchley Avenue, New Haven, Conn.

Enclosed please find 10 cents for which send me Gilbert Year Book for 1924.

Name.....

Address.....

City..... State.....



Bench Lathe No. 125
Price \$36.00

Handle Real Mechanics' Jobs Yourself



Mr. Punch says—

"If you have a bench lathe, you don't have to go running around asking favors whenever you have a turning or boring job to do."

Slide Rest No. 132
Price \$16.00

Countershaft No. 130
Price \$11.00

With a good bench lathe, anyone who is handy with tools can do almost any kind of a turning or boring job well.

The Goodell-Pratt Bench Lathe illustrated is just the right size for home use. Length over all, 25 inches. Height, 11½ inches. Swing, 7 inches. Extreme distance between centers, 12 inches.

Another size, No. 494, has a larger tee rest and a larger bed, being 18 inches between centers. Length over all, 31 inches.

With every lathe is included an adjustable tee rest, a slotted face plate, a saw arbor and a drill chuck with a No. 1 Morse taper shank. The chuck holds round shanks of all sizes from 0 to ¼ inch.

Other Good Tools

If you are familiar with the Goodell-Pratt line, you know that there is a tool made for almost every conceivable kind of a job.

Each of the 1500 Goodell-Pratt Tools is made for good workmen by good workmen—toolsmiths who have spent their lives in the business.

Write for Catalog No. 15. It's free.

GOODELL-PRATT COMPANY

Toolsmiths

Greenfield, Mass., U. S. A.

GOODELL-PRATT

1500 GOOD TOOLS

Trade Mark Registered
WURLITZER
 200 YEARS OF MUSICAL INSTRUMENT MAKING

**Professional and Amateurs
 Praise Wurlitzer Instruments**

"I am proud to be the owner of one of your new cornets. The tone, tune and valve action are positively superior to any I have experienced in all my years of cornet playing."

Harry L. Jacobs
(Soloist with Sousa's Band, Brooks' & Murray's Band, Chicago Grand Opera)

"If I could not get another like it, my Wurlitzer saxophone could not be bought from me for \$200.00."

J. Russel David, Rockford, Ind.

"Without your credit system it would have been impossible for me to own this beautiful instrument."

Arthur M. Samp, Madison Wis.



**Try It
 in Your
 Own Home**

WURLITZER will send you any instrument for a week's trial in your own home. No obligation to buy—no expense for the trial—you do not risk a penny. Wurlitzer instruments are known the world over for artistic quality and excellence of workmanship. Used by the greatest musicians, bands and orchestras. The House of Wurlitzer has made the finest musical instruments for over 200 years.

Easy Payments

Payments are conveniently arranged in small monthly sums—a few cents a day will pay. All instruments to you at lowest factory prices. Special combination offers on complete musical outfits—velvet lined case, all accessories, self-instructor, etc.—everything you need at practically the cost of the instrument alone.

Send for New Catalog!

The greatest musical catalog ever published! Over 3,000 articles—every known instrument described and illustrated—many of them shown in full colors.

Wurlitzer has stores in over 30 cities, but no matter where you live, Wurlitzer is no farther than your nearest mail box. Send coupon today.

The Rudolph Wurlitzer Co., Dept. 1778

117 E. 4th St., Cincinnati — 329 So. Wabash Ave., Chicago
 120 W. 42nd St., New York — 250 Stockton St., San Francisco

Send me your new catalog with illustrations in color and full descriptions of every known musical instrument, also details of the Wurlitzer Free Trial Easy Payment Plan. No charge, no obligation.

Name.....

Address.....

(State musical instrument in which you are interested.)

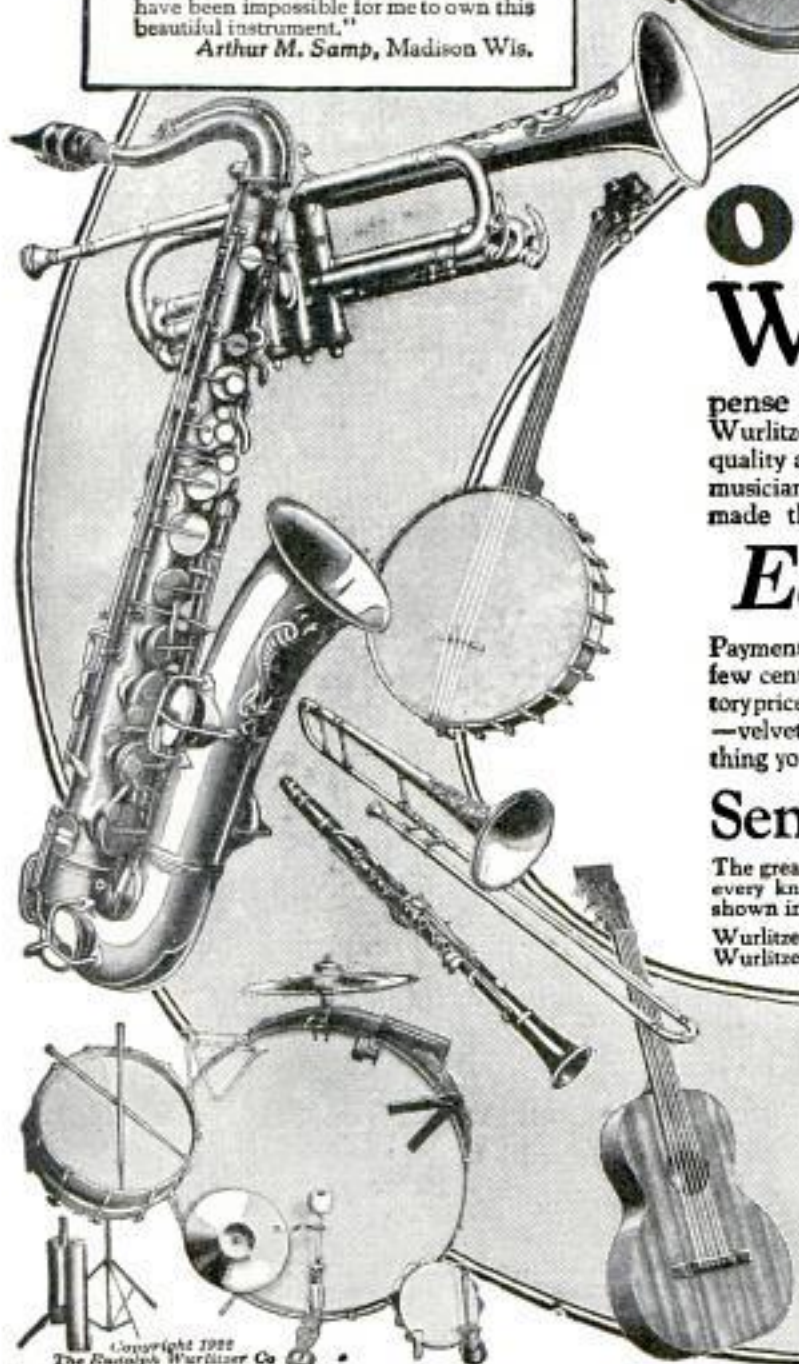

Copyright 1922
 The Rudolph Wurlitzer Co.

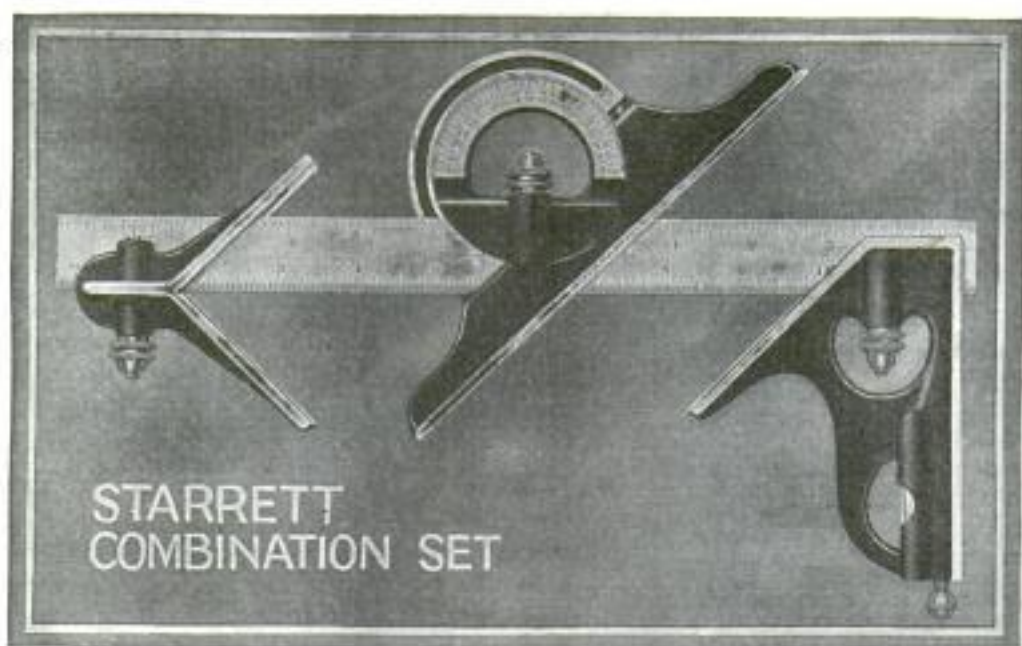

"The most useful tool ever built"

YOU ought to own one of these famous Starrett Combination Sets. With its Drop-Forged Steel Combination Square, Reversible Protractor Head and the Center Head, here's a practical, handy tool that for general all-round work has yet to be equalled.

The Combination Square (with Spirit Level and Scriber in the Head) alone gives you seven tools in one—Rule, Square, Miter, Depth Gage, Height Gage, Marking Gage, Level and Plumb. Add the Protractor and Center Head, and you've got a set of accurate tools that you'll use constantly in a hundred and one different operations.

And useful as it is, the Starrett Combination Set (No. 434 is illustrated) takes up but little room in your kit and saves littering the bench with the separate tools needed to do the same work.

Heads slide easily along the Blade and can be instantly removed or clamped at any desired position. All parts nicely finished, of the best workmanship and reliably accurate. For doing close work easier, you'll find the purchase of one of these Starrett Sets the best investment you ever made.

For complete description of the different Starrett Sets and Attachments, write for the Starrett Catalog No. 22 AP.

THE L. S. STARRETT CO.

The World's Greatest Toolmakers
Manufacturers of Hacksaws Unexcelled
ATHOL, MASS.

a few uses—

Machinists

Laying out
Bench work
Leveling shafting, etc.
Setting up machine tools

Auto-Mechanics

Lining up shafts, bearings, connecting rods, crank shafts, etc.
Truing cylinders
Checking up valve seats
Timing valves

Carpenters

Laying out mortises, tenons, dentils, stringers, etc.
Cutting rafters and jacks
Scaling blue prints
Leveling and plumbing jambs, casings, etc.
Marking gage, rabbit gage, butt gage, etc.

5757

Starrett Tools



1088 Diamond Bargains

YES—1088 of the best diamond bargains you have ever seen. See these—also hundreds of diamonds and other jewels in the latest issue of "The Diamond Bargain List." Send today for this money-saving book. See the wonderful offerings that give amazing opportunities to purchase diamonds and other bargains at special low prices.

60% of Market Price will Buy Diamonds Here



Here's why we can offer such remarkable values: This famous 75 year old firm—rated at over \$1,000,000.00 capital—the largest and oldest diamond banking institution of its kind in the world, has made loans on diamonds, watches, and jewels in excess of \$25,000,000.00.

Why Pay Full Prices Costs Nothing to See

We now have thousands upon thousands of unpaid loans and other special advantage bargains that we must sell to get back our cash. Loan Value—not market value is our price basis on unpaid loans. Send now for Bargain List. Don't delay. Learn all about the startling offerings that you can get at a fraction of their real value. The Buys of a lifetime. Costs nothing to see.

FREE—On Approval!

The "Buys" of a Lifetime!

At our risk—we send you any bargain you wish for absolutely free examination. No red tape. No reference required. No obligation. Compare it carefully. Have it valued any way you wish. Don't buy unless satisfied you can not match the bargain at 60 per cent more. If you decide not to buy, you are not out one penny. See how much we can save you—or see how much more we can give at other's prices.

As Low As \$60 Per Carat

Not all, but some. Yes, some even lower priced, also finest gems obtainable at higher per carat, but proportionately low Bargain Prices. Get a diamond now around half its market price.

Send for Latest List of Diamond Loans

Entirely different from the ordinary catalog. You will find hundreds of Diamond Bargains described in full detail with exact weight, color, quality, etc., which hardly any others do. You know what you're buying before you buy. Besides the Bargain list tells of Guaranteed Loan Value, unlimited exchange privilege at full price paid, and complete details of free examination offer.

Use Coupon Now!

Or just send name. Postal will do. We'll send our latest Bargain list. It's free. No obligation. No expense. Write now.

Jos. De Roy & Sons
1914 De Roy Building
Only Opposite Post Office
Pittsburgh, Pa.

References by permission:—
Bank of Pittsburgh—N. A.
Marine National Bank—
Union Trust Co. Pitts-
burgh, Pa. Your bank
can look us up in mer-
cantile agencies.

Name

Address

Guaranteed Cash Loan!

Diamonds bought here are like insurance policies. You know what you can borrow before you decide to buy—SEE OUR CASH BACK GUARANTEE!



JOS. DE ROY & SONS

PITTSBURGH, PA.

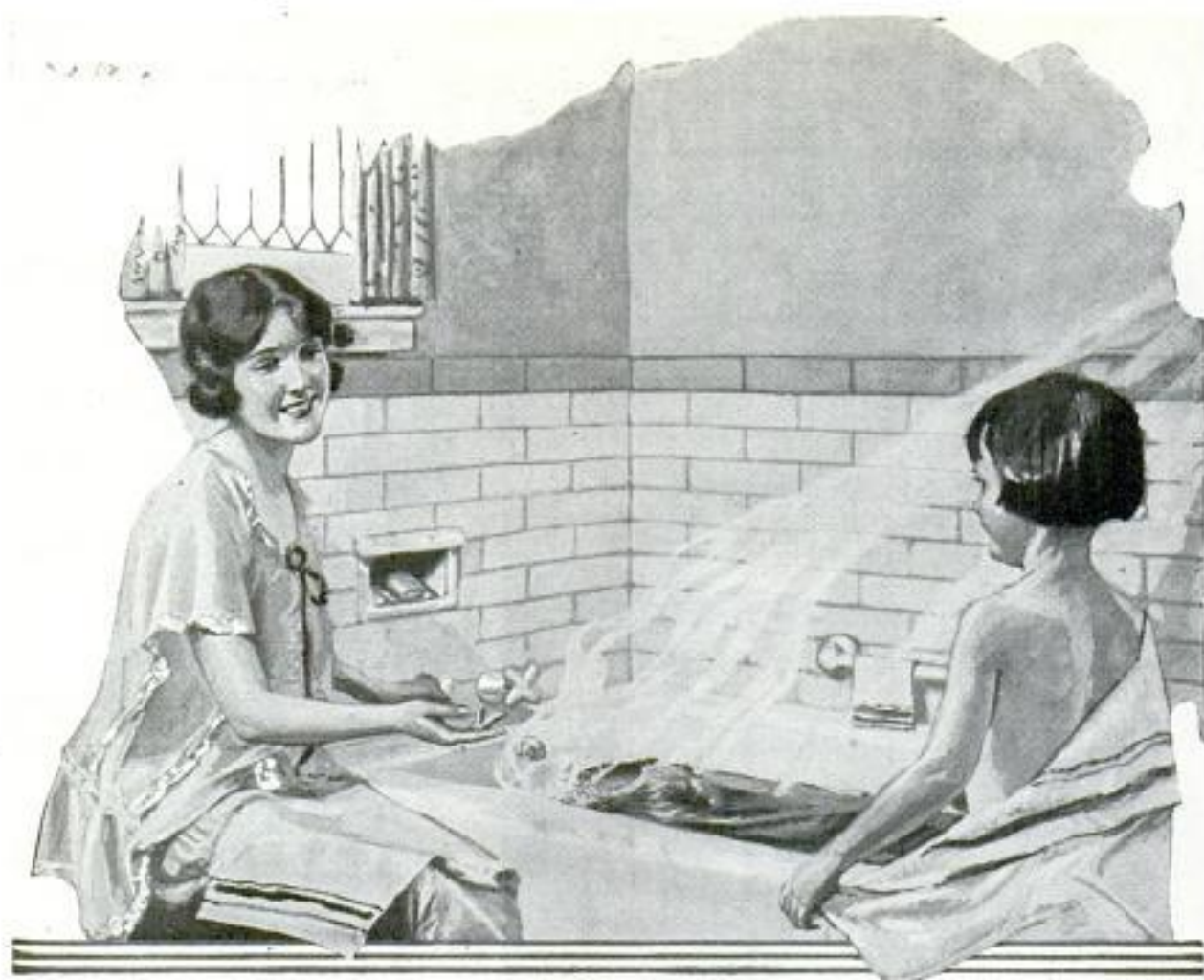

The new oaken bucket

"I wish to do something both great and useful for Paris," said Napoleon to an advisor. "Give it water," was the reply.



This monogram, which you see upon electric motors, generators, fans and lamps is the symbol of a nationwide organization for the service of every community which wants to make electricity do more and better work—the General Electric Company

No longer do city homes depend on wells or nearby rivers. The old oaken bucket is replaced by electrically driven pumps. In Detroit, for instance, eight 100 h. p. General Electric motors in one station drive pumps which supply 720,000,000 gallons a day.

GENERAL ELECTRIC

ONLY
\$ **3**
DOWN
and you
keep this
typewriter



DIRECT
to you
from our
Factory

Big Saving
In Price

Yes, we will ship you this Genuine Underwood

Rebuilt in our own factory just like new for
ONLY \$3 down—NOT ONE CENT MORE

Until you have tried the machine 10 full days at our expense



Our Factory

Write Right Now

and learn how it is possible for us to ship you this Underwood Typewriter upon our **free trial** plan and our **direct-to-you money saving methods**. Get the full details now—just sign the coupon and mail today. Get all the facts—then decide.

No Obligation

—to buy. You don't have to order. Just sign the coupon, send it to us and we will mail you our big catalog absolutely free.

Send the
Coupon
Today

10 Days'
Free Trial

You have ten full days in which to try the typewriter before deciding whether you want to keep it. Give it every test—see for yourself—make the Underwood prove its worth to you. Don't take our word for it—put the Underwood before you and see if you don't think it the greatest typewriter bargain ever offered.

This is the genuine Underwood Typewriter. We offer you the same three models of the Underwood Typewriter being made and sold by the manufacturers today. **Standard 4-row single shift keyboard. Absolutely visible writing—the full line of typewriting is visible at all times.** All the improvements and attachments that any high grade typewriter ought to have.

Big Saving to You

Our plan of selling to you **direct** makes possible enormous savings, which are all for your benefit. **Send in the coupon and we will send you prepaid** our big catalog, including "A Trip Through Our Factory." This shows how the Shipman-Ward Rebuilt Underwood is the best that can be produced at our **Special Price**.

EVERY MACHINE is fully guaranteed. New parts wherever needed. New enamel, new nickel, new lettering, new platen, new key rings—a complete, perfect typewriter. Impossible to tell it from a brand new Underwood either in appearance, durability or quality of finished work.

An up-to-date machine with two-color ribbon, back spacer, stencil device, automatic ribbon reverse, tabulator, etc. In addition we furnish **FREE** waterproof cover and special Touch Typewriter Instruction Book. You can learn to operate this Underwood in one day.

Big Book FREE

Our big handsomely illustrated catalog will be sent **free** on request. It tells you all about the advantages of owning a **STANDARD SIZE UNDERWOOD**; how and why this machine will last for years, saving many dollars not only in the purchase price but in its operation.

Send in the coupon and let us send you this beautifully illustrated book **FREE** without any obligation whatever.

Shipman-Ward Mfg. Co.
"Typewriter Emporium" 2128 Shipman Bldg.
Montrose and Ravenswood Aves., Chicago

don't have to do a thing to get our big **Free** catalog and complete details of our amazing

typewriter offer except to sign and send in the coupon. There is no obligation.

**FREE TRIAL
COUPON**

SHIPMAN-WARD MFG. CO.
2128 Shipman Bldg., Chicago

Please send me **FREE**, all charges fully prepaid, your **BIG NEW** catalog of **UNDERWOOD TYPEWRITERS** and complete details of your **FREE TRIAL Offer**.

It is understood that I am under no obligation whatever and that this is to be sent without one cent of cost to me.

Name.....
Street.....
City..... State.....

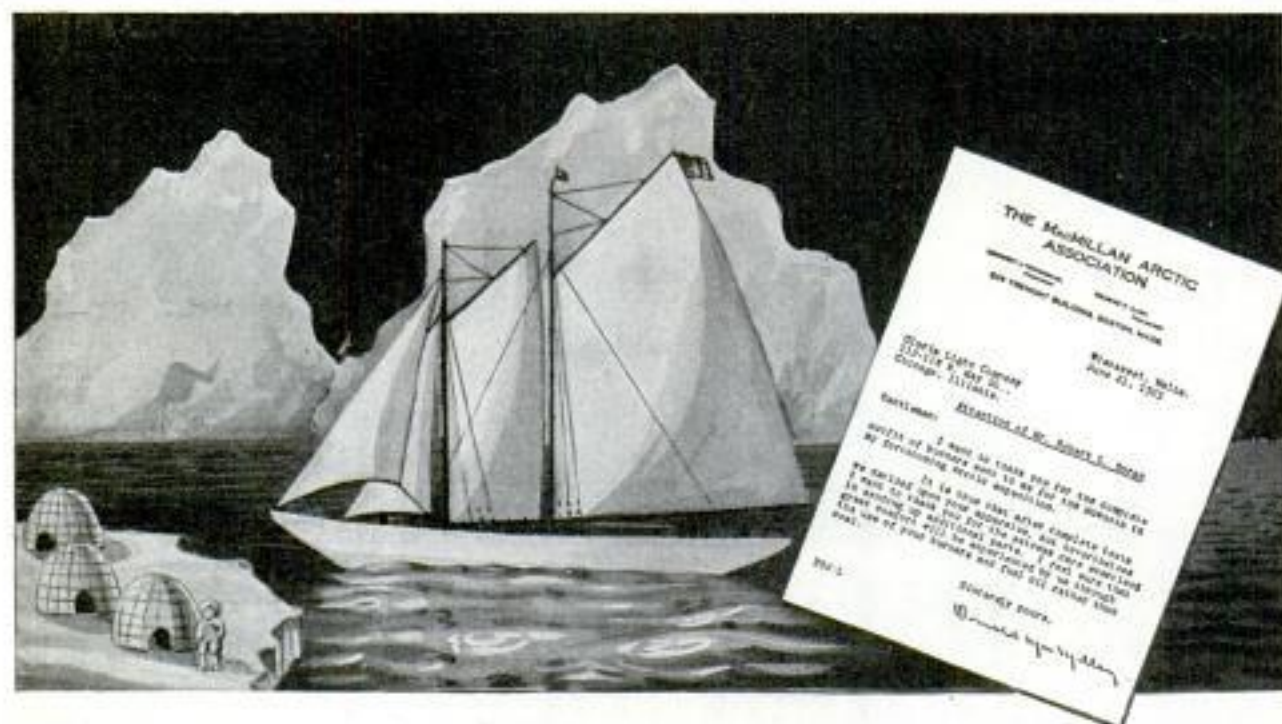

Science Conquers the Cold of the Arctic Circle

Donald MacMillan, the great explorer who went to the North Pole with Peary, has chosen Oxo-Gas in preference to all other methods of heating submitted. A full two years' supply of Oxo-Gas, the new scientific fuel, could be stored in much smaller space and at far less cost than coal or wood. In fact, the use of Oxo-Gas reduced the fuel space to such an extent as to make it possible to install a complete broadcasting and receiving radio outfit on the vessel, thus keeping the explorers in touch with the world, besides keeping them thoroughly comfortable and reducing their work to a minimum.



These two illustrations show all there is to a complete outfit: The Heater, which is put in the stove, without making any alterations, and the tank to hold the oil. A small, flexible pipe conveys the oil to the Heater, where it is converted into OXO-GAS.

The Most Efficient Fuel Known to Science

Oxo-Gas is made from Kerosene, Stanolin or Distillate.

The Vapor (4%) is mixed with air (96%). This Mixture creates a non-carbon blue flame of high heating intensity.

Which Heats indestructible perforated lava discs to incandescence, thus increasing the heat units of the fuel from 25% to 30% by refraction.

Will Operate from eight to ten hours on one gallon of Kerosene, Stanolin or Distillate. Two gallons of kerosene (according to Government tests) will make heat units the equivalent of 1,000 feet of city gas.

Fifty Gallons of kerosene equal to a ton of the best coal, a cord of wood or 25,000 feet of gas.

Kerosene is the only fuel delivered anywhere in any quantity. The oil man can serve ten customers cleanly and efficiently while the coal man serves one.

Over a Million Oxo-Gas plants are giving incomparable service to delighted users for cooking and heating.

Oxo-Gas appliances are absolutely guaranteed by a responsible corporation. References: Dun and Bradstreet Mercantile Agencies or any bank in the United States.

Oxo-Gas is equally efficient Summer or Winter. An abundance of heat in the Winter. Cooler than any other method of cooking in the Summer, because the heat can be shut off instantly when not in use.

OXO-GAS is, in fact, the only logical substitute for the diminishing supply of coal with its consequent high price!

Send for Catalog

illustrating and descriptive of twenty different, distinctive designs of heaters for all purposes.

Agents Wanted Some choice territory for Oxo-Gas agencies and distributorships still open to thoroughly responsible parties. Your own locality may yet be unassigned. If you can qualify, we offer you a genuine opportunity to make \$10,000 a year and more. Just write and ask us for our agent's proposition, and we will discuss the matter with you either by mail or in person.

Gloria Light Company, 133 N. May St., Chicago, Ill.

21 Jewel Santa Fe Special

Sent
on

21 Perfect Jewels
Adjusted to Positions
Adjusted to Temperature
Adjusted to Isochronism
Adjusted to the Second
25 Year Gold Strata Case
Your choice of Dials (including
Montgomery R. R. Dial)
New Thin Models. All sizes.

Approval

WHILE other watch dealers are raising their prices, asking you for larger monthly payments, and making payment terms harder for you to meet, we are offering you our new model Santa Fe Special, no advance in price, no money down, easier terms and smaller monthly payments. We realize the war is over and in order to double our business we MUST give you pre-war inducements, better prices, easier terms, and smaller payments

Send No Money Without one penny of advance payment let us place in your hands to see, to examine, to inspect, to admire, to approve a real masterpiece in watch creation. Our determination to this year double our sales of the world famous Santa Fe Special and Bunn Special Watches prompts this matchless offer.

Santa Fe's "New Elite"

This Artistic dependable Ladies' Wrist Watch, fitted with genuine Illinois Springfield movement. A perfect timepiece. Beautiful 14 Karat white or green solid gold case. Many designs—Ask for New Watch Book showing New Elite case designs in color. Watch sent on approval and sold on payments.

Page 12 of Our Watch Book Is of Special Interest to You!

Ask for our Watch Book free—then select the watch you would like to see, either the famous Santa Fe Special or the 6 position Bunn Special, and let us explain our easy payment plan and send the watch, express prepaid, for you to examine. No money down. **REMEMBER**—No money down—easy payments buys a master timepiece—a 21 Jewel guaranteed for a lifetime at about half the price you pay for a similar watch of other makes. No money down. A wonderful offer.

SANTA FE WATCH COMPANY
Dept. B6, Thomas Bldg. TOPEKA, KANSAS
"Home of the Great Santa Fe Railway"

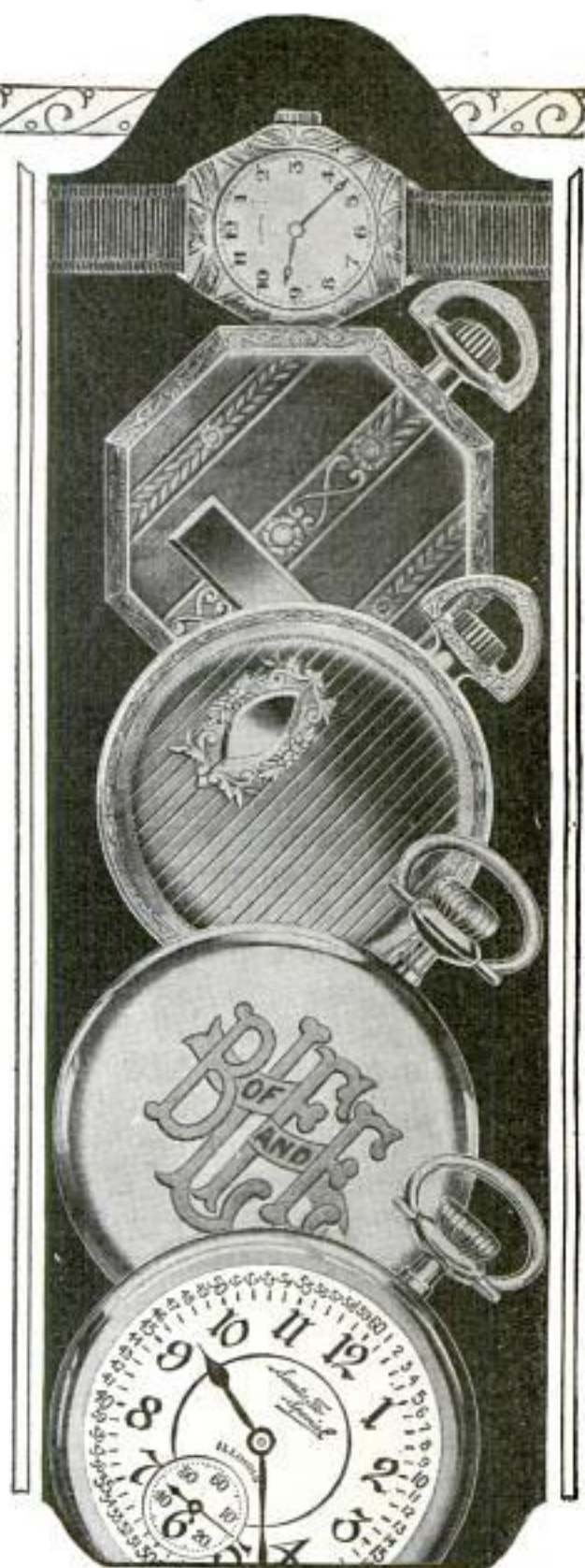

SANTA FE WATCH CO.
Dept. B6, Thomas Bldg., Topeka, Kans.

Please send prepaid and without obligation your Watch Book free, explaining your "No Money Down" Offer on this Santa Fe Special Watch.

Name.....

Address.....

State.....

Radio Catalogue Free—

**Write us
a post card—
Address Dept. 6-R**

and we will send you free this 52 page catalogue of radio sets and parts. It also contains explanation of radio terms, map and list of broadcasting stations and much radio information, including an explanation of successful hook-ups and circuits.

You will be amazed at the low prices Ward's quote. A complete tube set having a range of 500 miles and more, including tube, head set, batteries, and antenna equipment, as low as \$23.50.

This catalogue contains everything for the expert and amateur. Complete sets and every improved part for building sets, all the most up-to-date devices—at the lowest possible prices.

Headquarters for Radio

Montgomery Ward & Co. is headquarters for Radio, selling everything direct by mail without the usual "Radio-profits." Why pay higher prices? Ward quality is the best and the prices will often save you one-third. Everything sold under our Fifty Year Old Guarantee—Your Money Back if You Are Not Satisfied. Write today for your copy of this complete 52-page Radio Book.

Write to our house nearest you. Address Dept. 6-R
Chicago Kansas City St. Paul Portland, Ore. Ft. Worth

Montgomery Ward & Co.

The Oldest Mail Order House is Today the Most Progressive



Thousands Now Find It EASY to Make Their Own MUSIC



with a

BUESCHER True-Tone Saxophone



TOM BROWN
Director
Six Brown Brothers
Saxophone Sextet
Victor Records



BEN SELVIN
Director
Selvin's Orchestra
Aeolian-Vocalion
Records



DAN RUSSO
Director
Ortola Orchestra
Brunswick Records



BENNIE KRUEGER
Director
Bennie Krueger and
His Orchestra
Brunswick Records

These Famous Saxophone Players

whose portraits are shown—use and recommend Buescher True-Tone Saxophones. Almost without exception, the great Professionals use Buescher Instruments exclusively. They are so flawless in scale, so perfect in tone and so accurate mechanically that more than 75 per cent of the popular Phonograph Records are played with them.



JASCHA GUREWICZ
Former Soloist
with Sousa's Band
Electric Records



CLYDE C. DOERR
Director
Clyde Doerr's Orchestra
Victor Records



NATHAN GLANTZ
Director Nathan Glantz
and His Orchestra
Edison and
Other Records



KEITH PITMAN
Manager
S.S. Leviathan Orchestra
Victor Records

Everyone has a perfectly normal desire to produce music, but the average person has not the time nor patience to spend months or years in learning to play. Heretofore, the making of music has been the privilege of the talented few.

But now it is different. With this wonderful new saxophone, Buescher has made music a universal accomplishment, and has placed it within the possibility of practically everyone.

See How Easy It Is

With the aid of the first three lessons, which are sent free (upon request) with each new Saxophone, the scale can be mastered in an hour; in a few weeks you can be playing popular music. Practice is a pleasure because you learn so quickly. You could even take a place in a band or orchestra in 90 days, if you so desired.

Wins a Welcome Everywhere

You're always welcome with a sweet-toned Buescher Saxophone. Thousands of men and women, of all ages, have found it an infallible key to social popularity. For home entertainment, for church, school or lodge affairs, the Saxophone is the most popular and adaptable instrument. Saxophone players enjoy, also, many opportunities of earning money. They are always in demand for dance orchestras.

Free Trial Six days' Free Trial of any Buescher Grand Saxophone, Cornet, Trumpet, Trombone or other instrument. Easy terms of payment arranged. Mention instrument interested in and complete catalog will be mailed free.

A Remarkable Saxophone Book—Free!

We have prepared a very interesting book on the history and development of the Saxophone. It tells which saxophone takes violin, cello and bass parts, and many other things you would like to know. Also illustrates first lesson. It is sent free on request. Just send a postcard or clip and mail the coupon.

BUESCHER BAND INSTRUMENT CO.

Everything in Band and Orchestra Instruments
2599 Buescher Block, Elkhart, Ind.

Buescher Band Instrument Co.
2599 Buescher Block, Elkhart, Ind.

Gentlemen:
I am interested in the instrument checked below:

Saxophone..... Cornet..... Trombone..... Trumpet.....
(Mention any other instrument interested in)

Name

Street Address

Town..... State.....

THE GREATEST FIELD THERE IS

except electricity and applied motive power, is the range for ORIGINAL ideas—creative notions—of useful things now made by casting or other means, which might better be produced in

PRESSED METAL

Can't you think of something?—Look around. What article is in sight that is METAL, and that is made by casting or otherwise, that ought to be made of PRESSED METAL with greater speed and greater ease and greater economy and at least as great efficiency? (Take another look around.) Then

Write for the PRESSED METAL BOOK

The **Pressed Metal** industry includes many of the largest high-class manufacturing concerns in the United States, and through the Pressed Metal T. E. C., welcomes the co-operation of every bright mechanical mind in the country, on a cash basis.

“JUST A THOUGHT”—NOT A PATENT

Sell us a practical idea *of some new and useful WAY* to utilize Pressed Metal *in place of other materials*. The undersigned will promptly pay cash for every acceptable suggestion approved by our Engineering Advisory Board. The *FREE BOOK* gives you the facts and procedure.

**DO NOT SEND US PATENTS OR MODELS
JUST WRITE FOR FREE PRESSED METAL BOOKLET**

It tells all the conditions and the amounts to be paid for the successful ideas, and also how to protect yourself against misappropriation of your creative thoughts by others. **WRITE TODAY.** (A post card will do, but please make it easily legible so it can be properly filed and acknowledged.) Address

PRESSED METAL TRADE COUNCIL

27 QUINCY STREET, SUITE 1701, CHICAGO



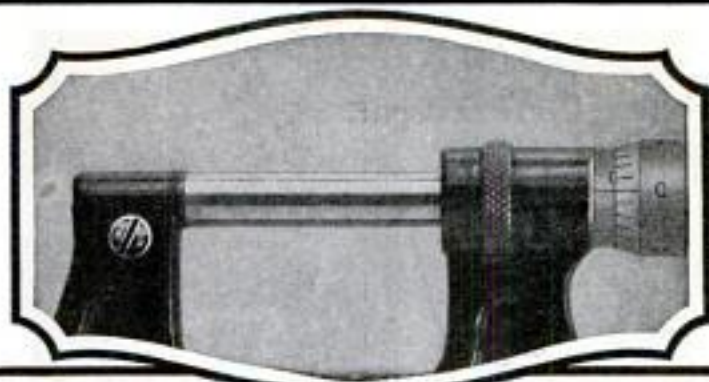

The Accurate Fit of the Spindle and Anvil

The Third Point of Superiority of Brown & Sharpe Micrometers

3

The three vital points of Micrometer construction which we have described are good reasons for the superiority of Brown & Sharpe Micrometers. You will find more valuable information in our booklet, "The Micrometer." Write for it today.

THE third point of superiority of Brown & Sharpe Micrometers lies in the accuracy with which the spindle fits in the frame and the squareness with which the measuring surfaces of the anvil and spindle come together.

The fact that Brown & Sharpe Micrometers have been giving faithful service for 30 and 40 years indicates the quality of material used and the accuracy of fitting the spindle in the frame and lapping the faces of the spindle and anvil.

The general appearance of Brown & Sharpe Micrometers, together with the accuracy of the measuring screw, graduations and measuring surfaces, give every mechanic a Micrometer to be proud of and one that will give long, dependable service.

A close inspection of a Brown & Sharpe Micrometer clearly indicates the reason for its popularity with mechanics the world over.

Small Tool Catalog No. 28 describes the complete line of Brown & Sharpe Tools. Write for a copy today.

BROWN & SHARPE MFG. CO.
PROVIDENCE, R. I., U. S. A.

BROWN & SHARPE TOOLS

\$25 A DAY
Clear Profit

—every day you work. Make \$5,000 to \$10,000 a year in the Floor Surfacing Business with the American "Universal" method. Work for yourself. Experience, special training or large investment unnecessary.

New Field; Big Profits

Better floors are demanded everywhere. American "Universal" electric machine, doing work of six men, assures **BIG PROFITS** in this new uncrowded field. Every floor,—old or new,—in town or city, is your prospect. Work easy to get. Profit possibilities unlimited. Positive guarantee and 5-day trial offer protects you. Write today for complete details.

AMERICAN FLOOR SURFACING MACHINE CO.
523 S. St. Clair St., TOLEDO, OHIO

CLASS PINS

FREE CATALOG GIVE NAME OF SCHOOL OR CLUB AND NUMBER IN CLASS



Either pin illustrated made with any 3 letters and 2 figures, 1 or 2 colors enamel Silver plate, 25¢ ea., \$2.50 doz., Sterling silver, 40¢ ea., \$4.00 doz. Write for catalog of sterling and solid gold pins and rings.



Bastian Bros. Co. 548 Bastian Bldg., Rochester, N.Y. 3529

FOLDING SAWING MACHINES \$21.95

Fitted with Atkins Silver Steel Guaranteed Saw



9 cords in 10 hours by one man. It's King of the woods. Catalog X115 free. First order gets agency. Established 1890.
FOLDING SAWING MACHINE CO., 1005 East 75th Street, CHICAGO, ILLINOIS

"I Can Do the Job in a Jiffy"

**A
TORIT
TORCH**
No. 13

will not only do radiator repairing quickly and efficiently, but saves time in general soldering, wire splicing, light brazing, loosening corroded nuts and bolts, and hundreds of other jobs. Thousands in use are earning big profits.



USES ACETYLENE ONLY

A splendid use for old auto-acetylene tanks. Easily carried to the job. Ready the instant you light torch. Outfit complete including torch, 4 different tips, soldering copper, 5 ft. hose and tank connection. **\$7.50**

Order from your jobber, or

ST. PAUL WELDING & MFG. CO.
177 W. Third Street St. Paul, Minn.

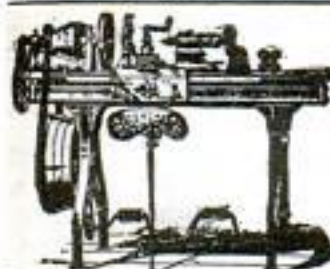
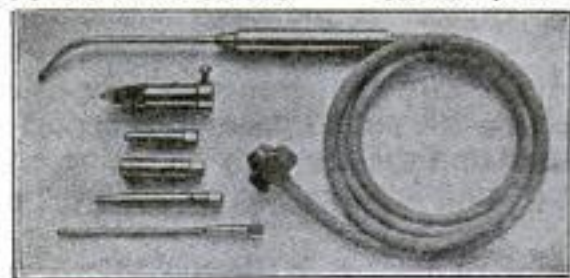

LATHES

9 to 18-inch Swing

List price \$105 and up according to size. When ready to buy send for Lathe Catalog and prices.

W. F. & John Barnes Co.
100 Ruby Street, ROCKFORD, ILL.

General Utility Motor

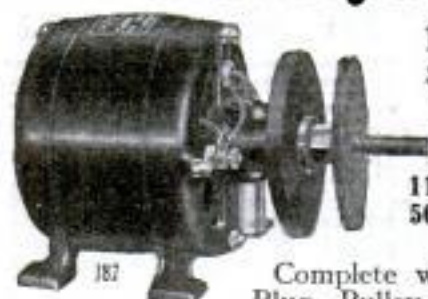

1/6 H. P.
32 and 110
Volt D. C.

or

110 Volt A. C.
50 or 60 Cycle

Complete with Cord, Plug, Pulley, Grinding and Buffing Wheel. Can be used for cleaning and polishing silver, sharpening knives or for operating sewing, washing or other household machine.

PRICE \$17⁹⁵ Satisfaction Guaranteed or Money Refunded
Send Cash with order

PETER BROS. MFG. CO.
ALGONQUIN, ILL.



Direct From
Factory

1 1/2 H.P. \$43⁴⁵
OTTAWA

NOW, it is easy to own one of these dependable, easiest to start engines. New Advanced Model—Twin cylinder 5 H-P and 7 H-P. Easy to operate. Better built throughout to do more work.

\$3.50 more f. o. b. Pittsburgh, Pa. Proportionally Low Prices on 2 1/2, 3 1/2, 5 and 7 H-P models.

Try 90 Days 10-Year Guarantee, Cash or Easy Terms.

FREE BIG Engine BOOK, "How to Know Better Engines." Also Special Factory Offer. Send a post card for it today. Address

OTTAWA MFG. CO.
530-C King St., Ottawa, Kans.
Desk 138-C Magee Bldg., Pittsburgh, Pa.

**How to
KNOW
BETTER
ENGINES**



MCCORMICK & CO., Baltimore



It is the well known quality of **CRESCENT** machines that justifies you in selecting one of them each time you have need for wood working machinery. The **CRESCENT** line is better than ever and will always give you satisfaction in every particular. Ask today for catalog of hand saws, saw tables, jointers, shapers, planers, borers, planers and matchers, swing saws, disk grinder, cut off table, hollow chisel mortiser, variety wood worker, Universal wood workers.

THE CRESCENT MACHINE CO., 83 Columbia Street, Leetonia, Ohio

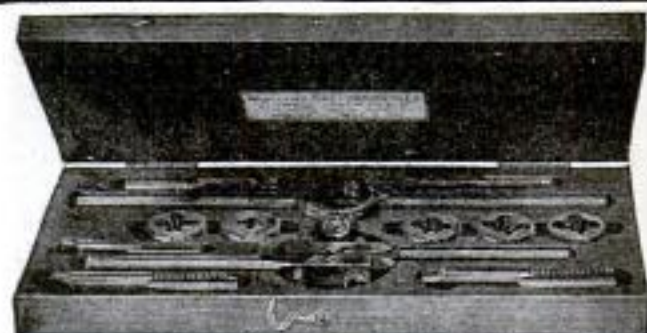

5 SIZE AUTOMOBILE TAP AND DIE SET, ONLY \$3.00

DIRECT FROM THE FACTORY TO YOU!

Our No. 12 Automobile Set furnished in our highly finished chestnut box contains 5 each taps and dies (1-4, 5-16, 3-8, 3-16 and 1-2"), in the S. A. E. thread, 1 die stock, and one tap and resamer wrench.

Our No. 11 Set is the same as No. 12 except that the thread is U. S. S. instead of S. A. E. You are purchasing a splendid set at a very low figure.

Send us your order at once and be one of our many satisfied customers.

Let us also send you one of our circulars illustrating our full line of Handy Tools. **WORCESTER STEEL PRODUCTS CO., Dept. T, 25 Union Street, Worcester, Mass., U. S. A.**

Saws as much as 10 Men!

One man, now, can saw 15 or more cords of wood each day with the OTTAWA Log Saw. No more back-breaking work with a cross-cut saw; no more lugging logs to a circular saw, for it's easy to take this power saw to the wood.

Fastest sawing; easiest moved—easy to start in any weather. 4 H-P Kerosene Engine—you need plenty of power. Shipped quick from nearest to you of nine branch houses.

Make Money!

Thousands making big money sawing wood for neighbors and to sell. Coal is high and may be higher—wood is in good demand for fuel. Send your name on a postcard today for full particulars about the OTTAWA.

350
Cuts
a
Minute

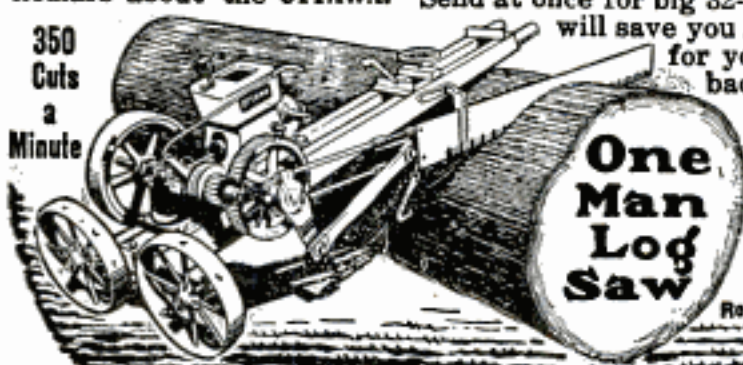

OTTAWA 4 in 1

1-Cuts Down Trees 3-Buzzes Up Branches
2-Saws Logs 4-Does Belt Work

LOG SAW

Get Big Factory-To-User Offer!

Send at once for big 32-page Free Book telling how it will save you hard work, provide cheap fuel for yourself and to sell, and pay back its cost in a short time. CASH OR EASY TERMS.

30-Day Trial—10-YEAR GUARANTEE. Send your name and address on a post card. WRITE TODAY.

OTTAWA MFG. CO.

1742-M Wood Street, Ottawa, Kansas
Room 1742-M Magee Bldg., Pittsburgh, Pa.

ALVAN CLARK TELESCOPES



Famous throughout the world as the highest grade Astronomical and Terrestrial Instruments. Now bringing to you at a reasonable price, these wonderful instruments—a source of pleasure and education—for the home—the school—the college. Send for circular and prices.

ALVAN CLARK & SONS CO.
Makers of the great "VEREES" and "LICK" Telescopes
55 Henry Street Cambridge, Mass.

TOOL CHESTS

for Machinists & Toolmakers
Every tool arranged in order. No up-to-date mechanic should be without one. A Gerstner Case costs no more than some tools, and will last a lifetime. Catalog free.

Gerstner & Sons

717 Columbia Street DAYTON, OHIO

MATHEMATICS

can be easily mastered with the Midget 5 in 1 Slide Rule. With this calculator you can instantly add, subtract, multiply and divide any combination of decimals, fractions, whole and mixed numbers. Also obtain all roots, powers, Logs, and Trig. Functions.

It is used at all colleges, 200 at Harvard, 300 at Cornell, etc. The Engine-Divided Scales are on white celluloid, mounted on aluminum and are grease and waterproof. Diameter 4 inches. Price with Instruction Book, \$1.50. Leather Case 50c extra. Catalogue Free. Your money back if you are not satisfied. GILSON SLIDE RULE CO., Niles, Mich.

The first machine to get

Parks' "Jewel"

\$75
complete

with
3/4-in.
Band
Saw



The machine you need most in your shop is a Parks' "Jewel" Band Saw. Speeds up every job, enables you to turn out accurate work rapidly, takes 90% of the tiresome handwork out of cabinet-making. Strong 2-inch angle steel frame, tilting table, ball-bearing saw-guides, 22-inch rubber-faced wheels, tension adjustment. Guaranteed 10 years.

Send for Parks' catalog of Lathes and Combination Woodworkers.

THE PARKS BALL-BEARING MACHINE CO.

1500-1540 Knowlton St. CINCINNATI, OHIO

Canadian Factory: 200 Notre Dame East, Montreal, Canada

PARKS

WOODWORKING MACHINES

BURN YOUR NAME ON TOOLS WITH

ARKOGRAF

Protect your tools from theft. Write any name, engrave any design on metal with electricity like writing on paper with pen or pencil. Complete outfit \$3.50, prepaid anywhere. Interesting descriptive circular free. Write today. Agents Wanted. Arkograf Pen Company 1007 Yeon Building Portland, Oregon



ATKINS

METAL CUTTING SAWS



Use
Atkins
"Non-Breakable"
Hack Saw
Blades

End Hack Saw Blade Breakage

WITH Atkins "Non-Breakable" Hack Saw Blades you can eliminate practically all losses due to blade breakage, and do metal cutting faster and easier.

Made of selected steel, these blades are hardened and tempered by an exclusive gas and oil process which makes the cutting edge extremely hard and the body of the blade unusually tough and flexible. That's why they out-cut and out-last other blades. Prove it for yourself. Send us ten cents and tell us what metal you cut and we'll send a sample blade. You'll say it's the best you ever used.

Saws for Every Use

No matter what wood or metal-cutting you do, there are Atkins' Saws to save you time, labor and money. Ask for our free booklets on saws you're interested in.

Get "Saws in the Shop" Sent You FREE

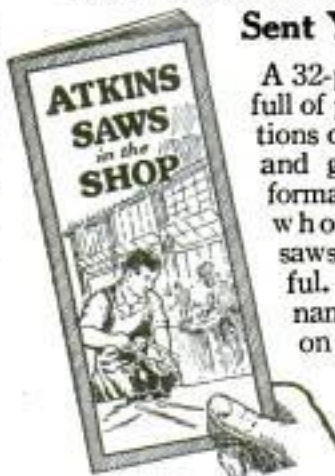

A 32-page book that's full of practical suggestions on metal-cutting, and general shop information. Every man who buys or uses saws will find it helpful. Just write your name and address on the margin of this page and mail it to us.

Do It NOW

E. C. ATKINS & CO., Inc.
Dept. P INDIANAPOLIS, IND.
Makers of "Silver Steel" Saws and Tools

Please Mention Popular Mechanics

Fix it with BERNARD PLIERS



From a
Sewing
Machine

to a farm tractor, machinery of every description deserves the protection which Bernard Pliers afford. The little adjustments and many of the big ones are best made with Bernards, the tightest grippers and the cleanest cutters.

Booklet "P" Free on Request



**BERNARD
PLIERS**
Wm. SCHOLLHORN CO.
NEW HAVEN, CONN.



PILLIOD Tool Cases Excel

Machinists, Tool Makers and Carpenters find them most satisfactory in construction, appearance, service and price. Immediate shipment.

Booklet describing 20 styles on request.

THE PILLIOD LUMBER CO.
Dept. 1 Swanton, Ohio



Dealers and agents; request attractive proposition.

Interlox
MASTER SLIDE RULE

MASTER
RULE MFG. CO.,
Inc., 841-43 East
136th St., NEW YORK CITY

SEND NO MONEY 2 GENUINE DIAMONDS $\frac{4}{100}$ Each

Solid Gold

\$25

14 kt. White Gold Top.
Gold Emblem Inlaid
in Genuine

Hope Ruby

Can be had in all Lodge emblems and in all INITIALS (Old English). Send size of finger and ring will be sent for inspection.



This Reg. Trade Mark guarantees you genuine diamonds.

B F G A S W Any Letter
Buffalo Jewelry Mfg. Co., "The Mail-Order House"
Dept. P, Brisbane Bldg., Buffalo, N. Y.

Copyrighted material

Don't Fuss With the Muss of Old Kerosene Lamps and Lanterns

New Bright White Light For Every Home

Wonderful Invention

I have made it easy for every home to have bright, cheery, healthful light—in cities, villages and on farms—anywhere—at a price all can afford. No more need you put up with the dingy, smoky, foul-smelling oil wick lamps and lanterns. No more need you put up with the drudgery of cleaning and trimming greasy, dirty wicks and chimneys. For less cost than you would pay for a good oil lamp you can have an abundance of brilliant, white light—20 times brighter—for every room in the home or for outdoor chores.

300 Candle Power

—beats electricity or gas for economy, brightness and quality of light. Burns 96% Air—Only 4% cheap gasoline or kerosene (coal-oil). Produces a light bright as daylight. Soft, mellow, easy on the eyes.

Lights with match as quickly and easily as old-style lamp. Simple to operate and positively safe. Greatest advancement in home and farm lighting in a century. **30 Days Trial**

I want to put at least one of these Lamps or Lanterns in every home. I am making a sensational introductory offer to do it. I back it with my 30-day trial guarantee. You try it without a penny of risk. I take all the responsibility. The coupon, a letter or post card brings this offer and big attractive, descriptive catalog FREE, from which you can select any one of the many handsome designs. Be first in your locality to write and get this liberal money-saving introductory offer. Send your name and address today.

J. C. Steese, President

THE AKRON LAMP COMPANY
111 Lamp Building AKRON, OHIO

Write Me Quickly

Let me send you complete particulars and information together with my amazing special introductory offer. My wonderful invention is the sensation of the age. Each Lamp and Lantern is a complete gas generating unit in itself—light in weight—easily carried, safe, convenient, easy to operate. Table Lamps, Hanging Lamps, Wall Lamps for every lighting purpose, also most durable, certain outdoor Lantern ever made. Wind-proof, storm-proof, bug-proof. Costs only half as much as wick lamps or lanterns to operate.



Mail
Coupon
Today

Lights
with
Match

AGENTS

\$60 to \$100 A Week

If you want to earn big money, write me quickly for sales plan. No experience—no capital required. Exclusive territory. Big season now on. FREE Outfit to workers. Check and send coupon for full details. Address me personally.

J. C. STEESE, President.

Special Offer Coupon

J. C. Steese, Pres., THE AKRON LAMP CO.,
111 Lamp Bldg., Akron, Ohio.

Send me without obligation your limited Special 30-Day-Trial Introductory Price Offer and Big Free Catalog of DIAMOND LAMPS and LANTERNS.

Name.....

Address.....

City.....State.....

If interested in Sales Agency, check here.



HUNTERS, FARMERS AND MECHANICS' Powerful Carbide Head Light, Bull's Eye Type, Long Range. Illustrated Catalog on request.
BRILLIANT SEARCH LIGHT MFG. CO., 508 South Dearborn Street, Dept. P, CHICAGO, ILL.

Starting a Company?

Save expenses and taxes by organizing on the popular, COMMON LAW plan under a pure DECLARATION OF TRUST. No experience required to fill in DEMAREE STANDARD FORMS, issue shares and begin doing business at once. Genuine DEMAREE FORMS are nationally known, approved by attorneys, and utilized by successful concerns throughout the United States. Send for large, free pamphlet (D-53) containing valuable information that you may need. C. S. DEMAREE, legal blank publisher, 708 Walnut, Kansas City, Missouri.



NEW AUTOMATIC ADDER, \$3.50

Makes adding easy. It's accurate, quick, durable and easily operated. Capacity 8 columns. Saves time, brain work and errors. 75,000 pleased owners. Fully guaranteed. Price \$3.50 delivered. With metal operating bands, \$5.00 delivered. Agents wanted.

J. H. BASSETT & CO., Dept. 233, 1458 Hollywood Ave., Chicago, Ill.

Learn to Play SAXOPHONE

EASY PAYMENTS

"C Melody"

Artists' Model Saxophone

Boy, it's a WOW! As easy to play as one-finger tunes on a piano—easiest fingering, easiest blowing, richest TONE "Sax" ever! The choice of teachers and professionals all over the world. Now offered direct from factory at wholesale price, on small payments!

10 MONTHS to PAY!

Thousands of snappy young fellows have made their ARTISTS' MODEL SAXOPHONE pay for itself in spare time earnings! Now at last you can be Everybody's Favorite—you can turn your saxophone playing into pleasure and profit!

FREE TRIAL—you can turn your saxophone playing into pleasure and profit!

Sensational offer right now! Big complete outfit on 6 DAYS' FREE TRIAL! Consists of \$10 case, self-instruction book, sheet music, reeds, strap, pearl keys, etc. \$1 reserves your Saxophone. Small first payment, then only \$5 a month!

Highest quality PROFESSIONAL Saxophone now within your reach. Write for catalog today!

Standard Music Co., Dept. 1523, P. O. Box 503, Chicago



Complete
Professional
Outfit

CATALOG
FREE!

Get Manufacturer's Prices

SAVE \$5.00 to \$40.00 ON YOUR NEW RANGE OR HEATER

—direct from manufacturers—and get the finest quality and newest improvements made? See our beautiful new design blue and gray porcelain enamel ranges that you can buy for less money than others ask for just ordinary stoves.

MAIL A POSTAL TODAY

for the greatest money saving bargain book of our 22 years. Any stove, range, heater or furnace on 30 days' trial. Quick, safe delivery guaranteed. Easy payments. 500,000 pleased customers. Send us your name today.

KALAMAZOO STOVE CO., Mfrs., 396 Roch-ster Ave., Kalamazoo, Mich.

A Kalamazoo
Direct to You

30 Days'
Trial

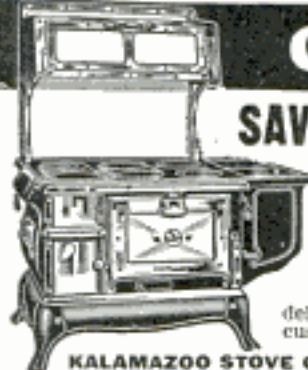

Tell Dad You Want **PLANERT'S**



SKATES—That Build Health for Your Boy and Girl

Planert's Northlight Racing and Hockey Skates will make you happy and healthy. These skates have been built for safety—service—and lifetime enjoyment. Nothing but the best quality and high-grade workmanship throught. They're the World's Best.

New Hockey Feature

Our hockey skates are the only skates made having this new patented strap feature, which holds strap at proper angle to give free foot action and gives greater support. Straps easily replaced.



Get **FREE HOCKEY RULES** with every pair. Accept no substitutes. If your dealer can't supply you, write us, giving your dealer's name.

F. W. PLANERT & SONS
Builders of Tubular Skates for 25 Years
939-41 N. Robey St. Chicago, Illinois

PLANERT'S "NORTHLIGHTS"
The World's Best Tubular Skates



WHITING-ADAMS BRUSHES

52 Varieties of Nail Brushes

A different Nail Brush for every week in the year. All good, some of them lower prices than others. Different shapes, different stiffness of bristles, suiting all requirements.

Send for Illustrated Literature

JOHN L. WHITING-J. J. ADAMS CO.
Boston, U. S. A.

Brush Manufacturers for Over 114 Years and the
Largest in the World

91



Pin Up Your Drawings

Without injuring wall paper or wood-work, by using

Moore Push-Pins

Glass Heads—Steel Points
TO HANG HEAVY PICTURES, USE
Moore Push-less Hangers

"The Hanger with the Twist"

10c pkts. Sold everywhere. In Canada 15c.

MOORE PUSH-PIN CO., Philadelphia, Pa.

Does shaving
irritate
your
skin?

THERE

is no

need of it. Ingram's

Therapeutic Shaving

Cream takes the sting and

burn out of shaving. It has an

exclusive medicinal property that

soothes the most sensitive skin—heals an-

noying little cuts—leaves your face smooth

and cool. No need to use a lotion.

Get a jar from your druggist today—50c. If he is not supplied, send us 50c with his name and address, for which we will mail you a jar of Ingram's Therapeutic Shaving Cream, and without charge a full-sized tube of Ingram's Zodenta for the teeth. Or send 2c stamp for sample.

Frederick F. Ingram Co.

97 Tenth Street,
Detroit, Mich.

Also
Windsor, Ont.

There
is Comfort
In Every Jar



SELF-FILLING INK PENCIL "INDEPENDENT"

Meets all requirements. Self-filling, non-inkable, safety cap. Attached clip. Smooth writing gold style point.

Your Name in Gold—25 Cents Extra

AGENTS WANTED

J. C. ULLRICH & CO., 161 Washington St., New York

Guaranteed Improved Fountain Pen. Eliminates fatigue. Promotes efficiency. Writes uniform. A business necessity.

\$2 By Mail



Beautiful HOUSES \$900 and BUNGALOWS

CAN BE BUILT FOR AND UP

This and many others in my new book, **Building Plans for Modern Homes**, will save you hundreds of dollars. One of the most complete and comprehensive books of plans ever published by any architect. New edition just off the press. Nearly 100 floor plans and photographs of bungalows, Colonial houses, etc., costing from \$200 up; gives sizes and cost to build.

Sent postpaid for \$2.00



FREDERICK H. GOWING
ARCHITECT

101 Tremont St., BOSTON, MASS.

GOOD POSITIONS OPEN

Earn \$75 to \$150 a Week

selling Style-Center made-to-measure suits and overcoats. Thousands of satisfied customers. Wonderful opportunity for right men to get permanent positions with established firm. Write to-day for full particulars.

STYLE-CENTER TAILORING COMPANY

Dept. 32-L Sixth and Broadway, Cincinnati, Ohio

Cheapest Way to Go

to work or school and recreation is on a Ranger bicycle. You can have your choice of 44 Styles, colors and sizes. **30 DAYS' FREE TRIAL.** Express prepaid. **Factory-to-Rider Prices** save you \$10 to \$25.

12 Months to Pay if desired. Save time and expense. Parents often advance first payment.

Tires best quality, at factory prices, express prepaid. **Lamps, wheels and equipment**, low prices. **Send No Money**, do business direct with makers.

Mead Cycle Company
Dept. D108 Chicago

Write today for free Ranger Catalog. Factory prices and marvelous easy payment terms.



Different from all others—the NEW BENJAMIN



AIR RIFLE

Made on a different principle from all other Air-Rifles. The Benjamin is really a strong air-pump used to compress the air in the air chamber to any degree of power desired. From one to six strokes of the pump give all the force necessary. Each additional stroke gives increased power. The Benjamin works on the same principle as all air-drills and air-hammers—with this difference:

You control the shooting force as you desire. Look at this block of hardwood. It shows how Benjamin power is regulated as you wish.

You can't have accidents with a Benjamin. It's safe, always, because you control the power. The Benjamin never loses shooting force, and has no springs to get out of order or shake your aim. Write us for an interesting folder about this wonderful air-gun.

If your dealer does not handle same, send direct to factory.

(PRICE \$5)
POSTPAID
BENJAMIN AIR-RIFLE & MFG.
CO., 615 N. Broadway, St. Louis, Mo.

Ask your dealer for demonstration.

Pacific-Coast
Representatives
THAYER &
BOWER
Los Angeles
Calif., and
San Francisco
Calif.



Build This Phonograph Yourself



TREMENDOUS SAVING IN COST

Easy, fascinating work with our SIMPLIFIED PLANS. We furnish blue prints, diagrams, motor, cabinet pieces, ready-built horn, etc. You don't need to be a cabinet maker. A few hours assembling and you will have a fine instrument at one-quarter the regular retail price. **AGENTS MAKE MONEY** making and selling these instruments. Write today for full details and our FREE OFFER. Address

LUPERL PHONOPARTS CO.
2648 W. Chicago Ave. Dept. 7 CHICAGO, ILLINOIS

BOYS and GIRLS— Earn Xmas Money

Write for 50 Sets Yankee Christmas Seals. Sell for 10c a set. When sold send us \$3.00 and keep \$2.00. **No Work—Just Fun!**
ST. NICHOLAS SEAL CO., Dept. 43, BROOKLYN, N. Y.

GUM
1¢ a
pack

Chewing Gum 1c per pack

Full size—5 stick packs—spearmint, peppermint and fruit flavors. \$5.00 for 500 packs. Suitable for Premium or Scheme purposes. Deposit required.

Prompt shipments.
HELMET GUM MAKERS, Cincinnati, Ohio

AGENTS: \$6 a Day

taking orders for New Kerogas Burner. Makes any stove a gas stove. Burns kerosene (coal oil). Cheapest fuel known. Fits any stove.



\$40
A WEEK
for
Taking
Only 2
Orders
a Day

No experience necessary. No capital required. Work full or spare time. Easy to get orders on account of high price of coal. Get started at once. Big season now on. Write for demonstrating sample.

THOMAS MFG. CO. B-248 DAYTON, OHIO

21 Jewel ~ Extra thin STUDEBAKER The Insured Watch.

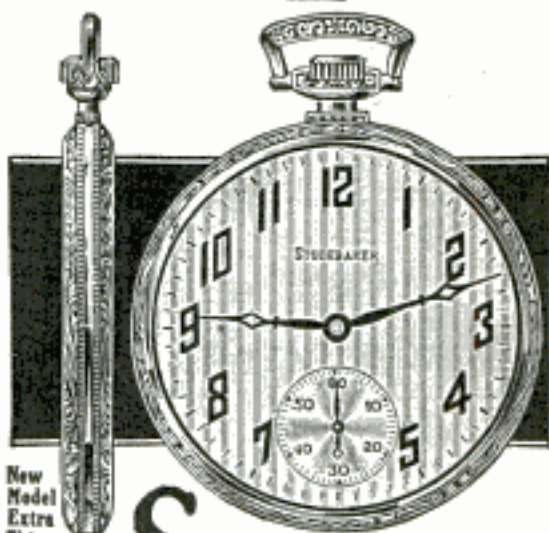

New Model
Extra
Thin

SENT FOR \$1.00 DOWN!

Only \$1.00! The balance in easy monthly payments. You get the famous Studebaker 21 Jewel Watch—Insured for a lifetime; a choice of 54 new Art Beauty Cases; 8 adjustments, including heat, cold, isochronism and 5 positions—direct from the maker at lowest prices ever named on equal quality. Write today for FREE BOOK of Advance Watch Styles.

Fine Chain FREE!

For a limited time we are giving away FREE with every Studebaker Watch a beautiful pattern Studebaker Watch Chain. Write now while offer lasts.

Mail Coupon for FREE Book of Advance Watch Styles

Send at once and get a copy of this book—FREE! See the newest, beautiful, advance styles in Studebaker Art Beauty Cases and Dials. Read how you can buy a 21 Jewel Studebaker Insured Watch direct from the maker—save big money—and pay for it on easy monthly payments.

Write! for our free book. It will post you on watch styles and watch values. Send coupon at once. Get Free chain offer today while it lasts.

Studebaker Watch Co.
Dept. 2211, South Bend, Ind.



STUDEBAKER WATCH CO.
Dept. 2211, South Bend, Indiana
Please send me your Free Book of Advanced Watch Styles and particulars of your \$1.00 down offer.

Name.....
Address.....
City..... State.....

Please Mention Popular Mechanics

Copyrighted material

"I have averaged \$7000

Per Year for Three Years—Have Made Over \$90 PROFIT in One Day'

That is the statement of Frank DePries, one of our live-wire representatives. Keeton of Mississippi made \$252 on his first sale. Vickers of Alabama made \$118 in one week. Conant quit a \$6,000 job to come with us.



DePRIES

Ford Auto FREE!

We have a plan whereby our active workers can get a Ford without cost, in addition to their big cash earnings. Get the plan—quick!

AGENTS WANTED

We need more men like these, because the demand for our Super Fyr-Fyter is growing by leaps and bounds. Sells to garages, stores, factories, schools, homes, hotels, auto owners. Approved by the Underwriters. If you are willing to work and ambitious to make some real money, get our plan. You need no experience, as we train you without cost for the work. No great capital required. Good territory going fast. Better write us at once.

THE FYR-FYTER COMPANY
1730 Fyr-Fyter Bldg., Dayton, Ohio

NO 8 \$4 28
NO 7 \$3 68
NO 4 \$3 96
NO 1 \$2 84
NO 5 \$3 54

AGENTS: \$6 PER DAY AND UP

Selling concentrated, non-alcoholic food flavors. Always fresh. Put up in collapsible tubes. Ten times the strength of bottled flavors. Guaranteed under U. S. pure food laws. All flavors. Sells in every home. Used every day. Not sold in stores. Big demand. Big repeater. 100% profit.



Men or Women
can make big money. Haut sold over \$300 in one month. You will find this a big, easy seller and a sure repeater. Must satisfy customers or money back. Write for territory and sample outfit. Get a big line of customers. Get repeat orders every month and have a steady income. Write quick.

AMERICAN PRODUCTS CO.
881 American Bldg., Cincinnati, O.

ACT QUICK WRITE TO-DAY

DIVINE RED DEVIL Water Motors
Simple—strong—durable. Wonderful little workers for all sorts of household and shop uses. Thousands in use. For all light power purposes. Attaches to faucet.
Two sizes: 4" — \$4.25
6" — \$6.75
The higher the water pressure the more work they do.
Send today for catalogue.
Divine Water Motor Company
Utica, N. Y.

Do Your PRINTING
Cards, circulars, labels, tags, book, menus, paper, Press, \$12. Larger \$35. Job Press \$150 up. Save money. Print for others. BIG PROFITS. All easy, rules sent. Write factory TODAY for press catalog, TYPE, cards, paper. **THE PRESS CO. D-37, MERIDEN, CONN.**

RAISE BELGIAN HARES
New Zealand Reds — Flemish Giants — American Blues. BIG PROFITS, WE PAY \$1.50 TO \$8 EACH. Also Cavies, Mink, Skunk, Fox, Muskrat, Etc. Easily raised anywhere. **FREE!** page Catalog and Contract. Illustrated book "COMMON SENSE RABBIT RAISING," quarterly journal, and copy of America's leading small stock magazine, all for 10 cents. Address **Outdoor Enterprise Co., 1005 O. E. BLDG., KANSAS CITY, MO.**

Agents—\$7 a Day
Brand New Oil Burner
Fits any Heating Stove. Burns kerosene—cheapest fuel known. Easy to install. Regulated by valve, safe, clean. Nothing to get out of order.
Fully Guaranteed
This new invention is a big money saver. Our agents having wonderful success. Work spare time or full time. Big money for you every day. Write for agency.
PARKER MFG. CO. Burner 1078 Dayton, O.

Get This Wonderful Ring. If You Can Tell It From a Genuine Diamond Send It Back
These amazing, beautiful CORODITE diamonds positively match genuine diamonds in every way—same blazing flash and dazzling play of living rainbow fire. They, alone, stand the diamond tests, including terrific acid test of direct comparison. Lifetime experts need all their experience to see any difference. Prove this yourself.
Wear a Corodite Diamond 7 DAYS FREE
Make this test. Your risk nothing. Wear a genuine Corodite and a diamond side by side on the same finger for 7 days. If you or your friends can tell the difference, send it back; you won't be out a single penny. That's fair enough. If you keep the ring, price printed here is all you pay. No installments. Remember, Corodites alone have the same cutting as genuine stones.
No. 1—Ladies' Solitaires 14K Gold S. Ring \$2.84
No. 4—Ladies' Hand-Carved Basket Setting, plat. finish \$3.96
No. 5—Ladies' Solitaire Bridal Blossom Engraved \$3.54
No. 7—Gents' Heavy Belcher 14K Gold S. Ring \$3.58
No. 8—Gents' Massive Hand-Carved Octagon Gypsy \$4.26
Carat size gems. Beautiful mountings of most modern design. Choice of gold or latest white platinum finish. Unqualified 20-year guarantee. Handsome art leather case free with each ring.
SEND NO MONEY Keep your money right at home. Just send name, address and number of ring wanted and size as shown by slip of paper, fitting and size as shown by slip of paper, fitting and size as shown by slip of paper. When ring arrives deposit amount shown above with postman. If you decide not to keep ring after 7 days' wear, send it back and your money will be immediately returned. Send today.
E. RICHWINE CO.
19 West Jackson Blvd., Dept. 713, Chicago, Illinois
Sole Importers Genuine Corodite Diamonds

BIG MONEY!
\$4.75
EX. SPECIAL TODAY SALE
SALE Price 35¢
Books 150

BIG MONEY IN SPARE TIME for one man in each locality making embossed show cards and price tickets for stores and others. Easy, quick work. No training needed. New embossing machine does it all. 400% profit. Signs sell on sight. T. W. Cushing of Chicago sold \$76 first call. S. D. Downes averaged \$15 a day for 6 months. Many sell \$5 to \$20 daily. No speculation. Before you invest a penny we send you free sample cards to show merchants and convince yourself they sell at sight. Write today.
PRAEMAFIX CORPORATION OF AMERICA
Dept. 600 Geneva, N. Y.



Free!
Get My New Book of Factory Prices

ON FURNACES, STOVES and RANGES

Let me show you how to save \$40 to \$200 on the finest quality pipe or pipeless furnace ever made. Sold direct to you at **Factory Prices—\$59.95 and up.** Easy to install. Easy payments. Quick shipments. Safe delivery. 300 days' approval test. More than 500,000 pleased customers. Mail a postal or letter today—get my new **Factory-to-Family Bargain Book—FREE.**



W. S. Dowling
"The Direct-to-You Man"
KALAMAZOO STOVE COMPANY
883 W. Rochester Ave.
Kalamazoo, Mich.

A Kalamazoo Direct to You



\$25 A DAY Selling Suits

Fifth Ave. New York Custom Tailors

want agents to sell advertised brand all wool tailored to measure suits and overcoats direct to wearer. Lowest prices, sell on sight. No capital or experience required. Big line, swatch samples free. Biggest commissions paid daily.

MONARCH TAILORING CO., 100 Fifth Ave., Dept. B-1, NEW YORK

SARGENT PLANES

make it easier to do the careful, finished work you can be proud of. The Sargent Auto-Set Bench Plane is best for all-round work. The Pocket Plane and Steel Block Plane add the finishing touches to your handicraft. At hardware stores everywhere.

SARGENT & COMPANY, 49 Water St., New Haven, Conn.

FASTEN IT WITH AN AJAX EYELET FASTENER



Binds Paper, Cardboard, Leather, Cloth. It Saves Time by Punching the hole, feeding the eyelet and clinching it in one operation. Order from your Stationer.

Machine Appliance Corp., Dept. P. M. BROOKLYN, N. Y.

BIG FREE BOOK

BEAUTIFUL FURNISHINGS

Just what you need now. Latest styles. Factory-to-Family prices. Save big money. Furnish a room or whole home. As little as \$3 down; a year or more to pay. Also Pianos, Players, Phonographs on longer time.

FOR PARLOR, DINING-ROOM, BEDROOMS

Before you buy any Furnishings, be sure to cut out this adv.—write TODAY, for new beautifully illustrated "Larkin Book of Better Homes".



Larkin Co Inc.
Dept. 1139 BUFFALO, N. Y.
Peoria, Ill. Chicago, Ill.



TYPEWRITER SENSATION!
Free Trial—Use as You Pay

After trial send us only \$4.00 a month until the low total price of \$44.80 is paid, and the machine is yours. This is absolutely the most generous typewriter offer we ever made. Do not rent a machine when you can pay \$4.00 a month and own one. Think of it—Buying a \$100.00 Machine for \$44.80. Cash price \$39.85, just a little less than half its original price.

REMINGTON MONARCH

Perfect machines, Correspondence size, Keyboard of Standard Universal arrangement, 42 Keys, writing 84 characters. The entire line of writing completely visible at all times, has the tabulator, the two color ribbon, with automatic reverse, the back spacer, variable spacer, self-starter, in fact, every late style feature and modern operating convenience. Comes to you with everything complete: tools cover, operating book and instructions—nothing extra to buy. You cannot imagine the perfection of this beautiful reconstructed typewriter until you have seen it. We have sold thousands of these perfect late style machines at this bargain price and every one of these thousands of satisfied customers had this beautiful, strictly up-to-date machine on five days' free trial before deciding to buy it. We will send it to you F. O. B. Chicago for five days' free trial. It will sell itself, but if you are not satisfied that this is the greatest typewriter you ever saw, you can return it at our expense. You won't want to return it after you try it, for we are sure you cannot equal this wonderful value anywhere.

Send No Money! \$4.80
Put in Your Order Now AFTER TRIAL

When the typewriter arrives deposit with the express agent \$4.80 and take the machine for five days' trial. If you are convinced that it is the best typewriter you ever saw keep it and send us \$4.00 a month until our bargain price of \$44.80 is paid. If you don't want it, return it to the express agent, receive your \$4.80 and return the machine. We will pay the return express charges. This machine is guaranteed just as if you paid \$100.00 for it. It is standard. Over half a million people own and use these typewriters and think them the best ever manufactured. The supply at this price is limited, the price will probably be raised when next advertisement appears, so don't delay. Fill in the coupon today—the typewriter will be shipped promptly. There is no red tape. We employ no solicitors—no collectors—no chattel mortgages. It is simply understood that we retain title to the machine until full \$48.80 is paid. You cannot lose. You will perhaps never have a greater typewriter opportunity. Do not send us one cent. Get the coupon in the mails today—now.

Young Typewriter Co., Department 210B Chicago
654 W. Randolph St.

Young Typewriter Co., Department 210B Chicago
654 W. Randolph St.

Ship me the Remington Monarch Typewriter, F. O. B. Chicago as described in this advertisement. I will pay you \$4.00 monthly as rent until the \$40.00 balance of the SPECIAL \$44.80 sale price is paid. The title to remain in you until fully paid for. It is understood that I have five days in which to examine and try the typewriter. If I choose not to keep it I will carefully repack it and return it to the express agent. It is understood that you give the standard guarantee.

Name

Street Address

City State

Business or Occupation

SAVE YOUR BODY

Conserve Your Health and Efficiency First
"I Would Not Part with it for \$10,000"

So writes an enthusiastic, grateful customer. "Worth more than a farm," says another. In like manner testify over 100,000 people who have worn it.

The Natural Body Brace

Overcomes WEAKNESS and ORGANIC AILMENTS of WOMEN AND MEN. Develops erect, graceful figure.

Brings restful relief, comfort, ability to do things, health and strength.

Wear It 30 Days Free at Our Expense

Does away with the strain and pain of standing and walking; replaces and supports misplaced internal organs; reduces enlarged abdomen; straightens and strengthens the back; corrects stooping shoulders; develops lungs, chest and bust; relieves backache, curvatures, nervousness, ruptures, constipation, after effects of flu. Comfortable and easy to wear.

Keep Yourself Fit Write today for illustrated booklet, measurement blank, etc., and read our very liberal proposition.
HOWARD C. RASH, Pres. Natural Body Brace Co.
 223 Rash Building SALINA, KANSAS



For
Boys
and
Girls
Also



YOU CAN SELL

Salesmen!
\$1.50
 an hour
 for full
 or spare
 time

IDEAL FIBER CUTTER

The Kitchen Convenience every housewife wants.

House-to-house salesmen average \$40.00 to \$100.00 weekly.

Write for free book, "Coining Cash," and read how other salesmen are making big money.

Don't put it off. Write at once. NOW!

M. H. TYLER MFG. CO., Dept. P. M. 2, Muncie, Ind.



Earn \$50 a day

Selling men's gas-mask

Goodyear Raincoats

\$1.90 each, in dozen or gross lots. Sample sent upon receipt of \$2.15. Agents wanted (Write for our 6 best sellers).

GOODYEAR RUBBER M'FG CO.
 Dept. A. 34 East 9th Street, New York City



Sell Shirts

Sell Madison "Better-Made" Shirts, Pajamas, and Nightshirts direct from our factory to wearer. Nationally advertised. Easy to sell. Exclusive patterns. Exceptional values. No experience or capital required. Large steady income assured. Entirely new proposition.

WRITE FOR FREE SAMPLES.
 MADISON SHIRT CO., 803 B'way, N.Y. City

Buescher-Grand

TRUMPET

Especially easy to blow, with an improved bore and new proportions. With the mute in, it blows so softly and sweetly that it will not annoy anyone. A splendid home instrument.

The Buescher-Grand Cornet is exceptionally easy to blow, yet possesses a tone of wonderful volume. It is the same instrument with which the greatest cornetists of America have made their reputations.

Send today for Free Book, mentioning instrument in which you are interested.

BUESCHER BAND INSTRUMENT CO.
 Makers of Everything in Band and Orchestra Instruments
 2593 Buescher Block ELKHART, INDIANA



Clear-Tone
 FOR

PIMPLES
 Your skin can be quickly cleared of Pimples, Blackheads, Acne Eruptions on the face or body, Enlarged Pores, Oily or Shiny Skin. \$1,000.00 Cold Cash says I can clear your skin of the above blemishes. WRITE TODAY for my FREE Booklet—"A Clear-Tone Skin"—telling how I cured myself after being afflicted for fifteen years.
FREE
E.S.GIVENS, 129 Chemical Bldg., Kansas City, Mo.

Buy Today 10 Months to Pay \$2⁰⁰ Down

WE'LL send you any one of these beautiful Diamonds for a thorough examination and approval—simply send us \$2.00. If satisfied, keep and pay balance in ten monthly sums—otherwise return, and examination will have cost you nothing. We don't want your money unless you are thoroughly pleased and satisfied. **Guarantee Value Bond given with every Diamond purchased. All transactions strictly confidential.**

SWEET Diamonds are all absolutely perfect in cut, blue-white in color and superior in quality. No matter how much or how little you pay you are sure to get the utmost for your money.

Makes Any Article YOURS

FREE!

Send for our beautiful DeLuxe Diamond Book, 98 pages in color, showing exquisite assortment of Diamonds, Watches, Jewelry, Silverware and Toilet Goods. Amazing values—all on 10 months' credit. Write for copy NOW to Dept. 63-5.



AA1 7-Diamond Solitaire Cluster set in hexagon-shaped Platinum mounting. Hand-engraved shank of white gold. **Price \$57.50**



AA3 Specially selected, blue-white Diamond set in graceful mounting of 14K Solid Gold. **Price \$90**



AA5 Ladies' fine 15-Jewel Wrist Watch with Sapphire Jewel Stem and beautifully hand-engraved case of 14K Solid White Gold. Guaranteed against repairs for one year. **Price \$20.50.**



AA2 Gentleman's Ring, perfectly cut, beautiful blue-white Diamond in six white gold prongs. Hand-carved shank of 14K Green Gold. **Price \$60**



AA4 SWEET Engagement Ring of 14K Solid Gold, set with a perfectly cut, blue-white Diamond. **Price \$50**



THE HOUSE OF QUALITY
CAPITAL \$1,000,000.
L.W. SWEET INC.
1650-1660 BROADWAY, NEW YORK

\$3 Cash Buys Typewriter



Balance Only \$5 Monthly
Save 35 to 60% on all standard makes—Underwood, Royal, Remington, etc. Every machine thoroughly rebuilt and **GUARANTEED**. Try five days at our expense before you buy.

WRITE at once for Free Descriptive Circular and Special Low Prices.

5 DAYS FREE TRIAL

WYNN TYPEWRITER EXCHANGE 11 Reliance Bldg. Kansas City, Mo.

30 DAYS FREE TRIAL \$10 Worth of Records FREE



Simply wonderful! The limit of value giving! Just think! **AGENUINE DAVIS PHONOGRAPH** on 30 Days' Free Trial, and on terms as low as

\$2 A MONTH
in case you decide to buy. Magnificent instruments in quartered oak or mahogany piano finished cases, equipped with the finest worm gear motors, rich toned machines—at less than half the standard prices—and \$10 worth of records **FREE**.

Send No Money
Just a postal with your name and address. Only a limited number of machines shipped on this extra-liberal offer. Better act quickly. This is a life-time opportunity.
DAVIS, 314 West 43rd St. Dept. F-41 CHICAGO



"Been on a vacation Bill?"

"No, Jim — I've stopped smoking. Gained six pounds in a week. You know how I used to smoke—a package of cigarettes and a cigar or two a day—it sure had some hold on me. But I'm cured—

took a scientific home tobacco treatment—fixed me up in two weeks.

"Wasn't hard on me at all—noticed improvement the first day—I feel like a new man. It didn't interfere with my work—didn't leave any druggish after-effects—the money I saved in the last two weeks has paid for the treatment alone.

"Why don't you take it! It has cured men like you and me for over forty years—it is a doctor's individual prescription that sure fixes you up. Just send the coupon for full information NOW. No obligation. All correspondence is strictly confidential."



"A Doctor's Prescription"

The Keeley Institute, Dwight, Ill.

Please send me, without any obligation on my part, your free booklet which will tell me how to rid myself of the tobacco habit.

Name.....
Town.....
Street..... State..... P. M. - 11

Ingersoll MODELS 2⁰⁰ to 10⁰⁰
RELIABLE WATCHES AT LOW PRICES

\$2 Brings This Genuine DIAMOND RING



Simply send \$2.00 for the Most Sensational Price Smashing Diamond Ring Offer Ever Made. A perfect cut, blue white, fiery Diamond in new and hand pierced model of 18 Karat White Gold. Both sides of Diamond set with a Genuine French Blue Sapphire. Send Only \$2.00 and ring comes to you charges paid. Guarantee Bond accompanies each ring. 10 Days' Free Trial—You take no chance. If you are not satisfied at the end of ten days, your deposit will be refunded to you. **No Red Tape, No Delay**—After trial, pay \$5.55 a month for ten months. Price only \$57.50. Ring furnished in gentleman's mounting without extra charge.

Free Book of Gems—Complete Diamond, Watch and Jewelry Catalog. 10 months to pay on everything from our TWO MILLION DOLLAR STOCK.

Address Dept. 877 for your copy today.

ROYAL DIAMOND & WATCH CO.
170 Broadway—New York

FREE 300 Candle Power FARM LANTERN



The world's greatest contribution to light is the New Improved Wizard Gasoline or Kerosene Table Lamp, equipped with automatic cleaning needle. The discovery of "Thema" metal, used exclusively in Wizard Lamps and Lanterns, has revolutionized this industry. Now 10¢ worth of kerosene or gasoline will give 30 hours' pure white, soft yet intensely brilliant light. To introduce this remarkable lamp, we give absolutely **FREE** a genuine \$8.50 Wizard Gasoline or Kerosene Lantern with the purchase of one lamp. But you must act **quick**. Offer limited to 5000 Free Lanterns. Write at once for **Free** book showing style of lamp you like and details of **Free Offer**. No obligation. Write **now**. Agents send for unusual offer and exclusive proposition.

THE NAGEL-CHASE MFG. CO., 284 E. Erie St., CHICAGO

\$47²⁵ Profit in 4 Hours

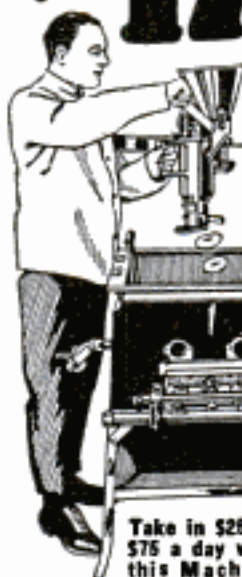

Doughnut Making business has wonderful possibilities. Doughnuts have taken the country by storm. Enormous demand. \$25.00 to \$75.00 a day. Capacity 800 doz. a day. Doughnuts sell fast at 30¢ to 40¢ a doz. 200% profit. No experience needed. Flour ready prepared—add water—put dough in hopper—turn crank—out drop sweet, savory, golden doughnuts

AMAZING PROOF FREE

Money-making possibilities unlimited. Put this Automatic Doughnut Machine in display window. Attract crowds. Enticing odor whets appetite. You take in money fast. Pay for the machine the first week. Joe V. Donmoyer, Pa., says: "Made \$47.25 profit in four hours." Others report earnings equal or better. Big money wholesaling.

WRITE NOW Get in on the ground floor—act quickly before others start. These machines pay big anywhere—no town too small. Get full details of this new profitable business—costs nothing to investigate. Write today.

Take in \$25 to \$75 a day with this Machine

BUTLER & BUTLER, Dept. 31, 5650 Lake St., Chicago

TAILORING SALESMEN

We Pay You Salary and Commissions

Greatest money-making line in America. Made to measure suits, overcoats, one price, \$33.65, express prepaid, all wool, all wool linings, hand tailored, finest workmanship. No extra charges for style or oversize. Bigger advance commissions, weekly salary besides. Protected territory. Apply at once.

GREAT WESTERN TAILORING CO.

837-841 W. Jackson Blvd.

CHICAGO, ILL.

New ¼ H. P. 110 Volt Guaranteed Motors Complete with Cord, Plug and Pulley



60 cycle A. C. 1740 speed ... \$13.00
60 cycle A. C. 1160 speed ... 16.50
25 cycle A. C. 1450 speed ... 16.50
Direct current 1740 speed ... 17.25
Direct current 1160 speed ... 19.75

HYRE ELECTRIC CO.

615M S. Dearborn St., Chicago, Ill.

WHITE FLAME

BURNERS make your old kerosene lamps and lanterns give a brilliant white light, better than electricity or gas. Doubles your light. Saves oil. **NO MANTLE TO BREAK.** Guaranteed Safe and Reliable. Delights every user. Send now for complete sample postpaid 50 cents, stamps or coin. 3 for \$1.25. Money Back if Not Satisfactory. Live Representatives Wanted. Exclusive Territory.

WHITE FLAME LIGHT CO., 68 Clark Bldg., Grand Rapids, Mich.



We Want Agents at \$50 to \$90 a Week

New Invention—Just out. Needed in every home every day. Patented. Nothing else like it. Low priced—**Sells on sight.** Sharpens any kitchen knife, paring knife, carving knife, bread knife, or shears and scissors in **ten seconds.** Mechanical masterpiece. A child can use it. Just put knife in slot—turn crank—sharpens both sides at once automatically. **We want representatives at once—men and women hustlers.** Get this position where **profits start first day.**

No Experience Necessary—200% Profit

Make as much money next week as these men are making now. J. C. Lewis, of Kansas, says: "I have sold one hundred sharpeners in four days." Hobart Kerr, of Md., writes: "The women can hardly wait till they get them." Herbert Cain, of Ky., sold nine after supper. At the end of the first day, J. W. Gordon, of Pa., writes: "I sold two dozen and I sold to every one I saw." Wm. G. Hall, of N. J., says: "I think it is great. I sold six in about one-half hour. The machine is a mighty fine proposition. I am a mechanic and I know what I am talking about." You can make this money. **WRITE TODAY. TERRITORY FREE.** Get busy at once.

QUICKEDGE SHARPENER CO., 111 Sharpener Bldg., 159 West Pearl St. Jackson, Mich.

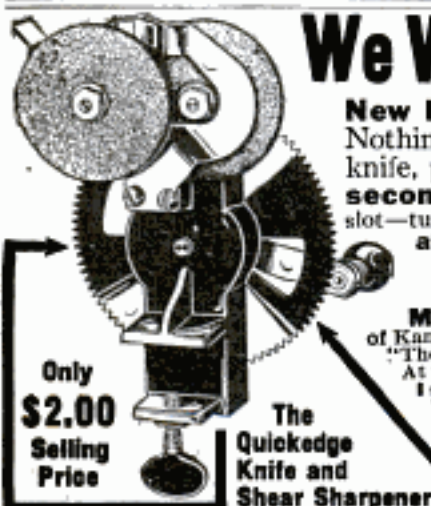

Only \$2.00 Selling Price

The Quickedge Knife and Shear Sharpener



Good Profits for Demonstrator Agents



Elto
3 HP Twin
Outboard
Motor

Exclusive territory for the ELTO — the only full 3 H. P. fast, light "twin!" Earn big money! Turn sport into profit! We'll send you a demonstrator at factory price. Or, if you cannot be an active agent, but will help us find one in your territory, you can have the latest ELTO at factory price. This is open to only one buyer in new territory. Write at once for liberal offer.

ELTO OUTBOARD MOTOR COMPANY
Manufacturers Home Building
Dept. AA Milwaukee, Wisconsin

MOTORCYCLES

RELIABLE STANDARD MAKES that you can **DEPEND ON.**

Enjoy the glorious experience of going wherever you like—whenever you like. The price is within your means—35% to 50% less than others. These machines are slightly used, thoroughly overhauled or rebuilt. Send for catalogue.



MYEROW BROS.,
258 Columbus Ave., Boston, Mass.

THE SHAW MOTOR ATTACHMENT Makes Your Bike Like a Motorcycle

A high grade 2½ H. P. Motor attachment quickly clamped to any bike frame. Speed 4 to 40 miles an hour. 90 to 125 miles per gallon of gas.

Special Low Price Now! Write today for complete Description and Special Low Prices on SHAW Motor Attachments and the SHAW Complete Motorbicycle.

SHAW MFG. CO., Dept. 37, Galesburg, Kans.



Delivered to You Free

for 30 days trial on approval. You can have your choice of 44 Styles, colors and sizes of the famous **RANGER** Bicycles. Express prepaid. Factory-to-Rider Prices save you \$10 to \$25 on your bicycle.

12 Months to Pay if desired. Many boys and girls easily save the small monthly payments. Parents often advance first payment.

Tires—best quality, at factory prices. **Lamps**, **Wheels** and equipment, low prices. **Send No Money**, do business direct with makers.

Mead Cycle Company
Dept. 108 Chicago

Write today for free Ranger Catalog, factory prices and marvelous easy payment terms.



MOTORCYCLE BARGAINS

Save 25% to 65%

on Slightly used and Rebuilt Motorcycles, Side Cars, Johnson Motor Wheels, Evans Power Cycles, Bicycles. Send for Free Bargain Bulletin and Money Saving Message, listing hundreds of Bargains in used, rebuilt and new machines, supplies, accessories, etc.

AMERICAN MOTOR CYCLE CO.
Dept. 1122, 2047 W. Chicago Avenue, CHICAGO



SEND for the INTERNATIONAL CATALOG

FOR FORD PRICES FROM \$27.85 UP.

Factory to Consumer direct—Pay only one profit.



Our net price list. Full line of auto bodies and accessories for Fords at Wholesale Prices.

Save big money on bodies by buying direct from factory.

INTERNATIONAL BODY WORKS, Dept. 7, 914 W. Ohio Street, CHICAGO, ILL.

EVINRUDE WILL

To insure delivery of a new **SPORT TWIN**, order from your dealer at once. Send for catalog.

EVINRUDE MOTOR CO., 207 Evinrude Bldg., Milwaukee, Wis.

BE OVERSOLD

Great New



Invention for seekers of Health Power Beauty

Elco Health Generators at last are ready for you! If you want more health—greater power to enjoy the pleasures and delights about you, or if more beauty is your desire—write! Ask for the book on these inventions which has just been prepared. It will be sent to you without cost. It tells you how Elco Health Generators aid you in leaving the lethargy and hopelessness of bad health and weakness behind forever. Re-vitalize yourself. Bring back energy. Be wholly alive. Write today!

10 Days Free Trial—Write for Free Book!



These great new inventions generate **Free Trial** Violet Ray, Vibration, Electricity and Ozone—combined or separate

They operate on the electric light in your home or on their own motive power at less than 50 cents per year. Elco Health Generators are positively the only instruments which can give you in one outfit Electricity, Violet Ray—Vibration and Ozone—the four greatest curative agents. Send the coupon below. Get the Free Book NOW!



For All These:

Paralysis	Catarrh
Pimples	Insomnia
Falling Hair	Skin Diseases
Headache	Hay Fever
Lumbago	Neuralgia
Nervousness	Deafness
Rheumatism	Pain
Sore Throat	Development
Asthma	Neuritis
Black Heads	Obesity

Mail Coupon for FREE Book!

Do not put this paper down without sending the coupon. Don't go on as you are with pains and with almost no life and energy. You owe it to yourself to be a better man or woman. You were put here to enjoy life—not just to drag through it. So do not rest another day until you have put your name on the coupon here. That will bring the whole story of these great new inventions. Do it today—now.

Lindstrom & Company

442-448 N. Wells Street, Dept. 13-58, Chicago, Ill.

Please send me your free book, "Health—Power—Beauty" and full information of your 10-day Free Trial Offer.

Name _____

Address _____



For Every Ford Job



MOSSBERG Chrome Manganese Steel WRENCHES and TOOLS

FOR every possible Ford job. Upstanding, two-fisted wrenches that are built to withstand the hardest work—day-in-and-day-out.

Examine the nearest stock of Mossberg Wrenches for Fords. You will find their construction superior to any you have seen. Their prices represent real value. Every Mossberg Wrench is made of Chrome Manganese Steel. Every wrench or tool is built to do a particular job—in the quickest, surest, easiest way.

Ask to see No. 654 Valve Lifter, Set No. 1944—"8 wrenches in 2" and other Mossberg leaders.



No. 654 Valve Spring Lifter for Fords



No. 1944 "Double Four" Socket Set—2 Wrenches, 8 Openings

FRANK MOSSBERG CO.
LAMB STREET, ATTLEBORO, MASS.

Please Mention Popular Mechanics

Secret Service!

At your service day or night, you will find Radiator Neverleak will find all leaks anywhere in cooling system and stop them permanently in from 5 to 10 minutes.

Simply pour contents of a 75c can of Radiator Neverleak into the water in your radiator. That is all that is necessary. And it is absolutely guaranteed not to clog or injure the cooling system in any way.

Radiator Neverleak should be put in all new radiators. It will add years to their life by preventing rust and scale from forming.

Just try it! If it is not entirely satisfactory in every way, we will refund your money.

Write for free "Secret Service" booklet.

Buffalo Specialty Company
357 Ellicott Street
BUFFALO, N. Y.



RADIATOR NEVERLEAK

FORD RUNS 57 MILES ON GALLON OF GASOLINE

A new automatic and self-regulating device has been invented by John A. Stransky, 824 Fourth St., Pukwana, South Dakota, with which automobiles have made from 40 to 57 miles on a gallon of gasoline. It removes all carbon and prevents spark plug trouble and overheating. It can be installed by anyone in five minutes. Mr. Stransky wants agents and is willing to send a sample at his own risk. Write him today—Adv.

VITALIC Bicycle Tires

TRADE MARK REGISTERED
Tougher Than Elephant Hide

FORD START HARD?

EASILY AND CHEAPLY FIXED WITH

C-A

(ADJUSTABLE CENTER)

BEARING CAP \$3.75

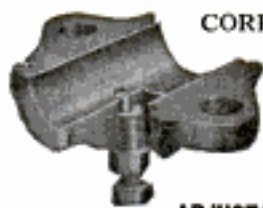

CORRECTS END-PLAY and sets magneto for full efficiency without removing motor from car. Saves battery on cars with starter, saves the arm on cars without. Installed in few minutes. Guaranteed for one year. Ask your dealer, or sent pre-paid on receipt of..... **\$3.75**

ADJUSTABLE BEARING CO., Dept. P, Brazil, Ind.

GET FACTORY PRICES ON GALVANIZED ROOFING



EDWARDS "REO" Metal Shingles

Absolutely rust-proof—edges as well as sides. Not the space of a pin point exposed to weather. Also fire and lightning proof. Reduce insurance. Outlast building. Need no repairs—and all roofing expense. Easy to lay—any man can do the work—hammer and nails only tools needed. Lay over old shingles if desired. Patent Interlocking Device makes water tight seams—all metal heads covered—no rust or leaks possible.

Exclusive "Tightcote" Process

Put all Edwards Galvanized Roofing in a class by itself. Bend, twist, strike it with a hammer as much as you like—you can't loosen or scale off the galvanizing—due to our "TIGHTCOTE" process which practically makes steel covering a part of the metal sheet. No other galvanized roofing can withstand this test.

FREE Roofing Book Don't buy roofing until you get our big free book, describing Edwards famous "Tightcote"



Corrugated



Patent Side Lock
No nail heads in sight or exposed to the weather



Brick Siding



Roofings, Sidings, and Ceilings, and our lowest factory prices. We sell you direct and save you in-between dealers' profits. Write for Roofing Book No. 100.

Low-Priced Garages

Lowest prices on Ready-Made Fire-Proof Steel Garages. Set up any place. Send postal for Garage Book showing styles.



THE EDWARDS MFG. CO. CINCINNATI, O.
1100-1156 Pike St.



How Did Your Garters Look This Morning?

The new Wideweb "Boston" is light—cool—secure—adjustable—and rests so easily on the leg that you forget you have it on. Insist on having the Boston because it is the only garter with the famous Oblong All Rubber Button Clasp.

GEORGE FROST COMPANY, BOSTON!
MAKERS OF VELVET GRIP HOSE SUPPORTERS FOR ALL THE FAMILY

You Can Save \$35.00



\$4.45 and up
Parcel Post Paid

Recover your old auto top frame yourself. Custom tailor made to fit all makes and models of cars. Any person that can drive a car can put it on. Roof and quarters sewed together, with rear curtain, fasteners, welts and tacks complete. Give name, year and model number of your car and we will send you catalog with samples.

LIBERTY TOP & TIRE CO., Dept. E-7, Cincinnati, O.

Steady Work

in a fast growing business with Vanderpool Latest Improved Vulcanizer. Made in America.

Ask for Catalog

Vanderpool Co., Dept. 11P, Springfield, Ohio

F. H. DIBB, Agent for British Isles
25 Fairfield Rd., Winchester, England

INSYDE TYRES

Inner Armor for Automobile Tires

Used over and over again. Will not heat or pinch. Positively prevent punctures and blowouts.

Guaranteed to Give Double Tire Mileage

Easily applied without tools. Low priced. Agents wanted in every county. Special terms.

AMERICAN ACCESSORIES CO., B-1376, Cincinnati, O.



AGENTS Make Big Money

Selling D-REX-U Safety Signal to automobile owners; complies with safety laws; guaranteed. Write today for wholesale price to agents and get territory quick. Big Winter Seller. Address Comstock-Bolton Co., Dept. K, 1925 E. 15th St., Kansas City, Mo.

DELTA ELECTRIC BICYCLE LAMPS



SAVE TIME GETTING HOME FROM WORK

You are home and dressed before your fellow workman returns from work because he prefers to walk rather than take a chance of accident by riding his bicycle after dark.

But your bike is equipped with a Delta Electric Bicycle Lamp and you have no fear of being run over for you can see the road ahead and passing motorists can see your light either from the front or rear. Complies with all laws. The Delta is a great convenience, protection and time saver.

Fits any bicycle instantly—under axle nut front left side.
Ask your dealer or Model 80 sent prepaid for \$2.25 complete (less battery).

DELTA ELECTRIC COMPANY
100 Delta Block Marion, Indiana
Standard Makers of Bicycle Lamps, Electric Lanterns, Automobile Spotlights, Radio Head Sets, Flashlights and Flashlight Batteries.

New York San Francisco
Winnipeg
MARION MANUFACTURING CO. KNOWN BY HIS PRODUCTS



WINDOW SIGNS

AGENTS 500% PROFIT
Genuine Gold Leaf Letters
GUARANTEED TO NEVER TARNISH



For store fronts, office windows, Bank windows, Office Doors, Panels, Board Signs, Trucks, Automobiles and Glass Signs of all kinds. Anyone can put them on and make money right from the start without previous experience. All you have to do is to show your samples; the letters are very attractive and easy to sell. Letters costing 3 1/2c sell for 25c. One agent says: "Your Letters are the best thing I have seen in years; I have made \$125.00 the first week and still going strong." Paul Clark says: "Smallest day \$28.70." H. Gilder made \$835.00 in six weeks.

\$60 TO \$200 A WEEK
GENERAL AGENTS—It is easy to appoint sub-agents for this line. We pay you 20% cash commission on all orders we receive from local agents appointed by you anywhere. We allow you 50% discount on your own orders. You can sell to nearby trade or travel all over the country, as you please. Large demand for window lettering everywhere. Write today for free sample, full particulars and liberal offer to general agents.

Metallic Letter Co., 433-B N. Clark St., Chicago



INSTALL AN ELECTRIC LIGHT IN YOUR HOME. It costs only a few cents a day. You can do it easily, quickly, with a Midget Marvel electric light outfit. No matter how far you are from a power plant this new discovery gives you a dazzling flood of electric light at the touch of the switch. You recharge your battery with a 10c powder obtained from your druggist. With ordinary use one charge supplies light 7 to 10 days. Outfit will last for years. Sent complete ready to install, including 60 feet wire, staples, switch, completely wired fixture with shade, guaranteed Mazda lamp, battery system, battery charger and instructions. **Postpaid for \$2. Agents Wanted.** Send today for complete outfit and schematic terms. No circulars or U. S. D. Your \$2 returned if not satisfied.

L.A. IRVING ELECTRIC CO., 1636 S. Lawndale Ave., Chicago

FINE OLD VIOLINS

On Easy Payments

30 Days' Free Trial



allowed, no matter where you live. If not more than pleased with our values, return violin AT OUR EXPENSE—and no harm done. Ability to play the violin brings social and financial success. Get a violin with a rich, mellow tone and it will create within you a desire to master it.

FREE! MAGNIFICENT ALBUM-CATALOG

containing portraits of the world's greatest violinists since Paganini's time, a half-tone of "Stradivarius in his Workshop" and the romantic story of The King of Musical Instruments. A postal brings all to you FREE—no obligations.

Old Violins Bought, Sold, Exchanged and Repaired

Send in your old violin by insured parcel post for examination. We may be able to make a very valuable instrument out of it at small cost. Many violins that were considered worthless brought high prices after they left our repair shop. No charge for estimates.

CREMONA VIOLIN SHOP

Forty-Third & Shields Ave., Dept. G-41, Chicago

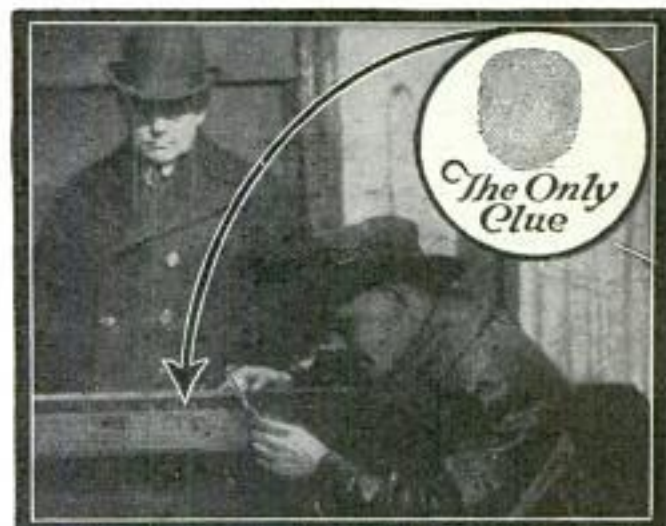

\$500 REWARD

for TWO HOURS WORK

It was in answer to a request from the Chief of Police that Warren Biglow, the Finger Print Expert, arrived at the scene of the daring robbery of the T—O— Company offices. The job was undoubtedly the work of skilled cracksmen and robbers of uncommon nerve, \$6,500 in currency—the company payroll—was gone. Not a single apparent clue had been found by the police. Almost immediately after his arrival Biglow turned his attention to a heavy table which had been tipped up on its side. Examination of the glossy mahogany showed an excellent set of finger prints. The thief might just as well have left his calling card. To make a long story short, his prints were photographed and taken to Central Office, where they were matched with those of "Big Joe" Moran, a safe blower well known to the police. Moran was subsequently caught and convicted on Biglow's testimony and finger-print proof. Most of the money was recovered. In the meantime the T—O— Company had offered a \$500 reward, which was given to Biglow—his pay for two hour's work.

Be a Finger Print Expert—Learn at Home in Spare Time

Could you imagine more fascinating work than this? Often life and death depend upon the decisions of finger-print evidence—and big rewards go to the EXPERT. Thousands of trained men are now needed in this great field. The finger-print work of governments, corporations, police departments, detective agencies and individuals has created a new profession. Many experts regularly earn from \$300 to \$10,000 a year in this fascinating game. And now you can easily learn the secrets of this new science in your spare time—at home. Any man with common school education and average ability can become a Finger Print Expert in a surprisingly short time.

FREE Finger-Print Outfit and Large Illustrated Book!

For a limited time we are making a special offer of a complete Professional Finger Print outfit, absolutely free and also a Free Course in Secret Service Intelligence. Mastery of these two kindred professions will open a brilliant career for you. Write quickly for fully illustrated free book on Finger Prints which explains this wonderful training in detail. Don't wait until this offer has expired—mail the coupon now. You may never see this announcement again! Address

University of Applied Science
 Dept. 93-58, 1920 Sunnyside Ave., Chicago

University of Applied Science, Dept. 93-58, 1920 Sunnyside Ave., Chicago

Gentlemen: Without any obligation whatever send me your new, fully illustrated, FREE book on Finger Prints and your offer of a free course in Secret Service Intelligence.

Name.....Age.....

Address.....

Town.....State.....

Please Mention Popular Mechanics

HERMAN'S SUPER-SERVICE SHOES



Style No. 67

"At Home" Everywhere!

Stanchly built to Government specifications—their service proven through 30 years in every country—HERMAN'S Shoes are always right "at home" where ease and comfort must be had with extra wear.

Write today for our new FREE catalog and the name of nearest Herman dealer.

Joseph M. Herman Shoe Co., Dept. P, Millis, Mass.

Makers of over 4,000,000 pairs of shoes for the U. S. Government.

Start Little Mail Order Business

Home employment evenings. Beginner's Outfit furnished. Also tell your easy way to get Agents. **FREE BOOK**

Write for Free Book. **PIER, 289-A, 74 Cortlandt St., NEW YORK**

MAIL ORDER \$

GUARANTEED
14 Kt. GOLD
FILED 19-
JEWEL LEVER
MOVEMENT

MEN'S

Special

Here's a really high grade watch at $\frac{1}{2}$ usual retail price. We give such unusual values as we are large manufacturers selling direct to you. This watch fitted with well-known Consume 10 Jewel lever movement, 14 Kt. gold filled, 20 yr. case, latest thin model, plain polished back and edge. Adjusted and regulated to keep excellent time. Written guarantee of "Satisfaction or money back" with every watch. Not necessary to send money with order. Pay on arrival. Free: gold filled knife and full length Waldemar chain for limited time only. Order today. Handsome jewelry bargain catalog Free with order. Supreme Jewelry Mfg. Co., Dept. 11142, 434 B'way, N. Y.



KNIFE & CHAIN FREE

SIX Machines in ONE

Saw, Sander, Drill, Grinder, Polisher and Buffer
Boice Pony Bench Machine

A decidedly practical, extremely compact, precision machine. Height 10". Handles 4" and 5" grinding wheels; 6" saws; 6" and 8" sand discs; $\frac{3}{8}$ " chuck. Top, 10"x12", easily removable. Saws up to 1 $\frac{1}{2}$ " stock. Easily driven by $\frac{1}{4}$ or $\frac{1}{2}$ h. p. motor.

BOICE-BUILT Machines are in daily use in hundreds of shops. Their size, absolute accuracy and low cost provide a means for producing a better job for less money. Boice saws are made in six models—are portable and attach to any light socket.

Write today for descriptive literature on this and other BOICE-BUILT Bench Machines and Motors.

W. B. & J. E. Boice, Dept. P. M. 11 Toledo, Ohio

The Lamp
with the
CLAMP

CLAMPS EVERYWHERE

Pat. U. S.
A., Canada
and Foreign
Countries.

Adjusto-Lite

A FARBERWARE PRODUCT
Reg. U. S. Pat. Off.

Projects a better, clearer, more direct light exactly where you need it—in home, office, store, studio, workshop. Solid brass; a quality product throughout. Clamp is felt-lined—can't scratch. 5 year guarantee. Complete with 8-ft. cord and 2-piece standard plug, \$5.

Sold by live dealers everywhere. If your dealer cannot supply you, order direct.

S. W. FARBER, 141-151 S. 5th St., Brooklyn, N. Y.

Prices in U. S. & Canada, brass \$5; bronze, nickel or white enamel finish, \$5.50. West of Mississippi River 25c higher.

Punctured 603 Times, Tire Leaks No Air

Mr. E. D. Harrison of Hammond, Ind., announces a new puncture-proof inner tube. Actual tests disclose that on puncturing the tube with 603 nails there is absolutely no loss of air. This puncture-proof tube costs no more than the ordinary tube—increases your mileage from 8,000 to 12,000 miles without removing tube from the tire. Mr. E. D. Harrison, 144 Indiana St., Hammond, Ind., wants every auto owner to benefit by his wonderful invention and makes an unusual offer to anyone who wishes to act as his agent in this territory. Write him at once.

SQUAB BOOK FREE!



Squabs are selling at highest prices ever known. Greatest market for 20 years. Make money breeding them. No mixing feed, no night labor, no young to attend. Start small, grow big. Start now. Read how our customers sell squabs for \$12 a dozen. We have been established for 28 years. Better look into this. Let us send now, at no cost to you, our big, illustrated free book telling how to make money breeding squabs. Address

Plymouth Rock Squab Co., 634 H St., Melrose Highlands, Mass.

EARN \$150.00 WEEKLY

Selling nationally known line Engraved and Monogrammed Xmas Greeting Cards. An immense seller in universal demand. Apply with references.

PROCESS ENGRAVING CO., Crawford at 18th St., Chicago, Ill.





FREE To Boys

We give these premiums and many others to boys absolutely free—without competition or contest—just for being agents to sell The Saturday Blade, Chicago Ledger and Lone Scout.

It's easy to deliver our papers to weekly customers and to get new customers. Only a little time on Fridays or Saturdays required.

Steady Money
In addition to Premiums

Our Agents earn from \$1.00 to \$5.00 a week in cash. It does not cost a penny to start. You sell the papers to weekly customers and take your money out. This money is in addition to the valuable premiums we give. Do not miss this chance. Just write us a letter or postcard and say "I will be Agent for your papers in my neighborhood." No risk—you cannot lose anything—you send us no money until you sell the papers. We tell you how to get customers.

W. D. BOYCE COMPANY
500 N. Dearborn St.,
Dept. 208 Chicago, Illinois

Stains Hard to Remove?
Just try some

GIT HAND PASTE



It works quickly
10¢ at F. W. Woolworth Co., McCrory and other stores

AGENTS!

If you are making less than \$150 a week, better write for information about selling SAAL HEAVY OIL SYSTEMS.

H. G. SAAL CO., Dept. 801, 1800 Montrose Ave., CHICAGO

A NEW WAY TO GET YOUR CLOTHES ABSOLUTELY FREE

and Make Big Money during your spare time—something different, better, bigger, more liberal than any offer ever made. Lower prices—better clothes—bigger cash profits—express or postage paid on everything.

DOUBLE PAY

Free Clothes and Cash Profits Besides. You can easily earn \$30.00 cash, extra, every week during your spare time, taking orders for our made-to-measure clothes. We don't ask you to use your cash profits for your own clothes. That's not our way of doing business. Ours is a new and better plan.

Fifty-six stylish, real cloth samples—FREE colored fashion plates; inside wholesale prices—everything FREE. Just drop us a line today and we will send complete outfit FREE.

SPENCER MEAD CO. Dept. Y-245 Chicago



Big Money in Music

A Conn instrument offers you a profitable career or a well-paying side-line, as you choose. Thousands are making big money with Conns; so can you.

The demand for players of saxophone, trombone, cornet, trumpet, tuba—in fact all wind instruments—is increasing. Popular orchestras for dance, vaudeville, phonograph recording and similar engagements need players. Directors search constantly for new material.

Choosing a Conn instrument is your first step in winning recognition. For Conns are known everywhere as the "instruments of the artists." They are easier to blow, perfect in scale; most reliable in action; beautiful in tone. Let us explain to you fully their exclusive features. Conns cost no more than others.



Some Famous Conn Artists

Upper Left: John Philip Sousa, Director Sousa's Band. Right: Bohumir Kryl, Director Kryl's Band. Lower Left: Isham Jones, Director Jones Orchestra. Right: Paul Biese, Director Biese's Orchestra.

FREE TRIAL: EASY PAYMENTS. Send postcard for details. Highest honors at world expositions.

Dealers and agents throughout the country. Factory branches in principal cities.

C. G. CONN, Ltd., 1131 Conn Bldg., Elkhart, Ind.

CONN

WORLD'S LARGEST MANUFACTURERS OF HIGH GRADE BAND AND ORCHESTRA INSTRUMENTS

CULTIVATE YOUR MUSICAL GUMP

ONLY \$2 DOWN

FAMOUS 21-JEWELLED ILLINOIS RAILROAD WATCH BUNN SPECIAL

**\$5.50
A Month**



PENN. TERMINAL



GRAND CENTRAL



We guarantee this watch to pass railroad inspection on any railroad in the United States. The requirements for passing railroad inspection are so severe that only the very finest watches can pass them. This watch is adjusted to six positions, although railroad requirements call for only five. A full description of the movement will be given if desired. Better still, order it on trial.



GUARANTEED 25 YEARS

This famous Bunn Special movement is put in a 25 year gold filled case that will wear like solid gold for more than 25 years. We guarantee it against any defect in material or workmanship. These movements are built to give a lifetime of satisfactory service just as the two famous Terminals pictured above were built to last for generations.

30 DAYS' TRIAL: 10 MONTHS TO PAY

You can test this watch in your own pocket for 30 days with the distinct understanding that if you return the watch we will return every penny you paid. Order it now or write for any additional information desired. Get our big catalog.

STERLING DIAMOND & WATCH CO.

Established in 1879

63 Park Row Dept. 1226 NEW YORK

STERLING DIAMOND & WATCH CO.,
63 Park Row, Dept. 1226, New York.
Gentlemen: Please send the famous BUNN SPECIAL, 21 jeweled Illinois Watch, as described above, to me on 30 days free trial. I enclose \$2.00 deposit to show my good faith. If I am not satisfied and return the watch within 30 days, you will return my money. If I keep the watch I will pay you \$5.50 every month for ten months until the total price of \$57.50 is paid. Title to this watch remains with you until I have paid you in full. It is understood that you fully guarantee this watch to be as described. Please send your catalog.

YOUR NAME _____

LOCAL ADDRESS _____

CITY & STATE _____

Please Mention Popular Mechanics

"DETROIT" BELT LACING OUTFIT



Detroit Wire Hook belt lacing used by ten thousand big factories and many more small shops and farms. Laces belts perfectly for one cent an inch. It is very strong, flexible and easy to apply. Saves time, belts, power and money.



Complete outfit including lacing tool (used in an ordinary vise as shown) and assorted box of lacing (as shown) for every kind and thickness of belt. Outfit postpaid \$5.50. Assorted lacing \$1.50 per box. Tool \$2.50. Money back if not entirely satisfied. Ask for folder.

Detroit Belt Lacer Co., Detroit, Mich.

HOME LOVERS' BARGAIN BOOK FREE

Showing Over 10,000 Furniture Bargains

All selections loaned free for a month. Take a year to pay if satisfied, paying little by little almost as you please.

SPiegel, MAY, STERN CO., 1108 W. 35th St., Chicago

DEAFNESS IS MISERY



I know because I was Deaf and had Head Noises for over 30 years. My invisible Antiseptic Ear Drums restored my hearing and stopped Head Noises, and will do it for you. They are Tiny Megaphones. Cannot be seen when worn. Effective when Deafness is caused by Catarrh or by Perforated, Partially or Wholly Destroyed Natural Drums. Easy to put in, easy to take out. Are "Unseen comforts." Inexpensive. Write for Booklet and my sworn statement of how I recovered my hearing.

A. O. LEONARD, Suite 226, 70 5th Avenue, New York City

"73 Years Young"



Is my age writes H. B. Ruth, Colorado man, yet for years Mr. Ruth suffered with prostate gland disorder. "Used medicines with no avail—had about given up hope until a Doctor recommended your treatment," he writes.

Thousands of men like Mr. Ruth are finding renewed health and vitality thru a wonderful discovery that has brought the most amazing results in Prostate trouble, frequent nightly risings, sciatica, aches in back and feet and chronic constipation. Statesmen, Bankers, Lawyers, Doctors use and endorse this method. Yet you can use it right in your own home—no drugs, electric rays or book—a simple but quickly effective new hygienic principle. No matter what your age—or what you have tried, find out about this discovery at once. "Why Many Men Are Old at 40" is the

FREE BOOK title of an interesting book that will be sent absolutely free. You may find relief from these distressing conditions the same as thousands of other men. Write at once to **THE ELECTRO THERMAL COMPANY, 2127 Main St., Steubenville, O.**

Swear Off Tobacco

Tobacco Habit Banished Let Us Help You

Quick Results

Trying to quit the tobacco habit unaided is often a losing fight against heavy odds, and may mean a serious shock to your nervous system. So don't try it! Make the tobacco habit quit you. It will quit you if you will just take **Tobacco Redeemer** according to directions.

It doesn't make a particle of difference whether you've been a user of tobacco for a single month or 50 years, or how much you use, or in what form you use it. Whether you smoke cigars, cigarettes, pipe, chew plug or fine cut or use snuff—**Tobacco Redeemer** will positively remove all craving for tobacco in any form in a few days. Your tobacco craving will usually begin to decrease after the very first dose—there's no long waiting for results.

Tobacco Redeemer contains no habit-forming drugs of any kind and is marvelously quick, scientific and thoroughly reliable.

Not a Substitute

Tobacco Redeemer is in no sense a substitute for tobacco, but is a radical, efficient treatment. After finishing the treatment you have absolutely no desire to use tobacco again or to continue the use of the remedy. It helps to quiet the nerves, and will make you feel better in every way. If you really want to quit the tobacco habit—get rid of it so completely that when you see others using it, it will not awaken the slightest desire in you—you should at once begin a course of **Tobacco Redeemer** treatment for the habit.

Results Absolutely Guaranteed

A single trial will convince the most skeptical. Our legal, binding, money-back guarantee goes with each full treatment. If **Tobacco Redeemer** fails to banish the tobacco habit when taken according to the plain and easy directions, your money will be cheerfully refunded upon demand.

Let Us Send You Convincing Proof

If you are a slave of the tobacco habit and want to find a sure, quick way of quitting "for keeps" you owe it to yourself and to your family to mail the coupon below or send your name and address on a postal and receive our free booklet on the deadly effect of tobacco on the human system, and positive proof that **Tobacco Redeemer** will quickly free you from the habit.

Newell Pharmacal Company
Dept. 300 St. Louis, Mo.

Free Book Coupon

NEWELL PHARMACAL CO.,
Dept. 300 St. Louis, Mo.

Please send, without obligating me in any way, your free booklet regarding the tobacco habit and proof that **Tobacco Redeemer** will positively free me from the tobacco habit or my money will be refunded.

Name.....

Street and No.....

Town..... State.....



Tobacco Tells on
Nervous System



Tobacco Ruins
Digestion



Tobacco Stunts
Boy's Growth



Tobacco Robs
Man of Vitality



Tobacco Steals
from You the
Pleasures, Com-
forts, Luxuries
of Life



LUMINOUS PAINT

Make Your Watches, Clocks, Etc., Visible by Night

The very latest discovery in the scientific world, Hitherto, practically unobtainable LUMINOUS PAINT, which, applied to the surface of any article, emits rays of white light, rendering it perfectly visible in the dark. **THE DARKER THE NIGHT, THE MORE BRILLIANT IT SHINES.** Quite simple to use. Anyone—you can do it. A little applied to the dial of your watch or clock will enable you to tell the time by night. You can use it on the push buttons or switch plates of your electric lights, match boxes, and innumerable other articles; make your own Luminous Cigarettes, Luminous Rosettes, etc. Small bottle, price 25c. Larger sizes, 50c and \$1 postpaid.

Serpent's Eggs

Box contains 12 eggs. When lit with a match, each one gradually hatches itself into a snake several feet long, which curls and twists about in a most life-like manner. Price per box, 10c postpaid, 3 for 25c.



Potmend

Mends Ironware, Agate-ware, porcelain, crockery, woodware, marble, etc. Comes in powdered form. Just mix with water and apply. **HARDENS LIKE IRON.** Mends a big hole or a small crack. PRICE 15c, 3 for 40c, postpaid.



Midget Bible

GREAT CURIOSITY Smallest Bible in the World. Size of a postage stamp. 200 Pages. Said to bring good luck to the owner. A genuine work of art. Must be seen to be appreciated. Make good money selling them to friends, church acquaintances, etc. PRICE 15c each, 3 for 40c, 12 for \$1.35, 100 for \$7.50.



STAGE MONEY

With a bunch of these bills, it is easy for each person of limited means to appear prosperous by flashing a roll of these bills at the proper time and peeling off a genuine bill or two from the outside of the roll, the effect created will be found to be all that can be desired. Prices, postpaid: 15 Bills 10c, 50 Bills 25c, 125 for 50c, or \$3.50 thousand.



Wonderful X-Ray Tube

A wonderful little instrument producing optical illusions both surprising and startling. With it you can see what is apparently the bones of your fingers, the lead in a lead pencil, the interior opening in a pipe stem, and many other similar illusions. A mystery that no one has been able to satisfactorily explain. Price 10c, 3 for 25c, 1 dozen 75c, Johnson Smith & Co.



Good Luck Ring

Quaint and Novel Design
A VERY striking and uncommon ring. Silver finish, skull and crossbones design, with two brilliant, flashing gems sparkling out of the eyes. Said by many to bring Good Luck to the wearer, hence its name, **Good Luck Ring.** Very unique ring that you will take a pride in wearing. **ONLY 25 CENTS.**



Address orders for all goods on this page to
JOHNSON SMITH & CO.
Dept. 6 RACINE, WIS.
Our large catalog (356 Pages) of all the newest and best novelties, unobtainable elsewhere, free with every order.

BLANK CARTRIDGE PISTOL

Protection against Burglars, Tramps & Dogs

Prices
50c
\$1.00



Well made and effective; modeled on latest type of Revolver; appearance alone is enough to scare a burglar. When loaded it may be as effective as a real revolver without danger to life. It takes standard 32 Cal. Blank Cartridges obtainable everywhere. Price 50c, superior quality, \$1.00 postpaid. Blank Cartridges, by express, 50c per 100. Johnson Smith & Co., Dept. 6, Racine, Wis.

DANCING BEAUTIES

BEST EVER

Got a Kinesograph and see the picture move. France's latest sensation. A great surprise. Is worth twice what they cost. Are made of solid brass, highly nickel-plated and very durable. Satisfactory, or your money back. Price 50c



Johnson Smith & Co., Dept. 6, Racine, Wis.

BOYS! BOYS! BOYS! THROW YOUR VOICE

Into a trunk, under the bed or anywhere. Lots of fun fooling the teacher, policeman or friends.

THE VENTRILO
a little instrument, fits in the mouth out of sight, used with above for Bird Calls, etc. Anyone can use it.

Never Fails. A 32 page book on ventriloquism, the Ventrillo, ALL FOR 10 CENTS

1000 Silk Remnants

For patching Crazy Quilts, Sofa Cushions, Head Rests, Pin Pads etc. Large pieces, all colors and shades. Sure to delight you. For 10 Cents stamps, we send a large package and Book of quilt designs. 3 packages, 25c. 1 pound makes a lovely large quilt. Price 75c postpaid. Our silk is the best. JOHNSON SMITH & CO., Dept. 6, RACINE, WIS.

LOOK 50c LOOK
Wonderful instrument. Greatest thing yet. Nine separate articles in one. Everybody delighted with it. Odd, curious and interesting. Lots of pleasure as well as very useful. It is a double Microscope for examining the wonders of nature. It is also an Opera Glass, a Stereoscope, a Burning Lens, a Reading Glass, a Telescope, a Compass, a Pocket Mirror, and a Laryngoscope—for examining eye, ear, nose and throat. It is worth all the cost to locate even one painful cinder in the eye. Folds flat and fits the pocket. Something great—you need one. Don't miss it. Sent by mail, with 356 page Novelty Catalog. **Only 50c or 3 for \$1.25**



Resurrection Plant

One of the most wonderful plants known. Possesses the strange power of turning in a few minutes from an apparently lifeless, dry herb to a beautiful living fernlike plant of a dark green color. Simply place the plant in saucer of water, it will open up and start to grow in 30 minutes. When taken out it will dry up and go to sleep until placed in water again. Fine house plant—summer or winter. 10 cents each or 3 for 25c. **AGENTS WANTED** post paid. JOHNSON SMITH & CO., Dept. 6, RACINE, WIS.



The Dying Pig



The most laughable novelty yet produced. Made of rubber, and you have only to blow it up and stand the pig on his feet, when he begins to squeal as he slowly collapses and finally lies down and dies in the most natural manner. You can blow him up as often as desired, and each time he will go through the same performance to the great amusement and delight of your friends. Price, 15 cents; 3 for 40 cents; one dozen \$1.35, mailed.

Popular Watch Charms

15c
ONLY 3 for 40c; \$1.35 doz.

Very pretty little curiosities and decidedly novel. Fitted with Magnifying Lenses that enlarge the pictures to a very surprising degree; in fact, it seems almost incredible that a clear picture could be possible in such small compass, and how sharp and distinct they show up when you look through. Come in assorted views—Actresses, views of Panama Canal, Lord's Prayer in type, etc.

Mystic Skeleton

A jointed figure of a skeleton 14 in. in height, will dance to music and perform various gyrations and movements while the operator may be some distance from it. 10c pd.

NEW BOOK ON ROPE SPLICING

Useful Knots, Hitches, Splices, etc.
A most practical handbook giving complete and simple directions for making all the most useful knots, hitches, rigging, splices, etc. Over 100 illustrations. All about wire rope attachments, lashing, blocks, tackle, etc. 27 Heraldic Knots illustrated. Of great value to mechanics, riggers, campers, boatmen. Price 20c ppd.

MAGIC FLUTE

Wonderfully Sweet Toned and Musical
The Magic Flute, or Human Stone, is a unique and novel musical instrument that is played with nose and mouth combined. There is just a little knack in playing it which, when once acquired after a little practice will enable you to produce very sweet music that somewhat resembles a flute. There is no fingering, and once you have mastered it you can play all kinds of music with facility and ease. When played as an accompaniment to a piano or any other musical instrument, the effect is as charming as it is surprising.



ALL WOOL

Sport Model Overcoat!



Only
\$100
 DOWN
 6 Months to Pay
 Total Price \$24.95

This handsome, sport model overcoat is yours for less than half the usual price. We are giving you the advantage of our best buy this season. But you had better hurry and order now. These wonderful coats will not last long. We'll have to raise the price when the lot is gone. Only \$1.00 down! You have 6 months to pay! Just think, you get 6 months additional wear out of your coat while you are buying it. If you aren't satisfied in every way with this overcoat after you have tried it on and inspected it carefully, send it back. Your money will be cheerfully refunded.

This heavy, double-breasted, all-wool overcoat will give you dandy service. It is beautifully made of pure all-wool material in a warm, deep, rich cinnamon brown. The back of the material is an attractive plaid in harmonizing colors. Partly lined in high grade, durable material. Large collars, semi-raglan sleeves, full belt, roomy patch pockets and bound seam. Length 44 to 47 inches. Sizes 34 to 46 inches chest measure. Give chest measure taken over vest. Order by number 4689.

Order Today

Don't miss this wonderful chance to get your winter overcoat at this amazingly low price. If you aren't satisfied with this high quality overcoat at this remarkable low price, your money will be refunded. Our new catalog showing amazing values in boy's and men's suits and overcoats is just off the press. Send for it NOW.

Babson Bros., Dept. 13-58

19th Street and Marshall Blvd., Chicago, Ill.

Enclosed please find \$1.00. Send me the double-breasted, all-wool overcoat at the advertised price. If I am not satisfied when I receive the overcoat, I can return it and get my money back. If satisfied, I will pay \$4.00 after inspection and \$4.00 per month — Total \$24.95. Order by No. 4689. My measures are:—

Chest (measured over vest) Height Weight

Name

Address

City State

Age Occupation

Munroe Great Coat

How Anyone Can Develop His INVENTIVE ABILITY

Let Great Inventors teach you how to invent, develop, patent and market your ideas; amazing new course teaches science of invention by mail



Raymond Francis Yates
author of the New Course in Inventive Science, in collaboration with 15 other inventors. Mr. Yates is known throughout the country as Editor of scientific magazines, writer of hundreds of articles and inventor of many practical devices and machines.

EVERY man, woman, and child is born with creative imagination. Some develop this faculty to a greater degree than others, and those who develop it to the greatest extent are successful inventors. Invention is an orderly process of the mind, which combines two or more known facts to produce a new fact. Anyone who develops the right mental process can become an inventor. Every successful inventor has this type of mind, developed by constant experience over a period of perhaps many years. Heretofore those who succeeded in the field of invention had to discover all the principles themselves. But, now, just as any student of medicine, law, or engineering can take full advantage of all the recorded experience in these fields of study, so can YOU take the same kind of short cut to the habits of thought, and the methods of work required of successful inventors.

LITTLE INVENTIONS WIN FORTUNES

Fortunes have been made by men who have thought of a "little" idea in a flash. The man who invented the bottle top, the man who invented the crimped hairpin, the man who invented the thin lead automatic pencil, the man who invented the snap fastener—all these men, perhaps, got their ideas in a flash, and founded their fortunes as a result of a single idea. But in every case their minds operated in accordance with the scientific laws of successful invention. Edison says: "Invention should be taught as a profession." Every inventor realizes the hopelessness of groping in the dark for the habits of thought and methods of work required for successful invention. Trying to invent without knowing the fundamental requirements of invention is like trying to build a bridge without knowing engineering.

Don't Waste Ideas! Every man at some time or other has an idea for something he would like to invent, but his mind doesn't know how to work. He doesn't know what to do about it—doesn't know how to think along inventive lines—and soon someone whose mind is trained along inventive lines invents just the thing you may have thought of.

BUREAU OF INVENTIVE SCIENCE
Dept. 311, Wisner Building
Rochester, N. Y.

Please send me your free book
"The Science of Invention."

Name

Address

City

State

WRITE FREE BOOK FOR

A wonderful book explaining this wonderful new course in detail has been written and will be sent free to those genuinely interested. This book explains the course in detail, and proves that anyone can become an inventor who trains his mind—it may be the beginning of a fortune for you. If you have ever had an idea for an invention, or if you would like to become a spare-time or professional inventor, and if you would like to know what to invent, send in your name at once on the coupon NOW!

Only a limited number of these books are available for free distribution.

Bureau of Inventive Science, 311 Wisner Bldg., Rochester, N. Y.

U.S. PATENTS



SEND FOR THIS FORM

DON'T LOSE YOUR RIGHTS TO PATENT PROTECTION

Before disclosing your invention to anyone send for blank form "EVIDENCE OF CONCEPTION" to be signed and witnessed. A sample form together with printed instructions will show you just how to work up your evidence and establish the same before filing application for patent. As registered patent attorneys we represent hundreds of inventors all over the United States and Canada in the advancement of inventions. Our schedule of fees will be found reasonable. The form "Evidence of Conception," sample, instructions relating to obtaining of patents and schedule of fees sent upon request. Ask for them—a post card will do.

PATENTS AND TRADE MARKS



480 Ouray Bldg. Washington, D. C.
Originators of forms "Evidence of Conception."

Have You An Invention?

If so the WORLD PROGRESS will show you how to PROTECT AND PROFIT FROM YOUR IDEAS
Sample copy free. One year's subscription \$1.00.
Send for free book,

"WHAT TO INVENT"

containing SUGGESTIONS TO INVENTORS as to Inventions Needed. We invite manufacturers to address us regarding inventions they want.

WORLD PROGRESS PUB. CO., Inc.
Room 203 Victor Bldg. WASHINGTON, D. C.

PATENTS

REGISTERED PATENT ATTORNEY SINCE 1905
CHARLES W. LOVETT SECURITY BLDG. LYNN MASS.
(SEND FOR FREE BOOKLET)

INVENTORS

who derive largest profits know and heed certain simple but vital facts before applying for Patents. Our book Patent-Sense gives those facts; free. Write Lacey & Lacey, 545 F St., Washington, D. C. ESTABLISHED 1869.

PATENTS

Trade-Marks, Copyrights and Patent Litigation
Write for advice and instructions how to proceed, costs, etc. Hand Book with illustrations of 100 Mechanical Movements sent free on request.

ALBERT E. DIETERICH
Patent Lawyer and Solicitor
Successor to Fred S. Dieterich & Co. 621 Ouray Bldg., Washington, D. C.

PATENTS TRADE-MARKS AND COPYRIGHTS

SPECIAL OFFER — Free Opinion as to Patentable Nature

Before disclosing an invention, the inventor should write for our blank form "Record of Invention." This should be signed and witnessed and if returned to us together with model or sketch and description of the invention, we will give our opinion as to its patentable nature.

Our Three Books Mailed FREE to Inventors

OUR ILLUSTRATED GUIDE BOOK

HOW TO OBTAIN A PATENT

Contains full instructions regarding Patents. Our Methods, Terms, and 100 Mechanical Movements illustrated and described; Articles on Patent Practice and Procedure, and Law Points for inventors.

OUR TRADE-MARK BOOK

Shows the value and necessity of trade-mark protection and gives information regarding Trade-Marks and unfair competition in trade.

OUR FOREIGN PATENT BOOK

We have direct agencies in all foreign countries and secure foreign patents in the shortest possible time and at the lowest cost.

LIST OF PATENT BUYERS SENT FREE

IDEAS WANTED: Send for LIST OF PATENT BUYERS containing unsolicited letters from Manufacturers and others WISHING TO BUY meritorious patents. There is a great demand for NEEDED INVENTIONS. We endeavor to assist OUR clients in the commercial development of their inventions.



Specifications and Drafting Departments, Victor Building

Prompt Attention
Reasonable Terms
Highest References

ALL COMMUNICATIONS AND DATA STRICTLY CONFIDENTIAL
INTERFERENCE AND INFRINGEMENT SUITS PROSECUTED

VICTOR J. EVANS & CO., Patent Attorneys

NEW YORK OFFICES
1007 Woolworth Building

CHICAGO OFFICES
1114 Tacoma Building

PHILADELPHIA OFFICES
714-715 Liberty Bldg.

PITTSBURGH OFFICES
514 Empire Building

SAN FRANCISCO OFFICES
Hobart Building

MAIN OFFICES: 765 9TH STREET, N.W., WASHINGTON, D. C.

Gentlemen: Please send me FREE OF CHARGE your books as described above.

Name Address

FREE
COUPON

PATENTS

Booklet Free

Highest References

Promptness Assured

Best Results

Send drawing or model for preliminary examination

ALL BUSINESS GIVEN PROMPT AND PROPER ATTENTION

WATSON E. COLEMAN, Patent Lawyer, 624 F St., Washington, D. C.

PATENTS

To the Man with an Idea

I offer a comprehensive, experienced, efficient service for his prompt, legal protection and the development of his proposition.

Send sketch, or model and description, for advice as to cost, search through prior United States patents, etc. Preliminary advice gladly furnished without charge.

My experience and familiarity with various arts frequently enable me to accurately advise clients as to probable patentability before they go to any expense.

Booklet of valuable information and form for properly disclosing your idea free on request. Write today.

Richard B. Owen, Patent Lawyer
9-303 Owen Building, Washington, D. C.
2276-E Woolworth Bldg., New York City

PATENTS

C. L. PARKER
Formerly Member Examining
Corps, U. S. Patent Office
PATENT LAWYER
MCGILL BLDG.
WASHINGTON, D. C.

Patents, Trade Marks, Copyrights, Patent Litigation

Handbook for Inventors, "Protecting, Exploiting and Selling Inventions," sent free upon request.



PATENTS

Send us sketch or model for patentability opinion and exact cost of patent. Our book "How to Obtain a Patent," Sent Free on request. It tells how to apply for Patents, Trade Marks, Foreign Patents, Copyrights, etc.; gives information on Patent Procedure; tells what every inventor should know. Thousands of inventors, who are our clients, are our references.

Chandlee & Chandlee, 25 Years' Experience,
455 7th St. Washington, D. C.



GEARS ALL KINDS SMALL

The most accurate made and prices reasonable. We carry a complete line of gears in stock for immediate shipment. Can also quote on special gears of all kinds. Send us your inquiries.

WRITE FOR CATALOGUE.

CHICAGO STOCK GEAR WORKS
105-109 S. Jefferson St., CHICAGO

How Would You Like To Grow Hair in a Month?

Getting bald, hair falling and fading? If you want to grow new healthy hair right away I will send you absolutely Free a sample of the famous Alexander Glandahair. No cost, no obligation, just send name to ALEXANDER LABORATORIES.
5104 Gateway Station, Kansas City, Mo.

PATENTS If You Have an Invention and Desire to Learn How to Secure a Patent

Send for our Guide Book, **HOW TO GET A PATENT**, sent Free on request. Tells our terms, methods, etc. Send model or sketch and description of your invention and we will give our opinion as to its patentable nature.

RANDOLPH & CO.
600 F St., N.W., Washington, D. C.

NAME.....

STREET.....

CITY.....STATE.....



PATENTS

EXPERIENCE SERVICE

CLARENCE A. O'BRIEN

PATENT ATTORNEY

REGISTERED IN UNITED STATES PATENT OFFICE
MEMBER OF THE BAR OF
SUPREME COURT OF UNITED STATES, COURT OF APPEALS DISTRICT OF COLUMBIA,
SUPREME COURT DISTRICT OF COLUMBIA, UNITED STATES COURT OF CLAIMS.
PRACTICE CONFINED TO PATENTS AND TRADE MARKS.

PATENTS

PROTECT YOUR IDEAS

ANY NEW article, machine, design or improvement thereof, or any new combination of parts or improvements in any known article which increases its efficiency or usefulness, **may be patented**, if it involves invention.

IF YOU HAVE ANY NEW IDEAS

which you feel are useful, practical and novel, **take prompt action to protect your rights.** If you have invented any new machine, or new combination of parts of improvement, or any new design or process, **SEND DRAWING, MODEL OR DESCRIPTION** of it for information as to procedure to secure protection.

Write Today for Blank Form "Record of Invention"

USE THE COUPON attached, and immediately upon its receipt I shall send you this form to be returned to me with drawing, description or model of your idea; promptly upon receiving your idea I shall write you fully as to procedure and costs.

No Charge for Above Information

My practice is devoted **exclusively** to United States and Foreign Patents and Trade Marks. Write me freely, frankly and with full confidence; it is very probable that I can help you. **Write TODAY.**

Clarence A. O'Brien, Registered Patent Attorney

325 Security Savings & Commercial Bank Bldg., WASHINGTON, D. C.

Directly Across Street from U. S. Patent Office

ALL COMMUNICATIONS

are held in strict confidence. My personal, careful and thorough attention is given to each case. I offer you efficient, reliable and prompt service—based upon practical experience. **Highest references.**

Write Today for free book, "How to Obtain a Patent." This book will give you valuable information, and it may save you much time and effort. **Send for it, NOW.**

CLARENCE A. O'BRIEN, Patent Attorney, 325 Security Savings & Com'l Bank Bldg., Directly Across Street from Patent Office, Washington, D. C.

Please send me your free booklet, "How to Obtain a Patent" and blank form, "Record of Invention," without any obligation on my part.

NAME.....

ADDRESS.....

(WRITE PLAINLY)



W. R. Meisner

W. R. Meisner

PATENTS

Seventy-six Years of Practice

THE firm of Munn & Company filed its first application for a patent in 1846, and for seventy-six years has endeavored to keep pace with the inventive genius of the United States.

An experience of many years is at your disposal. If you have an invention which you wish to patent, send your sketches or model together with a description of your device, explaining its operation, and you will receive prompt, courteous attention.

Write for our Handbook on PATENTS

A full and complete booklet on Patents, Designs, Trade-Marks, Foreign Patents, Copyrights, Labels and Patent Office Practice with an explanation about our methods, terms, etc.

All communications strictly confidential.

Keep in touch with the inventions of the world by reading

SCIENTIFIC AMERICAN

The MONTHLY MAGAZINE with a special appeal to every man of inventive genius. Recent rulings of the Patent Office, descriptions of the latest patented inventions, legislation and court decisions affecting patents, are noted in this authoritative publication.

MUNN & COMPANY

Patent Attorneys

672 Woolworth Building, New York City

Scientific American Building, Room 2
625 F Street, Washington, D. C.

Suite 801, Tower Building, Chicago, Ill.

601 Hobart Building, San Francisco, Cal.

Please Mention Popular Mechanics

Can You

think of a simple, practical idea that will fill one of the many requests we have on file for new inventions? It may mean a fortune for you. Thousands of things are needed **right now**. Your brains can help. Send today for our great new book—

"Inventions and Trade-Marks, Their Protection and Exploitation" and learn more about making money from ideas than you ever knew before. It tells many things that are wanted, too.

**A postal will do—
It is free**

We Help Our Clients

without charge, to get the dollars out of their ideas—having facilities none others possess. Advice free. Don't delay—get the book at once.

American Industries, Inc.
200 Patent Dept.
WASHINGTON, D. C.

**Patents
Advertised
For Sale Free**
in Invention and
Manufacturing Supplement

Published for the man with an idea. Send for free sample copy. One year's subscription, 50c

Our BUREAU OF INFORMATION will answer all questions regarding articles appearing in this magazine.

NO. 1
\$2.63



NO. 2
\$3.25



NO. 3
\$5.90



NO. 4
\$4.98



WEAR SEVEN FREE
DAYS

OUR MARVELOUS MEXICAN DIAMONDS

have delighted thousands of customers for 18 years. They positively match genuine diamonds. Same perfect cut, same dazzling play of rainbow fire. Stand intense acid test of side by side comparison with genuine. Noted experts positively need their experience to detect any difference whatever. Perhaps the gems you admire on your closest friends are MEXICAN DIAMONDS and you never knew it. Test a MEXICAN DIAMOND FREE! you risk nothing. Wear it seven days side by side with a genuine diamond. If you see any difference, send it back; it won't cost you a cent.

HALF PRICE TO INTRODUCE:

To introduce to new customers, we quote these prices which are all you pay and just half our catalog prices.

No. 1—Ladies 1 ct. Solitaire, fine 14k gold 7. 52.53

No. 2—Gents Heavy Tooth Belcher, 1 ct. gem, 14k gold 12.25

No. 3—Ladies 3 stone Duchess ring, fine platinum finish, two 5/8 ct. first water Mex. diamonds, one blue sapphire, 5.70

No. 4—Gents Ex. Heavy Gypsy ring, platinum finish, black inlay on sides; 3 7/8 ct. first water Mex. Diamond 4.98

SEND NO MONEY. Just send name, address and slip of paper that meets around ring finger to show size. Buy which ring you want. We ship promptly. On arrival, deposit price with postman. If you decide not to keep it, return in 7 days and we'll refund your money. Write TODAY. Agents wanted.

MEXICAN DIAMOND IMPORTING CO.
Dept. ET
LAS CRUCES, N. MEX.
Exclusive Controllers of Mexican Diamonds for 18 years.

Vacuum Tubes Do Triple Duty With Erla Synchronizing Transformers



Perfect synchronization of received and reflexed r. f. currents make Erla radio transformers indispensable in reflex work. List, \$5



Erla tested capacity condensers are unequalled in rigid, unvarying accuracy, so vital to success in reflex work. Eleven sizes, 35c to \$1 ea.



Erla bezels greatly enhance the finest cabinet assembly. Telescoping rim, in bright nickel or dull enamel, fits any 1/4" to 1/2" panel. List, 20c

Dealers and Jobbers—Erla progress constantly widens avenues of trade. Write for liberal terms and discounts



For the first time, the full efficiency of vacuum tubes is completely utilized and brought under control.

In Erla reflex circuits, tubes do triple duty, providing simultaneous amplification of radio frequency, reflexed radio frequency and reflexed audio frequency currents. Yet, so precise is the manipulation of this complex current flow, that the tremendous gains resulting are achieved without a single drawback.

Not only do Erla reflex circuits demonstrate decisive superiority in range and volume, but they are also unequalled in selectivity, purity of tone, and ease of control. Even the single-tube circuit provides far-flung loud speaker range, while the three-tube circuit surpasses costliest multi-stage units in transcontinental loud speaker reception. And the two-tube circuit is close behind.

Essential to the operation of these circuits, and the secret of their success, are Erla synchronizing radio and audio transformers. Providing perfect synchronization of received and reflexed currents having the same phase characteristics, they assure tremendously magnified amplification without distortion.

Complete diagrams and descriptions of perfected Erla reflex circuits are set forth in Erla Bulletin No. 14, obtainable gratis from leading radio dealers. Or write us direct, giving your dealer's name.



Rectified radio frequency and reflexed audio frequency currents are accurately synchronized by Erla audio transformers. List price, \$5



Difficult, dangerous use of soldering irons is eliminated by Erla solderless connections, saving time, temper and money. List, 5c ea.



Providing utmost sensitivity with perfect stability, the Erla fixed crystal rectifier is uniquely adapted for reflex work. List, \$1

Electrical Research Laboratories
Dept. J 2515 Michigan Avenue, Chicago

ERLA

Ear-Joy
\$1.00 a Pair
HEADPHONE CUSHION
HUDSON-ROSS
123 WEST MADISON ST.
CHICAGO

FREE —a book that tells how to get better results with radio tube sets. Address
WILLARD STORAGE BATTERY COMPANY
CLEVELAND, OHIO

ELECTRIC SOLDERING IRON
EVERY RADIO FAN has been looking for this iron for both radio and home use. Operates on A. C. or D. C. current.
\$2.28
GUARANTEED one year. Sent anywhere in U.S. or Canada Parcel Post prepaid on receipt of money order for \$2.28.
FANS Send 2c stamp for our list of RADIO BARGAINS
RADIO BARGAINS
17 N. LA SALLE ST. - CHICAGO

everybody's BLOW TORCH

Today there's as much need in your home, repair shop and garage for a blow torch as for any other time, money, and labor saving tool. No longer need you be without those hundreds of important uses to which a blow torch can be put. Science and master engineers have now given you a safe blow torch—the

TURNER BLOWTORCH
Safe as a Candle

And built into it 11 important features never before put in a blow torch. Its flame gives 400° more heat; its tank is leakproof; its "hot spot" insures perfect gasification of all gasoline or kerosene; its safety valve banishes danger. Unmatched in performance; unduplicated in uses. You shouldn't be without it. Fits scores of needs. Simple, sturdy construction; easy to operate. Get a Turner from your dealer TODAY, or write us direct.

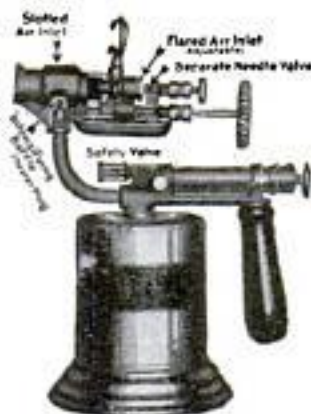

Great Turner production makes possible this unbelievably low price

\$8²⁵
Postpaid

DEALERS: Write at once, volume sales assured.

THE TURNER BRASSWORKS
Industry Ave., SYCAMORE, ILL.
The World's Largest Exclusive Manufacturers
of Blow Torches, Fire Pots and Brazers.

THE TRINITY LOUD SPEAKER

The only device of its kind in the radio field.



LAMINATED ADJUSTING SCREW CORE

TYPE B \$12.50

Study the illustration carefully and you will understand why it produces full, clear natural tones with perfect reproduction of all vocal and instrumental music. May be used with phonograph or built into your set.

Type A1, \$25.00
21" Fibra Horn

TRINITY RADIO CORPORATION
446 TREMONT ST., BOSTON, MASS.

FREE VACUUM TUBE RADIO SET

Can receive 100 miles and more.

RUSH your name to learn how you can get a Vacuum Tube Radio Set **ABSOLUTELY FREE**. Don't delay; write today for **FREE RADIO PLAN**.

HOME SUPPLY CO.
Dept. 10
131 Duane St., N. Y. C.

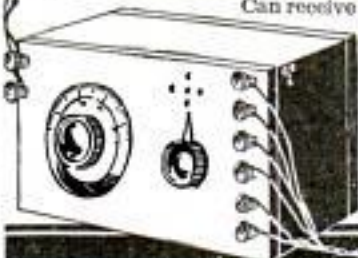

Price Only \$29.50

MIRACO
GETS 'EM
1500
MILES
AWAY

At the low prices shown below you get the efficiency of sets costing three times as much.

These radio frequency receivers—pick up stations over 1,500 miles away under good conditions—everywhere.

Operate either on DRY CELLS or storage battery. Cabinets of solid mahogany and workmanship the finest throughout. Order direct or send for bulletin.

Two tube outfit, as shown above, headphones only \$29.50
Four tube outfit for loudspeaker or headphones \$54.50

DEALERS AGENTS—write for proposition quickly—it's a winner.

THE MIDWEST RADIO COMPANY
807 Main Street CINCINNATI, OHIO

FREE Radio Text Book and Catalog

A Post Card Brings It

CONTAINS 75 VACUUM TUBE HOOK-UPS
300 ILLUS. 500 RADIO ARTICLES
All Armstrong Circuits: These important circuits are explained clearly, all values being given, leaving nothing to puzzle you.

Also 75 full, clear diagrams, explanations and instructions for all important vacuum tube circuits, from the simplest to the most advanced. How to make a wave-trap—how to increase wave length of set—aerial data—tube data—battery data—reflex—regeneration—radio amplifiers—audio amplifiers—loud speakers—tables of component parts, and endless other radio subjects covered in simple, understandable way.

The 75 diagrams in book form alone would cost you \$2 to \$5. Get this all FREE. Send for it right away. Offer limited.

RADIO SPECIALTY COMPANY, 98 E. Park Place, N. Y. City



Reliable RADIO Goods

Results are sure with RELIABLE goods

And it's easy to get such goods—anything you want in radio equipment. Big, complete stock—everything guaranteed; quick service; right prices. And you're sure it's reliable when it comes from Andrae. Get our complete catalog—free.

JULIUS ANDRAE & SONS CO., 116 Michigan St., Milwaukee, Wis.

ANDRAE In Business Since 1860

21 Jewel Burlington



Only \$1.00 Down

The 21-Jewel Burlington is sold to you at a very low price and on the very special terms of \$1.00 down—free examination—small monthly payments after acceptance. Send today for information.

Free Book Send for the most complete watch book ever produced. 100 designs and engravings beautifully illustrated in colors. Write for it today, it is free. A letter or a postcard will do.

Burlington Watch Company 19th St. and Marshall Blvd. Dept. 13-58 Chicago, Ill.

The Real Metal Solder in Paste Form

SOLDERALL

Introducing Our New
SOLDERALL BLOW TORCH
of Heavy Solid Brass

Indispensable in the Home, Garage
and to the Electrician. For soldering
Radio, House Wiring, Jewelry,
Ignition, Kitchen Utensils, etc.



IMPROVED BRASS TORCH \$1.25
SOLDERALL TUBE 25¢

SOLDERALL CO. Dept. P Newark, N.J.

**Rings Bells
Without Batteries**

Avoid the annoyance of having bells out of
order. At a nominal cost you can install this
little device which will ring electric bells, buzzers,
annunciators, electric heat regulators, door-openers,
etc., from the same current that lights your home.

Air-Way
Bell
Ringer
Transformer

Connects direct to lighting-current, and eliminates forever
the use of troublesome dry batteries. Does not use
enough current to register on meter. Buy it from any electrical
dealer, or we will send it anywhere postpaid upon
receipt of price. Your money back if you are not satisfied.
JOBBER, DEALERS, AGENTS—Write for selling proposition.
AIR-WAY ELECTRIC APPLIANCE CORPORATION
Toledo, Ohio

ONLY \$2.00
Canada \$3.00



Ear-Jay

Rejoice when using these
pneumatic phone cushions.
They gently hug
the ears, shutting out all
room noises. Fits any
type headset. Money back
guarantee if
you are not
satisfied.

HEADPHONE
CUSHION
HIDDEN HOLES

FANS List of Bargains **FREE** 100
BARGAINS **FREE** 100

RADIO BARGAINS
17 N. LA SALLE ST. - CHICAGO

ANT

"Read'em" Binding Posts

WITH KNOBS
That Won't Come Off

Anyone can "read 'em." All popular
styles—Antenna, Ground, Fones, A
and B Battery plus and minus—abbreviations
of different names engraved on
knobs. Ask your dealer for "Read'em"
—the kind for real Radio fans. If your
dealer does not have them, write direct.

The Marshall-Gerken Co.
Manufacturers
Dept. H. Toledo, Ohio



Coils and Mountings
Licensed under
DeForest Patents



Insist
on the
Genuine

They are
Duo-Lateral
We call them

BRANSTON Lateral Wound Inductance Coils

No other method of tuning has approached the wonderful flexibility of the Honeycomb Coil in changing to different wave lengths. If you are in doubt, ask your "Old Timer" radio friend why sets using Honeycomb Coils are better.

With Branston Honeycomb Coils you can get closer tuning, greater selectivity, greater range. Two outstanding features of the Branston Coils are—no dead end losses, ease of operation. Send 2c in stamps for Series 1 "Hook-Up" Circular, showing five good Honeycomb hook-ups, and Catalog of famous Branston Radio materials. Write today, giving your dealer's name. If he can't supply you, let us know.

CHAS. A. BRANSTON, Inc.
819 Main St., Buffalo, N. Y.
In Canada—Chas. A. Branston, Ltd.
Toronto, Ont.



BRANSTON
RADIO

**200 Sheets &
100 Envelopes**
\$1.00

Sent Post Paid
Printed with Name
and Address in Dark Blue Ink



Think of it! Beautifully printed individual stationery with your full name and address on both paper and envelopes; correct style, high grade white bond paper; fashionable note sheets, size 5½ x 6½ in. with envelopes to match; all printed in dark blue ink. Only \$1.00. West of the Mississippi and in foreign countries \$1.10. Everything sent postpaid.

Peerless Stationery Company
9-11 Exchange Street Rochester, N. Y.

PEERLESS STATIONERY CO.
9-11 Exchange St., Rochester, N. Y.
Enclosed is \$1.00. Send me postpaid 200 sheets
Stationery and 100 Envelopes to match.

Name _____
Address _____
City _____
PRINT NAME AND ADDRESS PLAINLY

\$4.00

2000 Ohms

**\$4.50**

3000 Ohms

NEW PRICES!

You are taking no chances when you use Murdock Headphones with your Radio Receiving Set. Standard for over 19 years.

And Murdock prices are so reasonable that every Radio enthusiast can afford them.

Get a pair from your dealer. Also ask him to show you the new Murdock \$5 Loud-speaker. If he doesn't have them send direct.

WM. J. MURDOCK COMPANY

General Offices and Factory

349 Washington Ave. Chelsea, Mass.

New York Chicago San Francisco

MURDOCK RADIO

STANDARD APPARATUS SINCE 1904

GIVEN



RADIO SET WITH DOUBLE HEAD PHONES

This wonder RADIO SET in special metal cabinet with double head phones complete ready to hook up

ABSOLUTELY WITHOUT COST

LISTEN in on concerts, sports, lectures, singing, etc. **QUICK!** Send only your name to-day for wonderful RADIO PLAN.

GUARANTEE SALES CO., 26 Washington Place, Dept. 13, NEW YORK

CHARGE YOUR RADIO or AUTO BATTERY OVERNIGHT FOR A NICKEL



GOLD SEAL HOMECHARGER
The World's Most Popular in Batteries-Chargers

—silently and efficiently charges your radio or automobile battery over night for a nickel. No stepping—no sticking—no noise—no fuss—no trouble. Self-polarizing

—high charging rate—finished in mahogany and gold—approved by Underwriters. Price \$18.50 complete with ammeter (\$25.00 in Canada)—no extras to buy.

LOOK FOR and INSIST ON the GOLD SEAL

WRITE FOR FREE BOOKLET THE AUTOMATIC ELECTRICAL DEVICES COMPANY

129 W. THIRD ST.

CINCINNATI

ALL-AMERICAN AMPLIFYING TRANSFORMERS
Radio and Audio Frequency

FREE Book of hookups
Send 2¢ Stamp for postage

RAULAND MFG. CO.
200 No. Jefferson St., Chicago, Ill.

WEIGHS ONLY 8 OZ.



A 200,000** COMPANY stands squarely back of the guarantee on every Scientific headset

SEND NO MONEY!

20,000 TURNS EQUIVALENT TO 3,000 OHMS

Order Today by Postcard and Pay Postman on arrival

LOUD SPEAKER UNIT

POST-PAID

We Guarantee The Scientific Headset to be the greatest value on the market. Try it for five days. If not satisfactory send it back and your money* will be refunded immediately. Circular* on request. Dealers wanted.

THE SCIENTIFIC ELECTRIC WORKS
95 Brookline Ave. 6th. C1 BOSTON, MASS.

RADIO PARTS

SIGNAL Are Better Cost Less

MOST EVERYTHING YOU NEED FOR BUILDING YOUR OWN SET.

SEND FOR BULLETIN 16—FREE

SIGNAL ELEC. MFG. CO. 1916 Broadway Menominee, Mich.

ELECTRIC SOLDER IRON

Fits Any Standard Appliance Plug

\$1.00
Iron Only



100 Watts
108-115 Volts

Radio-Auto-Home does work of any \$15 iron. Plain string solder, 60c lb. Acid or Rosin Core, 90c lb. Add 10c for postage.
M. A. Simon Co., Dept. X, 207 N. 7th St., St. Louis, Mo.

FREE RADIO BOOK



An easily understood explanation of Radio, written by Powel Crosley, Jr., President of Crosley Mfg. Co., Cincinnati, and The Precision Equipment Co., Cincinnati.

WRITE TODAY FOR THIS BOOKLET

Crosley Manufacturing Co.

1115 Alfred Street

Cincinnati, O.

"Lighting Fixtures"

READY TO HANG

(Direct from Manufacturers)

Completely wired, including glassware. New designs. Send for catalogue No 24. Send for DEALERS' proposition.

ERIE FIXTURE SUPPLY CO.

STA. A.

ERIE, PA.



"UNITED" Radio Condensers and Transformers

NO matter what you pay for radio parts you generally get just what you pay for—cheap parts are cheap—not only in price but in materials and workmanship, and you can only expect to get cheap results.

"United" Radio parts are not built to meet a price—but to meet the exacting requirements of the radio set owner. The price is then figured. Large production, modern machinery and plant—good management—all combine to keep the price way down and yet the products are built as well both mechanically and electrically as it is possible to build them.

You take no chance when you buy "United" parts. We are so sure that they are correct that we will sell them on a money back guarantee.

"UNITED" Variable Condensers without Vernier Dial and Knob

43 plate \$4.50	5 plate \$2.75
23 plate 4.00	3 plate 2.25
11 plate 3.50	Postpaid

With Vernier Dial and Knob
46 plate \$6.50 26 plate \$5.50

If your dealer cannot supply, remit to us, sending in dealer's name.



United Audio Frequency
Amplifying Transformers
\$4.50 Prepaid



UNITED MFG. & DISTRIBUTING CO.

9705 Cottage Grove Avenue Chicago, Illinois
New York Office: 50 Church Street, New York, N. Y.
San Francisco Office: 709 Mission St., San Francisco, Cal.

The Newest Simore Tool

"Lightning-Change"



Combination knife and screwdriver—a keen steel knife blade, and two screwdriver blades in the handle—blades produced by gravity; the knife blade can never fold or turn and injure the operator; change blades in two seconds.

This combination knife and screwdriver will be sent to you post prepaid for only \$2.25, check or money order. The only tool of its kind, ideal for radio fans, carpenters, motorists, and for household use. Order today.

\$2.25

Prepaid

Dealers are invited to write for proposition on this and other Simore tools.

THE SIMON & SKIDMORE MFG. CO.
Dept. 411 SANTA ANA, CALIFORNIA

Send for DEALERS Catalog

HARRY ALTER'S
"POCKETBOOK"
is a monthly net price
catalog of Radio, Elec-
trical and Lighting
supplies. All good dealers
should have a copy—get
on our mailing list now.
No obligation. Use your
letterhead.



HARRY ALTER & CO.
WE SELL WHOLESAL ONLY
OGDEN BOUL. & CARROLL AV. CHICAGO

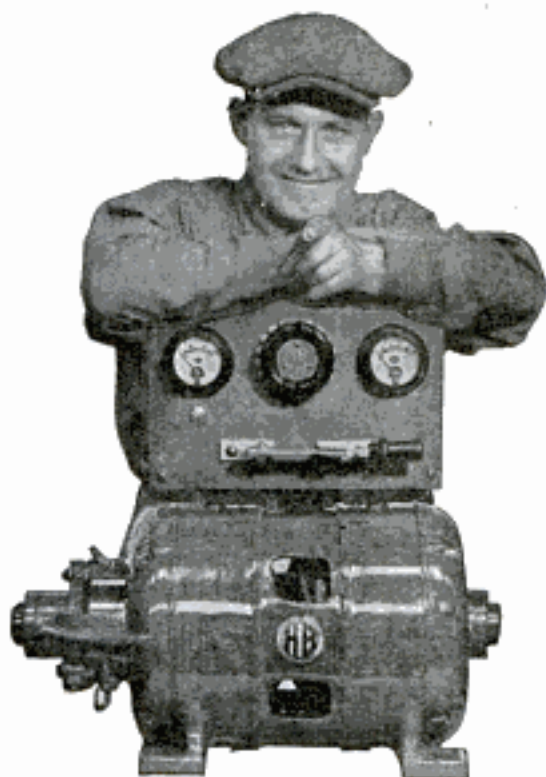

Bigger Profits for YOU Now With 8-Hour Battery Charging

Start a Money-making Battery Charging Business with the new 8-Hour Constant Potential System. Boost your present profits by installing it if you are now depending on old 2 to 3 day methods. Big steady monthly profits guaranteed. Other shops can't compete with their slow costly methods. Comes complete ready to connect up and operate. You do in 8 hours what it takes other shops 2 to 3 days to handle.

Only \$20 Monthly Pays for Your HB 8-Hour Constant Potential Battery Charger

A small cash payment brings your HB outfit on 30 days free trial. Your substantial monthly profits easily carry the reasonable \$20.00 monthly payments leaving a nice surplus besides. You can buy an HB on such terms because we know it will make big profits for you, and because we want energetic men to get started in their own money-making business.

More Shops Use HB Constant Potential Than Any Other Make

That's because an HB turns out more and better work, costs less at first and costs less to run, than any other outfit on the market. HB 8-Hour Constant Potential Charging is not an experiment but a real success—recommended by Leading Battery Makers. Established battery Shops installing HB Constant Potential save 30% to 50% on electric bills—one third less rental batteries are needed—saves labor—gives a better charge—pulls trade and boosts business because autoists prefer 8-hour service to waiting 2 or 3 days.

30 Days' FREE Trial

No obligation whatever on your part. Order your HB outfit on trial and use it 30 days. If it does not fulfill every claim we make—cut charging costs, bring new business, increase profits, and give more complete satisfaction than any other equipment—you return it, and we will refund every cent you have paid us. Our positive guarantee of satisfaction-or-money-back gives you complete protection. Don't let your opportunity slip. Order your HB outfit NOW, on trial, and prove these facts for yourself.

Send this ad with your letterhead or your name and address for full information.

Hobart Bros. Co., Box M11
Troy, Ohio



Cunningham
tubes

A MONUMENT TO SCIENTIFIC RESEARCH



$\frac{1}{4}$ Ampere
Filament Current.
Mutual
Conductance
700 Micromhos.

CUNNINGHAM VACUUM TUBES, built by one of the world's largest manufacturers with unlimited resources, are the product of years of research and development work by that great scientific organization, the Research Laboratory of the General Electric Company.

The development of the special filament used in the two new *Cunningham Tubes*, type C-301-A and C-299, is truly a monument to the scientific skill of that organization and the ability of its engineers.

The outstanding feature of this filament is its property of high electron emission at a low temperature. This results in a Vacuum Tube having a greatly increased output, with only a fraction of the filament power consumed by previous types.

Patent Notice: *Cunningham tubes* are covered by patents dated 11-7-05, 1-15-07, 2-18-08, and others issued and pending. Licensed for amateur, experimental and entertainment use in radio communication. Any other use will be an infringement.

Cunningham Radio Tubes

C-301A	—6 Volts $\frac{1}{4}$ amp. Amplifier.....	\$6.50
C-299	—3 Volts .06 amp. Dry Battery Det. & Amp.	6.50
C-300	—6 Volts Gas Content Detector.....	5.00
C-11	—1.1 Volts .25 amp. Dry Battery Det. & Amp.	6.50
	Special Base	
C-12	—Similar to C-11 with standard base....	\$6.50

E. J. Cunningham Inc.

Home Office: 182 Second Street, San Francisco, Calif.
154 W. Lake Street Chicago, Ill. 30 Church Street New York City, N. Y.

Please Mention Popular Mechanics

PIONEER INSTRUMENTS

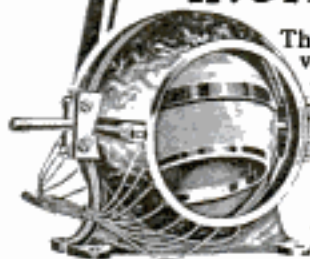

The old reliable stand-by variocoupler and variometer circuit has stood the test of time and is today in greater use than ever before.

Pioneer coupler and variometers are built to meet all the latest broadcasting wave lengths. The variocoupler has the primary winding on the inside, giving closer induc-

"Pioneer" Variocoupler \$7.00

tance, and with 16 taps permits of greater selectivity and closer tuning.

The shells and rotor are of moulded Bakelite, moulded in our own factory under personal supervision. All connections are positive and constant. Made for either panel or table mounting.

The beauty of these instruments has not yet been equalled — their electrical efficiency never surpassed. Send for illustrated folder

PIONEER RADIO CORPORATION

104 Pioneer Ave., Galesburg, Ill.



National Audio Frequency Transformers

The New 6 to 1 Ratio National Transformer is for use on the first stage of amplification. Its greater ratio means increased volume, but the tone qualities that characterize the $\frac{3\frac{1}{2}}$ to 1 ratio have been fully retained. Price of 6 to 1 ratio \$4.50 postpaid; of the $\frac{3\frac{1}{2}}$ to 1 ratio, \$4.00 postpaid. Dealers: Write for interesting sales proposition.

National Transformer Mfg. Co.
154 Whiting Street
Dept. 1110 Chicago, Ill.

FANSTEEL Balkite PATENTS APPLIED FOR. Battery Charger

A new battery charger for Radio "A" batteries, entirely noiseless, and indestructible. Has no moving parts, requires no attention, and cannot get out of order. Can be used while the radio set is in operation. A simple, positive, economical battery charger for home use. Write for folder giving full description.

Dept. P2-FANSTEEL PRODUCTS CO., Inc.
North Chicago, Illinois



A NEW FROST FONE

A SUPERFINE headset with maroon bakelite shells and caps, moulded terminal blocks and new type construction without lead wires. Order today from your dealer and note their superiority to all others.

HERBERT H. FROST, Inc.
154 West Lake Street, Chicago, Illinois
30 Church Street, New York

No. 172 \$6.00
3200 Ohms



Ace Type V ARMSTRONG REGENERATIVE RECEIVER

\$20

*Licensed under Armstrong
U. S. Patent No. 1,111,149*

HERE'S YOUR RADIO SET

Get ready for the long winter evenings—install this beautiful Ace Type V Armstrong Regenerative Radio Receiver in your home and enjoy the finest musical programs. The Ace V is a long range receiver and with it stations from coast to coast are heard clearly.

An Ace two-step amplifier in connection with this set at \$20.00 makes use of loud speaker practical. Has Crosley Multistat which permits use of any tube. Send \$20.00 today and receive the highest value ever offered in a radio receiving set. Ask for "Simplicity of Radio"—it's free.

THE PRECISION EQUIPMENT CO.
Powel Crosley, Jr., Pres.
1115 Vandalla Ave. CINCINNATI, OHIO

Play This JAZZY SAX

Without Practice —No Lessons Sweet Jazzy Tone

Any one can play this imported Jazzy Sax right away. No knowledge of music required, no lessons. Play by numbers instead of notes. All instructions and 15 songs free! Be popular at parties, dances, picnics, entertainments, *Glistening polished brass all over, except nickel mouth-piece. Looks just like regular saxophone the same size*

Weights over 3 lbs. Beautiful, clear, ringing tones and delightful harmony. No need to spend \$85 when you can own a Jazzy Sax.

**Supply
Limited**

**Send
No
Money**

Just fill out the coupon below. When the Sax arrives, pay the postman only \$5.98 plus a few pennies postage. Play Jazz right away. You don't risk a penny. *Satisfaction guaranteed or money refunded.* The supply is limited—so don't delay. Mail the coupon today.

"Easy to Play"

V. D. BEATTY SAYS: "This is easy. I played tunes after fifteen minutes and am delighted."

"I find your Jazzy Sax is very easy to play." CLARA LEMKE.

You will be delighted with your JAZZY SAX.
Send the coupon NOW.

Send This Coupon Today

FERRY & CO.,

75 W. Van Buren St., Dept. 1771, Chicago, Ill.

Please send me at once your Jazzy Sax and song book. On arrival I will deposit \$5.98 plus postage with the postman. If I am not satisfied you will refund my money.

Name.....

Address.....

City..... State.....

Please Mention Popular Mechanics

Copyrighted material



"Red Devil" Rapid Boring Auger Bits are 33 1/3% easier boring, have 10% greater clearance, and bore with or against the grain of any wood. Style 2400—10/16 in., shown here, 75c.

Red Devil Pliers

REG. U. S. PAT. OFF.

Made in 100 Styles — One for Every Need



A PAIR of "Red Devil" Pliers multiplies by many times the number of things you can do about the house, shop, factory, garage. Hanging pictures, turning nuts and bolts, mending vacuum cleaners or sewing machines, amateur plumbing, etc.

Forged of steel, and distinctly superior in design. Just a few of the 100 styles shown here.

Slip Joint Plier No. 1024

For all-around use. The thin nose gets into tight corners. Slip joint gives wide range to gripping jaw. Wire cutter and screw driver add to the number of things you can do with it. Sizes 5 and 6 1/2 inches. 6 1/2 inch size, \$1.00 a pair.



Side Cutting Plier No. 50

About as useful a tool as any mechanic can own. Powerful cutting edges. The standard electricians' plier the world over. Sizes 4, 5, 6, 7, 8 inches. 6 inch size, \$1.10 a pair.

"Red Devil" pliers are on sale at all dealers — ask to see the complete line.

The "Red Devil" Mechanic's Tool Booklet is a handy reference guide for users of good tools. Send for it, it's free.

SMITH & HEMENWAY CO., Inc.

Manufacturers of "Red Devil" Tools
260 Broadway New York, N. Y.

"Red Devil" Glass Cutters — the glaziers' standard tools of the world. "It's all in the wheel." Made in 40 styles. No. 024 shown here, 20c



Buy Parts That Fit Any Hookup

Quickly—Economically—Least Labor

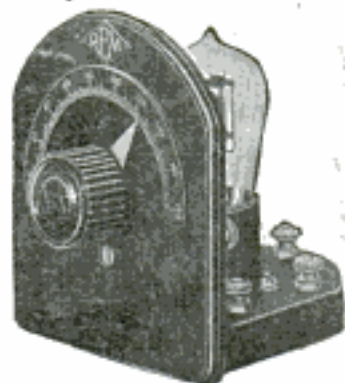

The R. P. M. Units are complete in themselves. All wires are concealed. Connections made to binding posts — simply and quickly — each unit can be moved into any position in a circuit by simply changing the binding post connections.

The units are made of Bakelite, moulded in our own factory.

For building your own set no other means is half as handy or economical. Start with a tuner and detector unit and add amplifiers as experience and your pocket book permits.

The units are made up of the following instruments: Variometer—Variocoupler—Coupled Circuit Tuner (both units come in mounted or unmounted models), Detector Units, Amplifying Units and Micrometer Variable Condenser Units.

Illustrated folder and prices on request. Your dealer will be glad to show you these units or write us.

Radio Products Mfg. Co.
667 West 14th St. Chicago, Ill.

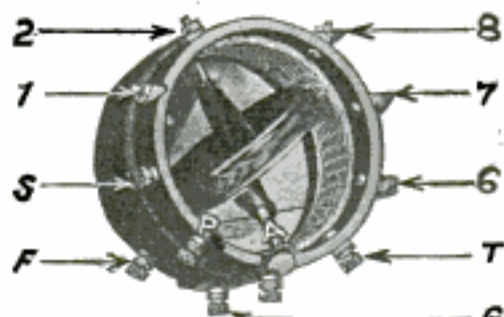

F to S—Main Inductance
A to G—Vernier Rotor

T to P—Untuned Primary
6 to 5—Loading Coil

The B-T Vernier Tuning Unit

has been successful far beyond the limit of our expectations.

World-wide reports show users are getting more satisfactory results in our No. 2 Hookup than any other circuit known today, when range, control, selectivity and dependability are considered.

Photo-diagrams are furnished for the B-T No. 2 and other circuits. Write for circular.

**Do Not Start Your Radio
Set Until You Receive It.**

Bremer-Tully Mfg. Co.
542 S. Canal St. Chicago, Ill.

Slide Saxophone

If you can sing a melody you can play this saxophone. No fingering to learn. Big money is paid saxophone players. Learn in your spare time.

Built in low pitch (A.440) can be played in any pitch by regulating slide. Two octave keys—the short up to and including C sharp; the long octave for tones above G sharp. Range from low B to upper G. The only reed instrument with crescendo effect over an entire octave.

PRICE \$60⁰⁰
BRASS



B FLAT TRUMPET

The easiest blowing trumpet made.



Write for Complete Catalog

REIFFEL & HUSTED

Mfrs. High-Grade Band Instruments

206 S. Wabash Avenue, CHICAGO, ILL.

A Home and Income For You in Sunny Florida



Be Independent—Own a Grapefruit and Orange Grove—A Truck or Poultry Farm. Increase Your Income

You Can Start a Grove Today Under Our New Plan

Develop a profit-earning fruit farm without leaving your present position—provide for your future. A small payment now and a few dollars invested each month.

A profit-producing fruit grove is a permanent investment and provides protection against old age.

**THE RIGHT LAND
IN THE RIGHT LOCATION AT
THE RIGHT PRICE**

We Have It—Any Size Farm

These splendid lands are suburban to Tampa, the metropolis of South Florida. Here you find the most healthful, the most delightful climate in North America. For ten years we have been right here helping develop Hillsboro—the banner agricultural County of Florida, and we are still here to serve you and to help you obtain the farm you want, on very easy payments extending over 2 or 3 years' time to suit.

Groves Developed for Non-Residents

If you want to remain in your present position for a few years we can develop a grapefruit and orange grove for you. When you are ready we will clear your land, furnish fruit trees, plant and care for your grove until you are ready to look after it.

We Raise Our Own Guaranteed Citrus Trees in Our Own Nurseries

This insures every purchaser the best fruit trees that can be grown. This also insures a successful grove. We can save you money on planting and caring for your grove.

\$300.00 to \$500.00 Per Acre Profit

This is not an unusual return for truck farmers in the Famous Tampa district. All kinds of vegetables can be grown. Big prices are paid for early potatoes, winter cabbage, Bermuda onions, tomatoes, celery and dozens of other vegetables during the winter and early spring, when the north is covered with ice and snow. Strawberries, Melons and other small fruits, also yield large profits.

Write for Facts About Sunny Florida

IT COSTS YOU NOTHING TO LET US PROVE TO YOU that we have the land you want—in the location you want—at a price you can afford to pay and on the easiest terms you can imagine. Let us show you.

Fill out and mail us the coupon today and receive our large descriptive book FREE!

NORTH TAMPA LAND CO.

404 Zack Street TAMPA, FLA.

Coupon for FREE Book on Florida

NORTH TAMPA LAND CO.
404 Zack St., TAMPA, FLA.

Please send me your large illustrated Book, "The Call of the Southland," on choice Citrus Fruit and Truck Farms suburban to Tampa, Florida, and information on how I can have a grove developed on the monthly payment plan. P.M. 11-23.

Name.....

St. No.....

City.....

State.....

Howard Micrometer Adjustment Rheostats



Instant adjustment. Made from special heat resisting materials; operates with single knob; positive smooth contact. Micrometer adjustment.

Rheostats, 6 3/4";—25 or 40 Ohm, Plain, \$1.10; Micrometer, \$1.50
Power Rheostats, \$1.50
Potentiometers, 200 Ohm, \$1.50; 400 Ohm, \$2.00

Ask your dealer or write us. Complete catalog of Howard radio parts and look-ups free on receipt of 2c for postage. Jobbers write for discounts.

HOWARD RADIO COMPANY 4244 N. Western Avenue CHICAGO

F O R D S P E E D
F O R S P E E D
F O R B E A U T Y
F O R C O M F O R T

SPORT \$29⁰⁰
BODIES Up



4, 8 and 16 Overhead Valve

Heads. Sport Fenders for Underslung and Standard Fords
FORDSPEED BODIES are known for their beauty of lines and quality of workmanship, and "Every day and in every way they are getting better and better." Complete line of bodies and speed and power specialties illustrated in our free catalog. Big display of complete cars in our show room.

Underslung Fixtures	\$12.50	\$9.95	Speed and Power Camshaft	\$19.00	\$11.95
3:1 or 2 3/4:1 Gears	12.50	8.95	Warm Steering Gear	30.00	18.95

SATISFACTION OR MONEY BACK guarantee, 30% with order, balance on delivery.
L. I. FORD SPEED & POWER EQUIP. MFRS., 250 W. 54th St., New York, 3rd Floor

Please Mention Popular Mechanics

Copyrighted material

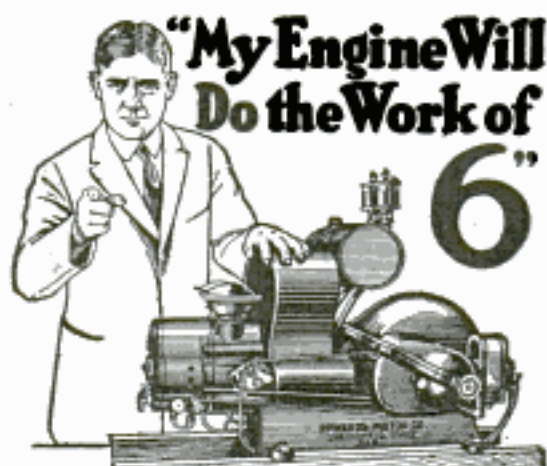

Try This Remarkable Engine

FREE The Edwards Farm Engine sells direct to you at low factory price. No other engine like it. 1½ to 6 H. P. in one engine. Change power while running. Efficient at all powers.

Fits Every Farm Job

Pumps, saws, grinds, cuts ensilage, runs spray rig, concrete mixer, washer—anything up to 6 H. P. Portable. Burns kerosene or gasoline. No cranking. All moving parts enclosed. Work it anywhere without fastening down. Endorsed by thousands of users.

Clarence Rutledge, of Ontario, says: "Have given my Edwards four years' steady work and like it fine. Runs 28-inch wood saw, 8-inch grinder, ensilage cutter and does all chores. Have had ten other engines. The Edwards beats them all." Write now for full description of Edwards Engine, low factory price and details of free trial offer.

**EDWARDS
FARM
ENGINE**

**For Special
FREE TRIAL
Mail Coupon
Now**

EDWARDS MOTOR CO.
218 Main Street, Springfield, Ohio
Without obligation, send complete description of engine, also free trial offer.

Name _____
Address _____

SWEATERS SAVE 20%-30%



**Any Style or Design
for Men, Women, Boys,
Schools, Clubs, Teams**

Order direct from mill. Save from 20% -30%. Pick any style, any color, size or design from our regular stock or special to order. Finest virgin wool and pure worsted only. Custom tailored workmanship of highest grade. Closely knit. Warm, soft, snug. Real beauties you will be proud to wear.

**FINEST QUALITY AT
BARGAIN PRICES**



FREE Always holds shape. Most customers get from 3 to 5 years wear easily. Can endure severe wear and retain bright, fresh appearance. Biggest values in history. **CATALOG** Workmanship guaranteed. Prices slashed. Unusual chance to save. Special offers to schools, clubs, teams. Write for free illustrated catalog.

AMERICAN KNITTING MILLS 1538 Clybourn Avenue
Dept. 14 CHICAGO

RADIO CATALOG

CONTAINING 14 UP-TO-DATE HOOKUPS AND LIST OF
STANDARD QUALITY PARTS AT REDUCED PRICES
SEND 10c TO COVER COST OF MAILING

SERVICE AND QUALITY GOODS BUILT THIS HOUSE

GREAT LAKES RADIO CO.

136 W. LAKE STREET Dept. P. M. 1 CHICAGO, ILL.

Baby Grand Lathes

For WOOD or METAL WORKING

Unexcelled for regular mechanical work or for use on experiments. Dependable. Useful. Economical. Speedy. Just the thing for those engaged in light manufacturing or repairing. Just the thing for home use. Inventors use them in private for building their experimental models. Finest thing for amateurs and students. Operation same as on large lathes. Accurately built. Sturdy and strong. Simple and easy to operate. Young men learn lathe work in a remarkably short time. Meets the need of a high-grade yet low priced lathe. Built by skilled machinists who specialize on lathe building. Made of carefully selected materials under rigid inspection. Quality far above the ordinary. With reasonable care will last a lifetime. Quantity production permits unusually low price. Direct from factory to you. (No middle-man's profit).

Make stable products inspire time—Xmas gifts, etc.

Write today for free illustrated folder giving complete description and prices.

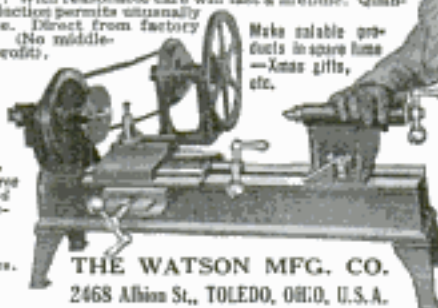

THE WATSON MFG. CO.
2468 Albion St., TOLEDO, OHIO, U.S.A.

Car Owners Wanted



—To show and sell the greatest improvement in Spark Plugs since Gasoline Engines were invented. Unbreakable, translucent core shows at a glance just which cylinders are firing.

Beacon Lite Spark Plugs You Can See Them Fire

Just lift the hood and look. See instantly which cylinders are "dead." No guessing. No testing. Cost no more than ordinary plugs. Sure fire. Extra durable. Sold only by "Paul Men". Agents smashing all earning records. Exclusive territory. Write quick.

THE PAUL RUBBER CO. (15)
25 Paul Park Salisbury, No. Car.

WATCH KNIFE CHAIN ALL 3 ONLY



Thin Model, 16 size. Accurate Time Keeper. Beautiful engraved, solid silver-plated case. This is a great bargain. Do not confuse this watch which others offered at lower prices. This watch is Fully Tested, Inspected, and Guaranteed, stem wind and set. Send No Money. Pay postman only \$2.90 and the Watch, Knife and Chain is yours. Consolidated Novelty Co., Dept. 225 20 E. Lake St., Chicago

MOTOR REPAIR BOOK FREE

**SMOOTH-ON
REPAIR
BOOK**



Why spend dollars for motor and household repairs when a few cents' worth of

SMOOTH-ON CEMENT No. 1 will do? Write for this FREE book and learn how Smooth-On can save you many dollars. Sold by Hardware and General Stores in 6-oz. tins 30c (by mail, add 6c); also in 1-lb., 5-lb. and larger sizes.

SMOOTH-ON MFG. CO.
Dept. 37 Jersey City, N. J., U.S.A.

SMOOTH-ON IRON CEMENT No. 1
For Motor and Household Repairs



Sharp turns are easy for the Auto-Wheel

Sharp turns are easy for the Auto-Wheel Coaster even with the heaviest load. The special hound brace which runs from the tongue through the steering pivot to the bed of the wagon gives you the supporting strength which you need for easy steering.

Auto-Wheel Coasters and Auto-Carts

This special hound brace is only one of the features which make Auto-Wheel Coasters sturdy, substantial, easy to control. Other features are: rubber-tired disc wheels, steel-tired disc or wood spoke wheels—all wheels interchangeable—hand-brake,

special hub cap, and locking pin, sides mortised as well as nailed, self-contained roller bearings.

Write for catalog which shows all models of the Auto-Wheel Coaster and the Auto-Cart, the Auto-Wheel's junior companion for little brother and sister. Send the names and addresses of three local coaster wagon dealers, and we will give you a year's subscription FREE to the "Auto-Wheel Spokesman," a dandy magazine for boys.



AUTO-WHEEL COASTER CO., Inc.
North Tonawanda, N. Y.

TIRES RUN 30,000 MILES

J. D. Cooper says their Cadillac Car ran 30,000 miles without changing a tire after equipping with a new puncture proof tube, invented by E. G. MILBURN, 339 W. 47th Street, Chicago, Ill. This wonderful tube in actual test has stood

500 NAIL HOLES WITHOUT LOSS OF AIR

and it costs no more than ordinary tubes. Mr. Milburn wants distributors. You can become his salesman. Write to-day.

FREE Book Tells How to Get More Eggs

SEND NOW!

Send Now!



HOW to save feed and get double egg yield. How to cull out poor layers. How Mrs. Wildt made \$2000. How Mr. Luttrell makes \$5 net profit per hen. This book explains Prof. Quisenberry's 87 system now being used by 46,000 successful poultry raisers. 1000 money-making secrets.

Write Today! Simply send name, a postcard will do, for this 96-page free book, "Dollars and Sense." No cost, no obligation. However, if you enclose 25c, we will send you 25 colored celluloid leg bands to mark your best layers without using trap nests.

AMERICAN POULTRY SCHOOL
Dept. 181 KANSAS CITY, MO.



Write for this bulletin



16" x 6' Quick Change Gear \$466.00
16" x 6' Standard Change Gear \$406.00

FOR manufacturing, for the machine shop, for the general repair shop, SOUTH BEND LATHES meet the most exacting requirements. Every concern should be equipped with this great lathe value. Every machinist should have this bulletin, "LATHE WORK SIMPLIFIED."

"LATHE WORK SIMPLIFIED" contains 52 illustrations of up-to-date lathe operations that your mechanic should study, showing how to take hand work out of the shop, how to increase production.

SIZE	Standard	Quick Change
9" x 3' Lathe	\$ 211.00	\$ 241.00
11" x 4' Lathe	248.00	288.00
13" x 5' Lathe	304.00	354.00
15" x 6' Lathe	376.00	431.00
16" x 8' Lathe	438.00	498.00
18" x 10' Lathe	656.00	721.00

Over 30,000 users attest to the performance, accuracy and durability of SOUTH BEND LATHES. They are standardized, manufactured complete in large quantities and thus represent the greatest lathe value per dollar of cost. Write today for the Bulletin. Catalog No. 83 will also be sent you without obligation.

SOUTH BEND LATHE WORKS
555 E. Madison Street South Bend, Indiana
New York Salesroom, 166 Centre Street

SOUTH BEND LATHES

South Bend Lathe Works, 555 East Madison St., South Bend, Ind.,
Gentlemen: Kindly send me without obligation, Bulletin No. 7,
also Catalog No. 83.

Name

Street

City

State

Concern

(If possible, attach coupon to your letterhead.)

Please Mention Popular Mechanics

Copyrighted material

Credit on DIAMONDS

Buy on Credit as Others Do

Easy for you to own or give as a gift either of these beautiful genuine diamond rings.

\$2 DOWN

No. 1
Special Price
\$52⁵⁰

No. 2
Price Only
\$32⁵⁰

No. 1. Cluster resembling \$750 solitaire, 7 blue white diamonds carefully matched and set in PLATINUM. Ring 14k. solid green gold with 18k. solid white gold prongs. Rare beauty. Special price \$52.50.

No. 2. Perfect cut blue white diamond set in hand engraved and pierced 18k. solid white gold mounting. Price only \$32.50.

SIMPLY SEND \$2.00

and we will send either of these rings for 10 DAYS' FREE TRIAL. If not convinced it is an amazing bargain, return ring to us and get your \$2.00 back immediately. Only if satisfied, pay \$1.50 a week for ring No. 1 or \$1.00 a week for ring No. 2. YOU TAKE NO RISK. Guarantee Diamond Bond with each ring.

FREE: Write for new catalog, Diamonds, Watches, Jewelry, \$10 to \$1000. All on easy credit terms. Wonderful values.

Est. 1890. Write Dept. C-26

BAER BROS. CO.
6 MAIDEN LANE - NEW YORK

Extra Fine Singing Canaries—Talking Parrots and other birds. Also a full line of cages and supplies. Retail and wholesale. We ship with safety anywhere in the United States or Canada. Cold weather does not affect shipping. *Send for new free catalog.*

SAM MEYER & CO., 24 W. Washington St., Dept. 59, Chicago, Ill.

YOU CAN PLAY THESE IMMEDIATELY!

A Remarkable Bargain for Lovers of Music

Here's your chance to own a musical instrument you can really play. **No lessons necessary; anyone can play at once and become popular at parties and dances.** This handsome Flute is the latest European invention. A sensation everywhere. **Imported to sell at \$2.65.** Do you like Jazz? Then send for this handsome new Saxophone. No need to pay \$85 when you can own this handsome nickel-plated instrument for

ONLY \$5.65

Plays real music in clear, mellow tone.

No lessons required
Popular Songs FREE

SEND NO MONEY

—merely your name and address—and pay the postman on delivery. Mail your order today and receive either one of these bargains by return mail. Payments must be sent with all Canadian and foreign orders. **Special Combination Offer—\$7.25 for both.** Free Catalog of Ukuleles, Banjos, Mandolins, Guitars, Accordions, Violins and others.

THE BENSBRAGO STUDIOS
Dept. 14R, 212 Fifth Ave., New York

ACT NOW!
Money Back if Not Satisfied

REAL COMFORT



for Ford Drivers

Keep the cold blasts of winter off your feet and legs with an

Acme No-Draft Mat

An entirely new idea for keeping the cold air from coming up through the pedal and emergency brake openings. Protects your health. Assures year 'round comfort by keeping out all cold air, hot air, dust and gases.

Fits snugly around the pedals—absolutely draft proof. Cannot interfere with operation of car.

Made of the best mottled rubber. Slots lined with sheep's wool. Will last for years. Attached by anyone in 10 minutes. Only device of its kind that's 100% efficient.

If your dealer can't supply you, send us your order direct. **\$1.75 Complete P. P. Prepaid**

Acme Sales Co. Dept. B, 1017 Euclid Avenue CLEVELAND, OHIO

Test this Imperial in Your Home at Our Risk

WONDERFUL BAKER—FUEL SAVER

Get This Book Free



Three big, exclusive, money-saving features: Stone Oven Bottom Flue—absorbs and holds heat, makes baking sure and successful; Fuelless Ash Sifter—sifts inside range; Outer Hood—free kitchen from all odors.

FACTORY PRICES

Save all in-between profits. Newest improvements—beautiful designs. Over 150,000 Imperials in use. All sold on 30 day test plan. All styles. Built to last a lifetime—and guaranteed. Credit if wanted. Mail a postal today for big FREE catalog—also combination gas and oil ranges, refrigerators, kitchen cabinets and tables, fireless cookers, etc.

THE IMPERIAL STEEL RANGE CO.
369 Detroit Ave., Cleveland, Ohio
Established 1889



"LYON" WINTER TOPS

ROADSTER
\$31²⁵
TOURING \$41.25
FOR FORD and CHEVROLETS

Late models. Warm, roomy and comfortable. Easily ventilated when desired. Don't envy others. Be comfortable yourself. Send for our "Special Fall Bulletin" containing also our full line of racing bodies.

AUTO TIRE SALES CO., Dept. P14
1346 S. Michigan Ave. CHICAGO Body Division



**World Radio
and
Auto Batteries**
**SAVE YOU
50%**
WRITTEN 2-YR. GUARANTEE

We maintain the same high quality material and workmanship found on the most expensive batteries and still are able to allow our remarkably low sale price by greatly reducing our overhead and sale costs.

COMPARE THESE PRICES

AUTO PRICES

6 Volt, 11 Plate . . . \$12.25
Ford, Chev., Mitchell, Hup., Grant,
Elgin, Vello, Saxon.

6 Volt, 13 Plate . . . \$14.00
Overland, Buick, Geo., Paige, Hud-
son, Nash, Stude., Dect.

12 Volt, 7 Plate . . . \$17.00
Maxwell, Dodge, Regal, Frank., Bris-
coe and Crow-Eikhart. Give year
and model of car.

Send No Money We ship C.O.D. subject to inspection, or will allow 5% discount for cash with order. Shipment made same day order is received. Save 50% on your next battery and get better service and longer life. Written 2-yr. guarantee is your proof of satisfaction. Order NOW!
WORLD BATTERY CO., Dept. 8, 1219 S. Wabash Av., Chicago, Ill.

RADIO PRICES

Special 2-Volt Storage Battery \$5.00
For W. D. 11 and W. D. 12 tubes.
Will run 200 hours on one charge.
Rechargeable.

Special 4-Volt Storage Battery \$8.00
For U. V. 129 tubes. Same features
as 2-volt.

6-volt, 60 amp. . . . \$ 8.50
6-volt, 80 amp. . . . 10.00
6-volt, 100 amp. . . . 12.50
6-volt, 120 amp. . . . 14.50
6-volt, 140 amp. . . . 16.00



Remington No. 10
Self-Starting \$38⁶⁵
30 Day Trial

Think of it — the most popular typewriter ever made—all late improvements — guaranteed 5 years—and you save at least \$60.

Biggest Value Ever Offered

—that's the comment we receive from thousands who have purchased from us. Guaranteed to have the same action, appearance and durability of a new machine.

Send Today — a postal will do — for details of our remarkable offer — or send \$38.65 NOW with the understanding that your money will be promptly refunded if you're not MORE than satisfied.

LINCOLN TYPEWRITER COMPANY
Dept. 134 298 Broadway, N. Y.

\$31.50 All Wool Free Suit Offer

The Bell Tailors, Dept. 1444, Chicago, Ill., will make a fine tailored to measure suit or overcoat free for one man in each locality who will show and recommend their high grade made-to-measure clothes to a few friends. Simply send them your name and address and they will send you a large assortment of wool samples, style book, self-measuring chart and their free suit offer.—Adv.

CAR OWNERS WANTED!

To use and introduce the greatest improvement in Inner Tubes since autos were invented. Air gauge in valve stem of every Tube shows at a glance through the Unbreakable Transparent Valve Cover amount of air in tires. (5)



AIR-GAGE Heavy Duty Tubes

—sell on sight to almost every car owner because they save trouble, time, worry and expense. Add one-third to life of tires. Paul salesman makes big profits selling direct to car owners. Our million dollar factory can use 500 more salesmen at once. Experience not necessary. Big Illustrated Free Book tells how the Paul Plans will start you in this big money-making business without capital. Write for Free Book Today.
THE PAUL RUBBER CO., Dept. 25, Salisbury, N.C.

Complete Telephone Instrument



\$12.50

These are army Field telephones, never having been used, made by the Western Electric Co. for receiving and transmitting. They couldn't be built for \$50.00. For homes, between house and garage, or on the farm, for mines, lumber camps, schools, churches, lodge rooms, office and factory use,

for contractors—any place where wire can be run over your own property, this instrument will prove of untold value.

The material and workmanship have passed government inspectors; there is nothing better; the government sold them because the war was over. Here is your opportunity. The leather case alone is worth \$5.00.

Easily moved about. You can install several phones on one wire and ground, or two wires if you prefer; can be used with either dry cell or No. 703 Tungsten Flashlight Battery. Nothing to buy but battery and wire. Full instructions with each instrument at the unheard of price of \$12.50 each. Order two for complete set.

Combination Phone and Buzzer Set

Every boy will be delighted with this instrument. He can learn the Radio code with the telegraph key and by stretching a wire to his neighbor's house or into another room,



\$12.50

practice with his friends. The phone transmitter for voice is equal to any phone made and is combined with the buzzer telegraph sending set, using the same wire. The instrument was used by U. S. Army in the war. The ones we are offering have never been used. Light weight, with carrying straps for Boy Scout camp work. Schools, etc. All you need is a 322 Burgess Battery and some wire. These instruments cost the government over \$50.00, yet we are selling them for \$12.50 each. Order two for complete set. Get your friend to buy one and hook up with yours. Both these items are sold on a positive guarantee of your money back if you are not satisfied. The supply is limited and we cannot get more. Orders will be filled in order received.

J. J. WATSON & CO.

634 Hearst Building

CHICAGO, ILL.

**"Sold 1st Dozen Today!
Rush 18
More"**

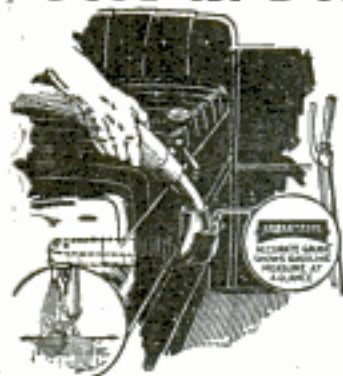

"First dozen received this morning and sold before night. Rush 18 more today. Order for gross follows."—D. C. ORTH, Menlo, Iowa.

You, too, can make quick, easy sales and big profits with the

Kirstin

Fil-O-Meter

A GASOLINE GAUGE AND FILLER COMBINED
Fills Ford Gas Tanks—Shows Gas Measure Without Lifting Cushion

Eliminates bother, dirt, and loss of time in filling Ford (or Chevrolet) gasoline tanks. It is a filler and gauge combined. Automatic Air Vent, allows full flow from pump. Accurate gauge with glass covered dial, always in plain sight. Prevents running out of gas and short measure at filling station. Made of aluminum. Weighs only two pounds. Easy to install—clamps into regular gas tank opening.

SELLS FOR \$5—BIG PROFIT

Retail price \$5.00 (\$5.50 on Pacific Coast). Big profit—Easy Seller. Ford owners now paying \$6.00 for gas gauges alone! KIRSTIN FIL-O-METER at \$5.00 gives visible gauge besides providing the only comfortable, clean, easy way of filling tank. Magnuson made \$48.00 in one day. Laux, as a side line, cleared \$56.00 in 3 days.

Territory Going Fast—Write Today

Get our proposition TODAY. Closing territory fast. Sample sent on 10 day Money-Back Trial.

A. J. KIRSTIN COMPANY

13 First Street

ESCANABA, MICH.

How to Build the Cockaday Set

told complete (with diagrams) in our latest 1923-24 handbook catalog. Send 15¢ (coin or stamps).

Mid-West Dealers: Make more money handling better radio equipment. Write for our special franchise on Mu-Rad Receivers. Western Electric, & General Radio Co. parts. **CHICAGO RADIO APPARATUS CO.** 415 So. Dearborn St. Dept. PM-11 CHICAGO, ILL.



THE 1923 New OLIVER SPEEDSTER

Send for 1923 Oliver Catalog Showing New Standard three bank Keyboard. The Oliver Typewriter Co., Dept. 1097, Chicago

THE FAMOUS GREEN AUTOMATIC



Grinds, hones and strips in one operation

A BIG MONEYMAKER

THE FAMOUS GREEN AUTOMATIC

grinds, hones and strips all kinds of safety razor blades in one operation. If you now own a business of your own or have at least \$300 in capital to start an independent, profitable business of your own which will make you a handsome profit of from \$3.00 to \$5.00 per hour, then write us.

Wonderful Opportunities in the Sharpening Station Business

We make the latest models of machinery for sharpening safety razor blades (all makes), scissors, clippers, surgical instruments, carving knives, butcher knives, razors and all cutting instruments. Operating cost small. Wonderful advertising value for window installations. Estimated by operators as greater than cost. **BEAR IN MIND—ALL MEN SHAVE. MOST MEN USE SAFETY RAZORS. UNLIMITED SERVICE OPPORTUNITY.** If wide awake and progressive, write for full particulars and further information. Address

AMERICAN SHARPENING MACHINE COMPANY
(Makers of sharpening and key cutting machinery)
Dept. P. 11 KALAMAZOO, MICHIGAN

AMERICAN KEY CUTTER

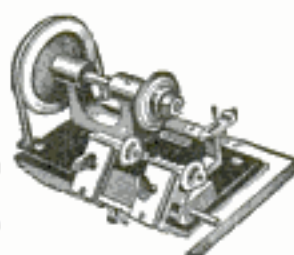

Built for Custom Service. Cuts square, angular or curved slots. Accurate work guaranteed.

Greatest Bargain Offer in History

Brand New Farm Tractors

List Price \$1485.00 f. o. b. Factory—Our Price \$375.00 While They Last, f. o. b. Chicago

25% deposit with order, balance eight draft attached to B/L.

Just Think of it!

\$375.00 FOR THESE TRACTORS

Our Guarantee We have been in the automobile business for nearly 15 years. We guarantee these tractors to be new and in perfect running order when shipped. We also are prepared to furnish service on parts at any time for these tractors should you need them. Never has there ever been such a bargain as this offered before. **SPECIFICATIONS—(MOTOR)** Waukesha—4 cyl.; bore, 3 1/2"; stroke, 5 1/2"; 26 H. P.; speed, 900 R. P. M.; governor, high tension magnet; cooling system, 9 gallon armored radiator, 18" fan, Centrifugal pump. **TRANSMISSION** Fuller selective sliding gear, 3 speeds forward, 1 speed reverse, power take-off, 850 R. P. M.; pulley 8" dia., 7" face. **REAR AXLE**—Torbenon double reduction tractor axle; gear reduction 44:1. **FRAME**—Pressed steel, channel 4" deep, 2" flange; wheels, front 22"x6", rear 40"x11"; wheelbase, 70"; weight 3500 lbs.; belt, horse power, 20; draw-bar, horse power, 12. We Can Furnish Anything From a Cotter Pin to a Complete Power Plant for Your Automobile or Truck. Write Us for Quotations on Anything in This Line You Require. Let Us Put You On Our Mailing List for Our "Air Snaps," Mailed Each Month. Also Our General Catalog. We Can Save You 20% on New and Used Parts Such as Tires, Speedster Bodies, Trays, Gears, Diff. Gears, Timing Gears, Tires & Tubes, Cushions & Springs, Fenders, Radiators, Lamps, Motors, Transmissions, Differentials, Wheels and Rims. Write Today for Our Descriptive Circular.

ORIGINAL WARSHAWSKY & COMPANY

World's Largest Replacement Parts House
1915-35 So. State St., Dept. PM 11, Chicago, Illinois

MYERS WONDERFUL AWL SEWING AWL

Tools in Hand! Have it when you need it. Don't stop work. A complete repair shop in itself. Sew anything heavy or light. Leather, Shoes, Harness, Automobile or Buggy Taps, Canvas, Belts, etc. Price to introduce, \$1.00 Postpaid. **C. A. MYERS CO., 6339 Woodlawn Ave., CHICAGO, ILL.**

AUTO SUPPLIES WHOLE SALE 3000 BARGAINS SEND FOR THIS CATALOG—**it's FREE!** Everything you need in Auto Supplies at Amazingly LOW PRICES. **NEMCO BARGAIN SUPPLY HOUSE** 849-851-853-855 W. Washington Blvd., Chicago, Ill.

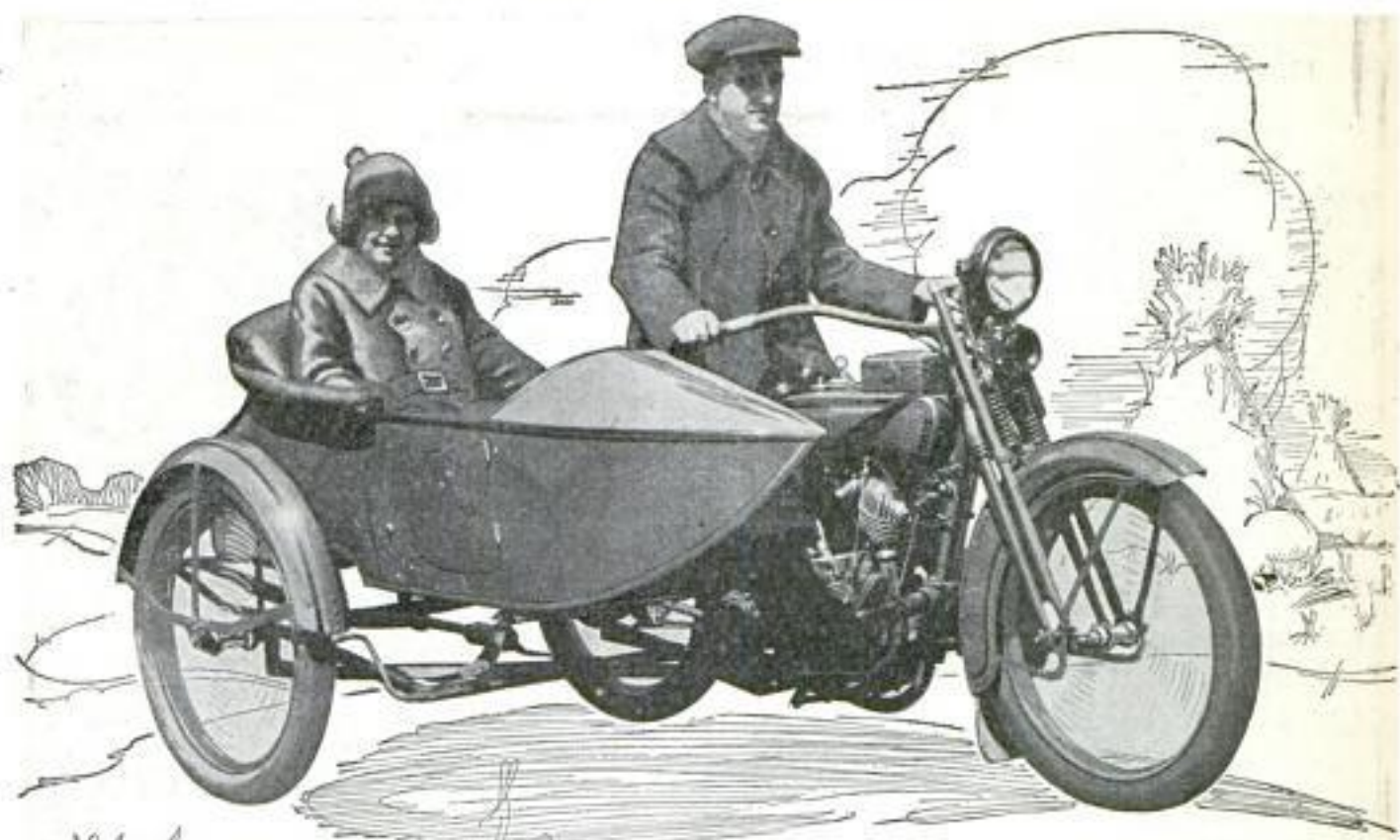

Speed! Easy Riding!

FORTY—fifty—even sixty miles an hour, and still you ride smoothly and comfortable on the 1924 Harley-Davidson. Even over roads that look rough this wonderful motorcycle glides you on — to haunts unknown to those who must travel by train or automobile.

Aluminum-alloy pistons add speed, give marvelous pick-up, prevent overheating. New spring construction takes the bumps out of sidecar riding. Alemite lubrication (first on any motorcycle) makes the 1924 Harley-Davidson easier to care for. New olive green finish, maroon striped, makes it more handsome. And it's just as economical as ever — 50 miles for a dollar (gas, oil, tires and all!)

Take a demonstration ride on a '24. It's the finest motorcycle ever built because it's Harley-Davidson's best. Ask your dealer about his Pay-as-You-Ride plan. Write us for free literature, showing 1924 models in actual colors.

HARLEY-DAVIDSON MOTOR COMPANY
Dept. P Milwaukee, Wisconsin

New!
Full-floating
semi-elliptic springs

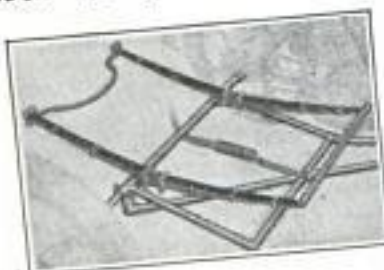

EVEN bad roads are smooth now—when you ride in the sidecar of the 1924 Harley-Davidson. Full-floating, semi-elliptic, 49-inch springs make it wonderfully easy riding.

Money-making sales opportunities in open territories. Write for particulars.

Harley-Davidson

The Motorcycle

Date.....

Send me descriptive literature, in full colors, showing the 1924 Harley-Davidsons and Sidecars.

Name

Address.....

England

Canada

AMPLION

Scotland

Australia

**Junior
DeLuxe**

Wales

New Zealand

\$26⁰⁰

List

Ireland

So. Africa

The Uncanny Amplion A "Human" Loudspeaker

Norway

India

YOU can scarce believe your ears when you first hear the Amplion Loudspeaker.

The clearness, softness and rich tone-quality with which it reproduces voice and music are so real as to be uncanny. You get a new thrill from radio. Delicious "chills" course up-and-down your spine, as they do when you listen to some master of voice or instrument face-to-face.

Sweden

France

American Engineers who have tested the Amplion are unanimous in their opinion that for true reproduction and volume it's the best loud speaker yet produced.

Denmark

Italy

The Amplion is not a head receiver fitted with a horn, but the adaption for Radio of an electro-magnetic and acoustic instrument which for thirty years has been successfully used in all parts of the world.

Ask your dealer to let you hear the wonderful "AMPLION" Loudspeaker. Send for illustrated folder.

Patentes Alfred Graham & Co.

SIGNAL ELECTRIC MFG. CO.

Sole United States Distributors Menominee, Michigan

Holland

Spain

BURNDEPT OF CANADA, LTD.

Canadian Distributors 172 King St., West, Toronto

Belgium

Japan

*The Supremacy of the AMPLION
is the Supremacy
of Actual Performance*



"Bob, You Be the Conductor— I'll Be the Engineer"

Think of the fun of running a railroad that is all your own! Lionel Electric Trains are exact duplicates of the equipment used on America's greatest railroads. They look alike and work alike. Even the block signals, warning bells, and crossing gates work the same—automatically.

A touch of your finger on the Lionel "Multivolt" transformer sends the Lionel train whizzing round the track, through tunnels, across switches and over bridges. Automatic crossing gates raise and lower as the train approaches and passes by. Warning bells sound danger at the crossings. Electric block signals with real electric lights flash "caution" and "clear."

Real Boys want the real thing. They want their railroad to be up-to-the-minute in every respect. That's why more and more boys buy Lionel Electric Trains every year. They know that Lionel Trains

are the real thing and built so perfect, electrically and mechanically, they will last a lifetime. There is economy in this preference besides pride of ownership and years and years of happiness.

Now come on, Dad, and give your boy the gift that you would have "jumped for joy" to receive when you were a kid. Nothing is more instructive and commands such interest from the boy.

You can buy a complete Lionel Train for as low as \$5.75, or you can buy a larger locomotive and track and add to it as you wish. You can see Lionel Electric Trains and Accessories in operation at the best toy, electric, hardware, sporting goods and department stores.

Send for the new 48-page Lionel catalog—a handsome book showing the complete Lionel line in actual colors. It's FREE. Write Today.

THE LIONEL CORPORATION
Dept. 14, 48-52 East 21st Street, New York City
"Standard of the World" Since 1900



LIONEL ELECTRIC TOY TRAINS

& Multivolt Transformers

\$10,000 to \$25,000 for Check Protecting Fountain Pens

**District Managers
and Agents
Wanted in
Every State
\$2,500 to
\$7,500**

**The
Wonder-
ful Selling
Points That
Make Every
Man a Buyer**

12 BIG FEATURES OF THE SECURITY PEN

- 1—Steel check-protecting wheel; scores paper, fills cuts with acid proof red ink.
- 2—Coil spring in automatic clip.
- 3—Automatic clip riveted to Pen on both sides.
- 4—Clips of **Rolled Gold**.
- 5—18 Kt. Gold Filled band. Protects cap.
- 6—Screw Pressure Filling Device. Fills in a second.
- 7—Hardened steel lever—copper plated.
- 8—Rounded Pressure bar (made of Monel Metal—rust proof) prevents injury to ink sack.
- 9—Seamless rubber sack, extra strong.
- 10—Air cushion (vacuum) fed bar. Gives perfect, even flow.
- 11—14 Kt. Gold Pen. Tempered by secret process.
- 12—Native iridium ball point. Cannot be harmed by inks or acids.

An unconditional FIVE YEAR written guarantee is furnished with each Pen.

PRICES

No. 300...\$3.50 No. 600...\$5.00
No. 400... 4.00 *No. 800... 7.00

Long and Short models.
*Giant Security made in a beautiful red and black (mottled) finish has an exceptionally large ink capacity.

PRICES IN CANADA

\$5.00—\$6.50—\$8.00—\$10.00

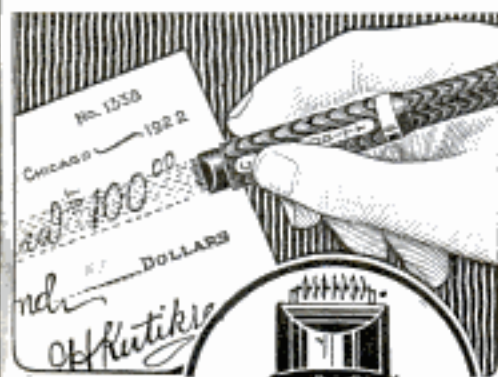

Just think! Last year \$53,000,000 was lost through alteration of checks and other papers.

And 70% of this amount—\$37,000,000—was due to changing the payee's name to bearer or cash or to changing dates and numbers so that payment could not be stopped. Many of these altered checks had been protected against raising of amounts—but the protection did not extend to other features.

The Security Check Protecting Fountain Pen prevents both classes of loss. It is designed to give protection of EVERY kind, EVERYwhere, against EVERY sort of check-manipulating crookedness. Its knife-edged, steel, rotating, cutting wheel scores the paper and fills the scoring with an ineradicable, acid-proof red ink, which cannot be removed. This protection is given to the amount, payee's name, check number, date and memoranda. It affords equal protection to names, amounts, signatures and important clauses in deeds, wills, contracts, etc.

The Fountain Pen itself is the result of 17 years' experiment. It flows so easily, is balanced so delicately, writes so smoothly and is so durable that on these merits alone it will cause most fountain pen users to discard their present pens in its favor.

The check protector attachment gives the maximum of check protection. It not only prevents raising of amounts as do expensive check protecting machines—but it goes further for it stops the still greater harvest which crooks now reap through changing name of payee, altering dates and numbers on checks and through changing sections of deeds, wills and contracts. Yet it is so light that its presence in the cap is not shown in the weight of the pen.

FROM INDIVIDUAL USERS

The Security is the best and smoothest writing pen I have ever used. Out of a dozen pens which I have in my desk I prefer to write with the Security. I paid \$5.00 for my Security and I wouldn't take \$50.00. The check protecting device alone is worth \$25.00 to any one who writes checks.

SECURITY PEN CORPORATION
Dept. 200 P. M., 900-910 W. Jackson Blvd., CHICAGO, ILL.

Distributors Selling

NEVER before in the history of direct selling has such a wonderful opportunity been offered to Specialty Salesmen to engage in a business of such rapid growth and that represents such splendid and unlimited possibilities. **JUST THINK OF IT!** One out of every seven persons in the United States purchased fountain pens last year—16,000,000 in all. More will be sold this year and many more next year. **WHY!** Because, while years ago a fountain pen was considered an article of luxury it has now become an absolute necessity, indispensable to every one who writes.

When you bear this in mind, you will readily appreciate the wonderful possibilities of the "SECURITY" as compared to the ordinary fountain pens on the market, not only on account of its novel and improved features which give it smooth and excellent writing qualities, but also on account of its unique and practical check protecting device which alone is worth many times the price of the pen, adding tremendously to its advertising value and overcoming all sales resistance.

Manufactured in our own complete and daylight factory by a group of competent, contented and profit-sharing employees with a long experience in the fountain pen industry, the "SECURITY" offers a product of PAR EXCELLENCE and is in a class all by itself.

No wonder it is becoming more and more popular every day and we have enjoyed such a meteoric success in a short period of ten months, ever since we inaugurated our new merchandising plan of selling through specialty salesmen direct to the user.

Now I want men to help me place a "SECURITY" in the hands of every business and professional man and woman in the United States and eventually in the hands of every one who writes.

Can this be done? Yes, it can and will be done.

Of course we can't accomplish this in six months or a year, but when I get the right kind of men behind this meritorious article and all of us work together and co-operate to the fullest extent, we are bound to put the "SECURITY" over the top.

First of all I want some real big men, good experienced organizers, to take over the exclusive distribution of the "SECURITY" in the remaining open states. I want these men to be real workers, of pleasing personality, full of determination and vision enough to picture what I see in the future and the unlimited possibilities of this "MASTER PEN" and fully convince themselves that the "SECURITY" is destined to be the leader in the field.

We have practically closed one-half of the States, and indications are, that the balance of the territory will be assigned within the next thirty or sixty days. When this is accomplished and our distribution plans are finally completed, we will commence a judicious and systematic, national advertising campaign, which will popularize the "SECURITY", create a large demand, and be of great assistance to our representatives throughout the country in their sales efforts.

CASH REQUIREMENTS

In order to avoid any possible misunderstandings and as I am not at all anxious to take up your time or mine by corresponding and for the purpose of keeping away the curiosity seekers I will endeavor to make our proposition very clear in every way.

1. If you wish to act as our Distributor, have had experience in organizing and maintaining an efficient sales force and are in a position to finance yourself to the extent of from \$1,000.00 to \$2,500.00 we will grant you the exclusive sales rights of our product in a territory having a population of from 1,000,000 to 5,000,000.

2. If you wish to act as a District Manager and are able to train and organize a small sales force and can finance yourself to the extent of from \$150.00 to \$500.00 we will allow you exclusive sales rights for the "SECURITY" within a territory ranging in population of from 100,000 to 500,000 people.

3. If you wish to become an Agent and to devote part or all of your time to the "SECURITY" you must have a capital of \$17.75 to enable you to purchase one of our complete sample outfits which will start you on the road to success, and as soon as you have proven to us your ability to successfully distribute our product I will make you a proposition offering you exclusive territory of from 10,000 to 50,000 people.

ATTENTION: We do not sell territorial rights. Your capital is always under your control and is to be used strictly for the purchase of pens and furnishing suitable office quarters when necessary.

In order to avoid unnecessary correspondence and speed up negotiations, when writing please don't say "I wish to act as Agent, District Manager and Distributor," but judge for yourself in what capacity you are able to serve yourself and our organization to the best advantage and specify exactly in the coupon below. Also write a personal letter giving me a brief history of yourself, your past experience, financial, commercial and character references; whether you wish to devote full or part time and mention territory wanted, specifying names of Counties or States. I will then give you full details.

NOTE.—Please do not ask for Credit, Free Samples or Samples at wholesale prices. We do a strictly cash business.

If you desire to see the "SECURITY" before taking further action, send with your letter check or money order for style wanted and a complete demonstrating outfit will be forwarded to you free of charge together with sample pen.

After you have received the pen, examined all the parts, noted the simplicity and strength of construction and followed carefully the directions relative to filling and the use of the pen and given it a thorough trial, we are confident you will agree with us that the "SECURITY" is all we claim it to be.

Then go and show the pen to your friends and acquaintances, also several business men including your Banker, get their opinion and let them be the judges. In the event however you are not completely sold on its merits and are not thoroughly satisfied with the "SECURITY" you may return the pen at our expense and the entire price will be refunded you without any "ifs" or "ands."

JOHN H. KRITIKSON, President.

Present Distributors

DOROKAY CORPORATION
25 West 43rd St., New York, N. Y.
Exclusive Distributors New York and New Jersey

SECURITY PEN COMPANY
152 Temple St., New Haven, Conn.
Exclusive Distributors Connecticut and Rhode Island

EASTERN SECURITY PEN COMPANY
Konnarock, Virginia
Exclusive Distributors Virginia and West Virginia

SECURITY PEN SALES COMPANY
30 Euclid Arcade, Cleveland, Ohio
Exclusive Distributors Cleveland and Surrounding Territory

SECURITY PEN COMPANY
805 Walton Bldg., Atlanta, Ga.
Exclusive Distributors Georgia, Alabama, Florida, North and South Carolina

E. E. PEOPLES
Prudential Hotel, San Antonio, Texas
Exclusive Distributor Southern Texas
NORTHWESTERN MFGRS. AGENCY
Lewistown, Montana

Exclusive Distributors Montana, Wyoming, Colorado
STANDARD SALES COMPANY
506 Chamber of Commerce Bldg., Los Angeles, Calif.
Exclusive Distributors California, New Mexico, Arizona, Nevada

TUNNELL, LIMITED
Harland Smith Bldg., Toronto, Ont.
Exclusive Distributors Dominion of Canada and Newfoundland



Security Pen Corporation, Dept. 200 P. M.,
900-910 W. Jackson Blvd., Chicago, Ill.

Gentlemen: I am interested in your proposition from the standpoint of DISTRIBUTOR DISTRICT MANAGER AGENT. I wish to devote FULL TIME PART TIME in the following territory. Explain in full.

Enclosed find check money order \$.....
Send me one Security Pen No. Long Short Medium
 Fine Stub Coarse in Flexible or Stiff Action.
Also DEMONSTRATING OUTFIT FREE.

Name.....

Address.....

City..... State.....

Ford Owners Make \$12 to \$36 Daily!

Startling Opportunity to Make Money Fast!

At home or traveling. All or spare time. Experience not necessary. Willingness to demonstrate all we ask. If you own Ford, you're lucky. It's a gold mine. Simply install GIDEWEL steering device. Show to other Ford Drivers. They're bound to buy. Quarter mile demonstration convinces most skeptical. Sell right and left. Makes you independent. Always have money. Ed. Krampton, Canada, makes high as \$300.00 week. W. H. Pfing, Ohio, clears \$75.00 week often. Each sale earns \$4.00. Two sales in one evening common. \$8.00 between supper and bedtime not bad. It's yours for the asking. Must act quick. Territory going fast.

There's Not a Ford Driver on Earth Who Wouldn't Gladly Pay \$10 for GIDEWEL!

It's a wonder. Nothing exactly like it. Absolutely and positively guaranteed. Stops steering vibration. Takes shock, jar, jolt, jiggle and jerk out of steering wheel. Eliminates front wheel wobble. Makes car track perfectly. Won't jump ruts. Rides bumps without swerving. Prevents locking on short turns. Makes driving a pleasure. Adds safety to motoring in a Ford. Car responds to slightest touch on steering wheel. Can steer for miles over roughest roads without fatigue. GIDEWEL easily attached. Installed without disturbing present construction of car. Is dirt, dust- and grit-proof. Practically no wear out to it. Lasts lifetime. Can be transferred from one Ford to another. Hundreds in use. Difference it makes in steering amazing. Be first man in your town to demonstrate and sell GIDEWEL. Ten dollar bill buys it. Where's Ford driver who wouldn't pay \$10 to make his Ford steer like large, heavy car? Every Ford driver live prospect. Hundreds swarming around in your territory. Think of the money-making possibilities for you! Again we say: Act quick. Wire or write at once for liberal proposition. Don't wait. Address

THE ROLLAWAY MOTOR CO.

1121 Southard Ave.

TOLEDO, OHIO, U. S. A.

THE NEW MOTORLESS SAIL PLANE

Fly in a Rider glider



Build your own for \$20 or less

Following my scientific drawings and simple instructions, an amateur can quickly build it. Safest glider ever designed, the result of my long experience in the Eng. Div. of the Govt. Air Service. Very simple construction. You can obtain the materials from your local stores for \$15 or \$20. Send only \$3 for complete blue print plans. Money refunded if not entirely satisfied.

W. KEITH RIDER

P. O. Box 1062

Arcade Station, Los Angeles, Cal.

It's Safe
Simple to handle
Scientifically
Designed

Any Amateur
can operate
Very Latest
construction
Glides with
least air pressure

Plans
in detail complete
(Guaranteed)

\$3⁰⁰

\$365⁷⁵ ONE DAY

Ira Shook of Flint Did That Amount of Business in One Day

—making and selling Popcorn Crispettes with this outfit. Profits about \$269. Bram bought first outfit Apr. 6, 1923 and 7 more outfits by Aug. 28, 1923. Iwata, Cal., bought one outfit, then 10 more within a year. Mrs. Lane of Pittsburg says, "Sold 8000 packages in one day (1923)". J. R. Bert, Ala. wrote, "Only thing I ever bought that equalled advertisement". J. M. Pattilo, Ocala, writes, "Enclosed find draft to pay all my notes. Getting along fine. Crispettes all you claim and then some."

John W. Culp, So. Car., writes, "Everything going lovely. Crispette wrappers lying all over town. It's a good old world after all." Kellog \$700 ahead end of second week. Mesner, of Baltimore, \$250 in one day. Baker sold 3,000 packages in one day. Perrin, \$380 in one day.



We Start You in Business

Furnish secret formulas, raw material, and equipment. Very little capital required; no experience needed.

Build a Business of Your Own

There is no limit to the sale of Crispettes. Everybody likes them. It's a delicious food confection made with or without sugar. Write me for facts about a business that will make you independent. Start now, in your own town.

Profits \$1,000 a Month Easily Possible

Send postal for illustrated book of facts. It contains enthusiastic letters from others—shows their places of business, tells how and when to start, and all information needed. Free. Write now!

LONG EAKINS COMPANY

1128 High Street

Springfield, Ohio

Tobacco

To introduce our old mellow sweet Green RIVER will sell 10 pounds, Mild Smoking \$1.95, Green River and Burley mixed \$2.55, Green River Chewing \$3.45. Free with each 10 pound order Genuine \$1.00 Wellington French Briar Pipe. Postage Extra. Satisfaction Guaranteed. Pay on delivery. Write for Price list.

KENTUCKY TOBACCO CO., Box 627, Owensboro, Ky.

Perfect Health Absolutely FREE through a Natural Law

Address ALOIS P. SWOBODA

1171 Berkeley Bldg.

NEW YORK



RADIO "B" BATTERY

DIRECT FROM FACTORY TO YOU SHIPPED PREPAID

Greatest radio B battery on market. Absolutely fresh, full voltage, seamless cells, noiseless—will bring in Concerts LOUDER and STRONGER! Built correctly—full number of voltage taps—will work any tube or load speaker. Real service GUARANTEED. Sold direct from our factories to you at lowest prices. Shipped prepaid to your door. ORDER TODAY. Send money order, check or pay C. O. D. Order By Number

No. 622B—22½ volt variable—regularly \$3.25—our price \$1.98

No. 622A—22½ volt variable—regularly \$3.00—our price \$2.65

No. 645A—45 volt—8 taps—regularly \$6.00—our price \$3.98

AYRES BATTERY CORPORATION, Cincinnati, Ohio



HEAT! THE NEW WAY

Amazing
Invention
Does Away With
Coal and Wood



Fits Any Stove



Twice the Heat at Half the Cost—On or Off with the Turn of a Valve.

Think of having instantly all the heat you want IN ANY STOVE without building fires; without kindling, ashes, dirt, or odors. Think of having—at the touch of a finger—a fire that is three times hotter than coal—or just enough to simmer a kettle. A fire that stays where you want it—high or low.

THREE TIMES HOTTER THAN COAL

Think of the wonderful cooking and baking you can do with such a fire, think of the better health and comfort the family will enjoy when you can keep every room in your home at just the heat you want, warm and cozy, day and night, in any weather. These are but a few of the advantages enjoyed by users of a remarkable new invention—

INSTANT-GAS—CHEAPER THAN COAL

A scientific combination of 96% superheated air and 4% kerosene (common coal oil)—the cheapest and safest fuel known. It is produced by an amazing invention which, in one minute, can be slipped into the fire-box of any coal or wood stove. All the convenience of gas at half the cost.

Start with the Turn of the Valve

Turn high or low to suit, heat your home, do your cooking and baking, and then stop with another turn of the valve. A child can operate it. Instant-Gas gives a clean, steady, dependable fire. No ups and downs to give the family influenza and pneumonia, no running out into the cold to fetch coal or wood, no fallen cakes or sodden biscuits from an unsteady oven. Saves cleaning bills, doctor bills, wall paper and curtains.

Works in Any Stove—Old or New

No holes to drill, no injury to stove, installed in a few minutes, makes old stove work like new, and makes a new stove last twice as long. Lasts a lifetime. For many years the markets have been flooded with oil burning devices—but a scientific improvement in the application of oil burning principles makes the Instant-Gas Oil Burner the one great, outstanding success of its kind. Yet it costs

no more than inferior out-of-date makes. Money-back guarantee gives you absolute protection.

TRY IT IN YOUR HOME FOR 30 DAYS FREE

Test the Instant-Gas for yourself, try it in your own stove at our risk for 30 days, see for yourself how much superior Instant-Gas is to any other fuel, how much money it saves, how easy it is to turn on and off, how much cleaning and scrubbing it saves, how much warmer you can keep your home, and how much better cooking and baking you can do. Join the hundreds of thousands of Instant-Gas users who have gained health and strength by cutting their work in half and doing away with the heavy, dirty, back-breaking coal and wood. Mail coupon today for 30 day trial offer and amazing new book "Scientific Oil Burning." No obligation. Special low introductory price to those who mail coupon at once. Mail yours today.

AGENTS Oil burning is the rage. People everywhere are turning to this remarkable new method of heating and cooking. \$60.00 a week sales plan for beginners and spare time workers. \$5,000.00 to \$10,000.00 a year easy for real producers, who can handle big territory. Write at once for details and be ready for big Fall and Winter sales.

INTERNATIONAL HEATING CO.

119 South 14th Street, Dept. 392, St. Louis, Mo.
Manufacturers of scientific heating equipment.

Mail this Coupon for Amazing Free Book

International Heating Co.,
119 South 14th Street, Dept. 392, St. Louis, Mo.

Without any obligation whatever to me, mail me, post paid, your Free Book entitled "Scientific Oil Burning," together with your special introductory price and 30 day trial offer to those who act at once.

Name.....
Address.....
City and State.....

If interested in making from \$60.00 to \$200.00 a week! as agent, like Lacey of Mass., mark X in this square.

ACEY-DUECY

The Great NAVY GAME

Luck and skill. More strategy than chess. More action than Mah Jong. 20 minutes' play makes all your friends real Acy-Duecy fans. Be the one to spring it. Complete layout, dice, board and chips.
Postpaid, \$1.00. NAVY GAMES CO., 215 E. & C. Bldg., Denver.



FREE 1000 Illustrations **ELECTRIC FIXTURE CATALOG!**

Write today for your copy. Save 50% direct from Manufacturer. No Middleman's Profit. OUR SPECIAL: 8 Room Electric Set, ready to hang, \$24.50—Other bargains.

UNITED LIGHTING FIXTURE CO.
280 Bowery Dept. 120 New York

Popular Mechanics Readers **FREE 2 WONDERFUL PURE SILK KNITTED TIES**

GREAT BARGAIN. 2 Shirts, neat colored stripes, highest quality madras and poplin. Soft Colls. Finished beautifully.
FREE 2 Ties of finest Silk Knit, fast colors, full length, with every shirt order.
SEND NO MONEY. Just name and size of shirts. Pay postman \$3.79 on arrival of 2 shirts and 2 ties. We pay postage. Satisfaction guaranteed. Free, pair of snap-on Coll Buttons if you send **cash** **RUSH ORDERS NOW.** Send for **FREE CATALOG** of Bargains.
—Public Trading Co., 263 Fifth Ave., Dept. 540, New York

20¢ A DAY PAYS for a Piano

Before you buy a Player-Piano or Piano, get our beautifully illustrated **FREE Book** showing popular melodies of famous sweet-toned Symphonies. Easy payments. Save \$100 or more. 25-year Guarantee. Write TODAY.

Larkin Co Inc. Dept. P-1139
BUFFALO, N. Y. Peoria, Ill. Chicago, Ill.

MAKE FORD INTO THIS SPORT CAR—SAVE \$50 to \$150 WITH Red-i-Kut Life-Size Patterns \$6.40 COMPLETE

Famous **Red-i-Kut** life-size patterns and pleasure-fit instructions show you how you can easily convert your Ford into this **Fast, Saucy, Sport Car** as thousands have done, with easily obtained materials. No need to lay up the car.
LOOK AT WILFRED ENO'S PAL. Eno says, "Total material cost with steel and paint for my Pal only \$14.31. It took me just 3 Sundays to build it and I save an proud to hear them say, 'He built that snappy sport car.' I never cut any steel or did any woodwork before but one can't go wrong with Kuempel patterns." (Overland City) St. Louis, Mo. The "Pal" with pressed metal streamline rear.

Life-size patterns for each part of the body so you can't go wrong, picture instructions and **CONICAL DISK WHEEL PATTERNS** Only \$5.40 delivered. Order now while we can make good delivery, and really enjoy these wonderful days in your "Pal." Keen, Classy, Up-to-the-minute. You can build it. Over 11,000 in use. Don't hesitate. "Swing Lo" Underlasing Irons, no frame cutting kind, \$7.01. Send 5c coin for new manual of other distinctive sport body patterns from \$2.50 up—"RRQ" Steel, "Swing-Lo" Irons, "Jig" Tops and "Gosum" Windshields. Order Right Now, Kuempel Co., 42 Kuempel Bldg., Guttanberg, Iowa

Easy-to-Understand Instructions and Tail Delivered

38-inch, Easy-riding seat

Let DIAMONDS say Merry Xmas



642 AD—18" Pearls, Diamond Clasp. \$14.50



643AD—Pre-
mierdiamond
Ring. \$95.00



644 AD—En-
graved, Dia-
mond \$37.50



645AD Hexa-
gon diamond
Ring. \$55.00



651 AD—Plat-
inum Dia.
Ring. \$118.50



649AD—Pre-
mier Cluster,
7 dia., \$73.50



653AD—W.
G. Cluster,
Dia., \$59.50



652AD—14 kt. Wh Gold
15-jwl. Wrist Watch
\$33.65



654AD—Blue-
white Dia. Rg.,
\$110.00



647AD—Bel-
cherDia. Ring
\$80.00

NO MONEY DOWN

The startling Diamond values pictured can be yours without risking a single penny. Each item is ideally suited for a charming Christmas gift. Your selection sent on your simple request without a single penny down. If you don't agree that it is the biggest bargain you ever seen, return at our expense. If you keep it, pay at the rate of only a few cents a day.

YEARLY DIVIDEND

You are guaranteed 8 Per Cent, yearly increase in value on all diamond exchanges; also 5 Per Cent bonus privileges.

J.M. LYON & CO.
2-4 MAIDEN LANE-NEW YORK
In Business Nearly 100 years

SEND FOR
**MILLION
DOLLAR
BARGAIN BOOK
FREE**

**MILLION DOLLAR
BARGAIN BOOK FREE**

Send for your copy today to Dept. 1778. See the greatest display of diamond and jewelry bargains in America for yourself sold under the Lyon Charge Account Plan.

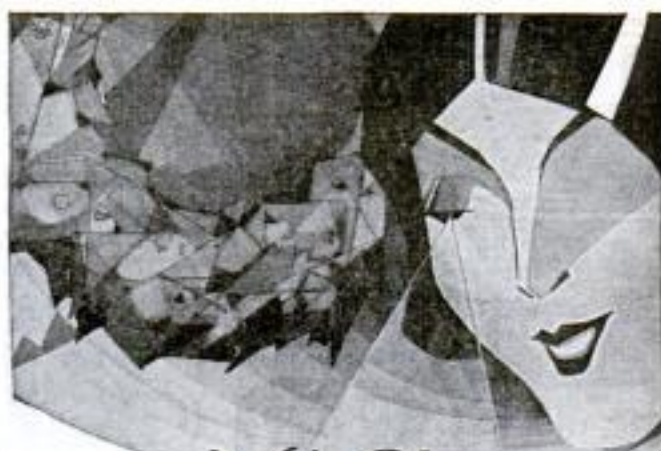

Mi Choice

The Aristocrat of Chocolates

coatings specially Bunte blended to enhance the deliciousness of the center.



A Bunte
Candy

BUNTE BROTHERS · CHICAGO

Pleasure and Profit With a "KING" Saxophone

IT'S so easy to learn to play the famous KING saxophone! A few weeks' practice and you can play popular music—then join a band or orchestra and make good money playing for dances and other entertainments.

"KING" Band Instruments and Saxophones are easiest to play because they are built acoustically correct. Scientific design, finest skilled workmanship, careful supervision at each phase of construction make "KINGS" the most perfect instruments in the world. The tone quality is impossible to duplicate. Leading bands and orchestras insist upon "KINGS." Let us send you one for 10 days free trial.

Free Trial—Easy Payments

"KING" Band instruments and Saxophones are fully described in beautifully illustrated circulars. Write today for complete information about our ten days free trial and our easy payment plan on any instrument. Ask for bargains in rebuilt instruments—old ones taken in trade.

THE H. N. WHITE COMPANY
5111-45 Superior Avenue, Cleveland, O.

SAVE MONEY
Get This Book

Install Your Own
PLUMBING & HEATING
NEW EASY WAY - SAVE HALF

25c
Reg. Price 50c

Brings you this big Plumbing and Heating Encyclopedia-Catalog. Write for your copy today without fail.

Guaranteed Heating Plants

Our Handy-Man Book shows how. Big 256-page well-bound encyclopedia of Plumbing and Heating Outfits, Systems, Supplies, Fixtures and Accessories—10,000 items—illustrated. Hundreds of floor plans, elevations, diagrams, trade secrets, money and trouble-saving kinks, etc. "How to save coal in heating," "Easy repair methods." Every householder, contractor, farmer, mechanic, institution needs this book. Shows how to save wages, work and

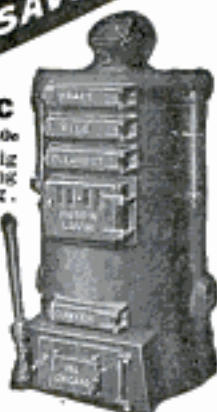

Hot Water Boiler materials.

BIG HANDY MAN BOOK

Tells how we help you plan and install. From rough sketch or description we supply working plans and clear instructions. We loan the tools needed. Any handy man can install. This is the place to buy on money-back guaranty. Plumbing Outfits and Supplies; Water Systems; Hot-Air, Water or Steam Heating Plants; Radiators, Pipes, Boilers or Septic Disposal Tanks.

Send 25c for Yours Today
We have spared no effort or expense to complete this remarkable and instructive book. To keep from sending it broadcast to disinterested persons, we request a deposit of 25c, which will be refunded on your first order—or send for our FREE Bulletin. Write today and save half.

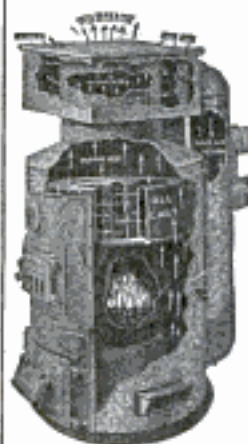

Pipeless Furnace

HARDIN-LAVIN CO.

50 Years
at 4547-57
Cottage Grove Ave.,
CHICAGO



Bathroom Outfit

MAKE AGENTS
\$100⁰⁰
A WEEK

Write at once for newest and greatest money maker ever offered. Wonderful article—quick seller—big profits. Can be sold in every home. *Yates of California* made \$200.00 weekly—other agents cleaning up. If you mean business, here's the chance of your life. Address Mr. Charles, Sales Manager, Dept. 81., 119 So. 14th St., St. Louis, Mo.

Build Your Own PHONOGRAPH

IT'S EASY WITH OUR HELP

A few hours' interesting work saves over half and gives you a machine to suit your ideas. We furnish motors, tone arms, case material, blue prints and full instructions. Plays any record. Make fine profit building phonographs for your friends.

Write today for our **FREE** Blue print offer.

GET YOUR **RADIO SUPPLIES** FROM US

Choraleon Phonograph & Radio Co.
1123 1st St., Elkhart, Ind.



SAVE OVER HALF

\$1.00 DELIVERS to Your Home

Complete Outfit

Violet Ray

ONLY \$1.00 brings this complete, scientific Violet Rays outfit to you. Treat yourself and family at home, save delay, costly doctors and medicines. Thousands use Violet Rays at home to relieve pain and sickness. The identical outfits doctors have bought from us for years and with which they successfully treat many ailments, including those listed below.

QUICK RESULTS—No Medicine

Violet Rays work quickly, it's scientific, goes after the cause. That's why results are quick, permanent. Dr. Duncan, Kewanee, Ill. writes, "Violet Rays is the finest thing I ever used... to relieve pain, treatments are so pleasant all my patients like it." Use it yourself at home, you save Doctor's bills.

BEAUTY AID

Brings natural, magnetic beauty of health, no dieting, exercise or drugs. FREE book tells in detail how high priced beauty specialists use it to improve scalp and skin.

EARN CASH

Men, women, without experience earn liberal profits in spare time showing Violet Rays to neighbors. Proves results first demonstration. Sells on sight. Get attractive offer and wholesale prices now.

SEND FOR FREE BOOK

Explains how Nikola Tesla discovered Violet Rays, how it works, why it heals. Tells what doctors and plain folks accomplish in conquering pain, disease and nervous trouble with Violet Rays.

Reveals Marvelous Scientific Discovery

Shows charts of human body, explains where pains start, how to banish them. Offered FREE for a limited time only, to introduce Violet Rays. Send for FREE copy.

Check Your Ailment Below for Free Advice

Here is a partial list of ailments successfully treated with Violet Ray:

Catarrh	Eye Diseases	Lumbago	Skin Diseases
Chilblains	Falling Hair	Nervousness	Sore Throat
Colds	Hay Fever	Neuritis	Sprains
Constipation	Headache	Paralysis	Tonsillitis
Earaches	Goitre	Piles	Whooping Cough
Eczema	Insomnia	Rheumatism	Asthma

Mail Coupon—Send No Money

VI-REX ELECTRIC COMPANY
326 West Madison St., Dept. 221, Chicago

Please send me without cost or obligation your free book describing your VI-REX Violet Ray outfit, and details of your \$1.00 offer.

Name _____

Address _____

City _____ State _____

Please Mention Popular Mechanics

Copyrighted material

TRAPPERS

Get **HONEST GRADING**
and **HONEST PRICES!**

Old timers will tell you McCullough & Tumbach pay every cent a skin is worth, based on honest grading by fur men who know the market. That's what you want! And we send cash the day your shipment is received. You want that, too!

You want the service that has earned the trappers' confidence for McCullough & Tumbach during 30 years of business—

A Square Deal to Every Shipper

One shipment will prove what we say. Just send it!

FREE shipping tags; full fur information; price lists. Write for them now!

McCullough & Tumbach
148 N. Main St.
ST. LOUIS, MO.



A Wise Old Trapper

In the state of Ohio there lived a bunch of boys who had this trapping business down to a science. They each sent for separate price lists every year and then sent all their furs to the house giving the best quotations. After five years they decided they weren't so dreadfully wise because they didn't have enough profits to make their efforts worth while.

One day they met Tom McMillan driving a new car to town. Tom said he made the price of his swell outfit shipping pelts. He told how he got wise to those funny prices and found it was better to deal with Chas. Porter because he always knew in advance just what he was sure of getting. He said that Porter never offered \$5 for a \$3 pelt but he always paid the \$3 which he promised and sometimes just a little better. Chas. Porter now has five wise trappers in that section instead of one.

Don't Take a Chance with Your FURS

Send us your name and address. Get our Free Bulletin, Shipping Tags and full particulars. Do it right now. This means real dollars to you, so don't put it off. Write today.

Your furs mean real dollars to you. Why sell them to some fellow who offers you \$1.25 when you know blame well you are lucky to get fifty cents. Ask the wise trapper who knows. Once a Chas. Porter shipper and you will always be one. You know in advance that we give a square deal and every shipment brings sure money.

CHARLES S. PORTER, INC.
133 WEST 27th STREET NEW YORK

10¢
A DAY
and Up

Bargain Prices

Celebrated Symphonola Phonographs. Genuine Mahogany, Walnut, or Oak. Portable and cabinet models. 10c a day and up pays. Plays any record. Write TODAY for Big FREE Book.

Larkin Co. Inc., Dept. S-1139
BUFFALO, N. Y. Peoria, Ill. Chicago, Ill.



MOVIES In Your Home

Our marvellous, practical **Movie Machines** sell as low as \$5.00—and what's more, we have wonderful films at lowest prices—with a new film rental service. **DON'T MISS THIS!**

Write NOW for Free Catalogue

PARAMOUNT MFG. COMPANY
Box 1371, Dept. M2, Boston, Mass., U.S.A.



FOUKE

Fur Outlook Good!
...as the largest direct buyers of raw furs in the world and as foremost outfitters to trappers we urge you to sign and send coupon below for **FREE HELPS TO TRAPPERS**. Fouke Fur Co., Saint Louis, Mo.

wants your name and address if you are going to trap or buy FURS

SEND TO-DAY

FOUKE FUR COMPANY
120 Fouke Building, St. Louis, Mo.
Send me new Fouke catalog of latest, best equipment, how to trap, how to grade, game laws, etc. Unexcelled price list service all season, all FREE.

Name _____
Town _____
State _____ R.F.D. _____ Box _____

Get Posted on Furs!

FREE Trapper's Guide
How to Grade Furs; game laws; trapping secrets; supply catalog. Also Market Reports all season.

WRITE TO

FUNSTEN

Bargains in Supplies

We can save you money on smokers, baits, traps—everything you need! Get ready NOW for a BIG year. Get your name on our list to **keep posted**. Write TODAY for valuable helps—FREE!

FUNSTEN BROS. & CO.
879 Funsten Bldg. ST. LOUIS, MO.





—a CRESCENT KIT!

If you want to see his eyes light up with pleasure, let them be greeted with the shiny gleam of brand new, polished Crescent Tools on Christmas morning. No man, whether he is 9 or 90, can quite resist the lure of fine tools—Crescent Tools, in particular.

The Crescent Kit, with wrench, pliers and screw-driver in a handy rattle-proof case, is only \$2.35 at hardware or accessory stores. Packed in attractive holiday box.

CRESCENT TOOL CO., JAMESTOWN, N. Y.
"The CRESCENT WRENCH people"



Can You Sell \$10 Shoes for \$6.45?

It's easy to sell "Chicago" shoes! You can build a permanent business, good for \$5,000 a year profit—no salesmanship or hard work needed—just show your samples! Direct-from-factory plan is sweeping the nation—get in on it!

AGENTS! 89% REPEAT ORDERS!
18 models this season, men's and women's latest styles! Biggest repeater you ever sold! They buy two or more pairs; they buy business and dress shoes; they recommend their friends! Every new customer means a steady income!

CATALOG FREE!

First in each locality gets valuable selling rights.

Write for Complete Information Today

\$6.45

Goodyear welt, oak-tanned soles, finest cal. skin inside and outside, all leather, Goodyear rubber heels, guaranteed \$10 quality, \$6.45

CHICAGO SHOE CORPORATION, Dept. 104, 2424-26 Orchard St., CHICAGO

FURS

If you are looking for a Square Deal, ship us your fur. Thousands of satisfied shippers send us every skin they get.

No Commission Charged

No lot too large or too small. Dealers' lots our specialty. Write us for prices. Satisfaction guaranteed.

SIMON SUMMERFIELD & CO.

312-314 N. Main St., Dept. 80, St. Louis, Mo.
Established 1872

SHIPPERS

DEALERS



SENSATIONAL SALE GUARANTEED TYPEWRITERS

only \$5.00 a month and the machine is yours. This is absolutely the most generous typewriter offer we ever made. Do not rent a machine when you can pay \$5.00 a month and own one. Think of it—Buying a perfect, late model highest grade \$105 Typewriter at a bargain price—at only \$5.00 a month.

The Famous **L.C. Smith** Silent Model No. 8

This is the famous L. C. Smith typewriter which has set the world's standard for quality and service for over twenty years. Perfect machines, Standard size, Keyboard of Standard Universal arrangement, 42 Keys, writing 84 characters—universally used in teaching the touch system. The entire line of writing completely visible at all times, has the decimal tabulator, the two color ribbon, with automatic reverse, the back spacer, ball bearing type bars, ball bearing carriage action, ball bearing shift action. Every late style feature and modern operating convenience. Comes to you with everything complete; tools, cover, operating book and instructions—nothing extra to buy. You cannot imagine the perfection of this beautiful typewriter until you have seen it. We do the most perfect factory rebuilding, adjusting and testing known to the industry. We have sold thousands of these perfect late style machines at this bargain price and every one of these satisfied customers had this splendid, strictly up-to-date machine on five days' free trial before deciding to buy it. We will send it to you F. O. B. Chicago for five days' free trial. It will sell itself, but if you are not satisfied that this is the greatest typewriter you ever saw, you can return it at our expense. You won't want to return it after you try it, for you cannot equal this wonderful value anywhere.

SEND NO MONEY Order Now—Before They're Gone

When the typewriter arrives deposit with the express agent \$8.20 and take the machine for five days' trial. If you are convinced that it is the best typewriter you ever saw keep it and after 30 days send us \$5.00 a month until our bargain price of \$86.20 is paid. All cash, \$81.70, just a little more than half its original price. If you don't want it, return it to the express agent, receive your \$8.20 and return the machine. We will pay the return express charges. This machine is guaranteed just as if you paid \$105.00 for it. It is standard. Over half a million people own and use these typewriters and think them the best ever manufactured. The supply at this price is limited; the price will probably be raised when next advertisement appears, so don't delay. Fill in the coupon today—the typewriter will be shipped promptly. There is no red tape. We employ no solicitors—no collectors—no chattel mortgage. It is simply understood that we retain title to the machine until full \$86.20 is paid. You cannot lose. It is the greatest typewriter opportunity we have ever offered. Do not send us one cent. Get the coupon in the mails today—sure.

SMITH TYPEWRITER SALES CO.,
200-350 E. Grand Ave., Chicago, Ill.

Ship me the L. C. Smith Model No. 8, F. O. B. Chicago. I will pay you \$5.00 monthly as rent until the \$86.00 balance of the Special \$86.20 sale price is paid. The title to remain in you until fully paid for. It is understood that I have five days in which to examine and try the typewriter. If I choose not to keep it I will carefully repack it and return it to the express agent. It is understood that you give the standard guarantee.

Name
Street Address
City Date

Please Mention Popular Mechanics

NEW INVENTION BURNS AIR IN ANY RANGE OR HEATER

Heats, Cooks and Bakes Better Than Coal or Wood. Cuts Housework in Half. Avoids Expensive Heat Waste. Proved by Many Severe Tests to Be Best Kind of Heat. Then Recommended to Housekeepers.

MANY modern homes are being built without coal bins or wood sheds simply because it is so much easier and cleaner to burn free air. Science has shown that one part of coal oil (kerosene), the cheapest of fuels, can be mixed with twenty parts of air (by a remarkable burner) and the result is a gas that is simply wonderful for heating, cooking and baking.

The Simplest Device of All

Following the original discovery of this new, easy way to make every stove a gas stove—a method which is used extensively in our Navy—devices were made which could be used in any kind of range, or heater, and those housekeepers who were abreast of the times began to install them as fast as they could be secured.

Heat at Twist of Wrist

Then, recently, later discoveries showed how to cut out certain parts and yet get even better results. The device which embodies these latest discoveries is called NU-HEAT. It is installed in any range or heater in a jiffy. It does away with all worry as to coal or wood prices or scarcity. It cuts half your housework and the dirtiest and most disagreeable half, at that. Not necessary to BUILD a fire. Just a twist of the wrist and in a few seconds there is an intense cheerful glow that warms the largest rooms on the coldest mornings in a few minutes. NU-HEAT gas is much cheaper than city gas. Gives three times the heat of coal—and it burns at a steady, even temperature that gives far better baking results than coal.



Don't freeze while building Winter Area. A twist of the wrist brings cheerful heat in a few seconds.

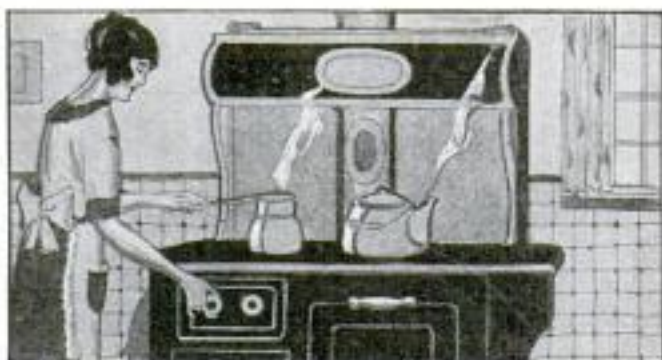

A twist of the wrist brings a fire in a few seconds. Good steady oven heat for better baking.

30 Days Free Trial

Absolutely safe. Nothing to get out of order. Sold under an iron clad guarantee. Sent on 30 days' free trial.

Send for Free Book

Write for complete information FREE. Learn how to cut housework in half. Learn how to economize by having all the heat you want but only when you need it. Learn how to have the warmest, cleanest, coziest home in town. Learn how to get better cooking and baking results than ever before. Just say "Send NU-HEAT information." Mention if you have heater, range or furnace. Write at once to

WADE HILL MANUFACTURING CO.

Dept. Y39 ST. LOUIS, MO.

Agents make \$50 to \$200 a week selling what every up-to-date woman wants. Here's a better burner at a low price—every home can easily afford. Personal co-operation. Free Sample Case offer. Write quick for exclusive territory.

CAMERAS

Over a Hundred Styles and Sizes

Send for new 1923 illustrated catalog showing newest models and latest reduced prices.

IT'S FREE

10 days' free trial given

Seneca Camera Mfg. Co.
300 Central Ave., Rochester, N. Y.



LONG RANGE RIFLE

SINGLE shot hunting rifle of finest blue, case hardened steel, modelled after famous Springfield rifle. Bolt action, take-down model 36 inches over all. Shoots 22 calibre long, extra long and short cartridges. Special at \$6.25

Front and rear sights; automatic shell ejector.

PAY POSTMAN

ON DELIVERY plus postage.

Money back if Not Satisfied

CONSUMERS CO., Dept. 5-CB

1265 Broadway, New York

FREE Send for free catalog of bargains in sporting goods.

\$\$\$\$ MAKERS

You can look far and wide—to the four corners of the globe—and then not find as rapid a seller as the money-back guaranteed Standard Art Products. Special FREE offer to every prospect.

Exclusive territory now open

STANDARD ART PRODUCTS CO.

Desk 111, FORT WAYNE, IND.



"If I hadn't been all through it myself, I wouldn't have the assurance to tell you to 'cheer up.'"

ERICKSON.

The Beginning—(1897)

Those who wear them say:
ERICKSON LEGS are Wonderful
because they do not chafe, overheat or draw end of stump.



If you have had a recent amputation send for new booklet on TEST LEGS for beginners.

E. H. ERICKSON CO.
38-A Washington Av. N.
MINNEAPOLIS MINN.

SPORT BODIES for FORD and CHEV. 490 at \$34.50

Life-size paper patterns—You can build your own body at small cost. We are manufacturers and our quantity production enables us to quote exceptional low prices. Our unique shipping methods save you 73% in FREIGHT CHARGES. Send at once for free particulars on Central Bodies. Our Book: "HOW TO BUILD A FORD RACER" sent anywhere on receipt of 25c in cash or stamps. WRITE TODAY!

Central Auto Supply Co. Dept. 120. Louisville, Ky.



UP
UNDER
SLUNG
PARTS
Per Set
\$6.75

"YANKEE" Ratchet Screw-drivers

No. 10 (illustrated) comes with 2, 3, 4, 5, 6, 8, 10, and 12 inch blades.

No. 11 is same as No. 10 except that Ratchet Shifter moves across instead of parallel with tool.

No. 15, with knurled thumb-turn, comes with 2, 3, 4, 5, 6, and 8 inch blades.

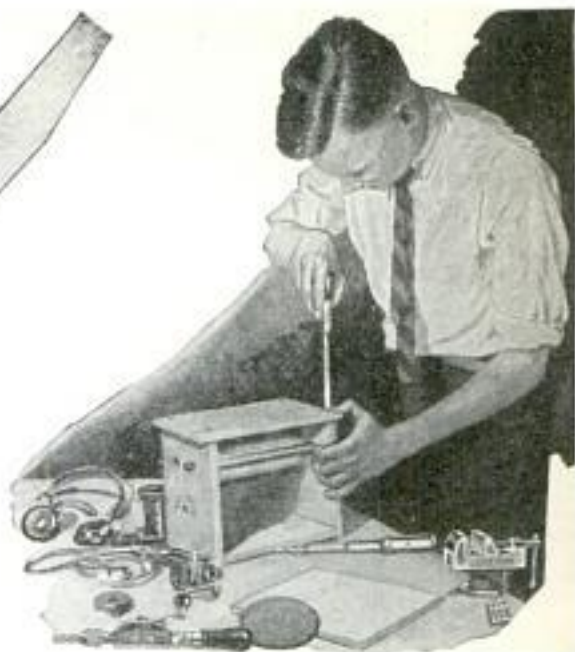

Make it easier

BECAUSE of the "Yankee" Ratchet you never need to release your first good grip until screw is home. "Yankee" Ratchet Screw-drivers aid in the accurate construction so necessary to satisfactory tuning.

Quicker. Easier. No tiresome grip-and-let-go. Knurled washer on No. 15 helps to start tiny, wobbly set screws. Long thin blade reaches in tap holes.

For drilling holes, use "Yankee" Ratchet Hand Drill No. 1530. Your hardware dealer sells "Yankee" Tools.

Write for "Yankee" Tool Book, showing all the "Yankee" Ratchet Tools—Hand, Breast, Chain and Bench Drills, Tap Wrenches, Push Drills, Spiral Screw-drivers, etc.

NORTH BROS. MFG. CO., Philadelphia, U. S. A.

"YANKEE" TOOLS

Make Better mechanics

**REMINGTON
PORTABLE TYPEWRITER
Dealers and Branches Everywhere**

Swing 4 in.; 11 in. between centers, 17 in. total length. Shipping weight 13 lbs. Bed of lathe is machined. Workmanship first-class. Equipped with wood turning chuck. Can be fitted with 3 in. face plate and drill chuck as special equipment. Order one today.



Price \$6.00 cash with order
Made also in larger sizes.
SYNER MFG. CO.
Dept. D, TOLEDO, OHIO

Direct at Factory Prices

This \$2 KNIFE \$1.18 Postpaid
Hand Forged Razor Steel Blades
Handy shaped Blade makes this knife best for mechanics, sportsmen and farmers; light but strong; re-sharpened easily. Stag handle. German silver finish; blades file tested, hand forged from razor steel and warranted.

Sample \$1.18 3 for \$3.00 Postpaid.

Send for our 100-page List and
"HOW TO USE A RAZOR" **FREE**

MAHER & GROSH CO., 106 A St., Toledo, Ohio

Hand Forged
Razor Steel
Blades, No. 57



A GENUINE \$2 KNIFE
FOR
\$1.18 POSTPAID

now Only

\$14²⁴ Down

(Magneto Equipped)

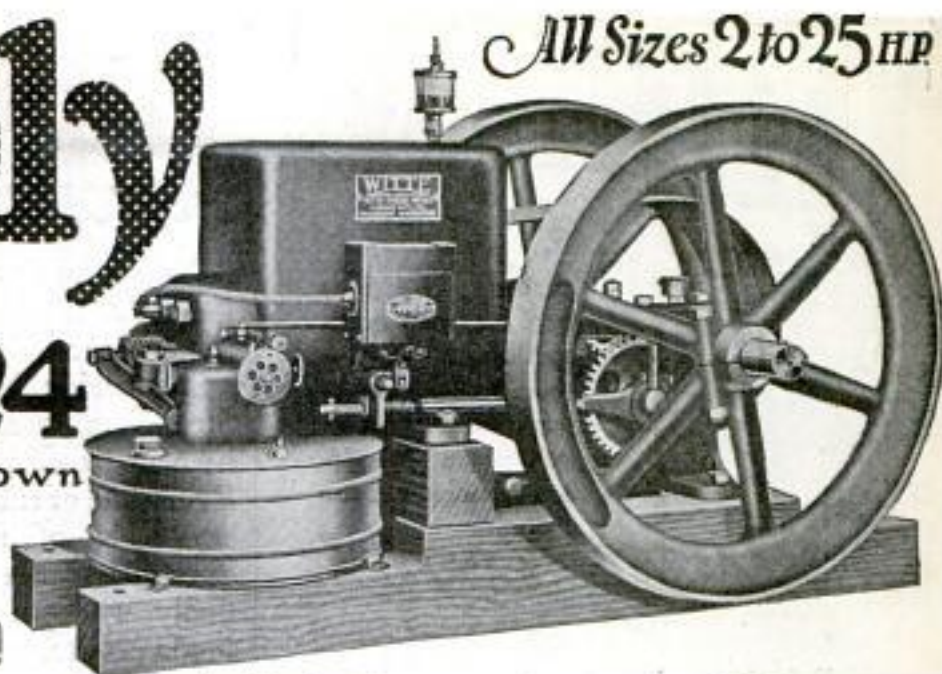

All Sizes 2 to 25 HP

Puts this THROTTLING GOVERNOR WITTE on Your Place

Here's a revolution in farm power—now a cheap, dependable engine is within the reach of every progressive person—you can make \$1,000.00 or more extra profit every year you have a Witte Engine working for you.

BURNS KEROSENE, GASOLINE, DISTILLATE or GAS!

(NO SPECIAL ATTACHMENTS NECESSARY)

Here's the standard engine value—the WITTE Throttling-Governor ENGINE which burns kerosene, gasoline, distillate or gas without any special attachments. With the WITTE you are no longer at the mercy of fuel fluctuations—you get steady, dependable power and always use the cheapest fuels.

An All-Purpose Engine

The WITTE delivers the big surplus of power that you need for the larger heavier jobs but can also be speeded down to handle small jobs at a minimum fuel cost. Easily moved from place to place—the WITTE answers every power need on the place. Trouble-proof and so simple to operate that a boy can tend to it. Makes all farm work easy and cheap—Louis Knoche says: "I didn't know a WITTE could show me such a profit. I do all the chores easily and quickly and have saved the wages of several hands this year. The engine works like a charm and I have kept it going steadily ever since I got it."



Built By The Man Who Sells Them

I build my engines and I sell them—I have been doing this for over forty years. Over 100,000 satisfied customers say that the WITTE is the one engine that can be relied upon all the time. And because I build the WITTE and sell it direct to you I give you a price that no one can equal on such a high-quality engine. I deal with you personally—if there is any problem confronting you in the purchase of an engine, write me PERSONALLY and I'll help you. ED. H. WITTE.

Equipped with the Famous Wico Magneto

THE WITTE comes equipped with the Wico Magneto—the most perfect system of high tension ignition known. A guarantee that the WITTE will always have a fast, hot spark and give perfect performance in all climates, under any weather condition or temperature. Far superior to the old-style battery-equipped engine—it combines dependability and economy all the time.

Lifetime Guarantee

The WITTE ENGINE is guaranteed for a lifetime of hard, steady work—mechanically perfect, built of only the best selected material in the largest factory of its kind in the world.

Sold Direct From Factory to You

I employ no salesmen—the WITTE ENGINE is sold direct from my factory to you at the lowest price in history and I give you nearly a year to pay on any size, 2 to 25 horse-power.

90 Days' Free Trial

So confident am I that the WITTE ENGINE will make you money day in and day out that I offer to let you try a WITTE 90 days at my risk and if it's not right, I simply say—"I'LL MAKE IT RIGHT AND IT WON'T COST YOU A CENT." Can I make a fairer offer to prove to you that now you can buy cheap, dependable farm power that is sure to show a profit?

Ed. H. Witte

WITTE ENGINE WORKS

1746 Oakland Ave., KANSAS CITY, MO.

1746 Empire Bldg., PITTSBURGH, PA.

Without obligating me in any way, please send me at once your big engine book and full details, prices, etc.

Write for my FREE Engine BOOK Now

Write me today—no obligation whatever, for my big free illustrated engine book that shows the low prices on this remarkable engine. Gives full details of operation and shows the way to the biggest profit year you will ever have.

—ED. H. WITTE, Pres.

Witte Engine Works

1746 Oakland Avenue, KANSAS CITY, MO.

1746 Empire Building, PITTSBURGH, PA.

Name.....

Address.....

City..... State.....

Different!



Through the ages there has been nothing like the Sphinx—it is *different*. Just as today in the motorcycle world the *different* machine is the

Indian Scout

New riders daily acclaim it as the complete answer to the demand for speed, power, and endurance without excessive weight, combined with lowest economy and greatest ease of control. Old riders find it *different* from anything they ever threw a leg over. It is a compact model of everything modern motorcycling calls for.

A demonstration at your dealer's will let you "feel" the *difference*. Other models and sidecar outfits if you prefer.

Send for descriptive folder
to Dept. P-9

HENDEE MANUFACTURING COMPANY
Springfield, Massachusetts

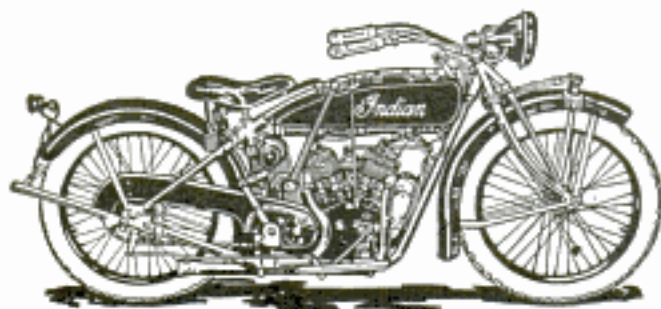

RIGHT-ALL WAYS ALWAYS

Spencerian Personal Steel Pens

When buying pens—here's a point to remember: There's a Spencerian Personal Steel Pen to fit *your* hand, perfectly. Every one of the many styles is of special Spencerian steel with finely worked, hand-made points. Result—a longer-lasting, smoother-writing pen than you ever used before.



No. 1—
College,
fine point,
double
elastic.



No. 28—
Congressional,
speedy and
flexible.



No. 40—
Medium
point, all-
around
ability.



No. 42—
Gold and
dome
pointed;
smooth
action.

SPENCERIAN
PEN CO.

349 Broadway, New York

A dozen sample pens for a
dime and our hand-writing
booklet free.

Why Burn Coal

or wood when you can burn gas in your stove or heater by installing a Uni-Hete Kerosene Burner (with exclusive 1924 features) in five minutes time. It gasifies common kerosene to the hottest and cheapest fuel known. Does away with dirt and high fuel cost. Heat regulated to any degree by valve. Increases stove efficiency 100%. Has brought joy and economy to thousands. **FREE TRIAL.** Saves its cost in 30 days. Write quick for full particulars and introductory price.

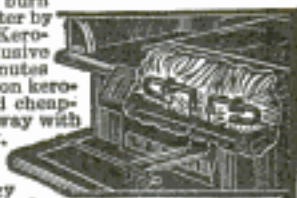

Special Offer to Agents

Today's fuel prices make the Uni-Hete a big money maker for agents. We have made oil heating devices for 33 years. Acorn Brass Mfg. Co., 1157 Acorn Bldg., Chicago, Ill.

DIAMONDS

\$195 PER CARAT

From 1-8 Carat to 2 Carats

Former Price, \$325.

You Save 40 per cent

If you can duplicate

these diamonds for

less than \$250.00

per carat, we

will RETURN

YOUR

MONEY.

30

DAYS

FREE WEAR

Genuine, sparkling

blue white diamonds

set in 18 Karat

solid white gold rings.

CATALOG FREE

It gives valuable information about

diamond weights and grades which you

should know before buying, and offers

a jewelry store full of bargains to select

from. Money back guarantee bond with each

diamond.

B. GUTTER & SONS ESTD. 1879
172 NASSAU ST., Dept. 681 New York

Genuine "RADIOLA"

Made by Westinghouse for the Radio Corporation of America

OUTFIT COMPLETE:

\$5⁰⁰
DOWN
*Puts it
 in Your
 Home*

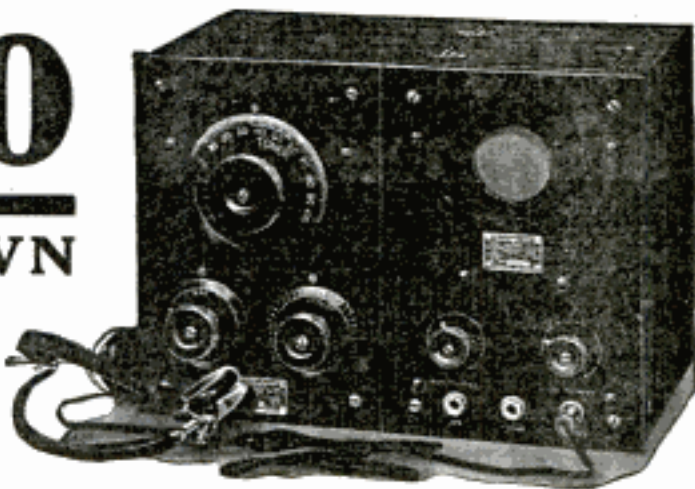

**Balance in Easy
 Monthly Payments**

Regenerative Receiver and 2-Step Amplifier

Now everyone can have the finest radio receiver and amplifier that is made. No need to put up with inferior equipment. For here we are offering you the set designed by the great Radio Corporation, the highest authorities in the industry—and built by the Westinghouse Electric Company. It comes to you complete with all the accessories you need, for just a five-dollar payment. Take advantage of this new way of selling radio. Get an outfit that will give you permanent satisfaction. Send the coupon below for our Great Special Offer, made for a limited time only.

The Perfected Radio At Last!

So simple to tune that it is just the thing for the beginner. Yet so perfect that it will delight the most hardened "radio fan" who has long been searching for the ideal circuit. Its long range will bring in stations never heard before, so loud and clear that a loud speaker will delight the whole family. Wonderfully selective. With it interference, internal noises and annoying body capacity are forgotten.

Send Coupon for Special Offer Circular

Just mail the coupon. Get all the details without any obligation. Don't think of buying an ordinary set without finding all about this new and better way. Very easy terms. Free Trial. The highest quality of radio equipment possible to have.

BABSON BROS. 19th St. and Marshall Blvd.
 Dept. 13-58 CHICAGO, ILL.

No Accessories to Buy

The radio outfits we sell are absolutely complete. Most others make an offer on the bare set and leave you to buy all the extras like tubes, phones, etc. in addition. The outfit we offer you now includes, the Regenerative Receiver and 2 step Amplifier all enclosed in a solid mahogany case. Also the batteries, head-phones, tubes, aerial, lightning arrestor, and full wiring installation equipment. You start operating without investing another single penny. Your \$5 payment brings it all.

WD 12 Tubes and Dry Cells Reduce Upkeep to Almost Nothing

Equipped with 3 of the latest type of dry battery tubes, WD 12 tubes use only $\frac{1}{4}$ ampere. Most perfect tube both for detecting and amplifying. Battery expense reduced to the absolute minimum.

Babson Bros., Dept. 13-58

19th St. & Marshall Blvd., Chicago, Ill.

Please send me your special offer on a Complete Radiola Outfit on terms of \$5 down and monthly payments.

Name.....

Address.....

EASY, NOW, TO OWN AN OTTAWA MILKER!

Now, with our Low Direct-from-Factory Prices and Easy Terms, any farmer or dairyman with 5 to 100 or more cows can not afford to be without the wonderful OTTAWA Milking Machine. Soon pays for itself milking only 5 cows. Saves

ALSO DOES
BELT
WORK



Cash or
Easy Terms

money, time and hard work. Find out today about this milker that milks the human way; is a self-washer and has no pulsator; no pipes or rods; no springs or valves. Easier to use; easier on cows. Milks 2 or 4 cows at once, 18 to 40 cows an hour. No cost to install; comes all complete, ready to milk.

30 Days' Trial Try the OTTAWA Milker on your own herd for full 30 days. Guaranteed for 10 years.

FREE! Before you buy any milker! be sure to get Free facts on the OTTAWA. Send your name and address on a postcard for "The Truth About Milking Machines" and other interesting and helpful information.

OTTAWA MFG. CO.
2604 White Street Ottawa, Kansas
Box 2604, Magec Bldg., Pittsburgh, Pa.

**POWER
MILKER**
\$142.50
\$5.00 more from Pittsburgh
**Costs Nothing
to Install**

The
TRUTH
about
MILKING
MACHINES

**CHARGE YOUR
RADIO or AUTO BATTERY
OVERNIGHT FOR A NICKEL**



**GOLD SEAL
HOMECARGER**
The World's Most Popular
in Batteries' Chargers

Reliably and efficiently charges your radio or automobile battery over night for a nickel. No stopping—no sticking—no fuss—no fuss—no trouble. Self-polarizing

—high charging rate—finished in mahogany and gold—approved by Underwriters. Price \$18.35 complete with ammeter (\$15.00 in Canada)—no extras to buy.

LOOK FOR and INSIST ON the GOLD SEAL
WRITE FOR FREE BOOKLET
**THE AUTOMATIC ELECTRICAL
DEVICES COMPANY**
129 W. THIRD ST.
CINCINNATI

Custom-Made Tops Less Than Half Price

SEND NO MONEY

You can attach them easily. Full instructions sent. Complete tops with beveled plate glass, tacks, fasteners and welts. Free delivery 1,000 miles. For an extra special price on Maxwells, Overland Fours, Dodges and Chevrollets. Describe your car. Samples and money-saving Bulletins free.
Automobile Trunks for Running Board or Rear Platform.
High grade—low cost.

S-C PRODUCTS CO., 767 Nicholas Bldg., Toledo, O.

NEW LAMP BURNS 94% AIR

Beats Electric or Gas

A new oil lamp that gives an amazingly brilliant, soft, white light, even better than gas or electricity, has been tested by the U. S. Government and 35 leading universities and found to be superior to 10 ordinary oil lamps. It burns without odor, smoke or noise—no pumping up, is simple, clean, safe. Burns 94% air and 6% common kerosene (coal oil).

The inventor, H. E. Johnson, 609 W. Lake St., Chicago, Ill., is offering to send a lamp on 10 days' FREE trial, or even to give one FREE to the first user in each locality who will help him introduce it. Write him to-day for full particulars. Also ask him to explain how you can get the agency, and without experience or money make \$250 to \$500 per month.

NO JOKE TO BE DEAF

—Every Deaf Person Knows That I make myself hear, after being deaf for 25 years, with these Artificial Ear Drums. I wear them day and night. They are perfectly comfortable. No one sees them. Write me and I will tell you a true story, how I got deaf and how I make you hear.



Address
GEO. P. WAY, Artificial Ear Drum Co. (Inc.)
80 McKerckey Building, 2631 Woodward Avenue, Detroit, Michigan

Medicated Ear Drum
Pat. Nov. 3, 1908

This Palatial

Florida Home

can be purchased at a very reasonable price. It is the finest estate in a community of 30,000 situated amid 5 acres of orange, grape fruit, sweet bay, palmetto and a large variety of semi-tropical trees and foliage. A water front of 400 feet, with entrance from a Boulevard, affording every modern convenience. House recently completed and never occupied. Has every modern improvement, large sun parlors, sleeping porches and 8 bath rooms. Inexhaustible supply of soft water, steam heat, high, light basement under entire house. Surf bathing all winter within 5 minutes' walk.

For full details, photographs and price address

E. H. PECK,

S. OSGOOD PELL & COMPANY
17 West 44th St. New York City

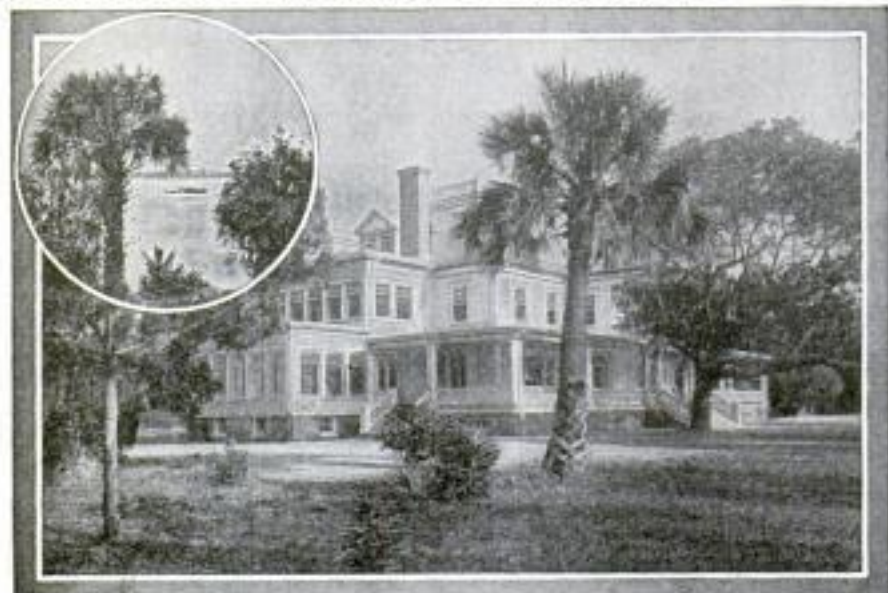

Do Away With Dirty Coal and Wood



No Chopping
No Shovelling
No Dirty Ashes

NEW KIND OF HEAT!



No Coal Bills

—no worry about high prices, coal strikes and shortages that come with discouraging regularity.

For Ranges—Heaters—Furnaces

No more big coal bills to pay—no more uncertain, uneven heat that brings colds, grippe and sickness all winter long. No more lifting and carrying of back-breaking scuttles—no more clouds of ashes to breathe, and hours of precious time spent each day poking and feeding fires. Amazing new invention of Mr. B. M. Oliver, of St. Louis, turns any range, heater, or furnace into a real oil-gas stove, that does away with all this—and gives you any amount of heat you want by simply turning a valve—just like a city gas stove.



Makes any coal or wood range a gas stove—on and off at the turn of valve.

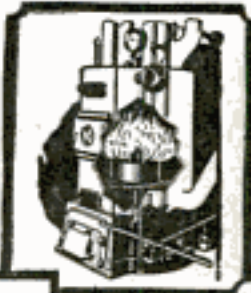

Made in 16 models to fit every type and size of Range, Heater, and FURNACE.



3 TIMES THE HEAT OF COAL

This amazing new invention is called the Oliver Oil-Gas Burner because it burns 95% air and 5% oil—the cheapest fuel there is—turning them into an actual gas that burns with an intense, hot, clean flame. No wicks, no odor, no smoke, no carbon. Absolutely safe. Will last a lifetime. Three times the heat of coal if you want it—and cheaper.

Cheaper Than Coal or Wood

AGENTS AND DISTRIBUTORS

Here is your opportunity to "cash in" on the big money opportunity that this amazing invention is bringing to agents and spare time workers in every part of the country. People are clamoring for this burner. You know lots of people who would be glad to buy one or more burners for their home if you would only tell them about it. You have two or three hours of spare time every day that could easily be turned into real money.

F. W. Bentley of Philadelphia made \$215 in one day. J. Carnegie, S. Dakota, writes: "Making \$1000 a month." A. M. Russell, Conn., averaged \$600 the last six months. Mrs. Seider, Kansas, made \$100 a month in her home.

If you want to earn \$50 to \$100 a week in your spare time write to me at once for full details of my exclusive territory and Free Sample Case Offer. Address me personally, Mr. B. M. Oliver, President, The Oliver Oil-Gas Burner Co. At address at right.

Every day you burn high priced coal means hours of extra work—emptying ashes, cleaning out and filling up stove—cleaning out ashes and coal dust. You literally burn up money, often using coal that is outrageously high, to keep fires all day and all night when you really need heat only part of the time. You stand and freeze on cold mornings waiting for slow fires to start. But now—how easy to do away with all these discomforts, inconveniences and waste.

OLIVER OIL-GAS BURNER

OLIVER OIL-GAS BURNER CO.
2048-K Oliver Bldg., St. Louis, Mo.

Oldest and largest manufacturers of Oil-Gas Burners in the world
Can. Dist.: 2048-K Oliver Bldg., Toronto, Ont.

Fits All Stoves Over 150,000 already in use

Mr. Oliver's invention is made in 16 different models to fit any kind of stove, range or furnace. No holes to drill, no bolts to fasten, no changes whatever to your stove. Simply set in firebox—easily installed by anyone in three minutes. At the turn of a valve you have much or little heat, when and as you want it. 150,000 homes already use this wonderful device.

FREE BOOK

Don't pay another coal bill. Don't go on with the work and drudgery of coal and wood, risking your family's health during the winter months. Send immediately for Free Attractive booklet which tells about this amazing invention. We are making a Special Low Price Introductory Offer to readers of this magazine, which you will be entitled to if you send in this coupon at once—no obligation. Fill out and mail this coupon at once.



Oliver Oil-Gas Burner Co.,
2048-K Oliver Bldg., St. Louis, Mo.

Send me your FREE book, "New Kind of Heat" and Special Low Price Introductory Offer. I am interested in the burner for a

Coal Range Heating Stove Furnace
Specify Steam, Hot Water, Hot Air

Name.....

Address.....

City..... State.....

Wouldn't you like to work this 10 ton CRANE ?

Look at it! A slight pull of a lever and away up into the air swings 10 tons as though it were ten pounds.

Every bit of the fun of working this crane is yours, if you have Meccano. You see, Meccano parts are real engineering parts and that makes your crane work just like the bigger ones. And just whenever you want to, you can take your crane to pieces and build a tower, a battleship, a bridge, a fire-escape—anything you like.



MECCANO

Engineering for Boys

Send for This New Meccano Book

It describes Meccano and tells interesting things about model building. Every page a pleasure. Free, if you send names and addresses of yourself and three chums. Put No. 63 after your own name for reference.



MECCANO COMPANY, Inc., Division H-11, Elizabeth, N. J.
In Canada: Meccano, Ltd., 11 Colborne St., Toronto

"Saws 25 Cords In 5 Hours"

Any hustler can make big money with the WITTE Saw Rig—Ed. Davis sawed 25 cords in 5 hours—another user sawed 40 loads of pole wood in 3 hours. Hundreds of owners make \$3,000 to \$5,000 a year. Sold on Easy Payments.

5 H-P
3-in-1
Saw
Rig

Big Cut in Price



Cuts 60 to 70 Cords a Day Easy

A real all-purpose outfit for farmers and men who make wood sawing a regular business. When not sawing you can fill silos, grind feed, shell corn, thrash and do other work. Easy to start at 40 below zero—equipped with the famous WICO Magneto.

FREE Write today for full description and low prices—no obligation.

WITTE ENGINE WORKS

Kansas City, Mo.
4749 Witte Bldg.

Pittsburgh, Pa.
4749 Empire Bldg.

ELECTRIC SOLDERING IRON

\$3.50
delivered

IDEAL FOR RADIO
& ELECTRICAL
REPAIRS



Every mechanic, motorist, and radio man needs it. With it you can make repairs yourself that you would otherwise pay to have done. Compact, efficient—universal screw driver tip. 50 Watts—110 Volts. Complete with cord and plug. Satisfaction guaranteed, or money refunded. Send P. O. or Exp. M. O. to ARRANDALE ELECTRIC CO., 100 Schley Street Newark, N.J.



**"TRUE-TONE" 3000 Ohm
SUPERSENSITIVE**

The *First* and *Still* the
ONLY Quality 3000 Ohm

Phones for only **\$5**

TRUE-TONE RADIO MFG. CO.
188 N. LaSalle Chicago, Ill.

NO MORE BALD HEADS



WHEN our VACUUM CAP is used a few minutes daily. We accept no pay until you have tried the Cap 60 days and are satisfied. The Vacuum Cap is an appliance that draws the blood to the Hair Roots and starts a new healthy crop of hair. It stops Dandruff, stops the hair from falling out.

Bought by Doctors and men who know that it is the only reasonable HAIR GROWER known to science. No Drugs Used. Write for application blank, testimonials, and booklet on "HAIR" sent sealed in plain envelope. FREE.

THE MODERN VACUUM CAP CO.
P 559 BARCLAY, DENVER, COLO.



Your Job!

Make it Pay You
\$70 to \$200 a Week

Be a **Certificated Electrical Expert**

It's a shame for you to work for small pay when Trained "Electrical Experts" are in great demand at such high salaries, and the opportunities for advancement and a big success in this line are the greatest ever known. "Electrical Experts" earn \$70 to \$200 a week. Fit yourself for one of these big paying positions.

Learn at Home to Earn \$12.00 to \$30.00 a Day

Today even the ordinary Electrician—the "screw driver" kind—is making money—big money. But it's the trained man—the man who knows the whys and wherefores of Electricity—the "Electrical Expert"—who is picked out to "boss" ordinary Electricians—to boss Big Jobs—the jobs that pay. You, too, can learn to fill one of these jobs—spare-time only is needed. BE AN "ELECTRICAL EXPERT"—Earn \$70 to \$200 a week.

Age or Lack of Experience No Drawback

You don't have to be a College Man; you don't have to be a High School graduate. If you can read and write English, my course will make you a big success. It is the most simple, thorough, and successful Electrical Course in existence, and offers every man, regardless of age, education, or previous experience, the chance to become, in a very short time, an "Electrical Expert," able to make from \$70 to \$200 a week.

I Give You a Real Training

As Chief Engineer of the Chicago Engineering Works, I know exactly the kind of training a man needs to get the best positions at the highest salaries. Hundreds of my students are now earning \$3,500 to \$10,000 a year. Many are successful ELECTRICAL CONTRACTORS.

Your Satisfaction Guaranteed

So sure am I that you can learn Electricity—so sure am I that after studying with me, you too, can get into the "big money" class in electrical work, that I will guarantee under bond to return every single penny paid me in tuition if, when you have finished my course, you are not satisfied it was the best investment you ever made.

FREE—Electrical Working Outfit, Radio Course and Employment Service

I give each student a splendid Outfit of Electrical Tools, Materials and Measuring Instruments absolutely FREE. You do PRACTICAL work—AT HOME with this Outfit. You start right in after the first few lessons to WORK AT YOUR PRO-

FESSION in a practical way. I also give free a complete Radio course and a special course for men going into business for themselves.

Get Started Now—MAIL COUPON

I want to send you the "Vital Facts" of the Electrical Industry including my Electrical Book, Proof Lessons, and a sample of my guarantee bond all FREE. These cost you nothing and you'll enjoy them. Make the start today for a bright future in Electricity. Send in the coupon—NOW.

L. L. COOKE, Chief Engineer

Chicago Engineering Works

Dept. 518 2150 Lawrence Ave., Chicago, Ill.

Use This "FREE OUTFIT" Coupon

L. L. COOKE, Chief Engineer
Chicago Engineering Works, Dept. 518, 2150 Lawrence Ave., Chicago, Ill.

Dear Sir:—Send at once the "Vital Facts" containing Sample Lessons, your Big Book, and full particulars of your Free Outfit and Home Study Course—all fully prepaid, without obligation on my part.

Name

Address

City and State

Occupation..... Age.....

The "Cooke" Trained Man is the "Big Pay" Man



This Beautiful Book on Wood Finishing FREE

GIVES complete instructions for finishing all wood—hard or soft—old or new. Explains just what materials to use and how to apply them. Tells how inexpensive soft woods may be finished so they are as beautiful and artistic as hard wood. This book is the work of experts—illustrated in color. Includes color card—gives covering capacities, etc.

Johnson's Wood Dye

Use coupon below for a free copy of "The Proper Treatment for Floors, Woodwork and Furniture." It is full of valuable ideas on Wood Finishing and Home Beautifying.

Johnson's Wood Dye is very easy to apply—dries in four hours and does not rub off or smudge. Penetrates deeply, bringing out the beauty of the grain. Made in fourteen popular shades, all of which can be easily lightened or darkened. Color card in book.

S. C. JOHNSON & SON, Dept. PA11, Racine, Wis.
Please send me, free and postpaid, your instruction Book on Wood Finishing and Home Beautifying.

Name.....
Address.....
City & State.....
Dealer's Name.....

S. C. JOHNSON & SON
"The Wood Finishing Authorities"
Dept. PA11 RACINE, WIS.
Canadian Factory—Brantford

FREE this beautiful pair of book-ends to 10,000 readers of Popular Mechanics Magazine



THIS unprecedented offer is made for advertising purposes—in order *quickly* to introduce a NEW Little Leather Library set of thirty world's masterpieces into a few thousand representative American homes. These Bas-Relief Lincoln Book-Ends will add grace to any library table; they are of heavy bronzed metal, antique finish; store price, from \$1.00 to \$1.50. Read below how and why, for a short period, you can obtain a pair for nothing.



to introduce a NEW SET of thirty Little Leather Library World's Masterpieces

HERE is good news for book-lovers. Little Leather Library Corporation has just published a new set of thirty world's great masterpieces. This new set is, in many respects, even better than the *old* set, of which more than *twenty million* volumes have been purchased. The entire NEW set of THIRTY volumes will be offered at the same low price of \$2.98, for all *thirty* volumes. Yet there are over 3000 pages in this wonderful set of masterpieces. The paper used is equal to that found in \$1.50 and \$2.00 books. The binding is NOT paper or cloth, but a beautiful limp de luxe croft material so handsomely embossed and tinted that it resembles hand-tooled leather. And the convenient pocket size of each volume makes it easy to carry a masterpiece with you wherever you go.

How many have you read?

The thirty volumes offered in this NEW Little Leather Library set are works that no person of intelligence cares to confess he has not read. They are not extracts; each volume is *complete*; they include the finest writings of such immortal authors as Barrie,

Kipling, Shaw, Yeats, Allen, Balzac, Browning, Eliz. Browning, Dumas, Emerson, Whitman, Whittier, Poe, Irving, Ibsen, Shakespeare, Lamb, Moore, Tennyson, Plato, Wilde, Maeterlinck, Turgenev, Longfellow, Dante, Elbert Hubbard.

How can thirty such books be sold for only \$2.98? Simply because they are printed in editions of at least one million copies at a time and sold direct to consumers! Quantity production—and eliminating middlemen's profits—that is the answer.

Free Book-Ends—Why?

This unusual offer of a pair of Lincoln Book-Ends FREE is made simply to introduce this NEW Little Leather Library set QUICKLY. The publishers know from experience that as soon as a few thousand of these NEW sets have been distributed in representative American homes, each set will act as a "silent salesman;" and the sales will increase naturally as they did on the OLD set after the first few thousand were distributed. For a limited time, therefore, these fine book-ends will be sent *free* with each NEW set ordered.

Sooner or later you will want to obtain, and read, or re-read, these great masterpieces of literature. Why, then, not order the set at once, when you can get this pair of Lincoln book-ends free?

Sent for free examination

If you question the unprecedented value, remember that this entire set of thirty volumes will be sent for examination at *our* risk. Do not send any money. Simply mail the coupon below. When the package arrives, give the postman only \$2.98, plus the few pennies for delivery charges. Then examine the books at your leisure. If you do not agree that this is one of the most wonderful bargains of your life, send the set and the book-ends back any time within thirty days and your money will instantly be refunded. Can a fairer offer be made? Reference, Manufacturers' Trust Co., New York.

LITTLE LEATHER LIBRARY CORP.

Dept. 8211

354 Fourth Ave. NEW YORK, N. Y.



LITTLE LEATHER LIBRARY CORP.

Dept. 8211
354 Fourth Ave.,
New York

Please send me the new set of 30 volumes of the Little Leather Library and a pair of Lincoln Bas-Relief Book-Ends Free. I will pay the postman \$2.98, plus the few cents delivery charges, upon arrival. It is understood, however, that this is not to be considered as a purchase. If the books do not in every way come up to my expectation, I reserve the right to return them any time within 30 days and you agree to return my money

NAME

ADDRESS

CITY.....STATE.....

Copyrighted material



There's a Fortune for You in / the Pages of this Free Book!

IF you are mechanically inclined I want to tell you of many opportunities, not merely of getting employment at \$50.00 a week and up, but of owning your own business or establishing yourself as a garage owner or partner, mechanic, vulcanizer, tire dealer, battery station, automobile agent. This is a young man's game—a game that doesn't take much investment, but does require training. Every man is a capitalist who has trained hands, trained brains, and KNOWS WHERE TO LOOK for opportunity. Of the 60,000 men I have trained, I estimate that 20,000 are in business for themselves. I want you to read letters from hundreds of men just like you, without experience, but with ENERGY, who prepared themselves by 8 weeks intensive training at the MILLION DOLLAR SWEENEY SCHOOL, for the big opportunity afforded by the automobile and tractor business.

BUSINESS IS ALWAYS GOOD

Over 12 million cars are running. You can't go anywhere without seeing the demand created for servicing these cars. Other industries have strikes, lockouts, labor troubles, factories close down; men are out of employment. But did you ever hear of a shut down in the mechanical service business? The man who is trained can travel, see the world, be independent, command employment, open his own shop, start in business anywhere and make good. *Sweeney Men Make Good.* I want to give you proofs. I want to open your eyes to what YOU can do in the automotive business.

The Sweeney System of Practical Instruction

Is the ONLY WAY to learn if you want to save time and money and be properly trained. You get this at the WORLD'S greatest trade school, the **Million Dollar Sweeney School** and you get it nowhere else.

Sweeney School
Dept. 1105
Kansas City, Mo.
**Send Me
Free
Catalog**

**—send this—
NOW**

EMORY J. SWEENEY, Pres.
1105 Sweeney Bldg., Kansas City, Mo.

Send me, free, your 64-page catalog and Sweeney School News and tell me of the opportunities in the auto and tractor business.

Name.....

P. O.

City.....

MAKE A START NOW!

You have a right to make a success of your life. Make a start now. I'd like to show you what thousands of men just in your position have done as a result of the *Sweeney System of Practical Instruction*. It's a shame for you to stick in a rut or work at jobs you don't really like. Ask any Sweeney Man. They are in good positions all over the country. Repairing and selling autos. Driving cars and trucks. Mechanics, running Garages, Tire Shops, Battery Shops, Welders. Handling Radio Supplies.

Learning is a real pleasure in the Sweeney School. World's finest equipment. Fine Associates. Healthful surroundings. Entertainment after working hours. Instructors who take a personal interest in you.

I will give you a **FREE RADIO COURSE**. Big radio broadcasting station—talks anywhere in U. S. Cost \$50,000 to erect.

FREE Catalogue and Special Offer

The most important thing you can do today is to clip the coupon and mail it right now. Get my big **FREE 64-page**. It shows hundreds of actual photographs of men at work in my magnificent new school. Tells all about wages, profits, opportunities in Auto and Tractor business. Explains step by step how you learn. Interesting letters from graduates telling how they made good. Shows how men came from all over the world to this big school. Makes you want to join the crowd. Tells everything you want to know. I will gladly send you a copy beautifully illustrated. Also a copy of the Sweeney School News, a most interesting monthly school paper published here. Learn about my Free Radio Course. My big special low cost tuition offer. Mail the coupon today or post ever you'll do. No colored students accepted.

E. J. SWEENEY, President.

**MAIL THE
COUPON
TODAY!**



LEARN A TRADE—

Sweeney
AUTOMOTIVE & ELECTRICAL SCHOOL
1105 SWEENEY BLDG. KANSAS CITY, MO.