

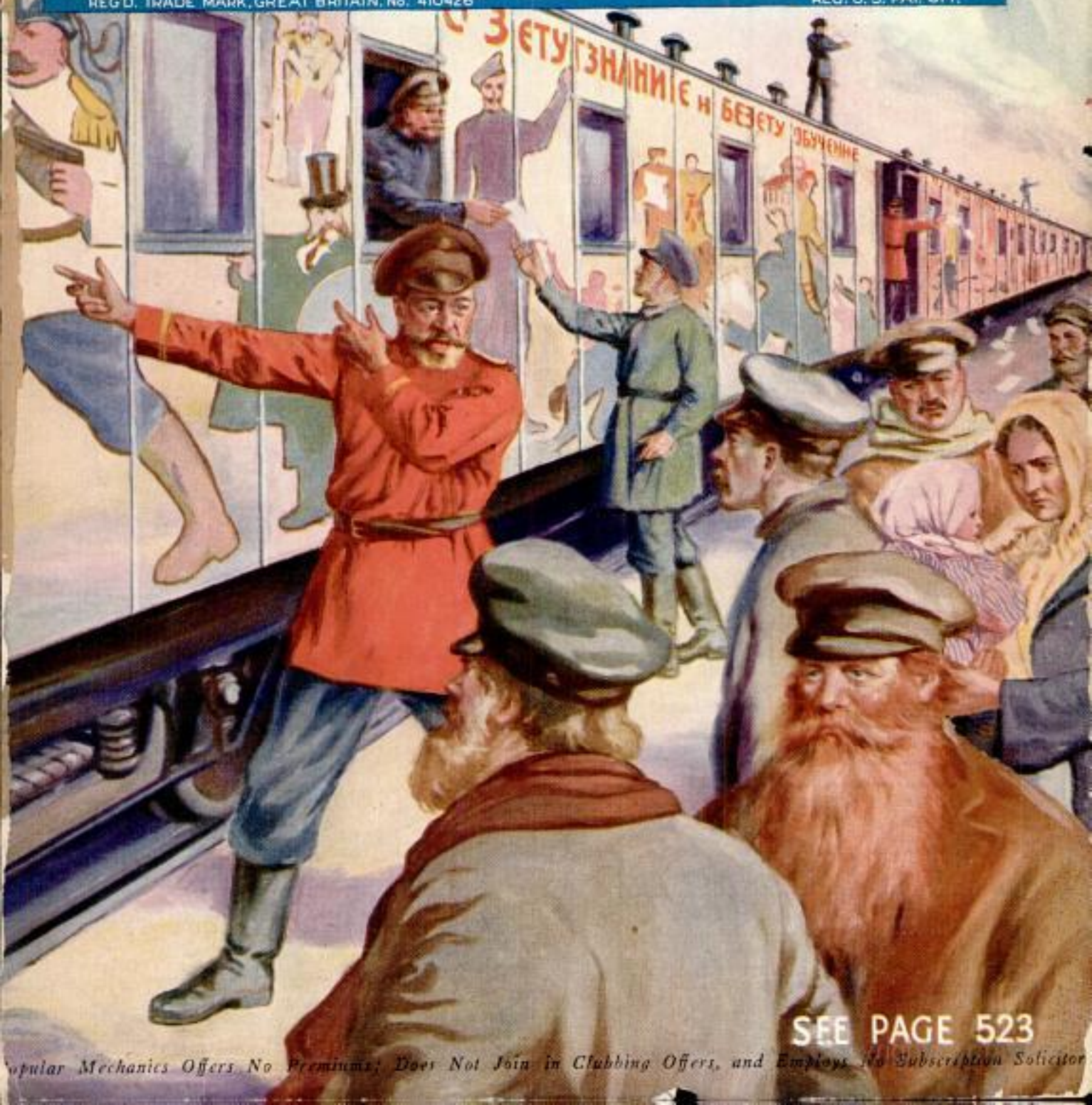
POPULAR MECHANICS MAGAZINE

WITH WHICH IS INCORPORATED THE ILLUSTRATED WORLD

WRITTEN SO YOU CAN UNDERSTAND IT

REG'D. TRADE MARK, GREAT BRITAIN, No. 410425

REG. U. S. PAT. OFF.



SEE PAGE 523

Insure Your Future Now!

SAVE \$100.00

GET IN THE AUTO BUSINESS



BOOKKEEPER
\$25 A WEEK —
NO FUTURE

FARM HAND
\$60 A MONTH

To you ambitious men this announcement presents a worthwhile opportunity—a chance to get out of the poor paying job with no future, into work where the big money is being made. The Rahe Auto & Tractor Schools, with thousands of successful graduates to its credit, make this real money-saving, income-increasing offer to you. Get away now from the tiresome grind of a poor job into a big paying position in the biggest business of today. You need not be a mechanic now. Thousands of men from all walks of life, even ex-doctors and ex-lawyers, are today enjoying fine incomes in the auto and tractor business because they took the RAHE training. You can do the same FOR HALF PRICE if you act NOW. Realize your biggest dreams; be independent and have no fear of the future.



OWN YOUR GARAGE
EARNINGS UNLIMITED
RAHE GRADUATE GARAGE



TRACTOR EXPERT
\$250 MONTH

Regular tuition price \$200 —

Now Cut To \$100



Luck has nothing to do with SUCCESS. THOROUGH TRAINING is the thing that COUNTS MOST. Start on your way today to get a thorough training — A RAHE TRAINING. It only TAKES YOU EIGHT SHORT WEEKS by our PRACTICAL-JOB-METHOD to get this valuable training. Then you can step right into a big paying job in the unlimited Automobile Field.

Insure your future now—the RAHE WAY—IT PAYS.
J. H. McSWEENEY.

Remember this offer is good SEPTEMBER ONLY. Because of our two big schools our operating expense is less. You get the advantage of this—a present of \$100—if you ACT NOW. After October 1st it will be too late.

Our method of teaching is practical. You learn in the best equipped schools in the country under the personal instruction of experts by actual work on all the various types of engines. You get a thorough knowledge of all parts of all motor cars, tractors, and stationary engines.

This year we actually expect to turn men away from October to March. Pack your grip. Come to school right now or write today before it is too late. Let us show you how you can save \$100.

Fill out and mail the coupon today. START NOW on your way to a better job with a better income; a more comfortable home, with more pleasure in years to come.



SUCCESS—does not require un-usual ability. It does require TRAINING—CONCENTRATION on one thing and STICKING-TO-IT until YOU WIN.

Begin—Right Now—Today! Get into this tremendous Automotive Field—AND WIN. You can do it with our JOB METHOD. Learn the "RAHE WAY". There's always BIG MONEY for the TRAINED MAN. RAHE training means—Learning with YOUR HANDS and NOT BOOKS. A REAL JOB at REAL PAY is waiting for you. The "RAHE WAY" PAYS.

R. C. CARMEIN.

RAHE AUTO & TRACTOR SCHOOLS

(Address School Nearest You) Dept. 891
Without any obligation, send me your big free book and all information about your limited offer. (Print name and address.)

NAME.....
ADDRESS.....
CITY..... STATE.....
(Rahe Schools have no facilities for colored men.)

MAIL COUPON TODAY—

Let us show you how you can save \$100 and get this valuable training in 8 short weeks.

Rahe Auto & Tractor Schools

CHICAGO 4445 Grand Blvd. Dept. 891
Ninth and Walnut CINCINNATI



The \$12 a week mechanic who became a millionaire!

TWENTY-THREE years ago, John C. Wahl was working as a mechanic in Peoria, Illinois, at \$12 a week.

To-day, he is a millionaire—having an income that runs into six figures—nationally and internationally known as the inventor of the Wahl Adding Machine, the Wahl Fountain Pen, and president of The Wahl Company, manufacturers of the famous Eversharp pencil.

It is interesting to note that the change for the better in the life of John C. Wahl came the day he saw an advertisement that hit him straight between the eyes. As he puts it, "it told how the International Correspondence Schools could make a draftsman of a fellow without interfering with his daily work." That day, John C. Wahl enrolled and started to build for the future. His present success is proof that he builded well.

"Pick the line of work you like best," he said the other day, "and stick to it. Study hard and success will take care of itself. Nothing is impossible when a man really makes up his mind that he's going to get ahead."

John C. Wahl is just one of thousands of I. C. S. students who have made good in a big way. The lives of such men should be an inspiration and a guide to every man who wants a better job and a bigger salary.

If the I. C. S. can smooth the way to success for other men, it can help you. If it can help other men to go forward to better jobs and bigger salaries, or to success in businesses of their own, it can help you, too.

At least find out *how* by marking and mailing this coupon. It doesn't obligate you in any way to do this, but it may be the means of changing your entire life.

MAIL THE COUPON TO-DAY!

----- TEAR OUT HERE -----
INTERNATIONAL CORRESPONDENCE SCHOOLS
Box 5546-D, Scranton, Penna.

Without cost or obligation, please tell me how I can qualify for the position or in the subject before which I have marked an X:

BUSINESS TRAINING COURSES

- | | |
|---|---|
| <input type="checkbox"/> Business Management | <input type="checkbox"/> Salesmanship |
| <input type="checkbox"/> Industrial Management | <input type="checkbox"/> Advertising |
| <input type="checkbox"/> Personnel Organization | <input type="checkbox"/> Better Letters |
| <input type="checkbox"/> Traffic Management | <input type="checkbox"/> Foreign Trade |
| <input type="checkbox"/> Business Law | <input type="checkbox"/> Stenography and Typing |
| <input type="checkbox"/> Banking and Banking Law | <input type="checkbox"/> Business English |
| <input type="checkbox"/> Accountancy (including C.P.A.) | <input type="checkbox"/> Civil Service |
| <input type="checkbox"/> Nicholson Cost Accounting | <input type="checkbox"/> Railway Mail Clerk |
| <input type="checkbox"/> Bookkeeping | <input type="checkbox"/> Common School Subjects |
| <input type="checkbox"/> Private Secretary | <input type="checkbox"/> High School Subjects |
| <input type="checkbox"/> Business Spanish <input type="checkbox"/> French | <input type="checkbox"/> Illustrating <input type="checkbox"/> Cartooning |

TECHNICAL AND INDUSTRIAL COURSES

- | | |
|--|--|
| <input type="checkbox"/> Electrical Engineering | <input type="checkbox"/> Architect |
| <input type="checkbox"/> Electric Lighting | <input type="checkbox"/> Blue Print Reading |
| <input type="checkbox"/> Mechanical Engineer | <input type="checkbox"/> Contractor and Builder |
| <input type="checkbox"/> Mechanical Draftsman | <input type="checkbox"/> Architectural Draftsman |
| <input type="checkbox"/> Machine Shop Practice | <input type="checkbox"/> Concrete Builder |
| <input type="checkbox"/> Railroad Positions | <input type="checkbox"/> Structural Engineer |
| <input type="checkbox"/> Gas Engine Operating | <input type="checkbox"/> Plumbing and Heating |
| <input type="checkbox"/> Civil Engineer | <input type="checkbox"/> Chemistry <input type="checkbox"/> Pharmacy |
| <input type="checkbox"/> Surveying and Mapping | <input type="checkbox"/> Automobile Work |
| <input type="checkbox"/> Metallurgy <input type="checkbox"/> Mining | <input type="checkbox"/> Navigation |
| <input type="checkbox"/> Steam Engineering | <input type="checkbox"/> Agriculture and Poultry |
| <input type="checkbox"/> Radio <input type="checkbox"/> Airplane Engines | <input type="checkbox"/> Mathematics |

Name.....
Street.....
Address..... 3-27-23

City..... State.....

Occupation.....
Persons residing in Canada should send this coupon to the International Correspondence Schools Canadian, Limited, Montreal, Canada.

Does Cypress ^{"The Wood Eternal"} Last?!

Study These Photographs of an "Ingrowing Fence"



WITHOUT A NAIL
OR A PEG IN IT.

Below is a glimpse down a country highway ("de big road," as Uncle Remus called it) near Monroe, Louisiana. That fence has no posts. It was built by forcing split Cypress boards between saplings. This occurred so many years ago that nobody knows when it was, nor who was the labor-saving genius who did it. Then the trees grew, and grew, and grew.

NOW, PLEASE, study the larger photograph and see in detail how the fence looks today. Note the size of the tree, and how deeply are embedded the ends of those old Cypress rails—no one can tell how deep they extend in. Note, also, how weathered they are, yet they ring as true and sound under a hammer as though just hewn. Were those old Cypress boards somebody's money's worth? Why should not YOU do as well with your lumber money—whether you are building a beautiful home or just patching up the old place? (USE CYPRESS.)



**"THE PROOF OF
THE FENCING IS
IN THE LASTING."**

"Build of Cypress Lumber and You Build but Once."

SOUTHERN CYPRESS MANUFACTURERS' ASSOCIATION

1219 Poydras Building, New Orleans, La., or 1219 Graham Bldg., Jacksonville, Fla.

INSIST ON TRADE-MARKED CYPRESS AT YOUR LOCAL LUMBER DEALER'S. IF HE HASN'T IT, LET US KNOW.

World's Oldest Living thing - 534
Household Reminders 595

Popular Mechanics Magazine

200 E. Ontario Street, Chicago, U. S. A.

Color Music H. H. WINDSOR, Editor

London: Hachette & Cie., 595
16-17 King William Street, Charing Cross, W. C. 2

Paris: Hachette & Cie.,
111 Rue Reaumur

Melbourne, Australia
The Australasian News Co.

holding hanger for clothes 595

ISSUED MONTHLY SUBSCRIPTION: SINGLE COPY, 25 CENTS

In United States and its possessions, also Canada, Cuba, and Mexico, per year, postpaid . . . \$3.00

To all other countries in the Postal Union 3.50

All subscriptions are discontinued at expiration. Please examine the date printed on your wrapper.

Entered as Second Class Matter Sept. 15, 1908, at the Post Office at Chicago, Illinois, under Act of March 3rd, 1879.

Entered as Second Class Matter at the Post Office Department, Canada.

Published monthly by POPULAR MECHANICS CO.

Copyright, 1923, by H. H. Windsor. Copyright in Australia

Talking through sea with wireless phone 533

Vol. 40 Contents for October, 1923 No. 4

<i>non-sinkable Bathing Suit</i> 595	Counter, Egg, on Hen's Back 515
Aerial Torpedo Called "Bloodhound of Sky" 503	Cover for Pipe Keeps Pocket Clean 509
Air Jacket Aids Swimmers 503	Cross Made with Pins Instead of Jewels 538
Airplane, Foot Propelled, Flies Seven Yards 586	Cup, Pocket, Folds in Tube Size of Fountain Pen 495
Airplane, Rolling Dice by, Latest of Sports 507	Currency, U. S., Displaces Panama Money 606
Airplanes Run by Music Roll 525	Deer, Wild, Friends of Exile 585
America, Discovery of, Cost Seven Thousand Dollars 495	Depots on Wheels Moved by Locomotive 494
Animal, Flying, Fur Bearing, Reported Found 521	Derrick, Portable, Has Many Uses 612
Animals, Wild, Scarcity Sends Price Up 565	Diamonds Made from Sugar 553
Automobile Engine, Air Scrubber Bars Dust from 498	Drivers, Warning to Careless 599
Automobile for Every Nine Persons 586	Drug Cult Dying Out in Far West 534
Automobile Gas Tank Cover cannot be Lost 561	Ducks, Five Hundred, Killed by One Shot 526
Automobile, "Gat" Shoots Oil under Pressure into 507	"Dummy Boy" Keeps Railway Clear 588
Automobile Ground between Street Cars 519	Dye Industry Shatters Growth Records 599
Automobile, Like a Tank, Wins Foreign Meet 511	Dynamo, Submersible, Used in Water 614
Baby Crib for Travelers 525	Earth's Age "Set" at Two or Three Billion Years 495
Baby Crib in Window Gives Air and Light 509	Egg Holder, Saves Finger Burns 563
Ball, Flower Fairies Appear at 519	Egg Slicer Cuts Egg into Nine Pieces 593
Balloons Chart Air for Weather Forecasts 535	Electricity Aids in War against Boll Weevil 538
Balloons Spray Poison on Moth Pests 507	Empires, Ancient, Overthrown by Iron Age 554
Banditry and Mechanics Conspired, by Sidney Mc- Neill Sutherland 508	Engine, Giant Fire, Feeds Many Lines 594
Barrel, Rolling in Frame, Helps Keep Fit 515	Engines Run on Sugar Alcohol in Hawaii 586
Bathtub, Safety, for Baby 569	Eye's Sensitiveness to Light, Electric Cell Rivals 582
Bed, Folding, Projects from Window 588	Eye Shades Snap on Glasses to Mellow Light 570
Bees, Diseased, Mails Bar 525	Fan, Folding Ceiling, Is Part of Light Fixture 514
Bees Not So Busy Despite Poems About 498	Farm, City Lot, Pays \$2,500 Profit Yearly 524
Bees Sting Lizard to Death 504	Feeder Reduces Danger to Hands 598
Beetle Illuminates Room 594	Finger Moistener in Palm of Hand 565
Bells of Chimes are Tuned by Cutting in a Lathe 492	Fire Drives Thrills Crowds 521
Berth Provided for Poorest Traveler in Japan 562	Fishes Swim in Glass Tubes Joining Bowls 581
Bible, Ancient, Dug Up from Egyptian Tomb 563	Flame, Hottest Known, to Aid in Study of Planets 585
Boat, Model Power, Speeds Seventy Miles an Hour 514	Flour Sifter Run by Thumb on Handle 610
Boat Travels on Water or Land 505	"Foot Cuffs" Keep Horse Tethered 602
Boiler Cleaner Does Ten Tubes a Minute 514	Forest, Petrified, Millions of Years Old 533
Boots Made of Shark Hide Used by Fishermen 515	Fountain of Eternal Life Described in Legends 601
Brides of Nile in Old Days Cost Four Dollars 505	Frame Protects Auto Radiators 601
Bug Sought in Orient to Kill Plant Beetle 574	Freezer, Crankless Ice Cream, Saves Labor 528
Cake Mixed by Motor 582	Fruits Kept Warm in Winter by Ice 521
Camera, Clamps Serve as Tripods 565	Gang Drill, Straight Line, Speeds Up Work 613
Camera "Shoots" toward Floor 509	Gas "Mined" from Air 524
Canal Makes Longest Way Cheapest 587	Gauge Warns of Weakening Girders 592
Cap, Bathing, Keeps Hair Dry 572	Geese, Thousands Killed for Hotel's Pillows 555
Card, Visiting, Passing Out 514	Gold, Billions in U. S. 599
Carrier Saves Space and Money 511	Golf Course, Indoors, Teaches Putting 599
Cars, Soviet Picture, Draw Peasants' Interest 522	Grasshoppers, Flame Thrower Fights 583
Carving of Wood a Dying Art 600	Hanger, Folding, Keeps Clothes in Order 595
Caverns in Old Fort Used for Storing Grain 553	Harpoons Ten Thousand Years Old, Found 595
Chain Carved from Match Stick 507	Helmets, Trench, Protect Workers in Mines 570
Chair, Folding, Saves Nursery Space 589	Horse, Vacuum Cleaner for 570
Chair, Iron, Used to Punish Tramps 552	Horses Increasing in Number 491
Chair Legs, Adjustable, Aid to Workers 557	Houses Made from Ant Hills in Africa 611
Chair, Vanishing, Folds under Table 582	Houses, Plate Glass, as Strong as Concrete 561
Chariot in Flames, Indian Legend of Meteorite 560	Hurdle Racing for Dogs 532
Cherry Tree Supported by Props 510	Husband, African, Does Cooking 507
Chicks, Hatcher for, Sprouts Oats 502	Ice and Wind Nature's Freight Train 569
Churches on Wheels 527	Ice Machine, Small Enough to Carry in Hands 540
City, Ancient, Fire Swent, Found in River Bed 594	Indians Cheaper than Trucks as Beasts of Burden 585
City, Bible, Fate of, Bared 590	Inventions, One Man's, Keep Million Busy 538
City, Buried in Desert, Yields Ancient Culture 532	Island of Iron Ore Target for Bombs 519
City of David's Secrets Dug Up 561	Island of Pearl Divers Ruled by White Woman 607
City Revived for Visit of King 600	Jewelry, Indian Gems Fads of Present Day 495
Clock Calendar Tells Date, Day, and Month 526	Jewels of Romance in Far Japan, by N. Sakata 496
Cooker, "Dead Air" Space in 550	Kitchen Run for Germs 533
Copper, Two Tons in Brewing Pan 610	Ladder, Fire, Serves as Battering Ram 493
Cotton Grafted to Tree 583	Lather, Shaving, Pressure on Bulb Spreads 555

[Continued on Page 4]

This One



T96N-AZ9-63ZW

Typewriter and Linotype

581

[Contents—Continued]

Cover 609 Pearl on Chere 49

[4]

Lid Holder Protects Hands from Steam..... 494
 Life, Fifteen Years Added to Span of, in Past Fifty..... 570
 Light Bracket Movable About Room..... 607
 Lights, Electric Christmas Tree, Clamp on Boughs..... 557
 Liquid, Odorless, Cloth Made Moth Proof with..... 555
 Locomotive Carried on Special Trucks..... 510
 Locusts Eaten by Islanders..... 602
 Lumberjack, Passing of, Recalls Drama of Woods..... 590
 Machine Measures Rotating Part's Balance..... 613
 Man as an Electric Machine..... 592
 Mankind, Progress of, Measured by Bells..... 597
 Matches Used for Money..... 583
 Measles, Serum for..... 574
 Menus, Turn of Dial Varies..... 572
 Million Loaves for One Fifteen Years Ago..... 488
 "Minister, Silent," Broadcasts Sermon on Streets..... 495
 Mirror, Red, Serves as Tail Light..... 575
 Money, Paper, Leaves Trail of Ruin in Europe..... 576
 Moss, Spanish, Used to Stuff Furniture..... 508
 Mount Everest, Conquest Sought with Oxygen..... 557
 Movie Film Shown by Toy without Use of Screen..... 585
 Mummies and Idols, Does a Curse Fall on Those Who Touch?..... 501
 Music, Making, with Chisel and Saw..... 609
 Music Traced through Ages..... 545
 Natural Power Runs Engines..... 598
 Nozzle for Dishwashing Has Soap Spray..... 526
 Nuts on Double Lock Bolt cannot Work Loose..... 527
 Oil Trucks, Safety Device for..... 533
 Oysters Attached to Gun Found on Beach..... 522
 Packer Output 18,000 per Day..... 612
 Palaces, Son of Heaven's, Fire Razes..... 575
 Pan, Frying, Has Grooves to Improve Cooking..... 521
 Papers Keep Pipe Bowl Clean..... 572
 Parrots, "School" Teaches Them to Talk..... 611
 Patent Given to the People..... 522
 Pear Pest, Prickley, Insect Parasites to Battle..... 562
 Pearls "Planted" in Oysters Detected by Light Rays..... 557
 Peculiar, Missouri, Got Its Name in a Peculiar Fashion..... 492
 Pen, Fountain, Has Turned-Up Point..... 560
 Pencil, Lead, Aids Autoist in Testing Spark Plug..... 505
 Pests, Rodent, Exhaust Gas Used to Kill..... 493
 Phonograph, Vest Pocket, Built Like Watch..... 586
 Photographs, Exposure Meter Dot Tells How to Time..... 498
 Photographs, Fifty Thousand a Day Work of Two Men..... 555
 Piano Tones Improved by New Microphone..... 557
 Pipe, Sir Walter Raleigh's, Shown in London..... 580
 Poison Arrow Used to Kill Bugs..... 534
 Poison Drives Away Evil Spirits..... 505
 Popular Mechanics Magazine Twenty Years Ago..... 558
 Prize Offers and Announcements..... 553
 Race, Lost, Trace on Islands of Pacific..... 489
 Rack Keeps Tools within Easy Reach..... 482
 Rake, Two Rows of Teeth on..... 506
 Radio, Aerials De Luxe, Placed in Ballroom..... 581
 Radio Empire to Link World..... 553
 Radio Noises Filtered Out..... 608
 Rain, More in Afternoon..... 611
 Railway, Electric, Peaks of Spain Conquered by..... 557
 Railway, Electric, Space Problem Solved by..... 594
 Range Finder, Vest Pocket, Aid to Photographers..... 561
 Ray to Neutralize Force of Gravity..... 609
 Ray to Overcome Gravity Sought in Secret..... 561
 Remedies, Old, Hundreds Found in Book..... 556
 Rice Planted to Dance Music..... 608
 Rites of Indians Recall Frontier Days..... 550
 River, Forty Mile, Dammed to Prevent Floods..... 582
 River, Isar, Dig New Bed for..... 488
 River Reverses Flow When Swelled by Rain..... 502
 Rock, Coral, Hardens When Used in Houses..... 538
 Rocker Made into Invalid Chair..... 600
 Roses Made from Gold in Natural Colors..... 574
 Saw, One-Man Adjustable, Weighs Six Pounds..... 534
 Science Notes for Daily Use..... 554
 Scorer for Card Game Avoids Mistakes..... 586
 Scraper, Electric, Cleans Scale and Rust from Ships..... 525
 Screwdriver Has Blades in Handle..... 587
 Searchlights/Equal Millions of Candles..... 539
 Ship—"Dolphin" Sold for Junk..... 581
 Ship Found on Iceberg Reveals Mystery..... 533
 Ship Model Whittled from Log with Jackknife..... 587
 Shipwreck—Three Weeks in Open Boats..... 574
 Shovel, Underground, Cuts Mining Costs..... 613
 Sifting Machine Is Economical..... 614
 Sky Scrapers, No Limit to Height of..... 573
 Smokestack Repaired with Iron Bands..... 608
 Speed, Science Answers Crv for..... 499
 Spirits, Evil, Cast Out by Blowing in Ear..... 505
 Spotlight with Side Ray for Night Driving..... 570
 Springs in Rubber Heels Aid Hikers..... 606
 Square Measures Angles for Woodworkers..... 612

Squirrels Aid in Reforesting Timberland..... 525
 Steel Road Scraper Has Long Life..... 614
 Stone Age, Shrine of Yields Many Relics..... 499
 Stove, Oil, Like Phonograph..... 576
 Strainer for Folding Jelly Bag..... 588
 Submarine, Secret of, Revealed by Camera..... 517
 Sugar More Expensive than Jewels..... 526
 Suit, Nonsinkable Bathing, Has Air Pockets..... 515
 Sun Rays a Cure for Ills..... 507
 Sun, Ten Degree Change in, would End All Life..... 506
 Tarpon, Camera Catches, in Battle for Life..... 563
 Telephone Numbers on Wheel..... 517
 Temperature, Coldest to Obtain Helium Gas..... 587
 Tennis Net, Holder for, Serves Many Purposes..... 572
 Test Shows Freaks of Climate..... 571
 Throttle, Step On to Open..... 532
 Tide Machine Does Work of Sixty Experts..... 604
 Tissue, Silky, Proof against Acid..... 493
 Tool Box, Keyless, Has Combination Lock..... 494
 Tractors, Caterpillar, in Peat Land..... 600
 Trap for Grasshoppers Hauled by Mule..... 593
 Tree, Christmas, Kept Fresh by Water in Holder..... 507
 Truth Sought by Drug..... 571
 Vacuum Cleaner, Six-Pound, Strapped to Shoulder..... 506
 Vacuum Clip for Window Display..... 593
 Vanity Case in Book Cover..... 522
 Veils Worn by Men..... 509
 Victims of Fire Slide to Safety..... 601
 Voices, Talking Library of, to Make Words Live..... 555
 Wasps Freed to War on Pests..... 599
 Water Cooled Icebox..... 604
 Wells, Oil, Saved by Steam Fire Extinguishers..... 517
 Wheat, Smutless, Increases Yield..... 498
 Wilds of Peru, Facing Death in the, by J. T. Edwards Jones..... 528
 Windmill, Sail First Hitched to, by Missionary..... 527
 Wireless Ray Controls Bombs..... 534
 Wireless Set in Hollow Log, Jungle Tribes Have..... 560
 Wolverines Make Final Stand..... 593
 Women Barred from Monastic Republic..... 595
 Women Inventors Busy on Industrial Problems..... 609
 Wood Turned to Milk and Butter..... 593
 World's Oldest Thing Saved by Highway..... 534
 Wrench, Speed, cannot Slip and Is Self Adjusting..... 505
 X-Ray Shows Reason for Poor Putting..... 605

Wagner Auditor

SHOP NOTES

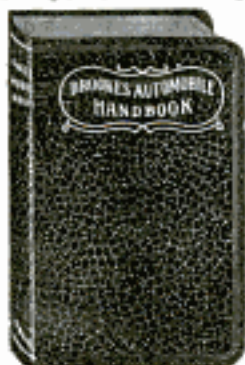
Automobile Axles, Assembly Stand for..... 628
 Automobile Clincher Rims, Damaged, Straightening..... 621
 Automobile Radiators, Cement and Cloth Repair for..... 620
 Automobile Rims, Removing Scrap Casings from..... 629
 Automobile Springs, Lubricating..... 628
 Automobile Top Repairs, Cement for..... 622
 Automobile Vacuum Tank, Method of Filling..... 621
 Band Saw, Heavy Duty, for Bench..... 627
 Celluloid, How to Mark..... 624
 Chimney Extension Cap of One Piece..... 626
 Copper, Coloring Brown and Black..... 631
 Crane, Floor, How to Build..... 622
 Cropping Blocks, Economizing on..... 634
 Door Knob Screws, Locking..... 629
 Drawings, Method of Protecting..... 628
 Electrical Test Leads, Convenient Arrangement for..... 624
 Fence Wire Straightener, Homemade..... 631
 Fence Wire Stretcher, Novel..... 616
 Ferrotyping Made Easy..... 621
 Fish Wire Puller, Handy..... 630
 Gauge, Hook, for Mechanics..... 618
 Glass Tubing, Method of Cutting..... 617
 Hen, Broody, How to Cure..... 618
 Holder, Simple, for Handling Light Work..... 629
 Instruction Manual, Novel Mounting for..... 617
 Instructions Cast on Machines..... 632
 Ladder Arrangement for Working on Building..... 625
 Lathe, Compound Rest, Setting for Tapers..... 620
 Lathe Test Piece..... 628
 Micrometer, Beam, How to Make..... 633
 Paste Spreader, Efficient Homemade..... 617
 Piping, Conductor, Painting Inside of..... 625
 Planing Tool, Side, Holder for..... 619
 Pulleys, Small "V," Increasing Diameter of..... 616
 Punch Press, Safety Gauge for..... 629
 Round Stock, Drilling Holes in..... 620
 Round Work, Tanning..... 630
 Rubber, Hard, Method of Turning..... 624
 Scaffold Lumber, Identifying..... 632
 Sheet Metal, Device for Carrying..... 626
 Silk, Testing..... 630
 Smokestack Made from Old Kitchen Boilers..... 632
 Steel, Hardened, Drilling..... 631
 Step-ladder Clamps, Simple and Useful..... 621
 Street Oil, Excess, Method of Absorbing..... 619
 Studs, Corner, for Frame Houses..... 624

DRAKE'S PRACTICAL MECHANICAL BOOKS

THEY WILL RAISE YOUR PAY—

ORDER ON 5-DAY TRIAL

The books listed below will perfect you in your chosen trade — pave the way to the big positions. Written in non-technical language—easy to read and understand. *Every book covers its subject completely. An entire course of instruction condensed into one volume.* Your choice sent postpaid — you benefit 5 days — money refunded in full if not entirely satisfactory. Order direct from this page.



Automobile Books

- Automobile Ignition, by ManlyLeatherette \$2.00
 Automobile Starting and Lighting, by Manly.....Leatherette \$2.00
 Brookes' Automobile Handbook.....Leatherette \$2.00
 Ford Motor Car, Truck and Tractor, by Manly.....Cloth \$1.50
 Starting and Lighting Troubles, Remedies and Repairs, by ManlyLeatherette \$2.00
 Automobile Battery, Care and Repair, by Manly.....Leatherette \$2.00
 Automobile Catechism and Repair Manual.....Leatherette \$1.50
 Tires and Vulcanizing, by TurfordCloth \$2.00
 Gas and Oil Engine Handbook.....Cloth \$1.50
 Automobile Upkeep and Care, by Manly.....Cloth \$1.50
 Motorcycle Handbook, by ManlyCloth \$1.50

Shop Practice Books

- Sheet Metal Workers' Manual.....Leatherette \$2.00
 Oxy-Acetylene Welding and CuttingCloth \$1.25
 Slide Rule and Logarithmic TablesLeatherette \$2.00
 Handbook for Millwrights.....Cloth \$2.00
 Modern Blacksmithing.....Cloth \$1.25
 Machine Shop Practice.....Cloth \$2.00

- Mechanical Drawing and Machine DesignCloth \$2.00
 Pattern Making.....Cloth \$1.50

Carpentry Books

- Cloth Binding
 Modern Carpentry, 2 vols.....\$3.00
 The Steel Square, 2 vols.....\$3.00
 Wooden Boat and Shipbuilding.....\$1.50
 Modern Estimator\$1.50
 Timber Framing\$2.00
 Builder's Architectural Drawing.....\$2.00
 Concrete\$1.50
 Practical Bungalows\$1.00
 Low Cost Homes.....\$1.00
 Roof Framing, by Van Gasbeck.....\$1.50
 Stair Building and Hand Railing\$1.50

Electrical Books

- Practical Applied Electricity.....\$2.00
 Alternating Current\$1.50
 Electric Motor Control Systems.....\$1.50
 Wiring Diagrams and Descriptions\$1.50
 Electrical Tables and Data.....\$1.50
 Armature and Magnet Winding.....\$1.50
 Modern Electrical Construction.....\$1.50
 Modern Electric Illumination.....\$1.50
 Electricians' Operating and Testing\$1.50
 Motion Picture Operation.....\$1.50
 Drake's Electrical Dictionary.....\$1.50
 Electric Motors, D. & A.....\$1.50
 Electrical Measurements and Meter Testing\$1.50
 Drake's Telephone Handbook.....\$1.50
 Easy Experiments.....Cloth \$1.25
 Wireless Telegraph and Telephone Handbook.....Cloth \$1.25
 Telegraphy Self-Taught...Cloth \$1.25

Steam Engineering

- Swingle's Handbook for Steam Engineers and Electricians.....Leatherette \$4.00
 Examination Questions and Answers for Marine and Stationary Engineers.....Leatherette \$2.00
 Steam Boilers.....Leatherette \$2.00
 Swingle's Catechism of Steam, Gas and Electrical EngineeringLeatherette \$1.50

Painting Books

- Scene Painting and Bulletin ArtCloth \$4.00
 A Show at Show Cards.....Cloth \$4.00
 Sign PaintingCloth \$4.00
 Strong's Book of Designs.....Leatherette \$4.00
 Strong's Art of Show Card WritingCloth \$4.00
 Signist's Alphabets.....Cloth \$1.50
 Modern Painter's Cyclopaedia.....Cloth \$2.00
 Automobile Painting.....Cloth \$1.50
 Estimates, Costs and Profits, Painting and Decorating.....Cloth \$1.50
 New Hardwood Finishing.....Cloth \$1.50
 The Amateur Artist.....Cloth \$1.50
 New StencilsCloth \$1.25
 Chalk Talk and Crayon PresentationCloth \$1.25

Farm Books

- Farm Mechanics.....Cloth \$1.25
 Farm Buildings.....Cloth \$1.25
 Farm Engines.....Cloth \$1.25
 Traction Farming.....Cloth \$1.50

Business and Reference Books

- Better Business Letters.....Cloth \$1.00
 Better Business English.....Cloth \$1.00
 Better Advertising.....Cloth \$1.00
 Finger Prints Simplified.....Cloth \$2.00
 Practical Bricklaying.....Cloth \$1.25
 Practical Instruction for DetectivesCloth \$1.00
 Practical PlumbingCloth \$1.50
 Hot Water Heating.....Cloth \$1.50
 Elementary Chemistry.....Cloth \$1.50
 Courses in Civil Service...Cloth \$1.50
 Cyclopaedia of Recipes.....Cloth \$1.50
 American Star Speaker...Cloth \$1.50

Modern Languages

- By Prof. P. S. Allen, U. of Chicago
 French without a Teacher.....Cloth \$1.25
 Spanish without a Teacher.....Cloth \$1.25
 German without a Teacher.....Cloth \$1.25
 Everyday French.....\$1.25
 Everyday Spanish.....\$1.25

ORDER DIRECT FROM THIS PAGE—ON OUR MONEY-BACK PLAN

The books listed above are only a few of the many in our catalogue, which you will receive promptly after filling out and mailing us the attached coupon. For quick action order direct from this page—cross name of each book wanted and send in with price quoted. We prepay postage and send the books on our money-back plan.

FREDERICK J. DRAKE & CO.

PUBLISHERS

1008 Michigan Ave., Chicago

Drake Books Are For Sale at All Book Stores

FREDERICK J. DRAKE & CO.
 1008 Michigan Avenue
 Chicago, Ill.

GENTLEMEN:—Please send me free, postage paid, your illustrated catalogue which lists and describes over 100 Practical Mechanical Books for Home Study.

My name is

and my address

Mail Coupon For Free Catalogue
 Your Guide to Home Study

St. Louis Man Discovers a New Kind of Heat!



B. M. OLIVER

Mr. B. M. Oliver of St. Louis has invented an amazing device which ends forever the days of woman's slavery to dirty, mussy coal and wood fires. It sets into the fire-box of any kind of heating stove, cook stove or furnace without changes and just turning a valve it gives any degree of heat from a tiny flame to a roaring inferno—

3 times the heat of coal if it is needed.

Mr. Oliver calls his invention the Oliver Oil-Gas Burner because it makes its own gas from 95% air and 5% coal oil (kerosene) the cheapest fuel there is. The wonderful story of a woman's freedom from building fires, carrying heavy scuttles, emptying ashes has spread so rapidly that already over 150,000 burners are being used by American housewives. Mr. Oliver wants every woman to have the use of his invention. If you will write to him at 2048-V Oliver Bldg., St. Louis, Mo., you will receive an attractive booklet FREE that tells all about it. Mr. Oliver is now making a Special Low Price Offer. He is also looking for good, live distributors and will tell you how to earn \$500 a month in full or spare time if you are interested and request his sales plans.

Electrical Course

In
Book
Form

Here is the quickest, easiest, cheapest way to learn electricity. Think of it! A complete electrical course in book form. No tiresome lessons with a lot of mathematics. Just plain everyday electrical facts—the very things and the only things you need know to hold down a good paying job. Written and simplified by 27 of the biggest men in the electrical field. 8 big books—4100 pages and 5330 pictures.

Electricity Means Success

—Good Pay and a Good Job. You can succeed in electricity. It's one of the best paying fields open to young men who know.

You do not have to give up your present position, just a few pleasant hours spent in the evenings on this subject, and success is yours.

FREE TRIAL!

Just mail the coupon—don't send a cent. We send books for a week's free use. Look them over yourself, and see how thoroughly and completely everything about electricity is explained in them.

American Technical Society
58th St. & Drexel Ave. Dept. E-719

American Technical Society, Dept. E-719 Chicago

Send me your 8-volume set of Electrical Books for a week's free use. I will either return the books in 7 days or remit \$2.00 and pay you \$1.00 each month until a total of \$29.50 is paid.

Name.....

Address.....

Employed by.....

Copy this coupon on larger sheet if more convenient

Please Mention Popular Mechanics

[Contents—Continued from Page 4]

Universal Chuck, Adjustable.....	625
Upholsterers, Auto, Stuffing Tool for.....	632
Walls, Concrete Retaining, How to Build.....	615
Wire Gauge Attachment for Plates.....	634
Wristpins, Lubricating.....	619

AMATEUR MECHANICS

Ash Tray, Appropriate Camp.....	645
Automobile Engine, Method of Replacing.....	652
Automobile Gas Tank Cap, Emergency.....	640
Automobile Headlights, Emergency.....	646
Automobile Leaf Spreader, Simple Homemade.....	636
Automobile Rim Spreader for Changing Tires.....	649
Automobile Side and Tail Lamps, Homemade.....	645
Automobile Steering Wheel, Upholstery Nails Improve.....	647
Baseball Batting Practice Device.....	649
Blowtorch for Cooking.....	647
Boat, Fishing, Improvements for.....	636
Boat Oars, Hanger for.....	649
Book Ends, Inexpensive.....	637
Burglar Alarm, Simple and Effective.....	647
Camera, Color Screen for.....	640
Camera Tripod Substitute for Time Exposures.....	637
Cow's Tail "Anchored" While Milking.....	638
Crutch, Seat on, for Cripples.....	650
Droplight Shade Adjuster, Simple.....	652
Fishing Device for Center of Swift River.....	646
Glue Pot Heater, Cheap Homemade.....	645
Golf Course Sand Stand, Portable.....	651
Grass Bag, Skirt Used as.....	646
Heater, Gas, Used as Stove.....	639
Hedge Trimmer, Electrically Driven.....	635
Hens, Nonproductive, Segregating.....	645
Inner Tube Holder Makes Repairing Easy.....	650
Jack Used as Rim Tool.....	639
Lock, Door, Made Jimmy Proof.....	650
Post Puller, Ratchet.....	652
Poultry Feeder and Rat Trap.....	639
"Poultry Pastures" for Back Yard.....	648
Radio Dials, Homemade.....	650
Radio Spider Web Coil, Novel Mounting for.....	638
Rubber Remover, Simple.....	640
Salvaging Device, Handy, for Submerged Objects.....	648
Tape, Gummed, Preventing from Unrolling.....	652
Teakettle Attachment Warns of Boiling.....	638
Theater Sign Lamps, Saving.....	639
Tile, Cement, Ornamenting.....	638
Tire Repairs in the Home Garage.....	641
Wagon, Small, Reconstructing.....	651
Washub Stand, Handy.....	640
Wrench, Extension for.....	652

LEARN WATCHMAKING AND ENGRAVING



Earn while learning. Most practical watch school. Individual instructions. Graduates in great demand. Book free. Chicago School of Watchmaking, Dept. 20, 6540 Lincoln Ave., Chicago

TRI-STATE COLLEGE OF ENGINEERING

Makes you a Civil, Mechanical, Electrical or Chemical Engineer in two years, 48 weeks each. No entrance examinations. High School Diploma not required. Compact courses made up of essentials only. Expenses low. FOR CATALOG ADDRESS 100 M. Street, Angola, Indiana

What Shall I Be?

YOU CANNOT ATTAIN REAL SUCCESS and happiness unless you are in the right occupation. Expert Vocational Guidance, of the right kind, now available to everybody by mail. Write for free information today.

BUREAU OF VOCATIONAL RESEARCH, 296 Broadway, Department 13, NEW YORK CITY

BLANK CARTRIDGE PISTOL

Protection
Against
Burglars,
Tramps,
and Dogs



PRICES
50c
\$1.00

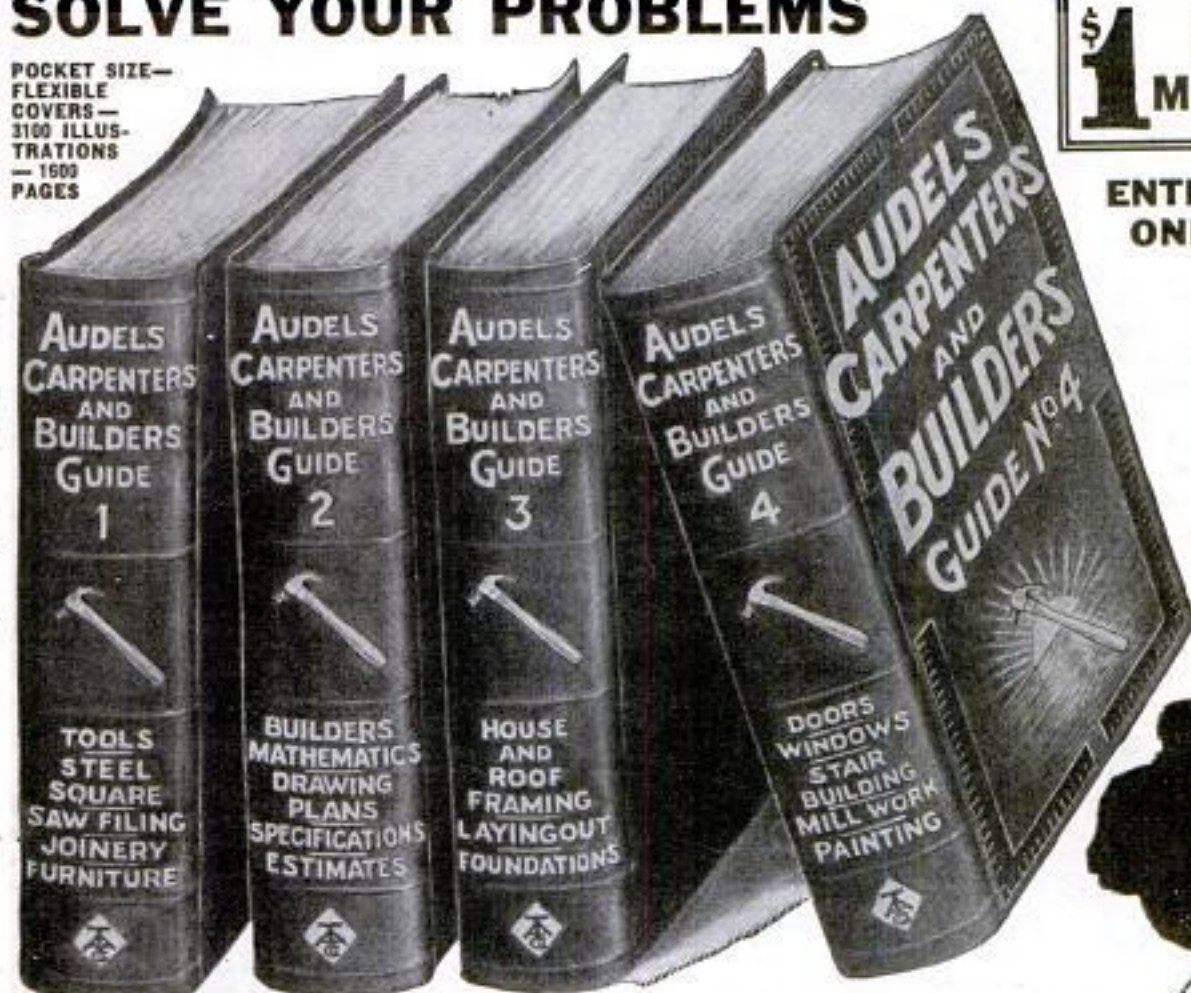
Post-paid

Well made and effective; modelled on latest type of Revolver; appearance alone is enough to scare a burglar. When loaded it may be as effective as a real revolver without danger to life. It takes standard .22 Cal. Blank Cartridges obtainable everywhere. Price 50c. Superior quality \$1.00 postpaid. Blank Cartridges, by express, 50c per 100. Johnson Smith & Co., 1218 Washington Ave., Dept. 951, Racine, Wis.

CARPENTERS

LET THIS NEW AUDEL SET SOLVE YOUR PROBLEMS

POCKET SIZE—
FLEXIBLE
COVERS—
3100 ILLUSTRATIONS
— 1600
PAGES



\$1 PER MONTH

ENTIRE SET ONLY \$6

JUST OUT!

Audel's Newest Set, Concise and up-to-date FOUR Handy Volumes

QUESTIONS AND ANSWERS—CLEAR ILLUSTRATIONS—SHORT CUTS THAT MAKE YOU A BETTER WORKMAN AND INCREASE YOUR PAY

Just available—Audel's Carpenters and Builders Guides—the short cut, professional information you want. A Guide that keeps you in close touch with your work and shows you how you may increase your earning power. No need to guess or take chances. Every day you have before you in this set, exact, practical, useful information to help you with your daily work.

HOW To Handle the Job That Puzzles YOU

There are thousands of examples of modern construction and building work—new methods, new ideas, proved efficiency plans, short cuts, time saving suggestions, new ways that cover the entire theory, and practice of modern carpentry. Every point is easy to read and understand and clearly illustrated with sketches and forms. Inside Trade Informa-

tion for Carpenters, Builders, Joiners, Building Mechanics and all Woodworkers on—Care and Use of Tools—How to Use the Steel Square—File Saws—Make All Kinds of Joints—Draw and Read Plans—Write Specifications—Make Estimates—How to Frame Roofs and Houses—Lay Out Work—Put in Foundations—Full Instruction on In and Outside Building Work—Stair Building—Saw Mill Work—Practical Painting—Thousands of Short-Cuts that save time and money—Information usually obtained only by hard experience.

NO MONEY!
MERELY SEND COUPON AND LOOK THE SET OVER AT AUDEL'S RISK

FREE EXAMINATION
Not a cent to pay until you see the books. No obligation to buy unless you are satisfied. Fill in coupon in pencil. Send now—today—get this great help library for carpenters and builders.

TEAR OFF COUPON ALONG THIS LINE

THEO. AUDEL & CO., 72 5th Avenue, NEW YORK CITY

Send me for free examination AUDEL'S CARPENTERS AND BUILDERS GUIDES 4 numbers. If satisfactory I will send you \$1 within 5 days and mail \$1 monthly until \$6 is paid.

Name.....
Address.....
Occupation.....
Employed by.....
Reference.....
P. M. Oct. '23

Guaranteed for Life

FREE 10-Piece Kitchen Set
White Enamelled

Wonderful 32-Piece Aluminum Set consists of 2 Bread Pans; Doughnut Cutter; 2 Loose Bottom Jelly Cake Pans; Combination Tea-Kettle and Rice Boiler with lid; Saucepan Set with lid; Dipper; Colander; Measuring Cup; Percolator; 2 Pie Pans; Complete Castor Set; Tea or Coffee Strainer; Fry Pan; also cooker set of 5 pieces—makes 11 utensil combinations; Preserving Kettle; Convex Kettle; Combination Cooker; Casserole; Poaching Pan; Tubed Cake Pan; Colander; Roaster; Corn Pepper; Steamer Set; Double Boiler.

No Money Down!

Just mail the coupon and we send this 32-Piece Aluminum Cooking Set, and the 10-Piece Kitchen Set Free. When the goods arrive, pay only \$2.00 and small postage charges on the Aluminum Set. Nothing for the Kitchen Set—it is FREE. Use both sets 30 days on Free Trial and if not satisfied send them back and we will refund your money and pay transportation both ways. If you keep them, pay for Aluminum Set, only a little every month.

FREE 10-Piece Kitchen Set
Not a penny to pay for this set. You get it absolutely free with Aluminum Set.
Potato Masher
Mixing Spoon
Measuring Spoon
Ice Pick
Egg and Cream Beater
Can Opener
Vegetable & Pan Brush
Fork
Egg and Cake Turner
Wall Rack
All have white enameled handles and hang on wall rack—keeping them conveniently at hand.

Complete 32-Piece Aluminum Set and FREE Kitchen Set

Hartman's special, selected set of heavy gauge Aluminum Ware—a complete cooking outfit, light to handle, easy to clean, always bright as silver. Will never chip, crack or rust. We guarantee it for life. 32 utensils—everything for baking, boiling, roasting, frying. And—absolutely free—a Combination Kitchen Set, 10 utensils with pretty white handles.

Nearly a Year to Pay

You pay only \$2.00 and postage on arrival (on the Aluminum Set—not a penny to pay at any time on the Kitchen Set). The balance a little every month.

Order by No. 417EEM7. Price for Aluminum Set, \$18.95. No money down. \$2 and postage on arrival. Balance \$2 monthly. 10-Pc. Kitchen Set is Free.

HARTMAN Furniture & Carpet Co.
Dept. 5672 CHICAGO, ILLINOIS

Copyright, 1925, by Hartman's, Chicago

FREE BARGAIN CATALOG and FREE GIFTS

This great 316-page book offers the world's greatest bargains in home furnishings, jewelry and farm machinery—all sold on easy monthly payment terms and 30 days' free trial on everything.

316-Page Book FREE

Wonderful Gifts

Catalog explains how you can get Glassware, Silverware, Tablecloths, Napkins, etc., free with purchases. Send for it today. "Let Hartman Feather YOUR Nest!"



HARTMAN FURNITURE & CARPET CO.

Dept. 5672 Chicago, Ill.
Send the 32-Piece Aluminum Cooking Set No. 417EEM7, Price \$18.95, and 10-Piece Kitchen Set. Will pay \$2 and postage on the Aluminum Set on arrival. Kitchen Set is FREE. I am to have 30 days' free trial. If not satisfied, I will ship both sets back. If I keep them, I will pay you \$2 monthly until the price of the Aluminum Set, \$18.95, is paid. Title remains with you until final payment is made.

Name.....
Occupation.....
R. F. D., Box No.
or Street and No.....
Post Office..... State.....
(If shipping point is different from your post office, fill in line below.)
Send shipment to.....

How "Modest Jim" Won the \$50 Prize

By WILLIAM LAWRENCE

Author of "The Awakening"

"YES—I remember why they call the Big Boss 'Modest Jim,'" said the Old Timer. "It started way back twenty years ago.

"I was in my third apprentice year when Jim Hadley came to work here—a quiet, bashful boy. His father had died and he was forced to leave grammar school and go to work.

"He was never among the groups of boys dodging the boss or watching the clock nor mixed up in anything that wasn't strictly business. And he never fooled away his time with the bunch after hours, so we left him pretty much to himself. We called him 'Modest Jim.'

"One day Old Man Adams, who owned this outfit in those days, came out into the shop and tacked up a sign over the foreman's desk.

"It seemed that the Old Man and his designer had run into a stone wall or what was Greek to most of us kids those days, and was offering a prize of fifty dollars to anyone who solved the problem. He must have been up against it or he never would have asked our bunch for help.

"About two weeks later, after the rest of us had forgotten all about it, the Old Man rushed out to Jim and fairly pushed five crisp ten dollar bills into his hand. He had solved the problem.

"When the foreman asked him how he did it, he replied, 'Oh, it wasn't anything great. Only a fresh brain on a stale subject.' That's all he ever said about it. But do you know what that boy had been doing? He'd been studying with the International Correspondence Schools in his spare time. No wonder he got ahead!

"And he went right up, and up and up, until today he is the Big Boss. And the rest of us are just about where we started. He's still 'Modest Jim,' but he's earning five times as much as I am.

"Take my advice, lad, and follow along in Jim's footsteps. Don't wait until it's too late to get the special training that is so essential to success."

Employers everywhere are looking for men like "Modest Jim"—men who want to get ahead—who are willing to devote a part of their spare time to training for advancement.

How much longer are you going to wait before taking the step that is bound to bring you a better job and more money?



Isn't it better to make your start now than to wait a year or five years and then wish you had? It certainly is!

No matter where you live, the I. C. S. will come to you. No matter what your handicaps or how small your means, we have a plan to meet your circumstances. No matter how limited your previous education, the simply-written, wonderfully-illustrated I. C. S. lessons make it easy to learn. No matter what career you may choose, some one of the 300 I. C. S. courses will surely suit your needs.

This is all we ask: Without cost, without obligating yourself in any way, put it up to us to prove how we can help you. Just mark and mail this coupon.

----- TEAR OUT HERE -----
INTERNATIONAL CORRESPONDENCE SCHOOLS
 Box 5547-D Scranton, Penna.

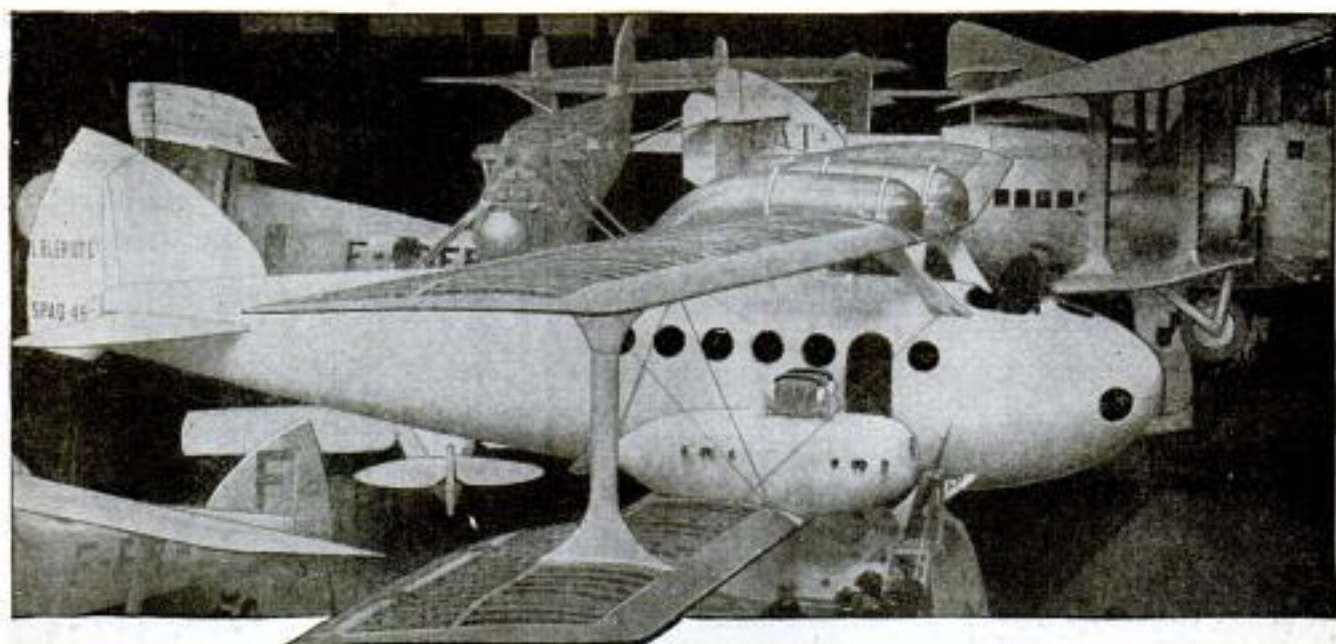
Without cost or obligation, please tell me how I can qualify for the position or in the subject before which I have marked an X:

- | | |
|---|--|
| BUSINESS TRAINING COURSES | |
| <input type="checkbox"/> Business Management | <input type="checkbox"/> Salesmanship |
| <input type="checkbox"/> Industrial Management | <input type="checkbox"/> Advertising |
| <input type="checkbox"/> Personnel Organization | <input type="checkbox"/> Better Letters |
| <input type="checkbox"/> Traffic Management | <input type="checkbox"/> Foreign Trade |
| <input type="checkbox"/> Business Law | <input type="checkbox"/> Stenography and Typing |
| <input type="checkbox"/> Banking and Banking Law | <input type="checkbox"/> Business English |
| <input type="checkbox"/> Accountancy (Including C.P.A.) | <input type="checkbox"/> Civil Service |
| <input type="checkbox"/> Nicholson Cost Accounting | <input type="checkbox"/> Railway Mail Clerk |
| <input type="checkbox"/> Bookkeeping | <input type="checkbox"/> Common School Subjects |
| <input type="checkbox"/> Private Secretary | <input type="checkbox"/> High School Subjects |
| <input type="checkbox"/> Business Spanish <input type="checkbox"/> French | <input type="checkbox"/> Illustrating <input type="checkbox"/> Cartoning |
| TECHNICAL AND INDUSTRIAL COURSES | |
| <input type="checkbox"/> Electrical Engineering | <input type="checkbox"/> Architect |
| <input type="checkbox"/> Electric Lighting | <input type="checkbox"/> Blue Print Reading |
| <input type="checkbox"/> Mechanical Engineer | <input type="checkbox"/> Contractor and Builder |
| <input type="checkbox"/> Mechanical Draftsman | <input type="checkbox"/> Architectural Draftsman |
| <input type="checkbox"/> Machine Shop Practice | <input type="checkbox"/> Concrete Builder |
| <input type="checkbox"/> Railroad Positions | <input type="checkbox"/> Structural Engineer |
| <input type="checkbox"/> Gas Engine Operating | <input type="checkbox"/> Plumbing and Heating |
| <input type="checkbox"/> Civil Engineer | <input type="checkbox"/> Chemistry <input type="checkbox"/> Pharmacy |
| <input type="checkbox"/> Surveying and Mapping | <input type="checkbox"/> Automobile Work |
| <input type="checkbox"/> Metallurgy <input type="checkbox"/> Mining | <input type="checkbox"/> Navigation |
| <input type="checkbox"/> Steam Engineering | <input type="checkbox"/> Agriculture and Poultry |
| <input type="checkbox"/> Radio <input type="checkbox"/> Airplane Engines | <input type="checkbox"/> Mathematics |

Name.....
 Street.....
 Address..... 3-27-23

City..... State.....

Occupation.....
 Persons residing in Canada should send this coupon to the International Correspondence Schools Canadian, Limited, Montreal, Canada.



Quick Success in Aviation Fascinating—Daring—Big Paying

To young men of daring, no other field of work offers such a fascination, such high pay, nor such opportunities for quick success as the field of Aviation. As yet, aviation is practically in its infancy. NOW is the time to get in.

Amazing Opportunities in Airplane Industries

In the automobile industry and in the moving picture business hundreds of men got rich by getting in at the start. They made their success before others woke up. Today, these lines offer no greater opportunities than a hundred and one others. BUT AVIATION IS NEW. Get in while the opportunity and pay are big. All over the country there is a clamor for trained men. It is not a question of pay but of getting capable men.

**HERE ARE REAL
POSITIONS, \$50 TO
\$150 PER WEEK**



View in an Airplane Factory

Aeronautical Instructor, Aeronautical Engineer, Aeronautical Contractor, Airplane Repairman, Airplane Mechanic, Airplane Inspector, Airplane Salesman, Airplane Assembler, Airplane Builder.

AMERICAN SCHOOL OF AVIATION
3601 Michigan Ave., Dept. 1197, Chicago, Ill.

Without any obligation, send me your Free Book, "Opportunities in the Airplane Industry," also information about your Course in Practical Aeronautics.

Name.....

Street.....

City..... State.....

A Sure and Easy Way to Learn Aviation—at Home



A New Job—The Aerial Postman

The study of aviation is almost as fascinating as the actual work. Every lesson is full of interest. That is why it is easy to learn aviation. You do not have to make yourself study—it is like reading an interesting book that tells you things you have always wanted to know. Only one hour each evening will give you the basic training in a surprisingly short time. You need only a common school education.

One of my students, James Powers, Pa., says, "I am indeed surprised that such a valuable Course can be had from such practical men for so little cost."



A New Seven-Passenger Airplane

Personal Instruction by Experienced Men

Men who have had actual experience give you personal attention. They select the lessons, lectures, blueprints and bulletins. They tell you things that are essential in everyday practice. Each lesson is easy to read and understand.

Big Book of Opportunities FREE

Send coupon at left for New Book, just out, "Opportunities in the Airplane Industry." It is interesting and instructive. It will show you many things you never knew before about aviation. Due to shortage of paper we could get only a limited supply of these books—send the coupon before they are all gone.

AMERICAN SCHOOL OF AVIATION
3601 Michigan Ave., Dept. 1197 Chicago, Ill.

Look Here!

Are you ambitious—are you looking for the way to Success?
Do you want an easy, pleasant job?
Do you want to make from \$60 to \$100 a week?
Do you want to enjoy the luxuries of life?

**Then Read
My Offer!**



FREE!

This Expert Draftsman's Complete Outfit gives you practical training. Includes complete set of fine "professional" drawing instruments with double set of compasses and dividers in velvet lined case, drawing board, T square, triangles, pens, ink, all accessories. This superb complete outfit given free to every Coyne student. Coupon brings details of this great free offer.

My 2 Free Books bring your Big Opportunity!

Find out all about this wonderful system, the most complete Drafting Instruction ever offered for home-study. Grasp this great money-making opportunity now! To supply enormous demand for Cooke-trained draftsmen, I am offering special inducements to ambitious men everywhere. Coupon brings 2 free books, free draftsman's pocket rule and complete information. Mail it to Me Today!

B. W. COOKE, President

COYNE SCHOOL OF DRAFTING

COYNE
SCHOOL OF DRAFTING

Dept. 702 552-598 So. Throop Street CHICAGO

I Guarantee to train you right at home for the position of Expert Draftsman. Every factory, big or little—every railroad, automotive plant, shipyards, the U. S., State, County and City governments, Army and Navy, everywhere you turn Draftsmen are in demand at \$150 to \$400 a month. Take advantage of this money-making opportunity. *I positively guarantee to train you for the position of Expert Draftsman until you are earning at least*

\$250 a Month!



YOU CAN BE THIS MAN!

The Expert Draftsman is the key-man of Industry. Executives depend on him. Not a wheel can turn without him. Naturally, he is high-priced! Look at the picture! You'd almost rather be the draftsman than the boss! YOU—no matter what your job today, no matter how limited your schooling—can REMAKE yourself by learning Drafting the new way—by the "Job-Method" of home instruction. You "learn by doing" and train quick for the big pay job. I have done it for hundreds. I can do it for you.

Radio Course FREE!

For a limited time only!
Enables you to build and operate any Radio Outfit.
Coupon brings my free offer!



COYNE SCHOOL OF DRAFTING

B. W. COOKE, President

Home Study Dept. 702, 552 to 598 So. Throop St., Chicago, Ill.

Without obligating me in any way, please send me your two books, "Drafting, the Foundation of Industry" and "Learn Drafting by the Job-Method"—all absolutely free. Also complete information of your rapid home-study Drafting course, free instruments and other features.

Name.....
St. No.....
City.....State.....

LEARN Modern Barbering NEW EASY WAY Earn \$50 to \$150 EACH WEEK



NO matter what you are now doing, no matter how much you earn, our amazing new system of training for the barbering profession enables you to step into this clean, pleasant, profitable business in a few short weeks. Start right in earning \$50 to \$150 a week.

J. E. McGregor, of New Orleans, writes: "I have never been out of a job since you sent me to the one from the Post Graduate department a year ago. I have saved up a nice bank account. I am glad I learned Modern Barbering with you."

F. Erbat, of Chicago, writes: "I own my own home! I have my own automobile! I am independent! Have made it all since graduating from your school five years ago."

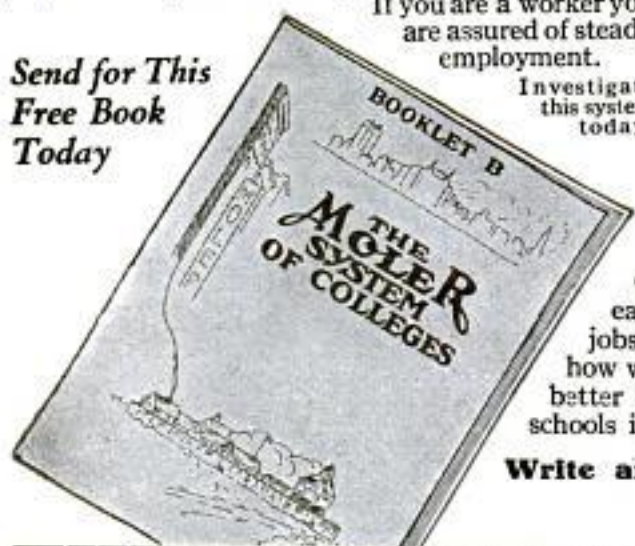
What Moler System Means to You

Our national advertising educates the public to the safety, comfort and economy of Moler post graduate work. It makes you the sought-after barber in your locality. It keeps your chairs filled and turns profits into your pocket. You as graduate are a part of a national institution which assures steady, profitable business. Through no other method can you get this.

We Equip Your Shop on Easy Terms

If you own your own shop your success is assured. If you are a worker you are assured of steady employment.

Send for This
Free Book
Today



Investigate
this system
today.

We Train You to Be An Expert IN A FEW WEEKS

You want to get ahead—you want to make more money—big money. Our short, practical course gives you a complete training in modern barbering, including the electric hair cutter, the mechanical massage and scientific treatments. It also affords a study, if one desires, on hair and skin—it makes you an expert and expert barbers are always in demand.

Easy Work Always Busy BIG PAY

A trade that enables you to travel and see the world—one that pays in tips and commissions in addition to salaries. Moler System graduates are in great demand and have no trouble in securing good jobs.

Write for Free Book

Our catalog that we mail free tells how we enable you to earn while learning, how we put you into the best city jobs, how we equip your shop on easy payments. In fact, how we take you just as you are, make your life's work easier, better paying and more independent. We have 33 branch schools in leading cities. We have one near you.

Write anyone of the following addresses for our booklet B. Do it today.

The Moler System of Colleges

157 Third Ave. New York, N. Y.	1045 Cass Ave. Detroit, Mich.	80 N. 2nd St. Memphis, Tenn.
105 S. Wells St. Chicago, Ill.	1229 17th St. Denver, Colo.	910 Main St. Dallas, Texas
810 N. 6th St. St. Louis, Mo.	110 S. 14th St. Omaha, Nebr.	712 Franklin Ave. Houston, Texas
544 Main St. Kansas City, Mo.	513 E. Water St. Milwaukee, Wis.	727 W. Commerce St., San Antonio, Texas
206 E. 4th St. Cincinnati, Ohio	1005 Canal St. New Orleans, La.	198 Queen St., E. Toronto, Ont., Can.
215 Huron Rd. Cleveland, Ohio	23 N. Forsyth St. Atlanta, Ga.	

MOLER SYSTEM OF COLLEGES

Address Nearest Branch →

Please send me without obligation on my part your Booklet B.

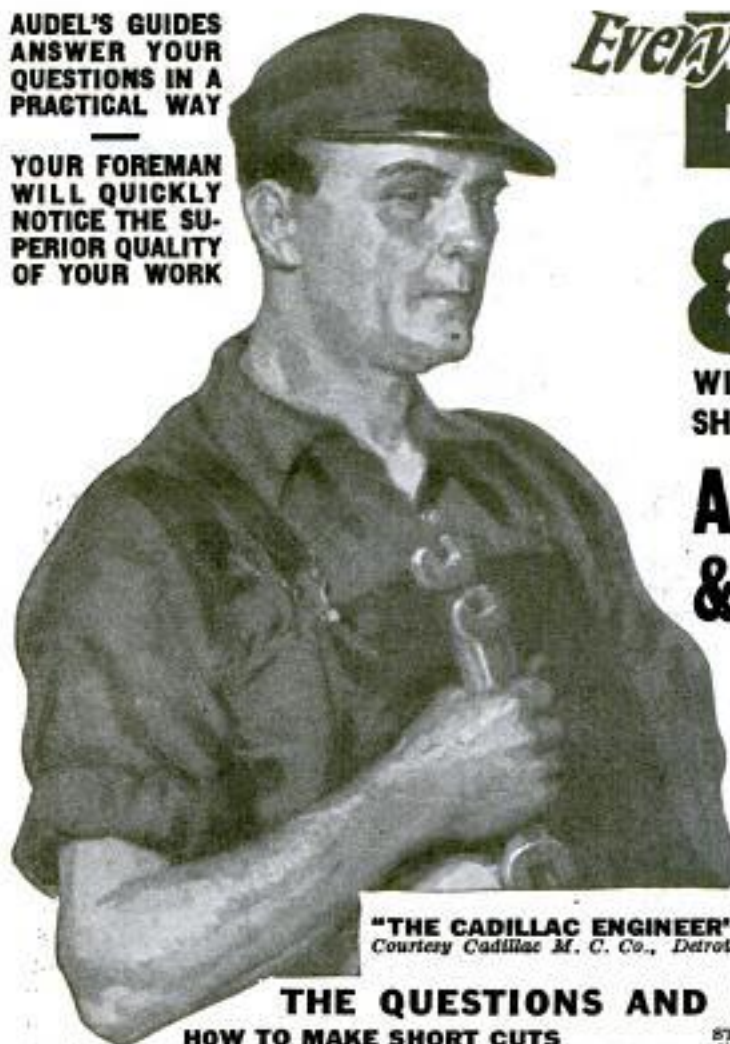
Name.....

Address.....

City.....State.....

AUDEL'S GUIDES ANSWER YOUR QUESTIONS IN A PRACTICAL WAY

YOUR FOREMAN WILL QUICKLY NOTICE THE SUPERIOR QUALITY OF YOUR WORK



"THE CADILLAC ENGINEER"
Courtesy Cadillac M. C. Co., Detroit

Every ENGINEER & MECHANIC

WILL FIND PRACTICAL INFORMATION ON SHORT CUTS AND MODERN METHODS IN

AUDEL'S ENGINEERS & MECHANICS GUIDES

Every Engineer, Mechanic and Electrical Worker will welcome this new master set. It will answer your problems.

It will help you with your daily work.—A sure source of advancement and higher pay. Complete up-to-date information that is thoroughly and easily explained on every branch of modern engineering and electrical practice. **The entire set costs you only twelve dollars—knowledge and instruction that has cost thousands of dollars and years of time—yours for \$12.00—\$1.00 a month.**

THE QUESTIONS AND ANSWERS TEACH YOU QUICKLY

HOW TO MAKE SHORT CUTS

HOW TO HANDLE THE JOB THAT PUZZLES YOU

Study This Brief Table of Contents: Theory, Practice and Operation of ALL Steam Engines, Valve Motions—VALVE SETTING: complete information on ALL engines and pumps—CORLISS ENGINES and the Theory, Construction and Operation of all Steam Engines, including UNIFLOW and POPPET VALVE ENGINES, and LOCOMOBILES—Locomotive Marine Engines Turbines: Rotary Engines—the Indicator—Lubrication—PRACTICAL MANAGEMENT: How to use Indicator—GAS, GASOLINE, OIL, SEMI- and FULL DIESEL ENGINES—Aeroplanes and Aviation—HOW TO SELECT AN ENGINE, working instructions, drawings on

STEAM ENGINE DESIGN, including rules and formulae, Theory and Construction of ALL Steam Boilers; Heat-Combustion; Fuel and Flue Gas Analysis—COI records—Characteristics of Boilers—Materials—Construction of all types of Boilers (THE LATEST PRACTICE)—Boiler Construction—Mechanical Stokers—Oil Burners—Settings—Chimneys—Mechanical Draught—HOW TO SELECT A BOILER—Complete instructions and drawings on BOILER DESIGN based on A. S. M. E. BOILER CODE—OPERATION, including installation, FIRING, care and repair of Steam Boilers—Pipes, Fittings and Pipe Fitting—Heating and Ventilation—Refrigeration—Cooling Towers—Condensers—Distilling Apparatus—Elevators—Crane and Hoisting Machinery—Ropes and Cables—Splicing—electric wiring in ALL branches; synopsis of practical electrical engineering as an aid for engineers and electricians in obtaining a license—37 chapters—study reference index, covering entire field of Modern Electricity.

AUDEL'S MASTER SET 8754 ILLUSTRATIONS 4750 PAGES—8 VOLUMES



POCKET SIZE—FLEXIBLE COVERS

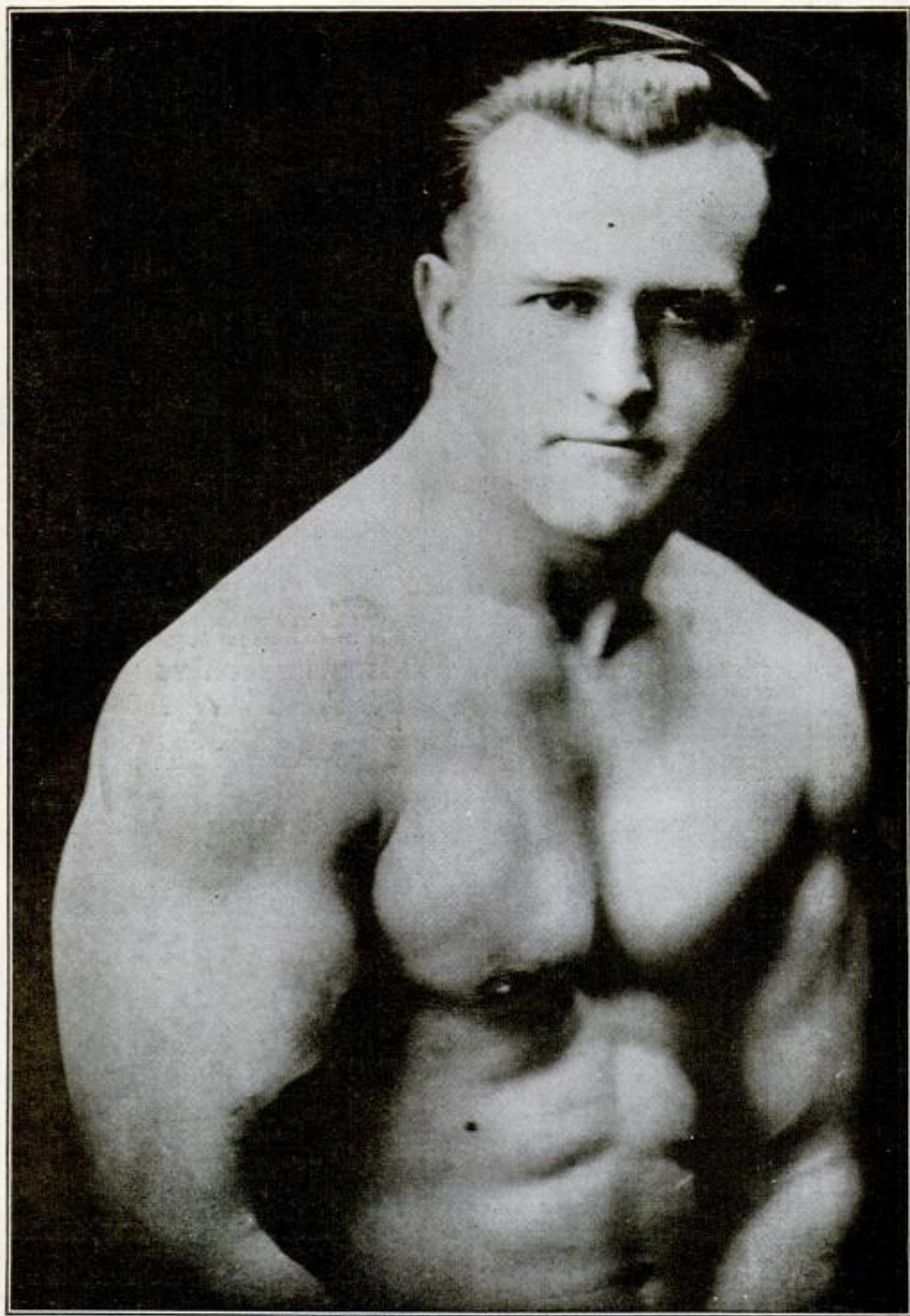
TURN SPARE TIME INTO CASH BY STUDYING THE GUIDES,

Take a volume with you where ever you go. They can be easily slipped in and out of your coat pocket without damage. Study the questions and answers. In fifteen minutes a day study you will in a few weeks acquire information that will make you a more valuable man.

FREE EXAMINATION
Not a cent to pay until you see the books. No obligation to pay unless you are satisfied. Send coupon now—today and get this new master set for engineers.
Pay only \$1 a month.

THEO. AUDEL & CO., 72 Fifth Avenue, NEW YORK CITY
Please submit me for free examination, AUDEL'S MASTER SET FOR ENGINEERS AND MECHANICS, shipped at once prepaid, the 8 volumes, total cost \$12.00. If satisfactory, I agree to send you \$1 within seven days and to further mail you \$1 each month until paid.

Name.....
Occupation.....
Employed by.....
Home Address.....
Reference.....
P. M. Oct. 23



EARLE E. LIEDERMAN, *as he is today*

Pills Never Made Muscles Wishing Never Brought Strength

NO one can paste muscles onto your arms and shoulders. If you wish a strong, healthy body, you must work for it. And if you don't have one, you are doomed to a life of misery.

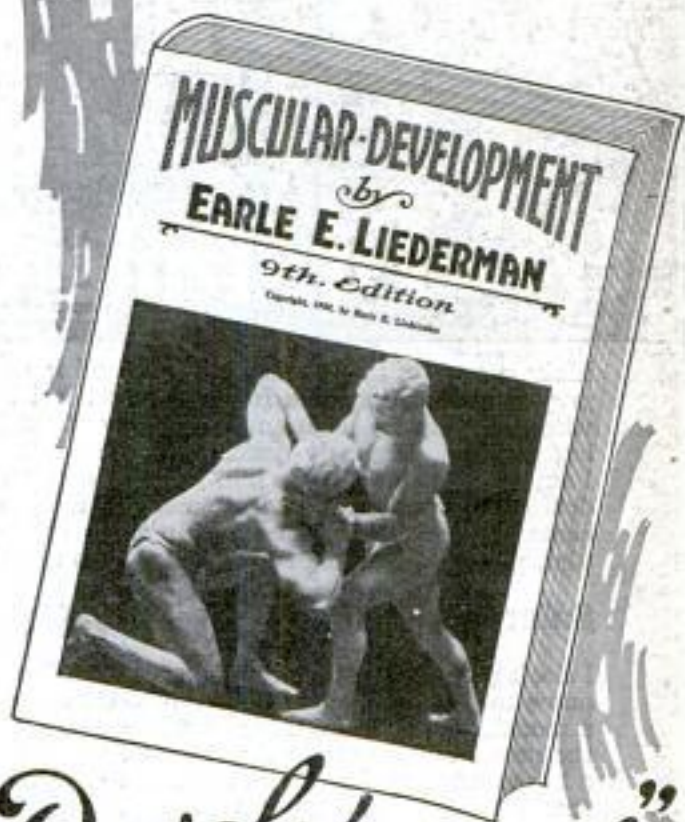
Modern science has taught us that we must keep our bodies physically fit or our mental powers will soon exhaust themselves. That is why the successful business man resorts to golf and other active pastimes.

Examine Yourself

Do you have the strong, robust body which keeps you *fit* at all times to tackle the daily tasks confronting you—always looking for bigger things to do? Do you jump out of bed in the morning full of pep; with a keen appetite and a longing to enter the day's activities? Do you finish your daily tasks still thrilling with pep and vitality? Or do you arise only half awake and go through a languid day?

PEP UP!

Don't let it get you, fellows. Come on out of that shell and make a real *he* man of yourself. Build out those skinny arms and that flat chest. Let me put some real pep in your old backbone and put an armor plate of muscle on you that will make you actually thrill with ambition. I can do it. I guarantee to do it. I will put one full inch on your arm in just 30 days and from then on, just watch 'em grow. This is no idle boast. It's the real works. A genuine guarantee. Come on now. Get on the job and make me prove it.



Send For My New
64 Page Book—

"Muscular Development"
It Is Free

This will show you some of my remarkable achievements. Sixty-four pages with dozens and dozens of full page photographs of myself and a number of my pupils. Read what *they* say about my system. Don't take my word for it. This book will be an impetus, an inspiration to every red-blooded man. All I ask is the price of wrapping and postage—10 cents. Remember this does not obligate you in any way, so don't delay one minute. This may be the turning point in your life. Tear off the coupon and mail at once—now, while it is on your mind.

EARLE E. LIEDERMAN
Dept. 2010, 305 Broadway, New York City

EARLE E. LIEDERMAN

Dept. 2010, 305 Broadway, New York City

Dear Sir:—I enclose herewith 10 cents for which you are to send me, without any obligation on my part whatever, a copy of your latest book, "Muscular Development." (Please write or print plainly.)

Name.....

Street.....

City..... State.....

Copy this Sketch



and Get
This Rule

FREE

and I also will tell you how
you can get a

\$90 Drafting Course FREE

Make a copy of the sketch above. Send it to me at once and I will mail you free and prepaid the Draftsman's Ivorine Pocket Rule. I will also send you an offer I am making whereby you may have an opportunity of getting without any expense to you a \$90 Drafting Course. The only condition of this offer is that you must be at least 16 years old. I am making this offer to find young men interested in drafting. Now is the time to learn drafting as thousands of draftsmen are in demand at big salaries. I will train you to become a draftsman and designer in a short time by my own personal method of giving regular, practical drafting-room work. You remain right at home.

Salaries up to \$250 and \$300 a Month

I don't give you just a "course in drafting" and then let you shift for yourself. I guarantee to train you until you are placed in a position paying you a salary of at least \$250 a month. I can make this guarantee because I limit and select my students. I know that the men I take as students if they will follow my practical instruction, are certain to land a big money-earning job. So, write to me today. Whether you copy the sketch or not send for my free book anyway.

Write Today!

The coupon shown below or a postcard or letter will bring my book telling you all about the career of a draftsman and all about other very exceptional offers I am making, such as, for instance, a fine folding drafting table which I am giving now to all my students. Write at once. Use this coupon, or send postcard or letter.

Chief Draftsman Engineer's Equipment Co.
1951 LAWRENCE AVE. DIV. 13-57 CHICAGO, ILL.

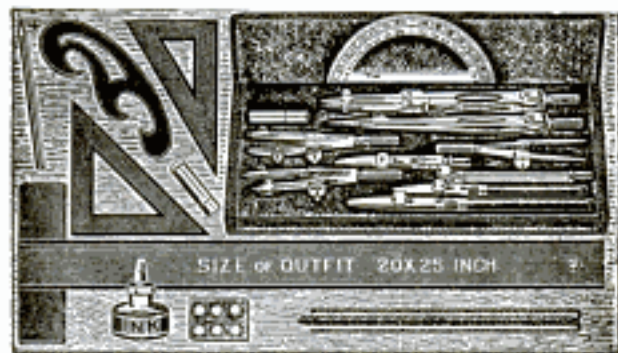
Chief Draftsman Engineer's Equipment Co.
1951 LAWRENCE AVE. DIV. 13-57 CHICAGO, ILL.

Without any obligation whatsoever, please mail your book, "Successful Draftsmanship", and full particulars of your liberal "Personal Instruction" offer to few students.

Name.....

Address.....

Age.....

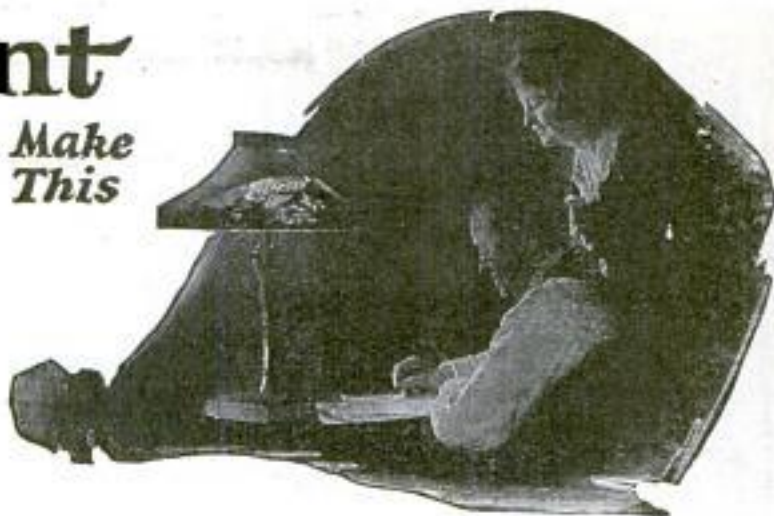


FREE This Draftsman's Working Outfit

These are regular working instruments—the kind I use myself. I give them free to you if you enroll at once. Don't delay. Send coupon, postcard or letter for my free book.

If You Want Bigger Pay *Make This* **FREE TEST**

There's a sure way to increase your earning power. And here is such an opportunity. Look into it—you may recognize it as your one chance to earn the biggest money of your life.



ARE you ready for a shock? Then, let me tell you that if you have average intelligence and can read and write, there is a quick and easy way for you to earn enough money to satisfy any average ambition. And after reading this offer, if you do not quickly make more money, you have no one to blame but yourself.

Don't take my word for it. By a simple test—you can make in the privacy of your home—you will know that every word I say is true—or otherwise. The test does not obligate you or cost you one penny. But make it! Then judge for yourself. It has proved to be THE opportunity for thousands. They have found the way to bigger pay—are now earning from five to twenty times as much as formerly. And the beauty of it is they enjoy every minute in the day's work. They are their own bosses.

The thousands who have made this test before you, and who are now making the money you would like to make, are now salesmen. Ninety-five per cent once thought they were not "cut out for selling" that salesmen were "born" and not made. They found it was a fallacy that had kept them in the rut. They discovered that anyone with proper training can sell, and they are making from \$5,000 to \$10,000 a year, because they had the vision to recognize opportunity.

Thousands Have Proved It!

For instance, Ellis Summer Cook, 20 E. Jackson Blvd., Chicago, left a \$25 a week job and last year made \$9,000! H. D. Miller, another Chicago boy, was making \$100 a month as a stenographer in July 1922. In September, 3 months later, he was making \$100 a week as a salesman. W. P. Clenny of Kansas City, Mo., stepped from a \$150 a month clerkship into a selling job at \$500 a month. He is making \$850 a month now. M. V. Stephens of Albany, Ky., was making \$25 a week. He took up this training and now makes 5 times that much. J. H. Cash of Atlanta, Ga., exchanged his \$75 a month job for one which pays

him \$500 a month. O. H. Malfroot of Boston, Mass., stepped into a \$10,000 position as a SALES MANAGER—so thorough is this training. All these successes are due to this easy, fascinating and rapid way to master certain invincible secrets of selling.

Simple as A B C

Sounds remarkable, doesn't it? Yet there is nothing remarkable about it. There are certain ways to approach different types of prospects to get their undivided attention—certain ways to stimulate keen interest—certain ways to overcome objections, batter down prejudices, outwit competition and make the prospect act. If you will learn these principles there is awaiting you a brilliant success and more money than you ever thought of earning.

As you will see by the affidavit to the left thousands of reputable selling organizations in America turn to this Association for their Salesmen. We can never take care of all the demands made on us for this

better type of trained salesmen.

Make This Free Test at Once

Don't turn this page until you have clipped the coupon, filled it out, and sent it on its way. The test is contained in a free book, "Modern Salesmanship" which we will gladly send you without obligation. After reading the book through you will ask yourself the question it brings up. The answers will prove whether this is your opportunity or not. So mail the coupon NOW.

NATIONAL SALESMEN'S TRAINING ASS'N.

Dept. 12-R

Chicago, Ill.

National Salesmen's Training Ass'n.

Dept. 12-R, Chicago, Ill.

Please send me without obligation on my part your free book, "Modern Salesmanship" which will enable me to test my ability at home, and full information about the N. S. T. A. System of Salesmanship Training and Employment Service.

Name.....
Address.....
City.....State.....
Age.....Occupation.....





High School Course in Two Years!

You Want to Earn Big Money!

And you will not be satisfied unless you earn steady promotion. But are you prepared for the job ahead of you? Do you measure up to the standard that insures success? For a more responsible position a fairly good education is necessary. To write a sensible business letter, to prepare estimates, to figure cost and to compute interest, you must have a certain amount of preparation. All this you must be able to do before you will earn promotion.

Many business houses hire no men whose general knowledge is not equal to a high school course. Why? Because big business refuses to burden itself with men who are barred from promotion by the lack of elementary education.

Can You Qualify for a Better Position

We have a plan whereby you can. We can give you a complete but simplified high school course in two years, giving you all the essentials that form the foundation of practical business. It will prepare you to hold your own where competition is keen and exacting. Do not doubt your ability, but make up your mind to it and you will soon have the requirements that will bring you success and big money. **YOU CAN DO IT.**

Let us show you how to get on the road to success. It will not cost you a single working hour. Write today. It costs you nothing but a stamp.

American School

Dept. H774, Drexel Ave. and 58th St., Chicago

American School

Dept. H774, Drexel Ave. and 58th St., Chicago

Send me full information on the subject checked and how you will help me win success.

- | | |
|------------------------------|----------------------------|
| Architect | Lawyer |
| Building Contractor | Machine Shop Practice |
| Automobile Engineer | Photoplay Writer |
| Automobile Repairman | Mechanical Engineer |
| Civil Engineer | Shop Superintendent |
| Structural Engineer | Employment Manager |
| Business Manager | Steam Engineer |
| Cert. Public Accountant | Foremanship |
| Accountant and Auditor | Sanitary Engineer |
| Bookkeeper | Surveyor (& Mapping) |
| Draftsman and Designer | Telephone Engineer |
| Electrical Engineer | Telegraph Engineer |
| Electric Light & Power | High School Graduate |
| General Education | Fire Insurance Expert |
| Vocational Guidance | Wireless Radio |
| Business Law | Undecided |

Name

Address

Please Mention Popular Mechanics

DRAW CARTOONS

Cartoonists Trained by W. L. EVANS



MAKE MONEY

SOME of the cleverest cartoonists in America today are former students. They studied during their spare time and are now making good money. Cartoonist Evans' system of teaching is so simple, easy and practical that it is not hard to learn to draw originals. The school has a long established reputation and is recommended by well-known cartoonists because they know the students are handled right.

If you like to draw, send us a sample of your work, either a copy or an original. You may have more ability than you think. We will send you a portfolio of cartoons and full details about the school.

The Course is NOT EXPENSIVE

THE W. L. EVANS SCHOOL OF CARTOONING

821 Leader Bldg. CLEVELAND, OHIO



STAMMER

If you stammer attend no stammering school till you get my large FREE book entitled "STAMMERING, Its Origin and the Advanced Natural Method of Cure," bound in cloth and stamped in pure gold. Ask for special tuition rate and a FREE copy of "The Natural Speech Magazine." Largest, best equipped and most successful school in the world for the cure of stammering; stuttering, etc. No sing-song or time beat. Write today. The North-Western School, 2317 Grand Ave., Milwaukee, Wis.

Rider Agents Wanted

Select from the 44 Styles, colors and sizes of Ranger Bicycles. Ride and exhibit sample Ranger and make money. Delivered free, express prepaid, on Approval. Factory-to-Rider prices save \$10 to \$25, 12 Months to Pay on any Ranger if desired. Boys and girls easily save the small monthly payments. Parents often advance first payment. best quality, at factory prices, express prepaid. Large, wheels and equipment, low prices, send No Money, do business direct with makers.

Mead Cycle Company
Dept. 100, Chicago

Write today for free Ranger Catalog, factory prices and marvelous easy payment terms



Learn Watchwork, Jewelrywork and Engraving.

A fine trade commanding a good salary, and your services are always in demand. Address **Herological**, Dept. P, Bradley Institute, PEORIA, ILL., for our latest catalog.



How to Box 40c

By Terry McGovern, James J. Corbett, J. Gardner Smith, M. D., Arthur P. Keeley and Gus. E. Keeley.

How to Box to Win. How to Build Muscle; How to Punch the Bag and How to Stand, Walk or Run.

This interesting book written by experts is known also as "The Book of Health and Strength." It will greatly assist everyone in keeping fit, in putting them in condition to master a strenuous undertaking either physical or mental.

62 Illustrations. Size 4 1/2 x 7 1/2 in. Paper copy, 132 pages
SHREWSBURY PUBLISHING CO.
3325 West Lake Street, Chicago, Ill.

PRACTICAL ELECTRICITY

SELF TAUGHT COMPLETE COURSE IN ELECTRICITY FOR FREE EXAMINATION



HAWKINS ELECTRICAL GUIDES

3500 PAGES—4700 PICTURES—\$1 A VOLUME—\$1 A MONTH—10 VOLUMES

OVER 5000
READERS
HAVE
OK'D
THIS
SET

Know the facts in Electricity. They mean more money and better position for you. Hawkins Guides tell you all you need to know about Electricity. Every important electrical subject covered so you can understand it. Easy to study and apply. A complete, practical working course, in 10 volumes. Books are pocket size; flexible covers. Order a set today to look over.

LEARN ALL ABOUT THESE IMPORTANT POINTS

Magnetism—Induction—Experiments—Dynamometers—Electric Machinery—Motors—Armatures—Armature Windings—Installing of Dynamometers—Electrical Instrument Testing—Practical Management of Dynamometers and Motors—Distribution Systems—Wiring—Wiring Diagrams—Sign Flashers—Storage Batteries—

Principles of Alternating Currents and Alternators—Alternating Current Motors—Transformers—Converters—Rectifiers—Alternating Current Systems—Circuit Breakers—Measuring Instruments—Switchboards—Wiring—Power Stations—Installing—Telephones—Telegraph—Wireless—Bells—Lighting—Railways—Also many Modern Practical Applications of Electricity and Ready Reference Index of the ten numbers.

**USE FREE SHIPPED FREE
COUPON**

Not a cent to pay until you see the books. No obligation to buy unless you are satisfied. Read Coupon now—today—and get this great help—library and see if it is not worth \$100.00 to you—you pay \$1.00 a month for ten months or return it.

NOW →



THEO. AUDEL & CO.,
72 Fifth Ave., New York City

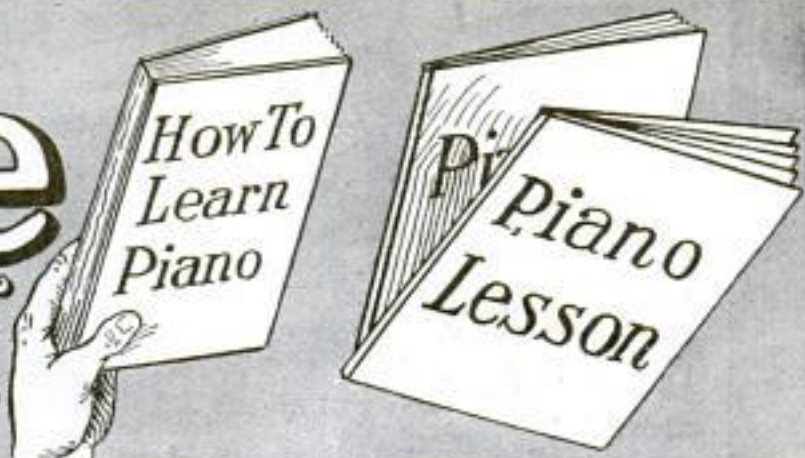
Please submit me for free examination, HAWKINS ELECTRICAL GUIDE. (Price \$1 a number). Ship at once prepaid, the 10 numbers. If satisfactory, I agree to send you \$1 within seven days and to further mail you \$1.00 each month until paid.

Name.....
Occupation.....
Employed by.....
Home Address.....
Reference.....

PM Oct. '23.

Free

Booklet &
Sample Lessons



Stop Wondering *How I Teach* Piano; I'll Show You, **FREE!**

Year after year you've seen my advertisement in all the leading publications, offering to teach you piano in **quarter** the usual time. Year after year my school has grown and grown until now I have far more students than were ever before taught by one man. In 1922 over two thousand students **graduated** from my Piano or Organ course and received their diplomas.

Yet when I first started giving piano and organ lessons by mail in 1891 my method was laughed at. Could my conservatory have grown as it has, obtained students in every State of the Union, and in fact, practically every civilized country of the world, unless it produced very unusual and satisfying **RESULTS** for its students? See for yourself what it is that has brought my method so rapidly to the front. Write for free booklet and sample lessons.

Now, for the first time, you can obtain sample lessons without charge. In the past, I have always been opposed to sending out free lessons, even to persons who were seriously interested in my course. But my friends have insisted that I give everybody a chance to see for themselves just how simple, interesting and **DIFFERENT** my lessons are, and I have consented to try the experiment **for a short time**. Simply mail the coupon below or write a postcard, and the 64-page booklet and sample lessons will go to you at once absolutely free and without obligation.

Within four lessons you will play an interesting piece on the piano or organ, not only in the original key, but in all other keys as well.

Most students practise months before they acquire this ability. It is made possible by my patented invention, the Colorotone.

Another invention, obtainable only from me, is my hand-operated moving picture device, Quinn-dex. By means of Quinn-dex you actually see my fingers in motion on the piano, and can learn just how to train your own fingers.

When I say that I can teach you piano in **quarter** the usual time, do not think that this is too good to be true. Modern inventions and improved methods have accomplished just as great wonders in other branches of education.

You at least owe it to yourself to **investigate**. Send coupon or postcard at once, before the offer of free sample lessons is withdrawn.

QUINN CONSERVATORY STUDIO
PM70, 598 Columbia Road
BOSTON, 25, MASS.

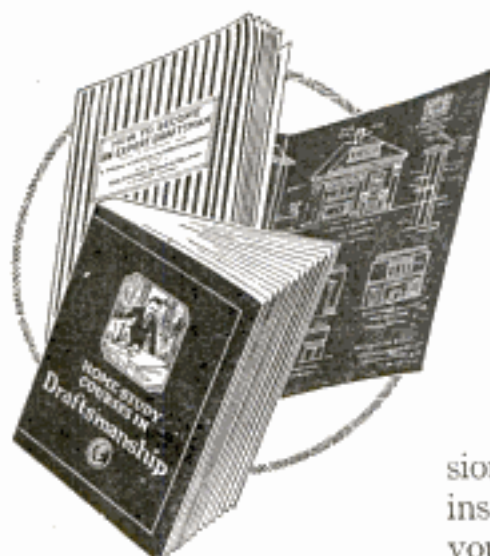


FREE BOOK COUPON
QUINN CONSERVATORY STUDIO, Boston, 25, Mass.
PM70, 598 Columbia Road

Please send me, without cost or obligation, your free booklet, "How to Learn Piano" or Organ, free sample lessons and full particulars of your method.

Name

Address



FREE TRIAL LESSON

Send the coupon and get this lesson in Drafting. It will show you how well qualified you are to take up this great profession. Also shows the Chicago Tech. method of instruction by mail. Find out about all this before you enroll or pay a penny. Mail the coupon now.

DRAFTING

Train in Spare Time—Double Your Income

Put yourself in the big pay class. Get expert training in Drafting under the Chicago Tech. experts. Be master of a profession in which there are not enough highly skilled men to fill the paying jobs that are open. The Chicago Tech. method of training men by mail gives you a finished, practical education in Drafting—in your own home in spare time. Just a few hours a week and you get a thorough training under the personal direction of experts.

Get Your Instruction Under Practical Men

Enrolled at Chicago Tech. you are instructed by practical engineers—not by mere theorists. These men have been "through the mill." They know just what problems you will have to solve in actual practice and show you how to master them. No time wasted on unnecessary studies. You graduate early and can stand beside men of long experience. You get this training at a low cost and on easy terms.

The Big Job Will Be Ready When You Are

Everywhere there is a call for capable Draftsmen—men who can take hold of important work and see it through. Men of this kind are always in demand at high salaries by railroads, manufacturers, architects, contractors, electrical works and other big industries. Chicago Tech. training which you can get by mail or in day or evening classes at the College in Chicago will make you the man wanted for the big positions that are open to highly trained men.

Chicago Tech. Men Succeed

Every year Chicago Tech. graduates step into the ranks of successful men. You find them everywhere employed at high salaries or in business for themselves—independent and prosperous because they have the practical knowledge that enables them to handle the kind of jobs which command big pay.

Chicago Tech. training increased my salary 300%.
F. L. Cary.

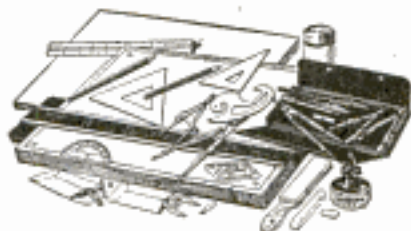
Successful in own business as a result of Chicago Tech. training.
O. L. Roalin.

Have had my pay raised \$73.70 a week since I took Chicago Tech. course.
S. Schrier.

To Employers:

Chicago Tech. men are practical. Write to us when you need Draftsmen.

FREE Drawing Outfit



Enrolled in the Chicago Tech. Home Study Drafting Course you get this complete Drawing Outfit (Retail price \$25.00) without extra cost (or you are given a credit on fees if you have an outfit).

Send the Coupon

Mail the coupon and get the Free Trial Lesson—also catalogs and full information about the Chicago Tech. Method of teaching Drafting by mail. Find out about the opportunities that Drafting offers to ambitious men. No cost to you—no obligation. Send the Coupon.

Chicago Technical College
1030 Chicago Tech. Bldg., Chicago, Ill.

Without cost or obligation on me please send instructive matter about opportunities in line I have marked with "X."

- Drafting.** (The Big Salary Course)
No experience necessary. Free lesson sent free.
- Building Trade Course.**
For men in the building lines.

Name.....

Address.....

Postoffice.....

State.....

BE A HOTEL EXECUTIVE

Earn \$2,500 to \$12,000 a Year



*This Door
Wide Open
for YOU!*

Many Are Entering with the
Aid of S. B. T. I. Training

Graduate Doubles Salary

"I have got the position as Steward for the _____ at a salary of \$250 per month with a free house and board, or almost double my present salary. I feel that you and the Institute have helped me through the course to get this position."

"Actions Speak Louder Than Words"
An S. B. T. I. Graduate Writes:

"The question that worried me the most was 'Will they be able to get me a job?' Actions speak louder than words x x x x. I had not been under your instructions even two months before you placed me here at the _____ Hotel x x x x. Previous to the day I started your instructions I had not one single hour of any kind of hotel experience."

Many Letters Like This One

"I have made application for the position as you suggested and have accepted the opportunity offered me by _____"

Endorsed by Leading Hotel Men

"It might be interesting for you to know that before I enrolled for your course I wrote Mr. _____, Manager of the _____ Hotel, New York City, one of the leading hotel men and one of the best hotels in the United States, to ask his opinion. I acted on his recommendation."

For obvious reasons we do not publish names of our graduates but we will gladly furnish them to you as well as their addresses and the names of the hotels referred to if you care for this information.

Your Chances Are Equal to Theirs

Hotels are looking to us for ambitious employees trained in hotel fundamentals. No method of training is so quick and sure as the Hotel Operation and Management Course. It is a series of concise, thorough lessons, easily acquired in a few weeks of your spare time. Cost is moderate. Easy terms if desired. Rapid advancement certain. More positions waiting than we can fill. Our Employment Service helps to connect you with one of these positions.

STANDARD BUSINESS TRAINING INST.
Carlton Court BUFFALO, N. Y.

Standard Business Training Inst.

Carlton Court, Buffalo, N. Y.

Send me Free Booklet H 166 giving full information about Hotel Operation and Management Course, also Employment Bulletin.

NAME

STREET

CITY

Please Mention Popular Mechanics

New Easy Way to DRAW



Wonderful new method makes it possible for *anyone* to learn Illustrating, Commercial Designing and Cartooning. Many of our students never touched a drawing pencil before starting our course. The simplicity of this method is astounding. You will be amazed at your rapid progress. It's fun learning to draw this

way—at home in spare time, yet all your work receives the individual criticism of one of America's most successful artists.

\$50 to over \$300 a week — that is what good commercial artists earn. Tremendous demand now for trained artists. Learn to draw and earn big money as an artist.

Send for FREE Book

Just printed — new, handsomely illustrated book which describes wonderful opportunities in Commercial Art, and explains this amazing new, easy method. Tells all about our students, their successes, what they say, etc. Sent free without obligation. Send for this free book. Mail post card or letter for a NOW.

Washington School of Art
Room 3010, 1115 15th St., N. W.
WASHINGTON, D. C.

STAMMER NO MORE

Kill the fear of stammering. Re-education the key. The widely famed Hatfield Method fully outlined in an accurate, dependable, worthwhile book—"HOW TO STOP STAMMERING." It has helped thousands. Free copy today!

THE HATFIELD INSTITUTE, 109 N. Dearborn, Chicago, Ill.

TELEGRAPHY

BOTH MORSE AND WIRELESS taught thoroughly. Big salaries; tremendous demand. Object, largest school. Endorsed by Telegraph, Railway, Wireless and Government officials. Expenses low—opportunities to earn large portion. Catalog free.

DODGE'S INSTITUTE, Jones Street, Valparaiso, Ind.

LEARN WATCH REPAIRING



You can learn by our modern and original system of instruction every part of the **Watch Repairing Trade** at home as good or better than at a shop. You can earn money while learning and secure a well paying position or start in business after completing our course of instruction. Good watch repairers are always in demand and earn from \$30 to \$70 per week. For particulars apply to the **Wisconsin School of Watch Repairing** 106 Mason St., MILWAUKEE, WIS.

IT'S EASY TO PLAY THE TENOR-BANJO

THIS \$15.00
TENOR BANJO
FREE

No Previous Musical Knowledge Necessary. Play Music Your First Lesson. Wonderful Method Only motions and you master them quickly. After a short period of easy practice you will be playing **all the popular hits**, just as you have heard experts play them on the stage, in Dance Orchestras—everywhere! It is the most popular instrument of the age and you can quickly learn to play it. Fred Barker will teach you to **chord and harmonize** exactly as he does in an amazingly short time! And remember we furnish your **tenor banjo free**. Write for details of our course and free offer. Address



First Hawaiian Conservatory of Music, Inc.
Desk 60, 233 Broadway, (Woolworth Bldg.) N. Y.

**Be An Electrical
Expert—
Earn Big Money**



What Are You Going To Do About It?

You want more money. A doubled pay check would do a lot of things for you and yours! Then why don't you quit dreaming about it, get into the electrical game where there is **BIG MONEY** and **BIG OPPORTUNITY** and make your dreams come true!

\$75 to \$200 a Week

You can earn from \$75.00 a week up to \$200.00 a week. That's how the pay runs in this new, fast expanding and tremendously fascinating field of electricity. Seventeen different branches and ten times as many jobs as there are men to fill them! Do you realize what that means to you? It means that in a few months you can slip from your present job right into one of these regular he-man big-pay positions and never lose a day.

No College Education Needed

Not with the training we offer you! This is the *only* course that gives you the combined theoretical and practical training you *must* have before you can be a successful practical electrician—you cannot fail.

This practical electrical training is prepared by not one man with a narrow one-man's viewpoint, but by 22 of the brainiest, most successful electrical experts ever drawn from Technical and Practical Sources.

We give you complete mastery of electricity—we qualify you as electrical expert to boss big jobs—fit you right into the *kind* of a job you want—and do it in the shortest time—at lowest cost—with the *most binding guarantee of results ever offered.*

Find Out All About It!

Investigate! Find out about the thousands who have taken this course in preference to all others and *made good!* Find out about the Free Electrical Library—alone worth \$25.00—the Free Drafting Course worth another \$30.00—the wonderful Free Outfit including high grade electric motor, Wheatstone Bridge, etc.—the most scientific and complete outfit ever furnished any electrical student. Let us lay all the cards right on the table. Then you can decide as you wish.

Send the More Money Coupon Now

Brings full details, enables you to decide once and for all whether you want to become an electrical expert at a big salary or stay where you are. Don't put off prosperity. Act Now.

American School

Dept. E-774

Drexel Ave. and 53th St., Chicago

©A.S.1923

AMERICAN SCHOOL,
Dept. E-774, Chicago.

Please rush all information relative to your course in Practical Electricity. This obligates me in no way whatever. No agents will bother me.

Name.....

Address.....



AMAZING OFFER! 12 massive complete 5,000 pages—a book form—a LA BAREFRAC-TION of the usual cost! Sent for 7 days' FREE examination. No money down!

LEARN LAW

Read law in your spare time and become a lawyer or a law-trained man in business. Great opportunities for wealth, prestige and power awaits you in the profession of law. Equally great opportunities in being a legally trained man in business. Business firms and corporations are looking for the man who knows law, for law enters into every phase of business, into every single business transaction. Gain a knowledge of law and you can command an executive position—a position of responsibility at big pay! Why don't you learn law in your spare time? Here is a real chance to get a legal training at a bare fraction of the usual cost.

\$280 After Examination

Make these 12 large volumes your law school. They contain all the law. A complete text, the work of the highest authorities. Prepared especially for home study with quiz questions on every subject. Every subject in commercial and professional law covered. Every point made clear. No tiresome daily lessons.

Written in interesting, fascinating form. Never before so complete and thorough a law course as this. Never before so masterly a presentation of the law in easily learned form. Already several of the leading law schools have made application for the use of these volumes as class-room texts. Splendidly bound in law Buckram, with red and black labels and titles in gold. Only 482 sets to be sold at slashed price on this special introductory offer. Act quick to get in on this offer.

Send No Money See Before You Buy

We'll ship the whole set right to your home or office for 7 days' free trial upon your simple request. If after the 7 days' free examination you are highly pleased and decide to keep them simply pay the small initial payment of \$2.80, and then only \$3.00 a month until the special reduced price of \$44.80 is paid. Regular price \$110. Think of it—a saving of \$65.20—and over a year to pay—only 75¢ a week. Act quick, as this cut price offer holds good only on 482 sets. So rush the coupon.

FREE!
Reading Course

Act at once and we will include, extra and FREE, our Reading Course of 33 complete lectures in law, which will help you prepare for the bar examination. This with the books amounts to a complete course in law.

NOW!!

The Johansen Corporation
618 Manhattan Bldg., Chicago

Mail the coupon now. Get the books for 7 days' trial. Decide for yourself whether you want to keep them or not.

\$5.00 required with order outside of United States.

Please send your 12-volume Home Study Course in Law for 7 days' examination, shipping charges collect. I will either send \$2.80 as initial payment and \$3 a month thereafter until \$44.80 is paid, or return the books within 7 days at your expense! Special cash with order price \$39.80.)

Name

Address

Employed by Age

WE TEACH COMMERCIAL ART

Meyer Both Company, the largest Commercial Art Organization in the World, offers you an unusual opportunity

for practical training, based upon twenty-three years of success. This nationally known organization each year produces and sells to advertisers over 15,000 commercial drawings. Meyer Both instruction is the difference between successful fact and experimental theory. This well paid profession equally open to men and women. Home study instruction.

Get Facts Before You Enroll in Any School

Ask the Advertising Manager of the leading newspapers in your city, anywhere in the United States, Canada, England or Australia about the Meyer Both Company—let them tell you about us. Write for our illustrated book telling about the success of our students—for one-half the cost of mailing—four cents in stamps.

MEYER BOTH COMPANY
Department of Art Instruction

Michigan Ave. at 20th St., Dept. 16 CHICAGO, ILL.

Note—To Art and Engraving Firms: Secure practical artists among our graduates. Write us.

ELECTRICAL men with training are in demand. For more than a quarter of a century this school has been training men of ambition and limited time, for the electrical industries. Condensed course in Electrical

ENGINEERING enables graduates to secure good positions

and promotions. Theoretical and practical Electricity, Mathematics, Steam and Gas Engines, Mechanical Drawing. Students construct dynamos, install wiring and test electrical machinery. Course with diploma complete



Thoroughly equipped fireproof dormitories, dining hall, laboratories, shops. Over 3000 men trained. Write for catalog. 31st year begins Sept. 26, 1923.

BLISS ELECTRICAL SCHOOL

104 TAKOMA AVENUE, WASHINGTON, D. C.



Wonderful, new device, guides your hand; corrects your writing in few days. Big improvement in three hours. No fallouts. Complete outline FREE. Write C. I. Ozment, D-34, St. Louis, Mo.

SEND for the INTERNATIONAL CATALOG

FOR FORD—PRICES FROM \$27.85 UP.

Factory to Consumer direct—Pay only one profit.

International Body Works, 914 W. Ohio Street, Dept. 7, Chicago, Ill.



Our net price list. Full line of auto bodies and accessories for Fords and

Wholesale Prices. Save big money on bodies by buying direct from factory.

WRITE JOKES

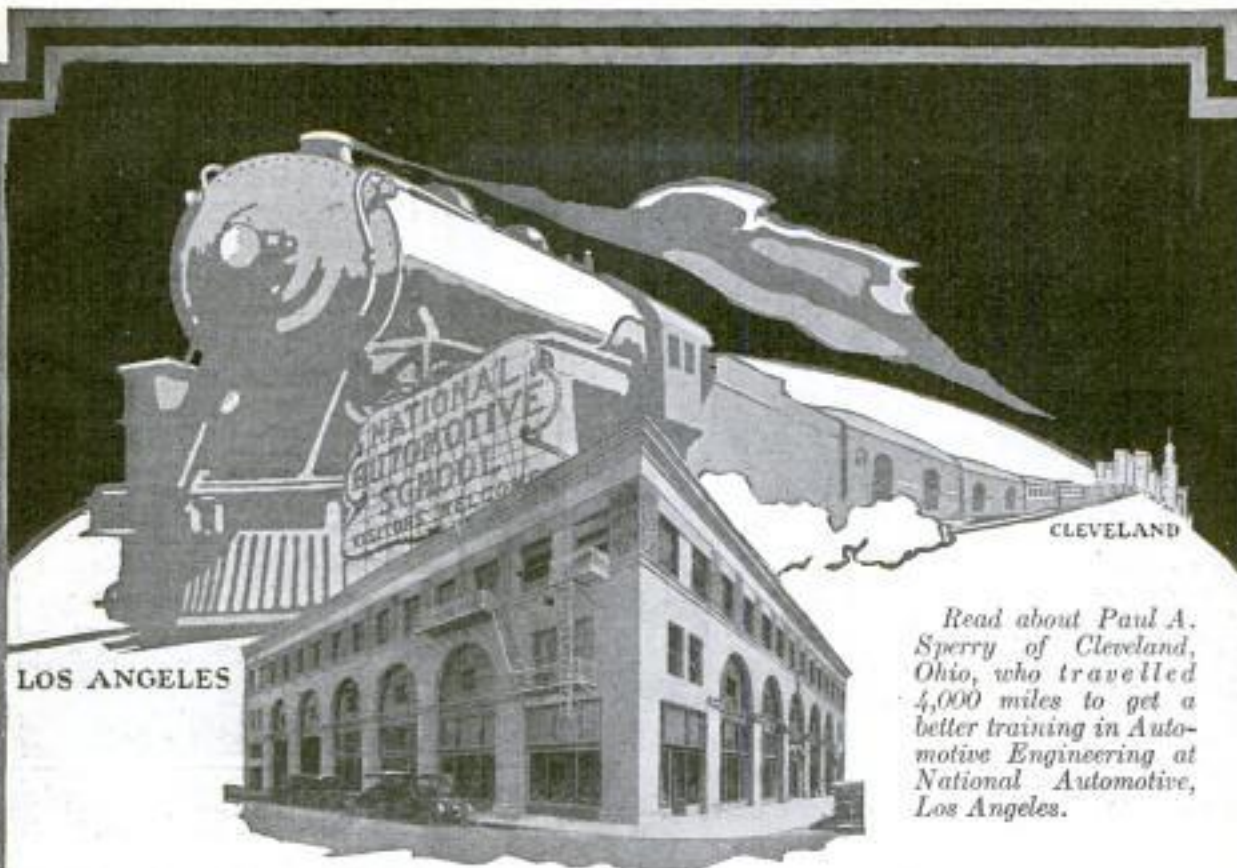
EARN FROM \$50 TO \$150 PER WEEK

writing jokes, epigrams and humorous stories for publications. Tremendous demand for material. Our short course in Humor Writing teaches you to write humorous material that sells. Learn in your spare time—earn in your spare time. Complete marketing plan and markets furnished.

Write for full particulars

AMERICAN INSTITUTE OF HUMOR
Office J, 414 Park Bldg., Cleveland, Ohio





Read about Paul A. Sperry of Cleveland, Ohio, who travelled 4,000 miles to get a better training in Automotive Engineering at National Automotive, Los Angeles.

"I Travelled 4000 Miles to Get National Training"

SHAKING hands all round with the fellows that had made life pleasant for him during training, Paul A. Sperry of 1863 Stanwood Ave., Cleveland, Ohio, said, "I travelled 4000 miles to get National Automotive training; any other fellow should be glad of a chance to do the same. He was bubbling over with enthusiasm and full of ambition when he left N. A. S., for he knew that he possessed the knowledge and training that would enable him to get a big-pay job as automotive expert. He had insured his future success by National training.

Only One in a Hundred

Paul Sperry is just one of hundreds of men who come to Los Angeles to get a better and more thorough course of automotive training at National. Men with auto schools at their very door make this wonderful trip to California because of the special advantages offered by National, and because of the great opportunities for quick success that await them in this fast-growing Western state. Life is at its best in California. Automotive training conditions are at their best at National.

Many Take National Training For Post-graduate Course

You could ask for no better evidence to prove the value of National training. Every year men come to National for a post-graduate course. They want the thorough training in every branch of automotive engineering, the special, advanced electrical and ignition work for which National is famous.

Even Better Training Facilities Now

The new National Automotive building erected at a cost of more than \$300,000 offers you many special training advantages. It is situated right across the street from 130-acre Exposition Park, yet only 20 minutes trolley ride from the heart of the city. All the advantages of the park are FREE to you—ball grounds, swimming pool, gymnasium, etc. And in N. A. S. building many entertainment features have been provided—roof garden, gymnasium, basketball and handball courts, reading rooms, etc.

Sun-Lighted Training Shops

Every training shop in National Automotive is fitted with great big windows, through which come plenty of California sunshine and fresh air. Training conditions are ideal at National—work and play go hand in hand. You are kept interested and happy so that you can accomplish more than you ever dreamed you could in a few short months.

New, Up-to-Date Equipment

More than \$200,000 has been expended in equipment alone. Chassis, motors, electrical equipment, machine shops, modern garage equipment, vulcanizing machinery and all sanitary facilities are of the highest quality.

Personal Instruction by Experts

Because National Automotive does not attempt to turn out graduates by the thousands, but rather to limit attendance, you are assured of special attention while training. Expert automotive engineer instructors show you how; explain every detail; help you every step of the way.

Send for FREE Auto Book

Read the many interesting stories of how men just like yourself have gained success, money and happiness through National training. This free book explains everything. How you can earn your room and board while learning. How National places hundreds of men in big-pay auto jobs. Mail the coupon today for this big, free, illustrated book.

NATIONAL AUTOMOTIVE SCHOOL
Dept. 53, 4004 S. Figueroa Street, Los Angeles, Cal.

Please send me, absolutely free, your illustrated book about National Automotive.

Name.....

Street No.....

City..... State.....



"Don't tell me you never had a chance!"

"Four years ago you and I worked at the same bench. I realized that to get ahead I needed special training, and decided to let the International Correspondence Schools help me. I wanted you to do the same, but you said, 'Aw, forget it!' You had the same chance I had, but you turned it down. No, Jim, you can't expect more money until you've trained yourself to handle bigger work."

There are lots of "Jims" in the world—in stores, factories, offices, everywhere. Are you one of them? Wake up! Every time you see an I. C. S. coupon your chance is staring you in the face. Don't turn it down.

Right now more than 180,000 men and women are preparing themselves for bigger jobs and better pay through I. C. S. courses.

You can join them and get in line for promotion. Mark and mail this coupon, and find out how.

TEAR OUT HERE

INTERNATIONAL CORRESPONDENCE SCHOOLS
Box 5549-D Scranton, Penna.

Without cost or obligation, please tell me how I can qualify for the position of in the subject before which I have marked an X:

BUSINESS TRAINING COURSES

- | | |
|---|---|
| <input type="checkbox"/> Business Management | <input type="checkbox"/> Salesmanship |
| <input type="checkbox"/> Industrial Management | <input type="checkbox"/> Advertising |
| <input type="checkbox"/> Personnel Organization | <input type="checkbox"/> Better Letters |
| <input type="checkbox"/> Traffic Management | <input type="checkbox"/> Foreign Trade |
| <input type="checkbox"/> Business Law | <input type="checkbox"/> Stenography and Typing |
| <input type="checkbox"/> Banking and Banking Law | <input type="checkbox"/> Business English |
| <input type="checkbox"/> Accountancy (including C.P.A.) | <input type="checkbox"/> Civil Service |
| <input type="checkbox"/> Nicholson Cost Accounting | <input type="checkbox"/> Railway Mail Clerk |
| <input type="checkbox"/> Bookkeeping | <input type="checkbox"/> Common School Subjects |
| <input type="checkbox"/> Private Secretary | <input type="checkbox"/> High School Subjects |
| <input type="checkbox"/> Business Spanish <input type="checkbox"/> French | <input type="checkbox"/> Illustrating <input type="checkbox"/> Cartooning |

TECHNICAL AND INDUSTRIAL COURSES

- | | |
|--|--|
| <input type="checkbox"/> Electrical Engineering | <input type="checkbox"/> Architect |
| <input type="checkbox"/> Electric Lighting | <input type="checkbox"/> Blue Print Reading |
| <input type="checkbox"/> Mechanical Engineer | <input type="checkbox"/> Contractor and Builder |
| <input type="checkbox"/> Mechanical Draftsman | <input type="checkbox"/> Architectural Draftsman |
| <input type="checkbox"/> Machine Shop Practice | <input type="checkbox"/> Concrete Builder |
| <input type="checkbox"/> Railroad Positions | <input type="checkbox"/> Structural Engineer |
| <input type="checkbox"/> Gas Engine Operating | <input type="checkbox"/> Plumbing and Heating |
| <input type="checkbox"/> Civil Engineer | <input type="checkbox"/> Chemistry <input type="checkbox"/> Pharmacy |
| <input type="checkbox"/> Surveying and Mapping | <input type="checkbox"/> Automobile Work |
| <input type="checkbox"/> Metallurgy <input type="checkbox"/> Mining | <input type="checkbox"/> Navigation |
| <input type="checkbox"/> Steam Engineering | <input type="checkbox"/> Agriculture and Poultry |
| <input type="checkbox"/> Radio <input type="checkbox"/> Airplane Engines | <input type="checkbox"/> Mathematics |

Name.....
Street.....
Address..... 3-27-23
City..... State.....

Occupation.....
Persons residing in Canada should send this coupon to the International Correspondence Schools Canadian, Limited, Montreal, Canada.

Learn to Write

I Teach by Mail

I can make a good penman of you at your home during spare time, no matter where you live or how poorly you now write. My simplified system has shown thousands the way to good penmanship during the past twenty-five years—it CAN and WILL do the same for YOU.

My beautifully illustrated 32-page Book

"How to Become a Good Penman" FREE!!

It contains many beautiful specimens of penmanship showing what others have accomplished by the Tamblin System, with testimonials and general information about our course. (Your name elegantly written on a card if you enclose stamp for postage.) Ladies taught as successfully as men. Write Today. Address

F. W. TAMBLIN
410 Ridge Bldg. Kansas City, Mo., U. S. A.

F. W. Tamblin

Learn to Mount Birds

Learn at home by mail, to mount birds, animals, game heads; tax furs, make rugs and robes. Complete lessons. Easily and quickly learned by men, boys and women.

FREE Write today for Free Taxidermy Book. Tells all about it. Every Nature lover should know this wonderful fascinating art. Save your trophies. Big profits. Success guaranteed. Our school is 20 years old—15,000 graduates. Investigate today. Write for Free Book.

Northwestern School of Taxidermy 1777 Elwood Bldg., Omaha, Neb.

HOW TO BECOME A PROFESSIONAL PHOTOGRAPHER

EARNING \$35 TO \$125 A WEEK

Three to six months' course. Motion Picture, Commercial, Portraiture. Practical instruction. Modern equipment. Ask for Catalog No. 49.

N. Y. INSTITUTE OF PHOTOGRAPHY
NEW YORK CHICAGO BROOKLYN
141 W. 36th St. 630 So. Wabash Ave. 505 State St.

Learn to PAINT SIGNS and SHOW CARDS

Big field—unlimited possibilities—increasing demand for men with creative ideas. Our course develops ability and originality. Work intensely interesting.

EARN \$25 TO \$75 WEEKLY

You can do it! Ambitious, successful graduates everywhere. Our course thoroughly covers every phase of work. Our graduates command big salaries. Write for catalog, samples, guarantee and Free Outfit Offer.

Detroit School of Lettering, 830 D. S. L. Bldg., Detroit, Mich.

RAISE POULTRY FOR PROFIT

We teach you how. Easily learned at home. Our guaranteed methods make success certain—indorsed by leading Agricultural Colleges. Send TODAY for FREE BOOK—"How To Raise Poultry For Profit."

National Poultry Institute
Dept. 312 Washington, D. C.

"BECOME A LIGHTNING TRICK CARTOONIST"

MAKE MONEY CHALK TALKING. SEND \$1.00 FOR SHARP, MODERN DAY TRICK DRAWINGS WITH INSTRUCTIONS BY A PROFESSIONAL CARTOONIST. SATISFACTION GUARANTEED. CIRCULAR FREE BALDA ART SERVICE, 61, OSHKOSH, WIS.

Get The Pay of the Man Higher Up!



\$200
per week

\$150
per week

\$100
per week

\$75.00
per week

\$50.00
per week

\$25.00
per week

\$20.00
per week

\$18.00
per week

You are not the kind of man who is always going to take orders from others. What you want is to give—not take orders. You want the bigger pay that goes with that kind of work; and here in this great Library of Practical Books for Self-training, you are offered the sure way of getting what you want.

In these books you will find a wealth of the very information you need to GET MORE MONEY in the trade you are following. There are thirteen sets, each set devoted to one particular line of work. Each set is written by a group of highly trained practical experts who cover the entire subject from a technical standpoint yet do it so clearly and illustrate every thing so plainly with diagrams and blue prints that you can't fail to understand every word.

Thousands of men who have read and studied these books have gained by it. If you were to get only one idea that helped you prove an UNUSUAL knowledge of your work, that one idea would be worth what a dozen sets would cost you. Every book is simply packed with such ideas and helpful information.

Reference Books That Make Happy Days of Pay Days Select Your Own Line From This List for Week's Free Use

5 vols. Carpentry & Contracting—was \$37.50 now.....	\$19.80	8 vols. Business Management—was \$52.50 now.....	\$29.80
12 vols. American Law & Practice (including free reading course and 250 page book of standard legal forms)—was \$97.50 now.....	49.80	7 vols. Steam and Gas Engineering—was \$52.50 now.....	24.80
8 vols. Applied Electricity—was \$60.00 now.....	29.80	4 vols. Sanitation, Heating & Ventilating—was \$30.00 now.....	14.80
6 vols. Auto Engineering—was \$45.00 now.....	21.80	4 vols. Fire Prevention & Insurance—was \$30.00 now.....	14.80
9 vols. Civil Engineering—was \$67.50 now.....	34.80	6 vols. Modern Machine Shop Practice—was \$45.00 now.....	21.80
		4 vols. Telephony & Telegraphy—was \$30.00 now.....	14.80
		4 vols. Drawing—was \$30.00 now.....	14.80

Free Consulting Membership

A resident consulting staff of from 15 to 20 practical experts is waiting to solve for you any difficulty that you may have. A letter or a wire to American Technical Society will bring you an immediate answer and the solution to your problems. This advisory staff of practical men plus your working and reference library will enable you to handle successfully any job in your line. These men know all the latest methods and the newest and best ways of doing things. Let this pay-raising consulting staff be YOUR SILENT PARTNER. Use this service daily if necessary.

This free consulting membership offer is good for a limited time only and can be withdrawn without notice.

Use Books FREE For One Week—Send No Money

—just fill out the coupon. After you receive the full set of books, express collect, read them over and test them out for seven days. If you don't want them, send them back at our expense. If you decide they will do for you what they have done for more than 200,000 others, pay \$2.80 within one week and \$3.00 each month thereafter until the special price is paid. This amounts to only ten cents a day. Mail coupon NOW if you want a bigger, better job at higher wages.

Here's your opportunity, if you want to EARN MORE MONEY. Remember, we are taking all the chances—you pay NOTHING unless you are absolutely satisfied after seeing the books. Isn't this about the fairest proposition that was ever put up to you?

American Technical Society, Dept. X-719 Chicago, U.S.A.

©A.T.S. 1923

AMERICAN TECHNICAL SOCIETY, Dept. X-719 Chicago

Please send me a set of for seven days' FREE EXAMINATION, shipping charges collect. I will examine these books thoroughly, and if satisfied, will send \$2.80 within seven days and \$3 a month until I have paid the special price of \$..... If I decide not to keep the books, I will return them within one week at your expense. It is understood that if I keep the books I am entitled to a FREE Consulting Membership in the Society.

Name

Address

Reference

[Please fill out all lines, give local merchant, banker or employer as reference.]

WANTED



RAILWAY POSTAL CLERKS STEADY POSITIONS

These are steady positions. Strikes, poor business conditions, lockouts or politics will not affect them. Railway Postal Clerks get their pay for twelve full months every year. There is no such thing as "HARD TIMES" in the U. S. Government Service.

\$1,600 TO \$2,300 A YEAR

These Railway Postal Clerks will get \$1,600 the first year, being paid on the first and fifteenth of each month. (\$66.67 each pay day.) Their pay will be increased to a maximum of \$2,300 a year. (\$95.84 each pay day.)

PAID VACATION

Railway Postal Clerks are given a yearly vacation of 15 working days (about 18 days). Also—they usually work a week and have a week off duty or in the same proportions. During this off duty and vacation, their pay continues just as though they were working. When they grow old they are retired with a pension.

TRAVEL ON PASS

They have a railroad pass for traveling while on business. They have an excellent chance to see the country.

COMPARE

Compare these conditions with your present or your prospective condition, perhaps changing positions frequently, kicking around from post to pillar, no chance in sight for PERMANENT increase or advancement; frequently "laid off" and the year's average salary very low. DO YOU EARN \$1,600 EVERY YEAR? HAVE YOU ANY ASSURANCE THAT A FEW YEARS FROM NOW YOU WILL GET \$2,300 A YEAR?

POSITION IS EASY TO GET

These positions are not hard to get. Country residents and city residents stand equal chance. Good common sense education is all that is needed. Experience is unnecessary, and political influence is not used.

GET FREE LIST OF POSITIONS

Fill out the following coupon. Tear it off; and mail it today—now, at once. We will immediately send you a free list of U. S. Government positions now obtainable, also free copy of our illustrated book, "How to Get a Government Position;" we will also explain to you our proposition of FREE COACHING for these coming examinations—DO IT NOW—This investment of two cents for a postage stamp may change your entire future life.

COUPON

FRANKLIN INSTITUTE, Dept. B177, Rochester, N. Y.

Without cost or obligation of any kind, send me list of U. S. Government Positions and tell me how I can quickly get a position paying \$1,600 to \$2,300 a year.

Name

Address

Please Mention Popular Mechanics

\$75⁰⁰ CASH WEEKLY *also* Guaranteed Salary

A sure income; pleasant, easy work, demonstrating Violet Rays. Experience not essential; the demonstration makes the sale for you. Many buy on sight; this marvelous, scientific device brings health, happiness and beauty to all. Endorsed by leading doctors, specialists and plain folks.

Men and Women

earn big money, spare time or all time. We guarantee salary to experienced producers. Commissions very liberal, paid in cash. We deliver and collect. Exclusive territory to workers. A push-over for quick money, steady income.

VI-REX CO. 326 W. Madison - Chicago
Dept. D-10



THE PRACTICAL Automobile, Wagon, House and Sign Painter

By W. F. White

Postpaid \$1.00

This book is written for the man who wishes to paint his automobile, or his home, or wagon. It will tell the inexperienced just how to do it, and it will tell him how to mix paints. It also

contains many painters' recipes and trade secrets of great value. Bound in Cloth—157 pages—Size 5 x 7½.

Postpaid \$1.00

SHREWSBURY PUBLISHING COMPANY
5525 West Lake Street Chicago, Illinois

MUSIC LESSONS FREE



IN YOUR
OWN
HOME

You can read music like this quickly
Piano, Organ, Violin, Mandolin, Guitar, Banjo, etc.
Beginners or advanced players. One lesson weekly. Illustrations make everything plain. Only expense about 20 per day to cover cost of postage and music used. Write for FREE booklet which explains everything in full.

AMERICAN SCHOOL OF MUSIC, 51 Lakeside Building, CHICAGO

LEARN WATCH REPAIRING

Be a watchmaker—you can learn this profitable trade by correspondence in a few weeks in your own home by the DeSelms Chart System. After you complete the course you will know a watch from A to Z. You will know just what the matter is and how to repair one. When you graduate you will be a practical watchmaker and repairer and competent to fill any position. Positions for our graduates. Ask for our Free Book. It explains our system and terms.

THE DeSELMS WATCH SCHOOL
23 Perry Street ATTICA, INDIANA



PIMPLY SKIN made WELL

When a few applications of this wonder-working lotion has cleared faces of pimples, **FREE blackheads, acne eruptions** on the face or body, **barbers itch, eczema, enlarged pores, oily or shiny skin**, you can realize why **CLEAR-TONE** has been tested and approved in over **100,000 Test Cases**. The simplicity of the treatment, and *The Story of How I Cured Myself* are all explained in my free booklet, "A Clear-Tone Skin." Write for your copy today and learn of the results gotten by thousands of men and women.



E. S. GIVENS, 128 Chemical Bldg., Kansas City, Mo.

Miracle Men of Science

*Their Amazing Achievements Told At Last
In One Absorbing Story*

For centuries men of genius have been making wonderful discoveries, have been disclosing the amazing secrets of nature, have been getting her great forces under control. Their achievements have changed our world and transformed our daily lives. The record of their triumphs forms a thrilling romance—a romance which has now been told, for the first time, in one simple flowing story. So that you may know about this epoch-making work we offer

A Striking Booklet With Over 30 Fascinating Pictures FREE to You

This profusely illustrated little book, with three plates in full color and over thirty half-tone illustrations of unusual interest, tells how Professor Thomson and his associates have described in the four magnificent volumes of *The Outline of Science* all scientific achievement from the beginning of time. This fascinating book is yours free—send the coupon below, no obligation and no expense.

The Most Fascinating Story Ever Told

More entertaining than fiction is THE OUTLINE OF SCIENCE, revealing all the marvels of the wonder world of science—the romance of the heavens—the ascent of man—the invisible world—marvels of animal, insect, bird, fish, and plant life—miracles of electricity, wireless, chemistry, and hundreds more.

The Romance of a Thousand Thrills Acclaimed Everywhere with Enthusiasm

"Should be read by every human being."—*William Beebe, famous scientist.* "More interesting to read than any romance."—*N. Y. Globe.* "A tensely absorbing narrative."—*Providence Journal.* Hundreds of other authorities are unanimous in its praise.

Send Now For Your Copy of This Free Book

It costs you nothing and obligates you in no way whatever. It tells a remarkable story that will interest you tremendously. Its many illustrations, taken from *The Outline of Science*, are of unusual value in themselves. And then you want to know more about the great work which has been hailed as the most important publishing achievement in years. Simply sign and send us the attached coupon and your copy of this unusual booklet will be mailed immediately.

The Coupon Brings It

G. P. Putnam's Sons
Dept. 213, 2 West 45th St., New York

Send me by mail, without cost or obligation of any kind on my part, the free booklet with three color plates and over thirty half-tone illustrations, describing *The Outline of Science*.

Name.....

Street and No.....

City and State.....

Occupation.....

G. P. PUTNAM'S SONS, Dept. 213, 2 West 45th St., NEW YORK

ELECTRICITY

In the Great Shops of

COYNE

LEARN

Free Railroad Fare

WE PAY YOUR RAILROAD FARE TO CHICAGO—the Electrical Center of the World—from any place in the United States. Grasp this opportunity to see the country at our expense. Don't stick in one spot—travel—get experience. Come to Coyne—the largest electrical school in the country specializing in electrical instruction only. Learn electricity in 3 months. Fit yourself for a big paying job. Get a complete training so you can make big money as Power Plant Operator, Superintendent, Telephone man, Construction worker, auto, truck or tractor electrician, battery man, radio expert, or you can go into business for yourself as electrical contractor, dealer, auto ignition or battery expert and make from \$3,000 to \$20,000 a year. Hundreds of our graduates today are making big money and you can do the same if you grasp this opportunity—act now.

Fit Yourself for a Big Paying Job

No books or useless theory. You are trained on \$200,000 worth of electrical equipment. Everything from door bells to power plants. You work on motors, generators, house-wiring, autos, batteries, radio, switch-boards, power plants—everything to make you an expert ready to step right into a position paying from \$45 to \$100 a week.

No Previous Experience Necessary

You don't need to know anything at all about electricity to enter Coyne. Nor do you need to have any considerable schooling. We have no classes; use no books. We teach by the most practical methods. Our instructors, all electrical experts, work with you in the actual doing of the thing to be learned. They tell you **what** to do, **how** to do it, and **why**. You pass along from the simplest task on signal bells to the finishing work on the monster dynamos, just as fast as you can learn. (And you can spend as much time over 3 months as you wish, without extra cost.) Here you work with your hands just as you will when you get on the job after graduation. The Coyne method of teaching practical Electrical Engineering is not only the most efficient, but the simplest and quickest known.

COYNE

Electrical School

Endorsed by Electrical Industry

1300-1310 W. Harrison St., Dept. 13-57, CHICAGO, ILL.

IN 3 MONTHS

Radio Course FREE

We give you free a course in Radio—the marvel of the age. Constructing, installing and operating. You can build your own receiving set. The complete electrical course gives you practical training in Circuits, House Wiring, D. C., A. C., Armature and Stator Winding, Drafting, Auto, Truck and Tractor Electricity, Battery Building and Repairing and Radio. In addition you receive Free, a Life Membership which enables you to stay as long as you want or come back for further training at any time without charge.

Earn While You Learn We help students to secure jobs to earn a good part of their expenses while studying.

Send Coupon Today!

Don't delay a minute; send that coupon *right now* for our big free catalog and full particulars of Free Railroad Fare offer. Take the first step now—get started in this great industry—the industry that offers the greatest opportunities for big money.

Remember this special offer is limited so act now

B. W. COOKE, Pres.
Coyne Electrical School
1300-1310 W. Harrison St.
Dept. 13-57, Chicago

Dear Sir: Please send me free your big catalog and full particulars of your special offer of Free Railroad Fare and free Radio course.

Name _____

Address _____

MAKE \$150 to \$400 A MONTH

ELECTRICITY

Lifts Men Out of Small Pay Jobs



Without
Training



With
Training

**Are You Satisfied With Your Job?
Have You Got all the Money You Want?
If Not Send for MY BIG NEW
FREE BOOK and Learn How to**

Earn \$3,500 to \$10,000 a Year As an Electrical Expert

TRAINED "Electrical Experts" are in great demand at the highest salaries, and the opportunities for advancement and a big success in this line are the greatest ever known.

"Electrical Experts" earn \$70 to \$200 a week. Fit yourself for one of these big paying positions. Big jobs everywhere are waiting for trained men to fill them.

**Learn at Home to Earn
\$12.00 to \$30.00 a Day**

Today even the ordinary Electrician—the "screw driver" kind—is making money—big money. But it's the trained man—the man who knows the whys and wherefores of Electricity—the "Electrical Expert"—who is picked out to "boss"

ordinary Electricians—to boss Big Jobs—the jobs that pay. You, too, can learn to fill one of these jobs—spare time only is needed. Be an "Electrical Expert"—Earn \$70 to \$200 a week.

I Give You a Real Training

As Chief Engineer of the Chicago Engineering Works, I know exactly the kind of training a man needs to get the best positions at the highest salaries. Hundreds of my students are now earning \$3,500 to \$10,000 a year. Many are successful ELECTRICAL CONTRACTORS. Every branch of Electricity is open to you when you have finished my course. My experience as a practical engineer and my most unusual course makes this possible. I even have special lessons for those who want to go into business for themselves.

FREE—Electrical Working Outfit—FREE

I give each student Outfit of Electrical Tools. Materials and Measuring Instruments absolutely FREE. I also furnish them with all supplies, including examination paper, and many other things that other schools don't furnish. You do PRACTICAL work—AT HOME with this Outfit. You start right in after the first few lessons to WORK AT YOUR PROFESSION in a practical way.

Age or Lack of Experience No Drawback

You don't have to be a College Man; you don't have to be a High School graduate. If you can read and write

English, my course will make you a big success. It is the most simple, thorough, and successful Electrical Course in existence, and offers every man, regardless of age, education, or previous experience, the chance to become, in a very short time, an "Electrical Expert," able to make from \$70 to \$200 a week.

Your Satisfaction Guaranteed

So sure am I that you can learn Electricity—so sure am I that after studying with me you, too, can get into the "big money" class in electrical work, that I will guarantee under bond to return every single penny paid me in tuition if, when you have finished my course, you are not satisfied it was the best investment you ever made.

Get Started Now—Mail Coupon

I want to send you the "Vital Facts" of the Electrical Industry, including my Electrical Book, Proof Lessons, and a sample of my guarantee bond all FREE. These cost you nothing and you'll enjoy them. Make the start today for a bright future in Electricity. Send in the coupon—NOW.

**L. L. COOKE, Chief Engineer
Chicago Engineering Works**

Dept. 17

2150 Lawrence Ave. Chicago, Ill.

**USE THIS FREE
OUTFIT COUPON**

**L. L. COOKE, Chief Engineer
Chicago Engineering Works,
Dept. 17, 2150 Lawrence Ave.
Chicago, Illinois**

Dear Sir:—Send at once the "Vital Facts" containing Sample Lessons, your Big Book, and full particulars of your Free Outfit and Home Study Course—all fully prepaid, without obligation on my part.

Name.....

Address.....

The "Cooke" Trained Man is the "Big Pay" Man

CLASSIFIED ADVERTISEMENTS

WORLD'S BEST WANT AD MEDIUM

Advertisements in this section, 25 cents per word, each insertion, minimum 10 words, payable in advance. To be inserted under proper classification in November issue, copy should be in our office September 18th.

ADVERTISING AGENCIES

ADVERTISING. We sell Display in all publications at Publishers' rates and advise for your profit. What do you sell? Write. Capital Advertising Co., Inc., Munsey Bldg., Washington, D. C.

To secure agents or salesmen or for selling farms and reaching investors, use classified (want) ads in largest newspapers and magazines. Price list No. 39 sent free. Ankrum Advertising Agency, 29 W. Jackson Bldg., Chicago, Ill. The largest classified advertising agency in the U. S.

25 WORDS—355 Rural Weeklies, \$14.29. Ad-Meyer Agency, 4112-M Hartford, St. Louis.

FOR ADVERTISERS

FREE Suggestions for improving your follow-up letters, booklets, folders, catalogs, advertisements. Send samples and full details. L. Taylor, Box 44X, Freeport, Ill.

HOOVER-LEE Intelligent Advertising Service, Hammond, Indiana. Specialize in circulars, booklets, letters.

INCH Display 199 Magazines thrice, \$8. Beck, 5406 Alaska, St. Louis.

ADVERTISE in 24 Big Sunday Newspapers, 25 words \$15.00. Catalog listing 1,000 leading Dailies, Weeklies, Magazines, 40 stamps. Union Advertising, Baltimore Bldg., Chicago.

SALES LETTERS

SALES letters, booklets, folders masterfully prepared by Ad-Expert Mac Fee, 2731 Warren Avenue, Chicago.

AUTOMOBILE SUPPLIES

CHEVROLET Gasoline Gauge, F198 1922-23-24 Models. Price \$2.90. Money returned if it fails to please you. Jos. Woodwell Co., established 1847, 201 Wood St., Pittsburgh, Pa.

STANLEY Steamer Owners, inclose stamp for "List" Acme Boilers, Burners, Vaporizers, Superheaters: Everything for your Steam Automobile. "Doc" Palmer, Denver, Colo.

FORD Owners, Chevrolet, Overland: Do your hubs loosen, go on too far, keys wear, wheels wobble? Avoid cost of renewal. Use our improved hub bushing. Quickly applied, thoroughly tightens. Prepaid 50c each; 5 for \$2.00. Auto Specialties, 327 Pasadena Ave., Youngstown, Ohio.

AUTOMOBILE owners, garagemen, mechanics, send for free copy America's popular motor magazine. Contains helpful, money-saving articles on repairing, overhauling, ignition, carburetors, batteries, etc. Automobile Digest, 505 Butler Bldg., Cincinnati.

AUTOMATIC Air Compressor, quietest, most compact outfit on market. No noisy breaking belts. Motor and pump one unit. Thousands garages, filling stations, tire shops, using. Most economical to operate. Absolutely dependable. \$35 cash, balance terms. Iron Clad satisfaction or Money-back guarantee. Write for details. Hobart Brothers, Troy, Ohio.

BIG Profits. Wonderful VIX Vapor Humidifier. 30 to 60 miles 1 gallon. One free to introduce. Walter Critchlow, Suite 302, 716 Madison, Chicago.

AUTO Mechanics: It will pay you to send in postal for full details on Ford Magneto Tester, Sun Company, 4344 Cottage Grove, Chicago.

AUTOMOBILISTS. Representatives, Mechanics—Extraordinary necessity. "Saves Money Three Ways." Guaranteed. Patented. Scientifically simple, thousands purchased. Everybody "satisfied"—"De-lighted." \$12.00 upwards daily. Communicate immediately. "Wizard," 453 Central Avenue, Rochester, N. Y.

REPAIRING Ford Cars, Trucks and Tractors in the most proper and efficient way is explained in a new 229-page book by the former director of the Ford Motor Co. Service School. This information is otherwise unavailable outside of the Ford plant. Written more especially for the mechanic and repairman. Price \$2 postpaid. Popular Mechanics Book Dept., 209 E. Ontario St., Chicago.

BEAUTIFUL Three Initial Auto Monograms with any lodge emblem. Hand engraved and colored. No transferring. Sketch free. "Engraver," B. I. Box 801, San Diego, Calif.

SPARK Plugs, any size, \$1.50 per dozen. Bendix Drives, any type exchanged—\$1.05 each. Auto Bulbs, 50% off Mazda list. Free Delivery anywhere: Money-Back guarantee; 24-hour service. Terms C.O.D. Kelly Lamp Works, Oak Park, Ill.

SAVE half on new gears, bearings, shafts for all automobiles made since 1910. State what you want, we will cheerfully give estimate on same. Orders filled same day as received. Money refunded if not satisfactory. Gault Auto Parts, 2833 Warren Ave., Chicago, Ill.

WHY pay \$25.00 to \$200.00 repair bills? Buy "Automobile Repairing Made Easy" and do the job yourself. Every detail of every car fully handled. All owners, mechanics, chauffeurs, dealers need it. 1060 profusely illustrated pages. \$4.00 postpaid. Catalogue free. Wells and Edwards, P852 George, Chicago.

8-HOUR Battery Charging with Constant Potential Pays Big. Easy Payments. Profits Pay. Postal brings details. Hobartson, Troy, Ohio.

AUTOMOBILE parts, guaranteed new for all cars. Save money; get our wholesale prices on gears, shafts and bearings. State make of car, model and parts wanted. Parts shipped immediately from stock. We refund your money, including transportation charges, if not satisfied. Mechanics Gear Co., 3708 No. Halsted St., Chicago.

AUTOMOBILE Parts—Used parts for most any car at half factory list prices. Allen, Briscoe, Buick, Cadillac, Chalmers, Chevrolet, Dodge, Dart, Grant, Hudson, Hupmobile, Oakland, Overland, Oldsmobile, Reo, Studebaker and many others. Send list of parts wanted. Maxwell Bros., 4106 Olive St., St. Louis, Mo.

LIBERTY Air Compressors, for garages, tire-shops, filling stations, also paint spraying equipment. Air Compressor & Equipment Co., 1437 Carroll Avenue, Chicago, Ill. Distributors wanted.

MAGNETO Recharger: State Rights free. State Distributors, Reliable, 328 Jay St., Utica, N. Y.

AUTO parts—Save 25-30%. New gears, axles, bearing, springs, radiators, magnetos—4,000 models. Bankrupt supplies, retopping outfits. Brightman Auto Exchange, 321 Windsor Ave., Hartford, Conn. Largest in the East.

TOURIST Auto Sleeping Beds—Camp Equipment, Vanderpool's, Springfield, Ohio.

WANTED to manufacture or will handle sales, high grade automobile specialties. Especially interested in devices to be applied as standard equipment. Zimmerman, 4952 Blackstone Ave., Chicago, Ill.

AUTOMOBILES

AUTOMOBILE owners, garagemen, mechanics, send for free copy America's popular motor magazine. Contains helpful, money-saving articles on repairing, overhauling, ignition, carburetors, batteries, etc. Automobile Digest, 505 Butler Bldg., Cincinnati.

PATENTS Procured. Send sketch or model today for examination, prompt report and advice. No charge for preliminary advice. Write for free Booklet and blank form on which to disclose your idea. Highest references. Promptness assured. Clarence A. O'Brien, Registered Patent Lawyer, 562 Southern Building, Washington, D. C.

REO and Buick flat rate sheets ready for shop use; price \$2.50. Address The Predmore-Henry Motor Co., Akron, O.

DO you remember where the money you spend on your car goes? Moeller's Cost Finding Automobile Record will tell you. Three year record, flexible Badgeride Cover \$5.00. One month's sample sheet 25c silver. No agents. Moeller & Co., 1019 West Ninth St., Des Moines, Iowa.

PATENTS—Write for our free illustrated Guide Book and Evidence of Conception Blank. Send model or sketch and description of your invention and we will give our opinion of its patentable nature. Highest references. Prompt service. Reasonable terms. Victor J. Evans & Co., 185 Ninth, Washington, D. C.

25c BRINGS the funniest Automobile Guide Book. Good Anywhere. E. R. Smith, Walla Walla, Wash.

AUTO Trails Maps, Pocket Size, Rand McNally Official; Most Popular Road Guides, 21 Maps, covering 21 touring districts, each complete in itself. Featuring marked auto routes with explanation of markers; all main traveled auto roads; mileage between towns; city maps of larger towns; reliable information concerning hotels, garages and service stations. Price 35c ea. postpaid. Send for further particulars. Popular Mechanics Book Dept., 290 E. Ontario St., Chicago.

FOR FORD OWNERS

AUTOMOBILE owners, garagemen, mechanics, send for free copy America's popular motor magazine. Contains helpful, money-saving articles on repairing, overhauling, ignition, carburetors, batteries, etc. Automobile Digest, 505 Butler Bldg., Cincinnati.

STOP that uncertainty of lubrication in your Ford engine. Send \$3.75 for a "Ford Faithful" Oiling System and you'll have no more burned-out bearings or under-lubricated motor. Installed in twenty minutes with pair of pliers. Money Back Guarantee. W. O. Thompson Mfg. Co., Pasadena, Calif.

FORD Car Repair Book Sent Free. This complete and well illustrated valuable book explains in a simple way how to overcome Ford car troubles: Repairing, Economical Winter Driving, Cold Weather Car Starting, Equipment for Fall and Winter, Curing Piston Ring Troubles, Carburetor Adjustments and Repairs, Connecting Rods, Timers, Transmission Troubles, and practically every phase of Ford car driving, repairing and equipment. Send 25c coin for three months' trial subscription and get the valuable repair book free. Ford Owner and Dealer Magazine, 534 Montgomery Bldg., Milwaukee, Wis.

CAN you do 60 miles on 1 gallon? Wonderful VIX Vapor Humidifier. One free to introduce. Walter Critchlow, Suite 302, 716 Madison, Chicago.

FORD Owners! Learn About Wonderful New Power Maker. Practically eliminates spark lever—stops misfiring—adds power and speed—saves gas and is waterproof. Price is low. Ask for booklet and learn about Free Trial Offer. A. B. M. Co., Box Z, Brightwood, Mass.

UNDERSLING with "REO" Swing Lo Irons. See "Red-i-Kut" ad, page 163.

RELINE your transmission bands in a few minutes for Seventy Cents each; \$2.25 per set. Satisfaction Guaranteed. Write, Ever-Ready Brake Lining Co., 305 St. Clair N. E., Cleveland, Ohio.

MOTORCYCLES, BICYCLES AND SUPPLIES

SEND for our Bargain Bulletin and Money Saving Message. It will save you money on Motorcycles, Side Cars, Motor Wheels, Repair Parts, and Accessories. Some used parts at less than half. Cleveland and Ace Motorcycles our specialty. See our ad on page 129. American Motor Cycle Co., 2043-5-7 W. Chicago Ave., Chicago.

1920 HARLEY-DAVIDSONS, \$90; 1919, \$65; 1917, \$55; 1915, \$40. Guaranteed. Money refunded if not satisfied. Circular free. Wisconsin Cycle Sales Co., 726 National Ave., Milwaukee, Wis.

USED parts for all motorcycles, cheap. State wants, Schuck Cycle Co., 1922 Westlake, Seattle, Wash.

WONDERFUL bargains in reconditioned motorcycles. Priced as low as \$35. Sidecars from \$25 up. Everyone expertly rebuilt and guaranteed in absolutely first-class condition. Don't delay. Send 2c for new big catalog showing 1923 bargains. Western Supplies Co., 539 Hayutin Bldg., Denver, Colo.

'19 INDIAN 3 Speed \$75.00. '20 Indian 3 Speed \$95.00. '21 Indian 3 Speed \$125.00. Howard A. French Company, Baltimore, Md., Washington, D. C.

SEND for big list of slightly used motorcycles on the easy payment plan. Howard Cycle Co., Trenton, N. J.

DON'T buy a Bicycle Motor Attachment until you get our new catalogue and prices. Also runs washers, pumps and shop machinery. Shaw Mfg. Co., Dept. 27, Galesburg, Kans.

AVIATION

"LEARN to Fly." Pay as you learn. \$10 per 20 minute lesson. Curtiss and Lincoln-Standard biplanes used. Pilots licenses issued. Mechanical training free. Several good planes for sale. Aviation Engineering Co., Lawrence, Kan.

DON'T worry over building Sport, Hydro or Sailplanes. I'll ship you crated for fifty dollars a Midget Fiberglass Fuselage. Hicks, Ft. Worth, Texas.

ONE Dollar for beautiful pair of sterling silver wings mounted on stick-pin or on bar-pin, with safety catch. Wear one to show your interest and connection with aviation. Clip this ad and mail with name and address to Wallace Aero Company, Davenport, Iowa, the oldest commercial aviation company in the middle west. Pay the postman.

PATENTS Procured. Send sketch or model today for examination, prompt report and advice. No charge for preliminary advice. Write for free Booklet and blank form on which to disclose your idea. Highest references. Promptness assured. Clarence A. O'Brien, Registered Patent Lawyer, 561 Southern Building, Washington, D. C.

BRAND New Curtiss Two Passenger Aeroplanes, Army Type, Delivered, Nine Hundred Dollars. Brand New Curtiss Ninety HP, OX5 Motors \$150. Elgin Aviation Co., Elgin, Kan.

TEN lessons in the air, of twenty minutes each, will make you a pilot, by our advanced method of training. This, together with our five-week shop course at \$100.00, makes America's oldest aircraft factory the most popular flying school. Work after class hours guaranteed. Heath Airplane Co., Chicago, Ill.

THE American School of Aviation announces a new correspondence course in Mechanics of Aviation. A thorough training in Practical Aeronautics. American School of Aviation, Dept. 186-B, 3601 Michigan Ave., Chicago, Ill.

HIGHEST, best catalogue Model Aeroplanes, Parts and Supplies; 5c Postpaid. Ideal Aeroplans Co., 72½ Green St., New York.

INVENTORS desiring patents should write for our Free Illustrated Guide Book and Evidence of Conception Blank. Send model or sketch for our opinion of its patentable nature. Highest references. Prompt service. Reasonable terms. Victor J. Evans & Co., 187 Ninth, Washington, D. C.

SEND 10c for our latest aeronautical catalog listing a complete line of airplane goods at reduced prices. Propeller catalog 4c; Ford or Motorcycle motored airplane catalog, 4c each. Heath Airplane Co., Chicago, Ill.

WELDING

ELECTRO plating Generators. Make money doing Plating Work. Priced reasonable. Terms if desired. Write us, Hobartsons, Troy, Ohio.

BOOKS AND PERIODICALS

YOU should have our New Illustrated List of Practical Books. Free. Spoon & Chamberlain, 120 P. M. Liberty Street, New York, N. Y.

MAKE \$10 to \$50 daily in your own home. How to Start a Mail Order Business (Copyrighted 1923) prepaid \$1.50. Free advice six months. G. C. Shaver, Publisher, Oil City, Pa.

SEND Today for free sample copy of Writer's Digest, America's greatest magazine for writers. Filled with practical articles by leading writers. Will help you write and sell stories, photoplays, songs, etc. 603 Butler Bldg., Cincinnati.

TRADE, class, technical magazines. List free! Local agents wanted everywhere. Trade Magazine Agency, Middletown, N. Y.

LEFAX—"Facts on Leaves." You make your own handbook, loose-leaf. From our complete list of Lefax data sheets you select only those that you actually need, then fill in your own notes or diagrams on extra blank sheets which come in 100 different styles. These in loose-leaf binder make up a book covering your individual needs. Send for complete information and price list to Popular Mechanics Book Dept., 200 E. Ontario St., Chicago.

HYPNOTISM Astounds, controls others. Wants gratified. 25 easy lessons \$1.10. Mindreading (any distance). Wonderful, \$2.75. Popular Institute, OP1014 Belmont, Chicago.

NEW and funny. The Yellow Touring Guide. Colors on quality paper. 25c. Edward R. Smith, Walla Walla, Wash.

INDUSTRIAL Alcohol. Wright's book everybody wants. Full directions for making with drawings of necessary apparatus. \$2.50 postpaid. Spoon & Chamberlain, 120 P. M. Liberty Street, New York, N. Y.

ELECTRICIANS' Examination book of questions and answers, with diagrams, symbols, tables, notes and formulas, for preparation for license, \$1.25. Address Reade Pub. Co., 296 Broadway, New York.

"LIGHTS, Colors, Tones and Nature's Finer Forces," covering Vibrations; Odic-Auras; Cold-lights; Radio; Inventions; 270 pages. Satisfaction guaranteed; \$2.00. Circulars Free. M. Stevens, Publisher, 242 Powell, San Francisco.

NOVELTIES, CURIOS, ETC.

IMPORTED Japanese Wonders, dropped into water, expand five times original size, turning into fish, flowers, animals, babies. Pretty package twelve assorted, 15c. Six 50c. Thirteen \$1.00. Prepaid. Heitch Insurance Policy, latest Prohibition joke, free, each order. Heinemann, 7242 Pingree, Chicago.

PICTURES AND POSTCARDS

JOIN Live Postcard Club; Membership Lists, including catalog, 10c. Harvey Teple, Decatur, Ind.

JOIN the Old Reliable Card Club. Membership 10c. Riverside Club, Frederick, Md.

BEAUTIFUL Aluminum Hood Stereoscope and 25 World War views \$1.25 postpaid. Catalogue free. Eagle Printing Co., Richmond, Ind.

GAMES AND ENTERTAINMENTS

CARTOONISTS—15 lessons cartooning, 25 chalk-talk hits. Complete instructions for newspaper and vaudeville cartooning. \$2. Comic Art Studios, Owatonna, Minn.

VENTRILQUISM taught almost anyone at home. Small cost. Send 2c stamp today for particulars and proof. George W. Smith, Room M-740, 125 N. Jefferson Ave., Peoria, Ill.

200 KINDS Iron, wood and wire puzzles. Leader and Illustrated list 10c. Western Puzzle Works, St. Paul, Minn.

MAGIC TRICKS, BOOKS, AND JOKERS' NOVELTIES

TRICKS, magic, cards, books. Catalog free. C. Fenner, 2401 Jefferson, Louisville, Ky.

25c "PACKAGE Magic Trick Cards, and Catalog, 10c. Hamilton, Barnes City, Iowa.

470 TRICKS, Puzzles, Jokes and big catalog 10c. "Andco," 4047-P, North Whipple, Chicago.

TRICKS, Puzzles, Pocket Novelties, Art View Pencils, 15c. Just out. Send for list. Retail and wholesale. Grandfield Mfg., 1238 Theriot Ave., Bronx, New York.

GOOD Books on Tricks, Magic, Puzzles, etc.—Houdini's Paper Magic, \$2.50; Houdini's Miracle Monkeys and Their Methods, \$3; Walker's Conjuring Tricks, \$2; Hoffman's Later Magic, \$2.50; Goldstein's More Tricks and Puzzles, \$1; Mashlyne and Derant's Our Magic, \$2.50; Elbiquet's Supplementary Magic, \$2; Elbiquet's Text Book of Magic, \$1.60. Prices postpaid. Popular Mechanics Book Dept., 200 E. Ontario St., Chicago.

TWO good card tricks and magic fan for dime. Woolley Novelty Co., Peoria, Ill.

MAGIC—Tricks, Books and Supplies. For Amateurs as well as the great professionals. Anyone can learn through our instructions. Feature Acts in Mind Reading, Spiritualism, Rope Ties, etc. Large Illustrated Professional Catalog, 10c. Chicago Magic Co., 140 S. Dearborn St., Dept. B, Chicago, Ill.

TRICKS, Puzzles, jokes, magical apparatus, plays, stage supplies, mini-reading, sensational escapes. 160-page illustrated professional catalog, 10c. Oaks Magical Co., Dent 548, Oshkosh, Wis.

EVERYTHING in Magic, Four Catalogs 15c. Gilmaglio, Morgan Park, Ill.

STAMP COLLECTING

FREE! 25 varieties French Colonials and 100 var. Foreign to applicants for Net Approvals. Reference required. A. M. McFadden, 3105 Ash Street, Mt. Ranier, Md.

250 DIFFERENT stamps 25c; 500 65c. Fred Onken, 630 79th Street, Brooklyn, N. Y.

ALL Different; 9 Epirus, 6 Greece, 4 Siam, 5 China, 8 Cuba, 5 Peru, 6 fine sets only 10c. McKenzie Co., 1313½ Railroad Ave., Bellingham, Wash.

\$4.00—CATALOG Value 10c. Packet scarce Venezuela, Haitian, German stamps to approval applicants. Midwest, Kemper Building, Kansas City, Mo.

FREE—200 different stamps to approval applicants sending 4 cents postage. H. W. Myers & Co., 1018 Florida St., Richmond, Calif.

100 RARE and valuable foreign stamps, all different, and big catalog, 7c. Stanton, Niantic, Conn.

FREE Set, 14 varieties to all applicants for 1 and 2c approvals—more premiums later. Send 2c postage. Elmer, 12 Altemarie St., Boston.

BEST one-cent approvals in America. P. P. Hand, 1117 So. 60th St., Philadelphia, Pa.

ARYSSINIAN stamps Free to approval applicants. 50% commission. Enclose 2c. 1,000 different stamps \$1.35. Ioor, 801 State Life, Indianapolis, Ind.

START a Stamp Collection—70 different stamps from 70 different foreign countries, including Africa, Asia, Australia, Europe, West Indies, etc. Our pamphlet which tells "How to make a collection properly," and price list of albums, packets and sets all for only 16 cents. Queen City Stamp Co., Room 86, 604 Race St., Cincinnati, O.

GERMAIN—Air Mail Set Free, to applicants for my 1c to 15c net approvals; also high-priced stamps at 50 per cent discount. References required. Chas. W. Schmidt, Jr., 3227 Benner St., Wissinoming, Philadelphia, Pa.

STAMPS ¼c up. The beginner and the collector with up to 15,000 varieties will save money by buying from my approval sheets. Free premium. Herbert Keigwin, Middletown, N. Y.

SUPERFLUOUS Stamps Free, value 10c upwards. Send postage for approval books. John W. Aymer, Ashbury Park, N. J.

FREE—Set Russian Occupation, gauge, \$1 U. S. stamp lists, etc., for 2c stamp and reference for approvals. 100 diff. U. S. 2c; 25 diff. Bulgaria 9c. Hawkeye Stamp Co., Cedar Rapids, 39, Iowa.

UNIVERSAL Packet, 100 varieties, all over the world, 10 cents. Covert Stamp, 39 State, Rochester, N. Y.

ZAMBESIA, Zanzibar, Abyssinia, Herzegovina, Allenstein stamps, menagerie collection, hinges, 10c. Liberty, 3974 Arsenal, St. Louis, Mo.

FREE! World's smallest stamp. Postage 2c. Approvals. Cannon, 1415 Carey, Davenport, Iowa.

OUR valuable catalog of over 500 practical books arranged for easy reference under 80 different subject headings will be sent free on request. Popular Mechanics Book Dept., 200 E. Ontario St., Chicago.

A DOVER Bargain Stamp Outfit! 250 Peelable Hinges, 50 all diff. stamps, Plume (triangle), Nyassa, French Coins. (Pictorials), Malay (Tiger), etc.; 29 Varn. War and New Europe, 5 Blank Approval sheets, 36-page list and Bargain list, all for only 10c to those asking to see my choice 50% approvals. L. B. Dover (Dept. C), Buena Vista, Colo.

NYASSA Giraffes and packet of 52 different scarce stamps, Plume Triangle, large \$1.00 U. S. Rev., millimetre scale, perforation gauge and ruler for only 9c. To introduce our Sudden Service approvals, Fennell Stamp Company, Dept. P, Fullerton Bldg., St. Louis, Mo.

FREE! Rare Hayti cataloging \$1, to approval applicants. Penna Stamp Co., Manor, Pa.

FREE—12 different British Colonials to approval applicants. Postage 2c. Head Stamp Co., 1232½ Oakland, Milwaukee, Wis.

2,000 DIFFERENT Stamps \$3.65; 1,000, \$1.55; 500, 55c; 300, 25c. Michael, 5353 Calumet, Chicago.

200 DIFFERENT stamps ten cents to approval applicants only. K. C. Stamp Co., Lee Bldg., Kansas City, Mo.

\$9-VALUE 15c. Packet of scarce stamps from South and Central America, including Cuba, Hayti, Salvador, Venezuela, Uruguay, having catalog value of over \$9.00. Price to new applicants for Fenway net approvals 15c. Fenway Stamp Co., Fenway Station, Boston, Mass.

FREE set to applicants for 50% approvals. Dorval Stamp Co., Gloversville, N. Y.

FREE—50 varieties or set to approval applicants sending 2c. Richard P. Lamrecht, Valparaiso, Ind.

\$3.00 FOR 12c!! 100 different Neurope, catalogued \$2.10; triangle stamp, Red Cross set, airplane set, perforation gauge, millimetre scale, fine wallet, 5 approval sheets, 250 hinges, scarce packet from Nyassa, Abyssinia, etc., price lists and approvals—all for 12c!! Atlanta Stamp Co., Box 532, Atlanta, Ga.

FREE, Dollar Stamp Free to applicants for my 60% approvals. Norman Shultz, Colorado Springs, Colo.

STAMPS sent on approval at 70% discount. Reference required. Emory Renold, Hanover, Pa.

STAMPS, 50 Varieties, Africa, Brazil, Peru, Cuba, Mexico, etc., 10c. 50 different U. S., 25c; 1,000 mixed, 40c; 1,000 hinges, 10c. List free. C. Stegman, 5048 Cote Brilliante, St. Louis, Mo.

158 GENUINE Foreign Stamps Mexico War Issues, Venezuela, Salvador and India Service, Guatemala, China, etc., only 10c. Finest approval sheets 50 to 60%. Agents Wanted. Big 72-p. Lists Free. We Buy Stamps, Estab. 29 yrs, Hussman Stamp Co., Dept. 54, St. Louis, Mo.

FRENCH Colonies Free—Beautiful Picture set, including Native Chiefs, Tigers, Pictorials, 2c Postage. Empire Stamp Company, Toronto, Canada.

24 VARIETIES Cuban stamps, 10 cents. List of 6,000 low-priced stamps free. Address Chambers Stamp Co., 111P, Nassau St., New York City, N. Y.

STAMPS, 29 unused, all different, free. Postage 2c. Mention paper. Quaker Stamp Co., Toledo, O.

PACKET of 23 stamps, no two countries alike. Packet hinges. Set of \$1 and \$2 U. S. Rev., all for 5c. Mention paper. Miami Stamp Co., Toledo, Ohio.

20 UNUSED stamps free. All different. Postage, 2c. Flak Stamps, Toledo, Ohio.

FOREIGN Stamp Collection Sent Free. Cornish Company, Schenectady, N. Y.

105 CHINA, etc., stamp dictionary, list, 2c. Album (500 Illustrations), 3c. Bullard, Stn. A, Boston.

FREE—Nyassa Set, also one set Neurope, for a request for my 1, 2 and 3c net approvals, also the higher-priced desirable stamps at 50% discount and better. You will find many good British Col. on my sheets and books. None better. Chas. T. Egner, 4821 Frankfort Ave., FR'D, Philadelphia, Pa.

STAMPS Free—War Stamps, Surcharged, Unused Pictorials, British, French Colonials, 2c postage. Midland Stamp Co., Toronto, Canada.

BIG Variety Packet Foreign Stamps free for 2c postage. Gray Stamp Co., Station E, Toronto, Canada.

RARE COINS

GENUINE Confederate \$10 bill 10c. Durso, 25 Mulberry, N. Y. City.

CALIFORNIA gold, ¾ size, 27c; ½ size, 53c; three-cent-piece and catalogue, 10c. Norman Shultz, Colorado Springs, Colo.

50,000 COINS, medals, paper money, antique firearms, Indian relics, curios. Lists free. Nagy, 33P South 18th, Philadelphia.

HOW'S This for Ten Cents? Mail 10c with your name and address, and you'll get a genuine old coin over 100 years old and a 50-page illustrated Coin Catalog. A "just-to-get-acquainted offer." Coin Collecting will prove pleasant and profitable to you. Start Now. B. Max Mohl, Numismatist, Mehl Bldg., Dept. P, Fort Worth, Texas. Largest Rare Coin Establishment in the United States.

40 OLD coins all different \$1.00. List free. Claud Denney, Box 315, Dallas, Texas.

OLD Coins. Large Fall selling catalogue of coins for sale, free. Catalogue quoting prices paid for coins, 10c. William Messlein, 101 A Tremont St., Boston, Mass.

WILL pay Fifty Dollars for nickel of 1913 with Liberty Head. We pay cash premiums for all rare coins. Send 4c for large Coin Circular. May mean much profit to you. Numismatic Bank, Dept. H, Fort Worth, Texas.

100,000 GERMAN Marks, \$1.25; also Banknotes of Austria, Poland, Russia and Hungary. Write for prices. George Grigolet, 20 E. Jackson, Chicago.

10 DIFFERENT foreign coins, 25c postpaid. Otto Oddehon, Independence, Mo.

CAMERAS AND PHOTO SUPPLIES

EARN Money With Your Kodak. You doubtless have a camera. Are you using it to its full capacity? Are you making it pay you a dividend? If not, Why? How many regrets do you have from your negatives? Answer, None, Why? Because you never are satisfied with the gray-and-white prints representing what you visualized when you snapped the camera shutter. The incentive, the emotional urge of color, is always missing. Thousands of photographers and others have learned that color is as easily added to a print as tints are to a gray-and-white Greeting card. Peerless, —self-blending—Japanese Transparent Water Colors make tinting easy. Anyone can color prints. Ask your dealer for them, or send us \$1.00 for a Complete Set, 15 colors, with full instructions. Free—With the above offer we will tint one of your own prints, up to 5x7, absolutely free, showing the charm and beauty of a well colored photograph, and to serve as a model. Add stamps for return of your print. Peerless colors have been the acknowledged standard everywhere for more than two decades. Address, Japanese Water Color Co., Peerless Building, Rochester, N. Y., U. S. A. Rochester Bank References.

SUPERIOR quality finishing and enlarging. Trial offer: Any size 6 exposure roll developed and printed, 25 cents. 8x10 enlargement unmounted, 30 cents. Carshuff Photo Finishing Co., 2129 W. Van Buren St., Chicago, Ill.

SEND \$2.95 and film or kodak picture. I'll enlarge it 11x14 inches and oil-color it. Original returned without damage. Otto Hueser, 4356 No. Lincoln St., Chicago, Ill.

BARGAINS in Cameras, lenses, binoculars and field glasses. Shotguns, revolvers, microscopes taken in trade. National Camera Exch., 7th and Marquette, Minneapolis, Minn.

JUST Published—Our new complete 128-page catalog and bargain book of new and used cameras and supplies. Our goods are guaranteed finest quality obtainable. We have thousands of satisfied customers. Write at once for this bargain bulletin, just hot from the press. Address Central Camera Co., 124 S. Wabash Ave., Dept. E-74, Chicago, Ill.

ARE you satisfied with your camera? We will take it in trade for any other kind or pay you cash for it. Give full description as to size, kind and condition. We have a large line of High-Grade Imported cameras, and many good used ones. Also Graflex, Kodak and others. Money back if not satisfied. Philadelphia Camera Exchange, 1129 Chestnut, Philadelphia, Pa.

FILMS developed, prints made, prompt service. List free. Koscielnak, 17214 Lamont, Detroit, Mich.

JUST Out—Bargain List, Cameras, Lenses, Etc. Pacific Photo Supply Co., 408 Market Street, San Francisco, Calif.

BIG Money Saved on Photographic Lenses and Apparatus—goods exchanged; repairing done. Ralph J. Golsen, 1128 Argyle St., Chicago, Dept. P.

KODAK Films—Special trial offer; your next kodak film developed, 5c—prints, 2c each. Moser & Son, 1917 St. James Ave., Cincinnati.

MODERN Photography in all its branches now taught by mail. New Successful Method. Students earning \$300.00 while learning. Big Opportunity. Write for particulars and unusual offer open for short time. Dept. 3435 International Studios, Inc., 3691 Michigan Ave., Chicago.

SPECIAL Trial Offer: Any size Kodak film developed for 5c; prints 3c each. Overnight service. Get a Free Auto. Ask for details. Roanoke Photo Finishing Co., 209 Bell Ave., Roanoke, Va.

MAKE money with your camera. Lancaster, Box 267, Los Angeles, Calif.

TINT Your Own Pictures. Swain's Oil Portrait Paints, 16 Tubes, Complete Instructions, Special Only \$2.00 Per Box While They Last. Pacific Photo Supply Co., 408 Market Street, San Francisco, Calif.

MOTION PICTURES

\$\$\$ FOR Ideas. Photoplay plots accepted any form; revised, criticized, copyrighted, marketed. Advice free. Universal Scenario Corporation, 206 Security Bldg., Santa Monica and Western, Hollywood, Calif.

1,000-FOOT motor-driven suit-case Projector, \$75; hand-driven \$59. 400-foot Projector \$25. Movie Camera \$69. DeVry Automobile Electric Movie Generator \$109. Gas Engine Electric Generator and Projector, new, \$250. Movie Films, 100 feet \$1.00, postpaid; 800 feet \$3. Films wholesale to dealers. Ray, 324 5th Avenue, New York.

MOVIE Film: For Home Use. Send \$5.00 Cash or Money Order and we will ship you postage prepaid, Big 1,000-foot Reel. Complete stories with best screen stars. Dramas—Comedies—Features—Westerns. Special—only while they last. Monarch Theatre Supply Co., Dept. P, 724 So. Wabash Ave., Chicago.

FILM For Sale—12 Two-Reel Slapstick Comedies \$2.50 per Reel. Seven Comedies \$3 per reel. Special—only while they last. M. Gordon, 1002 Mollers Bldg., Chicago.

BIG Money Nightly—Good assortment. Complete outfits, installment plan. Splendid Home Outfit \$25.00. Ralph J. Golsen, Dept. M, 1128 Arabelle St., Chicago.

FILMS: Special Features—Comedies—Cartoons—Dramas and Serials. Lowest Prices. Bargain List Free. Monarch Theatre Supply Co., Dept. 81, Memphis, Tenn.

JUST in time to get in on the big money to be made! Bass will start you in the Motion Picture Making Business, enormous profits making Industrial Films, News Weeklies, etc. Catalogue and full information free! The Cinema Handbook, 575 pages, for \$3.00 postpaid. Bass Camera Company, 105 No. Dearborn St., Chicago, Ill.

AMERICA'S Greatest Fortunes made in the Motion Picture Business. We furnish Complete Theatre Equipment on easy payments. Openings everywhere. Catalog Free. Monarch Theatre Supply Co., Dept. F—724 South Wabash Ave., Chicago.

\$35.00 PROFIT nightly. Small capital starts you. No experience needed. Our machines are used and endorsed by government institutions. Catalog free. Atlas Moving Picture Company, 482 Morton Bldg., Chicago.

FREE to Writers—A wonderful little book of money-making hints, suggestions, ideas; the A B C of successful story and play writing. Absolutely Free. Just address Authors Press, Dent, 12, Auburn, New York.

ONLY \$98.00 starts you in this business. Wonderful opportunities for making Fortunes. Details Free. Monarch Theatre Supply Co., Dept. 46, Memphis, Tenn.

REMARKABLE value: Light Weight Professional Motion Picture Projector, Mazda Illuminated, with 1,000 feet of film. \$37.50. Send for photograph. DePranne, Importers, 109 No. Dearborn St., Chicago, Illinois.

MAKE money writing photoplays; details free to beginners. No correspondence course. Producers League, 239 Wainwright, St. Louis.

VIC'S Movie Handwriter, 10c. Everybody delighted. Vic. Hansen, Wallace, Idaho.

SCENERY TO RENT

SETTINGS for Opera, Plays, Minstrels. Flush Drops. Address Amelia Grain, Philadelphia.

COSTUMES AND SUPPLIES

COMPLETE line of costumes, wigs, make-up, etc., for Masquerades, amateur theatricals and minstrel shows. We will mail a 2-cd. box of Jack Weber's Blackface Makeup and Jack Weber's Negro Joke Book for 25 cents. Write for rental terms and free lists. Chicago Costume Works, 116 N. Franklin St., Chicago.

EDUCATIONAL AND INSTRUCTION

EXPERT advice and criticism to ambitious writers. One dollar places manuscript in hands of competent critic who has made a specialized study of Writing Psychology and English Composition. Send return postage. Robert Thomas, 116 Lotus, Willowood, N. J.

MEN and Women—Learn showcard writing evenings. Course free. Pay for material only. Sample lesson for stamp. Modern Studio of Lettering, Dept. 5, Maxwell Station, Detroit, Mich.

ROPP'S Calculator and Shortcut Arithmetic shows the answer as quickly as a watch shows the time to all problems likely to occur in office, store, shop, bank, farm or factory. Price, pocket size, paper 35 cents; cloth 50 cents; leatherette \$1. Desk size, cloth, \$1.50 postpaid. Popular Mechanics Book Dept., 200 E. Ontario St., Chicago.

MECHANICAL Drafting. Are you studying drafting? Then it will pay you to write at once. Engineer, Box 294, Derby, Pa.

BECOME an expert Stenographer and earn while you learn. Best systems of Shorthand and Touch-typing taught by mail. Information free. Mattox Twomey Institute, 5292 Sacramento St., San Francisco, Calif.

PENMANSHIP, Trial lesson 25c (silver). Price, 130 W. 104th, New York.

LEAK Indicating Pocket Piece; an ocular demonstrating instrument. Orifices show at a glance enormous waste of water. Useful for illustrating other wastes. Furnished to many universities. Send 25c coin for sample. H. W. Clark Co., Mattoon, Ill.

SAVE money on used business and vocational books. Business Methods, 153 E. Ontario St., Chicago.

USED books and educational matter bought, sold, exchanged. Bulletin free. Instruction Correspondence Exchange, 1969 Broadway, New York.

CONCISE Astronomy and Astrology. Explains eclipses, horoscopes, stars, etc., 15c. Leroy Watts, 1431 Martindale, Indianapolis, Ind.

SHOW-CARD Writing, a pleasant, profitable profession, quickly and easily learned by our new simple "Instructograph" method. No canvassing or soliciting. We show you how, no matter where you live. Full particulars and booklet free. American Show Card System Limited, 263 Adams Building, Toronto, Canada.

BE a Laboratory Expert. Earn \$300.00 to \$500.00 a month. Study Microbiology, Bacteriology, Laboratory Technology, Sanitation. Interesting Extension and Residential Courses. Diplomas and Degrees granted. 71-piece Urinalysis Outfit Free to students. Write for Free 48-page Prospectus Today. Int'l Physicians and Surgeons College of Microbiology, Room 955, 556 Garfield Ave., Chicago, Ill.

YOU can have a business profession of your own and earn big income in service fees. A new system of foot correction; readily learned by anyone at home in a few weeks. Easy terms for training; openings everywhere with all the trade you can attend to. No capital required or goods to buy, no agency or soliciting. Address Stephenson Laboratory, 1 Back Bay, Boston, Mass.

ARTIFICIAL Marble, sanitary flooring instructions, ornamental casting, concrete plaster, papier-mache decorations, garden furniture, statuary, Rubber-moulds, Electrometallurgy, particulars and 200 Illustrations free. Chris Mahler, Box 122, Huntington, N. Y.

"WHAT to Invent for Profit" free. Patent News-N, Washington, D. C.

MAIL-ORDER Books of Knowledge. Particulars and Privilege Card for Red Stamp. Byron, 27, Station 1, New York.

USED educational books sold, rented, bought and exchanged. Bargain list free. Leo Mountain, Pisgah, Ala.

DOUBLE Entry Bookkeeping mastered in 60 hours with 8 keys; guaranteed; diplomas. Our graduates lead in bookkeeping, auditing, accountancy, balance sheets, and financial statements. International Bookkeeping Institute, Dept. 8, Springfield, Mo.

WRITE articles, stories, news, in spare time for newspapers and magazines. Big pay. Copyright book free. Press Syndicate, 552, St. Louis, Mo.

STUDY Bacteriology, Hygiene, Public Health. Laboratory technologists make good income. Interesting course, can be mastered at home or school in a few months. Also courses in Arts and Sciences, Chiropractic, P. G. Pharmacy, etc. 15th year, Diplomas conferred. Free announcement. National University of Sciences, 2923 So. Michigan Blvd., Chicago.

USED books and educational matter bought, sold, exchanged. List 1,000 items free. Students' Exchange, 47-A West Forty-second Street, New York, N. Y.

SHOW-CARD writing a pleasant, profitable profession easily and quickly learned by our new, simple graphic block system. Artistic ability not necessary. We teach you how. Distance no object. Full particulars and booklet free. Wilson Methods, Limited, Dept. M, 64, East Richmond, Toronto, Canada.

SHORTHAND in 100 Hours. Most rapid readable system. Introductory booklet free. Manuscript Institute, Roanoke, Va.

MATHEMATICS taught by mail. Arithmetic, Algebra, Geometry, Mensuration, Trigonometry, Logarithms and Mechanics courses. Harding School, 76 Brighton, Highland Park, Mich.

TELEGRAPHY

TELEGRAPHY—Both Morse and Wireless—taught thoroughly and quickly. Tremendous demand. Big salaries. Wonderful opportunities. Expenses low; chance to earn part. School established fifty years. Catalog free. Dodge's Institute, H St., Valparaiso, Ind.

RADIO OUTFITS AND SUPPLIES

RADIO World. Great National Illustrated Weekly. 15c copy. All newsdealers. Trial sub. \$1.00, seven issues. 1493 Broadway, New York.

RADIO Tubes repaired and exchanged; write for free circular. Radio, Box 43, Roosevelt Station, Newark, N. J.

RADIO Generators, 500 Volt, 100 Watt, \$28.50 each. Battery Chargers \$12.50. High Speed Motors, Motor-Generator Sets, all sizes. Motor Specialties Co., Crafton, Pa.

YOU can receive concerts over 1,000 miles on my crystal hook-up. Tubes unnecessary. Send self-addressed envelope for picture of set. Leon Lambert, 539-4, South Volusia, Wichita, Kan.

RADIO Books, catalogue free. R. Dobbin, 146 West 27th Street, Indianapolis, Ind.

FREE—Complete price list of radio parts. Write Aitken Radio Co., 504 Superior St., Toledo, Ohio.

1700-MILE Guaranteed Radio Set, complete with aerial equipment, tube, batteries and headset, ready to operate, \$38.00. Three tube set with storage battery, loud speaker, tubes and necessary equipment, \$91.75. Highest grade apparatus. Quality Radio Company, 833 West 14th, Chicago.

SELF-ALIGNING Rotor Bearings and Tuner Cylinders. Manufacturer, Bogis, 26 S. 15th Street, Philadelphia.

MEMORIZE Radio Code, 3 hours or less. 50c postpaid, guaranteed. Particulars for stamp. Corydon Snyder, 1161 Ridgeland Ave., Oak Park, Ill.

TRADE SCHOOLS

PAINT Automobiles, Trim Automobiles. Become a certified Electrician. We fit you for a big-money job. Make you an expert, able to step right into a position paying \$45 to \$100 per week. We secure you a job while training that more than returns tuition costs and expenses. Come to Detroit, the Automobile Hub; the World's wonder city. Write today. Standard Trades Schools, 416 Woodward Avenue, Detroit, Mich.

BIG Money in the Painting Trade. Be your own Boss—Learn Sign Painting—Auto Painting—Decorating—Paperhanging—Graining—Marbling—Pictorial Painting—Card Writing, in a few weeks. Write for Special Summer Rates Now. Chicago Painting School, 148 West Austin Ave., Chicago, Ill.

BUSINESS OPPORTUNITIES

TONY PERRONE \$887.69 first month! Distributor, over \$6,000.00 in July. Salesmen \$18.00 to \$60.00 daily. Wonderful VIX Vapor Humidifier. For all cars. Doubles mileage; eliminates carbon, plug cleaning, valve grinding; cools better; saves 1/4 oil. More power, pep and speed. One free to introduce. Walter Critchlow, Suite 306, 716 Madison, Chicago.

I MADE \$30 a Week Home. French Breadmaking. 15 years' experience! Free Booklet tells. Ashbrook, 67, Marengo, O.

I HAVE over 100 stores paying \$5 monthly. You can do the same in your city. Month practice qualifies. Midnight Alarm System, 2965 Algonquin, Detroit.

PUBLISH Magazine of Your Own; Start Mail Order Business and make Money. Sample Magazine and Plan 100. Harvey Teeple, Decatur, Ind.

SOLD by licensed operating Engineer and Electrician. Not a firm. I will refund your 50c paid for my book of valuable information if you can't increase your income on the side, in a locality investing little or no money. Unusual opportunity. Stamps accepted. Address Engineer A. Wendt, 3108 Canal St., Chicago.

A BUSINESS of your own; make parking class name plates, Numbers, Checkerboards, Medallions, Signs. Big Illustrated book free. H. Palmer, 26, Wooster, O.

ESTABLISH a Cash Business—no canvassing. Capital \$100 up. Information, Dept. M, Paul Kaye, 149 Broadway, New York.

START in Business for yourself. Five successful plans, 25c. W. Carlson, 8239 S. Moran St., Chicago.

MONEY in Cash Grocery Business. 31 years test. A, B, C, Booklet, 64 pages, tells all about; only One Dollar. John P. MacDonald, Box 15, Detroit, Mich.

MONEY-MAKING opportunities; particulars free. Lemke, Box 572, Cincinnati, Ohio.

FORMULAS, Trade Secrets—Different dependable. Catalog free. B. Thaxt Co., Washington, D. C.

LEARN Candy Making. Make big profits at home or in shop. Big demand for good candy. Easily, quickly learned through our correspondence course. Write today for booklet 1-10. The Candy Institute, Sixty West Fifth Street, New York.

PATENTS Procured; Trade Marks Registered—A comprehensive, experienced, prompt service for the protection and development of your ideas. Preliminary advice gladly furnished without charge. Booklet of information and form for disclosing idea free on request. Richard B. Owen, 30 Owen Bldg., Washington, D. C., or 2276-B, Woolworth Bldg., New York.

PATENTS Procured. Send sketch or model today for examination, prompt report and advice. No charge for preliminary advice. Write for free Booklet and blank form on which to disclose your idea. Highest references. Promptness assured. Clarence A. O'Brien, Registered Patent Lawyer, 561 Southern Building, Washington, D. C.

FREE Book—Start little mail order business anywhere; home employment evenings; beginner's working outfit furnished, 500 circulars, samples, things to sell; you deal direct with manufacturers; no stock to carry; instructive booklet free. Pier, 268-A, 74 Cortland St., New York.

ARE you a misfit? Write for free circular on human nature. Robert Knox, Box 728, San Francisco, Calif.

SLOT Machines; Headquarters for Premium Machines, 1016 Germantown Ave., Philadelphia.

START a Real Estate Office of your own. Earn from \$3,500 upwards. Our course of 21 lessons tells you how. Booklet M, on application. Frederick Jenkins, Corlaer Heights, Schenectady, N. Y.

648 WAYS to Make Money—2716 Formulas "Encyclopedia Business Opportunities," 3 volumes, \$1. Ideal Book Shop, 5501-PV, North Robey, Chicago.

SIGN Painting Self-Taught. Samples, 5c stamps. Healy Sign Co., 21 Old Colony Ave., Wollaston, Mass.

COLLECTION Business Opportunities.
Box 327, Battle Creek, Mich.

MONEY-MAKING Opportunities are right in your locality. Let us point them out for you. Send today for interesting Circular. Explains everything. It's Free. Central Book Co., 127 South Liberty St., Indianapolis, Ind.

ATTENTION! You can have a business of your own. Establish and operate New System Real Estate Business, brokerage and insurance agency in your community. Office at home. Earn \$5,000 year. Representatives wanted everywhere. Send stamp free booklet. Hayes Realty Association, Cincinnati, Ohio.

START Cleaning, Dyeing and Pressing Establishment. First Instruction Book 10c. Byron, 27, Station I, New York.

"GET Into the Specialty Manufacturing Business" or "Why Work for Others?" may sound good to you, but you won't succeed in that business unless you possess formulas that are absolutely reliable, the same required by leading manufacturers supplying the Best. Don't be Bunked into buying a Collection of cheap "Formulas" and expect to succeed. Send today for my valuable literature and Formula Lists and Real Money-Makers in the Specialty Manufacturing Business. 24 years supplying the Best. Miller, Chemist, 805 De Leon St., Tampa, Fla.

"HOW to Sell Patents" free. Patent News-H., Washington, D. C.

MAKE Money at Home—making toys. We show you how. Send \$1 for complete working drawings and instructions. DeLaino Designing Co., Decatur, Ga.

STOP! Flooding! Be Successful. Operate a Tire Repair Shop. Make big profits in any locality. We teach you and furnish complete equipments \$100.00 up. Book of opportunity free. Haywood's, 1305 South Oakley Avenue, Chicago.

BE a Laboratory Expert. Earn \$300.00 to \$500.00 a month. Study Microbiology, Bacteriology, Laboratory Technology, Sanitation. Interesting Extension and Residential Courses. Diplomas and Degrees granted. 71-piece Urinalysis Outfit Free to students. Write for Free 48-page Prospectus Today. Int'l Physicians and Surgeons College of Microbiology, Room 971, 550 Garfield Ave., Chicago, Ill.

EARN \$10 daily silvering mirrors, plating and refinishing metalware, autos, chandeliers, bedsteads, headlights. Outfits furnished. E. Decie Laboratories, 1133 Broadway, New York.

GO into the Crispette business. Everybody likes Crispettes. You can make a lot of money. We start you. Write for facts. Long Eakins, 1959 High St., Springfield, Ohio.

\$3,000 TO \$6,000 Yearly. Want it? Others are making it. Send check or money order today for our invaluable books "How to Sell Real Estate," \$3.00—and "How to Conduct Real Estate and Insurance Business," \$1.50. Absolute satisfaction guaranteed. Free catalogs. Realty Book Co., Dept. 52, Cleveland, Ohio.

DOLLARS yearly in your spare time. Indoors or outdoors. I'll show you how. Particulars free. PM Metz, 313 East 89th, New York.

"WHAT to Invent for Profit" free. Patent News-C., Washington, D. C.

BECOME a Landscape Architect. Dignified, exclusive profession not overrun with competition. Crowded with opportunities for money-making and big fees. \$5,000 to \$10,000 incomes attained by experts. Easy to master through our correspondence methods. Established 1916. Get information today. American Landscape School, 56-K, Newark, N. Y.

ENTER a new business. Earn \$3,000 to \$6,000 yearly in professional fees making and fitting a foot specialty, openings everywhere, with all the trade you can attend to; easily learned by anyone at home in a few weeks, at small expense; no further capital required, no goods to buy, job hunting, soliciting or agency. Address Stephenson Laboratory, (1) Back Bay, Boston, Mass.

INCH Display Advertisement 161 Magazines. Thrice \$15. Year \$50. Page \$100. Wool's Popular Services, Atlantic City, N. J.

LEARN the collection business. Good income, quick results. Interesting booklet, "Skillful Collecting," free. National Collectors Assn., Long St., Newark, O.

\$50 WEEK evenings—1 made it. Mail Order business; booklet for stamp tells how. Sample and plan, 25c. Free 12 articles worth \$3. Alpine Scott, Colons, N. Y.

MAIL Order Business is your opportunity. Brenner's Famous Handbooks teach how to start small, grow big. Sell merchandise, service, ideas; enormous profits. Spare time to begin. Get complete set, 11 books, \$3.98, and be posted. Brenner, 335 Walnut, Philadelphia. Descriptive Catalog and big batch interesting mail order information, 25c. None free.

RAISE guinea pigs. Pay better than poultry or rabbits; easy to raise; little space required. We guarantee market. Particulars and booklet how to raise free. Carles Distributing Co., 3102 Grand Ave., Kansas City, Mo.

WE Start You in Business, furnishing everything; men and women, \$30.00 to \$100.00 weekly operating our "New System Specialty Candy Factories" anywhere. Opportunity lifetime; booklet free. W. Hillier Bagdale, Drawer 4, East Orange, N. J.

EXCEPTIONAL Opportunity for Sales Manager capable of handling state distribution. Marvelous new Adding Machine. Retail \$15. Work equals \$350 machine. Tremendous possibilities. Unlimited profits. Write quick for details. Lightning Calculator Co., Dept. B, Grand Rapids, Mich.

"SCHEMER Magazine," Alliance, Ohio, prints big profit schemes; one subscriber making \$25,000 from three; another \$10,000 from one. Try your luck. Year, only \$1.00; three months, 25c.

MARBLE mixing instructions, covering wood or cement flooring 1/2 inch thick, fireproof, waterproof, low cost, sanitary, all colors. Particulars, 200 illustrations free. Chris Mahler, Box 122, Huntington, N. Y.

100,000 GERMAN Marks, \$1.25; also Banknotes of Austria, Poland, Russia and Hungary. Write for prices. George Grigolcic, 20 E. Jackson, Chicago.

CHEMISTRY

CHEMICAL Processes, Analysis, Research, Technical Information, Consulting Chemist, Madison, Maine.

YOUR chemical problem solved and working process furnished Five Dollars. Write me, W. Stedman Richards, Consulting Chemist, address Box 2402, Boston, Mass.

FORMULAS AND TRADE SECRETS

SECRETS for putting up over 60 fast-selling articles, 25c. Stearns Co., Waltham, Mass.

500 VALUABLE Formulas, 25c; Formula Literature, 2c. Harvey Teeple, Decatur, Ind.

1,000,000 FORMULAS, 1,016 pages, \$2.50. Formulas Free if you order quick. Ideal Book Shop, 5591-PM, North Robey, Chicago.

FORMULAS—Best that Chemical Science can devise. Not "Better Sort" Formulas, but Guaranteed Reliable processes in all lines. Stamp brings valuable literature and latest Summer Sellers from an Analytical Chemist, Miller, Chemist, 807 De Leon, Tampa, Fla.

800 FORMULAS 25c; Luminous Paint—Resilvering Mirrors—Renewing Dry Batteries—Mechanics Soap—Gas Tonic—Carbon Remover—Puncture Plugger, 20c each. Entire collection 50c. Catalog Free. Ideal Book Shop, 5591-PC, North Robey, Chicago.

VALUABLE manufacturing secrets. Every one a money maker. Postpaid \$1.00. Your money back if not satisfied. S. Virginia, Ph. G., 135 Meadow St., Pittsburgh, Pa.

500 FORMULAS; resilvering mirrors, valuable collection, 20c. Universal, 4047-P North Whipple, Chicago.

10,000 SELECTED chemical, technological and practical recipes and processes, including hundreds of so-called trade secrets for every business, alphabetically arranged in one large volume of 800 pages. Price \$4 postpaid. Popular Mechanics Book Dept., 200 E. Ontario St., Chicago.

20,000 FORMULAS 557-page volume, \$1.30. Universal, 4047-P, North Whipple, Chicago.

FORMULAS—Guaranteed, Catalog Free. Restovall Laboratories, 4047-P, North Whipple, Chicago.

BEST guaranteed formulas. Douglas Chemists, 707 S. Lawndale Ave., Chicago.

5,000 RECIPES, \$1.25. Best formulas and processes for every business, trade or occupation are in "Youman's Guide." Many never before published. Worth \$1.25 each, 530 pages, paper cover \$1.25. Cloth \$2.00, postpaid. Book catalog free. Wells and Edwards, X852 George, Chicago.

"BEATS ALL" Auto Cleaner and polish combine. One operation. Cleans anything. Formula, full directions \$1. Fiandt & Co., Wolcottville, Ind.

AGENTS WANTED

NO Dull Times Selling Food. The greatest, safest and safest business in the world today is selling Federal Pure Food Products, and here is your opportunity to get into this business. You can make \$3,000, \$5,000, \$10,000 or more per year—the only limit is your ability to take care of the business. People Must Eat, and our food products are the fastest selling, surest and quickest repeat order getters in the world. Sell on sight in every home where food is used. Repeat orders immediate and every week thereafter. We supply you with effective Free Advertising Matter, Free Samples and a Free Course in Salesmanship. We also have over 100 high-grade, beautifully packaged Toilet Preparations. Your future will be a financial success. A Real Big Business All Your Own. Every New Customer adds a great deal to your weekly income. Your business once established has a market value just like a store and can be easily sold. The greatest money-making opportunity of your lifetime because you risk absolutely nothing, as we guarantee your sales, and we will not let you fail. Remember! Guaranteed! Best products, biggest sellers, surest repeat orders. No capital or experience is required. We furnish capital and everything necessary for you to become a Federal Distributor. Exclusive territory will be given honest men or women who will write at once asking us to send our "Success Guaranteed" proposition. Address, Federal Pure Food Company, Dept. A, Chicago, Ill. Largest inventors of and packers of Pure Food specialties in the world. Reference, any bank, Dun or Bradstreet rating agency, Express or Railway Company in America.

AGENTS—Make big money selling Earl's "Cutwell" imported Pocket Pencil Sharpener. Sample 15c prepaid. Sells on sight. B. G. Earl, 56 E. Randolph St., Chicago, Ill.

WILLIAMS' No Water Hand Soap, in tubes, has taken Auto owners by storm; washes dirtiest hands perfectly clean without water. Easy demonstration makes quick sale; 150% profit. W. B. P. Williams, Mountclair, N. J.

EARN \$10.00-\$15.00 a day and more selling "Classical Ivory" Toilet sets, brushes, cloaks, perfume bottles, manufacture articles, etc. Salesman's Catalog sent on receipt of \$2.50. Very big for holidays. Gurney Sales, Inc., Leominster, Mass.

WE have first-class side line proposition for live agents. Samples free. Lorraine Press, Beverly, Mass.

17 CENTS Profit on every 25-cent sale means big daily profits. Box 500, Shreveport, La.

AGENTS: \$60 a week selling guaranteed hosiery for men, women and children. Must wear 12 months or replaced free. All styles and colors, including finest line of silk hose. Mrs. McClure makes over \$2,000 a year. Mrs. Schurman averages \$60 a month working spare time. Geo. Nohlmade \$35 in one day. Write for sample outfit. Thomas Mfg. Co., Class 542, Dayton, O.

SELL Vic's Movie Handwriter. Big profit; everybody delighted. Sample 10c. Vic Hansen, Wallace, Idaho.

AGENTS—Our soap and toilet article plan is a wonder; get our free sample case offer. Ho-Ro-Co., 125 Locust, St. Louis.

WILL your Ford go 66 miles on 1 gallon gas? Or other makes do equally well? Startling records made. Wonderful VIX Vapor Humidifier. \$18.00 to \$66.00 daily. District Distributor over \$6,000.00 in July. One free to introduce. Walter Critchlow, Suite 359, Chicago.

AGENTS—Sell Hammond's Atlases to firms and individuals and make from \$4.00 to \$20.00 per copy. Without delivering or collecting you can daily sell two to ten of these handsome necessary products. C. S. Hammond & Co., Room 225, 69 Franklin Ave., Brooklyn, N. Y.

YOU Can Make Good Durable Paint and Varnish 40c per gallon. Write Dept. 2, Emmelmann Bros. Mfg. Co., Indianapolis, Ind.

AGENTS—Got my proposition. Brings dollars. Write W. Bedell, 789 So. 181st St., Newark, N. J.

MEN'S Wonder Combination Hair-Overcoat. Send \$5.00 for sample. Coar sells for \$15.00. Jogert Mfg. Co., Dept. P, 41 West 21st St., New York.

START a profitable and permanent business of your own with our capital. Our salesmen make \$75 to \$125 weekly selling our \$50 all-wool tailored to order suits and overcoats for \$31.50 direct to wearer. World's greatest clothes values. Your profit paid in advance. Experience unnecessary. We teach you how to sell and take measures and supply you with the largest and finest tailoring selling outfit free. 6 x 9 woolen samples. Monarch Tailoring Co., Dept. 51, 109 Fifth Ave., New York.

THESE Advertisements of mine have appeared in Popular Mechanics for sixteen years. Hundreds of Successful Manufacturers today owe their success to my formulas and valuable information. Majority started with practically nothing. You can do the same—write today for my valuable literature relative to my Guaranteed Manufacturer's Formulas for making Non-Thermic Ice-Saving Cloths, Delicious Beverages for Home, Bottlers and Fountain sale, Pure Food Products, Non-Alcoholic Flavors, Launderite Washing Marvel, Zest, greatest Stain remover, Sta-Comed, Marcel Hair Curler, and latest Toilet specialties, Mexican Yucca Soap, Laundry Soaps, Flynox, Sensol, and all latest disinfectants. Amazon Tire Repair, Toy Rubber Balloons and all latest selling goods in all lines. Don't compare these with "junk" commonly offered. Analytical work carefully done. Highest references. Miller, Chemist, Tampa, Fla.

NEVA-LOST Gas Tank Cap for Automobiles sells on sight; 100 per cent profit. Big opportunity for producers. State territory desired. Trinity Mfg. Co., Hartford, Conn.

Big Profits Selling New \$3.50 Automatic Adding Machine. Absolutely accurate. Fully guaranteed. Quick sales. Ten daily easy. No competition. Pocket size. Business people everywhere positive customers. Thousands being sold. Tremendous demand. Here's high-grade money-maker. Bassett Co., 1458-Y Hollywood Ave., Chicago.

300% PROFIT; Whirlwind Seller. Tremendous repeater. "Kleanrite." Marvelous Discovery. Washes clothes without rubbing. Premiums for customers. Sells 25c. You make 18c. Free samples make easy sales. Write quick. Bestever Products Co., 1941-K16 Irving Park, Chicago.

ENERGETIC Men and Women to distribute samples and write orders for greatest household necessities and sellers. Stoner Mfg. Co., Forsyth Bldg., Atlanta, Ga.

FREE Sample. "Rain Shield Wiper." Details \$1.00—Costs (25c). Sold, Clear and Rainy Days. No Cloth—No Paste—No Attachment. (1) Rub keeps Windshield Clear (48) Hours. Experience unnecessary. NuLife (H) Corporation, Hartford, Conn.

AGENTS—New style guaranteed hosiery for men, women, children. All colors. Must give satisfaction or new hose free. Full line of silk hose. Write for particulars. Parker Mfg. Co., Sample 178, Dayton, Ohio.

AGENTS—Steady Income. Large manufacturer of soaps, perfumes, toilet articles and pure food products, etc., wishes representatives in each locality. Manufacturer direct to consumer. Big profits. Honest goods. Whole or spare time. Cash or credit. Send at once for particulars. American Products Co., 9546 American Bldg., Cincinnati, Ohio.

AGENTS: We pay \$9 a day taking orders for 360-candle power coal-oil lantern. Get orders from farmers, dairymen, hucksters, gardeners, contractors. Auto furnished to travel in. Write for particulars. Thomas Mfg. Co., Class 2962, Dayton, Ohio.

THE wonderful arch support and shoe preserver, for every shoe; unequalled for agents. S. P. M. Co., 359 Pearl St., New York.

AGENTS—Free Offer Captivates Customers. 20 First Day—\$20.00 Profit. 100 Celebrated Necessities. National Products Co., 855 Grand St. Joseph, Mo.

MEN or Women Sell Our Men's Silk Neckties on Large or Small Scale Direct to Wearer. Big Opportunity for Christmas Trade. Box 450, Madison Sq. Station, New York, N. Y.

\$5 TO \$15 daily easy—Introducing New Style Guaranteed Hosiery. Must wear or replaced free. No capital or experience required. Just show samples, write orders. We deliver and collect. Your pay in advance. Elegant outfit furnished. All colors and grades including silks, wool and heathers. Mac-O-Chee Mills Company, Desk 25610, Cincinnati, Ohio.

COUNTY Agents! Here's your chance to obtain agency for guaranteed product selling like hot cakes to car owners. Demonstration sells seven out of ten. 150% profit. Investment \$45.00 in initial stock starts you. Write for details and learn if your territory is open. Act quick if you mean business and avoid disappointment. Manufacturer, 3964 Grand River Ave., Detroit, Mich.

NEW Business. Re-Dye Hugs on the Floor. Fibertint applied with brushes. Nine colors. \$1.00 box dyes 8x12. Sample for small rug, 10c. Agencies granted. Texply Co., Inc., 15-A, Somerville, N. J.

AGENTS wanted in every territory to sell the best anti-rattler for all sedan and coupe doors; fits nearly all makes; big seller. Write, Sales Manager, 620 East Water Street, Milwaukee, Wis.

I HAVE a new patented article that can be sold in every home by both men and women Agents. Because of the big waiting demand and lack of competition, my agents make tremendous profits. Absolutely no experience is required and can use part as well as full-time workers. If you want the biggest money-making proposition in America, write me at once. Sales Manager, Arden Products Corp., Dept. 47, 214 W. Kinzie, Chicago, Ill.

EARN \$5,000 annually, selling well known washing compound. Washes without rubbing. Greatest repeater on market. Credit given. Ford furnished agents. Premium to customers. Write today for sample and terms. Sale of every package guaranteed. Buss-Beach Company, Dept. 27, Chippewa Falls, Wis.

AGENTS: New product, no equal. 150% Profit, 100% Repeater year round. Sells to everybody. Ascending results from first day. Surety Manufacturing Co., 26 W. Washington, Chicago.

TAILORING Agents Wanted—Make \$50 to \$100 and more per week selling our wonderful virgin wool one-price line. Suits and overcoats sell for \$31.50. None higher. Retail stores ask at least \$50 for the same quality. Commissions in advance. We ship C. O. D. to customer for balance. We furnish beautiful 6x9 swatch outfit and powerful cooperation. Several hundred successful salesmen are now earning \$50 to \$100 a week and more. The low price and wonderful quality wins enthusiastic customers and repeat business. That's what counts. Hustlers write at once. Mention territory wanted. Sales Manager, J. B. Simpson, Inc., Dept. 633, 821-843 W. Adams St., Chicago, Ill.

AGENTS, Stop Wishing—Work—You can make \$10 Daily selling Articles everybody needs. Particulars Free. Write B. & G. Hubber Co., Dept. 445, Pittsburgh, Pa.

MEN'S Shirts. Easy to sell. Big demand everywhere. Make \$15.00 daily. Undersell stores. Complete line. Exclusive patterns. Free samples. Chicago Shirt Manufacturers, 241 W. Van Buren, Factory, 113, Chicago.

LIVE Agents to sell R. C. W. overalls. New invention—quick sales—big profits. No triflers. R. C. W. Co., 260 Carmita Ave., Rutherford, N. J.

EARN \$30 to \$35 extra every week taking orders for our high-class tailoring made-to-measure suits from \$14.95 to \$29.50. Your own clothes at low wholesale prices. No experience necessary. Write for our Big Free Sample Outfit. The Progress Tailoring Co., Dept. X-142, Chicago, Ill.

START in a permanent business of your own selling guaranteed Hosiery and Underwear direct from mills. No capital or experience is needed; many representatives make \$3,000 to \$5,000 per year. Become our district manager—get others working for you. Write for details to Malloch Knitting Mills, 5310 Grant St., Grand Rapids, Mich.

DISTRICT representatives, men and women, for "National" Household Rubber Necessities. Exclusive territory and over 100% profit. National Mfg. Co., Room 3512, 5713 Euclid Ave., Cleveland.

AGENTS, travel by auto, distribute soap samples. \$8.75 a day full time. Or we can pay you \$1.25 an hour spare time. Write today for free sample and big offer. Harley Co., Dept. 10, Dayton, Ohio.

AGENTS: \$100.00 weekly selling established quality raincoats at \$3.95. Pay advanced. We deliver. Free coats. Hydro Raincoat Co., 3510 Polk, Dept. 108, Chicago.

MOST Wonderful Seller. 96c profit every dollar. No stock to carry. License unnecessary. Sample free. Mission Factory PM, 519 No. Halsted, Chicago, Ill.

AGENTS, sell shoes direct to ladies at home or at work. Fast selling line. Liberal pay. Splendid opportunity. Apply Now, Style-Arch Shoe Company, 503 Butler Bldg., Cincinnati, Ohio.

AGENTS Wanted (in U. S. only). Make your Christmas Money. Sell our exclusive line of engraved Xmas Cards. The very best in design, quality and price. Big commission allowed. No money needed. Write for free samples and particulars at once, as no answers will be considered if received later than November 30th. Knight & Co., Box 276, Riverton, N. J.

AGENTS—For fast-selling Fall. Winter wearing article. Nationally advertised. Energetic canvassers wanted handling wearing specialties House to House trade. Selling helps, gratis. Territory open: New England, Northern New York, Colorado, Wyoming, Montana, Canada, West Indies, South America. Box 549, General Post Office, West 51st, New York City.

AGENTS: Our line of Unique Diversified Products will make you big money. National Auto Accessories Mfg. Co., Saginaw, Mich.

TAILORING Agents: Get our powerful proposition. \$35.00 suits for \$21.85, including a good profit for you. Big swatch line of samples in handsome carrying case. Hustlers make \$75.00 a week. Territory going fast. Write at once. Address Dept. 251, Knickerbocker Tailoring Company, 131 So. Peoria St., Chicago, Ill.

AGENTS—Steady Income. Large manufacturer of handkerchiefs and dress goods, etc., wishes representative in each locality. Factory to consumer. Big profits. Honest goods. Credit given. Send for particulars. Freeport Mfg. Co., 59 Main St., Brooklyn, N. Y.

FORMULAS, Trade Secrets—Different, dependable, Catalog free. S. Thaxly Co., Washington, D. C.

ANOTHER New Man is Rolling the Dollars Home. H. E. Ellington, our Utah hustler, with only forty days' experience, earns \$748.80 in that time. Just turned in a bunch of subscriptions for Alexander Motion Picture Publicity, which net him \$193.20, all sold in one afternoon. Free Sales Training Course helps you start. We want a few more big men—with an active brain and fightin' blood in their veins. A profession for you—worthy of the name—advertising combined with motion-pictures. Try to get in! Alexander Film Co., 3389 Broadway, Denver, Colo.

HANDKERCHIEFS, "Kwaliti" line. Agents get bedrock factory prices. Write for the plan of this dependable business. Turnover Sales Company, 18-A East 17th St., New York.

AGENTS: \$75.00-\$100.00 weekly taking orders for popular price-smashing raincoats, \$3.95. Largest commission advanced. Prompt shipment. We collect. Free coats. Eagle Raincoat Co., 566 Mid City Bank Building, Chicago.

FLORIST'S Plant Food Promotes Luxuriant growth, prevents diseases. Agents' profit large. J. W. DeMuth, Camden, Mich.

27,000 RECORDS guaranteed with one Everday Phonograph Needle; new—different; cannot injure records; \$15.00 daily easy. Free sample to workers. Everday, McClurg Bldg., Desk 106, Chicago.

WANTED—Tailoring salesmen, make \$40 to \$125 per week. Biggest merchants in many towns have started with our lines. We are the largest made-to-measure tailoring house in the country, furnishing elaborate sample equipments, including 500 all wool fabrics and guaranteed absolute satisfaction, perfect fit, best workmanship, or no sales. Write me for line and all accessories to be sent free. Tell us all about yourself. Address G. H. Mitchell, Sales Manager, Box 483, Chicago, Ill.

AGENTS, Salesmen, Demonstrators, you will have the devil's own time trying to find a better seller than "Zippe." If there was such a thing we'd have it. Splendid profit on 56c "Go Getter" repeat article that sells on ten second demonstration. Works While You Watch It. Demonstrates value, while others waste time making claims. New Discovery! Greatest Scientific Triumph of the age. It's the berries. Haven't room to tell our story here. Write immediately. Karam-Smith Co., 610 Clark St., Ft. Wayne, Ind.

EARN \$10 to \$25 a Day. Sell beautiful, durable "Novo" Hosiery, Knitted Neckwear and Full-Cut Shirts. Direct Mill to Wearer. Complete family line, silks, sport wools. Customer satisfaction defies competition. All or spare time. Investigate. Novo Mills, Dept. E, 3rd and Sedgley, Philadelphia, Pa.

TAILORING Salesmen: Biggest producers in the country handling our line of guaranteed Virgin-Wool tailor-made clothes at one low price of \$31.75. We supply finest Sample Outfit, give unexcelled service and deliveries and pay big cash profits. There are other reasons. Write for them at once. Address Dept. 624, Goodwear Chicago, Inc., Chicago.

PATENTS Procured. Send sketch or model today for examination, prompt report and advice. No charge for preliminary advice. Write for free Booklet and blank form on which to disclose your idea. Highest references. Promptness assured. Clarence A. O'Brien, Registered Patent Lawyer, 542 Southern Building, Washington, D. C.

CHRISTMAS Greeting Cards— Make \$100.00 weekly. Spare time. Wholesale Prices. Manufacturer, 1235 Arch, Philadelphia, Pa.

CLARKE made \$18 an hour selling rest-pouch windshield cleaner needed by every autoist, motorman, engineer; one rub keeps glass clear 24 hours; 60,000 sold; amazing proposition free. Security Mfg. Co., Dept. 704, Toledo, Ohio.

START your own business as our sole agent, selling 100 famous home products. All or spare time. Dr. Blair Laboratories, Dept. 524, Lynchburg, Va.

PORTRAIT agents earn big money selling our Photo medallions. Photo medallion clocks, Religious medallions, Photo pocket mirrors, Photo buttons, Photo jewelry, and Fraternal Photo medallions. Send for free catalogue. Satisfaction guaranteed. Four-day service. Address Gibson Photo Jewelry Co., Apartment 7, 603 Grand Ave., Brooklyn, N. Y.

AGENTS—\$15 a day—Easy, quick sales—Free Auto—Big weekly Bonus—\$1.50 premium Free to every customer. Simply show our Beautiful 7-piece Solid Aluminum Handle Cutlery Set. Appeals instantly. We deliver and collect. Pay daily. New Era Mfg. Co., 803 Madison St., Dept. 21-S, Chicago.

WONDERFUL Invention—Eliminates all needles for phonographs. Saves time and annoyance. Preserves records. Lasts for years. 12,000,000 prospects. \$15.00 daily. Free sample to workers. Everplay, Desk 1023, McClurg Bldg., Chicago.

PORTRAITS, photo pillow tops, frames, sheet pictures, medallions, merchant's signs, water-proof and tea aprons, guaranteed hose, toilet requisites, luminous crucifixes; catalog, 50 specialties free, 30 days' credit. Jas. C. Bailey Co., Desk M-10, Chicago.

TAILORING Agents—We've got a wonderful line of tailor-made suits to sell at \$18 and up. Beautiful assortment of fabrics, \$10 to \$25 cheaper than retail. No experience needed. Our free suit offer is a wonder. Write American Woolen Mills Co., Dept. 1850, Chicago, Ill.

YOU can sell every merchant in town our changeable signs. Large profits; easy sales. Write for territory now. Changeable Sign Co., 581 East 102nd, Cleveland.

AGENTS—Earn \$75.00 to \$100.00 weekly selling "Sun Bright" Pure Aluminum guaranteed Cooking Utensils direct to housewife. Prices 25 to 50% lower than retail. Write today for particulars and state what territory you want. Chicago Distributing Co., Direct Factory Rep., 35 So. Dearborn St., Chicago, Ill.

AGENTS—Make \$7 to \$14 a day. Brand new Aluminum handle Cutlery Set. You take orders, we deliver and collect. Pay you daily. Full or spare time. No experience necessary. No capital. We need 1,500 Sales agents, men or women, to cover every county in the U. S. Demand enormous. Write quick. Jennings Mfg. Co., Dept. 1868, Dayton, Ohio.

AGENTS—Send for sample "Fretnot"— the washday wonder. Be convinced you can do a whirlwind business. You can clear at least \$20 to \$100 weekly, according to spare or whole time. You don't have to talk; if she doesn't buy at sight, leave sample; she will be looking for you long before you are able to make the rounds again. Samples furnished free. Premiums for your customers. Exclusive territory guaranteed to agents who can produce. Credits given. Don't call P. M. Mother & Sons, 20 E. Jackson Blvd., Chicago.

AGENTS: New 2 in 1 Reversible Double-Duty Raincoat. One side rich tan dress coat, other side storm coat. Two coats for the price of one. Saves \$15. Positively guaranteed waterproof. Commission paid same day you take orders. Sample furnished. Parker Mfg. Co., Coat 1578, Dayton, Ohio.

GENUINE Gold Leaf Letters anyone can put on store windows. Guaranteed to never tarnish. Large profits. Enormous demand. Free samples. Write today. Metallic Letter Co., 438-A North Clark, Chicago.

AGENTS—Easy trial offer to sell direct to consumer well known line of guaranteed hosiery for ladies, men and children. All grades, including full line wool hose for Fall. Big commission. Teach you how to sell. Immediate delivery. Write today. Lynx Knitting Mills, 72F Leonard St., New York.

LIVE Agents make \$10 day selling Eureka Strainer and Splash Preventer for every water faucet. Takes on sight. Widely advertised and known. Get details today. A. B. Seed Filter Company, 73 Franklin, New York.

AGENTS wanted to distribute Blecco Washing Wonder. Big profits. Permanent business. Exclusive territory. Guaranteed sales. Sample, particulars free. Yonover, 1037-A10 Roosevelt Rd., Chicago.

EASY Money. Sell 35c article with \$25 guarantee, 100% profit. Wun-der Remor-R, Pittsfield, Mass.

AGENTS—\$10 to \$15 daily possible selling a line of factory-priced rubber-goods specialties for women direct from manufacturer. Free catalog. American Rubber Products Co., Dept. 108, Pittsburgh, Pa.

RUMMAGE sales make \$50.00 daily. We start you. Representatives wanted everywhere. "Wholesale Distributors," Dept. 92, 609 Division Street, Chicago.

MAGICAL Necklace. "Shines in the Dark." Absolutely new. Be the first to sell this charming and captivating necklace. 100% to 400% profit. Send \$1.00 for sample and territory protection. W. G. Hanson Co., Dept. E, 57 E. 18th St., Chicago.

DUSTLESS Sponge Cloth. New Invention. Retalls (50c)—Costs (16c). (1) Rub Cleans, Polishes Automobiles, Pianos, Furniture. NuLife (A) Sponge, Hartford, Conn.

BIG Money in Emblem Goods. \$25.00 daily easy. Wall and Auto emblems; pins, buckles and leather goods sell on sight. Sales guaranteed. Get free sample and cash bonus plan. Kier Emblem Co., Dept. P.M.10, Como Bldg., Chicago.

PULLEMP Kuf Buttons, marvelous convenience, shirt saver. Works automatically. Sales unlimited; direct to users with protected territory. Sample pair \$1.00. Flexo Copm., Sheboygan, Wis.

AGENTS: \$30.00 daily representing factory. Electric-lighted vanity cases. Fastest seller out. Pay advanced. We deliver. Write for sample. Goldsmith, 29 So. Clinton, Dept. C, Chicago.

BURGLAR Proof Key Lock. Just out. No competition. Self advertises and demonstrates itself. No tools required to install. Absolutely guaranteed. Sample 25c. Agents wanted. Clinton Supply Co., 1326 Clinton St., Sandusky, Ohio.

IF you want to make big money, look for the Central Book Company's ad, under "Business Opportunities" column.

MAKE \$30.00 Daily, taking orders for \$3.98 Union-made raincoats. Factory prices. Fast sellers. Wonderful values. Your pay daily. We deliver and collect. American Eagle Raincoat Mfg. Co., 155 N. Union St., Dept. 30, Chicago.

AGENTS to sell Kerosene Burners for all purposes. Big Profits. Economy Mfg. Co., 616 W. Monroe St., Chicago.

POLMET—The polishing cloth approved by "Good Housekeeping" and "Modern Priscilla." Sells fast at 25c. Sample free. Gale & Co., Inc., 15 Edinboro St., Boston.

TAILORING Agent. Men who buy suits also buy shirts. We specialize in one number, furnishing any sleeve length ordered. Outfit free. Trinity Shirt, 12 East 30th St., New York.

AGENTS—\$12 daily easy, introducing Ladies' and Men's sweaters in silk, wool and artificial silk; 12 colors. Latest novelties. Going like wildfire. You simply show samples we furnish; take orders; we deliver and collect. Your pay daily. Mac-O-Choc Mills Company, Form 11010, Cincinnati, Ohio.

CALIFORNIA Rosebuds selling like hot cakes. Agents coinng money; few stuff. Big profits. Catalog free. Mission Factory P.M. 519 No. Halsted, Chicago, Ill.

NEVER trust cutlery agents make big money. Whole or spare time. No capital or experience required. The C. Westchester Co., 92 Vark St., Yonkers, N. Y.

BIG Steady Income. No investment. Protected territory. Sell Harper's ten-use brush set. Sweeps, scrubs, washes windows, cleans walls, etc. Big seller 14 years. Scores making up to \$30 daily. Investigate this. Harper Brush Works, 132 B St., Fairfield, Iowa.

OUR Ex-Cel Luminous Crucifix "shines brilliantly in the dark." Sells on first demonstration. Big profits. Free Selling Talk with first order. W. C. Hannan Co., Dept. B, 57 E. 18th St., Chicago.

AGENTS, both sexes, we manufacture and control new household article. Fast seller. Big profits. Exclusive territory. Write now. Connolly, 123 Liberty St., New York.

EARN \$40 to \$60 weekly selling our beautiful umbrellas. Compendial work; rapid sales. Every umbrella nets \$1 commission. Write for particulars. A. E. Erasmus Specialty Co., 305 Broadway, New York.

RUG Salesmen—Get next to the biggest seller of the year—Loomrite Felt Rugs. Sell at sight at \$2.50; cost \$15 dozen. Big, complete Rug Catalog, Free. Mabley-Payne Mfg. Co., 104-D Hanover St., Boston, Mass.

AGENTS and district managers wanted everywhere for our Ideal Exhaust and Pet Cock Whistles, also Glare Shields. Men with autos preferred. Exclusive territory given. Address Interstate, 192 Market Street, Newark, N. J.

WORLD'S Greatest 10c sellers—Aluminum Pencil Sharpeners, \$8 Gross. Sample 10c. Also needle threaders. Hutter Specialties, Milton, N. Y.

AGENTS! A sale in every home for our beautiful dress goods, silks and general yard goods. Quick sales! Big profits! Large book of nearly 1,000 handsome fabric samples furnished to agents. Write today. National Importing & Mfg. Co., Dept. 6X, 573 Broadway, New York, N. Y.

AGENTS—Earn \$100 a week selling our "Fashion" knitted silk men's neckwear, direct from manufacturer. Popular price; latest designs; easy sellers; permanent proposition. Write today for liberal offer. Fashion Specialty Co., 799 Broadway, New York.

SILK Hosiery—Men or Women, write quick. Brand new proposition, selling 4 pairs guaranteed Japanese silk hose \$5. Direct from mill. Biggest money-making offer ever made. Stylia Hosiery Mfg. Co., New Haven, Conn.

AGENTS, Distributors, Energetic Men everywhere earn \$10 daily handling the HyKon Sewing Machine Belt; a new household necessity; sells on sight to homes, dressmaking and tailoring establishments. Be first; get this money-maker; put out sub-agents. Opportunity folder free. HyKon Mfg. Co., Alliance, Ohio.

BIG money and fast sales—every owner buys gold initials for his auto. You charge \$1.50. Make \$1.44. Ten orders daily easy. Write for information and free samples. World Monogram Co., Dept. B, Newark, N. J.

SILVER Mirrors! \$10 Daily. Complete instructions \$1.00. American Sign Co., 149-a LaSalle Street East, Montreal.

MEN and women agents. Sell Box Stationery and Xmas card sets with name and address. New big profits. Samples. Texply Co., 15D, Somerville, N. J.

AGENTS Wanted. Free samples. Large manufacturer wants agents sell shirts direct to wearer. Latest patterns; new patented cuff. Fisher Shirt Co., 543 Broadway, New York.

BIG Profits Easy. Every housewife wants Perfection Pressure Cooker. Saves ¾ fuel and time. Whirlwind seller. Write Jubilee Mfg. Co., 13 Sta. C, Omaha, Nebr.

AGENTS: You Can Obtain \$12.75 Outfit Free and make big money selling beautifiers. Women buy easy and repeat. 100% Profit. Don't miss this. Belle Plaine, P.M., 1442 Belle Plaine Ave., Chicago.

"FORGET-ME-NOT Desk Memorandum Machine!" Every store, office, doctor, etc. needs one. Patented. No competition. Sells \$4.35. Big commission. Selling outfit free. Memo Manufacturing Co., 2153 West Warren Ave., Detroit, Mich.

AGENTS: Where to buy 12,000 articles Wholesale. Actually worth \$50. Enclose 2c stamp. Wholesale Supply Co., Valdosta, Ga.

INCREASE your sales! See advertisement page 176 this issue. J. B. Simpson, Inc.

SHEEP Wool Moccasins, Polishers, Dusters. Box 28, East Boston, Mass.

FORTUNE Maker—Thread-Cutting Thimble. Live wires only. Sample, 15c. Automobile Mfg. Co., 3753 Monticello, Chicago.

YOUR Spare Time Is Valuable! We will pay you big money to use it taking orders for our Beautiful Rubber Tea Aprons, in Green, Red, Blue, Rose, and Grey colors, trimmed with White Ruching—Extra Fine Quality Throughout. Taking just ten orders a day will make you over \$40.00 a week. Twenty orders a day \$80.00 a week! Sales easy made, because women and girls everywhere buy on sight. Millions will be sold within a few months. Why not get your share of this money? Complete Selling Outfit and Case of Samples, price \$6.00, sent C.O.D. for only \$3.00. May we send you an Outfit? Address The Horsey-Bassett Co., Inc., Crisfield, Md.

AGENTS Wanted—Something New—Fire Fighter sells easily. Makes a spectacular demonstration: car owners, homes, factories, stores, practically buy on sight, our men make \$10.00 to \$50.00 a day; exclusive territory. If you wish to establish a business of your own with unlimited possibilities for making big money, write us today. Fyr-Fytor Co., 103 Fyr-Fytor Bldg., Dayton, Ohio.

MAKE \$31.00 Profit—Cost You \$1.50. Complete Gold Monogramming Outfit. Transferred Instantly on Automobiles, Trunks, Bags, Windows. Experience unnecessary. Free Samples. Nulife (A) Monogram, Hartford, Conn.

\$60-\$200 A WEEK. Genuine Gold Letters for store windows. Easily applied. Free samples. Liberal offer to general agents. Metallic Letter Co., 435-D, North Clark, Chicago.

SELL "Amens" Shirts. Wonderful opportunity, big profits. Made-to-measure and stock shirts; finest materials. Write for details. Mensin Shirt Co., 479-A, East Tremont Ave., New York.

AGENTS: C. T. A. prices lower than ever. Suits \$18.00, made to order, any size or style. Orders easy to get. Big profits. Agents' outfit free. Sample suit at cost. Write Chicago Tailors Ass'n, Dept. 418, Sta. C, Chicago.

AGENTS: Big profits, no competition. Make \$5 to \$15 daily selling our beautiful Scripture Text Calendars. Agents now selling from 10,000 to 50,000 yearly. Write now. Address Messenger Publ. Co., Dept. 116, 314 W. Superior St., Chicago, Ill.

AMAZING auto necessity. Retail \$4.00. Your profit \$2.50. Territory going. Write Super, 1306 Fondulac, Milwaukee, Wis.

AGENTS—\$4.25 Profit on every sale of Nibco Service Set. Needed in every home and building. Get particulars quick. A. A. Silver-Chamberlin Company, Clayton, N. J.

EARN \$10 daily silvering mirrors, plating and refinishing metalware, auto, chandeliers, bedsteads, headlamps. Outfits furnished. E. Decle Laboratories, 1133 Broadway, New York.

MEN'S Shirts. Easy to sell. Big demand everywhere. Make \$15.00 daily. Under-sold stores. Complete line. Exclusive patterns. Free samples. Chicago Shirt Manufacturers, Franklin and Van Buren, Factory 113, Chicago.

AGENTS: \$16 a day. Latest improved portable talking machine. Does more than machines costing five times its price. Built-in just like a suitcase. Fully guaranteed. Pay you daily. Write Perry-Ladlow Co., S-1942, Dayton, Ohio.

A SALE in Every Home: The Burn's Guaranteed Bread Knife. Cuts warm bread or cold bread—cuts it without leaving a crumb. All you have to do is to let people try the knife. They will buy. We guarantee the sale and a good profit. Write now. Don't delay. Some one is going to sell this knife in your community. J. M. Pitkin and Co., 322 Commercial Block, Newark, New York State.

BIG Fast Profits for Agents. Repeater Six Fuse Plugs sell on sight wherever there is electricity. Do away with lighting troubles. Welcomed everywhere. Get details. Sample 25c. Moss-Schury Manufacturing Company, Inc., 10-A, Detroit, Mich.

HEATING with oil is in its infancy. Get in while the getting is good. Our burners make good. Agents wanted. Exclusive rights. Economy Oil Burner Co., 718-721 Second St., Webster City, Iowa.

INSTANT Rubber Weld. Repairs largest punctures without cement or heat. Lenn's profit one day, \$56. Write quick. Free sample; territory going fast. Tourists' Pride Mfg. Co., Desk T, Minneapolis, Minn.

GOLD Leaf Sign Letters; make and sell; profits exceed 1,000%; immense demand; particulars free. Johnston Co., Quincy, Ill.

AGENTS, \$100 weekly selling fancy knitted ties. Sample 35 cents. Raymond's Mfg. Co., 31 East 132nd Street, New York.

EIGHT Dollars for seven hours! Peck's Rivets quickly mend leaky kitchenware. Sell everywhere on sight. Samples free. Box 25c, Peck Company, 7 Medina, N. Y.

AGENTS sell made to measure gabardines, whipcords, \$14.50; reversible raincoats; \$75-\$100 weekly. Outfit free. Standard Raincoat, Dept. 5, 129 West 17th St., New York.

AGENTS (both sexes): We manufacture and control new household articles. Fast seller. Big profits; exclusive territory. Write now. Connolly, 123 Liberty St., New York.

AGENTS—If you have formerly sold felt rugs, write for our new proposition concerning new goods. It's a winner. Newark Felt Rug Company, 27-C Bergen Street, Newark, N. J.

\$15.00 DAILY easy selling Unbreakable Amseroid Combs, kind can hit with hammer, saw wood with teeth, etc. Top-notch sellers with agents. Streetmen selling over \$100.00 worth Saturday afternoon and evening. You can do as well. Terms and convincing proof free. Oliver Gandy, Crisfield, Md.

SELL Something nine out of ten women will buy because it saves double its cost the day it is bought, 50c each, \$2.00 profit on \$3.00 sales. Premier Mfg. Company, Dept. 813, Detroit, Mich.

SELF-threading Needles find sales in every home. Fine side line. Easily carried. Big profits. Sample free. Prentice-Lee, 145 East 23rd St., New York.

IDEAL Side-line: \$1 Check Protector. 300% profit. K. Home, 1957 Warren, Chicago.

AGENTS—Everywhere—to sell Women's and Children's shoes direct to wearer. Quality guaranteed. We deliver. A. B. Condon, Sales Manager, The Allen Shoe Co., 110 Summer St., Boston, Mass.

PORTRAIT Agents—\$50,000 Profits I made canvassing. My valuable Free book explains all. Guaranteed Prints, Portraits, Frames, Photo-Pillow-tops, Sheet Pictures, shipped all over the world. Samples free. Picture Man Friedman, Dept. 8-H, 673 Madison, Chicago.

SUCCESS in Business and Personal Affairs! Read character by handwriting and features. Conlin System. Low price for entire course. Write H. E. Conlin, Dept. B, 21 St. John's Place, Buffalo, N. Y.

ANY man handy with paint brush or light tools can start new mechanical business on nearly nothing; needed everywhere; nearly all profit; experience not required. John Braeland, 1457 So. Ninth, Philadelphia, Pa.

EASY, pleasant work for Mechanics, Shop Men, Clerks, during spare hours; will add many dollars to their salaries. Also want persons who can give full time. Big wages assured. Novelty Cutlery Co., 67 Bar St., Canton, O.

SPECIALTY Salesmen or State Distributors to sell Keystone E-Z Steering Post Bushings. This is a money maker. Reports big. Keystone Sales Co., Pacific Bldg., San Francisco, Calif.

YOUR big opportunity. Make \$1 an hour. Everybody enjoys music. Particulars free. Crocker-Steinkamp Music Publishers, Quincy, Ill.

WONDERFUL Seller. Big Profits. Harper's Ten Use Cleaning Set washes and dries windows, scrubs, mops, cleans walls, sweeps, etc. Complete set costs less than brooms. Can start without investing a cent. Write Harper Brush Works, 111-A St., Fairfield, Iowa.

START and Operate Your Own Business and acquire financial independence. Openings everywhere. Either men or women. We furnish everything and show you how. Big explanatory book "The Open Door to Fortune" free. Ask for it now. National Scientific Laboratories, 16A, Richmond, Va.

AGENTS: Big Money Monogramming by Transfer Method. Catalog Showing Over 50 Styles and Particulars Free. Motorists' Accessories Co., Mansfield, Ohio.

SELL Madison "Better Made" Shirts direct from our factory to wearer. No capital or experience required. Easily sold. Big profits. Write for Free Samples, Madison Mills, 503 Broadway, New York.

"HOW to Sell Patents" free. Patent News-O, Washington, D. C.

FOUR \$7.50 Sales to Merchants Net you \$20.00 Daily. Sayers Systems, 2815 Sheffield, Chicago.

AGENTS—W. F. Omels, a former brush salesman, made over \$5,000.00 during 1923 selling our \$1.50 kitchen specialty. He is now a district manager. We are offering you the same proposition—an opportunity as big as you want to make it. You can do what Omels did. Write today to M. H. Tyler Mfg. Co., Manager's Desk, Muncie, Ind.

AUTO owner tire agent wanted each locally to use and take orders for hand-made Mellinger fabric and cord tires; guarantee bond 8,000 and 12,000 miles (no seconds); shipped prepaid on approval; get your tires free; no capital or experience required; make \$100 to \$300 weekly. Write for wholesale prices and sample kit. Address, Mellinger Tire Co., Dept. 100, Kansas City, Mo.

AT Last—World's Greatest Adding Machine. Almost human. Retail \$15; work equals \$300 machine. \$99 monthly easily made, demonstrating to stores, offices, garages, factories. Simple, easy; adds, subtracts, multiplies, divides automatically. Speedy, accurate, durable, handsome. Five year guarantee. Tremendous demand; amazing profits. Liberal trial offer. Protected territory. Write quick. Lightning Calculator Corp., Dept. F, Grand Rapids, Mich.

GREATEST Sensation! Eleven piece tail-let article set selling like blazes at \$1.75, with \$1.00 dressmakers' shears free to each customer. Spying rush on. Foster Beld Co., 38 Winslow Bldg., Station C, Chicago.

REX India Fibre Broom: One of the biggest sellers on market. Outlasts five ordinary brooms—price no higher. 100% profit. Rex Fibre Products Company, 145-C New Jersey Ave., Brooklyn, New York.

BIG Money and Fast Sales. Every owner buys Gold Initials for his auto. You charge \$1.50; make \$1.35. Ten orders a day easy. Write for particulars and free samples. American Monogram Co., Dept. 60, East Orange, N. J.

"\$10 A DAY and More," our new book, shows clearly how you may gain sure success and large profits selling Guaranteed Hosiery and Underwear, factory to family. It is Free. Write today. C. & D. Company, 41-E, Grand Rapids, Mich.

AGENTS—\$3 per hour and more! Sell Iron Board Covers, Rubber Aprons, Shopping Bags, Embroidered Aprons, Satens Coverall Dresses. Free Sample offer! American Hosiery Company, Dept. P, 329 W. Monroe, Chicago.

MAKE \$25 to \$50 Week representing Clow's Famous Philadelphia Hosiery, direct from mill—for men, women, children. Every pair guaranteed. Prices that win. Free book "How to Start" tells the story. George Clow's Company, Desk 31, Philadelphia, Pa.

YOU can be your own boss with our Key-Check outfit. Good for \$5 a day stamping names on pocket key checks, fobs, etc. Sample check with your name and address, 20 cents. Pease Die Works, Dept. M, Winchester, N. H.

PORTRAIT and Medalion Agents—Our Goods Will Make You Big Profits; delivery guaranteed; prompt shipments; low prices; send for latest catalog. Adam J. Kroll & Co., 602 Blue Island Ave., Chicago.

EARN big money fast applying gold initials to autos. Every owner buys—\$1.35 profit on \$1.50 sale—particulars and samples free. Write quick. Lithogram Co., Dept. 17, East Orange, N. J.

MAN in each town to plate auto parts, reflectors, bathroom fixtures, refinish beds, mirrors, chandeliers; by new method. No capital or experience required. Simple plan of manufacturing at home starts you in big money-making business. Outfit furnished. Free particulars and proofs. Gun Metal Co., Ave. H., Decatur, Ill.

AGENTS: Big profits. Best and cheapest window letters made. Easily applied. Dime loings five samples. Particulars free. Stalbritte Co., 1115 Second Ave., New York.

AGENTS—Clever Invention! Inkspoon makes every pen a fountain pen. Fast office seller; big profit, demand increasing everywhere. Exclusive territory offered. Sample free. H. Marul Company, Tribune Bldg., New York, N. Y.

RAINCOAT Agents. Get Our Prices. Sell made-to-measure raincoats. We deliver and collect. Outfit free. World Raincoat Co., 639 Morris Park Ave., New York.

EVERYBODY uses extracts. Sell Duo Double Strength Extracts. Complete line household necessities. Big repeaters. Write today. Duo Co., Dept. E1, Attica, N. Y.

AGENTS—Stamping names on Pocket Key Protectors; sample Check with your name and address, 25c. Stamping Outlets, Emblem Checks, Check Folds, Name Plates, Hart Mfg. Co., Desk 2, 303 Degraw St., Brooklyn, N. Y.

IF you need good live agents—fellows who can get the business—ask me how others are doing it. I'll gladly render the necessary assistance. Geo. F. Baker, Mgr. Classified Advertising, Popular Mechanics Magazine, Chicago.

\$8.00 TO \$20.00 per day. A wonderful seller. Any man, woman, boy or girl can make big wages Selling Crimp Grip Clothes Line Fasteners. It is a perfect rope holder and can be used for many purposes. Crimp Grips are a simple, time-saving device. They last a life time and will not rust; it holds the line tight, and saves time on wash days. Every buyer is a booster. Send 50c for Mounted Sample and one pair of Crimp Grip Clothes Line Fasteners. Write for particulars. Crimp Grip Company, Belvidere, Ill.

WANT Distributing Agents everywhere for Hanslick, the new original powdered handsoap. Removes grease, grime, ink, paint, and most anything from the hands without injury to the skin. Every mechanic and auto-owner, everybody who gets his hands dirty will be a customer. A great opportunity for a hustler to get in business for himself. Full information free. Send 10 cents, coin or stamps, for liberal sample can. Solar Products Company, 122 West Lake Street, Chicago.

AGENTS—Best seller: Jem Rubber Repair for tires and tubes; supercedes vulcanization at saving of over 50% per cent; put it on cold, vulcanizes itself in two minutes, and is guaranteed to last the life of the tire or tube. Sells to every auto owner and accessory dealer. For particulars how to make big money and free sample, address Amazon Rubber Co., Amazon Bldg., Philadelphia, Pa., Dept. 505.

AGENTS clear \$50.00 weekly selling Opaline Portraits. Expense money advanced. Credit given. Big line now ready. Samples and Catalog free. Consolidated Portrait Co., Desk 2, Chicago.

AUTOMOBILE Safety Device. Sells at Sight. Men making \$10 a day alone, \$50 with subagents. No competition. Exclusive contracts. Lindl, 306 M & M Bank Bldg., Milwaukee.

MAKE money silvering mirrors, all kinds plating, knives, spoons, auto headlights. Outfits furnished. Free booklet. International Laboratories, Dept. 25, 311 Fifth Avenue, New York.

AGENTS—N-R-G Laundry Tablets, the old reliable money-maker for live agents. Millions sold—used in many homes—sales waiting for you. Clothes washed spotlessly clean in 10 minutes without rubbing. Free samples. N-R-G Company, 732-A N. Franklin, Chicago.

SELL Necessities. Everybody needs and buys the "Business Guide." Bryant cleared \$800.00 in July. Send for sample. It's free. Nichols Co., Box 4-B, Naperville, Ill.

\$190 WEEKLY. Agents, Crew Managers. Absolutely new article selling big to housewives. No capital required. Commissions paid in advance. No collections. No delivery. Exclusive territory. Write quick. Pioneer Corp., 6301 Yale Ave., Chicago, Ill.

AGENTS make 500% profit handling Auto Monograms, New Pictures, Window Letters, Transfer Signs; Novelty Signs. Catalog Free. Write Hinton Co., Star City, Ind.

GET Our Free Sample Case—Toilet articles, perfumes and specialties. Wonderfully profitable. La Derma Co., Dept. A, St. Louis, Mo.

AGENTS—Good salary and commission selling "Ratskill," new rat and mouse exterminator; ready for use; no bait required; non-poisonous; rodents die outside premises; no odor. Empire Specialties Co., 1549 N. Wells, Dept. 301, Chicago, Ill.

BE Independent—Here's your opportunity. It's your loss if you pass this up. Parham, Box 104, Ripley, Tenn.

WANTED—Representatives to sell Automobile necessity. Kills headlight and sun glare. Write for sample. Dept. F, The Clark Products Co., Springfield, Ohio.

PORTRAIT Agents and Others. Get Big Profits. Sell Perry Photo Medallions. You charge \$2.98; make 400% profit, \$10 daily easy. Big exclusive line, 4-day service. Perry Photo Novelty Corporation, Section 16, 360 Bowery, New York.

WE start you Without a Dollar. Soaps, Extracts, Perfumes, Toilet Goods. Experience unnecessary. Carnation Co., Dept. 201, St. Louis.

AGENTS make a dollar an hour. Sell Mendets, a patent patch for instantly mending leaks in all utensils. Sample package free. Collette Mfg. Co., Dept. 404-B, Amsterdam, N. Y.

AGENTS—Sell Patented Cigar Lighters and Cigar-Case Moisteners. Big Profits. Start making money at once. Write for circulars, cuts and sales plan. Drake Mfg. Co., Dept. M, Milwaukee, Wis.

LARGE corporation wants a Service Man in every town to paste up his signs on store-keepers' windows. Excellent opportunity for reliable party. Steady work. No experience necessary. We also have attractive proposition for agents and salesmen. Guarantee Sign Service, 361 West Superior, Chicago.

AGENTS make \$10 daily—Big line guaranteed extracts, food products, perfumes, toilet goods, household necessities. No capital or experience needed. Free sample case and instructions. Write for amazing offer. Perkins Products Co., Desk 6, Hastings, Neb.

AGENTS; Big Returns, fast office sellers; particulars and samples free. One Dip Pen Co., 2 Daily Record, Baltimore, Md.

AGENTS, Dealers, Individuals—Chance to make some real money quick. While 10,000 Genuine Gold Plated Gillette Safety Razors, Blades and Cases last. This is not the cheap imitation that is imported but the Genuine Gillette made in the U. S. A. A nationally advertised article at this remarkably low price. Can easily be sold at \$2. Sell to your friends for Xmas gifts. Agents clean up on this! \$1 each; \$11 doz.; \$120 gross. W. Stenzel, 6159 St. Lawrence Ave., Chicago, Ill.

WONDERFUL Little Article; something new; make it yourself; men and women make \$15 daily; experience unnecessary; article cost 5c, retail \$1. Particulars Free. Taylor's Novelty Shop, Columbia City, Ind.

TAKE orders for Bleacho—the new amazing preparation for lightening skin. In enormous demand by colored people. Guaranteed to satisfy. Nationally advertised. Going like wildfire. Live agents earn—from \$50 to \$200 a week easy. Write now for exclusive territory. Superior Drug Sales Co., 4909 Broadway, Chicago.

LIFETIME Guaranteed metal outfit makes article costing 1c, sells 10-15c like wildfire. Price, \$7.50. Samples 25c. New Jersey Specialty Co., 16 Bergen St., Jersey City, N. J.

DELICIOUS Desserts—\$1.00 an hour selling Stuart's delicious desserts, pudding powders and pie fillers. Write for terms and free samples. C. H. Stuart & Co., 5847 B'way, Newark, New York.

HIGH-GRADE SALESMEN WANTED

DISTRICT Managers: Are you making 290% on your sales? If not, get our proposition. High-grade line of Household Necessities. Write for territory and full particulars. Midwest Drug Co., 185 East Nighthelm St., Columbus, Ohio.

\$3,000 AND more a year easy for capable salesmen selling Kit-Chin-Kits. Great, new idea. Tremendous sales possibilities. Get full particulars. Kit-Chin-Kit Corporation, A-923, 6 West Randolph St., Chicago.

LARGE Jewelry firm wants representatives. Sell high-grade jewelry direct. Full or spare time. Factory prices. Satisfaction guaranteed. Your generous profits in advance. Direct Jewelry Co., 16 Central Parkway, Cincinnati, O.

OIL or Coal? "The Burning Question," interesting booklet, discusses high efficiency residence oil burners. Copy free. Write E. L. Miller, Manufacturer Climax Burners, 23 Climax Bldg., Kansas City, Mo.

\$30 DAILY taking orders. Union made Raincoat \$2.82. We deliver, collect. 921 Roosevelt, Chicago.

SELL something you make yourself. Most independent life on earth. Buy supplies anywhere. Machinery unnecessary. Every motorist your customer. Enormous profits. Send self-addressed envelope. Leon Lambert, 500 South Volusia, Wichita, Kan.

TAILORING Salesmen: Make more profit. Get our complete outfit made-to-measure suits, 160 fabrics. Six wholesale prices \$18.00 to \$30.00. Fix your own selling prices. Make all the profit you want. Undersell all competition. Lower prices than any other line—big profits for you. Guaranteed quality by firm established 1885. Write for full particulars. Fred Kauffmann, The American Tailor, 1300 W. Harrison St., Chicago, Dept. 102.

SALESMAN calling on department, drug and stationery stores can make desirable commission. Give full particulars as to territory covered, etc. The Bardette-Murray Company, 2530 Superior Avenue, Cleveland, Ohio.

YOU can establish a permanent business with Davis \$29.50 made to measure Quality Clothes. Our Fall line a beauty. Big double swatches mostly sturdy worsteds "Square Deal" policies. Money-back guarantee. Liberal commission collected in advance. Universally regarded fastest selling quality line in field. Write The P. H. Davis Tailoring Co., Sales Director, Cincinnati, Ohio.

MACHINERY and Supply Salesmen, open for side line; good selling specialties, money makers. Saint Louis Machine Tool Co., 932 Loughborough Ave., St. Louis, Mo.

SPECIALTY Salesmen, highest type, to sell Butterfly Tints, a non-boiling dye; good commission, permanent position, territories open. Butterfly Tinting Company, Minneapolis, Minn.

COMMISSION \$15.00 per day selling our high-grade line of Men's Shoes direct to wearer. We deliver. Build up a steady repeat business for yourself. Write for details of our selling plan. Knapp-Well Shoe Co., 184 Summer St., Boston, Mass.

SALESMAN: If You Want \$6,000 This Year, write now. Strong line for retail stores. Nationally advertised; established concern. Liberal weekly advances to producer. George R. Williams, 1920 Euclid, Cleveland, Ohio, Dept. 290.

SALESMEN. We pay larger commissions than any other Brush House in the country to men selling our line of Sanitary twisted-in wire Brushes, Sanitary Wire Grip Brush Co., 15-17 Mercer St., New York.

SELL coal in carload lots. Salesman Wanted. Side or main line. Experience unnecessary. Earn week's pay in an hour. Washington Coal Company, Stock Yards Station, Dept. J, Chicago.

MANUFACTURER of new type, water, steam and heat proof fibro transmission and conveyor belting. Substitutes leather belt. Costs less. Wants high grade salesman who can sell mills and factories a high grade necessity. Good and permanent income, repeats credited. Super-speed, 170 Summer St., Boston, Mass.

\$18.00 TO \$60.00 daily. No experience required. Wonderful VIX Vapor Humidifier. For all cars. Doubles mileage; eliminates carbon, plug cleaning, valve grinding. More power, pep and speed. One free to introduce. Walter Critchlow, Suite 358, 716 Madison, Chicago.

TAILORING Salesmen, add to your sales and profits. Sell boys' suits as well as men's. Make double profit on every sale. Get our complete outfit of men's and boys' suits. The greatest line in America, \$8.45 and up for boys' two-pants suits, \$23.50—\$26.50—\$29.50 and up for regular \$50.00 men's suits made-to-measure. Guaranteed quality. Our salesmen making \$75.00 week easy. Complete sample outfit in carrying case free. Write quick for full particulars—exclusive territory. Wright & Co., Dept. C102, 500 S. Throop St., Chicago.

SALESMEN—Crew Managers. You will have the devil's own time trying to find a better seller than "Zippe." If there was such a thing we'd have it. Splendid profit on 50c "Go Getter" repeat article that sells on ten second demonstration. Works While You Watch It. Demonstrates value, while others waste time making claims. New Discovery! Greatest Scientific Triumph of the age. It's the berries. Haven't room to tell our story here. Write immediately. Karam-Smith Co., 6610 Clark St., Fort Wayne, Ind.

BRUSH Salesmen, 50% and Bonus. \$75 weekly easy. Write quick for territory. Neway Brush Co., Hartford, Conn.

\$4.00 PROFIT on Every \$3.00 Sale. "Free Sample."—New Specialty. (Money Getter.) Every Storekeeper, Doctor, buys quickly. Experience unnecessary. Territories open. Box 596, Hartford, Conn.

INCREASE your sales! See advertisement page 176 this issue. J. B. Simpson, Inc.

SALESMEN: Sideline or Exclusive. Earn \$2500 by Christmas calling on drug, variety, stationery and department stores selling new game which has had tremendous sale in New York. Big commission, Pocket sample. Olsen Games Co., 53 West Washington, Chicago.

\$5 PROFIT selling \$7.50 necessity. Write for sample. Merchants Ass'n, Minneapolis, Minn.

A WONDERFUL Seller! Any man, woman, boy or girl can make big wages. Some agents make from \$8.00 to \$20.00 per day. Crimp Grip Clothes Line Fasteners are a simple, time-saving device for holding a rope—also used for many other purposes. It stays for itself quickly in time saved on wash days. No knots—it fastens and releases quickly. Every home a prospect. Every housewife who uses Crimp Grips—and there are thousands of them—is a booster. There is but one Crimp Grip. Write for particulars, or send 50c for one pair and a mounted sample, with full particulars to agents, Crimp Grip Company, Belvidere, Ill.

\$40-\$200 A WEEK. Genuine Gold Letters for store windows. Easily applied. Free samples. Liberal offer to general agents. Metallic Letter Co., 438-B North Clark, Chicago.

SALESMEN and Distributors for our Nationally Advertised line of Motorene Oils and Columbia Paints. We desire men of real ability who can establish a going business in their communities. This is an opportunity to establish a permanent business which will pay from \$2,000 to \$5,000 a year. Central Petroleum Company, Cleveland, Ohio.

"ZIM'S Foolish." Quickest seller; surest collector. Biggest—best Collection System published. Retail \$7.50. Creditors' Association, E-312 McKnight Bldg., Minneapolis, Minn.

PHOTO medallion salesman: Earn \$100 to \$200 every week selling P. & G. Photo medallions. No investment—free equipment. Guaranteed 4-day service—send for sales plan and free 1923 catalogue with 102 beautiful designs, including clock and religious medallions. Puddin & Goldstein, 259 Bowers, Dept. A, New York.

EARN Money at Home. \$25.00 to \$50.00 a week increased income selling our 1923 line of personal greeting cards. Full or spare time. Weekly payment. Samples free. Selling experience unnecessary. Get details. John A. Hertel Co., Dept. D-9, So. Clinton, Chicago.

WORLD'S Fastest Selling Auto Accessory! County distributors wanted; write today. G. L. W. Spring Offer Co., San Diego, Calif.

\$742 LAST month for Beck of Buffalo, introducing latest advertising plan; nothing else like it; every merchant wants it; easy sales; no deliveries; no collections; specialty salesmen write quick for offer. National Adv. Service, P. O. Box 38, La-Grange, Ind.

SALESMEN to sell our Asprin and Gillette Razor deal. Every merchant a prospect; commissions paid in advance. Big surplus waiting. World's Products Co., Spencer, Indiana, Dept. 25.

SALESMEN Can make \$5.00 a day selling our Calendars, Pencils, Signs, Advertising Novelties, Yardsticks, Whistles, etc. Liberal terms. Sells entire year. Fine side line. Local and traveling agencies. Model Calendar Co., Dept. 226, South Bend, Ind.

BEST Seller: Jem Rubber Repair for tires and tubes; supersedes vulcanization at saving of over 80%; put it on cold, vulcanizes itself in two minutes, guaranteed to last life of tire or tube; sells to every auto owner and accessory dealer. Get particulars how to make big money and free sample. Amazon Rubber Co., Philadelphia, Pa., Dept. 516.

TRAVELING Salesmen calling on retail stores wanted by large manufacturer to sell wonderful line of business-boosting articles. Year round, fast selling, main or side line. If not earning \$150 weekly, address Elbaser Works, 222 Charles St., Bensenville, N. Y.

SALESMEN—Become Independent. Own your business; experience unnecessary; selling our \$7,500 Accidental Death, \$50 Accident, \$25 Sick Weekly Benefits; \$12.50 yearly; other amounts proportionate. Guaranteed steady income from renewals. \$250,000 deposited Insurance Department. Registration Dept. A, Newark, N. J.

WELL? You Ever Offered a Grocery Store? Our Proposition is Better. You can handle Sugar, Flour, Canned Goods, Dried Fruit, Coffee and entire line of Groceries, as well as Walnuts, Roofing, and Automobile Oils, with no rent to pay; no money invested; take large orders from samples. Goods are guaranteed and proven quality. Selling experience not necessary. Steady, profitable work for "workers." Address Hitchcock-Hill Co., Dept. 200, Chicago, Ill. Reference: Any Bank or Express Co.

SIDELINE Salesmen Wanted: sell coal to your trade in carload lots. Earn week's pay in an hour. Washington Coal Co., Stock Yards Station, Dept. J, Chicago.

SALESMEN—Sideline pays five to ten dollars a day taking orders for Specially printed gummed advertising and Match Box Stickers. Write for proposition, samples, etc., today. Beardsley's Printery, Rock Island, Ill.

SALESMEN: Secure exclusive protected territory, high class, permanent business, worth \$10,000 yearly. Only small capital needed; no risk. Address Box 1336, New Haven, Conn.

CALIFORNIA Rosebuds selling like hot cakes. Agents coming money. Absolutely new. Big profits. Catalog free. Mission Factory SP, 519 No. Halsted, Chicago, Ill.

HELP WANTED

AGENTS: \$130 to \$375 monthly easy—Introducing New Guaranteed Hosiery. Must wear or replace free. You simply show samples furnished you and take orders. We deliver and collect. Promotions to General Agency made from active workers. Steady repeat business. Cotton, lisle, silk's, leather, wool hose for all the family. Spare time satisfactory. No experience required. No capital needed for stock. Your pay daily. Mac-O-Cheo Mills Company, Desk 26010, Cincinnati, Ohio.

WANTED, Men, Boys, 18 Up, to travel. See the country. Become U. S. Government Railway Postal Clerks. Steady employment. Commence \$133 month. Quick raise. Life position. Paid summer vacation. Experience or influence unnecessary. Common education sufficient. Write today for free list Government positions now obtainable. Franklin Institute, Dept. B-3, Rochester, N. Y.

GOVERNMENT positions, \$1,400-\$2,300 yearly. Many openings. 36-page information booklet free. Chicago Civil Service College, A-41, Kesner Building, Chicago.

EARN \$110 to \$250 monthly, expenses paid as Railway Traffic Inspector. Position guaranteed after completion of 3 months' home study course or money refunded. Excellent opportunities. Write for Free Booklet CM-46, Stand. Business Training Inst., Buffalo, N. Y.

FIREMEN, Brakemen, Baggage-men, Sleeping car, train porters (colored). \$140-\$200. Experience unnecessary. 810 Railway Bureau, E. St. Louis, Ill.

IS your job steady? Be U. S. Railway Postal Clerk. \$133-\$192 month. Travel. See the country. Particulars free. Write immediately. Franklin Institute, Dept. B-20, Rochester, N. Y.

RAILWAY Postal Clerks—Start \$133 month. Railroad pass; expenses paid; questions free. Columbus Institute, E-2, Columbus, Ohio.

START Silvering Mirrors, Headlights, Tableware, Replate shoes, jewelry. Plans free. Clarence Sprinkle, Dept. 28, Marion, Ind.

BOYS—Men. Become automobile experts. \$35 week. Earn while learning. Write. Franklin Institute, Dept. B-101, Rochester, N. Y.

LOCOMOTIVE Firemen for railroads nearest their homes—everywhere; beginners \$150-\$250 monthly. Railway Association, Desk M-1, Brooklyn, N. Y.

BE a Finger Print Expert. Demand increasing. Write for special free offer. American Finger Print System, 1908 Broadway, New York.

INCREASE your sales! See advertisement page 176 this issue. J. B. Simpson, Inc.

EARN \$15 daily, painting Theatrical Scenery. We teach by mail. Send stamps for literature. Enkeboll Art Studios, Omaha, Neb.

MEN, Women, Girls Wanted, \$92-\$192 month. Government jobs. Steady. List positions free. Write immediately. Franklin Institute, Dept. B-20, Rochester, N. Y.

LEARN Moving-Picture Machine Operating at actual work in spare time; jobs secured \$45 weekly; course short; fees small. Write, Operating School, Box 38, Sioux Falls, So. Dak.

MAKE money writing Photo-plays; details free to beginners. No correspondence course. Producers' League, 250 Wainwright, St. Louis.

ALL men, women, boys, girls, 17 to 69, willing to accept Government Positions, \$117-\$190, traveling or stationary. Write Mr. Gament, 101 St. Louis, Mo., immediately.

RAILWAY Mail Clerks wanted. Commence \$133 month. Sample examination questions free. Franklin Institute, Dept. B-20, Rochester, N. Y.

MAKE \$150 to \$600 monthly. Be an expert automobile painter and refinisher. We teach you this fascinating profitable business in your own home. Free particulars. Automobile Finishing Co., Shelbygan, Wis.

\$133-\$192 MONTH. Railway Mail Clerks wanted. Steady work. Sample examination questions free. Franklin Institute, Dept. B-20, Rochester, N. Y.

SILVERING Mirrors, French plate. Easily learned; immense profits. Plans free. Address, Wear Mirror Works, Excelsior Springs, Mo.

EARN \$10 daily silvering mirrors, plating and refinishing metalware, autos, chandeliers, bedsteads, headlights. Outfits furnished. E. Dece Laboratories, 1133 Broadway, New York.

RELIABLE Men and Young Men Wanted Everywhere to distribute free samples and simulators, etc. No selling or soliciting. No experience or capital needed. Permanent business opportunity at big pay. Do not fail to write us at once for contracts and details. American Advertising Association, File AA-1, 6930 North Clark St., Chicago, Ill.

INVENTORS desiring to secure patents should write for our book "How to Get Your Patent," tells our terms and methods. Send sketch for our opinion of its patentable nature. Randolph & Co., Patent Attorneys, 620 F. Washington, D. C.

\$80-\$200 A WEEK. Genuine Gold Letters for store windows. Easily applied. Free samples. Liberal offer to general agents. Metallic Letter Co., 438-C, North Clark, Chicago.

WRITE articles, stories, news, in spare time for newspapers and magazines. Big pay. Copyright book free. Press Syndicate, 553, St. Louis, Mo.

OUR genuine gold window sign letters are an excellent money-making proposition for handy men. Slans Sign System, Bethune Ave. E., Detroit, Mich.

WANTED: Railway Mail Clerks—\$1,600 to \$2,300. Exams everywhere. Write today for full information. Patterson, Civil Service Expert, Box 4025, Rochester, N. Y.

BE a Finger Print Expert—Opportunities opening everywhere. Write National System, 186 East 79th, New York.

STORIES, poems, plays, etc., are wanted for publication. Good ideas bring big money. Submit manuscripts or write Literary Bureau, 522, Hannibal, Mo.

ART AND ADVERTISING

CARTOONISTS—Improve your style by following the work of the greatest cartoonists found in the bound volumes of Cartoons Magazine. Eight volumes, each covering six months, Jan.-June, 1917, to July-Dec., 1920, inclusive, 1,200 cartoons, 300 pages to a volume 7 by 9½ in., 3 in. thick. New books, durable and attractive binding. Sold separately at \$2 per volume. Supply limited. Send at once. Popular Mechanics Book Dept., 200 B, Ontario St., Chicago.

INFORMATION

COMPLETE, accurate, information on any subject \$1. National Information Bureau, 1429 Milton St., S. E., Grand Rapids, Mich.

MAILING LISTS

2400 COUNTY Agricultural Agents, 1300 Home Demonstration Agents, \$8 thousand. Morrison, Box 588, Atlanta, Ga.

GUARANTEED accurate names, addresses, many classifications. Martineck, Corona, N. Y.

TYPEWRITERS AND SUPPLIES

UNDERWOOD Typewriters at far less than manufacturers' price; rebuilt, all worn parts replaced, guaranteed good as new. Cash, installment payments. Write for Catalog 1517. Shipman-Ward Mfg. Co., estab. 1892. Montrose and Ravenswood Ave., Chicago, Ill.

ALL standard makes, \$10 up. Fully guaranteed. Free trial. Write for complete illustrated lists. Northwestern Typewriter Exchange, 320 West Goethe Street, Chicago.

TYPEWRITERS. All Makes. Save one-half. Thoroughly Rebuilt in our factory by the famous "Young Process." Fully guaranteed. Free trial. We handle all standard makes. Cash or sold on easy terms. Write for Catalog. Young Typewriter Co., Dept. 502, Chicago, Ill.

BLACK ribbons—Visible makes 33c. Typewriter Supplies, 7927-29 Colfax Av., Chicago.

ADDING MACHINES

NEW \$2.50 Automatic Adding Machine. Adds, Subtracts, Multiplies. Absolutely accurate. Capacity 999,999.99. Fully guaranteed. 75,000 pleased users. Makes adding easy, positive, quick. Eliminates Mistakes. Saves Time. Postpaid, \$3.50. Bassett Co., 1458-X, Hollywood Ave., Chicago.

FREE Trial. Marvelous new Adding Machine. Adds, Subtracts, Multiplies, Divides, automatically. Work equals \$250.00 machine. Price only \$15.00. Speedy, durable, handsome. Five-year guarantee. Used by largest corporations. Write today for catalog and free trial offer. Lightning Calculator Co., Dept. E, Grand Rapids, Mich.

DUPLICATORS AND DEVICES

YOU can make 50 to 100 copies of a letter, notice, etc., at a cost of three cents on a Hoyer Quality Duplicator. Write for free trial offer. The Hoyer Duplicator Co., 14 S. Wells St., Chicago, Ill.

"MODERN" Duplicators save Time, Labor, and Money. Gets Business, Reproduces Typewritten or Penned Letters, Drawings, Lessons, Music, Menus, Bills, Notices, Specifications, Maps or anything in one or more colors. Prints Two per minute. Special Sale On 30 Days' Free Trial, \$2.25 up. Booklet Free. J. E. Durkin-Reeves Co., Pittsburgh, Pa.

BUSINESS SERVICE

INCORPORATE. Our lawyers do the work, saving you time, annoyance and money in incorporating under the most liberal laws of Arizona. Laws and forms free. Southwestern Securities & Investment Co., Box D488, Phoenix, Ariz.

PRINTING, ENGRAVING AND MULTIGRAPHING

CARDPRESS (Automatic), 16,000 cards. Equipment, \$125. Autopress, 678 Bloomfield Ave., Montclair, N. J.

200 CORRESPONDENCE Sheets, 100 Envelopes, printed \$1.00. "Superior," 1835 Roosevelt, Indianapolis, Ind.

250 FULL-SIZE Bond Letterheads \$1.25, 500 for \$1.75, 1000 for \$2.65. Our complete price list covering Envelopes, Bill-boards, Business Cards, etc., and samples will interest you—they are free. Send for same to-day. Progress Printing Co., 717 Bienville St., New Orleans, La.

ALL Printing Prices Smashed. 5,000 Letterheads or envelopes \$13.85. Samples. Quality Printshop, Marietta, Ohio.

AUTOMATIC Card Press Sale: prints 100 cards per minute. Hatten, 2127 Locust, St. Louis.

PRINTING and Binding. Book work, pamphlets, circulars, and all kinds of Commercial Printing. Rates reasonable. Prompt Mail Order Service. The Shenandoah Press, Dayton, Va.

SPECIAL—250 20-lb. bond letterheads or envelopes, \$1.50. Samples. O-B Company, Fargo, N. D.

1,000 BUSINESS Cards, \$2.75. Samples. Rose Printing Co., 740 Hodapp, Dayton, Ohio.

EVERYTHING Printed! Samples free. Franklin Press, B-32, Milford, N. H.

150 EACH, Letterheads and Envelopes, \$1.50. Jacobus Service, Irvington, N. J.

WE print everything. Stationery, Booklets, Catalogs, Circulars, Samples. Commercial Press, Batavia, Ohio.

250 LETTERHEADS, 250 white envelopes, printed and mailed, \$3.00. Samples printing free. Sunco, Mohawk, N. Y.

PRINTING Outfits—Presses, type supplies, type novelties. Send stamp for catalogue. Model Press, York, Penna.

QUALITY Printing! Reasonable Prices! Tell us your wants and let us quote our Money-Saving prices. Best Work. We print anything. Ernest Fantus, 525 South Dearborn Street, Chicago.

1,000 LETTERHEADS or Envelopes, \$3.00. Sent Prepaid. Samples Free. Monitor Press, Morrisville, Pa.

225 BOND letterheads, envelopes, bill-boards, cards, \$1.25 each. Combination, \$4.00. Economic Press, Leonia, N. J.

10,000 MILK Bottle stoppers printed. Name and Address, \$5.00; 5,000 plain caps, \$2.00. Samples free. Muncie Bottle Cap Co., Muncie, Ind.

1,000 HAMMERMILL letterheads, envelopes, \$3.25; 250, \$1.25. Samples free. Troib Press, 95 Providence, Worcester, Mass.

FOR MEN

ARE you old at forty? See our advertisement on page 156 of this issue. The Electro Thermal Company, 2128 Main St., Steubenville, Ohio.

FOR SMOKERS

ENJOY Life. Smoke Old Field Tobacco. Sample 10c. East Mailing Co., Paducah, Ky.

BOATS AND LAUNCHES

16' ROWBOAT, easily made; construction blueprint 30c. Weesho-Co., West Market, Detroit, Mich.

CHAMPION 35-mile speed boat building plans and directions, \$1.00. Send for free catalogue. The Builder Publishing Co., 9 Murray St., New York City.

ROWBOATS—easily made. Blueprint list free. Weesho-Co., West Market, Detroit, Mich.

RAZORS AND BLADES

BLADES, resharpened, one edge 2c; double 3c. New York Edge Co., Glen Cove, N. Y.

DIAMONDS, WATCHES AND JEWELRY

WATCHMAKERS: Earn highest wages. Understand adjusting thoroughly. Circular free. Write Walter Kleinlein, Publisher, Waltham, Mass.

OPTICAL GOODS

IMPORTED pocket telescopes at ridiculously low price. Unexcelled for hunting, nature study, etc. Enlarges 4 1/2 times, with a large field and excellent illumination. Send no money with order, pay postman \$2.50 on delivery. Money back in ten days if not satisfactory. Borsch & Co., Opticians, 61 E. Adams St., Chicago. Founded 1886.

SIX Power Binocular, \$5.00. Famous Wollensak Binocular, pocket size, light weight, excellent optical quality, fine illumination, handsome, durable finish. Complete with case, only \$5.25 postpaid. Money-back guarantee. Wollensak Optical Company, 17-19 Clinton Ave., N., Rochester, N. Y.

FOR THE HOME

GRANDFATHER Clock works, \$3.00. Build your own case; Instructions free; make good profits selling your friends. Clock works with chimes for old or new cases. Write for full particulars. Clock Co., Ruffner St., Philadelphia.

ANTIQUES, WAR RELICS AND INDIAN GOODS

SEND 5c for list Coins, Indian Relics, Firearms. F. E. Ellis, Webster Groves, Missouri.

INDIAN Goods—Thousand articles. Catalogue 10c. Indiancraft Company, Desk P, 466 Connecticut, Buffalo, N. Y.

INDIAN Baskets, Blankets, Wampum, Mats Wholesale. Catalogue. Gilham, Keeseville, Calif.

PHONOGRAPHS AND RECORDS

BUILD your own phonographs. We can supply you with motors, tone arms and all accessories at wholesale prices. Write for catalogue AX. Pleasing Sound Phonograph Co., 204 East 113th St., New York, N. Y.

BUILD a genuine Choralion phonograph and save over half. Big profit building and selling. We furnish motors, tone-arms, full instructions and all necessary parts. Send for catalog and free blueprint offer. Choralion Phonograph & Radio Co., 1023 11th St., Elkhart, Ind.

BUILD your own phonograph. We furnish everything. Catalog free. American Phonograph Co., 3515 North Crawford, Chicago.

SUPERIOR equipment at lowest price for building fine phonographs. Superior Phonoparts Co., Erie, Pa.

BUILD Your Phonograph. Quality phonoparts. Quality Serenade motor and motors of other types. Electric Motors, tonearms, reproducers, amplifiers, case material, accessories. Free blueprints and building instructions. Big saving. Wonderful results. Prompt delivery. Catalog mailed for ten cents. Hoosier Manufacturing & Supply Co., 313 Baldwin Block, Indianapolis, Ind.

MUSIC AND MUSICAL INSTRUMENTS

BANJOISTS Wanted: Learn to play Professional Tenor Banjo. Twenty-lesson course of chords and harmony complete for \$3.00. Clear and Simple, easy to learn. Send prepaid for \$3.00. Satisfaction guaranteed or money refunded. Walter J. Haas, 566 East 115th Street, Cleveland, Ohio.

"MUSIC Composed" to words. Bauer Bros. (formerly of Sousa's Band), Oshkosh, Wis.

GENUINE Amber Violin varnish. 2 oz. \$2.00. Perin, Rushville, Ind.

MUSIC rubber stamps. Sign marker catalogue 25c. Rubber Type catalogue 25c. W. Karstaedt, Dayton, Ohio.

LEARN Drumming. Expense small, details free. Walberg & Auge, Worcester, Mass.

SAXOPHONIST. Clarinetist. Something you really need. Send for Free Offer. Reed Controller Co., 4839 Prairie Ave., Chicago.

WE make liberal allowance for old player rolls, you are tired of and don't want, in exchange for new, late, 88-note rolls. Word or Instrumental. Write for catalog and plan. Standard Music Exchange, 30 E. Randolph St., Chicago.

SAXOPHONE for \$2.00—By attaching a Hornola Mute to your cornet or trombone. Cornet \$2.00, Trombone \$3.00. Will send Hornola on receipt of amount; money back if not perfect saxophone imitation. Must know actual size bell of instrument. Willard Bryant, 1420-A Woodward Ave., Detroit, Mich.

CORNETISTS—Trombonists—Saxophonists—Clarinetists. Send for "Free Pointers No. 2." Name instrument. Virtuoso Music School, Concord, Mass. Formerly of Buffalo, N. Y.

COMPLETE, easy self-instructors—Harp, Monia, Violin, Piano, Drum, Ocarina, Ukulele, Accordion, Saxophone 25c each. G. Elsea, Bowling Green, Ohio.

VIOLINS—Deep, Mellow, Soulful—on credit. Easy terms for wonderful instrument. Get details today. Gustav F. Henning, 2424 Gaylord St., Denver, Colo.

WRITE Songs. Big money and reputation. Write for information. J. Gordon Pub. Co., 201 N. Hoyne Ave., Chicago.

PATENT ATTORNEYS

INVENTORS should write us for our book, "How to Obtain a Patent," which clearly sets forth what may be patented and the necessary steps to protect an invention; it describes the procedure in patent office and tells about assignments, licenses and trade marks, and gives many useful facts about patents which every inventor should know; many persons well versed in patent matters have pronounced the book the best of its kind they have ever read; it is written so you can understand it; copy free upon request. Talbert & Talbert, Patent Lawyers, 481 McGill Bldg., Washington, D. C.

PATENTS, trademarks, copyrights procured; all countries; very reasonable; booklet entitled "The Last Word on Patents" sent free; "Evidence of Conception" form free; ask about Free Sales Service; 20 years' experience. H. Sanders, 7 Rand McNally Building, Chicago, Ill.

LACEY Patent Sense. See page 146.

INVENTORS: Send sketch or model of invention for opinion concerning patentable nature and exact cost of patent. Book "How to Obtain a Patent," sent free. Tells what every inventor should know. Established twenty-eight years. Highest references, prompt service, reasonable charges. Address Chandlee & Chandlee, 458 Seventh, Washington, D. C.

UNPATENTED Ideas can be sold. I tell you how and help you make the sale. Particulars free. Write W. H. Greene, Jenifer Building, Washington, D. C.

SEND sketch for search report. Get my latest book on Patents. H. L. Woodward, 714—9th St., Washington.

PATENTS—Booklet and full instructions without obligation. R. P. Fishburne, Registered Patent Lawyer, 331 McGill Bldg., Washington, D. C.

PATENTS and Trade-marks obtained. Prompt service. Write for our new book on patents. Established in 1889. D. Swift & Co., 369, 7th St., Washington, D. C.

EDWARD C. SASNETT, formerly a Principal Examiner U. S. Patent Office. Personal Service. 516 McGill Bldg., Washington, D. C.

INVENTORS—Send for form "Evidence of Conception" to be signed and witnessed. Form, fee schedule, information free. Lancaster and Albino, 221 Ouray Bldg., Washington, D. C.

MONROE MILLER, Ouray Building, Washington, D. C., patent attorney, mechanical and electrical expert. Best quality of work and results. Moderate charges.

H. P. LOWENSTEIN, Registered Patent Attorney. Technical expert. McLachlen Building, Washington, D. C.

INVENTORS: Record invention legally before disclosing to others. Our Invention-Record and Data Sheet shows how. Sent free and valuable information given on patent procedure, costs, etc. Report on patentability includes copies of patents nearest your idea. O'Connell & O'Connell, Jenifer Bldg., Washington, D. C.

MILLIONS spent annually for ideas! Hundreds now wanted! Patent yours and profit! Write today for free books—tell how to protect yourself, how to invent, ideas wanted, how to help you sell, etc. American Industries, Inc., 500 Kresge Bldg., Washington, D. C.

PATENTS Procured; Trade Marks Registered—A comprehensive, experienced, prompt service for the protection and development of your ideas. Preliminary advice gladly furnished without charge. Booklet of information and form for disclosing idea free on request. Richard B. Owen, 29 Owen Bldg., Washington, D. C., or 2276-R, Woolworth Bldg., New York.

PATENTS Procured. Send sketch or model today for examination, prompt report and advice. No charge for preliminary advice. Write for free Booklet and blank form on which to disclose your idea. Highest references. Promptness assured. Clarence A. O'Brien, Registered Patent Lawyer, 561 Southern Building, Washington, D. C.

PATENTS promptly procured. Personal, careful and efficient service. Highest references. Moderate fees. Send sketch or model for actual search and advice. George P. Kimmel, Master of Patent Law, 54-M, Loan and Trust Bldg., Washington, D. C.

PATENTS—Before disclosing an invention the inventor should write for our blank form "Record of Invention." This should be signed, witnessed and returned to us together with model or sketch and description of the invention and we will give our opinion as to its patentable nature free. Our Three Books mailed Free to inventors. Our Illustrated Guide Book, "How to Obtain a Patent," contains full instructions regarding patents. "List of Patent Buyers" sent Free, contains unsolicited letters from manufacturers and others who are constantly writing us regarding the purchase or leasing of meritorious patents. Victor J. Evans & Co., 934 Ninth, Washington, D. C.

PATENTS, Booklet free. Highest references. Best results. Promptness assured. Send model or drawing for preliminary examination. Watson E. Coleman, Patent Lawyer, 624 F Street, Washington, D. C.

"INVENTORS' Guide" free on request; gives valuable information and advice for all who have original ideas or improvements. Frank Ledermann, Registered Attorney and Engineer, 15-P Park Row, New York.

PATENTS. My fees in installments. Advice book free. Frank Fuller, Washington, D. C.

BEFORE or after filing application for patent on your invention it will pay you to read over my "Inventor's Advisor No. 3," free for asking. M. Labiner, Registered Patent Attorney, 3 Park Row, New York.

INVENTORS desiring patents, read the free treatise, "Reducing Inventions to Property Rights." Lester E. Barrett, 629 F Street, Washington, D. C.

BOOK on inventions, patents, trade-marks, sent free, advice given; excellent references. Twenty-three years' experience. Bobb, Bobb & Hill, 1348 Hanna Bldg., Cleveland, Ohio, 811 McLachlen Bldg., Washington, D. C.

PATENTS, trade marks, copyrights. Prompt, personal, reliable service. Over 30 years' active practice. Write for terms—book free. Address E. G. Siggers, N. U. Bldg., 918 F St., Washington, D. C.

FOR INVENTORS

PATENTS. If you have an invention which you wish to patent you can write fully and freely to Munn & Co. for advice in regard to the best way of obtaining protection. Please send sketches or a model of your invention and a description of the device, explaining its operation. All communications are strictly confidential. Our vast practice, extending over a period of seventy-seven years, enables us in many cases to advise in regard to patentability without expense to the client. Our Handbook on Patents is sent free on request. This explains our methods, terms, etc. in regard to Patents, Trade Marks, Foreign Patents, etc. "Scientific American" contains Patent Office Notes, Decisions of interest to inventors and particulars of recently patented inventions. Munn & Co., Solicitors of Patents, 623 Woolworth Bldg., New York; Scientific American Bldg., Washington, D. C.; 801A Tower Bldg., Chicago, Ill.; Hobart Bldg., San Francisco, Calif.

INVENTORS, if you're not fully experienced on patent matter, better learn from one who is. My facts will prove valuable assistance. Adolphe Plouffe, 88 South St., Woonsocket, R. I.

COMPLETE instructions for getting Patents, application blanks, sample drawing, all for \$1. Will Wait, Box 31, South Pasadena, Calif.

NEW Ideas Wanted in the Toy and Novelty Line. Something to retail for one dollar or less. Will make and sell on royalty or purchase outright. Patent not necessary, but preferred. Splendid facilities for manufacturing and selling. Address Box 618, East Hampton, Conn.

PATENTS Procured. Send sketch or model today for examination, prompt report and advice. No charge for preliminary advice. Write for free Booklet and blank form on which to disclose your idea. Highest references. Promptness assured. Clarence A. O'Brien, Registered Patent Lawyer, 562 Southern Building, Washington, D. C.

PATENTS Procured; Trade Marks Registered—A comprehensive, experienced, prompt service for the protection and development of your ideas. Preliminary advice gladly furnished without charge. Booklet of information and form for disclosing idea free on request. Richard B. Owen, 30 Owen Bldg., Washington, D. C., or 2276-R, Woolworth Bldg., New York.

I SELL Patents, Established in 1900. A service for the inventor that serves Bankers, Lawyers, Patent Attorneys, Corporations, Mechanics, men in every walk of life, are my clients. Why not you, if you have a patent to sell? Charles A. Scott, 773PM Garson Avenue, Rochester, N. Y.

INVENTORS should write us for our book, "How to Obtain a Patent," which clearly sets forth what may be patented and the necessary steps to protect an invention; it describes the procedure in patent office and tells about assignments, licenses and trade marks, and gives many useful facts about patents which every inventor should know; many persons well versed in patent matters have pronounced the book the best of its kind they have ever read; it is written so you can understand it; copy free upon request. Talbert & Talbert, Patent Lawyers, 495 McGill Bldg., Washington, D. C.

LET me develop that idea or model you contemplate inventing. Address for terms, R. J. Weaver, Engineer, 1203 Big Falls Ave., Akron, Ohio.

DON'T waste money on ideas. Before patenting secure my opinion as to patentability. Including copies of nearest patents, based on search of pertinent U. S. Patents, for \$5. Send sketch. Ralph Burch, Registered Patent Lawyer, Jenifer Building, Washington, D. C.

INVENTOR'S Models and Experimental work. Kempf, 51 Mercer St., New York.

PATENT Senses—"The book the inventor keeps." Free. See Lacey ad, page 146.

WANTED to buy good patent. Simon, 1218 International Life Building, St. Louis, Mo.

INVENTORS—Send your ideas for manufacturing development in our modern sheet metal and angle-iron fabricating plant. Those pertaining to dust collecting or ventilating preferred. Liberal payment for accepted inventions. Kirk & Blum Manufacturing Co., 2851 Spring Grove Ave., Cincinnati, O.

PATENTS. Write for free illustrated guide book. Send model or sketch and description for free opinion of its patentable nature. Highest references. Prompt attention. Reasonable terms. Victor J. Evans & Co., 157 Ninth, Washington, D. C.

UNPATENTED Ideas can be sold. I tell you how and help you make the sale. Particulars free. Write W. T. Greene, Jenifer Building, Washington, D. C.

INVENTORS' Educator: 900 Mechanical Movements, 50 Perpetual Motions. How to procure and sell patents. Mechanical Movements greatly assist inventors, suggest new ideas. Explains how to select an attorney and avoid Patent Sharks. Price \$1.50. Postage Free. Albert E. Dieterich, 621 Ouray Building, Washington, D. C.

PATENT Application Blanks free to inventors. Patent News-D, Washington, D. C.

GET your own patents. Application blanks, complete instructions \$1. Cutting Sons, Campbell, Cal.

"INVENTORS' Guide" free on request; gives valuable information and advice for all inventors. Frank Ledermann, Registered Attorney and Engineer, 15-P Park Row, New York.

MODEL Making and experimental work; Modern Shop; expert workmen. Manufacturing. Lamson Electrical & Mfg. Co., 625 W. Jackson, Chicago.

HAVE You an Invention? If so, write for our free book, "How to Get Your Patent," tells our terms and methods. Send model or sketch for our opinion of its patentable nature. Randolph & Co., Dept. 144, Washington, D. C.

INVENTORS, write for free copy of Modelfact. R. G. Clynne, St. Louis, Mo.

PATENTS FOR SALE

UNITED STATES Patents, Numbers 1,373,700 and 1,443,698. Machines for assembling and feeding paper and carbon sheets to typewriters. Economical manufacture; unlimited market. W. C. Avery, Box 2260, Honolulu, T. H.

FOR Sale on Royalty—Funnel radiator cap; prevents spilling. Fits all makes of radiators. Neat in appearance. Patent pending. Address B. E. Lundeen, Box 14, Avondale, Mont.

WILL sell Patent outright. Fast catcher Fly Trap. Fred Day, Alcester, S. Dak.

PATENT for Sale, outright. New invented Extension Table, patented U. S. A. 477,790, and Canada 256,286. Jos. Blazek, 1814 W. 30th St., Cleveland, Ohio.

SHOCK Absorber for automobiles, hydraulic, cheap to make. Morton Francis, Tannersville, N. Y.

PATENT for Sale—Hoe and Rake combined. Garden and Field Tool. Just out. Micajah Harris, 8 Chestnut St., Flushing, N. Y.

OUTRIGHT or royalty, recently patented Combination Compass, Square, etc. Makes 18 different tools. For information, write Robt. H. Johnson, No. 830 E. 45th St., Los Angeles, Calif.

OUTRIGHT or royalty, new sleeve protector; market unlimited in corn belt; investigate. R. C. Janson, 137—19th St., Milwaukee, Wis.

PATENTED "Auto Coaster." Royalty or Cash. Eddie Berard, Bennington, Vt.

STREAM Clothes Brush (patent pending), renovates cloth, raises the nap on plush, bolivia, velour, etc. Handy for tailor shops, milliners, ladies' clothing stores, and the home. Splendid field. Royalty or outright. A. George Bernat, 1644 Sixth Street, San Diego, Calif.

IMPROVED clothes dryer for rainy days. A necessity in every house. Outright or royalty. M. B. Halliday, Walkkill, N. Y.

STEP OUT *from the* CROWD

You can be a

Dental Laboratory EXPERT!



**This Expert
Is Making
\$15 to \$20
a Day!**

Easiest, pleasantest work you ever saw! Your own boss, money and success yours from the very beginning. You can start with a "shoe-string." We prepare you in a few months to run a business of your own, to do any job. Common schooling, ability to use your fingers ALL YOU NEED!

Rubber Plates

Learn to make partial upper or lower plates with soldered, cast or wire clasps, with palatal bars; with lingual bars. McCarrie-trained Experts learn to make full rubber plates of every type, including Vulcanite base-plates, butted gums, carved gums, etc.

CROWNS

Here's only a small part of your practical training in Crown-work: Two-piece, seamless, open-face, Richmond, cast-base porcelain, Carmichael, split-pin, carved (swaged) cusp, cast cusp, etc.

BRIDGE WORK

Complete training in both fixed and removable bridge-work. Interchangeable teeth, gold dummy, sanitary porcelain dummy jobs—Roach, Gilmore, Blischoff and all forms of cast-clasp work is taught—not with books but in actual Laboratory.

METAL BASE DENTURES

Cast bases of Aluminum, gold, Watt's metal, etc. are included in your training. Both centrifugal and air pressure casting machines are used. Free Catalog contains complete list of subjects in course.

Jobs at \$60 to \$125 a Week!

In a business where there are many times as many jobs as Experts, salaries are high, hours are easy, opportunities are everywhere! McCarrie-trained Experts always get the preference—Dentists everywhere recognize the high-standing of our graduates. No books here—learn with tools and instruments. Start quick—get ready in 12 weeks for your big opportunity! Mail Coupon today!

FREE!
R.R.
Fare
to
Chicago

What's the use of training for the old, overcrowded trades? If you're going to prepare for big-salaried jobs or a profitable business of your own GET INTO THE NEWEST PROFESSION—"Laboratory Dentistry." Biggest opportunity for success of the century, because there are ten times as many jobs as men to fill them, because there are a dozen cities crying for Laboratories for each EXPERT capable of operating one!

60,000 DENTISTS NEED LABORATORY WORK!

Only a few hundred Laboratories in all the U. S.—most of them in Chicago and New York. Dentists can't afford to do their own mechanical jobs. They can buy the services of a Laboratory Expert at \$3.00 an hour and sell their own time at \$6 to \$15 an hour. Dentists will encourage you to learn mechanical work, start a "Lab" of your own, give them quicker service than sending to Chicago or New York. Dentists can't wait and keep their patients waiting.

OPEN a LABORATORY of your OWN!

Joe Wilk of Chicago started a couple of years ago ALONE. Today he employs 60 Experts and his Laboratory is one of the biggest in the U. S. Boss in Minneapolis is reported to employ 125 men and to clear \$40,000 to \$50,000 a year. Start with the same tools you use in this big SCHOOL-LABORATORY. Start your own Laboratory with as little as \$100 investment. No limit to profits you can make in this wonderful new profession.

INTERESTING CATALOG—FREE!

Right this minute we can place 150 Dental Laboratory Experts in locations where they can make \$5,000 to \$20,000 a year. But you can't cash in, take advantage of these OPPORTUNITIES until you're TRAINED. Catalog tells you how quickly and easily you can get ready, how hundreds of others have SUCCEEDED! Tells you how you learn in few months BY DOING ACTUAL LABORATORY JOBS under world's greatest Mechanical Dentists! Brings you FREE R. R. Fare offer and other big inducements. Write for free Catalog today!

McCarrie School of Mechanical Dentistry

Dept. 101, 34-36 W. Lake St., Chicago

EARN while you LEARN!

Day students make all or part cost of course by part-time night work. Night students can find plenty of good jobs in Chicago "to see them thru." We'll help you!

McCarrie School of Mechanical Dentistry, Dept. 101, 34-36 W. Lake St., Chicago

Without obligation, please send me your Free R. R. fare offer and free catalog with complete information about how I may become a Dental Laboratory EXPERT.

Name

St. No. or R. F. D.

City State

Continued from Page 44

NEWLY patented invention for repairing punctures. Especially successful for bicycles and motorcycles. Proven the best method yet discovered. Cheaply and easily manufactured from rubber. Outright or royalty. W. C. Ranney, Elbridge, N. Y.

FOR Sale or Royalty—Patent 1,437,869 on patent head construction; every railroad a prospect. J. E. Sullivan, Jackson, Ohio.

PATENT application-right in foreign countries on small real farm accessory. Write immediately. Leslie L. Wells, Pilger, Nebr.

YOU have a worth-while patent, haven't you? Why don't you tell our two million readers about it? Most of them are specially interested in patents and new inventions. Ask me to tell you how other inventors successfully sold their patents. Geo. F. Baker, Manager, Classified Advertising, Popular Mechanics Magazine, Chicago, Ill.

PATENTS For Sale: To sell, buy or obtain patents write Patent News—P. Washington, D. C.

PATENT for Sale. Foldable screened rocking chair, against mosquitoes and flies. Stransky, 200 Greenway Ave., Darby, Pa.

SELF-PROTECTING container for valuables. For bank or pay-roll messengers. Outright or royalty. H. F. Johnson, 4441 Wabash Ave., Apt. 1, Chicago, Ill.

AUTOMATIC Safety Signal for motor vehicles indicating stop, right and left turn, on dash, front and rear of car. No buttons or levers. Works from foot brake. Accurate and simple. Will sell outright. Cash terms only. Write or call. Michael Rebarchak, Goodrich Transit Company, care Baggage Room, Chicago, Ill.

OUTRIGHT or royalty, sanitary adjustable fruit and vegetable display rack. Fred Minder, Pawnee, Ill.

REFRIGERATOR without drain pipe or drip pan. Fountain Manufacturing Instrument; Sponge Filled Absorbent Pad; Writing Board; Gift Novelty. M. V. Bauer, 661 McLachlen Bldg., Washington, D. C.

SURVEYING INSTRUMENTS

NEW and used surveying instruments direct from factory. Satisfaction guaranteed or money refunded. Wissler, 619 Broadway, St. Louis.

MODELS AND MODEL SUPPLIES

MODELS, Tools, Castings and General Machine Work. Send sketch and description. Lowest Terms. Arthur Schmidt, 394 Canal St., New York.

7/8 GAUGE Miniature railway castings, trucks and blueprints. Send stamp for circulars. Model Railway Supply, Box 64, Pueblo, Colo.

PATENTS Procured. Send sketch or model today for examination, prompt report and advice. No charge for preliminary advice. Write for free Booklet and Blank form on which to disclose your idea. Highest references. Promptness assured. Clarence A. O'Brien, Registered Patent Lawyer, 562 Southern Building, Washington, D. C.

MAKE Pirate Ship Models. 25 cents brings plans. See our display ad on page 151 this issue. Maas & Richter, 421 Bramler Bldg., Milwaukee, Wis.

WE Build Models, design, develop, and manufacture articles in large or small quantities. Homeyer Machine Products & Mfg. Co., 1385 E. 17th St., Cleveland, Ohio.

WE make working models for inventors and do experimental work and carry a complete stock of brass gears and model supplies. Send for catalogue. The Pierce Model Works, Tinley Park, Ill.

INVENTORS—Write for our free illustrated guide book and Evidence of Conception Blank. Highest references. Prompt attention. Reasonable Terms. Victor J. Evans & Co., 145 Ninth, Washington, D. C.

BEFORE ordering your model write for free copy of Modelcraft. R. G. Clyne Engineering Co., St. Louis, Mo.

MODEL Making and experimental work; Modern Shop, expert workmen, Manufacturing. Lamson Electrical and Mfg. Co., 625 W. Jackson, Chicago.

FOR MANUFACTURERS

MANUFACTURERS: Can sell your products. Good market. Bank references. J. A. Gutierrez, Aguilera y Pomento, Holguin, Cuba.

SPECIAL labor saving machinery, Jigs and Fixtures and other production tools, Punches and Dies for all kinds of metal stampings, Gauges, manufacturing and machine work to order. Simplex Tool Company, Woonsocket, R. I.

WANTED—Metal Stamping and Model work taken on contract basis. We are ideally located and equipped to develop patents. Meyers Company, Box 326, Bedford, Ind.

MANUFACTURING

MACHINE parts, bearings, electrical devices, coils and magnets manufactured in any quantity. No order too small. Write for prices. Electric Machine Co., 329 Brewer St., Norfolk, Va.

SPRINGS made to order. Wright Bros., 5616 Huron St., Chicago.

UNUSUAL opportunity for dies, stamping, die-casting, plating, enamelling, screw-machine and wire products. Reasonable. Large, excellent equipped factory. Metal-Craft Manufacturing Company, Box 259, Chicago.

OUR factory will make your models, manufacture your articles as well as build your tools, dies and fixtures. Standard Die & Specialty Co., 317 W. Washington Blvd., Chicago, Ill.

EXPERIMENTS developed, dies, models and manufacturing, machine designing. Estimates and information promptly given. Address Schroer Bros. Machine Works, 512 East 25th Street, Kansas City, Mo.

LONG established manufacturer of auto accessories which are daily sold by practically all wholesale and retail accessory houses will consider manufacturing and distributing new automobile products, capable of equally wide sale through same channels. Patented articles preferred. Address Auto Accessory Manufacturer, 1512 North American Bldg., Chicago, Ill.

SCREWS, nuts, screw machine products, all metals. Autoscrew Works, 355 West Broadway, New York City.

WE design and build special machinery. Send for free copy of Modelcraft. R. G. Clyne Engineering Co., St. Louis, Mo.

SPECIAL labor saving machinery, Jigs and Fixtures and other production tools, Punches and Dies for all kinds of metal stampings, Gauges, manufacturing and machine work to order. Simplex Tool Company, Woonsocket, R. I.

IRON, Brass, Aluminum Castings, Models, Patterns. Light Manufacturing. Welch Brothers Co., North Chicago, Ill.

PATTERNS, wood and metal. Models, tools and dies. Brass, bronze, aluminum and iron castings. Screw machine work, production work of all kinds. Write Modern Machine & Pattern Co., Terre Haute, Ind.

WIRE Goods, all kinds, made to order. Crosby Mfg. Co., 524-529 N. Western Ave., Chicago.

IF you want dies and metal stampings write us. Lyons Machine Works, Lyons, Ia.

PATENTED Articles, Models, Brass Work, Machine Construction; Dies Made. Baum's Metal Specialties, Kansas City, Mo.

MACHINERY, TOOLS AND SUPPLIES

FOR Sale—1-14"x5" Screw Cutting Compound Best Engine Lathe, \$180.00, 7 Turret Lathes, No. 1 to No. 3, at \$125 to \$250, 1 Fox Lathe, \$250. All excellent condition. Peru Brass & Mfg. Co., Peru, Ind.

CONCRETE Building Block Machines and Molds. Catalogue free. Concrete Machine Co., 293 South Third St., St. Louis, Mo.

6-11" x 4' ARTISIAN engine lathes, brand new. Price \$149.00 each. 16" Davis Shaper \$175.00. We handle everything in machinery and supplies. Write us. Cincinnati Machinery Supply Co., 218 E. Pearl St., Cincinnati, O.

2—No. 2 DAY Change Can Paint Mixer, 10 extra cans; 1-80 gal. Day Hero Mixer; 2—No. 4 Day Hero Mixers; 1—No. 2 American Blower, 7 1/2 HP. Wagner Motor; 1—Jeffery 16x16 Coke Crusher; 1—American Laundry Washing Machine complete, 32x48"; 1—Centrifugal Drier; 1—6x8x8 Drying Oven complete. Flint Varnish and Color Works, Flint, Mich.

ENGINES, MOTORS AND DYNAMOS

GOVERNORS to control Auto Engines when used as stationary engines. Circulars. Candee-Smith Governor Co., Springfield, N. Y.

FOR Sale—Waukesha Tractor Engine, slightly used. Otto Kongslow Mfg. Co., Cleveland, Ohio.

MOTORS—G. E. 1/4 hp. \$15.00—1/2 hp. \$32.50—1 hp. \$62.50. Generators 8v, 10 amp. \$15—32v, 500 watt \$30. Other sizes low prices. Motor Specialties Co., Crafton, Pa.

SMALL steam engine patterns, castings, small dynamo. Homer Boals, Salineville, Ohio.

ALTERNATING Current Motor Bargains. Reliable Makes only, including new 1/4 H. P., \$13.00; new 1/2 H. P. General Electric \$29.00. Westinghouse, Crocker-Wheeler, Wagner, Emerson, Century motors, special prices. All guaranteed for one year. Buy now before prices advance. Motors repaired and exchanged. Hyre Electric Co., 633-FX South Dearborn St., Chicago.

ELECTRICAL

LEARN how to wind D. C. Armatures. Engineering students will find in this book by W. E. Hennig a simplification of a difficult yet important subject. Mathematical and technical discussions have been avoided as far as possible. Contains all diagrams; heretofore scattered in many books. 205 pp. illus. in colors. Cloth binding. Price \$3.50 postpaid. Popular Mechanics Book Dept., 200 E. Ontario St., Chicago.

WHOLESALE Prices Motors and Electrical supplies, including sockets, tape, rossettes, switches, wire, conduit, chisels, lams, porcelain goods. Illustrated Catalog free. Hyre Electric Co., 633-FX S. Dearborn St., Chicago.

ELECTRICAL Experimenters—Here is the book you have been waiting for—"How to Make Things Electrical." 256 articles, 427 pages, 353 illustrations. Price \$2 postpaid. Popular Mechanics Book Dept., 200 E. Ontario St., Chicago.

FOR MECHANICS

1,000,000 INDUSTRIAL Facts, Calculations, Recipes, Processes and Trade Secrets for every business are contained in the 1016-page book "Moore's Universal Assistant and Complete Mechanic." 500 Engravings. Cloth. Price \$2 postpaid. Popular Mechanics Book Dept., 200 E. Ontario St., Chicago.

PATENTS—Write for our free illustrated guide book and Evidence of Conception Blank. Send model or sketch and description of the invention for our opinion of its patentable nature free. Highest references. Prompt attention. Reasonable terms. Victor J. Evans & Co., 184 Ninth, Washington, D. C.

BLACKSMITHS

BLACKSMITHS, Plumbers, etc. Here's what you have needed for years. Simple, Powerful, Inexpensive Universal Bending Machine. Bends Eyes, U's, Angles, etc. Bends 1 1/4" standard Pipe cold. Also bends Automobile Spring Eyes. Send for circular. Little Giant Bender Co., Lewiston, Minn.



If He Had Passed It Up

He Would Still be a Laborer at \$2 a Day. No Money, Nothing Ahead but Hard Work, Longer Hours—and Regrets. But He Didn't Pass It Up

He decided to learn Mechanical Drawing. He buckled down to work with the Columbia School of Drafting. When he had a quiet half hour to spend he spent it—as a wise man spends money—to get full returns.

MADE \$275 EXTRA IN 3 DAYS. He recently received \$275 for one drawing that only took him three days to draw.

NOW HOW ABOUT YOU? Are you working up hill or down? Count the money in your pay envelope next pay day. You'll find the answer there.

MAKE \$35 TO \$100.00 A WEEK. We will train you to be an expert Draftsman in your spare time at home by mail. There's lots of room for you if you act now.

PROMOTION IS QUICK. WE'LL QUALIFY YOU for a high-salaried position in the drafting field and keep you in touch with openings for Draftsmen in the big machine shops, industrial plants and United States Government departments. Men who start as

Draftsmen are often advanced to Chief Draftsmen, Chief Engineers, Production Managers and so on.

GET THE RIGHT TRAINING. Mr. Claffin, the founder and director, stands personally in back of the Columbia School of Drafting. You spend no time in long-winded theories—useless and expensive to you. You start on actual drawing work the day you receive your first lesson.

YOU NEED NO PREVIOUS TRAINING. The course is easy to understand and easy to follow. Many students are qualified even before they complete the course.

SUCCESS CALLS MEN OF ACTION ONLY. If you are a man of action clip the coupon now and show that you are a man of action. Keep right on top of this opportunity to make real money. Don't go looking for a pair of scissors. Tear the coupon off and mail it right now. We have a special offer for those who reply promptly. Get started now.

What We Give You

PRACTICAL PROBLEMS. You are carefully coached in practical Drafting work.

WE HELP YOU GET A JOB. We help you get a position as a practical Draftsman as soon as you are qualified.

PERSONAL INSTRUCTION AND SUPERVISION THROUGHOUT THE COURSE. You receive the personal instruction and help of Roy C. Claffin, president of the Columbia School of Drafting and a practical Draftsman of many years' experience.

DRAFTSMAN'S EQUIPMENT. We furnish you with a full set of Drawing Equipment and Drafting Instruments as shown in the picture below when you enroll. You keep both sets on completing the course.

CONSULTATION PRIVILEGES. You are free to write to us at any time for advice and suggestions regarding your success.

DIPLOMA. The diploma we give you on completing the course attests to your proficiency as a Draftsman. It is an "entering wedge" to success.

FREE SUBSCRIPTION TO DRAFTSMAN'S PUBLICATION "THE COMPASS." You are given free a subscription to our helpful, inspiring publication, "The Compass."

U. S. Civil Service Commission Needs DRAFTSMEN

The following are a few of the many positions open in Government Departments from time to time. The salaries are starting salaries, subject to increase. Practically all of them carry a bonus of \$240 a year additional.

Architectural Designer..... \$4,000

Chief Draftsman (Aeronautical) Naval Aircraft Factory, per day..... 15.04

Aeronautical Draftsman—Field Service of Navy Department, \$5.20 per day to \$12 per day.

FREE BOOK

Send in this coupon today. Immediately on receipt of it we will send you our book, "Drafting—Your Success," which tells you all about our new method of teaching Mechanical Drawing and gives full details of our special offer to those who reply promptly.

THE COLUMBIA SCHOOL OF DRAFTING

Roy C. Claffin, President

Dept. 2146, 14th and T Sts., N. W., Washington, D. C.

Free Book Coupon

COLUMBIA SCHOOL OF DRAFTING,
Dept. 2146, 14th and T Sts., N. W., Washington, D. C.

Enter my name for a free subscription to "The Compass" and also send me without charge your illustrated book on Drafting, telling me how I can secure your complete Home Study Course and your help in securing a position as Draftsman.

Name.....

Address.....

City..... State.....



FREE We give you free with our course this professional Drafting outfit. It is yours to keep when you complete the course.

Continued from Page 46

BLACKSMITHS. Listen: Any Handy man can make more money doing hard jobs easy. Forging and welding solid, with Toy's Modern Methods of Blacksmithing. Hardening and tempering to a standard with colored tempering charts. All for one dollar. Samples Free. W. M. Toy, Sidney, O.

FOR SALE—MISCELLANEOUS

UKULELE \$5.50. Crystal Detector Set \$2.50. Delmas Gorr, Empire, Calif.

ADDRESSOGRAPHs. Letter Folders, Multigraphs, Envelope Sealers, Duplicators, less than half price. Guaranteed. Pruitt Co., 112-B N. La Salle, Chicago.

BUY—Exchange—Sell! Many of our readers have for sale or exchange the article you are looking for—and lots of them are looking for the very items you want to turn into cash. Get together! Let our two million readers know your wishes—they'll help you! Send your ad today to Geo. F. Baker, Manager Classified Advertising, Popular Mechanics Magazine, Chicago.

GASOLINE Lamps and Lanterns. Catalog Free. Little Wonder Light Co., Terre Haute, Ind.

MITER boxes. \$2. Mustin Mfg. Co., Box 36, Newport, Ky.

WANTED—MISCELLANEOUS

CASH for Platinum, Diamonds, Magneto Points, Old Gold, Silver. Inquiry solicited. Yonover, 1637-P Roosevelt Road, Chicago.

WANTED—Complete file of Popular Mechanics Magazine for the years 1902 and 1903. Must be in good condition. Will pay \$5.00 for full sets of either year. Address, Geo. F. Baker, Room 304, Popular Mechanics Bldg., 200 East Ontario, Chicago, Ill.

WILL buy, sell and exchange for you anything you have in Jewelry, Diamonds, Pearls, Rubies, Gold, Platinum, Silver, Etc. Quick returns. Wiegand & Co., Irvington, N. J.

WANTED—State contracts. Kitchen specialties. Mail complete detailed offers. United Supply House, Lyons, Iowa.

WANTED. Copies of Popular Mechanics Magazine of October 1922 in good condition. Will pay 25 cents per copy. Address Room 311, Popular Mechanics Magazine, 200 East Ontario St., Chicago, Ill.

MAIL us your discarded Jewelry. Gold Crowns and Bridges, Watches, Diamonds, Silver Platinum, and Old False Teeth. Money promptly mailed. Goods returned if offer refused. United States Smelting Works (The Old Reliable), Dept. 71, Chicago.

REAL ESTATE, FARM AND ORCHARD LANDS

BIG returns from Pecan, Orange and Fig Groves. Guaranteed care. Small monthly payments. Dent, M. Suburban Orchards Co., Biloxi, Miss.

FOR Sale: Summer cottages, fruit farm, equipped. A Bargain. Inventory. Write F. Albright, Box 73, Marinette, Wis.

ATTENTION—"Get acquainted." Cash for your property. Farm, Hotel or Retail Store, no matter where located; confidential service. Hayes' Business Agency, Cincinnati, Ohio.

WONDERFUL Opportunity!!! Non-resident owner will sell farm, in best farming district Northeastern South Dakota, at great sacrifice! Carl A. Hansen, Brookings, S. Dak.

WANTED—I want farms for cash buyers. Describe and state price. R. A. McNow, 312 Wilkinson Bldg., Omaha, Neb.

FOR Sale—Silver-Lead properties with good titles located in western part of State of Zacatecas, Mexico. Chalchihuites District, within twelve miles of railroad station. Cheap labor and transportation. For detailed information and description of properties, address A. T. Bittling, Chalchihuites, Zacatecas, Mexico.

SELL your property quickly for cash, no matter where located. Don't pay big commissions. Particulars free. Real Estate Salesmen Co., Desk B., Lincoln, Neb.

CALIFORNIA, Alhambra, where life is worth while, eight miles from Los Angeles. Homes, Chicken Ranches, industrial sites. H. W. Dionysius, Realtor, 16 E. Main St., Alhambra, Calif.

\$5.00 DOWN. \$5.00 monthly; 10 acres unimproved poultry, fruit, stock, woodland; \$100; Ozarka, Fishing, hunting, trapping. Alfred Zimmerman, 1800 N. Fifth, Kansas City, Kan.

FOR Sale—Three full sections in McKenzie County and two sections in Billings County, North Dakota. Each section contains land suitable for crops, balance for cattle. Each section has valuable deposits of lignite which some day will alone be worth many times the present value of the land. This part of the state is developing very rapidly, with good schools within easy access. As owner cannot use this land himself, will sell one or more sections at a price which almost anyone can afford to pay. Address W., care Popular Mechanics, 200 East Ontario St., Chicago.

DOGS

HANDSOME Registered Puppies and Grown Dogs. Big Boned Intelligent Fellows. Bred in the Purple from Imported Stock. Vert-Best Police Dog Kennels, Portland, Indiana, Box 426-H.

GUARANTEED Hunting Dogs—Coon, Mink, Opossum, Skunk, etc. Hounds or mixed breeds. Prices right. Catalog Ten Cents. Burrow, Pocatamos, Ark.

TRAINED Beagles, Foxhounds, Rabbit Dogs, Broken Coon Dogs. Trial. Setters. Geo. Brown, Lancaster, Pa. No. 5.

SILVERBLACK Foxes \$300.00; Muskrats, Skunks; time payment. Arthur Schumacher, Lockland, O.

BOSTON Terrier and French Bull Puppies. Pedigreed. V. Winsor, Excelsior, Minn.

FOR Sale—Registered English Setter Puppies. Champion Eugene M and Champion Candy Kid, blood lines crossed. Pedigree furnished. Address Dr. C. C. English, Booneville, Ark.

CHOICE Airedale Puppies. Champion Grown Stock. Reasonable. Sales List. Rehound Kennels, Wauseon, Ohio.

IRISH Terriers—\$35 up. Garrett, 1563 Loan Ave., Youngstown, Ohio.

COLLIES for Sale. Training Book 35c. Sunnybrae Kennels, Bloomington, Ill.

POULTRY

PLANS for Poultry Houses. All styles. 150 illustrations; secret of getting winter eggs, and copy of "The Full Egg Basket." Send 25 cents. Inland Poultry Journal, Dept. 74, Indianapolis, Ind.

PERSONAL

YOUR Horoscope—Business, Character, Changes, Friends, Enemies. Send birth date and ten cents (stamps) for remarkable test reading. Zanya, No. 292, 105th St., New York City.

UNUSUAL Horoscope—Six pages. Consisting of extensive four-page Special Horoscope, Astro-Analysis, and two-page valuable guide giving daily and monthly advice covering entire year. Send 50c and birthdate. Money returned if dissatisfied. Prof. Bolles, Box 5, Fordham Station, New York, N. Y.

DON'T Die Yet! Eat for health. Order "Chemist's Tested Health Recipes and Scientific Cook-Book." One dollar. "Making Sixty Delicious Drinks and Tonics." Fifty cents. M. Holson, Box 407, Riverside, Calif.

TOBACCO, liquor and morphine habits can be overcome with the aid of Hill's Chloride of Gold Preparations. Liquor remedy can be given secretly. Particulars free. Ohio Chemical Works, Dept. 9, Westfield, N. Y.

HEAVEN on Earth now by "Automatic Civil Service." World's greatest discovery to utilize selfishness and civilize civilization. \$1. New World, S. Benton Harbor, Mich.

ARE You Old at Forty? See our advertisement on page 156 of this issue. The Electro Thermal Company, 2126 Main Street, Steubenville, Ohio.

TOBACCO or Snuff Habit, cured or no say. \$1.00 if cured. Remedy sent on trial. Superior Co., TP, Baltimore, Md.

FREE—Stop using tobacco. We will give free information how to conquer habit easily and permanently. Results guaranteed. Anti-Tobacco League, Box K, Omaha, Neb.

YOUR greatest asset is Personality. Add to your stock. Success Tips and Self-Revealing chart 10c. Thomson-Heywood, Dept. PM, Chronicle Bldg., San Francisco, Calif.

ARE you bashful, self-conscious, easily embarrassed? These troubles overcome. Send dime for particulars. C. Veritas, 1400 Broadway, New York, N. Y.

TOBACCO Kills Manly Vigor. Quit easily. Cigarettes, chewing, smoking, snuff conquered or no charge. Small sum if satisfactory. Stops craving; harmless. Full treatment on trial. Perkins Co., 34-A, Hastings, Neb.

MISCELLANEOUS

CUTS anybody can make. Simple, cheap process. \$1. Specimens, particulars, 20 stamp. M. Day, Windfall, Ind.

LOCKSMITHING, complete 500 tricks of the trade, new edition, many added features, \$1.50; money back if dissatisfied. H. Routson, 3406 Andover St., Oakland, Calif.

POCKET Maps. We will send you a reliable and comprehensive Rand-McNally indexed pocket map, tourists' and shippers' guide of any state in the union, Canadian provinces, Alaska, Mexico or Central America, postpaid, upon receipt of 35 cents; also a splendid pocket reference map of practically any foreign country at 50 cents postpaid. Popular Mechanics Book Dept., 200 E. Ontario St., Chicago.

300% SAVED on Rubber and Overshoe Bills; cheap, simple; guaranteed. Send quarter. Bartlett, 614 John St., Bridgeport, Conn.

STARTING a Company? Save expenses and taxes by organizing on the popular Common Law plan under a pure Declaration of Trust. No experience required to fill in Demaree Standard Forms. Issue shares and begin doing business at once. Genuine Demaree Forms are nationally known, approved by attorneys and utilized by successful concerns throughout the United States. Send for large free pamphlet (C-53) containing valuable information that you may need. C. S. Demaree, local blank publisher, 708 Walnut, Kansas City, Mo.

CONCRETE Handbook, New, for the Amateur. We have just published a book describing 173 ways of using concrete in the home, shop and on the farm, with full directions for doing these things yourself with ordinary tools. 138 illustrations. It is "written so you can understand it." Price 50 cents, postpaid. Popular Mechanics Book Dept., 200 E. Ontario St., Chicago.

MONEY in Minerals. Many common minerals have market value. List 25c. Minerals identified, \$1.00. Mineralogist, Joplin, Mo.

ARE You Old at Forty? See our advertisement on page 156 of this issue. The Electro Thermal Company, 2126 Main Street, Steubenville, Ohio.

ARTIFICIAL Eyes, \$3. Booklet free. Denver Optic, 559 Barclay, Denver, Colo.

INCORPORATION in Arizona Completed in One Day. Any capitalization, least cost, greatest advantages. Transact business anywhere. Laws, by-laws and forms free. Stockard Incorporating Co., Dept. 2, Phoenix, Arizona.

HOMEOPATHIC and Biochemic preparations sent postpaid to all parts of the world. Manual and booklets free. Halsey Bros. Co., 111 N. Wabash Ave., Chicago, Illinois. Established 1855.

DYKE'S Automobile Encyclopedia. 13th edition, new, greater than ever, entirely rewritten and rearranged. Contains greatest array of automobile facts ever published in one volume. Separate books containing same information cost \$21. Over 1,200 pages and 4,100 illus. Cloth \$6. Flex. Amer. Morocco \$7.50 postpaid. Popular Mechanics Book Dept., 200 E. Ontario St., Chicago.



PLAY PIANO BY EAR

Be a Jazz Music Master

Anyone who can remember a tune can easily and quickly learn to play popular jazz or American rhythm by ear at a very small cost. The New Niagara Method makes piano playing wonderfully simple.

No matter how little you know about music—even though you "have never touched a piano"—if you can just remember a tune, you can quickly learn to *play by ear*. I have perfected an entirely new and simple system. It shows you so many little tricks that it just comes natural to pick out on the piano any piece you can hum. Beginners and even those who could not learn by the old-fashioned method grasp the Niagara Idea readily, and follow through the entire course of twenty lessons quickly. Self-instruction—no teacher required. You learn many new styles of bass, syncopation—blues, fill-ins, breaks and trick endings. It's all so easy—so interesting that you'll be amazed.

A Simple Secret to Success

No need to devote years in study to learn piano nowadays. Special talent unnecessary. Every lesson is so easy, so fascinating that you just "can't keep your hands off the piano." Give it part of your spare time for 90 days and you will be playing and entertaining almost before you realize it. No tiresome scales, no arpeggios to learn—no do-re-mi—no difficult lessons or meaningless exercises. You learn a bass accompaniment that applies to the songs you play. Once learned, you have the secret for all time—your difficulties are over and

You Become Master of the Piano

Even talented musicians are amazed at the rapid progress of Niagara School students and can't understand why this method was not thought of years ago. Naturally, the Niagara Method is fully protected by copyrights and cannot be offered by any other school. A special service department gives each pupil individual attention.

Learn at
home in
90 days

Be Popular in Every Crowd

One who can sit down at any time *without notes or music*, reel off the latest jazz and popular song-bits that entertain folks, is always the center of attraction, the life of the party, sought after and invited everywhere. Make yourself the center of attraction—master the piano by spending an hour a day studying the fascinating Niagara Method.

As easily as thousands of others have learned, so you too, can learn and profit—not only through the pleasure it provides, but also by playing at dances, motion picture houses and other entertainments.

Decide to Begin Now!

Just spend a part of your spare time with a few easy, fascinating lessons and see how quickly you "catch on" and learn to play. You will be amazed, whether you are a beginner or an advanced student. Write for interesting, illustrated booklet, "The Niagara Secret"—it describes this wonderful new method of playing piano by ear. This booklet sent FREE. Enclose 6¢ in stamps and you'll also receive an interesting chart.

Ronald G. Wright, Director, NIAGARA SCHOOL OF MUSIC, Niagara Falls, N. Y.

CLIP THIS COUPON NOW

Niagara School of Music, Dept. 580, Niagara Falls, N. Y.
Without obligation mail me your booklet, "The Niagara Secret." I enclose 6¢ in stamps for chart and names of successful students.

Name.....

St. and No. or R. F. D.....

Town..... State.....

Age..... Ever take piano lessons?..... How many?.....



This Book
FREE



Own Garage or

Look at the pictures on these two pages. Twenty thousand Sweeney trained men own garages, tire shops, vulcanizing and service shops, just like these

You can be your own boss. You can be independent. It is easy to start in business for yourself. Then you don't have to bow down to some employer and do work you don't like. Sometimes it looks like carpenters, plasterers, etc., get big wages, but when hard times come they are out of work. I say work for yourself. Then you are not bothered by strikes, lockouts, factories closing down. *Own your own business*; work for yourself with enthusiasm, not drudgery. It's the yearning of every young man TO BE HIS OWN BOSS, and Sweeney makes it possible. How would you like to see your name above the door of a neat and profitable garage like one of those shown in the pictures?

Sweeney trains men in eight weeks in the auto and tractor business. I have had over 60,000 graduates. I estimate 30,000 are in business for themselves. You don't need previous experience. These men had no previous experience. You don't need any capital to speak of. There are opportunities everywhere. Other fellows with money are often looking for trained men to handle the mechanical end as partners. These men hadn't much money. But they had Sweeney training and made good.

The picture on the opposite page is of John Boyer's garage at Milford, Illinois. John says: "Having a good business; busy all the time." Look at the National Garage. Roy Atkinson sent me this picture from Everett, Mo.

"Worked on a farm," says Roy. "At nineteen had only \$14.00. Got father to send me to the Sweeney School. Three days after I came home I fixed a neighbor's Ford Car. That was my start. Today this garage is worth \$4,785.00. My business takes three men to handle. I never worked in any other garage. I used my Sweeney training. If you want to get that start, do as I did and go to the Sweeney School."

Look at Clayton Eden's nice garage at Ainsworth, La. Clayton says:—"We operate the leading garage. Have all the business we can do. Also handle Hudson, Essex and Buick cars. Owe my present success to the wonderful training received at the Sweeney School." Then just to the right of Eden's garage is picture of S. A. Noller's business in far off Australia.

What these boys have done YOU can do. If you like mechanics, write me today. Get my big free Catalog. There is a fortune for you in the pages of this book. Mail the coupon on opposite page or post card will do.



LEARN

Sweeney

AUTOMOTIVE &

1221 SWEENEY BLDG.



Your Business!

Sweeney System of Practical Instruction

is the ONLY WAY to learn if you want to save time and money and be properly trained. You get this at the WORLD'S greatest trade school, the MILLION DOLLAR SWEENEY SCHOOL and you get it nowhere else. 8 weeks' practical training with Tools, not books!

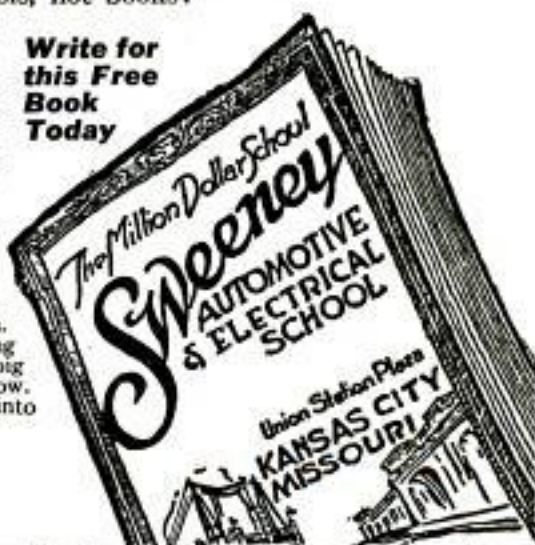
I Pay Your Ry. Fare If you will come now I will help by paying your railway fare from any point in the U. S. to the Sweeney School. I will also give you a FREE RADIO COURSE. SWEENEY BROADCASTING STATION. Call W. H. B. Is one of the finest in the world. Talks all over the U. S. Cost \$50,000 to erect. I will also tell you about my New Offer—a wonderful opportunity for you. I am making a special THIRTY DAY OFFER. That is why you should not delay. The first step is to send for my Free Catalog.

**Write for
this Free
Book
Today**

FREE Catalog and Special Offer

Get my big FREE 64-page catalog. It shows hundreds of actual photographs of men at work in my magnificent new school. Tells all about wages, profits, opportunities in auto and tractor business. Explains step by step how you learn. Interesting letters from graduates telling how they made good. Shows how men come from all over the world to this big school. Makes you want to join the crowd. Tells everything you want to know. I will gladly send you a copy beautifully illustrated. I'll tell you how to get into business for yourself. No colored students accepted.

E. J. SWEENEY, President



A TRADE

Sweeney
ELECTRICAL SCHOOL
KANSAS CITY, MO.

EMORY J. SWEENEY, President

1221 Sweeney Bldg., KANSAS CITY, MO.

Send me, free, your 64-page catalog and Sweeney School News and tell me of the opportunities in the auto and tractor business.

Name

P. O.

State



BIG PRICES PAID TO ARTISTS

YOU are indeed fortunate if you like to draw! Develop your talent—become a commercial artist! Thousands of business firms pay millions of dollars yearly for good advertising drawings and designs. Well-trained artists command \$50, \$75, \$100, \$150 a week—sometimes even more. "Top-notch" designers receive \$250, \$500, \$1000 and up for single drawings.

Learn Quickly at Home in Your Spare Time

Get into this fascinating profession which has a future as big as modern advertising and modern business. The Federal "Master Course" teaches you the methods and ideas that make your drawings worth real money. It gives you individual personal criticisms on your lessons. No previous training or experience needed. And best of all—Leading successful artists are authors of exclusive lessons in the Federal Course. They will give you the benefit of their experience and advice, only in this Course.

Get This Free Book "YOUR FUTURE"

Investigate now—by all means send for this book. Beautifully illustrated in colors, it gives facts about the field of commercial art, names of the famous artists who are Federal Authors, and every detail you will want to know about the Course. It is a proven result-getter. If you are in earnest and 16 years or older, send 6c in stamps today for this book. Kindly state your age and occupation.

COUPON

Federal School of Commercial Designing
694 Federal Schools Building
Minneapolis, Minn.

Please send me "YOUR FUTURE," for which I enclose 6c in stamps.

Age..... Occupation.....

Name.....

(Write your address
plainly in
margin.)

OIL EXPERTS in Demand Good Positions Await Trained Men

The Petroleum Engineering field needs men. It needs them badly. With 10 million autos and thousands of new power plants a great shortage of lubrication engineers now exists—greater than ever before. Petroleum experts and lubrication engineers command big pay—\$250 to \$600 monthly. Thousands of National men are doing it—so can you. Learn at home in your spare time with the oldest and only school giving same instructions by correspondence as given through resident school. (Certificate of Lubrication Engineering given.)

BIG BOOK of Opportunities FREE

Send NOW for New Book, just out, "Opportunities in Petroleum Engineering." It is intensely interesting and instructive. It will show you many things you never knew about oil and lubrication problems. Also full particulars and special low fee awaiting those who **ACT NOW!**

National Engineering Schools
617 Manhattan Bldg. Chicago, Ill.



How to Speak and Write Masterly English

Every time you speak or write you show just what you are. Mistakes in English reveal you as a person who lacks education and refinement. Lack of language power prevents you from presenting your thoughts in the strongest possible way. No matter what you do, real command of English will help you to your goal. Stop making mistakes in spelling, punctuation, pronunciation. Increase your vocabulary.

WONDERFUL INVENTION

Only 15 minutes a day with Sherwin Cody's New Invention—and you can actually SEE your English improve. It touches by HABIT, makes it easier to do the RIGHT way. Wonderful self-correcting lessons include Spelling, Punctuation, Grammar, and Expression.



FREE BOOK ON ENGLISH* AND 15 MINUTE TEST

Lack of language power may cost you thousands of dollars every year. See what Mr. Cody can do for you; it costs nothing to find out. Mail a Postal card or letter this very minute for free book, "How to Speak and Write Masterly English," and 15 minute test, which you can take in your own home. It will prove a revelation to you. **WRITE NOW.** Address

Sherwin Cody School of English, 510 Searle Bldg., Rochester, N.Y.

BECOME AN

Electrical Expert IN 6 MONTHS

Learn by the thorough, approved, scientific methods which our seventeen years of specializing enable us to give you. You learn house, factory, and theater wiring, testing, and meter work. D. C. and A. C. Armature and Transformer Winding, Power Plant Maintenance, or You can become an



Expert Repairman on Motors and Generators in 3 months

Repairmen are in great demand and earn big pay—particularly men expert in D. C. and A. C. Armature Winding. Get into this well-paid line. "Earn While You Learn" while taking **Electrotechnics, Commercial Electrical Engineering or Electrical Engineering with B. S. Degree in 3 years. Fall Classes Organize NOW.**

Write for 72-page illustrated catalog. It's FREE. Mention course most interested in.

SCHOOL of ENGINEERING of Milwaukee

P. M. 10, 415-417 Marshall Street Milwaukee, Wisconsin

Make \$10 a Night

Be a Drummer Professional drummers in demand everywhere and make big money. You can quickly and easily learn to play band, orchestra and dance music through my home study course. Write for particulars Today, NOW! Write for folder of special snare drum offer.

The Herman H. Rinne Correspondence School of Modern Drumming
3154 Park Ave. INDIANAPOLIS

HOME STUDY

Become More Efficient

through courses in Chemistry, History, Mathematics, English, Psychology, Education, Business and 35 other subjects which the University gives by mail. They command credit toward a Bachelor degree and may be begun at any time.

The University of Chicago 15 Ellis Hall
Chicago, Ill.

Don't Envy Successful Salesmen—BE One!

Those fellows who are making anywhere from ten to thirty thousand dollars a year—who travel first class, stop at the best hotels, are in daily contact with prosperous business men—did you ever figure out what it is that enables them to SELL with such success?

It can't be size—or good looks!—

Otherwise keen sales executives would specialize in furniture heavers and chorus men—whereas some of the best salesmen you ever knew measure less than five feet five and are so homely that you actually feel sorry for them.

It can't be schooling—

Otherwise only college graduates would hold the records—and men like Schwab wouldn't have a chance in the world.

It can't be any special GIFT which they inherit—

For there's many a salesman straight from the land where the tall corn grows—his father a farmer and his father's father before him—who fairly astonishes the "boss" at the way he brings in the business.

If it isn't any of THESE things—then it is surely possible for ANY man of average intelligence—provided he has the courage to TRY and the willingness to LEARN—to become a successful salesman.

—For the REASON for success in selling is nothing more nor less than the knowledge and application of SALES-MANSHIP.

GET that knowledge and APPLY it—whether you are now in the selling field or not—and we predict that your income will mount and will NEVER CEASE TO MOUNT—so long as your health is good and you stay in business!

How You Can Get the Training That Will Bring Success

A bold statement, you may think—but it is based on bed-rock facts.

When LaSalle Extension University was preparing its training in Modern Salesmanship, it made a careful study, over a period of years, of the selling processes of more than a thousand outstanding salesmen engaged in selling a wide variety of products and many different types of service. These men were already rated as exceptional. Their records proved it.

Under the direction of a nationally known sales executive—himself a \$50,000 man—the particular methods which were found to yield the highest percentage of results were sifted out—and for two years, and at a time when selling was anything but "easy," more than four hundred salesmen—comprising a number of separate sales crews—were instructed to specialize in these particular selling methods.

Out of this test came unusual and often surprising results. The best men on various forces—in lines ranging from boots and shoes and electrical apparatus to motor cars and life insurance policies—thru the basics furnished them MATERIALLY INCREASED THEIR SALES.

One salesman stated that what was furnished him was responsible for the establishing of more than 100 new accounts in his territory and a large increase with his old trade.

Increases of 100% and in some cases 500% were reported.

On the strength of these findings, the identical principles and methods used by these men and proven sound and practical by the severest kind of tests, were organized and incorporated into the present training offered by LaSalle in Modern Salesmanship.

And AGAIN they are proving out—as witnessed by the following statements, typical of hundreds that have been received by LaSalle within the last few months:

"The first two texts have given me so much that I am firmly convinced that if I never learn anything more from the course, I would have a full return for the entire investment. I tell you frankly that I would not take \$25,000 for my scholarship if another could not be had."—C. J. JONES, Canada.

"From a salesman in the ranks, in two short months



my sales have shot up nearly 150 per cent, and I have received a promotion from a company I had been with only six months. I am now a district manager with eleven men working under me. Not only have my immediate sales shown an increase—and right in the middle of the summer months—but I have had a keener grasp of the principles of selling. I know the meaning of 'fundamentals' now; I know that by the application of certain definite truths, certain definite results can be attained. My effort, formerly more or less of an uncertainty, is now a certainty. Getting down to brass tacks, I know what I am doing now."

—C. RUTHERFORD, Ontario.

Send for "Modern Salesmanship"

To explain within the brief limits of a page how LaSalle training in Modern Salesmanship is conducted, or to give more than the barest hint of its value to the man ambitious to develop as a salesman, is impossible. We have therefore prepared a 66-page book entitled "Modern Salesmanship"—an interesting and compelling presentation of the present-day opportunities in salesmanship and a clear outline of the way they may be quickly realized.

No man engaged in selling—or looking forward to salesmanship as a career—should be without a copy of "Modern Salesmanship." The University will be glad to mail a copy to any man who marks and signs and mails the coupon just below this text. There is, of course, no obligation.

LASALLE EXTENSION UNIVERSITY

The Largest Business Training Institution in the World

Dept. 1064-SR

Chicago, Illinois

Please send me catalog and full information regarding the course and service I have marked with an X below. Also a copy of your book, "Ten Year's Promotion in One," all without obligation to me.

Modern Salesmanship

Training for Sales and Advertising Executives, Solicitors, Sales Promotion Managers, Salesmen, Manufacturers' Agents, and all those engaged in retail, wholesale or specialty selling.

Other LaSalle Training Courses

LaSalle is the largest business training institution in the world. It offers training for every important business need. If more interested in any of these courses, check here:

- | | |
|---|--|
| <input type="checkbox"/> Business Management | <input type="checkbox"/> Modern Business Correspondence and Practice |
| <input type="checkbox"/> Traffic Management | <input type="checkbox"/> Modern Foremanship and Production Methods |
| <input type="checkbox"/> Higher Accountancy | <input type="checkbox"/> Personnel and Employment Management |
| <input type="checkbox"/> Railway Station Management | <input type="checkbox"/> Expert Bookkeeping |
| <input type="checkbox"/> Law—Degree of LL. B. | <input type="checkbox"/> Business English |
| <input type="checkbox"/> Commercial Law | <input type="checkbox"/> Commercial Spanish |
| <input type="checkbox"/> Industrial Management | <input type="checkbox"/> Effective Speaking |
| <input type="checkbox"/> Efficiency | <input type="checkbox"/> C. P. A. Coaching |
| <input type="checkbox"/> Banking and Finance | |

Name.....

Present Position.....

Address.....

Learn to Make BIG MONEY As an Inventor



Raymond F. Yates, who with fourteen other famous inventors, now makes it easy for you to learn how to invent in your spare time at home.

Amazing new home-study course now teaches you inventive science in your spare time; shows how to develop, patent, sell your ideas; how to make big money from inventions.

Famous Inventors Now Teach You!

Invention is not a matter of luck. Edison says, "Invention is a science, and should be taught as a profession." Suppose you went home tonight and found a window rattling. Almost instinctively you would stop the rattle with a wedge. That instinct is the germ of your inventive ability, and you can develop it so strongly that in a remarkably short time you will

think and act inventively. Every invention is based on exactly the same principles that you use to "fix" the rattling window—first to see a problem, and then to find some fact which solves that problem. And now, for the first time, 15 famous inventors teach you how to acquire these simple, easily learned principles of invention.

A Fortune for One Little Idea

Even so small an idea as a new kitchen knife can bring you thousands of dollars. Waterman, the inventor of the fountain pen, became a millionaire. The inventors of the metal-tip shoe-ace, the "humped" hairpin, the metal tape measure, the paper-match holder, have all received thousands of dollars for just one idea. It doesn't matter who you are, where you live, what you do—every day you meet problems which suggest ideas for money-making inventions.

Learn How to Invent at Home

If you have ever had an idea for an invention, or if you would like to become a spare-time or professional inventor, see what this fascinating new course can do for you. Fifteen famous inventors now teach you at home the secrets of invention; show you how to get the information you want, how to perfect your ideas quickly, what to invent, and (just as important) what not to invent. You also learn how to avoid the mistakes which cost many inventors thousands and thousands of dollars. This complete course teaches you everything you want to know—how to get a patent, how to protect your patent rights, how to dispose of your invention to get the greatest possible profits, and hundreds of other facts about invention worth a fortune to you.

FREE BOOK On Inventive Science

A wonderful book explaining this fascinating course will be sent to you free. It explains the course in detail, and proves that you can easily train your mind to think inventively so you may become a successful inventor. It shows how this course gives you, in a short time, a wealth of information which other inventors learned only after years of hard work and bitter experience. Get the advice of these fifteen famous inventors. Send for this book today. There is no cost or obligation. This bureau is not connected with patent attorneys or manufacturers. Our only work is to teach you how to develop your ideas so they will bring you big money.

BUREAU OF INVENTIVE SCIENCE
Dept. 310, Wisner Bldg., ROCHESTER, N. Y.

BUREAU OF INVENTIVE SCIENCE,
Dept. 310, Wisner Building, Rochester, N. Y.

Please send me without cost or obligation your free book "The Science of Invention."

Name..... Age.....

Address.....

City..... State.....

Please Mention Popular Mechanics

VALPARAISO UNIVERSITY

Founded in 1873

An unparalleled opportunity

Departments—Education, Arts and Sciences, Engineering, Pharmacy, Law, Pre-Medicine, Home Economics, Public Speaking, Music, Manual Training, Preparatory, High School, Commerce, Stenography and Typewriting.

LOW COST of LIVING

Under University supervision, the cost of board and room, as well as tuition, is exceptionally low. Detailed figures are available in our catalog. The University is governed by a board of trustees—all influential men, eager for the students' welfare. It is not operated for profit. Valparaiso is beautifully situated, 44 miles from Chicago.

FIFTY-FIRST YEAR OPENS OCT. 1, 1923

Address President for free catalog

Box 11, University Hall VALPARAISO, IND.



SHORTHAND IN ONE MONTH

Wonderful, Easy System—The BOYD

Writers hold World's Record

100 to 150 words a minute in 30 days guaranteed. Big demand for trained Stenographers and Private Secretaries. Learn a profession that pays big.

What Students Say:

"Your Course is Wonderful."—M. R. W.

"It beats all other Systems."—F. Z.

The Boyd can be learned in one-sixth the time of other systems. It is the NEW WAY in Shorthand. Dictation first week—in 30 days you are ready for a position. Send today for Catalog and Money-Back Guarantee.

CHICAGO HOME-STUDY SCHOOLS

802 Reaper Block

Chicago, Illinois

30 Days' Free Trial

Select from 44 Styles, colors and sizes, famous Ranger bicycles. Delivered free on approval, express prepaid, at Factory Prices. You can easily save \$10 to \$20 on your bicycle.

12 Months to Pay on any Ranger if desired. Parents and girls can easily earn small monthly payments.

Tires best quality, at factory prices, express prepaid. Lamps, wheels and equipment, low prices. Send No money, do business direct with makers.

Mead Cycle Company
Dept. 5, Chicago

Write today for free Ranger Catalog, factory prices and marvelous easy payment terms.



STAMMERERS

I can teach you to speak normally. Send for low booklet telling how. BOSTON STAMMERERS' INSTITUTE, FOUNDED 1867 Samuel A. Robbins, Director, 246 Washington Ave., Boston 17, Mass.

LEARN WATCHMAKING

and become independent. Good-paying positions secured. Easy to learn. Send for FREE CATALOG.

ST. LOUIS WATCHMAKING SCHOOL, Dept. 5, ST. LOUIS, MO.

LEARN Penmanship

I Teach Penmanship by Mail

Small Cost. Spare Time. Write for my Free Book, "How to Become an Expert Penman." It contains specimens and tells how others became expert writers by the Tevis Method. Your name written on card if you enclose stamp. Write Today.

T. M. TEVIS, Box 25K, CHILLICOTHE, MO.

NO JOKE TO BE DEAF

—Every Deaf Person Knows That I make myself hear, after being deaf for 25 years, with these Artificial Ear Drums. I wear them day and night. They are perfectly comfortable. No one sees them. Write me and I will tell you a true story, how I got deaf and how I make you hear.



Medicated Ear Drum Pat. Nov. 3, 1900
GEO. P. WAY, Artificial Ear Drum Co. (Inc.)
89 Mc Kerchey Building, 2631 Woodward Avenue, Detroit, Michigan

LEARN TO DO ANY JOB!



The Cooke "Job-Way" trained man gets the big money, because no job is too hard for him! He finds the trouble instantly and can repair it quickly.

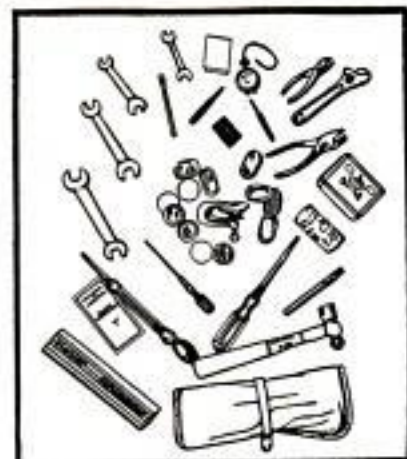
Your Name HERE!

A business of your own, paying \$3,000 to \$10,000 a year in profits! Cooke-trained Experts have gone into business with little or no capital and have found their future and their fortune repairing Automobiles, Trucks, Tractors, Gas Engines. You can, too!



Be an Auto-Tractor-EXPERT!

LEARN WITH TOOLS!



\$18.50 Repair Kit FREE

No books or useless theory in my home study "JOB-WAY" Course. That's why you can crowd training that would ordinarily take two years into a few months of spare-time home study. This \$18.50 repair kit only one of many inducements offered to get you started on the road to success NOW! Mail coupon for complete information. Learn how you can MAKE MONEY almost from the start with this outfit.

Men Wanted!

I train you to hold down these big-pay Jobs:

MASTER MECHANICS	\$3000 to \$8000
ELECTRICAL EXPERTS	\$3600 up
GARAGE MANAGER	\$3000 up
TRACTOR ENGINEER	\$2400 up
SALESMAN	\$3000 to \$12000
EXPERT WELDER	\$2400 up
BATTERY EXPERT	\$2400 up

NOW YOU CAN LEARN AT HOME!

At last! you can become an auto, truck and tractor expert right in your home with our practical, "Job-Way" training. If you like machinery, if you want to get ahead, here is the quickest road to BIG PAY! In what other way can you trade your spare time right at home for TRAINING that will prepare you to go into business or take your choice of a hundred jobs paying

\$75 to \$125 a Week!



B. W. COOKE,
President Cooke Auto School, "greatest institution of its kind in the world."

Good jobs everywhere! In garages, repair shops, service-stations, factories. As Salesman, demonstrators, electrical experts, Master Mechanics. In Battery stations, Vulcanizing Shops, Welding plants or in business for yourself. Salaries sky-high, easy hours, and opportunities for a business of your own all around you! Man alive! You can't afford to hesitate a minute!

Learn Automotive Mechanics Electricity, Welding Battery and Vulcanizing

Now 15 million autos, trucks and tractors crowding the cities, highways and farms. 15,000,000 electrical systems to maintain and repair. 50 million tires to replace and repair. 15 million batteries to test and service. 15 million autos, trucks and tractors to keep going! Do you realize that COOKE "JOB-WAY" training prepares you right at home for the opportunity—that when you're EXPERT you don't need "luck" or an "opportunity"—they're right here NOW waiting for you to start and finish!

Start NOW! I'll help you start and help you finish! Inducements you cannot resist, RIGHT NOW to ambitious men; terms within reach of everybody! Free Employment Service to help you get the job you want at top pay! Many extras, but not one penny extra for anything. Find out how easy I have made it for you to SUCCEED thru my SUCCESS coupon. **Mail Coupon Today**

COOKE AUTO SCHOOL, DEPT. 201, 500 S. THROOP ST., CHICAGO

Radio Course FREE THIS MONTH

Only one of the many surprises waiting for the man who has "gumption" enough to write for my big offer right away! Without one cent of cost, I am giving away a limited number of these \$45 courses. Why not get one? SUCCESS Coupon entitles you to this money-making course Free!

SUCCESS COUPON

B. W. COOKE, President
Cooke Auto School, Dept. 201, 500 S. Throop St., Chicago

Please send me Free Book and complete information about your Home Study Course. I am mailing this promptly to secure FREE RADIO COURSE, FREE REPAIR KIT and the reduced prices and special terms you offer now. Of course, I am not obligating myself in any way.

Name

St. No. or R. F. D.

City..... State.....

COOKE AUTO SCHOOL



"Salary Increased \$1080 a Year"

"I have not yet completed my course," a student wrote to us the other day, "but already my salary has been increased \$90 a month. That's \$1080 a year. Does spare-time study pay? I should say it does. I might still be plugging along in the same old job at the same old salary if I hadn't sent in that I. C. S. coupon."

Wouldn't you like to earn \$90 more a month, or \$1080 more a year? Wouldn't such an increase in salary make a tremendous difference in your life? Isn't it about time you stopped *wishing* for a better job and made a real, honest-to-goodness effort to get it?

If the I. C. S. can raise the salaries of other men, it can raise yours. If it can help other men to advance, it can help you, too.

At least find out how—by marking and mailing the same coupon that has brought success to so many other men just like yourself. It doesn't obligate you in any way to do this, yet it may be the means of changing your entire life. Make your start now.

Mail the Coupon To-day!

TEAR OUT HERE

INTERNATIONAL CORRESPONDENCE SCHOOLS Box 5551-D, Scranton, Penna.

Without cost or obligation, please tell me how I can qualify for the position or in the subject before which I have marked an X:

BUSINESS TRAINING COURSES

- | | |
|---|---|
| <input type="checkbox"/> Business Management | <input type="checkbox"/> Salesmanship |
| <input type="checkbox"/> Industrial Management | <input type="checkbox"/> Advertising |
| <input type="checkbox"/> Personnel Organization | <input type="checkbox"/> Better Letters |
| <input type="checkbox"/> Traffic Management | <input type="checkbox"/> Foreign Trade |
| <input type="checkbox"/> Business Law | <input type="checkbox"/> Stenography and Typing |
| <input type="checkbox"/> Banking and Banking Law | <input type="checkbox"/> Business English |
| <input type="checkbox"/> Accountancy (including C.P.A.) | <input type="checkbox"/> Civil Service |
| <input type="checkbox"/> Nicholson Cost Accounting | <input type="checkbox"/> Railway Mail Clerk |
| <input type="checkbox"/> Bookkeeping | <input type="checkbox"/> Common School Subjects |
| <input type="checkbox"/> Private Secretary | <input type="checkbox"/> High School Subjects |
| <input type="checkbox"/> Business Spanish | <input type="checkbox"/> Illustrating |
| <input type="checkbox"/> French | <input type="checkbox"/> Cartoning |

TECHNICAL AND INDUSTRIAL COURSES

- | | |
|---|--|
| <input type="checkbox"/> Electrical Engineering | <input type="checkbox"/> Architect |
| <input type="checkbox"/> Electric Lighting | <input type="checkbox"/> Blue Print Reading |
| <input type="checkbox"/> Mechanical Engineer | <input type="checkbox"/> Contractor and Builder |
| <input type="checkbox"/> Mechanical Draftsman | <input type="checkbox"/> Architectural Draftsman |
| <input type="checkbox"/> Machine Shop Practice | <input type="checkbox"/> Concrete Builder |
| <input type="checkbox"/> Railroad Positions | <input type="checkbox"/> Structural Engineer |
| <input type="checkbox"/> Gas Engine Operating | <input type="checkbox"/> Plumbing and Heating |
| <input type="checkbox"/> Civil Engineer | <input type="checkbox"/> Chemistry |
| <input type="checkbox"/> Surveying and Mapping | <input type="checkbox"/> Pharmacy |
| <input type="checkbox"/> Metallurgy | <input type="checkbox"/> Automobile Work |
| <input type="checkbox"/> Steam Engineering | <input type="checkbox"/> Navigation |
| <input type="checkbox"/> Radio | <input type="checkbox"/> Agriculture and Poultry |
| <input type="checkbox"/> Airplane Engines | <input type="checkbox"/> Mathematics |

Name.....
Street.....
Address..... 3-27-23

City..... State.....

Occupation.....

Persons residing in Canada should send this coupon to the International Correspondence Schools Canadian, Limited, Montreal, Canada.

Please Mention Popular Mechanics

LEARN BY DOING

Every phase of all branches of

ELECTRICITY

Taught by Actual Practice

In America's foremost and oldest institution for trade training

No Books Used
Individual Instruction
Start Any Day

A SPECIAL and SEPARATE Course in Ignition, Auto Lighting and STARTER Systems. Write for FREE 64-page catalog.

THE
NEW YORK ELECTRICAL SCHOOL
44 West 17th Street, NEW YORK CITY

LAW BOOK FREE

Send for it today

Whether you are a corporation president or a clerk, capitalist or wage earner—whatever your ambition is—this book will be of vital interest to you—of direct positive value. It tells you frankly about the amazing secrets of successful lawyers and law trained men in business. It proves conclusively how a law education will quickly fit you for a better position and bigger pay. It shows true stories of successful men who before taking this course saved for practically nothing. Three year course covers preparation for bar examination. Degree of LL.B. conferred.

\$5,000 to \$12,000 a Year
as a lawyer or law trained man in business. Read at home—aided by reading course. Moneyback guarantee if not satisfied upon completion. Low fee, easy monthly terms include complete up-to-date 12 volume library by the highest authorities. Send for free book now. No obligation to you whatever.

HAMILTON COLLEGE OF LAW
431 S. Dearborn St., Dept. 67
Chicago, Ill.

BECOME A RAILWAY MAIL CLERK

Examinations soon. \$1600 to \$2300 a year. No strikes or lockouts. Common education sufficient. No "pull" necessary. Mail coupon for catalog.

Patterson Civil Service School
Dept. 810, Rochester, N. Y.

Dept. 810
Patterson Civil Service School
Rochester, N. Y.

Sirs:—Send me without charge your Catalog, describing this and other fine U. S. Government positions.

Name.....
Address.....

I CAN HELP YOU—

IF I CAN PUT
INTO YOUR HANDS
THIS BOOK ON

STRONGFORTISM



LIONEL STRONGFORT
Dr. Sargent, of Harvard, declared that "Strongfort is unquestionably the finest specimen of physical development ever seen".

Are You To Blame?

No one should be blamed for being dumpy, grouchy, disheartened if he feels all off when he rises in the morning and feels languid and sluggish all day; but anyone should be blamed who permits such a condition of the body and mind to ruin his whole life and the lives of those about him without making an effort to throw off the monsters—disease and ill health—when I stand ready to help him in a way that no other man in the world can help him—when I offer to place within his grasp a system of self help, rehabilitation, up-building and strengthening, that is leading the way in making better men, happier men out of thousands who counted themselves failures.

You should be blamed if you refuse to listen to the advice of the man who first made of himself the most perfect specimen of manhood in the world and who now extends his hand to you and offers to point the way to health, strength, happiness and hopefulness. **MY HAND IS HELD OUT TO YOU IN FRIENDSHIP—I WANT TO HELP YOU**

Strongfortism has lifted thousands of weak, ailing, discouraged men out of the bog of hopelessness and despair and placed them on the broad straight road to health, happiness and prosperity. Strongfortism has given them renewed vitality, ambition and power to Do Things.

STRONGFORTISM Is A Science In Itself

Strongfortism is a long stride ahead of any so-called physical course or system that you know of. It embraces all the essentials of such systems, but is not limited to them—it goes far beyond, reaching out to a variety of Nature's aids, employing them to an advantage that brings surprising results to every Strongfort follower.

That is why I have been able to banish all drugs and medicines and clumsy devices of all sorts intended to relieve disease. I get results that are most astounding because my plan is so simple—my instructions so easily followed. My search after the basic truths of Nature and the facts about the diseases affecting humanity has led me to discoveries that are proving of inestimable benefit to all to whom I have imparted them.

My Free Book Tells All About It

Send today for your copy of "Promotion and Conservation of Health, Strength and Mental Energy." It's free, but the information it contains will be of inestimable value to you. It will tell you how you can, without medicines or drugs, and without the use of expensive apparatus, build yourself up to perfect health—how you may become a strong, healthy man. It will point the way to social and business success and to a happy life. It will show how to attain complete enjoyment of all your faculties and the full realization of all the blessings and joys of living. In short, it will tell you how to REALLY LIVE, by devoting a few minutes every day, in the privacy of your own room if you wish, to following my easy, simple instructions. **FILL OUT THE COUPON BELOW AND MAIL IT WITH a 10c piece, one dime, to cover packing and postage and you will receive your copy by return mail, with a personal letter from me concerning the subject or subjects in which you are most interested.** Sending for this book will not obligate you in any way, but it will show you how to attain to a fuller, freer, gladder, more perfect life. Take the first step toward their attainment by mailing that coupon now.

LIONEL STRONGFORT *Physical and health specialist*
709 Strongfort Institute **NEWARK, N. J.**

FREE CONSULTATION COUPON—ABSOLUTELY CONFIDENTIAL

Mr. Lionel Strongfort, Dept. 709, Newark, N. J.—Please send me your book, "PROMOTION AND CONSERVATION OF HEALTH, STRENGTH AND MENTAL ENERGY," for postage on which I enclose a 10c piece (one dime). Send me special information on subjects marked (X) below, as well as those I may write on extra line, without obligation.

- | | | | | | |
|--------------|---------------|-----------------|---------------------|-------------------------|-------------------------|
| .. Colds | .. Lumbago | .. Anemia | .. Torpid Liver | .. Increased Height | .. Blackheads |
| .. Catarrh | .. Neuritis | .. Debility | .. Indigestion | .. Despondency | .. Round Shoulders |
| .. Hay Fever | .. Neuralgia | .. Fear | .. Nervousness | .. Female Disorders | .. Lung Troubles |
| .. Asthma | .. Flat Chest | .. Neurasthenia | .. Poor Memory | .. Skin Disorders | .. Weak Back |
| .. Obesity | .. Insomnia | .. Short Wind | .. Rheumatism | .. Falling Hair | .. Drug Addiction |
| .. Headache | .. Bad Breath | .. Flat Feet | .. Gastritis | .. Deformity (Describe) | .. Weaknesses (Specify) |
| .. Thinness | .. Bad Blood | .. Constipation | .. Heart Weakness | .. Stomach Disorders | .. Muscular Development |
| .. Rupture | .. Weak Eyes | .. Billiousness | .. Poor Circulation | .. Pimples | .. Great Strength |

Mention Other Ailments Here: No matter what ails you write me fully about it and I shall prove to you that I can help you.

Name.....

Age..... Occupation.....

Street..... City..... State.....



DENTISTRY MECHANICAL

THE IDEAL VOCATION FOR MEN WHO ARE MECHANICALLY INCLINED

Dentistry needs more Mechanical Dentists. For men who like mechanical work, Mechanical Dentistry offers an exceptional opportunity to rise above a limited income into professional work with professional earnings.

TRAIN 3 MONTHS—THEN EARN \$35 TO \$125 A WEEK

The Dental Profession is constantly calling for graduates of the four great schools of this institution. Salaries from \$35 to \$45 a week to start, with advancement up to \$125 a week. Many positions are unfilled for weeks because of the great shortage and the demand.

ESTABLISH A BUSINESS OF YOUR OWN

Work with a Surgeon Dentist, in a Dental Laboratory, or establish a business of your own with unlimited earning possibilities. Dental experience or special education not required.

FREE 36-PAGE ILLUSTRATED CATALOG

Contains illustrations of students "Learning by Doing" actual practical work through individual instruction, day and evening sessions. Describes the great field and demand, and how you can "Earn While Learning." Investigate—Write today for Free Catalog No. 2.

BODEE DENTAL INSTITUTE

Founded 1892—No Correspondence Courses

NEW YORK
136 West 52d Street

PHILADELPHIA
1305 No. Broad Street

BUFFALO
1226 Main Street

BROOKLYN
15 Flatbush Avenue

LEARN CARTOONING

Successful cartoonists earn big salaries. Many of the most popular cartoonists of to-day learned to draw in their spare time, at home, through the Landon Course of Cartooning and now earn \$75 to \$200 a week.



The Landon Picture Chart Method of teaching ORIGINAL drawing makes cartooning easy to learn. Hundreds of sketches like the above explain every step in creating ORIGINAL heads, figures, animals, etc.

Write today for Sample Landon Picture Chart, long list of successful Landon students and full information showing possibilities for you. Please state your age. **The LANDON SCHOOL, 738 National Building, CLEVELAND, OHIO**

Results Prove Merit

In the leading publications and reviews which monthly reproduce the work of America's best cartoonists, you will constantly find the work of Landon students, including:

Dorman Smith of the N. E. A. Service.

Craig Fox of the Rochester Democrat and Chronicle.

Leo Thiele of the Sioux City Tribune.

Fred O. Seibel of the Knickerbocker Press of Albany.

Cartoonist Kuhn of the Indianapolis News—and others.

A constantly increasing number of Landon students are becoming nationally known as America's leading cartoonists.

WANTED

RAILWAY POSTAL CLERKS
\$1600 to \$2300 Year
MEN—BOYS 18 UP.

MAIL COUPON IMMEDIATELY

Steady work. No layoffs. Paid Vacations

Common education sufficient:

Travel—See the country

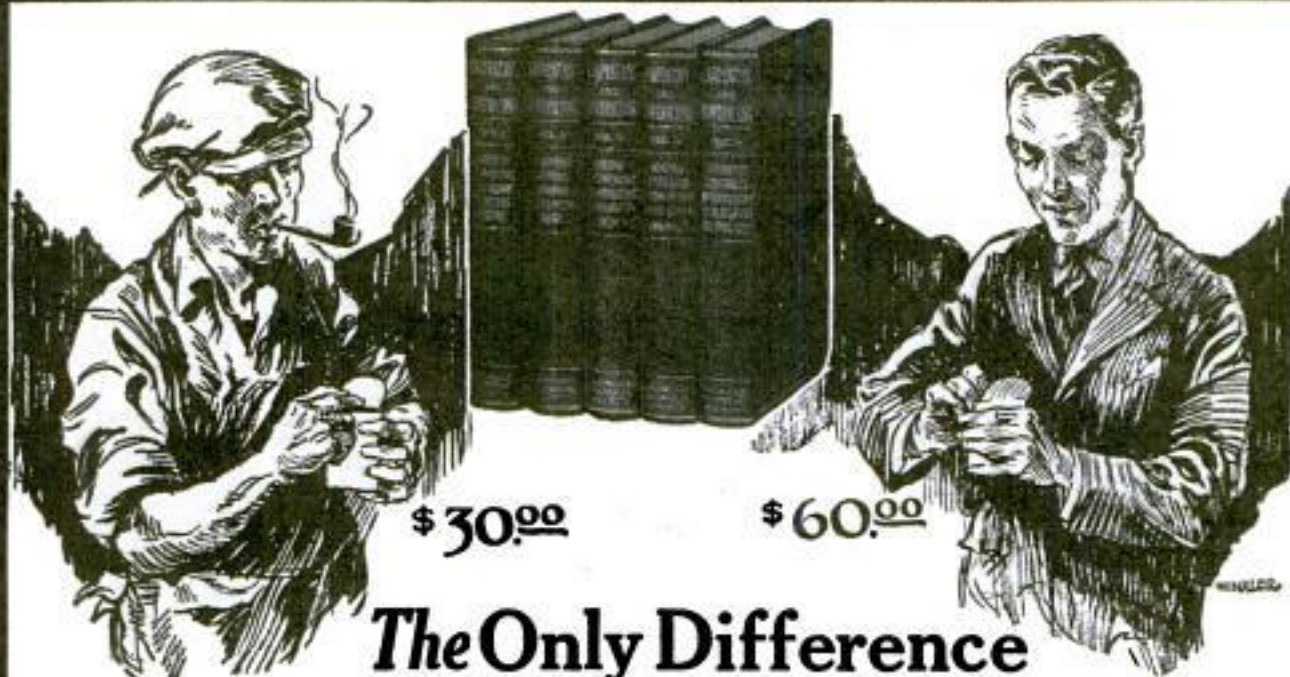


FRANKLIN INSTITUTE, Dept B180, Rochester, N. Y.

Sir: Send me without charge, (1) Sample Railway Postal Clerk Examination questions; (2) List of government jobs now obtainable; (3) Send free illustrated book, "How to Get Government Jobs."

Name.....

Address.....



The Only Difference Between Them Is a Set of Books

One earns \$30 a week—the other \$60. A year ago they were equal in skill, and both got the same pay. But one stood still, while the other was ambitious to get a bigger, better job. He read our "Carpentry and Contracting" and it told him a thousand things he never knew before—gave him ideas—better ways of doing things—enabled him to do jobs successfully—by so doing helped him to solve the problems that came up in his daily work. The big boss was quick to notice his progress. Today he has a better job and a man's size income. He is the boss himself.

FREE Consulting Membership

A resident consulting staff of 17 practical experts is waiting to solve for you any building or contracting troubles that you may have. A letter or a wire to the American Technical Society will bring you an immediate answer and the solution to your problems. This advisory staff of practical building men plus your library of Carpentry and Contracting will enable you to handle successfully any building job. These men know all the latest methods and the newest and best ways of doing things. Let this pay-raising consulting staff be YOUR SILENT PARTNER. Use this service daily if necessary.

This free consulting membership offer is good for a limited time only and can be withdrawn without notice

Free Examination 6 Months to Pay

Send the coupon for these pay-raising Carpentry and Contracting books TODAY. You will receive the whole set, by express collect, for a week's FREE examination and use. If you don't think they are worth twice the money, notify us to take them back at our expense. If you like them send us only \$2.80 in seven days and \$3 each month until \$19.80 is paid, or cash with order \$17.80. Remember, sending the coupon does not obligate you to buy.

**American
Technical Society**
Dept. G-719
Chicago, Illinois

With the big building boom sweeping across the country, there is a demand for more and better carpenters, plasterers, painters, masons, plumbers—every branch of the building trade is crying for good men at BIG WAGES. Now is the time for you to "cash in"—you can earn more if you learn more. Every man in the shop or on the job should have this set of

Carpentry and Contracting

Five big, wonderful volumes, bound in black flexible binding that will last a lifetime, 2138 pages of practical wisdom and more than 1,000 blue prints, plans, pictures and diagrams, prepared by 25 well-known experts.

Here are a few things this set of books will tell you:

Estimating	Blue Print Reading	Concrete Work
Drafting	Use of Steel Square	Stair Building
Drainage	Heating and Ventilating	Plumbing

Why not spend a little of your spare time at home fitting yourself for a much better job and a fatter pay envelope? Read this FREE trial offer and easy payment plan.

© A.T.S. 1923

AMERICAN TECHNICAL SOCIETY, Dept. G-719
Chicago, U. S. A.

Please send me a set of Carpentry and Contracting, for seven days' FREE EXAMINATION, shipping charges collect. I will examine these books thoroughly, and if satisfied, will send \$2.80 within seven days and \$3 a month until I have paid the special price of \$19.80. If I decide not to keep the books, I will return them within one week at your expense. It is understood that if I keep the books I am entitled to a FREE Consulting Membership in the Building division of the Society.

Name.....

Address.....

Reference.....

(Please fill out all lines, give local merchant, banker or employer as reference.)

\$5000⁰⁰— Agents to call on Established Trade
Big Profits—Permanent Business

**And a
 Business
 of your
 own**

**AGENTS-SALESMEN! OLD TIMERS OR NEW BEGINNERS!
 FULL TIME OR PART TIME WORKERS!**

We have a proposition to offer that puts you in a permanent—growing business of your own where your profits are limited only by the time and effort you give to it. Full time workers who sell our complete line of men's made-to-order suits and overcoats—raincoats and Boys' clothes make \$5000 a year easy.

Double Sales—Double Profits The greatest line of men's made-to-measure suits and overcoats in America. Fine foreign and domestic fabrics—lowest prices \$23.50 — \$26.50 — \$29.50 RETAIL. Boys' suits with two pair of pants—\$8.45 to \$14.75. Prices always 20% to 30% less than local stores. Sales easy to make—every man—every boy buys on sight. You make double profit because every man who buys a suit or overcoat will buy one for his boy also.

COMPLETE SAMPLE OUTFIT FREE

We furnish complete sample outfit of 160 finest styles for men—more than 50 styles for boys. Neat carrying case and everything needed—to make full success you do not invest one penny in merchandise—you have a larger stock of goods to sell from than any store in town and lower prices. Folks buy quick, the minute you show them your complete line and low prices.

Advance Profits

You get your profit the minute you make your sale. Customer pays you a deposit with order—you put this in your pocket—it's your profit—you send us the order—we ship goods to your customer c. o. d. for wholesale price—you have no deliveries to make—no collection and your profits are from \$4.00 to \$10.00 on every sale.

UNLIMITED FIELD—CUSTOMERS WAITING

Every man and every boy in your locality is a live prospect for a suit or overcoat. You sell them easy when you have our complete line because we sell real men's \$45.00 suits for \$29.50—boys' suits that retail everywhere for \$15.00 we sell for \$8.45. We have been in business since 1885—more than 37 years and have thousands of satisfied customers who are waiting for our representatives to call on them.

Do You Measure Up? We want \$5000.00 a year men to take hold of our proposition. Men who stand for honesty and integrity in their community. Hard hitting men—the kind who want a permanent ever growing business of their own. To such men we offer the chance of a lifetime. Unlimited field for sales and profits—old customers waiting to buy—our active help in getting new customers—the highest grade of goods and service. No experience is necessary—we teach you every step—full instructions are included in our selling outfits.

Now Is The Time To Line Up Our Fall and Winter sample outfits are ready. Orders are being taken every day by our present representatives—profits being made—customers writing us to have our representatives call to see them. Every day's delay means profit lost to you and the possibility that the territory you want may be taken. Write us today for more information and a copy of our free booklet "The Secret Memorandum Book."

WRIGHT & CO., Dept. A102, Congress, Throop and Harrison Sts., CHICAGO, ILL.

**Sell Men's made to Measure clothes
 — Boys Suits too!**



**BE A
 TRAFFIC
 MAN**

DEMAND INCREASING DAILY

With the energetic revival of business activities, the demand for men trained to handle transportation problems is greater than ever before. Our highly specialized course prepares you for this high salaried profession. Personal attention and practical experience—with successful Traffic Men. Special plan to help pay your tuition. Post graduate course FREE. Write today for full information.

INTERSTATE TRAFFIC SCHOOL
 110 Traffic Bldg. Fort Wayne, Ind.

LEARN AUTOS AND TRACTORS



Wonderful opportunities constantly offered trained men—we train you thoroughly to start your own business, or to make good money as motor expert, driver, shop foreman, etc., and furnish you with a \$12.00 tool kit free of charge. This is the pioneer auto school. Over 7000 graduates making good. Catalog free.

CLEVELAND AUTOMOBILE SCHOOL, 1814 East 24th Street, Cleveland, Ohio

Anyone CAN LEARN

No talent or experience necessary. Fascinating work. Pays big money. Complete instruction book tells about: Alphabets, Colors, How to Mix Paints, Show Cards, Window Board and Wall Signs, Ready made letters, Gilding, Tricks of the Trade, also gives 100 Alphabets and Designs. Book bound in indestructible leather-gold edge, and four tall bearing Show Cards. Pans. Sent postpaid \$3.00. (C.O.D. 10cex.)
 Signite Pub. Co., 57 Russ St., Dept. 50, N. Y. City

**EARN MONEY IMMEDIATELY—
 WE FURNISH EQUIPMENT TO START!!**



Violin, Hawaiian Guitars, Ukulele, Guitar, Mandolin, Cornet, Banjo-Ukulele, Tenor Banjo or Banjo
 Wonderful new system of teaching note music by mail. To first pupils in each locality, we give a \$20 superb Violin, Mandolin, Ukulele, Guitar, Hawaiian Guitars, Cornet, Tenor Banjo or Banjo absolutely free. Very small charge for lessons only. We guarantee success or no charge. Complete outfit free. Write now. No obligation.
SLINGERLAND SCHOOL OF MUSIC, Inc., Dept. 214, CHICAGO, ILL.



WANTED! Get \$1600 to \$2300 a Year

U.S. RAILWAY MAIL CLERKS
MEN—BOYS 18 OR OVER SHOULD MAIL COUPON IMMEDIATELY

Franklin Institute, Dept. B178, Rochester, N. Y.

Sirs: Send me, without charge, (1) sample Railway Mail Clerk Examination questions; (2) tell me how to get a U.S. Government job; (3) send list of places at which examinations will be held; (4) send copy of illustrated book, "How to Get Government Jobs."

Name
 Address

**Steady Work—No Layoffs—Paid Vacations
 Travel—See the Country
 Common Education Sufficient—Send Coupon Today—SURE**



MEN WANTED

This Don't Mean Any Kind of Men. It Means Trained Men



MEN WHO KNOW A TRADE. SKILLED MEN

What is the difference between trained men and untrained men today? Trained men are receiving from \$8 to \$15 per day, steady time. Untrained men are receiving from \$2.50 to \$5.00 per day and work wherever and whenever they can find employment.

One of our men recently qualified as an automotive engineer for a job paying from \$3,600.00 to \$5,000.00 per year, another for \$1.00 per hour, steady time as an electrical expert and so it goes.

There are all kinds of big paying jobs for you as well as thousands of others, if you will but wake up to what is waiting for you. *Will you answer the call or are you satisfied with an unskilled, small pay job.* Office men all over the country

are realizing the opportunities in the trades for them, are quitting their jobs and learning a trade.

Blame yourself if you do not take advantage of this opportunity. Write today, now, for our big, FREE catalogue, the most practical course of training at the lowest price. *Everything complete, practical and made so simple that any man can master it.* Night business course, night Radio course, Y.M.C.A. membership. Life Scholarship privileges. *All for the one low fee.*

"Teach Your Dollars to Have More Cents"

IOWA STATE AUTO TRACTOR SCHOOL

"The Best By Test"

739 Nebraska St.

Sioux City, Iowa

COUPON
IOWA STATE AUTO TRACTOR AND ELECTRICAL SCHOOL,
178 Nebraska St., Sioux City, Iowa

Please send me free your big 72 page illustrated book.

Name

Address

R.F.D.

You Can Easily Learn to Play Any Music on the HAWAIIAN GUITAR

Just As Hawaiians Do—Native Instructors Teach You QUICKLY!

Here's Proof of our Remarkable Course

Buchanan, Va.
First Hawaiian Conservatory of Music, Inc.

It has been two months since I have finished your course on the Hawaiian Guitar and I can play anything I wish. The course was all that could be desired and I am perfectly pleased with my playing ability since finishing your course.

Respectfully yours,
Louise R. Hammond

Koester School,
314 So. Franklin St.,
Chicago, Ill.

First Hawaiian Conservatory of Music, Inc.

I shall certainly be very glad to recommend your course whenever the chance is mine to do so. Mr. W. N. Johnson has not phoned me yet, and if he does not phone in a day or so, will write him. Am sending a letter to Miss Helen Slavik today which I think may help to secure her enrollment, and I shall be glad at any time to write a personal letter to anyone whom you may suggest.

Your former student,
W. L. Walker

Special Courses under famous Teachers. Tenor-Banjo, Violin, Banjo-Ukelele and Ukelele. Fine Toned Instruments FREE!

In Half an Hour You Will Be Playing "ALOHA". Soon You Will Be Winning Praise Everywhere Playing "Stumbling", "Three O'Clock in the Morning", "Hot Lips" and ALL Popular Music as Well as the Beautiful Hawaiian Melodies

Here's the chance you've been waiting for—the opportunity to play popular music quickly on the most entrancing instrument of the age—the Hawaiian Guitar. *No previous musical knowledge necessary.*

ONLY FOUR MOTIONS TO LEARN

and these you acquire in a few minutes. No troublesome scales or runs, you begin to play harmonious chords immediately! We don't care if you never saw a note of music in your life, we guarantee to teach you to play just as the Hawaiians do!

We Furnish Everything—a Beautiful Hawaiian Guitar, Picks, etc., and 52 Pieces of Music FREE!

You have always wanted to play some instrument, so we have made it unusually easy for you by furnishing everything—a beautiful Hawaiian Guitar, complete Conservatory Course of instruction and 52 pieces of especially selected music.

No Other Course Teaches as Quickly and Easily

This is the only Conservatory Course where you get the personal instruction of Native Hawaiian Experts—Frank Ferera, Walter Kolomoku, Lawrence Kalaluki and Carl Seville, famous the world over and the most noted makers of phonograph records, supervise your playing.

Mail Coupon for Details of FREE Offer

Don't wait another minute—clip, fill in and mail the coupon NOW and get full details of our remarkable offer to teach you how to play the Hawaiian Guitar just as the Hawaiians do.

Special Arrangements for Lessons if You Have Your Own Instrument

FREE

This \$15
Hawaiian
Guitar

You will be delighted with the fine tone of this splendid Hawaiian Guitar

First Hawaiian Conservatory of Music, Inc.,
Desk 45 233 Broadway (Woolworth Bldg.), New York.

Send me at once details about your 52 easy lessons and FREE Hawaiian Guitar offer!

Name

Address

Town

State

Print name and address clearly.



Guess This Man's Age!

Is it 30, 35 or 40? You would never guess right — he is 65 years of age! Sixty-five, yet young as any man of 25! He never has an "off" day, nor headache, backache, stomach ache. Yet he lives no "regulated" life; keeps what hours he pleases, eats and drinks what he likes. How?

By keeping his spine a half inch longer than it would ordinarily measure at his age!

Why a Person with a Full Length Spine is Rarely Sick!

How does this benefit? The spine is a series of small bones held apart by pads of cartilage. With years, the spine "settles," and the pads become so thin the bones close in on the nerves between. This abnormal pressure on the nerves plays havoc with health; brings on nervous disorders—nervous exhaustion. And nervous exhaustion means old age, regardless of your years. Keep the spine "elongated"—the vertebrae apart—the nerves free—and every part of your body will have a full supply of the nerve energy that is life—health—youth!

No Apparatus!!
Try SPINE-MOTION FREE!

See if your nervousness, your constipation, your stomach trouble, your "old age" isn't really in your spine. See if your nerves are not in a vice. Try SPINE-MOTION. Just five movements to it—that's all—but in five minutes you'll feel like a new person. Try the method for 5 days, 5 minutes each day. Remember, please—**NO APPARATUS**. Note the difference in your appetite, in your sleep—in your "pop," vigor and desires. Pay nothing unless you feel and see wonderful benefits. If you are more than amazed and delighted with the results, remit only \$3 in full payment for everything.

FREE Trial Coupon
— Mail It Now! —

Hobart Bradstreet, Suite 1777
 630 South Wabash Avenue, Chicago, Ill.

Send me your SPINE-MOTION. I will either return it in 5 days or send \$3 in full payment.

Name

Address

City State

Please Mention Popular Mechanics

The Key to Success

Stop forgetting

Make Your Mind a File—Not a Pile

The Key to Success is the ability to remember. I can make your mind an infallible classified index from which you can instantly select thoughts, facts, figures, names, faces. Enables you to concentrate, develop self-control, overcome bashfulness, forgetfulness, address an audience. Easy. 20 years' experience developing memories of thousands.

Write Today for free booklet, "How to Remember," and Copyrighted Memory Test, and how to secure Free my \$3.00 book, "How to Speak in Public."

DICKSON MEMORY SCHOOL
 Dept. 705X Evanston, Ill.

BE AN ARTIST

We can teach you **DRAWING** in your own home during your spare time

Our 18 years of successful teaching prove our ability. 10 Courses in Commercial and Illustrative Drawing. Teachers Normal and Applied Art. Endorsed by high art authorities. Students trained by members of our Faculty are filling high-salaried positions. Artist's Outfit **FREE** to Enrolled Students. Write today for Art Year **FREE** Book.

SCHOOL OF APPLIED ART
 ANNEX ART BLDG. No. 2 BATTLE CREEK MICH.

High School Course in Two Years

This simplified, complete High School Course—specially prepared for home study by leading professors—meets all requirements for entrance to college and the leading professions.

Whether you need High School training or specialized instruction in any trade or profession the American School can help you. Check and mail coupon for Free Bulletin.

30 Other Courses

American School
 Drexel Ave. and 58th Street
 Dept. H774A
 Chicago

American School, Dept. H774A, Drexel Ave. and 58th St., Chicago
 Send me full information on the subject checked and how you will help me win success.

- | | |
|-------------------------------|------------------------------|
| Architect | Lawyer |
| Building Contractor | Machine Shop Practice |
| Automobile Engineer | Photoplay Writer |
| Automobile Repairman | Mechanical Engineer |
| Civil Engineer | Shop Superintendent |
| Structural Engineer | Employment Manager |
| Business Manager | Steam Engineer |
| Cert. Public Accountant | Foremanship |
| Accountant and Auditor | Sanitary Engineer |
| Bookkeeper | Surveyor (and Mapping) |
| Draftsman and Designer | Telephone Engineer |
| Electrical Engineer | Telegraph Engineer |
| Electric Light & Power | High School Graduate |
| General Education | Fire Insurance Expert |
| Vocational Guidance | Wireless Radio |
| Business Law | Undecided |

Name

Address



FREE!

Actual Reports of Secret Service Operator 38

HERE is something money can't buy. More fascinating than detective stories. Confidential reports of a real operator—No. 38—to his Secret Service Bureau, headed by the most famous detective in America. Absolutely Free. No cost. No obligation. Don't fail to send for them.

They may point the way to Big Money for you.

See how the modern detective works. Read these inside stories of the solution of great mysteries. See what possibilities this most fascinating and eventful of all professions offers to you—and how you may fit yourself for it.

Be a Finger Print Expert

To command the highest fees, the Secret Service man must also be a Finger Print Expert. These reports show why. This profession may be easily learned at home, in your spare time. Wonderful opportunity in this **UNCROWDED, PROFITABLE** field.



Cases of 12 Famous FingerPrint Experts

Stories and pictures of *real* crimes solved by Finger Print evidence. Pictures and life stories of famous experts—many, graduates of my school. True facts, but better than fiction.

Also Sent Free
Send the Coupon →

Make \$5,000 to \$10,000 a Year

The unfilled demand for trained Finger Print men is increasing daily. Opportunity is waiting for YOU. No time to lose. Send today for these reports, also our big Free book on Finger Prints. Gives all particulars and success stories of our graduates. Brilliant future ahead of you if you act now.

Special Offer—Limited Time

Everyone getting these Free Reports will also receive my Special Offer of a Professional Finger Print Outfit, absolutely Free. Made for limited time only. Send coupon today—sure. Reports, Finger Print Book, and special outfit offer, all Free and Prepaid. Don't delay, and perhaps forget. Do this right now.

T. G. COOKE, Pres., University of Applied Science
Dept. 13-57, 1920 Sunnyside Avenue, Chicago, Illinois

T. G. COOKE, Pres., University of Applied Science
1920 Sunnyside Avenue, Dept. 13-57, Chicago Illinois

Dear Mr. Cooke:—Please send me FREE and prepaid, Reports of Operator 38, your new illustrated book on Crime and Crime Detection and your Special Outfit Offer. It is fully understood that I assume no obligation.

Name.....Age.....

Address.....

Town.....State.....



Do You Want A Better Job?

THE only difference between success and failure is a matter of training. The big men in business today did not reach their present success through luck or chance.

They got into the work for which they were best fitted—and then trained themselves to know more about their jobs than anyone else. When opportunity came—as it always comes—these men were ready to grasp it and turn it into fame and dollars.

You have just as good a chance to succeed as these men had—perhaps better! Good positions are always waiting for trained men—positions that you can get if you train yourself to deserve them.

You can secure this training easily and quickly at home through spare-time study with the International Correspondence Schools, just as so many other men have done. The I. C. S. way is the practical way—the fascinating way—the profitable way.

All that we ask is this:—Fill out the coupon printed below and mail it to Scranton. This doesn't obligate you in the least—but it will bring you the full story of what the I. C. S. can do for you. Today is the day to send in that coupon. "Tomorrow never comes."

— YEAR OUT HERE —

INTERNATIONAL CORRESPONDENCE SCHOOLS

Box 5550-D, Scranton, Penna.

Without cost or obligation, please tell me how I can qualify for the position or in the subject before which I have marked an X:

BUSINESS TRAINING COURSES

- | | |
|---|---|
| <input type="checkbox"/> Business Management | <input type="checkbox"/> Salesmanship |
| <input type="checkbox"/> Industrial Management | <input type="checkbox"/> Advertising |
| <input type="checkbox"/> Personnel Organization | <input type="checkbox"/> Better Letters |
| <input type="checkbox"/> Traffic Management | <input type="checkbox"/> Foreign Trade |
| <input type="checkbox"/> Business Law | <input type="checkbox"/> Stenography and Typing |
| <input type="checkbox"/> Banking and Banking Law | <input type="checkbox"/> Business English |
| <input type="checkbox"/> Accountancy (including C.P.A.) | <input type="checkbox"/> Civil Service |
| <input type="checkbox"/> Nicholson Cost Accounting | <input type="checkbox"/> Railway Mail Clerk |
| <input type="checkbox"/> Bookkeeping | <input type="checkbox"/> Common School Subjects |
| <input type="checkbox"/> Private Secretary | <input type="checkbox"/> High School Subjects |
| <input type="checkbox"/> Business Spanish <input type="checkbox"/> French | <input type="checkbox"/> Illustrating <input type="checkbox"/> Cartooning |

TECHNICAL AND INDUSTRIAL COURSES

- | | |
|--|--|
| <input type="checkbox"/> Electrical Engineering | <input type="checkbox"/> Architect |
| <input type="checkbox"/> Electric Lighting | <input type="checkbox"/> Blue Print Reading |
| <input type="checkbox"/> Mechanical Engineer | <input type="checkbox"/> Contractor and Builder |
| <input type="checkbox"/> Mechanical Draftsman | <input type="checkbox"/> Architectural Draftsman |
| <input type="checkbox"/> Machine Shop Practice | <input type="checkbox"/> Concrete Builder |
| <input type="checkbox"/> Railroad Positions | <input type="checkbox"/> Structural Engineer |
| <input type="checkbox"/> Gas Engine Operating | <input type="checkbox"/> Plumbing and Heating |
| <input type="checkbox"/> Civil Engineer | <input type="checkbox"/> Chemistry <input type="checkbox"/> Pharmacy |
| <input type="checkbox"/> Surveying and Mapping | <input type="checkbox"/> Automobile Work |
| <input type="checkbox"/> Metallurgy <input type="checkbox"/> Mining | <input type="checkbox"/> Navigation |
| <input type="checkbox"/> Steam Engineering | <input type="checkbox"/> Agriculture and Poultry |
| <input type="checkbox"/> Radio <input type="checkbox"/> Airplane Engines | <input type="checkbox"/> Mathematics |

Name.....
Street.....
Address..... 3-27-23

City..... State.....

Occupation.....
Persons residing in Canada should send this coupon to the International Correspondence Schools Canadian, Limited, Montreal, Canada.

Please Mention Popular Mechanics

GOODWEAR can use a few more GOOD MEN

Our men make \$50 to \$100 per week and up—depending on their ability and the time they give to our proposition. **We can prove it.**

Profits of \$4.25 to \$5.50 on every sale—collected and kept by salesmen when order is taken. Two to four orders a day easy. More possible. Men have sold as high as 20 suits a day. **Figure for yourself the profit possibilities of this Line.** All-Wool fabrics, high-grade tailoring and an absolute guarantee of satisfaction insure repeat sales. **Steady season after season income assured.**

Real co-operation from our end: Selling helps and advertising matter that get the business, make **selling easier—business bigger—profits greater.**

These are the simple facts about the GOODWEAR proposition. If they appeal to your reason let us hear from you promptly—but let us urge you to **make it prompt.** A dwindling supply of lines makes it almost certain that many applicants will be disappointed before the season is over. Wherefor we are particularly desirous of having every honest, ambitious, aggressive salesman put in his application **now, while we still have lines.** When you write, tell us about yourself and your experience. It will help us to give you action. Address Dept. 638.

GOODWEAR, Chicago, Inc.
West Adams Street at Peoria, Chicago



WANTED! RAILWAY MAIL CLERKS

Free list of Government Positions obtainable
MEN AND WOMEN Salary \$1600 to \$2600
17 TO 45 YEARS

Write today for booklet, list and sample lessons

UNITED BUSINESS TR. ASS'N, 214 Dinan Bldg., Detroit, Mich.

A THRILLING CAREER

Become a reporter and news writer at home. Practical New York newspaper men quickly teach you this fascinating, well-paid work. Personal instruction in Reporting, Writing for Out-of-Town Papers, Sports, Publicity, Society, etc. You can earn \$100 to \$400 monthly, part or whole time. Men and Women. Write for free book NOW. Metropolitan School of Journalism, Dept. 104, 90 E. 42nd St., New York, N.Y.

Become A Reporter! FREE BOOK Tells All

BE AN ARTIST

Comics, Cartoons, Commercial, Newspaper and Magazine Illustrating, Pencil Crayon Portraits and Fashions. Our simple method quickly develops your talent in spare time. By Mail or Local Classes. Write for terms and list of successful Students. ASSOCIATED ART STUDIOS 87-B Flatiron Building, NEW YORK

DEAFNESS IS MISERY



I know because I was Deaf and had **Head Noises** for over 30 years. My invisible Antiseptic Ear Drums restored my hearing and stopped Head Noises, and will do it for you. They are Tiny Megaphones. Cannot be seen when worn. Effective when Deafness is caused by Catarrh or by Perforated, Partially or Wholly Destroyed Natural Drums. Easy to put in, easy to take out. Are "Unseen comforts." Inexpensive. Write for Booklet and my sworn statement of how I recovered my hearing.

A. O. LEONARD, Suite 226, 70 5th Avenue, New York City

New Easy Way to Equip for the Biggest Electrical Jobs



S. V. Smith has been called "The Electrical Wizard". His title is well earned by his vast knowledge of this fascinating subject. He is perhaps even better known as the inventor of the amazing "Shop Practice Extension Method" of instruction. For this is the Easy New Form of study that has turned out such expert electricians that Mr. Smith has given them the very cream of the jobs offered to S. & H. Graduates. His personal instruction is now available to you. The services of the great S. & H. Employment department are at the disposal of every one of Mr. Smith's graduates FREE OF ALL COST.



SUPERVISING ENGINEER
\$10,000 A YEAR

tricians that Mr. Smith has given them the very cream of the jobs offered to S. & H. Graduates. His personal instruction is now available to you. The services of the great S. & H. Employment department are at the disposal of every one of Mr. Smith's graduates FREE OF ALL COST.

Discovers New Way to Give Shop Practice in Your Own Home

It is now made possible for any one, regardless of education or experience, to be trained for big pay jobs. By an amazing new easy system discovered by Mr. Smith it is made possible to give actual shop practice to the student right in his own home. Everything is so clearly explained and so wonderfully illustrated with original cuts, pictures, diagrams, plans and designs—and Mr. Smith's own personal supervision is so thorough that you work out in practice every step of the course just as though you were at a resident school. It is the only system by which actual shop practice can be given the student in his home.



And when you enter this profession you cannot afford to be without the prestige and backing of the S. & H. Electrical Works.

Free Outfit

To all who send coupon at once Mr. Smith is now offering free a complete outfit of electrical apparatus, instruments and appliances for experimental and practical home shop work. By sending the coupon below you will be entitled to this offer whether you enroll now or later—but you must send it immediately. Now is the time to act—don't take a chance of losing this big free offer. Get the information that will open a wonderful career to you. Mail the coupon now.

Every Branch of Electricity

No matter what you want to learn, you will find it in this wonderful course. You are taught all types of electrical work, such as house wiring, central and sub-station operating and maintenance, automobile and tractor starting, lighting and ignition, electrical jobs and battery station service. You are taught motor maintenance, armature winding, illuminating engineering and line construction. Best of all you are fitted for jobs as supervisor, foreman, electrical technician and equipment manager—the big pay jobs at the top of your profession.

Men Needed

If you want to get out of the Low Pay rut, study Electricity. It is the most fascinating and best paying field in the world.

S. V. Smith
S. & H. Electrical
Works

Dept. 1-M
1422 W. Monroe St.
Chicago,
Ill.

Chief
Engineer
Smith

S. & H.

Electrical Works
Dept. 1-M, 1422 W. Monroe St.,
Chicago, Illinois

Please send me catalog and full particulars of your course in Practical Electricity and details of your free offer to those who enroll now. I understand this is free of charge and does not obligate me in any way.

Name

Address

City, State

mail for Free Offer

Learn AUTO PAINTING

\$25 TO \$50 A DAY

800 MEN WANTED

We want 800 men to enroll for our Fall and Winter course to fill position in the industry. Start your course any time.

10,000,000 AUTOS NEED PAINTING

Factories calling on us for men—you can start a business or get a job painting autos in any town or city—THE BIGGEST, QUICKEST PAY in the industry. START A BUSINESS without capital—all you need to start business is a few brushes, some paint and Our Trainer.

Get Free Book "MIXING PAINT WITH BRAINS"

Write for catalog and information. We have the best instructors and equipment. You'll like the course—Auto Factories endorse our methods and employ our men. Detroit, the Center of the Auto Industry is the place to learn auto painting.

30 D. A. P. S. Bldg., 426 Superior St. DETROIT, MICH.

DETROIT AUTO PAINTING SCHOOL

WILL A FORD GO 66 Miles ON ONE GALLON? Or Other Make Do Equally Well?



AGENTS WANTED!

Wonderful new Vapor Humidifier. Many users claim 43 to 66 miles per gallon; official tests show 30 to 33 miles. Vapor moisture does it! Permanently eliminates carbon from motor. Does away with frequent plug cleaning and valve grinding. In its 4th year. 35,000 in use. Two models for all Cars, Trucks and Tractors. First cost only cost; no adjustment or attention after simple installation. Is scientific—automatic—permanent—outlasts the motor—good looking. Guaranteed 5 years. Not a toy or makeshift. Retail at \$10.00 and \$15.00. Installation simple and easy.

BIG PROFITS TO HUSTLERS

The inventor is giving one free to help introduce it. Every car owner should write for one. Give make car.

Agency appointments now being made.
WALTER CRITCHLOW, Inventor
 Suite 356 716 Madison CHICAGO

Why Good Dancers Are Popular

EVERYONE admires and wants to dance with the person who knows the latest steps. There is no need of being a wall-flower! By my remarkable new easy method anyone can learn the newest dances at home in a few hours. Much less expensive than from a personal teacher. No music or partner needed. So simple even a child can learn quickly. 90,000 have learned dancing by mail. Your own success is guaranteed.



To prove I can quickly and easily make you an accomplished dancer, I will send you FREE, in plain cover, a lesson in Fox Trot, Secret of Leading, How to Gain Confidence, How to Follow and How to Avoid Embarrassing Mistakes. To help pay the cost of handling, mailing, etc., send 25c. Learn in private—surprise your friends. Act now and be a good dancer soon!

ARTHUR MURRAY, Studio 856, 290 Broadway, N. Y.

Become a **Earn \$5,000 to \$10,000 per year.** Write for Book-Dancing Teacher let 56, to Arthur Murray at above address.

MASTER ELECTRICITY AT HOME

A practical man will lead you to success. Write only if you are in earnest. Our FREE Book plainly tells how Burgess Home Training enables men and boys to get good jobs and hold them. Shows world-wide opportunities in electricity. Tells how fellows like you have stuck and studied until now they are on top. Write for your copy today. Romance of real success on every page.

PRACTICAL COURSE, EASILY APPLIED

No frills or feathers; no mystery; no bunk. Just honest, helpful instruction which any one can understand and follow. For the man high in the profession as well as for the beginner. All branches of electricity covered: Hydro-Electricity, Alternating Current, Motors, Power-Plant Practice, Slide Rule (30 additional lessons), Automotive Electricity, Electrical Drafting, Etc. We help you to position during and after instruction. The Course for you if you mean business. Write for Our Fully Illustrated Book Today. New Radio Course Now Ready.

BURGESS ELECTRICAL SCHOOL
 YORKE BURGESS, Superintendent
 744 East 42nd St., CHICAGO, ILL.
 Canadian Branch: 201A Crawford St., Toronto

LEARN MUSIC AT HOME!

Special Short Time Offer — Easy Lessons Free — Piano, Organ, Violin, Banjo, Mandolin, Guitar, Cornet, Harp, Cello, Singing, etc. You pay only for music and postage—which is small. No extras. Beginners or advanced pupils. Plain, simple, systematic. Twenty-five years' success. Start at once. Send for special short-time offer and free booklet and sample lesson by return mail. Address

U. S. SCHOOL OF MUSIC, 710 Brunswick Building, NEW YORK CITY

MEN WANTED

Prepare as Firemen, Brakemen, Electric Motormen, and colored Train Porters. Hundreds put to work. No experience necessary. 500 more wanted. Name position you want.

RAILWAY INSTITUTE Dept. 35 Indianapolis, Ind.

STUNTS

for meetings, parties, clubs, lodges. A real book of "100 Live Ideas," every stunt, plan and speech tested and proved. Highly endorsed by leading organizations. The standard book. Sent postpaid for \$1.

Nat'l Stunt Exchange, 20 E. Jackson Blvd., Chicago

\$50,000.00 REWARD

DEAD OR ALIVE

Toronto, Can., Millionaire Missing
Be a FINGER-PRINT SPECIALIST

Earn \$250 to \$300 per Month. Learn Scotland Yard Methods, Experience Not Necessary. Write today for FREE Illustrated Booklet.

UNITED DETECTIVE TRAINING ASS'N
 214 Dineen Bldg. DETROIT, MICH.

YOU



WHAT ABOUT AN AUTOMOTIVE JOB Paying \$50 to \$125 per Week

YOU CAN HAVE ONE after a few short weeks of mighty interesting training at Greer College. Never before in automobile history has there been such a demand for expert automobile workmen. Hundreds of requests for Greer Graduates are now in our files, waiting to be filled. We want more ambitious students to qualify for the big money jobs. We want YOU—AT ONCE.

Mail
Coupon
for
THIS
FREE
BOOK
NOW

Paying Jobs Furnished While You Learn

We can place you in positions paying up to \$30.00 per week while you learn. With this help you can get through easily. In eight short weeks you can graduate as a Certified Automotive Engineer with a lifetime of big earnings ahead of you.

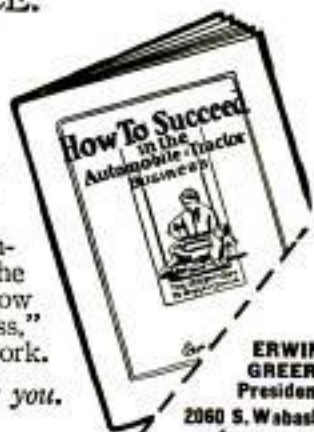
Complete Greer Course includes Machine Shop Practice, Shop Management, Selling, Truck, Tractor and Automobile Repairing in the big Greer shops, Lighting, Starting, Ignition, Tire Repairing, Storage Batteries, Driving—Everything you need to qualify you for high paid positions anywhere.

Day and Evening Classes

Your work need not interfere with your Greer studies. Classes are suited to your convenience.

Write at once for your earn-while-you-learn job—and send the coupon for FREE BIG Booklet "How to Succeed in the Automobile Business," all about automobile and garage work.

Act now, while there is still room for you.



ERWIN
GREER,
President
2060 S. Wabash
Avenue
CHICAGO, ILL.

Send me your Free Book, "How to Succeed in the Automobile Business," and Special Tuition Offer.

GREER COLLEGE

of Automotive Engineering

2060 South Wabash Avenue, CHICAGO, ILL.

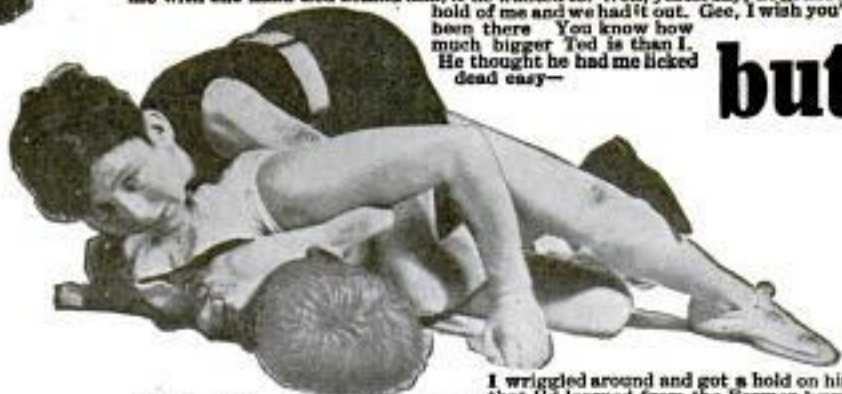
Name.....
Address.....

He thought he could throw me—



Dear Tom: You know how Ted Brown has always been saying he could throw me with one hand tied behind him, if he wanted to. Well, yesterday, he grabbed hold of me and we had it out. Gee, I wish you'd been there. You know how much bigger Ted is than I. He thought he had me licked dead easy—

but



I wriggled around and got a hold on him that I'd learned from the Farmer Burns School of Wrestling. The next second—KERFLOP, and I had Mister Ted Brown on the ground, yelling for me to quit. It's a cinch to handle a fellow half as big again as you are if you know the secret holds. If I were you I'd write to Burns School for their free book about wrestling. So long—FRED.

Learn Wrestling Secrets from Worlds Champions Farmer Burns and Frank Gotch

Learn the marvelous holds, breaks, blocks and tricks that will enable you to handle big, strong men with ease. The renowned FARMER BURNS—"father of scientific wrestling"—and FRANK GOTCH the world's champion, have prepared a series of lessons in which they reveal the inside secrets of training that will make YOU, too, an expert wrestler. All the great secrets of self-defense and jui-jitsu illustrated by printed word and picture. The lessons teach you how to become a great athlete, and secret knowledge enabling you to throw boys and men larger and stronger than yourself.

Farmer Burns School
1777 Railway Exchange Bldg., Omaha, Neb.
Please send me at once, without obligation, your FREE illustrated booklet on Scientific Wrestling, Physical Culture, Self-Defense, and How to Win.

Send for FREE Book



Our FREE ILLUSTRATED BOOK tells you all about the advantages in health, vigor and respect that being able to wrestle brings one. It tells you how to learn to become a skilled wrestler in your spare time. Brim full of interesting information about wrestling. Also lots of pictures. INVESTIGATE. Write today for this free book. No obligations. Tear out and mail coupon NOW!

Farmer Burns School 1777 Railway Exchange Bldg. Omaha, Neb.

Name.....

Address.....

Age.....

I want you to work for me—



I want you to be my salesman and take orders for my fine made-to-measure suits. I don't care if you've never sold before—I'll take you and teach you. I'll show you all about the work and make it so plain and simple you'll be surprised when you see how easy it is, and you'll wonder how I can afford to pay so much.

GET STARTED AT ONCE

Lose no time. If you want to be a Star Salesman, dress in finest style, earn big money at the nicest, easiest work you have ever done. Fill out the coupon and mail it to me quick—right away.

To L. E. ASHER, President

BANNER TAILORING CO., Dept. 950, CHICAGO, ILL.

Dear Sir: Send me your special offer at once.

Name.....

R. F. D..... Box..... St. & No.....

P. O..... State.....

Please Mention Popular Mechanics

LEARN TO GET DOLLARS OUT OF WATCHES. WATCH-REPAIRING, ENGRAVING, JEWELRY REPAIRING.

WRITE NOW. ENICAR TRADE SCHOOL 630 W MONUMENT SQUARE, RACINE, WIS.

Be a Newspaper Artist!



Win Fortune and Fame. MANUEL ROSENBERG COURSE IN NEWS-PAPER ART tells you how. 71 lessons and 150 illustrations. Drawing made easy. Complete instruction in layouts, lettering, illustration, cartooning and sketching. Ten years' experience as staff artist of important American dailies. Send \$5 or pay the postman C. O. D. Only 200 copies left. Order yours TODAY.

MANUEL ROSENBERG Butler Building Cincinnati, O.

Learn Photography at HOME

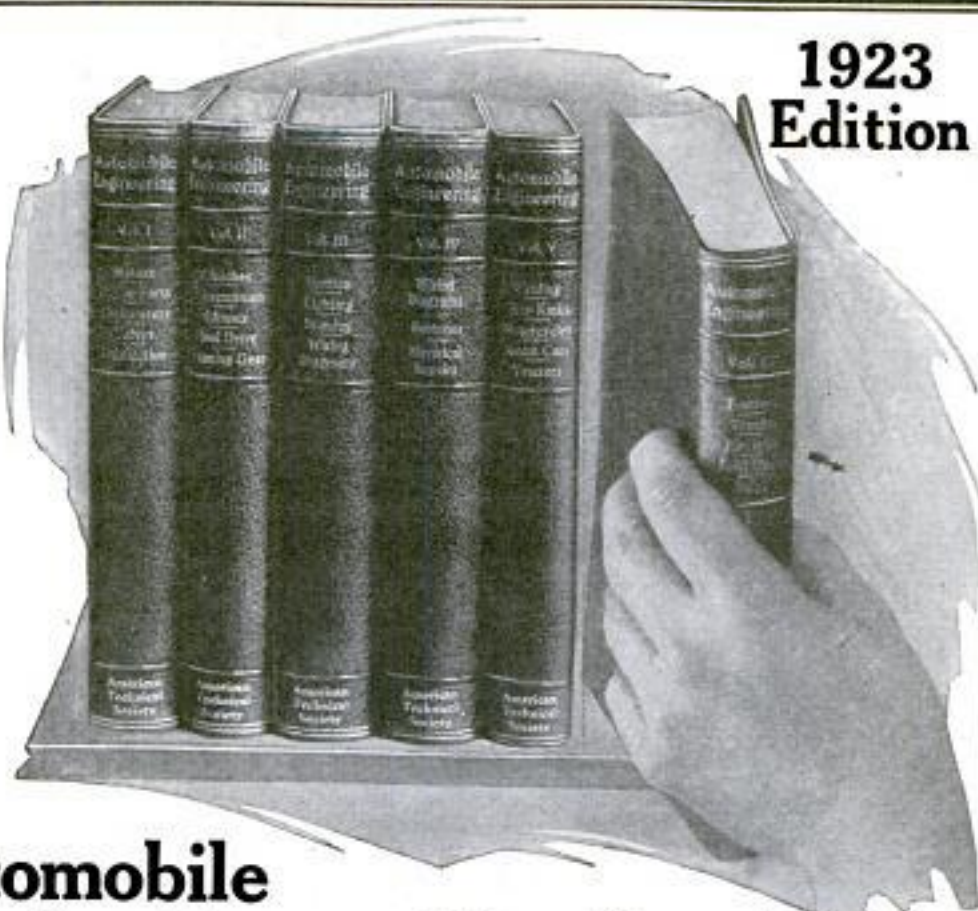
Make \$75.00 a Week on the Side

Establish yourself as a Photographic Expert quickly—during your spare time—under a leading photographer. I'll show you how to start your own business—or command a large salary. Send for my unusual offer—it's only temporary. Act at once. A postal will do. H. R. VANT, INTERNATIONAL STUDIOS, Inc. Dept. 1197, 3601 Michigan Ave., Chicago, U. S. A.



These Books FREE For One Week

Send no money—just fill out the coupon. After you receive the full set of books, express collect, read them over and test them out for seven days. If you don't want them, send them back at our expense. If you decide they will do for you what they have done for more than 100,000 others, pay \$2.80 within one week and \$3 each month thereafter until the special price of \$21.80 is paid. This amounts to only ten cents a day. Mail coupon NOW if you want a bigger, better job at higher wages.



All Automobile Engineering Facts at Your Fingers' Tips

Six Complete New Books for Study or Reference
Also Year's Consulting Membership in
American Technical Society—FREE

Here's the most practical set of books ever written on automobile engineering. Each book is brimful of information about the various phases of this work. 2,600 pages, 2,300 pictures and diagrams, 125 blue prints on every subject. Practical problems are solved in everyday language. They make automobile engineering as plain as day. Completely cross indexed for ready reference.

Know All About Automobiles and Earn Big Pay

These are just the books for the man who wants to know all about automobiles and fit himself for a big-paying job. They are interesting from start to finish and crammed with information. A little regular reading in them during spare hours will soon equip you for

FREE Consulting Membership

A resident consulting staff of 18 practical experts is waiting to solve for you any auto, tractor or motorcycle troubles that you may have. A letter or a wire to the American Technical Society will bring you an immediate answer and the solution to your problems. This advisory staff of practical automobile men plus your library of Automobile Engineering will enable you to handle successfully any auto job. These men know all the latest methods and the newest and best ways of doing things. Let this pay-raising consulting staff be YOUR SILENT PARTNER. Use this service daily if necessary.

This free consulting membership offer is good for a limited time only and can be withdrawn without notice.

American Technical Society
Dept. A-719 Chicago, U. S. A.

the automobile business. Then after you get into the auto game, you'll still have them for reference.

Let These Books Solve Your Daily Problems

To the man now engaged as a mechanic or shop foreman, these books will give a world of help. They dig deep into the technical angles and theories and explain them in everyday words. If you have trouble on any point, you'll find the answer in these books. They are the work of fifteen auto experts who know from experience, the problems and difficulties of the shopman.

Repair Your Own Car

The car-owner will find these books extremely valuable as an aid in repairing his own car. Think of the heavy repair bills this will eliminate. Think of the money you can save.

© A.T.S. 1923

AMERICAN TECHNICAL SOCIETY, Dept. A-719
Chicago, U. S. A.

Please send me a set of Automobile Engineering, for seven days' FREE EXAMINATION, shipping charges collect. I will examine these books thoroughly, and if satisfied, will send \$2.80 within seven days and \$3 a month until I have paid the special price of \$21.80. If I decide not to keep the books, I will return them within one week at your expense. It is understood that if I keep the books I am entitled to a FREE Consulting Membership in the Automotive Division of the Society.

Name.....

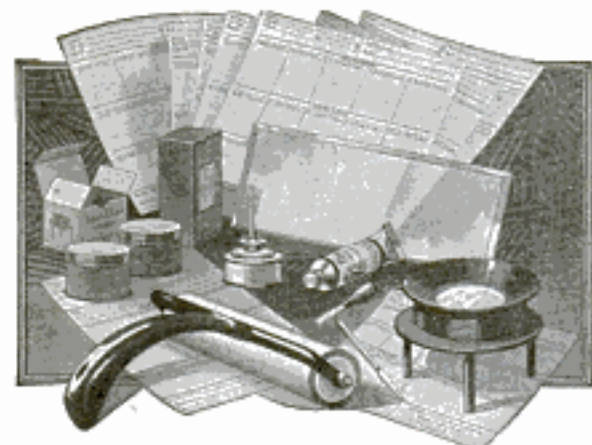
Address.....

Reference.....

(Please fill out all lines, give local merchant, banker or employer as reference.)

FREE

Finger Print Outfit



Yes, I will give you this complete Finger Print outfit absolutely free. It is the regular expert's working outfit—the same kind that I use myself. I am making this offer to those who enroll right now. Start today and get this outfit absolutely free.

Be a Finger Print Expert Learn at Home — 30 Minutes a Day

Only 30 minutes a day for a few months—that is all the time necessary. I am a Finger Print Expert and I know what is required. I will give you just the training that you need to be an expert yourself. You need not give up your present occupation while you are studying this fascinating work. But get started in this big paying profession.

More Men Needed Right Now!

The Professional Finger Print Expert is always in demand. I have so many positions waiting to be filled right now that I am guaranteeing to place every man as soon as he has finished my course. And I am backing this remarkable offer with \$1,000 bank guarantee, deposited with the Phillips State Bank of Chicago. Let me make you a Finger Print Expert and start you in a big paying permanent position.

WRITE today! I will send you full information about this fascinating big paying profession. Get started! The big opportunity you have been waiting for is here. Send the coupon and learn all about it.

U. S. SCHOOL OF FINGER PRINTS
Room 13-57, 7003 No. Clark Street, CHICAGO, ILL.

U. S. School of Finger Prints,
7003 No. Clark St., Room 13-57, Chicago, Ill.

Dear Sir: Send me at once, without obligation, complete information about your Guaranteed-Position offer, Free Finger Print outfit offer, and tell me how I can become a Finger Print Expert.

Name

Address

Age

**I Guarantee
to place You
in a Position**

Serious Shortage of Auto Mechanics

**Positions Now Waiting—Special Terms
on Training—Free Railroad Fare
Allowed—Write Today**



"I can train any man, young or old, who will apply himself, in a few weeks' time, to fill one of these steady positions at big pay now waiting right in his own community." This statement comes from Henry Rahe, President of the Rahe Auto and Tractor School, Kansas City, Mo. Few of us realize, according to Mr. Rahe, what a serious shortage of trained mechanics has been brought about by the rapid yearly increase of Automobiles, Trucks and Tractors.

To help overcome this condition, Mr. Rahe is offering not only special terms on a complete course of six to eight weeks' training at his big School in Kansas City, Mo., but will allow your railroad fare to Kansas City for training. This offer is all the more remarkable from the fact that during the past fifteen years Mr. Rahe has successfully trained more than 40,000 Auto and Tractor Mechanics. Right today you will find Rahe-Trained men are owners of garages or leading mechanics in practically every town and community from coast to coast.

If you want one of these steady jobs now waiting, write today to Henry J. Rahe, President of the Rahe Auto and Tractor School, Dept. 1755, Kansas City, Mo., for full particulars and Free Carfare Offer. You will also receive a copy of his students' paper, the Pictorial School News, showing the vast equipment used in training, and describing the many opportunities now existing in all branches of the Auto and Tractor business. No colored applications. Write today as this Special Offer is being made for a limited time only.

WHY PAY FOR COAL?



HEAT AT TWIST OF WRIST!

Burn free air in your present heater, range or furnace. Remarkable new device—NU-HEAT—causes one part coal oil (kerosene) to turn TWENTY TIMES its bulk of free air into intense gas for heating, cooking and baking. Installed in a jiffy. Heat at twist of wrist. Heats largest rooms in few minutes. No dirt,

ashes, or coal and wood drudgery. Better, cheaper, quicker. Absolutely safe. Ironclad guarantee. 30 days' free trial. Send post card for Free information. Mention if you have heater, range or furnace.

WADE HILL MFG. COMPANY
Dept. X40 ST. LOUIS, MO.

AGENTS

Make \$50 to \$200 a week. Full or spare time. Personal cooperation. Write quick for exclusive territory and free sample case offer.

FOUR CONGOLEUM RUGS

LESS than the price of ONE



Pattern No. 534 is shown above

3 RUGS FREE

This is Pattern 408

TRIPLE GUARANTEE—There is only one guaranteed Congoleum, identified by the Gold Seal above. It protects you against dissatisfaction and gives you an unconditional money-back guarantee. Behind the Gold Seal Guarantee is our own Double Bond.

Choice of Two Famous Patterns— 3 Rugs Free—Year to Pay

We show above two of the most popular Congoleum patterns that have ever been produced. One dollar pinned to the coupon below brings you either pattern on approval. One 9 foot by 12 foot rug and three small rugs to match, each small rug 18x36 inches.

Be sure to ask for our Free Book of 10,000 Furniture Bargains—anyway!

Pattern No. 534 This is the Oriental Gold Seal Congoleum Art Rug shown at the top of the page. On the floor, it looks unbelievably like an expensive pile fabric. The richest blue color dominates the ground work. Mellow ecru old ivories, and light tans, set off the blue field. Mingled with these lovely tints are peacock blue, robin's egg blue and darker tones. Old rose, tiny specks of lighter pink and dark mulberry are artistically placed. Darker browns and even blacks, subdued to faintness, lend dignity and richness.

The border background contrasts with the blue all over center by reversing the color scheme. Ecru and tan shades form the border background. In this rug you have all the advantages of design and coloring, of cheerful warmth and lovely color effects so much sought after in high grade pile fabrics. An ideal all purpose rug, beautiful in any room. Perfect for living room or parlor. Lovely in bedroom or dining room. Charming in the kitchen.

No. E4C534 9 ft. x 12 ft. Congoleum Gold Seal Rug with 3 small rugs to match, each 18 x 36 inches—all four only \$17.95

Tile Pattern No. 408 Probably no floor covering of any quality or kind, ever piled up the popularity of this wonderful design. It is a superb tile pattern that looks like mosaic. Lovely robin's egg blue, with shadings of Dutch blue, and a background of soft stone gray, give a matchless effect. This design is particularly suited for the kitchen or dining room.

No. E4C408 9 ft. x 12 ft. Congoleum Gold Seal Rug with 3 small rugs to match, each 18 x 36 inches—all four only \$17.95

10000 Other Furniture Bargains

Our Catalog of 10000 Other Furniture Bargains—Now Ready. A Postal Card Brings It FREE!

Ask for FREE Catalog

Spiegel, May, Stern Co.

1755 W. 35th Street, CHICAGO, ILLINOIS

\$100

Brings All Four Rugs on a Months Free Trial

Ours is the only house in America that can make you such an offer. No one else can bring you a genuine guaranteed Gold Seal Congoleum Rug, in the full 9 ft. by 12 ft. size, with three small rugs extra, and all for less than the regular price of the big rug alone. And on a years credit.

Clip the coupon below. Write your name and address plainly. Say which pattern you want. Pin a dollar bill to it—mail at once.

We will ship immediately, on a months trial, all four Congoleum Rugs—in one complete neat package. No muss, no bother, no trouble to lay. If satisfactory, take a year to pay.

The Greatest of Bargains Pay Almost as You Please

Almost everybody knows the price of the famous Congoleum Gold Seal Art Rugs. They are advertised and sold at the same standard price everywhere. And bear in mind that you don't send us the full amount. Only one dollar now and the rest later—taking a year's time. Look everywhere else first if you wish—stores, catalogs, magazines and newspapers. You'll find no offer like ours.

If you return the rugs, your dollar will be refunded and also all freight costs.

Three Rugs Free

For the heavy wear spots in front of range, sink, kitchen. At thresholds, in the hall, in front of dresser or bed. While this offer lasts, we give three of these small rugs free with each large rug; all four for less than the price of one.

The Rug of Guaranteed Wear

Congoleum Gold Seal Art Rugs are the fastest selling floor covering known. They are rapidly becoming the national floor covering—highly prized in good homes for any and all rooms.

Waterproof. No burlap for water to rot. Surface is hard, smooth and wear-resisting. Does not stain. Not marred or hurt by spilling of hot liquids.

They lay flat from the first moment without fastening. They never curl up or kick up at edges or corners. No need to tack or fasten them down. Dirt cannot accumulate underneath.

Less work. Rid yourself of back-breaking drudgery. Dirt, ashes, grit, dust or mud cannot "grind into." Congoleum Gold Seal Art Rugs. A damp rag or mop keeps it clean and colorings bright. No laborious beating, no sending to cleaners. Absolutely sanitary. All this guaranteed by the famous Gold Seal that means complete satisfaction or your money back.

VERY IMPORTANT We do not offer our bargains or send our free catalog into bigger cities. If you live in a city of 100,000 population or over, we cannot fill your order for this Congoleum Rug Offer or send our free catalog. To everyone else we bring all the advantages of our house freely.

PIN A DOLLAR TO THIS COUPON

Spiegel, May, Stern Co. 1755 W. Thirty-fifth Street, CHICAGO, ILL. I enclose \$1 for the 4 Gold Seal Congoleum Art Rugs—exactly as described—in the pattern selected below, on 30 days free trial. If I return them, you are to refund my \$1, also all transportation costs. Otherwise I will pay \$1.50 monthly until special price of \$17.95 is paid.

I SELECT PATTERN NO. If you wish both patterns write down both numbers, send \$2.00—pay \$3.00 monthly and get all 8 rugs.

Name

Street, R.F.D.

or Box No.

Shipping Point

City State

Also send me your latest FREE Furniture Book.

Get Into This

You Can

Follow in the lead of Bradley, shown on the opposite page, and scores like him who have taken advantage of the amazing money-making possibilities in the automobile, truck and tractor business. Here is a chart of facts—authentic figures which point out the opportunities. If you are ambitious and seeking a money-making opening, here's your chance—a chance to cash in to a degree that will satisfy your highest aims.

Thousands of competent garages, battery shops, auto electrical shops, tire and welding shops are needed now. Trained men can run them.

13,000,000
Automobiles in U.S.

60,000,000
Tires to be repaired.

10,000,000 Batteries,
13,000,000 Ignition
Systems and only
50,000 Garages.

and welding shops are needed now. Trained men can run them.

Learn Autos, Trucks and Tractors in the Heart of the Industry

Without any previous experience—just a liking for mechanics—you can learn the auto business from A to Z in a few weeks at the Michigan State Automobile School—the factory endorsed school in Detroit—the heart of the industry. Then step out, equipped with knowledge and training, to a future of certain, big money making. You have distinctive advantages, learning the business here. It's the fountain head of the automotive industry. You are taught under factory endorsed methods. You learn both theory and practice on latest equipment. You visit the great auto factories—learn their methods first hand—and it all means greater opportunities and more certain success.



Read What Factories Say:

MAXWELL MOTOR SALES CORPORATION AUTOMOBILES DETROIT, MICH.

"We heartily recommend to you the Michigan State Auto School. We consider this one of the best in the country and their instruction will give you a complete education in motor car mechanics. There is an immense demand for properly trained men in this business."



BUICK MOTOR COMPANY

"We believe the MICHIGAN STATE AUTO SCHOOL, Detroit, would best meet your requirements, as its course of technical training is most thorough and complete in every detail."

THE STUDEBAKER CORPORATION OF AMERICA

"We do not know of a better automobile school than the MICHIGAN STATE."



HUDSON MOTOR CAR COMPANY DETROIT, MICH., U.S.A.

"This school is thought very highly of by the automobile men of Detroit, and is considered one of the best equipped and most efficient schools in the country. You will make no mistake in attending the M. S. A. S."

Learn in a Few Weeks—Start Now

A thorough training in Detroit, at the M. S. A. S., is the thing that fattens the pay envelope if you are working for others, or puts more profit in business for yourself. You can take a full Automotive Course, or specialize in any one of its money-making branches; you can be an Auto Electrician; a Tire Expert; a Battery Service Man; a Repair-Man; a Welder; a Machinist; or specialize in motorized farming, with truck, tractor and farm electric-lighting and farm engine training. Classes are always open. You need make no special arrangements—you can start at once—now—and that's the thing to do.

Life Scholarship Your enrollment entitles you to a life membership, with privilege of our service any time you want it. Many students come back to brush up on latest automotive ideas and new equipment. It doesn't cost a penny extra. The position of the M. S. A. S. (The Detroit Auto School) in the heart of this industry, insures most thorough, most practical, systematic training, at a cost so low and terms so easy that any man, anywhere, can afford it.

Earn While You Learn If necessary we can assist students to secure part time work to earn a small amount each week. Or students who wish to take our evening course will be assisted to full time day jobs. Ask for details, and when writing please explain your circumstances fully.

MICHIGAN STATE AUTOMOBILE SCHOOL

310 Auto Bldg.

DETROIT, MICHIGAN

The Factory Endorsed School

Big Money Business

Have Success Like This

Here is Bradley—merely one of thousands of M. S. A. S. students who have achieved success far beyond their fondest hopes. What these men have done you can do. The opportunities are now greater than ever. There are more autos—more trucks—more tractors and every year adds to the money-making possibilities. You have ambition—you want success. Success is certain if you are willing to work for it. You can have independence—be your own boss—stop the plodding and get into work you like. You can earn big money, be prosperous, happy and independent. Bradley is no exception, we have graduates who have made as high as \$10,000 in less than a year. These records may seem amazing, but they are true. It is all done through head and hand training at the M. S. A. S. Decide now to give yourself the training that will pay you big and establish you in a successful life work.

Detroit-Trained Auto Men Earn More Money

Detroit-trained men are preferred. Your diploma from the M. S. A. S. is a valuable money-making asset—an advantage that you can get from no other school. The Michigan State Automobile School is known the world over. Wherever autos are used—Detroit-trained men get the best jobs, highest pay. Auto, truck, tractor factories employ M. S. A. S. graduates. Leading factories, dealers, service stations, garages, shops and farms want men who have trained their heads as well as their hands—the M. S. A. S. Detroit-kind.

Good Positions Open

Right now the demand for men who know automotive mechanics and electricians is greater than the supply. We have more calls than we can fill. The years ahead are predicted to be the biggest years of the industry. Every Detroit plant has increased its production. Most are working over-time. All are behind on orders, and that means certain money-making advantages to men who start in the business now.

Mail This Coupon

Get all the interesting facts from our big catalog. It's a book of information concerning your future that you must not fail to get. It gives complete information about all courses, which makes it easy to decide. It's alive with photos of classes, school, equipment and graduates. It tells you how you can get a good paying job—how you can go into business for yourself with little capital. Let us send it to you FREE without obligation. Mail the coupon or send us a postcard today. Write now.

Michigan State Automobile School
A. G. ZELLER, Pres. and Gen. Mgr.
310 Auto Bldg., 3729 Woodward Avenue
DETROIT, MICHIGAN

**From \$12⁰⁰ a Week
to
\$500⁰⁰
a Month**



Read Bradley's letter below. It's his own story of the credit he gives to M. S. A. S. for his success. The success you can enjoy, too, if you accept this opportunity.

H. S. BRADLEY

BRADLEY GARAGE
CLEVELAND, OHIO
Distributor Vesta Storage Batteries
ALEMITE LUBRICATOR SERVICE
Automobile Repairing

Michigan State Auto School, Detroit, Mich.

Gentlemen: I wish to state that before going to your School I was employed as shipping clerk with a well-known concern at the enormous salary of \$12 per week. Incidentally, this included overtime. I knew absolutely nothing about an automobile. I couldn't even drive one and didn't know the difference between a carburetor and a wheel-base; in fact, I didn't know they had a wheel-base.

After leaving the School I worked as service repairman for the Oakland Motor Company of Pontiac, Michigan. I left the Oakland to accept a position as night service foreman for the Studebaker Company at Detroit and was later connected with such firms as the Northway Motor and Manufacturing Company, and the Continental Motor Manufacturing Company. I have since been service-manager for two large concerns—one in Detroit and one in Cleveland. The salary mounted all the time—the last position paying me \$300 per month.

I, then, decided to go in business for myself, which business I have successfully built and maintained up to the present time and expect to maintain for a long time to come. I estimate the present earnings of my business at \$500 per month clear and growing all the time.

I believe that the M. S. A. S. is by far the best School of its kind in the country. For the man who will apply himself to the work and to the studies I can safely say that the Michigan State Auto School is the best place to learn the automobile business.

Yours very truly,
H. S. BRADLEY.

FREE CATALOG
MICHIGAN STATE
AUTO SCHOOL

Mail Coupon To Day

Michigan State Automobile School 310 Auto Building
DETROIT, MICHIGAN

Send me FREE and without obligation your 100-page catalog and Auto School News, giving complete information about Detroit-training to make the most money.

I am interested in Resident Course at your School.
 Home Study Course.

Name.....

Street or R. F. D.....

City.....State.....

MY 3 NEW INVENTIONS

Will Enable
You to
Quickly Learn

VIOLIN

You have always longed to play the sweetest of all music—the Violin. Now with the aid of my 3 new inventions—master of the Violin is easily within your reach! My system of teaching by written and pictured instructions is far advanced over any other method! Endorsed by the foremost violinists of the country! I make it so simple and easy that

You Will Play a Complete Piece Your First Lesson

Just think of it—you play real music at once! No boring scales—no long, dreary hours of practice. Under my instruction you will actually play a complete piece your very first lesson—and a new piece each succeeding lesson.

FREE VIOLIN OUTFIT

Most Complete Violin Outfit Ever Offered—furnished free to my students with the complete Conservatory course of 32 lessons. No extras to buy—everything is furnished. Outfit includes: splendid toned imported Violin, Bow, Extra Stripes, Tuning Pipe, Mute, Rosin, handsome nickel trimmed carrying case exactly as shown, and my 3 remarkable inventions.

Write Me Today

—and I will gladly tell you all about my 3 New Inventions and how you can learn to play the Violin quickly and thoroughly. Here is the opportunity you have waited for so write me **RIGHT NOW**.

Prof. A. Hinchcliffe, First Hawaiian Conservatory of Music, Inc.
Dept. 70 Woolworth Bldg. 233 Broadway, New York

FREE
This \$20.00 Outfit



Become an Expert Wireman PAYS BIG MONEY

Your future is assured if you become a wireman. Be independent, your service will be in constant demand—earn from \$75 to \$100 weekly. Remarkable book of instruction covering every phase of electrical wiring—400 pages. Contains every necessary rule and table. Also elaborate series of illustrations showing construction and wiring of all kinds of inside and outside jobs for both direct and alternating current in conformity with the underwriters' rules. A valuable guide for every home owner. The most complete and accurate book published—20th edition—Limp Leather cover—gilt edges—Pocket size. Sent postpaid for \$2.00.

H. C. CUSHING, Jr., 6 W. 40th St., N. Y. City

FREE FIRST LESSON RECORD

Learn to Play

Violin, Mandolin and Banjo-Mandolin quickly. No embarrassment. You learn to play or pay nothing. Play for money in two months.

Beautiful Instrument FREE

No charge for instrument to one pupil in each locality. Few cents a week pays for lessons. **Write for First Record**—Sent without cost on 1 week's approval with complete details of Personal Instruction Record Course.

SCHNEIDER SCHOOL OF MUSIC
Dept. B-10, 238 Vermont St., Blue Island, Ill. (A suburb of Chicago)



Learn Radio

\$50 to \$200 a Week

No other business offers you such amazing opportunities as this new uncrowded field of Radio. Thousands of trained men are needed. Wonderful salaries are paid for easy, fascinating work.

Become a Radio Expert

We train you at home to design, construct, install, operate, repair and maintain radio equipment, and, upon completion of your course, to help you to the highest paid positions in Radio. **FREE**—Special offer of wonderful vacuum tube receiving set free. Mail postcard or letter for full information.

RADIO TRAINING ASSOCIATION OF AMERICA
Dept. 15-J 1223 Connecticut Ave., N.W., Washington, D. C.

LAW STUDY AT HOME

Become a lawyer. Legally trained men win high positions and big success in business and public life. Greater opportunities now than ever before. Lawyers earn \$3,000 to \$10,000 Annually. We guide you step by step. You can train at home during spare time. Let us send you records and letters from LaSalle students admitted to the bar in various states. Degree of LL. B. conferred. Thousands of successful students enrolled. Low cost, easy terms. We furnish all text material, including fourteen-volume Law Library. Get our valuable 120-page "Law Guide" and "Evidence" books **FREE**. Send for them—**NOW**.

LaSalle Extension University, Dept. 1051-1 Chicago, Ill.

Learn Expert Auto Painting



There is **Big Money** in auto painting and refinishing. Our Home Study Course in Practical Auto Painting will enable you to do the finest work and earn big wages. Wonderful opportunity for new money-making business of your own

FREE circular tells all about this big new business. Be first. Write quick.

CHICAGO COLLEGE OF AUTO PAINTING

Dept. 303 140 S. Dearborn St., CHICAGO, U.S.A.

BE A PIANO TECHNICIAN



Our Tune-a-Phone Guides You to Success

Tuning, Voicing, Regulating, Finishing and General Care of Pianos Taught in ONE Complete Course. 25 years of successful Correspondence instruction makes our guarantee worth while. Knowledge of music NOT necessary. Write for **FREE BOOKLET** and the plan that saves you all risk in testing our method of teaching.

NILES BRYANT SCHOOL, 74 Bryant Bldg., Augusta, Mich.

We Pay Your Railroad Fare to Washington, D. C. and 8 Weeks' Board and Room

In 8 weeks we graduate you a first class **AUTOMOBILE MECHANIC**, and help you get your first job. One of our recent pupils makes \$250 to \$400 monthly. Another made \$3,200 4½ months after graduating.

AMERICAN MOTOR SCHOOLS
WASHINGTON, D. C.



WANTED MEN AND WOMEN TO LEARN PHOTOGRAPHY!

Photographers and Photo-Engravers earn \$200 to \$500 a month. The field is uncrowded. Learn these profitable and fascinating professions. Taught by largest and best college of its kind in the world. Established over 30 years. Demand for our graduates far exceeds supply. Good positions secured. Tuition and living expenses low.

Get this FREE Book! Write today for free beautifully illustrated book describing wonderful opportunities in this field.

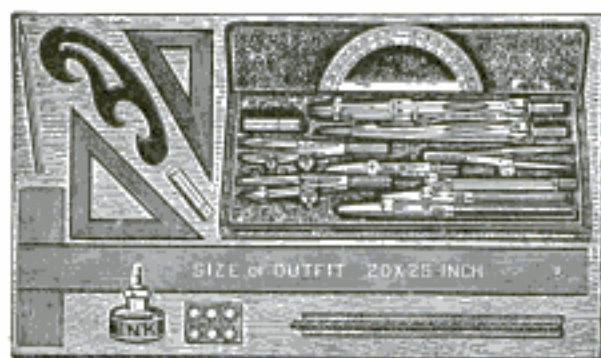
Illinois College of Photography, Box 4103, Effingham, Ill.



Drawing Table -FREE!

I am giving this practical folding Chief's Own drawing table to each of my students positively without cost. I am making this offer to get men everywhere interested in the great future which a draftsman has. More draftsmen are in demand to-day—right now—than ever before. It has been estimated that there are 6,000 calls for draftsmen every month. So, I want students to enroll early. As I train all students personally in the practical work of the drafting room, I cannot, will not and do not take everybody. I select my students.

Send the free coupon below and find out how and why I give this drafting table without cost to my students.



Drawing Outfit - FREE

Here is a regular drawing outfit for the draftsman and designer which I am presenting to each of my students who enrolls before this offer is withdrawn. In this outfit is every instrument necessary to the skilled draftsman. All of the drawing instruments are nickel-plated and the rules and all other materials are of the finest quality. I am making this offer because all men who want to become draftsmen, working under fine, clean conditions, and with opportunities for fast advancement, should enroll at this time. They should not wait.



Pocket Rule FREE!

To everyone who writes now for the offers which I am making, I will send this Ivoryine pocket rule free. All you need tell me is that you are more than 16 years old and that you are interested in becoming a draftsman. I want you to have this constant reminder of the great future which will be in store for you if you become a draftsman.

\$90 Drafting Course FREE

In addition to all of my other offers, I have also made arrangements whereby you may get a regular \$90 Drafting course entirely free. I have determined to do all I can in preparing draftsmen for the thousands of calls which are being made for them by offering every inducement possible to ambitious men anxious to succeed in a big way.

Salaries Up To \$250 and \$300 a Month

I guarantee to train you in my personal, practical work until you are placed in a position earning \$250 to \$300 a month. This is a positive, actual guarantee.

Get My Book of FREE Offers

Send coupon at once for my book, "Successful Draftsmanship." I will send it prepaid. I will also send you a list of the free offers which I am making to my drafting students now. Send this coupon, postcard or letter, at once.

Chief Draftsman Engineer's Equipment Co.,
1951 Lawrence Ave. Div. 93-57 Chicago, Ill.

Chief Draftsman, Engineers Equipment Co.
1951 Lawrence Ave., Div. 93-57 Chicago, Ill.

Without any obligation, whatever, please mail your book, "Successful Draftsmanship", and full particulars of your liberal "Personal Instruction" offer to few students.

Name _____

Address _____

Age _____

Amazing and Supreme Life and Health Absolutely FREE

**The Newest, Surest and Easiest Way
to Regeneration and Supremacy**

*A Novel, Original, Unique, Startling, Sensational
and Marvelous Method of Regeneration*

**A Revolutionary, Natural, and Ultimate Law that
Requires No Change in Your Habits, Morals,
Religion, Faith, Ways, Attitudes or Beliefs.
Requires No Charms, Images, Symbols,
Phrases, or Action of Any Kind**

By JUNGARY RUSS



THIS extraordinary and Universal Law does not require you to buy anything, or to actively do anything or give up anything. It requires no exercise, nor time, nor conscious deep breathing—no stretching, dieting, drugs nor medicines.

This natural and supreme Law—must not be confounded with hypnotism, auto-suggestion, psychology, spiritual science, psychic science, mental science, nor with electricity, osteopathy or any other method—mental or physical—ever devised in the past.

No self-hypnotizing phrases or formulas to repeat—no yielding, no recession, no giving up of anything, nothing to study, nothing to actively practice, no lessons to read, no books to buy, nothing to memorize, no self-deception—nothing but truth—reality—Natural Law.

A Marvelous, Mystifying Power of Nature Absolutely Free

Perfect health cures every known and conceivable disease. This Natural Law is guaranteed to give perfect health.

Death Eliminates the "Unfit" to Live

Thousands of human beings die of various so-called diseases, but, all of these die of but one disease—unfitness to live.

Regardless of What Be Your Ailment, It Is But the Effect of Unfitness to Live—Deficient Power of Life and Health

There are twenty-five thousand quadrillions of units—living beings—in each human body. This Amazing Natural Law, when used, makes every one of these units more highly alive, more vital, more powerful, more efficient and thus more able to ren-

der the highest type of service unto self, as well as unto the entire organism. Each human being is only as alive as these units are alive, no more—no less.

This Marvelous Natural Law is pleasant and agreeable. Through it, you positively put yourself in harmony with the forces of Life and thus, you cause them to cure for you, heal for you, work for you, function for you and manifest power and supremacy for you. It makes the Creative Principle of life your servant and you the Master of your health, life, conditions and destiny.

Through this startling Natural Law anyone can rid self permanently, of nervousness, weakness, congestion, indigestion, rheumatism, constipation, tuberculosis, catarrh, nervous exhaustion and every weakness of male and female.

This unique Natural Law gives immunity from every disease of the inferior life—colds, tuberculosis, pneumonia, nervous prostration, auto-intoxication, biliousness, sour stomach, acidity, asthma, malnutrition, anemia, sleeplessness, morbidness and impotency.

This sensational Natural Law produces new and superior arteries, new and superior veins, new and superior heart, new and superior lungs, new and superior glands, new and superior organs, new and superior cells, and a new and superior organism and powers of every kind.

This revolutionary Natural Law contains no disadvantages—it has no drawbacks. Remember it requires no time, no exercise, no dieting, no drugging, no believing, no changing—nothing but advantages and gratification through and through. It superiorizes health and life—the results are immediate—anyone can use it.

I prophesy that this mysterious Natural Law will drive every disease weakness and delusion entirely from the human race.

I am positive it is destined to banish weakness

and delusion from the human race by making supreme health and supreme reality inevitable.

Through this rejuvenating **Natural Law** any one may have the health and vitality of a lion or a tiger, without the inconvenience of being a wild animal, compelled to live in a wild state of Nature, with all of the inconveniences—the natural law that keeps a lion and a tiger vital and well is now yours, free, to use.

Tigers and lions living in a wild state of Nature do not look out for their health—this Natural Law looks out for their health. They do not run from one doctor to another or take pills and powders and try out remedies. They put the responsibility for their health on this Natural Law—you may do the same through this unique Natural Law.

It is no longer necessary for anyone to spend money for treatments and doctors and drugs and dieting and books and systems and lessons and cures and pills and devices, because perfect and supreme health and life are absolutely free through this health-producing Natural Law.

Why be weak, why be ill, why be fat, why be thin, when you may, absolutely free, become in every way, perfect and supreme through this sensational Natural Law?

This startling **Natural Law** yields amazing nerve force, amazing energy, amazing vitality and extraordinary power of every character of mind and body—a new and superior life.

Through this wonderful Natural Law you may have all of the benefits of exercise, without exercise or its disadvantages; all of the benefits of conscious deep breathing with none of the disadvantages; the full and complete benefit of every vitamin and organic iron without drugs or dieting; all of the benefits of medicine and drugs with none of the

disadvantages of medicine and drugs; all of the benefits of auto-suggestion, hypnotism and psychology, without the disadvantages of auto-suggestion, hypnotism and psychology; all of the benefits of dieting and every other kind of treatment, device or assistance, with none of the disadvantages.

This marvelous **Natural Law** will banish high blood pressure, hardening of the arteries, "old age," nerve-exhaustion and tuberculosis from the human race.

Perfect health prevents all disease of an infectious and contagious character—all of the diseases that thrive in inferior organisms. Every disease fails when it attacks an organism fully fortified by this vitality-producing Natural Law.

This creative Natural Law can so energize, vitalize and vivify every one of the twenty-five thousand quadrillions of living beings or units in your body, as to make ill health absolutely impossible, and, at the same time, giving you a new meaning for life, health, power and gratification.

There exists in every living being or thing, a creative, curative, healing, thinking, knowing and acting Force. This force acts only in terms of reactions. This dominant Natural Law arouses within it, the highest type of reactions—all of this without waste of time or any active effort or exercise of any character.

This demonstrable Natural Law energizes, vitalizes and enlivens every one of the living units in the human body. Through this Law you actually harness the creative and living power of the creative force of life. You attain results accordingly as you demand.

It has been discovered that every quality and power and process and function of mind and body arises out of, and springs from, one source. The Law through which this "source" is harnessed and capitalized without effort has also been discovered.

This secret is offered to you absolutely free. There are no "conditions" or "strings" attached to this offer.

This astonishing Natural Law is most marvelous, most simple, most subtle, and most powerful. It is the Law of creative power.

Remember there is nothing to buy, nothing active to do, nothing to study, nothing to believe, no time to waste, no habits to give up, nothing to lose—there is no mystery—it is merely a Natural Law.

• If you are not enjoying life to the full—if you are in any way handicapped—if you are not in possession of all of the powers of mind and body in the highest degree, you owe it to yourself to at once procure for yourself, free of charge, this surprising Natural Law.

Remember that demonstration and results are immediate.

If you wish to feel newly alive, newly vital, newly ambitious, newly and supremely well, send your name today.

This powerful Natural Law creates perfect health just as heat converts rigid ice into yielding water.

It is a perfectly natural phenomenon—demonstrably true, yet so marvelously simple, as to be almost unbelievable.

It transforms the gloom of disease into the bloom of health, as the rays of the spring sun transform the dead soil into a "sea" of luxuriant vegetation. It is destined to revolutionize human health and happiness—Humanity.

Any one—male or female—above fifteen years of age is eligible to receive this marvelous secret, absolutely free.

SPECIAL NOTE: When you receive this supremely Natural Law, it will be the principle itself—not merely information about it or how to ultimately get it—you will possess it—there is nothing for you to buy. Are you fit or unfit to live? Test yourself by this Natural Law of Supreme Life and Health. Swoboda has priceless secrets for every human being who wishes to be happier, healthier, more vital and successful in a new degree.

**Alois P. Swoboda, 1157 Berkeley Bldg.,
21 West 44th Street, New York City**

I am ready to receive free, the Swoboda Natural Law of Supreme Life and Health.

To help cover cost of publishing and mailing, I enclose postage. (Not more than ten cents, please.)

My age is.....

Name.....
(Write plainly)

Address.....

A Few Representative People Who Are Profiting Through the Swoboda Principles

Senator R. L. Owen, Woodrow Wilson, Wm. H. Anderson, F. W. Vanderbilt, William Barnes, Gen. W. F. Knobbe, Howard Gould, W. R. Hearst, Alfred I. duPont, P. F. duPont, Percy A. Rockefeller, Otto H. Kahn, Charles F. Swift, E. A. Cudahy, Oscar Strauss, Simon Guggenheim, A. Lewinsohn, Mrs. C. P. Huntington, Mrs. Archer M. Huntington, Countess de Louquenille, Mrs. Hermann Oelrichs, Maxine Elliott, Mr. H. C. Chatfield Taylor, Clarence Buckingham, Cyrus Curtis, Daniel Willard, Charles E. Hughes, W. P. Clyde, Francis Wilson, F. L. Perley, Henry L. Doherty, Frank A. Vanderbilt, Pilsny Flak, Sam Sloan, Edward Lauterbach, J. R. Roosevelt, R. Fulton Cutting, Samuel W. McCall, W. Lyman Riddle, Edward Thaw, G. Schwab, Elihu Root Jr., Coldwell K. Biddle, Stanley Washburn, W. M. K. Olcott, James H. Post, Theodore Starritt, George A. Post, Burton Holmes, Dr. Lucius Roberts, Dr. J. H. Jolliffe, D. H. S. Robinson, D. B. Ashmore Capehart, Dr. Robert S. Ivy, Dr. Lewis M. Reichard, Dr. George R. Harris, Dr. Martin L. Holbrook, Dr. F. O. Cobb, Dr. R. E. Wyatt, Dr. William S. Eisenhart, Dr. John Cutler Shedd, Dr. Julian H. Clark, Dr. H. W. Sheldon, Dr. W. A. VanNorden, Dr. J. W. Robinson, Dr. J. Murphy, Dr. G. D. Morgan, Dr. Hal Van Doren, Dr. G. R. Clark, Dr. J. H. McCullough, Dr. J. W. Van Doorn, Dr. E. W. McWilliams, Dr. F. W. Montfort, Dr. B. R. Marsden, Dr. L. G. McAloney, Dr. C. B. Roberts, Dr. William McCracken, Dr. S. M. Kyles, Dr. Herbert McConathy, Dr. Claude P. Jones, Dr. Charles W. Demong, Dr. Walter Duke, Dr. John C. Champion, Dr. Fred W. Delmage, Dr. R. E. Birsons, Dr. S. G. Burkholder, Dr. F. K. Hollister, Dr. R. B. Brundage, Dr. Carl R. Meloy, Dr. T. C. Rivera, Dr. E. Reed Whittemore, Dr. T. A. Hughes, Dr. J. R. Wright, Dr. W. L. Adams, Dr. Alonzo Andrews, Dr. W. W. Alderdyce, Dr. F. W. Baker, Dr. G. E. Gardner, Dr. W. C. Abbott, Dr. L. L. Archinard, Dr. J. Stow Ballard, Dr. W. P. Armstrong, Dr. Gaspard Long, Dr. C. W. Hughes, Dr. Edwin H. Allen, Dr. A. L. Amann, Dr. M. Eugene Street, Dr. H. W. Adams, Dr. Walter R. Ashe, Dr. Charles Gardner, Dr. W. J. Andrews, Dr. E. W. Baker, Dr. A. L. Stansbury, Dr. DeLancey B. Armstrong, Dr. L. P. Allen, Dr. William H. Harrison, Jr., Dr. H. B. Van Dorn, Wm. G. McAdoo, et al.

What Do You Call an Opportunity?

IN my lifetime I have heard many men speak of opportunity. I have read some very fine definitions of this wonder-word. It has been the subject of many splendid speeches; authors have written abundantly about it in prose and poetry.

You have said, "I wish I had an opportunity."

But I am wondering what you call an opportunity.

Do you—as so many do—mistakenly associate it with "good fortune" or "good luck"?

Suppose tomorrow you heard of a \$10,000 position seeking a man. Could you fill it? If so, it would be an opportunity. If not, it would be no opportunity at all so far as you are concerned. It would be merely a bit of information from which you could not benefit.

Opportunity, I believe, is usually a recognition of worth.

The biggest opportunity that can ever come to you will never be any bigger than your preparation—your worth-whileness.

If you are not worth considering, Opportunity won't give you a thought.

The biggest job of all the big jobs open and

filled in the last twenty-four hours would have been an opportunity for you—

—if you had been prepared.

And I am not one who believes that Opportunity knocks but once.

The hundreds of opportunities which are here to-day will come again to-morrow—

—if you are prepared.

But you can be sure they will never be found on the door-steps of worthless prospects—men who are not ready.

Opportunity seeks and finds only those who have paid the price of preparation. She does not pick men as

you pick a number from a lottery; neither does she cover up what she has to offer. Her gifts are an open book—yours from which to choose.

Pick the thing you want, and get ready for it. Opportunities do not come except as you attract them. LaSalle training offers a sure way to increase your powers of attraction.

Just bear in mind that the biggest opportunity that can ever come to you will never be greater than your preparation.

J. M. Sullivan
President LaSalle Extension University
of Chicago, Illinois

HOME-STUDY COURSES

THAT LEAD TO BUSINESS CAREERS

LaSalle Extension University

The Largest Business Training Institution in the World

—INQUIRY COUPON—

LA SALLE EXTENSION UNIVERSITY Dept. 1064-R CHICAGO, ILLINOIS

Please send me catalog and full information regarding the course and service I have marked with an X below. Also a copy of your booklet, "Ten Years' Promotion in One," all without obligation to me.

- | | | |
|--|--|---|
| <input type="checkbox"/> Business Management: Training for Official, Managerial, Sales and Executive positions. | <input type="checkbox"/> Railway Station Management: Training for Railway Auditors, Comptrollers, Accountants, Clerks, Station Agents, Members of Railway and Public Utilities Commissions, etc. | <input type="checkbox"/> Modern Foremanship and Production Methods: Training in the direction and handling of industrial forces—for Executives, Managers, Superintendents, Contractors, Foremen, Sub-foremen, etc. |
| <input type="checkbox"/> Modern Salesmanship: Training for Sales and Advertising Executives, Solicitors, Sales Promotion Managers, Salesmen, Manufacturers' Agents and all those engaged in retail, wholesale or specialty selling. | <input type="checkbox"/> Industrial Management Efficiency: For Executives, Managers, Office and Shop Employees and those desiring practical training in industrial management principles and practice. | <input type="checkbox"/> Personnel and Employment Management: Training for Employers, Employment Managers, Executives, Industrial Engineers. |
| <input type="checkbox"/> Higher Accountancy: Training for positions as Auditor, Comptroller, Certified Public Accountant, Cost Accountant, etc. | <input type="checkbox"/> Modern Business Correspondence and Practice: Training for Sales and Collection Correspondents; Sales Promotion Managers; Credit and Office Managers; Correspondence Supervisors, Secretaries, etc. | <input type="checkbox"/> C. P. A. Coaching for Advanced Accountants. |
| <input type="checkbox"/> Traffic Management—Foreign and Domestic: Training for positions as Railroad or Industrial Traffic Manager, etc. | <input type="checkbox"/> Banking and Finance. | <input type="checkbox"/> Commercial Law. |
| <input type="checkbox"/> Law: Training for Bar; LL. B. Degree. | | <input type="checkbox"/> Expert Bookkeeping. |
| | | <input type="checkbox"/> Business English. |
| | | <input type="checkbox"/> Commercial Spanish. |
| | | <input type="checkbox"/> Effective Speaking. |

Name..... Present Position..... Address.....

C. J. Buckwalter, President, the man behind the remarkable instruction which has astonished the teaching profession and which offers wide-awake men a 50-day short-cut to big earnings.



1933 SEPTEMBER 1933						
SUN	MON	TUE	WED	THU	FRI	SAT
						1
2	3	4	5	6	7	8
9	10	11	12	13	14	15
16	17	18	19	20	21	22
23	24	25	26	27	28	29

1933 OCTOBER 1933						
SUN	MON	TUE	WED	THU	FRI	SAT
			1	2	3	4
5	6	7	8	9	10	11
12	13	14	15	16	17	18
19	20	21	22	23	24	25
26	27	28	29	30	31	

50 days - then \$132 a week

In New Automotive Electrical Business

The shortest road to big earnings ever known. Scarcity of experts makes positions certain and pay high. A remarkable new system of training enables you to earn \$132 a week in less than two months. And we can prove it. Get my free book.

THINK of it! Only 50 days training puts you in a position to earn \$132.00 a week! All because there is an enormous demand for Automotive Electrical Experts and there are far from enough. Employers are ready to snap up our graduates at once. Our free employment service helps you to get the very "pick" of such positions. See facts and figures in my free book.

Experience Not Necessary

You don't need to know about Automobiles or Electricity at the start. Nor do you need any more education than the ability to read simple English. We give you all the knowledge you need—teach you completely—in 50 days. My book explains everything free.

Amazing New Way to Train

When the government needed Auto-Electrical Experts for the war there was no time to waste. Men had to be trained 100% right and sent out almost overnight. The man who invented the 50 day method was the man to whom Uncle Sam went for help. Results were amazing. Never before had such a thing been accomplished by anyone. A complete practical thorough training in 50 days. So remarkable that after the war and at a great cost it was made available to Ambu students only. Ambu has even improved on the original plan by not admitting more than 20 men to a class. No other school does this and the smaller the class the more you learn.

Get Out of the Grease

All my graduates are masters of their profession. And they are so enthusiastic over the way in which they've stepped from their former poor-pay jobs into this delightful, big-pay profession that I am glad to have you write them. I'll give you their names. They will tell you how fine it is to get out of the grease into big money.

Unusual Short Time Offer

I have a most remarkable offer to make for a short time to those who send for my free book at once. It will be a revelation to you. So be sure to mail the coupon at once, while this offer is in force. Write me personally.

C. J. BUCKWALTER, President

AMBU ENGINEERING INSTITUTE
Dept. 110 2632 Prairie Avenue, CHICAGO

BIG JOBS OPEN FOR AMBU MEN

78% of all auto troubles occur in the electrical system—battery timing, wiring, etc. And the ordinary automobile mechanics will fiddle around for 10 hours without discovering a trouble which an Ambu man will locate and repair in 15 minutes. No wonder Automotive Electrical Experts are in such big demand and the pay is so large.



Makes 4 Times His Former Salary
"I was making \$40 a week as Head Bookkeeper when I took up your training. Last week I made \$175, including overtime, and hardly a week passes in which I don't make about \$100. No hard work either—I locate the trouble and make the mechanics do the hard work."
Henry L. Ludlow, Ind."

Makes \$1,000 a Month

"I trained with you people 7 weeks, if you remember, then started right to work with big garage. Averaged about \$150 a week. After 8 weeks of this I opened a shop of my own. Sell a few batteries but make my big money on electrical repairs. Find it easy to get any price I charge. Clearing over \$1,000 a month."
M. J. Ellard, Can."



Come to Chicago or Stay At Home

For those who cannot come to Chicago I have prepared a home study course. Makes you as proficient as a resident course at Chicago. So easy a child can master. Learn in spare hours. Positively fascinating. Personal coaching given by mail by the instructor to whom we assign you. Hundreds of our graduates are "home study" men and they are just as expert and their earnings are as large as those who trained in Chicago.

FREE BOOK Explains all about this new field. Shows why there is such a big demand for Automotive Electricians and why the pay is so large. Tells what our graduates are making and reprints copies of their own grateful letters. Shows how you get paid for your head work rather than handwork. And how you can do the directing while others perform the labor, and handle the dirt and grease. Get this remarkable book at once.



C. J. Buckwalter, Pres., Ambu Engineering Institute,
Dept. 110, 2632 Prairie Ave., Chicago, Illinois

Please send me FREE Book and complete information about the big-pay uncrowded field of Automotive Electricity. Explain also your remarkable short time offer. I am interested in
 Home Study Course
 Resident Course at Chicago

Name

Address

City..... State



Adventurers Courted Death at Hands of Fanatic Worshippers and Ill-Fortune, Said to Follow Those Who Desecrated Sacred Temple to Steal Blazing Gems from Foreheads of Idols—See Page 501

Popular Mechanics Magazine

REGISTERED IN U. S. PATENT OFFICE

WRITTEN SO YOU CAN UNDERSTAND IT

Vol. 40

OCTOBER, 1923

No. 4



View of Fifth Avenue in New York, Taken in 1923

Horses Increasing in Numbers Despite Automobiles

WITH more than 13,000,000 automobiles now in use throughout the country, a recent census has shown that the horse, instead of becoming a museum curiosity, has increased greatly in numbers.

Better horses, and more of them, it is reported, are being bred now than at any time during the past quarter of a century, a gain in numbers of 2,750,000 being shown in the 25 years since motorized vehicles began to appear.

While more horses than ever before are being used on farms, they are gradually disappearing from city streets, many municipalities having laws forbidding their use on certain thoroughfares and in congested districts, in order to expedite the flow of traffic.

With the change, new problems in city planning have arisen. As the speed of transportation increases, square street corners are being changed to long, sweeping curves. It has been found by experience that the short turns slow up, while the long ones hasten, traffic. Fronts of buildings also have been cut away, the

sidewalks being placed under the overhanging second stories to permit the widening of the streets.

Another problem has been the growing number of accidents. Approximately 14,000 persons were killed by motor cars last year, it is estimated. Based on figures, furnished by surveys of 60 cities with populations numbering 25,000 and over, during the past eight years, the following table has been prepared:

Year	Deaths per 10,000 Cars	Total Deaths
1915	24.0	5,800
1916	20.8	7,300
1917	18.2	9,000
1918	15.5	9,300
1919	13.0	9,700
1920	12.0	11,000
1921	11.9	12,500
1922	11.6	14,000

To meet these conditions, double-decked streets have been proposed in New York and Chicago. Subways and great underground parking spaces also are seen as a means to relieve the crowding. One-way streets already are in use in many cities with good results.

Crit. Norman C. Mc Loud
1717 St. Paul St.
Baltimore, Md.

401

Copyrighted material

In a letter to Popular Mechanics Magazine, D. J. O'Brien, chief of police of San Francisco, says that the traffic problem must be met by opening up other avenues, as he declares, "we have reached a stage in our city life where it appears that regulations, from a police standpoint, are no longer effective to cope with the increasing automobile traffic."

California leads all other states in the number of its automobiles per capita, having a car to every 4.9 inhabitants. After pointing to this fact, Chief O'Brien suggests the following relief measures: One-way streets; subways under principal thoroughfares; changing

streets paved with cobblestones to bituminous surfaces; reduction of the width of sidewalks to allow more space for vehicular traffic; establishment of new roadways, and the building of underground parking spaces beneath skyscrapers and in public parks and squares.

Similar plans have been advocated by other traffic experts and some of them already have been put into effect in several of the larger cities throughout the country.



Horse-Drawn Cabs Filling Thoroughfare in New York City in 1900 Before They were Crowded Off the Streets by the Growing Popularity of the Automobile

3/199
PECULIAR, MISSOURI, GOT ITS NAME IN PECULIAR FASHION

Connected with the naming of Peculiar, Mo., is a queer story. This small town decided that it had reached a stage where it was entitled to a place in the post-office directory, and its citizens suggested several names, all of which were rejected by postal authorities, as they had already been taken by other cities in the state. One official wrote "that it was very peculiar they could not find a name for their town." He received this reply: "Acting on your suggestion, we select the name of Peculiar." Thus, Peculiar was given its place in the postal guide book. Although the government does not name towns, it prohibits duplication within the borders of any one state. The same

name, however, may occur in several states. For instance, there are 45 proper nouns used more than 20 times to designate cities and towns in the United States. There are 2 Chicagos, 6 Philadelphias, 7 Detroits, and 14 Denvers. In Pennsylvania, 13 communities begin with Green.

Ⓢ Typewriter keyboards arranged like that of the linotype machines have appeared on the market, to enable apprentices on slug-casting machines to finger the "board" more easily. This displaces the old-fashioned method of practicing on a paper chart. Publishers of small papers, who set their own type, can use this typewriter with greater ease on account of the duplicate keyboard.

Empire Type
 Foundry
 Buffalo, N.Y.

Chicago Evening Post
 July 27, 1923

3257

POPULAR MECHANICS

American-La France Fire Engine Co., 493

BEES NOT SO BUSY DESPITE POEMS OF ENDLESS TOIL

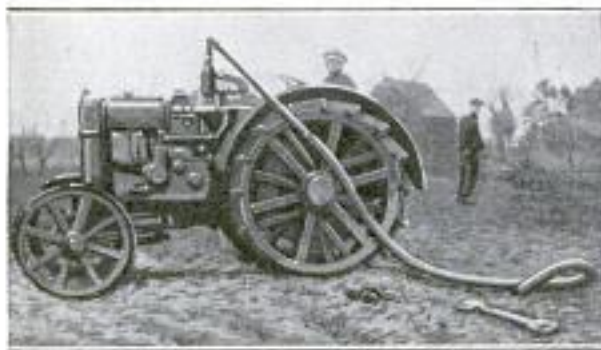
Is the "busy bee" not so efficient as it is believed to be? Experiments by government experts now indicate that stories of the ceaseless toil of the honey gatherers have been due more to the number of bees than to individual effort. By means of a very delicate apparatus and quick-drying paints of many colors, they made a check of the insects' activities and found that each worker makes on the average of five or six trips a day to the fields. The length of these depends upon the plenteousness of pollen and nectar, ranging upward from 15 minutes. After a bee deposits his load, he enters his cell and remains at rest for a half an hour or so, before taking to the wing again. His actual work is performed in about a half day, while the remainder of the 24 hours is his rest period. While apparently disproving the accepted idea of the insects' capacities for work, the investigators also learned that the harder bees labor, the shorter their lives. Some, who seemed more industrious than others, died within three weeks, while those who moved slower lived as long as five months.

Detroit News Aug. 4, 1923

USES TRACTOR EXHAUST GAS TO KILL RODENT PESTS

Poisonous gases passing out of the exhaust of a tractor engine are used by a Wisconsin farmer to kill gophers, wood-

3302



Piping Deadly Exhaust Gas from Tractor Motor to Underground Home of Rodent Pest

chucks, and other burrowing pests. A hose, attached to a piece of pipe, is inserted into one of the holes leading to the animal's home, after the other entrances have been plugged up with earth. The pipe is screwed to the exhaust outlet, and the engine started. The deadly fumes filling the underground chamber, smother the rodents in a short time.

Cont. E. O. Wiggins

Western Advertising Agency, 506 Peaper Block, Racine, Wis.

FIRE LADDER FOLDS INTO POLE, SERVES AS BATTERING RAM

3301

Armed at the ends with steel ferrules, a fire ladder that folds up to resemble a pole, can be used as a bat-

Chicago



Fighting Fire from Folding Ladder that Can Be Opened in a Few Seconds: Left, Ladder Collapsed into Pole

tering ram. Built of strong, light wood, and occupying no more space than the ordinary pike, it may be easily carried through small windows and narrow passageways by one man. Only a few seconds are required to open or close it, an automatic lock preventing its collapse while in use.

SILKY TISSUE, CLEAR AS GLASS, IS PROOF AGAINST ACID

327

By a secret process, a product as flexible as silk and as transparent as glass has been developed. This discovery, coming after years of experimentation, is said to open a new field in the paper industry. Manufactured in various thicknesses, it can be wound in rolls so consumers can cut it into desired lengths. Acid, alkali, or oxidizing agents of ordinary concentration do not affect it, and it burns less readily than other paper.

Cellulose Corporation, 835 Caswell, Milwaukee, Wis.

Copyrighted material

3270

326 W. Madison, Chicago
DEPOTS ON WHEELS ARE MOVED BY LOCOMOTIVES



Railroad Station from Abandoned Town Being Transported to New Location, Where It Will Remain until Another Shift of Population may Cause It to be Moved Again

In a sparsely settled section of the country, where populations of small towns find it necessary to change locations from time to time, because of various conditions, a railroad has adopted the novel

plan of moving its stations. Instead of putting up others, where towns spring up almost overnight, they load stations of some deserted villages onto flat cars and transport them to the new communities.

LID HOLDER PROTECTS HANDS FROM SCALDING STEAM

To protect the housewife's hands from scalding or burning, a kettle lid holder has been invented. Slots riveted to the



upper rim of the kettle hold the lid firmly in place when the utensil is tilted to drain hot water from vegetables or meat, thus preventing the escape of burning steam. The cover slides easily in and out of the holder and permits more freedom of ma-

nipulation without possible injury than the old-style pot.

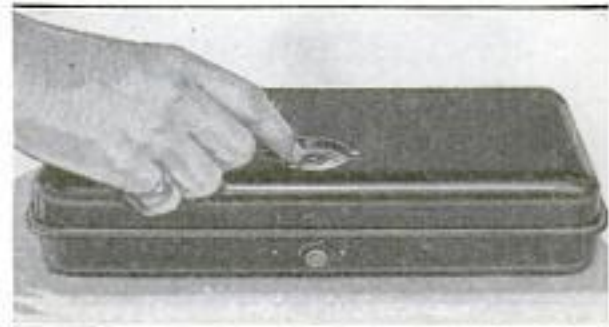
BELLS OF CHIMES ARE TUNED BY CUTTING IN A LATHE

By turning bells in a lathe, their proper tone can be restored. To lower the tone, the bell tuner reams it out from the point at which the swell begins, nearly down to the rim, frequently testing it with a tuning fork. The moment the proper pitch is produced he stops his work. In raising the tone, he shaves off the lower side, shortening the bell, for

of two of equal diameter and thickness, the shorter will give the higher note. A notable instance of bell tuning occurred at Lausanne, where twelve bells, in three neighboring church steeples, had only seven notes, and caused a curious discord.

KEYLESS TOOL BOX FOR AUTO HAS COMBINATION LOCK

As a safe repository for automobile tools, a keyless box that is opened by a simple combination lock has been marketed. It is intended for use by owners



Keyless Automobile Tool Box with Combination Lock Prevents Careless Borrowing in Public Garages

who keep their cars in public places. The receptacle, made of heavy material, is large enough to hold a complete repair kit, yet is so compact that it may be placed out of the way under the cushions or in the running-board container. There is no key to be lost or misplaced.

Siddler's Aluminum Ware, 328 E. 61st St., Kansas City, Mo. 328

Conf. Edwin Tarone, The Farragut, Washington, D. C.

Patent Novelty Co., Fulton, Ill.

State card missing

POPULAR MECHANICS

Chas. Turner hearing, 1400 W. Macon St., Sh. Decatur, Ala. 1925

EARTH'S AGE IS "SET" AT TWO OR THREE BILLION YEARS

After long investigation, scientists have announced that the earth has been in about its present state for two or three billion years. Geological measurements previously made were all lost in a maze of time before they had traced the history of the planet beyond 100,000,000 years. The present discovery rests on the rate by which radioactive substances change form. These materials are not permanent, but in time turn into lead.

3310

"SILENT MINISTER" ON STREET BROADCASTS DAILY SERMON

As a supplement to his regular Sunday sermons, an eastern pastor has erected on the principal street intersection of his city, a structure termed the "silent

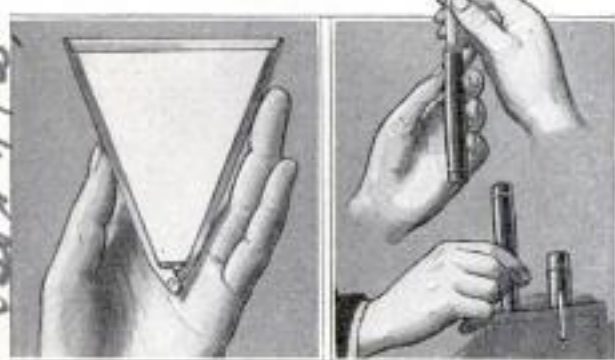


"Silent Preacher" at Busy Street Intersection, Giving Out Its Daily Sermon to Hurrying Crowds

POCKET CUP FOLDS IN TUBE SIZE OF FOUNTAIN PEN

Sanitary, compact, and easily carried, a patented drinking cup made of waterproof fabric on a thin wire frame folds into a tube the size of a fountain pen. It is specially designed for travelers and persons who live in states where individual cups are required. Placed in the pocket, and secured by a metal

3241



At Left: Tube Drinking Cup Opened. At Right: Closed and Placed in Vest Pocket

clip on the top of the tube, it takes no more space than a pencil. The two-piece container keeps the cup clean.

DISCOVERY OF AMERICA COST SEVEN THOUSAND DOLLARS

After a searching inquiry, it has been estimated that it cost \$7,250 for Christopher Columbus to discover America. The explorer was paid about \$320. Luis Santangel, a nobleman, and not Queen Isabella, of Spain, provided most of the money to outfit the three ships and pay the sailors, who were seeking a new route to Asia, says the investigator. The Pinzons, who commanded two of the ships, were paid \$130 each, and a common seaman got \$29 for the voyage.

3261

3311

INDIAN GEMS LIKE JEWELRY FADS OF PRESENT DAY

Relics of the early American aborigines, resembling the "novelty jewelry" of today, have been found in excavations now in Progress at Burton Mound, Santa Barbara, California. Among the adornments unearthed are hairpins of bone tipped with asphaltum and studded with tiny crystals; gems of abalone shell; pendants and similar decorations, said to be unlike anything ever before found on the continent. The tribes that made them are thought to have been highly skilled in the art of carving ornaments.

*Jacoma Ledger 8/6/23
Inventor H. W. Benner, Okla.
Box 412 - Norman*

Christian Science Monitor Aug. 8, 1923

Kansas City Star August 5, 1923

JEWELS OF ROMANCE IN FAR JAPAN

Report No. 170 from Popular Mechanics Magazine's
Japanese Correspondent,
N. SAKATA OF TOKYO

#10 Eschohorn, Sidamachi, Kiyomachi-Ku, Japan.
I herewith wish to explain something of the cultured pearl which is only made in this country, except few other places in the world. There may be some who does not know name of the Mr. Mikimoto, a noted maker of the cultivated pearl in this country, but there must not be such persons in your and especially in European land. In England and France, you cannot pick out of people a man who does not know name of Mikimoto. To such a extent, name of him is known. Mr. Mikimoto, when I met him yesterday in his shop at Ginza, Tokyo, told the following story.

He once was a owner of the small tea-house near the beach of Yise-Bay where is numbers of pearls are being cultivated. That was about 30 or 40 years ago. From such time a youth who became a noted business man in the world, was trying to find out a field where he could find his true success.

The said Yise-Bay has very beautiful range of scene and inasmuch as that bay is sarounded by three land, with only one outlet to the outer ocean, consequently there is not comparratively wild waves. Calm sea with beautiful landscape attracts very many city people for their trip or one day pleasure. One day a gentleman who has returned from the foreign country after deep investigations of the culturing of the pearl, came there and stopped his pleasure at Mr. Mikimoto's small tea-house. That is the first chance on which Mr. Mikimoto and the gentleman made a touch. Since that time, both of them became intimate for friendship, though one of them is a noted gentleman and other is a mere owner of the poor tea-house.

From that time, that gentleman paid major part of his life in investigation of the pearl cultivating and stepped to such a extent that more one year or half investigation would be enough for producing the perfect true circle pearls. At this time Mr. Mikimoto was a best assistant for the gentleman. He closed his poor tea-house and aided the gentleman as if he was a hand or leg of the gentleman. Mr. Mikimoto had no other intention except he wished the gentleman could make out true circle pearls. About two months after, the gentleman got ill, though it



Oyster Basket or Cage



Inserting Glass into the Oysters





was very slight one, and put him on the bed, from which he directed Mr. Mikimoto.

The ill which considered to be slight one became very serious and after only one month sick, he went to the heaven, leaving very precious material, in Mr. Mikimoto's hand, which would be changed into enormous amount of wealth. Consequently Mr. Mikimoto had to continue the left enterprise of pearl cultivating. Since he worked and worked, from dawn to fall, in investigations and labour.

Sometime he immersed in the water for several hours in handling the pearl oyster. His story continues to the interesting part, while my keen interest grow. He presented me a coffee and I accepted it with thanks.

He continued. It is by no means easy task, working in the water in coldest season in the year though he had set such a thing as cold, or poverty at nought. Yet he sometime determined to give up the enterprise, but he could never give up the job if he thought of the died gentleman to whom he debited very much.

After three or four years after the gentleman died, he first picked up the basket from the water. That was the first time on which he picked up the basket in which many oysters were put. In the oyster a glass ball was put on which oyster will cover with it's flesh. If oyster cover the glass ball in true circle, that is success. But when Mr. Mikimoto picked out them, he found that his efforts was in vain. Such effort which spent in vain continued several times. He after ten days deleverations, he thought it would be better shut up his enterprise and commence again his poor tea-house. And he stepped to ending the enterprise.

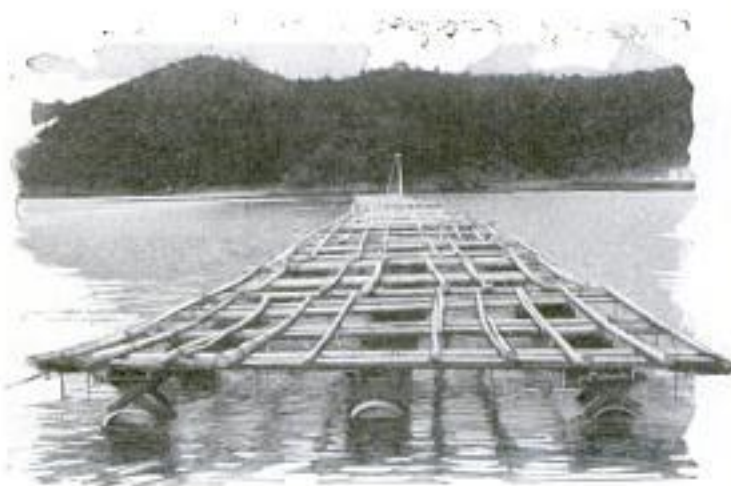
One day when he picked up, expecting again fault work, the basket, he found that his effort was not in vain. He wondered whether it was true or a mere dream. But it was not dream but a real success. He thanked and thanked to God for success. This was the first time he could get true circle pearl, and found a key to success.

Mr. Mikimoto gazed at me with passionate eyes and told me that he could not write down or speak how he was glad at a true circle pearl.

You may not know how a cultivated pearl is being made. I will tell you, as it is very simple to do. If you can get blessed place from our God, your success is on your foot. How Mr. Mikimoto succeeded is due

to the fact that he is blessed by the God.

First make a glass ball about $\frac{1}{8}$ " diameter and insert it in the body of the oyster and immerge that oyster in the water about from one to five years, depending upon the desired size of pearl. During that period, as oyster itself can not bear the pain, will cover that glass ball with his own flesh. In this five or so period, special handling should be paid and according to degree of



Frame from Which Cages are Hung



carefulness of handling, success or failure is determined.

The pearls made by Mr. Mikimoto's shop have fixed value or estimation among the world's jewellers. You cannot by any way or test determine whether it is natural pearl or cultivated pearl. Many severe tests were made in finding whether it is cultivated one or not, but such all attempts ended in vain.

On front of me there are shown very many kind of jewels and Mr. Mikimoto showed me one of pearl and explained. He also showed me one of natural pearl and asked me could I distinguish both of them. You had better go home jewel store in your city and ask them to show you both Japanese cultivated pearl and natural pearl. That test will convince you better than I try explain you here.

Of famousness of Mr. Mikimoto, I must put women diver in my consideration. Mr. Mikimoto told that that is only his place where women divers are employed. Beginning stage of his enterprise he im-

merged his basket containing oyster on the bed of the sea water, so, in taking it up again, he had to use divers. He found that women in the territory are suitable for the diving work. But increasing wage and difficult to gather the women diver caused him to use other method which will overcome the above difficulties.

So he constructed a frame work and hanged very many baskets from the wood frame by the steel wire to about two feet depth from the sea bed. This will go into about twenty or 30 feet in the water. This story must be very interesting one of your readers, especially women and I hope you accept my labour paid for this.

This Mr. Mikimoto's pearl is not imitated one to natural pearl as "Roman Pearl" or "Venetian" pearl."

Hopping to be favoured with your prompt answer.

Yours Very Truly,

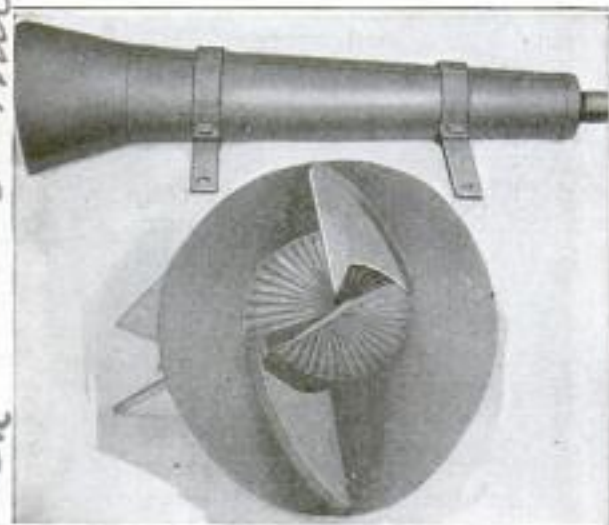
U. Sakata

*Chicago Wabash 425 S
James, 4 no. 270 E. Ontario*

3803

826 AIR SCRUBBER BARS DUST FROM AUTO ENGINES

Entrance of dust into a gasoline engine is claimed to be prevented by a recently invented attachment that clears the air



Rotating Air at Great Speed, This Device Prevents Dust from Entering Automobile Engines

before it reaches the carburetor. As the air passes through a spiral channel, it is rotated at great speed, the gritty matter being thrown outward and held by the walls of the tube, instead of being carried into the motor, where it forms carbon, and grinds down pistons and cylinders.

HOW TO TIME PHOTOS IS TOLD BY EXPOSURE METER DOT

By uncovering a piece of sensitized paper on a camera meter, recently patented, the photographer can tell at a glance how long to time his exposure. If the paper has darkened in four seconds, a snapshot would be wasting the film. For comparison, a normal tint appears on the meter dial, eliminating much of the guesswork of amateur camera owners. The idea has been adapted for use with various lenses, speeds, and conditions of light. When the meter shows the light to be too weak for a snapshot, the length of time exposure is indicated. Disks of photo paper may be replaced at small cost.



In the country east of the great plains and north of Maryland, a little more than a pair of birds is the average to an acre of farm land as shown by a recent survey.

*Chas. A. of Wash. } Detroit Mich.
Arthur L. Cash*

Burke



Every Sort of Vehicle from an Electric Lawn Mower to a Small "Tank," and Others Including Motorcycles and a Truck Drawn by a Baby Elephant, Shown in the South Recently

Land transportation had its origin in the prehistoric age, according to scientists. First, the woman was the burden carrier, and, to make her more efficient, trails were created through forests and across plains. These marked the course of the future highways of civilization.

Just when primitive man transferred the load to the back of an animal is a matter of conjecture, but the change was final, and the first step in solving the problem of land carriage. Next came the roughly hewn plank, drawn by a beast. This was transformed into a sled. Then came rollers, wheels, the cart, and, finally,

four-wheeled vehicles. These served until the seventeenth century, when the necessity for increasing capacity led to the adoption of wooden rails over which coal, in England, was hauled to river and sea for supplying boats.

With the use of steam, a new era of progress set in that has almost annihilated distance. Gas engines brought the motor car and tractor, and made the airplane possible. Answering the ceaseless cry for more speed, every device known to science has been applied to transportation problems, resulting in the saving of time and increase in human efficiency.

SHRINE OF STONE AGE YIELDS MANY HEATHEN RELICS

Relics, estimated to be about 4,000 years old, have been found by scientists in a tomb and shrine of heathen worship built during the Stone Age. Located in the southern part of Sweden, it lay buried beneath ten different strata of earth. Constructed of large rock slabs, it has a central chamber, 10 by 5 feet. Around

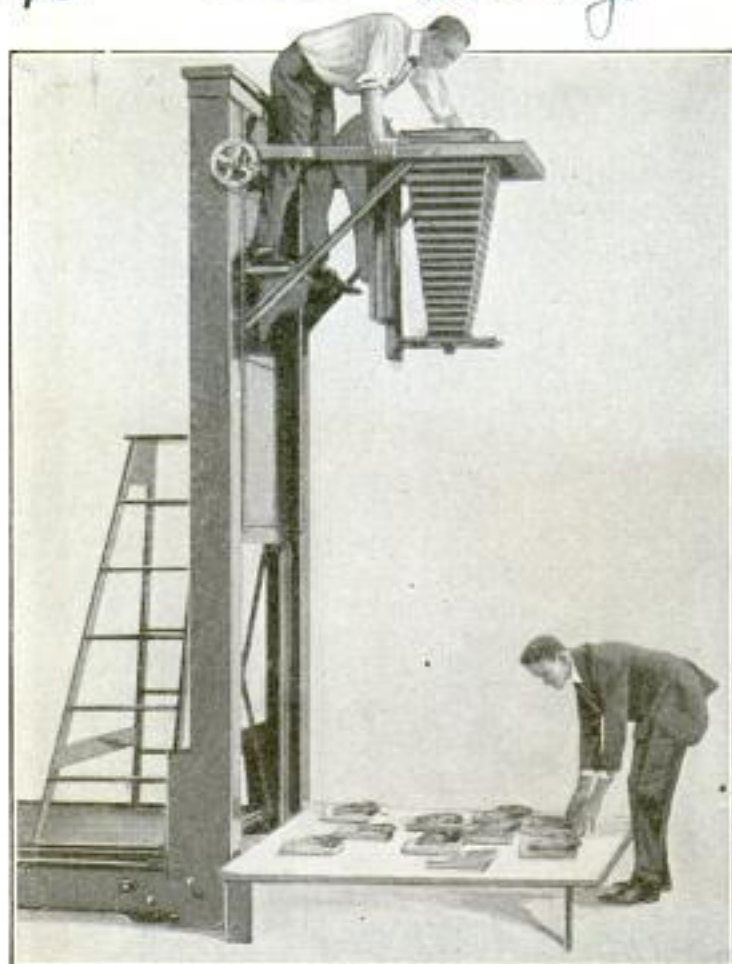
this is a circular pavement, from which radiate a number of curious walks marked by stones. A considerable quantity of human and animal bones, together with flint daggers and spearheads, were unearthed. Also, there were about 7,000 fragments of ornamented vases, which had been thickly strewn outside the tomb. The shattering of these containers probably took place in connection with heathen religious ceremonies.

3215
detroit news August

*326 W. Madison
Chicago*

3296

BIG CAMERA IN AIR "SHOOTS" TOWARD FLOOR



Operating Camera on Platform That Moves in Frame to Make Pictures of Large Displays Below

For making photographs of large displays that cannot be mounted on an upright wall, a Middle Western man uses a large camera that slides up and down in a frame 18 feet high, and focuses on a big table below, on which objects are placed for reproduction. The operator climbs a stepladder to the platform under the camera, which he moves by turning wheels. A white background is provided by lights under the "ground" glass. Two big lamps placed at the sides bring out detail in the display. Photographs to replace blueprints, and pictures of sample exhibits for salesmen, are made with this equipment.

"CATERPILLARS" HELP TO TILL WESTERN PEAT

3356 LANDS

By the use of "caterpillar" tractors, peat lands of Minnesota, long regarded as unfit for any kind of cultivation, are being reclaimed. Because of the soil's looseness, it is almost impossible to work in these sections with plows drawn by horses.

Detroit News, Aug 4, 1923

8275 "DEAD-AIR" SPACE IN COOKER PREVENTS FOOD BURNING

To prevent food from burning, a pan with a double bottom has been made which may be used for frying, roasting, self-basting, or steam cooking. The out-



Combination Cooker with "Dead Air" Space at Bottom to Prevent Burning of Food

side is of steel and the inner part of aluminum, with a "dead-air" space at the

bottom, which eliminates the possibility of a scorched dinner without the usual watching. When the roast is partly done, the sidewall and cover can be easily removed to allow it to be turned over for browning both sides.

WHERE THE MEN ARE VEILED

3338
While the women of the warlike, Tuareg tribe, residing on a mountainous plateau well within the great Sahara desert, go about with bared faces, custom forces the men to appear in public heavily veiled. Only a narrow slit is left for the eyes in the turban wrapped about their heads. The territory where these people live was almost unknown until 1850, when one of three explorers escaped death at the hands of the desert savages and returned to report his experiences. After a 30-year struggle with this tribe, the French government found it necessary to compromise, so relentlessly did these hooded warriors keep to the fray.

*Kansas City Star
Aug. 12, 1923*

*Wm. E. C. Graves
6820 S. Park Ave.
Chicago*

Does a Curse Fall Upon Those Who Touch Mummies and Idols of Mystic East? 3171

Sinister Influences Attributed to Relics and Jewels That Are Believed to Result in Disaster and Ill-Fortune for Those Who Possess Them



WITH the completion of preparations for the re-opening of the tomb of Tutankhamen, interest has revived in the curious superstition that a curse falls upon those who disturb the ancient dead of Egypt, bringing calamity to them and their families, even extending to their close friends.

The death of Lord Carnarvon soon after he had penetrated into the burial chamber, where the ancient ruler slept among all the splendors of his vanished empire and recent dispatches telling of the illness of the leader of an American expedition to "The Valley of the Kings," again has brought up the question:

"Is the curse of an Egyptian priest, invoked more than 3,000 years ago at the entombment of a king, operating over the centuries upon those who have disturbed his slumbers?"

Investigation shows that few authenticated cases of disaster following upon the disturbance of a mummy are so utterly bewildering as that of No. 22,542, which is the British Museum number for a certain relic of an Egyptian priestess of the temple of Ra, in the great city of Thebes.

According to Egyptologists, the priestess lived about 1600 B. C. The only remaining thing belonging to her is the lid of her coffin on which is painted in crude colors the face of the dead woman. The first heard of this sinister relic was its purchase by an Englishman from an Arab at Thebes. Before he reached Cairo, his gun exploded, and his arm was shattered. One week later he received word that he had lost the whole of his fortune, and shortly afterward, with the picture of the priestess in his possession, he died, poor and miserable. His companion passed away soon afterward.

Misfortunes followed hard upon the

mummy relic, which then came into possession of a woman living in London. She lost health and seemed to be dogged by some malign and unaccountable influence. One day a famous Russian mystic visited her. Immediately she complained of a sinister presence. Before she left, she had seen the coffin lid.

"There is the evil influence which I felt on entering the house!" she exclaimed, and implored its owner to get rid of it as soon as possible.

The next owner sent the painted face to a photographer. Although it was just a piece of primitive art, partly destroyed by the ravages of time, the photograph is said to have shown a living face with an expression of intense hate.

Those who hold that the explanation of such a history as this is an occult one, say that it was no less than a photograph of the spirit of the priestess.

However that may be, the last owner of No. 22,542 sent it to the British Museum where, it is only fair to say, the priestess has been behaving, and, while there are many stories of her evil doing since then, none of them are credited by the authorities.

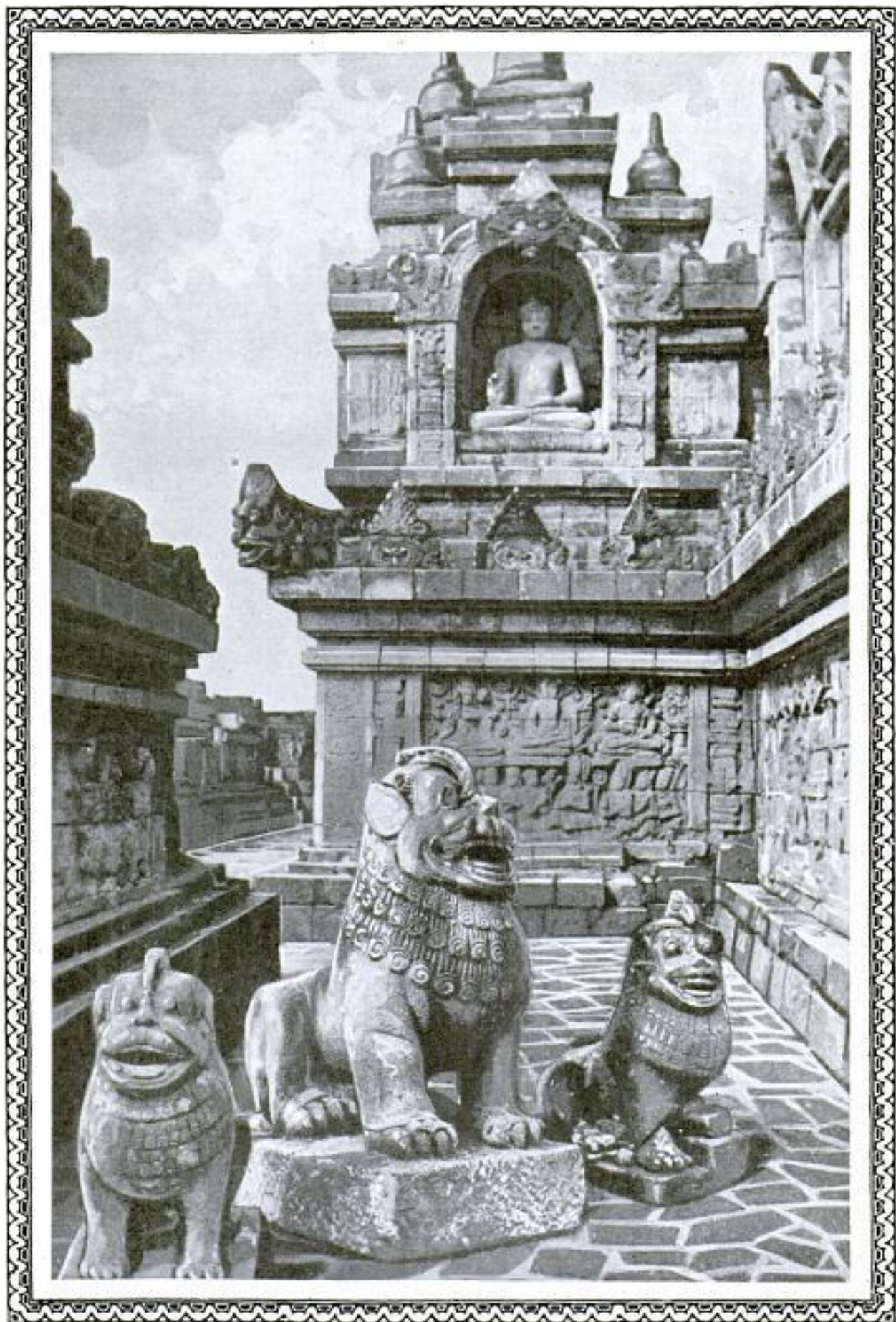
Somewhat similar stories are told about a figure of the Gautama Buddha which came into the hands of another London museum in 1911. This idol had been bought by a sea captain during a voyage to India. Before his ship reached England, it caught fire in a mysterious way. The crew, many of whom were Lascars, were afraid of the great teak figure, and insisted upon casting it overboard. Ultimately the vessel was towed into Liverpool, and some time later the Buddha was washed up off the coast of Wales, and

claimed by the captain when he heard of it.

Following his death—which took place shortly after the recovery of the

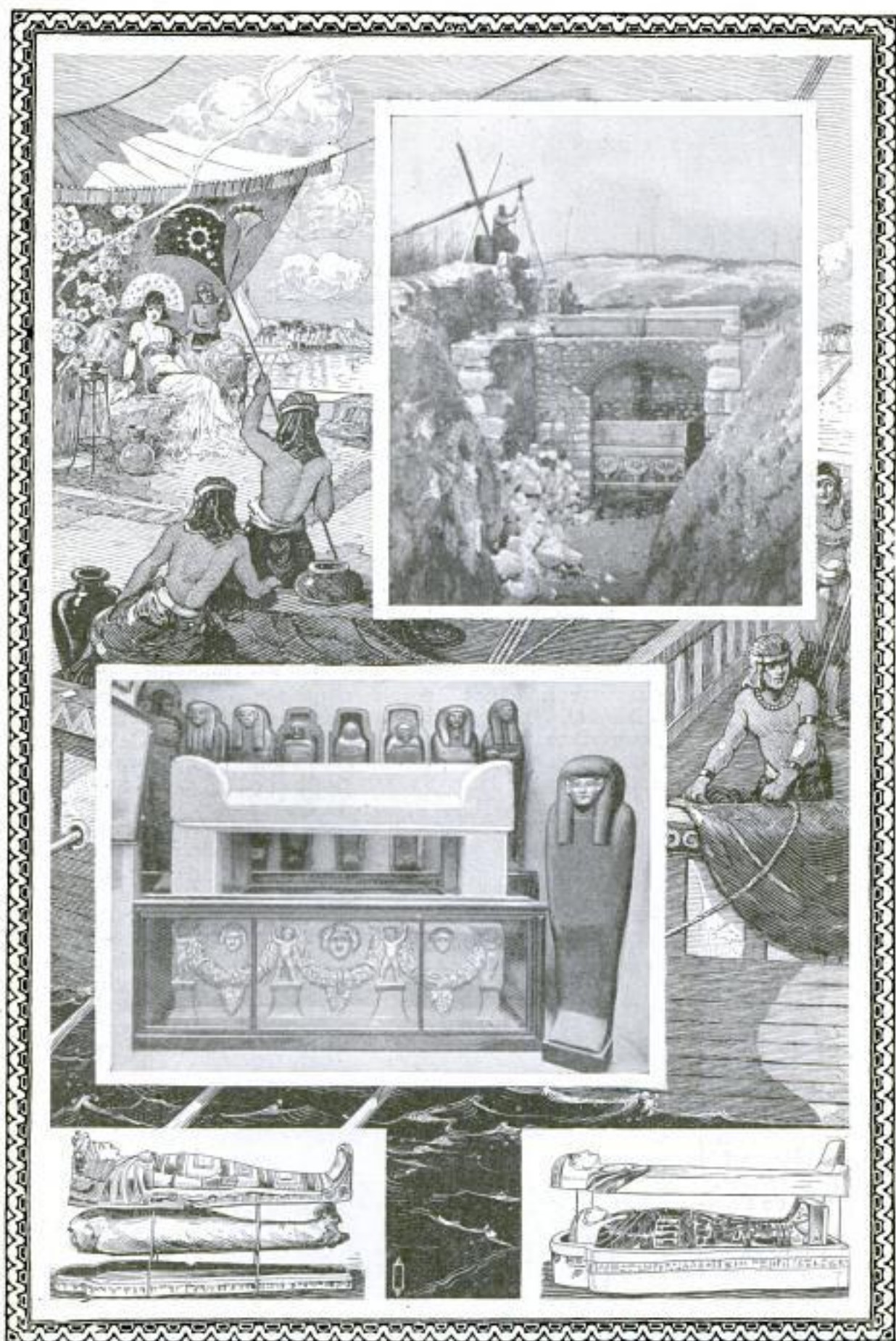


Figure on Prow of Boat to Drive Off Evil Spirits of Sea and Protect Sailors

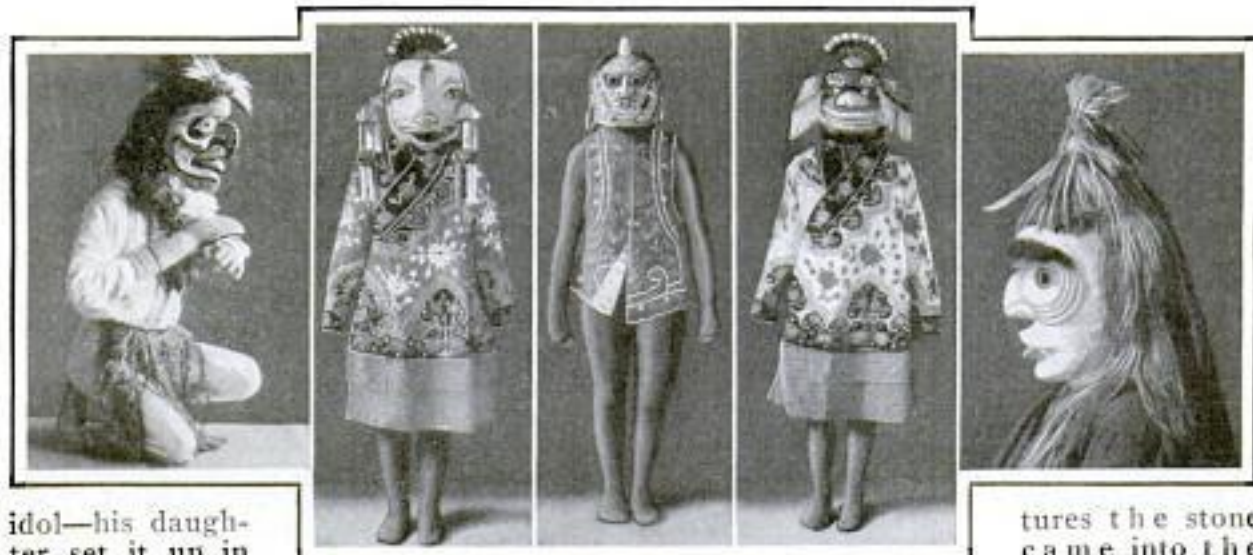


Mystic Figure of Buddha, Believed by Natives to be Protected by Ancient Curse That Brings Evil Fortune, Tragedy, and Death to Those Who have Sought to Remove It

COPYRIGHT, 1911, BY K. B. JONETT



Entrance to the Tomb of Cleopatra, and Mummies of Ancient Rulers, before Whose Frowns All Egypt Once Trembled: Their Remains Are Now Only Museum Relics



Grotesque Masks and Elaborate Costumes Worn by Devil Dancers in Asia to Terrorize Evil Spirits

idol—his daughter set it up in her house. Then began the trouble. The servants complained of it. One asserted that it moved, another that it frightened her. The children were scared by it, and said they dreamed horrible dreams in which the face of the Buddha peered at them. Visitors were frightened away, and so the figure was given to the museum, where it has remained under close observation without any peculiar manifestations.

Another story of a strange influence concerns the Hope diamond. Everywhere this gem has gone since it was stolen from the head of a figure in a Hindu temple, it is said to have left a trail of death and desolation. It was first brought to Europe by the French traveler, Tavernier, in the seventeenth century. Ruin overtook him in a few years. He sold the diamond to Louis XIV, of France, who gave it to his beautiful favorite, Mme. Montespan. She wore the stone, and quickly fell from royal favor.

Princess de Lambelle was the next victim to wear the jewel, and met death at the hands of a Paris mob during the days of the revolution. After many adven-

tures the stone came into the possession of one Fals, a Frenchman, who, fearful of being accused of theft if he disposed of it, died of starvation.

In 1830, it fell under the ownership of Henry Thomas Hope, a collector, and then, after two generations of quiet, went to his grandson, Lord Francis Hope, who was the victim of many misfortunes.

So long is the list of tragedies connected with the Hope diamond that it would require a full volume to relate its entire history. From the time it was released by Lord Francis Hope, it passed through the hands of men who met with sudden death, lunacy, and bankruptcy.

It was owned by American millionaires, by French dealers, by the Russian Prince Kanitovski, by Abdul the Damned. To each it is credited with bringing death and disaster. Its last possessor was the wife of an American millionaire whose son was killed.

Mummy, sacred idol, precious stone stolen from some Oriental temple, what power do these inanimate things possess? Is there any real explanation of the tragic histories with which they are connected?



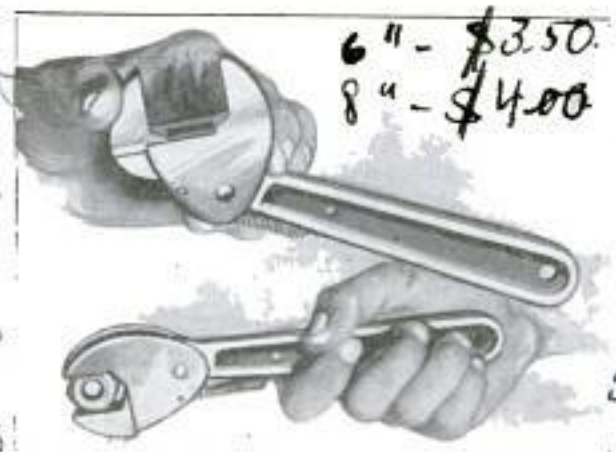
Alaskan Medicine Man Praying Before Totem Pole Carved and Painted with Symbols of His Tribe

**BRIDES OF NILE IN OLD DAYS
COST FOUR DOLLARS**

328 7
Marriage contracts were in vogue among early Egyptians, according to tablets found in the Nile region by explorers. The earliest-known nuptial contract there dates from 590 B. C., the terms of which were drawn by the husband. It has been translated as follows: "Since God willeth that we should unite one with the other in righteous wedlock, after the manner of every free man and every wise woman, therefore I have given thee four dollars in gold as a bridal gift. And for my part I will not neglect thee. Neither shall I put thee forth without a cause, having legal ground. But should I wish to put thee forth, I will pay 17 dollars for the matter."

**SPEED WRENCH CANNOT SLIP
AND IS SELF-ADJUSTING**

331 7
Taking a lightning grip upon any nut within its wide range, a recently patented wrench adjusts itself without a thumb



Jaws of Automatic Speed Wrench Extended and Gripping Nut for "Ratcheting"

screw, and the harder the pull, the tighter it holds. The mechanism for opening and closing the jaws allows it to be "ratcheted" rapidly, bolts being either loosened or tightened with surprising quickness. There is no possibility of the wrench slipping, or of working loose on the nut faces, and, as all parts are made of high-grade steel, it is practically impossible to bend the jaws. A spring aids in keeping its grip in constant adjustment.

So far as is known to scientists, no insect has a fatal bite although deaths have resulted from blood poisoning induced by scratching the irritations.

Speednut Wrench Corp.,
20 E. Jackson Blvd.
Chicago

**EVIL SPIRITS ARE CAST OUT
BY BLOWING IN EARS**

332 3
In Zululand, South Africa, native doctors collect rich fees by blowing into the ears of their patients to cast out evil

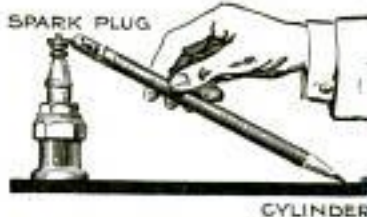


Native Doctor of South Africa Casting Out Evil Spirits by Blowing in Patient's Ear

spirits. The medicine man seats the victim on the blanketed floor of the outdoor surgery, after announcing that he is to dispel the wicked demons causing sickness. He places a horn to the patient's ear and blows. The ill one generally makes a bad face, cries "enough," and, being convinced that he has been cured, is troubled no more. In severe cases herbs are used as a remedy, when the horn is not effective.

**LEAD PENCIL FOR SPARK-PLUG
TESTING AIDS AUTOISTS**

32 94
With a metal tip at the eraser end through which electric current passes, a pencil to test spark plugs has recently been placed on the market. Because the lead is insulated, it is a good conductor of electricity as it passes from the cylinder to the tip of plug. The test is made by touching the cylinder with the point, and the brass cap of the plug with the other end of the device.



In one year, it is estimated, smoke causes a damage of \$500,000,000 to property in the United States.

John V. Larson
164 W. Washington
Chicago

Blaisdell Penail Co.
141 Berkeley
Berkeley, Ca

Electric Vacuum Cleaner Co.

506 **POPULAR MECHANICS**
 Euclid Ave. + Cleveland Road

SIX-POUND VACUUM CLEANER STRAPPED TO SHOULDER

3306 *Cleveland, Ohio*
 So small that it is supported from the shoulder by straps, a vacuum cleaner, that weighs only 6 pounds, can be car-



Renovating Upholstering of an Automobile
 with Vacuum Cleaner That Straps to Shoulder

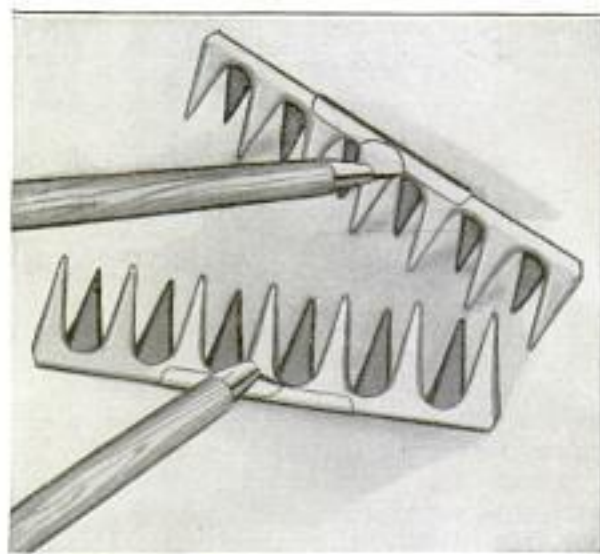
it are called "Spanish hair." Harvesting the moss requires little labor, since it falls from the trees when it ripens. Several methods are used to cure it for the market, the most popular being to pile it on the ground, wetting it, and allowing it to remain for three or four months, during which time it changes its color from green to black. Preparing the plant for dealers already has become a thriving industry.

TEN-DEGREE CHANGE IN SUN WOULD END ALL LIFE

3337
 Were the sun's heat to vary ten degrees, all life would perish from the earth, according to a scientist, who says that life here will continue indefinitely as it has existed for hundreds of millions of years. From the color of rays given off, the temperature at the sun is said to be about twice that of an electric arc. If the earth were a ball of ice, this solar heat would melt it in little more than 15 minutes.

TWO ROWS OF TEETH ON RAKE PREVENT DRAGGING OF SOIL

3298
 With two rows of teeth placed so that stones and rubbish cannot become wedged between them, a rake that makes a smooth, level surface, has been devised by an eastern inventor. Pulling of the loam and dragging of small plants are also prevented by the extra teeth, which



Two Rows of Teeth that Prevent Stones and Rubbish from Clogging the Rake

are set behind, and between, the front ones. The prongs, all separated by an inch of space, thus permit the soil to pass freely through them.

ried about without any discomfort, yet performs as many tasks as a larger instrument. For removing dirt and dust from crevices, where heavier tools cannot be manipulated, blower and suction attachments are provided, making it possible to clean inaccessible corners, telephone-switchboard equipment, motors, and radiators. It is also handy for drying hair after a shampoo.

SPANISH MOSS BECOMES "HAIR" FOR STUFFING FURNITURE

3335
 Spanish moss, that grows so abundantly on the hardwood trees in the swamps of southern Louisiana, has been found of value as stuffing for mattresses and furniture. Although not yet a staple on the market, the product is said to have a growing demand. Dry, resilient, and nonadhesive, it is especially serviceable for upholstery. Owing to its resemblance to coarse hair, certain grades of

new Orleans La.
Moss +
Cotton Field
411
Suggest. Kohlman

Kansas City Times
Aug 11
1923

non-clog Rake Mfg. Co.
86 Monroe St.
Newark N.J.

3083

International Newsreel Corp

POPULAR MECHANICS

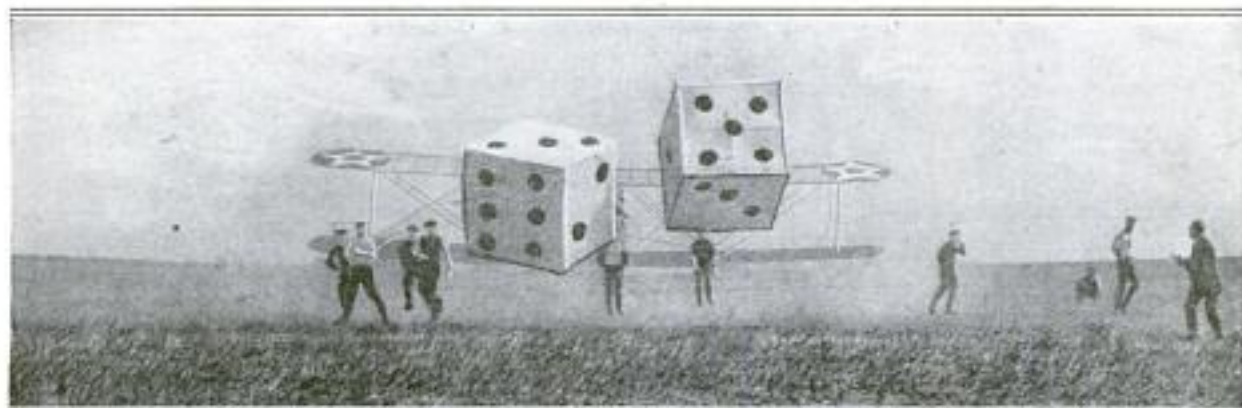
507

326 W. Madison, Chicago

ROLLING DICE BY AIRPLANE LATEST OF SPORTS

With giant dice made of light material, aviators now play the game of dice from their airplanes as one of the latest American sports. Placed in front of the

machine, the propeller is twirled, and the rush of air sends the dice rolling down the field with the plane in pursuit. The cubes are then placed in position again.



Playing the Game of Dice by Airplane: Huge Cubes of Light Weight are Rolled down the Field by a Blast of Air from the Machine's Spinning Propeller

HUSBAND DOES COOKING, WIFE HUNTING, IN AFRICA 3140

Husbands are the cooks and wives the fishers and hunters in Barotse, a province of northern Africa. Though there is a well-organized modern government, the natives still observe some curious customs. It is no unusual sight to see a woman wading in a stream and carrying a big fish basket. When she returns home, the husband does the cooking. Then the wife sits down alone to dine, because, owing to his superior strength, a man might be tempted to take the choicest pieces before the woman gets her share. Another unwritten law is that when triplets are born, two of the babies must be killed for good luck.

out the oil at a pressure sufficient to force it into tiny crevices. It may be refilled by removing a cap at the big end.

CHRISTMAS TREE KEPT FRESH BY WATER IN HOLDER 2984

By supplying moisture to the stem, a stand recently invented for Christmas trees keeps the branches fresh for a long time. Screws in the side of the holder can be set for any size, gripping the tree firmly after it has been pushed down to reach water in the basin. Filling is done through an opening covered by a threaded cap.



Carl A. Diederichs, Pittsburgh, Pa.

"GAT" SHOOTS OIL INTO AUTO UNDER HIGH PRESSURE 3090

Shaped like a pistol, a device is being marketed that is designed to make the oiling of an automobile chassis a clean



Oiling an Automobile Chassis Made an Easy and Clean Task by Oil "Gat"

and easy job. With its 16-inch long barrel, the most inaccessible parts of the car may be handily reached. Operated with only one hand, the instrument shoots

To hasten the handling of large amounts of cotton from the Orient passing through San Francisco for further shipment eastward, a fumigating plant is to be built at that port. It will be so located that moving of goods will be made with the least possible delay.

Warner-Patterson Co.

914 S. Michigan Ave Chicago

When Banditry and Mechanics Conspired

How a Homemade Cannon Served the Purpose
of an "Excellency" of Old Mexico

BY SIDNEY McNEILL SUTHERLAND

Chicago Tribune
Chicago

[This is the first of a series of articles by Mr. Sutherland, relating his experiences in the land of the Mexican bandit. Particularly capable of portraying the native character and its fascinating background, his stories will be found frequently amusing, often strange, sometimes thrilling, and always interesting and informative. Mr. Sutherland has had rare opportunities to become acquainted with our neighbors below the Rio Grande. Born in Monterey, Nuevo León, on April 13, 1888, the son of an American missionary and his wife traveling in Mexico, Mr. Sutherland learned Spanish in infancy. Altogether he lived in Mexico and other Latin-American lands more than fifteen years. Later, his knowledge of the country, the language, and the people, led to his employ at various times as a newspaper war correspondent in the many revolutions which have ravished that great country.—Editor.]

IN January of 1912, I occupied the dual rôle of news editor of a Mexican newspaper, and special correspondent of a New York daily. For the latter I made many trips into the states of Puebla, Tlaxcala, Guerrero, Hidalgo, Oaxaca, and Morelos, where scores of rebel leaders were indulging in Mexico's favorite outdoor sport—uprising.

The best "copy" for American readers, aside from incidents affecting American citizens, was furnished by the Zapata brothers, Emiliano and Eufemio, whose bands often raided the incredibly rich sugar, coffee, and tobacco plantations of Morelos. There is an "inside" story connected with the Zapatista forays against the Castillians, which has never seen print in this country, and which helps explain the strangely successful career of the Zapatistas.

Gustavo Madero, brother of the president, was a grafter whose sagacity, re-

sourcefulness, and utter shamelessness would arouse the envy of the most conscienceless politician. To Gustavo and his coterie of knaves may be attributed the Felix Diaz revolt and the ensuing collapse of that country. A "chance" bullet fired in front of the Felicista headquarters at dawn of Feb. 20, 1913, ended Gustavo's buccaneering exploits.

Now, Emiliano Zapata and his followers might steal commissary stocks, steers, horses, saddles, and clothing; and he might ravage the cane crops, burn tobacco barns, and destroy coffee mills and residences, but he could obtain scant quantities of the two articles indispensable to Mexican banditry—arms and money. The latter had been transferred by the Spaniards to Mexico City, and the former were kept out of Morelos.

Emiliano confined his activities to the state of Morelos; but Eufemio and his cutthroats sometimes wandered farther afield.



The Famous Cannon Mr. Sutherland Made for Eufemio Zapata: The Tragedy-Comedy That Followed the Attempt to Fire It is Described in the Accompanying Narrative



"Zapata yelled with laughter 'dios de mi vida!' he gasped, wiping his eyes."

About the middle of January, a reporter from the Mexican newspaper succeeded in interviewing Emiliano in his mountain lair—no insignificant feat—and on his return told me he had heard that Eufemio was preparing to plunder an American mining camp in Guerrero sometime before February 1. I at once proceeded overland into the Sierra Madre range on horseback, after leaving the train at Iguala, and reached the camp of the brigands three days later about dusk.

After responding as warily as I could to the outer sentry, who challenged me at the foot of the mountain, I was blindfolded and conducted to Eufemio. Pro-

ing in keeping his men armed. Not strong enough to attack a garrison, he didn't know what he was going to do for carbines and ammunition.

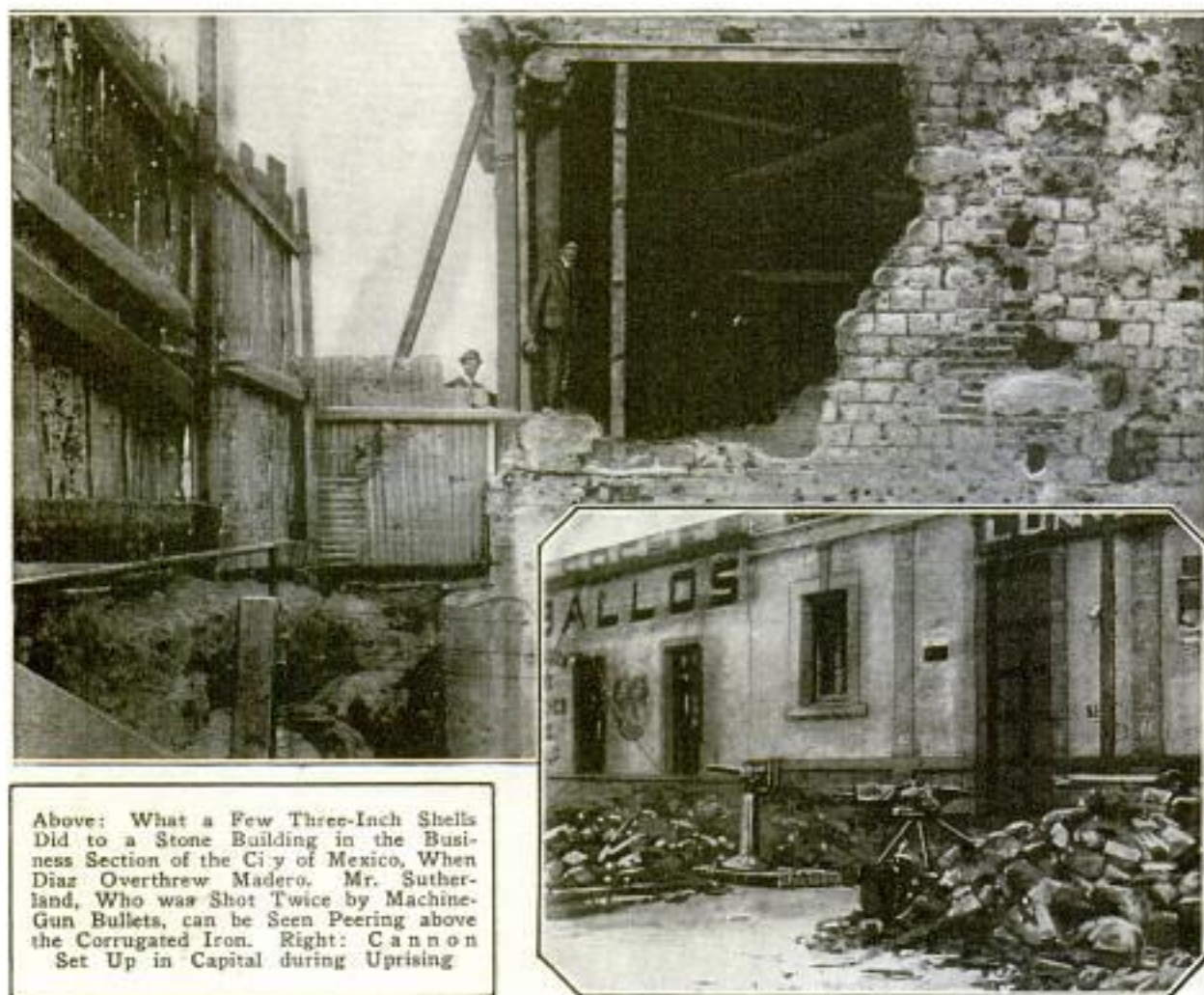
"If I only had a machine gun, or a cannon, or some bombs," he said, "I could surprise a cuartel and supply my valiant soldiers."

A whimsical thought came to me.

"I can't get you a machine gun," I told him. "But I can make you a cannon and all the bombs you want."

"What!" he exclaimed. "You can? O, señor, if you would do that I would—I would do anything you might ask."

"Anything?"



Above: What a Few Three-Inch Shells Did to a Stone Building in the Business Section of the City of Mexico, When Diaz Overthrew Madero. Mr. Sutherland, Who was Shot Twice by Machine-Gun Bullets, can be Seen Peering above the Corrugated Iron. Right: Cannon Set Up in Capital during Uprising

longed and searching questions finally persuaded him that, although a gringo, I had only a newspaperman's interest in the forthcoming raid. He assured me that my "paisanos" (countrymen) would not be injured, but that he intended to take anything and everything he could carry away.

After we had eaten a modest supper of beans, goat meat, and tortillas, Eufemio complained of the difficulty he was hav-

"Anything. Si señor, if you will make a cannon for me I'll agree to do anything. Have you an enemy you would like to have—disposed of permanently?"

"No, thank you," I laughed. "But if you will not molest the gringo mining camp, I'll make the weapons you need."

"Agreed!" he replied.

The next morning, accompanied by twenty ruffians, we rode down the mountain, crossed the valley and ascended the



other slopes to the mining camp. I went ahead and explained to the superintendent; and then fired a shot to notify Eufemio to come on. The Americans effusively welcomed the outlaws, who, not to be surpassed in politeness, swept the ground with their sombreros, embraced the señor Americanos, and kissed the hands of the reluctant ladies.

After luncheon, I made the bombs. They consisted of Vienna-sausage tins, tomato cans, and heavy stone jugs filled with black powder and bits of dynamite, of which the Americans had a large stock, and buckshot, bolts, nuts, and broken glass. A small piece of woolen underwear was torn and twisted into fuses, and lengths of rope were looped about the "bombs," furnishing at once a means of carrying the things and a sort of "slingshot" so that they could be lighted, swung rapidly about the head, and thrown 50 yards or so.

I hadn't the remotest idea whether they would explode; but Eufemio, who had

drank much warm beer, was in ecstasies, rubbing his hands and proclaiming loudly that Americanos were the smartest people in all the world.

The next morning I made the cannon. I obtained a length of iron pipe, three inches in diameter. In the blacksmith shop, we cut off a piece eight feet long and closed one end by heating it red hot and hammering it down. About two feet up the heated pipe I

drove in a ten-penny nail, leaving a hole for the fuse. Back of the farrier's shop was a dilapi-



dated, homemade buckboard which had formerly run on two discarded, wire-spoked motorcycle wheels. I took these wheels, made an axle of a three-foot piece of iron; nailed the cannon to a heavy board, and bolted the board to the axle.

"There's your cannon, general," I said to Eufemio, who had hovered about me all morning.

"Wonderful! Superb!" he exclaimed. "Now, indeed, the forces of liberty and justice shall rout the tyrant's armies, and righteousness prevail throughout our glorious country."

He picked up the rope "traces" and stalked to and fro, pulling the contrivance after him, the end of the plank bouncing over the rocks.

"Immediately following the siesta we shall fire a salvo to salute the new bri-



Left: Eufemio Zapata, Right: Mr. Sutherland

gade," he announced. "Let us see, we must select a target for practice this afternoon."

"I have it!" he continued, leaning close to me and whispering. "There are a couple of colonels and a major with me that I greatly distrust and dislike. They shall be placed a hundred yards away, and when they are not aware we shall accidentally fire in their direction! What say you?"

I said it would be all right with me.

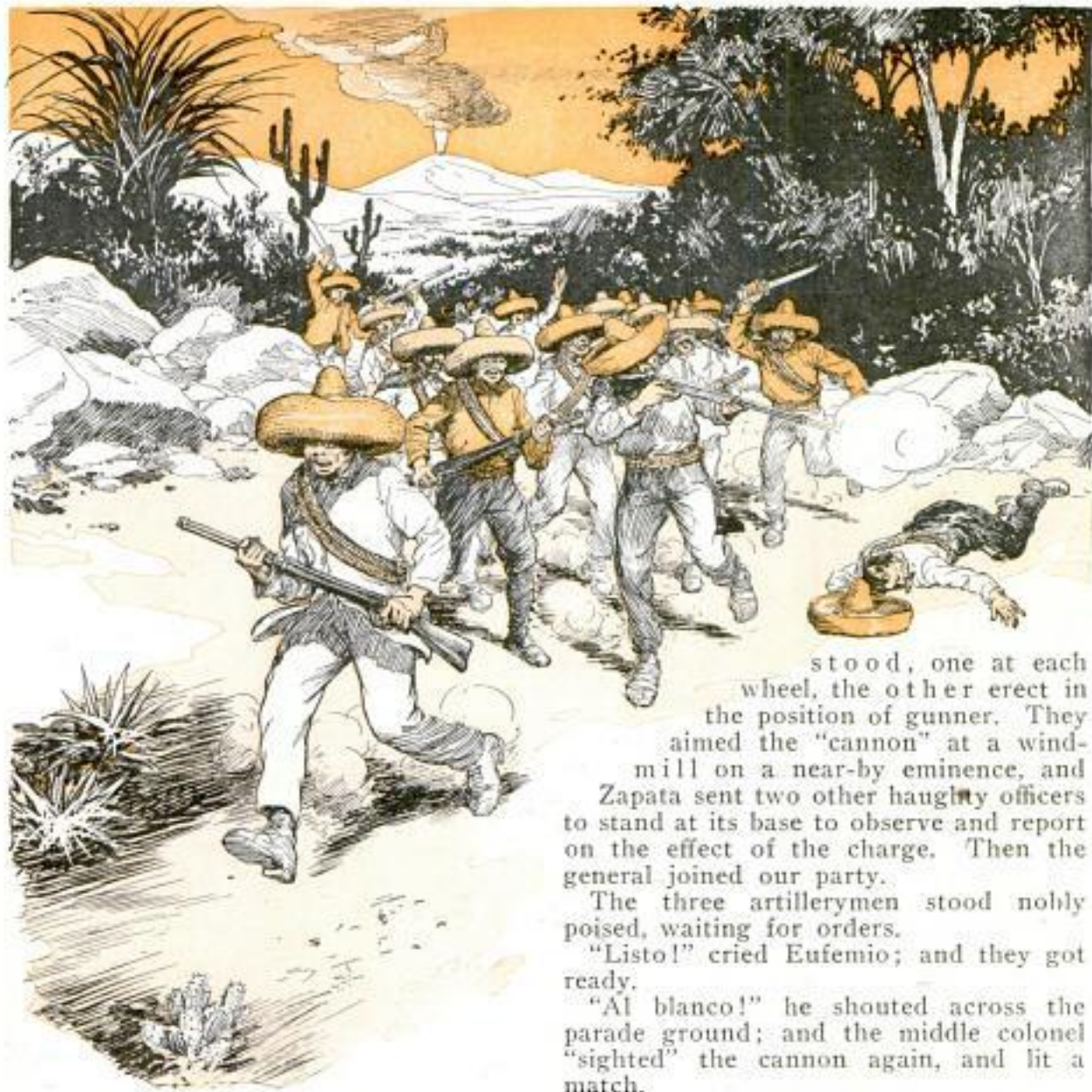
"But, general," I added, "I am not sure how far this weapon will carry. If I had better materials and facilities, I could make

you a real cannon. As a matter of fact, it may be more dangerous to fire this thing than to be fired at."

"Very well," rejoined the alcohol-mellowed patriot. "We'll have the colonels



What a Street Barricade Looks Like in the Ludicrous "Wars of Independence" Waged from Time to Time in Mexico



and the major shoot the cannon. I can find a couple of other members of my staff to use as targets."

The salute of honor was a solemn affair. The cannon was wheeled out into the yard, the rebels ordered to fall in—at a safe distance; and Eufemio, quite drunk, and I proceeded to load it. We poured black powder into the muzzle until for three feet the pipe was packed tight. Then we filled it nearly to the upper end with scrap iron, worn ball-bearings, and broken cogwheel teeth. I got a piece of cloth, rolled it into a short fuse, and thrust it into the nail hole.

While the Americans, the ladies, and I retreated to a doorway about a hundred yards away, Zapata commanded the two colonels and the major to advance. Proud of having been selected for the post of honor, they strutted forward and

stood, one at each wheel, the other erect in the position of gunner. They aimed the "cannon" at a windmill on a near-by eminence, and Zapata sent two other haughty officers to stand at its base to observe and report on the effect of the charge. Then the general joined our party.

The three artillerymen stood nobly poised, waiting for orders.

"Listo!" cried Eufemio; and they got ready.

"Al blanco!" he shouted across the parade ground; and the middle colonel "sighted" the cannon again, and lit a match.

The outlaw chieftain waited a moment until he could control his mirth, the women clenching their hands and turning their faces. Then he cried:

"Fuego!"

The colonel leaned over, lit the fuse and cupped his hands about the tiny spark, blowing vigorously on it to keep it alive.

Suddenly, there was a terrific, splintering roar and a whirl of dust and leaves that completely obscured the spot. Above the cloud, we saw flying sombreros, sandals, a cartridge belt, and pieces of wheels and pipe.

When we reached the place we found a deep hole in the ground, a twisted wheel and three shattered bodies. Zapata threw his hat into the air and yelled with laughter, pounding the Americans on the backs, and kissing me heartily on both cheeks.

"Dios de mi vida!" he gasped, wiping his eyes. "Gringito, I ought to make you a general in my army. This is the most remarkable hour in my life. O, what exquisite comedy! Too bad my noble officers died; but thus it is, there must always be sacrifices in the development of science. Well, well! That was an excellent cannon you made, but I forgive

you, amigo; and I shall live up to my pledge to spare this mine. I suppose your bombs will be as big a failure as the cannon. But never mind—I have other officers on my staff who shall become bomb throwers in our first battle!"

After effusive adieus the outlaws rode away, Eufemio's laughter echoing along the mountainside.

MODEL POWER BOAT SPEEDS SEVENTY MILES AN HOUR



Fashioned by hand, a model power boat, barely outside the realm of toys, has been made that attains a speed of 70 miles an hour for a brief period. With the same grace and smoothness of a 30-foot craft, it skims over the water by power generated by a tiny steam boiler, heated by a gasoline torch. Building these miniature speedsters has developed into a small industry.

Racing them has become so popular that an eastern city has set apart a pond in one of its parks for that purpose.

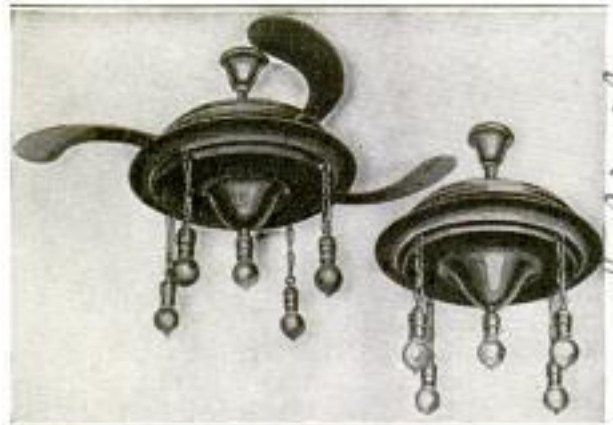
VISITING CARD, RELIC OF OLD CUSTOM, PASSING OUT

Visiting cards, originated about 170 years ago when messages and names were scribbled on common playing cards and handed to a servant, are said to be passing out of use. This custom, which arose in Paris, became later to be considered crude, and was replaced by cards, engraved with pictures of landscapes, towers, and ruins, with space for written matter. The next development was to

have the name printed on the card with some special design instead of writing it, one sculptor using a drawing of a rough-hewn block of marble. A nobleman of the 18th century displayed his name in the midst of an Egyptian picture of pyramids and sphinxes, while a duchess announced herself by a card bearing an illustration of a Chinaman with streaming pigtail, leaning over a fence, pointing to her name. Nowadays, the calling card is not so important as it was in the latter part of the last century, when each visitor to a person's home dropped a highly engraved pasteboard on a polished metal plate as a social requirement.

FOLDING CEILING FAN IS PART OF LIGHTING FIXTURE

Ceiling fan and lighting fixture are combined in a recent invention. When not in use, the four large blades of the



Electric-Light Fixture That Combines Ceiling Fan, Showing Blades Out and When Not in Use

fan fold away out of sight in the ornamental metal part from which the electric lights hang. Starting of the motor swings them out into position. The fan was made to save ceiling space and provide a comfort for home or place of business that is artistic, and that must not be moved twice yearly.

☛ In the mines of India, 50,000 women are employed.

Pacific + Atlantic Photos, Inc., 35 Park Place, New York City

Kansas City Star July 21, 1913

*Santa Fe
Wichita, Kan.
Le Valle, 1807 + 1808
C.W. C.W. C.W.*

Ans. William Pelton
7133 S. Paulina St.

Edwin J. Anderson,
R. 300, 140 515.

POPULAR MECHANICS

Chicago's

H. Dearborn, Chicago

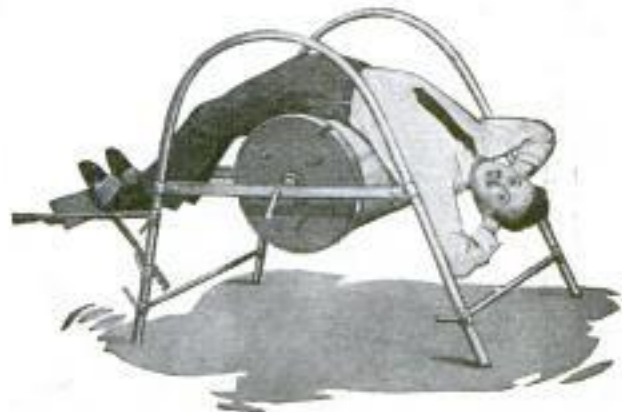
**NONSINKABLE BATHING SUIT
HAS POCKETS FOR AIR**

Made of rubberized silk, a bathing suit made with air pockets so it will float a person in the water, has been patented by a middle-western man. Because the air pockets are not filled until the swimmer gets into water above the knees, the suit looks like any other when worn on the beach. Lowering of the skirt into the water fills the upper part of the suit with air that remains until the wearer leaves the water.

3105

**ROLLING BARREL IN FRAME
HELPS IN KEEPING FIT**

To aid persons in keeping fit, an exercising machine made of a rolling cylinder mounted on a metal frame has been pat-

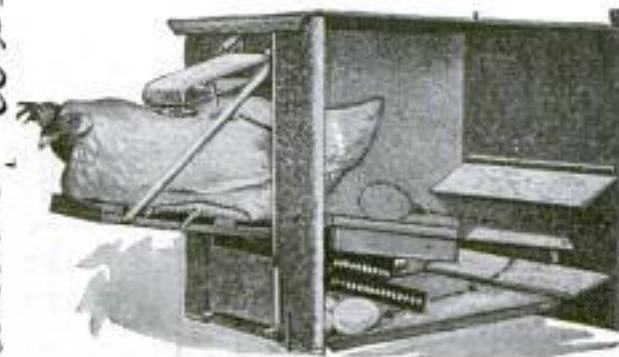


Exerciser That is Made to Cure Ailments and to Keep the Body Fit

**EGG COUNTER ON HEN'S BACK
KEEPS LAYING RECORD**

To make an individual record of the number of eggs each hen lays is the object of a recording nest patented by a middle-western man. The egg counter is carried on the hen's back, held firmly by leather straps fastened around the wings. Every time she leaves the nest, after laying, an egg rolls against a setting flap,

3063



Nest That Makes Separate Record of Eggs Laid: The Counter is Worn on Hen's Back

turning the dial to the next number. If no egg is laid, the flap does not move and the dial on the back remains unchanged. A shield prevents the counter from recording by contact with bushes and shrubbery.

**BOOTS MADE OF SHARK HIDE
USED BY FISHERMEN**

By fashioning the hides of sharks into hip-high boots, finished for use in the mountains or along the trout streams, a northwestern shoemaker has developed a flourishing business. Because the footwear gives such satisfactory service, its popularity is increasing rapidly, and there is a steadily growing demand for the raw product, not only for that industry but for furniture upholstery.

3086

**ENGINE IS CARRIED ON TRUCKS,
AS TRACK IS TOO WIDE**

In South America, where the railroads are built to more than one width, it is often a problem to transport equipment from the seaports to the inland lines. Recently a road in the interior received new locomotives, which had to be shipped

3075



Narrow-Gauge Locomotive Riding a Specially Built Truck for Shipment over Standard Track

to it over a standard, wide-gauge track. On specially built trucks, whose wheels fitted the wider rails, the engines were hauled 40 miles and set up on the narrow gauge.

Wash. A. J. Wriggall Co., Bldg. 167,
Lacrosse, Wis.

Kansas City Times
Ohio State Journal 7/13/23

Comb. George T. Paul
400 Ellisworth Bldg.
Chicago



How High Pressure Steam from Boilers is Used to Smother a Burning Oil Gusher, about Which a Wall of Sand Has Been Built to Dam the Flaming Flood

SECRET OF SUBMARINE REVEALED BY CAMERA

Interest in England's large submarine, the K-26, said to be able to cruise across the Atlantic without a stop, is revived

by the first pictures of the gigantic craft. Although great secrecy attended the launching, a newspaper photographer, by evading the guards, managed to take a snapshot of the event. Government agents failed to arrest him and then unsuccessfully searched his office for the plates. Within a few hours after the undersea boat had slid from the ways, the newspaper appeared with the photograph spread across the front page.



England's Latest and Largest Submarine Craft Undergoing Trials: Cruising on the Surface the Vessel Is Reported as Capable of Attaining a Speed Equal to That of the Average Ocean Liner

FIGHTING FIRE WITH STEAM SAVES MANY OIL WELLS

In the great oil fields of the West, where the ever-present danger of fire haunts the drillers, steam has been found to be one of the most effective means of combating the flames. As a flash of lightning, a spark from a piece of metal, or a lighted match, may start a blaze that will result in the destruction of millions of dollars' worth of property, ceaseless guard is maintained over the wells. Nevertheless, fires are frequent, and batteries of steam boilers are kept in readiness to fight them, as water would only aid their spread. When a gusher turns into a volcano of liquid fire, it is surrounded by a sand embankment to catch the blazing oil; then huge boilers are brought up, and jets of live steam are turned into the heart of the flames, slowly smothering them.

⊕ A section of inner tube makes an emergency substitute for a radiator hose.

PHONE NUMBERS ON A WHEEL ARE QUICKLY FOUND

To save time, a revolving telephone directory has been devised by a western railroad for attaching to the upright post of a telephone. The numbers are written on a slip of paper and pasted on the surface of a small, rotating wheel. Light and compact, for large establishments with private telephones, this contrivance also can be used for a record of departmental numbers.



COPYRIGHT, HARRIS & SWING

compressed in magazine
11 Broadway
New York City

Fluorite-Childs Corporation
Utica, N.Y.

3196

3181

directly



Spectacular Scene in Tableau at Paris Opera Ball in Which Beautiful Flower Fairies, Golden-Hued Birds, and Awe-Inspiring Dragons Sprang to Life at Summons from "Magician"

COPYRIGHT, THE ILLUSTRATED LONDON NEWS

2261 Cont. Hogg & Ford, 416 Union League Bldg.

POPULAR MECHANICS

519

Los Angeles, Calif.

IRON-ORE ISLAND TARGET FOR AIRPLANE BOMBS

In the Pacific Ocean, near the coast of Panama, the island of Tortola, about 5 acres in size and composed almost entirely of iron ore, has been set aside by the United States government as a bombing target for army airplanes. The rocks, virtually lumps of pure metal, keep

it from being destroyed by powerful explosions of the aerial bombs. Boats are prohibited from landing on the island or traveling within two miles of it. Launches patrolling the waters warn all craft, and a red flag, visible for miles, flies as a danger signal from the highest point.



Coast of Island Picked as Target for United States Airplane Bombers Because Explosions do Little Damage to the Five Acres Composed Almost Entirely of Iron Ore

FLOWER FAIRIES AND GOLDEN BIRD APPEAR AT BALL

3/103

With a dazzling costume ball that combined the mysticism of the Orient and the grace, the richness, the splendor of the French court before the Revolution, this season's social activities in Paris recently were brought to a close. Against a background of black, a stately King Louis XV and his court marched with royal dignity, a Pompadour was borne aloft by slaves, sailors of an early period swaggered by with backs laden with treasures from India, and the court and theaters of China, with a quaint display of finery, ended the procession. Posing as a Chinese sorcerer, a noted painter suddenly waved a magic wand and summoned flower fairies from the steps of a gigantic staircase. A fantastic golden bird, with iridescent plumage, leaped high into the air, and a great dragon swirled down to devour it.

At the reported price of 3,300,000 francs (about \$350,000), the Italian government recently purchased, for patriotic reasons, the famous D'Este Bible, an illuminated manuscript in two volumes. It was formerly among the possessions of the late Emperor Charles of Austria.

AUTO GROUND BETWEEN CARS, BUT SIX ESCAPE DEATH

3/23

Brooklyn

Wedged between two street cars, an auto was crushed to pieces recently in an accident in the East, yet no one was killed outright and one of the front headlights was not broken. The tires, front fender, radiator, one wheel, and a headlight were

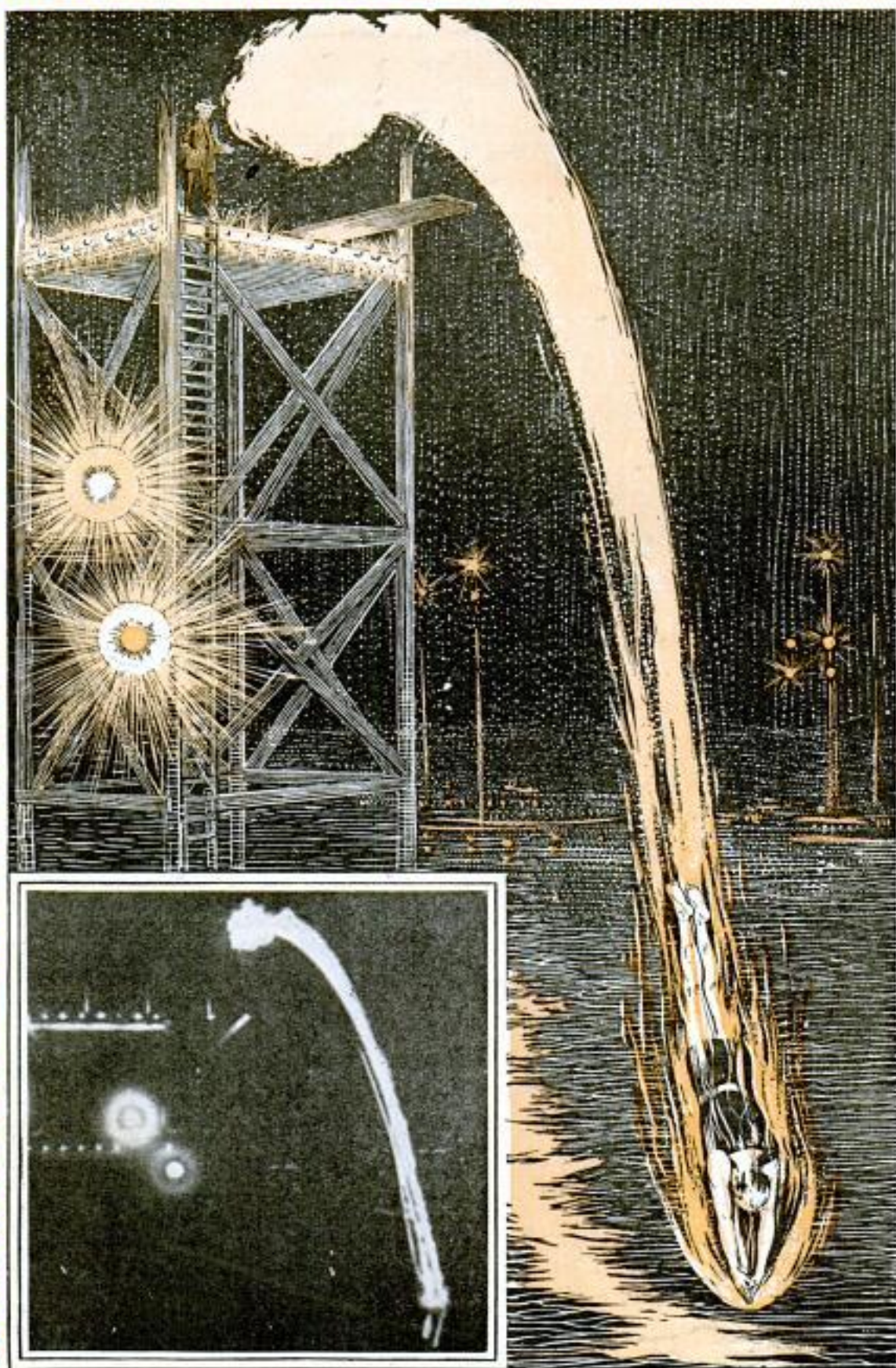


Auto That had been Crushed between Two Street Cars, Showing One Headlight Unbroken

the only parts not destroyed. The chassis was bent out of shape, the engine wrecked, and body ground up, but the glass of one light was not even cracked. Six persons in the machine escaped death, but were severely injured. The wrecked auto was an object lesson in safety first.

Brooklyn, N.Y.

Pacific & Atlantic Photos
25 Park Place
New York



"Fire Diver" Leaping into Water in Blazing, Gasoline-Soaked Suit, 1913. Below, How the Plunge Appeared to the Camera's Eye: He was Protected from the Flames by the Speed of the Leap

"FIRE DIVE" AT NIGHT THRILLS CROWDS OF WATCHERS

3015

To thrill crowds, an expert swimmer in a western city, wearing a burning gasoline-soaked canvas suit, dives through the darkness at night from a great height into the deep waters of a bay. The swift plunge of the flaming body in the so-called "fire dive" is somewhat comparable to the sight of the passing of a meteor. Photographers made some remarkable pictures by exposing the camera through the entire dive, from the applying of a match to sinking of the body.

ICE KEEPS FRUITS WARM IN WINTER SHIPPING

3112

Ice is used not only to keep fruits and vegetables cold, but also to prevent them from freezing while being shipped in cold climates. This is because ice is a poor conductor of either heat or cold and thus prevents the escape of heat that is furnished in railway refrigerator cars. Plain ice in large metal cylinders serves in winter, while a mixture of ice and salt is needed during the hot months to help cool the air.

FRYING PAN WITH GROOVES TO IMPROVE COOKING

3091

Designed to prevent the burning of food, a frying pan has been invented, the bottom of which has a series of circular grooves so that surplus fat, instead of being partly absorbed by the meat while it is cooking, runs into them. Thus fatty meats fry to a nice brown and are better



Cooking Surface of Frying Pan with Its Small Grooves That Catch Surplus Fat

prepared. The channels are easily cleaned, as the grease prevents anything from sticking to them.

Inventor: Hiram C. Hughes, 64 Brighton Ave., Allston, Mass.

AERIALS OF DE LUXE RADIO PLACED IN BALLROOM

3079

Radio is not so widely used in France as it is in the United States. Expense of the devices is one reason. There, sets are



Listening to Message from French Radio, the Sound Intensified by Plate on Pedestal at Right

made for use of the wealthy, who place them in the drawing room or ballroom, where they harmonize with costly furniture. One type is made to be placed on a table, the aerial being a ten-sided frame on top of the set. Close by, the magnifier is mounted on a 6-foot, ornately carved pedestal. This particular apparatus employs no outside wires.

FLYING FUR-BEARING ANIMAL REPORTED FOUND

3129

Without wings and heavier than air, a newly discovered type of fur-bearing animal, or bird that can fly, was reported recently to the French Zoological Society from the wilds of French Cochin China. About the size of a cat, the creatures are said to rise to a height of several yards by distending their stomachs until they appear like small balloons. Off the ground, they remain either motionless or slowly paddle themselves along with their webbed feet, not unlike the flight of a dragon fly, but lacking in its speed. The creatures have bills like ducks.

discovered by Jean Paul Christophe, Cochin-China.

*Conf. Edwin Sarsie Washington
The Harrington D.C.*

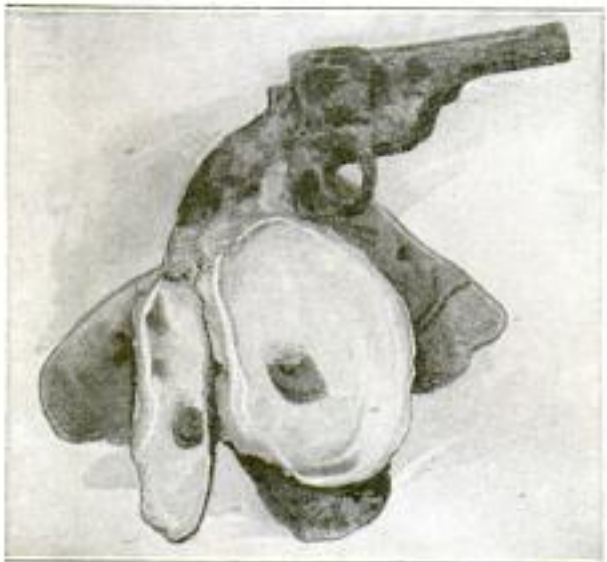
*Societe de Publications Radios. Techniques
98 Boulevard Haussmann, Paris*

Com. H. H. Shunn
2722 Bruce St,
Berkeley, Calif.

3197

522
POPULAR MECHANICS
OYSTERS ATTACHED TO GUN
ARE FOUND ON BEACH

Oysters attached to the butt of a rusty revolver were found recently on a beach in the South. They had taken several



Oysters Clinging to the Handle of a Loaded Revolver Thrown from Ship Years Ago

years to develop a firm grip on the weapon that probably had been thrown from a ship long ago. Although it contained cartridges, they could not be removed because of rust on the cylinder and in the chambers. The weapon is being shown in a museum.

BOOK COVER HIDES A VANITY CASE AND MANICURE SET

Manicure sets and vanity cases are now being combined in holders resembling books. When the cover is opened, the tools fitted in a folding roll, may be spread before the user. It can be kept on the dressing table or taken as a convenience when traveling about. The cover, decorated in the same way as ordinary volumes, can be fastened when closed.

3153

PATENT GIVEN TO THE PEOPLE

For the benefit of the public, the government has patented a water-resisting glue developed by one of its research departments. Any person may obtain the directions for its manufacture by applying to the bureau. It is an improvement on a glue made during the war by adding certain copper salts to the old formula, giving it more strength, resistance to moisture, and better working qualities.

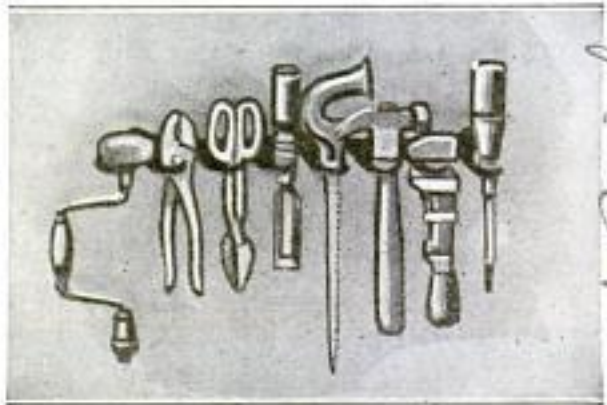
U. S. Forest Products Laboratory, Madison, Wis.

SOVIET PICTURE CARS DRAW INTEREST OF PEASANTS

Throughout Russia, the Soviet government's picture trains, designed to teach communism to great masses of illiterate farmers, have attracted much attention. Huge crowds greet the cars and show great interest in the drawings that cover the coaches inside and out. Lecturers and government officers use the illustrations to show that the workers fare better than they did under the czars. These trains have been placed on all railroads, so that most isolated sections are reached by them.

RACK-KEEPS TOOLS OR CLOTHES WITHIN EASY REACH

Tools that are easily mislaid or damaged by rough handling, can be protected when not in use, by a rack with hooks curved to the side, making it convenient to take down or replace articles quickly. The holder becomes a handy space-saver when attached to walls of garages and dwellings, or within reach of workbenches. By substituting it for nails and screws around bathrooms, and over kitchen sinks and tables, regularly needed



Space-Saving Rack That Keeps Tools within Reach and Protects Them against Damage

household utensils can be kept clean and safe from damage. Fastened to ceilings, the undersides of shelves, or in small closets, the rack offers a neat arrangement for hanging up clothing without danger of wrinkling.

Found recently in the Tonga Island of the South Pacific Ocean was a turtle supposed to have been left there in 1773 by Capt. James Cook, the English mariner. Its finder reported that it was blind and creaked like an oxcart when it moved.

N. Shure Co., Franklin Madison Chicago

Ernest Reich Co., 337 W. Madison Chicago



Remote Corners of the Former Land of Czars Are Reached by Agents of Russia's Bolsheviki Rulers in Trains Adorned with Picture Stories and Exhibits of Soviet Government

CITY-LOT FARM PAYS \$2,500 PROFIT YEARLY



Vegetables in this City-Lot Farm Grow in such Profusion That There Is Hardly Room to Move About without Stepping on Flowers or Plants

With almost wizardlike touches of the hoe and spade, combined with inventive ability, a retired business man of the West has turned his back yard into a fairylike garden producing more than 160 varieties of fruits, vegetables, nuts, and flowers, bringing him a return of about \$2,500 yearly. By an unusual arrangement of planting it is practically two gardens, one for small crops close to the ground, and another, elevated, for rambling plants.

Racks ranging from 10 to 40 feet in height support the vines of climbing plants. When one of these begins to form fruit, frames are erected to hold them well up in the air, where they receive plenty of sunlight.

A profitable section of the garden is that devoted to savory herbs, such as thyme, sage, caraway, dill, anis, wormwood, mint, and others, whose dried leaves and seeds are sold to druggists.

Crowded into this small space are 12 fruit trees, all bearing. Strawberries are grown in barrels to save space, while castor beans are planted in out-of-way corners, their stalks serving as climbing racks for beans and other vining vegetables. Twenty-five grapevines produce fine table grapes, for which the grower receives the highest market prices. Last year he sold 300 pounds of walnuts, 300 pounds of almonds, 350 pounds of

peaches, 150 pounds of apricots, 140 large navel oranges, which brought 10 cents each; cut 28 pumpkins and squashes, picked as high as 50 pounds of beans a day, gathered hundreds of melons, and then donated specially developed seeds, bulbs, cuttings, and roots to farmers' organizations and civic clubs.

Accurate crop rotation makes possible this heavy and varied yield. Before one crop has ceased to produce, another is planted between the rows of the first. Every summer the soil is treated with fertilizer and the upper crust removed.

MINING THE AIR FOR GAS "ORE" IS PROFITABLE INDUSTRY

From sinking shafts in the earth, engineers have advanced to "mining" the air for gases important in the commercial world. After liquefying the air by subjecting it to heavy pressure, the various elements are separated. Oxygen obtained in this manner is used in oxyacetylene torches for welding and cutting steel and iron. Nitrogen and argon are employed in filling incandescent lamps. Neon, one of the rare gases, which is very sensitive to electricity, is used for testing spark plugs and in the manufacture of electric signs. It is said that \$30,000,000 is invested in air-products plants in America.

Kansas City Star
July 28, 1923

Run by Paul A. Stude - Sacramento Calif.
% N. H. Slum, 29 23, Prince St, Berkeley, Calif.

Lot 40 x 151 ft.

U. S. ENLISTS SQUIRRELS' AID TO REFOREST TIMBERLAND

With the aid of squirrels, great areas of timberland in the Far West, lately burned over, are to be reforested by the government. At one time a price was set on the little animals' heads because they destroyed birds' eggs, but when the government offered to pay for green-pine cones, it was found that these could be obtained only with their help. The squirrels climb to the tops of the trees while the cones are still green, bite them off and carry them to nests from which they are taken by the forest rangers. When the government first obtained all the cones wanted, they were stored in a large warehouse that was destroyed by a fire originated by spontaneous combustion. Again the rangers went to the squirrels for help, and it was found that the animals stored the cones end to end to allow the passage of air. This arrangement was copied and no further trouble with fire was experienced. As a reward for their aid, the forestry service has ordered that only a few of the cones be taken and that others be left for the needs of the animal that gathered them.

PLANES RUN BY MUSIC ROLL WITHOUT AID OF PILOT

Without passenger or pilot, airplanes have been made to operate by means of an electrically controlled roll of paper perforated in the same manner as a music roll. With this device a plane has been started on a lone 20-mile flight, attained a height of almost a mile and a half at the end of the third mile, released a dummy bomb, circled for several miles, descended to 1,500 feet above the ground, snapped a photograph, and finally returned to its home station and negotiated a safe landing.

MAILS BAR IMPORTED BEES BECAUSE OF DISEASE

Because adult male honeybees are now subjected to a strange plague in many foreign lands, importing of bees through United States mails was forbidden by recent order. They may be sent in from Canada, though, because the government believes careful efforts are being made there to prevent spread of the plague. If for scientific purposes, special orders may be obtained, to permit sending them by mail.

ELECTRIC SCRAPER FOR SHIPS CLEANS SCALE AND RUST

For removing barnacles and rust from steel hulls of ships, an English inventor has designed a scraper driven by electric-



Scraping Rust-Coated Steel Plates of Ship's Hull with Machine Operated by Electricity

ity. Light in weight, it is easily held against the metal plates without exhausting the operator. Goggles must be worn for protecting the eyes from the fine particles it throws off.

BABY CRIB FOR TRAVELERS IS EASILY CARRIED

To overcome the difficulty of putting a baby to sleep in a strange bed, a collapsible crib that can be carried or shipped easily as part of the luggage, has been patented for travelers. When not in service, it folds into a compact package, 4 inches square and 40 inches long, weighing 40 pounds. To set it up or dismantle it, four thumbscrews in upright posts are loosened or tightened. As the sheets covering the framework are easily removed, and clean ones substituted, a sanitary bed may be provided for the baby at all times. Either of the long sides may be lowered, thus enabling the mother to place the crib against the side of her bed so that the child may sleep near her.

Once reckoned one of the fastest vessels of its type in the world, the "Glory of the Seas," a famous clipper ship, was burned on the beach near Seattle recently, after efforts to have it preserved as an historic relic had failed.

Experiments made in France

Aeronaute r. in air

Thomas H. Selfield

Anaconda Standard July 15, 1923

Tacoma Ledger July 28, 1923

Mr. Wright, inventor, The Stem Crib & Cradle Co., Gardner, Mass. No information as to address

FIVE HUNDRED DUCKS KILLED BY ONE SHOT

3229



Gun, Nine Feet Long with Inch and a Half Bore, That Kills Five Hundred Ducks at a Single Shot, Was Fowling Piece of Hunters Arrested by Federal Officers

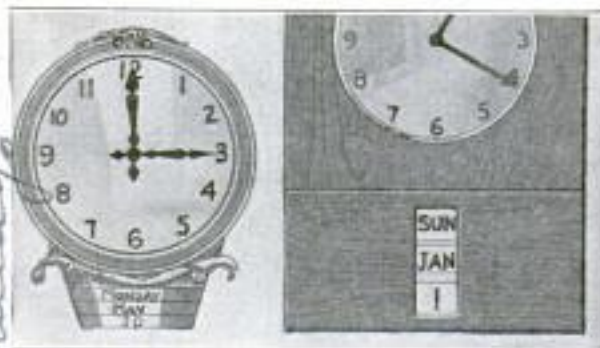
More than 500 ducks were killed by one shot from a nine-foot gun, similar in appearance to a muzzle-loading rifle, used illegally by poachers on an eastern river. It has an inch and a half bore and is discharged by a percussion cap. Under cover of darkness, the poachers would slip up on a flock of ducks feed-

ing along the river edge and blind them with a powerful searchlight. As the birds fluttered aimlessly about in the strong glare, the piece would be trained on them, a single shot bringing down hundreds. Government officials finally captured the law breakers after hiding for five nights in succession.

CALENDAR FOR CLOCK TELLS DATE, DAY, AND MONTH

3233

Although all months of the year do not contain the same number of days, a



Accurate Date Attachment Fitted to Clock to Give It Useful Features of a Calendar

date attachment for clocks, recently patented, overcomes that difficulty and makes it possible for a timepiece to automatically give not only the date, but the day of the week and the month. Any clock may be equipped with it. The device needs no regulating.

POUND OF SUGAR COSTS MORE THAN SOME JEWELS 3256

Sugars that cost from \$75 to \$375 per pound, because of the excessive care required to make them, are used in scientific laboratories. One is useful in detecting typhoid germs, as these tiny or-

ganisms multiply rapidly when feeding on it. A sugar, made from corn cobs, brings \$120 per pound, while another, manufactured from scraps left over in making vegetable buttons, sells for \$140.

SOAP IN NOZZLE SPRAY AIDS IN WASHING DISHES

3239

For quick and easy dishwashing, a nozzle that sprays either soapy or clear water, has been invented to connect with any faucet. Pressing a trigger above the handle causes a strong stream of soapy water to flow against a wire tray. Releasing it brings a spray of clean, hot



Pressing a Trigger at the Nozzle Causes this Dishwasher to Spray Soapy Water

water. It has no delicate mechanism to get out of order, needs no power, and does not require cleaning. The washer also may be used to cleanse vegetables.

Hygienic Mfg. Co.,
1128 Argyle Chicago

G. H. Proctor & Co.
6315 Parmell Ave.
Chicago

Detroit News
Aug 3, 1923

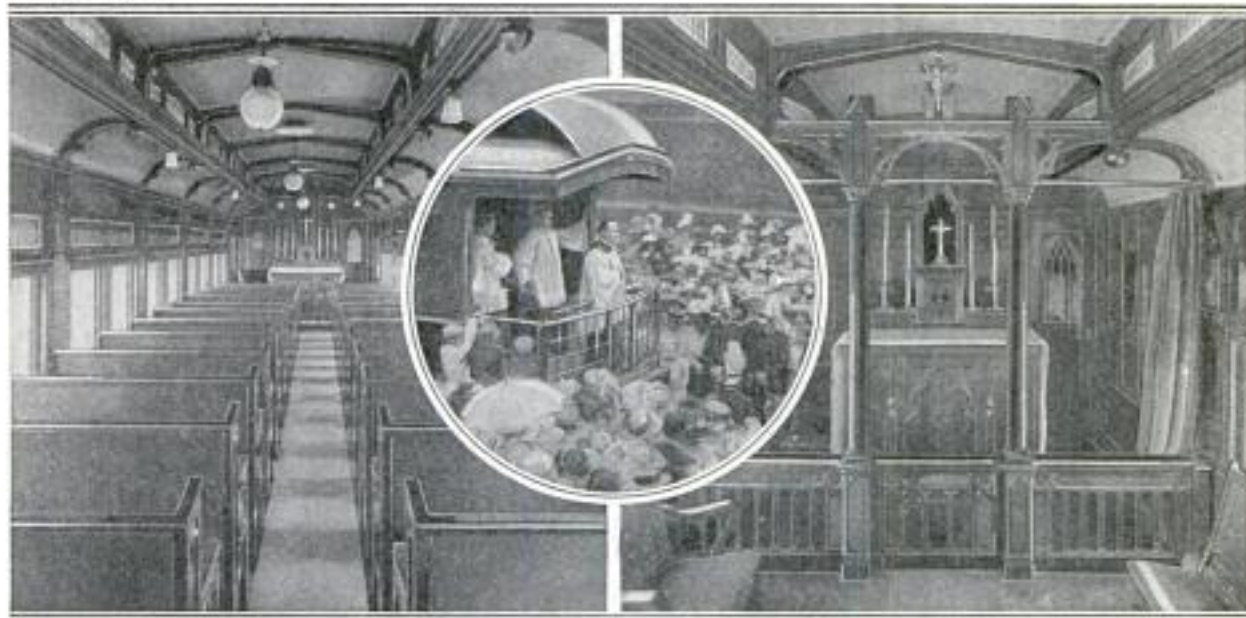
3200 The Barney + Smith Car Co,

General

POPULAR MECHANICS

Dayton, Ohio. 527

CHURCHES ON WHEELS CARRY RELIGION TO THOUSANDS



At Left: Pews of Traveling Church; Center: Missionaries Preaching to Crowd from Observation Platform; At Right: Altar and Sanctuary, Behind Which are the Living Quarters

Miniature churches on wheels are being used by a missionary society to carry forward its work in the sparsely settled sections of the United States. Already three railroad cars have been put in service in the South and West, visiting small towns that are churchless. One of these cars is 86 feet long and is equipped with pews for 75 persons as well as an

organ and other fixtures of a church. It is lighted by electricity, and running water is supplied by overhead tanks. The same organization is experimenting with a motor chapel, which, unlike those that have appeared in several foreign countries, is built on a trailer instead of being fastened directly to the frame, similar to the ordinary touring car.

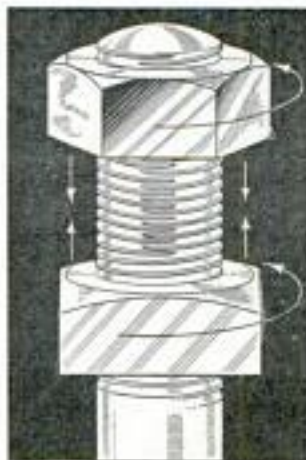
SAIL HITCHED TO WINDMILL
FIRST BY MISSIONARY 3/33

As a result of a missionary's observations nearly three quarters of a century ago, the manufacture of windmills has developed into a large industry. He originated the device that makes it possible to automatically regulate the speed of those machines. Stationed at the Bad River Indian reservation in northern Wisconsin, the clergyman needed a wind-driven pump to supply water for the post. Windmills of that day could not be kept into the wind, or the speed regulated. Noticing that the sail of a boat would swing into a position with the wind if unrestrained, he reasoned that a perpendicular saillike rudder fixed to the wheel, and mounted on a pivot, would keep it broadside to the air currents. From that idea came the modern windmill that often furnishes enough power to run several pieces of farm machinery, besides pumping the necessary water.

*Kansas City Star
Milwaukee Journal 7/8/13*

3756
NUTS ON DOUBLE LOCK BOLT
CANNOT WORK LOOSE

Unique in design, a recently patented bolt has two nuts, both of which turn in the same direction, but while one moves upward, the other goes downward until the two lock at the desired point. This movement is the result of the positions of the threads. Any pressure exerted on the nuts, either from above or below, only tends to lock them more firmly together. They afford the maximum amount of security when adjusted and are not affected by jars or vibration such as they would be subjected to on automobiles.



*Mr. Crossed
March Central Ave
Chicago
145
dmentor.*

1906



Facing Death in Wilds of Peru

BY J. T. EDWARDS JONES

Bloodsucking "Vampire"
and "Whisky-Faced"
Monkey



Editor of Publications, Field Museum, Chicago

STUNTED forests, cathedral-like caves, a jungle wilderness of beauty and of death far from the beaten paths of civilization, are described by explorers for Field Museum, Chicago, who recently returned from a 7,000-mile trip through the wilds of Peru.

Outlaw bands, strange Indian races that are said to eat their grandparents, bloodsucking bats known as "vampires," "whisky-faced" monkeys, "oil birds,"

and a curious rodent called the "dinomys," of which there is said to have been only one previous specimen on exhibition in the world, were encountered.

With the record of the hardships of his expedition written in the deep lines on his face and with his left arm in a black sling, slowly mending after four operations, Edmund Heller, companion of Theodore Roosevelt in the latter's explorations in Africa, told of the adventures he and his wife met with during their 14-



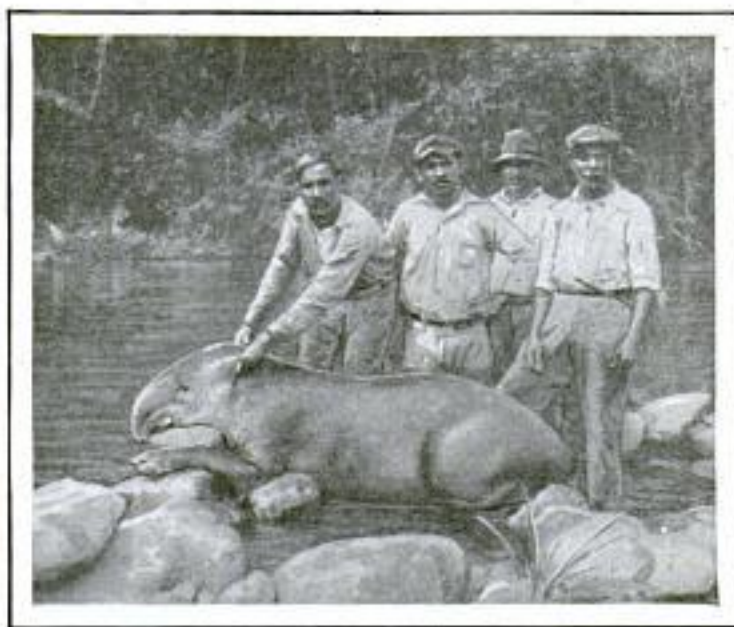
Edmund Heller and Rare "Rucupí" He Made into a Pet

month trip through one of the least-known and almost uninhabited regions of South America.

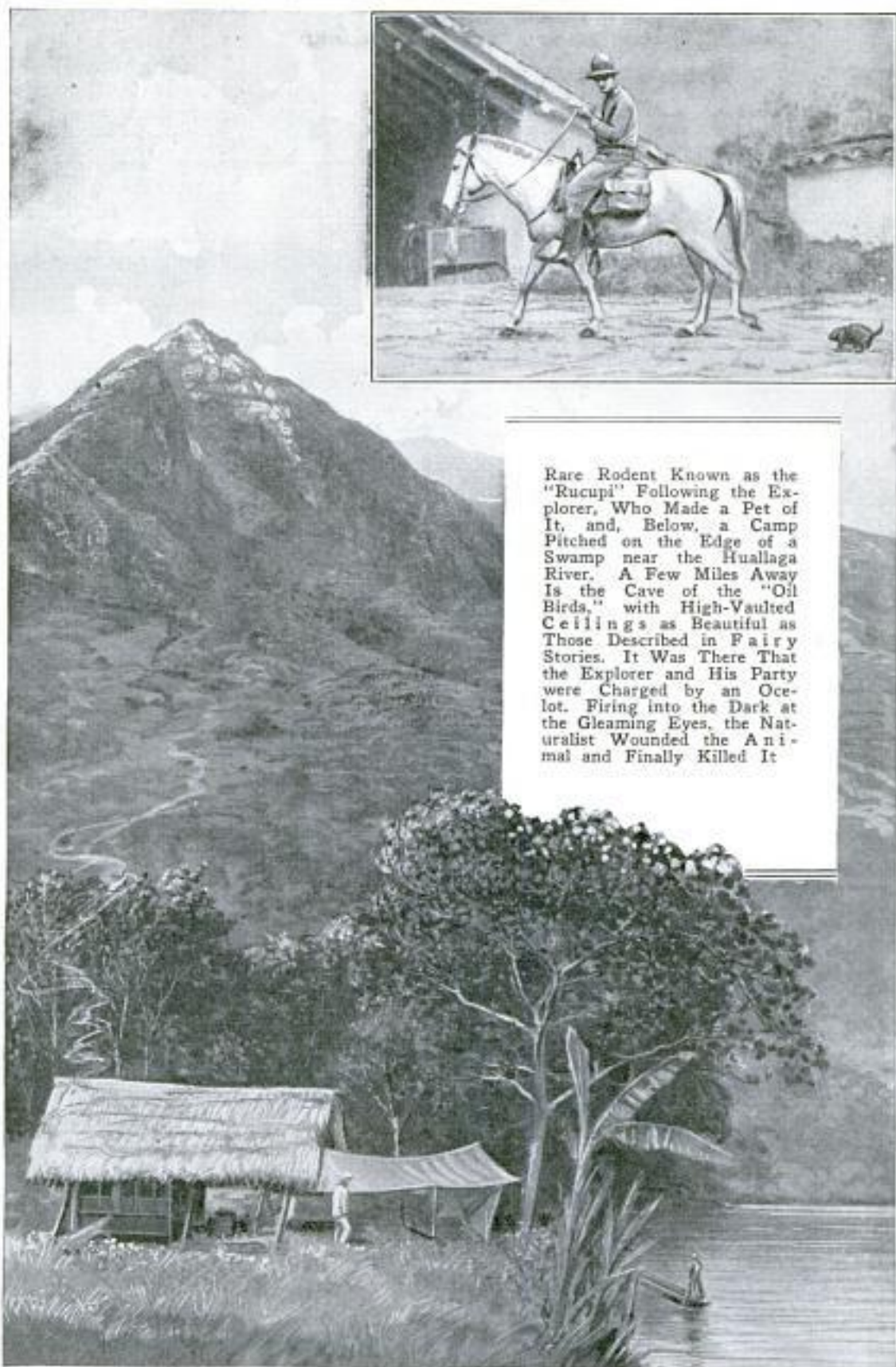
In his search for rare specimens for a middle-western museum, the two covered thousands of miles of trackless jungle, infested with numberless wild animals, and traversed countries where epidemics of terrible, nameless diseases had swept away almost the entire population. Sluggish tropical streams were forded in long, unwieldy dugouts un-

der canopies of rank vegetation through which the sunlight dripped like sewage through a filter.

Sometimes cutting a trail afoot through almost impenetrable forests, then riding pack mules down into sizzlingly hot jungles and on into cold moorlands where civilization ends, they made their way to a plateau elevated 12,000 feet above the sea level, where they found a tribe of Inca Indians who could not live in lower altitudes. Before



Tapir Killed in Forest Stream by Party of Explorers during Expedition in British Honduras



Rare Rodent Known as the "Rucupi" Following the Explorer, Who Made a Pet of It, and, Below, a Camp Pitched on the Edge of a Swamp near the Huallaga River. A Few Miles Away Is the Cave of the "Oil Birds," with High-Vaulted Ceilings as Beautiful as Those Described in Fairy Stories. It Was There That the Explorer and His Party were Charged by an Ocelot. Firing into the Dark at the Gleaming Eyes, the Naturalist Wounded the Animal and Finally Killed It

Snowcapped Peak of Lofty Andes Whose Slopes are Covered by Dense Forest, Inhabited by Descendants of the Incas, Who Cultivate Coca, from Which Cocaine is Extracted

surmounting the Andes, a group of outlaws was encountered. There were no laws and no taxes and most of the inhabitants were fugitive murderers.

"Their leader was quite a nice chap," declares Heller. "He had killed a few men, I understand, but he treated me very kindly."

In company with the bandit chief, he visited a cave inhabited by "oil birds."

"As beautiful as those in fairy tales," the explorer said, "the cave looked like a great cathedral inside. Birds—thousands of them—lived there."

In the darkest corner of the cavern, two flaming eyes stared out at the intruders. With a gasp, Heller raised his gun, which was loaded only with bird shot, and fired.

Before the thunderous echoes and the noise of invisible wings subsided, a furry shape rolled to the feet of the party. As they stared down, it moved and a native, armed only with a knife, jumped on it, slashing wildly.

When finally the animal was killed, it proved to be a large ocelot. Some of the birds that fell at the shot were seized by the guides and later squeezed to obtain something resembling olive oil. This was used for everything from rheumatism to food.

Then the march was continued through uninhabited wilds where it rains every day. Here was found an anteater that has a tail which it uses for an umbrella; a vampire bat that comes by night and sucks the blood from horses and other animals, and of human beings if it can find an arm or a nose sticking out from under the bedclothes.

Strange pets were encountered that ate and slept with the explorers. There were

opossums that lived among the luggage a small weasel that made its home in a stocking while traveling, the young "dinomys" which was called by the native name of "rucupi." Weighing 10 pounds, the latter was carried by the explorer, but, as it grew, a porter was provided, and later a horse, for its convenience.

In Para, Brazil, where the journey ended, one of the pets bit the explorer severely on the left forearm. Blood poison set in and for a time he was in danger of losing his arm.

Another scientist attached to the same museum, Karl P. Schmidt, who recently returned from a lengthy trip in the wilds of Honduras, tells of capturing a 5-foot crocodile with his bare hands.

After a long journey through dense tropical swamps, the scientist's party arrived at a small lake.

Peering through the undergrowth that surrounded the shore, the naturalist sighted a crocodile, and, armed only with a small-caliber rifle, hastily clambered into a clumsy dugout and paddled furiously after his quarry. The animal silently lowered itself from its log in the sun, bubbles of marsh gas on the slimy surface marking its tracks.

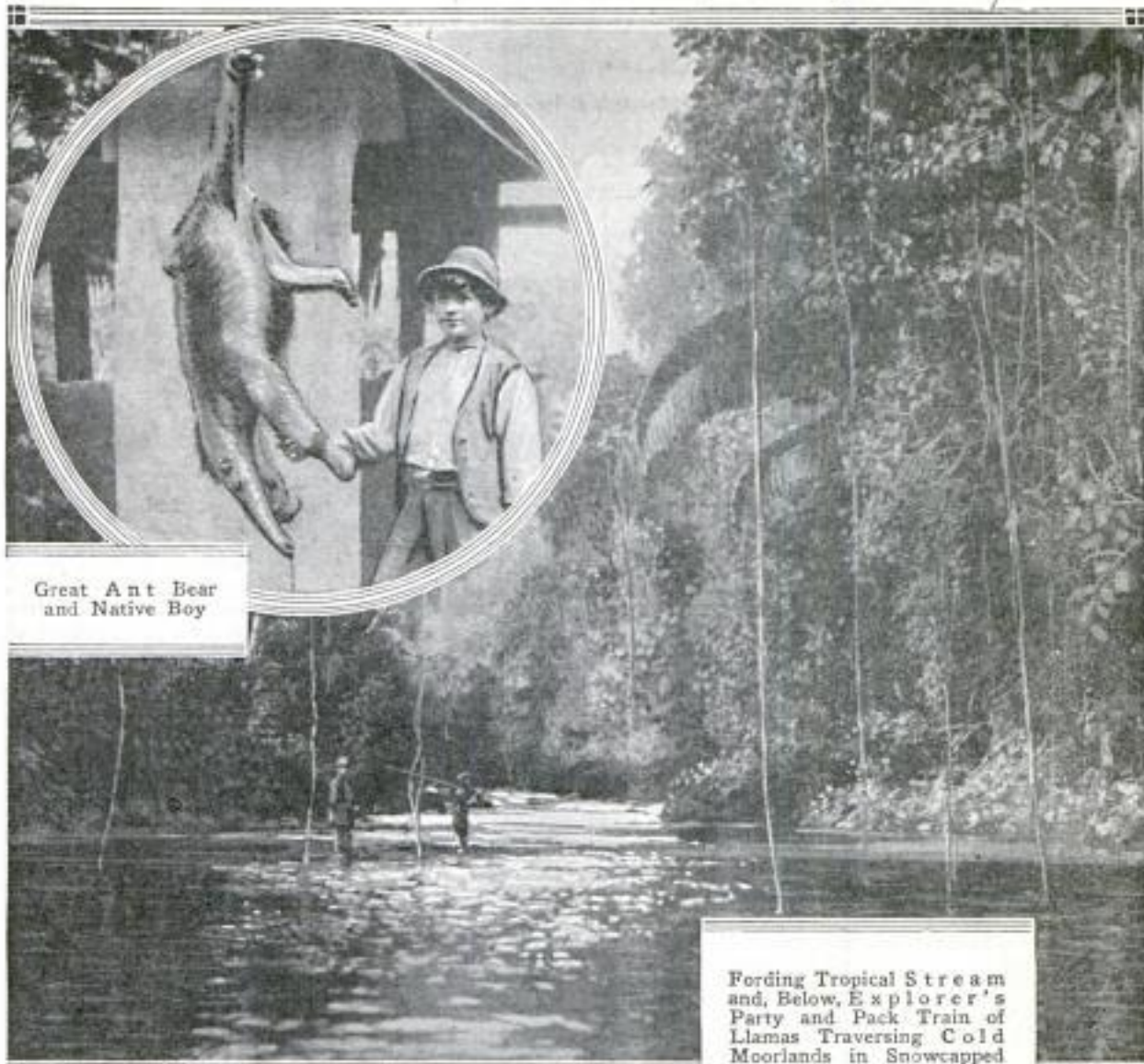
"Here he is!" shouted the hunter to his companions on shore. And the chase was on. Paddling rapidly, the lone canoeman kept within a few feet of the monster, prodding it continually with a long pole.

Suddenly, the vegetation parted at the bow of the canoe, a yawning snout was thrust forward, with its rows of hideous teeth. A hastily aimed shot missed—and the "croc" again slowly started to sink.

Throwing aside his light rifle, the explorer leaped into the shallow lake, grasped the creature and waded ashore.



Museum Scientists Examining the Gorgeous and Glittering Display of Two Trays Filled with Specimens of Many-Hued Humming Birds Gathered by Explorers during Trip to Central Peru



Great Ant Bear
and Native Boy

Fording Tropical Stream
and, Below, Explorer's
Party and Pack Train of
Llamas Traversing Cold
Moorlands in Snowcapped
Mountain Region

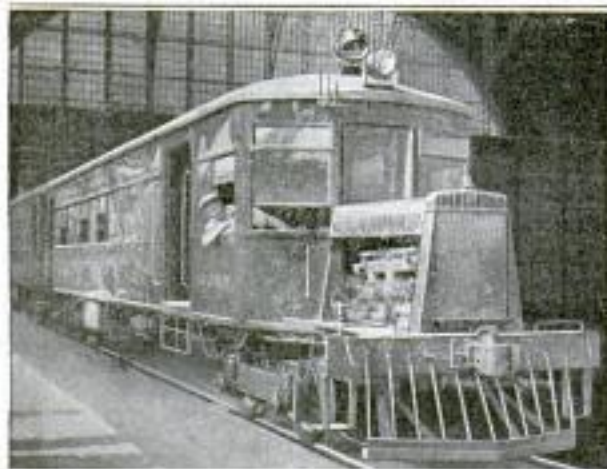


STEPS ON THROTTLE INSTEAD OF PULLING IT OPEN

3186

Chicago

To replace locomotives on short-line runs, a railroad in the central West has had constructed a specially designed gasoline engine, similar to that of an



COPYRIGHT, UNDERWOOD & UNDERWOOD

Gasoline Motor Train Designed to Replace Steam Equipment on a Railroad's Branch Lines

automobile, that is capable of pulling two steel coaches at a speed of 70 miles an hour. One of the cars is entirely for passengers while the other is divided into the engineer's cab, a baggage room, and a smoking compartment. Officials of the road assert that this equipment provides better service to patrons off the main line.

CITY BURIED BY DESERT SAND YIELDS ANCIENT CULTURE

3143

In search of additional traces of an ancient civilization, a Russian explorer who discovered the city of Kara-Khoto in the shifting sands of the Mongolian desert, recently announced his intention to lead a second expedition through that section and Tibet. While outlining the plans of this venture, the scientist related the difficulties encountered on his first trip. For years there had been rumors of a dead city, abandoned by its inhabitants centuries ago. Nomadic tribes were suspicious and declined to help. Working patiently, however, the explorers employed a Mongolian to travel about in that region in the guise of a merchant in an effort to obtain information. The natives shunned this representative of the foreigners until a storm one night compelled him to camp near the buried city, although he was unaware of the fact. After that, no more trouble was experienced, as the natives regarded that incident as an indication of the favorable

attitude of their gods. Although the ruins of streets and houses had been worn down by wave after wave of traveling sand hills, many remains of Buddhist temples, Mohammedan mosques, packages of Chinese paper money, inscribed with threats of death for counterfeiters, silver ornaments and coins, all apparently carefully hidden by the original owners, were found. Outside the walls was a cone-shaped monument containing a library of 2,000 books, written in seven Eastern languages. Other relics helped to substantiate legends about the fate of the inhabitants. In the thirteenth or fourteenth century, the Chinese sent an army to capture Kara-Khoto. The siege waged for years until a Chinese engineer conceived the scheme of blocking the river that flowed through the city and gave the inhabitants their water supply. Bags of sand were thrown across its channel and the course diverted. The besieged, frantic from thirst, sought water by digging a well within the walls. But that failed. Then in desperation, the chief ordered the populace to bury their treasures and killed his wife and daughter with his own hand. In the battle that followed all the inhabitants were mercilessly slain by their foes.

HURDLE RACING FOR DOGS

IS POPULAR SPORT

Matching greyhounds, the speed kings of dogdom, in hurdle races has become a popular sport. Throughout the United States there are many kennels devoted almost exclusively to the raising of these fleet creatures for the racetrack. At a



Racing Greyhounds Taking a Hurdle in Their Swift Flight Around Racetrack

recent meeting in an eastern city, greyhounds from all parts of the country participated in what was termed a world's championship contest.

International Newsreel

326 W. Madison

Copyrighted Material

Chicago

Atlantic City Dog Race Track

N.Y. Times 7/22/23

**SHIP FOUND ON BIG ICEBERG
REVEALS MYSTERY OF SEA**

For centuries mystery ships have sailed the seas, guided only by the winds of chance. One of them was found by a steamer captain rounding the Horn recently. While groping his way into the open, a gigantic mass of ice carrying a large three masted schooner, with its boats still in the clefts, was sighted. Efforts were made to find the survivors but no trace of them was discovered. Another sea tragedy was added to the already long list of those as yet unsolved when a Greenland whaler came upon a strange looking derelict, battered and weather-worn, apparently built in the last century and ice bound for years. A boarding crew found in the cabin the body of a young woman, preserved by the arctic frosts. Near a long dead fire was the remains of a young man, still holding a flint and steel.

**PETRIFIED FOREST, MILLIONS
OF YEARS OLD, FOUND**

Millions of years old, petrified trees, presumably the remains of a forest of 2,000 acres or more, have been excavated in the vicinity of Pikes Peak, Colorado, at an altitude of 8,000 feet above sea level. The trees are covered with a strata of volcanic ashes and lava and appear similar to the redwoods of California, which flourish at an altitude of 2,000 feet. The theory has been advanced that when the Rocky Mountain range was formed by expansion of the earth's crust, the ex-



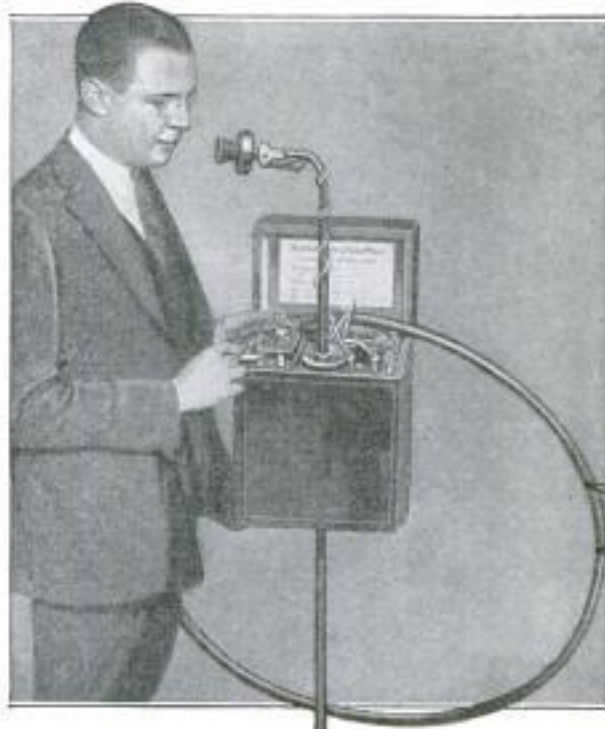
COURTESY C. P. WHITNEY
Shattered, Petrified Stump of One of Giant Trees Which Flourished Ages Ago

isting mountains in this locality were elevated another 6,000 feet, and that Pikes Peak, then a crater, turned loose a destructive flow of fiery liquid which leveled the forest.

Critchell Miller
Wiggins & Barboza
insurance to change Pldy

**TALKING THROUGH SEA EASY
WITH WIRELESS PHONE**

Talking through solid stone walls from submerged submarines or from below the earth's surface, is said to be possible



Radiotelephone That Carries Voice through Earth, Water, or Stone without Use of Aerial

by means of a radiophone invented recently. Use of the instrument, it is believed, will reduce the hazards of underground and undersea work that have caused the loss of hundreds of lives in the past. Entombed miners or laborers entrapped in fallen caissons, men engaged in the building of tubes under water, and crews of disabled submersibles, will be able to direct the work of rescue with the device. Simply constructed, it requires no aerial or ground and is so compact that it may be carried easily. Power is supplied by small dry batteries which operate novel transformers, these generating the electric waves. It has a range of 200 feet under ground.

SO OIL TRUCKS CAN'T EXPLODE

To carry away static electricity from oil trucks and thus lessen the possibility of explosions, iron chains that dangle to the ground are fastened to the frames. The same principle is applied to oil pumps.

CA crutch tip on the head of a hammer serves as a rubber mallet.

Bernays Johnson
485
Barrow Dig
Sh. Newark
Kansas City Times
July 25, 1923

Dr. W. Graves

534

900 E. Jersey
Eliz. Street N.J.

MECHANICS

ONE-MAN ADJUSTABLE SAW WEIGHS BUT SIX POUNDS

Folding into a small space and weighing only 6 pounds, a one-man saw recently invented is provided with a handle adjustable to almost any angle. It per-



Woodman Using One-Man Saw Constructed So He Can Work in Upright Position

mits the worker to stand erect, thus doing away with tiring strains. Hand grips attached to the frame may be moved back and forth to meet requirements. When not in use, the saw may be folded up and carried easily.

WEIRD DRUG CULT IS DYING OUT IN THE FAR WEST *3146*

Chewing peyote, found in the top of the spineless cactus, is said to make members of an Indian cult confess their sins. For 20 years the cult, known as Peyotism, now passing out of existence, has been a picturesque religion in the West. Their rites are conducted while the members are under the influence of the drug. A ne'er-do-well of the Indians, who became a victim of the peyote habit, introduced the religion to his people after weird visions had come to him while under the influence of the drug.

WORLD'S OLDEST LIVING THING SAVED BY HIGHWAY *3160*

Construction of a highway is preserving for future generations the oldest living things on earth—the big trees of California. The Redwood Highway, the first links of which have been opened to travel, is to pass through the forests and groves of redwood that still dot the Coast Range mountain country, where it is believed the giants began to grow before the dawn of Christianity.

By reserving some in national parks and forest preserves, the government has saved many of the groves from the lumberman's ax, and at the same time provided places of interest for the tourist. Protective organizations that turn over each grove as rapidly as funds can be raised to buy it, to the state, have found most of their aid coming from the motorists who see and admire the big redwood trees while traveling over the roads passing through them.

This tree grows about 30 feet in its first 10 years, and thereafter very slowly, until at the age of 60 years it is only about 60 feet high and not more than 14 inches in diameter. They are believed to have required from 10 to 20 centuries to reach the present size.

ARROW POISON TO KILL BUGS IN PLACE OF NICOTINE

3148
From the tuba root, formerly the source of a death-dealing poison with which the "wild men of Borneo" coated their spear heads, and which is still used in the Malay states for killing fish, scientists have developed an insecticide reported to be a substitute for nicotine. Although the plant is poisonous to man as well as insects and animals, the experts hope to extend its use to relieve the shortage of bug-destroying drugs. The fatal fluid is crushed from the green stems, or drawn from the dry roots with chemicals.

WIRELESS RAY CONTROLS BOMB TO BLOW UP BATTLESHIPS *3245*

Touched off by a radio ray, a bomb has been invented that is powerful enough to blow up a battleship. It is said to be so small that one could be



Blowing Up a Miniature Battleship with a Bomb Fired by a Special Wireless Wave

carried aboard without detection, and, after concealment, exploded by a special wireless wave released many miles away.

Chas. Bernays Johnson

For cutting wild wood, aged wood, pine wood, R. trees, mine props.
Indianapolis News July 24, 1923

3096 Underwoods' news photo -
Service 205 W. Washington
Chicago

Hundreds of Radios Are Used to Broadcast Weather for Millions of Persons

Farmers, Sailors, and Shippers Are Protected by Government Service That Sends Out Warnings of Approaching Storms

SO vast has been the progress of radio development that now its swift energy is being harnessed to broadcast weather reports, resulting in untold savings for farmers and shippers, and adding to the safety of navigation. Government experts were quick to see the importance of a recent report that 573 broadcasting stations had sprung up throughout the country, and that between 2,000,000 and 3,000,000 people "listened in" daily. Only one state, Mississippi, is without a broadcasting station.

As a result, it has been planned to extend perhaps the greatest weather-broadcasting service in the world. Already more

than 150 stations are sending out weather news, and the number is being increased daily in response to demands from both rural communities and cities. Besides the larger stations, there are many smaller ones that pick up the reports and pass them along.

From the great naval plant at Arlington, the wireless telephone sends out forecasts three times every day. From others there are two reports daily, one in the morning and another at night. So interested are the farmers in the service, that they have sent in many demands for it to be speeded up.

"Can't you folks get the weather here before I have to go to bed?" one rural citizen in Minnesota wrote to his congressman.

Investigation disclosed that he had been receiving the reports every night at 10:05 o'clock on a homemade radio "set"



PHOTOS COPYRIGHT, UNDERWOOD & UNDERWOOD

Sending Standard Time by Radio from Naval Observatory: Above, One of the Balloons Sent Up Daily from Many Stations to Chart the Upper Air for Weather Forecasters

built and operated by his young son.

To help those who retire early, efforts are being made to get the forecasts out before bedtime, but, because of the large amount of work required to make them up, it has proven quite difficult.

Surrounded by many strange instruments, the government scientists watch the progress of storms, cyclones, cold waves, and hurricanes moving across the country or approaching it from the sea. As a result, they are now able to predict floods as much as ten days or two weeks before they happen.

One of the latest developments has been the charting daily of the upper-air currents thousands of feet above the earth's surface. This is done with toy balloons that sometimes reach a height of several miles. Besides being of value in making general forecasts, the results of these experiments have proved of great aid to aviators, enabling them to pick air levels where winds are favorable to their journeys.

Weather maps made up every morning and night show the results of hundreds of reports sent into five forecasting centers by telegraph. Information from ships received by wireless also is used in charting the course of storms before they reach the seacoast. Experts regard the wind's force and direction as the principal factor in making their predictions.

By charting the high and low pressure areas as they exist in all parts of the country at a given time, and knowing the cloud movements, changes that will take place in any section within 36 hours can be told with the greatest accuracy.

"Will next week be good haying weather?" the farmer wants to know, and the answer is sent to him, wherever he may be, by radiophone twice a day.

"Will orchard heaters be needed tonight?" the vineyard owner inquires before retiring, and looks at the map he has received by rural delivery that day to find out.

"What degree of cold must I protect this citrus fruit against?" the western shipper wonders, and the reply comes in

an instant over the telephone he uses to connect him with the nearest weather man.

These are but a few of the ceaseless activities of the weather bureau in protecting the lives and property of the citizens of every community.

Warnings have been sounded by the weather man from 12 to 24 hours in advance of every big storm on the Great Lakes or ocean coasts of the United States for many years.

Eighty-eight and four-tenths per cent of the daily forecasts are accurate predictions of conditions 36 hours later, and scientists are seeking, by use of new methods, to make them more exact.

Delicate instruments record the duration of sunshine, and whirling thermometers, with wet and dry tubes, measure humidity of the air. Anemometers show velocity of the wind, and gauges register the amount of rainfall.

The barometer and a device, called an aneroid barograph, indicate air pressure. Sitting in his office, the scientist can read the outdoor temperature on a telethermograph that rests on his desk. Some of the stations use a triple register to record sunshine, rainfall, and speed and direction of wind.

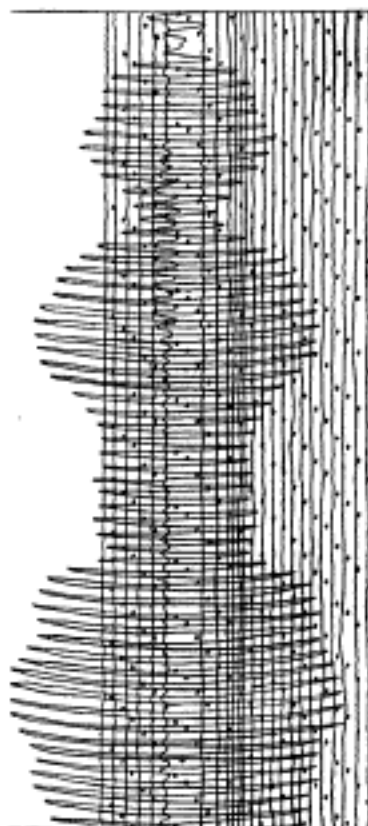
Areas of high and low air pressure are foretold when the scientists know at what speed and in what direction winds are moving. This information is received from hundreds of observers and charted on the weather

maps and in the records.

Study of cloud movements and careful comparisons of maps showing weather for several days past, are used as a basis for the forecast.

Most of the weather in the United States, according to government observers, comes from Canada. Because of its central location on the continent, Medicine Hat is noted for the storms which have had their origin there.

As far back as the records go, however, it is declared that there has been no perceptible change in the weather of the nation, either in the heat of the summers generally, or the severity of the winters.

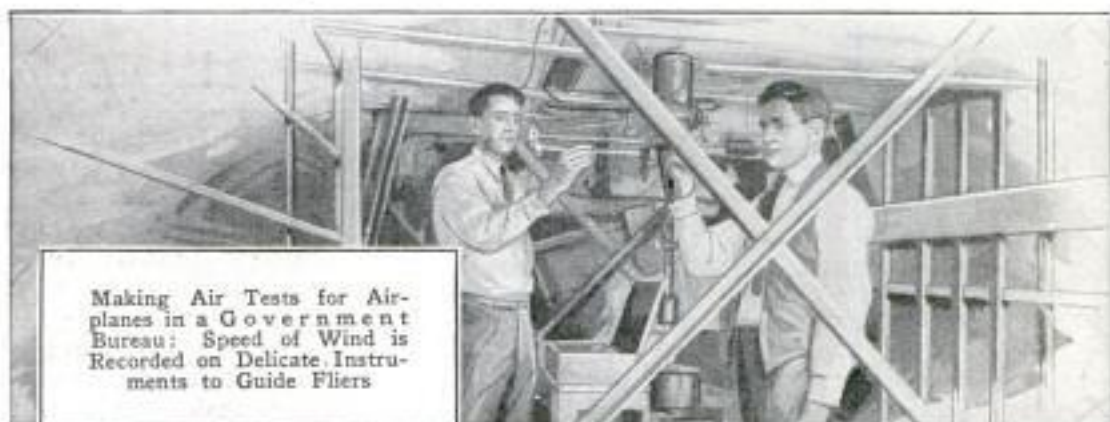


COPYRIGHT, UNDERWOOD & UNDERWOOD
Record of Earthquake in Rome
Made on Instrument in Chicago

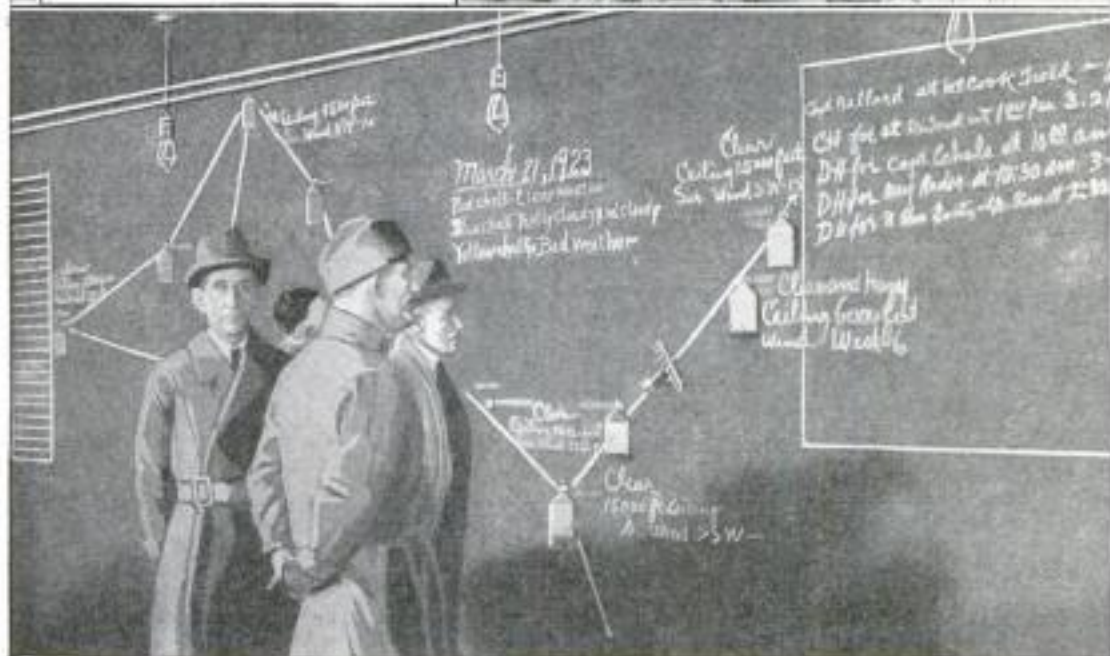
MAKING THE WEATHER FOR NATION'S MILLIONS



Left to Right: Barometer to Record Air Pressure; Inventor with Machine That Predicts Tides; Measuring Rain and Snowfall



Making Air Tests for Airplanes in a Government Bureau: Speed of Wind is Recorded on Delicate Instruments to Guide Fliers



Where Radio Reports on Weather Conditions Aloft at Various Flying Fields and Airplane Routes are Recorded with Chart, Showing Location of All United States Army Fliers

**CROSS IS MADE WITH PINS
TO REPRESENT JEWELS**

323

Although 92 years old and an inmate of a home for the aged, a western man



Reproduction of a Famous Jeweled Holy Cross Studded with Thousands of Pins

recently completed a reproduction of a famous jeweled cross, using colored pin-heads to represent the precious stones inlaid in the original. More than 15,000 pins were required in its making, each carefully placed to follow the design of the original. Weeks of painstaking effort were necessary, yet the finished article was exact in every detail, even to the intricate patterns formed by the priceless gems. Brooches set with clear and colored glass were used to represent diamonds, rubies, and amethysts, while opaque-headed pins served as pearls.

**ELECTRICITY TO AID IN WAR
AGAINST BOLL-WEEVIL**

3154

Electricity is the latest weapon of science to be used in the effort to exterminate the boll weevil in the cotton states. With its aid, cheaper methods have been devised for producing a poison that has proved deadly to the insects. Heretofore, it is reported, the supply has been short and the product expensive, since nitric acid, one of the principal chemicals in the old mixtures, has fluctuated considerably in price. With these two drawbacks eliminated, the experts expect the insecticide to become more

popular, resulting in larger yields and fewer losses. It is estimated that 700,000,000 pounds are needed annually, yet only 30,000,000 pounds are now used. The boll weevil first came to the United States from Mexico, and within 15 years has spread throughout the South. Authorities figure that the annual damage caused by its ravages amounts to almost 400,000,000 dollars.

**ONE MAN'S INVENTIONS KEEP
MILLION PERSONS BUSY**

3174

Through the inventive ability of Thomas A. Edison, nearly 1,000,000 men and women in America alone, it is estimated, are furnished steady employment. For the most part, the work is clean and wholesome and the employes well paid. Thousands are engaged in the manufacture of electric-light bulbs, one of his greatest discoveries, and in making phonographs and other devices.

DIG NEW BED FOR ISAR RIVER

3172

By changing the course of the Middle Isar River, Bavaria expects to make possible the development of an electric current totaling 480,000,000 watt hours a year, an output that will put the plant among the largest of the world. It is estimated that this use of water power will result in a saving of 500,000 tons of coal annually. In digging the river's new channel, 7,000 men were employed.

CRANKLESS FREEZER FOR ICE

3218 CREAM SAVES LABOR

In a crankless ice-cream freezer now on the market, ice and salt are packed around the cream can and also in a metal tube that extends through the mixture. In this way cold comes from all angles, making the double freezing even. Because of its lightness, the freezer can be carried on autos and to picnics. Freezing takes place in about an hour and 15 minutes for cream.



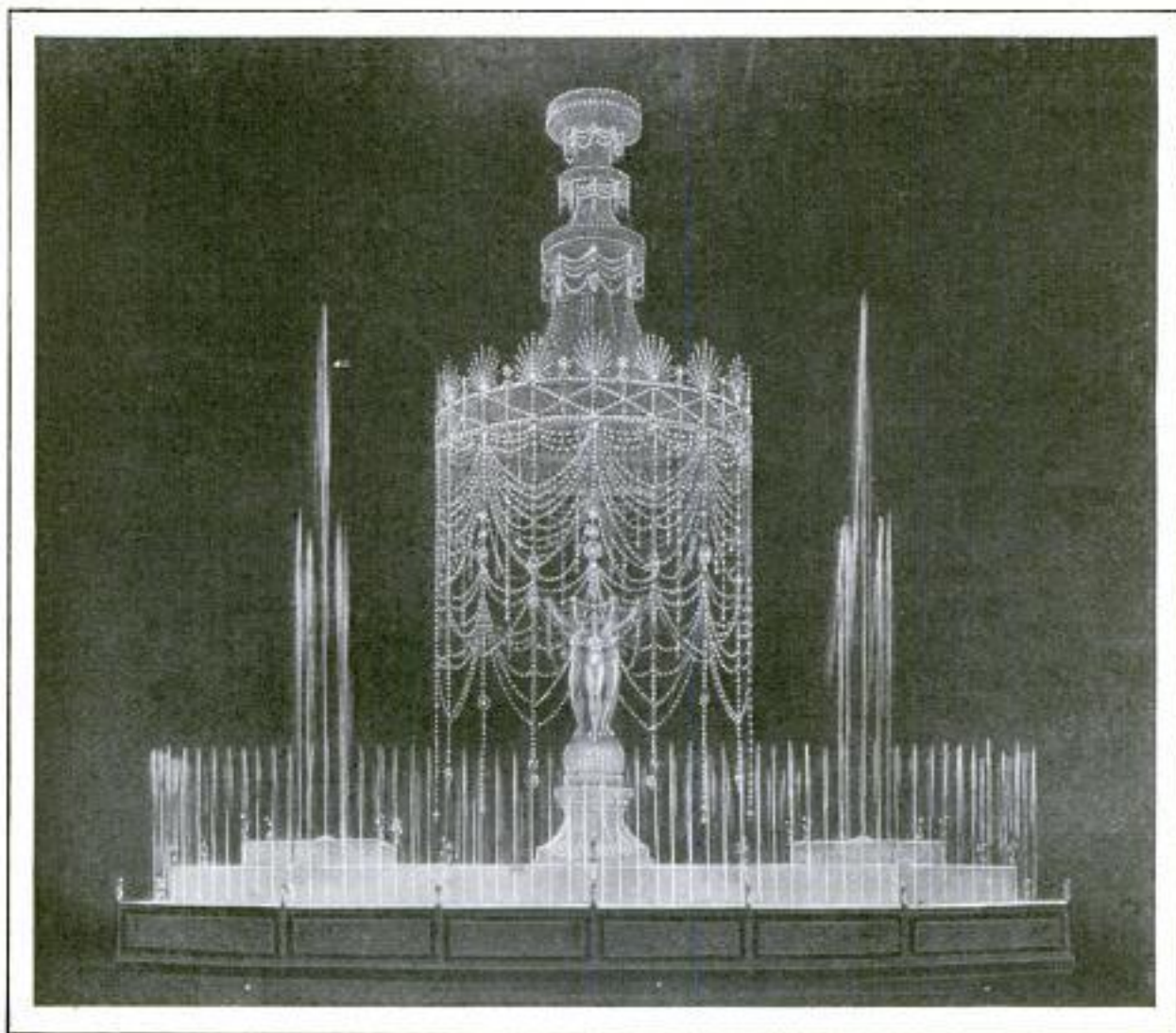
National Manufacturers Sales Co., 6 S. Lake Chicago

Experiment made by General Electric Co., Schenectady, N.Y.

FORTY SEARCHLIGHTS EQUAL MILLIONS OF CANDLES

During a celebration in a midwest city, 40 big searchlights throwing 450 million candlepower of light, were used to illuminate the place at night. Towers 90 feet high, each festooned with 50,000 crystals, shed floods of dazzling splendor, rivaling the rainbow in gorgeousness.

Around the bases of these minarets, a forest of water jets seemed to spurt liquid light into the air, and sparkled under the spangled hues cast upon them from the jeweled draperies above, while electrical displays were used to strengthen the effect of the crystal designs.



Jeweled Minaret Draped with 50,000 Crystals That Reflect Floods of Rainbow Tints: Water Jets Serve to Give It an Appearance of a Fountain of Liquid Colors

SOFT CORAL ROCK HARDENS WHEN USED IN HOUSES

Houses in the Bermuda Islands with walls of coral rock are cool and fireproof. The substance is a poor conductor of heat. Slabs for roofing are made waterproof by being covered with a coat of asphalt or tar and then whitewashed. Because under the surface the rock is almost as soft as cheese, though it looks like a chalky limestone, it can be cut with primitive tools. It is quarried in blocks

6 feet square and several feet deep, and broken off with a strong pole. Natives with big saws cut these pieces into various sizes for building. When exposed to air they become hardened. If in contact with weather for some time, the rock breaks into pieces, but when used for interior walls, it is said to be ideal, as it keeps out heat and is fireproof.

It is a generally accepted rule that the more brilliant the color of a flower, the less fragrant its perfume.

3/30
 Com. George T. Paul
 900 Ellsworth Bldg, Chicago

3082 Capt. Robert H. Inoulton,
Room 2. Board of Trade, Chicago



Passing of the Lumberjack Recalls Heroic Drama of the Woods

Days of Rawhide for Leather, Buckskin for Cloth, and Venison for Beef, Are
Followed by Chugging Switch Engines, Portable Sawmills,
Electric Lights, and the Radio

AS heroic and romantic a figure as the scout, trapper, or Indian of frontier days, the lumberjack is fast fading from the screen of American life.

Wars, raids, and feuds of one camp against another, where iron fists, backed with 190 pounds of muscle, took part in free-for-all, knock-down-and-drag-out, kicking, and gouging battles, have passed into memories of an age that is rapidly passing away.

In the vast solemn forests of the North and West, the ring of the ax is still heard, flexible ribbons of steel sing as they bite through the pine under the graceful swing of powerful shoulders, and the "Hi! yup!" cry of the teamsters echoes through the thickets of birch and balsam.

But above it all comes the shriek of a switch engine, the shrill whine of a circular saw tearing apart the logs, and in the clearings are ugly frame buildings covered with tar paper and equipped with electric lights, phonographs, the latest magazines, and radio sets, that have replaced the picturesque log camps of former days.

Although the twentieth-century lumberjack is pretty much the same kind of a man that he was thirty or forty years

ago, when logging was at its zenith, he has been surrounded by the comforts of civilization, and, as a type, is rapidly disappearing, like the forests he loved, before a machine-made civilization.

Stalwart, powerful, self-reliant, bold, he is the same masterful man of the woods as of old, juggling with death a dozen times a day, tugging and straining with his peavey under a tangled wall of timber, behind which presses the full power of a spring freshet, jumping with the agility of a cat from one bit of unstable timber to another when the first sharp crack warns him that the mass is about to break down on him like a wave on the shore.

With quiet, humorous eyes that smile a challenge, and movements as quick and certain as a panther's, he still rides logs down rapids where loss of balance means injury or death under some following battering ram, and pries at key logs in the rollways on the banks of a stream, until the whole pile begins to rattle down like a cascade, forcing him to jump, ride, or even dive, to safety.

But as forests are turned into miles of dreary stubble, the ranks of the old-time woodsmen are thinning and the days

SPLITTING FALLEN MONARCH OF THE FORESTS



After It Is Down, the Hemlock Giant is Divided by the Spreader and Cut into Smaller Logs That Are Easier to Transport to the Railroad Siding for Shipping

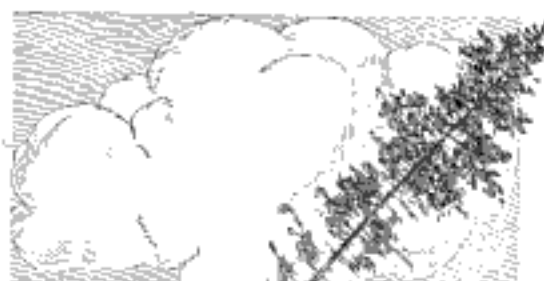
3082
when the "gang" boiled into some little lumber town on a "jamboree" are gone forever.

Having proved his ability to work untiringly in great extremes of temperature, to master the science of "felling" trees so they will not damage those still standing, or shoot down mountain sides, the man who bears the proud, but ugly, name of "hick," looks with scorn on the clumsy alien laborers who follow him and cut out the small "paper" wood after the hemlock, birch, maple, beech, and poplar trees have been disposed of.

While cutting methods have changed greatly in the past score of years, the lumberjack must still be able and willing to find his place in the forests on dark winter mornings when the thermometer is down to 30 degrees below zero. Two of the oldest of hand tools, the wedge and the ax, are still leading devices in his art. It is true that the cross-cut saw has taken over some of the duties of the ax, but, nevertheless, the latter is quite as necessary as it ever was.

There are two methods of felling trees—with the ax alone, or with the ax and crosscut saw. Power-driven machines for felling trees have been invented, but while these are more or less successful in the actual cutting, the trouble lies in transporting them to the spot where the work is to be done, which is often in the midst of heavy underbrush or at great distances over uneven ground, making it difficult, if not impossible, to move a power-driven device.

One of the most interesting operations is always the felling of trees. If a saw is to be used, the first step is to make a wedge-shaped notch with the ax on that side of the tree looking in the direc-



tion in which it is desired to have it fall, the lower cut being horizontal and the upper at an angle of 45 degrees. This not only directs the fell of the tree, but also prevents the trunk from splitting.

After the notch has been made, the cutting with the saw is started on the opposite side and a few inches higher. Swaying rhythmically, with sleek muscles rippling under their woolen shirts, two lumberjacks direct the blade.

"Wedge it!" comes the cry from one of them a few minutes later, and a wedge is driven in behind the saw to keep it free from the weight of the tree.

"Z-z-z!" the song of the saw continues.

Then there comes a warning "crack," followed by the shrill cry of:

"Tim-BER!" and the swampers withdraw to safety.

With a shiver, the great tree leans slowly and then falls with a rush, tearing through surrounding branches with a tremendous swish.

When it drops it may crash through the limbs of another tree, leaving one of its own hanging in the latter's branches, from where it is easily dislodged by the wind, imperiling all whose work might take them in its vicinity.

Men with axes leap on the fallen giant and trim away the branches. Others, with cant-hooks, roll it to the skidways, sleds, or cars, where the logs are piled in a high triangular peak. If weight causes the pyramid to break down, the rolling logs will crush anything in their paths.

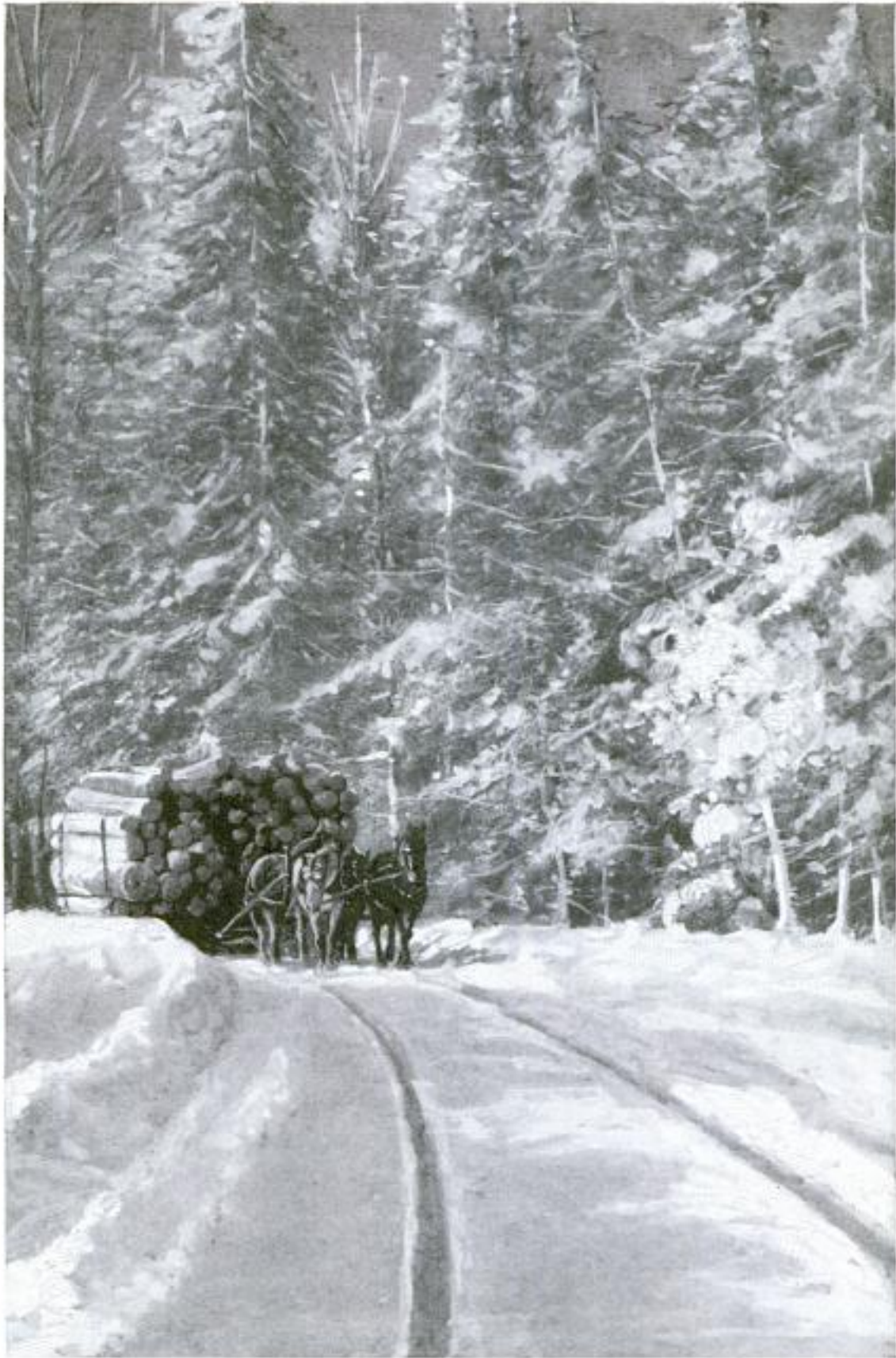
Besides felling trees, the modern lumberjacks take a hand in building railroads through the

forests, as well as cutting paths for the teamsters. "Swampers" clear the roads and the way to the logs as they lie in the woods.



"Topping the Mast": Master Woodsman Bringing Down the Top of a Giant Tree—a Perilous Task Requiring Nerves of Steel

SLEDDING LOGS BENEATH SNOW-LADEN TREES



"Hi! Yup!" Echoes the Cry of the Teamsters on Frosty Mornings through Thickets of Birch and Balsam,
While the Ring of Axes Makes Merry Music in the Clearing



Toil is Often Made a Pleasure for Laborers of Korea Who have Tasks Lightened and Hearts Gladdened by the Performances of the Hired Musician, Who Tempts Them to Speed with Rhythmic Throbs Created by His Drum and Stick



Paid Street Bands and Organs have Long Helped to Ease the Dull Monotony of Summer Days in Stifling Cities of Civilization. As in Other Countries, Wandering Minstrels are Found in Upper India. Offering Programs of Weird Harmony to Beguile Coins and Morsels of Food from the People in Villages through Which They Pass. Festeoned with Jangling Bells, the Bows, Used to Coax Quaint Strains from Their Crude Violins, Play Dual Parts

From Tom-Toms to Jazz, Music's Magic Lure Is Traced Through Ages

Scientists Follow Its Evolution Before the Dawn of History to Explain Fascination
Rhythm Has Held for the People of All Races Since the Beginning of Time

"IT'S the voodoo!" As the words were uttered, the sob of a violin, the cry of a clarinet, and the blare of a saxophone echoed through the great hall—paused an instant—and then, with a crash of cymbals, rushed together into the latest jazz dance.

Rubbing his eyes, the speaker, a scientist recently returned from abroad, gazed about him at the swaying figures, while memory took him back to the mysterious forests surrounding Port au Prince in Haiti where the murmuring night wind brought the sound of a drum, beating like a great, tireless heart.

Sometimes fast, and then again, more slowly, the rhythm rose and fell like the pounding of an invisible pulse telling of strange rites being performed by dark shadows flitting about the embers of dying fires—the dread voodoo from whose shackles civilization has been powerless to free the natives.

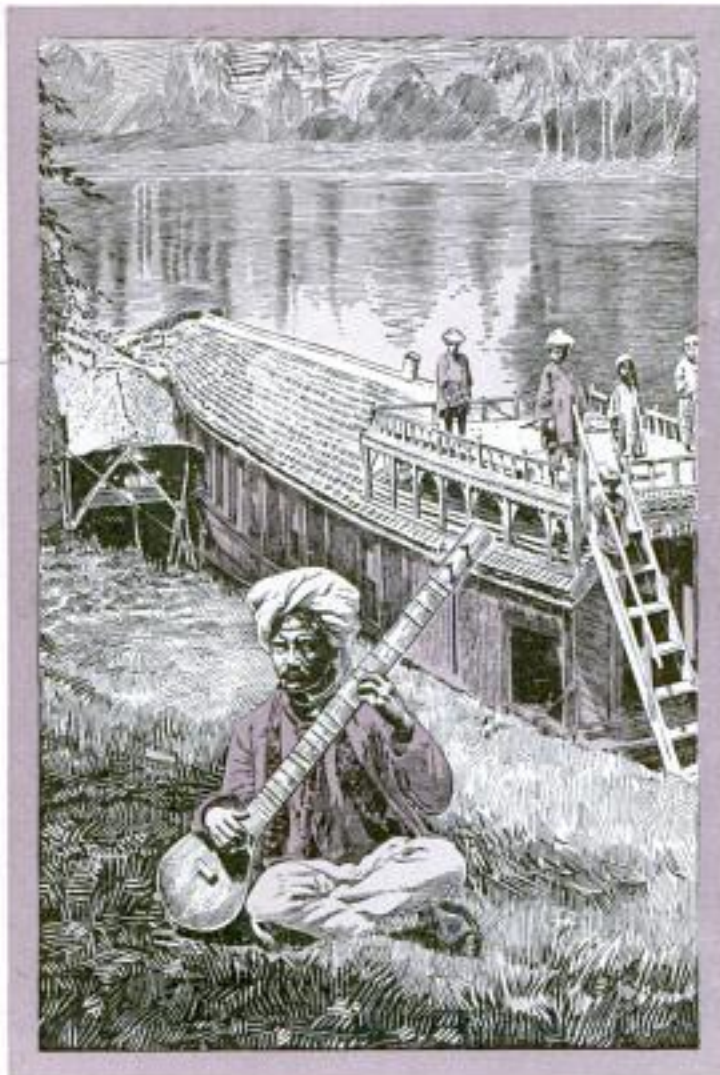
Strangely like the jazz music found in the dance halls and centers of culture today—perfect rhythm without much melody—the note of the tom-toms has been traced back to the ages before the dawn of history by scientists seeking to explain the magical lure it has held for the peoples of all races.

First of all musical instruments, the drum is believed to have been the result of early man's effort to imitate the pounding of his own pulses by beating on a hollow log with clubs. In the wilds, however, great gorillas challenge their enemies to combat by standing erect and striking on their chests.

In nearly all primitive lands the drum is to be found in some form. Often it is an empty gourd tapped with a stick or a hollow log, over the ends of which dried skins have been stretched. In Africa, parchment placed over wooden kettles and struck with clubs serve to arouse various tribes. Hollow poles of varying lengths that are hammered with bamboo rods also are used.

With the beat of the drum as the underlying motive, other sounds are produced by wind instruments and by stretching cords of dried skins to poles of various forms. One of the earliest of such devices is a flute made of a giant elk and found in a prehistoric cave in France.

In the East Indies, musicians perform on crude types of fiddles that give forth soft, droning notes, accompanied by the jangling of bells festooning the rough bow drawn across the



Popular Melodies of Hindu Boatmen are Sung by Native Minstrels to the Twang of Banjolieke Instruments

strings. There also is found a sort of banjo, having a fingering board marked with ridges by which various notes and tones are produced, as well as many other instruments.

In Korea, land of the hermits, native laborers are often inspired to greater efforts by the music of a drum beaten by a hired player who stands in their midst as they toil. Chinese celebrations are usually attended by bands equipped with grotesque horns, cymbals, and stringed boxes.

In whatever form it is found, primitive music seems to hold its hearers under hypnotic spells, arousing within them strange responses to its weird harmony. The so-called "jazz" strains lately written into the popular songs of the western world, by many are supposed to have been copied from the jungle orchestras of Africa, where native dances done to the rattle of pot drums and shrill pipes, mark barbaric tribal feasts and councils.

Digging into ruins of ancient cities, scientists have found many queer musical instruments, resembling some of those in use today. The gong was employed by early Romans in their households and to mark time for the feet of marching legions. The lyre, a harp-like instrument, said to have first appeared in old Babylon, later was used by the Greeks to accompany songs and recitations of poets.

While the familiar piano is a development of recent years, its sounding board received its beginning in the earlier forms of the harp which were well known in the

hands of ancient peoples. Grind organs now played about the streets of large cities are believed to have found their origin in the hurdy-gurdy, a stringed affair, played by having a small wheel of pins turned against rosined threads.

Not long ago it was discovered that stringed musical devices, believed to have originated in Europe during the middle ages, really came from the lute, an instrument of the Egyptians, made by stretching silken cords across a hollow pear-shaped vessel, and picked with a piece of shell or quill. In Japan and eastern Asia many forms of flutes were known to have existed centuries before Christianity.

South Sea islanders, by inserting rude wooden mouthpieces into the ends of sea-shells, cause them to give forth sharp sounds that often are heard for miles across the waters, while guitars have been familiar for years to the natives of Hawaii, their softly thrummed notes picturing the languorous lassitude of the tropics. Although many of these instru-

ments are strange to civilization, they all lend sound, harmony, and a means of expression to the people who wrought them.

Aided by every advance of science, the making of modern musical devices has reached a notable degree of perfection. One factory alone turns out 3,500 band instruments of the finest quality every month.

These are the result of the combined skill of thousands of workers, long years of laboratory research, and plants filled with ma-



COPYRIGHT, UNDERWOOD & UNDERWOOD

Village Musicians of Northern India Play on Crude Fiddles Whose Notes Resemble Those of the Modern Violin. The Strings are Twisted Cords, Heavily Rosined.

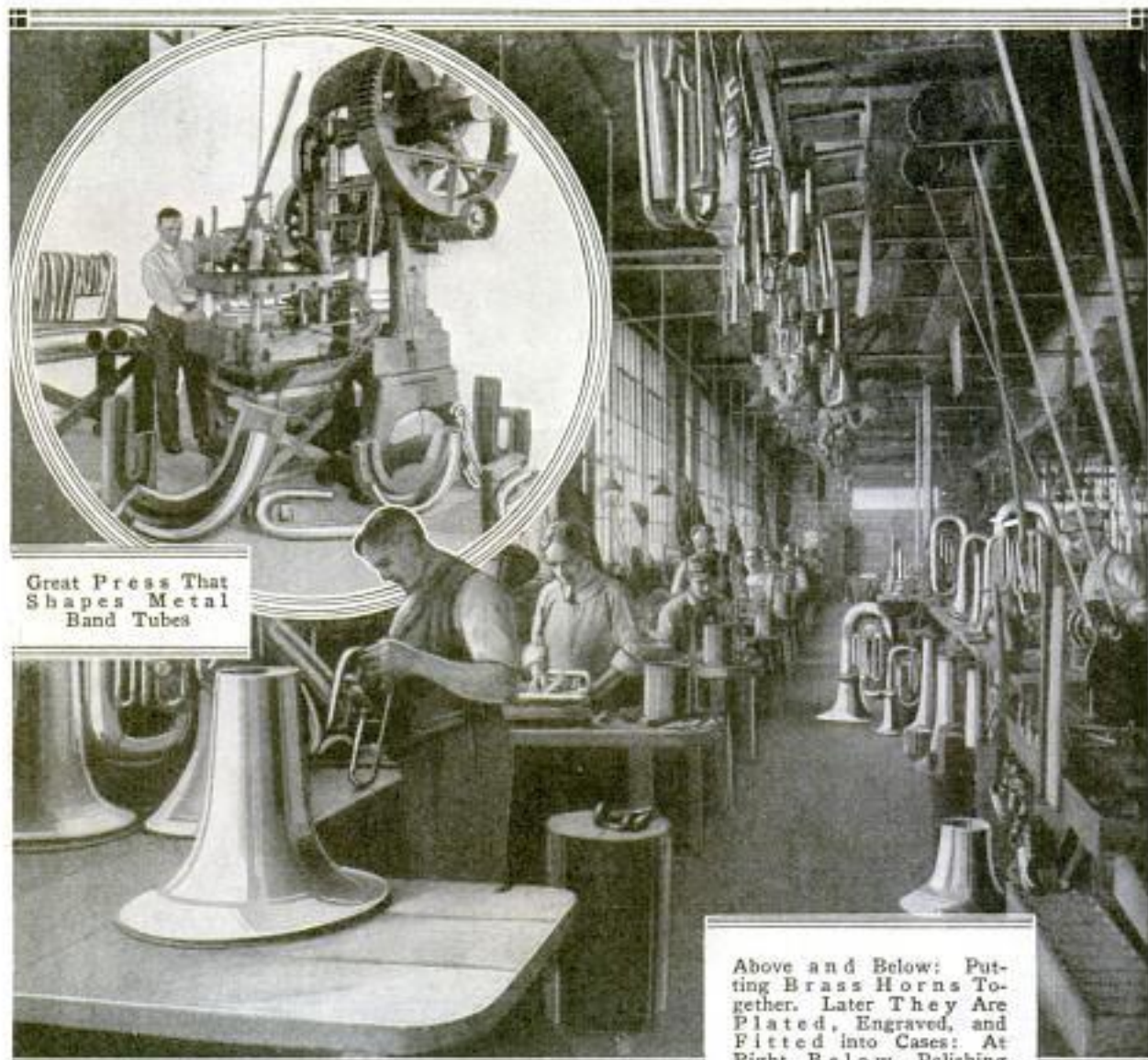


Serenaded by Blatant Notes of Peculiar Horns Played to the Accompaniment of Gong Racks and Blanketed Drums in the Hands of Native Orchestras, Chinese Marriage Ceremonies are Celebrated with a Happy Spirit, Akin to That Shown Wedding Parties of the Western World



Java Has Its Bands of Juvenile Musicians to Entertain Appreciative Audiences with National Airs Performed on Unique Types of Flutes. Instead of the Conductor's Baton Used by Leaders of Modern Orchestras, Beats Sounded on a Small Drum Carried by the Director Guide the Youthful Artists through Various Measures of Time

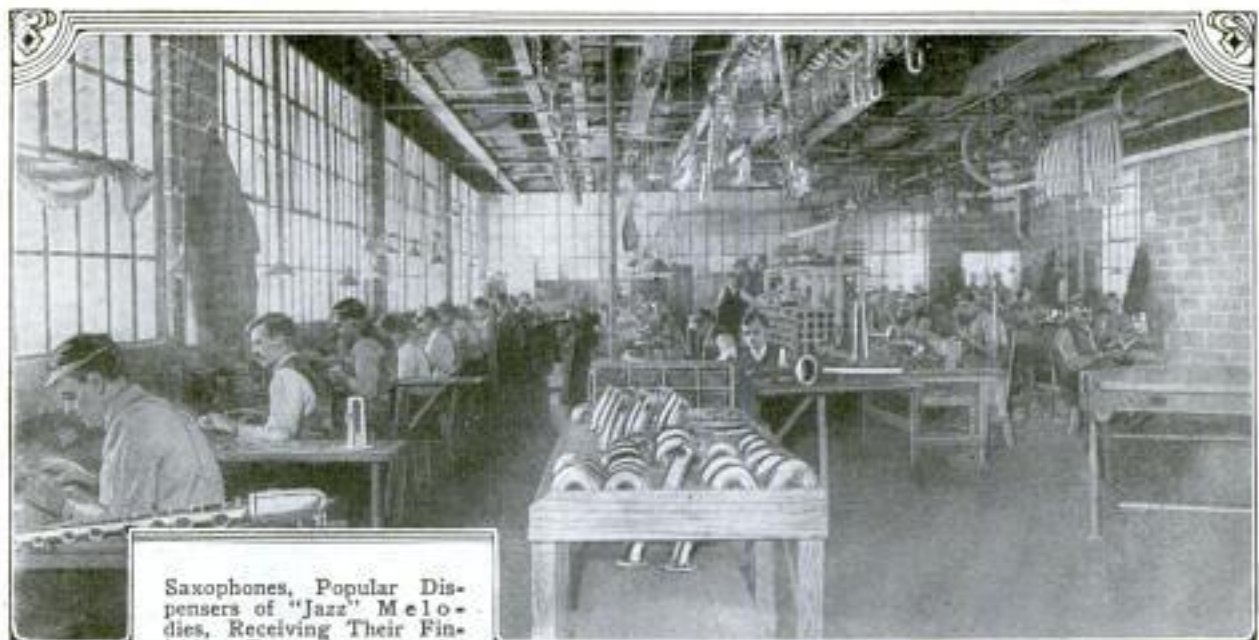
3085



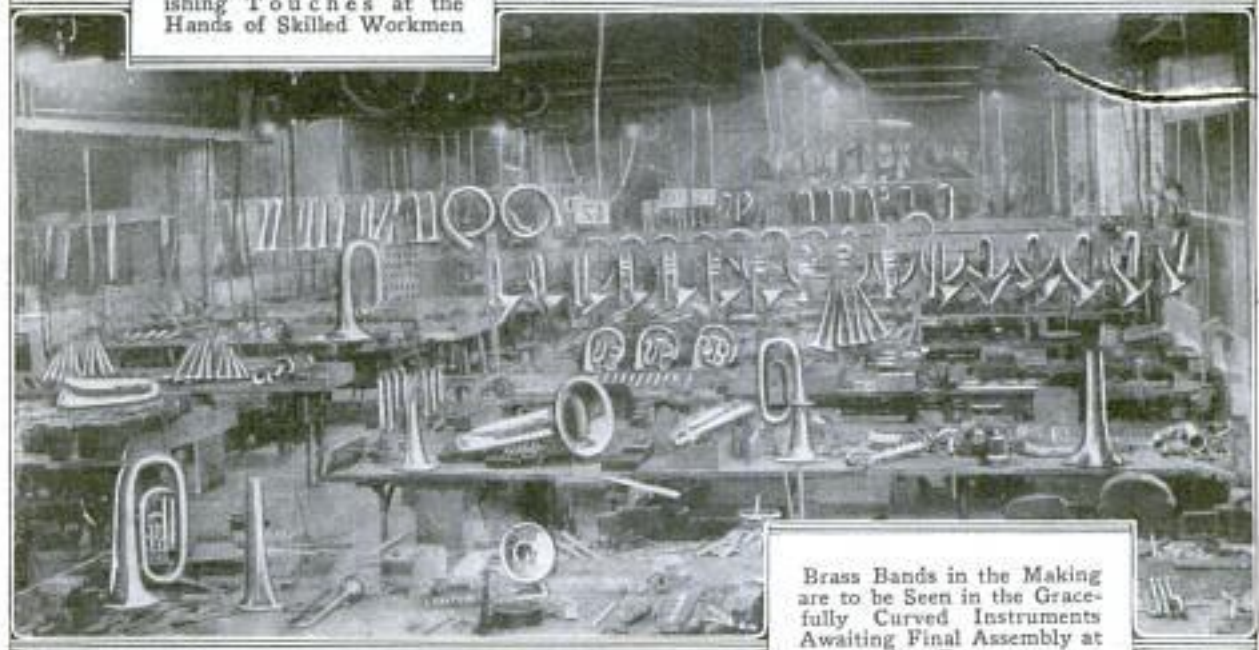
Great Press That Shapes Metal Band Tubes

Above and Below: Putting Brass Horns Together. Later They Are Plated, Engraved, and Fitted into Cases: At Right, Below, Polishing Finished French Horns

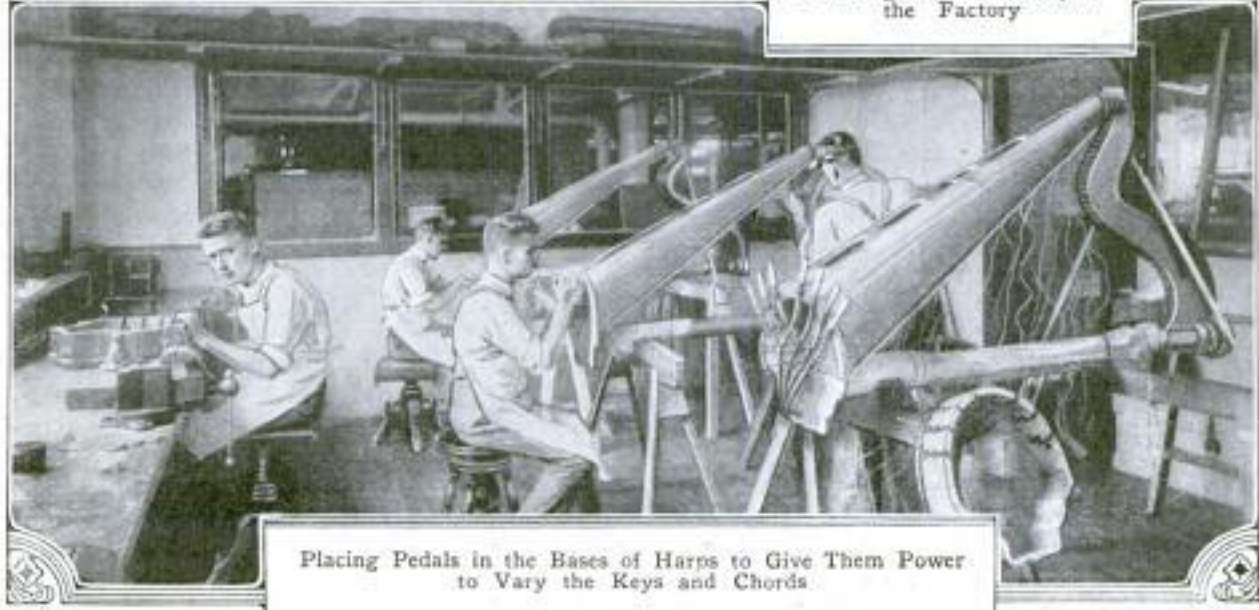




Saxophones, Popular Dispensers of "Jazz" Melodies, Receiving Their Finishing Touches at the Hands of Skilled Workmen



Brass Bands in the Making are to be Seen in the Gracefully Curved Instruments Awaiting Final Assembly at the Factory



Placing Pedals in the Bases of Harps to Give Them Power to Vary the Keys and Chords



Strange Indian Rites Recall Glory of the Old Frontier Days

TRADITIONS of frontier-days' glory were recalled and the centuries-old rites of a vanishing race were revived at a Navajo Indian ceremony in the West recently.

For a few brief hours the barriers of civilization were swept aside as thousands of moccasined feet beat time to the plaintive chants of the medicine men.

Moving about the smoking camp fires like grotesque shadows, painted braves in feathered headdresses mingled peacefully with a little group of scouts of the Santa Fe trail, companions of "Kit" Carson and Buffalo Bill.

One, limping on crutches under the weight of 90 years, bore the scar of a scalping knife all the way around beneath his long hair, and was pointed out by his companions as Dan Du Bois, the hero of untold frontier adventures.

For what was said to be

the first time in history, the Indians had gathered to bless the opening of a white man's dwelling with the same solemn rites attached to the dedication of their own "hogan."

Fifteen medicine men, the high priests, physicians, singers, painters, and dancers of their race, were the leading actors in the services that marked the opening of the structure, a railway hotel.

Old men these priests, with grizzled hair, bent with years, but active in the weird dance. Like the bards of old, they depend upon the memory for details and teach the cult in turn to their followers. Their paintings, many of them made with sand, are said to rank with the best decorative art of any people, and are reminiscent of Assyria and Egypt, of Greece and Japan. Every line is a religious symbol, having a significance.



Sand Painting of Arrow
Man Has Religious
Meaning

While scientists have written of these works of art, novelists have woven them into stories, and every student of Indian lore knows more or less about them, few "palefaces" have ever actually beheld them, because they are serious records of the Navajo's religious faith, and the secrets of their design and composition have been carefully preserved.

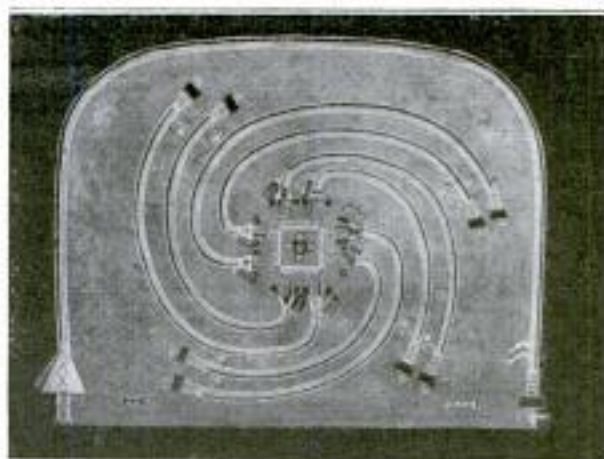
During the "blessing-of-the-house" ceremony, many of these sand paintings were made.

After the evil spirits had been expelled from the home, there were no references to any evil spirit or thing. Instead, all that is good and beautiful and perfect was invited to take possession of the dwelling and its occupants, leaving no room for the evil spirits to return.

In the opening chant, which is sung during a procession by the medicine men, there is a prayer to the "Unnamed God" — the "one Spirit," of whom the numerous gods of the Navajo are merely various manifestations.

In the sand painting, a field of white is first spread. Then the coloring and drawing are done with marvelous dexterity by spreading colored sands outlined with almost penciled delicacy and great accuracy. One of the traditional requirements is that the painting

Hash-kay Yashi, Oldest Medicine Man of Navajos, with Last of Frontier Scouts



Nat-Sil-Id-Iy-Ishi, the Rainbow, Whose Design was Carried through Ages in Minds of Medicine Men

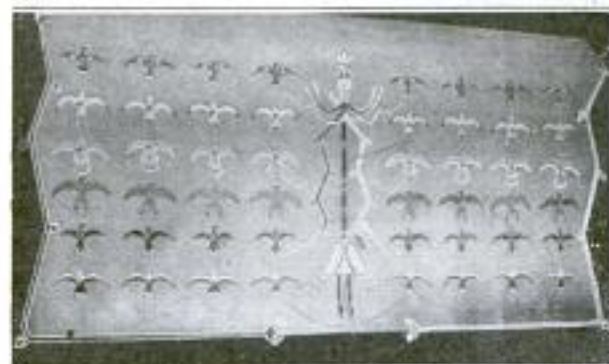
must be completed between sunrise and sunset. Medicine men, depending entirely on memory, direct the work. As soon as the paintings have served their purpose, they are destroyed. Among members of the tribe no one is allowed to copy the figures.

A person or patient requiring prayers is seated on the sand painting. Part of the ritual consists in destroying the design by rubbing color on the patient. To make the treatment effective, the medicine man

must receive some gift for his services in averting evil, curing sick, or petitioning for unusual blessings.

Various ceremonies are used with the sand paintings. When the sand is not practicable, dry paintings are made on buckskins, but the figures are identical. There are hundreds of designs covering nearly every human ill and joy, representing prayer, blessing, faith, hope, and charity, protest, and many other elements.

Authentic copies of the more commonly used were placed in the white man's home, a flattering tribute to the friendship that has developed between the Indian and his neighbors. One called "The Day" is used in the buffalo chant,



Design of the Rainbow Made by Spreading Colored Sands on a Field of White

a ceremony so old that it has almost faded from the memory of the oldest priests. A chieftain, 110 years old, described this to the visitors.

A throng gathered for the event because it was so unusual for Indians to stage the sacred housewarming for members of another race. Some said that it would never again occur because, though the tribe numbers 32,000, the old medicine men are dying off, and these ancient ceremonies may pass away with them.

At the blessing two old men, who, years ago were engaged for many months in persistent

efforts to shoot each other, sat quietly together while they were photographed. They were Du Bois, the last of the frontier scouts, and the oldest living medicine man of the Navajos, Hashkay Yashi, who was war chief of his people in their final outbreak during the Civil War.

Du Bois and Carson rounded up the rebelling Indians and corralled them in a military stockade until the final peace pipe had been smoked. Then the Navajo went to his reservation.

Opening of the white man's home with the picturesque ceremony recalls the curious religious ideas of these Indians. They be-

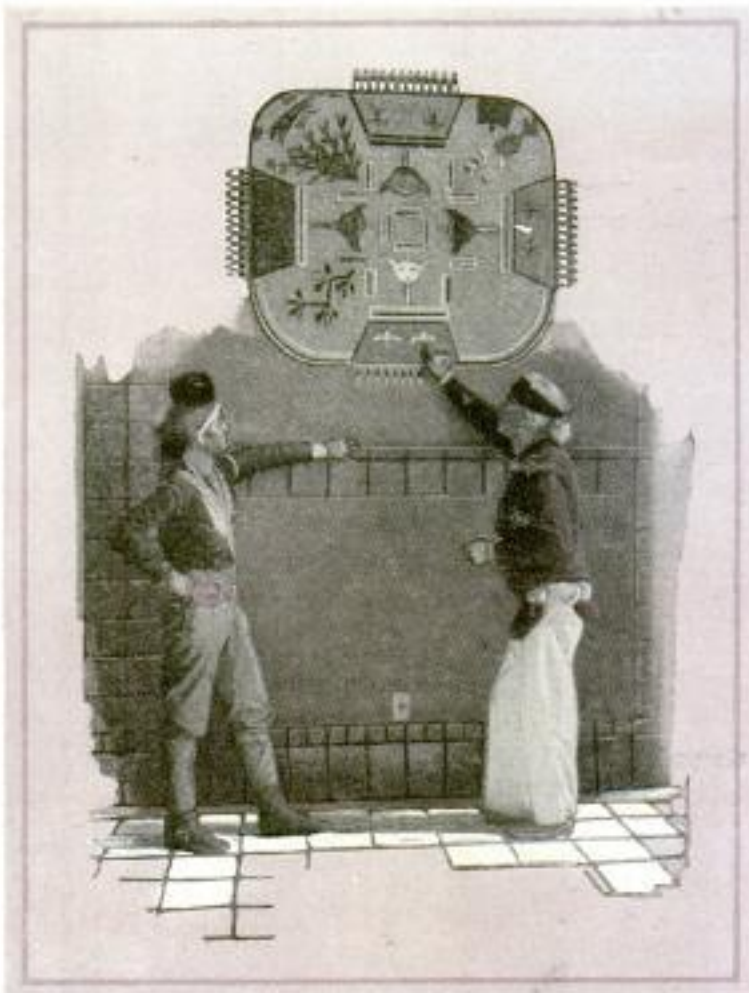
lieve that everything is some person, alive, thinking, and willful. Fish, birds, beasts,

and inanimate objects they regard as possessing spirits. To them, all things are of the same nature and are accorded respect and honor in the pictures.

How they call on the spirits through sand paintings to bring better crops is typical. Plots of ground are burned, trees girdled, and seeds planted by pointed sticks. The first year the crop is free from weeds. The second year the yield is small, and the third year it is abandoned after a

futile appeal to the spirits by the farmer as he kneels on a sand painting. Instead of using his own resources in properly cultivating the land, he moves to a new field. The Indians believe that spirits bring rich or lean crops according to their whims, when addressed through medicine men and paintings.

Ceremonies on various occasions are held for one purpose—to impress their old friends in the other world, which is the reason the medicine men were so anxious that the white sponsors at the housewarming correctly repeated chants word for word. An imperfect ceremony might give evil a chance to enter.



Aged Chieftains Examining a Painting Called "The Day," Used in a Chant So Old It Has Almost Faded from Memory



"Eagle Trap," Sand Painting for an Indian Ceremony

3044 Cont. William Thompson,
 % Comptar national d'Escompte
 POPULAR MECHANICS 553
 Cherbourg France

GRAIN CAVERNS IN OLD FORT USED AS MARKET

Built centuries ago as a storing place for grains during sieges, great caverns still exist beneath the fortifications of Valletta, the capital of Malta. The place where they are located is now used as the city's marketing place. Standing in the central channel that connects the eastern and western basins of the Mediterranean, the island, even before the

Romans attained their pinnacle of power, was a much prized possession. For hundreds of years it was the battleground of many races, and; as a matter of course, came the grain pits for protection against famine during war, since the island has always depended upon other countries for grain. Within these wells can be stored an enormous amount of cereal.



Removing Grain from Deep Pits Built Centuries Ago in Courtyard of Fortress to Serve as Warehouses in Times of Famine, but Which are Now Used for Storing Cereals for Market

3139 DREAM OF A RADIO EMPIRE TO LINK WHOLE WORLD

Within a few months, a chain of powerful wireless stations circling the globe is expected to be in operation, enabling a person in London, for instance, to communicate daily with individuals in Peking, China. Necessary licenses have been obtained by Marconi, the famous radio engineer, who has linked London with New York, a distance of 2,920 miles, and is in daily touch with Glace Bay, 1,906 miles away, and Montreal, 2,700 miles distant. The link is being extended to Winnipeg, Edmonton, and Vancouver, thence to Peking (4,630 miles), and Melbourne (7,300 miles). Another route planned is by way of the Azores, Madeira, and Cape Verde to Buenos Aires, and from there

to Punta Arenas, near Cape Horn. From Great Britain there is yet another line joining South Africa with Nairobi, proceeding to Madras, Rangoon (Burma), and Hongkong. When the last of the wireless lines is completed, it is said that every portion of the British empire will be able to communicate easily with every other state or colony.

DIAMONDS MADE FROM SUGAR

3117
 Lumps of sugar may be converted into diamonds, according to those interested in the experiments, by first separating the carbon from other substances they contain. The gems thus produced are said to be too small for commercial purposes, but will withstand all tests usually applied to detect the real article.

Wm. James 7/22/23

Cont. Edwin Larisse
 of The Washington, D.C.

How Ancient Empires Built of Bronze Were Overthrown by Iron Age

DISCOVERIES made by scientists delving in the ruins of ancient Babylon have drawn attention to the little-considered fact that an empire — then a world power — flourished more than 4,000 years ago without iron enough to build a modern battleship.

When the treasures found in the tomb of King Tutankhamen were brought to light, after lying untouched for 300 decades, many articles of bronze were found, recalling the claim by many historians that iron in the form of weapons in the hands of enemies, caused the downfall of the Egyptian civilization.

And yet, 1,000 years before King "Tut" was born, iron was fast coming into use in other, and in some cases, less civilized parts of the world. China and India were employing it for tools and weapons. First it was used in warfare. The rise and expansion of the Assyrian empire came on the crest of the first wave to mark the beginning of the iron age.

Through contact with the Hittites, iron was introduced among the Assyrians, and their armies were the first to be equipped with the metal that proved itself far superior to the bronze and copper weapons employed by enemies and resulted in their

utter defeat. That the Egyptians obtained iron from the Hittites is recorded on a clay tablet written about 1250 B. C. by one of the barbarian rulers who mentions that he

was about to send a shipment of "pure iron" to Rameses II, who had asked for it, and that in the meantime an iron sword was being sent to the Egyptian king as a gift. While the Hittite civilization was lower than that of the Egyptians, the nation made up for its lack of culture by serving as the world's ironmonger.

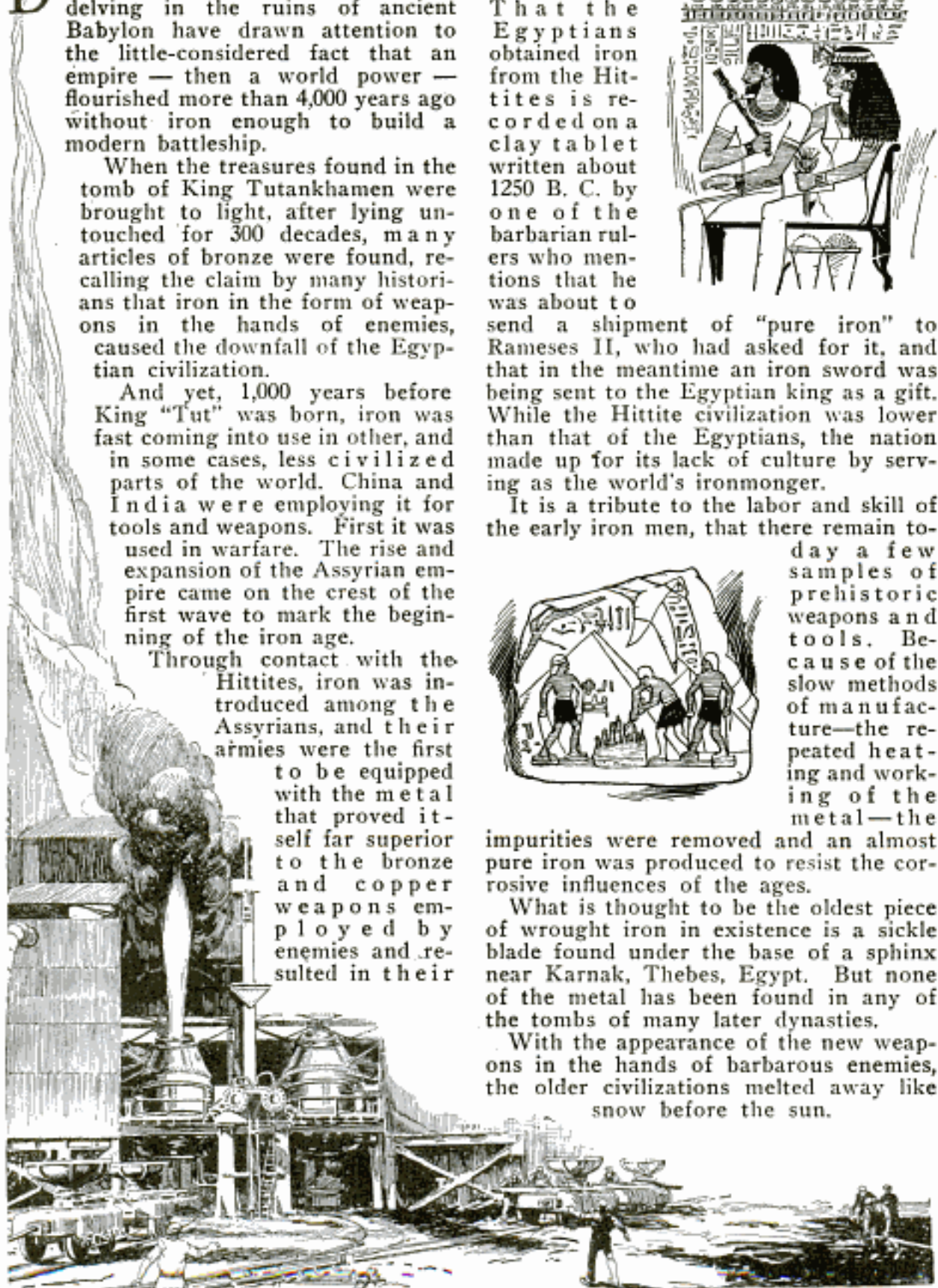
It is a tribute to the labor and skill of the early iron men, that there remain to-

day a few samples of prehistoric weapons and tools. Because of the slow methods of manufacture—the repeated heating and working of the metal—the

impurities were removed and an almost pure iron was produced to resist the corrosive influences of the ages.

What is thought to be the oldest piece of wrought iron in existence is a sickle blade found under the base of a sphinx near Karnak, Thebes, Egypt. But none of the metal has been found in any of the tombs of many later dynasties.

With the appearance of the new weapons in the hands of barbarous enemies, the older civilizations melted away like snow before the sun.



Wager Mfg Corp,
108 Academy St
POPULAR MECHANICS
Jersey City N.J.

PRESSURE ON BULB SPREADS SHAVING LATHER 3267

By pressing the rubber bulb of a lather-making device, soapy foam for shaving, which it forms, is forced through a flat nozzle, and spread without need of a brush. Made to fit the hand, of light, nonbreakable materials, it may be used in the home or barber shop, or carried by the traveler. Having few parts to gather dirt and germs, it is sanitary and does not require sterilizing. Soap is supplied to it in small tablets.



nonbreakable materials, it may be used in the home or barber shop, or carried by the traveler. Having few parts to gather dirt and germs, it is sanitary and does not require sterilizing. Soap is supplied to it in small tablets.

is sanitary and does not require sterilizing. Soap is supplied to it in small tablets.

CLOTH IS MADE MOTH PROOF WITH ODORLESS LIQUID 3283

Garments of moth-proof cloth are now being manufactured, guaranteed to resist the ravages of the insects during the life of the fabric, as a result of the discovery of a liquid disinfectant that not only kills the pests but destroys their eggs as well. For household use, the chemical is dispensed in bottles equipped with a plunger that works like an atom-



Household Dispenser for Spraying Clothing with Moth-Destroying Liquid

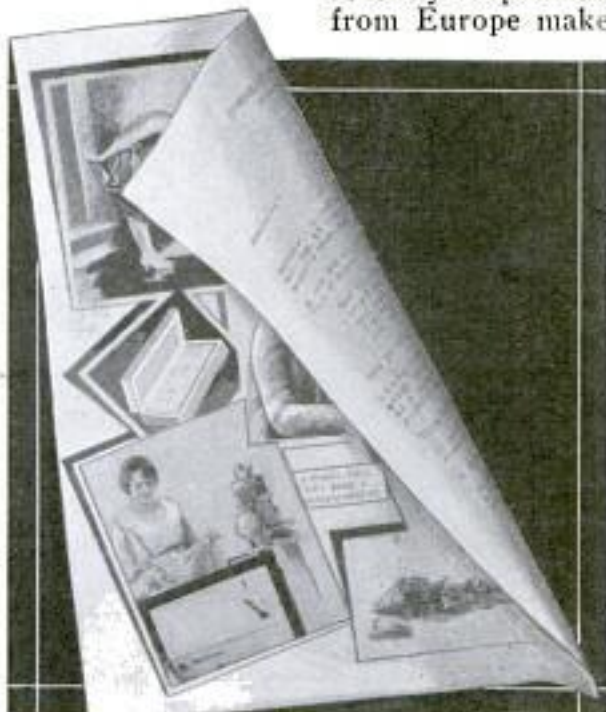
izer. Stainless, odorless, and noninflammable, it may be applied to the most delicate fabrics without causing injury.

Price - \$1.50.

Larver Distributing Co.,
817 N. Ninth St.
St. Louis Mo.

FIFTY THOUSAND PHOTOS A DAY WORK OF TWO MEN 3295

Doing more work than 50 expert photographers can accomplish, two machines recently imported from Europe make



Actual Photographs on Back of Letterhead Used to Carry Writer's Message

more than 50,000 completed photographs in a day. Blank paper is fed into one end and finished pictures are delivered from the other. Prints are made directly from the negatives and then are developed, washed, and cut into desired shapes. Photos of various sizes can be made at the same time. The machines also can print typed inscriptions on the backs. The devices, each of which can be operated by one person, are used in a dark room so the light cannot reach the highly sensitized paper.

THOUSANDS OF GEESE KILLED FOR HOTEL'S PILLOWS 3339

In furnishing a modern hotel recently erected, 37 miles of carpet were laid on the floors of the guest rooms and corridors, while 25,000 pounds of horsehair were used to stuff the bed mattresses. To obtain 7,000 pounds of feathers and down for the pillows, 90,000 geese were killed. If this number of living fowls were formed into columns four abreast, the line would be two miles long. Marching in "goose step," at a normal speed, the host would be 3 hours and 41 minutes passing a given point.

New York Times
Copyrighted material

National Commercial Photograph Co.,
326 W. Madison, Chicago



Cataloguing the Almost Priceless Collection of Books and Manuscripts, Regarded as the Greatest Jewish Library Ever Assembled

INCLUDED in a library of 40,000 books and 4,200 manuscripts recently assembled at a Jewish theological institute and termed the most complete collection of early Jewish literary efforts, is a volume of notes of a physician who practiced about 1400 A. D., listing 1,300 prescriptions popular at that time.

Just how much medical science has advanced since then can be determined by the then accepted cure for a scorpion's bite:

"If a man who is riding a donkey is bitten by a scorpion, turns around and faces the donkey's tail, the pain will leave him and go to the donkey." The author, known only as "Abram," also noted that "Arabic women were used to cleaning their teeth by using the bark of a young nut tree upon which no fruit had been borne. They rubbed their teeth to prevent pain, and to keep them white."

The cure for earache in those days was to "take the fine roots of an olive tree and cook them in water and keep your ear over the steam that issues forth."

Depilatories, however effective, were not unknown, for the book lists the following: "To stop hair from growing:

Take the fat of a hare and the marrow of its bones and anoint the shaven place." For safety in traveling, the physician recommended the carrying of the right eyes of 20 geese, a sure protection against robbers. The remedy for sleeping sickness was to place the tooth of a black dog under the sufferer's pillow.

Written in Hebrew and on thin parchment, the notes can hardly be read even with a strong glass. Other volumes, some of them dating back to 640 A. D., are of great worth because of their historical value. Writers of volumes during the inquisition period, at the peril of their lives, set down royal decrees signed by King Ferdinand and Queen Isabella of Spain, and by the Grand Inquisitor of the Ancient Emperors of Austria.

Difficulties of carrying on a conversation in a moving train or in a subway can be eliminated partly if the person being addressed will close his ears with the finger tips. Without pitching his voice above the ordinary tone, the speaker then may be heard plainly, despite the conflicting noises.

**PEARLS "PLANTED" IN OYSTERS
DETECTED BY LIGHT RAYS**

Pearls formed by inserting particles of hard matter into the shells of living oysters can now be detected by holding them before strong light, according to reports of investigators. Those built around a piece of mother-of-pearl are rotated on a string before a window or in the sunlight, when the sheen cast by the core can be plainly seen in certain positions. Another test is to place it over a hole bored in a thin sheet of metal, and held to the light. The shadow of any foreign substance on the inside of the gem will be outlined. Sometimes a small pearl of inferior value is used as the center of one "grown" in the oyster's shell. To recognize these, a gold wire is melted to create a tiny ball at its end, forming a small mirror, which is thrust into the beading hole of the jewel. The reflection of the dividing line between the two materials can then be seen with the aid of a magnifying glass.

3260

3314

**CONQUEST OF MOUNT EVEREST
SOUGHT WITH OXYGEN**

In a new effort to conquer Mt. Everest, British and American explorers have combined, and will employ an oxygen apparatus in an attempt to reach the top of the peak next year, it is announced. The device, which will be depended upon to supply proper air to the climbers, is now being tested in the Alps. The extreme altitudes make breathing difficult.

Christian Science Monitor

**ADJUSTABLE CHAIR LEGS ADD
TO WORKER'S COMFORT**

Chairs with adjustable metal legs have been designed to add to comfort and increase efficiency of the worker. Any change in height from an inch to a foot is made possible by sliding the legs and bolting them to the frame. By altering to suit the individual worker, the chairs relieve the strain resulting from being seated too high or too low at a table or desk.



no price

Royal Metal Mfg. Co.
2318 S. Western Ave
Chicago

**PEAKS OF SPAIN CONQUERED
BY ELECTRIC RAILWAY**

Steep, forest-covered slopes of the mountains near Madrid, in Spain, can now be reached by electric railway, built

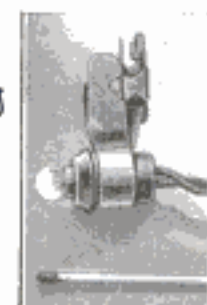


First Electric Train Operated over Picturesque Road in Mountain Range of Central Spain

along a picturesque *International* right of way. The first train was run over the new road recently. Specially designed, bow trolleys, with which the cars are equipped, hold firmly against the feed wires, while passing at great speed around the sharpest curves.

**ELECTRIC XMAS-TREE LIGHTS
CLAMP ON THE BOUGHS**

Tiny electric lamps that clamp on Christmas-tree branches are being made to eliminate danger of fire. They are made in various colors and are scarcely larger than a match head, giving the light of about a single candle. Only a small amount of current is required to light them, and this is supplied either by a storage battery or from a lighting fixture. As the bulbs last for a long time without burning out, they may be stored away.



bulbs last for a long time without burning out, they may be stored away.

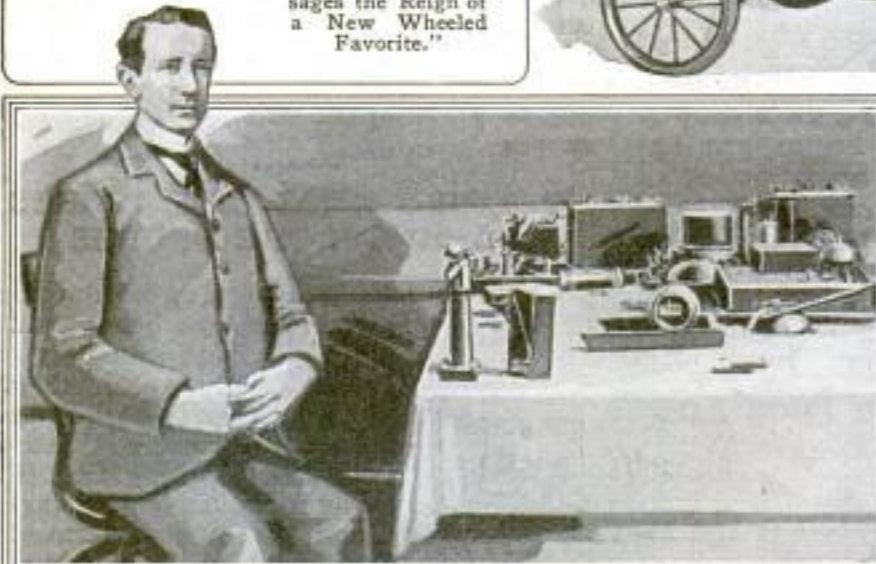
In a little more than two years, a tightly sealed bottle floated westward across the whole width of the Pacific Ocean, a distance of 8,400 miles in a direct line from Central America to New Guinea. It is estimated that the bottle would have had to travel 11 miles every day, if it took the shortest route.

*J. F. Blackbe & Co.
603 15th Street
Chicago*

"Marvels of Science" Twenty Years Ago

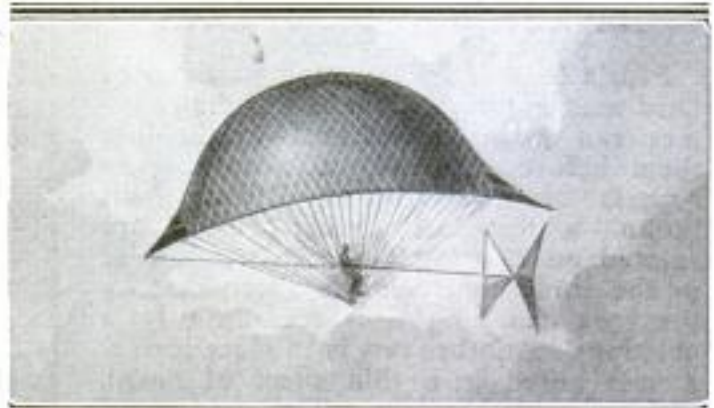


"The Automobile's Successor Is Here," Asserted a Writer in Describing a "New Electrical Vehicle," That Twenty Years Ago had Won "Societies Approving Smile and Pre-sages the Reign of a New Wheeled Favorite."

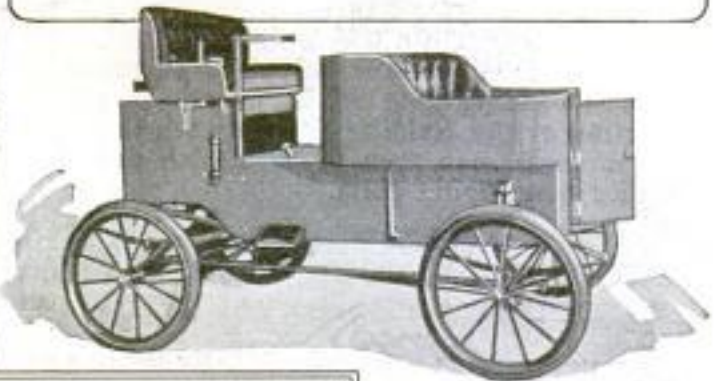


In Discussing the "Future of the Wireless," Popular Mechanics Printed a Picture of Marconi and Said: "It may Link All the World So Closely That the People will Be Like Those of One City."

Hailed as the "Oddest Hotel in the World" the Construction of a Multi-Sided Hostelry was in Progress at West Baden, Ind. It Had an Oval Interior and was to be Crowned by a Huge Glass Dome.

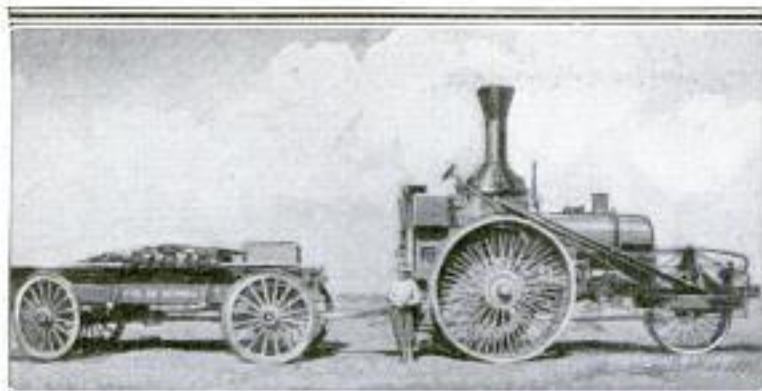


"Sky-Cycle," or Gas Kite, Built in 1902 by Carl E. Meyers on His Balloon Farm at Frankfort, N. Y.

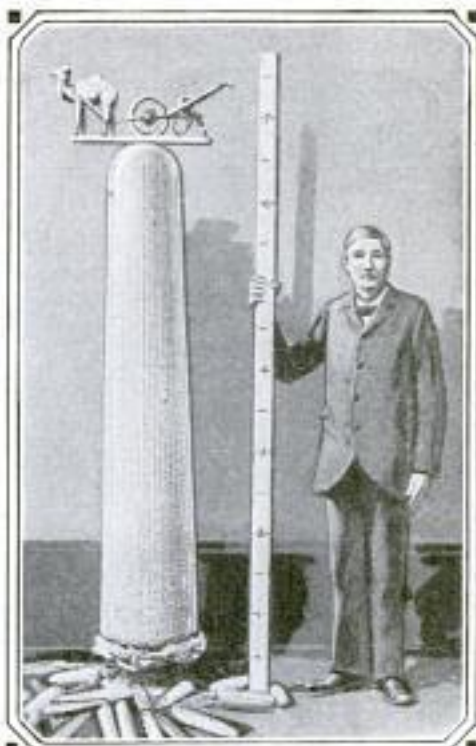


Described as First Vehicle Ever Built to Run Either on a Track or Public Highway, This Automobile is Declared to Be Equally at Home in the Boulevards of a City or Mountainous Flights of a Railroad. Seating Seven Persons, It was Designed by W. S. Rogers, Keene, N. H.

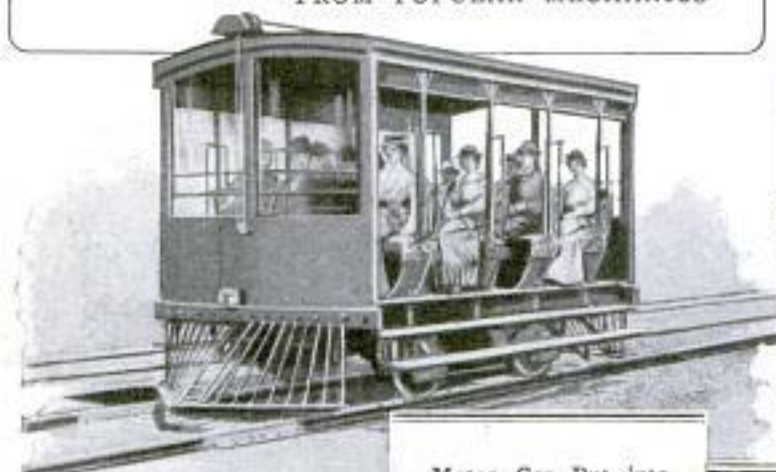
From the Pages of Popular Mechanics



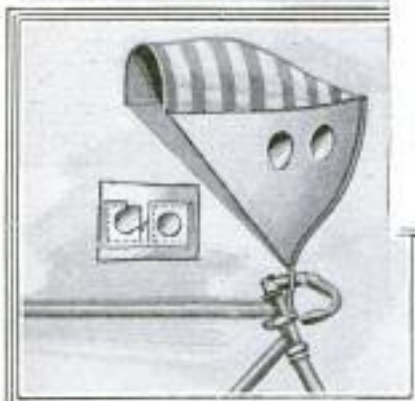
"Horses are Giving Way to the Tractor and Its Influence is to be Felt Even More in the Future"
FROM POPULAR MECHANICS



Ear of Corn, Seven Feet Long, Shown at the Cincinnati Vehicle and Implement Show in 1902: It was Not Grown, However, but was Made by Pasting 40,462 Grains in a Wooden Cob

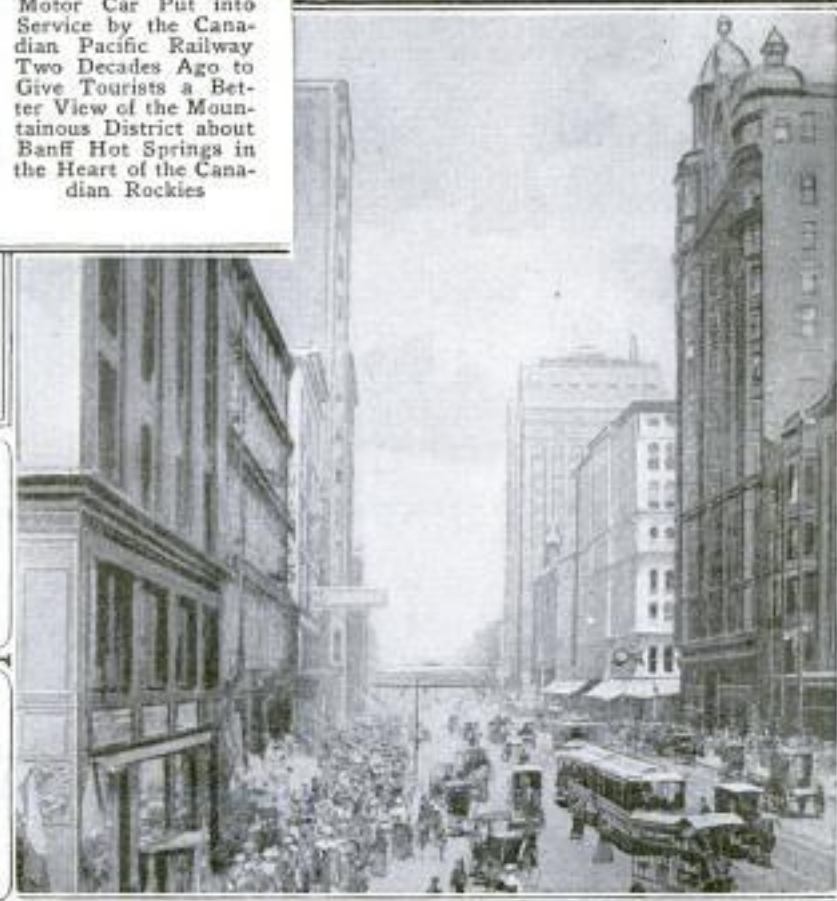


Motor Car Put into Service by the Canadian Pacific Railway Two Decades Ago to Give Tourists a Better View of the Mountainous District about Banff Hot Springs in the Heart of the Canadian Rockies



"Now the Scorcher will Have No Excuse, for He can Carry It with Him All the Time," Said Popular Mechanics of a Bicycle Canopy That Had Holes for Air and View

"Great Steel Structures on State Street, Chicago," in 1902 Resulted in Arguments as to Whether They should be Allowed Because of Danger of Earthquakes and Corrosion of Steel Frames



3204

HOLLOW LOG IS WIRELESS SET OF WILD JUNGLE TRIBES

Long before the first modern radio set came into being the wild South Ameri-



South American Indian Sending a Wireless Code Message from a Primitive Broadcasting Station

can tribes that live in dense forests and grass-covered plains near the equator, had "wireless" outfits made from the trunks of hollow trees. For years the jungle and tundra have echoed the booming of these huge drums. By means of code systems, each tribal chieftain keeps in touch with his people, calling his warriors, ordering raids against enemies, warning of marauders, or announcing the approach of strangers. The sound emitted by one of these instruments which, it is said, can be heard for many miles, is like the dull, distant boom of a cannon.

BIBLE CITY'S FATE IS BARED BY LINES ON CLAY BLOCK

Dug up after 2,600 years, a clay tablet, covered with the writing of some ancient scribe, paints a graphic picture of the fall of Nineveh, famed city of the Old Testament. "Whoso loveth Nabu and Marduke, let him preserve this, and not suffer it to leave his hands," is the charge on the record, which goes on to tell of

new York Times 8/5/23

an attack on the city and of how a band of its defenders broke through the enemy lines and established a new kingdom on the banks of the Euphrates River. Since the two gods mentioned are associated with Babylon, it is believed that the text of the tablet refers to the actions of a Babylonian king. The writings also place the destruction of the city as having taken place in 612 B. C.

CHARIOT IN FLAMES IS INDIAN LEGEND OF METEORITE

What is a meteorite? Is it a treasure house of diamonds, or is it just a chunk of fused stone? To answer these questions, scientists have been studying for years one of the largest of these celestial visitors, which, they believe, fell during prehistoric times into Cañon Diablo, in Arizona. According to Indian tradition, it was a flaming chariot bearing three gods, who, enveloped in a sheet of flame, extending as far as the eye could reach, rode from the stars to the earth in search of eternal rest. Small diamonds have been found in the mass, together with many metals. The fragment is now infested with rattlesnakes and houses thousands of rabbits, which attract birds and animals of prey.

new York World 8/5/23

LEFT-HANDED FOUNTAIN PEN HAS TURNED-UP POINT

To fit the needs of left-handed writers, a fountain pen has been placed on the market with a turned-up point, designed to prevent catching and spluttering. It is furnished in fine, coarse, or medium stroke. As a result of numerous experiments, it has been found that different individuals have varying styles of holding pens and that an instrument which may be suitable for one is not satisfactory to another. Based on these tests, one company has developed nine different styles of points. There is the flexible nib for the stenographer, the medium for correspondence and general work, the fine, stiff point for the bookkeeper, the special fine point for the accountant, and the nib for clerks and salesmen who desire to make manifold copies.



L. E. Waterman Co., 191 Broadway New York

ANCIENT CITY OF DAVID'S SECRETS TO BE DUG UP

Within sight of historical Jerusalem, on a spot believed to mark the location of the ancient City of David, scientists have started excavations with the expectation of unearthing important relics of Biblical times. Whether the tomb of King David, from whom the early metropolis received its name, is located in the area to be explored is a question research has not yet settled. However, even though the sepulcher is not found, the experts are confident of digging up traces of the city's inhabitants. Early historians, although failing to mention the exact place of burial of the long-dead ruler, have recorded two robberies of his grave, one directed by Herod the Great, who had rich furniture, gold, and other articles removed from it.

VEST-POCKET RANGE FINDER AID TO PHOTOGRAPHERS

For amateur photographers, a device has been marketed, small enough to fit in the vest pocket, which correctly gives the distance of any object to be photo-



Small Range Finder That Is Aid to Amateur Photographers in Correctly Focusing Objects

graphed within a few seconds, thus reducing the possibility of bad exposures. Pointed at the subject, the end is pulled outward until the image shows sharp on its "ground" glass. A scale on one side of the instrument indicates the number of feet. It can be used in focusing for any kind of pictures.

Price - \$3.00

RAY TO OVERCOME GRAVITY IS SOUGHT IN SECRET

Hidden away in laboratories in the heart of Russia, German scientists are engaged in a secret search for a new ray to overcome the law of gravity, according to recent reports. Air experts are quoted as saying that they would not be surprised if this quest has resulted in discoveries which may revolutionize aviation. With abundant money and years of practical experience, the searchers are well equipped to carry on their work.

Auckland News 6/28/1923

HOUSES BUILT OF PLATE GLASS AS STRONG AS CONCRETE

Glass houses are declared to have been made possible as the result of the recent discovery of certain chemical processes, together with a glass-making machine.



Model House Built of Glass with the Exception of Window and Door Casings

As strong and sturdy as the present residences of stone, concrete, or wood, it is said that homes of opaque glass will be much cheaper and yet will be warm in winter and cool in summer. Plastering, painting, and papering will be made unnecessary by artistic colorings added to the glass during its manufacture. The upkeep expense will be small, for there is no danger of decay from the effects of the weather. Plans call for the erection of five and six-room cottages, which, with the exception of the frame, will be built entirely of glass, in both plate and block form.

GAS-TANK COVER FOR AUTO CANNOT BE LOST

To prevent its loss, an automobile gas-tank cap is being made that is permanently fixed to the car. Once attached, there is no need for removing it, as a spring cover, lined with cork, lifts up to permit filling. A quarter turn of its bar handles fastens or unlocks the lid, which also may be used for radiators.



In an attempt to rid Russia of rats that are threatening the nation's health, the government recently sent a commission to Poland to buy 10,000 cats.

Antograph Screen Co., 500 Fifth Ave., New York

The S. A. Shields Co., 1433, Arcade Station, Columbus, Ohio

St. Helens Manufacturing Co.,

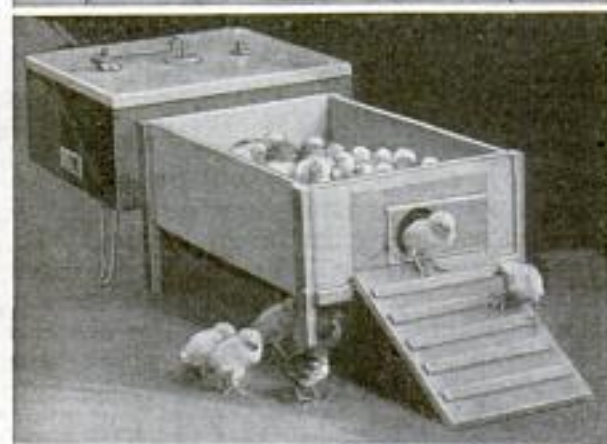
562

POPULAR MECHANICS

Centralia, Wash.
HATCHER FOR CHICKS SPROUTS
OATS FOR THEIR FEED

3301

By adding a runway made of a dry-goods box, a chicken hatcher that weighs 14 pounds, can be easily converted into



Incubator that Serves as Brooder for Newly Hatched Chicks; Above, Crop of Oats Growing in Hatcher

a brooder. The incubator, which has a capacity of sixty eggs, may also be used for sprouting oats for feed, requiring three days in winter and two during summer, to start growth of the grain.

RIVER REVERSES ITS FLOW WHEN SWELLED BY RAIN 3320

So heavy was the rainfall during a recent storm over Chicago, that the Chicago River, normally draining from Lake Michigan through a canal, and thence to the Mississippi River, was reported to have changed its course, and flowed into the lake for nearly an hour. The deluge raised the water level at the locks, almost 40 miles away, until the height there was greater than that at the source. The stream emptied into the lake until 23 years ago, when it was reversed by engineers, so that it would carry away the city's sewage.

Chicago Post Aug 11, 1923
Chicago News

INSECT PARASITES TO BATTLE PRICKLY-PEAR PEST

3313

With approximately 40,000,000 acres in Queensland and about 6,000,000 in New South Wales invaded by the prickly-pear pest, cochineal insects have been imported from Ceylon and northern India to check the plague. Various methods have been adopted to control the plant's spread, including its use for cattle fodder and as material for paper-pulp making and alcohol production. For many years bonuses of \$20 an acre have been offered by the government to assist in clearing the land.

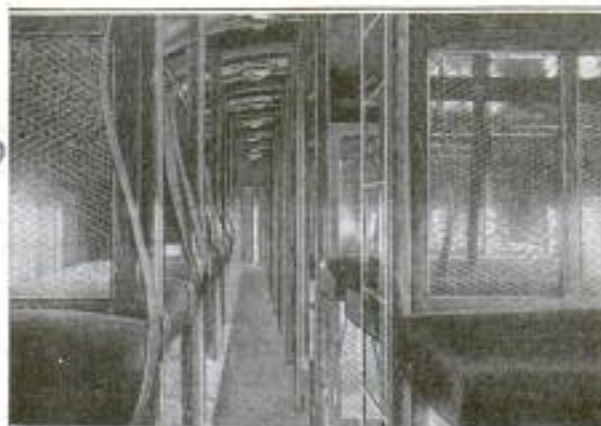
Christian Science Monitor 8/12/23
IRON CHAIR ON WHEELS USED TO PUNISH TRAMPS

3225

Used 25 years ago as punishment for tramps, a queer-looking cage, shaped like a chair and set on wheels, was found recently on a scrap pile in the East. Made of iron straps, it completely inclosed a prisoner, giving him no opportunity to move. A shelf on the front served as a table. Regarded as torture, the practice was stopped.

Kansas City Times 7/12/23
BERTH FOR POOREST TRAVELER PROVIDED IN JAPAN 3253

Sleeping cars for third-class passengers, said to be the first of their kind in the world, are operated by a railroad in Japan. Overnight travelers, heretofore unable to provide themselves with sleeping quarters at higher rates, are quick to take advantage of the accommodations that offer a clean, comfortable berth to the poorest patron at low cost. Like the



Interior of Third-Class Sleeping Car on Japanese Railroad: Note Bamboo and Wire Construction

ordinary railroad sleeper, the beds are built to fold up into seats for use of daylight riders.

*n. Sakata #10,
Esabome, Iidamachi
Kojimachi, Ku-Tokyo*

3268

CAMERA CATCHES TARPON IN BATTLE FOR LIFE

After two months of constant effort, a remarkable photograph of a giant tarpon, the silver king of the deep, valiantly fighting for his life, was obtained. Maddened by fear and pain, the huge fish broke water on a taut line, and, enveloped in spray, hurled itself with terrific force high into the air, trying to cast the cruel barb from its mouth. Even to the end, the gasping monster battled vainly to regain its freedom. The picture is regarded as among the most unusual ever taken of a leaping fish. While the tarpon is prized as food, it is more sought after because of



the sport it affords the fisherman. Having seized the baited hook, a struggle begins that taxes skill and tackle to the utmost. The fish, the moment it feels the point of the hook, jumps from the water again and again, and, with gills distended, shakes itself violently. Then is displayed the marvelous strength which this giant of the herring family puts forth in its daily search for the smaller fishes upon which it feeds. Its scales, of beautiful silver tint, as large or larger than a dollar, are often used in making ornaments by residents along the southeastern coast.

In Last Game Fight for Life, This Giant Tarpon Hurlled Itself High above Water to Throw Barb from Mouth

SAFETY EGG-HOLDER SAVES FINGER BURNS

3300

As an addition to kitchen equipment, a lifter has been marketed that safely picks eggs from boiling water without crack-



ing the shells or scalding the cook's fingers. It is also useful in handling vegetables while cooking, holding them firmly when taking them from steaming

pans, and is of especial service in lifting corn-on-the-cob from containers in which it is boiled.

Hughes & Beauregard Co.,
46 Thayer St., Boston, Mass.

ANCIENT BIBLE IS DUG UP FROM EGYPTIAN TOMB

316

Excavating in an early Egyptian cemetery, explorers recently discovered what is regarded to be the earliest Egyptian version of the Gospel of St. John, believed to have been written about 400 A. D. Seventy-five papyrus leaves, three-fourths of the complete work, wrapped in a rag, were taken from a pot unearthed in one of the cliff tombs. When translated, the find is expected to shed light on the accepted idea of the Greek text in ancient Egypt. One of the oldest previous records of the gospel dates back to A. D. 200.

What is believed to be one of the first pleasure power cruisers built with fish "wells" was launched recently. Underway, water flows through the tanks.

Electrolit News 8/10/23

ELECTRIC RAILWAY SOLVES SPACE PROBLEM

ENGINEERING problems of no little difficulty have been solved by an electric interurban railroad running between Chicago and Milwaukee in putting into service a new chair car and diner on one of its special express trains. The problem confronting the company was to create cars having all the necessary safety features and comfort of a steam railroad's service, yet so compactly built as to be practicable on its line.

Special framework construction was worked out, after several months' study, which assured safety, for the train travels often at a speed of 75 miles an hour.

The diner represents unusually efficient building. In the tiny kitchen no space, however small, has been neglected or remained unused. With a working space only 2½ feet wide and 9 feet long, stoves,

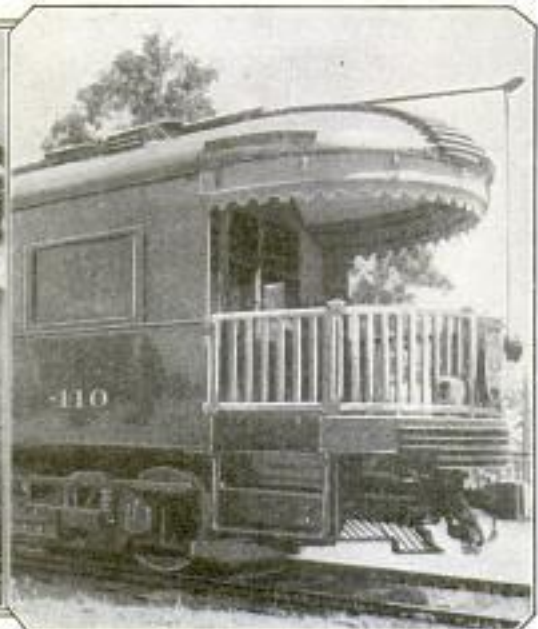
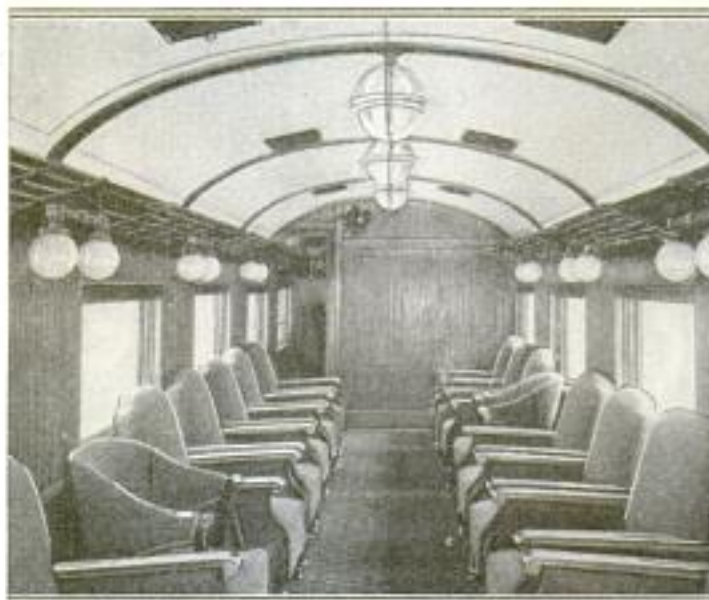
utensils, tableware, refrigeration, worktables, sinks, coffee urns, a steam table, clothes lockers, and many other storage spaces have been provided. The little room has been thought out scientifically to permit the cook to have every convenience "right under his hand" when needed.

Odd-shaped spaces have been given doors so that they may be used. Notches had to be cut here and there to allow doors to open or slide back and forth. By clever arrangement, water, both hot and cold, has been piped from place to place—the tanks being on the roof of the car.

Many details have been worked out cleverly. For instance, it has been found most practical to make the coffee in the urn with water boiled elsewhere in the kitchen and then kept hot with a patented heating appliance burning alcohol.



In This Tiny but Remarkably Complete Kitchen All Necessities Have a Place



Chair Car and Observation Platform Offering Added Passenger Comforts on Intercity Electric Line

*Ever Ready Finger
Moistener Co.*

POPULAR MECHANICS
1051 W. 7th St. St. Paul, Minn.

**FINGER MOISTENER IN PALM
OF HAND SPEEDS UP WORK**

3293

For convenience and speed in handling papers in such tasks as bookkeeping, machine posting, and feeding printing presses,



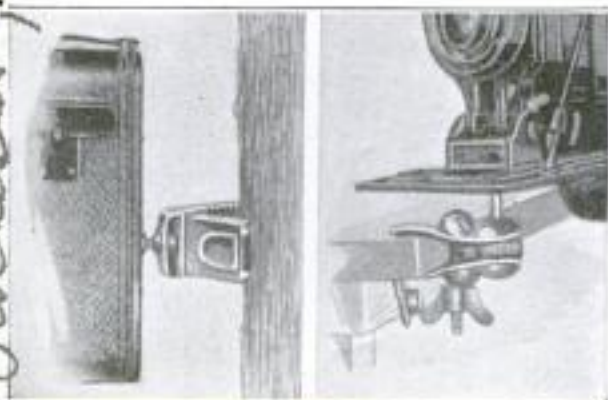
a finger moistener that fits in the palm of the hand is being marketed. It eliminates reaching to a pad. The fingers are kept damp by touching them against a piece of felt, mounted on a small metal

water reservoir, without hampering freedom of movement. As there is little wear on any of the parts, the device will last for a considerable time.

**CLAMPS SERVE AS TRIPOD
FOR HOLDING CAMERA**

3307

To serve the purpose of a tripod, small clamps that attach a camera with a firm grip to a tree trunk, fence, post, table top, or almost any other solid object, are



Small Clamps That Act as Tripods by Clamping to Trees or Other Solid Objects

being made in two types. One has felt pads to prevent marring the surface to which it fastens; the other has sharp sawlike edges pressed together by a strong spring. The clamps fit the ordinary tripod hole, and can be carried in the vest pocket.

Graphite, from which lead pencils are made, was first discovered in Siberia in 1842.

**"TALKING" LIBRARY OF VOICES
TO PRESERVE LANGUAGES**

To keep the words of all languages alive, a "talking" library has been established in Germany. Efforts are being



Radio Device Used for Carrying Voices in Germany in Long-Distance Concerts

made to collect the actual sounds of all languages and dialects of the earth, and to record and reproduce them with the aid of a special type of phonograph. At present, specimens of the languages of 217 nationalities have been recorded for study.

**SCARCITY OF WILD ANIMALS
SENDS THEIR PRICE UP**

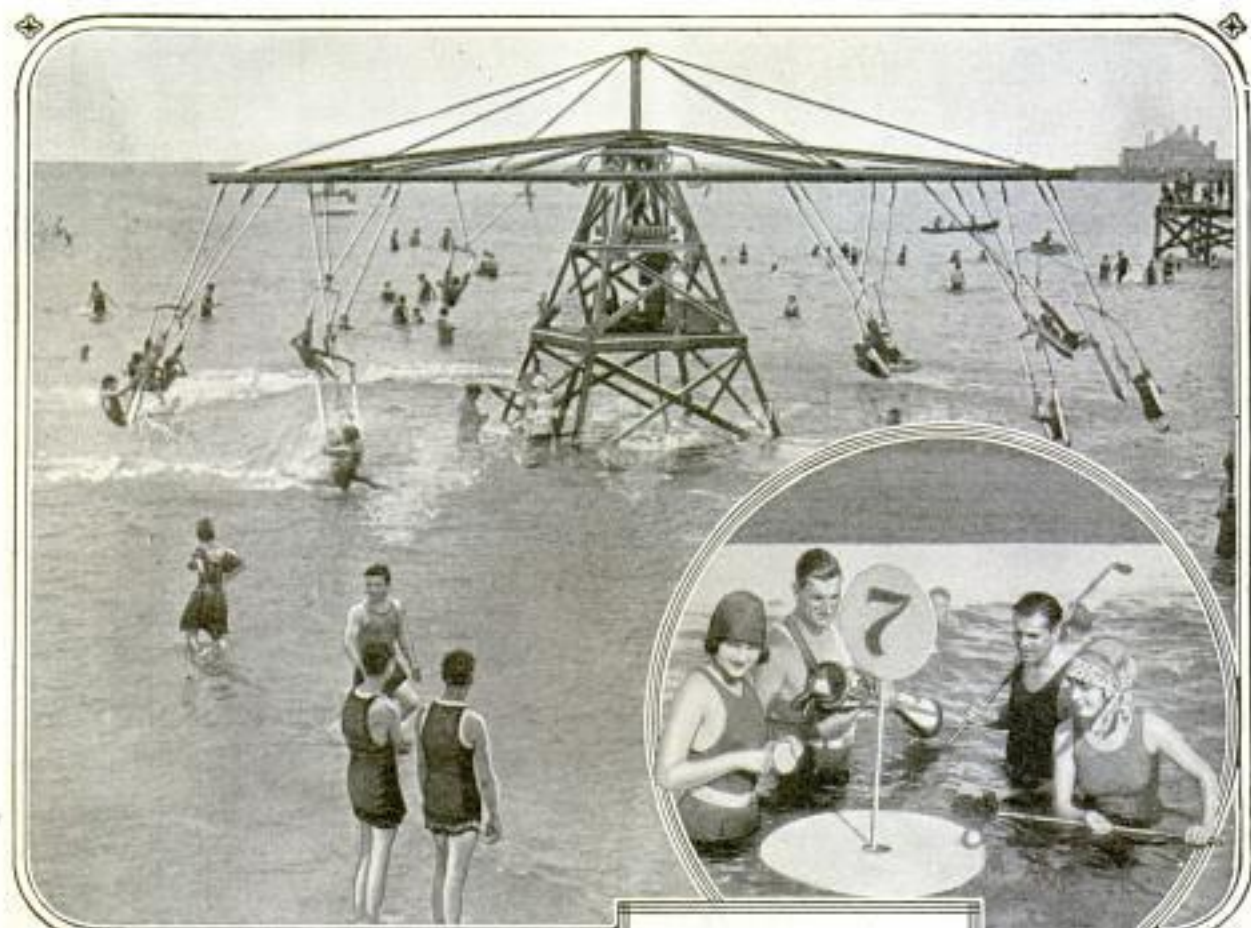
3336

Prices paid for wild animals are going up. Post-war conditions have so interfered with the industry of providing wild beasts for circuses and zoos, that few can be bought in the world market, the center of which is Hamburg, Germany. A giraffe brings \$5,000; a hippopotamus, \$2,500 to \$5,000; and good lions are sold at \$1,250. To replenish depleted stocks in captivity, hunters are planning a trip to a province in India, where, in previous years, many tigers were obtained. That territory now abounds with lions. Eight shipped there several years ago, have so increased as to become the terror of the country.

*Chicago Post
8/13/23*

*Christian Science Monitor
8/9/23*

*Eastman Kodak Co.
Rochester N.Y.*



Merry-Go-Round and
Water Golf Game De-
vised to Lend Variety
to Beach Sports



Both Exercise and Amusement are Provided for Bathers by
Great "Medicine" Balls, Tossed About in the Water

Life-Giving Rays of Summer Sun Are Found to Be a Cure for Many Ills

Science Reveals Why People Instinctively Seek the Sunlight; Beams, Invisible to the Eye, Are Stored in Coats of Tan for Making of Red Blood; Solar Energy Contains Power to Operate Devices of Man

WHY do human beings instinctively seek the sunlight?

Because of an instinct as old as mankind, science answers, and turns to the laboratory to study the effect of the sun's rays on the body.

In a long series of tests made recently in the East, it was found that these beams, many of them invisible to the naked eye, stimulate the production of red blood corpuscles. Two litters of rats were fed upon a diet that was weak in vital elements, one set being kept in a dark place and the other in the sunlight. While the latter thrived, despite the lack in their food, the former contracted diseases, and died.

In the experiments, some of the rats were kept under glass, and much the same thing happened to them as to the ones that had been placed in the dark, which was taken as proof that the direct rays of the sun, in some mysterious way, made up for the deficiency in diet.

Attention was then given to the study of sunburn, to find out its place in the general health of the body. It was found that this layer of bronze not only acts as a protection to the skin, but also ab-

sorbs and stores up for future use the life-giving rays in proportion to the lightness or the heaviness of the coat of tan. As a result, it was found by actual count that the red blood corpuscles increased, while the muscles were stimulated and deeper breathing was set up.

Like all other human organs, the sense of sight is limited, the experimenters explained. It is sensitive to only a certain range of light waves in its reactions, waves of greater or shorter length being invisible but producing dull pains in the eyes.

Artificial light is declared to contain a greater amount of these invisible rays than does natural light. As a result, the eye tires more quickly under artificial glares.

And so, in fleeing from crowded tenements, hot offices, and secluded homes, to lakes, fields, and streams each summer, mankind is only obeying an instinct as old as the race, the demand of tired bodies for something essential to their welfare. This also is shown by the experience of a sun school in Switzerland.

Built high up on the Alps, it was first thought that the wonderful results ob-



Summer Skies and Blue Waves Prove an Irresistible Magnet in Pulling Toilers from Work Benches and Desks in All Parts of the Country to the Cool Bathing Beaches



Crude Rafts in Tropical Wilds and Specially Built Pools in
Modern Cities Testify to Mankind's Love for the Water

2589

tained in treating ailing children were due entirely to the effects of the sunlight on germs. But it has also been proved that germs can be killed, or at least rendered inactive, in very cold climates, without helping the patient as much as the sunlight does. The new discoveries are said to show that even more than the germ-killing qualities of the sunlight, is the creation of new vital red blood, which is itself one of the most potent destroyers of germs, and the restoring of chemical balance, without which no body can work properly.



Swiss Sun School in Alps Where Ailing Children Are Exposed to Life-Giving Rays

Since earliest days, the sun has been regarded with awe by mankind. Traces

of sun worship appear in the oldest records of the human race. They are present in the old theology of Egypt where it was believed that "Ra," who traveled the upper and lower regions of the universe in his boat, was the sun himself.

Modern Hinduism is full of sun worship and it exists among the Kol tribes, the Khonds, and the Tartars, and is still found among the native races of Central America.

Now scientists are looking to the sun to provide a practically limitless amount of power. Harnessing solar energy, it is pointed out, offers a great field for inventors.

3175

ICE HAULS NATURE'S FREIGHT WITH WIND AS LOCOMOTIVE

Although man has covered the world with railroad systems and steamship lines, Mother Nature is the pioneer in transportation service. For ages she has been moving her own products from point to point by many different methods. One of the most unusual of these transfers occurs in the formation of bottom ice which freezes at the bottom of fresh and salt-water bodies. Stones, rocks, and other debris become imbedded in these cakes, which, after a time, move upward toward the surface, often with sufficient force to shoot high into the air.

Then these pieces of ice, sometimes as large as a house, become huge "freighters," traveling considerable distances with the winds and current. As they melt, the stones and other fragments sink to the bottom again. That parts of sunken ships have been carried many miles in this manner has been proved by deep-sea divers, who have found them literally covered with stones that came from other localities. Near Copenhagen, a block of granite weighing more than 400 tons was lifted from the ocean bed and moved to a place miles distant. In the same neighborhood hurricanes drove far up on the shore sheets of ice that, when melted, left piles of ocean-bed rocks, chains, and parts of sunken vessels.

3185

SAFETY BATH TUB FOR BABY HAS DRESSING-TABLE TOP

With a movable cover that acts as a dressing table, a safety bath tub for babies has been invented by a western man. Made of canvas, and hung from a wooden frame, it fits across the ordinary bath tub, so that the child is almost



Baby's Bath Tub with Cover Down, Serving as Dressing Table; Below, Infant Safely Held in Water

on a level with the top. When the bath is completed, the cover can be used as a table, providing space for clothes and toilet articles. Thus the person bathing the child need not bend over the tub.

*The Infantable Co.,
456 Broadway
New York*

*Cont. Edwynne Fightingale
1442 W. Sunnemat Ave
Chicago*

**VACUUM CLEANER FOR HORSE
 REPLACES HAND COMB**

8305

With a currycomb attached to a vacuum cleaner, members of the fire department of a Middle Western city clean and dress



Cleaning and Dressing the Hair of a Horse With Currycomb Attached to Vacuum Cleaner

the hair of several horses in the same time as required by hand for one animal. The scrubbing is more thorough, too, it has been found, and requires much less physical effort. The comb can be applied to stationary types of suction cleaners by using a hose long enough to enable the operator to pass around the animal.

**EYE SHADES SNAP ON GLASSES
 TO MELLOW LIGHT GLARE**

3297

For workers who perform their tasks under strong lights, eye shades have been devised that snap to the frames of spectacles of any size or style. Attached or detached in an instant, the shades, made of colored transparent material, soften the rays from overhead lighting fixtures, thus lessening the probability of strain, fatigue, or headaches resulting from glares.



"Mellow-lite")

**FIFTEEN YEARS ADDED TO SPAN
 OF LIFE IN PAST FIFTY**

Figures have been compiled showing that the average length of life for inhabitants of the United States has increased almost 15 years in the past 53. In 1870, the average was 41 years, while now it is almost 56. By 1950, the span will have reached the biblical threescore and ten, provided the present high standards of civilization and correct living are maintained, a scientist has predicted. In the 16th century the ordinary term of life was between 18 and 20 years, and about 1800, it was still less than 25 years. At the end of the 19th century, it ranged between 45 and 48 years.

**TRENCH HELMETS IN MINES
 PROTECT WORKERS' HEADS**

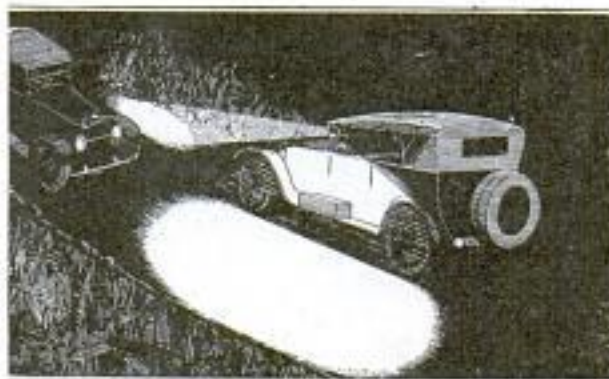
3337

Heavy trench shoes and tin hats, that served to stop shrapnel on war-swept fields of France, are being used by many miners in the West as protection against falling ore and rock. Recently a large company was so impressed with the value of these war implements that its officers provided all their miners with them. The safety idea spread. Men who left the mines for war and were there convinced of the worth of the helmets, have induced others to use them.

**SPOTLIGHT WITH SIDE RAY
 FOR NIGHT DRIVING**

3101

Not only is the dark road ahead illuminated, but also that at the side of the car, by an automobile spotlight patented recently, having two lights within one shell.



Front and Side of Road Illuminated by Spotlight to Lessen Danger of Accident

Thus, the danger of collision or running off narrow highways at night is avoided. By moving the bracket, the side light can be made to throw its rays rearward.

The Side-Ray Spotlight Co.,
 86 W. Park St.,
 Portland, Oregon

H & A Mfg. Co., 1753 E. 21st,
 Cleveland, Ohio
 Price - 25c

Ferris, Texas
TRUTH IS SOUGHT BY DRUG IN "TWILIGHT SLEEP"

EVER since the time of Diogenes, philosopher of ancient Greece, who is said to have carried a lighted lantern with him night and day in a quest for truth, men have been seeking a means to accurately distinguish between the false and the true, a method that would unerringly judge a person's honesty. Within recent years, science has brought forward inventions to aid in that century-old search. One of the latest that has been called to assist criminologists is scopolamin, a drug that produces what is termed "twilight sleep."

For years it was used in a western penal institution as a treatment for drug addicts. The first announcement of its power as a producer of truth from those even unwilling to give exact information came recently, after more than 500 tests are said to have shown its worth. Since then it has been tested publicly on men convicted of crime and serving prison sentences.

As a result of the tests conducted in the prison, it is reported that a convict suffering from loss of memory revealed his correct identity, and another inmate cleared up seven robberies that had puzzled the police. The police department of one western coast city already has adopted the scopolamin test as part of its regular method in examining persons suspected of crimes.

One of the men given the twilight-sleep treatment was under indeterminate

sentence of ten years to life on conviction of the murder of a Chinese at Sacramento. He was anxious to undergo the test, and, placed in the semiconscious condition, he was asked:

"Did you ever kill a Chinese?"

His reply came immediately, "I did not."

"Who killed the Chinese?"

"My partner, _____, shot him."

"What did you do?"

"I robbed him and put the money in my overcoat pocket."

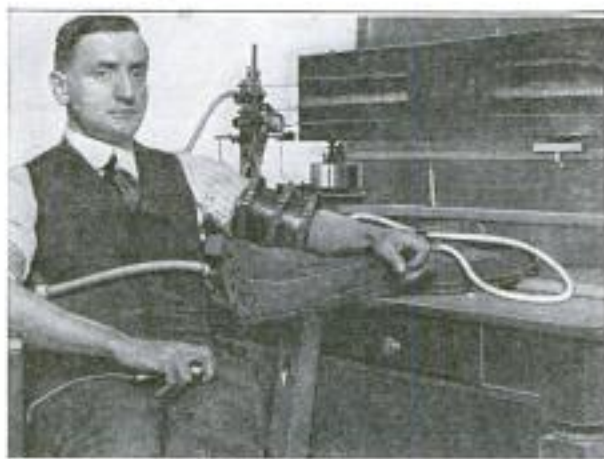
"What kind of money?"

"Coin."

It is said that the drug deadens a man's reasoning powers, and his control over the "dress" of words with which he clothes his statements. The subject rationally replies to questioning, but since the conscious mind is under the curb of the administered drug, the imagination is dormant and the replies are statements of fact coming from the subconscious mind, unaltered in the telling by the desire of the speaker.

It is claimed that it is impossible for a person who has been given this twilight sleep in the proper quantity to tell an untruth, to exaggerate the truth, or to evade the truth in any way.

The "lie detector" is another device being used by investigators to aid them in the solution of crimes.



"Lie Detector" being Tried Out on Man Who was Freed of Murder Charge

August Volney Davis, Chief of Police, Berkeley, Calif.

3066

FREAKS OF CLIMATE SHOWN IN WATER-BOTTLE TEST

Through underground observation stations, scientists have recently completed a series of experiments that indicate Mt. Desert Island, a few miles off the coast of Maine, has a higher average temperature and greater evaporation than Long Island, more than 200 miles to the south. The recording instruments consist of thermometers that register maximum and minimum temperatures and specially designed bottles, filled with distilled water

and fitted with porous stoppers that protrude above the ground. When the sun strikes them, the liquid is drawn from the glass containers in the same manner that moisture is extracted from the earth. Measurements of the water are taken at intervals and the differences noted give the amount of evaporation. On this island, trees, flowers, and plants that are characteristic of the lands of ice and the more southern climes thrive, while birds of the arctic and the southland make it their common home during the spring and summer months.

Lewiston Evening Journal 7/13/23

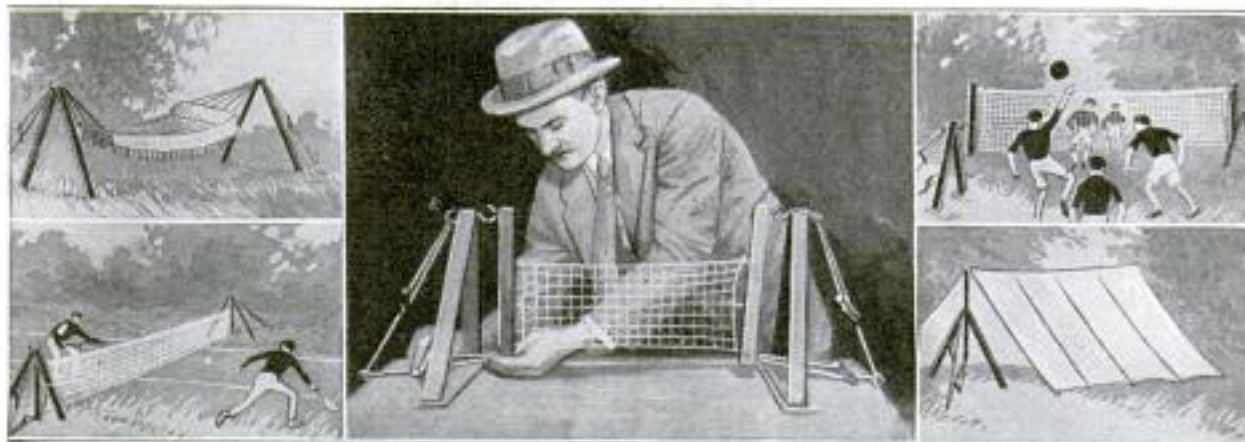
Mallinckrodt Chemical Works 3600 N. 2nd St. St. Louis, Mo.

Copyrighted material

29 41 **TENNIS-NET HOLDER SERVES FOR MANY PURPOSES**

Camp and playground are both provided for by a convertible apparatus that may be changed in a few minutes from a support for volley-ball or tennis nets, to a swing for hammocks, or a tent frame.

It may also be changed to a turning pole for gymnasium work, or used as a sunshade. For parks and large playgrounds, any number may be set up to meet the demand for various games.



Convertible Apparatus That can be Easily Changed for Camp Comfort or Playground Pastime

VARIETY IN MENUS GIVEN BY TURN OF A DIAL

Variety in meals is suggested by a turn of the dial on a card recently made to hang in the kitchen. It is designed to relieve cooks of the task of planning well-balanced menus that differ from day to day. Twenty-four kinds of breakfasts, luncheons, and dinners are given a number. A meat is selected and, by turning the dial, side dishes are suggested. There are five kinds of breakfasts and special menus.

BATHER'S HAIR IS KEPT DRY BY GUARD UNDER CAP

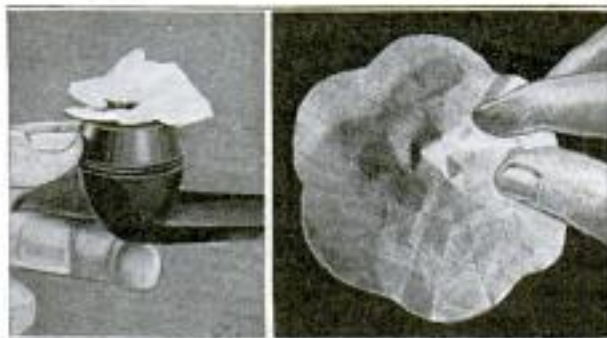
To take the place of a tight-fitting diving cap, a water guard, made of rubber, has been patented. It is in two pieces, a heavy rim fitting around the ears and the hollows at the back of the neck so that when the cap, just tight enough to press against the rim, is worn over it, there is no possibility of getting water into



the hair or ears. By relieving the head of pressure, it contributes to the comfort of swimmers and bathers.

3022 **PAPERS FOR PIPE TOBACCO KEEP THE BOWL CLEAN**

To save cleaning a pipe, smokers in Europe wrap tobacco in small pieces of tissue paper. This makes a pellet shaped



Tobacco Wrapped in Tissue-Paper Pellets, Shaped Like Torpedoes, to Save Cleaning Bowl

like a torpedo. After tearing a hole in the base, so smoke will draw through the stem, the tobacco is placed in the pipe bowl and a light applied to the tissue at the top. Packages of circular pieces of tissue were recently placed on the tobacco market in the United States for this purpose.

Through an agreement of airplane companies with continental railways, it is now possible to travel from London across Europe to Constantinople in less than 30 hours. Passengers, leaving London in the late afternoon, arrive in Constantinople the following night, part of the trip being made by rail and part by the air route.

Cl. W. L. E. & people Madison, Wis.

*3022
Papers for Pipe Tobacco
Pipe Co.,
Job*

*Lew. Mar Products Co.,
39 E. 27th St.
New York.*

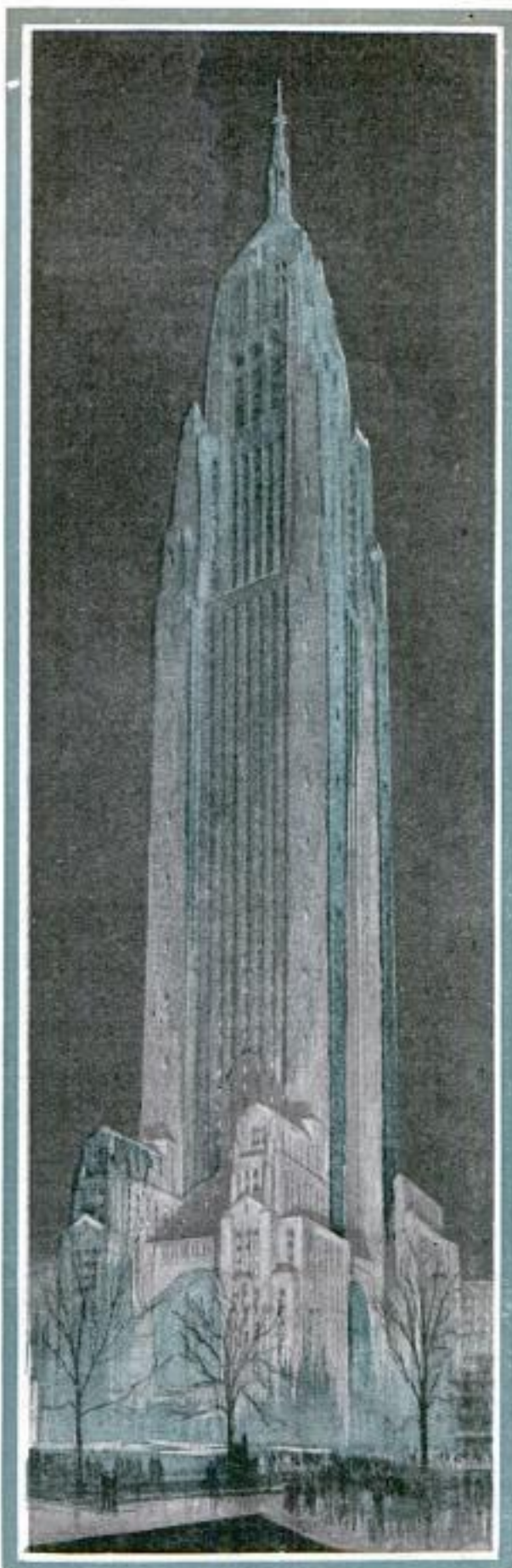
NO LIMIT NOW IN SIGHT FOR SKYSCRAPERS

How tall and how large can a building be? Just recently an eastern architect conceived a structure 80 stories high. The Woolworth building, known as the highest commercial structure now, is 58 stories. As to size, the answer seems to be, "As large as practical."

Although fire hazards and other considerations have resulted in limiting the heights of buildings in many cities, architects declare that the general tendency is continually upward.

With 1,237,000 square feet of floor area, the Equitable building in New York is still the largest office building in the United States. The Union Trust company building in Cleveland is second with 1,173,000, and the General Motors building in Detroit, third, with 1,054,685. The Woolworth has 550,000 square feet.

It is a curious fact that the Woolworth building, although not the largest, has the most tenants—almost 14,000. The Equitable has 12,000, the General Motors about 6,000, and the Union Trust will have about the same number. The Equitable building is equipped with 63 elevators, the Woolworth building has 29, and the



Proposed Eighty-Story Skyscraper to House Church Activities in New York City

General Motors, 27.

Washing the windows of great skyscrapers is a considerable task. The Equitable, for example, has 11,000 panes of glass and but ten men wash them. In the same structure, 90,000 persons use the elevators, 43,000 pieces of mail are received, and 88,000 sent out every day.

In general, the trend in large buildings is toward something restful to the eye as well as strictly utilitarian. An example of this is to be noted in the Chicago Temple building, declared to be one of the most beautiful in the world. Twenty-one stories high, it was constructed by the Chicago Methodist Episcopal Church and Society, and although a downtown office building, houses one of the finest churches in the city.

In the Wrigley building, Chicago has another imposing structure, to which will be added a third when the new building of the Chicago Tribune is completed, the design for which was selected at the conclusion of a \$100,000 prize contest among architects.

In New York, an 80-story building has been designed by Bertram Grosvenor Goodhue to house the religious activities of the Protestant denominations.

New York Times 7/22

2 W. 47th St. 573

Copyright

Sent by Pope Pius XI

The Sphere July 7/1923

574

POPULAR MECHANICS

to Queen Victoria of Spain.

ROSES ARE MADE FROM GOLD
IN COLORS OF NATURE

BATTLE SEA IN OPEN BOATS
ADRIFT THREE WEEKS

3038

Fashioned of jewels and beaten gold, a vase of roses in natural colors was recently made for the queen of Spain. To make the flowers and leaves the proper color, various shades of red, yellow, lemon, green, and white gold leaf were used. Working with a metal so malleable that more than 1,000 three-inch squares can be beaten from one ounce, an exact model of blossoming roses and buds on the stem was created. Leaves were given a greenish tint by use of gold leaf about the 150,000th part of an inch in thickness. Alloys of silver and copper were mixed with gold to produce the desired colors and then the metal was melted in a crucible. After this it was cast in an ingot, flattened into long, narrow strips, and beaten with a 17-pound hammer for 20 minutes. Then it was cut into sections and put between ox skins of a "shoder," where it was pounded again. Artists of a family that for generations has been skilled in this ancient craft spent months in perfecting the queen's gift.

3104

For more than three weeks members of the crew of the Australian ship "Trevesa," shipwrecked recently in the Indian Ocean, rivaled tales of fiction when they battled against death in tiny, open boats as they steered their way by sun and stars to safe island harbors. One boat traveled 1,740 miles in 25 days. Death claimed nine sailors. The other boat reached safety in 22 days, after experiencing high seas and very heavy weather most of the 1,450-mile journey. Two firemen died from exposure on the 10th day. When 1,800 miles off the mainland, a heavy storm had come up and the ship's captain ordered life-boats launched. For five days the captain and the chief officer kept their boats together in a vain hope that they would be rescued, but they were separated by storm. Though frequently blown off their courses, the men kept up courage in the face of what seemed almost certain death, and finally came the triumph of the brave when they landed on the island of Rodriguez.



Golden Roses Made for a Queen in Europe That Show Skill of Artists in the Craft

BUG IS SOUGHT IN THE ORIENT
TO KILL PLANT BEETLE

3088

In an attempt to stamp out the Japanese beetle, a beautiful copper-colored insect that has infected plant life over an area of almost 1,000 square miles in two eastern states since 1916, when it was accidentally introduced into this country, scientists have been sent to China, Japan, Korea, and Hawaii to find a bug that may prey upon it and eventually wipe it out. Unrestrained by attacks of parasites that feed upon it in its native home, where it is called the bean beetle, the insect has multiplied rapidly despite strenuous efforts to exterminate it. Its ravages have become so destructive that the federal

government and the states of New Jersey and Pennsylvania have been forced to quarantine a number of farms in an endeavor to check it. Despite the invention of death-dealing sprays, the march of the pest every year increases about five square miles on each side. The first specimen migrated to the United States on the roots of azaleas imported from Japan.

SERUM HAILED AS ABSOLUTE
PREVENTIVE OF MEASLES

3121

After years of search, a preventive of measles is said to have been found recently by French scientists. Although experimental work still continues, it is said that the results already obtained will

Dr. Chas. Nicolle
Director of Pasteur
Institute, Paris, France.

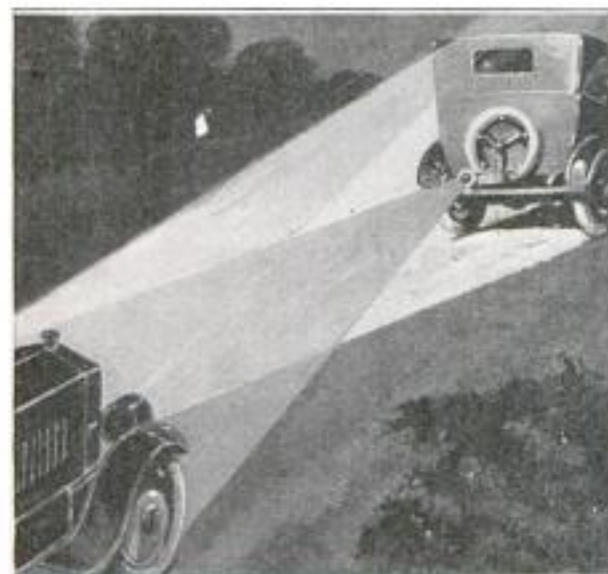
Public Ledger 7/14/23

Chicago

be of great value in stamping out epidemics. In tests at the Pasteur Institute in Paris, France, in 1911, a small amount of serum was taken from a person afflicted with the illness and injected into a healthy individual to produce immunity. Subsequent trials are declared to have brought out the fact that by following the initial vaccination with a secondary one, consisting of a small quantity of blood from a person suffering from the contagion, and repeated several times at intervals of a month, complete immunization would occur.

RED MIRROR ON AUTO SERVES AS WARNING TAIL LIGHT

306 H
With a lens and a conical-shaped reflector of spun glass placed on the rear license plate of an auto, rays of the headlight of a car at the rear are picked up and cast back in a red glow. There are no wires, battery, globes, or oil lamps that might fail. With a metal nameplate around the lens, some types are being made to carry an advertising message. The principle is the same as that of some



Signal That Picks Up Light from Autos at Rear and Sends Back a Red Glow

warning signals that are placed on dangerous curves to pick up lights from approaching autos.

¶To aid the farmer with reports of market service, the government has recently completed a 7,000-mile leased-wire telegraphic circuit. It extends from Boston to San Francisco and connects the leading live-stock and market centers of the country.

OIL STOVE LIKE PHONOGRAPH - BOTH HEATS AND COOKS

306 J
An oil stove that looks like a cabinet phonograph, with mahogany or oak fin-



Oil Stove for Heating and Cooking That Looks Like a Cabinet Phonograph and Takes No More Space

ish to the metal, is made for heating and cooking. Opening the top doors reveals not a sound box but the plate for boiling and frying. The heat that warms the room does the cooking. There is no costly motor, the flame being made on a small burner. Absence of coal dust, ashes, dirt, or bother about renewing fuel are features that are aimed to attract women users of the stove. One filling will last for several hours, it is said.

FIRE IN FORBIDDEN CITY RAZES SON OF HEAVEN'S PALACES

311 K
Mystery surrounds the fire that recently destroyed several of the beautiful and historic buildings of the Forbidden City at Peking, the "Holy of Holies" of the Celestial Empire and the proudest product of Chinese genius and culture. In its exquisite gardens, its delicate halls filled by the piety and industry of 300,000,000 subjects with the noblest art of a great civilization, lived the Son of Heaven, the emperor. The very names of the buildings he inhabited are poems. "Palace of Earthly Bliss," "Throne Room of Perfect Peace," "Palace of Cloudless Heaven"—such were the designations of the wonderful structures within its walls. While a disinherited Son of Heaven still lives in these fairylike surroundings, his power has vanished, apparently beyond recall.

Adwin J. Anderson
R. 300, 140 N. Dearborn
Chicago

Manchester Guardian
7/6/23

Deluge of Paper Money Leaves Trail of Ruin, Famine and Death in Europe

3034

Beggars Are Turned into Millionaires and Princes into Paupers in a Day, while
Poor Lack Even the Necessities of Life

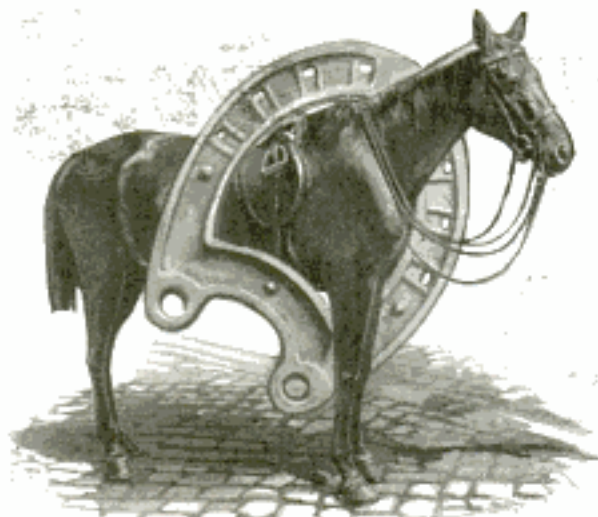
UNDERMINING the very foundations of once powerful nations, turning beggars into millionaires and princes into paupers while the children of the poor cry for the bare necessities of life, the flood of cheap paper money continues to rise in Europe.

Like a ghost city, with its population diminished and its glories departed, once merry Petrograd stands as a symbol of the tragedy that has engulfed so many former centers of civilization in the past few years. Even the main roadways, like the Nevsky Prospect, seem to be caving in.

Stranded vessels rot at their docks along the quays. Long thoroughfares present grim pictures of desolation such as can be furnished only by empty, fallen, and stripped houses. Among the tarnished splendors of the Winter Palace and the Tarskoye-Selo, sit bearded bolshevist officials.

In Moscow, now the seat of the government, there is more activity, but here, too, are found strange contrasts. Within the shadow of the walls of the Kremlin, a relative of the late czar is found driving a street car. Nearby is a former general in the tattered remnants of a uniform, selling newspapers.

Along the Unter den Linden in Berlin, and the Ring Strasse in Vienna, similar incidents are to be observed as the poorly nourished inhabitants struggle to obtain the barest necessities of life. Small apricots sell at 60 cents each. At the dairy, a quart of milk commands a price that would have purchased three first-class cows before the war. Next door the baker smilingly asks as much for a loaf of bread as would have bought a richly furnished automobile in the old days. The bottle of beer, that the innkeeper places before the tourist, has the same value as a truckload of it a decade ago.



Ten Years Ago This German Horse's Value Equaled that of One of Its Shoes at Present

German post offices will not accept a piece of mail until at least 500 marks in stamps have been attached to it. Asking a genial stranger for a match is equivalent to seeking the gift of the hundredth part of a wagonload of cord wood, as the box of matches now costs as much as the wood would have brought in former times. Money is so plentiful and so easily

produced that its value has almost vanished.

In the Balkan countries and farther east, similar conditions prevail. Almost all of Europe is overburdened with floods of paper currency. Germany alone has 41 plants working 24 hours a day and turning out 17,563,819,142 marks' worth of notes every hour.

During July the total paper currency circulating in that country was 20,241,782,966,000 marks. In addition there was 21,200,000,000 marks in aluminum coinage. At that time it was officially stated that no note under the face value of 1,000 marks will be printed in the future, as it costs more than the note itself actually is worth to print any of the smaller denominations.

One curio collector is said to be paying from five to ten times the face value of certain old 100-mark and 1,000-mark notes, declaring that those printed from copper plates are the only ones acceptable abroad, as the later ones, printed from type, are refused because they are too easily counterfeited. This is discredited in some quarters on the belief that the counterfeiters would lose money by producing false notes of such low denominations. In July for a single American dollar, the tourist received nearly 1,000,000 marks that formerly were worth more than 20 cents each.

In general, this flood of money has increased wages to amounts that would



Even the Postal Systems of Central Europe Feel the Downward Slide of Money Values. Ten Years Ago a Carload of Express Matter could be Carried for Less than the Postage Charge Now Required for an Ordinary Letter. Also, Only a Handful of Potatoes can be Purchased for the Price Paid the Pre-War Merchant for a Wagonload.

3034
578

POPULAR MECHANICS

have represented comfortable fortunes a few years ago, but the burden has fallen heaviest on those dependent upon incomes from investments made before the value of the money reached the vanishing point.

Those who borrowed funds, in other days, now find it easy to pay their debts, but the creditors receive practically nothing. Less than a decade ago, the family or man with an income of 25,000 marks a year was considered wealthy. Today this sum would not buy a good meal.

In Russia the whirl of the printing presses has almost ceased. Replacing the almost worthless paper rubles, there is a new gold-guaranteed currency. In July the new 10-ruble notes fetched more in both Russia and abroad than the English pound sterling. A 10-ruble gold note is worth just 825,000 paper rubles in Moscow, and the pound sterling is worth 815,000 paper rubles.

Austria has gone through a somewhat similar regeneration as the result of financial assistance given by other nations, but in some of the other countries little or no improvement has been shown.

Meanwhile, it is estimated that approximately 2,000,000 members of the former Russian aristocracy have fled to foreign lands. Stripped of their possessions, they are to be found in scattered groups in Constantinople, Paris, London and New York.

One of the largest bodies of these exiles is said to have been aboard a strange squadron which the Russian Admiral Stark led into Manila harbor early this year. From there they journeyed westward in an effort to eke out a scanty livelihood.

In Paris lives the Grand Duke Dimitri, first cousin of the late czar and one of those accused of having slain the monk, Rasputin. In some circles he is recognized as the hope of Russian imperialism. After the collapse of the imperial army, he wandered about Europe for some

time, finally arriving in France with less than 100 francs in his pocket.

With his brother-in-law, Prince Poutiatine, and the latter's wife, the Grand Duchess Marie Pavlovna, he started a little embroidery factory in a modest house in the section of Paris in which servants dwell. The princess, sixty-five years old, sad-eyed, tired and thin, acts as forewoman and saleswoman of the establishment.

Bent over a dozen embroidery machines, their eyes hardly ever leaving their work, may be seen a dozen members of the Russian nobility, glad to work for a wage of 2 francs an hour. Eight hours of this labor was worth about \$1.50—just enough to keep the young woman in a widow's veil, the Countess Apracisine, from starvation.

In a Paris dressmaking establishment over the door of which appears the single word, "Yteb," is the Baroness Wrangel, sister-in-law of the General Wrangel who failed in his campaign against the bolshevik army. In another is the Princess Kougoucheff who, through her courage and devotion, saved



German Banknote, with Concealed Vampire Face Biting the Bust's Throat, Visible When It is Turned Lengthwise

her mother, her old governess, and her two young children during the dark days of the revolution.

Brought up in luxury with no idea of ever working for a living, the lot of these refugees has been hard.

For the middle classes, physicians, lawyers, doctors, college professors and others living on fixed salaries and incomes, who were unable to flee from their countries, conditions have been almost equally trying, as the decrease in the purchasing power of their money often reduced them to a condition of actual want. Sometimes they entered the service of their governments without hope of pay.

On the other hand, the wages of skilled laborers generally have kept pace with the increasing cost of necessities and the farmers, except in times of famine, have been able to provide for their own wants,

PAST AND PRESENT VALUES CONTRASTED IN EUROPE



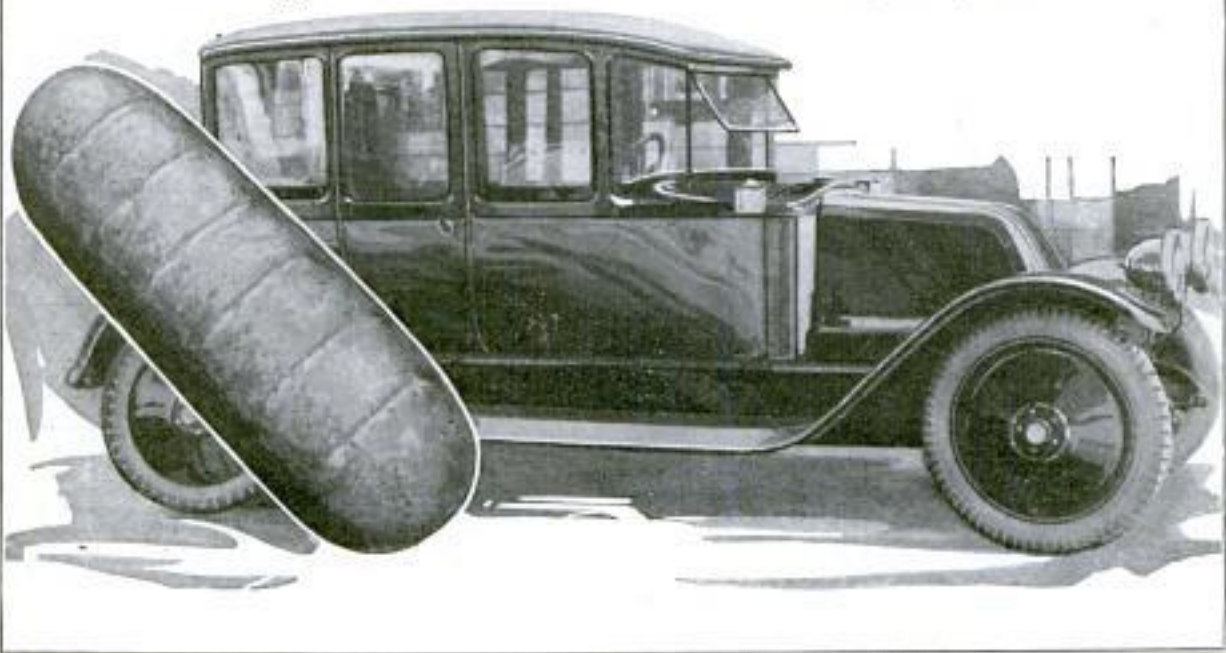
When Money Figures are Considered, Buying a Bottle of Beer in Germany Is Equal to the Purchase of a Pre-War Truckload



Matches Cost More than a Load of Wood Did



Today's Pitcher of Milk Bought Three Head of Cattle Before Cheap Money Came



Prior to the Decline of Currency in Europe, the Cheap Rye Loaf Was Peasants' Fare. Its Present Price would have Bought an Automobile in Those Days

Mr. H. A. Polzine
3350 Beach Ave
POPULAR MECHANICS
Chicago

580

3065

FISHES SWIM IN GLASS TUBE JOINING BOWLS

As a novelty in aquariums, a middle-western inventor has joined two fish bowls with a two-inch glass tube shaped like the letter "U." Fish swim from one jar to the other through this tube, which is filled with water before the bowls are connected. As many bowls as desired may be joined in this way. For his home the inventor has connected ten, making a unique display. Moss and other plants placed in the jars make the setting realistic. On the bottoms are models of turtles and frogs. Around these and up through

the tubes the fish swim, their bright colors creating pleasing contrasts. A person's hand thrust into a bowl, forces the water to move through the tubes. Some of the goldfish have learned to remain motionless when this is done and seem to enjoy the ride as they are carried along in the current. Metal clamps resting on the jar tops, support the tubes. For refilling, a rubber cap is put on one end of the tube and water is poured into the other end. When full, both ends are closed, the tube is set in the bowls, and the caps taken off.



Bowls That are Connected by Glass Tube through Which Fish Swim High above Level of Water in Jars

JUNK HEAP FOR OLD "DOLPHIN" MAKER OF NAVAL HISTORY—

Sold for junk, the historic "Dolphin," pioneer of the present United States Navy and once the first ship of the famed White Squadron, has passed into oblivion after a long and proud career under the Stars and Stripes. The launching of the "Dolphin," more than 30 years ago, marked the beginning of the growth of American sea power. Built as a "steam cruising vessel" and fitted with American armor plate instead of the European product that had been used exclusively prior to that time, the craft was greeted by a storm of ridicule that found an echo even in Europe. Rear Admiral Meade, then a commander, termed it "a marine crazy quilt, with not enough strength to attack an enemy, and not enough speed to run from one." The government at first rejected it, but later relented and consented to a trial trip. Commander Meade was ordered to try it. He headed into the "Atlantic Port

of Storms" and waited for a hurricane. It came, and the old "Dolphin," although it rolled, tossed, and stood on its beam ends, came through with colors flying. At the outbreak of the Spanish-American War, it was ordered into active service, and throughout the hostilities performed blockade duty along the Cuban coast. When trouble with Mexico threatened in 1913, it was sent to Vera Cruz and then to Tampico, where it became a center of storm when a party of its sailors were arrested by Mexican authorities. Almost the oldest ship in the navy, the coming of the World War saw it again in active duty, overhauling and examining outward-bound and incoming steamers. In 1916, it performed its last conspicuous service, carrying Secretary of Navy Daniels and his party when they reviewed the Atlantic fleet. After 37 years of continuous service, the "Dolphin" was put out of commission in 1921, later it was sold, and now has been towed to its last harbor—the junk heap.

New York Times 7/22/23

SIR WALTER RALEIGH'S FIRST PIPE SHOWN IN LONDON

Sir Walter Raleigh's first pipe with which he is believed to have introduced tobacco smoking in England, has recently



Sir Walter Raleigh's First Pipe, Now on Exhibition in a London Cigar Store

been found in London. Made by American Indians, and decorated with carved heads of people and animals, it is said that he smoked it on the eve of his execution. In the three centuries that have elapsed since, the spread of the habit has covered the civilized world. In the United States, a million and a half acres of land are given over yearly to cultivation of many varieties of the plant, producing a crop which occupies a leading place in the country's agricultural output. Government reports show the annual tobacco yield to be far above a billion pounds, with a value of over \$250,000,000. While the industry gives employment to more than 158,000 people in this country, the manufacture of pipes and smokers' articles requires many thousands of workers to supply the demand for them that exists wherever tobacco is used.

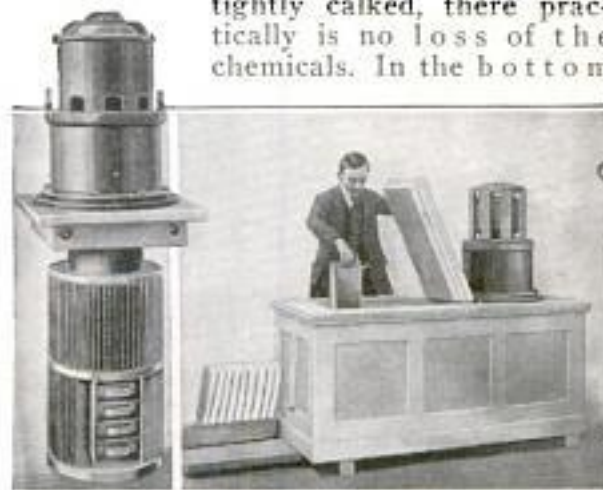
For the dog living in an apartment, costly baskets are being made in color designs to match the decorations. These sleeping cribs are furnished with mattresses and covers.

TRACE OF LOST RACE IS FOUND ON ISLANDS OF PACIFIC

What may be remnants of a civilization that existed 2,000 or more years ago have been found by explorers on the small islands of Necker and Nihoa, part of the Hawaiian group now set apart as a bird reservation. For centuries past, it is believed that those isolated spots have sheltered the secrets of once powerful colonies that may have flourished hundreds of years ago, prior to the Polynesian migration which resulted in the settlement of the Hawaiian chain. In the parts of temples, houses, and traces of system of agriculture, which have resisted the fury of the elements for an unknown period, the experts believe may be found the solution to the mystery surrounding the origin and travels of the ancient Polynesian tribes. The scientists brought back with them bowls hewed from solid rock, a headless idol, and other relics, and told of ruins they regard as evidence that the two islands were the homes of peoples skilled in navigation thousands of years ago.

ICE MACHINE SMALL ENOUGH TO CARRY IN HANDS

So small that it may be carried easily, an ice-making machine that is operated by an electric motor has been invented in Germany. Frigid air is produced by the alternate evaporation and condensation of a chemical contained in the upper part of the device. Since all the seams are tightly caulked, there practically is no loss of the chemicals. In the bottom



Ice-Making Machine Easily Carried, That Makes Own Ice and Freezes Cream

are pans that may be filled with pure water or ice-cream mixtures. Within a short time the contents are turned into ice or ice cream.

8135
mfg. by Escher, Wyss & Co., Zurich, Switzerland

Free Press
Detroit 7/19/23
Mr. S. Agent - J. W. Powell, Vernon Place, Boston, Mass.

Hamilton-Beach Co.

582

POPULAR

Racine, Wis
CAKE IS MIXED BY MOTOR
QUICKER THAN BY HAND

8100

To make mixing a cake easy, an attachment has been invented to be run by a household electric motor, such as are



Attachment for Small Electric Motor That Replaces Hands in Mixing Cake Dough

used to operate sewing machines. The device stirs the dough just as thoroughly as if done by hand, and in a fraction of the time. Quickly adjusted, it may be set up on the bread board, kitchen table, or cabinet within any bowl deep enough to hold the ingredients.

ELECTRIC CELL RIVALS EYE'S SENSITIVENESS TO LIGHT

So sensitive that rays from the flame of a match held 4 feet away will affect it, an electric cell, undergoing a series of tests by eastern experts, can be operated by having beams of light thrown upon it. In appearance, it resembles an ordinary electric-light bulb, except that its inner surface is coated with a silver-colored chemical that offers less resistance to the flow of electricity as the amount of light showing upon it is increased. When light rays strike this delicate substance, they cause the cell to open an electric circuit that carries current to four large lamps. With the aid of this cell it is believed that daylight and darkness can be used to do the work of men in starting and stopping machinery, operating powerful beacon lights in lighthouses, and for setting off alarms. It could be made to turn street-lighting systems on and off, and control the flow of water in reservoirs. Weather experts would be helped in recording the number

Shawn at *American Institute of Electrical Engineers, Sampson, Miss*

Perfected by General Electric Co., Schenectady, N.Y.

Clipping from The Star Johannesburg South Africa 6/16/23

and length of sunny days, or cloudy periods for different places, while the cell could be made to show the presence of storm clouds in the skies between distant points for the purpose of timing their speeds of travel.

copy from R. Perceval 147
not St. Marysburg
FORTY-MILE RIVER DAMMED TO PREVENT FLOODS

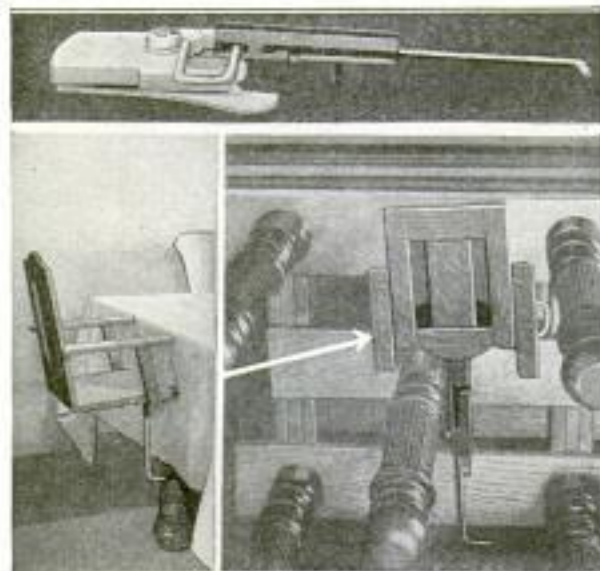
3125

After seven years of building, a dam that stops a 40-mile river in South Africa was recently completed. A barrage type was chosen to prevent collecting of mud and earth in the reservoir and to avoid flooding of private property on the river banks. In the average year enough dirt is carried down this river to cover 720 acres a depth of 6 inches. Passing through tanks and filters and being treated with chemicals clears the water. Thirty-six sluice gates control the huge barrage, 1,400 feet long. When full, the depth of the water will be 25 feet. At the formal opening a British prince officiated.

2982

VANISHING CHAIR FOR BABIES FOLDS UNDERNEATH TABLE

Holding up and sliding on a rod beneath the table top when not in use, a baby chair has been designed to meet the needs of small rooms and apartments. At mealtime it can be drawn out from its place and opened up for the occupant, making an extra chair unnecessary. It



Folding Chair for Small Children That Disappears beneath Table Top When Not Needed

can be attached to any dining table without taking up space usually occupied by larger persons on ordinary chairs.

William C. Stolty
403 Hickory St.
Ottawa, Kans.

3071
Detroit News
7/12/23

Department of
Agriculture
583
KITCHEN IS RUN FOR GERMS
BY GOVERNMENT EXPERTS

**MATCHES USED FOR MONEY
WHERE COPPER IS RARE**

Where copper coins are scarce in some parts of Manchuria, matches and postage stamps are used for small purchases. In one city, a bank has granted loans of \$200 to \$500 worth of coppers to each of 500 small shops. They are worth about 160 to the American dollar.

—3110
**GRAFTING COTTON TO TREE
MAKES CROPS RICHER**

Grafting a single cotton plant to the root of a mulberry tree has produced 900 bolls, or pods, where formerly 40 was a good crop. The process, an invention of a southern plant breeder, is being widely watched because of the possibilities it offers in reducing the cost of cotton. Some of these grafted plants are nearly 8 feet tall and have well-developed fibers, called staples. The production



Inventor Examining Cotton Plant That was Grafted to Mulberry-Tree Root, Increasing Production

rate is greatly increased, three mother plants giving about 60 pounds of seed cotton, or four bales per acre.

3071
**FLAME THROWER TO FIGHT
GRASSHOPPERS IN WEST**

To combat plagues of grasshoppers, a flame thrower has been devised in the West. By means of an air compressor, gasoline and air are projected through a long rubber hose, lighted at the nozzle and the blaze sprayed over the ground, killing the grasshoppers instantly. The insects usually travel in ranks with a front from 100 yards to one quarter of a mile and with a depth of perhaps 50 to 100 feet. When bunched in that manner, the instrument has been found effective

Perfected on Klamath project, Oregon Calif.

2088
In a kitchen where test tubes, flasks, funnels, and jars replace pots and pans, where stoves are single-flame gas burners,



COPYRIGHT, CLINEBART STUDIO, WASHINGTON, D. C.
Preparing Food for Large Family of Germs Used in Study of Plant Diseases

where the cookbook is a scientific journal, government experts prepare food for millions of germs used in research work to determine the causes of plant diseases. For this large family, the most precise care must be taken by the chefs, as each group of the germs demands a different dish, specially treated. While the kitchen contains some foodstuffs that do not differ greatly from those cooked by the housewife, it resembles more the workshop of a chemist, with its rows of small glass containers and instruments.

Tubes of cornmeal mixture correspond to the potatoes and other vegetables. Every day almost 6 pounds of beef are turned into an extract by a most intricate process to please the taste of the germs. Instead of by the spoon, the food is measured by drops, and every step taken is carefully recorded for future reference.

Even dishwashing is a task that demands very careful attention. Empty tubes are first immersed in acid to cut away the particles of food that may cling to the sides, then comes an alcohol bath, a rinsing in distilled water, and finally a baking for an hour and a half in an oven heated to 150 degrees centigrade, nearly 240 degrees Fahrenheit. More than 40,000 test tubes are in constant use.

It takes 61 days' work a year to pay the taxes of every producer in the United States, it is estimated. In 1921, taxes consumed 16.7 of all value produced in this country.



Accustomed to the Movements of Their Human Protector, Buck and Doe Await Daily Portions of Fodder



Born on the Island, Fawns Grow Up to Regard It as Their Haven of Peace and Plenty



Board Tables Laden with Bowls of Feed are Frequently Visited by Arrivals from the Mainland

WILD DEER FRIENDS OF EXILE ON LONELY ISLAND

LIVING alone on a tiny island on the British Columbia coast, a wilderness dweller, fond of animals, has succeeded in winning the friendship of a herd of wild deer.

In doing this, he first laid out corn-stalks on the paths near his house. Gradually one deer came to accept him as a friend. In a few weeks' time this animal brought another. By the end of a year the two had persuaded five more that here at least was one of the man-beings who could be trusted. The seven soon got quite tame and would come up to the man.

Near the little island is a larger one, which, in turn, is close to the mainland. That animals can communicate with each other is evident, for by the middle of the second year the number of the deer on the island had increased to thirty. The only explanation of this is that the first to make friends must have passed on the word to other wild ones.

Finally, the man decided to build a

table with bowls for his visitors. The deer kept increasing, however, in such numbers that he had to build several others, and thus came into existence the first and only "wild-deer restaurant" in the world.

Today, six years after beginning the experiment, there are hundreds of deer upon his island. They come and go as they please, as they have the whole of British Columbia to roam in. But the deer now recognize the place as a sanctuary, and here the little fawns are born in great numbers.

Some of the deer, not satisfied with the food at the tables alone, come to the house and knock on the door with their heads and horns, or rattle the door knob with their teeth, in this way begging for extra delicacies.

In the springtime the front yard is an interesting sight, for nearly always there are a number of deer hanging around, or a few fawns playing about, or sleeping on the doorstep.

INDIANS, BEASTS OF BURDEN, CHEAPER THAN TRUCKS

3138

Because labor is so cheap, Indians in Bolivia, South America, are beasts of burden, trudging along with huge loads at less cost than motor trucks. There are few cars even in the capital, where tiny burros and queer-looking llamas with packs pass up and down the streets, guided by natives, also heavily laden. In this city, founded almost 400 years ago by Spaniards, labor-saving ideas are almost unknown. In digging for a store in the capital, recently, Indian men and women carried away all the dirt in small baskets on their backs.

HOTTEST FLAME KNOWN TO AID IN STUDY OF PLANETS

What is declared to be the hottest flame known to man has been produced by artificial means in experiments held to study the form of atoms. An electric blast, lasting for only a small part of a second, occurring on a charged wire, seemed to explode, creating heat so intense that it could not be measured, although estimates put it at 30,000 to 80,000 degrees. Pictures taken as the explosions occur are expected to aid astronomers in solving the causes for different kinds of light thrown off by many of the planets.

Dr. Ralph Sawyer
University of Michigan
Ann Arbor, Mich.

TOY SHOWS REAL MOVIE FILM WITHOUT USE OF SCREEN

Cut-outs and strips from standard movie films appear lifelike when viewed through a toy recently invented. At one



Tube through Which Cut-Outs of Movie Film Appear Lifelike without Use of Screen

end of a tin tube is a thin piece of glass for a lens. At the other end is a plate across which the movie film passes. Motion is by hand and the scenes are inserted one at a time so that, although the films are duplicates of those shown on the screen, the figures shown do not move. A large variety of cut-outs is given with each eyepiece. They are taken from films once shown in the movies.

Built by W. F. Lserhart
Aeronautical Engineer

Inventor -
Stephen Vadesz
Hungarian
Engineer

586

POPULAR MECHANICS

Mr Cook Field Nav. Chicago

PLANE IS PROPELLED BY FEET
IN SEVEN-YARD FLIGHT

VEST-POCKET PHONOGRAPH
IS BUILT LIKE WATCH

Propelling an airplane with his feet, an inventor at a middle-western field recently flew almost 7 yards. He rose 3

No larger than an ordinary watch, a gramophone has been invented by a Hungarian engineer that is said to be capable of producing jazz, waltzes, and one-steps. The instrument is wound like a timepiece and fits conveniently in a waistcoat pocket. An inside compartment holds 10 plates that may be played on both sides. In England a midget machine that is only 6 inches high and weighs 4 pounds is being marketed. It has a collapsible horn, takes full-size records, and folds together like a camera.



Seven-Winged Airplane That Made Seven-Yard Flight Propelled Only by Foot Power

inches from the ground. The flight was said to be the first of any craft moved by foot power. The plane, which is constructed of light materials, was not made for sky trips, but merely to prove that it is possible to fly by pedal power alone, the engineer said.

SCORER FOR CARD GAME AIDS
IN AVOIDING MISTAKES

With a device for scoring card games that recently has been invented, there is less chance of making an error in figuring the standing of the players. Made to rest upon the table, the progress of the game can be determined from it at a glance. Although especially intended for auction bridge, it may be used for registering points in other games. Two lines crossing the board at right angles divide it into "we" and "they" sides, the part above



Mechanical Card-Game Scorer Designed to Avoid Errors and to Add Interest to Game

SUGAR ALCOHOL RUNS ENGINES
ON HAWAIIAN PLANTATIONS

Molasses, a waste by-product of the sugar industry in Hawaii, sometimes used as fertilizer and stock feed, is being turned into alcohol to run machinery, automobiles, and tractors on Hawaiian plantations. As a fuel for heating purposes, it is said to leave no sooty deposit, burning with a clear flame, and easily affected by water in case of accidental fire. Most of this sugar alcohol is produced by the plantations in their own distilleries, one of which furnishes enough to run its 32 trucks, 20 passenger cars, and two tractors, aside from supplying the kitchen stoves of hundreds of field laborers. Sugar being the chief crop, gasoline shortage holds no terrors for automobile owners on the islands, as they are not only able to supply all local needs for fuel alcohol, but can make a surplus for exporting. Ether can also be manufactured from the molasses.

the horizontal line is fitted with two series of numerals on disks, ranging from 0 to 9, that count the honors. Below that line is a similar arrangement for tabulating tricks, with markers to show the first and second, or rubber, games.

AUTO FOR EVERY NINE PERSONS

Registration of trucks and automobiles as reported recently indicates that there are now more than 13,048,128 motor vehicles in the United States, an average of one machine for every 8.5 persons. Between July 1, 1922, and July 1, 1923, there was a gain of 2,440,000, almost 23 per cent.

H. P. Agee director, Experimental Chicago
Station, Hawaiian Sugar Planters.

Michael H. Huges, Harbor
Newfoundland, Canada.
L. W. Grace.

Anchorapolis News
7/1/23

Detroit News
7/10/23

Com. R. J. Kirhpatrik - General Electric Co.
Balboa Heights
POPULAR MECHANICS 587
Schuetzady, N.Y.

Canal Zone
**LONGEST ROUTE IS CHEAPEST
 VIA PANAMA CANAL**

Although the longest way may not be the quickest, it has often proved the cheapest since the building of the Panama Canal. Recently a vessel sailed 5,770 miles via the canal to deliver a shipment from one city in South America to another only 650 miles away by air line. Despite the length of the voyage, the charges were less than they would have been if the merchandise had been transported directly overland, because of the almost impassable jungles separating the two points. In another instance it was found less costly to ship lumber more than 8,000 miles by steamer through the canal than to send it to the same destination 2,500 miles by railway. The trip from the west coast, through the canal, up the east coast, and to a middle-western city by rivers and lakes, took more than two months. It even has been found cheaper to send products 1,000 miles by rail to the east and thence by boat through the canal to the west coast, a total distance of approximately 7,000 miles, than to ship them 2,500 miles overland.

**MODEL SHIP IS CUT FROM LOG
 WITH A JACKKNIFE**

With a jackknife as his only tool, a mechanic has carved from a single log of cedar, a model of the United States' Oriental liner, "President Grant." Although it is built on a small scale, every



Putting Finishing Touches on Model Ship Whittled with Jackknife from Block of Wood

detail down to the rows of portholes and ventilator shafts, is correctly reproduced. It took thirteen months of whittling to complete the miniature.

Our Bureau of Information will answer all questions regarding articles appearing in this magazine.

*made by L.A. Maynard
 Seattle, Wash.*

**TRUE PIANO TONES BROADCAST
 BY IMPROVED MICROPHONE**

Radio transmission of exact qualities of piano music is said to have been made possible by means of a microphone re-



Piano Equipped with Lately Devised Microphone Designed to Correctly Transmit Its Varying Tones

cently developed and now being used in one of the large wireless stations in the East. The device consists of a magnetic system with a coil. The magnet is firmly attached to the frame of the piano while the coil is fixed to the sounding board. In this manner, the tones are correctly converted into electric waves.

**COLD GREATER THAN ARCTIC'S
 TURNS OUT HELIUM GAS**

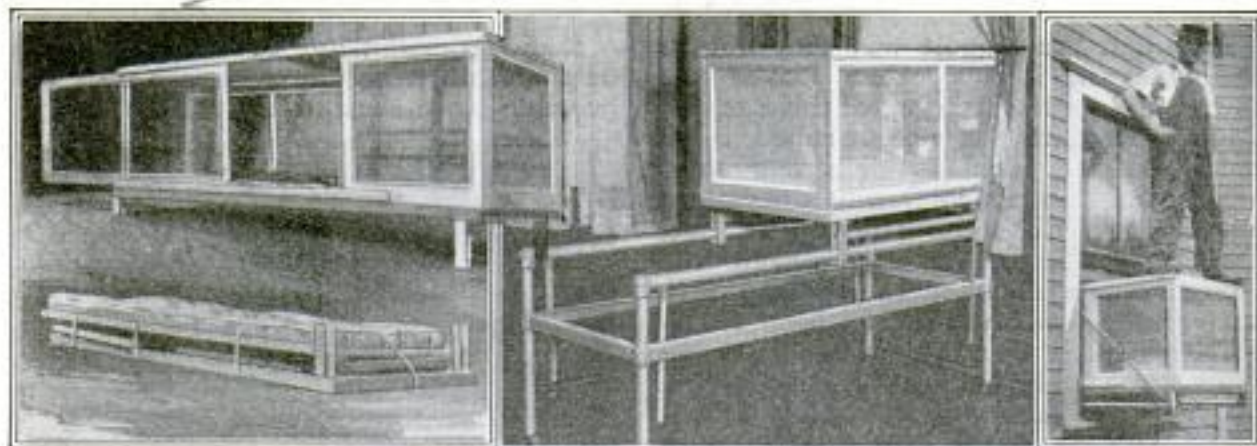
Cold, many times lower than any temperature found existing naturally on the face of the earth, is used in making helium for the government's balloons and dirigibles. By a secret process, natural gas subjected to tremendous pressure, turns to liquid at 317 degrees below zero, and the helium is drawn off. To change nitrogen gas into a solid would require a temperature of 353 degrees below zero. A piece of raw meat subjected to such freezing would shatter to bits, if dropped on a hard floor, while a pencil would burst into splinters.

**QUICK-CHANGE SCREW DRIVER
 HAS BLADES IN HANDLE**

For use in the shop or home, a screw driver is being made that has three different blades in its handle. Any one desired may be set in working position when the tool is tipped up. A turn of the handle locks it in place. By reversing the operation, the blades are retracted.

*W. A. Maynard & Co. Kidmore
 110 E. 6th St.
 Santa Ana, Calif.*

8211



Left: Bed Folded for Use With Camping Outfit; Center: Metal Frame on Which It Rolls Through Window; Right: Man Testing Strength of Chains Holding Bed

For outdoor sleepers, a screened bed that can be suspended out of a window and held safely in position by heavy chains, has been invented. When not in use, it rolls back over a metal frame equipped with casters that permit it to be

moved with ease to any part of the room. In the house the bed can be used as a davenport, or it can be detached from the frame, folded up, and carried with a camping outfit, short legs being provided to support it.

3151
AERIAL TORPEDO IS CALLED BLOODHOUND OF THE SKY

Because it actually trails the sound of an airplane motor and explodes on reaching the craft, a torpedo recently invented is called "the bloodhound of the sky." Shaped like those fired from vessels, it is driven by liquid air. The operator, locating the noise of an airplane's engine by radio, launches the torpedo by pulling a trigger to release the turbine in the missile. With a roaring swish it takes to the air, pointing upward at first, and then turning straight toward the target. When the device strikes, an explosion of terrific force results. During a test one tuned to a motorcycle engine demolished the machine.

3163
MOUNTED "DUMMY BOY" KEEPS RAILWAY TRACKS CLEAR

Flagmen, mounted on horses, still ride ahead of trains on Tenth Avenue in New York to warn walkers and automobile drivers of the approach of locomotives. When required, they halt a train at a crossing by stationing themselves in front of the engine. - In these days of electric-signal systems and other similar inventions, people stop and look when a rider, known as a "dummy boy," passes down

the track. This system of signaling which was employed to announce the approach of the first steam train, passed out of general use about 100 years ago.

3194
FOLDING JELLY-BAG STRAINER SAVES MANY STEPS

Fashioned from wire so that it will fold, a jelly-bag strainer being marketed rests on any flat surface, and may be placed near the stove within easy reach of the cook, thus eliminating many steps. As all parts are accessible, it can be quickly cleaned. The bag may be replaced when worn, making the device serviceable through several canning seasons. While in use, the receptacle is kept from tipping by a wide base.



Before mummies came to be regarded as objects of value for museums, many were pulverized and turned into a brown paint.

*Kansas City Star
7/22/23*

*M. Wrepper & Co. Chicago
56 E. Randolph*

*Kansas City Star
7/23/23*

Case & Martin Co., Wood
& Walnut, Chicago

More than a Million Loaves for Every One that Grandmother Used to Make

How Science of Baking Bread Has Progressed Since Days of the
3081 Log Cabin, Lifting Burden of Toil from Women

FROM the log cabin, with its great, open fireplace, to the modern steam-heated, electrically lighted apartment seems a long journey, but it was made in much less than 100 years.

Until 15 years ago, bread was baked by hand in a way that had been passed down from prehistoric days in almost unchanged form. At that time, with few exceptions, none of the machines now used in the baking industry had been invented.

That is why bakers themselves like to call their industry "The newest-born babe of Mrs. Machinery." In one middle-western city alone, they make approximately 9,000,000 pounds of bread and rolls weekly, supplying more than 60 per cent of the total amount consumed.

For every loaf that mother used to make, great machines now turn out a million, and, according to food experts, the product is more uniform and better in every way.

When thin lines of pioneers from the New England states first turned their creaking, ox-drawn wagons toward the forests that covered all of the territory west of the Appalachian Mountains, bread-making was an art involving almost endless toil.

All of the cooking for the families, which usually were large, was done over open fireplaces, servants were unknown, and the housewife not only prepared the food, but carded the wool and wove all of the clothes used in her household. The usual workday began with dawn and ended with darkness, which found the fire banked and all of the household in bed.

Pioneers still living tell of having been



forced to walk miles through snowdrifts to the nearest neighbor for live coals to rekindle a fire that had gone out during the night. Matches, of course, were unknown, and steel and flint were rare. Once lighted, the fire on the hearth was constantly watched, as it often spelled tragedy for the settlers when allowed to die out.

Such a thing as an 8-hour day was unknown

for anyone, the men toiling as long as there was light, while the women molded candles and musket balls for hunting, and worked in their gardens, after their other tasks were finished.

Meat was cooked on spits turned before the open fire, and vegetables stewed in pots swung over it. Bread was baked in pans placed in the glowing coals or in ovens built into the sides of the fireplaces, and flour was usually ground from wheat on crude hand mills, as it was needed.

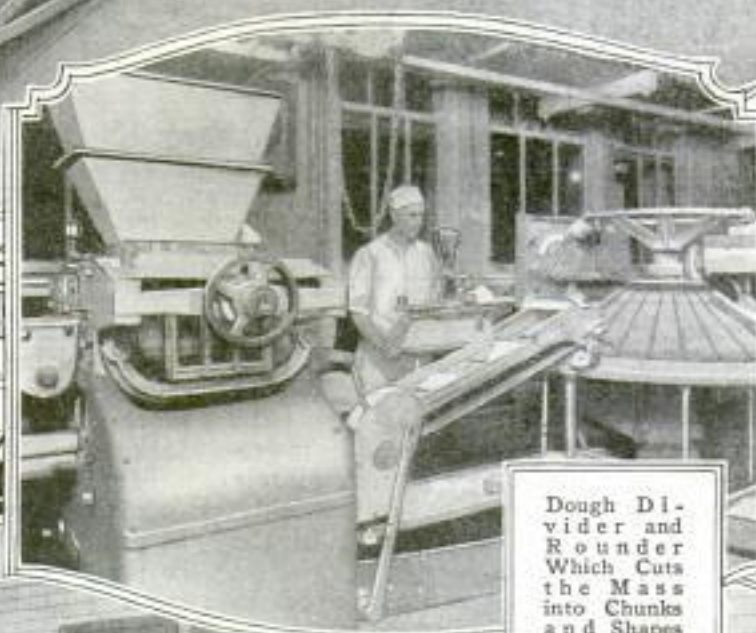
Today large wholesale baking plants supply entire cities, their forces of white-capped workmen beginning in the early evening and working through the night so that their product can be delivered fresh for the breakfast tables by fleets of motor trucks.

In the development of great bakeries, some of which do the work formerly performed by 200,000 women in the homes, research laboratories have been established to reveal the secrets of transformation in the baking process. Here chemists grow colonies of yeast germs and seek cures for all the troubles to which flour and bread are prey.

Machines used in the industry do away with handwork almost entirely. They mix the dough automatically, send it

MAKING BREAD FOR MILLIONS AS CITY SLEEPS

Finished Loaves Coming Down from Ovens on Automatic Conveyors to be Stored in Steel Racks for Cooling before They are Wrapped



Dough Divider and Rounder Which Cuts the Mass into Chunks and Shapes Them: Scales Test the Accuracy of the Machine



One Section of the Baking Room Which is Equipped with Long Rows of White-Tiled Ovens

WOMAN'S WORKSHOP OF YESTERDAY AND OF TODAY



This is the Kitchen in the Home of John Howard Payne, Who Wrote "Home Sweet Home," 100 Years Ago—a Typical One in Great - Grandmother's Time



Representative of the Conveniences Science has Put at the Disposal of Women, This Kitchen Cabinet Provides a Place for Everything

spinning along through loaf cutters, rounders, and proofers, and carry it through traveling ovens where the loaves ride until thoroughly baked, and when cooled are shunted through automatic wrappers to the delivery baskets.

A trip through a large bakery is a revelation of modern, scientific methods of cleanliness, wholesomeness, and quality in food products. Large machines may be seen that operate with so little outside direction, and with such precision and thoroughness, that they seem almost human.

An automatic flour elevator delivers the flour in its original sacks to a room at the top of the building, where it is

blended and mixed. It then goes to the bolting reels and is sifted through large revolving screens of the finest silk mesh.

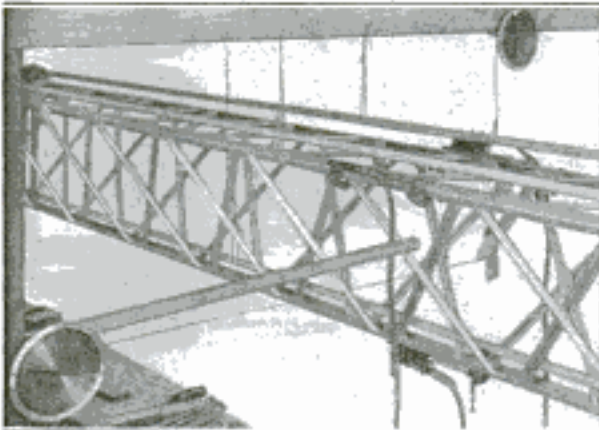
In the mixing room, compressed air drives the flour dust out of every crevice before the next dough enters the mixer. Each piece of machinery is kept absolutely clean. Even the air is washed by being passed through sprays of water before entering the mixing room.



SAFETY GAUGE GIVES WARNING OF WEAKENED BRIDGES

3155

Bridges of the future may be supplied with recently invented strain detectors as permanent equipment, to guard against excessive stresses and danger of collapse.



Strain Gauge for Detecting Weak Braces, Clamped in Position on Girder for Airship

On metal rods, braces, and beams regularly exposed to heavy loads, the recorder will give warning of weakened parts in time for inspection and repair to prevent accidents. Clamped on the girders, the device records strains by

means of two sets of carbon blocks whose resistance to electricity is raised and lowered by pressure. If the strain is in one direction, pressure on one set of blocks is increased, and if the pull is reversed, it affects the other set, causing corresponding variations in dial readings.

MAN AN ELECTRIC MACHINE, IS THEORY OF DOCTOR

3134

Likening the brain and liver to positive and negative poles of an electric battery, a scientist recently advanced the theory that the human body is a machine without a soul, driven by electricity and controlled by the strong emotions, which act as levers. Nerves are regarded as connecting wires. The supporter of the idea asserts there is much evidence to show that men and animals are constructed of component cells, each of which is an important "electrochemical" part. Sleep is explained by this theory as the period when the voltage used in driving the battery is being restored.

So keen are the organs of smell in a vulture and a carrion crow that they can scent their food for 40 miles.

*George R. Burgess,
Director, Dept. of Commerce
Bureau of Standards, Washington, D. C.*

Chicago Tribune 7/21/23

**WOLVERINES IN FINAL STAND
IN WILDS OF SIERRAS** 3142

Driven from other parts of the country, many wolverines inhabiting the wilds of the Sierras, whose appetites cause them to eat porcupines, are being killed off by the quills of their victims. These strong, heavy beasts often follow the lines of fur-trappers, eating and destroying the catches.

**WOOD IS TURNED INTO MILK
THROUGH CATTLE FODDER** 3242

Old paper, cardboard, and sawdust are being made to yield milk and beefsteak in Europe as a result of a discovery of a scientist by which those articles are turned into a substitute for fodder. Treated with chemicals, a quantity of paper is passed through a machine and emerges as varicolored flakes or strings resembling macaroni. This, mixed with the usual foodstuff, not only supplements it, but the cattle like it, and, seemingly, thrive on it. Reports state that the milk is improved both in quality and quantity. Thousands of tons of sawdust are turned into animal fodder also.

**VACUUM CLIP FOR WINDOWS
HOLDS DISPLAY CARDS** 3215

As a substitute for gum stickers, a vacuum clip has been made that provides a neat and clean way of holding posters, announcements, advertisements, and price tags on store windows or show-cases. By moistening the face of the rubber cup and pressing it firmly against



RUBBER VACUUM CUP

glass or any smooth, non-porous substance, it will cling so tightly that it will support a weight of 10 pounds. Inserting the finger nail under the cup releases it. Thus it is possible to display cards or posters on surfaces where it would be impossible to drive tacks, or where glue would leave an unsightly mark. It also may be used in suspending glass shelves for exhibiting jewelry or novelties. In the home it is handy for holding curtains, ice cards, and rent and "for sale" signs.

Prim. Benthin Co.,
Saginaw, Mich

**GRASSHOPPER TRAP IS HAULED
OVER FIELDS BY MULE** 3236

To rid his farm of plant-destroying grasshoppers, a man in the middle West has designed a moving trap. On either



Moving Trap with Pitch-Covered Wings that Catch Grasshoppers as They Jump from Its Path

side of a frame, he placed wings, which he paints with a thick coat of soft pitch. A mule hauls the device over the fields, disturbing the insects which jump into the air, and are caught as they strike the sticky substance. The wings are scraped off, when they become covered with the pests, and more tar put on.

**EGG IS CUT INTO NINE PIECES
WITH STROKE OF SLICER** 3264

With one stroke, a slicer, recently patented, cuts a hard-boiled egg into nine



thin layers for salads, sandwiches, and other uses, by drawing fine wires through it. To protect the delicate wires from damage they may be lowered beneath the frame when the device is not in use. Another similar device is being

manufactured for the cutting of bread into thin slices.

To encourage the adoption of the American national game, the government printing office of the state of Yucatan, Mexico, has translated baseball rules into Spanish.

invention of a
Missouri Farmer
Light & Coke Co.
Chicago
Peoples Lead
Aluminum Leads
Manufactured by
Mfg Co

Young People Phila.
1781 Chestnut 7/28/23

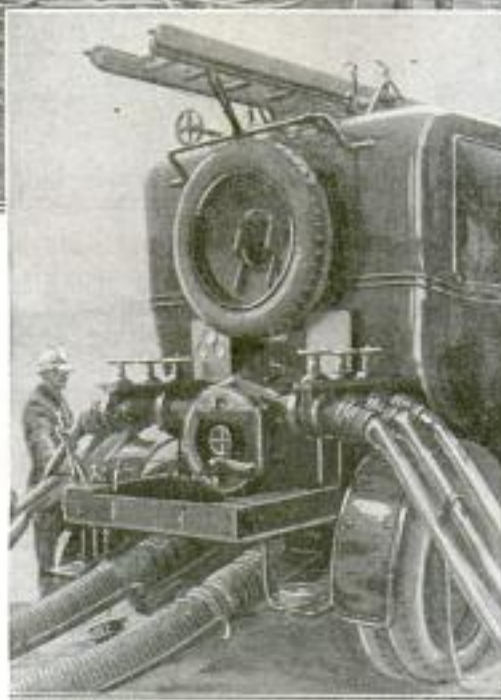
3144 GIANT FIRE ENGINE FEEDS MANY PIPE LINES



Right, Fire Engine That Feeds Twenty-four Lines of Hose

Above, Making Flood Big Enough to Cover Ordinary Building

With a powerful engine that feeds 24 lines of hose, a giant fire truck has been tried in France. Congesting of streets with fire-fighting apparatus will not be necessary when this monster is used. Two intake pipes connected at the bottom of the engine supply hose attached at the front and back of the truck. In a recent test, 24 men with fire



hose, lined up on a river bank, created a curtain of water 100 feet long and almost as wide. By using extending intake lines, the truck can be stationed far from the water plug and develop pressure enough to cover an ordinary-sized building with a flood of water. The machine's heavy base supports an extension ladder.

308 ANCIENT, FIRE-SWEPT CITY FOUND IN RIVER BED

Charred remains of a beautiful Indian city, believed to have been destroyed by the fire of enemies long before the advent of the white man in America, were discovered recently in a river bed in the South. Temples and terraced hills bore mute testimony to the splendor of a long-forgotten people. Charred woven reed tapestry was found under an overturned wall. In the center of the city, the original summit of a great hill had been cut away to form a level plaza 1,000 feet in length and 500 feet in width. Around the

edge of this space were built small mounds and earth lodges of sun-baked clay. It is believed that several thousand persons once lived in this forgotten city.

3149 BEETLE'S GLOW LIGHTS ROOM

In the wilds of Costa Rica, large beetles have been found recently that emit an almost continuous light so brilliant that one or two of them, imprisoned in a glass, will illuminate a large room sufficiently to make print readable. Although the color of the glow is mostly yellow, it differs with individuals, some casting green or ruby shades.

S. Michelson & Institute

Discovered by W. E. Myer, Special Archaeologist, S. Michelson & Institute

Washington D.C.

Indianapolis News 7/21/23

ALL WOMEN ARE BARRED OUT OF MONASTIC REPUBLIC

8231

It is unlawful for a woman to set foot on Athos peninsula, in Greece, where monks of the Greek church live. Eggs, milk, and other farm products, are brought from across the border for the 20 walled-in monasteries built on the steep slopes of Mt. Athos. Outside the inclosures are olive groves, fruit orchards, and vineyards, worked by the monks and lay brothers, who maintain a republican form of government.

3195

TEN-THOUSAND-YEAR-OLD BONE HARPOONS ARE FOUND

Belonging to the time of prehistoric man, two bone harpoons, one four and a half inches long and the other 10 inches, have been dug from a peat bed in Yorkshire, England. The peculiar markings on the weapons show them to be the work of Maglemose men, people supposed to have lived 10,000 to 20,000 years ago in a place in Denmark called Maglemose, where many relics of the ancients have been discovered.

HOUSEHOLD REMINDER KEEPS TAB ON SUPPLIES

3216

When groceries should be ordered, red arrows are pointed at the required items named on a household reminder recently patented. On a metal frame that hangs in the kitchen are listed 52 kinds of supplies, from almonds to wax. Beside each name is a white arrow. When things are needed, the proper arrow is turned over so that the red side appears as a warning.

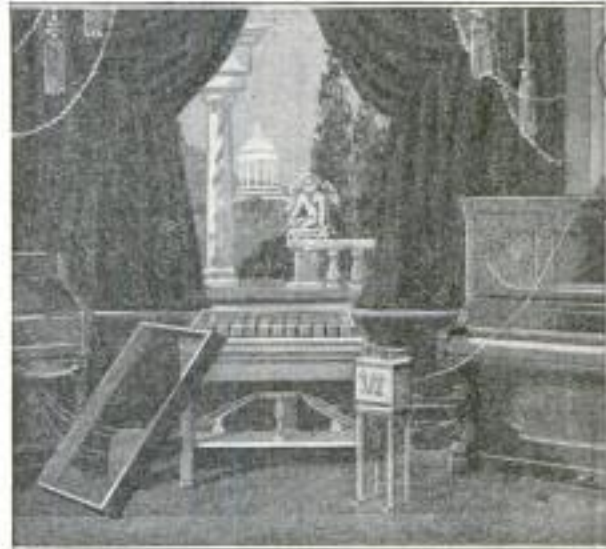
Thus the busy woman is saved time in preparing her marketing list.

Flood lights that flash out part of the name of the landing field in the telegraphic code are being used at an eastern air station to guide airplane and dirigible pilots at night.

COLOR MUSIC RIVALS HUES OF SUNSET OR RAINBOW

3209

Color music, or the production of constantly changing hues like the shades of a rainbow, is the feature of an invention of an Australian. Organ or piano keys



Piano Equipped with Device That Flashes Brilliant Colors on Screen When Played

are connected by electric wires with a series of incandescent lights that are illuminated when the instrument is played. Bass notes control darker tints than those produced by the treble notes. Pneumatic control is used for varying the intensity of the lighting in accordance with the force or lightness with which the keys are depressed. The globes are inclosed in reflectors, in front of which are placed screens of varying hues. To produce pleasing shades, there are interposed palms, flowers, rocks, and figures between the lamps and a white screen. Alternately, the bulbs may be made to project their rays on a semiopaque glass.

FOLDING HANGER FOR CLOTHES KEEPS SUITS IN ORDER

3106

Designed to conserve space in a crowded wardrobe and to store garments in an orderly fashion, a clothes hanger that may easily be installed in a wardrobe or closet has been patented recently in England. The device attaches vertically to the wall or door of the receptacle and holds suits, coats, and dresses flat and free from creases. To put clothing away, an arm with notches, each receiving an outfit's individual hanger, may be swung outward and then returned to its normal position and locked in place.

Sold by C. L. Uphos & Co., 38 Conduit St., London, W. I., England.

Patented by Alex. Arvidson, Greenmitch, Australia, Inventor.

Peoples Gas Light & Coke Co.

Kansas City Star 7/29/22

Atlantic Photo Co. King Graber Strause & Berlin S.W. Va.



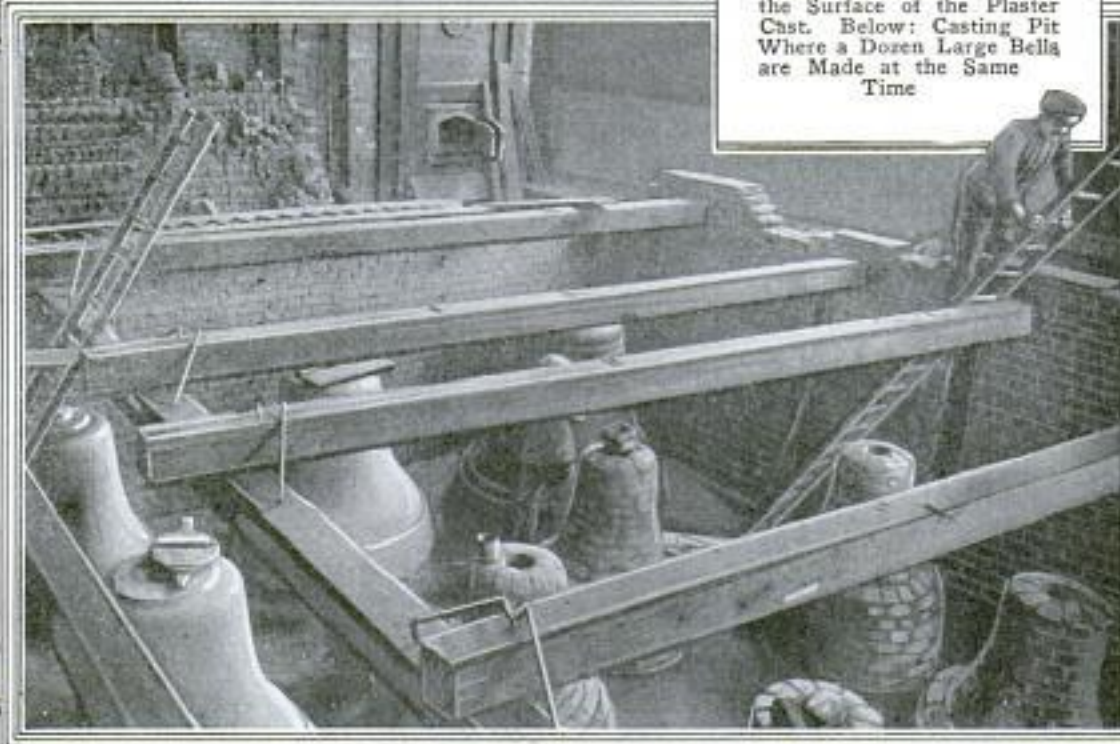
In Shaping the Core to Form the Inside of the Bell, the Curved Board is Drawn over a Layer of Soft Clay

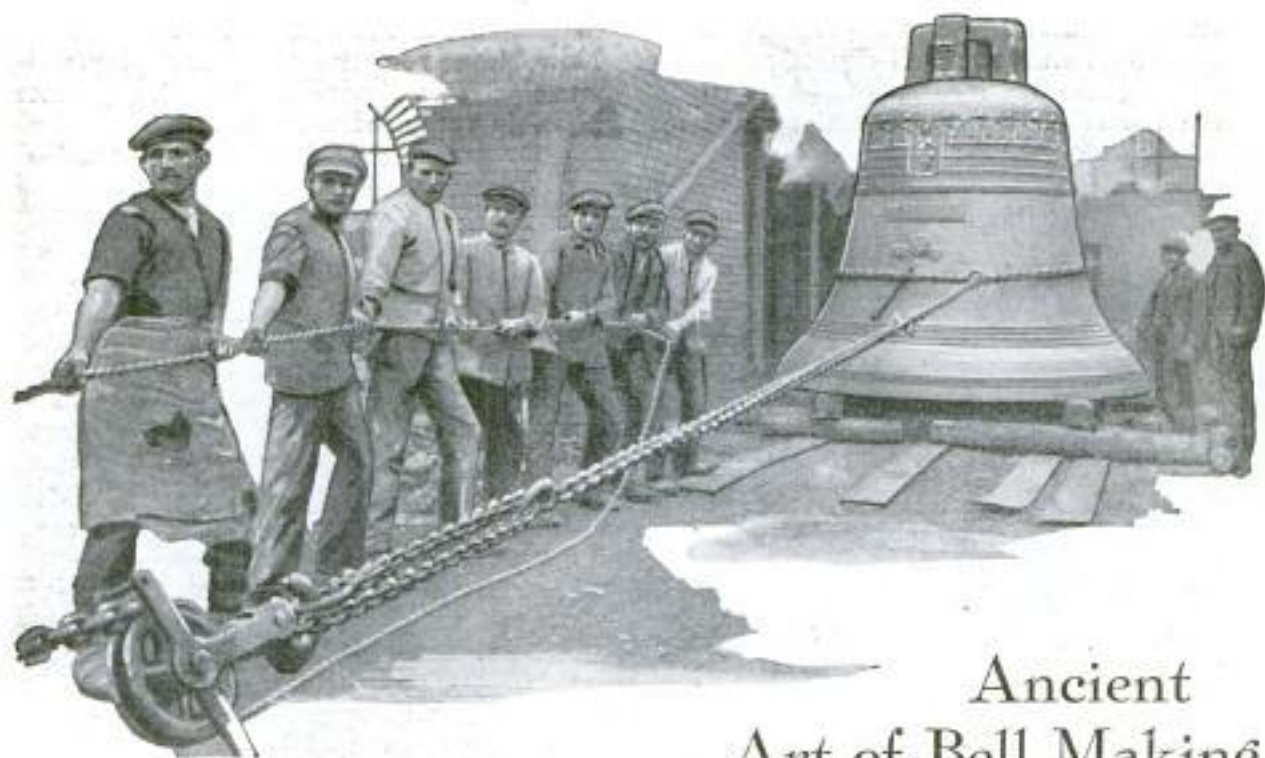


Grease is Applied to the Plaster Cast of the Bell, So That the Clay Molds can be Easily Removed When Hardened



Above: Placing Ornamental Designs of Wax on the Surface of the Plaster Cast. Below: Casting Pit Where a Dozen Large Bells are Made at the Same Time





Ancient Art of Bell Making Records the Progress of Mankind

SINCE the first dawn of civilization all of the terror, sorrow, and joy of mankind have been voiced through the brazen throats of bells.

For more than 1,500 years they have heralded the crash of falling empires, the birth of new nations, wars, revolutions, catastrophes. Sometimes clamoring in wild alarms and then again pealing out messages of good will, their notes have marked every page in history.

Evolved slowly through the ages from the great gongs used to call together members of a tribe, bells have been made of many metals and their construction has taxed the skill of artisans for countless generations. They also have influenced architecture, lofty towers and steeples being built to house them as they increased in size.

Like many other things which have come down through long years of change, bells have been made in many shapes. Long, narrow ones, square and low, preceded the gracefully curved, trumpet-mouthed type designed about the 16th century, many of which still exist to charm the ear with their soft, sweet tones, carried from afar.

Some of the earliest bell makers traveled about, setting up their foundries and casting bells wherever they were desired. Later, as the size increased and the means of transportation were improved,

central manufacturing plants were established where large molds could be built.

In making a bell, it is first drawn on paper. Then two wooden legs are made, the underside of one curving to the shape of the bell's inner shape, while the other leg conforms to its outside surface. These legs are pivoted to the top of a stake driven into the ground, around which is built a brick cone. This is covered with soft clay and the first leg run around it, shaping it to the inside of the bell.

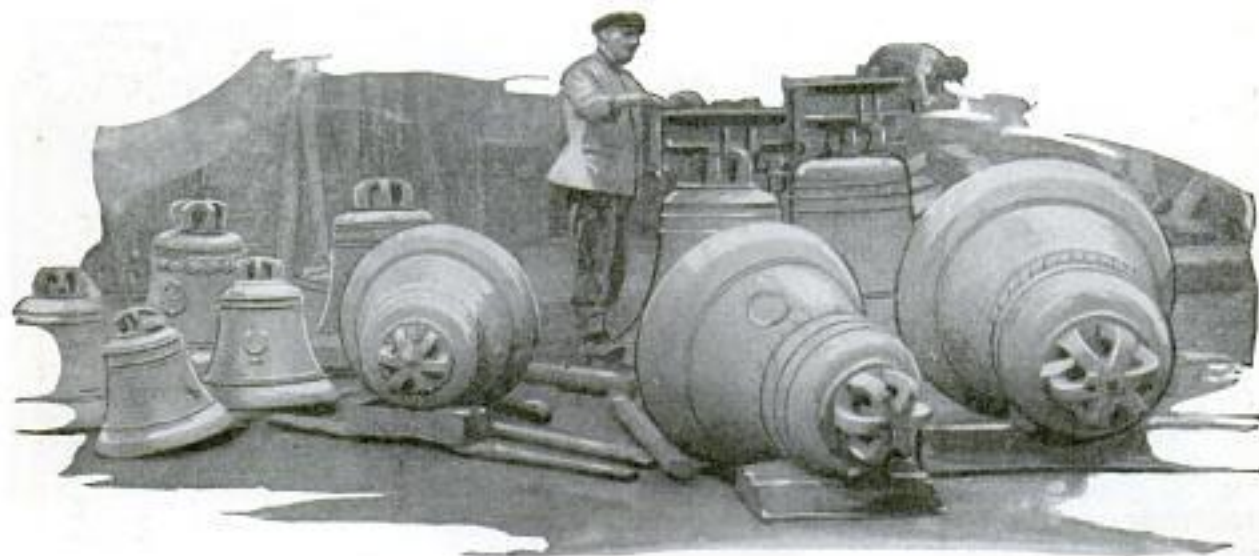
Grease is smeared over the form, another coat of clay added, and the second leg drawn over it, forming a complete plaster cast of the bell. This also is greased and the entire mass covered with another layer of clay. When this is dry, it is lifted off and the inner shell removed. After the cover is replaced, the melted metal is poured into the mold to form the bell.

First used singly, bells of many sizes were combined later in groups to produce various effects, from the faint, musical tinkle of the clock to the deep-toned, cathedral chime.

As years passed, the number was increased so that the playing upon them of complicated musical compositions became possible. A variety of tones was made possible by changing the composition of the metal of which they were cast.

In the early days the chimes were played by hand, the bell-ringer swinging the tongues by means of long ropes. Then the ropes were attached to a series

of pedals for the operators' convenience. Now, however, the bells are played by an electrical device giving the greatest possible range of tone effects.



**STEAM OF NATURE'S BOILER
HARNESSED FOR POWER**

In a quest for cheaper power, engineers have long been engaged in attempts to shackle the earth's internal energy. Experiments are being conducted in a region called the "hot belt" of northern California and Nevada, to learn the possibility of harnessing the steam that is there generated. By drilling into the ground a pressure of from 30 to 70 pounds has been received at the surface. Already one engine is using underground power and experts expect to pipe this low-cost energy over a large radius. Electrification of railroads in that territory and extraction of carbonic gas from the steam for preserving shipments of fruit are regarded as future steps. Since 1904, northern Italy has been supplied with electricity produced by engines driven by such underground steam power.

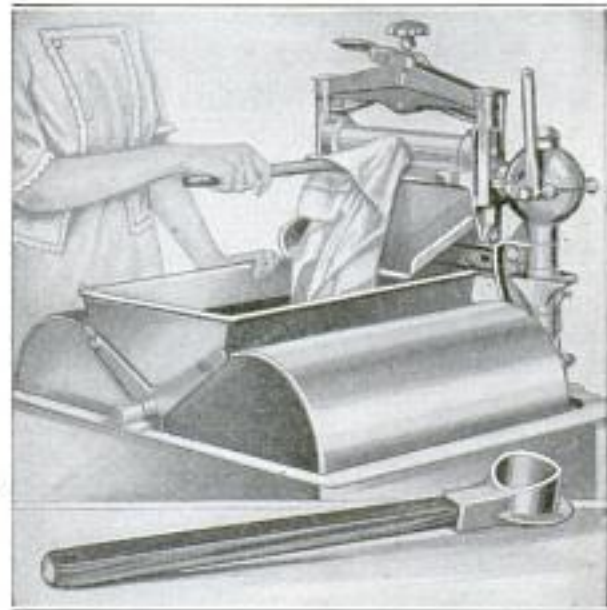
**SMUTLESS WHEAT NOW GROWN
TO INCREASE YIELD**

After ten years of experimenting, scientists in a western college have found a way to grow smutless wheat. Tests on an acre of grain showed less than one-tenth of 1 per cent of smut. Farmers who visited the field declare it will provide 40 bushels to the acre. The discovery, it is believed, will result in a larger production and less loss by dam-

age to threshing machines. By various processes, the scientists destroyed the texture from which smut grows.

**WRINGER FEEDER CUTS RISK
OF CRUSHED FINGERS**

To remove the risk of crushing fingers in a clothes wringer, a handle with rounded ends for placing material be-



How Clothes are Placed in Wringer, and, Below, Handle That Lifts Pieces to Rollers

tween the rollers has been invented. It is unnecessary to have the hands near moving parts of the machine when this feeder is used.

*Christians Science Monitor
7/24/23*

3/80

3/88

*Developed at
Washington State
College Pullman Wash.*

*Voss Bros. Mfg. Co.
Lavenport, Iowa
Copyrighted material*

3224

POPULAR MECHANICS

Cont. Cyril E Lamb, 599
209 Ballard St
Silante, Neb

MILLION WASPS ARE FREED TO WAR ON CROP PESTS

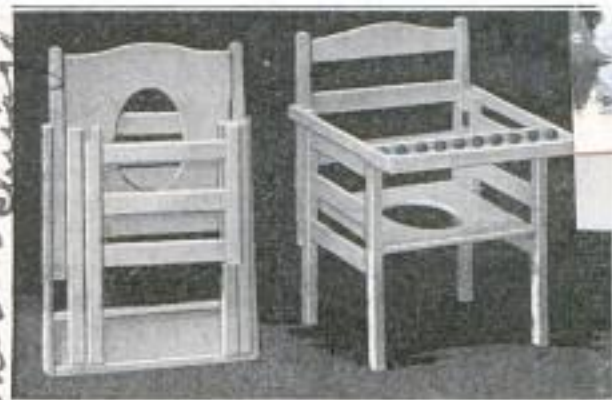
One million wasps, the size of pin-heads, have been imported by the government and are now distributed in the East to destroy the corn borer. The wasps will save millions of dollars in crops for the farmer, if they serve as well as they have in Europe. Whether they can flourish in this climate has not been determined. The borer, resembling a caterpillar, attacks corn, beets, celery, beans, rhubarb, potatoes, buckwheat, clover, and many other products. By laying eggs on it, the female wasp kills the borer.

U. S. DYE INDUSTRY'S GROWTH BREAKS ALL RECORDS

Since 1914 the dye industry in the United States has increased its production almost ten times. Now American dyes supply 93.5 per cent of the color used in this country for cloth, paper, leather, hats, inks, polish, food, and many other things. The number of makers has increased from seven in 1914 to 87. The amount made in this country in 1914 was more than 6,000,000 pounds. Last year it was 64,632,187 pounds. Dye experts on a research staff of chemists are constantly engaged in bringing out new colors and new processes.

FOLDING CHAIR FOR BABY SAVES NURSERY SPACE

Space in a crowded home is conserved by a baby chair that is made to be folded up and placed out of the way when not in use. For the entertainment of the



When Not Needed This Baby Chair May Be Folded Up and Put Away

child, a row of colored beads is fastened to a rack that locks it in the seat.

no data

GRIM FIGURE OF UNDERTAKER IS WARNING TO CARELESS

To warn pedestrians of the danger of crossing a street against traffic, Detroit has tried the experiment of erecting queer signs, fashioned after the figure of a giant man. These are put on corners where fatalities or serious injuries have occurred. The striking figures, almost ten feet high, hold in their hands a card that calls attention to an accident that has happened at the locations where they are placed. Black crepe cloth is fastened to their hats and swings in every passing breeze as a grim reminder to "jay-walkers." It is said that very good results have been obtained by their use, as the quaint figures never fail to attract the eyes of the passers-by.



INDOOR GOLF COURSE OF FELT TEACHES HOW TO PUTT

For entertainment as well as instruction, a golf course for playing indoors has been placed on the market. It teaches beginners correct stance, grip, and putting stroke, and permits the accomplished golfer to practice at home. The hole is similar to that of an outdoor putting green, while the "course" is of smooth felt, so that the ball will roll in the proper direction. As there is a trap behind the hole a natural stroke may be used without danger. Grown-ups play with regular clubs, while children use smaller ones.

OVER FOUR BILLION DOLLARS IN GOLD IN AMERICA

Believed to be the largest amount of gold the world has ever known, there is in the United States, now, \$4,025,000,000 worth of the yellow metal. This is \$300,000,000 more than the country had a year ago.

Mine explosions are said to be prevented and foul air purified by spraying the shafts with a liquid recently discovered by an English miner.

Green Mfg. Co., 1647 N. Winchester St. Chicago
Cont. Elmer J. Sablin Chicago
Phila. Public Ledger
3117
3193
3238

The P. & W. Co. Chicago
S. J. Denton Chicago

Roll-A-Rocker Co.,
600

POPULAR MECHANICS

~~Chicago, Ill.~~
**INVALID CHAIR FROM ROCKER
PLACED ON WHEELS**

Any rocker can be made into an invalid's chair by placing it on a patented metal frame fitted with wheels. Chair

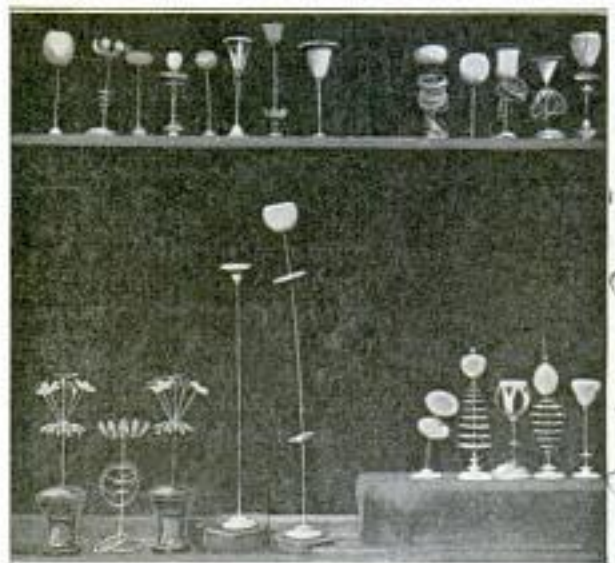


Invalid with a Wheel Chair by Clamping to Metal Frame. Rocker Made into

is still seen and the roof is covered with the same tiles that sheltered the long-dead owner. Advertisements, painted in red and white, election notices, and other posters still remain on the walls. Everything has been restored, as nearly as possible, to its original form in anticipation of a visit from the king of Italy.

**WOOD CARVING REVEALED
AS DYING ART**

Flowers, cups, goblets, and vases, turned and carved in wood by hand, are fashioned with realistic effect by a European artist. His is almost a lost art because machine methods have largely replaced handwork. From remotest ages carving of wood has been a foremost craft, believed to be of greater antiquity than working of ivory. It reached its zenith in glories of the 15th-century cathedrals. To carve in wood is said to be even more difficult than marble sculpture, because wood expands and cracks with changes in temperature and is often injured by insects. Failure to fashion the more delicate parts of a design with the vein may result in damaged work. Fragile petals and thin stems



Wood Carving of Delicate Parts and Thin Stems That are Turned by European Master of a Dying Art

arranged across the grain in reproducing a flower may break, owing to expansion of the wood fibers caused by moisture.

Scientists are contemplating experiments to determine whether seeds removed from the tomb of King Tutankhamen, in Luxor, Egypt, still retain life after their long burial. Powerful electric lights will be used in the tests.

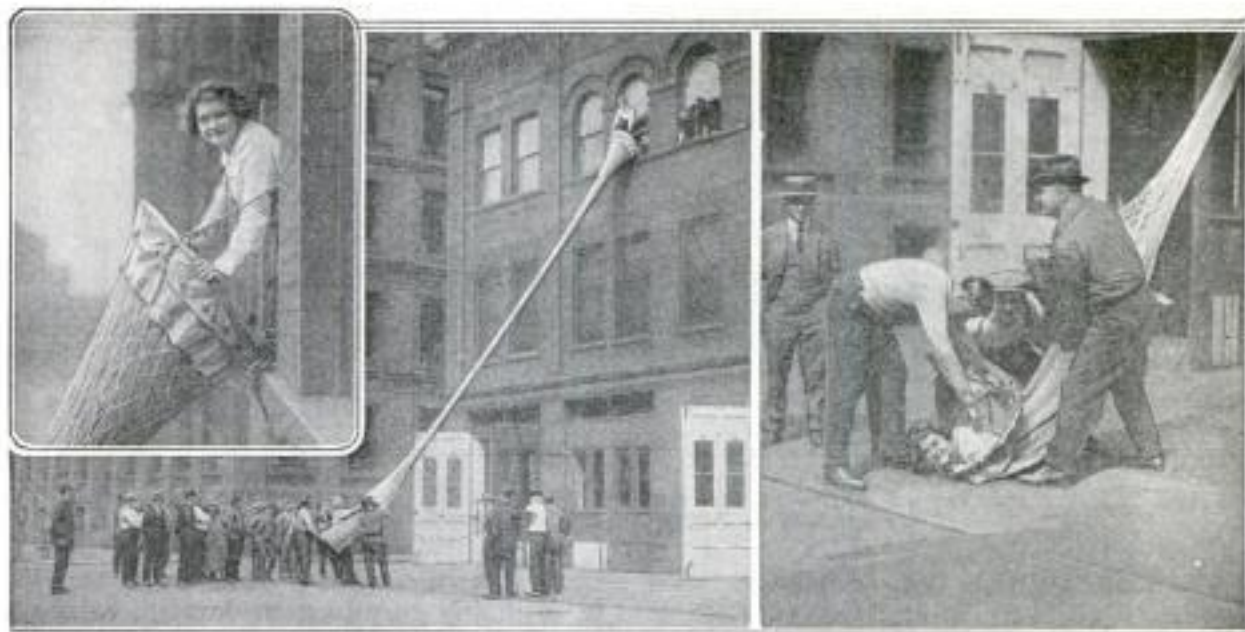
**CITY OF BURIED PAST REVIVED
FOR VISIT OF KING**

After being buried for many centuries on the lower slopes of Mt. Vesuvius, Pompeii again has taken on the glory of its past. Water still plays through pipes 2,000 years old. Fish swim in the original marble bowls. Vines and shrubs decorate the pergolas, just as they did in the days when Julius Caesar landed in Britain and London was a forest. Fresh roots recently replaced the ancient ones. For 12 years scientists have been clearing away debris covering one narrow street in the buried city. After digging a few inches at a time, they picked off the ashes and dirt by hand. When the slightest trace of a building appeared, they summoned experts who delicately removed material, strengthening the arches or pillars with cement, inch by inch. In one house the smoke of a lamp

Cannot locate
 Price - unknown
 1924 Railway Exchange Bldg
 1124 Broadway
 St. Louis, Mo.
 Roll-A-Rocker Co.
 1924 Railway Exchange Bldg
 St. Louis, Mo.
 Detroit Free Press
 7/30/23

Mr. A. H. Murgraff, 326 W. Madison, Chicago

FIRE VICTIMS TO SLIDE THROUGH SILK TUBES



At Left: Start of Plunge Through Silk Tube from Window; Center: Men at Bottom Controlling Speed by Grip on the Net Cover; Right: A Slide to Safety

For saving the lives of persons trapped in burning buildings, a long, silk tube, inclosed in strong netting, has been designed. Attached to a window, the victims may dive through it to safety. Firemen in the street control speed of the falling body by holding taut or loosening the bag at the bottom of the net. In a

recent test, firemen leaped from a third-story window, and a young woman plunged head-first through a forty-foot tube. Invented by a middle-western man, it is made in various lengths to be fastened to any window in a building several stories high, after hooks have been placed in the frame.

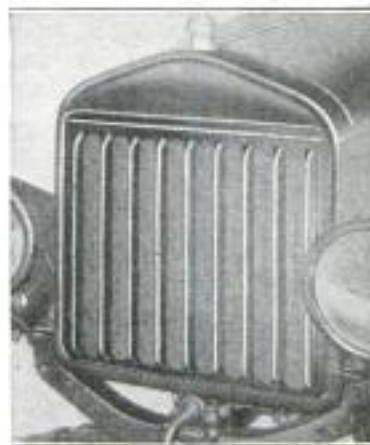
3/45
FOUNTAIN OF ETERNAL LIFE DESCRIBED IN LEGENDS

Jess County 7. m
Indian carvings signifying perpetual life, found on the rocks through which flow the hot springs of the Rio Grande Cañon, have caused much speculation recently as to whether the site is that described in legends of the extinct Aztec race which told of spouting waters that brought never-ending youth. Natives have named the place Wa-pu-me, meaning the Spring of Life, and for years have bathed there. Near by are ruins believed to be the remains of the ancient city of Mecitil, founded by Aztecs who marched northward from their former home and settled near springs reported to possess the power of preventing old age. History records the efforts of the early Spanish explorers to confirm these stories which resulted finally in the occupation of what is now New Mexico.

Of all the states, Florida has the most water within its boundaries, totaling 4,440 square miles.

3212
METAL FRAME PROTECTS AUTO RADIATORS FROM DAMAGE

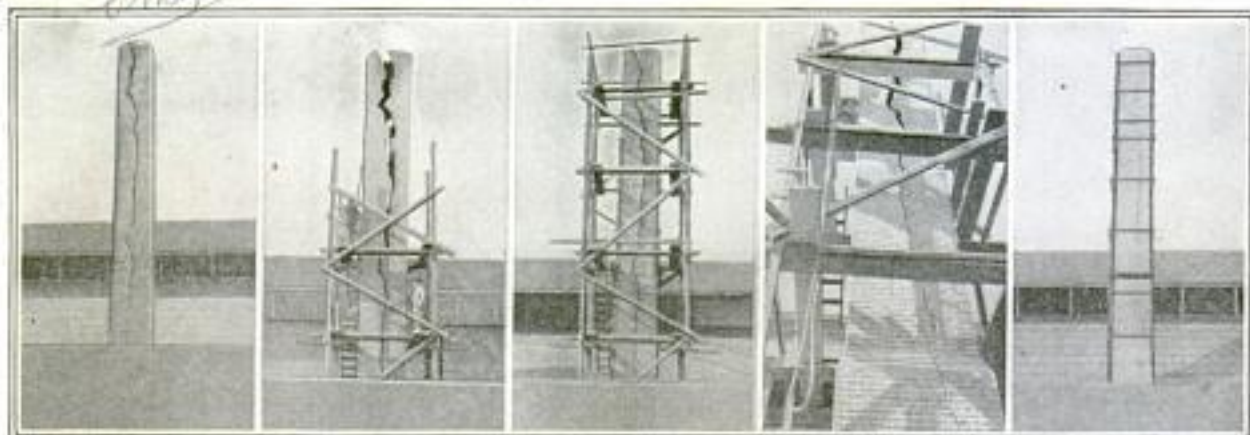
To prevent damage to automobile radiators, a metal frame that may be attached to any car in a few moments, has been marketed. Heavy bars widely separated so they cannot interfere with radiation, receive the heaviest part of any shocks occurring in head-on collision. The device,



strongly constructed, is enameled to correspond with the color of the body, and adds to its neat appearance. It requires no attention after once being placed in position.

The Stewart Iron Works, Cincinnati, Ohio

Wilmington, Del.
3 20 *Snake* SPLIT STACK TIED TOGETHER WITH IRON BANDS



PHOTOS FROM HERCULES POWDER CO.

Crack as It First Appeared; the Wider Gap Produced by a Slight Earth Tremor; and the Chimney after the Halves Were Drawn Together by Iron Bands

Cracked by the expansion of acid vapors, a 50-foot chimney at an eastern powder plant recently was tied together with iron bands. The stack served to carry off waste gases from the chamber of an oil-heated furnace. Breaking of pans in which material used for the recovery of sulphuric acid is heated, allowed the gas to flow into the crevices of the bricks, and, because of its enormous spreading and lifting power, caused the chimney to split into halves. A slight earth tremor completed the process, leaving the right half of the chimney separated from the left by a foot, and in such bad condition

that a heavy wind would have toppled it, probably resulting in damage to nearby apparatus. To quickly and economically draw the parts together again, workmen placed metal bands at each corner and welded them in place with iron rods.

Starting at the bottom, they gradually drew the halves together again, the right swinging into position as bolts in the rods were slowly tightened, while the left remained stationary.

The work was accomplished without accident, and the stack now is expected to last at least the life of its iron bands.

3178 BRACELETS FOR HORSES KEEP THEM SAFELY "HITCHED"

As few of the larger cities still have the once familiar hitching racks for horses, teamsters and drivers must find



Leather "Footcuffs" Placed on a Horse's Feet to Keep Him from Running Away

other means to meet the need. One of the methods now employed to prevent a

horse from wandering or running away, is to shackle him with "footcuffs," or leather bracelets. With the device fitted snugly around his forefeet, the animal cannot move far without throwing himself. Fastened with a snap, it is quickly removed, and can be kept under the seat of the vehicle.

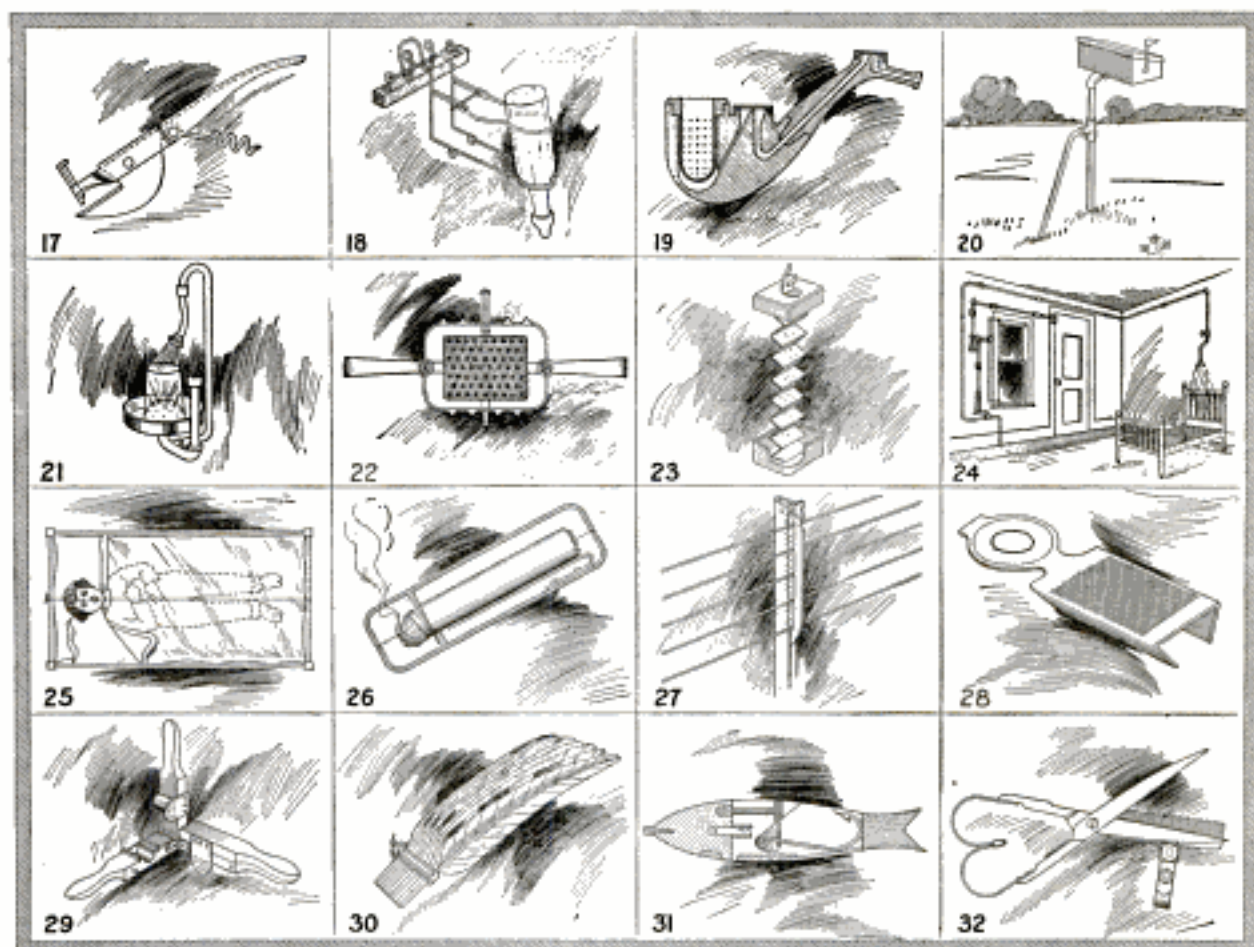
3234 LOCUSTS EATEN BY ISLANDERS

Although they destroy crops, locusts are highly regarded as food by natives in the Philippine Islands. When the swarms fill the air, looking like snowflakes, all sorts of nets are used to gather in the harvest. To prepare for a meal, they are put in a sack and soaked in hot water. Then they are cooked or fried, the legs and wings being pulled off. In one province recently, 1,500 sacks of the pests were caught during one swarm. Men, women, and children joined together in a small army to catch the insects.

Jerome Wagner
c/o St. Rita's Hall
Taff Ave. Manila P.I.

International
Newsreel

These Articles Are for Everyday Use
But—
Can You Name Them?



JUST to help you, the use for which the articles are intended is as follows:

No. 17, in the home. No. 18, in the home. No. 19, for man's use. No. 20, in the country. No. 21, in the home or restaurant. No. 22, in the wilds. No. 23, in the home or office. No. 24, in the home. No. 25, in the home. No. 26, for man's or woman's use. No. 27, on the farm. No. 28, anywhere. No. 29, in the home. No. 30, on the farm. No. 31, in a sport or business. No. 32, in the home or in a profession.

Popular Mechanics Magazine offers no prizes for correct answers to these problems, but presents them for the interest it believes its readers will find in attempting to determine the nature of the various articles shown.

If you think you have the right answers you can find out by comparing them with the correct list which will appear in Popular Mechanics Magazine for November.

In September the following articles were shown. No. 1, dentist's drill. No. 2, corncob curry-comb. No. 3, collapsible oven. No. 4, umbrella. No. 5, cigarette case. No. 6, book rest. No. 7, vacuum sweeper. No. 8, hook and eye. No. 9, hot-lid lifter. No. 10, necktie holder. No. 11, fly-swatter. No. 12, insect-proof cup for furniture. No. 13, spool holder to be attached to waist of seamstress. No. 14, milk-bottle carrier. No. 15, safety-pin. No. 16, clothes wringer.

Washington D.C.

WATER TAKES PLACE OF ICE
IN COOLER FOR FOOD

2951

For farmers and others who find it difficult to obtain ice, a cooler is being made



Iceless Cooler Installed in Deep Well to Keep Food Fresh at Little Cost

that is suspended by a windlass in a well, or which may be placed in the house or

cellar: When used indoors, the container is covered with woven burlap which is

kept saturated by water from a pan at its top. Rapid evaporation of the moisture from the cloth draws the heat from the interior and reduces the temperature to a point sufficiently low to prevent food from spoiling. A single filling of the basin usually lasts 24 hours. Light in weight, it may be moved about easily. When hung in a well, the evaporation system is not required. Suspended just above the top of the water, the provision chamber may be easily raised or lowered. A ratchet holds it firmly at any desired point. Built of steel and cylindrical in shape, both types are easily cleaned and sanitary.

BEES KILL LIZARD AND TURN
3080 IT INTO A MUMMY

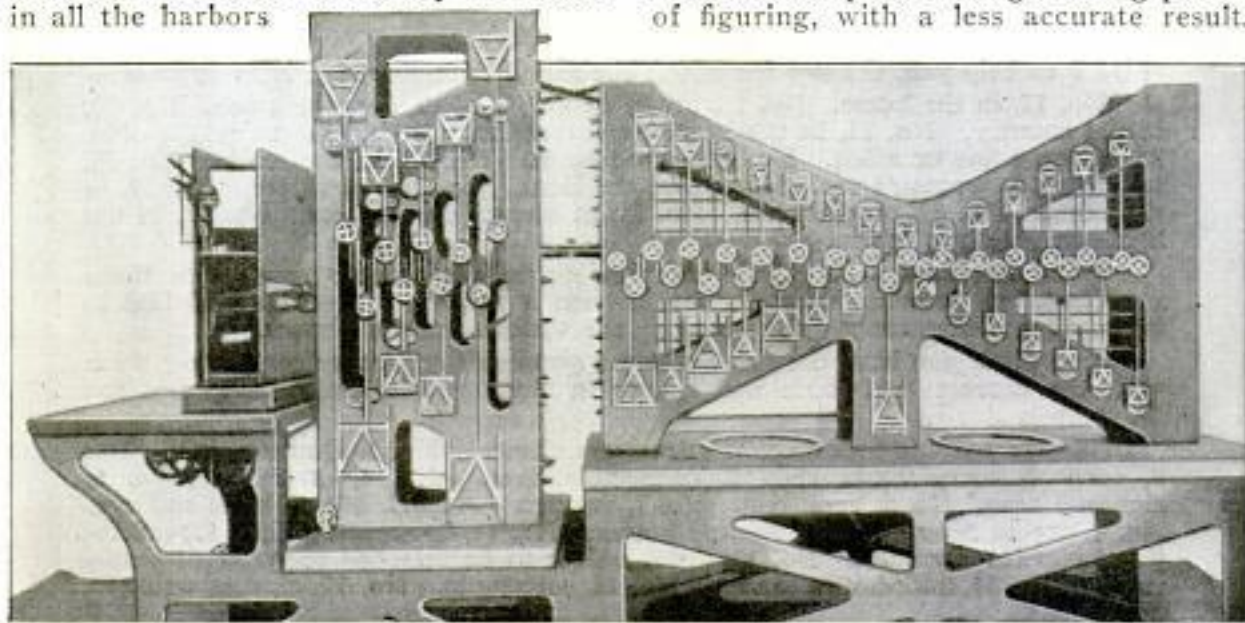
Evidence that bees stung a lizard to death and then embalmed the body was found recently in the South, when small boys pulled the reptile from a hive. Scientists agreed that it had wandered into the home of the bees about a year ago, squeezing under the opening, and was killed. There were signs that the bees had tried to cast out the intruder. When they failed, a thick coating of wax was applied to the body. This mummified it perfectly.

Empire Mfg. Co.
Washington D.C.

3018 TIDE MACHINE DOES WORK OF SIXTY EXPERTS

Equipped with a machine, recently designed, government officials have been able to predict the heights of tides and the exact hours at which they will occur in all the harbors

of the world during the year 1924. In order to prepare such a chart of information, it would require the services of at least 60 experts through a long period of figuring, with a less accurate result.



Predicting Time and Heights of Tides in the World's Principal Ports Far in Advance of Their Occurrence, Is the Work of This Remarkable Piece of Machinery

Chas. E. Is. Fischer, Retiring Mechanical Engineer, Government Coast & Geodetic Survey.

Anthony
 605
Chicago
 2298

POISON CUPS TO DRIVE AWAY EVIL SPIRITS IN KONGO

When natives of the Kongo find one of their number acting queerly, he is thought to be filled with evil spirits, and a meeting of the tribe council is held, deciding that the demons must be driven from the victim's body. To do this a poisonous root is boiled and the patient asked to drink it. If he refuses, he is charged with being a coward and claimed to be in the possession of devils. The natives placed in this position do not like to have their courage questioned, and swallow the liquid, which frequently results in death. The Belgian government, it is said, has passed a law against the practice, but it is still carried out in secret.

3070

AIR JACKET AIDS SWIMMERS BY FLOATING THE BODY

To aid in teaching persons to swim, an air jacket that is worn either under or



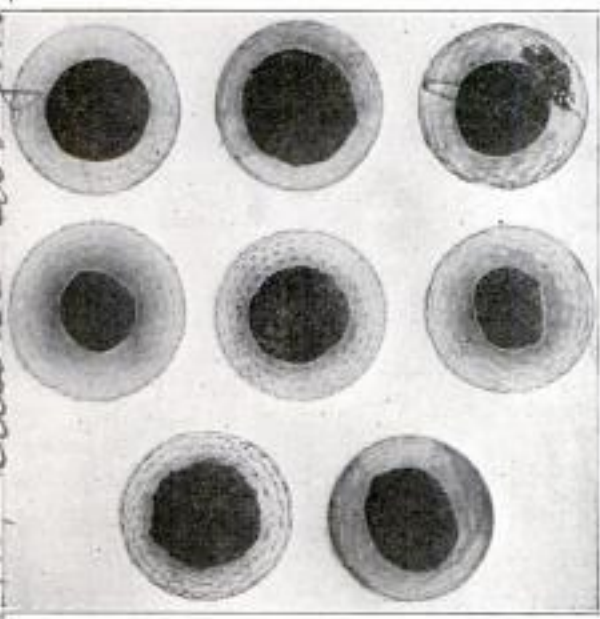
Inflated Life Preserver That can be Worn Either under or over Suit and will Float Heavy Body

Don Langeske to Anthony to S. Wabash. Chicago

X-RAY SHOWS WHY GOLFERS MISS HOLE IN PUTTING

Why golfers sometimes miss the hole in putting was shown by a western scientist recently when he made X-ray pictures of 20 kinds of golf balls. They showed that in only a few were the hard,

3081



X-Ray Views of Golf Balls That Show Imperfect Cores, Which Pull or Slice the Drives

resilient cores of gutta-percha exactly round. As a straight course through the air or along the green depends on a properly balanced ball, it was said that an imperfect core might pull or slice the drives, no matter how skillful the player.

No other information

☛ Sieves woven of bronze wire and used in the testing of the fineness of cement have 40,000 holes to the square inch.

over the clothing has been invented recently. It is strapped about the waist and the chest and when not filled with air lies flat against the body. Sides and bottom of this jacket, made of rubberized fabric, are filled with air blown through valves at the top. The section over the lungs is not inflated. The life preserver, which will roll into a small bundle and weighs only a few ounces, will support a weight of over 200 pounds.

ALLIGATOR BOAT ABLE TO PULL ITSELF UP ON BANKS

For use in hauling logs on small lakes there has been made in the East a 40-foot boat that moves on land or water. When on land the rudder is raised, the propeller shaft lifted, and the engine moves a rotary drum that works by tackle and fall to pull the boat ahead, the rope being hitched to some firm place. The boilers are set so that they are in an upright position no matter how rough the road. When the vessel reached the loggers, it pulled itself out of the railway car down to the water, sailed across a lake, moved across land, and at last, still under its own power, reached the river, where it is used in hauling logs floated down from a lumber camp. Because of the ability to move on both land and water, it is called an "alligator" boat.

newspaper clipping

Emb. Miss Jang Frederickson Los Angeles Calif. 1923

MAKING MUSIC WITH CHISEL, SAW, AND HAMMER

2902 With the application of modern methods that have developed since the 10th century, the piano no longer is the work of a single artisan but is the product of the combined ability of a number of skilled workers. Working with saw, hammer, chisel, and glue they make a musical instrument that rivals and even surpasses any creation of the old masters of the trade, who took

in the building of a piano, such as making the case, stringing the wires, putting in the keyboard and action, or glu-

ing wood parts together. Glue is one of the most necessary products in the making of an instrument as it is used to replace screws in so far as practicable to prevent rattling. Hardly a single screw is used in forming the case, all the many pieces of wood being held to-



COPYRIGHT, UNDERWOOD & UNDERWOOD

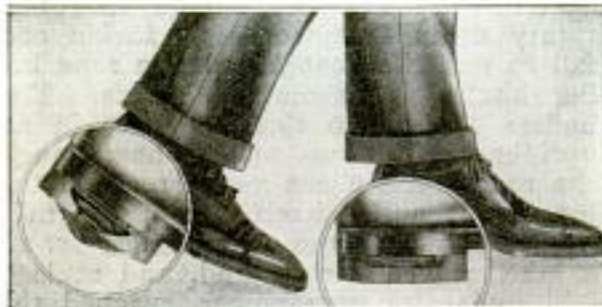
Above, Experts Placing Strings and Putting Finishing Touches on Piano; Left, Workmen Installing the Keyboard and Action; Right, Fashioning and Gluing Together Parts of the Case

weeks and even months to turn out one piano. Each man, an expert in his particular trade, is assigned to a certain part

gether by glue. Formerly the piano was an instrument that could be purchased only by the wealthy.

SPRINGS IN RUBBER HEELS MAKE WALKING EASIER

Rubber heels have been patented with steel springs tightly locked inside to add



X-Ray View of Rubber Heels That Have Steel Springs in Them to Help Absorb the Shock

to the wearer's comfort by cushioning the jar in walking. They contract at every

step and are said to absorb more of the shock than rubber alone. To prevent slipping on wet surfaces, the heel bottom is ribbed.

U. S. MONEY TAKES PLACE OF PANAMA CURRENCY

Panama's money, first made in 1904, has passed out of use in that country, and today practically the only kind in circulation is American banknotes and coins. This was brought about, it is claimed, by high prices of silver in 1917, resulting in natives secretly selling their coinage to outside buyers for more than it was worth in their own country. The dollar now acts as the basis for all kinds of business dealings, and is considered to be of great value to the people in general, who have shown a preference for it.

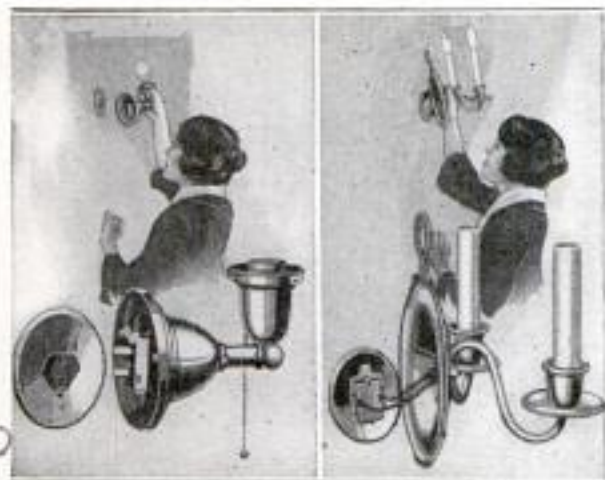
*Dynamo Rubber Co., New York
 1333 Argyle St., Chicago
 7/12/23*

**WHITE WOMAN RULES ISLAND
 OF RICH PEARL DIVERS**

Badu, one of the most prosperous islands off Australia, is ruled by a white woman. She is the governor, teacher, preacher, judge, and prohibition officer for dark-skinned pearl divers, who have found rich rewards in disposing of the shells under her management. The women, also under her control, make a lace, fine in texture and beautiful in pattern. When their day's work is done the "governor" meets them on the green, where they practice English folk dances. Liquor is forbidden and the island is reputed to be a model of cleanliness.

**WALL BRACKET FOR LIGHTS
 MOVABLE ABOUT ROOM**

Rearrangement or exchange of electric-lighting fixtures is now possible by a movable bracket that is being made with a special wall or ceiling receptacle. Thus any number or styles of lights may be tried out for the desired lighting effect without employing an electrician. By installing several of the receptacles, the location of bulbs may be changed as



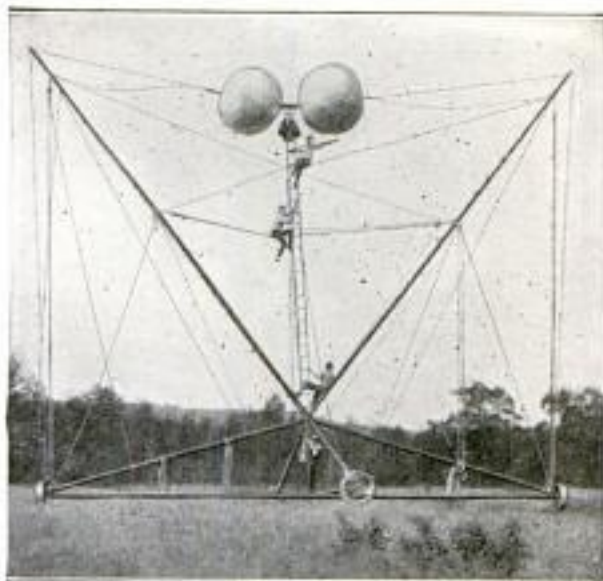
Lighting Fixtures may be Changed When Desired by Use of Movable Bracket

often as desired to harmonize with groupings of furniture. When a socket is not in use, any other household electrical appliance may be attached.

Blotting paper is being made from wood pulp. Heretofore it was made only from rags, as it was believed that sawdust would not prove sufficiently absorbent. A large proportion of the pulp used is from wood that has not been considered of much value.

**BALLOONS KILL GYPSY MOTHS
 WITH SPRAY OF POISON**

For spraying crops with poison powder to destroy gypsy moths, government experts have hung army balloons on a



Army Balloons are Suspended from Mooring Frame for Spraying Crops to Kill Destructive Pests

cable stretched between two tall poles supported on a ground framework that moves on wheels. A large supply of insect chemical is carried near the gas bags which furnish the force to scatter it.

**CHAIN CARVED FROM MATCH
 WITHOUT SINGLE BREAK**

With all the links joined together, a wood-carver has fashioned an ordinary match into a small chain. Less than 3 inches in length, it is an exact reproduction of a large cable. As the splinter of wood with its inflammable tip is about an eighth of an inch wide, extreme care was necessary to cut out the tiny units, one carved from within the other. Each circlet is about the size of the link of a fine watch chain. It was made by Henry L. Brown, of Seattle, Wash.



Office

Harvey Hubbell, of no. Bridgeport

Inventor, Wm. J. Scott, Electrician

608

POPULAR MECHANICS

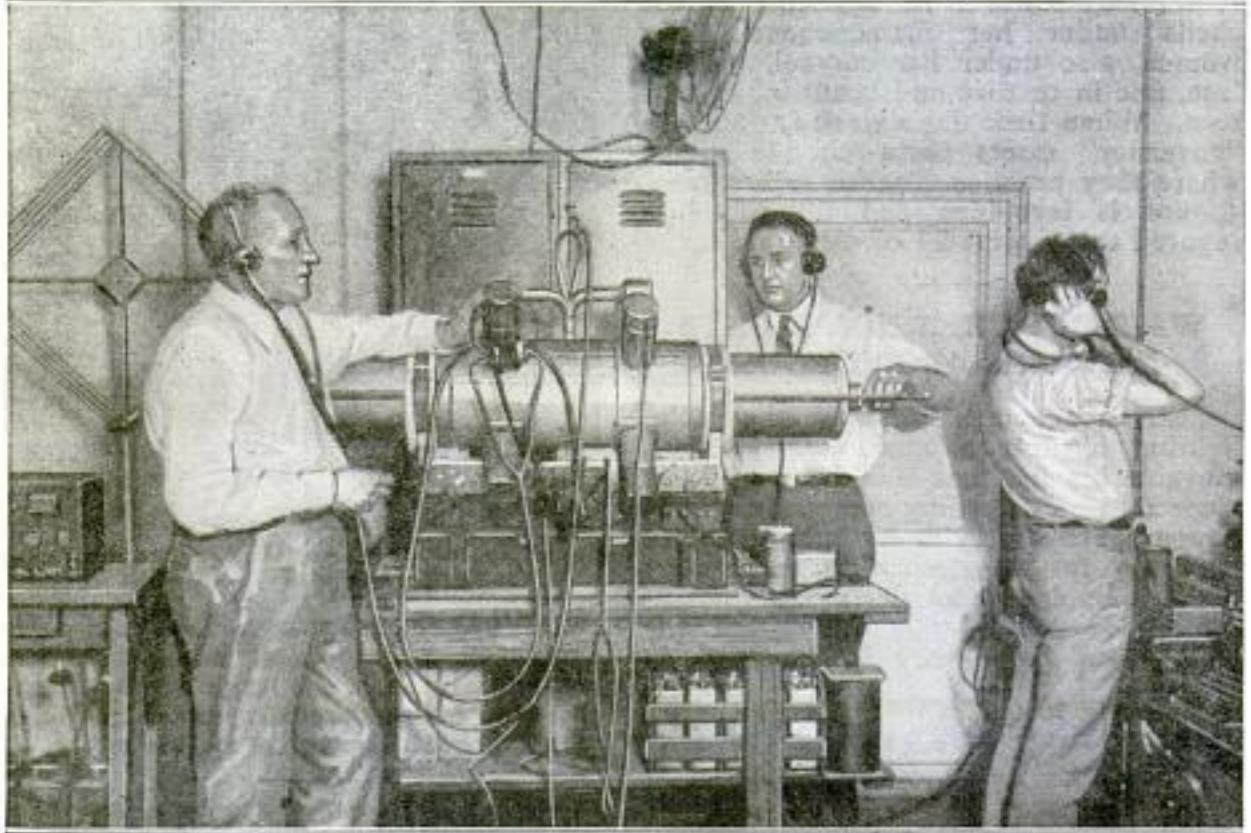
U. S. Navy Dept.

2985

RADIO NOISES STOPPED BEFORE REACHING EARS

Noises that interfere with wireless communication are said to be done away with by a machine being tested by the government. The apparatus has eight tubes that carry the sounds to the interior,

instrument, the operator finding it difficult to hear distant stations can put the clarifier in the circuit by means of a switch. The tubes then receive the message, convey it to an eliminator, where it

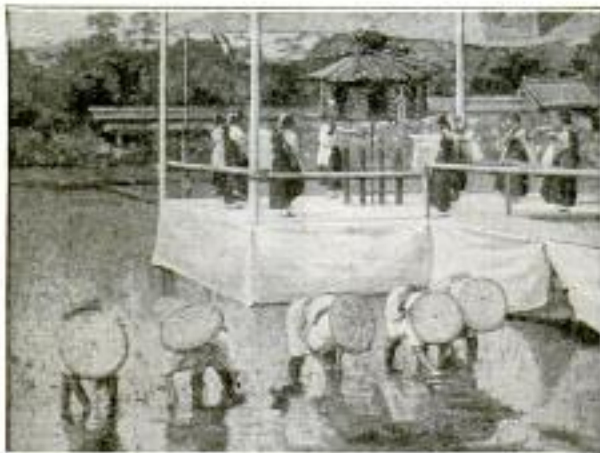


COPYRIGHT, HARRIS & EWING

Operators Using the Radio Clarifier, an Instrument Devised to Extract Static Noises and Other Disturbing Sounds from Wireless Messages Before They Pass into the Receiving Apparatus

where the disturbing noises are filtered out before reaching the receiving device. During the summer months the atmospheric sounds are more numerous than at other times. Equipped with the new

is separated from disturbing sounds. It is believed the instrument will prove suitable for use during communication between airplanes for barring out noises from the engines.



Japanese Planting Ceremonies Held to Celebrate the Beginning of the Rice-Growing Season

3027 RICE PLANTED TO DANCE MUSIC IN JAPANESE FIELDS

Near Osaka, Japan, each year when the rainy season begins, important ceremonies are held by the native farmers to celebrate the planting time for rice. Shrines close to the field where the event takes place are devoted to a kind of religious festival, marked by gay and solemn performances. In the center of a raised platform, a canopy is held by a girl in costume dress, while nine others go through strange dances. Five girls garbed as rice-field workers waded into the marsh and plant the grain in time to music.

W. Araki, Esq., No. 1, Koraihashi 2-chome, Asaka, E. Japan

Copyrighted material

Electro News
7/3/23

WOMEN INVENTORS ARE BUSY ON INDUSTRIAL PROBLEMS

To learn just what part women were taking in inventions, government officials recently undertook a survey that showed over 5,000 patents had been granted to them in 10 years, more than the total for 105 years previous. The first patent granted an American woman was given by the British government to the wife of a Pennsylvania planter, for a device to clean and cure corn. Labor-saving machines are said to make up the majority of women's inventions, one making an apparatus for scattering fertilizer, another an article to strip sugar cane, while an adjustable horse collar was made by a Montana woman. For the kitchen, a pie pan was brought out that prevented juices from overflowing the rim, and a wooden mixing bowl was invented that would not split. Almost every line of business was included, but 1,385 patents were for articles of housekeeping.

3069

BABY CRIB IN WINDOW CAGE FOR FRESH AIR AND LIGHT

In a wire cage attached to a third-story window of an apartment in London a baby crib is placed so that the infant will



Copyright, Pacific and Atlantic Photos, Inc.

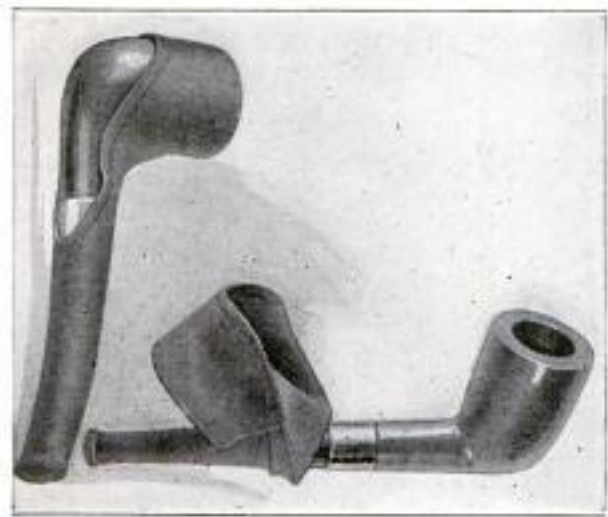
Wire Cage an Apartment Dweller Built for Window So Baby could Have Fresh Air and Light

have fresh air and light. Because the building was dark and unhealthy for the child, the father built a compartment of heavy wire netting, placing it on the window sill and bolting it to the brick walls with steel strips. By raising the window the crib is taken from the cage. Cloth or netting protects the baby from dust or insects.

RUBBER COVER FOR PIPE KEEPS POCKET CLEAN

3025

To keep tobacco ashes from spilling into the smoker's pocket, a rubber pipe cover has been made, having an asbestos top for the bowl. It can be put on while the pipe is hot without danger of sparks setting fire to the clothing, and also



Rubber Pipe Cover to Protect Smoker's Pockets from Ashes and Danger of Fire

serves to protect the stem from filling up with small particles of dirt when the pipe is not in use.

Mica is now being obtained from crystalline rocks that once were at least 5,000 feet below the surface of the earth.

LIGHT RAY TO HOLD WEIGHTS AFLOAT IN THE AIR

2714

To resist the attraction of the earth on heavy bodies, experiments are being made by a western man with a process which, it is claimed, will overcome the laws of gravity and cause the most solid-metal objects to rise without any other aid. This strange force, it is said, will come from a light ray capable of reducing the hardest material to dust thinner than air, and of printing a photograph through a steel plate 5 1/2 inches thick in five seconds. When developed, this power is expected to make wings on airplanes unnecessary, and to do the work of the airship's gas bag by creating an energy that will act against the strongest downward pull, raising and lowering the craft by the amount of current allowed to pass into it, while small propellers will move it.

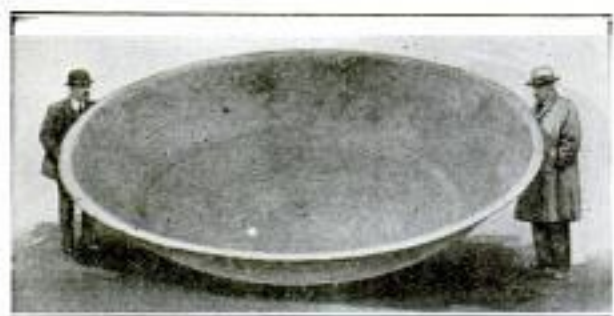
discovered by Edgar L. Hollingshead. Pasadena, Calif.

Atto Krabhu, 144 S. Wabach Chicago

So. W. Lightbend, Bloomington, London, Eng. land. Sutter Blvd.

TWO TONS OF COPPER IN PAN FOR BREWING PLANT

More than two tons of copper were used in making a pan for an English



More than Two Tons of Copper were Required in the Making of This Brewing Pan

brewery. The big dish is over 13 feet in diameter and acts as a sort of mixing basin when brews are first started. To transport it, the dish would have to be set on edge.

FLASHLIGHT FOR SCREWDRIVER

With a hollow handle holding a flashlight, a screwdriver is being marketed to

eliminate some of the trouble of working in the dark. The bulb throws a bright light upon the end of the tool. As only one hand is needed to operate it, greater freedom of movement is permitted.

FLOUR SIFTER RUN BY THUMB OVER THE HANDLE

So constructed that it may be operated by one hand, a flour sifter has been invented. Although simply made, it has all the durability and efficiency of the old type and is easier to use. Instead of the usual crank at the side, a spring lever is fixed to the handle of the utensil so that agitating bars within the receptacle are swung toward and away from each other by an up-and-down motion of the thumb. Thus the flour is sifted quickly, leaving one hand free.



inventor Arthur A. De Long

ANCIENT CHERRY TREE HELD UP BY PROPS

To support the limbs of a cherry tree two centuries old, growing in a Japanese park, crosspieces at the tops of long pine poles stuck in the ground, are bound to the branches by straw ropes. Lattice-

work arbors built close under the lower part of the tree, keep it from drooping. The natives are watchful of their favorite cherry trees, preserving them in various ways as they become aged.



Supported by Props, This Japanese Cherry Tree, Two Centuries Old, Still Bears Fruit

Chicago Motor Club Chicago

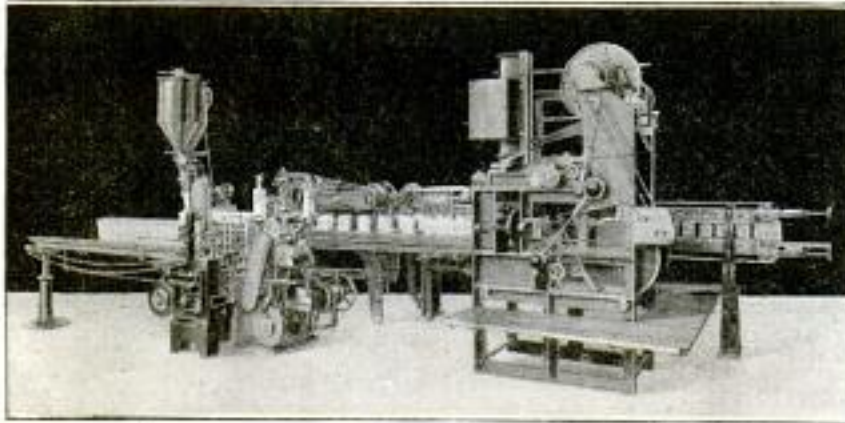
Emt. Everett W. Marquart, c/o U. M. C. Ag. & Water Sh. Yokohama, Japan.

data lost

3 m OUTPUT OF CARTON PACKER 18,000 PER DAY

Packaging and weighing of flour, cereals, chocolate, coffee, sugar, and many similar products, are greatly simplified by

an automatic machine now on the market. This machine feeds the cartons, seals the bottoms, lines the insides, fills and weighs the cartons, and seals the tops, the flat cartons entering at one end, and emerging, ready for the market, at the other. The output is from 15,000 to 18,000 packages per day, depending upon the material handled, and the type of carton employed. One machine of this type can do the work of about 35 hand operators, in a completely sanitary manner, and with a saving in material, owing to prevention of waste.



An Automatic Machine That Fills, Weighs, and Seals Cereal and Other Packages at the Rate of 18,000 per Day

PORTABLE DERRICK HAS WIDE
21 m RANGE OF USES

Wherever loads are to be hoisted, whether a few feet or several hundred, a

ing mechanism enables one man, with a three-strand cable, to lift a load of 1,000 pounds easily, and two men to hoist 2,000 pounds.

Two types are manufactured: one for general use, and one for attachment to a gondola car. The general derrick has a very wide range of uses, as permanent equipment on a loading platform, mounted on a factory tractor, as a shop utility crane, installed on a motor truck, or for construction work. The block has a ball-bearing swivel shackle.



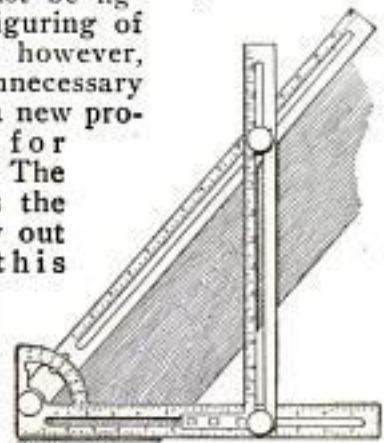
One-Man Portable Derrick Unloading Heavy Beams from Gondola

one-man portable derrick lately marketed will prove of value.

The derrick is made in two major parts, the beam, including the hoisting mechanism, and the base, each of which can easily be carried by one man. The hoist-

SQUARE MEASURES ANGLES
37 m FOR WOODWORKERS

It is a rather tedious process to get the proper length, pitch, and bevels for a rafter if it must be figured out; figuring of this character, however, is rendered unnecessary by the use of a new protractor square for woodworkers. The square enables the worker to lay out problems of this kind accurately and quickly, and, after the tool has been set, the length, pitch, etc., can be read off at once, and the tool used to mark off the bevels. It will be found



Stamping & Tool Co.,
La Crosse, Wis.

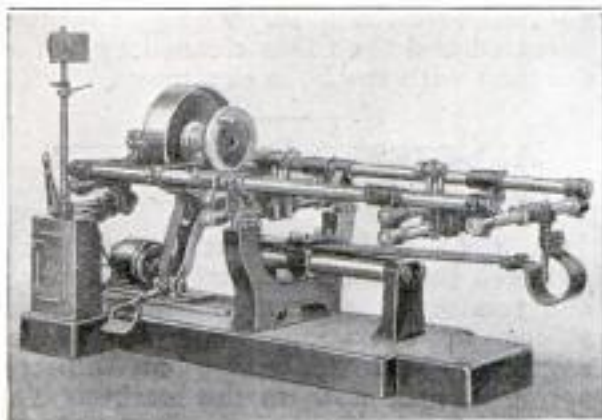
*Barrett & Stephens Co., Chicago
1328 W. Monroe*

exceedingly useful to anyone whose work requires the laying out of rafters of every description, stairway stringers, tank work, columns, silos—in fact, all work where calculations for length, pitch, or bevels are necessary.

MACHINE MEASURES UNBALANCE OF ROTATING PARTS *46 m*

Static and dynamic balance of the rotative parts of high-speed machinery may be obtained at the same time by means of a recently developed machine.

The machine measures how much, and just where, a part is out of balance, and will accommodate a wide variety of work, including crankshafts, motor and generator rotors, flywheels and spindles, and it is stated that the operation of determining the unbalance is as simple as using a pair of scales. The process of balancing parts is a rapid, exact, and economical one, owing to the simplicity



Machine That Determines Accurately How Much and Where Parts of High-Speed Machinery are Unbalanced

of operation, and the elimination of a preliminary static-balancing operation on separate shears. The machine will receive parts up to 25-in. swing, and 48 in. long, weighing up to 1,000 pounds.

UNDERGROUND SHOVEL CUTS MINING COSTS *4 m*

Hand shoveling constitutes one of the greatest cost factors in underground mining; not only is it hard to obtain efficient help, but, in the crowded "breast" of a vein, there is often not room enough for more than three or four men to work, and, after a blast, it is some time before the men can return to work, thus adding the idle time of many men to the cost of production.

For these reasons, and for many others,

an efficient underground loader now on the market will prove valuable. The machine is air-driven, and is made in three sizes; the smallest can pass through a space 42 by 48 in. in size, with seat and



View of Underground Shovel Swinging in Drift, Showing Small Clearance Required

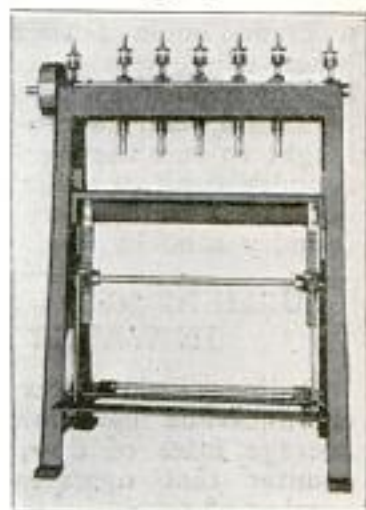
bucket arm removed, and can be pushed anywhere by one man. It is claimed that one of the machines, in driving a rock drift, 15 ft. wide and 9 ft. high, saved \$1,700 in 25 days, over the cost of hand shoveling.

STRAIGHT-LINE GANG DRILL SPEEDS UP PRODUCTION *42 m*

Designed to meet the requirements of work where the holes are all in one straight line, and at varying distances apart, a gang drill now on the market should meet with instant favor.

Each head is in a gear case by itself, and the heads can be set any distance apart from 1 3/4 in. to any required distance within the range of the tool.

The setting operation is very simple, as it is only necessary to loosen a few screws and slide the heads to the required positions. The machine may be furnished with a foot, hand, or automatic table feed, depending upon the work for which it is to be used, and the speed may be adjusted to suit either wood or metal.



Liebold Machine Co., Madison, Wis.

*Hoar Shovel Co.,
214 Sellwood Bldg.
Leubuth, Minn.*

*42 m
C. D. Haves 12 Adams St., Chicago
Liebold Machine Co.*

Love Mfg. Co.

614

6063

Wabash, Mich.

POPULAR MECHANICS

SIFTING MACHINE EFFECTS RIDDLING ECONOMY

34 m

While designed especially for foundry work, a sifting machine now on the market will prove of great value wherever



Riddling Sand in the Foundry with the Sifting Machine

sand or other granular material must be riddled in quantity. The machine is self-contained, and may be suspended from a crane hook, bracket, beam, or any other convenient place. There are no legs or tripods underneath to impede the operation, and it can be hung at any height to suit the workers. In ordinary foundry work, it will riddle 1 ton of oil-core sand in 3½ minutes, or 1 ton of foundry sand in 4 minutes.

SUBMERSIBLE DYNAMO USED IN WATER METER

48 m

Ordinary water-flow meters, using a cup-and-vane mechanism, indicate only average rates of flow, as marked by a counter that operates after a certain number of revolutions; an electric water-flow meter, recently invented in Switzerland, on the contrary, registers the rate of flow at any moment. The instrument is like a small torpedo, about 20 in. long, and is suspended in the water by means of an encircling strap. The nose of the torpedo carries a two-bladed propeller and shaft, which drives a simple dynamo

Mess. Stud. Jauber & Co,
Zurich, Switzerland

contained in the body. The current generated is recorded or indicated by a galvanometer, which is calibrated to show the rate of current flow.

The meter is said to be equally satisfactory in open water and in pipe systems, and for recording the flow of gases. It is very little influenced by temperature changes, and responds to flow in either direction.

BOILER-TUBE TOOL CLEANS

32 m

TEN A MINUTE

Ten tubes cleaned a minute is the record claimed by the inventor of a recently patented boiler-tube cleaner. The "gun" is mounted on trestles in front of the boiler, and an air hose, with a nozzle on the outer end to fit the tubes, is attached to it. One man operates the gun, another the hose. The gun may be operated and the tubes cleaned as fast as the man with the hose can move.



ALL-STEEL ROAD SCRAPER

40 m

HAS LONG LIFE

Built of materials that insure great strength and long life under hard wear, and reinforced wherever extra strain develops in operation, road-maintenance engineers will appreciate an all-steel spring scraper now on the market. The float or plane will go to the side or shoulder of the road, gather the loose gravel



Road Scraper of All-Steel Construction Attached to Truck

and move it to the center of the road in one operation. The scraper can be mounted on a truck, and can be raised and the truck backed up to perfect a bad piece of road without having to turn. In winter, the scraper can be used as a snow plane, and will handle 6 to 8 in. of snow at a speed of 15 to 25 miles per hour.

Wm. Chas. Corne, Dr. record. d. m.
Root Spring Scraper Co.,
Kalamazoo, Mich. # 601556



All Shop Notes published in 1922, in book form—Fifty Cents—from our Book Department.

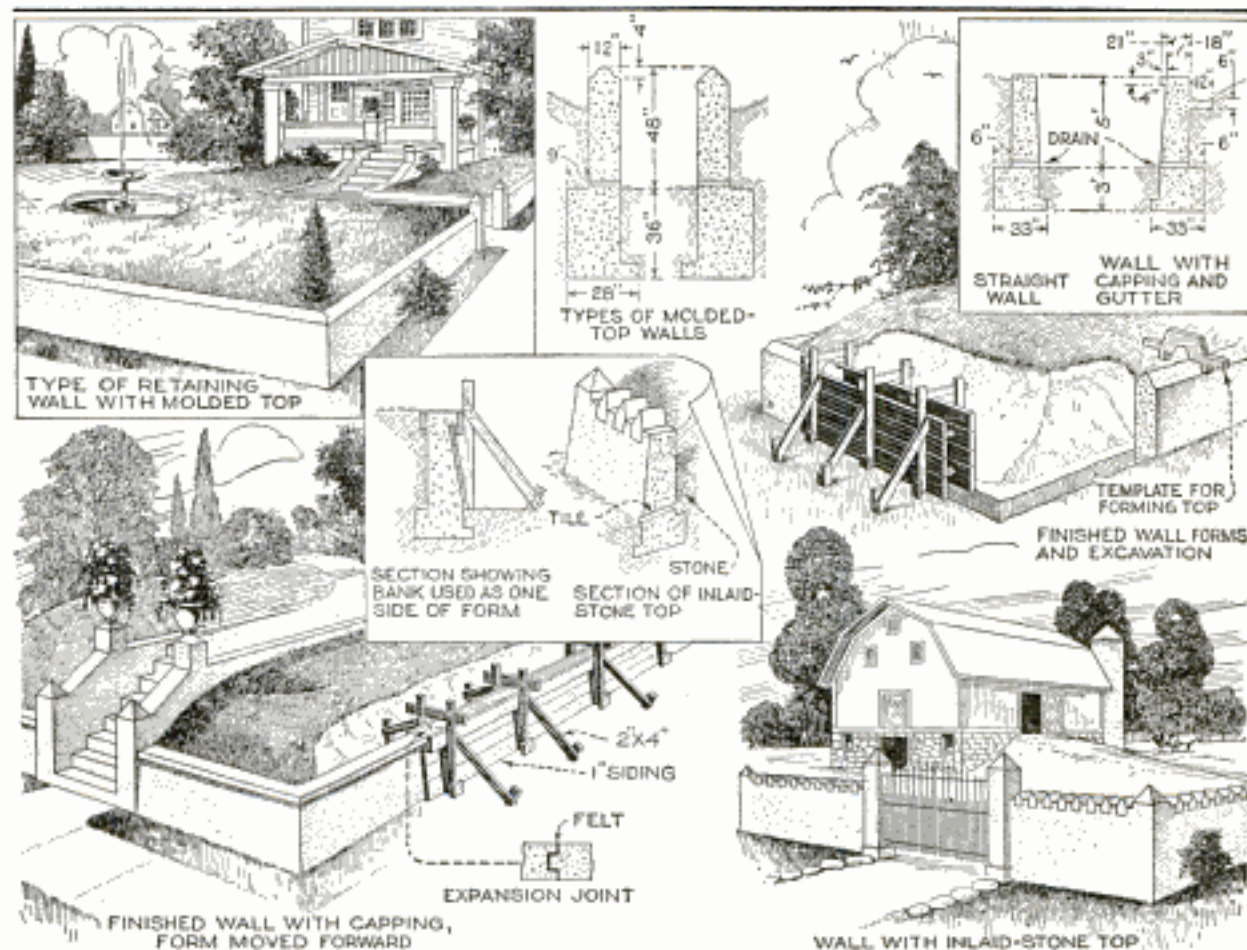
Building Concrete Retaining Walls

BY A. C. COLE

THERE is nothing at all difficult about the building of retaining walls in concrete, the cost of the work is low, and the finished wall adds greatly to the appearance of the inclosed grounds.

The excavation for the wall footings must be carried below the frost line, and,

to cut away the bank so that forms can be used on both sides and the wide footings poured. This, however, is not a disadvantage, as it allows a layer of loose stones, gravel, or cinders to be laid along the back of the wall before filling back the earth, and this helps the drainage.



Various Forms of Easily Made Retaining Walls in Concrete: Details of Molded, Capped, and Inlaid-Stone Tops are Given in the Inserts

where the earth is firm enough, the bank itself may be used as one side of the form, undercuts being made in the bank to form the projecting lower portions of the footings. Where the earth is not self-supporting, it is, of course, necessary

As may be noted in the drawings, the forms are very simple; 1-in. siding is used for the sides, with 2 by 3 or 2 by 4-in. uprights and braces. Enough uprights, braces, and struts must be used to prevent the forms from bulging, and

the walls held the proper distance apart by short pieces of the material used for the uprights. The walls are held by twisted-wire ties in the usual manner, and by cross braces at the top; the spacing pieces are moved upward as the concrete is placed.

As soon as the footings have been placed, and the forms erected, a number of concrete drain tiles are placed in the forms, as indicated in the sectional drawings, to carry off water, and the remainder of the concrete is then placed. The concrete used should be mixed in the proportion of 1 part cement, 2 parts sand, and 4 of clean, broken stone, and, when pouring the concrete, a flat, sharpened stick or a spade should be used to cut down between the form and the mixture, to work the stone back from the face of the wall, rendering the surface dense and smooth.

If the wall is at all long, the work should be done in 20-ft. sections, moving

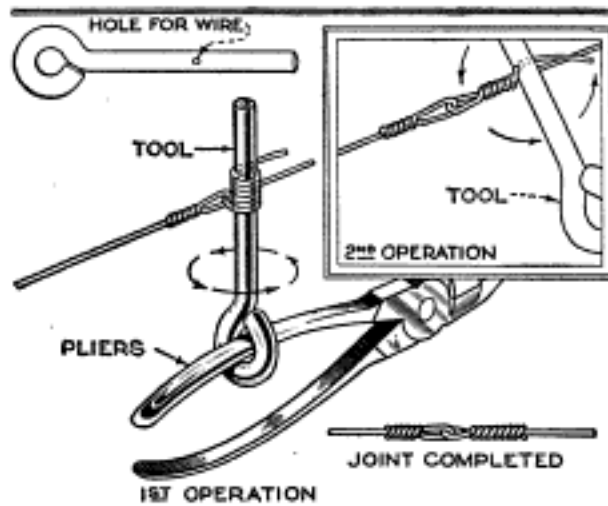
the forms along as soon as the concrete in one section has set, and expansion joints, of the type shown, filled with asphaltic felt, provided between sections.

Various forms of coping are shown in the drawing. The molded top presents a very neat appearance, and is easily formed by means of a wooden template, drawn along the top of the wall while the concrete is still "green." With a little more trouble, a neat gutter may be formed on the back of the wall, the trough being shaped with a trowel. A particularly attractive top is formed by inlaying stone blocks, as shown in the lower right-hand view, although this is rather more expensive.

The forms can be removed as soon as the concrete has set enough to sustain its own weight, and the surfaces may be finished by simply rubbing with a wooden float dipped in water and sand; in this way the form marks are rubbed off, and a smooth, permanent surface obtained.

Novel Fence-Wire Stretcher

The fence-wire stretcher shown in the illustration consists of a short length of



Lower Illustration Shows Method of Tightening Wire, and Insert, Method of Fastening Free End

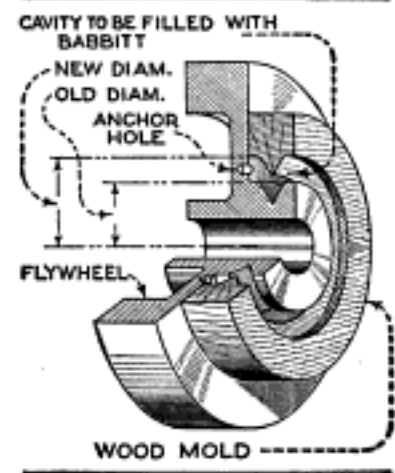
$\frac{1}{2}$ -in. iron rod with a hole drilled through it as indicated, and the end formed to a ring large enough to accommodate the handle of a pair of pliers. When the wire is to be tightened, it is not cut near a post, but midway between two posts. One end of the cut wire is formed into a loop, and the other end passed through the loop and through the hole in the tool. The tool is turned by means of the plier handle, as indicated, so that the wire is wound around it until sufficiently tight. The tool is then revolved around the wire

several times, as shown in the upper detail, and the surplus wire clipped off.

Increasing Diameter of Small V-Pulleys

When it is desired to increase the diameter of a V-pulley, such as often found on the side of a small flywheel, a "rim" of babbitt can be cast around it, providing the increase in size is not too great.

Small anchor holes are first drilled in the side of the wheel, as shown. A wooden mold is then turned out of good dry pine to the new diameter. The mold is placed around the pulley, concentric with the bore, and clamped in place, after which babbitt is poured into the open space between the mold and the old pulley. If it is desired to use the old pulley again, it is only necessary to cut off or melt the babbitt. When melting the babbitt, whittle a clean surface on the end of a pine stick and dip it repeatedly in the metal. When the stick chars, pour the babbitt.



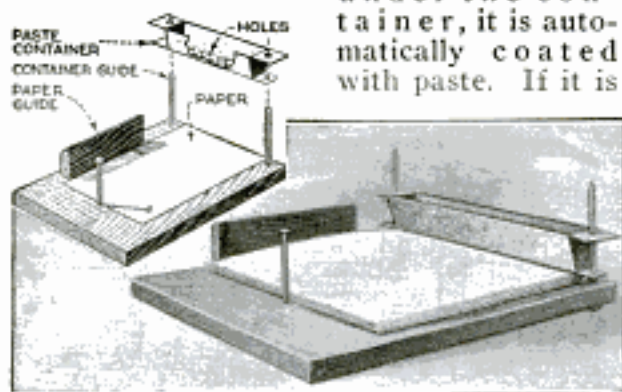
An Efficient Paste Spreader

In offices where many papers are wrapped by hand for mailing, the paste spreader illustrated will be very useful. It eliminates the paste brush, and speeds up the work considerably.

The base is made from an ordinary 1-in. board. An upright piece of the same material is screwed to one side of the base to keep the edges of the pile of wrappers even. Heavy spikes will serve for the paste container guides, although $\frac{3}{4}$ -in. iron rods are better. The container is a triangular trough with a flat bottom, in which a number of small holes are drilled to distribute the paste along the wrapper edges. Ears are left at each end of the container, and holes drilled to fit the guides, so that the container can move up and down easily. Medium-weight galvanized sheet metal is a suitable material for the container.

To use the spreader, the papers are first placed in a pile under the paste container, which is then filled with paste, mucilage, or glue, whichever is necessary. When a wrapper is drawn out from

under the container, it is automatically coated with paste. If it is



Device for Applying Paste to the Ends of Wrappers, That Speeds Up the Wrapping Process Considerably

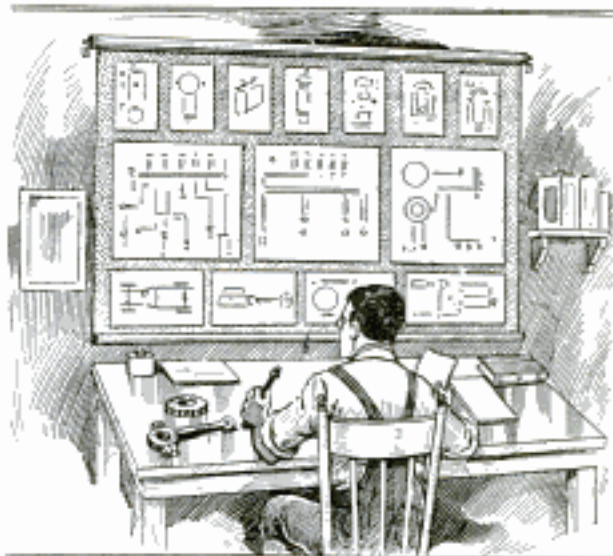
found that too much paste is applied to the wrappers, the container may be weighted down so that less paste will escape through the holes.—Lowell R. Butcher, Des Moines, Ia.

Novel Mounting for Instruction Manual

In garages and service stations where drawings and wiring diagrams are required for reference while working on cars, it is almost impossible to keep them from being soiled, as they are continually being handled with greasy hands.

To prevent this, in one station, the sheets were glued to the inside of an ordinary roller shade, which was mounted on the wall in front of the foreman's

desk. Whenever the reference prints were to be used, the shade was simply unrolled, and when the job was finished,

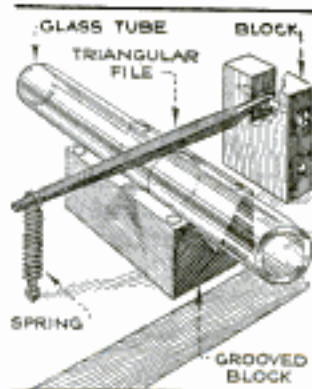


Novel Method of Mounting Reference Prints on the Inside of an Ordinary Roller Shade

rolled up again. Besides keeping the prints clean, this prevented them from being creased, torn, or lost.

Cutting Glass Tubing

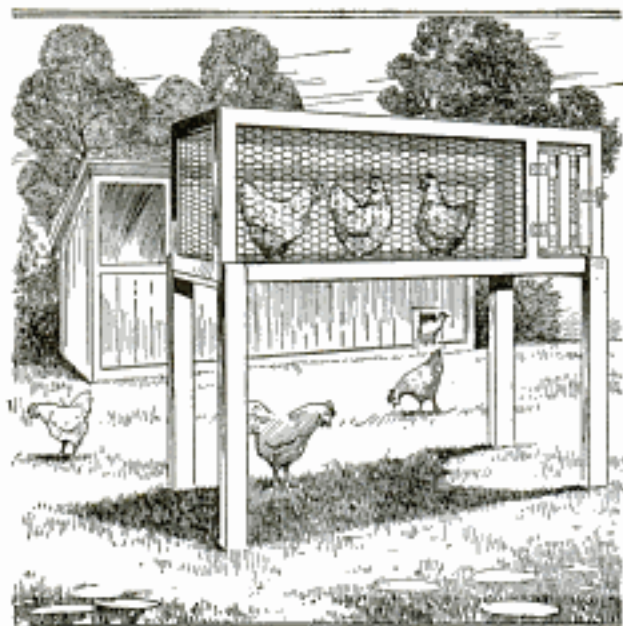
The illustration shows an excellent method of cutting glass tubing. A block of wood with a V-groove cut in it is attached to the bench; a triangular file is arranged across this, the tang of the file having an eye formed in it, which swings on a pin driven through another block attached to the bench, as shown. The other end of the file is slipped through the end of a coil spring which is fastened to a screw eye driven into the bench, and draws the file downward against the tubing. The tubing is placed in the V-block, between the block and the file. Turning the tube will then cause the file to score the glass, after which a few light taps will break it cleanly.



Information as to where materials and parts mentioned in these pages may be obtained will be furnished, on request, by the Bureau of Information.

Curing a Broody Hen

There are hundreds of ways advocated for curing broody hens, but most of these are not entirely effective. Simply confining the hen in a coop without nests



An Elevated Coop with Wire-Mesh Bottom Effects a Cure for Broody Hens in Five or Six Days

will not cure her, unless she is kept there until completely exhausted. A positive cure, which requires only 5 or 6 days, is shown in the drawing. An ordinary elevated coop will not do the work, as the idea is to prevent warmth under the hen when she sits down, and therefore the floor should not be made of wood, but of 1-in. wire mesh. The air from underneath soon effects a cure; it has done so with the most persistent hatchers.

The coop should be elevated about 3 ft. above the ground, and it should be large enough to accommodate 6 or 8 hens. Pans or narrow troughs, on which the fowls cannot sit, are used for food and water. The top of the coop should be covered to protect the hens from the hot sun and from showers.

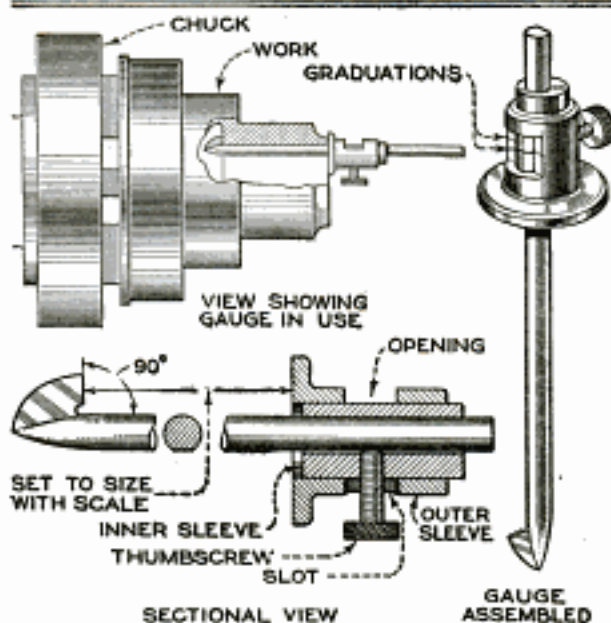
Machinists' Hook Gauge

Nothing is so hard to measure in the machining of work on the lathe as the thickness of hubs of wheels, gears, and pulleys. This is due to the fact that many holes are too small to allow the use of a regular hook rule, and even if one could be used, it is often too short to reach through the bore. A very serviceable hook gauge that eliminates these difficulties can be made as shown in the illustration.

The main part of the gauge consists of a suitable length of $\frac{1}{4}$ -in. drill rod provided with a hook at one end. The hook is made by forging a sharp bend in the rod, and filing it to the shape shown. The straight edge of the hook is filed perfectly square with the axis of the rod, and the corner is filed out with a small round file, to prevent the accumulation of dirt, which would result in incorrect measurements. The notching out of the corner also prevents a burr on the edge of the bore from showing a false reading on the gauge.

The head of the gauge consists of two parts; an inner sleeve, bored out of center as shown, which is necessary to allow sufficient metal for the thumbscrew, and an outer sleeve, bored to a neat sliding fit over the inner one, and having a flange at one end, which is turned perfectly square with the rod. The outer sleeve moves over the inner within the limits of the thumbscrew slot. This always holds the outer sleeve square to the graduation line on the inner sleeve, and as a flat is filed on the rod, against which the screw bears, the whole gauge is kept in line.

Across the face of the outer sleeve is filed an opening, as shown, to expose the surface of the inner sleeve. Midway be-



A Handy Hook Gauge for Measuring the Thickness of Hubs of Wheels, Gears, and Pulleys

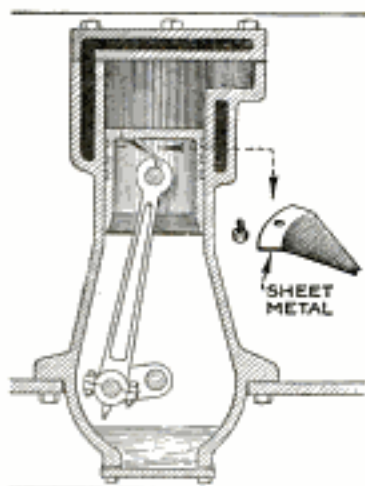
tween the limits of travel of the outer sleeve, a graduation line is scribed on the inner one as shown, and a similar line scribed across the center of the flats on the outer sleeve. The gauge is set by keeping both graduations in alignment

while measuring between hook and outer sleeve with the scale. When set to size, the thumbscrew is tightened, and, upon applying the gauge to the work, holding the hook against the inner face of the hub and sliding the outer sleeve against the outer face, the amount to be turned off is indicated by the distance between the graduations. This gauge not only indicates when the thickness of the hub is correct, but how much it may be over or under size.

A gauge of this kind, when used for general purposes, should be made of $\frac{1}{4}$ -in. rod; smaller or larger sizes can be used to suit the work. With the gauge of $\frac{1}{4}$ -in. steel, holes can be measured through $\frac{1}{2}$ -in. bores.

Lubricating Wristpins

During winter the tractor requires considerable care, as the heavy oil that is used in tractors becomes almost a grease in zero weather, and in this condition does not lubricate the wristpin bearings properly, so that there is danger of burning out the bearings or "freezing" them.

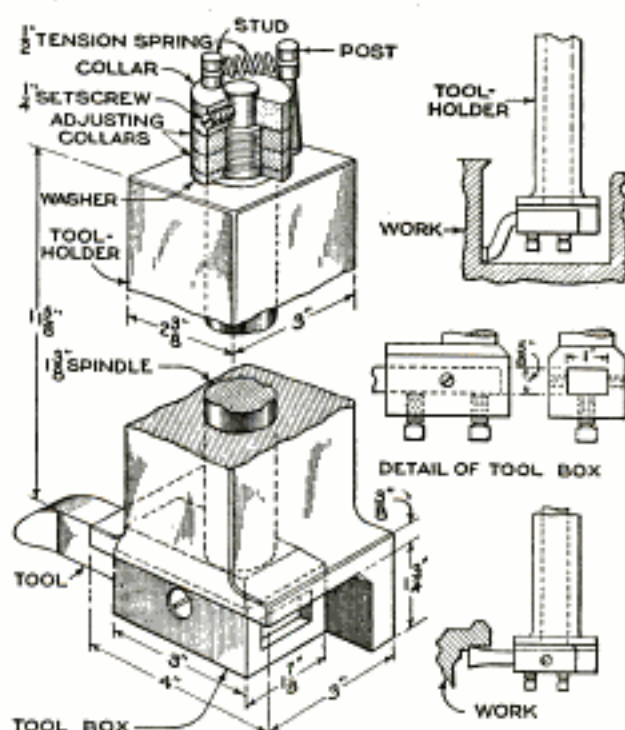


To offset this danger, I provided the auxiliary oiling device illustrated, which consists of a piece of No. 20 sheet steel, hammered to the shape shown in the detail and screwed to the underside of the piston head, so that the spout terminates directly over the oil hole in the top of the wristpin bearing. The point where the device is bolted must be opposite the point where the splash from the crank reaches the inside of the piston, so that the spout will catch some of the oil. This oil will then drop on the bearing where it is needed. The addition of this device has been found to eliminate much trouble previously experienced.—G. G. McVicker, North Bend, Neb.

⚠ A tap should never be used to clean a hole in hardened work, even if the work is soft enough to be scratched with a file.

Holder for Side-Planing Tool

The illustration shows a useful side-cutting planer-tool holder, which does work that at times cannot be done with



An Improved Holder for Side Planing That can be Used on Right or Left-Hand Work

the regular planer heads. It can be used on either right or left-hand work.

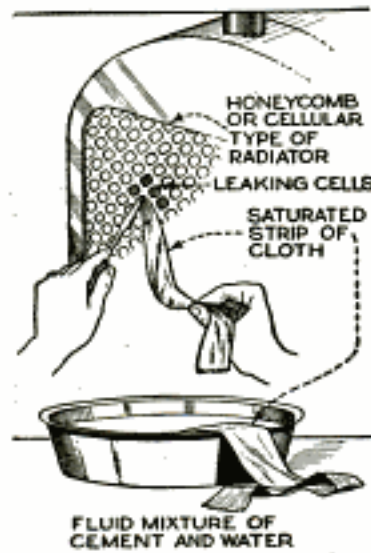
The tool box is machined on the lower end of the spindle, and fits against the shoulder at the rear of the body. The upper end of the spindle is threaded and fitted with a washer and two adjusting collars; over the latter is placed a collar, which is fastened to the spindle with a setscrew. A stud in the top of the collar, and a post in the body of the holder, are connected by a tension spring, which pulls the tool box back against the shoulder at the end of the return stroke. Cutters, forged with an offset large enough to allow the lowest edge of the tool to project below the heads of the setscrews in the tool box, allow cutting to the bottom of slots, as in the drawing.—R. W. Laing, Fergus, Can.

Absorbing Excess Oil on Dirt Streets

When a dirt street is oiled, the oil is usually tracked all over where it is not wanted. This was prevented, in an Iowa town, by spreading powdered stone—refuse from a stone crusher—over the road. The stone dust absorbed the excess oil, and it packed down at once.

Cement and Cloth Repair for Radiator

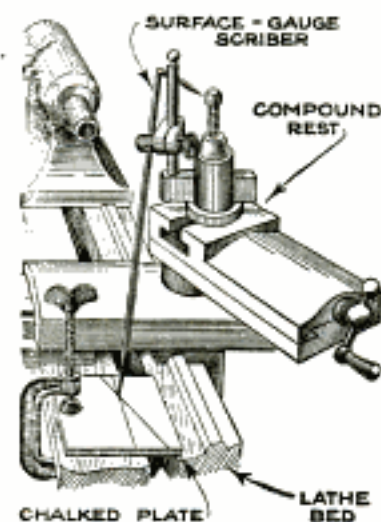
The soldering of a honeycomb radiator is difficult work and can be accomplished satisfactorily by an experienced repair-



man only. However, a repair for small leaks, that can readily be made by anyone, is shown in the illustration. It consists of packing strips of cloth, saturated with a thin mixture of Portland cement and water, into the small spaces where the leaks are found. The cement hardens and binds the cloth into a solid mass. It is not necessary to remove the radiator when making this repair, but the water should be drained out so that the cement particles in the cloth will not be washed away, and the cement should be permitted to set before refilling the radiator.

Setting Compound Rest for Tapers

For certain kinds of taper work, when the compound slide is used, swiveled around, and fed by hand or power, the



taper is best found by the trial scribing of a surface plate and clamping the slide in position when the scribed angle is found to be correct. A small surface plate, or any smooth metal plate, is clamped to the lathe bed, while a surface-gauge scriber is attached to a holder clamped in the tool block, the plate being either chalked or blued, according to the accuracy required. Then the lathe carriage is

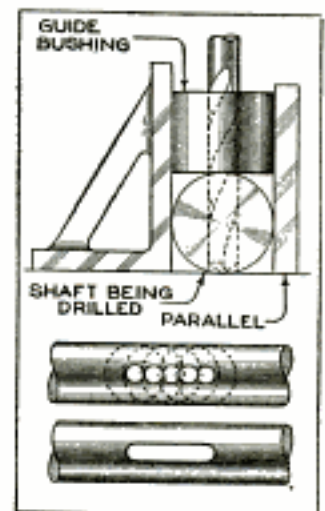
run along by hand, far enough to allow the surface-gauge pointer to scribe a line along the plate; this line, of course, being parallel to the lathe bed.

It is assumed that a template showing the correct taper is at hand, and that the exact reading of the taper angle, in degrees, is unknown, as is often the case. If the angle is known and the compound rest graduated, it can be set off at once without the necessity of the scribing process described. Using the template, another line is scribed on the surface plate to make the required angle to the line already made; then, the compound rest is swung around to approximately the right position, clamped, and the compound slide traversed. The surface-gauge pointer, being still in place, will indicate how closely the rest has been set, and the rest is swung and reset until the scriber follows accurately the line scribed from the template.

Drilling Holes through Round Stock

Every mechanic has more or less difficulty in drilling holes centrally in shafting and other round stock, the degree of trouble encountered depending upon the skill of the person doing the work. Even with an accurate layout and great care, the holes are frequently drilled off center.

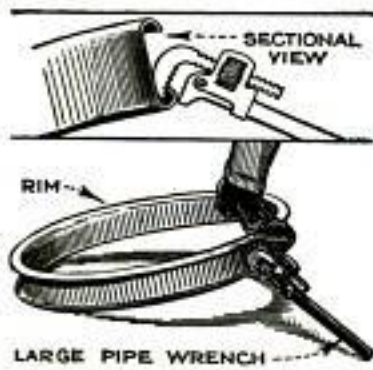
The method illustrated makes it possible to bore one hole or a succession of holes in cylindrical work with the certainty that all of them will be at right angles to the axis of the work. Also, no layout is required unless a hole has to be a certain distance from the end of the work, in which case a scale can be used,



or, where accuracy is required, a depth micrometer, by merely subtracting half the diameter of the bushing from the required dimension. The bushing is turned to exactly the same diameter as the work it is to be used with, and the central hole should be the same size as the one to be drilled in the work. The bushing and the job are then clamped in a vise, or, in cases where the work is too large, between parallels.

Straightening Damaged Clincher Rims

Clincher rims sometimes become dented and must be straightened to prevent injury to the tires. The rims can be

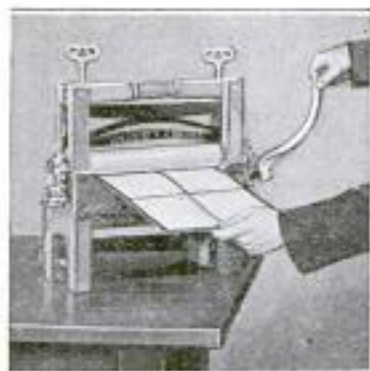


straightened by means of a large pipe wrench. The rim or wheel is removed and placed on the floor and the pipe wrench applied to the dented spot so that the head of the wrench bears against the center of the rim, and the upper jaw presses outward against the dented portion as shown. The end of the wrench handle and the side of the rim farthest away from the wrench will then rest on the floor. By standing on the rim as indicated in the drawing the dent can readily be removed.—E. T. Gunderson, Jr., Humboldt, Iowa.

Ferrotyping Made Easy

Many commercial photographers ferrotypes a great number of their prints to give them a glossy finish. This is usually done by laying the prints

face downward upon the ferrotyping plate and applying pressure with a hand roller, which is hard work and requires time and patience. A better



method of doing this is shown in the photograph. An ordinary hand wringer, adjusted to give a slight pressure between the rollers, is used to do the work, the prints being laid face downward on the ferrotyping plate and both run through the wringer. Buckling can be prevented by keeping the prints at least $\frac{1}{8}$ in. from the edge of the plate.—J. G. Pratt, Washington, D. C.

☐ When storing cement, never pile it directly on the ground, which always contains some moisture.

Simple and Useful Clamp for Stepladder

A simple and useful clamp for the stepladder, that serves as a rest for holding windows while setting the panes or



Handy Clamp on Stepladder for Holding Windows While Working on Them

painting, can be made from two pieces of oak about $2\frac{1}{2}$ ft. long, with a bolt passing through the center of both as shown; a wingnut is provided on the bolt. It is not necessary to remove the wingnut to attach the clamp. Merely push the clamp over one leg of the stepladder from the inside, and then over the other leg, after which the wingnut is tightened. This tool can be used equally well on a common ladder.—Edgar Wright, Brookfield, Mass.

Filling the Auto Vacuum Tank

If a funnel and small gasoline can are at hand, the simplest way to fill the automobile vacuum tank is to remove the plug at the top of the tank and pour in the gasoline. If no funnel is available, the best method of filling the tank quickly is as follows: Close the throttle and shut off the ignition, then press the starter switch. It may be necessary, with some starters, to switch on the ignition for a moment, in order that the starter gears may mesh. The action of the motor will then cause enough suction to draw the gasoline from the rear tank into the vacuum tank. The throttle must be kept closed, as otherwise the engine simply draws most of the air through the carburetor, and not enough through the vacuum tank.

Building a Floor Crane

BY J. V. ROMIG

ONE of the handiest pieces of equipment for the small machine shop, garage, or service station is a portable floor crane, which can be rolled to any part of the shop to take the heavy lifts, and, when not in use, can be shoved out of the way.

A strong and serviceable floor crane can be made in any small shop or garage, at small cost for labor and material, and it will prove a paying investment. With this crane, heavy work may be raised from the floor to the bench or the tables of the various machines, shafts can quickly and easily be placed between the centers of the lathe, and, in the garage, engines can be lifted out of chassis, and run over to the repair bench or stand; in fact, the uses that can be found for the crane are "too numerous to mention."

The lower frame or base of the crane is made from two pieces of 5-in. channel iron, upon which are mounted two columns made of pipe. On top of the columns is the hoist arm, also of channel iron, and fitted with pulleys over which runs the hoisting chain or cable. A drum and a set of winch gears, with their shafts and bearings, are bolted to the columns.

The base members are cut to a length of 62 in., laid out, and bent to the shape shown in the detail drawing; the bends are made at an angle of 45°, with the webs of the channels on the outside. The frame members are spaced apart by a piece of 3/8-in. boiler plate on the underside, and by the 4-in. pipe flanges used for the columns on top. The standard diameter of 4-in. extra-heavy pipe flanges is 10 in., so this will be the width of the length of boiler plate; the plate is cut long enough to project beyond the channels, to form a bearing for the back-caster pivot. Ball-bearing caster wheels are fitted to the three ends of the base as indicated, the caster at the back being provided with a forked handle or tongue, to enable the crane to be pulled about easily. The width of the front end of the base is 48 in., which enables it to be pushed between the wheels of an automobile of the standard 56-in. tread.

The columns are made of 4-in. extra-heavy pipe, and are fitted with flanges at both ends as shown. Both pipes should be cut and threaded so that, when the flanges are screwed home, the over-all length of the columns will be the same; they are bolted to the lower frame and hoist arm with 1/2-in. bolts, and must be perfectly square and parallel.

The arm or boom of the crane is also

made of 5-in. channel irons, 48 in. long. They are spaced apart by pieces of pipe, faced on the ends perfectly square and to the same length, and held with 1/2-in. or 5/8-in. bolts. Two cable pulleys are placed within the arm at the points shown, before the arm is assembled. The pulleys run freely on plain 3/4-in. pins, held in place by heavy cotter pins, and they should be provided with oil cups, and be kept properly lubricated.

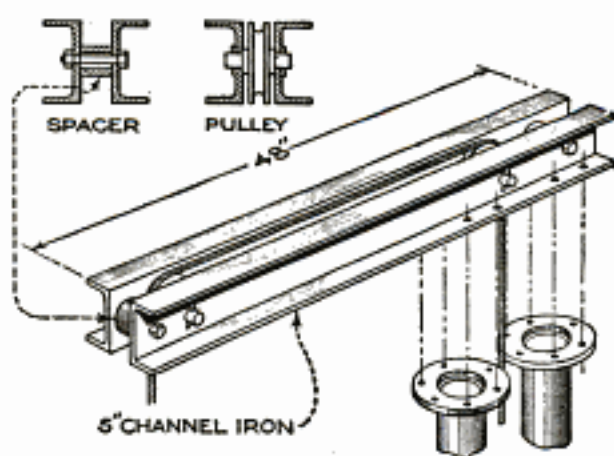
The hoisting mechanism consists of a cast-iron drum, mounted on a shaft carried in small pillow blocks on the columns. The bases of the pillow blocks should be machined to fit the curvature of the columns, or, if there is not metal enough in them for this, small plates, curved on one side to fit the columns, and flat on the other, should be used between the blocks and columns. The drum shaft carries a 12 or 14-in. gear at one end, meshing with a 3 or 4-in. gear carried on a shaft above the drum. This shaft is also carried in pillow blocks, fitted as before, and is provided with a strong crank handle. The assembly is bolted to the columns, with 1/2-in. through bolts, at a convenient operating height, the pillow blocks being spaced so that the gears will mesh with the minimum of backlash, while still running free. A bent bracket, made of 3/8-in. steel plate, is bolted to the back of one of the columns, and carries a pawl which engages with the large gear, and holds the load when hoisted.

Either a cable or chain may be used; if a cable, it should be of plow steel, not less than 3/8 in. in diameter, and if a chain is used, it should be strong enough to sustain a load of at least 800 pounds.

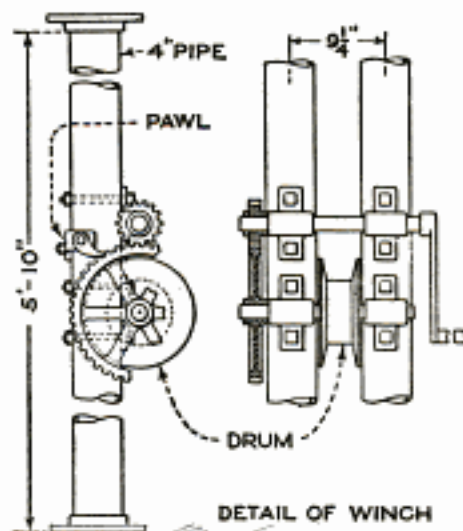
Most of the material for this exceedingly useful tool can be picked up at a junk dealer's for a few cents a pound; the work of cutting and assembling is quite simple, and may be done in the men's spare time, if necessary.

Cement for Auto-Top Repairs

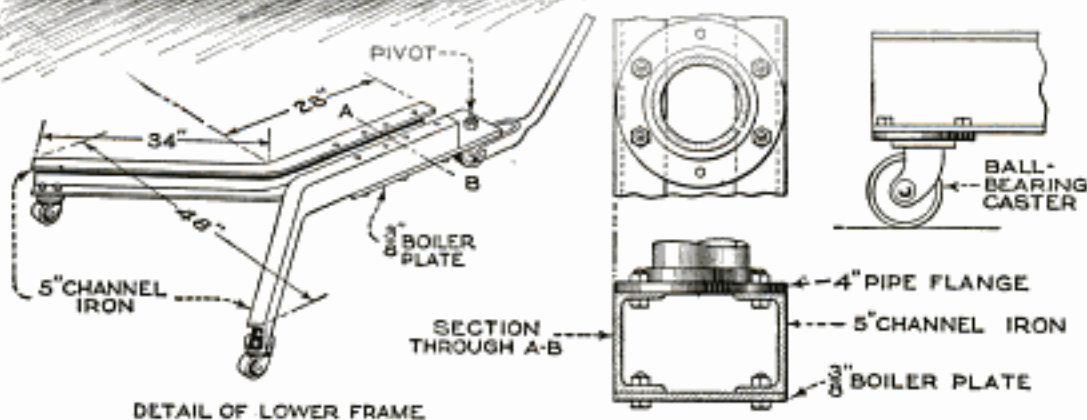
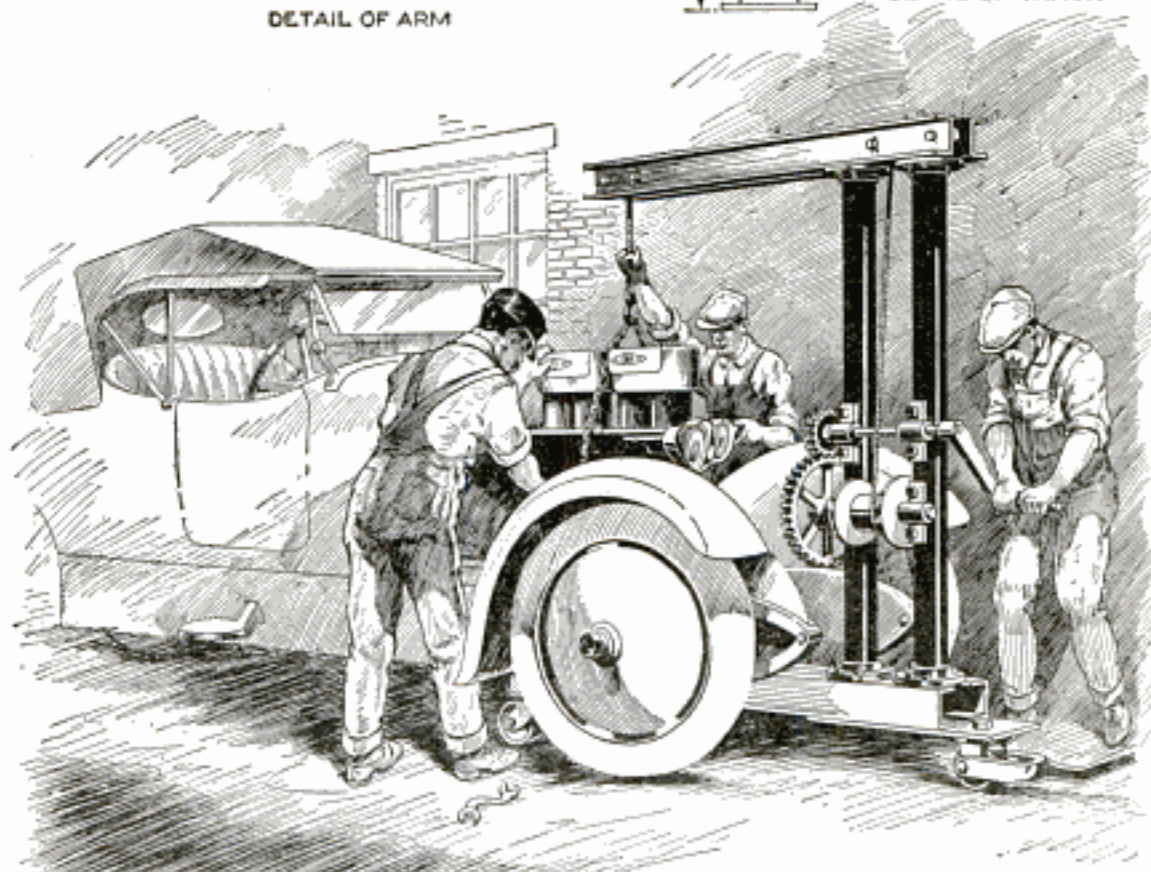
Many autoists repair a torn top with a piece of rubberized fabric and tube cement; it is found, however, that the cement deteriorates in time under exposure to weather. By substituting shellac for the cement, the repair can be made practically permanent. The portion of the top to be covered should be cleaned thoroughly, and the shellac should be spread so that there will be no spaces under the edges.



DETAIL OF ARM



DETAIL OF WINCH

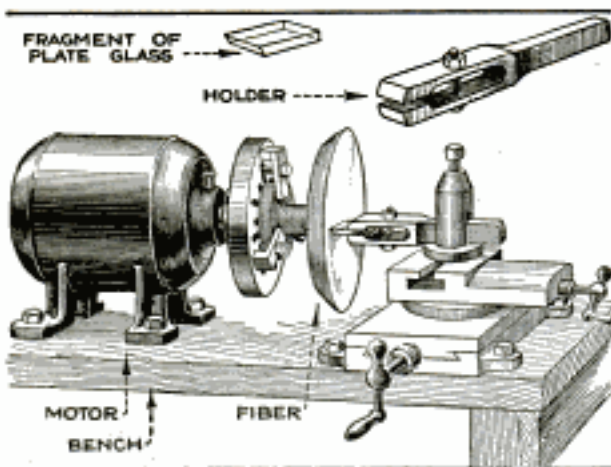


DETAIL OF LOWER FRAME

A Floor Crane That may be Constructed of Material Found in Any Junk Yard, and That will Very Quickly Pay for the Time Spent in Making It, by the Time Saved When Heavy Work must be Lifted

Turning Hard Rubber

Anyone who has had experience in turning hard rubber, ebonite, and bake-



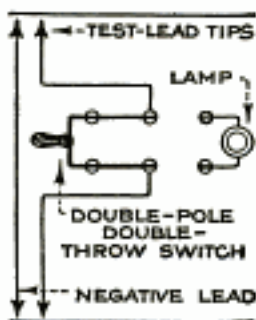
Method of Cutting and Facing Hard Rubber with Pieces of Plate Glass

lite, knows how difficult it is to keep the edges on the steel tools, and to produce a finely burnished surface. The tool dulls rapidly, and drags the surface of the material, so that the work presents a ragged appearance.

The difficulty can be avoided to a great extent by using a small piece of plate glass as a cutting tool; this has been found to give excellent results, both in cutting and in surfacing the work. The piece of glass is clamped in a toolholder of the design illustrated in the upper detail. The cutting edge is obtained by fracturing the glass; when this is dull a new break is made. Pieces of heavy glass broken from bottles can also be used but cannot be held so easily in the toolholder.

Convenient Arrangement for Test Leads

There are usually two pairs of test leads on the workbench of an electric repair shop; one pair is connected in series with a lamp, and the other pair



is used. One of the center terminals is connected to the positive line, and the

tapped directly to the line, to obtain full-line voltage when testing small motors and heating appliances. A very simple method of obtaining the same result with one pair of test leads is shown in the illustration.

A double-pole, double-throw knife switch

other to the test lead. The two terminals on one side of the switch are connected to a lamp, and those on the other side are short-circuited. The other test lead is tapped directly to the negative line. By throwing in the switch on one side, the lamp is put in series with the test leads; by throwing it in on the other side, as shown in the illustration, the full-line voltage is obtained. When the switch is open, the positive lead is dead.

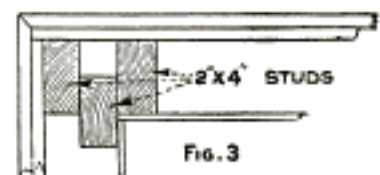
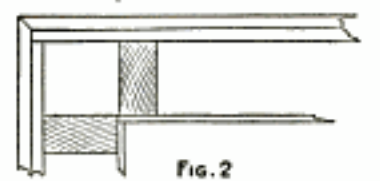
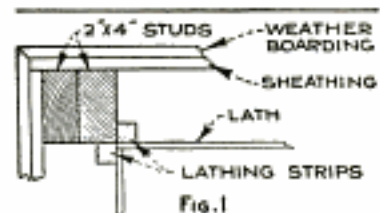
Marking Celluloid

A simple and effective method of marking one's name on any celluloid article, such as a draftsman's triangle, is to letter the name neatly on the surface of the celluloid with black drawing ink, and then, after inverting the triangle, to focus the sun rays with a reading glass on the written portion. After this is done the ink is washed off and a neat replica of the writing will be left on the celluloid surface.—O. S. Sawin, Worcester, Mass.

Corner Studs for Frame Houses

The large cracks appearing in the plaster at the corners of the walls of frame houses are very often due to the fact that the corners are not well made, properly braced, or strong enough.

For the sake of economy it is common practice to use two 2 by 4-in. studs, arranged as shown in Fig. 1, with two small lathing strips nailed at the inside corner of the inner stud. Another poor method is shown in Fig. 2, in which the corner studs are placed so that

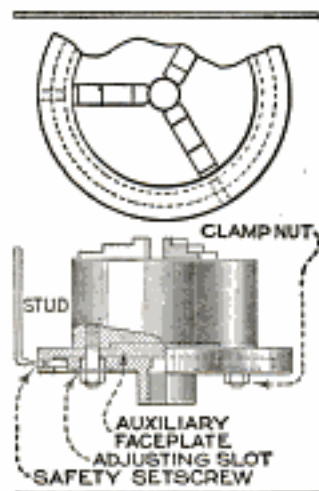


the edges butt together with a 4 by 4-in. space in the corner between the studs and the sheathing. Fig. 3 shows a good construction of a corner, using three 2 by 4-in. studs. The center stud, spiked firmly between the other two, projects about $\frac{1}{2}$ of its width so that the lath can be nailed to it, or a 2 by 6-in. piece of

timber may be used for the center member. This construction is about twice as strong as either of the two shown in Figs. 1 and 2, and only one extra stud for each corner is required. Strength should always be insisted upon in the details of frame houses, especially when the additional cost is slight.—John N. Sioussa, Washington, D. C.

Adjustable Universal Chuck

The illustration shows how a universal chuck may be fitted to act as an independent chuck, and, within limits, as an eccentric chuck; this method may also be used as a means of adjustment for a chuck out of true. A plain cast-iron faceplate, with a heavy flange, is screwed to the spindle nose and trued in the usual manner. Holes are drilled, or, better, slots cut through it for the studs that hold the



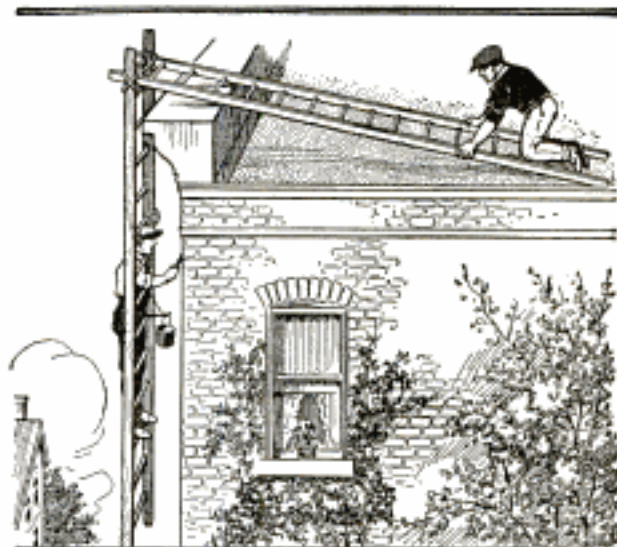
chuck; if holes are used, they are made a little larger in diameter than the bolts, to allow the chuck to be moved across the faceplate. An auxiliary faceplate is then made up, as shown, and recessed to fit the smaller one; 3 or 4 holes are drilled and tapped in the periphery, to fit safety setscrews

tightening against the smaller plate. The auxiliary faceplate is also provided with a shallow boss, which is made a push fit in the chuck counterbore. To center the work held in the chuck, or to set it eccentrically, the nuts on the studs holding the chuck and auxiliary faceplate are loosened slightly, and the setscrews adjusted until the work runs true; the nuts are then tightened. In case the lathe nose becomes inaccurate, the auxiliary plate and chuck are removed, and the smaller plate faced true; the chuck is then replaced and adjusted by means of an indicator.

☛ A good liquid tire paint is made by mixing 5 lb. whiting in 1 qt. gasoline, and, when thoroughly mixed, adding 1 qt. rubber cement. It is applied to the tire with a brush, and will not crack or chip, due to the elasticity of the rubber cement.

Working on Side of Building

The method of working on the wall of a building as shown in the illustration is used by circus-bill posters to put up their



A Practical Application of the Lever for Working on the Side of a Building

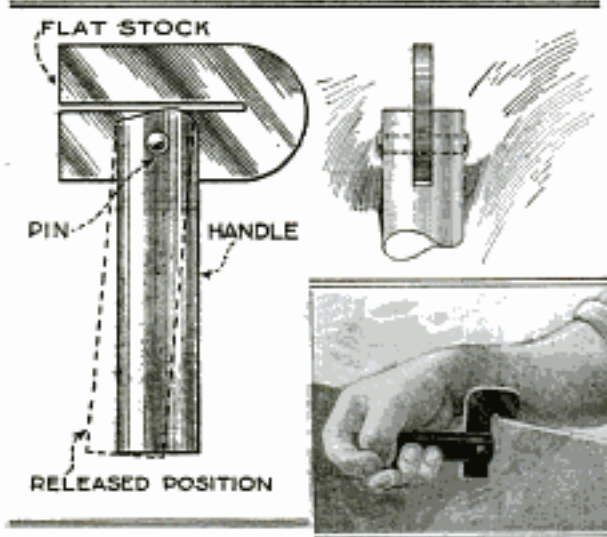
signs in places that are otherwise nearly inaccessible. Two ladders are used; one is laid on the roof, and projects a few feet beyond the edge; the other is lashed to the projecting end, and hangs vertically. One man remains on the extreme inner end of the horizontal ladder, while another climbs down the vertical ladder, the weight of the first man keeping the whole arrangement in position. The horizontal ladder should not project over the edge of the roof more than $\frac{1}{4}$ or $\frac{1}{2}$ of the entire length of this ladder and the man holding it down must apply his weight at the extreme inner end; he must be about equal to the other man in weight. In this way he will be able to hold the man on the ladder securely.

Painting Inside of Conductor Piping

Conductor piping rusts much more rapidly than the gutters, and for this reason it should be painted on the inside, which will protect it for a long time. The painting can conveniently be done by means of a sponge drawn up through the piping on a length of rope or heavy twine. The rope should be long enough to extend up through the inside of the piping and down to the ground on the outside, so that, when the rope has once been passed through the pipe, the remainder of the work can be done from below. A large sponge is tied to the rope and a weight tied under the sponge.

Carrying Sheet Metal

Where pieces of sheet metal have to be carried for short distances by hand, the device shown in the illustration will be found useful. For a handle, a short



A Simple Holder That Enables Sheet Metal to be Carried with Ease

piece of round stock is used; this is slotted at one end to take a piece of flat steel with a slot sawed in it to take the work. Both parts of the tool are held together by means of a pin. The end of the handle projecting over the slot in the flat piece is filed to the shape shown to form a cam. The handle will, when pulled upward, hold the sheet securely in the slot, and the weight of the material will also tend to tighten the grip of the holder. In use, the sheet is gripped so that the handle projects away from the workman. When carried in this manner the sheet swings slightly away from the worker's feet and clears the floor much better than if carried straight.

Lubricating Automobile Springs

Authorities on automobile maintenance agree that graphite is by far the best spring lubricant. Many motorists, however, refrain from using graphite because of the difficulty of getting it between the springs without taking the springs apart. A very simple and easy method of efficiently lubricating automobile springs with graphite is as follows:

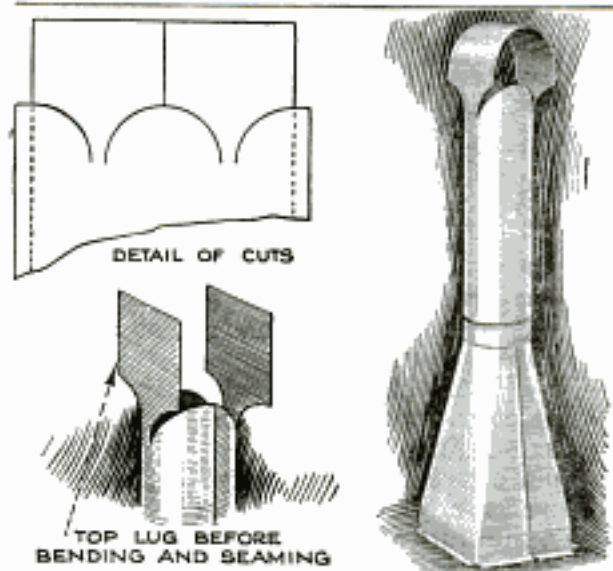
Take about 2 oz. of powdered graphite and mix it in 4 oz. of ordinary commercial ether. Put the mixture into an oil-can and apply it to the springs; it will be found to flow readily between the tightest leaves. The ether evaporates quickly and

leaves behind a deposit of graphite. The graphite left on the outside of the springs may be wiped off with a cloth.

Since ether is poisonous if taken internally, it should be mixed and applied to the springs out in the fresh air where there is not the slightest danger of inhaling it. It is also highly inflammable, and care should be taken to keep it away from fire.

One-Piece Chimney-Extension Cap

The drawing shows a one-piece chimney-extension cap that may be cut with little or no waste from a sheet of galvanized iron. The method of cutting is shown in the upper left-hand detail. The cylindrical part is first formed and the edges carefully seamed. The top flaps are then bent over, seamed and soldered, which completes the cap. If it is not thought necessary to have both sides exactly symmetrical, the extra allowance on the sides of the body for seaming may be omitted, and the sheet cut straight as indicated by the dotted lines. When the body is seamed, the upper curve on one side will be a little smaller than that on the other, but this is hardly noticeable, and allows the sheet to be cut with no



A One-Piece Chimney Extension Cap That may be Cut without Any Waste

waste at all. The cap not only forms a protection over the chimney, but also tends to increase the draft.—Francis T. Griffin, North Bend, Neb.

When broaching, see that all chips are removed before placing a new piece of work on the broach.

Wheels - Gustafson & Scott, Mfg. Co.
A Heavy-Duty Bench Band Saw

BY FRANK N. COAKLEY

16 3 7

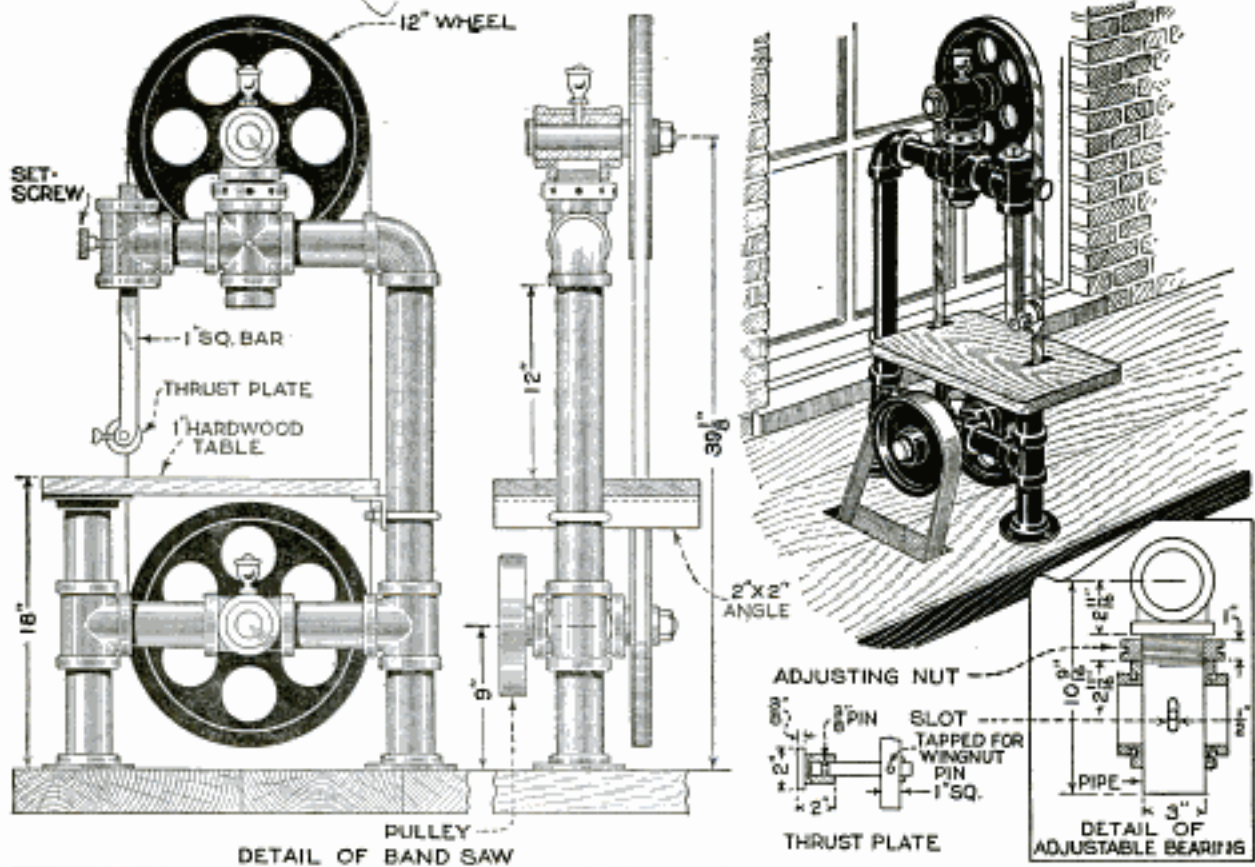
*Lowell
Chicago*

THE band saw shown in the accompanying drawing is built up mainly from the most easily obtained of materials—pipe and fittings; it will be found a most practical tool for the small shop, and one capable of heavy work.

The method of assembling the 2½-in. pipe frame is quite apparent from the drawing, so nothing need be said about this. The bearing for the bottom-pulley shaft is a babbitted cross, reamed to fit a 1½-in. cold-rolled steel shaft; an oil hole is drilled and tapped in the side of the cross, at the top, and an oil cup fitted

this keeps the bearing in alinement. A 5-in. circular adjusting nut, tapped to fit the bar, is run on between tee and cross before the bearing is assembled; this nut has eight ⅜-in. holes drilled around its circumference for a spanner wrench. If a bar of the proper size is not available, the sliding piece may be made of double extra-heavy pipe, turned to size. Care must be taken, when assembling the frame, to get the upper and lower bearings in line, and square with each other.

The thrust plate is made from 2-in. cold-rolled steel, turned to shape, bored to fit a ¾-in. pin, and casehardened.



Pipe and Fittings, About the Most Easily Obtained of Materials, are Used Exclusively for the Frame of This Sturdy Bench Band Saw for the Small Shop

to lubricate the shaft. The top-pulley shaft bearing is a tee, babbitted and reamed, in the same manner as the lower bearing, for a 1½-in. pin. This bearing is made adjustable, as shown in the sectional drawing, by screwing a 3-in. bar, with a long thread, into the tee outlet. The bar slides in one pair of the outlets of a 2½-in. cross, the outlets being machined to a good fit on the bar. A ½-in. pin is riveted through the cross, and fits in a slot cut through the bar;

The pin has a groove turned in it near its end, and a ⅜-in. pin, driven through holes bored in the thrust plate, runs in the groove and keeps the plate in place. The pin is carried by a 1-in. square bar, which runs through a babbitted hole in the end tee of the frame, and is held by a ⅝-in. setscrew with a large knurled head; the ¾-in. thrust-plate pin is held by a ½-in. thumbscrew.

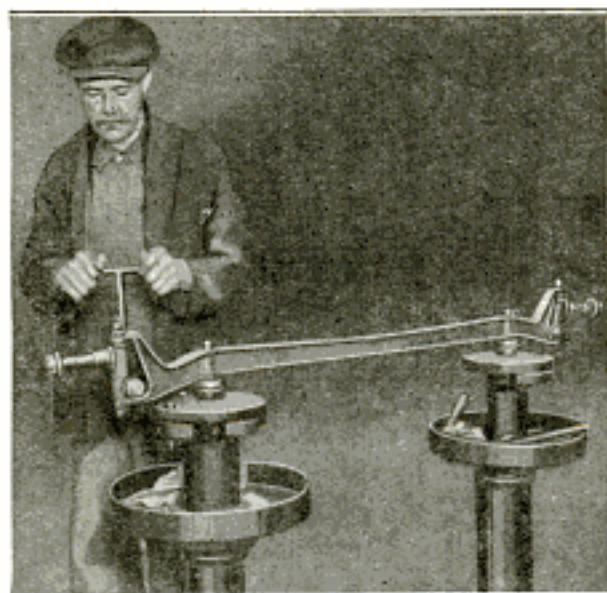
The table is made of 1-in. hardwood; it rests, at the front, on a pipe flange

screwed on the frame member, and, at the rear, is screwed to a 2 by 2-in. angle iron, which is fastened to the frame by a U-bolt.

The saw pulleys should be $\frac{3}{4}$ -in. face by 12-in. diameter, and should be turned and balanced to insure vibrationless running. It is advisable to cement endless rubber bands to the pulleys, to prevent the saw from slipping and heating. The

Assembly Stand for Automobile Axles

To allow the workman full use of both hands in assembling the front axles of automobiles, the simple stand shown in



Stand Used for Assembling Front Axles of Automobiles That Facilitates the Work Considerably

the photograph was devised. The spring-perch holes in the axle slip over two studs on two separate stands; then the workman can perform the necessary operations, knowing that the axle is just as rigid as if it were actually fastened to the automobile.—J. H. Moore, Toronto, Canada.

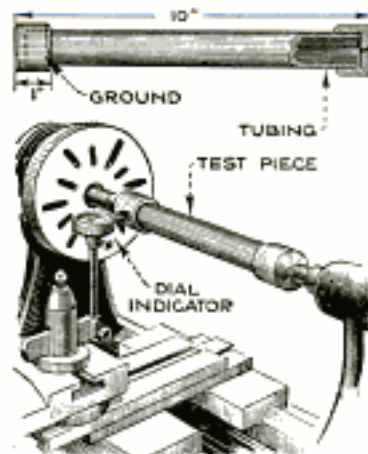
Protecting Drawings

Ordinary transparent lacquer used for coating brass and other metals can also be applied to paper reference sheets, tables, drawings, etc., to protect them from being soiled by handling. The lacquer is poured into a shallow tray, and the sheets are dipped so that both sides are thoroughly coated, then hung up to dry. If desired, another coating can be applied after the first has dried. The lacquer covers the paper without affect-

ing the printed matter, and it toughens and glazes the surface so that it will not collect dirt so quickly. It also prevents the paper from being stained or torn easily.

A Lathe Test Piece

When mounting a lathe job that is to run perfectly straight and true the alignment of the centers should be carefully checked. This is often done by running the centers together, or by using a thread gauge with male and female 60° angles, but these methods are not very accurate; it is better to use a test piece of the type illustrated. This consists of a 10-in. length of 1-in. tubing, fitting snugly into two steel endpieces, as shown. These endpieces are a driving fit over the tubing and are ground down after being assembled, the centers being carefully machined with a single-edge tool while running the test piece in the chuck and steady rest. The sides of the endpieces are also trued. As the head center rotates, it is always well to run the lathe, and to hold the test piece by hand in order to keep it from rotating. A dial indicator is brought to bear on the side of one endpiece, as shown, and after registering the position of the needle, the dial is moved over to the other end, which is similarly checked; the dial needle will check alike at both ends if the centers are in perfect line. By using a test piece of this kind, considerable guesswork will be eliminated, and the accuracy of the job assured.—J. V. Romig, Allentown, Pa.



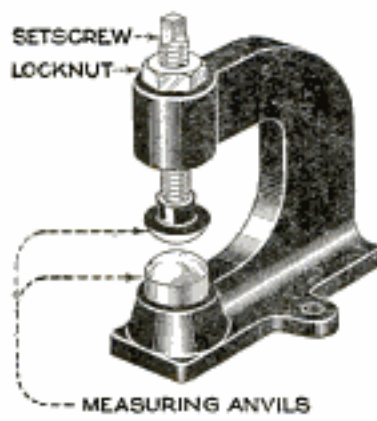
Locking Door-Knob Screws

The small setscrew used to hold a door knob in place on the lock shank often works loose and is lost. Although replacement of a few screws is not expensive, it is troublesome, and in large buildings, where this trouble happens often, it is advisable to prevent frequent recurrence by placing small lock washers under the heads of the screws.

Safety Gauge for Punch Press

It frequently happens that a punch-press operator places two blanks into the forming die instead of one, the result being that either the die or the press is broken. This accident usually occurs when blanks are stuck together with a layer of oil, and the double thickness is not readily noticed. Furthermore, piecework rates, which are usually paid for press work, are not generally conducive to giving the work close inspection.

To avoid the danger of breaking dies and presses in this way, I designed an adjustable safety gauge that is bolted on the punch-press table in a position convenient to the operator, who passes each blank between the measuring anvils before placing it in the forming die. The anvils are spaced to allow the passage of only one blank. Although the use of the gauge slows up production



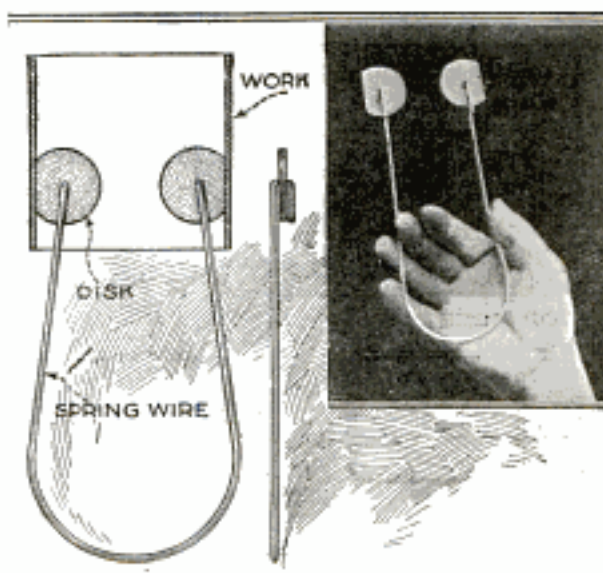
somewhat, not so much time is lost as when dies and presses are laid up for repairs. The elimination of repair costs also enables the firm to raise piecework rates.

The gauge has a flat cast-iron base, with lugs for bolts. Both measuring anvils have round faces to permit the easy passage of the blanks. The anvils are made of tool steel, hardened, and the upper one is threaded and provided with a locknut.—Chas. Homewood, Ontario, California.

☛ Wood that has been thoroughly soaked in an almost saturated solution of salt and water, and then dried, will not warp.

Tool for Handling Light Work

A piece of wire bent to a U-shape is often used to hold light tubular work



A Simple Holder for Handling Light Tubular Work for Such Operations as Dipping and Tinning

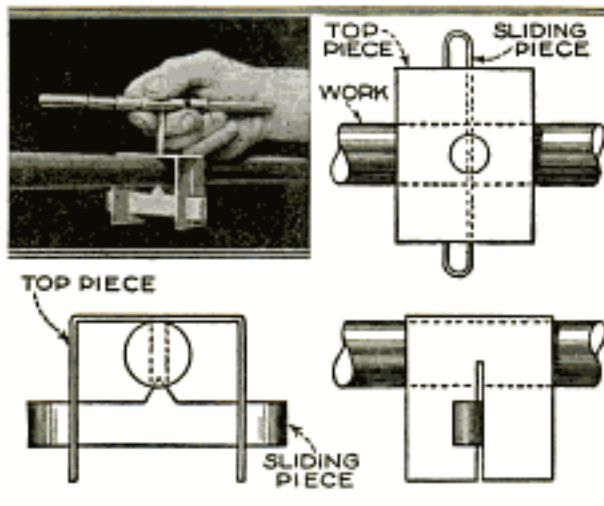
for minor operations, such as dipping, tinning, etc., where the full outside surface must be exposed. The illustration shows an improvement on this type of holder. The improvement consists in the addition of two disks, each flattened to fit the edge and drilled in the center to fit the wire; the ends of the wire are bent, pushed through the holes, and bent again, so that the disks are free to revolve, but cannot come off. The flattened sides of the disks make a much better contact with the work than wire alone, and one tool of this kind will serve for many sizes of work, while, when using the U-shaped wire only, several different sizes must be made to handle any large variety.—Harry Moore, Montreal, Can.

Removing Large Scrap Casings from Rims

To remove a scrap 40 by 8-in. casing from the rim in a short time, cut into the tire from the outer side, about 2 in. above the bead. Cut at an angle through the rubber and through the cords and keep on cutting all the way around the tire. The outer sidewall can then easily be pulled out to remove the inner tube and the flap, after which the casing can be taken off the rim without much trouble. This process takes about 30 minutes, while the ordinary method often takes from 2 to 5 hours.—Harold L. Fox, Atlantic City, N. J.

Tapping Round Work

It is usually more difficult to keep a tap straight and square on round work than on flat work, as there is nothing to



A Simple Guide Used for Tapping Round Work Square and Straight

guide the eye. The illustration shows a tap guide, made of flat stock, that aids in tapping holes straight in such work. One piece is bent at right angles on two sides, drilled with a clearance hole for the tap in the center, and a slot is sawed up each side. The second piece is made to slide up and down in the slots; the center is cut to a V-shape, and the ends are turned over to bear against the sides of the first piece so that both parts are held in line by the spring effect. To use the device as a guide it is slipped over the work and the sliding piece pushed up until the V-shaped point enters the bottom of the hole to be tapped. This movement centers the clearance hole in the top over the hole in the work, and brings the upper surface to a square position so that the tap can be guided straight with the eye. If greater accuracy is desired, a square can be used, with the stock resting on the flat upper surface of the guide.

Testing Silk

Silk fabrics are often "loaded" to give them the appearance and feel of heavy fabric, because a loaded silk is cheaper to produce than a piece of goods that is made entirely of silk and is of the same weight. The loading process generally consists in impregnating the silk with metallic salts, such as tin and lead. A chemical action is set up in the fiber by this process which weakens the goods to

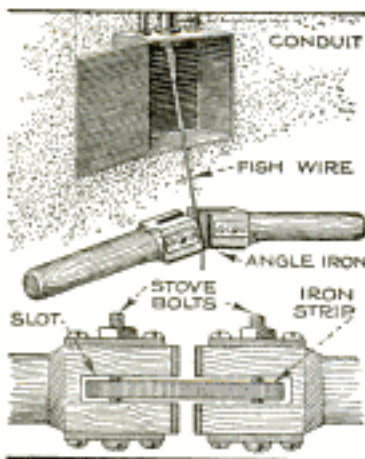
some extent; furthermore, when the loading materials have been removed from the fabric by washing, the garment is in many cases practically ruined. Loading also causes the silks to crack and split at folds and creases.

A simple method of detecting silks that have been treated with metallic salts is a burning test. A piece of pure silk, when burned, will shrivel up into a bunch in the same way as wool. If metallic salts are used, the silk will not shrivel up, but the ash will retain its original shape and pattern, and can often be handled without breaking, depending on the amount of loading that has been done.

Handy Fish-Wire Puller

It is a very tiresome job to pull fish wire through conduit by means of pliers, and it is not advisable to wrap it around a stick, as this is liable to ruin it. A puller of the type illustrated has therefore been found of considerable convenience; the harder one pulls on it the tighter it will grip the wire without injuring it, whether the wire is flat or round.

The handles are cut from pieces of wood about 2 in. square and 12 in. long. Part of each handle is rounded off to make a comfortable grip for the hand, and the square ends of the handles are slotted to receive a strip of flat iron, which acts as a hinge. Pieces of angle iron with slots cut across them to correspond with those cut in the handles, are fastened to the ends by means of flat-head wood screws, the sharp corners or edges of the angles being slightly rounded with a file, so that they will not cut the fish wire. A small piece of flat iron is screwed to each side of the handles to take the strain off the hinge, which is held by two stove bolts passing through the handles as shown.—W. W. Parker, Lead, S. D.



☐ All open flames should be kept away from any place where there is any possibility of acetylene escaping.

A Good Wire-Fence Straightener

BY J. R. KOONTZ

EVERY farm and ranch owner, in fact anyone who has occasion to use wire fencing, knows how soon it is bent and forced out of shape by horses, hogs, and cattle tramping or crowding it down in order to get grass, etc., that may be on the opposite side. In a short time the fence becomes unsightly, and if allowed to stay without straightening will become more of a nuisance than anything else.

The wires can be straightened with the hands, but, with heavy wire it is a difficult job, and painful to the hands, and, when much of it must be done, the enforced bending posture causes a pain in the back. With a wire straightener these aches and pains may be avoided, and the fence straightened much easier, thus transforming a difficult job, and one that is put off as long as possible, into an easy one.

A straightener of the type shown in the illustration can be made at practically no cost, beyond that of the labor, from materials usually to be found in the junk

heap. Two handles, taken from an old plow or cultivator, are used, or, if only a single-hook tool is desired, the handle of a discarded lawn mower will serve. The handles are cut to 30 in. long; two round braces or struts, 10 in. long, which may be taken from an old chair; two pieces of flat tire iron, 20 in. long, and two pieces of tire iron 10 in. long, are also necessary, in addition to eight wood screws and one iron rivet.

A hook is bent on one end of each of the 10-in. irons, and two screw holes are drilled in each, so that they can be fastened to the lower ends of the handles as shown. Screw holes are also drilled at the ends of the 20-in. pieces, and a hole for the rivet in the center of each. Holes are bored in the handles for the ends of the chair rails,



Left, Parts for the Wire-Fence Straightener; Center, Tool in Use; Right, Assembled Fence Straightener

which are then glued in place between the handles. The 20-in. cross braces may then be attached, and riveted together.

In using the tool, the hooks are placed over the line wires, the foot placed against the stay wire, and the line wire pulled back into shape without stooping.

Coloring Copper Brown and Black

Different shades on copper, ranging from a light brown to a deep black, may be obtained by using a weak solution of liver of sulphur. A half ounce of the liver of sulphur to a gallon of water is sufficient to make a solution strong enough for the brown colors. By increasing the quantity of the chemical, using the same amount of water, and bringing it to the boiling point, the same colors can be produced on brass.

To obtain the popular verd-antique finish, the work is stippled with a solution made from 4 oz. copper nitrate, 4 oz. calcium chloride, and 1 oz. bichromate of soda in 1 gal. of water. After coating the work with this solution, the high lights are rubbed down with a cloth and

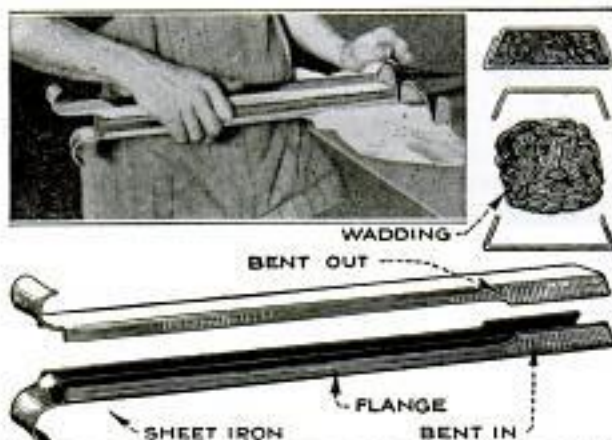
finely powdered pumice stone, after which lacquer or wax is applied as desired.

Drilling Hardened Steel

I have found the following method for drilling hardened steel very satisfactory. The usual pointed end of the drill is ground to a half-round shape, then made as hard as possible. The surface to be drilled is etched with dilute muriatic acid. Instead of oil, turpentine or kerosene in which a little gum camphor has been dissolved is used as a lubricant. Should the bottom of the hole become polished, so that the drill rides over it, remove the drill, etch the bottom of the hole with the acid, to roughen it, and proceed as before. —Wm. J. Edmonds, Rutland, Vt.

Auto Upholsterer's Stuffing Tool

It is common practice among automobile upholsterers, when filling pleated seat backs, to lay in a roll of wadding and



Auto Upholsterer's Stuffing Tool Permits Pleats to be Sewed First and Stuffed Afterward

sew the covering over it as they go. The process, which is a slow one, may be greatly facilitated by the simple stuffing tool illustrated, which permits the pleats to be sewed first and stuffed afterward.

The tool consists of two strips of sheet iron 31 in. in length; the width at one end is 5 in., for a length of about 2 in., and the remainder of the strip is 4 in. wide. The edges are bent over as shown to form flanges, then the flanges are cut off at one end of each piece, and the strips bent over to form handles, which are stiffened with ridges of solder. At the wide end of the tool, the flanges of one section are bent outward and those of the other section inward so that one may slide within the other. In use, the roll of stuffing is placed in the tool and slipped inside the pleat. By pulling the outer section back 2 in. the locking portions of the flanges slide clear, and the tool can be removed without difficulty.—Edwin M. Love, Alhambra, Calif.

Instructions Cast on Machines

On many machines it is necessary to attach a plate of instructions or warning so that they can be operated safely. Enameled plates are often used, but are not satisfactory because the enamel splinters. Etched and engraved brass plates give satisfactory service, but, as they are detachable, are often lost. The most permanent method of providing instructions is to cast the lettering on the frame. This is done by embossing the desired lettering on narrow aluminum

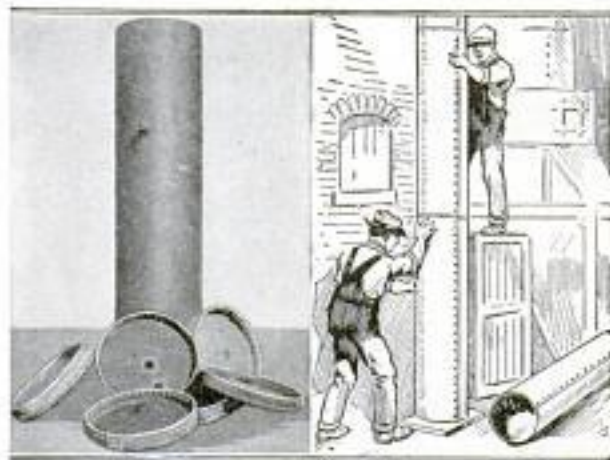
strips and nailing these to the surface of the pattern. The location is determined simply by reference to the parting of the mold, so that the lettering will not be obliterated in the molding process. The finished casting is ground to even up the tops of the letters and make them conspicuous.

Identifying Scaffold Lumber

Many contractors, and others having use for scaffolds at regular intervals, use special lumber for the purpose, particularly for the footboards. The material is generally 2-in. lumber and is selected for its freedom from knots and other defects. The ends of these boards are painted a conspicuous color so that they can readily be identified in a pile of lumber, should they get misplaced, but they are usually kept in a separate pile.

Smokestack Made from Old Kitchen Boilers

When installing a new furnace it was learned that the 40-ft. smokestack which was required would cost approximately \$40.00. Instead of paying this price, eight old kitchen boilers were bought for 50 cents each at a scrap yard. The ends were cut off with an acetylene torch in an hour's time and the small openings in the sides were plugged. One end of each



Left, Boiler with Ends Cut Off; Right, Erecting the Smokestack

tube was hammered down so that it would fit into the end of another section, and the sections riveted and welded to each other. The smokestack made of these boilers was heavier than one made of the usual material, not to speak of the saving in cost effected in this way.—J. E. Holstrom, Knoxville, Tenn.

Making a Beam Micrometer

The cost of a complete set of micrometer calipers prohibits the average toolmaker or machinist from owning one; a beam micrometer also, while not so expensive as a complete set, is beyond the reach of many. With the exercise of a little skill, however, accurate beam micrometers may readily be made by the workman himself.

The toolmaker, and others whose work demands an accurate tool, will find the micrometer shown in the larger drawing well worth making, as it can be made just as accurate as any of the high-priced tools on the market.

The beam or frame is made of $\frac{1}{4}$ -in. steel, $9\frac{1}{2}$ in. long and 5 or 6 in. wide, depending upon how high it is desired to make the spindle and anvil. This height should be either 3 or 4 in., and the width of the beam $1\frac{1}{2}$ in. The inner edges of the foot and beam must be absolutely true and square with each other, if the tool is to be accurate, and great care must be taken with this part of the work. The foot is drilled for the anvil, which is of tool steel,

made, as shown in the sectional detail, with a ball-shaped end and a shank smaller in diameter than the hole. This allows the inner face of the anvil to seat squarely against the surface of the foot; the ball must be a tight press fit.

The micrometer-head standard is built up of flat steel, the upper part, carrying the head, being shaped from $\frac{1}{2}$ -in. stock, leaving the diameter of the eye $\frac{1}{2}$ in., and the body $\frac{1}{4}$ in. thick. This is connected to the bottom piece by $\frac{1}{8}$ -in. side plates, the whole being assembled tightly by perfect-fitting rivets, neatly headed. A clearance slot is filed in the bottom surface of the upper part of the standard, so that it has a two-point bearing on the beam.

The locating spring tooth is made of tool steel, hardened and tempered, and is

fastened to the bottom piece by a round-head screw. The shape of the notches in which the tooth rests should be particularly noticed. This form of notch divides the work of locating the standard and of drawing it to position. When the screw is turned upward to press the tooth home, the inclined side of the notch, engaging with the corresponding side of the tooth, slides the standard until the straight sides of notch and tooth are in contact. It is only necessary to make the straight sides of the notches accurate as to location, and, as all of the wear comes on the inclined side, this accuracy is retained indefinitely. When

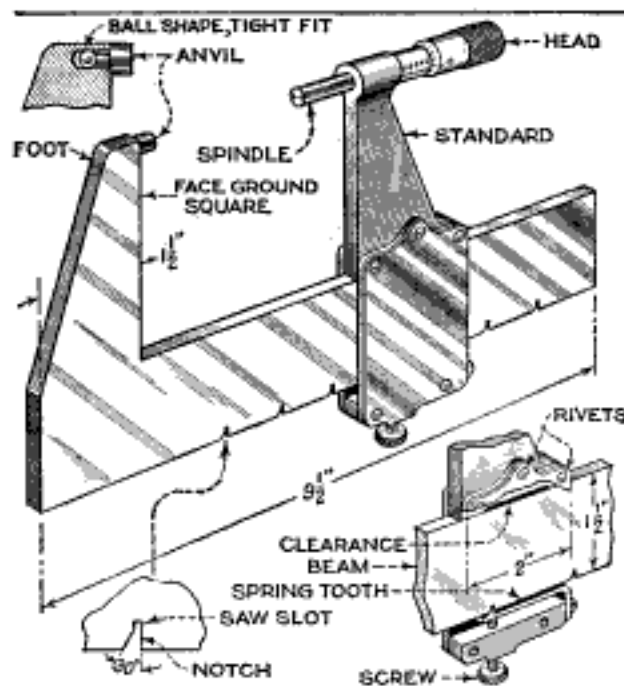
the screw is released, the tooth will spring out of the notch with a little end pressure. The micrometer head is lightly pressed into the eye in the standard in the usual manner, and the contact surfaces of the anvil and spindle lapped true.

Where extreme accuracy is not essential, a micrometer head, attached by means of a simple bracket, or auxiliary head, to the scale of a combination square, will serve the purpose, the head of the square being used as the anvil.

It is preferable to use a square with a hardened, drop-forged steel head.

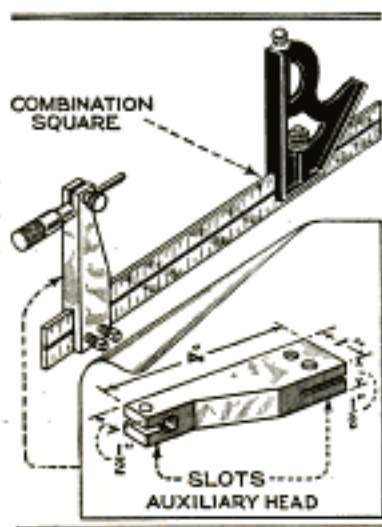
The auxiliary head is made from a piece of cast iron or steel, $\frac{1}{2}$ by 1 by 4 in. in dimensions, machined all over by the size given in the smaller drawing. A hole to fit a standard micrometer head is then drilled through it, and, at right angles to this, a hole is drilled and tapped for a binding screw, the head slotted as shown, and one side of the binding-screw hole drilled out to fit the body of the screw; the screw used has a knurled head. The bottom of the head is now slotted to fit nicely on the scale, holes for two small setscrews are drilled and tapped in one side, in line with the scale groove, and the screws fitted.

To use the tool, the square head is set on a scale division, and, with the microm-



Beam Micrometer, Measuring from 0 to 6 Inches, That may be Made by Any Skilled Workman

eter reading at zero, the auxiliary head is moved up, until the end of the spindle just touches the square head, and locked in position. The square head is then moved the desired number of divisions,



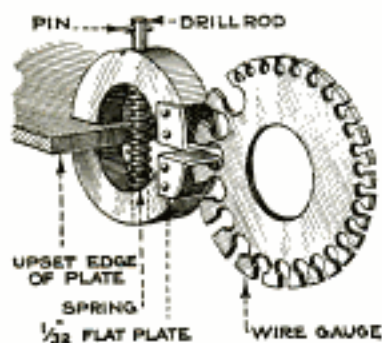
locked, and the micrometer used as usual. When setting the head on the scale divisions, a magnifying glass should be used.

A better way to set the tool is to use a set of the micrometer standards sold by various tool

companies, but where these are not available, the magnifying glass will enable the workman to set the tool as closely as the ordinary vernier caliper may be adjusted. A tool of this kind has been used for a long time, and has given splendid service.

Wire Gauge Attachment for Plates

Steel and iron plates are very seldom accurate as to thickness at their edges. Sometimes this is caused by the shear turning up the edges, by a saw, which leaves a burr, or perhaps the edges are just badly knocked. For this reason a wire gauge, when used to measure plates, is often unreliable, and the cause of many mistakes, because the actual thickness of the plate may be less than that shown by



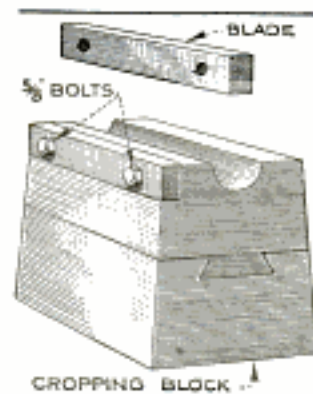
the gauge. To measure plates accurately they should be gauged at a short distance from their edges. The attachment shown in the illustration accomplishes this in a

handy manner when used in conjunction with a wire gauge. A collar, about $\frac{3}{8}$ in. thick, makes a good body for the device. A hole, about $\frac{1}{4}$ in. in diameter, is drilled through it, and it is then cut in two as shown. A

piece of drill rod is driven tightly into the hole in one part, and made a sliding fit in the hole in the other. The faces of both halves are then brought together and filed and lapped true to each other. Two pieces of $\frac{1}{32}$ -in. sheet steel are bent over to fit the two pieces at one side, and are riveted in place by a couple of pins in each, the faces of the collar pieces at this side being cut away to clear the gauge. To keep the two parts together a small pin is driven through the drill rod, and a shallow groove is filed in the top of the collar in line with the pin, so that the pressure of a light spring around the rod keeps the pin in the groove and prevents the two parts from coming apart when not in use. Any size of plate, from $\frac{1}{16}$ in. thick, can be measured with this device, as shown in the drawing; it is recommended that the gauge and attachment be fastened together by means of a short chain, if constantly in use.

Economizing on Cropping Blocks

It is a general practice in steel manufacturing plants to crop bars of steel before straightening them. This is done on a cast-steel cropping block, and when the edge of the block becomes rounded or chipped, which is caused by heavy cropping, the block is machined down to form a new edge.



An improvement on the ordinary block is made by rabbeting the edge of the block as shown, to a depth of $2\frac{1}{2}$ in. and a width of $\frac{3}{4}$ in., to form a seat for a removable tool-steel blade which is bolted to the block. The four edges of this blade can be used, and, when the last edge is worn, a new blade can be substituted for the old one. The holes in the blades and the block are drilled 2 in. from each end, and exactly on the center, so that the blade will fit the block and holes exactly in either position. The steel used for the blade should be 80-point carbon tool steel, with a Brinnell hardness of 477.

☐ To evaporate 1 cu. ft. of water requires the consumption of $7\frac{1}{2}$ lb. of coal, or about 1 lb. of coal to 1 gal. of water.



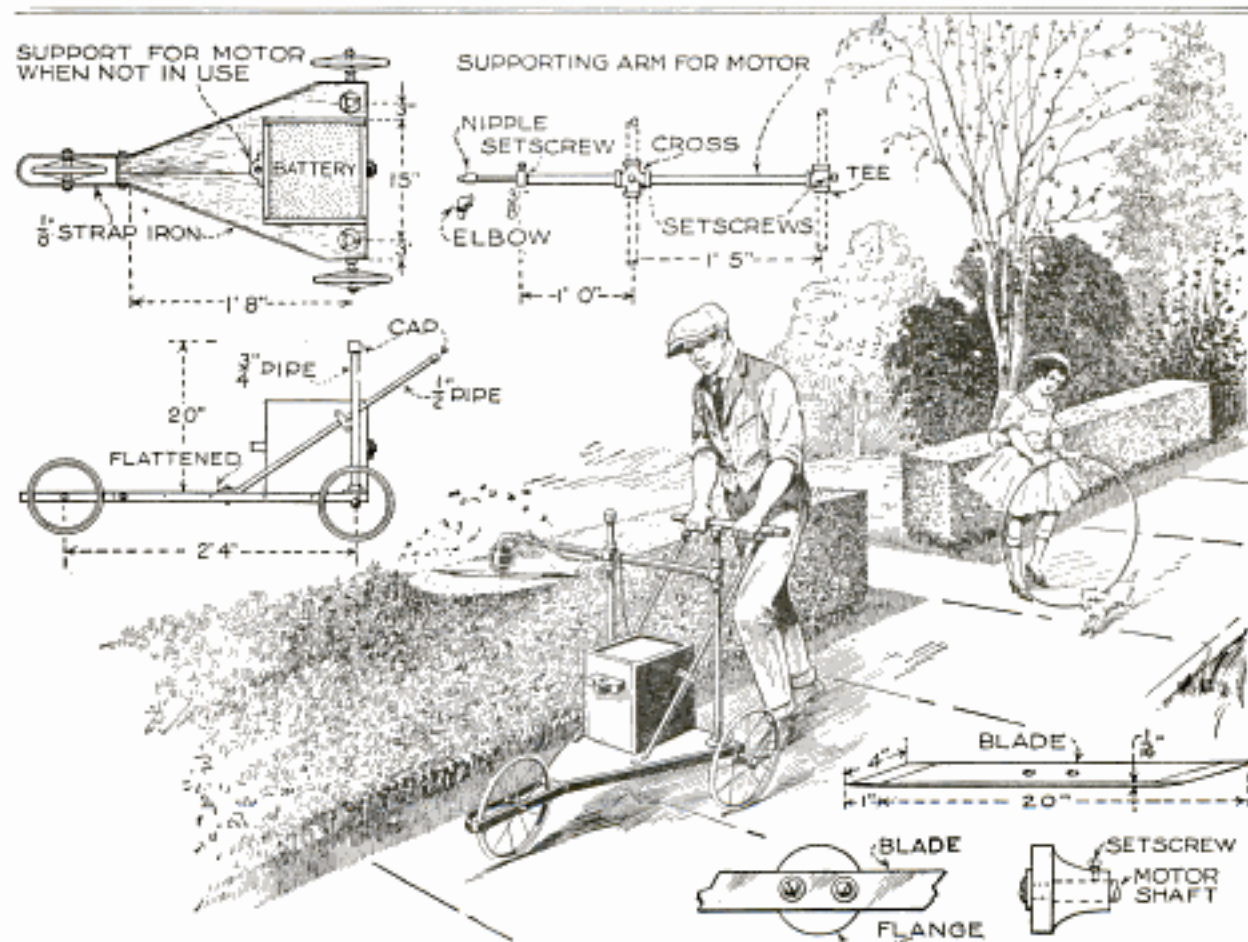
An Electrically Driven Hedge Trimmer

By A. E. SHAW

A MACHINE that will interest the man who prides himself on his well-kept grounds is the electric hedge trimmer shown in the illustration. There is no great amount of skill required to build the machine beyond that possessed by the average amateur mechanic, and, besides trimming the hedge very accurately and

extended at the front as shown, to form a bearing for the front wheel. The rear-wheel axle is strapped to the underside of the base; the wheels are 12 in. in diameter, rubber-tired.

The supporting frame for the motor is made up from $\frac{3}{4}$ -in. pipe and fittings, the vertical arms being attached to the



This Electrically Driven Hedge-Trimming Machine will Delight the Amateur Mechanic Who Prides Himself on the Appearance of His Grounds. It is Easily Made, and Quite Efficient

uniformly, the machine does the work in a much shorter time than it can be done by hand.

The base of the machine is made of 1-in. lumber, which is faced on the edges with $\frac{1}{8}$ by 1-in. flat iron. The iron is

base by means of floor flanges. The cross arm is fitted with a cross and a tee, from which the threads have been filed so that they will slide easily on the vertical pipes, and they are fitted with setscrews so that the arm can be locked in position.

A coupling, tapped for a setscrew, is screwed on the outer end of the arm, and a smaller pipe is telescoped within it. This pipe is threaded at the outer end, or fitted with a reducing coupling and nipple, to screw into the base of the motor. The size of this pipe and the thread used will depend on the motor available. For trimming the top of the hedge, the motor is mounted at right angles to the cross arm, the elbow shown being used for this purpose.

The motor is a small battery motor, which develops about $\frac{1}{15}$ hp. at 1,800 r. p. m., on 6 volts, and it is fitted with a tool-steel blade, ground to the shape and dimensions given in the drawings, and carried on the motor shaft by means of

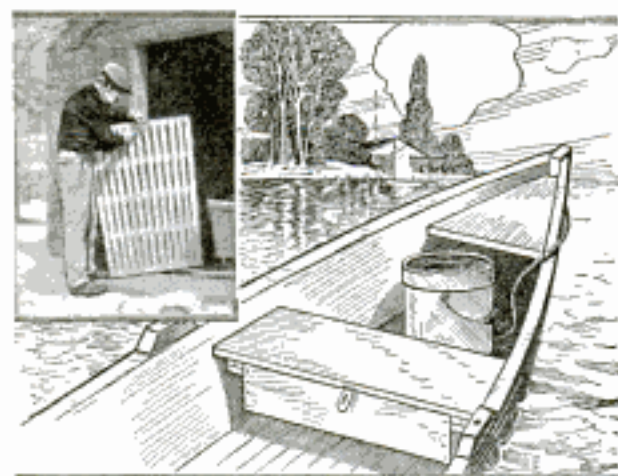
a machine-steel flange, drilled and tapped for two round-head screws and a set-screw.

It has been found convenient to drive the outfit by a storage battery mounted on the base, but it is perfectly feasible to use a 110-volt motor, provided a connection can conveniently be made. When the motor is not in use it is removed, with its supporting pipe, and carried in the bracket screwed to the front of the battery box.

The handle of the machine is made of $\frac{3}{4}$ -in. pipe and fittings, the lower end of each leg being flattened and screwed to the base, and each leg is attached also to the side of the battery box with pipe straps.

Improvements for a Fishing Boat

A tackle box fitted in the seat of a row-boat has many advantages over an ordinary tackle box, as it has not only much more room and cannot be knocked



Left, Making a Slat Floor for the Fishing Boat; Right, Tackle Box Built under Seat

around, but is kept completely out of the way. As shown in the drawing, the tackle box is made in the form of a drawer under the center seat, the one that is usually used the most. The drawer is about 30 in. long, $6\frac{1}{2}$ in. deep, and 12 in. wide, which gives plenty of room for two or three rods, and compartments for hooks and lures, so that these will not become mixed, as is generally the case in the ordinary tackle box. The box is protected from rain by the seat, and as it does not touch the bottom it is also free from water in the boat. A hasp and padlock should be provided on the box.

Another improvement for the boat is a slat flooring to prevent getting the feet

wet. For convenience the flooring can be arranged in three sections. The construction is simple, all that is necessary being a quantity of slats and a few cross members. The best wood to use is fir, and the flooring should never be painted, but should be given a liberal application of linseed oil. The slats, so protected, will last a long time. In addition to keeping the feet dry, the slat flooring protects the bottom boards of the boat.

Simple Homemade Leaf Spreader

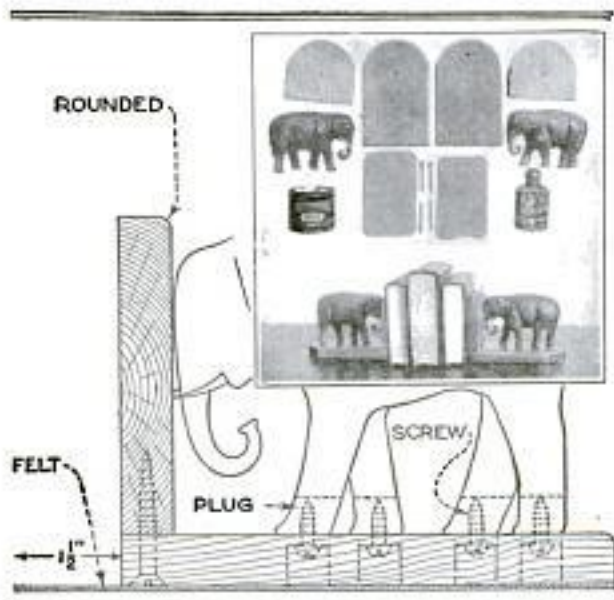
To lubricate the springs of an automobile properly it is necessary to loosen the clips and spread the leaves apart for the insertion of the lubricant. There are many methods of doing this, but the tool shown in the sketch will do the work with a minimum of effort. It is made from two pieces of a broken spring, bent as shown. The ends are ground to a knife-edge for wedging between the leaves; by tightening up the nut in the bolt the knife-edges are drawn together, separating the spring leaves. The bolt holes must be elongated to prevent the bolt from binding.



By fixing an 18 or 20-in. extension to his cane, a blind man has greatly increased its usefulness. Because of the increased length he is able to notice obstacles within a much greater radius.

A neat pair of ornamental book ends, which are just as presentable in appearance as many of the expensive ones on the market, can easily be made at home for a fraction of the cost of the manufactured article.

The wooden base and vertical part of each end are cut from 1 by 5-in. finished lumber, to the shape shown in the details of the photograph. The two parts are joined with 2-in. wood screws, small holes being drilled to prevent the screws from splitting the wood. Two small celluloid statuettes, such as elephants, which cost only 10 or 25 cents each, are obtained. The statuettes are attached by cutting off the bottom of the feet and gluing wooden plugs inside. Screws are driven up through the base into the plugs to hold the statuettes in place, the screw-holes in the base being counterbored to receive the screw heads. The underside of the base is covered with a piece of felt, which is glued on. The felt should project about 1½ in. beyond the vertical part of the book end; the outer book rests on this, and prevents the book end from moving. The wooden part of the book end is enameled to match the



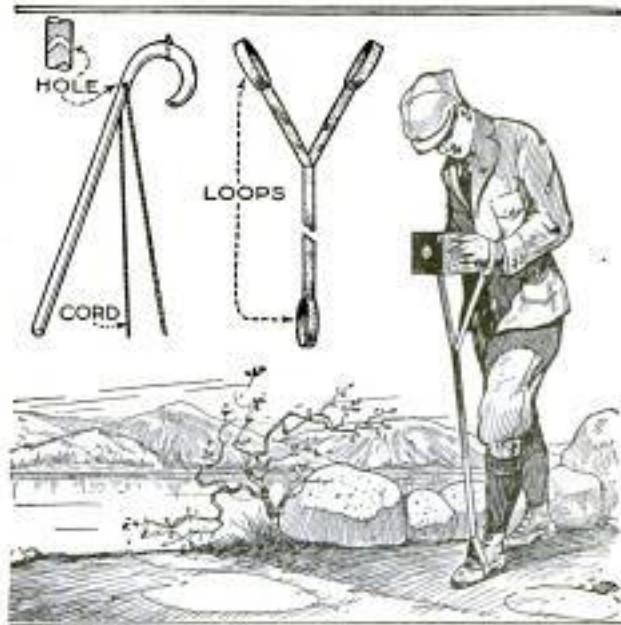
Ornamental Book Ends, Made at Home, but Just as Good as Expensive Purchased Ones

statuette, or both base and statuette may be finished in any other desirable way.—Glen McWilliams, Detroit, Mich.

☞The Bureau of Information will tell readers where materials mentioned in the Shop Notes and Amateur Mechanics departments may be obtained.

Time Exposure with Hand Camera

Tripods are more or less of an annoyance to the camera enthusiast, and few use them. However, it is sometimes nec-



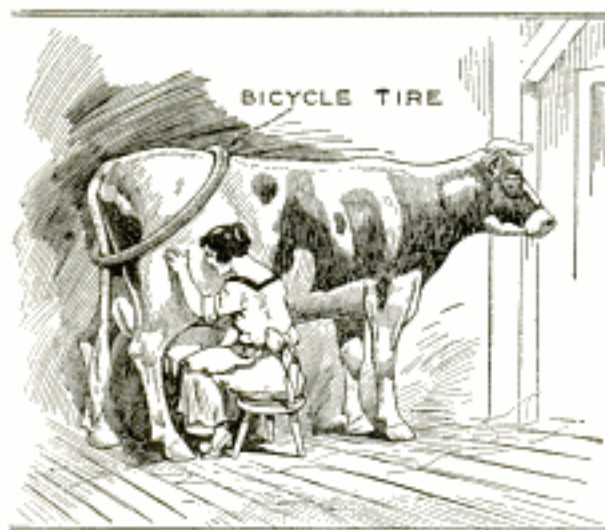
Simple Methods of Making Time Exposures without Using a Tripod

essary to make a time exposure to get the desired picture, but the camera cannot be held steadily enough with the hands to avoid doubling the image. It is, however, a simple matter to hold the camera steady if a cane is carried along. Just below the crook of the cane two holes are drilled from opposite sides to meet in the center, both slanting down from the point of junction. Another hole is drilled through the crook to take a tripod screw, on which the camera is mounted. A cord is run through the angular hole, the ends of the cord are stepped on, and pulled taut by pulling back on the cane, which has the end planted on the ground in the position indicated, thereby holding the cane firmly in position. The arrangement thus improvised is steady enough for long-time exposures.

Another method of steadying the camera is to cut a length of tape into three pieces, and to tie or sew these pieces together at the central point as shown, making a form of the letter Y. Loops are made at the ends so that the foot can be placed in one loop, and each wrist in another. Then, with the camera clasped between both hands, an upward pull will enable the user to hold the camera steadily enough for a time exposure of four or five minutes.—George Parke, Chicago, Ill.

"Anchoring" the Cow's Tail

Anyone who has milked cows has suffered from the annoyance caused by the animal switching its tail around to chase

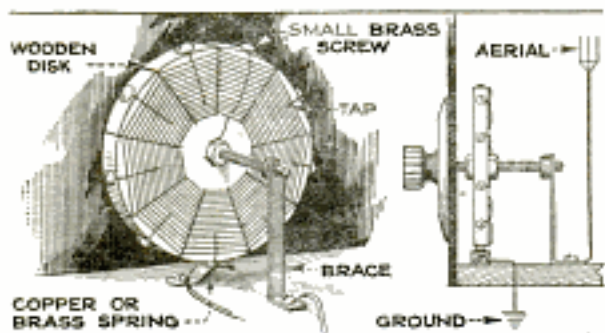


Simple and Effective Method of Preventing Cows from Switching Their Tails

away the flies. This trouble can be prevented very easily if there is an old bicycle tire lying around the yard. The tire is simply thrown over the cow's back as shown. This idea has been tried and found very effective.—F. H. Chick & Co., Strong, Me.

Novel Mounting for Spider-Web Coil

A simple and effective method of tapping a spider-web coil is shown in the drawing. The coil is wound on a wooden or fiber disk, $\frac{1}{4}$ in. thick. Each section is tapped as usual, and the taps are connected to small round-head brass screws, driven into holes, drilled and tapped in the edge of the disk. The coil is then



Rotating Spider-Web Coil That Permits the Use of a Greater Number of Taps than Usual

mounted on a long screw, to which is attached the knob and dial used for revolving the coil. A nut is run onto the screw, on each side of the disk, to hold it

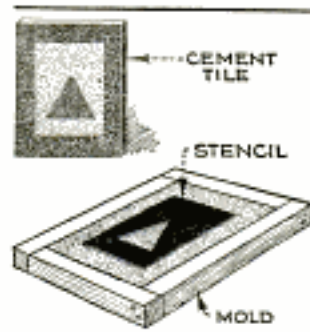
securely in place, and the end is filed down to fit a bearing made of sheet brass. The aerial end of the coil is fastened under one of the nuts, and the lead-in wire from the aerial is connected to the bearing. A flat copper or brass spring, connected to the ground, is fastened underneath the disk, so that the brass screws all come in contact with it in turn as the coil is revolved. This arrangement permits the use of a greater number of switch points than with the usual spider-web coil.—C. Wright Richell, Columbus, Ohio.

"The Kettle's Boiling"

A warning signal for a water kettle, indicating that the water is boiling, can be made from an ordinary flat tin whistle, soldered into a hole cut in the kettle lid. A little steam or vapor passing through the whistle will not cause it to sound, but when the boiling point is reached, so much steam is generated that the whistle is blown loudly. The housewife can put the kettle on and go about her work, confident that she will not forget it.—Wm. E. King, Monessen, Pa.

Ornamenting Cement Tile

Designs on the face of cement tiles, or other cement work, such as panels, can easily be made without the necessity of making wooden forms. Frequently, when wooden forms are used, and the cavities later filled with colored cement, the design appears very awkward, owing to the difficulty of forming the design in wood smoothly. The idea illustrated involves the use of a piece of a heavy waterproof-paper or sheet-metal stencil. In use the stencil is placed on the soft cement and the colored aggregate is pressed through it. A similar effect can also be obtained by dusting on dry cement color, but this is not so satisfactory, as it is not permanent. If the stencil is built up of several thicknesses of paper, a colored cement mixture can be used that will stand out in slight relief beyond the surface of the work when the stencil has been removed.



Saving Theater-Sign Lamps

Many theaters are closed for the summer months, and during this time the electric signs are not used. The lamps left on the signs accumulate dust and dirt, and some are usually broken, which gives the sign a very dilapidated appearance. To prevent this, it is advisable to remove the lamps as soon as the season is over. Removing the lamps leaves the receptacles open to catch dirt, but this can be overcome by screwing corks of the proper size into the receptacles in place of the lamps. The appearance of the corks is improved by painting them with a contrasting color.

Using a Gas Heater as a Stove

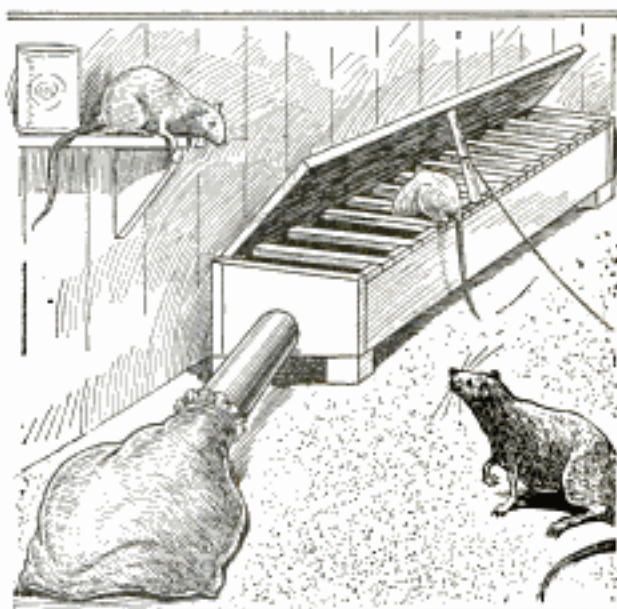
The cooking arrangement shown in the illustration has been found of considerable convenience in a room where a regular stove cannot be used, but only a gas heater is available. The device consists of a piece of russia iron, nearly as wide as the opening of the heater, with the edges bent upward as shown. Two shelf brackets are attached to the bottom to serve as legs on one side. The other side is supported by the lower part of the heater. When the gas is turned on, sufficient heat is radiated to heat water and food quickly.



Poultry Feeder and Rat Trap

A combination rat trap and dry-mash feeder is a rather novel addition to the poultry house. The feeder is a long box, 1 ft. high and 1 ft. wide, with a sloped and slatted top, through which the hens put their heads to eat during the day. To convert this into a rat trap, a 4-in. hole was bored in the end of the hopper, a short length of 4-in. stovepipe fastened in the hole, and a bag tied over the other end of the pipe and spread out on the ground. A heavy board cover was hinged to the feed box; this was kept open by

means of a hook during the day, but the hook was released, and a small prop with a string attached to it used at night. The string led away to a distant window



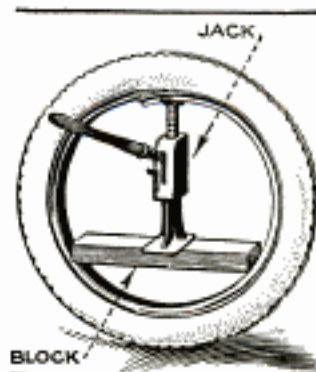
Combination Poultry Feeder and Rat Trap That Is Simple to Make and Very Effective

so that the poultryman could pull it without entering the poultry house and disturbing the rats. A yank at the string let the cover drop and trapped the rats inside. Then, by beating on the cover with a stick, the rats were made to run through the hole, down the pipe, and into the bag, where a few blows killed them. As long as the hens ate from the feeder the rats never seemed suspicious.

—L. Harris Hiscock, Skaneateles, N. Y.

Jack Used as Rim Tool

Automobile owners and drivers generally have trouble in bringing the ends of a split rim together when replacing a tire. Various tools are made for this work, but unfortunately they are not usually carried in the car. The drawing shows a simple method of using a jack and a block of wood for spreading the rim. The pressure is exerted equally on the rim at the three points of contact, thus spreading the rim evenly and without the danger of bending it out of shape.



Handy Washtub Stand

The illustration shows a convenient washtub stand that has been found to save much heavy lifting on wash days.



Movable Tub Stand and Burner Combined That Saves Much Lifting on Wash Days

The stand is triangular in shape and has a leg at each corner, casters being provided on the legs so that the stand can easily be moved about. The legs are joined by 1 by 3-in. pieces of wood at the top, and 1 by 10-in. pieces at the bottom. The stand may be equipped with a gas burner, as shown in the upper detail. If a gas burner is provided, it should, of course, be of large size, suitable for heating a considerable quantity of water. Protection for the clothes of the user should be provided by tacking heavy screen or similar material to the sides.—Ward H. Snook, Columbus, Ohio.

Inexpensive Emergency Gas-Tank Cap

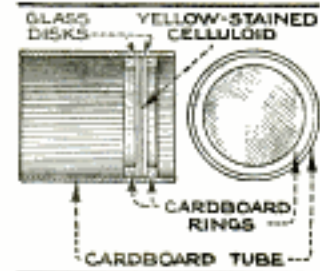
The cap of the gasoline tank is one detachable part of the car that will loosen and become lost unless care is used to screw it tight after each filling with gasoline. One motorist discovered that the tank cap had been lost at a place where no service station could provide a replacement part. A hardware store, however, provided a good substitute cap, and one that is worth noting, in case the reader should be caught in the same predicament.

A close pipe nipple and a pipe cap, of the same pipe-thread size as the opening in the tank, which was of a standard size, provided a substitute equal, except in point of appearance, to a regular cap. A

small vent hole was drilled into the cap. The cost of the two fittings approximated that of a single gallon of gasoline, and, as much gasoline waste was prevented, the improvised cap saved its cost several times over.

Color Screen for the Camera

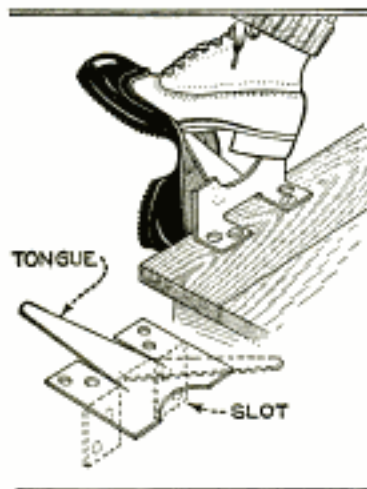
The illustration shows an easily made color screen for the camera. It consists of a short length of cardboard tube that fits the lens; a cardboard ring is glued in the end of the tube at the point indicated and two circular glass disks are cut to fit the inside of the tube. These disks must be free from



scratches and bubbles. Disks cut from old glass negatives are ideal for this purpose. A piece of celluloid, stained yellow, and cut to the same size as the glass disks, is placed between them. The assembly is then placed in the tube against the cardboard ring, and a second ring is glued in the tube against the other side of the assembly, to hold it in place.—Wm. J. Edmonds, Rutland, Vt.

Rubber Remover

The device illustrated has been found useful for removing tight rubbers, which are not easy or agreeable to remove with



the hands when muddy. It is made of sheet metal, cut and bent to the shape indicated and screwed to the floor or the edge of a step. In using the device, the heel of the rubber is first pulled off by inserting it in the U-shaped slot

and pulling the foot. The foot is then pulled back so that the tongue comes between the rubber and the sole of the shoe, after which a slight jerk of the foot will release the rubber.



TIRE REPAIRS IN THE HOME GARAGE

by
Lowell R. Butcher

Part I—Tire Damages and Their Prevention

THERE are but two kinds of tire damage: that caused by carelessness or inattention, and that resulting from unavoidable accidents or wear. The car owner is particularly interested in the first variety, the kind that can be prevented with proper knowledge of the causes. In addition, he will want to know what kind of tire damages can be repaired with economy, and what injuries are so severe that it is best to discard the tire in favor of a new casing.

To understand the common abuses and damages, something must be known about the parts of the tire. Each individual part of the tire has a duty to perform, and that duty cannot be done if the part is damaged or destroyed. Principal among the tire parts is the carcass. This is the framework of fabric, fabric cords, or cable cords that gives the tire its strength and serves to hold the air pressure. It is not designed to stand road wear; that function is left to the tread of the tire.

The tread of the tire is made of a compounded gum that resists wear. The rub-

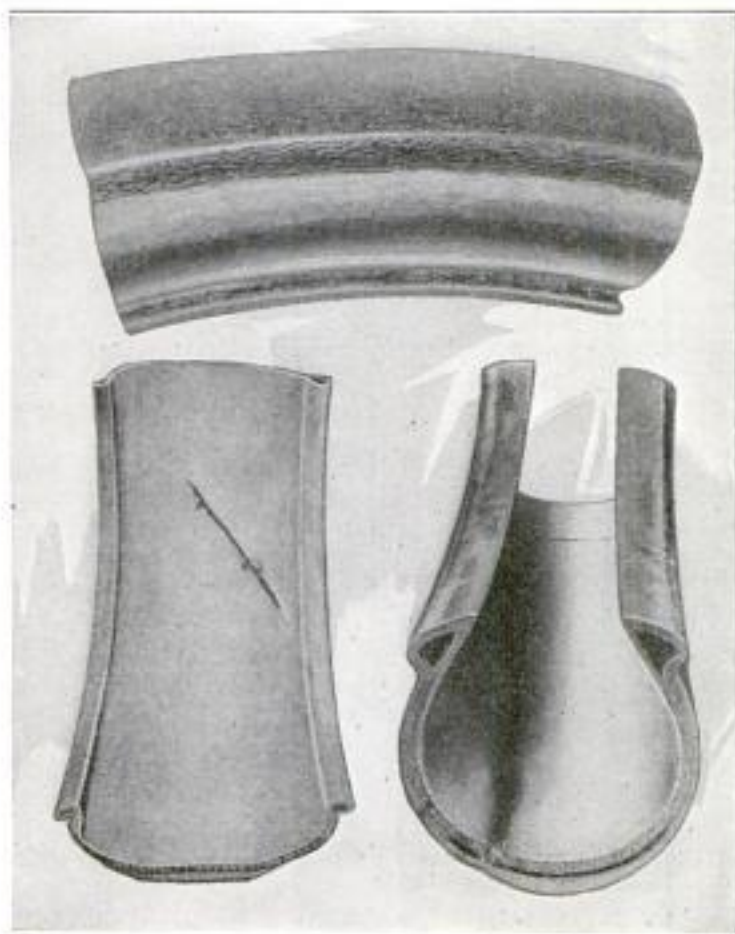
ber of this has little strength as far as retaining air pressure is concerned, but it is designed to combat wear and to protect the carcass from dirt, moisture, and direct contact with the road. The sidewall of the tire has much the same duties as the tread. It is not nearly as thick as the tread, for there should be little wear

on the sidewall unless the tire is abused.

A strip of loosely woven fabric is placed between the tread and the carcass; this is known as the breaker strip, and serves to distribute the road shocks more evenly over the carcass. A cushion of rubber, known as the cushion of the tire, is placed between the breaker strip and the carcass. In some cases there is a layer of the cushion stock between the breaker and the tread as well. This cushion serves to soften the road blows so

that the carcass does not take the shocks directly.

The bead of the tire simply serves to hold the tire in place on the rim. Its shape will vary with the type of rim used. The types used are two in number: the straight side and the regular clincher.



Above, Car-Track Wear; Left, Fabric Break from Stone Bruise; Right, Fabric Break Due to Running in Car Tracks

Most of the larger tires have beads to suit straight-side rims while a great many of the 30-in. tires still use the regular clincher type.

Without question, the greatest and most common abuse of tires is underinflation. With all the warnings that have been given, car owners still persist in running tires without sufficient air pressure. A multitude of damages is possible from underinflation. The carcass of the tire is constantly bent and "hinged," the gum that binds the layers of fabric or cords together is destroyed, and the plies rub together. Friction soon develops and the tire wears itself out.

It can be seen that the cushion of the tire will be put under great strain in an underinflated tire. The constant bending wears the cushion, which soon breaks down and rolls into tiny balls of rubber. Then the road shocks are taken more directly on the carcass, giving it punishing abuse. The binding gum between the tread and carcass gives way causing a condition known as a "separated" tread.

Rim cuts, as shown in Fig. 1, are a common ailment on tires that have been run soft or flat. The tire bends over the rim, which cuts the rubber of the sidewall and breaks the carcass of the tire. A blowout, which may be so severe that repair is impossible, soon follows. Other injuries of this character are due to bent or battered rims. Rusty rims will also help in making rim cuts. The rims should be straight, kept free from rust, and given frequent coats of rim paint.

The tread of the tire is often worn down through careless driving. Spinning the wheels to make a start, or in an effort to climb out of a mud hole, may grind several hundred miles from the life of the tire. Bad skids on rough pavement will wear the treads excessively, and sliding the wheels by locking the brakes will grind off the tread in patches, as shown in Fig. 2. A wobbly wheel or a bent axle will also wear the tread down unevenly, and if the front wheels are out of alignment the tread will wear off on one side. Nearly all these causes of premature tread wear can be avoided by a little care in driving.

It is often necessary to use tire chains when driving in the mud or on slippery pavements, but chains should be used no longer than absolutely necessary. A good chain, if applied correctly, will cause little wear, but an old chain or one applied incorrectly will grind the tread of the tire badly. Cheap chains should be avoided, as they are apt to be soft, and

will wear rapidly, presenting innumerable sharp cutting edges to the tire; old chains also are undesirable, for the same reason. Whenever used, tire chains should be applied with enough slack to allow them to creep slightly, thus distributing the wear more evenly around the tire. Chains should always be applied with the same side next the tire, as the road side of the chains wears, and, if placed next to the tire, will cause rapid destruction. A typical example of chain damage is shown in Fig. 3.

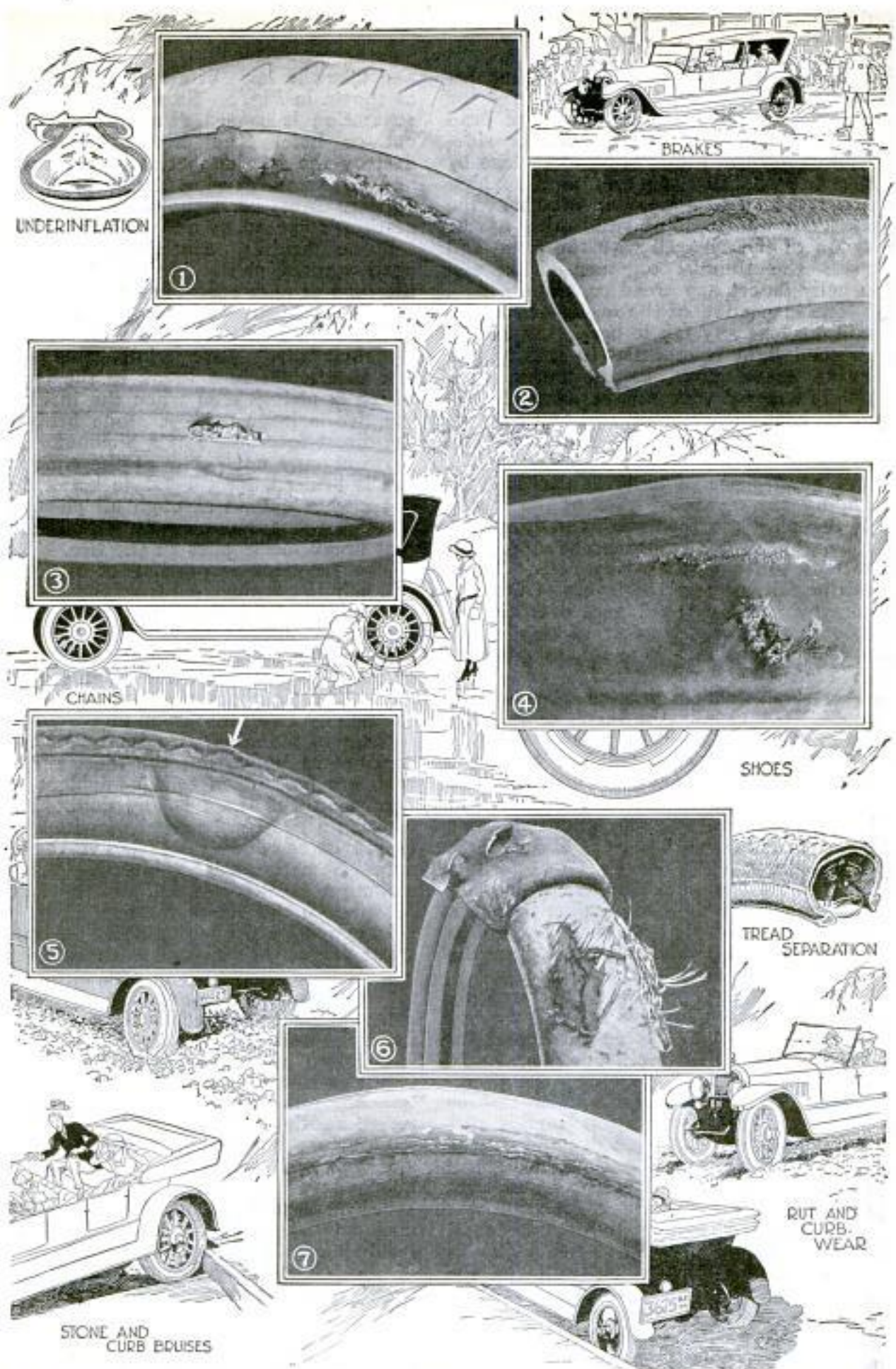
Most motorists know that grease and oil are not good for rubber, but a peep into their garages would not make one credit them with such knowledge. Tires should never be allowed to stand in grease or oil, and if a smear gets on the tire, it should be washed off with a little warm water. The rubber will rot quickly if the grease is allowed to remain.

The neglect of the tires frequently extends to the spare tire. Nearly every car nowadays is equipped with a spare tire at the rear, yet fully 50 per cent of these spares are unprotected. A tire cover is cheap insurance against the effects of heat, sun, and moisture. Most of the life of a tire may be destroyed by carrying it as a spare without any protection.

Loose inside shoes are another cause of tire damage, often unsuspected. Shoes must be used in emergencies, of course, but they should not be kept in the casing any longer than necessary, and, if they must be used, they should be cemented in place. A loose shoe will shift slightly, and will rub or chafe the fabric as it shifts, until the inside of the casing presents the appearance shown in Fig. 4. Aside from the liability of chafing, the shifting shoe may pinch or injure the inner tube.

To get the most out of his tires, every car owner should inspect them at frequent intervals. Many small damages, if found in time, may be repaired at a small cost, but their neglect may mean a more costly repair, or a damage that makes the tire worthless. Many of the small repairs may be made at home if the motorist finds the injury in time.

In going over the tires for damages, some systematic method should be followed. Hit-and-miss methods will not do, as one may pass up several injuries that a more methodical examination will disclose. Possibly the inspection is best started at the inside of the tire. Open the tire and prop the beads apart with short sticks, so that the inside of the tire is brought into plain view. Go over the



UNDERINFLATION

BRAKES

CHAINS

SHOES

TREAD SEPARATION

STONE AND CURB EDISES

RUT AND CURB WEAR

These Illustrations Show Some Other Common Types of Damages to Tires, and What Causes Them. The Best and Costliest Tires will Not Give the Service Expected of Them If Neglected

inside of the tire carefully, feeling for fabric breaks or chafed spots. Bend the outside of the tire just above the bead channel, opening any rim cuts or sidewall damages. Flex the tread surface by pressing the tire together and opening any tread cuts. Place one thumb at the center of the tread and the other at the union of the sidewall with the tread and press the thumbs together. This will usually detect any tread separation.

The inspection of the inside of the tire will disclose any fabric breaks or chafes. A good light is essential in making the inside examination, as the inside of a tire is covered with a light layer of gum and a coat of tire paint, and small cracks in the fabric may escape detection if the inspection is not carefully made.

A good sense of touch is necessary in finding any separated plies of the fabric. If the plies are separated, the friction—the light layer of gum between them—will be rolled up into tiny balls. These can be felt between the layers of the carcass by running the fingers over the inside of the tire. Neglect of this injury usually results in a blowout, as the plies of the carcass rub together and wear themselves out. Separated plies of the carcass are usually the result of running a tire soft or flat.

The bending of the sidewall near the bead will open up any rim cuts. The rim cuts in a clincher tire will be close to the bead channel and may pass unnoticed if the examination is not carefully made. Those on straight-side tires will be farther up on the sidewall. While looking for rim cuts, it is a good plan to check over the condition of the bead. A broken bead core or a chafed bead cover are the two most common bead damages.

Cuts on the tread can be found by bending, although they may not be noticed when the tire is mounted and inflated. Any tread cut, however small, should be repaired at once. In themselves, tread cuts may not be serious damages, but their neglect invites dirt and moisture to enter the tire and rot the carcass. Severe cuts and damages will often extend through the tread and open one or more plies of the carcass.

Tread separations are most often found at the hinge point of the tire. This is the point at which the sidewall and the tread meet. As explained, this damage can be detected by pressing together the hinge section with the thumbs. In aggravated cases, where sand and dirt have been allowed to enter through a small cut or hole, the separation may bulge out

and take the form of a sand blister, such as shown in Fig. 5. Sometimes the tread separation is caused directly by a small cut or hole. The dirt and moisture destroy the friction between the carcass and the tread, causing the separation to appear. Most often, however, tread separation is caused by underinflation.

Stone bruises, caused by bumping against curbs, or striking heavy stones in the road at high speed, are often hard to find. Usually they can be found at points in the carcass that seem to have lost their "life." More serious cases manifest themselves in a break in the fabric, which is plainly seen when the inside of the tire is inspected. A stone bruise is the direct forerunner of a blowout. The blowout may not occur at the time the tire is bruised, for the fabric break does not always extend through all plies, but pinched tubes often result from bruises that break inside plies of the tire.

The frequent inspection of the tires will help to get the most from them. This inspection or examination may be of the nature of looking over the tire for tread cuts or may be an elaborate examination of both the inside and the outside of the tire. The inspection should be made once every two months or oftener.

Many of the minor tire damages can be repaired at home, but the more serious ones are best taken to a competent tire repairman. If there is any doubt as to whether a tire can be repaired with economy, take the doubtful casing to the tire man. Sometimes a few dollars spent in making a small repair will add thousands of miles to the life of the tire.

In general, a tire with a badly separated tread cannot be repaired with economy. This tire ailment usually results from underinflation, and there are apt to be many other things besides the tread at fault. Sometimes a badly separated tread is repaired by retreading the tire. This repair is rather costly and should never be made unless the carcass of the tire is worth another tread.

Blowouts from stone bruises are usually repaired. Sometimes this damage happens to tires that are almost new. However, the permanent repair should not be postponed by using an emergency inside boot. If this is done for any length of time, the casing may be damaged to such an extent that its repair is doubtful economy. There have been many tires ruined by using blowout boots for some time after the blowout has happened. One such tire is shown in Fig. 6; the carcass was rotted by the dirt and

moisture which had easy access to the inside of the tire.

Rim cuts are hard to repair. In many cases this damage extends around the entire tire, and, when such is the case, no attempt should be made to repair it. To repair it properly would mean considerable expense, and after the job was done it is doubtful if the repair would hold. A short rim cut, however, can be repaired effectively.

Nail holes and small cuts are easily repaired at home, and they should not be neglected, as ignoring them may mean a serious damage later on.

The sidewalls of the tire are not as frequently injured as some other parts, but they can be almost destroyed by careless driving. Running in deep ruts or in street-car tracks will impose a great deal of wear on this part of the tire, which is not built for it. Very often the tire sidewalls are scuffed and bruised, as

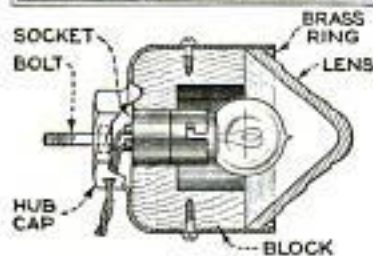
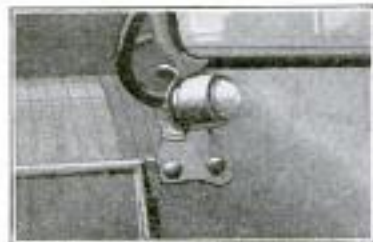
in Fig. 7, by attempting to place the car too close to the curb when parking. The remedy for these troubles is obvious—keep out of ruts and street-car tracks, and don't allow the tires to scrape against the curb.

Careful inspection of tires followed by the necessary repairs means dollars saved for the car owner. Many of the minor injuries can be repaired at home; in fact, if the tires are cared for as they should be, trips to the tire man will be few and far between. It is the neglect of tires that causes the more important and serious damages. Much of the dissatisfaction toward the service the car owner gets from his tires will be done away with if he will take care of his tires as he should. Repair the little damages before they become big ones and the tire mileage will correspondingly increase.

The next article will describe the repair of tire casings.

Homemade Side and Tail Lamps

Electric side and tail lamps for use on a light car can be constructed from nicked hub caps, and will look just as neat as the manufactured ones. A block of wood, cut to fit inside of the hub cap, is drilled to take a standard automobile-lamp socket, then counterbored for the lamp. The block is inserted into the hub cap in the position shown, and fastened in place by means of small wood screws,



driven in from the outside. The lens is held between the block and a brass ring, which is soldered at two points to the inside of the hub cap. Another method of holding the lens in place is to insert a single coil of spring wire

inside the hub cap, so that it will spring outward against the cap when released, in the same manner as a common tail-lamp lens is locked, the threads keeping the wire from slipping out. A small hole is punched in the end of the cap to receive a bolt for fastening the lamp.

Appropriate Camp Ash Tray

In harmony with the atmosphere of the camp and forests is the ash tray shown in the photograph, which is made to represent

a black bear, standing erect with its paw in the crotch of a small maple branch that supports the ash tray at a convenient height. The bear figure is cut from a very thin hemlock



board with a jig saw, and appropriately finished in glossy black paint, with a bit of buff on the muzzle.

Segregating Nonproductive Hens

In order to pick out nonproductive hens, we placed a piece of woolen cloth, saturated with glycerin and colored with a dye, above the entrance of each nest, so that the hens would strike against it when entering the nest. The result was that the laying hens bore marks on their heads, backs, or tails, while the nonproductive ones remained unmarked. After a second and third test the latter were segregated.—Abe Sair, Brandon, Can.

Skirt Used as Grass Bag

An old wide dress skirt, with the belt cut off, and the bottom stitched across, makes an excellent bag for carrying lawn

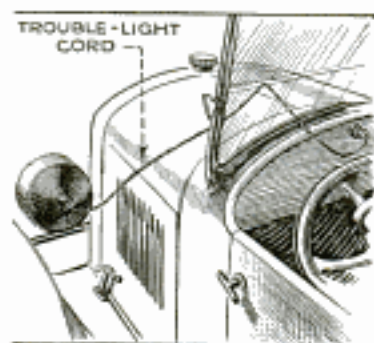


Large Bag Made from an Old Dress Skirt, and Used for Carrying Grass and Leaves Raked from the Lawn

rakings. Several bushels of mown grass can be carried in it conveniently, as it is short and wide, and does not weigh as much as a basket.

Emergency Headlights

When the headlights of an automobile are "out of commission," owing to a ground or a short, one or both of them can still be used, providing there is a trouble lamp in the car.



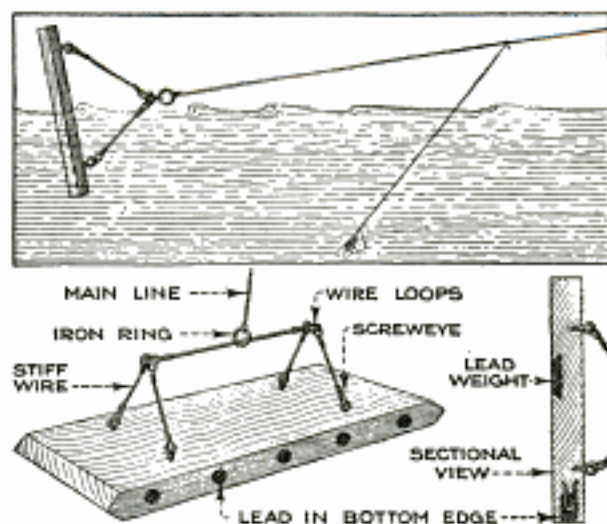
The trouble-cord lamp socket is removed, and the wires attached to the headlight plug, replacing the usual wires. The cord is then run from the dash-lamp socket to one

of the headlights, as shown, or better still, by means of an extra length of cord, it can be connected to both headlamps, in parallel. It is a good idea to be prepared to meet emergencies of this nature by carrying an extra trouble cord, fitted with a plug at each end.

Fishing in Center of Swift River

How to fish a rushing river in mid-stream successfully has been a mystery to many who have wanted to try their luck in the far-out pools, which are difficult, if not impossible, to reach from shore. For such fishing, the board or trolling guide shown serves excellently.

The device is made from light pine and is $1\frac{1}{2}$ ft. long, 6 in. wide, and $\frac{3}{4}$ in. thick. Both ends are pointed, as shown, the better to cut the water. Four screw-eyes are driven into one side of the board, and wires that are stiff enough to prevent bending easily are attached to the eyes, as shown, by making a ring or eye at the ends. A horizontal wire with an eye at each end is run between the end wires and is attached to eyes made in the outer ends of the first wires. The line that runs to the boat or fisherman's rod has a ring fastened to it that slides freely along the crosswire. The line with the lure on it is connected to the main line, and with it one can reach the deep spots that cannot otherwise be successfully fished. To make the block ride the water properly the bottom edge must be ballasted with lead.



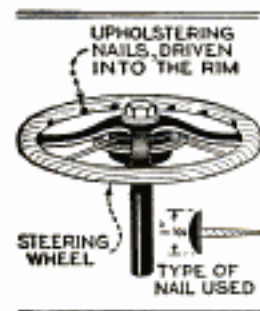
Fishing Block or Trolling Guide for Fishing in the Middle of a Swift Channel

Holes are drilled into the edge of the board with an auger bit, a staple or nail driven into the center of each hole, and melted lead is poured in. Enough holes are made and filled in this manner so that the block will be pulled down in the water to a depth of 3 inches. Also, as there is a pull on the line side this must be balanced by weighing down the opposite side, which can be done by cutting a dovetailed groove along the back of the board, and filling it with melted

lead, or by fastening a weight to the board, above the center. This will make the device swim at the proper angle, so that when there is a pull on the line, the device will not turn over toward the line side.—Robt. Page Lincoln, Minneapolis, Minn.

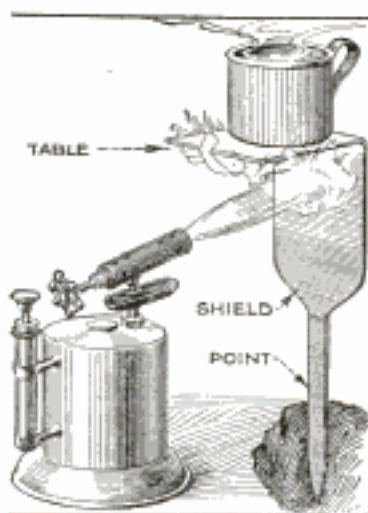
Upholstery Nails Improve Steering Wheel

The steering wheel of a light car, which has straight pinion gearing from the wheel to the steering knuckle, is deflected very easily by stones and ruts on the road, so that it is necessary to grip the wheel firmly on rough roads. To prevent the wheel from slipping in the hand, due to its smooth surface, ordinary round-head upholstery nails should be driven into the steering wheel on the inside. The nails used for this purpose have a large fiber head, about $\frac{1}{2}$ in. in diameter.



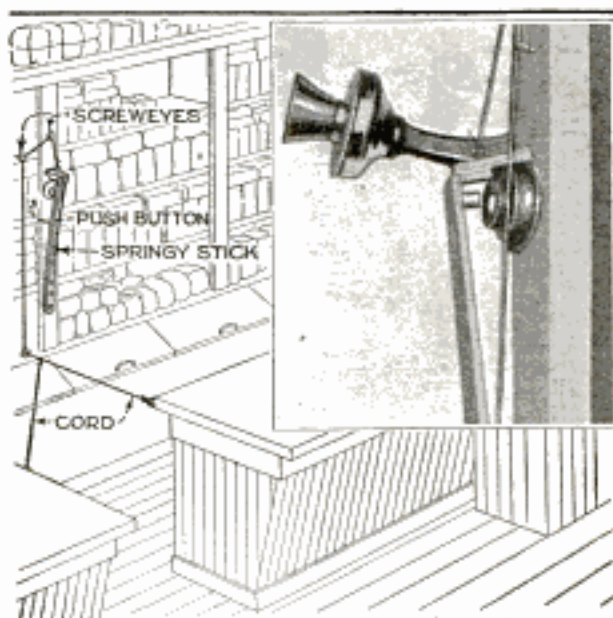
Cooking Lunch with a Blowtorch

The writer once worked at steam fitting and learned, among other things, a handy way to heat a lunch with a blowtorch. A piece of flat steel is cut to form a portion, 4 in. wide and 7 in. long, which narrows down to a section, about $\frac{1}{4}$ in. wide and 5 in. long, tapering to a sharp point. The wide portion is bent at right angles 4 in. from the end, and forms a table 4 in. square. The narrow part is stuck into the ground or floor when used, and a blowtorch is placed in the position indicated, with the flame directed under the table. A lunch can be heated in a surprisingly short time in this manner.—L. B. Robbins, Harwich, Massachusetts.



Simple and Effective Burglar Alarm

A village storekeeper, who did not wish to become a victim of robbery, of which a number had occurred in his vicinity,



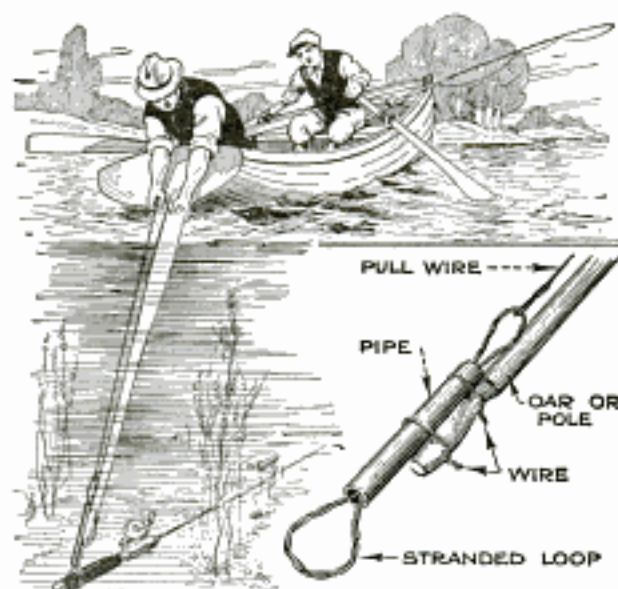
Simple Burglar Alarm Improvised by a Country Storekeeper: It Actually Aided in Catching a Burglar

improvised the simple burglar alarm shown in the photograph, and, with its use, succeeded in capturing one of the night marauders.

The alarm consists of a trip arrangement, which, when released, presses the telephone push-button switch, thereby ringing the call bell at the telephone exchange. The operator then notifies the sheriff, the owner of the store, and other interested parties. The trip is merely a springy stick, with the lower end securely screwed to the wall below the button, the upper end being loose and fitted with a short peg. The push-button switch is located directly under the peg, as shown, so that the button will be pushed down when the stick is released. A short piece of wood is set between the edge of the stick and the wall, and is connected to a long stout cord, passed through a few screweyes, and stretched in the position most likely to be passed by one attempting burglary. When this cord is pulled the piece of wood is dislodged and the peg presses the push button, which rings the bell at the telephone office continuously until a switch is released by the operator. As no alarm is sounded within the store, the intruder is unaware that he has "given himself away"—until the arrival of the officers. This idea can only be used, of course, where a push-button ringer is used on the telephone.

Salvaging Submerged Objects

While idling along close to shore in a rowboat one day the writer happened to "spot" an object lying in the mud about



A Handy Device for Salvaging Objects Submerged in Shallow Water

7 ft. under water. After ascertaining that this was a steel fishing rod, preparations were made to salvage it. Several attempts to hook it with a large fishhook proved futile, so in the end the writer had to don a bathing suit and go after it. This little incident suggested a better method of salvaging submerged objects, which was later tried out and found successful.

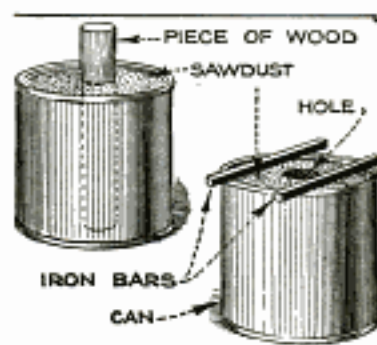
A piece of pipe about a foot long, and a length of hay-baling wire, were picked up around the barn. The wire was doubled and twisted to make it stiffer, then formed into a loop and inserted in the pipe so that it projected out of both ends as shown. These parts, and a coil of the baling wire, were kept in the bottom of the boat, to be assembled as shown in the sketch when an object worth salvaging was located.

When using the device, the length of pipe is wired to the handle of an oar, with the wire loop inside, and the lower end of the loop projecting enough so that it can be passed over the object to be salvaged. A wire attached to the upper end of the loop and running up to the user is then pulled, so that the loop holds the object securely. By lifting the oar the object is easily brought to the surface.

When trying to ascertain the nature of a submerged object, a powerful flashlight is of aid.—C. M. Wilcox, Torrington, Conn.

A Cheap Glue-Pot Heater

A small tin can filled with sawdust makes a glue-pot heater that will keep the glue hot all day; a ½-gal. can is large enough. Set a round piece of wood vertically in the center of the can and fill the space around it with sawdust. Then remove the piece of wood and drop a lighted match into the hole; this will cause the sawdust to start burning, giving heat enough to keep the glue soft. Two short iron bars are placed on top of the heater to provide an air space between it and the glue pot.



Back-Yard "Hen Pastures"

Green feed is necessary to the health and productivity of hens, and the farm-yard has no end of green things, bugs, worms, seeds, and grit, which may be had for a little desultory hunting. The commercial poultryman also takes special pains to supply free range if possible, or provides some kind of green feed in sufficient quantities to keep the birds flourishing, but the back-yard hen frequently has a hard time of it, and the owner often decides that there is something wrong with the breed or with the grain combination, when



there is nothing more the matter than lack of green feed.

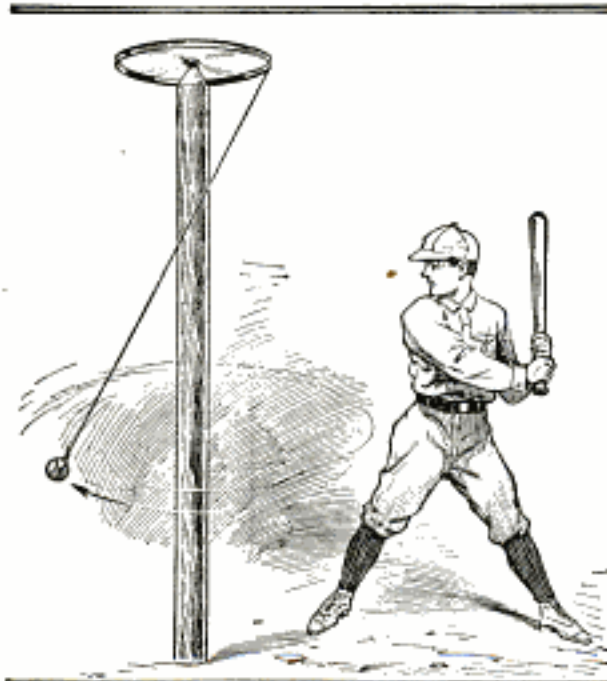
One of the principal things this back-yard hen needs is a "magic green carpet." That carpet, says the U. S. Department of Agriculture, can be made of oats grown in a small part of the yard. Instead of putting a fence around this tiny field to keep the fowl from destroying it before it has a chance to develop, some fine-mesh fencing wire is placed over it, the wire being tacked to a frame made from pieces of 2 by 4-in. wood. The oats will grow up through the mesh where the hens can pick them off, but they will be unable to reach in far enough to do any

serious damage to the plants. Such a patch of oats, if watered regularly, will last for a long time. The hens will walk over the wire and graze off the tops, but if the wire has been stretched tightly it will not sag down far enough to permit the hens to reach the ground.

"Solo" Batting Practice

The young baseball enthusiast often finds himself handicapped in batting practice because there is no one to pitch the ball. The device shown, while hardly taking the place of a pitcher, nevertheless affords the batter considerable practice.

On the top of a post, 12 ft. high, a bicycle wheel is mounted. A stout cord or light rope, about 10 ft. long, is tied to the rim, and a baseball is attached to the lower end by means of a screweye. The batter gives the ball a swing and the momentum carries it around the post, causing the bicycle wheel to rotate in the same direction. When the ball crosses

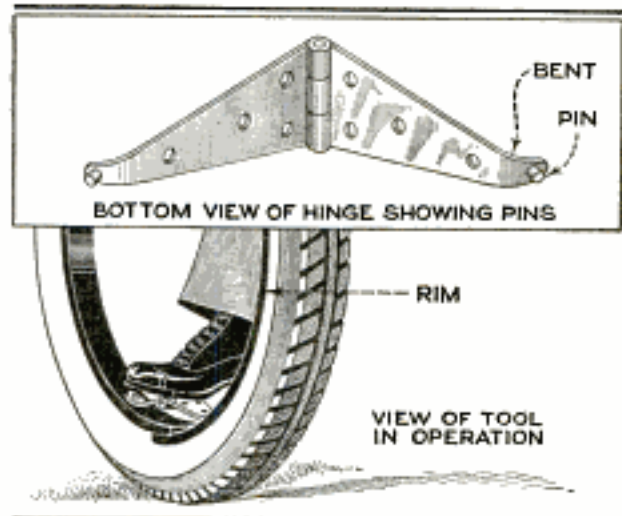


Mechanical Baseball Pitcher That Provides Continual Batting Practice When No Pitcher Is Present

the imaginary plate, the batter strikes it, sending it in the opposite direction. If the hit has been square, the ball will make several revolutions before it has dropped far enough to enable the batter to strike it again. The batter strikes first in one direction and then in the other, which, with practice, will enable the player to use either hand.—Dale R. Van Horn, Walton, Neb.

Rim Spreader for Changing Tires

A common 8-in. barn-door hinge can be used to good advantage for spreading automobile rims when changing tires. If



An Effective Automobile-Rim Spreader Made from a Barn-Door Hinge

the rims are perfectly plain at the split it will be necessary to drill two $\frac{5}{16}$ -in. holes about 4 in. from the ends. Two pins are riveted or welded to the end of the hinge and each end is then bent as shown. The pins are inserted into the holes drilled in the rim and the hinge is pushed down with the foot, thus spreading the rim. If there are studs on the rim, the hinge can be used without pins, by simply butting the ends against the studs, notching the ends if necessary to prevent the hinge from slipping.—Frank N. Coakley, Buffalo, N. Y.

Hanger for Oars

Boats are usually not provided with means for keeping the oars outside of the boat and above the water when they are not in use,

and this necessitates lifting the oars into the boat, with the result that the seats are bespattered with water from the wet blades. To overcome this, simple hangers of the kind shown in the illustration can easily be made from short lengths of strap iron, bent as indicated and fastened firmly to the gunwales by long screws.



Seat on Cripple's Crutch

A cripple, one of whose legs is amputated above the knee, uses a crutch to which a support of the type illustrated is

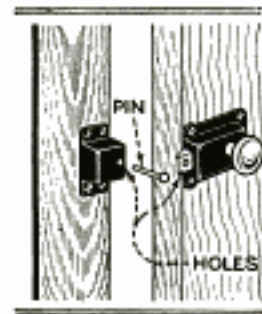


Convenient Crutch Seat or Support That Lessens the Pressure of the Crutch under the Arm

attached. The seat is located at the point most convenient for the user, and takes part of his weight, thus relieving the pressure of the crutch under the arm. It may also be used as shown in the drawing. The support is made of $\frac{3}{4}$ -in. wood, comfortably padded on top, and braced by means of $\frac{3}{4}$ -in. iron rods, flattened at each end, drilled, and bolted to support and crutch.—A. C. Cole, Chicago, Illinois.

Making a Lock Jimmy-Proof

An ordinary door lock can be made jimmy-proof by drilling a $\frac{3}{16}$ or $\frac{1}{4}$ -in. hole through the lock casing, the end of the bolt, and the door casing, as shown in the drawing, so that a nail or a pin can be pushed in. When the door is locked and the pin pushed into place, it will be a hard matter for anyone to jimmy the door from the outside. This idea has been tried and



found thoroughly practical.—L. E. Fetter, Portsmouth, N. H.

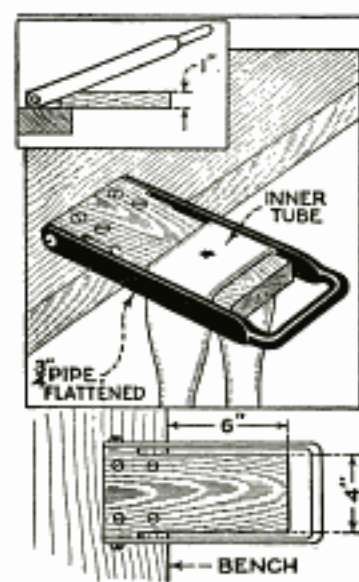
Homemade Radio Dials

Substantial radio dials of neat appearance can be cut from old rubber storage-battery jars. To facilitate cutting, the rubber is softened by heat. After the dial, cut roughly to shape, has hardened, which can be hastened by immersing it in cold water, it is trimmed down and beveled upon a lathe. If a lathe is not available, one can easily be improvised by mounting the dial concentrically on any wheel that can be revolved at a speed sufficient for cutting. A sharp chisel is then used in the ordinary way.

To graduate the dial, it is again heated, to enable neat impressions to be stamped upon it. The lines are pressed in with a knife edge, and the numbers with type obtained from a printing shop. After the impressions have been made, and the dial has cooled off, white paint is dabbed over the impressions. The dial is then carefully rubbed with a dry cloth, so that all the paint but that in the graduations and numbers is removed.

Simple Holder Makes Inner-Tube Repairing Easy

The fixture shown in the illustration is very convenient for holding inner tubes securely while making repairs. It consists of a



length of $\frac{3}{4}$ -in. pipe, bent and flattened as shown, and drilled at each end to receive the wood screws with which it is pivoted to one end of a 9-in. length of 1 by 4-in. wood. The base is screwed down to the bench securely, so that it pro-

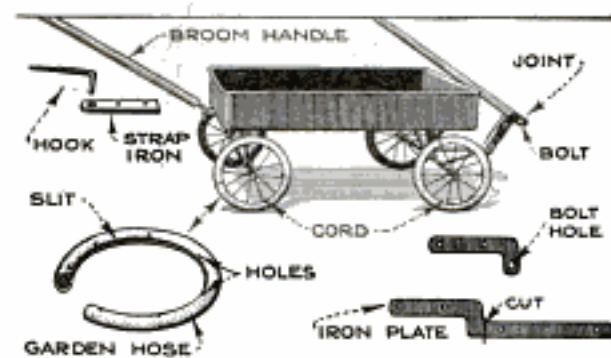
jects about 6 in. over the edge, as indicated. In use, the tube to be repaired is placed in the position shown, and the pipe is pulled down, flattening the tube and holding it securely while the surface is cleaned and the patch applied. A space is left between the sides of the pipe and the base, so that the tube will not be chafed.

Reconstructing a Small Wagon

An ordinary coaster wagon with flat steel-rimmed wheels was rubber-tired with lengths of ordinary garden hose, split open on the inside with a knife and stretched around the wheels as shown. A few holes were punched along the edges of the slit to permit the hose to be laced to the rim with shoestrings. The lengths of hose were made to fit together snugly at the ends.

The handle of the wagon was also changed to make it easier for the rider to steer. The tongue was cut near the end attached to the axle, and two iron plates, which, in this case, were taken from the legs of an old army cot, were attached so that the upper end of the tongue could be swung back over the cart. It is not essential to have the plates of the shape shown; straight pieces will do just as well if a little space is left between the cut ends of the tongue.

To make it an easy task for an older person to push the small cart, a short piece of strap iron, with a hole drilled in the end, was attached to the rear end of the cart as shown. A screwhook, screwed into the end of a broom handle, was hooked into the hole of the strip of strap iron, and the handle used to push the cart; this allows the rider to steer,



In Reconstructing a Small Cart, the Wheels were Rubber-Tired with Lengths of Ordinary Garden Hose

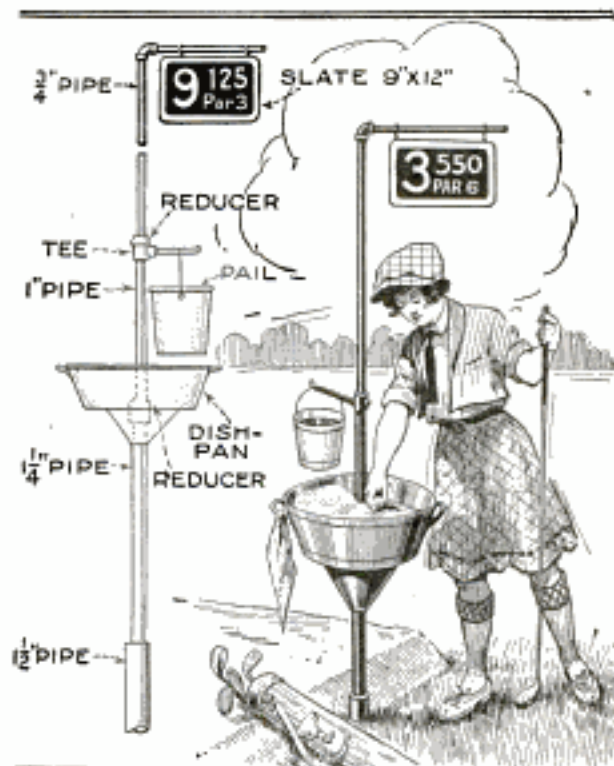
while giving the "motive power" complete control of the wagon at street crossings.—Mrs. Ruth D. Shultis, Albion, Michigan.

Portable Sand Stand for Golf Course

The drawing shows a portable homemade sand stand for the golf course. It can be made for a small sum in comparison with that asked for similar manufactured stands, and it gives just as much satisfaction.

The sand box is made from a 16-in.

dishpan, and the upright parts from lengths of ordinary galvanized-iron pipe and fittings. The base is a 2-ft. length



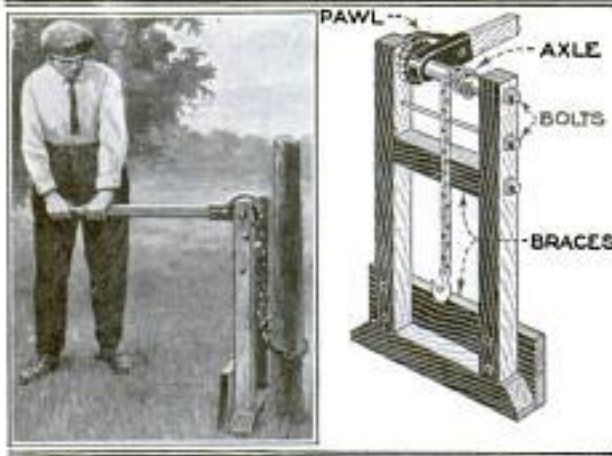
Homemade Sand Stand for the Golf Course That Is Just as Satisfactory as a Manufactured One

of 1½-in. pipe, driven into the ground. The stand is simply set into the base. The lower length of pipe, which is 1¼ in. in size, is 4 ft. long, and a reducer is screwed onto the upper end. On the shoulder of the reducer the dishpan is placed, a hole being, of course, cut in the bottom of the dishpan, and part of a funnel is soldered to it, as shown; the funnel prevents the pan from tipping, but allows it to be rotated if desired. The 1-in. pipe above the reducing nipple is about 18 in. long. A reducing tee is fitted on this, a 1-ft. length of ¾-in. pipe, notched to hold the water pail, is screwed into the tee horizontally, and a 3-ft. length vertically. An elbow is screwed onto the top, and a 1-ft. length of pipe is extended as a support for a sign, giving the number of the hole on one side, and ground rules relative to the individual hole on the other side. Ordinary school slates, with screweyes driven into the edge, have proved satisfactory as signs.

During the winter these stands are taken from the golf course, painted, and stored away. A seamless dishpan is used, the handles being left on to provide places to attach a towel.—Dr. Frank B. Swartzlander, Doylestown, Pa.

A Ratchet Post Puller

The ratchet post puller illustrated is operated by means of an ordinary pump



A Ratchet Post Puller will Pull Almost Any Post, Due to the Leverage Obtained

handle. The ratchet wheel is shrunk on an axle which is mounted in the vertical members of a strong wooden frame as shown. The pawl that engages with the ratchet wheel is attached to the handle, which pivots on the axle as indicated, and a strong chain, with a hook on one end, is securely pinned to the shaft. In use, the chain is hooked around the post to be pulled, and the handle is operated like a pump.

Simple Droplight Shade Adjuster

An ordinary droplight, fitted with a shade, is often used above desks and drawing boards, but when the light is adjusted high enough to enable one to work under it, it is impossible to



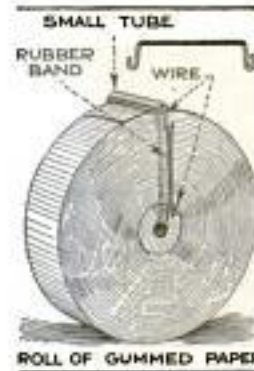
keep it from shining directly in the eyes without using an eyeshade, which some people dislike to wear. The trouble can, however, be prevented by adjusting the lamp so that the light is not thrown directly downward. This is done by means of a string, tied around the lamp cord above the shade, and looped over the point of the lamp as shown in the drawing. Obviously, the shade can be set at any angle to suit the user, so that the direct light is cut off from the eyes.—C. L. Hendrickson, Milwaukee, Wis.

Replacing an Auto Engine

In replacing an engine of a light car, it is sometimes difficult to slip the rear end of the engine into position without displacing the gasket on the front half of the universal case. If a jack is set against the rear end of one running board and against a block on the rear hub, the torque tube can be shoved back, and the universal case and gasket can be pushed or tapped far enough back to slip in easily.—A. O. Bosshard, East Moline, Illinois.

Preventing Gummed Tape from Unrolling

To prevent a large roll of gummed tape from unrolling, a simple attachment of the kind shown has been found effective.



A small aluminum tube, used for holding extra leads for a metal pencil, was used, and two wire paper clips, straightened to form hooks of the kind illustrated. One of these was run through the center of the roll of tape and the other through the tube. Two short rubber bands were then used to connect the hooks on each side of the roll. When the tape is pulled, the tube rolls back, but the tension of the rubbers prevents the roll from loosening.

Extension for Wrench

Every tractor or other piece of farm machinery has some nuts in locations that are difficult to reach; this necessitates the use of some extension on the wrench



when these nuts must be loosened or tightened. A good extension for this purpose is shown in the drawing. It consists of a steel bar, with a slot at one end to fit the wrench head, and having a rivet or pin driven through the slot. With this extension wrench it is possible to grip a nut from the top or side as indicated, in whatever way is most convenient.—G. G. McVicker, North Bend, Neb.

PRIZE OFFERS AND ANNOUNCEMENTS

PRIZE OFFERED FOR WORLD-PEACE PLAN OPEN TO EVERY AMERICAN

One hundred thousand dollars is offered by Edward W. Bok, of Philadelphia, as a prize for "the most practicable plan by which the United States may cooperate with other nations to achieve and preserve world peace." The prize, which is to be called the American Peace Award, is open to "every American," and according to preliminary announcements, the "plans will have to be in probably not later than the middle of November, next." The exact conditions will, however, not be made public for some time. A jury of award, whose membership has not yet been selected, will judge the plans, and the prize will be given in two parts, viz., \$50,000 for the plan itself, and \$50,000 after the practicability of the idea has been demonstrated, "either through its adoption by the United States Senate, or by a sufficient popular endorsement of it."

ESSAYS ON PLUMBING AWARDED PRIZES BY CARNEGIE TECHNICAL INSTITUTE

Recent announcements from the Carnegie Institute of Technology, at Pittsburgh, Pa., state that the award of two prizes donated by the Eastern Clay Products Company, of \$100 and \$50, respectively, has taken place. The subject of the prize competition was the "Use of Vitrified Clay Pipe in Plumbing Systems," the contest was nation-wide, and the quality of the papers submitted, exceptionally high. The first-prize winner is a student of the institute, and a master plumber won the second prize.

TEN THOUSAND DOLLARS FOR ONE WORD ACCEPTABLE AS MOVIE-PLAY TITLE

Ten thousand dollars for a word, \$20,000 for two words, and \$25,000 for a three-word combination that can be used as a title for a movie play will be paid by a producing company in the West. The word must be a motion-picture title that will earn more than \$10,000 for the company producing a picture with that title, it is announced. As many titles as have promise and prove available will be bought and it is believed the number of good titles to be submitted will be too few rather than too numerous.

PAY TEN DOLLARS FOR HARDWARE IDEAS OF VALUE TO OWNERS AND CLERKS

Ideas for hardware men are wanted by the editor of a trade magazine who will pay \$10 for the best one received each month and \$2 for all others accepted. Short letters on how deliveries are handled, unique window displays, how trade is increased, or anything else of particular interest to hardware clerks and merchants are asked.

OFFER PRIZE FOR NAME FOR NEW TRAIN RUNNING NORTH FROM NEW ORLEANS

The person who suggests a name for a new train passing between Washington, D. C., and New Orleans will receive \$200 from the operating company, if the name is accepted. There will be through sleeping-car service between New Orleans, Montgomery, Atlanta, Washington, Philadelphia, and New York City, it is announced.

RADIO MEN TO GET \$5,000 A YEAR FROM UNITED STATES GOVERNMENT

One hundred dollars a week is the highest salary offered radio engineers who take a test with the U. S. Civil Service Commission to fill vacancies now existing. Positions paying from \$2,000 to \$5,000

yearly are to be filled by examinations, applications for which close October 30. The duties are to superintend development of apparatus for land stations, airplanes, ships, and perform similar lines of work. Competitors will not be required to report for examination at any place but will be judged on education, experience, and general training.

GOVERNMENT SEEKS JUNIOR ENGINEER FOR BRANCH OF GEOLOGICAL SURVEY

To fill a vacancy in the water resources branch of the U. S. Geological Survey the U. S. Civil Service Commission will select a junior engineer from applications received before September 25. The entrance salary is \$1,620 a year, plus the increase of \$20 a month granted by Congress. The field of activity may be in any part of the United States.

GIVE \$5,000 IN PRIZES FOR BEST RADIO STORE WINDOWS

Five thousand dollars in prizes are offered radio dealers who prepare the best window displays showing Cunningham vacuum tubes, from September 24 to October 1.

CONTESTS PREVIOUSLY ANNOUNCED

Medals, Diplomas, and Money Awards: Announced August issue, 1921; awards offered by the Franklin Institute. The Franklin medal is for workers in technology; the Elliott-Cresson is for original research work and invention; the Howard N. Potts is for important development of previous discoveries and inventions. Each award consists of a gold medal with a diploma. There are also a silver medal, and a Certificate of Merit awarded for meritorious discoveries, and cash premiums for certain work in optics.

Best Treatise Regarding Immortality: Prize \$1,000; announced January issue, 1923; closes Dec. 1, 1923.

Awards to Further Science of Electricity: Medals and prizes, amounting in all to about \$20,000; announced February issue, 1923.

For Best Work by American Chemist: An annual award of \$25,000; announced February issue, 1923.

Names for Great Lakes Steamers: Two prizes of \$50 each; announced February issue, 1923; suggested names must be submitted before the opening of navigation season in 1924.

Essay on Economic Subject: Prize \$1,500; announced March issue, 1923.

Pulitzer Prizes, Columbia University: For best work in various literary and journalistic lines; announced April issue, 1923; nominations of candidates must be made before Feb. 1, 1924.

Scholarships for War Nurses and Ex-Service Men: Numerous scholarships provided at colleges and universities throughout the country under the will of the late La Verne Noyes; announced April issue, 1923.

Most Practicable Device for Recording Mine-Shaft Signals: Prize of £250, or about \$1,000; announced May issue, 1923.

Prizes for Essays: Three yearly prizes of \$2,500, \$300, and \$200; announced June issue, 1923; for articles on subjects relating to business development and the modern trust company; closes August 31, each year.

Boys' and Girls' Short-Story Contest: Two first awards of \$100, and other prizes; announced May issue, 1923.

Greatest Benefit to Community Rendered by Women's Club: Prize, \$1,000; announced May issue, 1923.

Endurance Prize for Aerial Engine: Prize, 1,000,000 francs (normally about \$200,000); announced June issue, 1923; applications for privilege to compete should be in before Dec. 1, 1923.

Device for Recording Shaft Signals: Prize, £250; announced May issue, 1923.

Prizes for Essays on Purchasing Power: Three prizes of \$1,500, \$300, and \$500; announced June issue, 1923.

Our Bureau of Information will furnish addresses and further details

Students' Essays on Municipal Government: Prizes \$250 and \$100 for postgraduates; \$100 for undergraduates; announced May issue, 1923.

Prize Offered by New York Academy of Science: The A. Cressy Morrison Prize for 1923, for paper on any subject covered by the academy; announced August issue, 1923; papers must be submitted on or before Nov. 1, 1923.

Preventive of "Klieg Eyes": Award of \$50,000; announced August issue, 1923.

Electric Storage-Battery Mine Locomotive: Prize, £1,000; announced August issue, 1923. Working trials of machines selected will be announced later.

Vertical Airplane Flights: Prizes aggregating £50,000; announced August issue, 1923; entries must be received before April 30, 1924.

SCIENCE NOTES FOR DAILY USE

2922 MODERN LIGHTS, RIVALING SUN, STUDIED TO AVOID HARM TO EYES

Cave dwellers of 50,000 years ago, lighting their ways with firebrands, suffered little from eye troubles, according to experts studying ways to prevent the strong glare of modern lighting systems, that are so injurious to the eyes of those working and living under their rays. When candles and oil wicks were replaced by bright gas lamps and electric bulbs, no great efforts were made to care for the increased brilliancy. This resulted in poor distribution of light, and had the same effect as looking into the sun on a bright day. Attention is to be turned to factory and school lighting for the purpose of devising rules by which such illumination will be governed.

2925 AUTOMOBILE RIDING INCREASES LIFE AN AVERAGE OF ELEVEN YEARS

Figures compiled recently by three physicians indicate that the universal adoption of the automobile as a means of individual transportation has added 11 years to the average life of an American citizen. In 1903, when only 10,850 cars were made, the average length of life was placed at 37.64 years. Ten years later, when the production of autos had increased to 461,500, the life expectancy had advanced to 41.01 years. In 1922, when 2,287,000 automobiles were turned out by the factories, the average life had increased to 48.66 years. Sunshine, open air and freedom from worry that results from driving on the open road, the doctors stated, caused the noticeable lengthening of life in the last twenty years.

2838

COAL FACTS

ONE pound will pull one ton of freight 16 miles. For each scoop of coal one full passenger fare for one mile is required to pay for it. Combined revenue from a train in which one passenger is riding in each coach will not pay for the coal required to pull them. There are more than 225 commercial articles extracted from coal. It takes 150 cubic feet of air to burn a pound of coal. Coal has not been in general use more than 100 years. A locomotive uses one pound of coal for every eight gallons of water.

National Health Association

3 physicians in Cincinnati

in as many minutes, keeping a flatiron hot for three hours, or for 20 mornings warming the curling iron. The dairyman could employ it to chop half a ton of hay, separate 350 gallons of milk, or churn 440 pounds of butter.

2949

EGG INCUBATOR USED TO TEST MILK IN THE MAKING OF CHEESE

Long used to hatch chickens, the incubator now has an important part in cheese making, having been adapted to the testing of milk. As the device supplies an even heat at the required temperature, it may be used in any one of the several curd tests. In addition to being simple and easy to operate, it adds accuracy to the experiments. Already a modified egg incubator has been placed on the market for cheese makers. Instead of trays, it is fitted with racks and glass tubes for the milk samples. Formerly it was a common custom in the industry to hang the specimens in the boiler room, but because of the uneven heat poor results were obtained and often undesirable milk went into the curdling vats.

CLAYS WASHED TO MAKE PORCELAIN 2952

In experimenting with Georgia clays, government experts have devised a new method of washing that has proved successful in the separation of the desirable and undesirable portions. As a result, they are being commercially tested in the manufacture of refractories, floor tile, wall tile, face brick, and electrical

porcelains. Other clays also are to be given commercial trials.

ENERGY FOR MANY TASKS SUPPLIED BY SINGLE ELECTRIC UNIT 2923

It has been shown by recent tests that one kilowatt-hour of electricity suffices to perform numerous tasks requiring heat and power. By it enough energy can be supplied to drive a sewing machine for 20 hours; clean 15 steel tableknives for a year; clip five horses or 25 sheep, or milk 20 cows. A man could heat his shaving water for a month with its help, or for five years light three cigars a day. In the household it becomes a busy little servant, frying 15 chops

TELEPHONING OVER POWER LINES WITH TWO COMPLETE SETS 2946

With two sending and two receiving sets working through single telephone instruments on a power transmission line, both parties may now talk and listen at the same time, as a result of a recent experiment in the middle West. On the lines of a power company a high-frequency automatic telephone system was installed, said to be a long step in advance of anything before attempted with so-called wired wireless. Previous tests made possible only one-way communication.

New York Times 7/1/23 Washington

IN accordance with the editorial policy of this magazine never to accept compensation in any form for what appears in our reading pages, and also to avoid all appearance of doing so, we are obliged to omit the name of the maker or the seller of any article described. This information, however, is kept on file and will be furnished free, by addressing Bureau of Information, Popular Mechanics Magazine, Chicago. [Editor.]

Chicago Tribune 7/2/23 New York Times 7/1/23

Samuel W. Wisconsin College of Agriculture



Men Who Care

For whiter teeth are now fighting film

Wherever you go among careful people you see teeth that glisten now. Millions of people every day combat the dingy film.

This test will show you how. The results will amaze and delight you. Make it, for your own sake, now.

Those dingy coats

Film is that viscous coat you feel. Much of it resists the tooth brush, clings and stays. Soon the film discolors, then it forms dingy coats which hide the luster of the teeth.

Film also causes most tooth troubles. It holds food substance which ferments and forms acid. It holds the acid in contact with the teeth to cause decay.

Germs breed by millions in film. They, with tartar, are the chief cause of pyorrhea.

Few people escaped these troubles. So dental

science has found two ways to daily fight that film. One acts to disintegrate the film, the other to remove it without harmful scouring.

After many careful tests these methods were adopted. A new-type tooth paste was created to apply them daily. The name is Pepsodent. Now leading dentists the world over are urging its adoption.

Watch its effects

Pepsodent also multiplies the alkalinity of the saliva as well as the starch digestant in saliva. Those agents are there to constantly fight acids and digest starch deposits on teeth. Every use of Pepsodent gives them manifold effect.

Thus Pepsodent does essential things which old ways cannot do. The results are quickly seen and felt. No one can doubt the benefits they bring.

Send the coupon for a 10-Day Tube. Note how clean the teeth feel after using. Mark the absence of the viscous film. See how teeth become whiter as the cloudy coats disappear.

Once learn this way to whiter, cleaner, safer teeth and you will always want them. Cut out coupon now.

Protect the Enamel

Pepsodent disintegrates the film, then removes it with an agent far softer than enamel. Never use a film combatant which contains harsh grit.

10-Day Tube Free

1307

THE PEPSODENT COMPANY,
Dept. 327, 1104 S. Wabash Ave., Chicago, Ill.
Mail 10-Day Tube of Pepsodent to

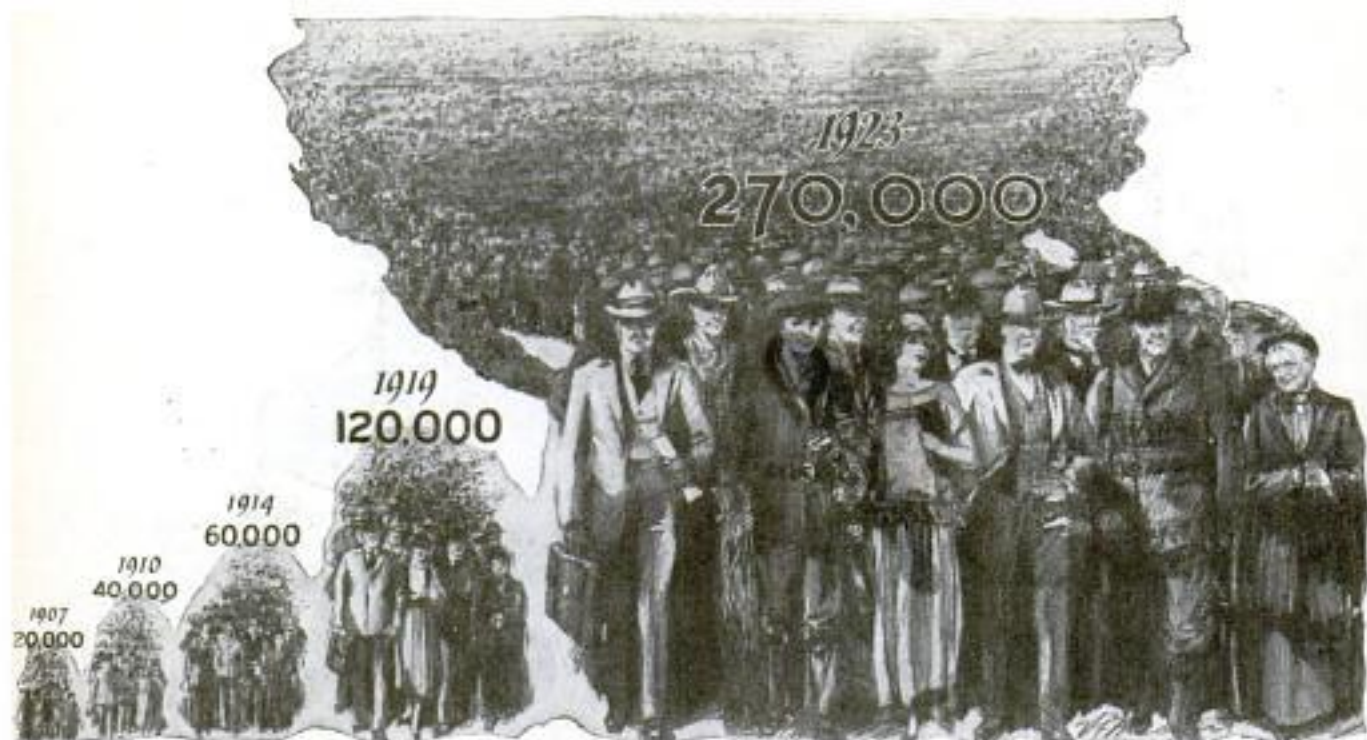
.....
.....

Only one tube to a family.

Pepsodent PAT. OFF.
REG. U.S.

The New-Day Dentifrice

Now advised by leading dentists
the world over.



These groups of stockholders illustrate the rapid growth in ownership of the Bell System.

A Community of Owners Nation-wide

"Who owns the company?" "What is behind it?" These questions are asked in appraising the soundness of a business and in determining its aims.

The American Telephone and Telegraph Company is owned by more than 270,000 people living in every state in the Union. Could the stockholders of the Bell System be gathered to one place, they would equal the population of a city about the size of Providence or Denver.

They constitute a representative cross-section of American citizenship. Among them, of course, are bankers and men of large affairs;

for the idea of ownership in the Bell System appeals to sound business judgment and a trained sense of values.

In this community of owners are the average man and woman, the storekeeper, the clerk, the salesman, the professional man, the farmer and the housewife—users of the telephone who with their savings have purchased a share in its ownership. The average individual holding is but twenty-six shares.

No institution is more popularly owned than the Bell System, none has its shares distributed more widely. In the truest sense it is owned by those it serves.

" BELL SYSTEM "

AMERICAN TELEPHONE AND TELEGRAPH COMPANY
AND ASSOCIATED COMPANIES

One Policy, One System, Universal Service, and all directed toward Better Service





Every Student Needs One
**Remington
 Portable**

Keyboard just like the big machine



THE compact, convenient and complete Portable Typewriter. Sold by over 3,000 dealers and Remington branches everywhere. Easy payment terms if desired. Send for our illustrated "For You—For Everybody." Address Department 12

*We believe we make the best typewriter ribbon
 in the world—and its name is PARAGON*

REMINGTON TYPEWRITER COMPANY

374 Broadway, New York

Branches Everywhere

Sargent
Auto-Set
Bench Plane

Sargent
Steel Block
Plane

Sargent
Steel Pocket
Plane



The Cutter of Chromium Steel HOLDS ITS EDGE

ALMOST as sharp as a razor blade; even after considerable cutting! Zing!—with the grain, 'gainst the grain and 'cross the grain—feel the Sargent Auto-Set Bench Plane cut smoothly and cleanly.

The diamond-like toughness of chromium alloy permits the use of a thin blade—and the thinner the blade, the keener the cutting edge. The advantage of a thin blade is also emphasized when it finally needs whetting. It is honed in a jiffy—replaced—and shaving away in short order, with the original adjustment unchanged.

For the finishing touches and working in restricted quarters, you need the Sargent Steel Pocket Plane and the Steel Block Plane. These smaller planes are indispensable to every work-bench. They are light, handy faithful—the tools of master craftsmen.

Write for the Sargent Book of Planes. It's full of interesting information. And see these Sargent Planes at your hardware dealer's.

SARGENT & COMPANY

Hardware Manufacturers

49 Water Street

New Haven, Conn.



SARGENT

Tools & Hardware

TRADE MARK REG.

WURLITZER

SUPREMACY IN MUSICAL INSTRUMENTS



Learn to Play

You are always popular and sure of a good time if you can play some musical instrument. By yourself, with your friends around the piano, in orchestras or bands,—there is no end to the pleasure music will give you. And there is no easier way to earn money in your spare time. Choose your instrument now and let Wurlitzer help you buy it and learn to play it.

Try Any Instrument in Your Own Home At Our Expense

You may now have any known musical instrument for a week's free trial in your own home. There is no obligation to buy—no expense for the trial. You may return the instrument at the end of a week if you decide not to keep it.

Monthly Payments

The Wurlitzer plan makes it easy for you to own the instrument you want. Payments are conveniently arranged in small monthly sums—a few cents a day will pay.

Wurlitzer instruments are known everywhere for their unusual tone quality and excellence of workmanship. They are used by the greatest

professional musicians, bands and orchestras. Harry L. Jacobs of Sousa's Band, Brooke's Marine Band, and Chicago Grand Opera says: "I am proud to be the owner of one of your new cornets. It is positively superior to anything I have had in all my years of cornet playing."

Easy to Buy

Thousands of amateur musicians are playing on Wurlitzer instruments. Many of them could not have bought except through the Wurlitzer selling plan. Wurlitzer is the world's greatest music house, with stores and dealers in all parts of the country. But no matter where you live you will receive the same service by mail as though you lived next door to the factory. Send the coupon today.

Send for Free Catalog

The greatest musical catalog ever published. Over 3,000 articles—every known instrument described and illustrated—many of them shown in full color. Gives you all details of the Wurlitzer plan. Send coupon now.

The Rudolph Wurlitzer Co., Dept. 1777

117 E. 4th St., Cincinnati 329 S. Wabash Ave., Chicago
120 W. 42nd St., New York 250 Stockton St., San Francisco

Send me absolutely free, your new illustrated catalog of musical instruments. Also tell me how I may try any instrument in my own home at your expense and how the Wurlitzer plan makes it easy for me to buy. No obligation.

Name _____

Address _____

City _____ State _____

Instrument _____

(State instrument in which you are interested.)

The handy-man's drill



No. 5 $\frac{1}{2}$
Hand Drill
Price \$5

Made by skilled toolsmiths for men like yourself who appreciate good tools. Has two speeds, making it adaptable for work on all kinds of materials.

The all-steel chuck takes all sizes of round-shank drills up to $\frac{3}{8}$ inch. Spindle runs in ball bearings. Malleable iron frame, steel pinions.

The polished rosewood handle is made to hold drills. Finished with a handy screw cap.

Handsomely enameled in black and red. Length 14 $\frac{1}{2}$ inches; weight 2 $\frac{1}{4}$ pounds.

Sold by good hardware stores everywhere. If your dealer hasn't it, write us.

Send for Catalog No. 15—Free to You

Illustrates and describes each of the Goodell-Pratt 1500 Good Tools. Your name and address on a postcard will bring your copy at once.

GOODELL-PRATT COMPANY, Greenfield, Mass., U. S. A.

Toolsmiths

Mr. Punch says:

"Drilling a lot of holes has no terrors for the man who uses this Goodell-Pratt Hand Drill. It does its job so thoroughly that you'll consider it one of the best tool investments you ever made."



GOODELL- PRATT

1500 GOOD TOOLS

ONLY
\$ **3**
DOWN
and you
keep this
typewriter



DIRECT
to you
from our
Factory

Big Saving
In Price

Yes, we will ship you this Genuine Underwood

Rebuilt in our own factory just like new for
ONLY \$3 down—NOT ONE CENT MORE

Until you have tried the machine 10 full days at our expense



Our Factory

EVERY MACHINE is fully guaranteed. New parts wherever needed. New enamel, new nickel, new lettering, new platen, new key rings—a complete, perfect typewriter. Impossible to tell it from a brand new Underwood either in appearance, durability or quality of finished work.

An up-to-date machine with two-color ribbon, back spacer, stencil device, automatic ribbon reverse, tabulator, etc. In addition we furnish FREE waterproof cover and special Touch Typewriter Instruction Book. You can learn to operate this Underwood in one day.

Big Book FREE

Our big handsomely illustrated catalog will be sent free on request. It tells you all about the advantages of owning a STANDARD SIZE UNDERWOOD; how and why this machine will last for years, saving many dollars not only in the purchase price but in its operation.

Send in the coupon and let us send you this beautifully illustrated book FREE without any obligation whatever.

Shipman-Ward Mfg. Co.
"Typewriter Emporium"
2127 Shipman Bldg.
Montrose and Ravenswood Aves., Chicago

Write Right Now

and learn how it is possible for us to ship you this Underwood Typewriter upon our free trial plan and our direct-to-you money saving methods. Get the full details now—just sign the coupon and mail today. Get all the facts—then decide.

No Obligation

—to buy. You don't have to order. Just sign the coupon, send it to us and we will mail you our big catalog absolutely free.

Send the
Coupon
Today

10 Days'
Free Trial

You have ten full days in which to try the typewriter before deciding whether you want to keep it. Give it every test—see for yourself—make the Underwood prove its worth to you. Don't take our word for it—put the Underwood before you and see if you don't think it the greatest typewriter bargain ever offered.

You will be amazed at the liberality of our offer, the beauty and all around excellence of our typewriters.

This is the genuine Underwood Typewriter. We offer you the same three models of the Underwood Typewriter being made and sold by the manufacturers today. Standard 4-row single shift keyboard. Absolutely visible writing—the full line of typewriting is visible at all times. All the improvements and attachments that any high grade typewriter ought to have.

Big Saving to You

Our plan of selling to you direct makes possible enormous savings, which are all for your benefit. Send in the coupon and we will send you prepaid our big catalog, including "A Trip Through Our Factory." This shows how the Shipman-Ward Rebuilt Underwood is the best that can be produced at our Special Price.

don't have to do a thing to get our big Free catalog and complete details of our amazing

typewriter offer except to sign and send in the coupon. There is no obligation.

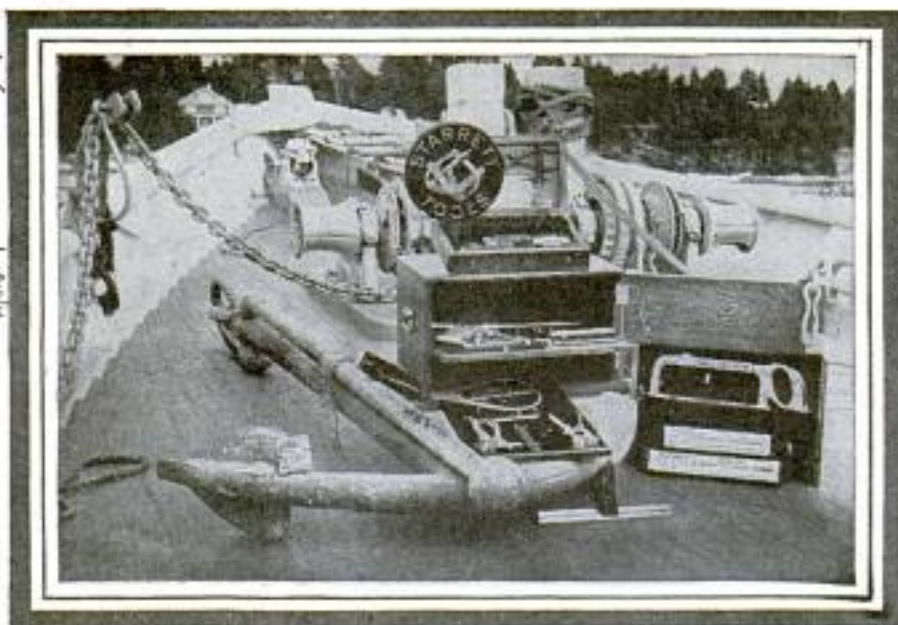
**FREE TRIAL
COUPON**

SHIPMAN-WARD MFG. CO.
2127 Shipman Bldg., Chicago

Please send me FREE, all charges fully prepaid, your BIG NEW catalog of UNDERWOOD TYPEWRITERS and complete details of your FREE TRIAL Offer.

It is understood that I am under no obligation whatever and that this is to be sent without one cent of cost to me.

Name.....
Street.....
City..... State.....



MacMillan's choice

Donald MacMillan chooses his equipment for a Polar Expedition as carefully as he chooses his personnel. Tools and men—they must be reliable for there is no test of character as severe as the arctic.

Starrett Tools accompany this world-famous explorer on every expedition to the frozen North. Starrett Tools are keeping the "Bowdoin's" engines tuned, her machinery in perfect trim—making nice adjustments on wireless and the most sensitive instruments—sure and reliable in every day service and ready for any emergency.

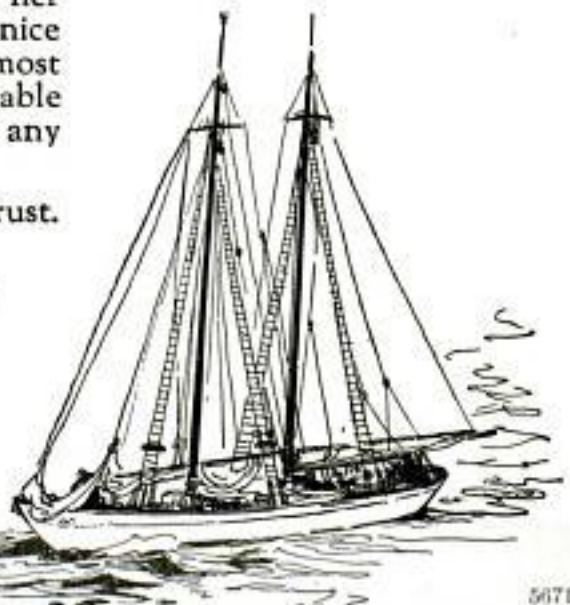
MacMillan knows the tools he can trust.

THE L. S. STARRETT CO.

The World's Greatest Toolmakers
Manufacturers of Hacksaws Unexcelled
ATHOL, MASS.

The Starrett Catalog
No. 22 AP

describes the tools shown in the photograph above (taken on board the "Bowdoin"). Send for this catalog showing over 2100 fine precision tools—you will be interested in some of the new additions to the Starrett line. Mailed free to any address.



5671



Starrett Tools

21 Jewel Santa Fe Special

Sent
on

21 Perfect Jewels
Adjusted to Positions
Adjusted to Temperature
Adjusted to Isochronism
Adjusted to the Second
25 Year Gold Strata Case
Your choice of Dials (including
Montgomery R. R. Dial)
New Thin Models. All sizes.

Approval

WHILE other watch dealers are raising their prices, asking you for larger monthly payments, and making payment terms harder for you to meet, we are offering you our new model Santa Fe Special, no advance in price, no money down, easier terms and smaller monthly payments. We realize the war is over and in order to double our business we MUST give you pre-war inducements, better prices, easier terms, and smaller payments.

Send No Money Without one penny of advance payment let us place in your hands to see, to examine, to inspect, to admire, to approve a real masterpiece in watch creation. Our determination to this year double our sales of the world famous Santa Fe Special and Bunn Special Watches prompts this matchless offer.

Santa Fe's "New Elite"

This Artistic dependable Ladies' Wrist Watch, fitted with genuine Illinois Springfield movement. A perfect timepiece. Beautiful 14 Karat white or green solid gold case. Many designs—Ask for New Watch Book showing New Elite case designs in color. Watch sent on approval and sold on payments.

Page 12 of Our Watch Book Is of Special Interest to You!

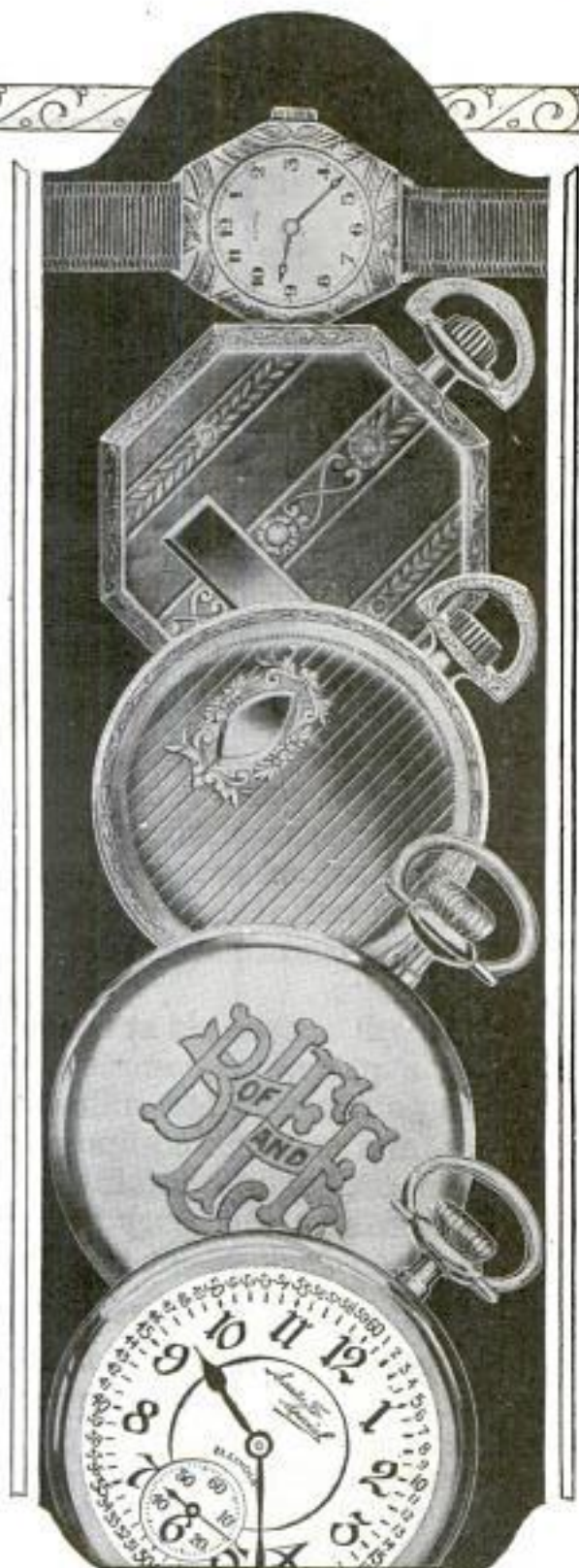
Ask for our Watch Book free—then select the watch you would like to see, either the famous Santa Fe Special or the 6 position Bunn Special, and let us explain our easy payment plan and send the watch, express prepaid, for you to examine. No money down.

REMEMBER—No money down—easy payments buys a master timepiece—a 21 Jewel guaranteed for a lifetime at about half the price you pay for a similar watch of other makes. No money down. A wonderful offer.

SANTA FE WATCH COMPANY

Dept. A6, Thomas Bldg. TOPEKA, KANSAS

"Home of the Great Santa Fe Railway"



SANTA FE WATCH CO.

Dept. A6, Thomas Bldg., Topeka, Kans.

Please send prepaid and without obligation your Watch Book free, explaining your "No Money Down" Offer on this Santa Fe Special Watch.

Name.....

Address.....

State.....

Radio Catalogue Free—

**Write us
a post card—**

Address Dept. 6-R

and we will send you free this 52 page catalogue of radio sets and parts. It also contains explanation of radio terms, map and list of broadcasting stations and much radio information, including an explanation of successful hook-ups and circuits.

You will be amazed at the low prices Ward's quote. A complete tube set having a range of 500 miles and more, including tube, head set, batteries, and antenna equipment, as low as \$23.50.

This catalogue contains everything for the expert and amateur. Complete sets and every improved part for building sets, all the most up-to-date devices—at the lowest possible prices.

Headquarters for Radio

Montgomery Ward & Co. is headquarters for Radio, selling everything direct by mail without the usual "Radio-profits." Why pay higher prices? Ward quality is the best and the prices will often save you one-third. Everything sold under our Fifty Year Old Guarantee—Your Money Back if You Are Not Satisfied. Write today for your copy of this complete 52-page Radio Book.

Write to our house nearest you. Address Dept. 6-R

Chicago Kansas City St. Paul Portland, Ore. Ft. Worth

Montgomery Ward & Co.

The Oldest Mail Order House is Today the Most Progressive





Wins a Welcome

You are welcome everywhere with a sweet-toned Buescher Saxophone. It is the one instrument that everyone can play—and it wholly satisfies that craving everybody has to personally produce music. It is so perfected and simplified that it is the easiest of all musical instruments to master. With the aid of the first three lessons, which are sent free (upon request) with each new Saxophone, the scale can be mastered in an hour; in a few weeks you can be playing popular music. Practice is a pleasure because you learn so quickly. You can take your place in a band within 90 days, if you so desire. Saxophone players are always in demand for dance orchestras.

75% of all popular phonograph records are played with Buescher instruments. Ask for pictures of the Nation's Record Makers.

Nothing can take the place of the Saxophone for home entertainment, church, lodge, school. It increases the pleasure you get out of life, increases your popularity and your opportunities.

Free Trial—Easy Payments

You may have six days' free trial of any Buescher Grand Saxophone, Cornet, Trumpet, Trombone or other instrument. Easy terms of payment can be arranged. Mention the instrument interested in and a complete catalogue will be mailed to you free.



Buescher-Grand Trumpet
An entirely new model, featuring the Buescher improved new bore and new proportions. It will meet every demand from the martial flourish to the tender love song. We guarantee it to be the best Trumpet you have ever heard.

Free Saxophone Book

Every music lover should send for a copy of this interesting book on the history and development of the Saxophone. It tells which Saxophone takes violin, cello and bass parts, and many other things you would like to know. Also illustrates first lesson. Send coupon for your free copy.

Buescher Band Instrument Co.

Everything in Band and Orchestra Instruments
2550 Buescher Bldg. Elkhart, Ind.



Clip and Mail

Buescher Band Instrument Company

2550 Buescher Block, Elkhart, Indiana

Gentlemen: I am interested in the instrument checked:

Saxophone.....

Cornet.....Trombone.....

Trumpet.....
(Mention any other instrument interested in)

Name.....

Street Address.....

Town.....State.....

BUESCHER

TRUE-TONE BAND INSTRUMENTS

SOUTH BEND LATHES

16" x 8'
Quick Change
Gear Lathe

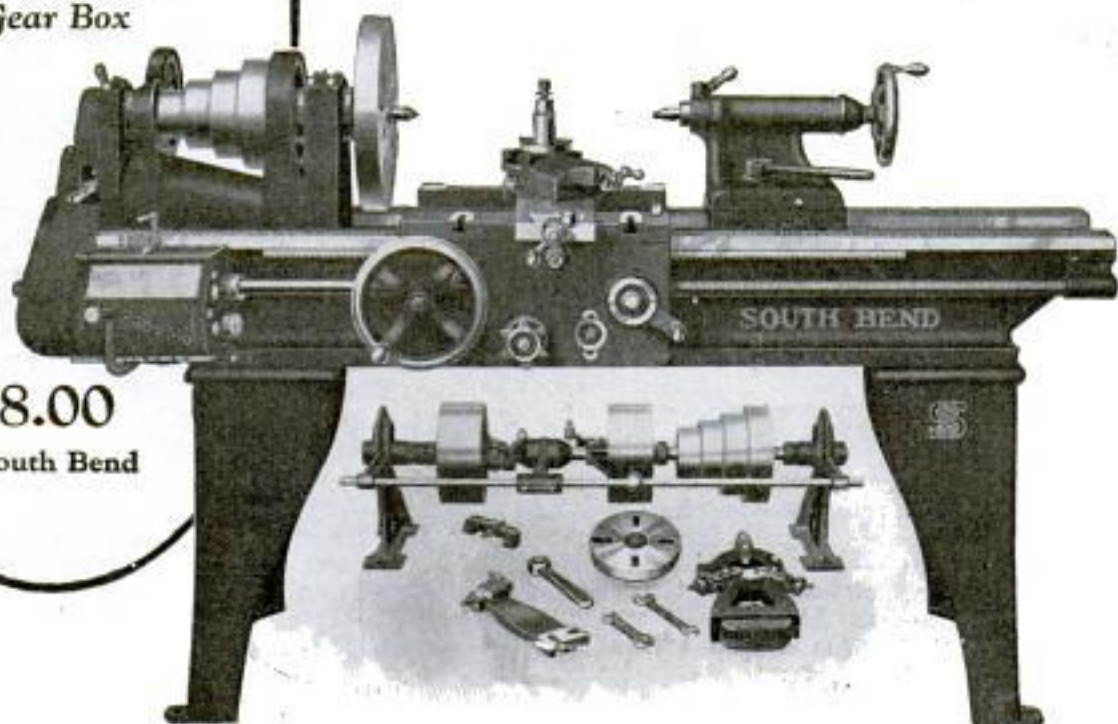
Flather Patent
Gear Box

\$498.00

f. o. b. South Bend

for
MANUFACTURING

for the for the
TOOLROOM MACHINE SHOP



Over 30,000 Satisfied Users

South Bend Lathes can be purchased from Machinery Dealers in all the principal cities.

Send for new No. 81 Catalog giving prices and descriptions on the entire South Bend Lathe Line.

SIZE	Standard	Quick Change
9" x 3' Lathe	\$ 211.00	\$ 241.00
11" x 4' Lathe	248.00	288.00
13" x 5' Lathe	304.00	354.00
15" x 6' Lathe	376.00	431.00
16" x 8' Lathe	438.00	498.00
18" x 10' Lathe	656.00	721.00

SOUTH BEND LATHE WORKS

555 East Madison St. South Bend, Ind., U.S.A.

NEW YORK SALESROOM, 166 Centre St.



Established
1906

Lathe
Builders
for 17 years

The Real Metal Solder in Paste Form

SOLDERALL

Introducing Our New
SOLDERALL BLOW TORCH
of Heavy Solid Brass

Indispensable in the Home, Garage and to the Electrician. For soldering Radio, House Wiring, Jewelry, Ignition, Kitchen Utensils, etc.



IMPROVED BLOW TORCH \$1.75
SOLDERALL TUBE 25¢

SOLDERALL CO. Dept. P Newark, N.J.

Reliable
RADIO
Goods

Results are sure with **RELIABLE** goods

And it's easy to get such goods—anything you want in radio equipment. Big, complete stock—everything guaranteed; quick service; right prices. And you're sure it's reliable when it comes from Andrae. Get our complete catalog—free.

JULIUS ANDRAE & SONS CO., 116 Michigan St., Milwaukee, Wis.

ANDRAE In Business Since 1860

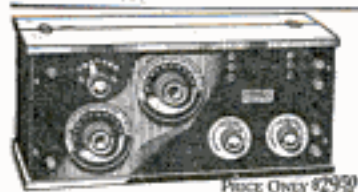
Earday

\$1.00 a Pair

HEADPHONE CUSHION

HUDSON-ROSS

123 WEST MADISON ST.
CHICAGO



Price Only \$29.50

At the low prices shown below you get the efficiency of sets costing three times as much.

These radio frequency receivers—pick up stations over 1,500 miles away under good conditions—everywhere. Operate either on DRY CELLS or storage battery.

Cabinets of solid mahogany and workmanship the finest throughout. Order direct or send for bulletin.

Two tube outfit, as shown above, headphones only \$29.50

Four tube outfit for loudspeaker or headphones \$54.50

DEALERS AGENTS—write for proposition quickly—it's a winner.

THE MIDWEST RADIO COMPANY
307 Main Street CINCINNATI, OHIO

MIRACO
GETS EM
1500
MILES
AWAY

Coils and mountings
licensed under
DeForest patents



Insist
on
the
Gen-
uine

Ask
Your
"Old Timer" Radio friend why sets using Honeycomb Coils are best. Then ask your dealer for Branston Lateral Wound Honeycomb Inductance Coils and Coil Mountings. Branston Coils are protected from injury and can not come loose from mountings. Positive contact assured. Guaranteed uniform maximum inductance with minimum distributed capacity.

Send 2c in stamps for Series 1 "Hook-Up" Circular showing five good Honeycomb Coil hook-ups and Catalog of famous Branston Radio materials. Write today. Give us name of your Radio Dealer. If he can't supply you, let us know.



CHAS. A. BRANSTON, Inc.
819 Main St., Buffalo, N. Y.
In Canada—Chas. A. Branston, Ltd.
Toronto, Ont.

BRANSTON
RADIO

ELECTRIC SOLDERING IRON

EVERY RADIO FAN has been looking for this iron for both radio and home use. Operates on A. C. or D. C. current.

\$2.28

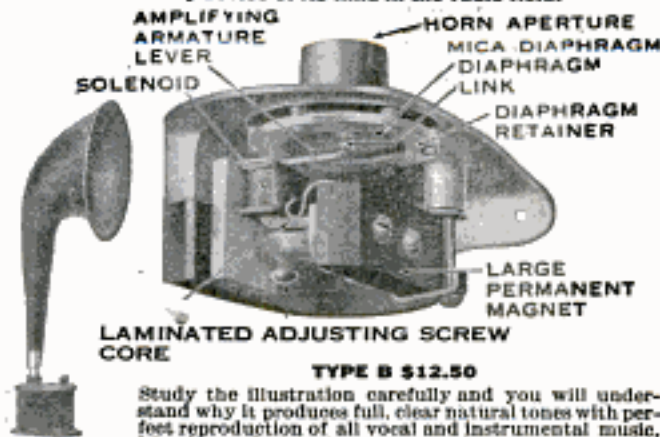
GUARANTEED one year. Sent anywhere in U.S. or Canada. Parcel Post prepaid on receipt of money order for \$2.28.

FANS Send 2c stamp for our list of RADIO BARGAINS

RADIO BARGAINS
17 N. LA SALLE ST.—CHICAGO

THE TRINITY LOUD SPEAKER

The only device of its kind in the radio field.



TYPE B \$12.50

Study the illustration carefully and you will understand why it produces full, clear natural tones with perfect reproduction of all vocal and instrumental music. May be used with phonograph or built into your set.

TRINITY RADIO CORPORATION
Type A1, \$25.00 21" Fibre Horn 168 DARTMOUTH ST., BOSTON, MASS.



Licensed under Armstrong U. S. Patent
No. 1,118,149

ACE TYPE V

Formerly called
Crosley Model V

Armstrong Regenerative Receiver

\$20

The low cost of this set together with its efficiency and simplicity makes the great demand for it increase daily. A long range receiver. Stations from coast to coast heard distinctly. An ace two-stop amplifier in connection with this set at \$20.00 makes use of loud speaker practical. Has Crosley Multistat which permits use of any make tube. Ask for "Simplicity in Radio"—it's FREE. Dealers, write on your letterhead for a very interesting sales proposition.

THE PRECISION EQUIPMENT COMPANY

Responsible for PRES.

1015 Vandalia Avenue

CINCINNATI, OHIO

FREE RADIO BOOK



An easily understood explanation of Radio, written by Powell Crosley, Jr., President of Crosley Mfg. Co., Cincinnati, and The Precision Equipment Co., Cincinnati.

WRITE TODAY FOR THIS BOOKLET

Crosley Manufacturing Co.

1015 Alfred Street

Cincinnati, O.



WEAR This Wonderful Ring

bonds a genuine diamond. If

you can tell the difference send it back.

Radio-Light Diamonds

dazzle with brilliant rainbow fire.

Ladies' exquisite model in platinum

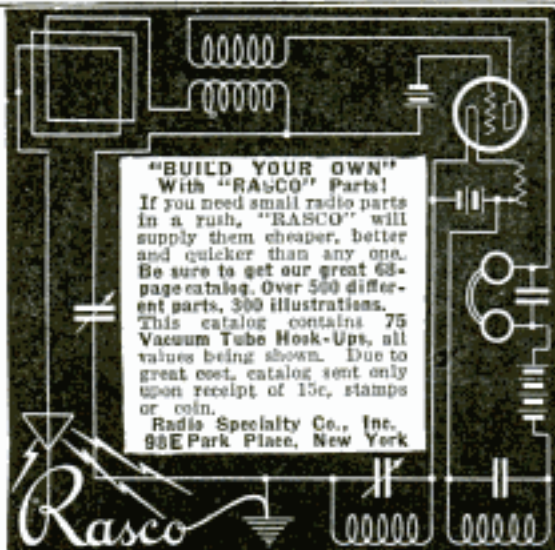
or gold finish. Men's heavy model in

solid gold and silver.

State choice. When ring arrives,

pay postman \$2.49 and postage.

Bradley Boston Co., D4, Boston, Mass.



"BUILD YOUR OWN"
With "RASCO" Parts!
If you need small radio parts
in a rush, "RASCO" will
supply them cheaper, better
and quicker than any one.
Be sure to get our great 68-
page catalog. Over 500 differ-
ent parts, 300 illustrations.
This catalog contains 75
Vacuum Tube Hook-Ups, all
values being shown. Due to
great cost, catalog sent only
upon receipt of 15c, stamps
or coin.
Radio Specialty Co., Inc.
88E Park Place, New York

Rasco

Rings Bells Without Batteries

Avoid the annoyance of having bells out of order. At a nominal cost you can install this little device which will ring electric bells, buzzers, annunciators, electric heat regulators, door-openers, etc., from the same current that lights your home.

ONLY \$2.00
Canada \$3.00

Air-Way Bell Ringer Transformer

Connects direct to lighting-current, and eliminates forever the use of troublesome dry batteries. Does not use enough current to register on meter. Buy it from any electrical dealer, or we will send it anywhere postpaid upon receipt of price. Your money back if you are not satisfied.

JOBBERS, DEALERS, AGENTS—Write for selling proposition.

AIR-WAY ELECTRIC APPLIANCE CORPORATION
Toledo, Ohio



HEADPHONE
CUSHION

FANS List of Bargains

RADIO BARGAINS

17 N. LA SALLE ST - CHICAGO

RADIO FANS

Rejoice when using these pneumatic phone cushions. They gently hug the ears, shutting out all room noises. Fits any type headset Money back guarantee if you are not satisfied.

FREE

RADIO BARGAINS

17 N. LA SALLE ST - CHICAGO

FREE — a book that tells how to get better results with radio tube sets. Address WILLARD STORAGE BATTERY COMPANY CLEVELAND, OHIO

F-F BATTERY CHARGER

CHARGES AT HOME

RADIO "A" & "B" & AUTO STORAGE BATTERIES Overlight For Few Cents From Any 110 Volt A. C. Lamp Socket. COMPLETE PORTABLE AUTOMATIC. No Skill Required. WILL PAY FOR ITSELF. 7 TYPES at POPULAR PRICES.

TYPE 6	charges 6 Volt Battery At 5 AMPERES	\$15
TYPE 12	charges 12 Volt Battery At 5 AMPERES	\$18
TYPE 12	charges RADIO "B" Batteries Up to 120 VOLTS	\$18
TYPE 4-2	is a COMBINATION of TYPES 6 & 12	\$20
TYPE 144	charges 6 Volt Battery At 12 AMPERES	\$20
TYPE 1412	charges 12 Volt Battery At 7 AMPERES	\$20
TYPE 1628	is a COMBINATION of TYPES 144 & 1412	\$28

SHIPPING WEIGHTS COMPLETE 9, 12 & 16 lbs. PURCHASE FROM DEALER, or Order CHARGER C. O. D. ORDER NOW, or WRITE for FREE CHARGER Bulletin 24

FRANCE MFG. CO., CLEVELAND, OHIO

SIGNAL RADIO

Signal Radio Apparatus has long endured strenuous service by government, professional, and commercial users, as well as by beginners. Costs no more than experimental kind.

Send for Catalog.

1910 Broadway
Menominee, Mich.

SIGNAL ELECTRIC MFG. CO

MOTORCYCLES

RELIABLE STANDARD MAKES that you can DEPEND ON.

Enjoy the glorious experience of going wherever you like—whenever you like. The price is within your means—35% to 50% less than others. These machines are slightly used, thoroughly overhauled or rebuilt.

Send for catalogue.

MYCROW BROS.,
250 Columbus Ave., Boston, Mass.

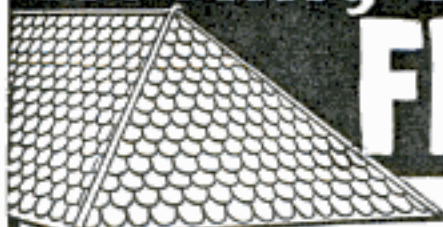
EVINRUDE WILL

To insure delivery of a new SPORT TWIN, order from your dealer at once. Send for catalog.

EVINRUDE MOTOR CO., 207 Evinrude Bldg., Milwaukee, Wis.

BE OVERSOLD

Roofing Book FREE



World's Best Roofing at Factory Price

Don't buy Roofing of any kind until you get our big Free Roofing Book, describing full line of Edwards Famous "Tightcote" Galvanized Roofings, Sidings and Ceilings, and our lowest factory prices. Then see for yourself how much we save you by selling direct and saving you all in-between dealers' profits.

EDWARDS Metal Shingles "REO"

Absolutely rust proof. By our patented "Tightcote" process, edges as well as sides of metal sheets are heavily coated with zinc—not a space the size of a pin point exposed to weather. Fire and lightning proof. Outlasts three ordinary roofs. Forever wind and weather proof. Need no repairs—end all roofing expense. Patent INTERLOCKING DEVICE makes water tight seams—all nail heads covered—no chance for rust or leaks.

EDWARDS Galvanizing Test

Edwards "Tightcote" Galvanized Roofing can be bent, twisted or struck by lightning, and the galvanizing will not crack or flake. Bend it or hammer it—you can't loosen or scale the galvanizing. No other galvanized roofing can withstand this test.

Low Priced Garages



Wide variety of styles, all sizes of Portable Fireproof Metal Garages. Lowest prices ever made. Postal Britain Big Garage Catalog free.

Write Today for free samples and proof that we can save you a lot of money on any kind of roofing, siding or ceiling you may need. Ask for Roofing Book No. 110.

THE EDWARDS MFG. CO.,
1000-1050 Pike St., Cincinnati, O.

FREE
Samples &
Roofing Book

DELTA ELECTRIC BICYCLE LAMPS



Ride Your Bike in Safety

Going to and from work on your bicycle after dark is dangerous unless you are equipped with a light to protect you from passing traffic and enable you to see the street ahead.

The Delta Electric Bicycle Lamp is the best made and the best priced.

It throws a powerful concentrated light one hundred feet ahead and is built to stand rough usage, nothing to wear out, break, work loose, can't be bumped out of commission.

Model 27 mounts on handle bar, fits any bicycle. Ask your dealer, or sent prepaid for \$2.25 complete (less battery).

DELTA ELECTRIC COMPANY
100 Delta Block Marion, Indiana

Standard Makers of Bicycle Lamps, Electric Lanterns, Automobile Spotlights, Radio Head Sets, Flashlights and Flashlight Batteries.

New York San Francisco Winnipeg

MARION
INDIANA
KNOWN BY THE PRODUCT



SEND for the INTERNATIONAL CATALOG

FOR
FORD—
PRICES
FROM
\$27.85
UP.

Factory
to Con-
sumer
direct—
Pay only one profit.



Our net price list. Full line of auto bodies and accessories for Fords at Wholesale Prices.

Save big money on bodies by buying direct from factory.

INTERNATIONAL BODY WORKS, Dept. 7, 914 W. Ohio Street, CHICAGO, ILL.

MOTORCYCLE BARGAINS

Save 25% to 65%

on Slightly used and Rebuilt Motorcycles, Side Cars, Johnson Motor Wheels, Evans Power Cycles, Bicycles. Send for Free Bargain Bulletin and Money Saving Message, listing hundreds of Bargains in used, rebuilt and new machines, supplies, accessories, etc.

AMERICAN MOTOR CYCLE CO.
Dept. 1022, 2047 W. Chicago Avenue, CHICAGO



We Pay \$6 a

taking

Easy Now to Keep Your WINDSHIELD CLEAR in Rain, Fog or Storms

A mysterious new liquid, which can be put on windshield in 30 seconds and gives a lasting transparent surface, now enables every motorist to see clearly through the glass, regardless of weather. Makes bad weather driving safe. Simply send name for absolutely free sample of this wonderful liquid to apply on your own windshield.

ALEXANDER LABORATORIES, Dept. 1, Kansas City, Mo.

Fords Don't Need Rewiring

When equipped with a "Union" Fuse Block. For then when a headlight or tail light grounds, a fuse blows. This enables you to trace the trouble instantly and make repairs for a few cents by inserting a new fuse. Also eliminates fire danger, flickering lights and damage due to overloading motor.

—John and

Secret Service



DON'T lay up your car if your radiator leaks. Simply pour contents of a 75c can of Radiator Neverleak into the water in your radiator. Guaranteed to mend *permanently* all leaks anywhere in cooling system. And it can not injure or clog the cooling system in any way.

Left in the water, it adds years to the life of the radiator by preventing rust and scale from forming.

There is a secret in every can. Always at your service. Entire satisfaction guaranteed or money refunded.

Write for free "Secret Service" booklet.

BUFFALO SPECIALTY COMPANY
357 Ellcott Street BUFFALO, N.Y.

50¢-75¢
a can



RADIATOR NEVERLEAK

VITALIC Bicycle Tires

TRADE MARK REGISTERED
Tougher Than Elephant Hide

FORD START HARD?

EASILY AND CHEAPLY FIXED WITH C-A Adjustable Center Bearing Cap

Corrects end-play and sets magneto for full efficiency without removing motor from car. Saves battery. Installed in few minutes. Guaranteed for year.

Ask your dealer or send prepaid for
ADJUSTABLE BEARING CO., Dept. P, BRAZIL, IND.

\$3.75

FORDS run 34 Miles

(on Gallon of Gasoline)

Low Gear Seldom Used

With Air Pump

SHOP WORK with a

CARNES ARTIFICIAL ARM

FOR nearly ten years a Carnes Artificial Arm has kept Mr. Pahbe Yazze of Lawrence, Kan., on the payroll as a draftsman and machinist at a good salary. Thousands of other mechanics, artisans, office workers, farmers and laborers owe their independence to this improved arm.

Life-Like in Action and Appearance

The Carnes Arm cannot be detected from the natural except by close inspection. Its user can dress himself, use knife, fork, pen, pencil and keys; pick up large or small objects, carry grips—in fact, do virtually everything that was possible before. He can bend the elbow of the Carnes Arm, bend and turn the wrist and open and close the fingers at will, even if the amputation is at the shoulder.

192-Page Book FREE. A book of 192 pages, profusely illustrated with photographs showing what can be done with this remarkable invention, will be sent free to any person interested. Send for it now.

CARNES ARTIFICIAL LIMB CO.,
208 Carnes Bldg., Kansas City, Mo.

Drive 100 Tacks and Save \$25
on your next Top or Seat recovering
Fords \$5.20 to \$10. Chevrolets \$7.95 to \$15. All other cars \$9.95 to \$22. Our Plate Glass Lights enhance the value of your car. Side Curtains \$5.95 up. Seat Covers \$2.50 to \$32. Quality and fit the best. Our instructions make it easy to apply. Send for samples. Our prices include delivery at your door. Eastern courts adapted from Ohio.
Auto Equipment Co., 1055 So. Broadway, Los Angeles, Calif.

\$5.20 up
Delivered

QUIT TOBACCO OR SNUFF RUINING YOUR HEALTH WASTING YOUR MONEY

Harmless treatment quickly overcomes craving for cigars, cigarettes, pipe, chewing or snuff. Sent on trial. Costs \$1.00 if it cures, nothing if it fails. Used by over 400,000 people. Superba Co. H-2 Baltimore, Md.

Delivered to You Free

for 30 days trial on approval. You can have your choice of 44 Styles, colors and sizes of the famous **RANGER Bicycles**. Express prepaid. **Factory-to-Rider** Prices save you \$10 to \$25 on your bicycle.

12 Months to Pay if desired. Many boys and girls easily save the small monthly payments. Parents often advance first payment.

Tires—best quality, at factory prices, express prepaid. Lamps, wheels and equipment, low prices. Send **No Money**, do business direct with makers.

Write today for free **Ranger Catalog**, factory prices and marvelous easy payment terms.

Company
Chicago

a Day



orders for Insyde Tyres—inner armor for automobile tires. Positively prevents punctures and blowouts. Guaranteed to give double tire mileage. **Work Spare Time or Full Time.** Every auto owner buys on account of low price. Enormous demand. Write quick for territory and special terms to County Representatives. **AMERICAN ACCESSORIES CO., B 1476, Cincinnati, Ohio**

You Can Save \$35.00



\$4.45 and up
Parcel Post Paid

Recover your old auto top frame yourself. Custom tailor made to fit all makes and models of cars. Any person that can drive

a car can put it on. Roof and quarters sewed together, with rear curtain, fasteners, welts and tacks complete. Give name, year and model number of your car and we will send you catalog with samples.

LIBERTY TOP & TIRE CO., Dept. E-7, Cincinnati, O.

and b' own lamp...
Permits use of single filament lamps for bright and dim lights. Anyone can install quickly. No additional wiring.

If not at your dealer's, sent postpaid for \$1.50. Money back if not satisfactory. Write for booklet.

CHICAGO FUSE MFG. CO.
1503 West 15th St. CHICAGO
Eastern Branch: New York





We guarantee all other cars nearly double present mileage, power and flexibility, make hills on high formerly difficult on low. Models for any car, truck, tractor, marine or stationary engine. See wonderful mileage guarantees—on gallon of gasoline for other cars. Makes old cars better than new.

Ford.....34 ml.	Reo.....24 ml.	Chevrolet...32 ml.
Buick 4.....30 ml.	Chalmers...23 ml.	Maxwell (25) 30 ml.
Buick 6.....24 ml.	Olds 6.....23 ml.	Nash 6.....23 ml.
Hudson.....20 ml.	Paige 6.....20 ml.	Lincoln 8....17 ml.
Hupp.....25 ml.	Oakland 6...74 ml.	Stdbkr Lt. 6..23 ml.
Dodge.....28 ml.	Overland 4..32 ml.	Cofo 8.....17 ml.

If your car is not mentioned here send name and model for particulars and our guarantee on it. AGENTS WANTED.

SENT ON 30 DAYS' FREE TRIAL

You can drive any car in heaviest traffic without shifting gears. Starts off on high in any weather without priming or heating—no jerking or choking. No more foul spark plugs or carbon in cylinders. No leaking of gas into crank case. Try it 30 days on our guarantee of money back if not entirely satisfied. No strings to our guarantee. **YOU ARE THE JUDGE.** Anyone who can handle a wrench can attach it. No boring of new holes or changing of operating mechanism. Write today.

AIR-FRICTION CARBURETOR CO.

15 Raymond Bldg. Dayton, Ohio, U. S. A.

Car Owners Wanted!

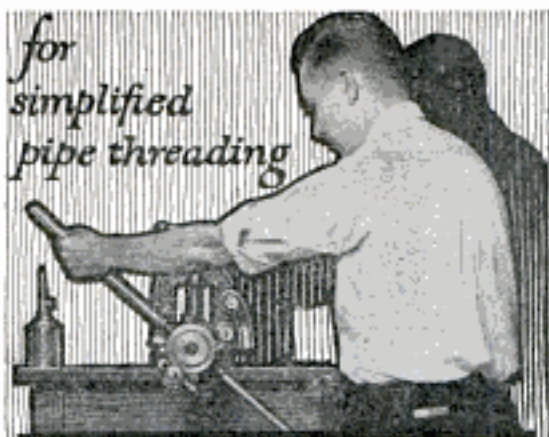
—to use and introduce the greatest improvement in Inner Tubes since autos were invented. Air Gauge in valve stem of every Tube shows pressure at a glance.



AIR-GAGE Inner Tubes

—sell on sight to almost every car owner. Save trouble, time and expense. Add one-third to tire life. Fuel salesmen make big profits selling direct to car owners. Secure own tires and tubes at factory prices. We can use 2000 more men at once. Experience and capital not necessary. **Big Free Book Explains All. WRITE TODAY.** **PAUL RUBBER CO.** Dept. 25, Salisbury, N. C.

for
simplified
pipe threading



Don't wrestle with a balky die-stock — use

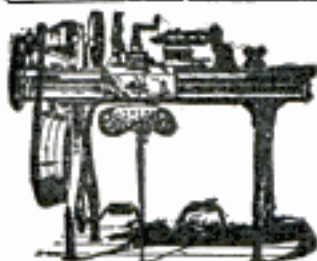
OSTER

BULL-DOG DIE-STOCKS

and get clean-cut threads the first time and all the time.

Ask your dealer
or write direct to

THE OSTER MANUFACTURING CO.
2100 East 61st Place CLEVELAND, OHIO



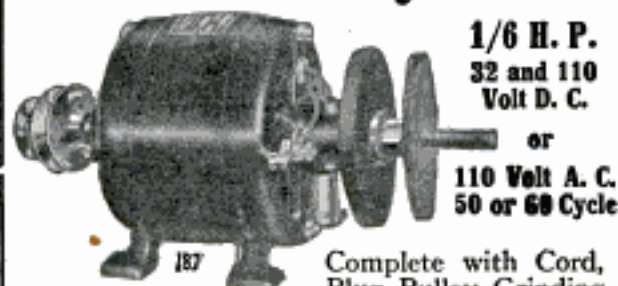
LATHES

9 to 18-inch Swing

List price \$105 and up according to size. When ready to buy send for Lathe Catalog and prices.

W. F. & John Barnes Co.
100 Ruby Street, ROCKFORD, ILL.

General Utility Motor



1/6 H. P.

**32 and 110
Volt D. C.**

or

**110 Volt A. C.
50 or 60 Cycle**

Complete with Cord, Plug, Pulley, Grinding and Buffing Wheel. Can be used for cleaning and polishing silver, sharpening knives or for operating sewing, washing or other household machine.

PRICE \$17.95 Satisfaction Guaranteed or Money Refunded

PETER BROS. MFG. CO.
ALGONQUIN, ILL.

ATKINS

METAL CUTTING SAWS



Use
Atkins
"Non-Breakable"
Hack Saw
Blades

Cut Faster, Easier and Do Not Break

ATKINS AAA Non-Breakable Hack Saw Blades are made of selected steels, hardened and tempered by an exclusive gas and oil process which makes the cutting edge extremely hard and the back unusually tough and flexible.

This not only prevents practically all blade breakage, but makes them cut faster and easier.

You can reduce your metal cutting costs and avoid losses due to blade breakage by using Atkins Hack Saw Blades. Let us prove it. Tell us what metal you cut, enclose ten cents and we'll send you a sample blade that will give you remarkable cutting results.

Saws for Every Service

No matter what kind of wood or metal-cutting you do, there are Atkins Saws to save you time, labor and money. Ask for our free booklets on saws you're interested in.



Get This FREE Book on Saws

A 32-page book that's full of practical suggestions on metal-cutting, and general shop information. Every man who buys or uses saws will find it helpful. Just write your name and address on the margin of this page and mail it to us.

E. C. ATKINS & CO., Inc.
Dept. P Indianapolis, Ind.

Makers of "Silver Steel"
Saws and Tools



E. C. ATKINS & CO.
INDIANAPOLIS, IND.

Please Mention Popular Mechanics

Put this Parks in your shop

Parks
"4-in-1"
Price
\$225

Why spend time on hand work? Why not do every job on this husky, convenient, fast-working Parks machine? Make your shop up-to-date and a money-maker. The Parks "Four-in-One" is a circular rip and cross-cut saw, band saw, jointer and borer, all in one. Angle-steel frame, channel-steel top, fully equipped and guaranteed 10 years.



Send for circular and Parks catalog showing lathes, saw-rigs, band saws and combination woodworkers for any shop requirements.

THE PARKS BALL BEARING MACHINE CO.
1500-1540 Knowlton St. Cincinnati, Ohio

Canadian Factory:
200 Notre Dame East, Montreal, Canada

PARKS

WOODWORKING MACHINES

Fix it with BERNARD PLIERS



For keeping
Wire
Fences

in shape, Bernards are the real thing. They cut cleanly, they grip like a vise, and the "open throat" swallows the wire to any length and is great for bending or stretching. None but Bernards do the three jobs so well. At good Hardware Stores.

Booklet "P" Free On Request

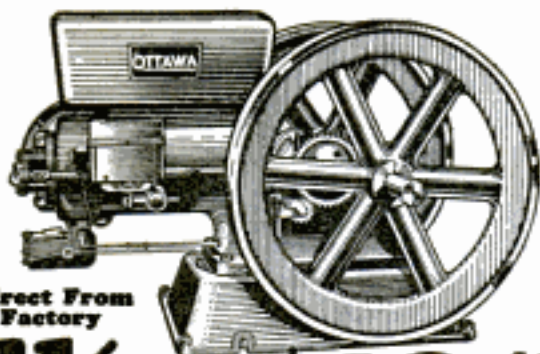


**BERNARD
PLIERS**
Wm. SCHOLLHORN CO.
NEW HAVEN, CONN.



PARALLEL JAWS

OUTSIDE CUTTER



Direct From
Factory

1 1/2 H.P. \$43.45

OTTAWA

NOW, it is easy to own one of these dependable, easiest to start engines. New Advanced Model—Twin cylinder 5 H-P and 7 H-P. Easy to operate. Better built throughout to do more work.

\$3.50 more f. o. b. Pittsburgh, Pa. Proportionally Low Prices on 2 1/2, 3 1/2, 5 and 7 H-P models.

Try 90 Days 10-Year Guarantee, Cash or Easy Terms.

FREE BIG Engine BOOK, "How to Know Better Engines." Also Special Factory Offer. Send a post card for it today. Address

OTTAWA MFG. CO.
530-C King St., Ottawa, Kans.
Dist 130-C Magee Bldg., Pittsburgh, Pa.

How to
KNOW
BETTER
ENGINES



IRON GLUE

AT ALL 5 and 10 cent STORES

10¢-15¢
SIZES

QUICK
TO
STICK

SOLD
TO
HOLD

MCCORMICK & CO., Baltimore

Interlox

ALWAYS READY to make instantly accurate inside or outside measurements.

Dealers and agents:
Request attractive
proposition.



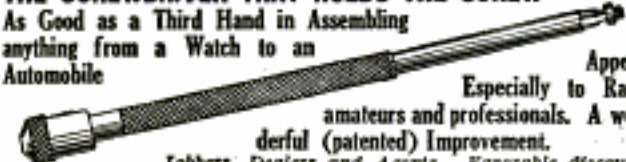
Slides
in and out.

No slow folding; strong
brass-rimmed beveled. Any
length, 2 to 5 ft., 20¢ per linear foot.

11 not at your dealer's, sent postpaid.
MASTER RULE MFG. CO., Inc.
841-43 East 136th Street New York City

THE SCREWDRIVER THAT HOLDS THE SCREW

As Good as a Third Hand in Assembling
anything from a Watch to an
Automobile



Appeals

Especially to Radio

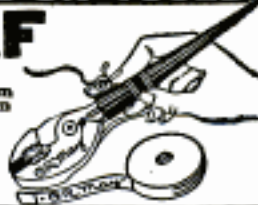
amateurs and professionals. A wonderful (patented) improvement.

Jobbers, Dealers and Agents. Favorable discounts

\$1.25 THE COBURN TOOL CO., 114 Bedford St., Boston

BURN YOUR NAME ON TOOLS WITH ARKOGRAF

Protect your tools from theft. Write any name, engrave any design on metal with electricity like writing on paper with pen or pencil. Complete outfit \$3.50, prepaid anywhere. Interesting descriptive circular free. Write today. Agents Wanted. Arkograf Pen Company 1007 Yeon Building Portland, Oregon



Saws as much as 10 Men!

One man, now, can saw 15 or more cords of wood each day with the OTTAWA Log Saw. No more back-breaking work with a cross-cut saw; no more lugging logs to a circular saw, for it's easy to take this power saw to the wood.

Fastest sawing; easiest moved—easy to start in any weather. 4 H-P Kerosene Engine—you need plenty of power. Shipped quick from nearest to you of nine branch houses.

Make Money!

Thousands making big money sawing wood for neighbors and to sell. Coal is high and may be higher—wood is in good demand for fuel. Send your name on a postcard today for full particulars about the OTTAWA.

OTTAWA 4 in 1

1-Cuts Down Trees 3-Buzzes Up Branches
2-Saws Logs 4-Does Belt Work

LOG SAW

Get Big Factory-To-User Offer!

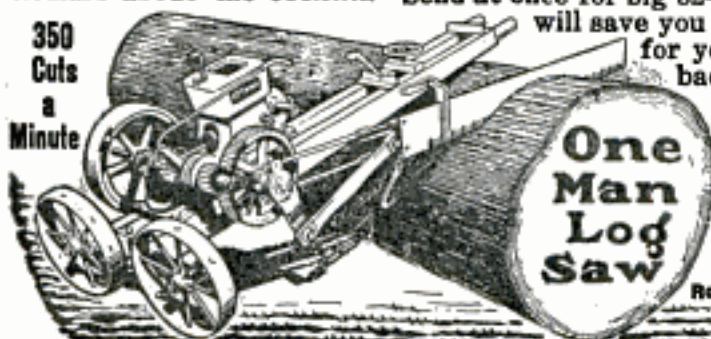
Send at once for big 32-page Free Book telling how it will save you hard work, provide cheap fuel for yourself and to sell, and pay back its cost in a short time. CASH OR EASY TERMS.

30-Day Trial—10-YEAR GUARANTEE. Send your name and address on a post card. WRITE TODAY.

OTTAWA MFG. CO.

1742-M Wood Street, Ottawa, Kansas
Room 1742-M Magee Bldg., Pittsburgh, Pa.

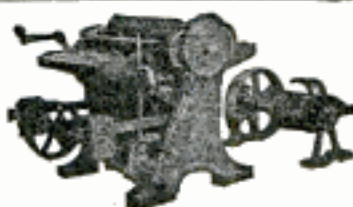
350
Cuts
a
Minute



MATHEMATICS

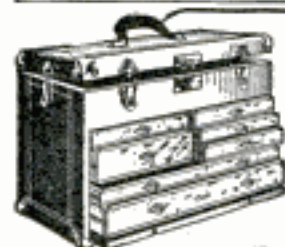
can be easily mastered with the Midget 5 in 1 Slide Rule. With this calculator you can instantly add, subtract, multiply and divide any combination of decimals, fractions, whole and mixed numbers. Also obtain all roots, powers, Logs, and Trig. Functions.

It is used at all colleges, 200 at Harvard, 300 at Cornell, etc. The Engine-Divided Scales are on white celluloid, mounted on aluminum and are grease and waterproof. Diameter 4 inches. Price with Instruction Book..... \$1.50
Leather Case 50c extra. Catalogue Free. Your money back if you are not satisfied. GILSON SLIDE RULE CO., Niles, Mich.



It is the well known quality of CRESCENT machines that justifies you in selecting one of them each time you have need for wood working machinery. The CRESCENT line is better than ever and will always give you satisfaction in every particular. Ask today for catalog of band saws, saw tables, jointers, shapers, planers, borers, planers and matchers, swing saws, disk grinder, cut off table, hollow chisel mortiser, variety wood worker, Universal wood workers.

THE CRESCENT MACHINE CO., 93 Columbia Street, Leetonia, Ohio



TOOL CHESTS

for Machinists & Toolmakers
Every tool arranged in order. No up-to-date mechanic should be without one. A Gerstner Case costs no more than some tools, and will last a lifetime. Catalog free.

Gerstner & Sons

717 Columbia Street DAYTON, OHIO

\$25 A DAY Clear Profit



—every day you work. Make \$5,000 to \$10,000 a year in the Floor Surfacing Business with the American "Universal" method. Work for yourself. Experience, special training or large investment unnecessary.

New Field; Big Profits

Better floors are demanded everywhere. American "Universal" electric machine, doing work of six men, assures BIG PROFITS in this new uncrowded field. Every floor,—old or new,—in town or city, is your prospect. Work easy to get. Profit possibilities unlimited. Positive guarantee and 5-day trial offer protects you. Write today for complete details.

AMERICAN FLOOR SURFACING MACHINE CO.
523 S. St. Clair St., TOLEDO, OHIO

Your Ideal Watch At Last

The Sensationally Popular New Styles.

Handsome watches you've seen. Designs like those used on highest priced watches. Low prices possible through enormous cash sales. First is Ladies' Watch of 14K White Gold filled (now all the rage) 25 years' guarantee on tonneau shape case—richly carved—5 jewel imported movement; hand made dial, sapphire crown, grosgrain ribbon; nest case. One year guarantee. SENSATIONAL OFFER AT \$6.75. Available in rectangular case with rectangular movement at \$11.75. Don't wait—only a limited number. SEND NO MONEY. WE PREPAY POSTAGE. You pay postman.

No risk—money back promptly if not satisfied. These are good time keepers. Write to-day for yours.

Precious Wares Co.

ART JEWELRY

389 FIFTH AVE., DEPT. 6110
NEW YORK, N.Y.





"Red Devil" Rapid Boring Auger Bits are 33 $\frac{1}{3}$ % easier boring, have 10% greater clearance, and bore with or against the grain of any wood. Style 2400—10/16 in., shown here, 75c.

Red Devil

REG. U.S. PAT. OFF.

Mechanic's Snips



YOU need a pair in the tool chest. You never know when you may have use for them.

For roof repairs, soldering jobs, for cutting tin, sheet zinc, sheet iron or copper, stove pipe, and for kindred work, you will find "Red Devils" mighty handy to have around.

They will enable you to do many things for yourself that you would

otherwise pay to have done.

Built of the best tool steel. Designed to cut with the least effort and stay sharp. Size 7 inches long.

"Red Devil" Snips No. 578—at all good hardware dealers, or if not in stock, send 90c and dealer's name for a pair.

The "Red Devil" Mechanic's Tool Booklet is a handy reference guide for users of good tools—send for it, it's free.

SMITH & HEMENWAY CO., Inc.

Manufacturers of "Red Devil" Tools

260 Broadway

New York, N. Y.

"Red Devil" Glass Cutters—the glaziers' standard tools of the world. "It's all in the wheel." Made in 40 styles. No. 084 shown here, 20c.



Different from all others—the NEW BENJAMIN

AIR RIFLE

Made on a different principle from all other Air-Rifles.

The Benjamin is really a strong air-pump used to compress the air in the air chamber to any degree of power desired. From one to six strokes of the pump give all the force necessary. Each additional stroke gives increased power. The Benjamin works on the same principle as all air-drills and air-hammers—with this difference:

You control the shooting force as you desire. Look at this block of hardwood. It shows how Benjamin power is regulated as you wish.

You can't have accidents with a Benjamin. It's safe, always, because you control the power. The Benjamin never loses shooting force, and has no springs to get out of order or shake your aim. Write us for an interesting folder about this wonderful air-gun.

If your dealer does not handle same, send direct to factory.

(PRICE \$5)
POSTPAID
BENJAMIN AIR-RIFLE & MFG.
CO., 615 N. Broadway, St. Louis, Mo.

Ask your dealer for demonstration.

Pacific Coast
Representatives
THAYER &
BOWER
Los Angeles
Calif., and
San Francisco
Calif.

\$7.50 Value for \$4.50 Metal Bottom Tool Bag

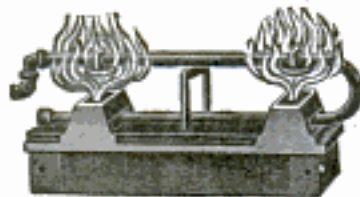


"Maderite," the most convenient general utility bag ever built for mechanics, plumbers, steamfitters. Built for extra heavy service. Non-rusting, galvanized bottom—waterproof duck body. Handles and shoulder straps of heavy halter style webbing. Nickel plated buckles. 20 in. long—6 in. wide. Sold with a Money Back Guarantee.

At all dealers, or send \$4.50 direct.

A. BRUNS & SONS, 50 Ralph Avenue, BROOKLYN

AGENTS: \$72 A WEEK



New Can't Clog Coal-Oil Burner Newest Invention

Most perfect burner ever invented. Intense blue flame. Can't clog up. Turns any coal or wood stove into a gas stove. Heats oven to baking point in ten minutes. Cheapest fuel known. Low priced. Sells everywhere. Nothing else like it. Not sold in stores. Write quick for agency.

PARKER MFG. CO., BURNER 578, DAYTON, OHIO

FREE 2 WONDERFUL PURE SILK KNITTED TIES

GREAT BARGAIN. 2 Shirts, neat colored stripes, highest quality macrae and poplin. Soft Collar. Finished beautifully.

FREE 2 Ties of finest SILK KNIT. Fast colors. Full length. With every shirt order.

SEND NO MONEY
Just name and size of shirts. Pay postman \$3.79 on arrival of 2 shirts and 2 ties. We pay postage. SATISFACTION GUARANTEED.

FREE. Pair of snap on Cuff Buttons if you send cash.
RUSH ORDERS NOW. Send for FREE Catalog of Bargains
PUBLIC TRADING CO., 253 Fifth Ave., Dept. 254, New York



Size 14 to 17.



FREE To You

Book of Factory Bargains in Stoves, Ranges, Furnaces, Furniture, Refrigerators, Farm and Home Needs

Let me send you my new free catalog and show you how to make great savings at wholesale—direct from factory, at money saving prices. *Everything guaranteed—set in your home on*

30 DAYS' TRIAL—DON'T RISK A PENNY
Your money back without question or quibble. More than 500,000 satisfied customers.

Easy Terms—Write at Once
Just send name and address. A postal will do. **W. S. DEWING, "The Stove Man."**

Kalamazoo Stove Company
395 Rochester Ave., Kalamazoo, Mich.

A Kalamazoo Direct to You

NEW LAMP BURNS 94% AIR

Beats Electric or Gas

A new oil lamp that gives an amazingly brilliant, soft, white light, even better than gas or electricity, has been tested by the U. S. Government and 35 leading universities and found to be superior to 10 ordinary oil lamps. It burns without odor, smoke or noise—no pumping up, is simple, clean, safe. Burns 94% air and 6% common kerosene (coal oil).

The inventor, H. E. Johnson, 609 W. Lake St., Chicago, Ill., is offering to send a lamp on 10 days' FREE trial, or even to give one FREE to the first user in each locality who will help him introduce it. Write him to-day for full particulars. Also ask him to explain how you can get the agency, and without experience or money make \$250 to \$500 per month.

REMINGTON PORTABLE TYPEWRITER

Dealers and Branches Everywhere

IT'S SO EASY **\$15 A DAY To Agents**



You can easily earn \$15.00 a day or more taking orders from your friends and neighbors for our fine tailoring. Orders come easy when you show our swell samples, smart styles and **EXTREMELY LOW PRICES**. We show you how—you can do it easy—you don't need any experience.

OUR SWELL TAILORING is worn by snappy dressers everywhere and big money is earned yearly by men who send us these orders. **WHY NOT GET YOUR SHARE OF THESE FINE CASH PROFITS?**

Save \$5.00 to \$10.00

We sell our tailoring at lowest wholesale prices to men who recommend and boost us to their friends. Get our **FREE SAMPLES** and pick your fine clothes at a saving of \$5.00 to \$10.00 on every suit.

FREE! Write today for big sample outfit. It will be sent FREE.

Washington Tailoring Co., Dept. X-345, Chicago, Ill.



WHICH ONE will help you win fame and fortune?

FOR half a century the world's great artists have used Conn instruments. The stars of today in concert bands, symphony, opera and popular orchestras, have risen to fame playing Conns. They accord a generous measure of their success to these superb instruments.

You will profit by following their example. Win success, profit, pleasure with a Conn, "the instrument of the artists." Remember, with a Conn you get these definite points of superiority:

Easier Blowing: each tone responds to the slightest lip pressure.

Perfect Scale: accurate intonation in all registers.

Most Reliable Action: lightest, easiest and surest, whether slide, valve or key.

Beautiful Tone: our exclusive hydraulic expansion process insures accurate proportions and perfect carriage for sound waves.

All exclusive Conn features at no greater cost. Highest honors at World Expositions.

FREE TRIAL; EASY PAYMENTS. Send postcard for details, mentioning instrument that interests you. Conn is the only maker of every instrument used in the band. We also make high grade violins and drums.

Dealers and agents everywhere. **Factory branches:**

Conn New York Co.	Conn Detroit Co.
Conn New Orleans Co.	Conn Cleveland Co.
Conn Chicago Co.	Conn Seattle Co.
Conn Portland Co.	Conn Atlanta Co.

C. G. CONN, Ltd., 1031 Conn Bldg., Elkhart, Ind.

CONN

WORLD'S LARGEST MANUFACTURERS OF HIGH GRADE BAND AND ORCHESTRA INSTRUMENTS

CULTIVATE YOUR MUSICAL BUMP

This Beautiful
DIAMOND RING



1
DOWN

WIN HER WITH THIS BEAUTIFUL DIAMOND

10 Days' Free Trial
Send only \$1.00 and this beautiful Diamond Ring will come to you without "red-tape" or delay. If not convinced it is the greatest Bargain in America, send it back and your \$1.00 will be returned. Only if pleased, pay \$3.15 a month until our Special Bargain price of only \$32.50 is paid.

10 months to pay—A few cents a day.

FREE Send for it today. It pictures thousands of amazing bargains. Address Dept. 1777

Million Dollar Bargain Book

J.M. LYON & CO. INC.
2-4 Maiden Lane, New York

BIG MONEY!

\$4.75
SPECIAL TODAY
EXTRA
SALE
BOOKS \$1.50

BIG MONEY IN SPARE TIME for you in each locality making embossed show cards and price tickets for stores and others. Easy, quick work. No training needed. New embossing machine does it all. 400% profit. Signs sell on sight. T. W. Cushing of Chicago sold \$76 first call. S. D. Downes averaged \$15 a day for 6 months. Many sell \$5 to \$10 daily. No speculation. Before you invest a penny we send you free sample cards to show merchants and convince yourself they sell at sight. Write today.

PRAEMAFIX CORPORATION OF AMERICA
Dept. 600 Geneva, N. Y.

1917
\$

Direct Factory Price for Limited Time Only
Double-Heat ELECTRIC STOVE



Newest, neatest, most economical of all Electric stoves, the Double-Heat does your cooking quicker, better, cheaper. Toasts, fries, boils in half usual time. Full size heating surface. New metallic treated reflect back ground to heating element utilizes all the heat. Operates on any lighting socket, direct or alternating current.

Direct From Factory on Approval
SEND NO MONEY

Amazing offer! Only \$1.97—and on approval! Just pay postman upon arrival, plus a few cents postage. One year full durability guarantee. If not delighted, return in five days, and every penny refunded. Order quick! Only limited number at this introductory price.

Acorn Brass Mfg. Co. 1034 Factory Bldg. Chicago, Ill.

KEITH'S \$2.50 OFFER



A new, big Plan Book, showing 112 designs and floor plans of artistic homes in frame, stucco, and brick, (your choice of bungalows, cottages or two story houses) and 8 months' subscription to Keith's Magazine—all for \$2.50.

Keith's Magazine for over 20 years an authority on planning, building and decorating homes—25c a copy on newsstands. With its help and Keith's Plans you can get the most distinctive, comfortable and satisfactory home with greatest economy.

3 big plan books (336 plans) and Keith's for 12 months—\$4.50
KEITH CORPORATION, 115 NORTH 7th STREET BLDG., MINNEAPOLIS, MINN.

Cheapest Way to Go

to work or school and recreation is on a **Ranger** bicycle. You can have your choice of **44 Styles**, colors and sizes. **30 DAYS' FREE TRIAL**. Express prepaid. **Factory-to-Rider Prices** save you \$10 to \$25.

12 Months to Pay if desired. Saved time and carefare easily meets the small payments. Parents often advance first payment.

Tires best quality, at factory prices, express prepaid. Lamps, wheels and equipment, low prices. **Send No Money**, do business direct with makers.

Mead Cycle Company
Dept. C108 Chicago

Write today for free Ranger Catalog, factory prices and material—same terms.



SQUAB BOOK FREE!

Squabs are selling at highest prices ever known. Greatest market for 25 years. Make money breeding them. No mixing feed, no night labor, no young to attend. Start small, grow big. Start now. Read how our customers sell squabs for \$12 a dozen. We have been established for 25 years. Better look into this. Let us send you, at no cost to you, our big, illustrated free book telling how to make money breeding squabs. Address

Plymouth Reel Squab Co., 634 HSL, Melrose Highlands, Mass.

FOR THE BOY'S WORK ROOM

No hammer needed to fasten up drawings, plans or charts, when you use

Moore Push-Pins

Glass Heads—Steel Points
To hang heavy articles, use


Moore Push-less Hangers
"The Hanger with the Twist"

10c pkts. Sold everywhere. In Canada 15c.

MOORE PUSH-PIN CO., Philadelphia, Pa.

"No matter how dark the outlook, keep up your courage; plain grit is half the battle. I know."

ERICKSON.



The Beginning

Those who wear them say:
ERICKSON LEGS are Wonderful
because they do not chafe, overheat or draw end of stump.



If you have had a recent amputation send for new booklet on **TEST LEGS** for beginners.

E. H. ERICKSON CO.
38-A Washington Av. N.
MINNEAPOLIS MINN.

Shaving irritation ~how to prevent it

USE
Ingram's

Therapeutic Shaving Cream. It has an exclusive medicinal property that soothes the sensitive skin—heals annoying little cuts—leaves your face smooth and cool. No need to use a lotion.

Get a jar from your druggist today—50c. If he is not supplied, send us 50c with his name and address. We will mail you a jar of Ingram's Therapeutic Shaving Cream, and a tube of Ingram's Zodenta for the teeth, free. Or send 2c stamp for sample.

Frederick F. Ingram Co.
97 Tenth Street
Detroit, Mich.

Also
Windsor,
Ont.

There
is Comfort
In Every Jar



Buescher-Grand TRUMPET

Especially easy to blow, with an improved bore and new proportions. With the mute in, it blows so softly and sweetly that it will not annoy anyone. A splendid home instrument.



The Buescher-Grand Cornet is exceptionally easy to blow, yet possesses a tone of wonderful volume. It is the same instrument with which the greatest cornetists of America have made their reputations.

Send today for Free Book, mentioning instrument in which you are interested.

BUESCHER BAND INSTRUMENT CO.
Makers of Everything in Band and Orchestra Instruments
2593 Buescher Block ELKHART, INDIANA

\$3 Cash Buys Typewriter



Balance Only \$5 Monthly
Save 35 to 60% on all standard makes—Underwood, Royal, Remington, etc. Every machine thoroughly rebuilt and **GUARANTEED**. Try five days at our expense before you buy.

WRITE at once for Free Descriptive Circular and Special Low Prices.

**5
DAYS
FREE
TRIAL**

WYNN TYPEWRITER EXCHANGE 11 Reliance Bldg.
Kansas City, Mo.

BRILLIANT SEARCH LIGHT

HUNTERS, FARMERS AND MECHANICS' Powerful Carbide Head Light, Bull's Eye Type, Long Range. Illustrated Catalog on request.

BRILLIANT SEARCH LIGHT MFG. CO., 508 South Dearborn Street, Dept. P, CHICAGO, ILL.



Business Cards that get you IN

YOUR name, business, address and phone number are important factors to a favorable and quick audience with the man you are trying to reach. No one should be without a good business card. They create immediately the impression of your importance and "GET YOU IN."

BOOK FORM CARDS

Carried in "Wear Well" Case are distinctive, beautifully lettered in either Roman or Gothic in process, Engraved effect, without use of expensive dies or plates. Used by officials and salesmen of the largest concerns in U. S.

Send \$2.00

cash with order for 100 cards and "Wear Well" cover. Give name, address, city and business (4 lines.) \$3.00 for 250 or \$4.50 for 500 cards. 10c each additional line

Note smooth edge of card when detached



State of cards held firmly by lever binder in case

COUPON

Modern Card Co., 49 E. 11th St., Chicago

Enclosed please find.....for which send me

.....Book Form Cards and "Wear Well" Cover.

My name is

City.....Phone No.....

Street address.....State.....

Additional lines at 10 cents per line:

You may have your club or business on your cards for the additional 10 cents.

SAVE 50% ON VIOLINS BANJO MANDOLINS

You cannot duplicate our prices. Buy from old established wholesale firm and save 50%—Satisfaction guaranteed or money back.

IMPORTED VIOLINS. Fine Tone Stradivarius Models. Beautiful \$20 instruments made by Europe's master craftsmen. **Imported bow and instruction course free with every violin.** Very special..... \$9.75

Mapo Tenor or Mandolin Banjos 15-inch white Celluloid head, Birds-eye Maple rim, Pearl position

and instruction book FREE. Special Order Now. Send No Money. Full postman when delivered.

P. MAPO CO. Wholesale Musical Mides. 98 Fifth Avenue New York

IMPORTED VIOLIN BOW AND COMPLETE INSTRUCTION COURSE GIVEN

FREE Wonderful Book

Tells how to learn taxidermy—how to mount birds, animals, game-animals, fishes, fur skins. Learn by mail. A necessary for hunters and nature lovers. Best methods, quickly learned, very fascinating. Success guaranteed. Decorate your home and den with splendid art. Make big profits. Write today for this fine illustrated, free book and our amazing offer.

Northwestern School of Taxidermy, 9777 Elwood Bldg., Omaha, Neb.



The
Prophy-lactic

Tooth Brush

Most of your friends use it
and profit by it



Are You Reaching for the Truth?

I will tell you
FREE

Under which Zodiac Sign were you born? What are your opportunities in life, your future prospects, happiness in marriage, friends, enemies, success in all undertakings and many other vital questions as indicated by ASTROLOGY, the most ancient and interesting science of history?

Were you born under a lucky star? I will tell you free, the most interesting astrological interpretation of the Zodiac Sign you were born under.

Simply send me the exact date of your birth in your own handwriting. To cover cost of this notice and postage, **enclose ten cents** in any form and your exact name and address. Your astrological interpretation will be written in plain language and sent to you securely sealed and postpaid. A great surprise awaits you!

Do not fail to send Birthdate and to enclose 10c.
Print name and address to avoid delay in mailing.

Write now — TODAY — to the

ASTA STUDIO, 309 Fifth Ave., Dept. 138, New York



HANES ATHLETIC UNDERWEAR

is guaranteed absolutely — every thread, stitch and button. We guarantee to return your money or give you a new garment if any seam breaks.
P. H. HANES KNITTING CO. WINSTON-SALEM, N. C.



"Been on a
vacation
Bill?"

"No, Jim — I've
stopped smoking.
Gained six pounds in a
week. You know how I
used to smoke — a pack-
age of cigarettes and a
cigar or two a day — it
sure had some hold on
me. But I'm cured —

took a scientific home tobacco treatment
— fixed me up in two weeks.

"Wasn't hard on me at all — noticed
improvement the first day — I feel like a
new man. It didn't interfere with my
work — didn't leave any druggish after-
effects — the money I saved in the last
two weeks has paid for the treatment
alone.

"Why don't you take it! It has cured
men like you and me for over forty years
— it is a doctor's individual prescription
that sure fixes you up. Just send the cou-
pon for full information NOW. No obli-
gation. All correspondence is strictly
confidential."



A Doctor's
Prescription

The Keeley Institute, Dwight, Ill.

Please send me, without any obligation on my part,
your free booklet which will tell me how to rid myself of
the tobacco habit.

Name.....

Town.....

Street..... State..... P. M. 10

Please Mention Popular Mechanics

SELF-FILLING INK PENCIL "INDEPENDENT"



Meets
all require-
ments. Self-
filling, non-leakable,
safety cap. Attached clip.
Smooth writing gold style point.

Guaranteed Improved Fountain Pen.
Eliminates fatigues. Promotes
efficiency. Writes uniformly.
A business necessity.

\$2 By
Mail

Your Name in Gold — 25 Cents Extra

AGENTS WANTED

J. C. ULLRICH & CO., 161 Washington St., New York

TAILORING SALESMEN

We Pay You Salary and Commissions

Greatest money-making line in America. Made to measure
suits, overcoats, one price, \$33.65, express prepaid, all wool, all
wool linings, hand tailored, finest workmanship. No extra
charges for style or oversize. Bigger advance commissions,
weekly salary besides. Protected territory. Apply at once.

GREAT WESTERN TAILORING CO.

837-841 W. Jackson Blvd.

CHICAGO, ILL.

RAISE BELGIAN HARES

New Zealand Reds — Flemish Giants — American Blues.
BIG PROFITS, WE PAY \$1.50 TO \$8 EACH.
Also Cavies, Mink, Skunk, Fox, Muskrat, Etc.
Easily raised anywhere. **FREE!**
Free Catalog and Contract.
Illustrated book "COMMON SENSE RABBIT
RAISING," quarterly journal, and copy of
America's leading small stock magazine, all for 10 cents. Address
Outdoor Enterprise Co., 1005 S. E. BLDG., KANSAS CITY, MO.

AGENTS 500% PROFIT

\$60 - \$200 per week. Free samples **GOLD
SIGN LETTERS** for store and office windows.
Anyone can put them on. Big demand every-
where. Liberal offer to general agents.

METALLIC LETTER CO., 433B N. Clark, Chicago

Earn \$50 a day

Goodyear Raincoats

\$1.90 each, in dozen or gross lots. Sample
sent upon receipt of \$2.15. Agents
wanted (Write for our 6 best sellers).

GOODYEAR RUBBER M'FG CO.
Dept. A. 34 East 9th Street, New York City



"I Would Not Part With It for \$10,000"

So writes an enthusiastic, grateful customer. In like manner testify over 100,000 people who have worn it. Conserve your body and life first.

The Natural Body Brace

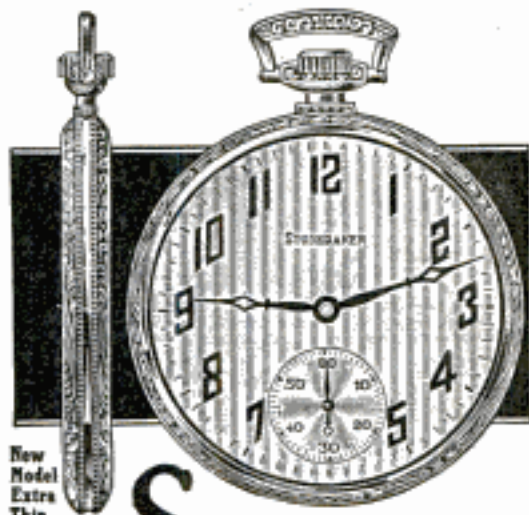
Overcomes WEAKNESS and ORGANIC AILMENTS of WOMEN and MEN. Develops an erect and graceful figure. Brings restful relief, comfort, energy and pep, ability to do things, health and strength. Does away with the strain and pain of standing and walking; replaces and supports misplaced internal organs; reduces enlarged abdomen; straightens and strengthens the back; corrects stooping shoulders; develops lungs, chest and bust; relieves backache, curvatures, nervousness, ruptures, constipation, after effects of Flu. Comfortable and easy to wear.

Costs You Nothing to Try It
Write today for illustrated book, free, with full information and measurement blank. Address
HOWARD C. RASH, Pres. Natural Body Brace Co.
223 Rash Building SALINA, KANSAS



For Children Also

21 Jewel ~ Extra thin STUDEBAKER The Insured Watch.



New Model Extra Thin

SENT FOR

\$1.00 DOWN!

Only \$1.00! The balance in easy monthly payments. You get the famous Studebaker 21 Jewel Watch—insured for a lifetime; a choice of 54 new Art Beauty Cases; 8 adjustments, including heat, cold, isochronism and 5 positions—direct from the maker at lowest prices ever named on equal quality. Write today for FREE BOOK of Advance Watch Styles.

Gold Chain FREE!

For a limited time we are giving away FREE with every Studebaker Watch a beautiful pattern Studebaker Watch Chain. Write now while offer lasts.

Mail Coupon for FREE Book of Advance Watch Styles

Send at once and get a copy of this book—FREE! See the newest, beautiful, advance styles in Studebaker Art Beauty Cases and Dials. Read how you can buy a 21 Jewel Studebaker Insured Watch direct from the maker—save big money—and pay for it on easy monthly payments.

Write! for our free book. It will post you on watch styles and watch values. Send coupon at once. Get Free chain offer today while it lasts.

Studebaker Watch Co.
Dept. 2210, South Bend, Ind.

STUDEBAKER WATCH CO.
Dept. 2210, South Bend, Indiana
Please send me your Free Book of Advanced Watch Styles and particulars of your \$1.00 down offer.

Name.....
Address.....
City..... State.....

Please Mention Popular Mechanics

Sell Shirts



Sell Madison "Better-Made" Shirts, Pajamas, and Nightshirts direct from our factory to wearer. Nationally advertised. Easy to sell. Exclusive patterns. Exceptional values. No experience or capital required. Large steady income assured. Entirely new proposition. WRITE FOR FREE SAMPLES.
MADISON SHIRT CO., 503 B'way, N. Y. City

Build This Phonograph Yourself.

TREMENDOUS SAVING IN COST
Easy, fascinating work with our SIMPLIFIED PLANS. We furnish blue prints, diagrams, motor, cabinet pieces, ready-built horn, etc. You don't need to be a cabinet maker. A few hours assembling and you will have a fine instrument at one-quarter the regular retail price. AGENTS MAKE MONEY making and selling these instruments. Write today for full details and our FREE OFFER. Address
LUPERL PHONOARTS CO.
2648 W. Chicago Ave. Dept. 6 CHICAGO, ILLINOIS



GUM 1c a pack
Chewing Gum 1c per pack
Full size—5 stick packs—spearmint, peppermint and fruit flavors. \$5.00 for 500 packs. Suitable for Premium or Scheme purposes. Deposit required. Prompt shipments.
HELMET GUM MAKERS, Cincinnati, Ohio

Clear-Tone FOR PIMPLES
Your skin can be quickly cleared of Pimples, Blackheads, Acne Eruptions on the face or body, Enlarged Pores, Oily or Shiny Skin. \$1,000.00 Gold Cash says I can clear your skin of the above blemishes. **FREE** WRITE TODAY for my FREE Booklet—"A Clear-Tone Skin"—telling how I cured myself after being afflicted for fifteen years.
E.S. GIVENS, 129 Chemical Bldg., Kansas City, Mo.



"I have averaged \$7000

Per Year for Three Years—Have Made
Over \$90 PROFIT in One Day"

That is the statement of Frank DePries, one of our live-wire representatives. Keeton of Mississippi made \$252 on his first sale. Vickers of Alabama made \$118 in one week. Conant quit a \$6,000 job to come with us.



DePRIES

**Ford
Auto
FREE!**

We have a plan whereby our active workers can get a Ford without cost, in addition to their big cash earnings. Get the plan—quick!



AGENTS WANTED

We need more men like these, because the demand for our Super Fyr-Fyter is growing by leaps and bounds. Sells to garages, stores, factories, schools, homes, hotels, auto owners. Approved by the Underwriters. If you are willing to work and ambitious to make some real money, get our plan. You need no experience, as we train you without cost for the work. No great capital required. Good territory going fast. Better write us at once.

THE FYR-FYTER COMPANY

1730 Fyr-Fyter Bldg.,

Dayton, Ohio

LOFTIS

BROS. & CO. EST'D 1858

Genuine DIAMONDS

Guaranteed

Cash or Credit

The Loftis Carved "Perfection" Diamond Ring illustrated in Solid 14-K Green Gold, Diamond set in White Gold, Bridal Blossom design.

WEDDING RINGS TO MATCH

14-K White Gold, 17 Jewels, \$35
14-K White Gold, 16 Jewels, \$29

Blue White Brilliant, Perfect Cut Diamond. Marvelous Values at \$50, \$75, \$100, \$125 and up

Over 2,000 bargains in Diamond-set Jewelry, Watches, Wrist Watches, Pearls, Mesh Bags, Silverware, etc. Sent prepaid for your Free Examination. Catalog explains everything.

CREDIT TERMS on all articles: One-fifth down, balance divided into equal payments within eight months. **SEND FOR CATALOG.**

LOFTIS BROS. & CO.
Dept. E894, 108 N. State St., Chicago, Ill.
Stores in Leading Cities

Starting a Company?

Save expenses and taxes by organizing on the popular, COMMON LAW plan under a pure DECLARATION OF TRUST. No experience required to fill in DEMAREE STANDARD FORMS, issue shares and begin doing business at once. Genuine DEMAREE FORMS are nationally known, approved by attorneys, and utilized by successful concerns throughout the United States. Send for large, free pamphlet (D-53) containing valuable information that you may need. C. S. DEMAREE, legal blank publisher, 708 Walnut, Kansas City, Missouri.

CLASS PINS

FREE CATALOG GIVE NAME OF SCHOOL OR CLUB AND NUMBER IN CLASS



Either pin illustrated made with any 3 letters and 2 figures, 1 or 2 colors enamel Silver plate, 25¢ ea., \$2.50 doz., Sterling silver, 40¢ ea., \$4.00 doz. Write for catalog of sterling and solid gold pins and rings.



3409 Bestian Bros. Co. 548 Bestian Bldg., Rochester, N.Y. 3529

SALESMEN WANTED

to sell established line of men's all-wool, made-to-measure suits, overcoats and raincoats. Unusual opportunity to earn \$75 to \$150 a week, and to advance to District Managers. Positions open now. Write to-day for full particulars.

STYLE-CENTER TAILORING COMPANY

Dept. 32-K Sixth and Broadway, Cincinnati, Ohio

Beautiful HOUSES \$900 and BUNGALOWS

CAN BE BUILT FOR AND UP
This and many others in my new book, Building Plans for Modern Homes, will save you hundreds of dollars. One of the most complete and comprehensive books of plans ever published by any architect. New edition just off the press. Nearly 500 floor plans and photographs of bungalows, Colonial houses, etc., costing from \$200 up give sizes and cost to build.



FREDERICK H. GOWING
ARCHITECT

Sent postpaid for \$2.00

101 Tremont St., BOSTON, MASS.

Free!
Get My New Book
of Factory Prices

ON
FURNACES,
STOVES and RANGES

Let me show you how to save \$40 to \$200 on the finest quality pipe or pipeless furnace ever made. Sold direct to you at **Factory Prices—\$59.95 and up.** Easy to install. Easy payments. Quick shipments. Safe delivery. 300 days' approval test. More than 500,000 pleased customers! Mail a postal or letter today—get my new Factory-to-Family Bargain Book—FREE.

W. S. Dewing
"The Direct-to-You Man"
KALAMAZOO STOVE COMPANY
302 W. Rochester Ave.
Kalamazoo, Mich.



Money-Making Opportunity for You

Selling attractive proposition to merchants on profit-sharing plan with unusual discounts allowed. Easy to sell. **EXCLUSIVE TERRITORY AND LIBERAL COMMISSION** Write at once for full details. Only one representative in each State wanted so don't delay. Dept. C.

THE CAPITAL SPECIALTY CORPORATION CO.
314-318 First National Bank, Columbus, Ohio

FASTEN IT WITH AN AJAX EYELET FASTENER

Binds Paper, Cardboard, Leather, Cloth It Saves Time by Punching the hole, feeding the eyelet and clinching it in one operation. Order from your Stationer

Machine Appliance Corp.
Dept. P. M. BROOKLYN, N. Y.



AGENTS ~ Free Proof You Can Make \$60 a Day

Amazing New Kind of Oil Burner Outsell Others Two to One. New Discoveries Cut Out Many Parts and Make a Better Burner at a Cheap Price. No Capital Needed.

YOU know how Oil Burners—devices which make any stove a gas stove—have taken the country by storm.

First the Navy used them. The gas they made was so superior to coal that they were then adapted to HOUSEHOLD use. One part of oil (kerosene), the cheapest fuel known, was mixed with twenty times its bulk in air. This made a hot, clean, intense gas, cheaper than city gas. Inserted in any stove in a minute. They did away with dirty coal and wood and cut housework in half. The very first device sold like wildfire.

The "Ford" Among Burners

Then six months ago came the device known as NU-HEAT. It was based on much later discoveries which eliminated unnecessary parts and made a better burner at a CHEAPER price. One user says, "It is the 'Ford' among gas making devices but it has 'Twin Six' efficiency."

The sales records made by the earlier burners were eclipsed completely by the records established by NU-HEAT Agents. They could offer the best burner of all at a price so low that everybody could afford one.

No wonder our agents found NU-HEAT the biggest money maker they had ever handled. Laurence Harcum of W. Va. made \$240 in one week! Mrs. Laura M. Marston of Tenn., now makes more than her husband and Harley Jackson of Mass. earns \$15,000 a year! Many others make \$150 and more a week.

Full or Spare Time

We can offer good agents in every section the biggest earnings of their lives. If you want a PERMANENT connection that should

double or treble your present earnings write us today for the wonderful story of NU-HEAT profits. Mail coupon for free sample case offer and exclusive territory. No capital required.

**WADE HILL
MFG. CO.
Dept. X39
St. Louis, Mo.**



No more fires to build. A twist of the wrist brings a high or low fire in a few seconds—warm rooms on arising—a hot oven in a jiffy.

Wade Hill Mfg. Co., Dept. X39, St. Louis, Mo.

Show me why agents double their incomes selling NU-HEAT. Explain your personal cooperation and Free Sample Case Offer. I am interested in

Full Time Offer Spare Time Offer
(Check which)

Name

Address

City State

**WRITE TODAY for
Our 168-PAGE
FREE BOOK on**

Deafness

and learn how Perfect Hearing is now being restored in every condition of deafness or defective hearing. Our "Little Wireless Phones for the Ears" require no medicine, but effectively replace what is lacking or defective in the natural ear drums. They are simple devices, which the wearer easily fits into the ears, where they are invisible. Soft, safe and comfortable.

WILSON EAR DRUM CO., Incorporated
104 Inter-Southern Bldg. LOUISVILLE, KY.

NO MORE BALD HEADS



WHEN our VACUUM CAP is used a few minutes daily. We accept no pay until you have tried the Cap 30 days and are satisfied. The Vacuum Cap is an appliance that draws the blood to the Hair Roots and starts a new healthy crop of hair. It stops Dandruff, stops the hair from falling out.

Bought by Doctors and men who know that it is the only reasonable HAIR GROWER known to science. No Drugs Used. Write for application blank, testimonials, and booklet on "HAIR," sent sealed in plain envelope, FREE.

THE MODERN VACUUM CAP CO.

0 559 BARCLAY, DENVER, COLO.



Are You All Primed?

We can supply you with Masonic books of reference, study, history, etc. Also fine aprons, regalia, novelties, jewelry and supplies.

Send for Free Catalogue X

REDDING & CO.

Publishers and Manufacturers

Dist. 25 9 West 23rd Street, New York

Sure Rupture Comfort

BE COMFORTABLE—Wear the Brooks Appliance, the modern scientific invention which gives rupture sufferers immediate relief. It has no obnoxious springs or pads. Automatic Air Cushions bind and draw together the broken parts. No salves or plasters. Durable. Cheap. Sent on trial to prove its worth.



MR. G. E. BROOKS

Never on sale in stores as every Appliance is made to order, the proper size and shape of Air Cushion depending on the nature of each case. Beware of imitations. Look for trademark bearing portrait and signature of G. E. Brooks which appears on every Appliance. None other genuine. Full information and booklet sent free in plain, sealed envelope.

BROOKS APPLIANCE CO., 126J State St., Marshall, Mich.

My Engine Will Do the Work of 6

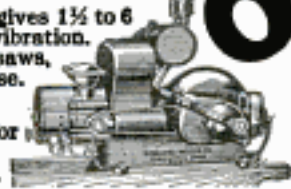


Write now for facts about this wonder engine. Same engine gives 1½ to 6 H. P. Gasoline or kerosene. Portable, light, and free from vibration. Requires no anchorage. Easy starting—no cranking. Pumps, saws, grinds and does all chores. Plenty of power for every purpose.

Low Factory Price—Free Trial Offer

Tremendous value. Thousands of satisfied users. Write now for details and free trial offer on this amazing engine.

Edwards Motor Co., 118 Main St., Springfield, Ohio



Great *New*



Invention for seekers of Health Power Beauty

Elco Health Generators at last are ready for you! If you want more health—greater power to enjoy the pleasures and delights about you, or if more beauty is your desire—write! Ask for the book on these inventions which has just been prepared. It will be sent to you without cost. It tells you how Elco Health Generators aid you in leaving the lethargy and hopelessness of bad health and weakness behind forever. Re-vitalize yourself. Bring back energy. Be wholly alive. Write today!

10 Days Free Trial—Write for Free Book!



These great new inventions generate Violet Ray, Vibration, Electricity and Ozone—combined or separate **Free Trial**

They operate on the electric light in your home or on their own motive power at less than 50 cents per year. Elco Health Generators are positively the only instruments which can give you in one outfit Electricity, Violet Ray—Vibration and Ozone—the four greatest curative agents. Send the coupon below. Get the Free Book NOW!



For All These:

Paralysis	Catarrh
Pimples	Insomnia
Falling Hair	Skin Diseases
Headache	Hay Fever
Lumbago	Neuralgia
Nervousness	Deafness
Rheumatism	Pain
Sore Throat	Development
Asthma	Neuritis
Black Heads	Obesity

Mail Coupon for FREE Book!

Do not put this paper down without sending the coupon. Don't go on as you are with pains and with almost no life and energy. You owe it to yourself to be a better man or woman. You were put here to enjoy life—not just to drag through it. So do not rest another day until you have put your name on the coupon here. That will bring the whole story of these great new inventions. Do it today—now.

Lindstrom & Company

442-448 N. Wells Street, Dept. 13-57, Chicago, Ill.

Please send me your free book, "Health—Power—Beauty" and full information of your 10-day Free Trial Offer.

Name _____

Address _____

Health
Power
Beauty

Please Mention Popular Mechanics



Get This Wonderful Ring. If You Can Tell It From a Genuine Diamond Send It Back

These amazing, beautiful CORODITE diamonds positively match genuine diamonds in every way—same blazing flash and dazzling ring of light in every light. They, alone, stand the diamond tests, including terrific acid test of direct comparison. Lifetime experts need all their experience to see any difference. Prove this yourself.

Wear a Corodite Diamond 7 DAYS FREE

Make this test. You risk nothing. Wear a genuine Corodite and a diamond side by side on the same finger for 7 days. If you or your friends can tell the difference, send it back; you won't be out a single penny. That's a fair enough. If you keep the ring, price printed here is all you pay. No installments. Remember, Corodites alone have the same cutting as genuine stones.

No. 1—Ladies' Solitaire 14K Gold S. Ring \$2.84
No. 4—Ladies' Hand-Carved Basket Setting, plat. finish \$3.96
No. 5—Ladies' Solitaire Bridal Blossom Engraved \$3.54
No. 7—Gents' Heavy Belcher 14K Gold S. Ring \$3.68
No. 8—Gents' Massive Hand-Carved Oregon Gypsy \$4.28

Carat size same. Beautiful mountings of most modern design. Choice of gold or latest white platinum finish. Unqualified 20-year guarantee. Hand-some art leather case free with each ring.

SEND NO MONEY Keep your money right at home. Just send name, address and number of ring wanted and size as shown by size of paper. Fitting end to end around finger joint. Your ring will come by return mail. When ring arrives deposit amount shown above with postman. If you decide not to keep ring after 7 days' wear, send it back and your money will be immediately returned. Send today.

E. RICHWINE CO.
19 West Jackson Blvd., Dept. 602, Chicago, Illinois
Sole Importers Genuine Corodite Diamonds

STOP USING A TRUSS

Do Away With Steel And Rubber Bands

FREE TRIAL



Inner surface is made adhesive to secure the PLAPAO-PAD firmly to the body, keeping the PLAPAO continually applied and the pad from slipping. No straps, buckles or springs attached. Soft as velvet—easy to apply.

It's the Non-Slipping, yet Non-Rigid Pad and What is Within It That Counts

FREE to 5,000 Truss Sufferers

To the extent of 5,000 sufferers who may apply I will send, ABSOLUTELY FREE, a sufficient quantity of the Plapao to positively convince them that this is the only logical, commonsense way of treating rupture. Plapao is a highly astringent medication placed within the Plapao-Pad and being absorbed through the skin, creates a wonderful feeling of relief and at the same time tends to strengthen the weakened muscles and thus permanently close the rupture opening. The process of recovery is natural, so you'll have no use for a truss—you can throw it away forever! Old and young have testified under oath that the Plapao-Pads cured their rupture—many of them long-standing, aggravated cases—without delay from work. Patent allowed in U. S. and foreign countries. Awarded Gold Medal at Rome and Grand Prix at Paris.

Send No Money—for a sufficient quantity of the Plapao is sent without charge to enable you to give it a thorough test; you pay nothing for this trial now or ever. Write for it and full information today. Address Plapao Laboratories, Block 1427 St. Louis, Mo.

PATENTS TRADE-MARKS AND COPYRIGHTS

SPECIAL OFFER — Free Opinion as to Patentable Nature

Before disclosing an invention, the inventor should write for our blank form "Record of Invention." This should be signed and witnessed and if returned to us together with model or sketch and description of the invention, we will give our opinion as to its patentable nature.

Our Three Books Mailed FREE to Inventors

OUR ILLUSTRATED GUIDE BOOK

HOW TO OBTAIN A PATENT

Contains full instructions regarding Patents, Trade-Marks, Foreign Patents. Our Methods, Terms, and 100 Mechanical Movements illustrated and described; Articles on Patent Practice and Procedure, and Law Points for inventors.

OUR TRADE-MARK BOOK

Shows the value and necessity of trade-mark protection and gives information regarding Trade-Marks and unfair competition in trade.

OUR FOREIGN PATENT BOOK

We have direct agencies in all foreign countries and secure foreign patents in the shortest possible time and at the lowest cost.

LIST OF PATENT BUYERS SENT FREE

IDEAS WANTED: Send for LIST OF PATENT BUYERS containing unsolicited letters from Manufacturers and others WISHING TO BUY meritorious patents. There is a great demand for NEEDED INVENTIONS. We endeavor to assist OUR clients in the commercial development of their inventions.



Specifications and Drafting Departments, Victor Building, Washington, D. C.

Prompt Attention
Reasonable Terms
Highest References

---FREE COUPON---

VICTOR J. EVANS & CO., Patent Attorneys

NEW YORK OFFICES
1007 Woolworth Building

CHICAGO OFFICES
1114 Tacoma Building

PHILADELPHIA OFFICES
714-715 Liberty Bldg.

PITTSBURGH OFFICES
514 Empire Building

SAN FRANCISCO OFFICES
Hobart Building

MAIN OFFICES: 765 9TH STREET, N.W., WASHINGTON, D. C.

Gentlemen: Please send me FREE OF CHARGE your books as described above.

Name Address



PATENTS

*Seventy-six
Years of Practice*

THE firm of Munn & Company filed its first application for a patent in 1846, and for seventy-six years has endeavored to keep pace with the inventive genius of the United States.

An experience of many years is at your disposal. If you have an invention which you wish to patent, send your sketches or model together with a description of your device, explaining its operation, and you will receive prompt, courteous attention.

*Write for our Handbook on
PATENTS*

A full and complete booklet on Patents, Designs, Trade-Marks, Foreign Patents, Copyrights, Labels and Patent Office Practice with an explanation about our methods, terms, etc.

All communications strictly confidential.

Keep in touch with the inventions of the world by reading

SCIENTIFIC AMERICAN

The *MONTHLY MAGAZINE* with a special appeal to every man of inventive genius. Recent rulings of the Patent Office, descriptions of the latest patented inventions, legislation and court decisions affecting patents, are noted in this authoritative publication.

MUNN & COMPANY

Patent Attorneys

672 Woolworth Building, New York City

Scientific American Building, Room 2
625 F Street, Washington, D. C.

Suite 801, Tower Building, Chicago, Ill.
601 Hobart Building, San Francisco, Cal.

Please Mention Popular Mechanics

U.S. PATENTS



DON'T LOSE YOUR RIGHTS TO PATENT PROTECTION

Before disclosing your invention to anyone send for blank form "EVIDENCE OF CONCEPTION" to be signed and witnessed. A sample form together with printed instructions will show you just how to work up your evidence and establish the same before filing application for patent. As registered patent attorneys we represent hundreds of inventors all over the United States and Canada in the advancement of inventions. Our schedule of fees will be found reasonable. The form "Evidence of Conception," sample, instructions relating to obtaining of patents and schedule of fees sent upon request. Ask for them—a post card will do.

PATENTS AND TRADE MARKS

LANCASTER & ALLWINE

480 Ouray Bldg. Washington, D. C.
Originators of forms "Evidence of Conception."

PATENTS

To the Man with an Idea

I offer a comprehensive, experienced, efficient service for his prompt, legal protection and the development of his proposition.

Send sketch, or model and description, for advice as to cost, search through prior United States patents, etc. Preliminary advice gladly furnished without charge.

My experience and familiarity with various arts frequently enable me to accurately advise clients as to probable patentability before they go to any expense.

Booklet of valuable information and form for properly disclosing your idea free on request. Write today.

Richard B. Owen, Patent Lawyer
9-303 Owen Building, Washington, D. C.
2276-E Woolworth Bldg., New York City

PATENTS

Booklet Free Highest References Promptness Assured Best Results

Send drawing or model for preliminary examination

ALL BUSINESS GIVEN PROMPT AND PROPER ATTENTION

WATSON E. COLEMAN, Patent Lawyer, 624 F St., Washington, D. C.

Can You

think of a simple, practical idea that will fill one of the many requests we have on file for new inventions? It may mean a fortune for you. Thousands of things are needed **right now**. Your brains can help. Send today for our great new book—

"Inventions and Trade-Marks, Their Protection and Exploitation" and learn more about making money from ideas than you ever knew before. It tells many things that are wanted, too.

**A postal will do—
It is free**

We Help Our Clients

without charge, to get the dollars out of their ideas—having facilities none others possess. Advice free. Don't delay—get the book at once.

American Industries, Inc.
200 Patent Dept.
WASHINGTON, D. C.

**Patents
Advertised
For Sale Free**
in Invention and
Manufacturing Supplement

Published for the man with an idea. Send for free sample copy. One year's subscription, 50c



treat bruises

and possible breaks of the skin with the antiseptic liniment. Removes pains and reduces swellings—kills germs and prevents infection. Only a few drops required. Safest for children. \$1.25 at druggists or postpaid. Liberal trial bottle, postpaid, 10c.

W. F. YOUNG, Inc.
347 Lyman St., Springfield, Mass.

Absorbine, Jr.
THE ANTISEPTIC LINIMENT

Have You An Invention?

If so the WORLD PROGRESS will show you how to **PROTECT AND PROFIT FROM YOUR IDEAS** Sample copy free. One year's subscription \$1.00. Send for free book,

"WHAT TO INVENT"

containing **SUGGESTIONS TO INVENTORS** as to Inventions Needed. We invite manufacturers to address us regarding inventions they want.

WORLD PROGRESS PUB. CO., Inc.
Room 203 Victor Bldg. WASHINGTON, D. C.

PATENTS

Trade-Marks, Copyrights and Patent Litigation

Write for advice and instructions how to proceed, costs, etc. Hand Book with illustrations of 100 Mechanical Movements sent free on request.

ALBERT E. DIETERICH
Patent Lawyer and Solicitor

Successor to Fred G. Dieterich & Co. 621 Ouray Bldg., Washington, D. C.



PATENTS

Send us sketch or model for patentability opinion and exact cost of patent. Our book "How to Obtain a Patent." Sent Free on request. It tells how to apply for Patents, Trade Marks, Foreign Patents, Copyrights, etc.; gives information on Patent Procedure; tells what every inventor should know. Thousands of inventors, who are our clients, are our references.

Chandlee & Chandlee, 25 Years' Experience.
455 7th St. Washington, D. C.

PATENTS **C. L. PARKER**
Formerly Member Examining
Corps, U. S. Patent Office
PATENT LAWYER
MCGILL BLDG.
WASHINGTON, D. C.

Patents, Trade Marks, Copyrights, Patent Litigation

Handbook for Inventors, "Protecting, Exploiting and Selling Inventions," sent free upon request.

PATENTS As one of the oldest patent firms in America we give inventors at lowest consistent charge, a service noted for results, evidenced by many well known Patents of extraordinary value. Book, Patent-Sense, free. **Lacey & Lacey, 646 F St., Wash., D.C. Estab. 1869.**



Buchstein's Fibre Limb

is soothing to your stump—strong, cool, neat, light. Easy payments. Braces for all deformities. **D. BUCHSTEIN CO.**
113 5th St. E., MINNEAPOLIS, MINN.

Send for Catalog Today

Buy Today 10 Months to Pay \$200

WE'LL send you any one of these beautiful Diamonds for a thorough examination and approval—simply send us \$2.00. If satisfied, keep and pay balance in ten monthly sums—otherwise return, and examination will have cost you nothing. We don't want your money unless you are thoroughly pleased and satisfied. **Guarantee Value Bond given with every Diamond purchased.** All transactions strictly confidential.

SWEET Diamonds are all absolutely perfect in cut, blue-white in color and superior in quality. No matter how much or how little you pay you are sure to get the utmost for your money.

Down Makes Any Article YOURS



AA1 7-Diamond Solitaire Cluster set in hexagon-shaped Platinum mounting. Hand-carved shank of white gold. **Price \$57.50**



AA3 Specially selected, blue-white Diamond set in graceful mounting of 14K Solid Gold. **Price \$90**



AA2 Gentleman's Ring, perfectly cut, beautiful blue-white Diamond in six white gold prongs. Hand-carved shank of 14K Green Gold. **Price \$60**



AA4 SWEET Engagement Ring of 14K Solid Gold, set with a perfectly cut, blue-white Diamond. **Price \$50**



AA5 Ladies' fine 15-Jewel Wrist Watch with Sapphire Jewel Stem and beautifully hand-carved case of 14K Solid White Gold. Guaranteed against repairs for one year. **Price \$20.50.**

FREE!

Send for our beautiful Deluxe Diamond Book, 98 pages in color, showing exquisite assortment of Diamonds, Watches, Jewelry, Silverware and Toilet Goods. Amazing values—all on 10 months' credit. Write for copy NOW to Dept. 63-R.



THE HOUSE OF QUALITY
CAPITAL \$1,000,000.

LW-SWEET INC.

1650-1660 BROADWAY, NEW YORK



GEARS ALL KINDS SMALL

The most accurate made and prices reasonable. We carry a complete line of gears in stock for immediate shipment. Can also quote on special gears of all kinds. Send us your inquiries. WRITE FOR CATALOGUE.

CHICAGO STOCK GEAR WORKS
105-109 S. Jefferson St., CHICAGO

THE GREATEST OF ALL
DIRT CHASERS

GIT 18 OUNCES
HAND PASTE

10¢ at F. W. Woolworth Co., McCrory and other stores

GREAT
2 IN 1
LAMP

A FLOOD OF LIGHT Indoors or Out



Remove
Shade for
Outdoor
Use
300
Candle
Power

Burns 97% Air

This great 2-in-1 (lamp and lantern) solves the lighting problem for millions who want a light brighter than gas or electricity. Requires no wiring or piping. Lights with matches. Smokeless, compact, handsomely nicked. Durable, economical—burns 97% air.

AGENTS—BIG MONEY QUICK

There's a way that brings quick and certain sales of this brilliant combination Handy-Lite. It's building profitable business for our agents in spare time.

Write for supreme selling secret and attractive agency proposition
ENTERPRISE TOOL AND METAL WORKS, Dept. 310
2441-9 No. Western Ave. Chicago, Ill.

PATENTS If You Have an Invention and Desire to Learn How to Secure a Patent

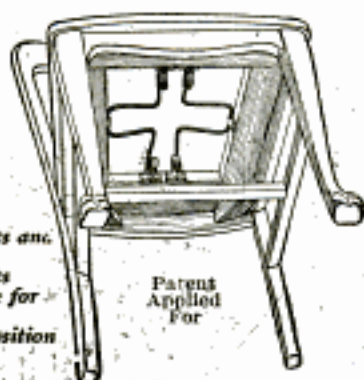
Send for our Guide Book, **HOW TO GET A PATENT**, sent Free on request. Tells our terms, methods, etc. Send model or sketch and description of your invention and we will give our opinion as to its patentable nature.

RANDOLPH & CO.
600 F St., N.W., Washington, D.C.

NAME.....

STREET.....

CITY..... STATE.....



Agents and
State
Agents
Write for
Our
Proposition

Patent
Applied
For

Hettinger's Spring Brace

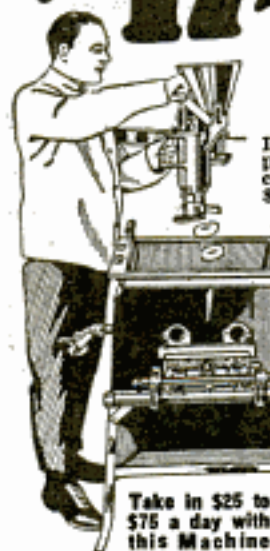
Raises sunken dining chair seats. Simple, practical and inexpensive—nothing to get out of order. Adjustable to different sizes and shapes of dining chair seats. Can be put on by anyone, from underneath, without disturbing the upholstering.

Comfortable, Resilient, Indestructible. Saves Cover and Makes a New Appearing Spring Seat.
PRICE ONLY 35 CENTS

IF YOUR DEALER CANNOT SUPPLY YOU, SEND DIRECT TO

H. C. HETTINGER, 4708-10 North Western Ave., CHICAGO, ILLINOIS

\$47.25 Profit in 4 Hours



Doughnut Making business has wonderful possibilities. Doughnuts have taken the country by storm. Enormous demand. \$25.00 to \$75.00 a day. Capacity 800 doz. a day. Doughnuts sell fast at 30c to 40c a doz. 200% profit. No experience needed. Flour ready prepared—add water—put dough in hopper—turn crank—out drop sweet, savory, golden doughnuts.

AMAZING PROOF FREE

Money-making possibilities unlimited. Put this Automatic Doughnut Machine in display window. Attract crowds. Exciting odor whets appetite. You take in money fast. Pay for the machine the first week. Jos. F. Donovan, Pa., says: "Made \$47.25 profit in four hours." Others report earnings equal or better. Big money wholesaling.

WRITE NOW Get in on the ground floor—act quickly before others start. These machines pay big anywhere—no town too small. Get full details of this new profitable business—costs nothing to investigate. Write today.

Take in \$25 to \$75 a day with this Machine

BUTLER & BUTLER, Dept. 31, 5650 Lake St., Chicago

WHITE FLAME

BURNERS make your old kerosene lamps and lanterns give a brilliant white light, better than electricity or gas. Doubles your light. Saves oil. **NO HANTLE TO BREAK.** Guaranteed safe and reliable. Highlights every user. Send now for complete sample postpaid 50 cents stamps or coin 3 for \$1.25. Money Back if Not Satisfactory. Live Representatives Wanted. Exclusive Territory. **WHITE FLAME LIGHT CO., 68 Clark Bldg., Grand Rapids, Mich.**



BIG FREE BOOK BEAUTIFUL FURNISHINGS

The very things you need now. Latest styles. Factory-to-Family low prices. Save big money. Furnish a room or whole home. As little as \$3 down; a year or more to pay. Also Pianos, Players, Phonographs. Cut out this adv.—Write TODAY, for new Fall "Larkin Book of Better Homes".

Larkin Co. Inc.

Dept. 1039

BUFFALO, N.Y., Peoria, Ill., Chicago, Ill.



Amazing Hand-Made Tools

Make \$20 Every Day!

That is a fact. Salesmen are making amazing incomes selling direct to mechanics, garages, shops, etc. These tools, put up in kits, are made by our famous Cornwell secret formula. Every tool guaranteed the finest made in the world. Salesmen make sensational demonstrations of chisels, wrenches, sockets, bearing scrapers, etc.

You Take No Money Risk!

We take all the money risk. You make instant sales and big cash profits. Tools like these never made before. Repeat orders tremendous. You make big money the very first day.

Write TODAY—Get Sample Outfit

Write or wire for complete sales plan, describing tools, money-back guarantee and offering sample outfit. Don't delay! Territories closing fast.

THE CORNWELL QUALITY TOOLS CO., Dept. 11, CU/AROGA FALLS, OHIO



PILLIOD Tool Cases Excel

Machinists, Tool Makers and Carpenters find them most satisfactory in construction, appearance, service and price. Immediate shipment.

Booklet describing 20 styles on request.

THE PILLIOD LUMBER CO. Dept. 1 Swanton, Ohio

Fibre-Lite Limbs

Easy Payments—Do Nature's Work. **AGENTS WANTED** who use Artificial Leg. **GOOD PAY.** FREE Fibre Sample. **WORMAN CO. 252-P HENNEPIN AVE. MINNEAPOLIS, MINN.** DESCRIBE STUMP TO



TYPEWRITERS



\$50 buys a brand new Corona, the Personal Writing Machine. Latest model with many improved features. Write for free booklet No. 8.

Corona Typewriter Co., Inc. GROTON, N. Y.

21 Jewel Burlington



Adjusted to the Second—Temperature—Ischronism—Positions—21 Ruby and Sapphire Jewels—Cased in a 25 year Gold Strata Case. Only \$1 down will bring you this masterpiece. Write today for free book to

Burlington Watch Company 19th Street & Marshall Boulevard Dept. 13-57, Chicago, Ill.



\$1 brings this Outfit

Artists' Model

"C Melody" **Standard SAXOPHONE**

Learn to play Saxophone! The easiest instrument to learn, it is also the most popular! Pick out tunes in an hour, as quickly as with one finger on the piano. And there's no faster way to make extra money than playing Saxophone at dance or church or theatre. Makes you a social favorite, always welcome everywhere!

10 MONTHS TO PAY! The Standard "C Melody" Saxophone is the supreme grade made in Elkhart. Choice of famous artists and teachers. The 1923 model with "bevelled sockets" makes all other Saxophones "out of date." Sent to you for 6 days' trial, to prove to you its ease of blowing, simplified fingering and golden tone can't be equalled at any price. Complete 12 piece outfit direct to you from factory at only \$1 down and \$8.00 a month. Small first payment. Sensational cut in price during this sale, no interest, no tax, not one cent extra!—Saxophone, \$10 case, self-instruction system, book of music, reed, strap, pearl keys, etc., everything you need. Quality that enables you to buy once for a life-time.

CATALOG FREE! Tells you how you can secure the greatest of Saxophones on easy terms at less than cash prices! Write today for this free book and complete information of our sensational offer! **Standard Music Co., Dept. 1422, P. O. Box 503, Chicago**



"Lighting Fixtures"

READY TO HANG

(Direct from Manufacturers)
Completely wired, including glassware.
New designs. Send for catalogue No 24.
Send for DEALERS' proposition.

ERIE FIXTURE SUPPLY CO.
STA. A. ERIE, PA.



Given GENUINE EASTMAN

Takes clear, beautiful photos 2 1/2x3 1/4 inches. Yours for introducing our new, interesting magazine, Fruit, Garden & Home, to a few friends. Only national popular priced magazine of its kind. Everyone having a garden wants it. Send me post card TODAY for FREE information.

ROLL FILM CAMERA

Clutch Pencil for Promptness

Write me with a one day after seeing this ad and I'll give you a dandy clutch pencil.

E.T. Meredith, 137 Success Bldg., Des Moines, Iowa

We Pay \$7 a Day



Wonderful invention. The SERENOLA does more than machines costing 10 times its price. Orders taken by our agents for over a thousand a week—making from \$7 to \$21 a day. Big demand. Easily carried with you anywhere. Built in just like a suitcase. Fully guaranteed. Low price.

Easy to Take Orders

No collecting. Pay you every day. Get started at once. Territory given. Write for terms.

PERRY-LUDLOW CO., S. 648, DAYTON, O.



TYPEWRITER SENSATION!

Free Trial—Use as You Pay

After trial send us only \$4.00 a month until the low total price of \$44.80 is paid, and the machine is yours. This is absolutely the most generous typewriter offer we ever made. Do not rent a machine when you can pay \$4.00 a month and own one. Think of it—Buying a \$100.00 Machine for \$44.80. Cash price \$39.85, just a little less than half its original price.

REMINGTON MONARCH

Perfect machines. Correspondence size. Keyboard of Standard Universal arrangement, 42 Keys, writing 84 characters. The entire line of writing complete'y visible at all times, has the tabulator, the two color ribbon, with automatic reverse, the back spacer, variable spacer, self-starter, in fact, every late style feature and modern operating convenience. Comes to you with everything complete; tools, cover, operating book and instructions—nothing extra to buy. You cannot imagine the perfection of this beautiful reconstructed typewriter until you have seen it. We have sold thousands of these perfect late style machines at this bargain price and every one of the thousands of satisfied customers had this beautiful, strictly up-to-date machine on five days' free trial before deciding to buy it.

We will send it to you F. O. B. Chicago for five days' free trial. It will sell itself, but if you are not satisfied that this is the greatest typewriter you ever saw, you can return it at our expense. You won't want to return it after you try it, for we are sure you cannot equal this wonderful value anywhere.

Send No Money! \$4.80 AFTER TRIAL

When the typewriter arrives deposit with the express agent \$4.80 and take the machine for five days' trial. If you are convinced that it is the best typewriter you ever saw keep it and send us \$4.00 a month until our bargain price of \$44.80 is paid. If you don't want it, return it to the express agent, receive your \$4.80 and return the machine. We will pay the return express charges. This machine is guaranteed just as if you paid \$100.00 for it. It is standard. Over half a million people own and use these typewriters and think them the best ever manufactured.

The supply at this price is limited, the price will probably be raised when next advertisement appears, so don't let it pass. Fill in the coupon today—the typewriter will be shipped promptly.

There is no red tape. We employ no solicitors—no collectors—to chattel mortgage. It is simply understood that we retain title to the machine until full \$44.80 is paid. You cannot lose. You will perhaps never have a greater typewriter opportunity. Do not send us one cent. Get the coupon in the mails today—sure.

Young Typewriter Co., Department 210A, 654 W. Randolph St., Chicago

Young Typewriter Co., Department 210A, 654 W. Randolph St., Chicago

Ship me the Remington Monarch Typewriter, F. O. B. Chicago as described in this advertisement. I will pay you \$4.00 monthly as rent until the \$40.00 balance of the SPECIAL \$44.80 sale price is paid. The title to remain in you until fully paid for. It is understood that I have five days in which to examine and try the typewriter. If I choose not to keep it I will carefully repack it and return it to the express agent. It is understood that you give the standard guarantee.

Name
Street Address
City State
Business or Occupation

Please Mention Popular Mechanics

Build this fine Crane with **MECCANO**

Every part of Meccano is a real engineering piece—pulleys, gears, strips, rods and couplings—all perfectly designed and accurately made.

Fun that never ends

You never come to the end of Meccano fun. All the models work just like the real thing. A beautifully illustrated Book of Instructions goes with each Outfit.



Send for this Free Book

It tells all about the fun of model-building with Meccano. Sent free to you for the names and addresses of three of your chums. Put No. 63

after your name for reference.



Hydraulic
Crane
Model

MECCANO COMPANY, Inc.
Division H
ELIZABETH, N. J.

In Canada—Meccano Ltd., 11 Colborne St., Toronto



Every Car Should Carry These CRESCENT TOOLS

No car is fully equipped without at least one Crescent wrench, a Crescent screw-driver, and pair of Crescent pliers. A convenient outfit is the Crescent Kit, carrying the popular size of each tool in a rattle-proof case. The outfit retails at \$2.35. Get the Crescent Kit, or separate Crescent Tools in a complete range of sizes, at hardware and accessory stores.

CRESCENT TOOL CO.
"The Crescent Wrench People"
JAMESTOWN, N. Y.

CRESCENT TOOLS

Why Burn Coal

or wood when you can burn gas in your stove or heater by installing a Uni-Hete Kerosene Burner (with exclusive 1924 features) in five minutes time. It gasifies common kerosene to the hottest and cheapest fuel known. Does away with dirt and high fuel cost. Heat regulated to any degree by valve. Increases stove efficiency 100%. Has brought joy and economy to thousands.



Special Offer to Agents
Today's fuel prices make the Uni-Hete a big money maker for agents. We have made all heating devices for 55 years. Acorn Brass Mfg. Co., 1067 Acorn Bldg., Chicago, Ill.

\$2 Brings This Genuine DIAMOND

Easy for you to own this beautiful ring or give it as a present. Simply send \$2—we will send the ring.

10 DAYS' FREE TRIAL
Wear it 10 days and if you don't agree it is an amazing bargain, return it and we will refund your money. If satisfied, pay \$1.50 a week until \$52.50 is paid.

FREE Write for catalog. Diamonds, Watches, Jewelry—\$10 to \$1,000 all on long credit. Est. 1890 Address Dept. A-26

Set in PLATINUM
Seven fiery blue white diamonds artistically set in solid platinum. Looks like \$750 solitaire. Ring is 14 Karat solid green gold handsomely engraved.

BAER BROS. Co.
6 MAIDEN LANE - NEW YORK



Beat 'em all with Auto-Wheel

You can beat 'em all, race or no race, if you are "driving" an Auto-Wheel—the speediest boys' coaster. Winning is dead easy. Only another Auto-Wheel can give you any competition. It's the self-contained, friction-reducing roller bearings which make an Auto-Wheel Coaster go so easily that it seems to be running itself. But roller bearings are only one of the many superior features in the Auto-Wheel Coaster.

Some of the other features are: rubber-tired disc wheels (3 largest models have over-size tires); steel-tired disc or wood spoke wheels if desired; all wheels interchangeable; hound brace; hand brake; special hub cap and locking pin; sides mortised as well as nailed. Every one is a reason why live boys prefer the:

Auto-Wheel Coasters and Auto-Carts

The
Auto-
Cart



Story writing contest now on. Write for full details and win a prize.

Write for Catalog which shows all models of the Auto-Wheel and also all models of the Auto-Cart, the Auto-Wheel's junior companion for your little brother and sister. If you send the names and addresses of three local coaster wagon dealers, telling which ones sell the Auto-Wheel, we will give you a year's subscription FREE to the "Auto-Wheel Spokesman," a dandy little magazine for a boy like you.

**AUTO WHEEL
COASTER CO., Inc.**
North Tonawanda, N. Y.

Custom-Made Tops Less Than Half Price SEND NO MONEY

You can attach them easily. Full instructions sent. Custom made tops with beveled plate FRAYS, LOCKS, HALL ENTRIES and wells. Free delivery 1,000 miles. For all special prices on Maxwells, Overland Fours, Dodges and Chevrolts. Describe your car. Samples and money-saving Bulletins free. Automobile Trunks for Running Board or Rear Platform. High grade—low cost.

S-C PRODUCTS CO., 767 Nicholas Bldg., Toledo, O.



BUILD SHIP MODELS

Collectors pay thousands of dollars for certain models. Send 27 cents for simple blue print plans and instructions How to Make Piase Ship Model. **MAAS & RICHTER,** 422 Brumder Bldg., Milwaukee, Wis.

22 CAL. GECO BOLT ACTION SINGLE SHOT RIFLE \$6.45

Unquestionably the most wonderful small bore rifle ever offered. Take down model, shoots 22-short, 22-long or 22-long-rifle rim cartridges; 22" round barrel.

Automatic floating ejector, length over all 39½ inches; plain front and open rear sights; oak finish stock with pistol grip and metal butt plate. No. 4..... only \$6.45.

GECO RIFLE, with genuine achromatic telescope attached, No. 10..... only \$23.95.

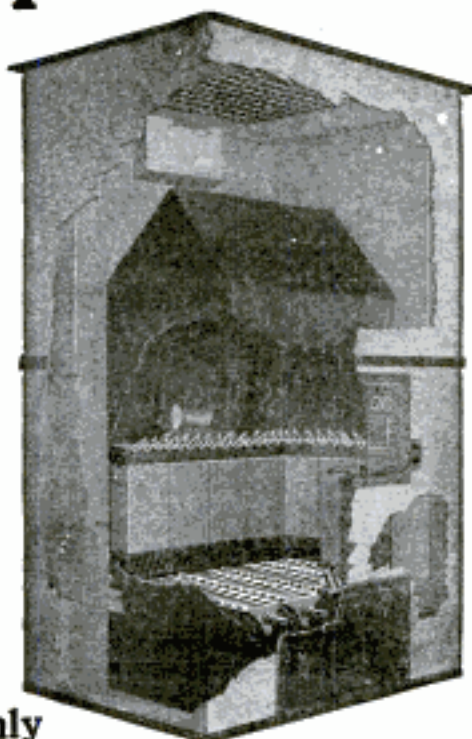
PAY POSTMAN ON DELIVERY, plus postage.

Service 100% Guaranteed or Money Back.

EDWARDS IMPORT TRADING CORP.

258 Broadway Dept. 10 New York

BULLDOG Pipeless Furnace



Only

\$10

Puts the
**BULLDOG
Pipeless
Furnace**
in Your Home!

Then Only \$10 a Month!

If you are even thinking of a furnace, write for our free catalog. The Bulldog is one furnace you must investigate. Heats without pipes! Comes completely erected. An extraordinary development in heating. Factory connections in both East and West. We ship from nearest point. Write for catalog before you forget.

Two Hours to Install

You do it yourself with nothing but a hammer and a saw. Rectangular shape (one of the common sense principles) allows passing through any door. Don't consider buying any furnace until you learn about the Bulldog!

Fits Any Floor Height

No matter what the depth of your basement or cellar may be—the Bulldog fits it. The adjustable casing (another common sense feature) takes care of this. When you read our catalog we think you will agree that this alone should be sufficient to influence you to choose the Bulldog. Mail this coupon TODAY!

Babson Bros.

19th and California Sts., Dept. 13 57 Chicago

Without obligating me in any way, please send me your free catalog and \$10 down offer on the Bulldog Pipeless Furnace.

Name.....

Address.....

Please Mention Popular Mechanics

OXO-GAS GOES to the ARCTIC



THE MACMILLAN ARCTIC ASSOCIATION

HERBERT L. BRIDGMAN,
PRESIDENT

GEORGE F. CARY,
TREASURER

H. A. LORR,
VICE-PRESIDENT

EDWARD N. GODDING,
SECRETARY

EDWIN W. SPANZ,
VICE-PRESIDENT

DONALD S. MACMILLAN,
MANAGING DIRECTOR

426 TREMONT BUILDING, BOSTON, MASS.

Wiscasset, Maine.
June 21, 1923

Gloria Light Company
112-118 E. May St.
Chicago, Illinois.

Attention of Mr. Robert L. Doran

Gentlemen:

I want to thank you for the complete outfit of burners sent to me for the snowain in my forthcoming Arctic expedition.

It is true that after complete tests we decided upon your apparatus, but nevertheless I want to thank you for the extreme care exercised in sending up additional parts. I feel sure that great comfort will be experienced by us through the use of your burners and fuel oil rather than coal.

Sincerely yours,

DBH:L

Donald S. Macmillan

Science conquers the cold of the Arctic circle! Donald MacMillan, the great explorer who went to the North Pole with Peary, has adopted OXO-GAS in preference to all other methods of heating submitted.

Heat for two years stored in smaller space and at a cost far below that of any other fuel. OXO-GAS will keep explorers thoroughly comfortable, provide heat for cooking and reduce work to a minimum.

OXO-GAS has reduced fuel space to such an extent as to make it possible to install a complete broad-casting and receiving radio outfit, thus keeping the explorers in touch with the world.

MOST EFFICIENT FUEL KNOWN TO SCIENCE

OXO-GAS is made from Kerosene, Stanolin or Distillate. THE VAPOR (4%) is mixed with air (96%).

THIS MIXTURE creates a non-carbon blue flame of high heating intensity.

WHICH HEATS indestructible perforated lava discs to incandescence, thus increasing the heat units of the fuel from 25 to 30% by refraction.

WILL OPERATE from eight to ten hours on one gallon of Kerosene, Stanolin or Distillate. Two gallons of kerosene (according to Government tests) will make heat units the equivalent of 1000 feet of city gas.

FIFTY GALLONS of kerosene equal to a ton of the best coal, a cord of wood or 25,000 feet of gas.

KEROSENE is the only fuel delivered anywhere in any quantity. The oil man can serve ten customers cleanly and efficiently while the coal man serves one.

OVER A MILLION Oxo-Gas plants are giving incomparable service to delighted users for cooking and heating.

OXO-GAS appliances are absolutely guaranteed by a responsible corporation. References: Dun and Bradstreet Mercantile Agencies or any bank in the United States.

OXO-GAS is equally efficient Summer or Winter. An abundance of heat in the Winter. Cooler than any other method of cooking in the Summer, because the heat can be shut off instantly when not in use.

OXO-GAS is, in fact, the only logical substitute for the diminishing supply of coal with its consequent high price!

These two cuts show all there is to a complete outfit: The Heater, which is put in the stove, without



making any alterations, and the tank to hold the oil. A small, flexible pipe conveys the oil to the Heater, where it is converted into OXO-GAS.



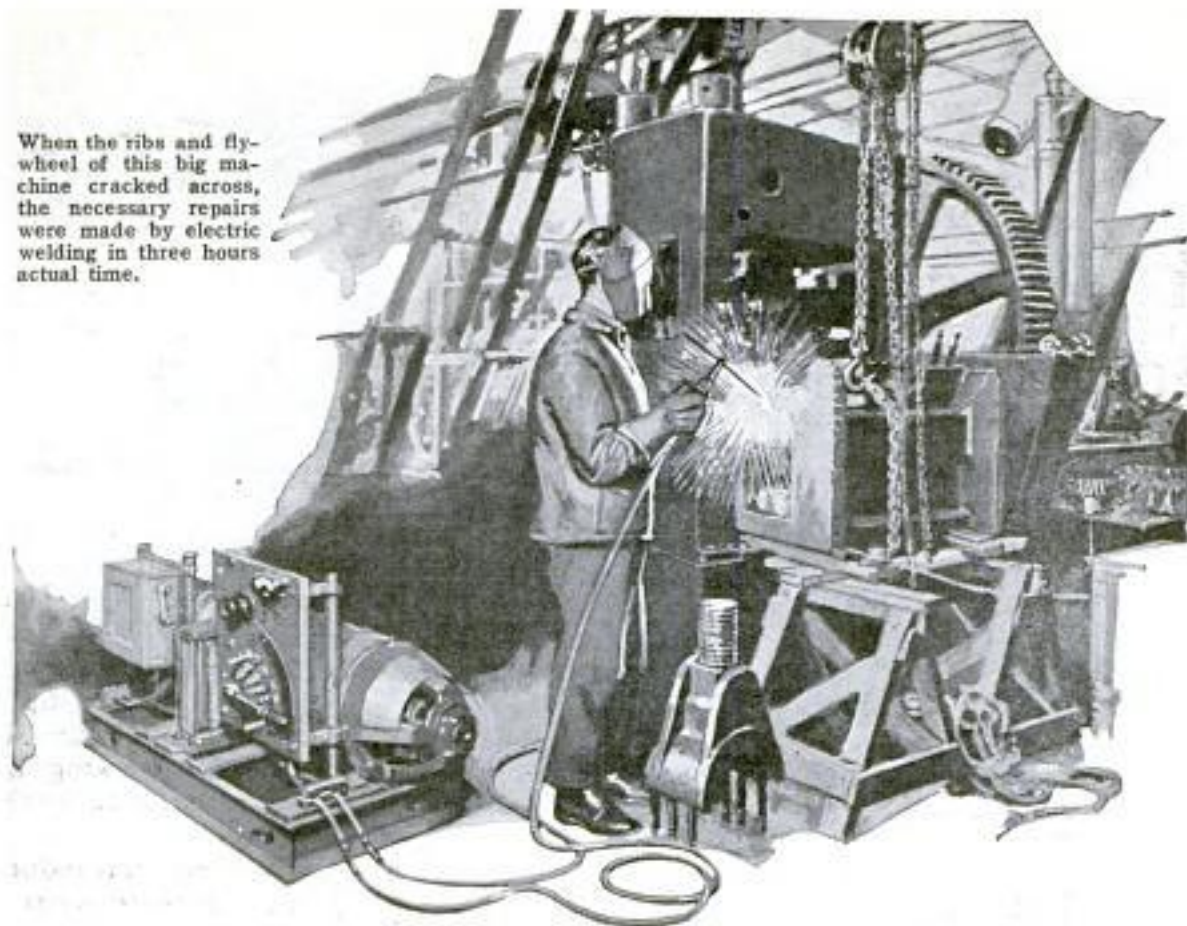
SEND FOR CATALOG

illustrating and descriptive of twenty different, distinctive designs of heaters for all purposes.

Agents Wanted Some choice territory for Oxo-Gas agencies and distributorships still open to thoroughly responsible parties. Your own locality may yet be unassigned. If you can qualify, we offer you a genuine opportunity to make \$10,000 a year and more. Just write and ask us for our agent's proposition, and we will discuss the matter with you either by mail or in person.

Gloria Light Company 90-98 North May Street
CHICAGO, ILLINOIS

When the ribs and fly-wheel of this big machine cracked across, the necessary repairs were made by electric welding in three hours actual time.



The needle that knits metals

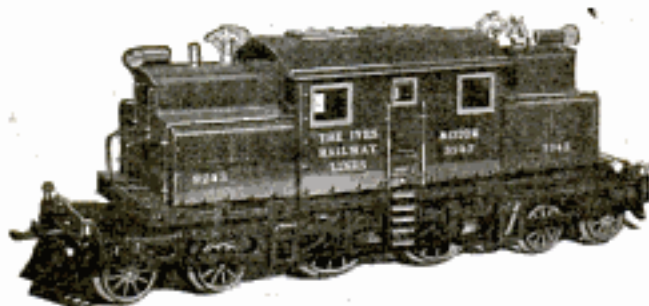


One of the interesting departments of the General Electric Company's works at Schenectady is the School of Electric Welding, to which any manufacturer may send men for instruction.

There was a time when a broken wheel would tie up a big plant for days.

Now electric welding tools literally knit together the jagged edges of metals and insure uninterrupted production. That means steady wages, steady profits, and a lower price to the consumer.

GENERAL ELECTRIC



Boys!

These are perfect working models

THINK of the fun of operating a complete Railroad System, all your own! One that is an actual reproduction, down to the littlest detail, of the most up-to-date railroads in the country.

Ives Railroads are perfect working models. There are powerful electric passenger engines, husky freight locomotives; parlor-cars, coaches and observation cars; mail and baggage cars; box-cars, tank-cars, cattle-cars, gravel-cars. You don't know what fun is, until you operate your own Ives Railroad.

If you're interested in ships, start an Ives Fleet. There are great liners, freighters, tug-boats, submarines, destroyers, pleasure crafts and racing yachts. All working models of the real thing.

Send for this book

SEND 10c in coin or stamps with your name and address and we'll mail you a beautifully illustrated book with 12 pages in full color that tells all about Ives Trains and Ives Boats.

THE IVES MANUFACTURING CORPORATION
206 Holland Ave. Bridgeport, Conn.



Ives Toys

MAKE HAPPY BOYS

NO. 1 NO. 2
\$2.63 \$3.25

NO. 3 NO. 4
\$5.90 \$4.98

WEAR SEVEN FREE DAYS

OUR MARVELOUS MEXICAN DIAMONDS

have delighted thousands of customers for 18 years. They positively match genuine diamonds. Same perfect cut, same dazzling play of rainbow fire. Stand intense acid test of side by side comparison with genuine. Mined experts positively need their experience to detect any difference whatever. Perhaps the gems you admire on your closest friends are **MEXICAN DIAMONDS** and you never knew it. Test a **MEXICAN DIAMOND FREE!** you ask nothing. Wear it seven days side by side with a genuine diamond. If you see any difference, send it back; it won't cost you a cent.

HALF PRICE TO INTRODUCE

To introduce to new customers, we quote these prices which are all you pay and just half our catalog prices.

No. 1—Ladies 1 ct. Solitaire, fine 14k gold \$3.63
No. 2—Gents Heavy Tooth Belcher, 1 ct. gem, 14k gold \$3.25
No. 3—Ladies 3 stone Duchess ring, fine platinum finish, two 5/8 ct. first water Mex. diamonds, one blue sapphire, \$5.90
No. 4—Gents Ex. Heavy Gypsy ring, platinum finish, black lining on sides, 1 7/8 ct. first water Mex. Diamond \$4.98

SEND NO MONEY paper that meets around ring finger to show size. Say which ring you want. We ship promptly. On arrival, deposit price with postman. If you decide not to keep it, return in 7 days and we'll refund your money. Write: **Y.O.D.V., Agents** write to:

MEXICAN DIAMOND IMPORTING CO.
Dept. E LAS CRUCES, N. MEX.

Exclusive Controllers of Mexican Diamonds for 18 years.

If I can show
how you can make \$75 a week without money or experience and get your pay daily, selling men's \$50.00 suits for \$31.75, would you investigate? Write **LOUIS S. SCHWARTZ, Mgr.**
GOODWEAR, Inc., Dept. 640, CHICAGO

FREE 1000 illustrations **ELECTRIC FIXTURE CATALOG!**

Write today for your copy. Save 50% direct from Manufacturer. No Middleman's Profit. **OUR SPECIAL:** 8 Room Electric Set, ready to hang, \$24.50—other bargains.

UNITED LIGHTING FIXTURE CO.
280 Bowery Dept. 120 New York

MOVIES In Your Home

Our marvellous, practical **Mov's Machines** sell as low as \$5.00—and what's more, we have wonderful films at lowest prices—with a new film exchange service. **DON'T MISS THIS!**

Write **NOW** for Free Catalogue
PARAMOUNT MFG. COMPANY
Box 1371, Dept. M2, Boston, Mass., U.S.A.

MAKE BIG MONEY

taking orders for Nationally known, hand-tailored **ARMSTRONG CAPS.** Exclusive designs, wonderful values, every cap guaranteed absolutely satisfactory. Get details now. Let us show you how you can build a business of your own—make big money right from the start. Write today.

ARMSTRONG CAP CO.
328 Marion Bldg. Cleveland, Ohio

Your Tires FREE and \$300 a Month



Agent Users Wanted

SEE how easy it is with the MASTER SALESMAN K'T, which I send Free, to make \$10 to \$15 a day in your spare time showing MELLINGER TIRES at BIG SAVING to car owners. This powerful, hand-made, oversize, non-skid Cord is guaranteed for mileage half way around the world.

The Mellinger Plan starts you in business, all or part time; no capital or experience needed. Tires shipped on approval. Lowest wholesale prices in United States.

FREE If you will boost MELLINGER TIRES, I have a surprise offer that will give you a set of tires free. Also the MASTER SALESMAN KIT with sample sections. Be first to get my free offer, again; confidential wholesale prices and big free book. Simply send name today.

MELLINGER TIRE & RUBBER CO.

5600,000 CAPITAL 1712 Grand Ave., Kansas City, Mo.

THE SHAW MOTOR ATTACHMENT Makes Your Bike Like a Motorcycle

A high grade 2 1/2 H. P. Motor attachment quickly clamped to any bike frame. Speed 4 to 40 miles an hour. 90 to 125 miles per gallon of gas.

Special Low Price Now! Write today for complete description and Special Low Prices on SHAW Motor Attachments and the SHAW Complete Motorcycles.

SHAW MFG. CO., Dept. 37, Galesburg, Kans.



We pay \$8 a Day

taking orders for New Kerosafe Burner. Makes any stove a gas stove. Burns Kerosene (coal oil). Cheapest fuel known. Fits any stove. Burns like gas.



Clean
Odorless
No smoke

Easy to get orders on account of high price and scarcity of coal. Work spare time or full time. Write for sample.

THOMAS MFG. CO. B-848 DAYTON, OHIO



Good Profits for Demonstrator Agents



Exclusive territory for the ELTO — the only full 3 H. P. fast, light "twin!" Earn big money! Turn sport into profit! We'll send you a demonstrator at factory price. Or, if you cannot be

Elto
3 HP Twin
Outboard
Motor

an active agent, but will help us find one in your territory, you can have the latest ELTO at factory price. This is open to only one buyer in new territory. Write at once for liberal offer.

ELTO OUTBOARD MOTOR COMPANY
Manufacturers Home Building
Dept. AA Milwaukee, Wisconsin



The 8 Differences Between Safe and Unsafe Bonds

THERE are 8 requirements that every bond must have to insure the safety of the investor's funds.

If a bond will pass every one of these 8 tests it may be identified as presenting the maximum of safety to the investor. If a bond will not pass one or more of these tests, it is lacking in the elements of safety that every conservative investor should insist upon.

These are the differences between safe and unsafe investments — the elements that characterize the difference between the successful and haphazard investing of funds.

Every Forman Bond has passed fully these 8 tests. Absolute proof of the safety of Forman Bonds is the successful handling of the funds of thousands of investors over a period of 38 years without the loss of one cent to any customer.

Out of this long and successful experience we have published an interesting booklet "How to Select Safe Bonds" which tells how to make the 8 tests that prove the safety of every investment. Every investor, large or small, should have a copy of this booklet. With it you will not only be able to test the safety of every investment scientifically, but you will be enabled to secure a larger income without any sacrifice of safety.

YOURS—FREE MAIL THIS COUPON

We have a limited edition of this book. It will be mailed only to those who ask for copies on the request blank below. Fill in, tear out and mail today.

GEORGE M. FORMAN & CO. 105 W. MONROE ST. CHICAGO 38 Years Without Loss to a Customer

George M. Forman & Co.
Dept. 4410, 105 W. Monroe St., Chicago, Ill.

Please mail me without cost or obligation a copy of your booklet "How To Select Safe Bonds." No solicitor is to call on me.

Name.....
Address.....
City.....State.....

SENSATIONAL SALE

TYPEWRITERS
with a
5 Year
Guarantee
FREE TRIAL
Before You Buy

This is the famous L. C. Smith typewriter which has set the world's standard for quality and service for over twenty years. It has every late style feature and modern operating convenience. Comes to you with everything complete; tools, cover, operating book and instructions—nothing extra to buy. You cannot imagine the perfection of this beautiful rebuilt typewriter until you have seen it. We do the most perfect rebuilding known to the industry. We have sold thousands of these perfect late style machines at this bargain price and every one of these thousands of satisfied customers had this beautiful, strictly up-to-date machine on five days' free trial before deciding to buy it. These typewriters will write as clean and as perfect a letter as quickly and easily as any typewriter you can buy at any price. We send it to you F. O. B. Chicago for five days' free trial. It will sell itself, but if you are not satisfied that this is the greatest typewriter you ever saw, you can return it at our expense. You won't want to return it after you try it, for you cannot equal this wonderful value anywhere.

Send TODAY For Details

The supply on this offer is limited, the price will probably be raised when next advertisement appears, so don't delay. Fill in the coupon today. There is no red tape to our free trial and easy payment plan. We employ no salesmen. It is the greatest typewriter opportunity you will ever have. Don't send us a cent. Get the coupon in the mails today—sure.

Smith Typewriter Sales Co., 300 360 E. Grand Ave., Chicago
Send me without obligation your FREE book of valuable typewriter information and sensational Special Sale Bulletin.

Name

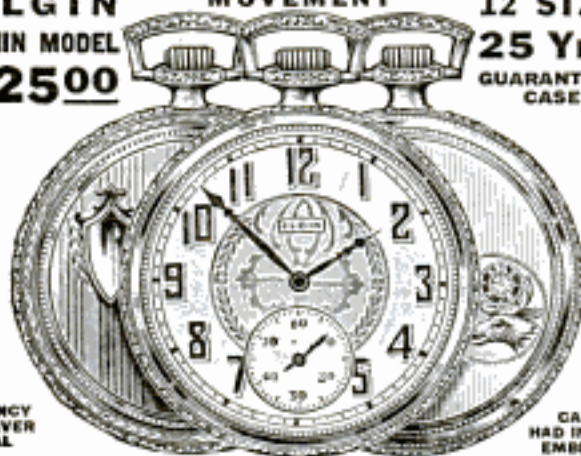
Street Address

City State

SEND NO MONEY!

"A BUSINESS MAN'S WATCH"

SOLID GOLD EMBLEM GREEN GOLD SHELL CASE
ELGIN MOVEMENT 12 SIZE
THIN MODEL 25 Yrs. GUARANTEED CASE
\$25.00



FANCY SILVER DIAL

CAN BE HAD IN ALL EMBLEMS

Send Us Your Name and the Watch Will Be Sent for Inspection
Can Also Be Had in ENGRAVED or PLAIN BACK without EMBLEM

BUFFALO JEWELRY MFG. CO.

"THE MAIL ORDER HOUSE"

Dept. 1, Brisbane Bldg. BUFFALO, N. Y.

GREEN AUTOMATIC MACHINE**ADD TO YOUR INCOME****WITH LITTLE EFFORT**
\$5 to \$10 A DAY MADE EASY WITH**New Improved Green Automatic Machine**

Sharpens, Hones and Strops all kinds of safety razor blades, in one operation, from four to six blades per minute. For both Quality and Quantity, this machine is in a class by itself. There is nothing like it on the market. Let us send you our descriptive literature explaining everything, including the "AMERICAN" Key Cutter—cuts square, angular or round slots.

AMERICAN SHARPENING MACHINE CO. (Inc.), Dept. 13, 184 W. Washington St., CHICAGO

Pleasure and Profit With a "KING" Saxophone

IT'S so easy to learn to play the famous KING saxophone! A few weeks' practice and you can play popular music—then join a band or orchestra and make good money playing for dances and other entertainments.

"KING" Band Instruments and Saxophones are easiest to play because they are built acoustically correct. Scientific design, finest skilled workmanship, careful supervision at each phase of construction make "KINGS" the most perfect instruments in the world. The tone quality is impossible to duplicate. Leading bands and orchestras insist upon "KINGS." Let us send you one for 10 days free trial.

Free Trial—Easy Payments

"KING" Band Instruments and Saxophones are fully described in beautifully illustrated circulars. Write today for complete information about our ten days free trial and our easy payment plan on any instrument. Ask for bargains in rebuilt instruments—old ones taken in trade.

THE H. N. WHITE COMPANY
5211-44 Superior Avenue, Cleveland, O.

Are You Old at 40?

A very common cause of early old age is the disturbed condition of an important gland. Even big, strong men are not exempt from this serious irregularity. Our plainly written, interesting, educational

FREE BOOK

"Why Many Men Are Old at 40" may bring a priceless message to you. It tells of a sensible

way by which thousands have relieved this prostate gland condition. It tells how sciatica, backaches, foot pains, interrupted sleep, mental depression, etc., are so often due to this gland. Sold for over five years upon a money-back-if-not-satisfied plan. Do not confuse it with massage, medication, violet rays, etc. No obligation. Write today.

The Electro Thermal Co.**Thermalaids**2126 Main St.
Steubenville
Ohio

Our BUREAU OF INFORMATION will answer all questions regarding articles appearing in this magazine.

Address Bureau of Information, Popular Mechanics Magazine, Chicago



Tobacco Is Hurting You

Look at the facts square in the face, Mr. Tobacco User. You may think tobacco is not hurting you.

That is because you haven't as yet, perhaps, felt the effects of the nicotine poison in YOUR system. For you know that nicotine, as absorbed into the system through smoking and chewing tobacco, is a slow working poison. Slow, yes—but sure.

Tobacco is lowering your efficiency. It slows a man down. Makes it harder for you to concentrate your mind on your work. You haven't near the amount of "pep" and energy you would have if you stopped using it. There's many a man twice as old as you in years who's twice as young in energy, simply because he lets tobacco alone.

Some day you will realize to what an alarming extent tobacco has undermined your system.

When your hands begin to tremble—
and your appetite begins to fail—
and your heart seems to "skip a beat" now and then—
and slight exertion makes you short of breath—
then you have a right to suspect that
TOBACCO is getting the upper hand.

Any well-informed doctor will tell you that these are only a few of many symptoms of tobacco poisoning.

And YOU know that the use of tobacco in any form is an expensive, utterly useless habit. You know you ought to quit.

Tobacco Habit Banished Let Us Help You

It doesn't make a particle of difference whether you've been a user of tobacco for a single month or 50 years, or how much you use, or in what form you use it—whether you smoke cigars, cigarettes, pipe, chew plug or fine cut or use snuff—Tobacco Redeemer will positively remove all craving for tobacco in any form in a very few days. Not the slightest shock to the nervous system. Your tobacco craving will usually begin to decrease after the very first dose—there's no long waiting for results.

Tobacco Redeemer contains no habit-forming drugs of any kind and is marvelously quick, scientific and thoroughly reliable.

It is in no sense a substitute for tobacco. After finishing the treatment you have absolutely no desire to use tobacco again or to continue the use of the remedy. It helps to quiet the nerves and make you feel better in every way.

Results Guaranteed

A single trial will convince you. Our legal-binding, money-back guarantee goes with each full treatment. We will refund every cent you pay for the treatment if after taking it according to the easy-to-follow directions, it should fail to banish the tobacco habit completely.

SEND Coupon for Free Proof

Let us send you our free booklet on the deadly effects of tobacco, together with testimonial letters from men all over the country telling how they have been absolutely freed from the tobacco habit by this simple home treatment. You could not ask for stronger proof that Tobacco Redeemer will free you from the habit than the evidence we will gladly send on request. Just mail the coupon—or a postal will do.

NEWELL PHARMACAL CO.

Dept. 300

St. Louis, Mo.



Free Book Coupon

NEWELL PHARMACAL CO.

Dept. 300

St. Louis, Mo.

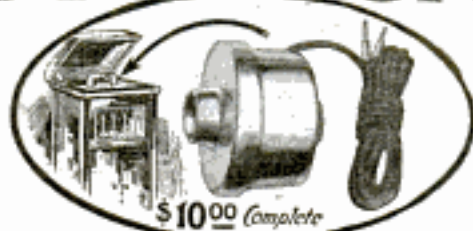
Please send, without obligating me in any way, your free booklet regarding the tobacco habit and proof that Tobacco Redeemer will positively free me from the tobacco habit or my money will be refunded.

Name

Street and No.

Town State

Morrison



Loud Speaker

Deep Notes—Sweet Notes

Both come equally true-toned and full-volumed over your Radio when your phonograph or horn has a Morrison Loud Speaker.

Perfect Reproduction

The real joy of radio, is assured you. No rattle or vibration, no metallic harshness, even when the amplification is extreme.

Anyone can attach the Morrison Loud Speaker to the tone arm of a phonograph in a moment's time. A slight adjustment of the knob or dial on the rear adjusts the tone, soft or loud, as you wish. Adaptable for use on any bulb set, with one or more stages of amplification. Sold on a money-back guarantee. Price, complete, with five foot cord—nickel finish

\$10.00

Order from your dealer or direct from us. Beautifully illustrated catalogue sent free.

Dealers If you are interested in one of the fastest-selling Radio Units on the market, wire or write at once for our proposition—it is interesting.

MORRISON LABORATORIES, INC.
337 Jefferson Ave., East DETROIT, MICH.

"UNITED" Radio Instruments

improve the range, clearness and tone quality of both nearby and distant broadcasting. Voluntary testimony from appreciative users all over the world leaves no doubt about this. The reasons are in the instruments themselves—their electrical correctness, and their precision workmanship, from better-than-need-be materials.



"United"

Amplifying Transformer

Audio Frequency, Magnetically shielded. Scientifically insulated. Sturdily constructed. Micrometered to a 1-1000-inch exactness. Ratio 5 to 1. Handsomely finished in nickel and black enamel. Efficiency unsurpassed. Loud, clear, no distortion. Price, complete, postpaid..... **\$4.50**

"United" Variable Plate Condensers

Remarkably delicate selectivity. Hard aluminum plates, held mechanically in perfect alignment, free from "shorting" troubles. 3 to 45 plate sizes, with and without Vernier Dial and Knob.

If your dealer can't supply you, remit to us and give his name and address.



UNITED MFG. & DISTRIBUTING CO.

9705 Cottage Grove Ave., Chicago, Illinois
New York Office: 50 Church Street, New York, N. Y.
San Francisco Office: 709 Mission St., San Francisco, Cal.



PRICES REDUCED

FROST-RADIO JACKS and No. 139 Cord Tip Plug

The following substantial reductions have been made in prices of Frost-Radio Jacks and Cord Tip Plug. These jacks are made with pickled brass frames, polished all over. No. 139 Cord Tip Plug is smallest, neatest plug made.

Note these new low prices

No. 133 Open Cir. Jack 60c No. 135 Filament Con'l Jack 85c
No. 134 Clo'd Cir. Jack 70c No. 136 Filament Con'l Jack 90c
No. 131 Dble. Cir. Jack 80c No. 130 Frost-Radio Jack 90c
No. 139 Frost-Radio Cord Tip Plug 50c

HERBERT H. FROST, Inc.
154 WEST LAKE STREET CHICAGO, ILLINOIS.
30 Church Street, NEW YORK



"Read'em" Binding Posts

WITH KNOBS That Won't Come Off

Anyone can "read 'em." All popular styles—Antenna, Ground, Fones, A and B Battery plus and minus—abbreviations of different names engraved on knobs. Ask your dealer for "Read 'em"—the kind for real Radio fans. If your dealer does not have them, write direct.

The Marshall-Gerken Co.
Manufacturers
Dept. H. Toledo, Ohio

MAKE \$120.00 WEEKLY IN YOUR SPARE TIME

Sell what the public wants—long distance radio receiving sets. Two sales weekly pays \$120 profit. No big investment, no canvassing. Sharpe of Colorado made \$955 in June. Representatives wanted in every county at once. This plan is sweeping the country—write today before your county is gone.

OZARKA, 801 Washington Blvd., CHICAGO

RADIO CATALOG

CONTAINING 14 UP-TO-DATE HOOKUPS AND LIST OF
STANDARD QUALITY PARTS AT REDUCED PRICES
SEND 10c TO COVER COST OF MAILING
SERVICE AND QUALITY GOODS BUILT THIS HOUSE
GREAT LAKES RADIO CO.
136 W. LAKE STREET Dept. P. M. CHICAGO, ILL.

BRAINS in a Blow Torch

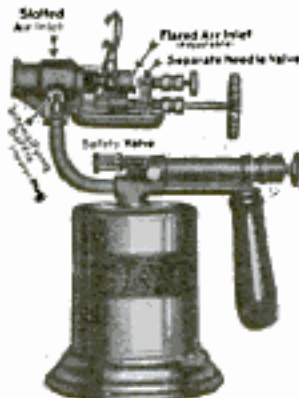
USE PRESENT DAY GASOLINE OR KEROSENE

Here's a blow torch that's a piece of real engineering. Everything about it demonstrates that the men who designed it knew to a hair line just how a blow torch had to be built to do a quicker, better job, and to be **SAFE, POSITIVELY SAFE.**

TURNER BLOWTORCH
Safe as a Candle

It cannot be matched in value. Quality permeates all through from the pistol grip handle to the seamless one-piece tank on to the famous super-heating Turner burner. It's the world's fastest seller. Thorough comparison with all others has made it so. To be **SAFE and SECURE**, order one today — **NOW!**

400° MORE HEAT



Go to your dealer and judge for yourself, or if you prefer we will send you one direct.

\$8.25

Postpaid

THE TURNER BRASSWORKS
Industry Ave., SYCAMORE, ILL.

The World's Largest Exclusive Manufacturers of Blow Torches, Fire Pots and Brazers.

Frank D. Pearne, Radio Authority, Says—

"The only reliable way to determine if 'B' Batteries are still capable of service is by testing with a Voltmeter." Thousands of radio fans are using the

Indian Head

Every radio fan needs this Pocket Voltmeter. Tests "B" Batteries up

to 45 Volts. Guaranteed accurate. Sent anywhere in U. S. or Canada, Parcel Post Prepaid, on receipt of money order for \$1.49. Indian Head Pocket Ammeter at same price. Please send 2¢ stamp for our list of Radio Bargains. Indian Head Company, Dept. 1, 417 S. Dearborn St., Chicago, Ill.

POCKET
VOLTMETER \$1.49
POSTAGE
PREPAID



RADIO PARTS

At wholesale prices.
Send for price list.

SYPPER MFG. CO., TOLEDO, OHIO

Send for **DEALERS**
Catalog

HARRY ALTER'S
"POCKETBOOK"
is a monthly net price catalog of Radio, Electrical and Lighting supplies. All good dealers should have a copy—get on our mailing list now. No obligation. Use your letterhead.



HARRY ALTER & CO.
WE SELL WHOLESALE ONLY
OGDEN BOUL. & CARROLL AV. CHICAGO

The "EZTOON"

(Easy-Tune)

Radio Dial

is two dials in one
with a 40 to 1 ratio



Gives a wonderfully fine Vernier adjustment. Stations that have always baffled you can be tuned in or out at will, with *one hand*. A quick, sharp, accurate tuner.

Saves the expense of a second set of adjustable plates on the condenser. Increases the sensitiveness and working efficiency of condenser, variometer, variocoupler, rheostat, potentiometer or tickler on all types of radio receivers.

Does away with friction springs, brakes and cogs or rubber clad gearing. No back lash or lost motion.

Attach to any instrument (3/16 in. or 1/4 in. shaft) without drilling or marring panel. Just tighten one set screw with a screw driver.

Sold under positive-money-back guarantee
3 in. dial, \$2.00 4 in. dial, \$2.25

Sent by parcel post prepaid

Attractive quantity discounts to manufacturers, jobbers and retailers. Send for circular.

BUTLER MANUFACTURING CO.
3234 W. Washington St., Indianapolis, Indiana, U. S. A.



Add-A-Unit Line

The ideal way of building a Radio Set—least labor, no "fussing"—least cost—and your set is flexible to meet all new conditions, hookups and discoveries as they arise.

Each unit is complete, with its own Bakelite panel, dials, knobs, contact points and wiring.

No shopping around for all these parts. Yet you have the excitement of testing out all the new hookups, by making new combinations of these standardized units.

RPM units include:

Variometers mounted and unmounted, variocouplers mounted and unmounted, Coupled Circuit Tuners mounted and unmounted, Detector Units, Audio Frequency Amplifying Units, Radio Frequency Amplifying Units, and a new type mounted or unmounted variable condenser—capacity from zero to .0006237 M. F.

RPM instruments are all moulded Bakelite. Mounted units come with uniform engraved panels. They are backed by an absolute guarantee of workmanship. Their splendid performance has made every user a proud booster for the RPM Unit line.

Send for our circular of these units and suggested hook-ups.

Radio Products Mfg. Co.
667 West 14th St. Chicago, Ill.



National Audio Frequency Transformers

There are many reasons why National Transformers are demanded and used by the majority of experts and amateurs—greater volume—absolutely no distortion—no interaction between fields—perfect results on any stage of amplification and with any type of tube—scientifically perfect—sturdy construction—beautiful design—highly nickel finished. If your dealer cannot supply—order direct mentioning his name. Jobbers and dealers write for sales proposition.

\$4.00
postpaid



NATIONAL TRANSFORMER MFG. CO.
154 Whiting St. Dept. 1010 Chicago, Ill.

Why Put a Poor Link in a Good Chain?

The best hook-up, with the best condenser, carefully wired and with the best tubes will not give the best results without the best Transformers.

All-American Audio Frequency —Radio Frequency Transformers



Radio Frequency
Transformer

have been proclaimed
in actual use the
standard of the Radio
World.

Send 2c for postage and
we will send you our
illustrated book of suc-
cessful hook-ups.



Audio Frequency
Transformer

RAULAND MFG. Co.
200 No. Jefferson St., Chicago, Ill.

2 BIG FOOTBALL SPECIALS

**\$7 RUGBY \$3
SHOES, Now**

Finest quality leather,
best workmanship,
cleated, made to give
best service. Give size.

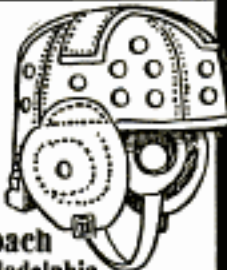
Money Back if Not Satisfied

Moskowitz & Herbach
512 Market St., Philadelphia

Sporting Goods Dealers for
27 Years

**\$10 Head
Harness
Now \$9**

Finest
quality
cowhide
& plunkin.
Felt-lined,
reinforced.



Ukulele Free!

Genuine Koa Wood
Finish Hawaiian Ukulele. Sweet ringing
tone. Given free with Short-Cut
Ukulele Instruction Course.

Clip
this Ad

**Learn to Play by
In One Hour!** our am-
azing new
copyright course. No months
of practice—just one hour.

Send No Money

for course and FREE Ukulele outfit. On
arrival deposit with postman only \$2.98 plus
a few pennies postage. We guarantee com-
plete satisfaction or money refunded. Send now
FERRY & CO, 75 W. Van Buren, Dept. 1770 Chicago, Ill.





World Radio and Auto Batteries SAVE YOU 50%

WRITTEN 2 YR. GUARANTEE

We maintain the same high quality material and workmanship found on the most expensive batteries and still are able to allow our remarkable low sale price by greatly reducing our overhead and sale costs.

READ SPECIAL OFFER BELOW

AUTO PRICES

6 Volt, 11 Plate . . . \$13.25
Ford, Chev, Mitchell, Bu., Grant,
Egin, Yale, Baxon.
6 Volt, 13 Plate . . . \$15.25
Overland, Buick, Geo, Paige, Hud-
son, Nash, Stude., Dorr.
12 Volt, 7 Plate . . . \$18.00
Maxwell, Dodge, Regal, Frank, Bris-
coe and Crow-Eikhart. Give year
and model of car.

RADIO PRICES

Special 2-Volt Storage Battery \$5.00
For W. D. 11 and W. D. 12 tubes.
Will run 200 hours on one charge.
Rechargeable.
Special 4-Volt Storage Battery \$8.00
For U. V. 199 tubes. Same features
as 2-volt.
4-volt, 60 amp. . . . \$10.00
4-volt, 80 amp. . . . 12.50
4-volt, 100 amp. . . . 14.50
4-volt, 120 amp. . . . 16.00

Send No Money We ship C.O.D. subject to inspection, or will allow 1/2% discount for cash with order. Shipment made same day order is received. Have 50% on your next battery and get better service and longer life. Written 2-yr. guarantee is your proof of satisfaction. Order NOW!
Special Offer: Just clip this ad, mail in with order, and we will include one Eveready "B" battery or one auto spotlight free. Accept this liberal offer now before it is withdrawn.

World Battery Co., Dept. 6
1219 S. Wabash Ave., Chicago, Ill.

GOLD SEAL HOMCHARGER

The World's
Most Popular
Battery Charger



—silently and efficiently
charges your radio or
automobile battery over
night for a nickel. No
stopping—no sticking—
no fuss—no trouble.
Self-polarizing—high charging rate—fin-
ished in mahogany and gold—approved by Under-
writers. Price \$18.50 complete with ammeter (\$25.00
in Canada)—no extras to buy.

LOOK FOR and INSIST ON the GOLD SEAL
WRITE FOR FREE BOOKLET
**THE AUTOMATIC ELECTRICAL
DEVICES COMPANY**
129 W. THIRD ST.
CINCINNATI

Have You Been Introduced To These New Words?

Thousands of NEW words have come into the language. Are you making them a part of your vocabulary? Can you spell, pronounce, and define them? The "Supreme Authority"

WEBSTER'S NEW INTERNATIONAL DICTIONARY

407,000
Words

6000 Ills.
2700 Pages

Growth in all activities of
modern life may be traced by the NEW words
in WEBSTER'S NEW INTERNATIONAL

Here are samples:

Czecho-Slovak	Fascista	Red Star	Schick test
junior college	realtor	B. L. E.	rotogravure
capital ship	vitamin	paravane	Air Council
Devil Dog	narcism	soviet	mystery ship
overhead	nacelle	Riksdag	agrimotor
megabar	precool	zircite	plasmon
duvetyn	cyper	kafirin	askari

and thousands of others



WRITE for a sample page of the New Words, specimen of Regular and India Papers, also Booklet "You are the Jury," prices, etc. To those naming Pop. Mechanics we will send free a set of Pocket Maps. G. & C. MERRIAM COMPANY, Springfield, Mass.

G. & C. MERRIAM Co., Springfield, Mass.
Send sample page of New Words,
specimen of Regular and India
Papers, Free Maps, per P. M.
(Your name and
address)

Our BUREAU OF INFORMATION will answer all questions regarding articles appearing in this magazine. Address Bureau of Information, Popular Mechanics Magazine, Chicago.

Tobacco

To introduce our old mellow sweet Green RIVER will sell 10 pounds, Mild Smoking \$1.95, Green River and Burley mixed \$2.55, Green River Chewing \$3.45. Free with each 10 pound order Cigarettes \$1.00. Wellingtons Free. Brier

Pipe, Postage Extra. Satisfaction Guaranteed. Pay on delivery. Write for Price list. KENTUCKY TOBACCO CO., Box 627, Owensboro, Ky.

Will a Ford Go 66 Miles on 1 Gallon Gas?

Or Other Make Do Equally Well?

A remarkable invention known as VIX Vapor HUMIDIFIER has been patented in this and foreign countries by **Walter Critchlow, Suite 357, 716 Madison, Chicago, Ill.** The success of this wonderful device is shown by several thousand reports received from users of the HUMIDIFIER, from which the following few were selected:

Geo. B. Cousins, of Ill.: "Last Sunday with the VIX on, we drove up to Nuttall, 33 miles, and back, a total of 66 miles, on a trifle over 1 gallon of gasoline."

J. D. Workman, of Kansas, with CUDAHY PACKING CO.: "Been getting 15 miles to the gallon without the VIX. Sunday with the VIX on I drove 40 miles with four in the car on a trifle less than 1 gallon of gas; expect to better that after awhile."

Berwin C. Fuller, New Hampshire: "The VIX is even better than you claim it to be. I drove over to Manchester, 16 miles, and back to Nashua, 32 miles, on a little over 2 quarts of gas, so you can see I am getting more than 50 miles to the gallon of gas."

C. E. Porter, St. Louis, Mo., President PORTER ADJUSTMENT CO.: "On Sunday drove to Terre Haute, Ind., and return; 372 miles, used 13 1/2 gallons of gas, average 30 2-10 miles per gallon; which I consider wonderful."

Charles McClain, of Iowa, TRUCK: "My truck used 35 to 40 gallons of gas a week; last week on the same run with the VIX on we used 20 gallons. Going to put them on all my other trucks."

F. W. Wheeler, Calif.: "I get from 35 to 38 miles to the gallon with my 1920 Ford and the VIX Vapor HUMIDIFIER I got of you two years ago."

Mr. Critchlow has well over 2,000 similar letters touching every phase of car operation from proud users of all makes of cars. He states that the HUMIDIFIER will do these things:

1—Eliminate the carbon from your motor, and then keep it free from carbon, and all carbon trouble in the motor; do away with frequent spark plug cleaning, and valve grinding from carbon pitting.

2—Cool the motor better, by relieving the vapor pressure in the radiator, and by cleaning the motor and giving a perfect clean running engine.

3—Use less oil; authentic tests show a 10% to 33 1/2% saving in oil used.

4—Use less gas; authentic tests show saving of 1/4 to 1/2 gas required to go certain distances; many users report even greater savings.

Mr. Critchlow gives one HUMIDIFIER free to help introduce it. Every Car Owner should write for one. Give make of car. Address Walter Critchlow, Suite 357, 716 Madison, Chicago, Ill.

8 Hr. BATTERY CHARGING

Pays Big Profits

Own your own big money-making battery charging business.

Small cash payment brings you 8 hour charging outfit. Easy terms of only \$30 monthly let your profits pay balance with nice surplus besides. Thirty day free trial on money back guarantee. His patented voltage-regulating winding absolutely prevents reversing. Saves current. You can easily clear \$150 to \$200 every month. Write today for information.

HOBERT BROS. CO. Box M102 Troy, Ohio



GUARANTEED
14 Kt. GOLD
FILLED 10-
JEWEL LEVER
MOVEMENT

MEN'S

Special

Here's a really high grade watch at 1/2 usual retail price. We give such unusual values as we are large manufacturers selling direct to you. This watch fitted with well-known Consumate 10 jewel lever movement, 14 Kt. gold filled, 20 yr. case, latest thin model, plain polished back and edge. Adjusted and regulated to keep excellent time. Written guarantee of "Satisfaction or money back" with every watch. Not necessary to send money with order. Pay on arrival. Free; gold filled knife and full length Waldemar chain for limited time only. Order today. Handsome jewelry bargain catalog Free with order. Supreme Jewelry Mfg. Co., Dept. 10142, 434 B'way, N. Y.





Diagram showing exact shape of tracks photographed above

Raccoon tracks were shown in September. Can you guess the tracks in this issue? Study them carefully. The answer will appear in November issue.

"Crack Shot" A well-named rifle for it's certainly accurate. The only rifle at the price, specially adapted for smokeless powder.

A Stevens is no weakling

You get a sturdy rifle that does a man's work

You *don't* want to get a toy. You want a gun that'll bring down the game.

That's Stevens—rifle or shotgun—as accurate as the day is long.

It's knowing how. When a Stevens barrel is rifled, the last cutting removes less than *one thirtieth of a thousandth part of an inch*. You can't beat that barrel for accuracy.

And for lasting qualities—there's many a man in his fifties knocking over game with the same Stevens he used when a boy.

And you're willing to look Stevens prices square in the face. For they're more than just reasonable—Stevens prices are *low*.

Ask at your dealer's or write direct for our interesting catalog.

J. STEVENS ARMS COMPANY
Dept. 543 Chicopee Falls, Mass.

Owned and Operated by the Savage Arms Corporation

Stevens

Just Out 13th Edition

A NEW AND GREATER

Dyke's Automobile Encyclopedia

Entirely Rewritten, Rearranged and Illustrated
Greatly Enlarged; 1238 Pages, 4143 Illustrations

A Practical Book for Everybody



The Repairman will find this book a ready reference and guide.

The Auto Owner will know how to diagnose troubles and know when repairs are done right.

The Student learns the fundamental principles, the key to a successful repairman.

This Book Will Teach You to Become

An Expert Automobile Repairman, not only on testing, adjusting and repairing engines, carburetors, clutches, rear axles, differentials, tires, etc., but an Electrical Expert on ignition, generators, starting motors, storage batteries, etc. Diagnosing any trouble will be easy.

Don't wait—Order Now!

Cloth \$6.00 — Limp American Morocco \$7.50 Postpaid

Popular Mechanics—Book Dept.

200 E. Ontario St.

Chicago

How to Wind D. C. Armatures

Those in need of this information will be glad to know that Mr. W. E. Hennig has been able to simplify this difficult yet important subject. His book containing all diagrams heretofore scattered in many books, avoids as far as possible all mathematical and technical discussions. 205 Pages. Illus. in colors. Cloth Binding.

Price \$3.50 Postpaid

POPULAR MECHANICS BOOK DEPARTMENT, 200 E. Ontario Street, CHICAGO



Small Steam Engines and Boilers

Gas and Gasoline Engines
 $\frac{1}{8}$ H. P. Up

Pumps, gears, model makers' supplies. Sent postpaid (2 dimes preferred) or 20c stamps.

Modern Engine & Supply Co.
334 Monadnock Bldg., Chicago



AGENTS!

If you are making less than \$150 a week, better write for information about selling SAAL HEAVY OIL SYSTEMS.

H. G. SAAL CO., Dept. 701, 1800 Montrose Ave., CHICAGO

FOLDING SAWING MACHINES \$21.95

Fitted with Atkins Silver Steel Guaranteed Saw



9 cords in 10 hours by one man. It's King of the woods. Catalog X115 free. First order gets agency. Established 1890.
FOLDING SAWING MACHINE CO., 1005 East 75th Street, CHICAGO, ILLINOIS

NEW!

Every Man Likes To See—Every Man Wants
A KRISS KROSS STROPPER
 UNDER OUR
NEW SALES PLAN

Selling is 100% easier and you may

MAKE \$2 to \$500 or More

From One Small Sale, Without Any Further Effort on Your Part

HERE AT LAST IS A REAL SHAVING COMFORT

Just show a Kriss Cross Stropper to any man. He will instantly reach for it. He can't help wanting to operate it. The way the blade automatically raises and reverses itself—bringing the other side to the leather, appeals to the mechanical instinct of all men and causes them to "sit up and take notice." Every man wants the Kriss Cross on sight because he instantly knows it is the first stropper ever made that has the right principle in stropping—the barber's diagonal stroke and adjustable pressure for dull or sharp blades. Our men have already established records of five sales in four minutes on one canvass, to 33 sales in one day. As this Adv. was being written we received a letter from an auditor who contracted to put in part time. He wrote: "Enclosed you will find eight orders taken today, my first trial, in less than 15 minutes."

RHODES MFG. CO.

4230 Cozzens Avenue

ST. LOUIS, MO.

Make Big Profits

Small cash payment brings you **HB 8 hour charging outfit**. Easy terms of only \$30 monthly; let your profits pay balance with nice surplus besides. **Thirty day free trial on money back guarantee** lets you try HB outfit at our risk. HB patented voltage-regulating winding **absolutely prevents reversing**. Saves current. Start now to make big profits with HB 8 hour battery charger. Write today for information.
HOBERT BROS. CO., Box 104, Troy, Ohio



Strops All Safety Razor Blades Diagonally Just Like the Barber.

Distributors looking for Opportunity, Write M. H. RHODES, Pres.

Instead of bronching they smile. Many exclaim: "What'll they get up next?" You'll enjoy selling it! One salesman wrote: "The man who can't sell it can't sell anything."

No experience or capital necessary to start your own business. This is your chance to get into something really big. Millions of people have been sold safety razors and they need a stropper. You have practically no competition. Page 253 Popular Mechanics, August issue, is one of many things now coming out to help the stropper business. Our 4500-word Sales Manual tells you all about how to sell Kriss Cross. We can't give you full details of our **NEW SELLING PLAN** and how you may make \$2 to \$500 or more from one small sale, but just write us and we'll give you full details. We'll send a stropper with sample outfit for remittance of \$2.50 with your inquiry from this Adv.

**AUTO SUPPLIES
 WHOLESALE
 3000 BARGAINS**

SEND FOR THIS CATALOG - **it's FREE!**

Everything you need in Auto Supplies at Amazingly **LOW PRICES.**

NEMCO BARGAIN SUPPLY HOUSE

849-851-853-855 W. Washington Blvd., Chicago, Ill.

RADIO CABINETS

No.	Size of Panel	Price Each
P. M. 100	7"x9"	\$1.95
P. M. 101	7"x12"	2.25
P. M. 102	7"x18"	2.95
P. M. 103	7"x21"	3.25
P. M. 104	7"x28"	3.75



Fine looking, solidly built. Finished in hand rubbed mahogany. Hinged top. Front rabbeted to fit panel. Depth of all sizes 7 inches. Base board included. Shipped by express. Send P. O. order or draft. Immediate shipment.
SELL SELF SYSTEM, 849-850-851 Washington Blvd., CHICAGO

MAKE THAT LUGER INTO A RIFLE!



Catalog 1 Ten Cents Free labor. Shoot 200 accurate shots per minute with our 32-shot magazine and boiler-stocks, equalling 8 riflemen. World famous V. Chr. Schilling super-accurate Mausers; Maasilcher sporters and other ultra-modern arms. Pacific Arms Corporation, Liberty Bank Bldg., San Francisco, U.S.A.

25,000 MILES
Without Puncture or Blowout



Cut your own tire bills—and make good money selling **National Tirefiller** to others. A proven success for 12 years. Eliminates tubes, punctures and blowouts. Increases tire mileage 30 to 50% and still outwears several casings. Easily inserted; easy riding. Over 300,000 enthusiastic users. Big sales possibilities. Some good territory still open. Driver agents make good profits. Mail coupon today for proposition.

AGENTS WANTED

NATIONAL RUBBER FILLER CO.,
 232 College St., Midlothian, Texas

I am interested in your agent's proposition
 I want your direct prices on National
 Tirefillers Please send full information.

MAIL THIS NOW

Name

Address



It Bridges the Vastness of Space

A Specially Designed Tube for Every Radio Use

SINCE Marconi first successfully spanned the Atlantic Ocean, with the wireless telegraph, radio has ever been outstanding as an invention of unlimited importance to humanity.

In 1909 the broadcasting of that now famous distress call, CQD, from the sinking passenger liner, S. S. Republic, established in the eyes of the entire world the tremendous importance of radio on the high seas.

In 1912, when that gigantic liner, the S. S. Titanic, struck an iceberg far from shore, in the north Atlantic, with thousands of passengers aboard, it was the SOS call of her wireless that brought rescue ships from all parts of the ocean. Here again radio demonstrated to the world its great service in the saving of human life.

During the war communication controlled the destinies of armies. Here radio played an exclusive part in the establishing of communication between ships at sea, from ship to shore, and from aeroplane to ground, where the use of wires was impossible.

In recent years the development of the vacuum tube has not only improved radio for the purpose of marine, commercial and military communications, but through radio telephony and public broadcasting, has established a new and even greater service to humanity.

Cunningham Vacuum Tubes are the product of years of research and experimental work by the Engineers of that great scientific organization, the Research Laboratory of the General Electric Company.

Cunningham Tubes are standard for all makes of receiving sets. Each of the numerous types have been designed to operate with maximum efficiency in one or more of the various applications of vacuum tubes to the radio art.

Cunningham Radio Tubes

C-301A—6 Volts $\frac{1}{2}$ amp. Amplifier.....	\$6.50
C-299—3 Volts .06 amp. Dry Battery Det. & Amp.	6.50
C-300—6 Volts Gas Content Detector.....	5.00
C-11—1.1 Volts .25 amp. Dry Battery Det. and Amp.	6.50
Special Base.....	6.50
C-12—Similar to C-11 with standard base.....	6.50

Patent Notice:

Cunningham tubes are covered by patents dated 11-7-05, 1-18-07, 2-18-08, and others issued and pending. Licensed for amateur, experimental and entertainment use in radio communication. Any other use will be an infringement.



E. J. Cunningham Inc.

154 West Lake Street, Chicago, Illinois

Home Office:
248 First Street
San Francisco, Cal.

30 Church Street
New York City, N. Y.

Please Mention Popular Mechanics

GET ACQUAINTED WITH LEFAX The Modern Method of Making Your Own Handbook

There is just one way to get a handbook that fits your needs exactly, and doesn't contain anything but what you really have use for—and that is, to make that handbook yourself. Lefax Data Sheets contain the best technical information, tables, etc., to be found anywhere, and you can take out or rearrange any sheets whatever, in any way you wish, or insert any other kind of sheet: blueprints, photographs, or your own notes or diagrams, made on the blank sheets which can be obtained in over 100 different styles. All these are $3\frac{3}{4}$ by $6\frac{3}{4}$ in. in size and fit any of the binders. Lefax is simply the principle of "Interchangeable parts" applied to the collection of the FACTS which are the tools that the technical or business man works with. Facts-on-leaves-LEFAX. Drop us a line today requesting complete information and price list.

POPULAR MECHANICS BOOK DEPARTMENT
200 E. Ontario Street, Chicago

Automobile Repairshop Short Cuts

Over 1500 time and labor-saving kinks, methods and devices from more than 1000 of the best garages, service stations and repairshops in the U. S., covering engine, clutch, gearset, running gear and body repairs. 255 Pages, 9x12, 1500 Figs. Cloth. Price, \$3.50 postpaid.

POPULAR MECHANICS BOOK DEPARTMENT
200 E. Ontario Street, Chicago

This Beautiful Coat FREE!



This Splendid Coat FREE!

The Goodyear Manufacturing Company is making an offer to send a handsome GOODYEAR RAINPROOFED coat to one person in each locality who will show and recommend it to friends.

It is a beauty, cut in the season's latest model, with all around belt, new semi-doll lapels, convertible collar and storm-tabbed sleeves. Guaranteed rain, dust and wind proof. A handsome topcoat, raincoat, motor coat and overcoat combined. Good all year around.

Big Pay for Spare Time

Just write your name and address on the coupon below and mail today. Send no money. Prove by your promptness that you are the one we seek. You must be quick.

Send No Money

When people see your wonderful sample All Weather Coat they will admire it, ask about it and want one like it. That's why we make this unparalleled offer.

You can make big money just taking these orders. Have all the money you want to spend. Don't lag behind and miss this great offer. Fill in the coupon and mail NOW!

THE GOODYEAR MANUFACTURING CO.
1748-R Goodyear Bldg., KANSAS CITY, MO.

GOODYEAR MANUFACTURING CO.,
1748-R Goodyear Bldg., Kansas City, Mo.

Without any obligation on my part please send me by return mail your FREE COAT and AGENCY OFFER.

Name.....
Address.....
City..... State.....

Play For Fun or Profit

Gibson
Instruments

Gibson MASTER-TONE TENOR BANJO

A masterpiece of workmanship, design, finish and tone. Easy to play and keep tuned, short scale, oval frets, light weight, completely equipped. Features are floating head, ball bearing contact, air chambers, tuned to pitch, correct voicing, high bridge, oo-ordinator, tone projector.

MAKE \$2,000 to \$5,000 A YEAR

Player-agents wanted; Organize Orchestras; we help you receive commission. Small payment, then \$5.00 a month pays for a Gibson; brings wholesome year-round entertainment and profit. Guaranteed for life.

Gibson
Instruments

Easy to Play
Easy to Pay

"Music Pairs of the Nation"

Liberal allowance on old instrument in exchange for a Gibson.

Mandolin	Mando-bass	Mandolin-banjo
Mandola	Guitar	Tenor-banjo
Mando-cello	Harp-Guitar	Cello-banjo
	Guitar-banjo	

Write today for free book, catalog, free trial offer, stating the Gibson you prefer.

Gibson Mandolin-Guitar Co.
1587 Parsons Street
KALAMAZOO, MICH.



What Are You Thinking About?

Day-dreaming led many a man to make plans that brought him big success. Don't be ashamed when your thoughts are wandering away, when you dream that you are a leader of men—a doer of big things in the business world—a builder of lasting structures. Your day-dreams are an indication of your ambition and of your desire to accomplish things. The man who never dreams has no imagination, he will not get very far. But you can make your dreams real—You can materialize your ambition.

Just dreaming alone won't do. Hitch your dreams up to facts and you will go far. You will get the facts through special training along the line in which you want to succeed. And the place to get just that training is the American School. This is proven by the quarter of a century of successful experience we have in helping many thousands of men and women gain an enviable place in the business and social life.

Another reason why the American School is the place to get your training—it is not a business corporation but a chartered Educational Institution, incorporated not for profit.

Space here is too limited to tell you of all the advantages you will gain by getting your training from the American School, but the coupon will bring you full information and a descriptive book, without cost or obligation to you. Fill out and mail the coupon NOW, while you are thinking about it. No agents will bother you.

American School

Dept. G774, Drexel Ave. and 58th St., Chicago

American School

Dept. G774, Drexel Ave. and 58th St., Chicago

Send me full information on the subject checked and how you will help me win success.

- | | |
|-----------------------------|---------------------------|
|Architect |Lawyer |
|Building Contractor |Machine Shop Practice |
|Automobile Engineer |Photoplay Writer |
|Automobile Repairman |Mechanical Engineer |
|Civil Engineer |Shop Superintendent |
|Structural Engineer |Employment Manager |
|Business Manager |Steam Engineer |
|Cert. Public Accountant |Foremanship |
|Accountant and Auditor |Sanitary Engineer |
|Bookkeeper |Surveyor (& Mapping) |
|Draftsman and Designer |Telephone Engineer |
|Electrical Engineer |Telegraph Engineer |
|Electric Light & Power |High School Graduate |
|General Education |Fire Insurance Expert |
|Vocational Guidance |Wireless Radio |
|Business Law |Production Manager |
|Advertising Manager |Undecided |

Name.....

Address.....

NEED A BOOK

on some practical subject and
don't know where to find it?

Popular Mechanics Book Department maintains a service you will appreciate.

Send to-day for our valuable free catalog listing over 500 books on the following subjects:

- | | | |
|----------------------|--------------------------|-------------------|
| Agriculture | Glass | Photography |
| Architecture | Heating and Ven-tilation | Physics |
| Arts and Crafts | Hydraulics | Plumbing |
| Automobiles | Inventions | Poultry |
| Aviation | Iron and Steel | Printing |
| Blue Prints | Leather | Radio |
| Boats | Locomotives | Railways |
| Bookbinding | Machine Shop Practice | Refrigeration |
| Books for Boys | Masonry | Rope Work |
| Building | Mathematics | Rubber |
| Business | Mechanical Engi-neering | Sheet Metal Work |
| Carpentry | Mechanics | Sign Painting |
| Cement and Con-crete | Metallurgy | Soap Making |
| Ceramics | Millwrighting | Soldering |
| Chemistry | Mineralogy | Steam Engineering |
| Civil Engineering | Mining | Surveying |
| Cleaning | Model Making | Taxidermy |
| Compressed Air | Motion Pictures | Textiles |
| Dictionaries | Motorcycles | Toys |
| Drawing | Navigation | Tractors |
| Electricity | Paints and Paint-ing | Upholstering |
| Engraving | Pattern Making | Watch Repairing |
| Finger Prints | Patents | Water Power |
| Formulas | Photo-Engraving | Welding |
| Furniture Making | | Windmills |
| Gas Engines | | Wireless |
| Geology | | Woodworking |

If you don't find what you are looking for in the catalog, write us a letter explaining the particular subject you are interested in and we will tell you of any books that may be available.

POPULAR MECHANICS BOOK DEPT.
200 East Ontario Street, CHICAGO

Please Mention Popular Mechanics



The B. T. Universal Tuning Unit

There is nothing on the market you can compare with the Bremer-Tully Universal Tuner. It is an entirely new instrument, that gives unequalled selectivity and control on practically all modern circuits.

It replaces coils in Reinartz, Ultra Audion and other regenerative and non-regenerative circuits. In most circuits taps are not required. Also gives remarkable results in Radio Frequency and all Reflex Circuits. Simple to connect, no soldering; connections made to binding posts, easily changed to any circuit.

Photo diagrams of above, also special Bremer-Tully circuits, in addition to key of windings, furnished. Write today.

Bremer-Tully Mfg. Co.
542 S. Canal St. CHICAGO, ILL.

\$12 to \$20 Daily for Ford Owners!

Demonstrate and sell GIDEWEL steering devices for Ford cars. A tried and proven invention. Entirely different. Nothing exactly like it. It's the device that sells itself. Does the talking. Whether you have ever sold goods or not you can sell the GIDEWEL. Just demonstrate GIDEWEL with your Ford for a quarter of mile and sale is made. A wonderful money-making proposition for full or part time. Exclusive territory given to workers. Millions of Fords swarming country. All need this wonderful device. Hundreds have been attached—not a single one has ever been removed.

Ford Drivers Wild about Gidewel

Stops steering vibration. Takes the shock, jar, jerk and jiggle out of steering wheel. Eliminates front wheel wobble. Makes car track perfectly. Won't jump ruts. Rides bumps without swerving. Prevents locking on short turns. It's a MARVEL. Makes driving a pleasure. Adds safety to motoring in a Ford. Car responds to slightest touch on steering wheel. Can steer for miles over roughest roads without fatigue. GIDEWEL easily attached. May be installed without disturbing present construction of car. Is dirt-, dust-, and grit-proof. Practically no wear-out to it. Runs in oil. Can be transferred from one Ford to another. Hundreds in use. Once tried, Ford owners won't drive without GIDEWEL. Difference in steering amazing. Be first man in your territory to show and demonstrate GIDEWEL. You can take orders right and left. Every Ford owner live prospect. \$12 to \$20 day possible. Get our liberal proposition. Write or wire.

THE ROLLAWAY MOTOR CO.
1021 Southard Ave. TOLEDO, OHIO

A New Book on Concrete For the Home, Farm and Factory

Describing 173 Ways of Using Concrete. Full directions for doing these things yourself with ordinary tools—138 Illustrations.

POPULAR MECHANICS'

CONCRETE

HANDBOOK NUMBER ONE

At the very outset it should be understood that while this book contains much that is of interest to the professional concrete worker, the clear directions and great variety of work covered make it especially suited to the needs of the amateur.

Shows you how to make such things as

- | | |
|----------------------------------|--|
| Concrete Fence Posts on the Farm | Concrete Garden Furniture (5 articles) |
| Cheap Concrete Mixer | Concrete Tile |
| Concrete Forge | Concrete Sidewalk Flagging |
| Concrete Boat Landings and Docks | Horse Stalls of Concrete |
| Garden Seats of Concrete | Concrete Block Milk House |
| Holds for Making Concrete Bkls. | Sanitary Drinking Fountain |
| Watering-Troughs in Concrete | Concrete Curbs and Gutters |
| Forms for Concrete Gate Posts | Faultless Concrete Sidewalks |
| Rural Mail Box Post | |
- And practically any other requirement in concrete.*

PRICE FIFTY CENTS POSTPAID

Popular Mechanics Book Dept.
200 East Ontario Street, CHICAGO

Popular Mechanics Books

Each one of the following books has been published by Popular Mechanics and is characterized by the same careful editing and authoritative presentation of the subject matter as is the magazine itself. All are unusually good values for the prices asked.

- | | | |
|--|--|--------|
| THE BOY MECHANIC—Book One | 480 Pages—700 Articles—800 Illustrations..... | \$2.00 |
| THE BOY MECHANIC—Book Two | 480 Pages—1000 Articles—995 Illustrations..... | 2.00 |
| THE BOY MECHANIC—Book Three | 480 Pages—800 Articles—802 Illustrations..... | 2.00 |
| MISSION FURNITURE, HOW TO MAKE IT, Part 1 | 128 Pages—30 Designs, Illustrated..... | .50 |
| MISSION FURNITURE, HOW TO MAKE IT, Part 2 | 128 Pages—32 Designs, Illustrated..... | .50 |
| MISSION FURNITURE, HOW TO MAKE IT, Part 3 | 128 Pages—36 Designs, Illustrated..... | .50 |
| WOOD-WORKING FOR AMATEUR CRAFTSMEN | 128 Pages—125 Illustrations..... | .50 |
| ARTS-CRAFTS LAMPS, HOW TO MAKE THEM | 96 Pages—16 Designs, Illustrated..... | .50 |
| LAMPS AND SHADES IN METAL AND ART GLASS | 128 Pages—18 Designs—64 Illustrations..... | .50 |
| METALWORK AND ETCHING | 96 Pages—Illustrated..... | .50 |
| ELECTROPLATING | 112 Pages—62 Illustrations..... | .50 |
| PRACTICAL COURSE IN MECHANICAL DRAWING | 160 Pages—157 Drawings..... | .50 |
| HEAT | 128 Pages—Illustrated..... | .25 |
| KINGDOM OF DUST | 128 Pages—40 Illustrations..... | .50 |
| HOW TO MAKE DEVICES FOR OUTDOOR WINTER SPORTS | 64 Pages—Illustrated..... | .25 |
| SHOP NOTES FOR 1923 | 224 Pages—544 Articles—436 Illustrations..... | .50 |
| SHOP NOTES SET | 15 Vols..... | 7.50 |
| CONCRETE HANDBOOK | 96 Pages—173 Articles—138 Illustrations..... | .50 |
| PATTERN MAKING | 224 Pages—312 Illustrations..... | 1.00 |
| POWER GAS AND THE GAS PRODUCER | 192 Pages—Illustrated..... | 1.00 |

Above prices are postpaid

POPULAR MECHANICS BOOK DEPT.
200 East Ontario Street CHICAGO, ILL.

5 SQUARES IN 1 TOOL

"Press the button—there's the angle!"



Locks instantly and automatically at ANY ANGLE desired. Convenient, accurate, a time-saver. Always ready. Strong, durable, simple.

**SIMORE "Lightning Change" TRY-SQUARE**

Write for details of sizes, uses and price. If you use a saw you need this tool! We make the Simore "Lightning Change" screwdriver also.

THE SIMON & SKIDMORE MFG. CO.

Dept. 410

Santa Ana, Calif.

**5 SIZE AUTOMOBILE TAP AND DIE SET, ONLY \$3.00****DIRECT FROM THE FACTORY TO YOU!**

Our No. 12 Automobile Set furnished in our highly finished chestnut box contains 5 each taps and dies (1-4, 5-10, 2-3, 7-10 and 1-2"), in the S. A. E. thread, 1 die stock, and one tap and reamer wrench.

Our No. 11 Set is the same as No. 12 except that the thread is U. S. S. instead of S. A. E. You are purchasing a splendid set at a very low figure.

Send us your order at once and be one of our many satisfied customers.

Let us also send you one of our circulars illustrating our full line of Handy Tools. **WORCESTER STEEL PRODUCTS CO., Dept. T, 25 Union Street, Worcester, Mass., U. S. A.**

Play this Jazzy Sax Without Practice

Any one can play this imported Jazzy Sax right away. No knowledge of music required, no lessons. Play by numbers instead of notes. All instructions and 16 songs free! So popular at parties, dances, picnics, entertainments. Wonderful brass instrument. Guaranteed nickel-plate. Looks just like regular saxophone, the same size. Weighs over 2 lbs. Beautiful, clear, ringing tones and delightful harmony.



V. D. Beatty says: "This is easy. I played tunes after fifteen minutes and am delighted."

No need to spend \$85 when you can own a Jazzy Sax.

Send No Money

Send just your name. When the Sax arrives pay the postman only \$5.95 plus slow postage. Play Jazzy right away. Guaranteed or money refunded. Don't delay, act now! **FERRY & COMPANY, Dept. 1779, 75 W. Van Buren, Chicago, Illinois**

Supply Limited**BIG PROFITS in 8 HOUR****Battery Charging**

30 Monthly Pays for Your Outfit

Make \$150 to \$300

Monthly charging batteries. Start NOW to build your own money-making business. No experience needed. Buy an HB 8-Hour Constant Potential Battery Charger on long easy terms, more than paid by big monthly profits. Small cash payment. 30 days' free trial on money-back guarantee. You will make big profits, build steady business. Write today for information.

HOBART BROS. CO.
Box M102 Troy, Ohio

All Right!
LETS GO!



They Never Took a Lesson

You Can Learn To Play These TODAY!

and they're dated up way ahead for concerts and good times. They make good money, too. No lessons necessary to play these instruments. This handsome Clarinette 14 in.

long, is a sensation everywhere. Sells at \$2.65. Easy instructions and popular songs free. Do you like jazz? Then you want this handsome nickel plated finely finished 17 3/4 in. long distinctly unique Saxophone. No need to pay \$85 when you can have this instrument for \$5.65, clear mellow tone. Easy instructions and popular songs free.

Snare drum has the snappy tone of an orchestra drum that will surprise you by its power. Very popular for theatre work or small orchestras. Two fine genuine calfskin heads. Adjustable snare, strainers; also nickel plated shell 12 inches in diameter. Easy instructions book free.

UNTOUCHABLE PRICES!

Clarinette	Saxophone	Drum	With sticks and shoulder straps
\$2.65	\$5.65	\$5.95	

A dollar off if you buy two instruments; \$1.50 off if you buy all three—that means a full orchestra for \$12.75.

Our new method of playing these instruments makes you able to play them as soon as you receive them without any tedious lessons.

SEND NO MONEY—

merely your name and address—and pay the postman on delivery. Fill out the coupon below and receive these bargains by return mail. Catalog Free. Ask for FREE CATALOG of Ukuleles, Banjos, Mandolins, Guitars, Accordions and other musical instruments.

The Benshrago Studios

212 Fifth Ave.

Desk 14

New York

ACT NOW! Money Back If Not Satisfied

The Benshrago Studios, 212 Fifth Ave., Desk 14, New York, N.Y.

Send me Flute Saxophone Drum and Free Catalog and I will pay postman on receipt. I understand that you will send back my money if I am not satisfied. (Note: specify if you want stand for Drum—\$1.35 extra.)

Name.....

Address.....

City or Town..... State.....

I Offer You \$100 a Week

Without experience, training or capital you can establish a big business for yourself. Be your own boss, work when you please, spare time or full time, and make from \$25 to \$100 a week.

FORD AUTO GIVEN

We want men and women to represent us. Wonderful plan. 350 Household Necessities direct from factory to home. We provide all instructions and equipment including automobile. Write quick for offer.

AMERICAN PRODUCTS CO., Dept. 8890, Cincinnati, Ohio.



Amazing New Lamp Burns 95% Air

Cheaper Than Gas or Electricity

Announcement was recently made by Theodore Nagel, well-known inventor of gasoline and kerosene lamps and lanterns, of the discovery of "Thena" metal, a secret process metal which dwarfs all other improvements ever made in artificial lighting. "Thena" metal makes possible an automatic cleaning device in kerosene lamps and lanterns so sensitive and yet so durable that ordinary coal oil can be used to make a light as white, soft and brilliant as city gas or electricity.

For five years Mr. Nagel tried every metal known to science to perfect a cleaning device which would forever end the inconvenience and expense of replacing generators and make possible the use of kerosene fuel where electric lights are either not to be had or too costly for ordinary use. The result is "Thena" metal which insures watch-making accuracy in Wizard lamps and lanterns. The surprising part is that these wonderful lights cost no more than ordinary ones and yet are guaranteed for years of service.

The wonderful story of his discovery, the tale of sleepless nights, countless laboratory tests, and finally the manufacture of Wizard Lamps and Lanterns, the only product of the kind in which such marvelous results are possible, will be sent to any one who will inquire of The Nagel-Chase Mfg. Co., 242 E. Erie Street, Chicago. An invitation is extended to visit the factory and witness a practical demonstration of the lamp itself. Agents, dealers, farmers, home owners everywhere pronounce this the greatest contribution in recent years to home comfort.

\$47. 10 MONTHS TO PAY \$49

SEND

\$200

DOWN

30 DAYS TRIAL

450 PER MONTH \$470 PER MONTH

Just pick out the ring you prefer, give finger size, and send deposit to show your good faith. WE WILL SEND THE RING WITHOUT ANY RED TAPE OR DELAY. DEALINGS CONFIDENTIAL. If you return it we will return your money. If satisfied, pay only a few dollars monthly.

GUARANTEED \$75.00 VALUES

The \$47.00 ring is 18-karat solid white gold, set with beautiful, blue-white, perfectly cut, sparkling, brilliant, GENUINE DIAMOND WORTH 50% MORE. The \$49.00 ring is 18-karat solid white gold, engraved with orange blossom design, and set with seven perfectly cut, blue-white, dazzling, genuine diamonds. CLUSTERED TOGETHER IN SOLID PLATINUM, looking like a \$600.00 solitaire 1 1/2-carat size.

WRITE FOR BIG CATALOG No. 1189

It brings a large jewelry store right into your home.

STERLING DIAMOND & WATCH CO.

63 PARK ROW, Dept. 1189 NEW YORK (Est. 1879)

"DETROIT" BELT LACING OUTFIT



Detroit Wire Hook belt lacing used by ten thousand big factories and many more small shops and farms. Laces belts perfectly for one cent an inch. It is very strong, flexible and easy to apply. Saves time, belts, power and money.



Complete outfit including lacing tool (used in an ordinary vice as shown) and assorted box of lacing (as shown) for every kind and thickness of belt. Outfit postpaid \$5.00. Assorted lacing \$1.50 per box. Tool \$1.50. Money back if not entirely satisfied. Ask for folder.

Detroit Belt Lacer Co., Detroit, Mich.



FORD "OILODUCT"

makes the filling of your Ford Car with oil easy and 1/3 as expensive. Swings out so no oil is wasted. Keeps oil off ignition wires. Stops timer trouble. Keeps oil from getting on fan belt and from getting all over your hands.

Simply remove your oil filler cap and in two seconds the "Oiloduct" is permanently and securely in place, ready whenever you put more oil in your car.

Saves its cost in oil every month. Send \$1.00 bill and the "Oiloduct" will be sent you postpaid. Dealers write for discounts.

SUPERIOR OIL & SUPPLY CO.
1748 Wilmot Street, Chicago

FANSTEEL Balkite Battery Charger

A new battery charger for Radio "A" batteries, entirely noiseless, and indestructible. Has no moving parts, requires no attention, and cannot get out of order. Can be used while the radio set is in operation. A simple, positive, economical battery charger for home use. Write for folder giving full description.

Dept. P 1 - Fansteel Products Co., Inc.
North Chicago, Illinois

Don't Fuss With the Muss of Old Kerosene Lamps and Lanterns

New Bright White Light For Every Home

Wonderful Invention

I have made it easy for every home to have bright, cheery, healthful light—in cities, villages and on farms—anywhere—at a price all can afford. No more need you put up with the dingy, smoky, foul-smelling oil wick lamps and lanterns. No more need you put up with the drudgery of cleaning and trimming greasy, dirty wicks and chimneys. For less cost than you would pay for a good oil lamp you can have an abundance of brilliant, white light—20 times brighter—for every room in the home or for outdoor chores.

Write Me Quickly

Let me send you complete particulars and information together with my amazing special introductory offer. My wonderful invention is the sensation of the age. Each Lamp and Lantern is a complete gas generating unit in itself—light in weight—easily carried, safe, convenient, easy to operate. Table Lamps, Hanging Lamps, Wall Lamps for every lighting purpose, also most durable, certain outdoor Lantern ever made. Wind-proof, storm-proof, bug-proof. Costs only half as much as wick lamps or lanterns to operate.



300 Candle Power

—beats electricity or gas for economy, brightness and quality of light. Burns 96% Air—Only 4% cheap gasoline or kerosene (coal-oil). Produces a light bright as daylight. Soft, mellow, easy on the eyes.

Lights with match as quickly and easily as old-style lamp. Simple to operate and positively safe. Greatest advancement in home and farm lighting in a century. **30 Days Trial**

I want to put at least one of these Lamps or Lanterns in every home. I am making a sensational introductory offer to do it. I back it with my 30-day trial guarantee. You try it without a penny of risk. I take all the responsibility. The coupon, a letter or post card brings this offer and big attractive, descriptive catalog FREE, from which you can select any one of the many handsome designs. Be first in your locality to write and get this liberal money-saving introductory offer. Send your name and address today.

J. C. STEESE, President

THE AKRON LAMP COMPANY
110 Lamp Building
AKRON, OHIO

AGENTS

\$60 to \$100
A Week

If you want to earn big money, write me quickly for sales plan. No experience—no capital required. Exclusive territory. Big season now on. Address me personally—say "Send Agent's Free Outfit Offer."

J. C. STEESE, President.

Special Offer Coupon

THE AKRON LAMP CO.,
110 Lamp Bldg., Akron, Ohio.

Send me without obligation your limited Special 30-Day-Trial Introductory Price Offer and Big Free Catalog of DIAMOND LAMPS and LANTERNS.

Name.....

Address.....

City.....State.....

If interested in Sales Agency, check here.

LYON BODIES



\$27.50
AND UP

1346 S. Michigan Ave., Chicago

Send For Our 1923 BOOK OF BARGAINS

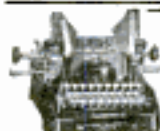
Containing a full line of bodies and accessories at exceptionally low prices. Buy direct from the factory.

**AUTO TIRE
SALES CO.**

Body Division Dept. F13

RUNS 22,000 MILES ON TIRES THAT LEAK NO AIR

A new Airtight, Puncture-Proof Inner Tube which in actual test ran 22,000 miles without the loss of air, although punctured many times, is the proud achievement of P. M. Hughes, of the Airlox Rubber Co., 2053 Jackson Blvd., Chicago. It is inflated with air and has a leak-proof valve-cap. Both puncture troubles and valve leaks are banished enabling one to keep tires up on proper air pressure, and hence double casing mileage. Yet, Airlox Tubes cost no more than ordinary tubes. If you want to try these wonderful tubes write P. M. Hughes today as he wants them introduced everywhere. Liberal offer to Agents. Write at once.



THE 1923 New OLIVER SPEEDSTER

Send for 1923 Oliver Catalog Showing New Standard three bank Keyboard. The Oliver Typewriter Co., Dept. 1087, Chicago

Art Corner Your Pictures—Album

where you can keep them safe and enjoy them always.

5 Styles **Engel** "Art Corners" 5 Colors

are on sale at Photo Supply and Album counters everywhere. They are the only Quick, Easy, Artistic, No Paste, No Fold way to mount Kodak Prints, Greeting and Souvenir Cards, Clippings, etc., on anything, anywhere. A done brings 100 and samples to try. Write

ENGEL MFG. CO.
Dept. 2X 4711 N. Clark Street, Chicago



SELLS for \$1.25 AGENT'S SAMPLE 65c.!

Self-Filling Bamboo Fountain Pen with Glass Point



Imported from Japan

"It makes Carbon Copies"

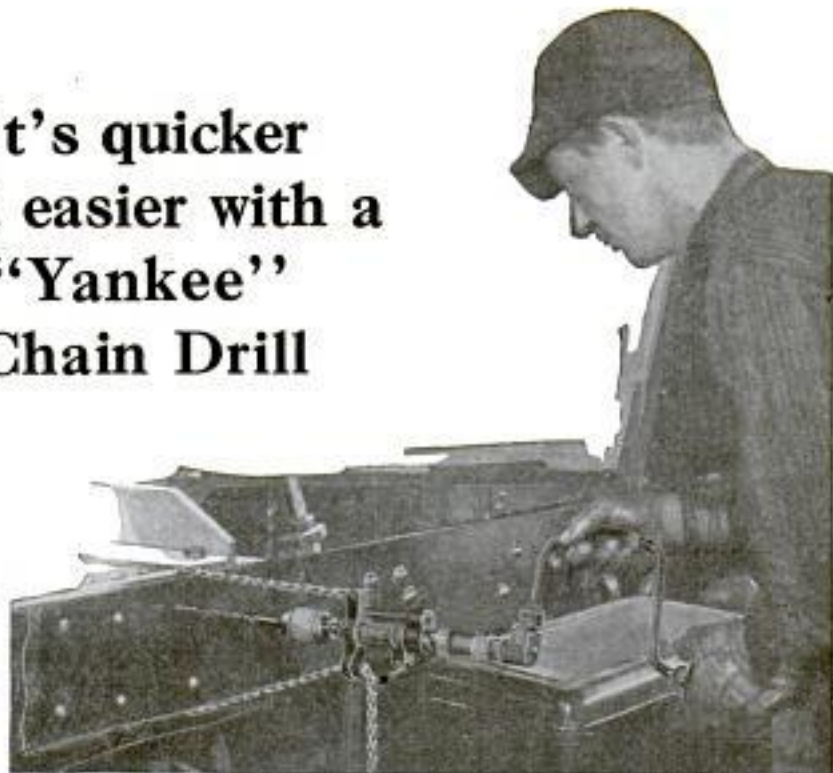
Guaranteed for 1 year

Hustlers Making \$20 Daily! Money refunded if you don't think it's the best pen you ever wrote with. Just out! Up to 150 per cent Profit. Send for quantity price list and distributing plans.

F. SPORS & CO., 330 Main Street, Lesueur Center, Minnesota



It's quicker and easier with a "Yankee" Chain Drill



Turn the brace—that's all you need think of when using a "Yankee" Chain Drill. No hand feeding. The "Yankee" Automatic Friction and Ratchet Feed does away with that. Saves drill breakage from inaccurate, uncertain pressure.

It's the only chain drill with automatic friction and ratchet feed. "Yankee" Bench Drills have same feed. No. 1500 (Illustrated) 3-jaw chuck for round shank drills up to $\frac{1}{2}$ in.

No. 500—2-jaw chuck for square shank drills up to $\frac{1}{2}$ in.

Dealers everywhere sell "Yankee" Tools

NORTH BROS. MFG. CO., Philadelphia, U. S. A.

"YANKEE" TOOLS

Make Better mechanics

Some other "Yankee" Tools

Ratchet Breast Drills
Ratchet Tap Wrenches
Ratchet Bench Drills
Ratchet Screwdrivers
Plain Screwdrivers
 $1\frac{1}{2}$ to 30 in. blades

Write for **FREE**
Book Describing
Them All

SWEATERS SAVE 20%-30%



**Any Style or Design
for Men, Women, Boys,
Schools, Clubs, Teams**

Order direct from m'f'l. Save from 20%—30%. Pick any style, any color, size or design from our regular stock or special to order. Finest virgin wool and pure worsted only. Custom tailored workmanship of highest grade. Closely knit. Warm, soft, snug. Send bonuses you will be proud to wear.

**FINEST QUALITY AT
BARGAIN PRICES**



**FREE
CATALOG**

Send name and address
for free illustrated catalog.

Always holds shape. Most customers get from 3 to 5 years wear easily. Can endure severe wear and retain bright, fresh appearance. Biggest values in history. Workmanship guaranteed. Prices slashed. Unusual chance to save. Special offers to schools, clubs, teams. Write for free catalog.
AMERICAN KNITTING MILLS
Dept. 10, 1538 Ciyborn Avenue, CHICAGO

Mathematics Made Easy by ROPP'S CALCULATOR AND SHORT-CUT ARITHMETIC

Shows the Answer as Quickly as a Watch shows the Time to all Problems likely to occur in the Office, Store, Shop, Bank, Farm, or Factory.



Explains and simplifies every principle in Arithmetic, Mechanics, and Mensuration.

**PRICES
POSTPAID**
Desk Size...\$1.50
Leatherette, Pocket Size...\$1.00
Cloth...\$0.50
Pocket Size,
Paper...\$0.35

Popular Mechanics Book Dept., 200 E. Ontario St., Chicago

GOLD SEAL HOMCHARGER
The World's Most Popular Battery Charger
 —silently and efficiently charges your radio or automobile battery over night for a nickel. No stopping—no sizzling—no fuss—no trouble. Self-polarizing—high charging rate—finished in mahogany and gold—approved by Underwriters. Price \$18.50 complete with ammeter (\$25.00 in Canada)—no extras to buy.

LOOK FOR and INSIST on the GOLD SEAL
 WRITE FOR FREE BOOKLET
THE AUTOMATIC ELECTRICAL DEVICES COMPANY
 129 W. THIRD ST.
 CINCINNATI

Test This Imperial Range in Your Home at our Risk

WONDERFUL BAKER—FUEL SAVER

Get this book Free

Three big exclusive, money-saving features: Stone Oven Bottom Flute—absorbs and holds heat, makes baking sure and successful! Dustless Ash Blower—sifts inside range; odor Hood—frees kitchen from all odors.

FACTORY PRICES

Save all in-between profits. Newest improvements—beautiful designs. Over 150,000 Imperials in use. All sold on 30 day test plan. All styles built to last a lifetime—and guaranteed. Credit wanted. Mail a postal today for big FREE catalog—also combination gas and oil ranges, refrigerators, kitchen cabinets and tables, fireless cookers, etc.

THE IMPERIAL STEEL RANGE CO.
 269 Detroit Ave., Cleveland, O.
 (Established 1889)

MAKE BIG MONEY Charging Batteries

Small cash payment brings you HB 8 hour charging outfit. Easy terms of only \$30 monthly let your profits pay balance with nice surplus besides. Thirty day free trial on money back guarantee lets you try HB outfit at our risk. HB patented voltage-regulating winding absolutely prevents reversing. Saves current. Start now to make big profits with HB 8 hour battery charger. Write today for information.

HOBERT BROS. CO., Box M101 Troy, Ohio

Our BUREAU OF INFORMATION will answer all questions regarding articles appearing in this magazine.

Address Bureau of Information, Popular Mechanics Magazine, Chicago

Diamonds Here at 60% of Market Price

Never in three quarters of a century have we offered such amazing bargains. Hundred of money-saving opportunities in latest Diamond Bargain List, equalling those shown here.

Here's why we can offer such remarkable values: This 75 year old firm—rated at over \$1,000,000.00 capital—the largest and oldest diamond banking institution of its kind in the world has made loans on Diamonds, Watches, and other jewels in excess of \$25,000,000.00.

Why Pay Full Prices Costs Nothing to See

Thousands of unpaid loans. Must sell now. Diamonds, Jewels, Watches and other Gems of unusual qualities—at an entirely different price basis—viz: loan values not market values. At our risk we send you any bargain you wish for absolutely free examination. No red tape. No obligation. Don't buy unless satisfied you can not match the bargain at 60 per cent more. *Diamonds of desirable quality at \$100 per carat. Yes, some even lower priced—also, best gems obtainable at higher per carat—but proportionately low bargain prices. Our bargains have guaranteed loan values also, unlimited exchange privilege at full prices.*

Latest List Diamond Loans

Send at once for latest list. Thousands of unpaid loans and other special advantage bargains described in full detail with exact weight, color, quality, etc. Get details of Free Examination offer. No obligation. List is free.

Mail Coupon Now

Jos. DeRoy & Sons,
 1913 DeRoy, Bldg., Pittsburgh, Pa.

Without obligation, send me free, your latest Bargain List of Diamonds, Watches and other jewelry.

Name.....
 Address.....
 City.....State.....

Cal. 30 **\$15**

U. S. Army Krag Carbines

All carbines have the new model 1899 stocks. The barrels, actions and parts are either new or have been refinished by the Government and are equal to new. Krag Sporting Rifles, \$14. Krag Rifles, \$12.50. Also Krag Parts. Ammunition, 4c each. Send for Kirk's Complete Catalog.

W. STOKES KIRK, 1627-P.M., N. 10th St., Phila., Pa.

We Want Agents at \$50 to \$90 a Week

New Invention—Just out. Needed in every home every day. Patented. Nothing else like it. Low priced—**Sells on sight.** Sharpens any kitchen knife, paring knife, carving knife, bread knife, or shears and scissors in **ten seconds.** Mechanical masterpiece. A child can use it. Just put knife in slot—turn crank—sharpens both sides at once automatically. **We want representatives at once—men and women hustlers.** Get this position where **profits start first day.**

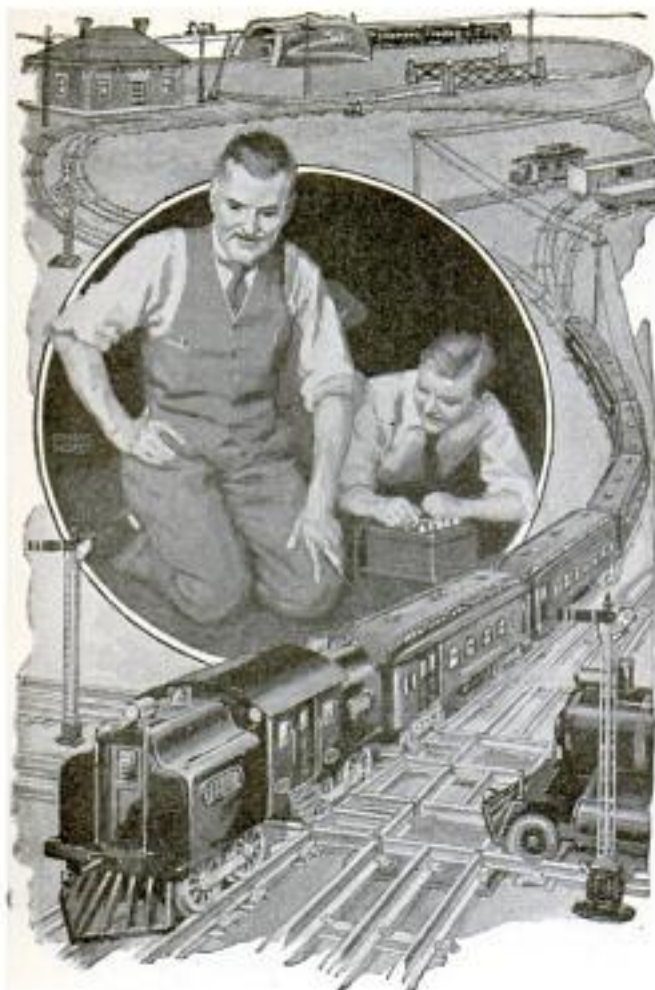
No Experience Necessary—200% Profit

Make as much money next week as these men are making now. J. C. Lewis, of Kansas, says: "I have sold one hundred sharpeners in four days." Hobart Kerr, of Md., writes: "The women can hardly wait till they get them." Herbert Cain, of Ky., sold nine after supper. At the end of the first day, J. W. Gordon, of Pa., writes: "I sold two dozen and I sold to every one I saw." Wm. G. Hall, of N. J., says: "I think it is great. I sold six in about one-half hour. The machine is a mighty fine proposition. I am a mechanic and I know what I am talking about." You can make this money. **WRITE TODAY. TERRITORY FREE.** Get busy at once.

QUICKEDGE SHARPENER CO., 110 Sharpener Bldg., 159 West Pearl St. Jackson, Mich.

Only \$2.00 Selling Price

The Quickedge Knife and Shear Sharpener



Great Fun for Boys— From Four to Forty!

You will keep young in joining your boy in operating his new Lionel Electric Train—will get as much fun out of it as he does.

And the youngster will simply glory in it—his playmates will beg for a chance to "get in" on the game—you'll be down there on the floor yourself. It's the most fascinating Toy ever invented, and the most instructive one.

You can buy a Lionel Electric Train for as low as \$5.75. Or, you can give your boy a larger locomotive and track and add to it as you wish.

The best Toy, Hardware, Sporting Goods, Electrical and Department Stores carry Lionel Electric trains and accessories. Send for handsome, new Lionel catalog, printed in colors, full of up-to-date miniature electrical equipment. It's free.

1923 Lionel Features

"Super Motor" Locomotive—Pullman Cars with Revolving Seats and Permanent Interior Lights—Electric Block Signals—Automatic Crossing Gates—"Lock On" Removable Track Contacts—Illuminated Bungalows and Villas for building Model Cities.

THE LIONEL CORPORATION
Dept. 14

48-52 East 21st Street, New York City

LIONEL ELECTRIC TOY TRAINS
and Multivolt Transformers

FREE To Machinists

POPULAR MECHANICS MAGAZINE

has prepared a table of decimal equivalents of the fractions of an inch, a copy of which will be mailed free to any machinist or auto repairman upon application. The table is 16½ in. wide by 23 in. long, printed on good, heavy paper, and will prove of great value in any shop.

There are no strings to this offer; simply send us your name, and the address of the shop or garage in which you work, and the table will be forwarded at once, carefully wrapped, and postpaid.

Address

The Editor, Shop Notes Dept.
Room 512, Popular Mechanics Bldg.
200 East Ontario Street, Chicago, Ill.

Summer Home in Maine

A gentleman's estate of 175 acres on the Maine coast, with frontage on a lake 9 miles long; master's house; large bungalow; caretaker's house; large garage; barns; private electric light and inexhaustible water works, and every modern improvement. Forty acres very large trees. Golf and yacht clubs only a few minutes away; good markets in the town.

The scenery of mountains, lake and ocean is pronounced one of the best five in New England. House and bungalow both completely furnished; steam heat.

Place will be sold at a great bargain as owner can no longer use it.

Address OWNER

206 East Ontario Street CHICAGO, ILL.

Genuine "RADIOLA"

Made by Westinghouse for the Radio Corporation of America

OUTFIT COMPLETE:

\$5⁰⁰
DOWN
*Puts it
 in Your
 Home*



**Balance in Easy
 Monthly Payments**

Regenerative Receiver and 2-Step Amplifier

Now everyone can have the finest radio receiver and amplifier that is made. No need to put up with inferior equipment. For here we are offering you the set designed by the great Radio Corporation, the highest authorities in the industry—and built by the Westinghouse Electric Company. It comes to you complete with all the accessories you need, for just a five-dollar payment. Take advantage of this new way of selling radio. Get an outfit that will give you permanent satisfaction. Send the coupon below for our Great Special Offer, made for a limited time only.

The Perfected Radio At Last!

So simple to tune that it is just the thing for the beginner. Yet so perfect that it will delight the most hardened "radio fan" who has long been searching for the ideal circuit. Its long range will bring in stations never heard before, so loud and clear that a loud speaker will delight the whole family. Wonderfully selective. With it interference, internal noises and annoying body capacity are forgotten.

Send Coupon for Special Offer Circular

Just mail the coupon. Get all the details without any obligation. Don't think of buying an ordinary set without finding all about this new and better way. Very easy terms. Free Trial. The highest quality of radio equipment possible to have.

BABSON BROS. 19th St. and Marshall Blvd.
 Dept. 13-57 CHICAGO, ILL.

No Accessories to Buy

The radio outfits we sell are absolutely complete. Most others make an offer on the bare set and leave you to buy all the extras like tubes, phones, etc. in addition. The outfit we offer you now includes, the Regenerative Receiver and 2 step Amplifier all enclosed in a solid mahogany case. Also the batteries, head-phones, tubes, serial, lightning arrestor, and full wiring installation equipment. You start operating without investing another single penny. Your \$5 payment brings it all.

WD 12 Tubes and Dry Cells Reduce Upkeep to Almost Nothing

Equipped with 3 of the latest type of dry battery tubes, WD 12 tubes use only $\frac{1}{2}$ ampere. Most perfect tube both for detecting and amplifying. Battery expense reduced to the absolute minimum.

Babson Bros., Dept. 13-57

19th St. & Marshall Blvd., Chicago, Ill.

Please send me your special offer on a Complete Radiola Outfit on terms of \$5 down and monthly payments.

Name

Address

Agents—District Managers—Distributors to Make \$2,500—\$5,000—\$15,000 and More Selling SECURITY Check Protecting Fountain Pens



CHECK-PROTECTOR
Security
FOUNTAIN PEN

12 BIG FEATURES OF THE PEN

- 1—Steel check-protecting wheel: scores paper, fills cuts with acid proof red ink.
- 2—Coil spring in automatic clip.
- 3—Automatic clip riveted to Pen on both sides.
- 4—Clips of **Rolled Gold**.
- 5—18 Kt. Gold Filled band. Protects cap.
- 6—Screw Pressure Filling Device. Fills in a second.
- 7—Hardened steel lever—copper plated.
- 8—Rounded Pressure bar (made of Monel Metal—rust proof) prevents injury to ink sack.
- 9—Seamless rubber sack, extra strong.
- 10—Air cushion (vacuum) feed bar. Gives perfect, even flow.
- 11—14 Kt. Gold Pen. Tempered by secret process.
- 12—Native irridium ball point. Cannot be harmed by inks or acids.

PRICES

No. 300 . . . \$3.50
No. 400 . . . 4.00
No. 500 . . . 5.00

LONG OR SHORT MODEL

No. 400
\$4.00

Never before in the history of direct selling field has such a wonderful opportunity been offered to Specialty Salesmen to engage in a business that had such a rapid growth and represents such splendid and unlimited possibilities.

JUST THINK OF IT! One out of every seven persons in the United States purchased fountain pens last year—16,000,000 in all. More will be sold this year and many more next year. **WHY?**—Because, while years ago a fountain pen was considered an article of luxury it has now become an absolute necessity, indispensable to every one who writes.

When you bear this in mind, you will readily appreciate the wonderful possibilities of the SECURITY as compared to the ordinary fountain pens on the market, not only on account of its novel and patented features which give it its smooth and excellent writing qualities, but also on account of its unique, practical and patented Check protecting device which alone is worth many times the price of the pen, adding tremendously to its advertising value and overcoming all possibilities of sales resistance.

Manufactured in our own complete and daylight factory under the same roof by a group of competent, democratic, highly paid, contented and profit-sharing employees with a long experience in the fountain pen industry, the SECURITY offers a product of **PAR EXCELLENCE** and is in a class all by itself.

No wonder it is becoming more and more popular every day and we have enjoyed such a meteoric success in a short period of ten months, ever since we inaugurated our new merchandising plan of selling through specialty salesmen direct to the user.

Having the distinction of possessing entirely new and superior features protected by six patents the SECURITY is placed in the non-competitive field, and although it could have been reasonably priced if sold at \$10.00 and upwards, the SECURITY costs no more than ordinary fountain pens on the market with an unconditional written guarantee for FIVE YEARS.

AGENTS—DISTRICT MANAGERS—AND DISTRIBUTORS

Think of the wonderful opportunities that this Pen offers as a money making selling proposition! Think of the millions of men and women throughout the Country who have individual checking accounts and who have no means of protecting their checks in spite of the fact that \$53,000,000 was lost last year in raised checks—forgeries and alterations of negotiable securities due to this negligence. **NOW YOU CAN PROTECT YOUR CHECKS WITH A SECURITY NO MATTER WHERE YOU MAY HAPPEN TO BE.** Think of the millions more of men and women and students who write! Each and every one is a splendid prospect for the SECURITY.

Think of the small business man, the store keeper, the lawyer, preacher, doctor, Real Estate man and farmer—they all have checking accounts and all are good prospects for the SECURITY. Even the big business men, Bankers and executives are excellent prospects for the SECURITY for though they may have Check Protecting machines in their offices, they nevertheless need a SECURITY for their personal checks which they write away from their business places, at home, club, or when travelling.

This is the best time of the year to get into the fountain pen business. More pens will be sold during the next four months than throughout the whole year, and quite a large percentage of these will be SECURITIES.

Now I want men to help me place a SECURITY in the hands of every business and professional man and woman in the United States and eventually in the hands of every one who writes.

Can this be done? Yes it can and will be done.

The men I am looking for don't have to be Geniuses, but must be hard working, ambitious, enthusiastic and perseverant. Of course I don't promise to make you rich within six months or a year neither must you expect that you will make a clean up over night, because our proposition is not of that nature. But if you possess the above qualifications and are willing to devote your own time and energy for the development and sales of the SECURITY then I can safely assure you of a steady and comfortable income that would grow tremendously each year as the SECURITY becomes more known, in addition to establishing yourself in a clean, profitable and permanent business, all of your own, in your protected territory without any off seasons.

If you are not satisfied in just making a fair living and wish to have an incentive and are anxious to better your condition, if you are not afraid of hard and persistent work and are prepared to make sacrifices, then you are the man I am looking for and my proposition will interest you, because the SECURITY is destined to be the leader in the field.

Of course we can't accomplish this in six months or a year, but when I get the right kind of men behind this meritorious article and all of us work together and cooperate to the fullest extent, we are bound to put the SECURITY over in a big way and our efforts will be highly rewarded.

CASH REQUIREMENTS

In order to avoid any possible misunderstandings and as I am not at all anxious to take up your time or mine by corresponding and for the purpose of keeping away the curiosity seekers I will endeavor to make our proposition very clear in every way.

If you wish to become an Agent and wish to devote part or all of your time to the SECURITY you must have a capital of \$17.75 to enable you to purchase one of our complete sample outfits which will start you on the road to success.

And as soon as you have proven to us your ability to successfully distribute our product I will make you a proposition offering you exclusive territory of from 10,000 to 50,000 people.

If you wish to act as a District Manager and are able to train and organize a small sales force and can finance yourself to the extent of from \$150.00 to \$500.00 we will allow you the exclusive sales rights for the SECURITY within a territory ranging in population of from 150,000 to 500,000 people. If you wish to act as our Distributor, have had experience in organizing and maintaining an efficient sales organization and are in a position to finance yourself to the extent of from \$1,000.00 to \$2,500.00 we will grant you the exclusive sales rights of our product in a territory having a population of from 1,000,000 to 5,000,000.

Attention. We do not sell territorial rights. Your capital is to be always under your control and is to be used strictly for the purchase of pens and furnishing suitable office quarters.

I have endeavored to make our proposition very clear and my cards are on the table face up. If you think you are the man that can represent us in either the capacity of an Agent, District Manager or Distributor and are willing to put your cards on the table, then I am sure we can get together and will be glad to show you how you can make some real money and consider it a pleasure to be associated with our progressive organization.

When writing please don't say I wish to act as Agent, District Manager and Distributor, but judge for yourself in what capacity you are able to serve yourself and our organization to a better advantage and specify exactly in the coupon below and write me a personal letter giving me a brief history of yourself, your past experience, also financial, commercial and character references, and mention territory you wish. I will then give you full details.

NOTE—Please do not ask for Credit, Free Samples or Samples at wholesale prices. We do a strictly cash business.

If you desire to see the SECURITY before taking further action, send with your letter check or money order for style wanted and a complete demonstrating outfit will be forwarded to you free of charge together with sample pen.

After you receive the pen, examined all the parts, noted the simplicity and strength of construction and followed carefully the directions relative to filling and the use of the pen and given it a thorough trial we are confident you will agree with us that the SECURITY is all we claim it to be.

Then go and show the pen to your friends and acquaintances, also several business men including your Banker, get their opinion and let them be the judges. In the event however you are not completely sold on its merits and are not thoroughly satisfied with the SECURITY you may return the pen at our expense and the entire purchase price will be refunded you without any ifs or ands.

JOHN H. KRITIKSON, President.

Security Pen Corporation, Dept. P. M. 10, 900-910 W. Jackson Blvd., Chicago

Security Pen Corporation, Dept. P.M. 10, 910 W. Jackson Blvd., Chicago, Ill.

Gentlemen: I am interested in your proposition from the standpoint of Distributor District Manager Agent.

I enclose letter giving my past experience, references, and territory desired.

Enclosed find check or money order. Send me one Security Pen

No. Long Short Medium Fine Stub

Also Demonstrating Outfit Free.

Name

Address City State



**TWICE THE HEAT
AT HALF THE COST**

**Amazing
Invention
Does Away With
Coal and Wood**

Fits Any Stove

**NOTE
SCIENTIFIC
APPLICATION
OF AIR TO FLAME**

No Wood no Coal

**Heat the
New Way—On
or Off With the
Turn of a Valve**

**Heat the
New Way—On
or Off With the
Turn of a Valve**

Think of having instantly all the heat you want IN ANY STOVE without building fires; without kindling, ashes, dirt, or odors. Think of having—at the touch of a finger—a fire that is three times hotter than coal—or just enough to simmer a kettle. A fire that stays where you want it—high or low.

THREE TIMES HOTTER THAN COAL

Think of the wonderful cooking and baking you can do with such a fire, think of the better health and comfort the family will enjoy when you can keep every room in your home at just the heat you want, warm and cozy, day and night, in any weather. These are but a few of the advantages enjoyed by users of a remarkable new invention—

INSTANT-GAS—CHEAPER THAN COAL

A scientific combination of 96% superheated air and 4% kerosene (common coal oil)—the cheapest and safest fuel known. It is produced by an amazing invention which, in one minute, can be slipped into the fire-box of any coal or wood stove. All the convenience of gas at half the cost.

Start with the Turn of the Valve

Turn high or low to suit, heat your home, do your cooking and baking, and then stop with another turn of the valve. A child can operate it. Instant-Gas gives a clean, steady, dependable fire. No ups and downs to give the family influenza and pneumonia, no running out into the cold to fetch coal or wood, no fallen cakes or sodden biscuits from an unsteady oven. Saves cleaning bills, doctor bills, wall paper and curtains.

Works in Any Stove—Old or New

No holes to drill, no injury to stove, installed in a few minutes, makes old stove work like new, and makes a new stove last twice as long. Lasts a lifetime. For many years the markets have been flooded with oil burning devices—but a scientific improvement in the application of oil burning principles makes the Instant-Gas Oil Burner the one great, outstanding success of its kind. Yet it costs

no more than inferior out-of-date makes. Money-back guarantee gives you absolute protection.

TRY IT IN YOUR HOME FOR 30 DAYS FREE

Test the Instant-Gas for yourself, try it in your own stove at our risk for 30 days, see for yourself how much superior Instant-Gas is to any other fuel, how much money it saves, how easy it is to turn on and off, how much cleaning and scrubbing it saves, how much warmer you can keep your home, and how much better cooking and baking you can do. Join the hundreds of thousands of Instant-Gas users who have gained health and strength by cutting their work in half and doing away with the heavy, dirty, back-breaking coal and wood. Mail coupon today for 30 day trial offer and amazing new book "Scientific Oil Burning." No obligation. Special low introductory price to those who mail coupon at once. Mail yours today.

AGENTS Oil burning is the rage. People everywhere are turning to this remarkable new method of heating and cooking. \$60.00 a week sales plan for beginners and spare time workers. \$5,000.00 to \$10,000.00 a year easy for real producers, who can handle big territory. Write at once for details and be ready for big Fall and Winter sales.

INTERNATIONAL HEATING CO.

119 South 14th Street, Dept. 335, St. Louis, Mo.
Manufacturers of scientific heating equipment.

Mail this Coupon for Amazing Free Book

International Heating Co.,

119 South 14th Street, Dept. 335, St. Louis, Mo.

Without any obligation whatever to me, mail me, post paid, your free book entitled "Scientific Oil Burning," together with your special introductory price and 30 day trial offer to those who act at once.

Name.....

Address.....

City and State.....

If interested in making from \$60.00 to \$200.00 a week as agent, like Lacey of Mass., mark X in this square



Steady Work

in a fast growing business with Vanderpool Latest Improved Vulcanizer. Made in America.

Ask for Catalog

Vanderpool Co., Dept. 10P, Springfield, Ohio

F. H. DIBB, Agent for British Isles
26 Fairfield Rd. Winchester, England



INSTALL AN ELECTRIC LIGHT IN YOUR HOME. It costs only a few cents a day. You can do it easily, quickly, with a Midget Marvel electric light outfit. No matter how far you are from a power plant this new discovery gives you a dazzling flood of electric light at the touch of the switch. You recharge your battery with a 10c powder obtained from your druggist. With ordinary use one charge supplies light 7 to 10 days. Outfit will last for years. Sent complete ready to install, including 60 foot wire, staples, switch, completely wired fixture with shade, guaranteed Mazda lamp, battery system, battery charger and instructions. Postpaid for \$2. Agents Wanted. Send today for complete outfit and wholesale terms. No circulars or C. O. D. Your \$2 returned if not satisfied.

L. A. IRVING ELECTRIC CO., 1636 S. Lawndale Ave., Chicago

Big Profits in 8 Hour Battery Charging

Start Your Own Money-Making Business

You can make big profits charging batteries with HB Constant Potential 8-Hour System. No experience needed. You Can Clear \$150 to \$300 Every Month. HB outfit comes complete, ready to connect and operate. New Built-in Patented HB Voltage Regulating Winding Absolutely Eliminates Reversing. Saves current and labor; runs all night without attention. Charges 6, 12 or 24 volt batteries. Better, longer-lived charge than old 3-day system. Quick service builds trade, satisfies customers, makes big, steady profits for you.

\$30 Monthly Pays for Your HB Charger

Smallest cash payment brings your HB Constant Potential Charger. Easy Terms of Only \$30 Monthly Quickly Pay Balance from Your Profits. 30 Days' Free Trial on Money-Back Guarantee Lets You Try HB Outfit at Our Risk. Oversize HB construction Insures 1-3 More Output Than Any Other Outfit of Similar Rating. Start now to make big battery charging profits. Write today for information. Ask about other HB money-makers—air compressors, buffers, motors, etc. All sold on easy payments.

Hobart Bros. Co.
Troy, Ohio



Small Cash Payment - Your Profits Quickly Pay Balance



Style No. 19

**For Men
On Their Feet All Day**

Thousands of policemen, firemen, mailmen, motormen and conductors who must have comfort as well as long wear depend on No. 19 to keep their feet "on the job."

Adopted by New York Police Department and many Police and Fire Departments throughout the country.

Let us send you our new **FREE** catalog and name of nearest Herman dealer

Joseph M. Herman Shoe Co
Dept. P
Mills, Mass.

HERMAN'S SUPER-SERVICE SHOES

FORDSPEED

FOR SPEED

FOR COMFORT
FOR BEAUTY

SPORT BODIES \$2900 UP

4, 8 and 16 Overhead Valve Heads
Sport Fenders for Under-slung and Standard Fords

FORDSPEED BODIES are known for their beauty of lines and quality of workmanship and "Every day and in every way they are getting better and better." Complete line of bodies and speed and power specialties illustrated in our free catalog. Big display of complete cars in our show room.

	Price	Now		Price	Now
Under-slung Fixtures	\$12.50	\$9.95	Speed and Power Camshaft	\$19.00	\$11.95
3:1 or 2 3/4 :1 Gears	12.50	9.95	Worm Steering Gear	30.00	18.95

SATISFACTION OR MONEY BACK guarantee. 80% with order, balance on delivery

G. D. FORD SPEED & POWER EQUIP. MFRS., 250 W. 54th St., New York, 3rd Floor

Build It Better—Quicker—Easier

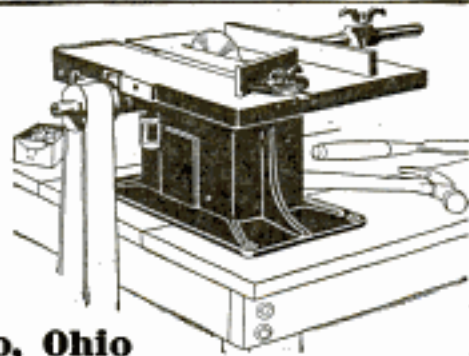
Hundreds of users are doing ripping, mitering, grooving, rabbeting, tenoning, sanding, grinding and many other operations with speed and accuracy on the

Boice Junior Bench Saw

A small compact, low-cost, precision machine of all metal construction. Saws 1 1/2" stock with ease. Dadoes 3/8"x3/8". Easily driven by 1/4 or 1/2 h. p. motor or from line shaft. Top 10"x13" easily elevated for grooving or tilted to 10 degrees for beveling. Attaches to any light socket. Built of best materials; bronze bearings. Sold on guarantee of satisfaction or money refunded.

Write today for descriptive literature on this and other Boice-Built Bench Machines and Motors.

W. B. & J. E. Boice, Dept. P. M. 10 Toledo, Ohio



\$2 Brings This Genuine DIAMOND RING

No Red Tape
No DelaySET IN
PLATINUM

Think of it.—seven brilliant genuine diamonds massed in setting of solid platinum so closely to ether that only close inspection will distinguish it from a \$750 solitaire.

10 DAYS'
REE TRIAL

Simply send \$2 if you can duplicate this diamond ring for less than \$65 your deposit will be refunded. Guarantee send accompanies each ring. After trial, pay balance \$1.65 a month for ten months. Price only \$18.50.

FREE ROYAL CATALOG

Illustrates thousands of special offers in Diamonds, Watches and Jewelry from our \$2,000,000 stock. Write Dept. 861.

ROYAL DIAMOND & WATCH CO.
35-37-39 Maiden Lane - New York

AGENTS: Make \$4,500 Next Few Months



\$15.00 a Day
Guaranteed for
Only Three
Sales a Day

Sell THURSTON OIL-GAS BURNERS

Sizes for any coal or wood Range, Heater, or Furnace. No changes to make in stove. Just set it in—Start it off. No tools needed to install. Use in any Worn Out or New Stove. Clean, intense, even blaze. Great for baking. Three times heat of coal at half the cost. No more coal or ashes to carry. No dirt, soot, or drudgery. Absolutely safe. \$15 a day a snap for hustlers. Popular price seller. Written guarantee. Sample free plan. Get yours free. Write.

Thurston Mfg. Co., 31 Dicky Bldg., Dayton, O.

TIRES RUN 30,000 MILES

J. D. Cooper says their Cadillac Car ran 30,000 miles without changing a tire after equipping with a new puncture proof tube, invented by P. B. MILBURN, 339 W. 47th Street, Chicago, Ill. This wonderful tube in actual test has stood

500 NAIL HOLES WITHOUT LOSS OF AIR

and it costs no more than ordinary tubes. Mr. Milburn wants distributors. You can become his salesman. Write to-day.

ANYBODY CAN PLAY

So simple a child can play—no numbers instead of notes.



FREE—15 SONGS!

"Futaba" at parties, entertainments, etc. SEND NO MONEY; just your name. Pay postman only \$2.75 on arrival. We pay postage. PUBLIC TRADING CO. 263 5th Ave., Dept. 253, New York



Harris Homes Beautiful PERMANENT BUILT

Your Home Is Within YOUR Reach
When You Buy From Us!

A mighty organization of thirty great departments ready to serve you. Managed by expert material buyers, designers and practical builders. We have vast stocks bought at huge quantities, price savings which are now at your command. Our sole aim and purpose is—

To help you get a home that will
prove entirely satisfactory at a price
that will mean a substantial saving
in actual dollars of your money.

The combined efforts of these great departments in experimenting and testing materials and methods of construction have produced for you a GUARANTEED home, expert machine cut, bundled and marked—the last word in building economy.

Not One Penny in Advance

So sure are we of the superior excellence of our material and our GUARANTEED Ready-Cut System that we will ship you any HARRIS HOME without the payment of one cent down. Our Plan Book explains our liberal terms fully.

**FREE
Plan Book**

The latest edition is waiting for you, contains our FREE PLAN OFFER and photographic reproductions, with floor plans and specifications of 100 beautiful homes. Write for full particulars now!

Our Specialties: Guaranteed Ready-Cut Homes, Plumbing, Heating, Lumber, Mill Work, "Presto-Up" Belt-Together Homes, Paints, Roofing, etc., etc., and Building Material of all kinds.

HARRIS BROTHERS CO.

Dept. PE-7, 1349 W. 35th St., Chicago



How Did Your Garters Look This Morning?

The new Wideweb "Boston" is light—cool—secure—adjustable—and rests so easily on the leg that you forget you have it on. Insist on having the Boston because it is the only garter with the famous Oblong All Rubber Button Clasp.

GEORGE FROST COMPANY, BOSTON!
MAKERS OF VELVET GRIP HOSE SUPPORTERS FOR
ALL THE FAMILY

LEARN TO PROTECT YOURSELF!



Art of Self Defense—Book explaining the means of attack and defense. The lessons are so simple that by little practicing any one may attain the utmost perfection in sparring and boxing. Also swimming, gymnastic training fully explained and illustrated. Sent for 25c Postpaid.

J. C. DORN, 725 So. Dearborn St., Dept. 54, CHICAGO

YOU NEED THIS BOOK



It illustrates and explains how you can permanently repair leaky kettles, motor radiators, cracked stove lids, fire pots and make dozens of other repairs economically with

SMOOTH-ON CEMENT NO. 1
An easy to apply as putty—lasting as iron.

SMOOTH-ON NO. 1 is sold by Hardware and General Stores in 6-oz. tins, 30c (by mail add 6c); also in 1-lb., 5-lb., and larger sizes.

SMOOTH-ON MFG. CO.
Dept. 37-1, Jersey City, N. J.
U. S. A.

Write for it—it's FREE



WINDOW SIGNS

AGENTS 500% PROFIT

GENUINE GOLD SIGN LETTERS

For store fronts, office windows and glass signs of all kinds. Guaranteed to never tarnish. No experience necessary. Anyone can put them on and make money right from the start.

\$75 TO \$200 A WEEK!

You can sell to nearby trade or travel all over the country. There is a big demand for window lettering in every town. Send for free samples and particulars. Liberal offer to General Agents.

Metallic Letter Co., 433-B N. Clark St., Chicago

MAKE YOUR FORD INTO THIS

SPORT CAR—SAVE \$50 to \$150 WITH

Red-i-Kut Life-Size Patterns \$6.40

Follows **Red-i-Kut** life-size patterns and picture-fit turn instructions show you how you can easily convert your Ford into this **FAST, SAUCY, SPORT CAR** as thousands have done, with easily obtained materials. No need to lay up the car. The "Pal" with a raised metal streamline rear. Life-size patterns for each part of the body so you can't go wrong and

CONICAL DISK WHEEL PATTERNS
Only \$6.40 delivered. Order now while we can make good delivery, and really enjoy the happy summer days in your "Pal." **Keen, Classy, Up-to-the-minute.** You can build it. Over 11,000 in use. Order Now.

"RED" Steel Set Complete for "Pal" \$9.31. Est. Wht \$11.98
The Ace of Fords—"I have finished my 'Pal.' It's some jazz boat. I go where others fail. I can run thru mud on high where others can't go so low. I am so proud. I am called the Ace of Fords, for I skip by them. It kind of like a rabbit."—Cal Fortuna, Columbia, Ky. "Swing Lo" Underlating Irons, no frame cutting kind, \$7.01. Send 5c coin for new manual of other distinctive sport body patterns from \$2.00 up—"RED" Steel Underlating Irons, "J.R." Type and "Gusam" Wheelwheels. Don't delay—Order Right Now.
Kuempel Co., 41 Kuempel Bldg., Gettensberg, Iowa

Easy-to-Understand Instructions and Tail Delivered



SAVE MONEY
Get This Book

HANDY MAN BOOK

Install Your Own
PLUMBING & HEATING
NEW EASY WAY - SAVE HALF

25c

Reg. Price 50c

Brings you this big Plumbing and Heating Encyclopedia-Catalog. Write for your copy today without fail.

Guaranteed Heating Plants

Our Handy-Man Book shows how. Big 256-page well-bound encyclopedia of Plumbing and Heating Outfits, Systems, Supplies, Fixtures and Accessories—10,000 items—illustrated. Hundreds of floor plans, elevations, diagrams, trade secrets, money and trouble-saving hints, etc. "How to save coal in heating," "Easy repair methods," "Every householder, contractor, farmer, mechanic, institution needs this book. Shows how to save wages, work and materials."



Hot Water boiler

BIG HANDY MAN BOOK

Tells how we help you plan and install. From rough sketch or description we supply working plans and clear instructions. We loan the tools needed. Any handy man can install. This is the place to buy on money-back guaranty. Plumbing Outfits and Supplies; Water Systems; Hot-Air, Water or Steam Heating Plants; Radiators, Pipes, Boilers or Septic Disposal Tanks.

Send 25c for Yours Today

We have spared no effort or expense to complete this remarkable and instructive book. To keep from sending it broadcast to disinterested persons, we request a deposit of 25c, which will be refunded on your first order—or send for our FREE Bulletin. Write today and save half.



Pipeless Furnace

HARDIN-LAVIN CO.

50 Years
at 4547-57
Cottage Grove Ave.,
CHICAGO

Bathroom
Outfit

FORD RUNS 57 MILES ON GALLON OF GASOLINE

A new automatic and self-regulating device has been invented by John A. Stransky, 391 Fourth St., Pukwana, South Dakota, with which automobiles have made from 40 to 57 miles on a gallon of gasoline. It removes all carbon and prevents spark plug trouble and overheating. It can be installed by anyone in five minutes. Mr. Stransky wants agents and is willing to send a sample at his own risk. Write him today—Adv.

The Finest
Yankee
Ever Made

\$2⁰⁰

**The New Improved
YANKEE**

THE New Ingersoll Yankee is now on sale in stores in all parts of the country.

It has the same stylish antique bow and crown that is used on expensive watches; a handsome new dial; a beautifully damaskeened back plate; and other refinements and improvements that make it the finest Yankee ever produced.

Ingersoll

Models \$2⁰⁰ to \$10⁰⁰

LONG RANGE RIFLE ^{cal}

SINGLE shot hunting rifle of finest blue, case hardened steel, modelled after famous Springfield rifle. Bolt action, take-down model 36 inches over all. Shoots 22 calibre long, extra long and short cartridges. Special at \$6.95

Front and rear sights; automatic shell ejector.

PAY POSTMAN
ON DELIVERY plus postage.
Money back if Not Satisfied
CONSUMERS CO., Dept. 4-CB
1265 Broadway, New York

FREE Send for free catalog of other bargains in sporting goods.

Birds—Parrots—Goldfish Cages and Supplies

Extra fine Singing Canaries, Talking Parrots, other Birds and Fancy Fish. We also have a full line of cages, aquariums and supplies. Retail and wholesale. We ship anywhere.

Weather does not affect shipping. Send for our beautiful new free illustrated catalog in true color.

SAM MEYER & COMPANY

24 W. Washington St., Dept. 20, CHICAGO, ILL.



Hand Forged
Razor Steel
Blades, No. 57

EL DIABLO RAZOR STEEL

A GENUINE \$2 KNIFE
FOR \$1.18 POST PAID

Direct at Factory Prices

This \$2 KNIFE \$1.18 Postpaid
Hand Forged Razor Steel Blades
Handy shaped Blade makes this knife best for mechanics, sportsmen and farmers; light but strong; re-sharpened easily. Stag handle, German silver finish; blades file tested, hand forged from razor steel and warranted.

Sample \$1.18 3 for \$3.00 Postpaid.

Send for our 100-page List and "HOW TO USE A RAZOR" **FREE**

MAHER & GROSH CO., 106 A St., Toledo, Ohio

Only \$14²⁴ DOWN



This WITTE Throttling ENGINE Is sold DIRECT from FACTORY to YOU on 90 Days FREE Trial

Here's the engine that has revolutionized power on the farm—makes every job easy and cheap. Low priced—in all sizes, 2 to 25 H-P. Simple to operate and free from usual engine troubles. Over 100,000 WITTE Engines in use today.

Burns **KEROSENE, GASOLINE,
DISTILLATE or GAS**

Delivers power far in excess of rating on the cheapest fuels. Built to burn any fuel—no attachments necessary. Practically no carbon and equipped with the famous WICO Magneto.

Write Today for my FREE BOOK Investigate this engine now. Write for my Big, Free, Illustrated Engine Book and details of amazing 90-Day FREE TRIAL Offer. No obligation. ED. H. WITTE, Pres.

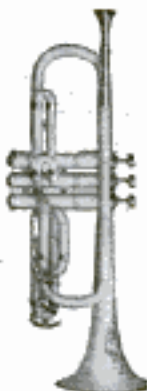
WITTE ENGINE WORKS

1748 Oakland Avenue
KANSAS CITY, MO.

1748 Empire Building
PITTSBURGH, PA.

Sent to Your Home on free trial

Take advantage of this offer now. You can have the famous York Saxophone sent to you for 6 days' examination and trial. Convince yourself that this is the easiest instrument to play. Note particularly its fine, deep, mellow tone, and its quality. Observe the skill and perfection of workmanship. Keep the York Saxophone 6 days, and then if you are not completely satisfied send it back to us and it won't cost you a penny.



EASY PAYMENTS

If you decide to buy you can make small monthly payments while learning to play. We send you everything you need, including carrying case, and first lesson—FREE.

TAKE YOUR CHOICE

You can have any of the famous York band instruments sent to you on 6 days' free trial. Send the coupon below for our beautifully illustrated literature and pick any of the following instruments: Saxophones, Cornets, Clarinets, Baritones, Trombones, Drums.

Send This Coupon

Use the coupon below. Fill out with your name and address and mention instrument—or instrument—you are interested in, and we will send you at once full details of our Trial offer and Easy Payment Plan—also how to practice and how to learn to play.



J. W. YORK & SONS

Dept. 221-J

Grand Rapids, Mich.

J. W. York & Sons, Dept. 221-J, Grand Rapids, Mich.

Gentlemen: Kindly mail, without cost to me, your beautifully illustrated literature and details of your Free Trial and Easy Payment Offer.

Name.....

Address.....

Instrument.....

(Mention above the instrument most interested in)

Please Mention Popular Mechanics

CAMERAS

Over a Hundred Styles and Sizes
Send for new 1923 illustrated catalog showing newest models and latest reduced prices.
IT'S FREE
10 days' free trial given
Seneca Camera Mfg. Co.
300 Central Ave., Rochester, N.Y.

DIAMONDS

1/2 CARAT \$99⁰⁰

We are direct importers of perfectly cut, sparkling, brilliant, blue-white, genuine diamonds, which we now offer at only \$197.00 per carat from 1-8 carats to 2 carats. The former price was \$225.00 per carat. YOU SAVE 40 PERCENT.

30 DAYS FREE TRIAL

You can send cash with order, or we will send to your bank or express office for inspection before paying. If you can duplicate these diamonds for less than \$225.00 per carat, we will return your money. Guarantee Certificate Given.

WRITE FOR CATALOG

You should know the exact weight and quality of any diamond you buy. Our catalog tells you, and it brings a large jewelry store into your home. You save 40 per cent when you buy from us. \$1,000,000.00 back up our guarantee.

B. GUTTER & SONS ESTD. 1879
172 Nassau St., Dept. 1188, New York

Three Tubes Is All You Need



With Erla Synchronizing Transformers



One of the most notable improvements of recent years is disclosed in the new Erla synchronizing audio frequency transformer. List \$5



Especially constructed for reflex work, the Erla fixed crystal guarantees success. Proof against disturbance, through jolt or jar. List \$1



Every Erla fixed condenser is individually tested to the exact capacity shown, an exclusive feature. Made in eleven sizes, 35c to \$1

Transcontinental reception, through a loud speaker, is assured when you tune in with the new Erla Triplex circuit, using three vacuum tubes and Erla synchronizing radio and audio transformers.

Results obtained surpass conventional six and seven-tube circuits in range and volume. Moreover, tone quality is remarkably improved, with complete absence of parasitic noises.

For all except the most distant stations, outdoor antenna can be dispensed with, an inside aerial serving equally well. Wet batteries, likewise, are no longer essential, low current consumption enabling satisfactory use of dry cells.

Accounting in large measure for the amazing efficiency of this circuit, and guaranteeing its success, are Erla synchronizing transformers. For the first time, perfect inter-relation and co-ordination between transformers has been secured in reflex work, producing unequalled amplification without distortion.

A further notable improvement is embodied in the new Erla fixed crystal detector. Providing maximum sensitiveness and purity of reception, with complete immunity to jolt and jar, it antiquates the costly vacuum tube for detector purposes.

Detailed working diagrams and descriptions of the Erla Triplex and other advanced Erla reflex circuits are included in Erla Bulletin No. 14, obtainable gratis from leading radio dealers. Or write us direct, giving your dealer's name.



Perfect synchronization of Erla transformers assures unequalled range and volume, with no trace of distortion. Cascade \$4, Reflex \$5



No high grade panel assembly is complete without Erla bezels, in bright nickel or dull enamel. Fit any panel, in 1" and 1 1/2" sizes, 20c ea.

Dealers and Jobbers—Erla leadership in radio progress spells rapidly mounting sales and profits. Write us today.

Electrical Research Laboratories
Dept. J. 2515 Michigan Ave., Chicago

ERLA

Miracle
Tooth Beautifier

25¢ per bottle

Don't let discolored teeth mar your smile and beauty. Remove yellow, discolored, or tobacco-stained teeth as white as snow. Eliminates tartar. Just a clear liquid, absolutely harmless. Teeth shine and glisten like polished ivory. Everybody wants MIRACLE TOOTH BEAUTIFIER. Recommend it to their friends. Not an ordinary tooth paste or powder. It's a new, scientific discovery. Nothing else like it. Sells like hot-cakes.

Your Money-Back Guarantee: Refund if not satisfied. Money-Back Guarantee: Refund if not satisfied. Money-Back Guarantee: Refund if not satisfied.

New Easy Way to Make Money Fast

Make \$75.00 to \$150.00 A Week.
All Time or Spare Time

Just Place Card on Dealer's
Counter, Collect Once A Week

MIRACLE TOOTH BEAUTIFIER amazes nation. Makes yellow, discolored, or tobacco-stained teeth as white as snow. Eliminates tartar. Just a clear liquid, absolutely harmless. Teeth shine and glisten like polished ivory. Everybody wants MIRACLE TOOTH BEAUTIFIER. Recommend it to their friends. Not an ordinary tooth paste or powder. It's a new, scientific discovery. Nothing else like it. Sells like hot-cakes.

All you have to do is place a card (containing 18 bottles) on the counter of drug, cigar and candy stores. Card brings in \$4.50. Dealer keeps \$1.50. Pays you \$3.00. You pay us \$1.50, making \$1.50 per card profit for yourself. Many stores sell first card in two hours. Drug-gists call it fastest seller in history.

\$50 to \$200 Weekly Easily Made

You don't need selling experience. You can make Big Money right from the start. All you have to do is place the cards and collect your profits. Territory going fast. Write today for complete details. Better still, mail \$1.50 for sample card. Don't delay.

MARCH PRODUCTS COMPANY
Dept. 24 2162 N. California Ave., CHICAGO, ILL.

Send \$1.50 for Sample Card
Place it on a drug list's counter. Wait for a day or two. See how fast MIRACLE TOOTH BEAUTIFIER sells. Then grab your territory! Not satisfied, return card and we'll refund your \$1.50. Order several cards now if you want to get started quick.

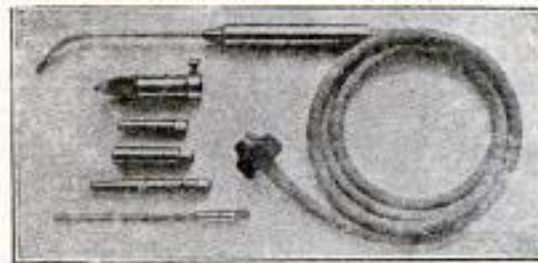


DON'T WASTE TIME

with slow methods. You can solder, or do light brazing in one-half the time with a TORIT TORCH OUTFIT NO. 13. Ready the instant you light it. For radiator repairing, battery work, loosening rusty and corroded nuts and bolts, splicing wires, heating, and hundreds of other uses. Uses acetylene only. Outfit complete including torch, 4 different tips, soldering copper, 5 ft. hose and tank connection \$7.50

Get your torch today from your jobber, or

ST. PAUL WELDING & MFG. CO.
177 W. Third Street St. Paul, Minn.



\$100.00 MEN

We want men who want to make \$100.00 a week. For such men we have a \$100.00 a week proposition. The job is selling our Virgi Wool tailored-to-order suits and overcoats at \$31.75. The story is too big to tell here. But if you're the kind of man that can and must make \$100.00 a week, then take our word for it—we've got the proposition for you. Write for the *proof at once*. Address Dept. 639.

GOODWEAR Chicago, Inc., Chicago

\$38.65 BUYS A SELF STARTER
Remington No. 10 Typewriter
Two dollars down, late model, all recent features, five-year guarantee, 30 day trial.
LINCOLN TYPEWRITER COMPANY
298 Broadway, Dept. 133, NEW YORK

Build Your Own PHONOGRAPH

IT'S EASY WITH OUR HELP

A few hours' interesting work saves over half and gives you a machine to suit your ideas. We furnish motors, tone arms, case material, blue prints and full instructions. Plays any record. Make fine profit building phonographs for your friends.

Write today for our **FREE** Blue print offer.

GET YOUR **RADIO SUPPLIES** FROM US
Choraleon Phonograph & Radio Co.
1023 1st St., Elkhart, Ind.



SAVE OVER HALF



"Mary, I Owe It All to You"

"MR. WILLIAMS called me into his office today and told me he was going to raise my salary \$50 a month.

"I am glad to give you this opportunity," he said, for the best reason in the world. You deserve it.

"You may not know it, but I've been watching your work ever since the International Correspondence Schools wrote me that you had enrolled for a course of home study. Keep it up, young man, and you'll go far. I wish we had more men like you."

"And to think, Mary, I owe it all to you! I might still be struggling along in the same old job at the same old salary if you hadn't urged me to send in that I. C. S. coupon!"

How about you? Are you always going to work for a small salary? Are you going to waste your natural ability all your life? Or are you going to get ahead in a big way? It all depends on what you do with your spare time.

More than 180,000 men are getting ready for promotion right now in the I. C. S. way. Let us tell you what we are doing for them and what we can do for you.

Mail the Coupon To-day

TEAR OUT HERE

INTERNATIONAL CORRESPONDENCE SCHOOLS
Box 5548-D, Scranton, Penna.

Without cost or obligation, please tell me how I can qualify for the position or in the subject before which I have marked an X:

BUSINESS TRAINING COURSES

- | | |
|---|---|
| <input type="checkbox"/> Business Management | <input type="checkbox"/> Salesmanship |
| <input type="checkbox"/> Industrial Management | <input type="checkbox"/> Advertising |
| <input type="checkbox"/> Personnel Organization | <input type="checkbox"/> Better Letters |
| <input type="checkbox"/> Traffic Management | <input type="checkbox"/> Foreign Trade |
| <input type="checkbox"/> Business Law | <input type="checkbox"/> Stenography and Typing |
| <input type="checkbox"/> Banking and Banking Law | <input type="checkbox"/> Business English |
| <input type="checkbox"/> Accountancy (including C.P.A.) | <input type="checkbox"/> Civil Service |
| <input type="checkbox"/> National Cost Accounting | <input type="checkbox"/> Railway Mail Clerk |
| <input type="checkbox"/> Bookkeeping | <input type="checkbox"/> Common School Subjects |
| <input type="checkbox"/> Private Secretary | <input type="checkbox"/> High School Subjects |
| <input type="checkbox"/> Business Spanish | <input type="checkbox"/> Illustrating |
| <input type="checkbox"/> French | <input type="checkbox"/> Cartooning |

TECHNICAL AND INDUSTRIAL COURSES

- | | |
|---|--|
| <input type="checkbox"/> Electrical Engineering | <input type="checkbox"/> Architect |
| <input type="checkbox"/> Electric Lighting | <input type="checkbox"/> Blue Print Reading |
| <input type="checkbox"/> Mechanical Engineer | <input type="checkbox"/> Contractor and Builder |
| <input type="checkbox"/> Mechanical Draftsman | <input type="checkbox"/> Architectural Draftsman |
| <input type="checkbox"/> Machine Shop Practice | <input type="checkbox"/> Concrete Builder |
| <input type="checkbox"/> Railroad Positions | <input type="checkbox"/> Structural Engineer |
| <input type="checkbox"/> Gas Engine Operating | <input type="checkbox"/> Plumbing and Heating |
| <input type="checkbox"/> Civil Engineer | <input type="checkbox"/> Chemistry |
| <input type="checkbox"/> Surveying and Mapping | <input type="checkbox"/> Automobile Work |
| <input type="checkbox"/> Metallurgy | <input type="checkbox"/> Navigation |
| <input type="checkbox"/> Steam Engineering | <input type="checkbox"/> Agriculture and Poultry |
| <input type="checkbox"/> Radio | <input type="checkbox"/> Mathematics |
| <input type="checkbox"/> Airplane Engines | |

Name.....
Street.....
Address.....

3-27-23

City..... State.....

Occupation.....

Persons residing in Canada should send this coupon to the International Correspondence Schools Canadian, Limited, Montreal, Canada.

Please Mention Popular Mechanics



Accurate, Clean Cut Graduations

The second point of superiority of Brown & Sharpe Micrometers

2

Did you see point 1 regarding the precision screw of a Brown & Sharpe Micrometer in last month's issue of this magazine? If not, ask for the booklet "The Micrometer" when you send for a No. 28 Catalog. Point 3 will appear in this magazine soon.

IN the accurate, clean cut graduations lies the second point of superiority of Brown & Sharpe Micrometers.

The first dividing engine to be used in America, for accurately graduating measuring tools, was built by Brown & Sharpe in 1850. 70 years of experience in accurately graduating tools together with the accurate machines which we have developed for this work give every Brown & Sharpe Micrometer graduations of superior accuracy.

Examine one of these tools at your dealers. Take particular notice of the graduation lines; they are clean cut, clear and straight and help produce the accurate measurements which mechanics look for and depend on in Brown & Sharpe Micrometer Calipers.

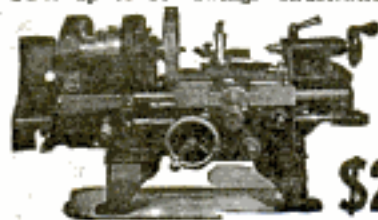
Write today for a copy of our No. 28 Small Tool Catalog. It lists over 400 styles of Brown & Sharpe Micrometers.

BROWN & SHARPE MFG. CO.
PROVIDENCE, R. I., U. S. A.

BROWN & SHARPE TOOLS

Send for FREE Catalog

INVENTORS, experimenters, designers, auto repairmen—you should have this catalog which illustrates and describes the various models of MONARCH Lathes which are built up to 30" swing. Illustration herewith shows the



MONARCH Jr. 9" engine lathe—accurate, compact and trouble proof. Has semi-quick change gear and automatic safety devices.

\$245 9 in. Lathes—
2½ ft. Bed—
with Bench Legs

Also built with bed lengths up to 5 feet. Made in 11-inch swing size too, at slightly higher price.

THE MONARCH MACHINE TOOL CO.
400 Oak Street SIDNEY, OHIO



MAKE A MOTOR CYCLE

OUT OF YOUR BICYCLE with a STEFFEY MOTOR ATTACHMENT. RELIABLE—ECONOMICAL—EFFICIENT. Easy to attach. Fits any wheel. Send stamp for circulars.

STEFFEY MFG. CO., Dept. P, 5025 Brown St., Phila., Pa.

SPORT BODIES for FORD and CHEV. 400 at \$34.50

Life-size paper patterns—You can build your own body at small cost.



\$8 UP UNDER SLUNG PARTS Per Set \$6.75

We are manufacturers and our quantity production enables us to quote exceptional low prices. Our unique shipping methods save you 75% in FREIGHT CHARGES. Send at once for free particulars on Central Bodies. Our Book: "HOW TO BUILD A FORD RACER" sent anywhere on receipt of 25c in cash or stamps. **WRITE TODAY!**
Central Auto Supply Co. Dept. 120, Louisville, Ky.


AMPLION

WITH the Amplion Loud Speaker the infinite clearness and softness of tone achieves an unsurpassed reproduction welcomed and admired everywhere. The human voice or musical sounds come to you in their true richness, without the slightest distortion, unalloyed—just as they are rendered.

It is hard to believe you are listening to reproduction. Originality is so unmistakably registered in every tone.

The Amplion is made by the world's oldest manufacturer of loud speaking instruments. It is not a head set receiver used as a loud speaker, but a development for radio purposes of a loud speaking device, used exclusively on every ship of the British and other leading navies.

The Amplion requires no battery. You simply attach it in place of head phones. The Amplion is being extensively used in every country mentioned in the border of this announcement.

That it has been adopted as standard by the leading countries of the world is the tribute it has achieved through its brilliant performance.

All models on view at the New York Radio Exposition, Booth 5, at the New York Show—Oct. 6th to 13th.

SIGNAL ELECTRIC MFG. CO.

Sole United States Distributors Menominee, Michigan

BURNDEPT OF CANADA, LTD.

Canadian Distributors 172 King St., West, Toronto

*The Supremacy of the AMPLION
is the Supremacy
of Actual Performance*



One Month's Earnings

G. B. George.....	\$780.00
A. B. Knapp.....	816.00
B. B. Budd.....	520.00
E. G. Pick.....	605.00
K. H. Holden.....	502.00

Many of our men who have been with us six months or more are averaging over \$100.00 a week selling Simpson's

All Wool Tailored ^{To} Order Suits--Overcoats **\$31⁵⁰**

We furnish 6x9 swatches of cloth—a real selling outfit, compact, easy to carry, easy to show and easy to sell. You'll find heavy weight blue, gray and brown serges, and Frenchback worsteds, winter weight suitings, in all colors and patterns, *mostly worsteds*, but with a good showing of cassimeres, tweeds and cheviots. You'll find a dozen topcoatings, and a wonderful assortment of overcoatings, including Meltons, standard kerseys, rug backs, through and through weaves, etc. Our fabric assortment is very fine. Remember, they are all one price, \$31.50 suit or overcoat, all wool, tailored to order, any style, at no extra charge, and satisfaction guaranteed always. We ship by express, subject to examination, if so instructed.

Commissions Paid Daily You Collect Deposit

We ship C. O. D. for the balance. Tailoring men write. We give protected territory. No deposit required on samples. We will train inexperienced men, with satisfactory references. You can do well right from the start, and when experienced, average \$100.00 a week and up. Write us fully, in strict confidence. No references investigated without your permission.

It pays to sell a quality product with which you can build up a steady, permanent business. Actual figures based on experience of our men show that after six months' work, from 35 to 65% of your business will be from previous customers or on leads furnished by them. Sales to old customers or to people recommended by your customers, are easy to make. If the line you now handle doesn't bring you a heavy percentage of repeat orders, drop it and tie up with a line that will.

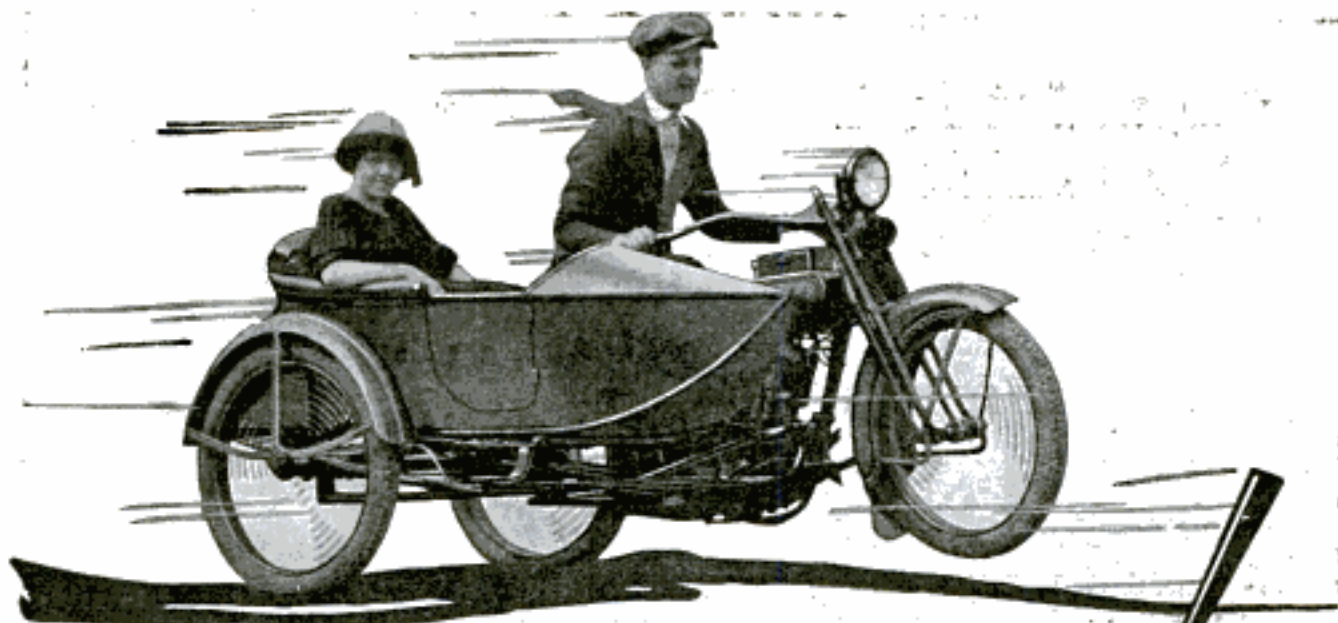
We believe ours is the easiest selling tailoring line in the United States. The fabrics are unusually attractive and the quality very fine. Every suiting is pure virgin wool. The linings and workmanship are very fine. The fit is seldom equalled and never excelled even at much higher prices. Our fall line is better than any other line in our history—in spite of the fact that prices on wool have gone skyrocketing.

Salesmanager J. B. SIMPSON, Inc.

Dept. 657

831-843 W. Adams St.

CHICAGO, ILL.



Get-away!

Aluminum-alloy Pistons!



HIT up any speed and hold it—all day long if you want to—and the 1924 Harley-Davidson won't overheat. The new aluminum-alloy pistons throw off the heat. They cut vibration in half. Far more durable, too—less wear on rings, bearings, piston pins and bushings.

EAGER get-away—the rushing acceleration of a zooming airplane—that's the 1924 Harley-Davidson, with its new aluminum-alloy pistons!

Lightning pick-up and sustained high speed, without overheating, are not the only features of the "1924". It's easier to care for (Alemite lubrication—first on any motorcycle). It's better looking than ever (olive green, maroon striped). And comfortable! Just wait till the new side car glides you over roads that look rough. Full-floating, semi-elliptic, 49-inch springs do that.

Yes, there's a real thrill waiting for you in these wonderful new Harley-Davidsons—a thrill that will make you want a "1924" more than anything else in the world. Take a free demonstration ride with your dealer and see.

Ask him about his Pay-as You-Ride Plan—most dealers offer one. Mail the coupon (below) for new catalog showing 1924 Harley-Davidsons in full color.

HARLEY-DAVIDSON MOTOR COMPANY
Dept. P. Milwaukee, Wisconsin

Harley-Davidson

The Motorcycle

Money-making sales opportunities in open territories. Write for particulars.

Mail this
Coupon
Today

Harley-Davidson Motor Co., Milwaukee, Wis., Dept. P.
Gentlemen: Send me free, postpaid, new catalog showing 1924 Harley-Davidsons in full color.

Name
Street or
P. O. Box
City State

YOU NEEDN'T BE "AN INVENTOR"

in the technical or professional sense, in order to "cash in" on ideas of practical use.

One of America's great Industries is interested in your IDEAS—and will pay you for them.

You have heard of "**Pressed Metal.**" It refers to *any* useful article that can be made by *stamping* from sheets of steel, brass, aluminum, copper or any practical metal, instead of by castings or other methods.

Pressed Metal is one of the greatest blessings that American mechanical genius has given the world. Its range of USEFULNESS, ECONOMY and CONVENIENCE to everybody is so great that, with a present volume of about \$20,000,000.00 a year, it has barely begun to meet its possibilities.

The **Pressed Metal** industry includes many of the largest high-class manufacturing concerns in the United States, and through the Pressed Metal T. E. C., welcomes the co-operation of every bright mechanical mind in the country, on a cash basis.

"JUST A THOUGHT"—NOT A PATENT

Sell us a practical idea *of some new and useful WAY* to utilize Pressed Metal *in place of other materials.* The undersigned will promptly pay cash for every acceptable suggestion approved by our Engineering Advisory Board. *FREE BOOK* gives you the facts.

DO NOT SEND US PATENTS OR MODELS. JUST
Write for the Free Pressed Metal Booklet

It tells all the conditions and the amounts to be paid for the successful ideas, and also how to protect yourself against misappropriation of your creative thoughts by others. WRITE TODAY. (A post card will do, but please make it easily legible so it can be properly filed and acknowledged.) Address

PRESSED METAL TRADE COUNCIL

EXTENSION
27 QUINCY STREET, SUITE 1701, CHICAGO



Stylish Moleskin Cloth Coat

\$1⁰⁰ Down

\$20.00 value
Special Price
\$13⁶⁵

Send only \$1 with coupon for this coat. Guaranteed rain proof and is also suitable for stylish top coat. Made from good weight moleskin cloth, a smooth, soft-finished material resembling chamois leather. Warm and comfortable in the coldest weather. Swagger double-breasted belted style with stylish plaited patch pockets. Adjustable strap on sleeve. Yoke back with inverted plait, giving the coat plenty of fullness. Collar can be converted into military style, buttoning close up to neck or worn as shown in illustration. Ventilated armholes. Ivory buttons. Backed with fancy plaid fast colored woven lining with extra coating of rubber between. All seams sewed, strapped and cemented. 45 inches long. Sizes 34 to 46. Rich Leather Brown shade.

Order by No. F-19.

Terms, \$1 with coupon, \$2.10 monthly.

Total price, \$13.65

6 Months to Pay

Buy the Elmer Richards way. You can always be well dressed and pay in small monthly sums, so small you will never miss the expense. Money back if not satisfied. No charge for credit. Don't miss this bargain. Supply limited at this special bargain price.

Elmer Richards Co.

Dept. 1777, West 35th Street, Chicago, Ill.

Enclose \$1. Send Moleskin
Cloth Coat No. F-19. Size.....

If I am not satisfied when I receive the coat I can return it and get my payment back with charges. Otherwise I will pay advertised terms, \$1 with coupon, \$2.10 monthly. Total price, \$13.65.

Name

Address

Post Office.....state.....



Rain
Proof

Plaid
Backed

No
C. O. D.
Charges
to Pay

Mail This
Coupon Today

Write for our
Monthly Bulletin of men's,
women's and children's
clothing and shoes.



\$ 215⁰⁰ In One Day

New Invention Sweeping Country Like Wildfire!

NO wonder this amazing new invention is bringing fortunes to agents. All over the whole country this new device is doing away with old-fashioned methods of heating with coal stoves, ranges and furnaces. Already over \$1,000,000 worth have been sold.

You can readily understand why this new invention—the Oliver Oil-Gas Burner—is sweeping over the country like wildfire. It does away with

all the expense of coal—making every stove and every furnace a modern oil-gas burner. Saves money, time and drudgery. Three times the heat of any other method. No wonder agents are riding in on the tide of big Oliver profits!

OLIVER Salesmen Making Big Money

These men know the secret of big money. They know a good thing when they see it and they know that the time is ripe for this new Oliver improved Oil-Gas Burner. They know that this age of high-priced coal and wood makes it necessary for some substitute. They see ships and locomotives being run by oil and big buildings being heated by it. And they know that an invention that makes use of this cheap fuel for every home—and yet does it so as to give more heat than coal or wood—is the thing they want to tie up to.

Big Profits Quickly Made

You too can use this secret of big money. You do not need to be a high-powered salesman. The Oliver's amazing features sell it for you. When people see it they know at once that it is the thing they want. You will realize that this is a proposition that will pay you as big money as it does others. We have a definite number of open territories which we are ready to dispose of to those who act quickly. Every territory allotted is filled with big-money opportunities. And this big money comes easily. Because not only does this invention practically sell itself on sight but when you have sold **one** this one will sell several others as soon as your customer's friends and neighbors see it. And thru our special plan you get credit and commissions for every sale in your territory.

You can also make big money just by using your spare time. Note how N. B. Chelan made \$43 in one evening.

Coupon Brings Full Offer

If you want to make at least \$5,000 a year easily, mail this coupon now for our offer. We are not making any extravagant claims about this. We do not have to. We believe that your common sense will indicate a good proposition to you when you know about it. We want to give you the facts. Won't you write us? And by doing so quickly you will be allotted an exclusive territory with private selling rights.

The coupon will bring you the facts and will save you writing a letter. But mail the coupon at once.

OLIVER OIL-GAS BURNER CO. 2014-V Oliver Bldg., ST. LOUIS, MO.
Canadian Distributor, 2014-V Oliver Bldg., Toronto, Ont.

SAYS F. W. Bentley of Philadelphia

"Ye Gods—some seller I made \$215 today!"

Buy Car with Profits
"Have earned enough in one month to buy me a new auto!"
S. W. Knappen, Cal.

\$7 Profit per Hour
"Started out and made \$21.50 in about 3 hours. The Oliver does the work. It certainly is the real thing."
L. Zucker, Ohio.

"Sells Like Beer in a Dry Town."

"Am sending today for 7 Oliver's. This is one day's orders (\$87 profit). Selling like beer in a dry town."
W. H. Deew, Mich.

Mr. T's 28th Order in Six Months

"Ship 52 Oliver's: 10 No. 20; 6 No. 1; 12 No. 2; 24 No. 4." (Mr. T's profit on this order alone is \$711).
O. T., Ottawa, Ont.

Russel Earned \$3300 in Five Months

"Have averaged \$660 profit a month for last six months."
A. M. Russel, Conn.

Carnegy—\$1000 a Month

"Am making \$1000 per month. I have made big money before but did not expect so much. Your Burner is just the thing."
J. Carnegy, S. D.

Berger—\$258.50 per Week

"Send following weekly hereafter: 10 No. 1; 8 No. 2; 4 No. 3."
B. Berger, Ont.

\$11.75 in Ten Minutes

"I took order for a neighbor, \$11.75 profit in ten minutes."
Mrs. N. B., Hattiesburg, Miss.

\$43 in One Evening

"I made \$43 last night selling Oliver Burners."
N. B. Chelan, Wash.

It Sells Itself

Agents find it no work at all to sell this amazing invention—the Oliver new improved Oil-Gas Burner. They just show it—taking only one minute to connect it—then light it. And the sale is made! This new invention is its own salesman. It sells itself! The Oliver Oil-Gas Burner is the most timely thing that could be put out. It dispenses entirely with coal and wood when both are now high-priced. It burns the cheapest fuel—oil. It saves a woman work now in times when she is looking for just such things. Just as much or as little heat as wanted, off and on instantly by simply turning a valve.

The Secret of Big Money

Of course, now that you know the facts you yourself can understand why this

new invention is going over like wildfire! And you can understand why F. W. Bentley made \$215 in one day. Why J. Carnegy made \$1,000 in one month and why hundreds of other agents are cleaning up big too.

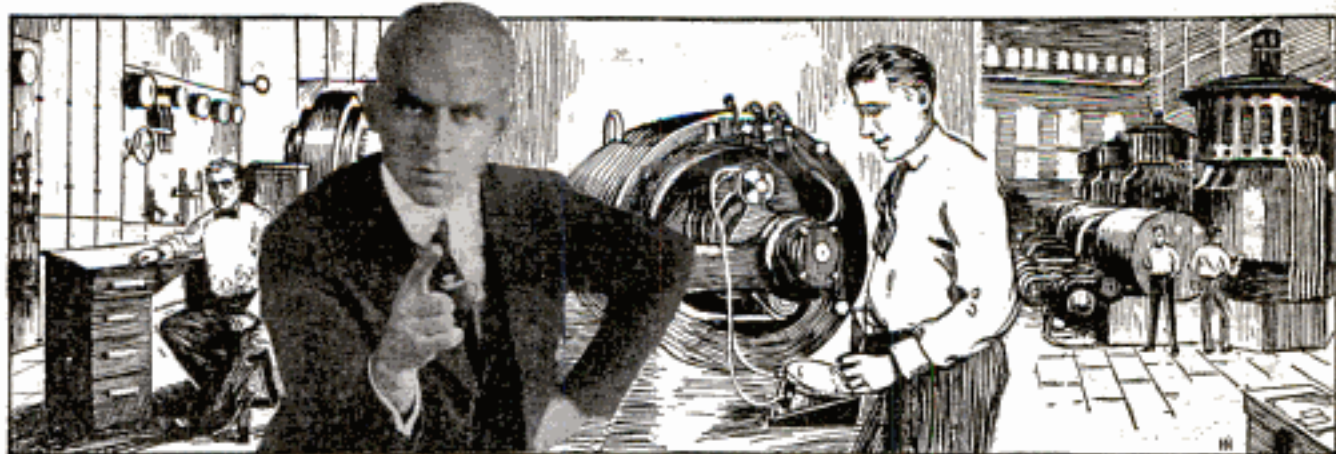
Oliver Oil-Gas Burner Co.

2014-V Oliver Bldg., St. Louis, Mo.

Please send me full facts about how I can make at least \$5,000 a year representing you in my territory. Also your plan if I just wish to make big money in my spare time.

Name.....

Address.....



Electricity Needs You

I WILL TRAIN YOU AT HOME

Stop right here. This is YOUR opportunity! Electricity is calling you, and the Electrical Business is in for a tremendous increase. But it needs more trained men—at big pay. By my Home Study Course in Practical Electricity I can train you for these positions.

FREE!

BIG ELECTRICAL OUTFIT

A fine outfit of Electrical Tools, Instruments, Materials, etc., absolutely FREE to every student. I will also send you FREE and fully prepaid —Proof Lessons to show you how easily you can learn Electricity and enter this splendid profession by my new, revised and original system of Training by Mail.

RADIO COURSE FREE

Special newly-written wireless course worth \$45.00 given away free. Full particulars when you mail coupon below.

Earn Money While Learning

I give you something you can use now. Early in my Home Study Course I show you how to begin making money in Electricity, and help you get started. No need to wait until the whole course is completed. Hundreds of students have made several times the cost of their course in spare time work while learning.

Earn \$70 to \$200 a Week

You've always had a liking for Electricity and a hankering to do electrical jobs. Now is the time to develop that talent; there's big money in it. Even if you don't know anything at all about Electricity you can quickly grasp it by my up-to-date, practical method of teaching. You will find it intensely interesting and highly profitable. I've trained and started hundreds of men in the Electrical Business, men who have made big successes. YOU CAN ALSO

Be a Big Paid ELECTRICAL EXPERT

What are you doing to prepare yourself for a real success? At the rate you are going where will you be in ten years from now? Have you the specialized training that will put you on the road to success? Have you ambition enough to prepare for success, and get it?

You have the ambition and I will give you the training, so get busy. I am offering you success and all that goes with it. Will you take it? I'll make you an ELECTRICAL EXPERT. I will train you as you should be trained. I will give you the benefit of my advice and 20 years of engineering experience and help you in every way to the biggest, possible success.

Valuable Book Free

My book, "How to Become an Electrical Expert," has started many a man on the way to fortune. I will send a copy, free and prepaid, to every person answering this advertisement.

Act Now! Good intentions never get you anywhere. It is action, alone, that counts. NOW IS THE TIME TO ACT.

L. L. COOKE, Chief Engineer

**CHICAGO
ENGINEERING
WORKS**

2150 LAWRENCE AVENUE
Dept. 517 Chicago, U. S. A.

Chief Engineer Cooke
Chicago Engineering Works
Dept. 517, 2150 Lawrence Avenue
CHICAGO, ILL.

Dear Sir: You may send me, entirely free and fully prepaid, a copy of your book, "How to Become an Electrical Expert," and particulars about your Home Study Course in Electricity and the Free Radio Course.

Name.....

Address.....

City..... State.....

FREE—Book on Wood Finishing

S. C. JOHNSON & SON, Dept. P. A. 10.
Racine, Wis. (Canadian Factory—Brantford)
Please send me free and postpaid your instruction book on Wood Finishing and Home Beautifying.

My dealer is.....

My Name.....

My Address.....

City & State.....

This book explains how inexpensive soft woods may be finished so they are as beautiful and artistic as hard wood. Tells what materials to use and how to use them. Includes color charts—gives covering capacities, etc. It is the work of experts beautifully illustrated in color. Fill out and mail this coupon.



Tells How to Brighten Up Your Home



WELL finished furniture, woodwork and floors add materially to the beauty and attractiveness of your home. You, yourself, can easily re-finish dingy, shabby, scratched wood. Our method involves practically no expense. All you need is a little time, a brush and

JOHNSON'S WOOD DYE

Johnson's Wood Dye is very easy to apply—it goes on easily and quickly, without a lap or a streak. It penetrates deeply, bringing out the beauty of the grain without raising it—dries in 4 hours and does not rub off or smudge.

Johnson's Wood Dye is made in fourteen beautiful shades, all of which may be easily lightened or darkened—full directions on every label.





8 weeks and then you can be an auto expert

Are you making \$50 a week? Are you going to be making \$75 a week a year from now? If you aren't, or if you are not sure of your future, every word of this advertisement is meant for you. It points the way for you to realize your ambition. It shows the way to prosperity, to happiness and to independence. How? It shows you how you can get into the automobile business after 8 weeks of training and how you can become an expert with an expert's salary.

Learn the Automobile Trade

The automobile business is an open, a big paying and an interesting field. Men of experience are constantly needed and right now thousands of jobs paying upward of \$200 a month or more are going begging while the ideal men to fill them fool around with \$25 and \$30 a week jobs that offer a limited future! Those men are poorly paid, not because they have not the brains but simply because they lack the energy to ACT. The automobile repair man or electrician is sure of his job. He does not have to wait for promotion and advancement at the boss's whim—because the boss needs him, more than he needs the boss.

How You Can Do It

There was a time when a man had to serve years as an apprentice in order to learn a business. He usually started by "sweeping out." But those days are gone. Now, all the information the apprentice got in years you can get in a few weeks, right here in New York. For 14 years Stewart instructions have been making automobile men. For 14 years the Stewart School has been recognized as the leading school by automobile companies all over the East.

Personal Instruction

At the Stewart School men are not pushed thru and turned out as so many factory products. Each man is taught in the way he learns the quickest—and the best. YOU STAY WITHOUT EXTRA COST UNTIL YOU SATISFY YOURSELF YOU HAVE LEARNED EVERY DETAIL. Eight weeks is the minimum time required. SEND FOR OUR FREE BOOK AND LEARN ABOUT OUR GUARANTY.

Pay As You Learn!

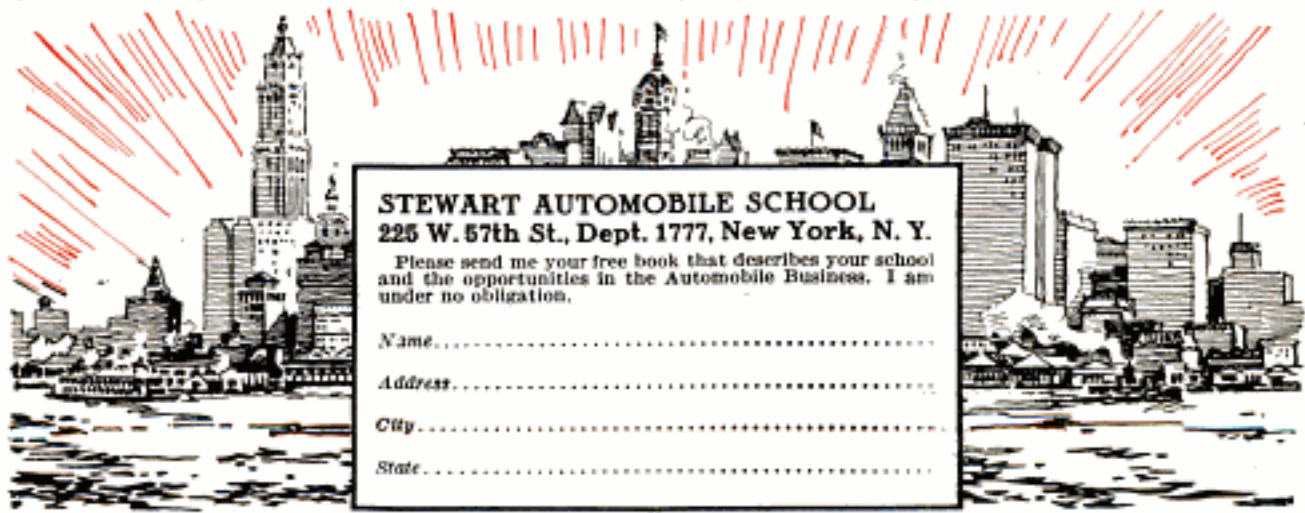
You can finish your course in about 8 weeks of fascinating work. That means eight weeks of practical work with tools spent among the pleasant and inspiring surroundings in New York. Find out about our easy payment plan. If you want to earn living expenses while learning our Employment Department will take care of you.

Decide Now

Make up your mind now to investigate the opportunities in the automobile business. Send the blank below and get our big FREE BOOK. You will be under no obligations. The book gives just the facts and figures you need. It shows just what chance you have in the automobile business and just how you can get in after 8 weeks in New York.

Send for Free Book Now

Where will you be eight weeks from today? In the same old rut? Or will you be on your way toward a big job—a happy job and \$200 or more a month? Every day of delay is a day lost. With a newer, bigger future before you your time is precious—send the coupon in now.



STEWART AUTOMOBILE SCHOOL
 225 W. 57th St., Dept. 1777, New York, N. Y.

Please send me your free book that describes your school and the opportunities in the Automobile Business. I am under no obligation.

Name.....
 Address.....
 City.....
 State.....

ALL THESE SELECTIONS

FOX TROTS

1. Carolina Mammy
2. Swingin' Down the Lane
3. Yes! We Have No Bananas
4. Bambalina
5. Wild Flower
6. Barney Google
7. Carolina in the Morning
8. Who's Sorry Now
9. Mr. Gallagher and Mr. Shean
10. I Love Me
11. Parade of the Wooden Soldiers
12. Sun Kist Rose
13. You Know You Belong to Somebody Else

WALTZES

14. Love Sends a Little Gift of Roses
15. Red Moon
16. Mellow Moon



Amazing Offer of DANCE RECORDS!

16 Latest Fox Trots and Waltzes **\$2⁹⁸ FOR ALL**
 on Eight Full-Size Double Face 10 Inch Records

Sensational Bargain!

HERE is the greatest phonograph-record bargain ever offered! All brand new records, right straight from factory to you! The very latest Broadway hits—the most popular dance music of today. All New York is dancing to these wonderful, catchy, swiny Fox Trots and Waltzes. Eight full size, ten-inch brand

new records which play on BOTH SIDES, giving you SIXTEEN complete selections, PLAYED BEAUTIFULLY by the most wonderful DANCE ORCHESTRAS you ever heard! A wonderful collection of latest hits—ALL FOR ONLY \$2.98. Never before such a bargain in up-to-the-minute records.

SEND NO MONEY!

Try these records for 10 days in your own home. Note the beauty of recording, the catchiness of the tunes, and the wonderful volume and clearness of tone. Send no money now—just give the postman \$2.98, plus delivery charge, on arrival. If not delighted with your bargain return the records and we will refund money and pay the postage BOTH WAYS. This low price made possible by manufacturing in enormous quantities and selling direct to users.

DO NOT WAIT! WRITE NOW
 THOUSANDS OF SETS ARE BEING ORDERED
 Mail Coupon or Postal to

National Music Lovers, Inc.
 Dept. 179A
 354 FOURTH AVENUE, NEW YORK CITY

NATIONAL MUSIC LOVERS, Inc.
 Dept. 179A, 354 Fourth Avenue, New York City

Please send me for 10 days' trial, your collection of 16 Fox Trots and Waltzes on eight double-face ten-inch records, guaranteed equal to any records made. I will pay the postman only \$2.98 plus delivery charge on arrival. This is not to be considered a purchase, however. If the records do not come up to my expectations, I reserve the right to return them at any time within 10 days and you will refund my money.

Note: If you also desire patented album for holding these eight records, place X in square
 Regular price, \$1.00. Our special price, 69c.

Name

Address

City State