

POPULAR MECHANICS

MAGAZINE

WITH WHICH IS INCORPORATED THE ILLUSTRATED WORLD

WRITTEN SO YOU CAN UNDERSTAND IT

REG'D. TRADE MARK. GREAT BRITAIN. No. 410426

REG. U. S. PAT. OFF.

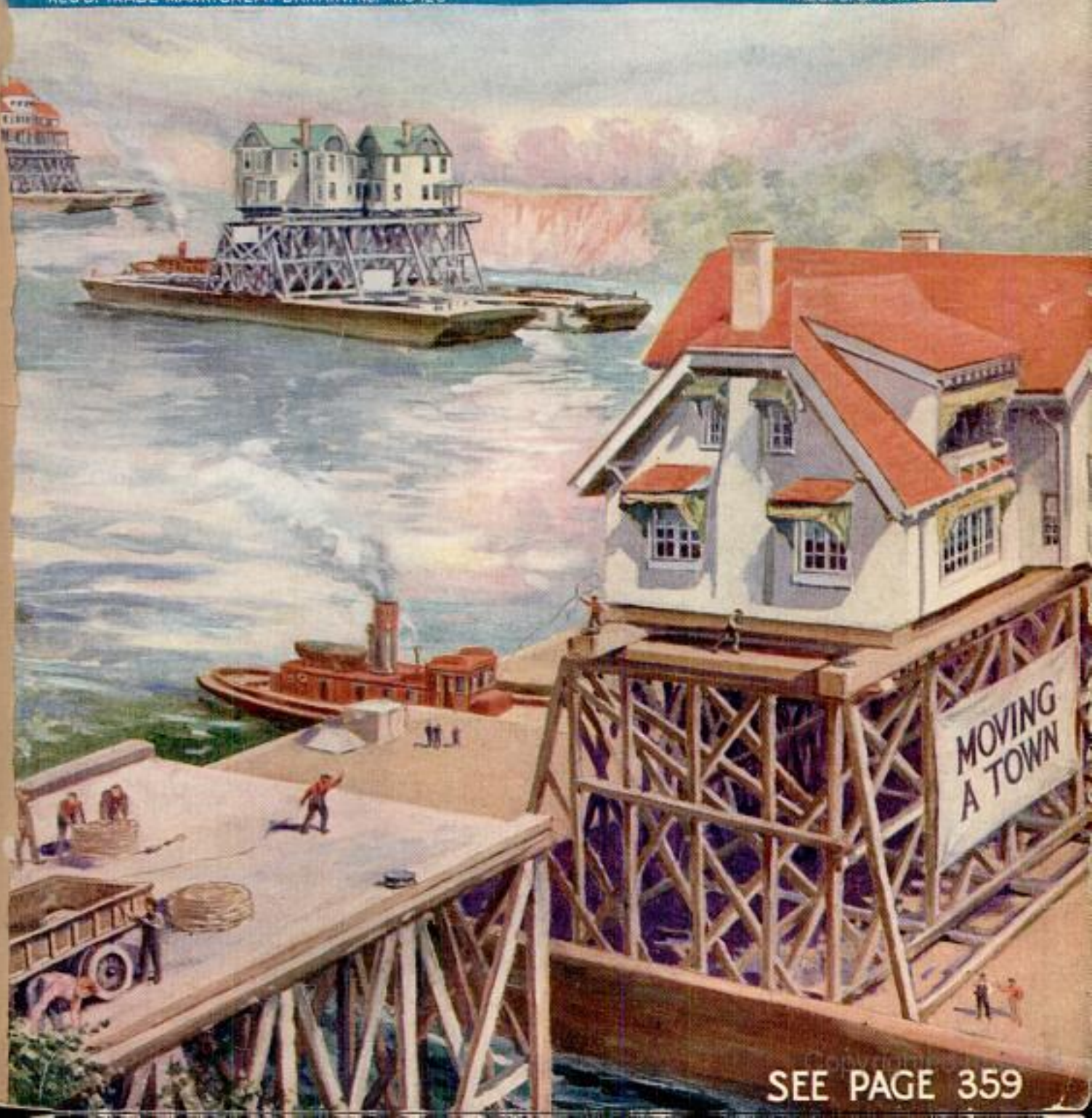

SEE PAGE 359

Insure Your Future Now!

SAVE \$100.00

GET IN THE AUTO BUSINESS



BOOKKEEPER
\$25 A WEEK —
NO FUTURE

FARM HAND
\$60 A MONTH

TO you ambitious men this announcement presents a worthwhile opportunity—a chance to get out of the poor paying job with no future, into work where the big money is being made. The Rahe Auto & Tractor Schools, the first and largest in the world, make this real money-saving, income-increasing offer to you. Get away now from the tiresome grind of a poor job into a big paying position in the biggest business of today. You need not be a mechanic now. Thousands of men from all walks of life, even ex-doctors and ex-lawyers, are today enjoying fine incomes in the auto and tractor business because they took the RAHE training. You can do the same FOR HALF PRICE if you act NOW. Realize your biggest dreams; be independent and have no fear of the future.



OWN YOUR GARAGE
EARNINGS UNLIMITED



TRACTOR
EXPERT
\$250
MONTH

Regular tuition price \$200 —

Now Cut To \$100



Luck has nothing to do with SUCCESS. THOROUGH TRAINING is the thing that COUNTS MOST. Start on your way today to get a thorough training — A RAHE TRAINING. It only TAKES YOU EIGHT SHORT WEEKS by our PRACTICAL-JOB-METHOD to get this valuable training. Then you can step right into a big paying job in the unlimited Automobile Field.

Insure your future now — the RAHE WAY — it PAYS.
J. H. McSWEENEY.

Remember this offer is good SEPTEMBER ONLY. Because of our two big schools our operating expense is less. You get the advantage of this—a present of \$100—if you ACT NOW. After October 1st it will be too late.

Our method of teaching is practical. You learn in the best equipped schools in the country under the personal instruction of experts by actual work on all the various types of engines. You get a thorough knowledge of all parts of all motor cars, tractors, and stationary engines.

This year we actually expect to turn men away from October to March. Pack your grip. Come to school right now or write today before it is too late. Let us show you how you can save \$100.

Fill out and mail the coupon today. START NOW on your way to a better job with a better income; a more comfortable home, with more pleasure in years to come.



SUCCESS—does not require unusual ability. It does require TRAINING—CONCENTRATION on one thing and STICKING-TO-IT until YOU WIN.

Begin—Right Now—Today! Get into this tremendous Automotive Field—AND WIN. You can do it with our JOB METHOD. Learn the "RAHE WAY". There's always BIG MONEY for the TRAINED MAN. RAHE training means—Learning with YOUR HANDS and NOT BOOKS. A REAL JOB at REAL PAY is waiting for you. The "RAHE WAY" PAYS.

R. C. CARMEIN.

RAHE AUTO & TRACTOR SCHOOLS
(Address School Nearest You) Dept. 890

Without any obligation, send me your big free book and all information about your limited offer. The Rahe Schools have no facilities for colored men. (Print name and address.)

NAME.....
ADDRESS.....
CITY.....STATE.....

MAIL COUPON TODAY—

Let us show you how you can save \$100 and get the valuable training in 8 short weeks.

Rahe Auto & Tractor Schools

Ninth and Walnut
CINCINNATI
Dept. 890
CHICAGO
4445 Grand Blvd.



Get Expert Training in **DRAFTING** Raise Your Income

Here is a great and highly paid profession open to you. **Learn Drafting now.** No matter where you live or what you are doing you can become a master-draftsman by spare time study at home. No previous experience necessary. If you can read and write you can become a high-salaried expert draftsman by Chicago Tech's quick and easy method. In twenty years we have trained thousands who are now top-notchers in the drafting business.

Construction Lines Are Booming—Get Ready

Drafting is the very foundation of building and construction lines. The architectural, structural steel, mechanical and electrical industries are all calling for expert draftsmen. There is a boom coming in these lines—it's here now! This is a real opportunity which every ambitious man should grasp.

Let Us Send You This Big, High Grade Drawing Outfit

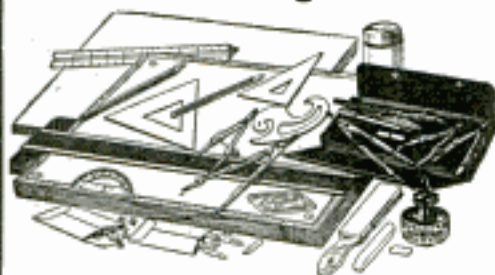

We furnish this highest grade drawing outfit to our students in Drafting—no extra charge. Same tools in every particular that are used by high-salaried, expert draftsmen.

Easy to Learn, Quick Results

By Chicago Tech's easy method you can learn Drafting quickly in your spare time right at home. Even though you cannot come and study Drafting in the day and evening classes of our big Chicago school, the same system of lessons used there with such pronounced success are sent to you. The same expert teachers guide you in your work at home.

Act Now. Mail the Coupon

Big jobs are waiting. We can train you to fill them. No experience or previous education required. Put your name on the coupon and get full information; it costs you nothing.

Building Experts Wanted

The Building Business is booming. Splendid opportunities are open. Big money will be made in the next five years by men in the building trades who know how to read plans, make estimates, superintend jobs, take contracts, etc.

Send Coupon for Free Book and Blue Prints

Mark "X" in the second square of the coupon if you have had experience in any building trade. We will send you free and postpaid, a book of drawings and blue prints, also our big new book, "How to Read Blue Prints." Tell every builder you know to send for these books—they're free to men in the building trades.

Chicago Technical College,

830 Chicago Tech. Building,
Chicago, Ill.

Without cost or obligation to me please send instructive matter about opportunities in line I have marked with "X."

Drafting. (The Big Salary course)
No experience necessary.

Building Trade Course
For men in the building lines.

Surveying and Map Drafting.

Automobiles, Gas Engines, Starting, Lighting, etc.

Aeronautic Engineering.

All about aeroplanes.

Plumbing, Heating and Ventilating.

Plan Reading, Estimating, etc.

Steam Engineering.

For Stationary Engineers.

Plan Reading for Shop Men;

For Machinists, Assemblymen, etc.

FREE Trial Lesson



While other schools ask you to enroll and send money first, we send the free lesson first. Read it, practice the exercises, and then decide for yourself whether to take the course or not.

Name.....

Address.....

Post Office..... State.....

"THE WOOD THAT
ALL ITS USERS PRIZE,
THE WISE
INVESTOR
SAFELY BUYS."

"BUILD OF CYPRESS
the 'Wood Eternal'
AND YOU BUILD
BUT ONCE."

HERE'S MY OPINION OF

Tide Water
Cypress
"The Wood Eternal"

*The following are excerpts from the U. S. Govt. Report on Cypress—
Bulletin 95, Dept. of Agriculture, Forest Service. (You know the
conservatism of Government Reports.)*

"As siding it practically wears out before it decays."

"When made into porch columns it retains its shape, holds paint, and has sufficient strength to sustain necessary loads."

"Cypress is put to almost every use as an interior trim for houses. It may be finished in natural color or stained. The wood contains little resin and thus affords a good basis for paint, which it holds well."

"It is a popular wood for kitchens, where it is subjected to dampness and heat. It shrinks, swells or warps but little, and is used for drainage boards, sinks, kitchen and pantry tables, cupboards and kitchen cabinets."

"The farmer puts this wood to many uses, in all of which it gives good service," etc.

Cypress is in truth "the wood eternal." If you are putting up a PALACE, a PASTURE-FENCE or doing a "LITTLE JOB OF BACK-STEPS" — remember — "WITH CYPRESS YOU BUILD BUT ONCE."

SOUTHERN CYPRESS MFRS' ASSN.



1219 Poydras Building, New Orleans, Louisiana, or 1219 Graham Building, Jacksonville, Florida



Popular Mechanics Magazine

200 E. Ontario Street, Chicago, U. S. A.

H. H. WINDSOR, Editor

London: Hachette & Co.,
16-17 King William Street, Charing Cross, W. C. 2

Paris: Hachette & Co.,
111 Rue Reaumur

Melbourne, Australia
The Australasian News Co.

ISSUED MONTHLY

SUBSCRIPTION:

SINGLE COPY, 25 CENTS

In United States and its possessions, also Canada, Cuba, and Mexico, per year, postpaid - \$3.00

To all other countries in the Postal Union - 3.50

All subscriptions are discontinued at expiration. Please examine the date printed on your wrapper.

Entered as Second Class Matter Sept. 15, 1903, at the Post Office at Chicago, Illinois, under Act of March 3rd, 1879.

Entered as Second Class Matter at the Post Office Department, Canada.

Published monthly by POPULAR MECHANICS CO.

Copyright, 1923, by H. H. Windsor. Copyright in Australia

Vol. 40

Contents for September, 1923

No. 3

African Women, Lips Stretching to Eyes Adorn.....	331
Air Chamber Saves Divers Stricken at Work.....	337
Air Craft Depot, Floating, in Middle of Ocean.....	336
Airplane, "Baby," Flies 80 Miles an Hour.....	334
Airplane Flight from New York to China Planned.....	438
Airplane Refueled in Mid Air through Hose.....	403
Airplane, Toy, Helps to Train Anti-Aircraft Gunners.....	440
Airplanes in Golf Match Drop Balls on Green.....	329
Airplanes, Passenger, Have Private Cabins.....	402
Airships Tested by Navy to Guard Lives of Crews.....	394
Alpine Guides, Heroism of.....	335
Animal, Tiny, Lives in Drop of Water.....	337
Antiques, Bogus, Flood of, Brought from Europe.....	370
Ants, Sugar Soaked Sponge Used as Trap to Kill.....	350
Asiatic Paths, Adventures in, by Sven Hedin.....	392
Automobile Accelerator Bulb Ends Jerking of Car.....	420
Automobile Chains in Footrest Save Space.....	330
Automobile Dial, Luminous, Tells Driver When Fuel is Short.....	421
Automobile Engines, Diesel, to Increase Mileage.....	336
Automobile Fenders Add Beauty to Body of Car.....	339
Automobile License Plate Lights Give Warning of Stolen Car.....	408
Automobile Lights under Fenders Remove Glare.....	408
Automobile, Roof Crashes, but Driver Escapes.....	444
Automobile Running Board Straps Hold Luggage.....	398
Automobile Shade, Rigid, Protects Driver from Sun.....	332
Automobile Steering Device Lessens Jerks and Shocks.....	418
Automobile Step Mat Secures Foothold.....	360
Automobile Washer Fitted to Hose and Regulated by Trigger.....	371
Baby Swing, Auto, Also Makes High Chair.....	395
Barber Clocks Instead of Poles Tell When to Shave.....	435
Bathing Machine Driven in Water with Pedals.....	329
Beacons, Flaming, to Guide Flight of Air Mail.....	447
Bird, Rare, First Picture of.....	371
Birds, Rare, Cities of, Found in Gulf States.....	379
Blackboard Vacuum Cleaner Removes Chalk Marks.....	420
Blind Taught to Fix Shoes on Electric Machine.....	370
Blond Race Found in Sahara by Danish Scientist.....	404
Blowtorch, Safe Pocket, for Home Use.....	332
Boat Made of Old Scraps Moved by Gas.....	404
Bones of Prehistoric Monsters in Nature's Trap.....	398
Breakfast Nook, Kitchen, Has Vanishing Seats and Table.....	353
Building, Futurist Art Gives Weird Effect in.....	375
Butterfly Farms, Rainbow's Colors Made on.....	392
Buttons Made from "Ivory Nuts" from Tree.....	408
Calculator Saves Farmer's Time by Doing His Figuring.....	330
Camera Lens Filter, Pocket, Is Adjustable.....	357
Camera, Tower Car Raises, above Heads of Crowd.....	332
Camping Kit, Pocket, Cooks Meal for Two Persons.....	415
Canoe, Indian, Paddled by Romans on Historic Tiber.....	377
Carpets and Rugs, Weaving Pictures for.....	343
Castle, Old Mormon, Kept as Frontier-Days Relic.....	407
Cave, Scientist Faces Death to Explore Wonders of.....	346
Chair Converted into Bed for Small Apartments.....	394
"Checkers," Human, Used in Game on Beaches.....	391
Chemist, Amateur, Whole Laboratory in Box for.....	370
City Buried in Jungle Larger than Old Rome.....	368
City, Fairy, of Future, Forecast at Exhibit.....	437
Clouds, Luminous, to Light Ocean Bottom.....	435
College Man, What the World Offers the.....	338
Concrete Road "Blows Up," Wrecking Auto.....	395
Cooker, Waterless, Is Safe and Improves Flavor.....	361

Cotton Shipped by Airplane is Worn Next Day.....	421
Coconut Sprouts More than an Inch a Day Due to Fire.....	375
Curtain, Record Size Lace, Bigger than City Lot.....	424
Cycle Race, Airmen, Found Harder than Flying.....	438
Desert City, Tented, Built for Movies.....	440
Desert, Sahara, Air Patrol over.....	344
Dishwasher Fits in Sink.....	358
Diving Suit for Seeking Treasures of the Sea.....	438
Drill Combines Strength and Accuracy.....	442
Drill Jig, Universal, Saves Time in Shop.....	442
Ear Muffs Hold Hat On with Hidden Spring.....	341
Emotions Tested by Machine and Accurately Recorded.....	341
Eye Defects Corrected by Exercising Scale.....	340
Eyes, Science Rivals Nature in Making, by A. N. Mirzaoff.....	416
Fire Fighters Shoot Water through Loops in Test.....	435
First Aid Kit, Red Cross, Built like Knapsack.....	341
Fish Net, One Man, Spreads like Huge Fan.....	441
Fish Stuffed and Painted Appear Alive.....	399
Floor Marking Machine Works Close to Wall.....	442
Fly Moves Toy Pig's Ears in Trying to Escape.....	379
Fountain Pen Has Light for Writing in Dark.....	332
Foxes, Silver, Bred on Ranch to Obtain Rich Furs.....	376
Frogs, Cold Robs, of Croak.....	402
Furniture, Electric Heat, Convenient and Safe.....	372
Furs, Wrapping the World in, Part III, by T. Winfield Thackeray.....	425
Garden Reached by Gate and Winding Stairs.....	440
Gas, Deadly War, Now Cures Sick.....	396
Gasoline from Sand.....	443
Gasoline Made from Coal by Distilling Process.....	350
Gear, Cogless, Hailed as Engineering Marvel.....	413
Geese Weed Cotton Fields, Replacing Human Labor.....	355
Gems Collected by Uncle Sam for Priceless Exhibit.....	331
Gloves, Wooden, Protect Hands from Wringer.....	395
Golf Balls, Millions of, Used in U. S.....	418
Golf Club Weight Changed to Suit Player.....	441
Golf, Obstacle, Has Thrills of Real Game.....	374
Grape Crop, Old Auto Tires Burned to Save.....	413
Grapes Protected with Paper Bags.....	434
Guessing Contest.....	439
Hair, Human, Made into Cloth Resists Heavy Pressure.....	355
Hair Kept for Generations Makes "Family Tree".....	444
Hairpin, Crinkle, Stays Put.....	358
Hands, Ten Tons of, Built for Movie Scene.....	419
Hanger and Brush in One for Coats.....	445
Helicopter Stays in Air Fifteen Minutes.....	409
Horses, Canter, Wooden, Raced by Children.....	379
Hothouse Built on Roof of Building.....	442
House, Electric, to Banish Drudgery in Future.....	443
Houses, Model, Mailed to Possible Buyers.....	443
Houses Moved across River on Barges to Make Room for Capitol.....	359
Ice Cream Shot into Shell Holder with Gun.....	416
Ice Holder for Pitcher Keeps Contents Clean.....	330
Idols, Power of, Still Great in Many Lands.....	333
India, Traditions of, Hold Natives in Slavery.....	407
Indians, Vanishing Race of, Visited by Explorers.....	437
Insect Pests, Rogues' Gallery of, Kept for Farmers.....	344
Insects' Sense of Color Shown by Tests.....	333
Invalid Cart Driven by Dog Power.....	396
Iron Mine, Old, Brings Wealth.....	351
Ivory Traded for Guns in African Market.....	424

[Continued on Page 4]

This One



RSH4-F66-91F7

material

[Contents—Continued]

Jack, Continuous Lift, Works Easily.....	448
Jewelers' Lens, Spring Holds It on Spectacles.....	389
Kitchen Equipment Lessens Steps of Housewife.....	354
Knapsack with Pockets Has Place for Everything.....	369
Knife and Scissor Sharpener Employs Two Stone Wheels.....	407
Lamp, Electric, Kills Flies, Moths, and Other Pests..	401
Lantern, Electric, Has Serviceable Features.....	435
Lathe, Wood Turning, Has Motor in Headstock.....	448
Lawn Mower Sharpened like Razor Blade.....	446
Lies, Device Detects.....	415
Lightning Bolt, Man Made, Wrecks Toy Village.....	353
Lions Tamed with Electricity Instead of Whip.....	375
Locomotive Ready to Run Carried on Ship.....	358
Locusts Plague Returns After Seventeen Years.....	423
Manicure Stick, Fountain, Carries Own Polish.....	390
Mask, Respirator, Saves Victims of Gas.....	405
Metals, Hardness of, Tested with Pendulum Instru- ment.....	448
Milk, Skimmed, Made into Articles of Beauty.....	396
Mine, Long Lost, Found in Mexican Wilds.....	391
Mine Phone to Save Lives of Miners.....	408
Mint, Mexican, Kept Busy Coining Money.....	398
Money—Dollar Bill, Printing of, Takes Month at Mint.....	360
Motion Picture Films, Paper, End Danger of Fire..	337
Motion Picture Thrills, Made to Order, at Risk of Life and Limb.....	380
Motion Pictures Made Safe with Golden Light Filter	377
Motion Pictures of 50 Years Ago Made to Settle Bet	354
Motor Bus De-Luxe Built like Chair Car.....	420
Motorcycle, "Round-You-Go," Runs on Single Wheel	447
Mountain Memorial, Work on, is Started.....	413
Mule as Caddy Carries Bags for Golfers.....	446
Music Notes Defy Mechanical Typesetting.....	433
Niagara Falls to be Lighted by Submerged Electrics	435
Northern Lights, Man Made, Created by Gas.....	421
Ocean Bottom, Pacific, Charted by Timing Sound Waves.....	371
"Oil Birds," Medicine from, Used in Peru Wilds..	353
Oyster Shells Bring Rich Crops for Farmers.....	423
Ozone Machine Makes Air Fresh.....	399
Pagodas, Mysticism of Far East Built into.....	401
Photography—Exposure Meter Tells by Dot of Light	402
Photography—Lens Ends Use of Cloth over Screen of Camera.....	360
Pipe, Cigar Shaped, for Outdoor Smoking.....	371
Pipe Joint, Flexible, Won't Leak.....	407
Pipes Lined with Concrete by Machine.....	450
Plant Roots, Rich Mine of, Yields Paper and Food..	390
Plant, Wax of, Turned into Varnish.....	421
Popular Mechanics Records of 20 Years.....	372
Powder, Moisture Proof, Also Smokeless.....	395
Radio Offers	389
Radio on Walking Chair Keeps Baby Amused.....	351
Radio Taught in Sleep by Phone on Ears.....	435
Railroad Jack Does Duties of Switch Engine.....	440
Railroad Trains, Pictures on, Advertise Communism..	350
Range Finders from Guns Used as Telescopes.....	336
Road Surfaces, Wavy, Studied by Uncle Sam.....	361
Ruler, Suction Cup Holds against Blackboard.....	388
Sailors Fear Perils of Ports More than Sea.....	432
Sand Needed for Glass Mined with Water.....	368
Scaffolding Clamps Used in Place of Nails.....	446
Scale, Pencillike, Solves Engineers' Problems.....	441
Science Notes for Daily Use.....	400
Sculpture—Heads Carved in Dirt Bank Show Skill of Sculptor.....	389
Sea Lions Slain to Protect Fish.....	389
Seals Shot from "Blind" Carried on Sled.....	446
Seaplane for Sea or Sky Has Detachable Wings.....	419
Selenium Light Rays Carry Voice through Air to Phone.....	340
Shaper, Hand, Aids Light Woodworking.....	449
Shears with Fixed Blade Give More Accuracy.....	341
Ship—Caravel, Columbus, Used by Sea Scouts for Training.....	377
Ship, Civil War, Found by Dredge in River.....	443
Ship, Lost Treasure, Hunted with Airplane.....	357
Ship, Nelson's, to Sail Again.....	388
Ship Saved by Radio Message.....	369
Ship's Behavior at Sea Studied by Machine.....	369
Shoe Brush, Revolving, for Passing Shoppers.....	330
Shrine, Japanese, Built of Gold and Gems.....	340
Silkworms Spin Colored Thread.....	361
Siphon Carries Water under Railway Tracks.....	376
Skeleton of Dinosaur Found.....	389
Spark Arrester Prevents Forest Fires.....	423
Spirits of Departed Speeded with Weird Rites.....	378
Stamp Exhibit to be Shown in London.....	442
Star Finder Traces Course of Far-Off Planets.....	371
Stove and Ice Box Built for Small Kitchens.....	355
Stove, Boltless Folding, to Aid Campers.....	445
Stove, Folding Camp, Cooks Meal for Ten Persons..	395
Stove, Tiny Folding, Heated with Canned Alcohol..	369
Street Car Fare Box Prints Transfer and Registers Coin.....	421
Street Car Window Wiper Aids Motormen.....	396
Suitcase Keeps Clothes Fit on Long Tours.....	389
Swimming Gloves with Webs like Duck's Foot.....	443
Swimming Lessons Given Boys by Wireless.....	335
Swimming Pool Warmed by Heating Plant.....	404
Taxi Meters Used in Rome.....	415
Taxidermy Behind the Scenes in a Great Museum, by J. T. Edwards Jones.....	409
Temple, Ancient Babylonian, Found by American Expedition.....	357
Tennis, Paddle, Played in Any Size Court.....	447
Tennis Rackets, Gut Strings on, Polished by Machine	450
Thermometer Tells Temperature without Mercury..	377
Thread Still Spun by Hand on Ancient Wheel.....	355
Timber, Fear of Knots in, Cause Millions Waste....	401
Tin, Scrap, Turned into Toys.....	337
Toadstool Poison Cure Sought in Serum.....	444
Toy Ducks Sealed in Globe Half Filled with Water..	407
Toys, Air Filled Rubber, Float and Keep New.....	369
Tractor Drawbar Height Quickly Adjusted.....	450
Trade Marking a City.....	442
Tree—Washington Elm, is Dying.....	391
Trees, Fossil, Forest of, Million Years Old.....	378
Trunk, Wardrobe, Has Doors on Top and at Sides..	336
Typewriter, Romance of the, Revealed on Its Fiftieth Anniversary.....	327
Volcano in Fresh Outbreak Destroys Many Homes..	434
Water Bicycle Saves Drowning Persons.....	388
Water Carried by Foot Power to China's Millions..	389
Window Washing, Safety Seat for.....	337
Wire Stretcher, One Man, Is Powerful.....	450
Wires Made to Sing by Electric Forks.....	445
"Wormholes" Sold in Europe.....	437
Writing Sent over Wire by Photo Process.....	351
X-Ray Aids Students in Study of Anatomy.....	390
X-Ray Used for Eight Hours in Cancer Treatment..	408

SHOP NOTES

Acetylene Generator, Increasing Capacity of.....	455
Arbors, Floating Nut and Washer for.....	454
Arbors, Wooden, Tail Center for.....	461
Bars, Long Thin, Supporting in Lathe.....	452
Belts, Holding for Cutting and Punching.....	456
Bench Block for Straightening Rods.....	466
Blower, Rotary, Made from Tin Can.....	463
Bucket Handle, Comfortable.....	459
Cleaner, Suction, for Machinery.....	459
Concrete Batch Hopper, Removing Dust from.....	465
Concrete Forms, Cheap.....	464
Cotter Pin Puller, Long Range.....	468
Cylinder Grinder Clamp.....	461
Dowel and Bolt Combination.....	453
Drawers, High, Lifter for.....	462
Elbow, Emergency, How to Make.....	455
Erosion, Stream, Preventing.....	465
Forge, Portable Electric, How to Make.....	461
Gear Teeth, Cutting on the Shaper.....	467
Glass, Method of Etching.....	452
Goldplate Work, Satin Finish for.....	466
Grinder, Horizontal Tool.....	453
Hammer, Tack, and Journal Hook for Car Inspectors	455
Jack, Homemade, for Erectors.....	467
Lathe Tailstock Clamp, Improving.....	465
Micrometer Attachment for Height Gauge.....	464
Milling Machine, Steady Rest for.....	464
Miter Nailing "Jack".....	468
Pipe, Long Discharge, Method of Supporting.....	456
Pulleys, Fastening to Small Motor.....	465
Pulleys, Large Homemade.....	466
Rafter Design for Semimonitor Laying House.....	454
Reboring Fixture for Garage.....	457
Saws, Crosscut, Filing.....	456
Scales, Live Stock Frame for.....	453
Scraper, Homemade Cabinet.....	462
Screwdriver, Offset, How to Make.....	462
Shaft Ends, Locating Squares on.....	468
Soapstone, Blowing through a Conduit.....	454
Sprinkler Guard, Department Store.....	461
Sulphur, Melting.....	467
T-Slot Cleaner, Homemade.....	453
Tank, Method of Lowering in Pit.....	455
Tinfoil, Soldering.....	460
Valves, Facing on Drill Press.....	468
Vise Support for Pipe Fitters.....	461
Window, Dark Room, Made Light Tight.....	460

[Continued on Page 6]

DRAKE'S PRACTICAL MECHANICAL BOOKS

THEY WILL RAISE YOUR PAY—

ORDER ON 5-DAY TRIAL

The books listed below will perfect you in your chosen trade — pave the way to the big positions. Written in non-technical language—easy to read and understand. *Every book covers its subject completely. An entire course of instruction condensed into one volume.* Your choice sent postpaid — you benefit 5 days — money refunded in full if not entirely satisfactory. Order direct from this page.



Automobile Books

- Automobile Ignition, by ManlyLeatherette **\$3.00**
- Automobile Starting and Light-
ing, by Manly.....Leatherette **\$2.00**
- Brookes' Automobile Handbook.....
.....Leatherette **\$2.00**
- Ford Motor Car, Truck and
Tractor, by Manly.....Cloth **\$1.50**
- Starting and Lighting Troubles,
Remedies and Repairs, by
ManlyLeatherette **\$3.00**
- Automobile Battery, Care and
Repair, by Manly.....Leatherette **\$2.00**
- Automobile Catechism and Re-
pair Manual.....Leatherette **\$1.50**
- Tires and Vulcanizing, by Tuf-
fordCloth **\$2.00**
- Gas and Oil Engine Handbook.....
.....Cloth **\$1.50**
- Automobile Upkeep and Care,
by Manly.....Cloth **\$1.50**
- Motorcycle Handbook, by Manly
.....Cloth **\$1.50**

Shop Practice Books

- Sheet Metal Workers' Manual...
.....Leatherette **\$2.00**
- Oxy-Acetylene Welding and Cut-
tingCloth **\$1.25**
- Slide Rule and Logarithmic Ta-
blesLeatherette **\$2.00**
- Handbook for Millwrights.....Cloth **\$2.00**
- Modern Blacksmithing.....Cloth **\$1.25**
- Machine Shop Practice.....Cloth **\$2.00**

- Mechanical Drawing and Ma-
chine DesignCloth **\$2.00**
- Pattern Making.....Cloth **\$1.50**

Carpentry Books

- Cloth Binding
- Modern Carpentry, 2 vols.....\$3.00
- The Steel Square, 2 vols.....\$3.00
- Wooden Boat and Shipbuilding.....\$1.50
- Modern Estimator\$1.50
- Timber Framing\$2.00
- Builder's Architectural Drawing.....\$2.00
- Concrete\$1.50
- Practical Bungalows\$1.00
- Low Cost Homes.....\$1.00
- Roof Framing, by Van Gasbeek.....\$1.50
- Stair Building and Hand Rail-
ing\$1.50

Electrical Books

- Practical Applied Electricity.....\$2.00
- Alternating Current\$1.50
- Electric Motor Control Systems.....\$1.50
- Wiring Diagrams and Descrip-
tions\$1.50
- Electrical Tables and Data.....\$1.50
- Armature and Magnet Winding.....\$1.50
- Modern Electrical Construction.....\$1.50
- Modern Electric Illumination.....\$1.50
- Electricians' Operating and Test-
ing\$1.50
- Motion Picture Operation.....\$1.50
- Drake's Electrical Dictionary.....\$1.50
- Electric Motors, D. & A.....\$1.50
- Electrical Measurements and Me-
ter Testing\$1.50
- Drake's Telephone Handbook.....\$1.50
- Easy Experiments.....Cloth **\$1.25**
- Wireless Telegraph and Tele-
phone Handbook.....Cloth **\$1.25**
- Telegraphy Self-Taught...Cloth **\$1.25**

Steam Engineering

- Swingle's Handbook for Steam
Engineers and Electricians...
.....Leatherette **\$4.00**
- Examination Questions and An-
swers for Marine and Station-
ary Engineers.....Leatherette **\$2.00**
- Steam Boilers.....Leatherette **\$2.00**
- Swingle's Catechism of Steam,
Gas and Electrical Engineer-
ingLeatherette **\$1.50**

Painting Books

- Scene Painting and Bulletin Art
.....Cloth **\$4.00**
- A Show at Sho' Cards.....Cloth **\$4.00**
- Sign PaintingCloth **\$4.00**
- Strong's Book of Designs.....
.....Leatherette **\$4.00**
- Strong's Art of Show Card Writ-
ingCloth **\$4.00**
- Signalist's Alphabets.....Cloth **\$1.50**
- Modern Painter's Cyclopaedia.....
.....Cloth **\$2.00**
- Automobile Painting.....Cloth **\$1.50**
- Estimates, Costs and Profits,
Painting and Decorating.....Cloth **\$1.50**
- New Hardwood Finishing.....Cloth **\$1.50**
- The Amateur Artist.....Cloth **\$1.50**
- New StencilsCloth **\$1.25**
- Chalk Talk and Crayon Pre-
sentationCloth **\$1.25**

Farm Books

- Farm Mechanics.....Cloth **\$1.25**
- Farm Buildings.....Cloth **\$1.25**
- Farm Engines.....Cloth **\$1.25**
- Traction Farming.....Cloth **\$1.50**

Business and Reference Books

- Better Business Letters.....
.....Cloth **\$1.00**
- Better Business English.....
.....Cloth **\$1.00**
- Better Advertising.....Cloth **\$1.00**
- Finger Prints Simplified.....Cloth **\$2.00**
- Practical Bricklaying.....Cloth **\$1.25**
- Practical Instruction for Detectives
.....Cloth **\$1.00**
- Practical PlumbingCloth **\$1.50**
- Hot Water Heating.....Cloth **\$1.50**
- Elementary Chemistry.....Cloth **\$1.50**
- Courses in Civil Service...Cloth **\$1.50**
- Cyclopedia of Recipes...Cloth **\$1.50**
- American Star Speaker...Cloth **\$1.50**

Modern Languages

- By Prof. P. S. Allen, U. of Chicago
- French without a Teacher.....Cloth **\$1.25**
- Spanish without a Teacher.....Cloth **\$1.25**
- German without a Teacher.....Cloth **\$1.25**
- Everyday French.....\$1.25
- Everyday Spanish.....\$1.25

ORDER DIRECT FROM THIS PAGE—ON OUR MONEY-BACK PLAN

The books listed above are only a few of the many in our catalogue, which you will receive promptly after filling out and mailing us the attached coupon. For quick action order direct from this page—cross name of each book wanted and send in with price quoted. We prepay postage and send the books on our money-back plan.

FREDERICK J. DRAKE & CO.

PUBLISHERS

1008 Michigan Ave., Chicago

Drake Books Are For Sale at All Book Stores

FREDERICK J. DRAKE & CO.
1008 Michigan Avenue
Chicago, Ill.

GENTLEMEN:—Please send me free, postage paid, your illustrated catalogue which lists and describes over 100 Practical Mechanical Books for Home Study.

My name is

and my address

Mail Coupon For Free Catalogue
Your Guide to Home Study

St. Louis Man Discovers a New Kind of Heat!



B. M. OLIVER

Mr. B. M. Oliver of St. Louis has invented an amazing device which ends forever the days of woman's slavery to dirty, mussy coal and wood fires. It sets into the fire-box of any kind of heating stove, cook stove or furnace without changes and just turning a valve it gives any degree of heat from a tiny flame to a roaring inferno—

3 times the heat of coal if it is needed.

Mr. Oliver calls his invention the Oliver Oil-Gas Burner because it makes its own gas from 95% air and 5% coal oil (kerosene) the cheapest fuel there is. The wonderful story of a woman's freedom from building fires, carrying heavy scuttles, emptying ashes has spread so rapidly that already over 150,000 burners are being used by American housewives. Mr. Oliver wants every woman to have the use of his invention. If you will write to him at 2048-I Oliver Bldg., St. Louis, Mo., you will receive an attractive booklet FREE that tells all about it. Mr. Oliver is now making a Special Low Price Offer. He is also looking for good, live distributors and will tell you how to earn \$500 a month in full or spare time if you are interested and request his sales plans.

Electrical Course

In
Book
Form

Here is the quickest, easiest, cheapest way to learn electricity. Think of it! A complete electrical course in book form. No tiresome lessons with a lot of mathematics. Just plain everyday electrical facts—the very things and the only things you need know to hold down a good paying job. Written and simplified by 27 of the biggest men in the electrical field. 8 big books—4100 pages and 5350 pictures.

Electricity Means Success

—Good Pay and a Good Job. You can succeed in electricity. It's one of the best paying fields open to young men who know.



You do not have to give up your present position, just a few pleasant hours spent in the evenings on this subject, and success is yours.

FREE TRIAL!

Just mail the coupon—don't send a cent. We send books for a week's free use. Look them over yourself, and see how thoroughly and completely everything about electricity is explained in them.

American Technical Society
58th St. & Drexel Ave. Dept. E-619

American Technical Society, Dept. E-619 Chicago

Send me your 8-volume set of Electrical Books for a week's free use. I will either return the books in 7 days or remit \$2.50 and pay you \$3.00 each month until a total of \$29.50 is paid.

Name.....

Address.....

Employed by.....

Copy this coupon on larger sheet if more convenient

[Contents—Continued from page 4]

AMATEUR MECHANICS

Automobile Crankcase Oil Low. Kink for.....	468
Automobile Door Straps, Improving.....	473
Bed of Boughs, How to Make.....	470
Bees, Device for Hiving.....	479
Binding Posts, Quick Detachable.....	473
Camera Finder Used as Range Finder.....	487
Camera Lens Shade, How to Make.....	470
Camera, Metal Parts of, Blackening.....	482
Camp Stove, Serviceable Homemade.....	473
Carburetor Needle Valve, Thermostat Control for.....	480
Cooler, California, How to Make.....	469
Doorstop Made from Hook.....	482
Drying Rack for Negatives.....	484
Felloe Bolts, Loose, Repair for.....	487
Fences, Temporary Wire.....	487
Funnel and Oil Container Combined.....	482
Garage Door Stop.....	484
Gate Post, Protector for.....	471
Hand Car, Four Passenger, How to Make.....	475
Heater, Bucket Used as.....	470
Hog Oiler, Homemade.....	486
Hose Water, Breaking the Force of.....	480
Ink Bottle Holder, Homemade.....	483
Mattress, Three Piece.....	477
Mirror as Effective Lure for Fish.....	488
Musical Instruments Made from Cigar Boxes.....	485
Package Fasteners, Homemade.....	487
Paint, Insulating.....	474
Phonograph Records, Worn, Method of Using.....	478
Photography, Miniature.....	472
Photography—Photographing Objects to Full Size.....	474
"Pushmobile" Brake.....	474
Radio Aerial Ground Switch, Plug Type.....	478
Radio Receivers, Increasing Wave Length of.....	481
Radio Tubes, Saving.....	484
Screen Door Fly Exit.....	470
Shelves Made from Broken Windshield Glass.....	474
Shoe Polish Box, "Built-In".....	483
Soldering with Alcohol Lamp.....	471
Sparrows Made Useful in Garden.....	486
Springboard, Diving, How to Make.....	478
Stove, Oil, Attaching Casters to.....	486
Trees, Pear, "Propping" with Twine.....	484
Tripod Feet, Nonslip.....	480
Turf Cutting Tool.....	478
Vacuum Cleaner "Blows" Organ.....	486
Wagon Box Derrick, Easily Made.....	471
Water, Well, and Cistern, Aerating.....	472
Window Boxes and Sills Combined of Concrete.....	488
Wrench, Special for Grease Cups.....	488

LAW

STUDY AT HOME

Become a lawyer. Legally trained men win high positions and big success in business and public life. Greater opportunities now than ever before. Lawyers earn \$3,000 to \$10,000 Annually.

We guide you step by step. You can train at home during spare time. Let us send you records and letters from LaSalle students admitted to the bar in various states. Money refunded according to our Guaranty Bond if dissatisfied. Degree of LL.B. conferred. Thousands of successful students enrolled. Low cost, easy terms. We furnish all text material, including fourteen-volume Law Library. Get our valuable 120-page "Law Guide" and "Evidence" books FREE. Send for them—NOW.

LaSalle Extension University, Dept. 934-1 Chicago, Ill.

BART CHALK-TALK

If you can draw a little, you can do the Bart Chalk-Talk. Send 4c in stamps for Chalk-Talk folder and complete catalog of art and Chalk-Talk Supplies.

Bart Supplies, Euclid Bldg., Minneapolis, Minn.



WANTED—Railway Postal Clerks

Travel—See the country

\$1600 First Year

MEN—BOYS
18 UP

Mail Coupon Immediately

Name.....

Address.....

FRANKLIN INSTITUTE
Dept. A181, Rochester, N. Y.

Fill: Send me, without charge (1) specimen Railway Postal Clerk Examination questions; (2) list of government jobs obtainable; (3) tell me how to get a government job.

CARPENTERS AND BUILDERS!

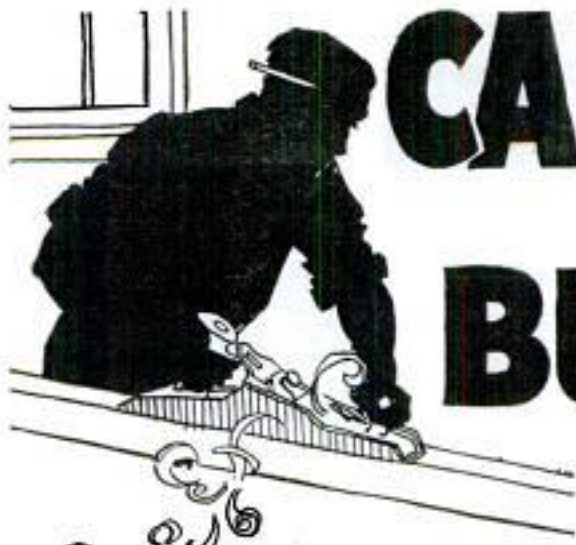

JUST OUT!

Giving You the How and Why of Modern Carpentry
**AUDEL'S CARPENTERS
and BUILDERS GUIDES**

Just available — Audel's Carpenters and Builders Guides — the short cut, professional information you want.

A Guide that keeps you in close touch with your work and shows you how you may increase your earning power.

No need to guess or take chances. Every day you have before you in this set, exact, practical, useful information to help you with your daily work.

HOW TO HANDLE THE JOB THAT PUZZLES YOU

How to use the different kinds of wood—complete detailed information on nails and screws—how to use the steel square—how to file and set saws—how to make wood joints—how to build furniture—how to make a mitre shooting board—how to plumb, and level work—how to lay out work—how to understand carpenter's arithmetic—how to solve mensuration problems—how to estimate the strength of timbers—how to proportion beams—how to read plans—how to draw up specifications—how to estimate

the cost of buildings—how to build houses, barns, garages, bungalows, etc.—how to build foundations—how to proportion foundation footings—how to frame houses—how to set girders and sills—how to frame joists—how to frame a studding—how to set window frames—how to cut rafters—how to use the settings 12, 13, and 17 on the steel square—how to put on wood, fibre and metal shingles—how to hang doors—how to frame windows—how to put on sheathing—how to do cornice work—how to build stairs—how to lay floors—how to paint.

FREE

EXAMINATION

Not a cent to pay until you see the books. No obligation to pay unless you are satisfied. Send coupon now—today and get this fine, helpful new set for Carpenters and Builders. After you have looked them over 5 days send only \$1, then

\$1 a month until \$6 is paid—if you want to keep them. Return them if you do not.

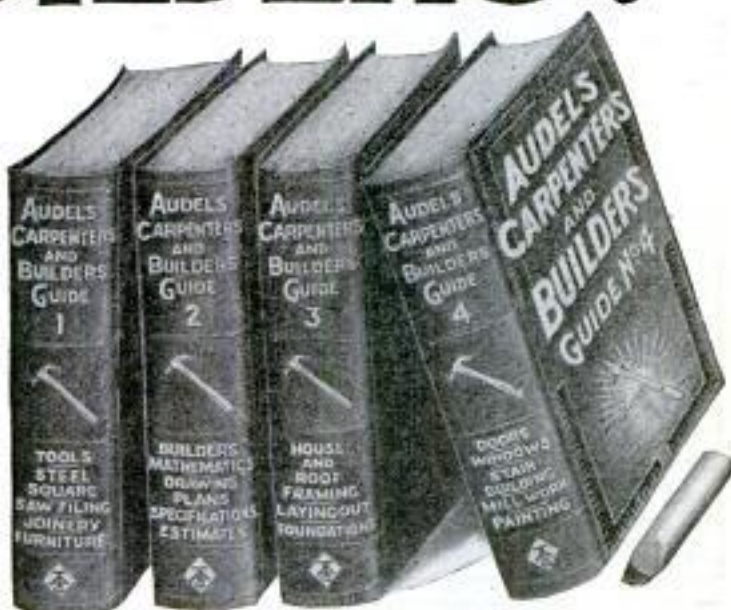

\$1 Per Month—Entire Set \$6
SIXTEEN HUNDRED PAGES
3700 TRADE ILLUSTRATIONS
POCKET SIZE—FLEXIBLE COVERS

There are thousands of examples of modern construction and building work—new methods, new ideas, proved efficiency plans, short cuts, time saving suggestions, new ways that cover the entire theory and practice of modern carpentry. Every point is easy to read and understand and clearly illustrated with sketches and forms. Decide for yourself whether they are worth the money to you. Pay only \$1 a month if you like them. Return the Guides if you don't. USE COUPON NOW!

SEND NO MONEY
NOTHING TO PAY
To the POSTMAN

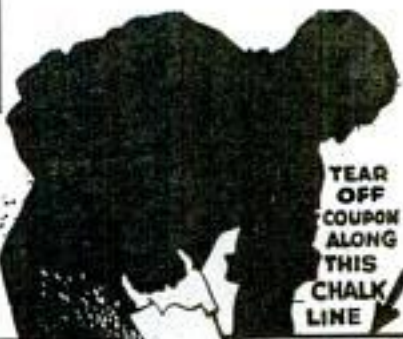

SEND NO MONEY
FILL IN AND MAIL
THIS COUPON NOW

THEO AUDEL & CO., 72 Fifth Avenue, New York City.

Please submit me for approval and free examination:—AUDEL'S CARPENTERS AND BUILDERS GUIDES. Ship at once, prepaid, the 4 numbers. If satisfactory I agree to send you \$1 within five days and to further mail you \$1 monthly until \$6 is paid.

Name..... Occupation.....

Address.....

Employed by..... Reference..... PM. Sept. '23



This superb 110-piece Set consists of:
 12 Dinner Plates, 9 inches
 12 Breakfast Plates, 7 in.
 12 Soup Plates, 7 1/2 inches
 12 Fruit Dishes, 8 1/2 inches
 12 Cereal Dishes, 6 inches
 12 Individual Bread and Butter Plates, 5 1/2 inches
 1 Platter, 13 1/2 inches

12 Cups
 12 Saucers
 1 Platter, 11 1/2 inches

1 Celery Dish, 8 1/2 inches

1 Sauce Boat Tray, 7 1/2 in.

1 Butter Plate, 6 inches
 1 Deep Bowl, 8 1/2 inches
 1 Oval Baker, 9 inches
 1 Small Deep Bowl, 6 inches
 1 Gravy Boat, 7 1/2 inches
 1 Creamer
 1 Sugar Bowl with cover (2 pieces)
 1 Vegetable Dish, 10 1/2 in., with lid (2 pieces)

1 Brings 110-Pc. Martha Washington Blue and Gold Decorated Dinner Set

Send only \$1 and Hartman will ship the complete set. Use it for 30 days on Free Trial. Then if not satisfied, send it back and Hartman will return your \$1 and pay transportation charges both ways. If you keep it, TAKE NEARLY A YEAR TO PAY—a little every month.

Your Initial in Gold, Surrounded by Wreath of Gold, in 2 Places on Every Piece (Gold Covered Handles)

Beautiful Colonial Martha Washington shape. All handles are of solid design and are covered with gold. Every piece decorated with a rich gold band edge, a mazarine blue fawn band and 2 pure gold initials in Old English design with gold wreaths. Guaranteed firsts; no "seconds."

FREE Beautiful Centerpiece, Six Dainty Doilies to Match and 6 Silver Plate Knives and Forks

With every dinner set, we send FREE a 36-inch "Indian Head" linene centerpiece, 6 doilies, 12 inches in diameter to match, 6 extra silver plated knives and 6 extra silver plated forks, Bear-de-lia pattern. Only 50,000 will be given free with the Dinner Sets—so act quick. Send the coupon—NOW!

Order by No. 320EEMA18. Bargain Price, \$34.85. Pay \$1 Now. Balance, \$4.00 Monthly.

The Centerpiece, 6 Dainty Doilies to Match, 6 Silver Plate Knives and 6 Forks are FREE

HARTMAN Furniture & Carpet Co. Dept. 5556 CHICAGO, ILL.
 Copyright, 1923, by Hartman's, Chicago

FREE BARGAIN CATALOG FREE GIFTS

316 pages of astounding bargains, farm machinery, etc.; all on our easy

in home furnishings, monthly payment terms—30 days' free trial. Also explains Hartman's FREE gift plan. Send postal for this big free bargain catalog today. "Let Hartman Feather YOUR Nest!"

HARTMAN Furniture & Carpet Co. Dept. 5556 CHICAGO, ILL.

Enclosed find \$1. Send me the 110-Piece Dinner Set No. 320EEMA18, Price \$34.85, as described, and with it the centerpiece and 6 doilies; also 6 silver plate knives and 6 forks absolutely FREE. It is understood that if I am satisfied, I will send you \$4.00 monthly, until full price of Dinner Set, \$34.85, is paid. Title remains with you until paid in full. If not satisfied, after 30 days' free trial, I will ship all goods back and you will refund my \$1 and pay transportation charges both ways.

Name..... Occupation.....
 R. F. D., Box No.
 or Street and No.

Post Office..... State.....
 If your shipping point is different from your post office, fill in line below.

Send shipment to.....



Print Initial You Want Here

Look Here!

Are you ambitious—are you looking for the way to Success?
Do you want an easy, pleasant job?
Do you want to make from \$60 to \$100 a week?
Do you want to enjoy the luxuries of life?

**Then Read
My Offer!**

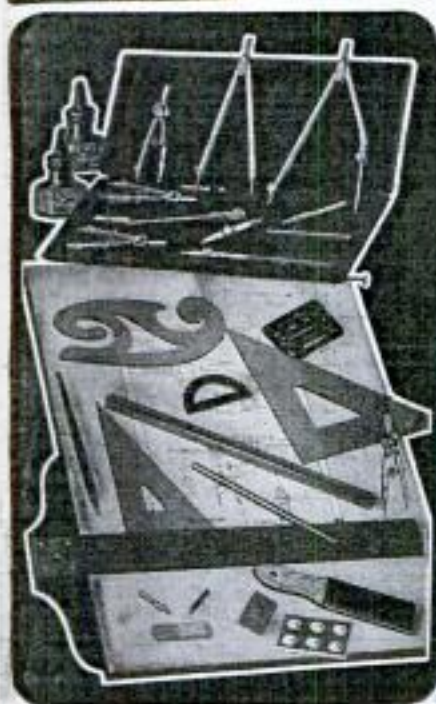

FREE!

This Expert Draftsman's Complete Outfit gives you practical training. Includes complete set of fine "professional" drawing instruments with double set of compasses and dividers in velvet lined case, drawing board, T square, triangles, pens, ink, all accessories. This superb complete outfit given free to every Coyne student. Coupon brings details of this great free offer.

My 2 Free Books bring your Big Opportunity!

Find out all about this wonderful system, the most complete Drafting instruction ever offered for home-study. Grasp this great money-making opportunity now! To supply enormous demand for Cooke-trained draftsmen, I am offering special inducements to ambitious men everywhere. Coupon brings 2 free books, free draftsman's pocket rule and complete information. Mail it to Me Today!

B. W. COOKE, President

COYNE SCHOOL OF DRAFTING

COYNE
SCHOOL OF DRAFTING

Dept. 602

552-598 So. Throop Street

CHICAGO

I Guarantee

to train you for the position of Expert Draftsman. Every factory, big or little — every railroad, every automotive plant, shipyards, the U. S., State, County and City governments, the Army and Navy, everywhere you turn Draftsmen are in demand at \$200 to \$500 a month. Take advantage of this money-making opportunity, the greatest you will ever see. I positively guarantee to train you for the position of Expert Draftsman until you are earning at least

\$250 a Month!



YOU CAN BE THIS MAN!

The Expert Draftsman is the key-man of Industry. Executives depend on him. Not a wheel can turn without him. Naturally, he is high-priced! Look at the picture! You'd almost rather be the draftsman than the boss! YOU—no matter what your job today, no matter how limited your schooling—can REMAKE yourself by learning Drafting the new way — by the "Job-Method" of home instruction. You "learn by doing" and train quick for the big pay job. I have done it for hundreds. I can do it for you.

Radio Course FREE!

For a limited time only!
Enables you to build and operate any Radio Outfit.
Coupon brings my free offer!



COYNE SCHOOL OF DRAFTING
B. W. COOKE, President

Home Study Dept. 602, 552 to 598 So. Throop St., Chicago, Ill.

Without obligating me in any way, please send me your two books, "Drafting, the Foundation of Industry" and "Learn Drafting by the Job-Method"—all absolutely free. Also complete information of your rapid home-study Drafting course, free instruments and other features.

Name.....

St. No.....

City..... State.....

"Most Interesting Position with Unlimited Opportunities"

Says Glen O. Trego, Waterloo, Iowa

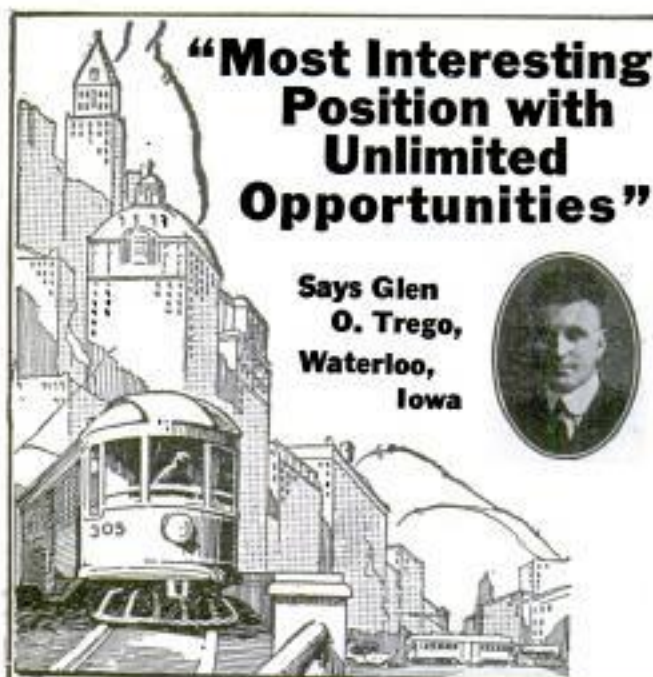

BE A RAILWAY TRAFFIC INSPECTOR

Earn Up to \$250 Per Mo.
Position GUARANTEED

Hundreds of openings for Trained Railway Traffic Inspectors. Any average man can qualify. Steady, pleasant, outdoor work; travel or remain near home. Something new every day.

Splendid Opportunities

Start at \$110 per month, expenses paid, after three months' spare-time study at home. Advancement rapid with experience. Earn up to \$250.00 and \$300.00 per month. Many splendid opportunities thru contact with big railway officials.

Read What G. O. Trego Says:

"Having completed your course in traffic inspection about nine months ago and received a position within a few days thereafter, I now feel it my duty to express my gratitude to you for the help which was extended to me after I began work. And that was far more than I expected.

"I find railway traffic inspection to be the most interesting position with unlimited opportunities that any man could look for. I find that being a railway traffic inspector does not only enable a man to receive higher positions in railways, but it also enables one so he is more capable of conducting any kind of business which may be chosen for the future.

"I must admit that the price paid for the course of traffic inspection is the best investment I made."

GUARANTEE

Our guarantee states that tuition will be refunded to you if, upon graduation, position is not obtained paying at least \$110 per month and expenses.

YOU TAKE NO RISK

If position is not obtained for you, enrollment fee is refunded without question. You have nothing to lose! Send coupon for full details and booklet No. D-63.

STANDARD BUSINESS TRAINING INST.
BUFFALO, N. Y.

STANDARD BUSINESS TRAINING INST.
Buffalo, N. Y.

Send me, entirely free, Booklet No. D-63, giving full particulars about course in Railway Traffic Inspection.

Name

Street

City

BECOME AN AUTOMOBILE PAINTING ENGINEER

HERE

is an amazing OPPORTUNITY to enter a new field and start in business for yourself. Learn Automobile Painting, Paint Mixing, Etc.,

The WULF WAY

LEARN IN 8 TO 10 WEEKS' TIME

No talent or education necessary. Instructions are individual. You can start any time. TODAY — RIGHT NOW — Write for our SPECIAL OFFER and catalogue.

DETROIT AUTO PAINTING SCHOOL

29 D.A.P.S. Bldg., 426 Superior St., DETROIT, MICH.

RAISE POULTRY FOR PROFIT

We teach you how. Easily learned at home. Our guaranteed methods make success certain—indorsed by leading Agricultural Colleges. Send TODAY for FREE BOOK—"How To Raise Poultry For Profit."



National Poultry Institute

Dept. 312 Washington, D. C.

LAW

IN YOUR SPARE TIME

Learn law with only institution giving same course by correspondence as was given for years at resident classes of this college. **DEGREE OF LL. B. CONFERRED.** One year business law course prepares you for success in business. Law trained business men in demand. Three year university course covers preparation for bar examination.

Money back guarantee if not satisfied. Low fee, easy terms, includes complete 1931 thirteen volume library, text material and all expenses. Write for **FREE BOOK.**
Hamilton College of Law 431 South Dearborn St., Dept. 65 Chicago

Learn Autos and Make Money



Our Graduates either get good Automobile Positions or make **BIG MONEY** in their own business. Let us tell you how to do the same. We have the **Oldest School—Lowest Rates—7000 Graduates. Catalog Free.**

Cleveland Automobile School
1814 East 24th St., Cleveland, Ohio

BE AN ARTIST

Comics, Cartoons, Commercial, Newspaper and Magazine Illustrating, Pastel, Crayon Portraits and Fashion. Our simple method quickly develops your talent in spare time. By Mail or Local Classes. Write for terms and list of successful Students.
ASSOCIATED ART STUDIOS 87-B Flatiron Building, NEW YORK



COLUMBIA SCHOOL OF DRAFTING

Specializing in training of professional Draftsmen—Mechanical, Architectural and others; personal instruction in spare time, at home by mail; complete course 3 to 9 months. Free Catalog. Address Dept. 2119, R. C. Claffin, Pres., 14th and T Sts., N.W., Wash., D. C.



WANTED!
U.S. RAILWAY MAIL CLERKS

\$1600 First Year

Raise to \$2300

Men—Boys, 18 or over, mail coupon at once.

FRANKLIN INSTITUTE

Dept. A-179 Rochester, N. Y.

Sirs: Send me, without charge (1) sample Railway Mail Clerk Examination questions; (2) list of many government jobs obtainable; (3) tell me how I can get a government position.

Name

Address

How I Increased My Salary More Than 300%

By JOSEPH ANDERSON

I AM just the average man—twenty-eight years old, with a wife and a three-year-old youngster. I left school when I was fourteen. My parents didn't want me to do it, but I thought I knew more than they did.

I can see my father now, standing before me, pleading, threatening, coaxing me to keep on with my schooling. With tears in his eyes he told me how he had been a failure all his life because of lack of education—how the untrained man is always forced to work for a small salary—how he had hoped, yes, and prayed, that I would be a more successful man than he was.

But no! My mind was made up. I had been offered a job at \$9 a week and I was going to take it.

That nine dollars looked awfully big to me. I didn't realize then, nor for years afterward, that I was being paid only for the work of my hands. My brain didn't count.

THEN one day, glancing through a magazine, I came across the story of a man just like myself. He, too, had left school when he was fourteen years of age, and had worked for years at a small salary. But he was ambitious. He decided that he would get out of the rut by training himself to become expert in some line of work.

So he got in touch with the International Correspondence Schools at Scranton and started to study in his spare time at home. It was the turn in the road for him—the beginning of his success.

Most stories like that tell of the presidents of great institutions who are earning \$25,000 and \$50,000 a year. Those stories frighten me. I don't think I could ever earn that much. But this story told of a man who, through spare-time study, lifted himself from \$25 to \$75 a week. It made an impression on me because it talked in terms I could understand. It seemed reasonable to suppose that I could do as well.

I tell you it didn't take me long that time to mark and send in that familiar coupon. Information regarding the Course I had marked came back by return mail. I found it wasn't too late to make up the education I had denied myself as a boy.

I was surprised to find out how fascinating a home-study course could be. The I. C. S. worked with me every hour I had to spare. I felt myself growing. I knew there was a bigger job waiting for me somewhere.

Four months after I enrolled my employer came to me and told me that he always gave preference to men who studied their jobs—and that my next salary envelope would show how much he thought of the improvement in my work.

Today, my salary is more than 300% greater than it was when I began my studies. That increase has meant a better home and all the luxuries that make life worth while.



What I have done, you can do. For I am just an average man. I had no more education to begin with than you have—perhaps not as much. The only difference is a matter of training and a resolve to be like Lincoln, who said—"I will study and get ready and some time my chance will come."

TO every man who is earning less than \$75 a week, I say simply this:—*Find out what the I. C. S. can do for you!*

It will take only a minute of your time to mark and mail the coupon. But that one simple act may change your whole life.

If I hadn't taken that first step four years ago I wouldn't be writing this message to you today! No, and I wouldn't be earning anywhere near \$75 a week, either!

----- TEAR OUT HERE -----
INTERNATIONAL CORRESPONDENCE SCHOOLS
 Box 5539-D, Scranton, Penna.

Without cost or obligation, please tell me how I can qualify for the position or in the subject before which I have marked an X:

- | | |
|---|--|
| BUSINESS TRAINING COURSES | |
| <input type="checkbox"/> Business Management | <input type="checkbox"/> Salesmanship |
| <input type="checkbox"/> Industrial Management | <input type="checkbox"/> Advertising |
| <input type="checkbox"/> Personnel Organization | <input type="checkbox"/> Better Letters |
| <input type="checkbox"/> Traffic Management | <input type="checkbox"/> Foreign Trade |
| <input type="checkbox"/> Business Law | <input type="checkbox"/> Stenography and Typing |
| <input type="checkbox"/> Banking and Banking Law | <input type="checkbox"/> Business English |
| <input type="checkbox"/> Accountancy (including C.P.A.) | <input type="checkbox"/> Civil Service |
| <input type="checkbox"/> Nicholson Cost Accounting | <input type="checkbox"/> Railway Mail Clerk |
| <input type="checkbox"/> Bookkeeping | <input type="checkbox"/> Common School Subjects |
| <input type="checkbox"/> Private Secretary | <input type="checkbox"/> High School Subjects |
| <input type="checkbox"/> Business Spanish | <input type="checkbox"/> Illustrating |
| <input type="checkbox"/> French | <input type="checkbox"/> Cartooning |
| TECHNICAL AND INDUSTRIAL COURSES | |
| <input type="checkbox"/> Electrical Engineering | <input type="checkbox"/> Architect |
| <input type="checkbox"/> Electric Lighting | <input type="checkbox"/> Blue Print Reading |
| <input type="checkbox"/> Mechanical Engineer | <input type="checkbox"/> Contractor and Builder |
| <input type="checkbox"/> Mechanical Draftsman | <input type="checkbox"/> Architectural Draftsman |
| <input type="checkbox"/> Machine Shop Practices | <input type="checkbox"/> Concrete Builder |
| <input type="checkbox"/> Railroad Positions | <input type="checkbox"/> Structural Engineer |
| <input type="checkbox"/> Gas Engine Operating | <input type="checkbox"/> Plumbing and Heating |
| <input type="checkbox"/> Civil Engineer | <input type="checkbox"/> Chemistry |
| <input type="checkbox"/> Surveying and Mapping | <input type="checkbox"/> Pharmacy |
| <input type="checkbox"/> Metallurgy | <input type="checkbox"/> Automobile Work |
| <input type="checkbox"/> Mining | <input type="checkbox"/> Navigation |
| <input type="checkbox"/> Steam Engineering | <input type="checkbox"/> Agriculture and Poultry |
| <input type="checkbox"/> Radio | <input type="checkbox"/> Mathematics |
| <input type="checkbox"/> Airplane Engines | |

Name.....
 Street.....
 Address.....

City..... State.....

Occupation.....
 Persons residing in Canada should send this coupon to the International Correspondence Schools Canadian, Limited, Montreal, Canada

\$90 Drafting Course FREE

There is such an urgent demand for practical, trained Draftsmen that I am making this special offer in order to enable deserving, ambitious and bright men to get into this line of work. I will teach you to become a Draftsman and Designer until you are **Drawing a salary of \$250.00 a month.** You need not pay me for my personal instruction or for the complete set of instruments. **But you must take advantage of this special offer at once.**

\$300 a Month Salary— \$450 on the Side at Home!



Chief Draftsman Dobe

That's the kind of money my drafting students make. Read what this one says:

"As a beginner I am doing fine. Am earning a salary of \$300 per month, besides I made over \$450 at home the last two months, drawing plans for private parties. The practical drafting training you gave me by mail put me where I am in less than six month's study. Thank you for all your personal interest and help you gave me so far."

(Signed) J. B.

(Name and address upon request)

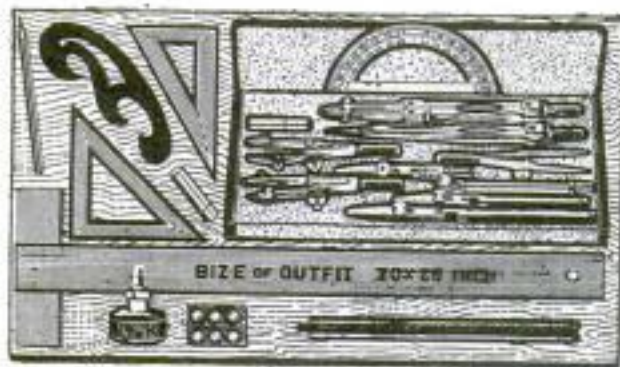

This \$25 Outfit FREE

And more—I give you a whole set of drafting tools the minute you become my student. You get every tool you need. A magnificent \$25 set of instruments which will build your success in draftsmanship.

Chief Draftsman Engineers Equipment Co.
1951 Lawrence Ave. Div. 13-56 Chicago, Ill.

Without any obligation whatsoever, please mail your book, "Successful Draftsmanship", and full particulars of your liberal "Personal Instruction" offer to few students.

Name.....

Address.....

Post Office.....State.....

I Guarantee

**To Train You Until You Are
Placed in a Position Paying
up to \$250 and \$300 a Month**

Write and I'll tell you how I make you a first-class, big-money-earning draftsman in a very few months! I do this by a method no other man nor institution can imitate. I give you personal training at home by mail until you are actually placed in a position paying up to \$250 and \$300 a month. Six thousand draftsmen are wanted every month.

Free Book

Send Coupon Today

No matter what plans you have for the future. Get this great book—"Successful Draftsmanship." Find out about the simply marvelous opportunities ahead now. How the world needs draftsmen, engineers, architects and builders. What great salaries and possibilities there are! Send coupon for free book today.

**Chief Draftsman
Engineers Equipment Co.**
1951 Lawrence Ave., Div. 13-56, Chicago, Ill.

LEARN TO DO ANY JOB!



The Cooke "Job-Way" trained man gets the big money, because no job is too hard for him! He finds the trouble instantly and can repair it quickly.

Your Name HERE!

A business of your own, paying \$3,000 to \$10,000 a year in profits! Cooke-trained Experts have gone into business with little or no capital and have found their future and their fortune repairing Automobiles, Trucks, Tractors, Gas Engines. **You can, too!**



Be an Auto-Tractor-EXPERT!

LEARN WITH TOOLS!

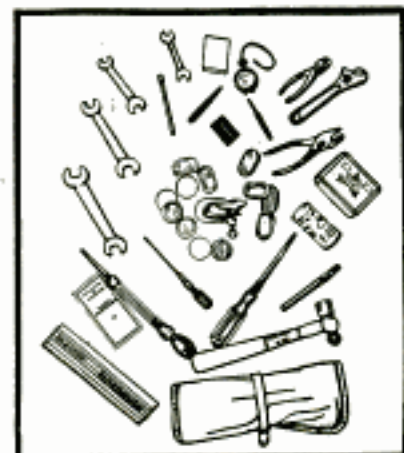

\$18.50 Repair Kit FREE

No books or useless theory in my home study "JOB-WAY" Course. That's why you can crowd training that would ordinarily take two years into a few months of spare-time home study. This \$18.50 repair kit only one of many inducements offered to get you started on the road to success NOW! Mail coupon for complete information, learn how you can MAKE MONEY almost from the start with this outfit.

Men Wanted!

I train you to hold down these big-pay Jobs:

MASTER MECHANICS	\$3000 to \$8000
ELECTRICAL EXPERTS	\$3600 up
GARAGE MANAGER	\$3000 up
TRACTOR ENGINEER	\$2400 up
SALESMAN	\$3000 to \$12000
EXPERT WELDER	\$2400 up
BATTERY EXPERT	\$2400 up

NOW YOU CAN LEARN AT HOME!

At last! you can become an auto, truck and tractor expert right in your home with our practical "Job-Way" training. If you like machinery, if you want to get ahead, here is the quickest road to BIG PAY! In what other way can you trade your spare time right at home for TRAINING that will prepare you to go into business or take your choice of a hundred jobs paying

\$75 to \$125 a Week!



B. W. COOKE, President Cooke Auto School, "greatest institution of its kind in the world."

Good jobs everywhere! In garages, repair shops, service-stations, factories. As Salesman, demonstrators, electrical experts, Master Mechanics. In Battery stations, Vulcanizing Shops, Welding plants or in business for yourself. Salaries sky-high, easy hours, and opportunities for a business of your own all around you! Man alive! You can't afford to hesitate a minute!

Learn Automotive Mechanics Electricity, Welding Battery and Vulcanizing

Now 15 million autos, trucks and tractors crowding the cities, highways and farms. 15,000,000 electrical systems to maintain and repair. 50 million tires to replace and repair. 15 million batteries to test and service. 15 million autos, trucks and tractors to keep going! Do you realize that COOKE "JOB-WAY" training prepares you right at home for the opportunity—that when you're EXPERT you don't need "luck" or an "opportunity"—they're right here NOW waiting for you to start and finish!

Start NOW! I'll help you start and help you finish! Inducements you cannot resist, RIGHT NOW to ambitious men; terms within reach of everybody! Free Employment Service to help you get the job you want at top pay! Many extras, but not one penny extra for anything. Find out how easy I have made it for you to SUCCEED thru my SUCCESS coupon.

Mail Coupon Today

Cooke Auto School, Dept. 101, 500 S. Throop St., Chicago

Radio Course FREE THIS MONTH

Only one of the many surprises waiting for the man who has "gumption" enough to write for my big offer right away! Without one cent of cost, I am giving away a limited number of these \$40 courses. Why not get one? SUCCESS Coupon entitles you to this money-making course free!

SUCCESS COUPON

COOKE AUTO SCHOOL

B. W. COOKE, President
Cooke Auto School, Dept. 101, 500 S. Throop St., Chicago

Please send me Free Book and complete information about your Home Study Course. I am mailing this promptly to secure FREE RADIO COURSE, FREE REPAIR KIT and the reduced prices and special terms you offer now. Of course, I am not obligating myself in any way.

Name.....
St. No. or R. F. D.....
City..... State.....

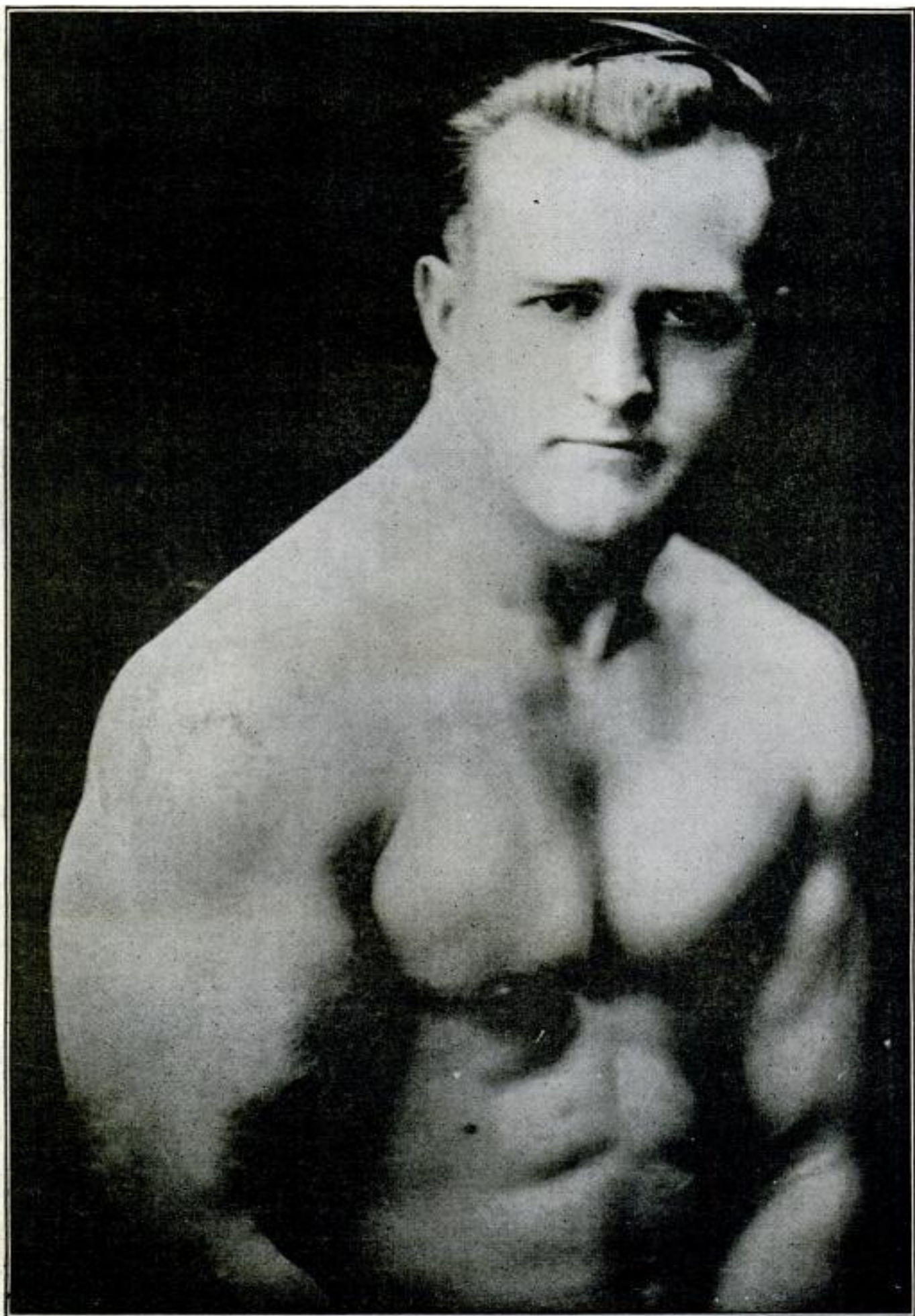

EARLE E. LIEDERMAN, *The Acme of Physical Perfection*

Copyrighted material

If you were dying to-night

and I offered you something that would give you ten years more to live, would you take it? You'd grab it. Well, fellows, I've got it, but don't wait till you're dying or it won't do you a bit of good. It will then be too late. Right now is the time. To-morrow, or any day, some disease will get you and if you have not equipped yourself to fight it off, you're gone. I don't claim to cure disease. I am not a medical doctor, but I'll put you in such condition that the doctor will starve to death waiting for you to take sick. Can you imagine a mosquito trying to bite a brick wall? A fine chance.

A Re-built Man

I like to get the weak ones. I delight in getting hold of a man who has been turned down as hopeless by others. It's easy enough to finish a task that's more than half done. But give me the weak, sickly chap and watch him grow stronger. That's what I like. It's fun to me because I know I can do it and I like to give the other fellow the laugh. I don't just give you a veneer of muscle that looks good to others. I work on you both inside and out. I not only put big, massive arms and legs on you, but I build up those inner muscles that surround your vital organs. The kind that give you real pep and energy, the kind that fire you with ambition and the courage to tackle anything set before you.

All I Ask Is Ninety Days

Who says it takes years to get in shape? Show me the man who makes any such claims and I'll make him eat his words. I'll put one full inch on your arm in just 30 days. Yes, and two full inches on your chest in the same length of time. Meanwhile, I'm putting life and pep into your old back-bone. And from then on, just watch 'em grow. At the end of thirty days you won't know yourself. Your whole body will take on an entirely different appearance. But you've only started. Now comes the real work. I've only built my foundation. I want just 60 days more (90 in all) and you'll make those friends of yours who think they're strong look like something the cat dragged in.

A Real Man

When I'm through with you, you're a real man. The kind that can prove it. You will be able to do things that you had thought impossible. And the beauty of it is you keep on going. Your deep full chest breathes in rich pure air, stimulating your blood and making you just bubble over with vim and vitality. Your huge, square shoulders and your massive, muscular arms have that craving for the exercise of a regular he man. You have the flash to your eye and the pep to your step that will make you admired and sought after in both the business and social world.

This is no idle prattle, fellows. If you doubt me, make me prove it. Go ahead. I like it. I have already done this for thousands of others and my records are unchallenged. What I have done for them, I will do for you. Come, then, for time flies and every day counts. Let this very day be the beginning of new life to you.

Send For My New
64 Page Book—

"Muscular Development"

It is chock full of large size photographs of both myself and my numerous pupils. Also contains a treatise on the human body and what can be done with it. This book is bound to interest you and thrill you. It will be an impetus—an inspiration to every red blooded man. I could easily collect a big price for a book of this kind just as others are now doing, but I want every man and boy who is interested to just send the attached coupon and the book is his absolutely free. All I ask you to cover is the price of wrapping and postage—10 cents. Remember this does not obligate you in any way. I want you to have it. So it's yours to keep. Now don't delay one minute—this may be the turning point in your life to-day. So tear off the coupon and mail at once while it is on your mind.

EARLE E. LIEDERMAN
Dept. 2009, 305 Broadway, New York

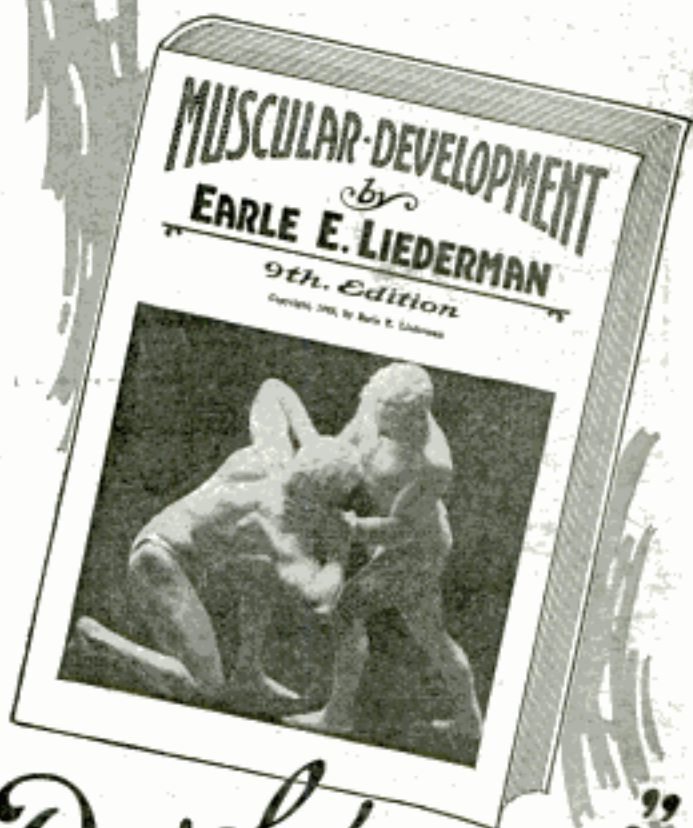

EARLE E. LIEDERMAN

Dept. 2009, 305 Broadway, New York City

Dear Sir:—I enclose herewith 10 cents for which you are to send me, without any obligation on my part whatever, a copy of your latest book, "Muscular Development." (Please write or print plainly).

Name.....

Address.....

City..... State.....

Are You the Boss? —or Are You Riley?

THE BOSS gives the orders—Riley takes them and does what he is told. Both started the same, had equal ability to begin with. Riley works harder than the BOSS and gets less money. What is the answer?

Training did it. Your brain is an engine that needs fuel. Study and training supply the fuel that makes it go. And when you mix brains with your work you **SIMPLY CANNOT HELP BUT GET AHEAD.**

Be a Contractor or Builder

Fit yourself for a big job in the Contracting or Building business. Train for it right at home. The Course is easy to learn, is simple but thorough, is taught by experts who have made it their life study. We teach you Estimating, Blue Print Reading, Building Regulation, Use of Steel Square, Water Supply and Drainage, Heating and Ventilating, etc.

The cost is low, terms easy, results quick and sure. Our money-back guarantee insures satisfaction. Thousands are earning **BIG MONEY** in this business today. Get ready to get yours. Fill out the coupon now. Check the Course you are interested in. It costs you nothing but a 2c stamp for full information. It will mean much for your future.

American School

Dept. G-674 © A. S. 1923
Drexel Ave. & 58th St. CHICAGO



"Riley—Take up These Bricks"

"All Right Boss"

AMERICAN SCHOOL,
Dept. G-674, Drexel Ave. & 58th St., Chicago
Send me full information on the subject checked.

- | | |
|-------------------------------------|--------------------------|
| .. Architect | .. Business Law |
| .. Building Contractor or Carpenter | .. Lawyer |
| .. Automobile Engineer | .. Machine Shop Practice |
| .. Automobile Repairman | .. Photoplay Writer |
| .. Civil Engineer | .. Mechanical Engineer |
| .. Advertising Manager | .. Shop Superintendent |
| .. Business Manager | .. Employment Manager |
| .. Financial Manager | .. Steam Engineer |
| .. Sales Manager | .. Foremanship |
| .. Cert. Pub. Accountant | .. Sanitary Engineer |
| .. Accountant & Auditor | .. Surveyor (& Mapping) |
| .. Bookkeeper | .. Telephone Engineer |
| .. Draftsman & Designer | .. Telegraph Engineer |
| .. Electrical Engineer | .. High School |
| .. General Education | .. Fire Insurance Expert |
| .. Personal Analysis | .. Wireless-Radio |
| | .. Undecided |

Name

Address

Occupation

Please Mention Popular Mechanics

Be Your Own MUSIC Teacher



Learn at Home

by wonderful print-and-picture method that teaches in half usual time. Far superior to private teachers. Simple as A, B, C—a child can master it. Your lessons consist of real selections instead of tiresome exercises. When you finish one of these delightfully easy lessons you've added a new "piece" to your list. You read real notes, too—no "numbers" or trick music. Method is so thorough that many of our 300,000 students are band and orchestra **LEADERS.**

Play by **NOTE**
Piano, Organ, Violin, Cornet, Mandolin, Harp, 'Cello, Trombone, Flute, Clarinet, Piccolo, Saxophone, Ukulele, Guitar, Harmony and Composition, Banjo, Tenor Banjo, Voice and Speech Culture, Drums and Traps Automatic Finger Control, etc.

Automatic Finger Control

Our own invention—the music marvel of all ages. Trains and guides your fingers so that they fall into proper place almost automatically.

Free Book and Trial Lesson

show you how you may quickly become a fine player or singer through the U. S. School home study method. *Write now*, however, before free books and sample lessons are gone. Mention your favorite instrument or whether you prefer vocal music. Please write your name and address plainly. Address

U. S. SCHOOL OF MUSIC, 79 Brunswick Bldg., N. Y. C.

BE AN EXPERT REPAIRMAN On MOTORS and GENERATORS

Repair and Maintenance Men are in Big Demand. **LEARN IN 3 MONTHS** Insure yourself permanent income and bigger opportunities—here at this Great Electrical School you actually wind D.C. and A.C. armatures under expert instructors. 72-page Book. It's FREE. Write for it today. **SCHOOL OF ENGINEERING OF MILWAUKEE** P.M. 9, 415 Marshall St., Milwaukee, Wis.

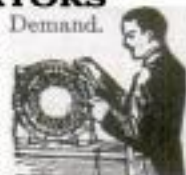

Learn Expert Auto Painting

There is **Big Money** in auto painting and refinishing. Our Home Study Course in **Practical Auto Painting** will enable you to do the finest work and earn big wages. Wonderful opportunity for new money-making business of your own.



FREE circular tells all about this big new business. Be first. Write quick.

CHICAGO COLLEGE OF AUTO PAINTING
Dept. 93, 140 S. Dearborn St., CHICAGO, U.S.A.

AGENTS

For the Biggest Money-Making Selling Proposition You Ever Saw

See Pages 60 & 61

**Taxidermy
Book
FREE!**



**Stuff Beautiful
Birds** Learn by mail to stuff and mount all kinds of birds, animals, fish and game heads, make rugs, tan skins. Mount your own specimens and make money preserving for others. **Men, women and boys learn easily and quickly. Success guaranteed or no tuition. Write today for our wonderful FREE book. "How to Learn to Mount Birds and Animals." N. W. School of Taxidermy, 1176 Elwood Bldg., Omaha, Neb.**

Write today.



NOW FREE!

The Book That Has Shown Thousands the Way to Amazing Salary Increases

Do you want to leave the rut of routine work for a position that will grow daily in its fascination? Do you want to start right out making more money than you ever thought possible? We have done exactly this for thousands of men. Here is the book which gave them their start. Read how it is now offered to you—FREE!

TAKE this situation. A man who had worked all his life in a routine job at low pay suddenly surprises his friends by moving into a better neighborhood, taking a big house, buying a car and blossoming out as a well-to-do and influential citizen in his new community. How did he do it? What is the secret that he used? Simple enough. He knew that the biggest money in business is in Selling and though he felt that he couldn't sell a thing, he learned the secrets that make Master Salesmen and then began to make big money.

If only one man had found inspiration enough in this remarkable book to make a brilliant success in the Selling field—in a job paying him many times his former salary—then you might call it luck. But thousands have done it.

Your One Chance to Make the Biggest Money of Your Life

Not one of the men whose names appear at the right had ever sold a thing before—not a dime's worth. If you had told one of them that he could sell he would have laughed at you.

Probably he would have come back with the old saw, "Salesmen are born, not made." They were frankly skeptical. Yet

every one of these men, through reading this book, discovered the fallacy of this vicious old idea that Salesmen are "born." They learned that **Master Salesmen are made!** And in this book they found a comparatively easy way to go from low pay to better earnings.

Simple as A B C

Sounds remarkable, doesn't it? Yet there is nothing remarkable about it. There are certain ways to approach different types of prospects to get their undivided attention—certain ways to stimulate keen interest—certain ways to overcome objections, batter down prejudices, outwit competition and make the prospect act. If you will learn these principles there is awaiting you a brilliant success and more money than you ever thought of earning. This book, "Modern Salesmanship," tells exactly how the National Salesmen's Training Association will make you a Master Salesman.

As soon as you are qualified and ready the Employment Service of the National Salesmen's Training Association will help you to select and secure a selling position as city or traveling salesman. Many of the biggest, most reputable selling organizations in America turn to this Association for their Star Salesmen.

Now Free to Every Man Who Will Act at Once

We are not making any extravagant claims about what we will do for you. We don't have to. The records of the real successes for which we are responsible are so overwhelmingly a testimonial of the fact that any man of average intelligence can become a Master Salesman that we are willing to leave

the decision entirely up to you. All of this proof and many important features about Salesmanship are contained in our salary raising book, "Modern Salesmanship." It is yours—FREE. Send the coupon for it today. It will show you how you can quickly become a Master Salesman—a big money maker. It will tell you about the National Salesmen's Training Association system of Salesmanship training that has meant prosperity to so many thousands of men—about the National Demonstration method that gives you actual experience while studying—and all about the fine opportunities that await you in the selling field. If you do not send this coupon we will lose merely the opportunity to train one more Master Salesman. But for you, failure to act may mean, that you lose the one big chance of your life to leave forever behind you the low pay of a routine job. It may mean the difference between this and a real success at a big salary. Is it worth 2c to find out? Then mail this coupon NOW.

National Salesmen's Training Association Dept. 12-M CHICAGO, ILLINOIS

National Salesmen's Training Association
Dept. 12-M, Chicago, Ill.

I simply want to see the facts. Send me FREE your Book "Modern Salesmanship" and Proof that I can become a Master Salesman. Also tell how you can help me to a position.

Name.....

Address.....

City.....State.....

Age.....Occupation.....

Read!

Charles Beery of Winterset, Iowa, stepped from \$18 a week as a clerk to a position making him \$1,000 the very first month. J. P. Overstreet of Dennison, Texas, read this book, left a job on the Capitol Police Force at a salary of less than \$1,000 a year and in six weeks earned \$1,800. F. Wynn, Portland, Ore., an ex-service man, earned \$554.37 in one week. Geo. W. Kearns of Oklahoma City found in this book a way to jump his earnings from \$60 a month to \$524.00 in two weeks and C. W. Campbell learned from it how he could quit a clerking job on the railroad to earn \$1,632 in thirty days.



The Hour That Counts!

When you see a man putting in his noon hour learning more about his work, you see a man who won't stay down. He'll never be satisfied until he hits the top. And he'll get there!

In shops, factories, offices, stores, in every line of industry, men are holding splendid positions won through spare time study with the International Correspondence Schools. Today they are earning four or five times—yes, some of them ten times as much money as when they started.

Employers everywhere are looking for men who really want to get ahead. If you want to make more money, show your employer that you're trying to be worth more money.

For 31 years the International Correspondence Schools have been training men and women right in their own homes.

Thousands of men have stepped up in just this way. More than 180,000 are studying now. Can you afford to let another hour pass without making your start toward something better? Here is all we ask—without cost, without obligation, mark and mail this coupon!

TEAR OUT HERE

INTERNATIONAL CORRESPONDENCE SCHOOLS Box 5540-D, Scranton, Penna.

Without cost or obligation, please tell me how I can qualify for the position or in the subject before which I have marked an X:

BUSINESS TRAINING COURSES

- | | |
|---|---|
| <input type="checkbox"/> Business Management | <input type="checkbox"/> Salesmanship |
| <input type="checkbox"/> Industrial Management | <input type="checkbox"/> Advertising |
| <input type="checkbox"/> Personnel Organization | <input type="checkbox"/> Better Letters |
| <input type="checkbox"/> Traffic Management | <input type="checkbox"/> Foreign Trade |
| <input type="checkbox"/> Business Law | <input type="checkbox"/> Stenography and Typing |
| <input type="checkbox"/> Banking and Banking Law | <input type="checkbox"/> Business English |
| <input type="checkbox"/> Accountancy (including C.P.A.) | <input type="checkbox"/> Civil Service |
| <input type="checkbox"/> Nicholson Cost Accounting | <input type="checkbox"/> Railway Mail Clerk |
| <input type="checkbox"/> Bookkeeping | <input type="checkbox"/> Common School Subjects |
| <input type="checkbox"/> Private Secretary | <input type="checkbox"/> High School Subjects |
| <input type="checkbox"/> Business Spanish <input type="checkbox"/> French | <input type="checkbox"/> Illustrating <input type="checkbox"/> Cartooning |

TECHNICAL AND INDUSTRIAL COURSES

- | | |
|--|--|
| <input type="checkbox"/> Electrical Engineering | <input type="checkbox"/> Architect |
| <input type="checkbox"/> Electric Lighting | <input type="checkbox"/> Blue Print Reading |
| <input type="checkbox"/> Mechanical Engineer | <input type="checkbox"/> Contractor and Builder |
| <input type="checkbox"/> Mechanical Draftsman | <input type="checkbox"/> Architectural Draftsman |
| <input type="checkbox"/> Machine Shop Practice | <input type="checkbox"/> Concrete Builder |
| <input type="checkbox"/> Railroad Positions | <input type="checkbox"/> Structural Engineer |
| <input type="checkbox"/> Gas Engine Operating | <input type="checkbox"/> Plumbing and Heating |
| <input type="checkbox"/> Civil Engineer | <input type="checkbox"/> Chemistry <input type="checkbox"/> Pharmacy |
| <input type="checkbox"/> Surveying and Mapping | <input type="checkbox"/> Automobile Work |
| <input type="checkbox"/> Metallurgy <input type="checkbox"/> Mining | <input type="checkbox"/> Navigation |
| <input type="checkbox"/> Steam Engineering | <input type="checkbox"/> Agriculture and Poultry |
| <input type="checkbox"/> Radio <input type="checkbox"/> Airplane Engines | <input type="checkbox"/> Mathematics |

Name.....
Street.....
Address.....

3-27-23

City..... State.....

Occupation.....
Persons residing in Canada should send this coupon to the International Correspondence Schools Canadian, Limited, Montreal, Canada.

Why Good Dancers Are Popular

Everyone admires and wants to dance with the person who knows the latest steps. There's no need to envy others. You can enjoy the pleasures and popularity of a really good dancer. Arthur Murray, America's foremost teacher of social dancing, has developed a remarkable new easy method which enables anyone to learn all the latest popular steps at home—in a few hours—at very little cost!

No music or partner is needed. More than 60,000 have learned by mail.

Your Success is Positively Guaranteed!

Five Dancing Lessons Free

To prove you can learn any step in a few minutes, and all of the dances in a few hours, Arthur Murray will send you free, in plain cover, 1. A lesson in Fox Trot. 2. The Secret of Leading. 3. How to Follow. 4. How to Gain Confidence. 5. How to Avoid Embarrassing Mistakes, and other dancing helps.

These valuable lessons will show you how easily and quickly you can become an accomplished dancer and how you can be more popular by dancing well! Learn at home and surprise your friends. This offer of free instructions may be withdrawn at any moment. Write for your lessons today! To pay the cost of mailing, handling, etc., send 25c.

Money back if not delighted.

Arthur Murray, Studio 807, 290 Broadway, N.Y.

ARTIST'S OUTFIT FREE

Write quick for our remarkable offer. Learn NOW at home, in spare time, by our new instruction method. Commercial Art, Cartooning, Illustrating, Designing. Delightful fascinating work in big demand. \$50.00 paid for one drawing. Handsome book free explains everything. SEND FOR IT TODAY.

WASHINGTON SCHOOL OF ART, Inc.
Rm. 309, 1115-15th St. N.W., Washington, D.C.

STAMMER

If you stammer attend no stammering school till you get my large FREE book entitled "STAMMERING, Its Origin and the Advanced Natural Method of Cure." Bound in cloth and stamped in pure gold. Ask for special tuition rate and a FREE copy of "The Natural Speech Magazine." Largest, best equipped and most successful school in the world for the cure of stammering; stuttering, etc. No sing-song or time beat. Write today. The North-Western School, 2317 Grand Ave., Milwaukee, Wis.

LEARN WATCHMAKING

and become independent. Good-paying positions secured. Easy to learn. Send for FREE CATALOG.

ST. LOUIS WATCHMAKING SCHOOL, Dept. 5, ST. LOUIS, MO.

IT'S EASY TO PLAY THE TENOR-BANJO

THIS \$15.00 TENOR BANJO FREE

No Previous Musical Knowledge Necessary. Play Music Your First Lesson. Wonderful Method. Only 6 motions and you master them quickly. After a short period of easy practice you will be playing all the popular hits, just as you have heard experts play them on the stage, in Dance Orchestras—everywhere! It is the most popular instrument of the age and you can quickly learn to play it. Prof. Barker will teach you to chord and harmonize exactly as he does in an amazingly short time! And remember we furnish your tenor banjo free. Write for details of our course and free offer to Address

First Hawaiian Conservatory of Music, Inc.
Desk 60, 233 Broadway, (Woolworth Bldg.) N.Y.

AUTOMOTIVE JOBS

Ready
for **GREER GRADUATES**
Jobs Furnished While You Learn to Make
The **BIG MONEY**



**FROM
HERE**

Located in the heart of Automobile Row, this magnificent building is completely devoted to training Greer Students. Its seven floors are filled with classrooms, shops and modern equipment that will make YOU a big money man. See views in FREE BOOK. Mail the coupon.

\$50 to \$125 per week Automotive Jobs are begging for trained men at once. Never before in automobile history has there been such a demand for expert automobile workmen. Hundreds of requests for Greer Graduates are now in our files, waiting to be filled. We cannot supply the demand. We need *more* ambitious students to qualify for the big money jobs. We need YOU!

**EARN WHILE YOU LEARN
AT GREER COLLEGE**

While you are learning we can place you in positions paying \$25 to \$32.50 per week.

With this help you can put yourself through easily. In only 8 weeks you can graduate as a Certified Automotive Engineer. Then you are set for life.

Here in the big Greer shops you get actual work on 4, 6, 8 and 12 cylinder engines. Electricity thoroughly covered. All known Lighting, Starting and Ignition units used. Special courses in Machine Shop, Batteries, Welding and Vulcanizing. Individual road lessons given.

ACTUAL SHOP PRACTICE

Day and Evening Classes

Complete Greer Course includes Machine Shop Practice, Shop Management, Selling, Truck, Tractor and Automobile Repairing, Lighting, Starting, Vulcanizing, Storage Batteries, Driving—everything you need to take the highest paid positions anywhere.

**Come
To
CHICAGO**

**IN
ONLY
8
SHORT
WEEKS**

**TO
HERE**

Here, in the wonder city of America, the greatest automobile market in the world, you will find everything to your educational advantage. Within ten blocks of Greer College are at least 40 large Automobile Sales Agencies. Hundreds of others are scattered throughout the city. All want trained men. Come to Chicago. We will find a home for you. Here you can grow as big as the opportunities that surround you. Mail the coupon for FREE BOOK and complete information. Do it now!

**GREER
COLLEGE**
of Automotive Engineering
2059 S. Wabash Avenue, Chicago



**Erwin
Greer,
President**

2059 S. Wabash
Ave., Chicago, Ill.

Send me your Free Book,
"How to Succeed in the
Automobile Business" and
Special Tuition Offer.

Mail
Coupon for
Free Book

Name.....

Address.....

LEARN CARTOONING

Successful cartoonists earn big salaries. Many of the most popular cartoonists of to-day learned to draw in their spare time, at home, through the Landon Course of Cartooning and now earn \$75 to \$200 a week.



The Landon Picture Chart Method of teaching ORIGINAL drawing makes cartooning easy to learn. Hundreds of sketches like the above explain every step in creating ORIGINAL heads, figures, animals, etc.

Write today for Sample Landon Picture Chart, long list of successful Landon students and full information showing possibilities for you. Please state your age. **The LANDON SCHOOL, 738 National Building, CLEVELAND, OHIO**

Four Successful Landon Students From One Village

Here is the record of Four boys—all from Nappanee, Ind., (2200 population) who after taking the Landon Course, won national reputations.

Merrill Blosser is now nationally famous as creator of "Freckles and his Friends."

Henry Maust's work appears in Saturday Evening Post, Cosmopolitan, etc.

Francis Parks, following their advice, is now a cartoonist for the Omaha News.

Fred Neher is comic artist with the Universal Feature Co.

If I Send You a Suit



made to your measure, in the latest style, would you keep and wear it, show it to your friends, let them see our beautiful samples and splendid new styles? Could you use \$3.00 an hour for a little spare time? **Every tailoring agent, send for our wonderful new proposition.** Just write a letter or postal or fill out and mail coupon below. I will send you our big new book of samples and styles to pick from and my new special offer, **all free.** Even if you don't care to be agent, send anyway, and learn how to get all your own clothes **FREE.**

To **L. E. ASHER, President**
BANNER TAILORING CO.
Dept. 884, CHICAGO, ILL.

Dear Sirs: Send me your sample book and special offer, all **FREE.**

Name.....

R.F.D. Box St. and No.

P.O. State

SEND for the INTERNATIONAL CATALOG

FOR
FORD—
PRICES
FROM
\$27.85
UP.
Factory
to-
Con-
sumer
direct—
Pay only one profit.

International Body Works, 914 W. Ohio Street, Dept. 7, Chicago, Ill.



Our net price list. Full line of side bodies and accessories for Fords at Wholesale Prices. Save big money on bodies by buying direct from factory.

Delivered to You Free

for 30 days trial on approval. You can have your choice of 44 Styles, colors and sizes of the famous RANGER Bicycles. Express prepaid. Factory-to-Rider Prices save you \$10 to \$25 on your bicycle.

12 Months to Pay if desired. Many boys and girls easily save the small monthly payments. Parents often advance first payment. Best quality, at factory prices, express prepaid. Lamps, wheels and equipment, low prices. Send **Tires** No Money, do business direct with makers.

Mead Cycle Company
Dept. 108 Chicago

Write today for free Ranger Catalog, factory prices and marvellous easy payment terms.



LEARN Penmanship

I Teach Penmanship by Mail

Small Cost. Saves Time. Write for my Free Book, "How to Become an Expert Penman." It contains specimens and tells how others became expert writers by the Tevis Method. Your name written on card if you enclose stamp. Write Today.

T. M. TEVIS, Box 25K, CHILLICOTHE, MO.



Whatever Your Question;—be it the pronunciation of Bolsheviki, the spelling of a puzzling word, the location of Murman Coast—the meaning of blighty, ace, lank, ukulele, etc., this Supreme Authority—

WEBSTER'S NEW INTERNATIONAL DICTIONARY

contains an accurate, final answer 400,000 Words, 2700 Pages, 6000 Illustrations.
Regular and India-Paper Editions. G. & C. MERRIAM CO., Springfield, Mass.
Write for specimen pages, prices, etc., and FREE Pocket Maps per Popular Mechanics



WANTED! Get \$1600 to \$2300 a Year

U.S. RAILWAY MAIL CLERKS

MEN—BOYS 18 OR OVER SHOULD MAIL COUPON IMMEDIATELY

Franklin Institute, Dept. A177, Rochester, N. Y.

Sirs: Send me, without charge, (1) sample Railway Mail Clerk Examination questions; (2) tell me how to get a U.S. Government job; (3) send list of places at which examinations will be held.

Name.....

Address.....

Steady Work—No Layoffs—Paid Vacations
Travel—See the Country
Common Education Sufficient—Send Coupon Today—SURE

Let These Guides

Solve Your Problems

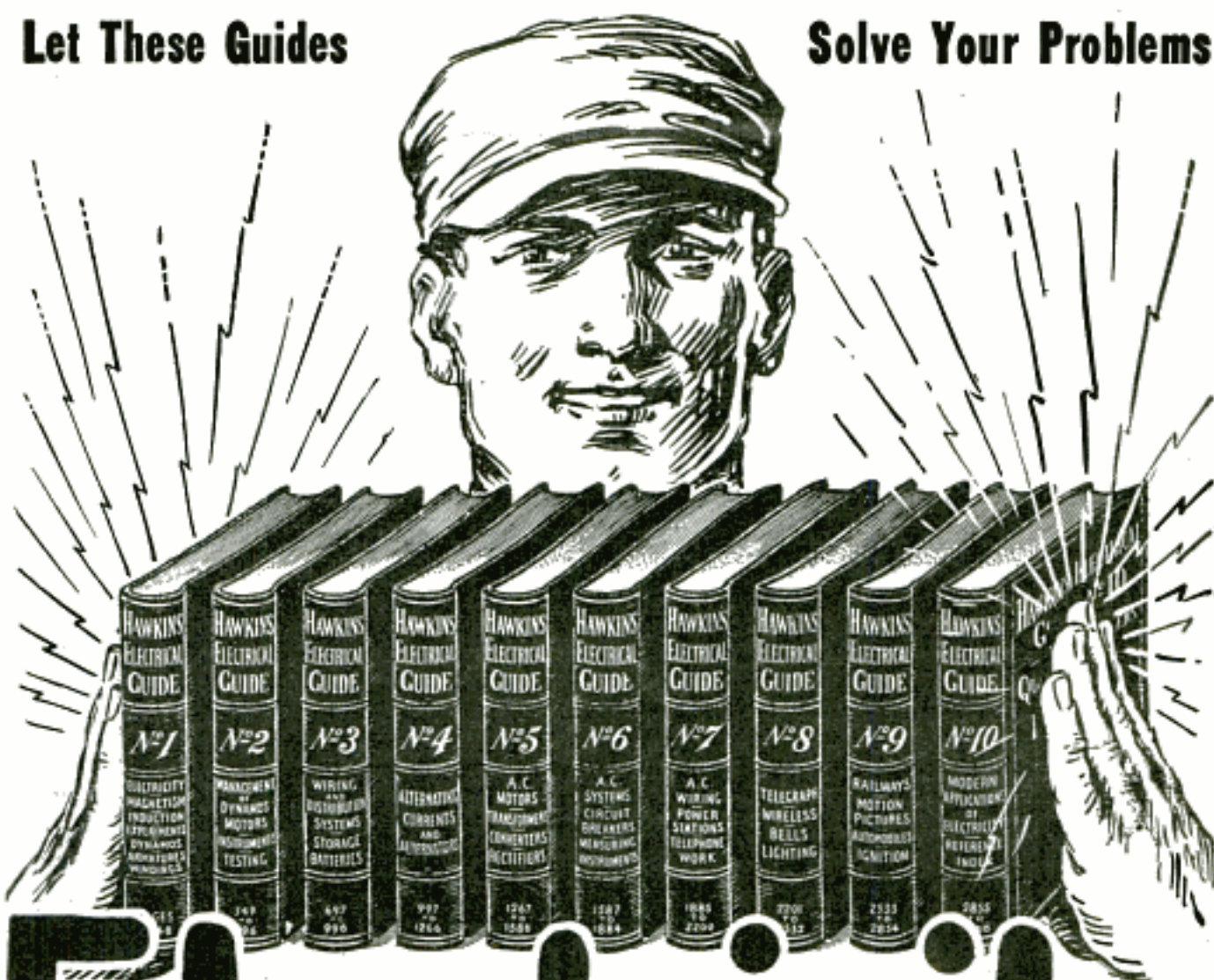

Electricity at your finger ends

HAWKINS ELECTRICAL GUIDES IN TEN VOLUMES

3500 PAGES

4700 PICTURES

\$1 A VOLUME

\$1 A MONTH

Send No Money--Send Only This Coupon

Know the facts in Electricity. They mean more money and better position for you. Hawkins Guides tell you all you need to know about Electricity. Every important electrical subject covered so you can understand it. Easy to study and apply. A complete, practical working course, in 10 volumes. Books are pocket size; flexible covers. Order a set today to look over.

LEARN ALL ABOUT

Magnetism—Induction—Experiments—Dynamoes—Electric Machinery—Motors—Armatures—Armature Windings—Installing of Dynamoes—Electrical Instrument Testing—Practical Management of Dynamoes and Motors—Distribution Systems—Wiring—Wiring Diagrams—Sign Flashers—Storage Batteries—Principles of Alternating Currents and Alternators—Alternating Current Motors—Transformers—Converters—Rectifiers—Alternating Current Systems—Circuit Breakers—Measuring Instruments—Switchboards—Wiring—Power Stations—Installing—Telephone—Telegraph—Wireless—Bells—Lighting—Railways. Also many Modern Practical Applications of Electricity and Ready Reference Index of the ten numbers.

SHIPPED FREE

Not a cent to pay until you see the books. No obligation to buy unless you are satisfied. Send Coupon now—today—and get this great help library and see if it is not worth \$100 to you—you pay \$1.00 a month for ten months or return it.

THEO. AUDEL & CO.,
72 Fifth Ave., New York City

Please submit me for free examination, HAWKINS ELECTRICAL GUIDE, (Price \$1 a number). Ship at once prepaid; the 10 numbers. If satisfactory, I agree to send you \$1 within seven days and to further mail you \$1 each month until paid.

Name

Occupation

Employed by.....

Home Address.....

Reference

FOR OCT. 20.



\$1,000 Reward For the Capture of This Man

CONVICT 6138, escaped from the State Penitentiary; Name, Charles Condray; age 37; Height, 5 feet 8 inches; Weight, 141 pounds; Hair, light brown; Eyes, gray.

Easy enough to identify him from his photograph and this description, you may say — but, Condray took the name of "Brown," dyed his hair, darkened his skin, grew a mustache, put on weight and walked with a stoop.

Yet he was captured and identified so positively that he knew the game was up and returned to the penitentiary without extradition. How was it accomplished? Easy enough for the Finger Print Expert. They are the specialists, the leaders, the cream of detectives. Every day's paper tells their wonderful exploits in solving mysterious crimes and convicting dangerous criminals.

More Trained Men Needed

The demand for trained men by governments, states, cities, detective agencies, corporations, and private bureaus is becoming greater every day. Here is a real opportunity for YOU. Can you imagine a more fascinating line of work than this? Often life and death depend on finger print evidence — and big rewards go to the expert. Many experts earn regularly from \$3,000 to \$10,000 per year.

Learn At Home in Spare Time

And now you can learn the secrets of this science at home in your spare time. Any man with common school education and average ability can become a Finger Print Detective in surprisingly short time.

Free Course in Secret Service

For a limited time we are making a special offer of a Professional Finger Print Outfit, absolutely Free and Free Course in Secret Service Intelligence. Mastery of these two kindred professions will open a brilliant career for you.

Write quickly for fully illustrated free book on Finger Prints which explains this wonderful training in detail. Don't wait until this offer has expired. Mail the coupon now. You may never see this announcement again! You assume no obligation. You have everything to gain and nothing to lose. Write at once. Address

University of Applied Science
Dept. 13-56 1920 Sunnyside Avenue, Chicago

UNIVERSITY OF APPLIED SCIENCE
Dept. 13-56 1920 Sunnyside Avenue, Chicago, Ill.

Gentlemen:— Without any obligation whatever, send me your new, fully illustrated, FREE book on Finger Prints and your offer of a FREE course in Secret Service Intelligence and the Free Professional Finger Print Outfit.

Name

Address

Present Occupation

Please Mention Popular Mechanics



Play PIANO By Ear

No matter how little you know about music, if you can just remember a tune, I teach you to play Jazz, Ragtime and Popular Songs BY EAR — easily and quickly. Why spend years studying tiresome scales and finger exercises when you can

Learn At Home in 90 Days

and play any tune you can remember, by ear—without notes. Original method, wonderfully easy. No do-re-mi, no scales—just a few simple rules, a little practice and the results are amazing. Names and letters from hundreds of enthusiastic pupils and interesting book SENT FREE. Simply write me your name, address, age—and state if you have ever taken piano lessons; if so, how many? Write today. Address

RONALD G. WRIGHT, Director,
NIAGARA SCHOOL OF MUSIC,
Department 570 Niagara Falls, N. Y.



Send for this Free Book

Accredited Day and Evening Courses leading to the degree of

Doctor of Medicine & Surgery

Study
Medicine
at night

Opportunity to work way through School, make up pre-medical credits. For catalog, address Registrar, Box 225.

Chicago Medical School, 3832 Rhodes Ave., Chicago

Learn to PAINT SIGNS and SHOW CARDS

Big field—unlimited possibilities—increasing demand for men with creative ideas. Our course develops ability and originality. Work intensely interesting.

EARN \$25 TO \$75 WEEKLY

You can do it if ambitious. Successful graduates everywhere. Our course thoroughly covers every phase of work. Our graduates command big salaries. Write for catalog, samples, guarantee and Free Outfit Offer.

Detroit School of Lettering, 629 D. S. L. Bldg., Detroit, Mich.



STAMMERERS

You can be cured by our course of natural individual lessons. Write today for free booklet, "How To Stop Stammering."

SAMUEL A. ROBBINS, Director,
Boston Stammerers' Institute, Founded, 1877
246 Huntington Ave. Boston 17, Mass.

LEARN WATCH REPAIRING



You can learn by our modern and original system of instruction every part of the Watch Repairing Trade at home as good or better than at a shop. You can earn money while learning and secure a well paying position or start in business after completing our course of instruction. Good watch repairers are always in demand and earn from \$30 to \$70 per week. For particulars apply to the Wisconsin School of Watch Repairing

166 Mason St., MILWAUKEE, WIS.



How Many Men are Fighting for Your Success?

ARE you trying to win single-handed and alone? Then stop—and consider the odds against you.

The battle for promotion, high position, big success, has seldom been won single-handed. Schwab, Woolworth, Ford, Carnegie, Napoleon and everyone of note found out early in life that the way to big success is thru the help of others. Many men of big achievements have told me:

"My success is due to the help others have given me—to the men I have gathered around me."

Carnegie said: "My biggest asset is my organization—I could afford to lose everything else I possess."

How many men are fighting for your success?

Have you a plan and an organization behind your fight for promotion?

Consider Napoleon and his strategy:

"Give me the largest number of men at the point of attack, and I'll win."

On this principle Napoleon defeated armies vastly outnumbering his own troops. He was not so much concerned about the size of the opposing army as he was to know where they would strike the hardest.

Where are the forces of failure striking at

you the hardest? Will your defense crumple at that point?

Have you determined upon your move? What is your objective? What is your goal? Have you thought out your campaign? What are you hitting at? What forces do you command—how many men are enlisted and ready to strike for you? Will you drive off the enemy? Will you gain your objective or suffer defeat?

The things you must attack are the things that stand between you and *specialized ability*.

And do you know that it is easily possible for you to reinforce yourself with an army of 1,750 promotion strategists—generals, colonels, majors, captains, and lieutenants of business, who have smashed to pieces more forces of failure than any other organization of its kind in the world?

LaSalle places such an army at your command. It is lined up ready for action in your behalf—ready to fight for *you*—if *you* are ready and willing to fight for *yourself*.

What are you going to do about it?

J. G. Chapline
President

LASALLE EXTENSION UNIVERSITY, Dept. 964-R CHICAGO, ILL.

The Largest Business Training Institution in the World

FREE BOOK COUPON

Please send me catalog and full information regarding the course and service I have marked with an X below. Also a copy of your booklet, "Ten Years' Promotion in One," all without obligation to me.

- | | | |
|---|--|--|
| <input type="checkbox"/> Business Management | <input type="checkbox"/> Industrial Management | <input type="checkbox"/> Personnel and Employment Management |
| <input type="checkbox"/> Modern Salesmanship | <input type="checkbox"/> Efficiency | <input type="checkbox"/> Expert Bookkeeping |
| <input type="checkbox"/> Higher Accountancy | <input type="checkbox"/> Banking and Finance | <input type="checkbox"/> Business English |
| <input type="checkbox"/> Law—Degree of LL. B. | <input type="checkbox"/> Modern Business Correspondence and Practice | <input type="checkbox"/> Commercial Spanish |
| <input type="checkbox"/> Traffic Management | <input type="checkbox"/> Modern Foremanship and Production Methods | <input type="checkbox"/> Effective Speaking |
| <input type="checkbox"/> Railway Station Management | | <input type="checkbox"/> C. P. A. Coaching |
| <input type="checkbox"/> Commercial Law | | |

Name..... Present Position.....

Address.....

664-B

DRAW CARTOONS

Cartoonists Trained by W. L. EVANS



MAKE MONEY

SOME of the cleverest cartoonists in America today are former students. They studied during their spare time and are now making good money. Cartoonist Evans' system of teaching is so simple, easy and practical that it is not hard to learn to draw originals. The school has a long established reputation and is recommended by well-known cartoonists because they know the students are handled right.



If you like to draw, send us a sample of your work, either a copy or an original. You may have more ability than you think. We will send you a portfolio of cartoons and full details about the school.



The Course is NOT EXPENSIVE

THE W. L. EVANS SCHOOL OF CARTOONING

821 Leader Bldg. CLEVELAND, OHIO



+ To Your Knowledge × Your Earning Power

There's a better job just ahead of you—if you fit yourself for it. The more you know, the more you can earn. Add to your knowledge and you will surely multiply your earning power. Train yourself to be worth more money—then GET IT.

We can help you to earn more money—perhaps double your present salary. Check, on the coupon below, the occupation you think you would like, fill in your name and address. We'll tell you where you belong and how to get there through an American School Course. The lessons are simple, you study right at home in your spare time, the results are sure. The cost is low, terms easy, satisfaction guaranteed.

Fill out coupon now. Learn how to make great big money in the line of work you should be doing. Full information free.

American School, Dept. G-674-A, Drexel Ave. & 58th St., Chicago

American School, Dept. G-674-A, Drexel Ave. & 58th St., Chicago

Send me full information on the subject checked.

- | | | |
|--------------------------|------------------------------|--------------------------|
| .. Architect | .. Accountant & Auditor | .. Employment Manager |
| .. Building Contractor | .. Bookkeeper | .. Steam Engineer |
| .. or Carpenter | .. Draftsman & Designer | .. Foremanship |
| .. Automobile Engineer | .. Electrical Engineer | .. Sanitary Engineer |
| .. Automobile Repairman | .. General Education | .. Surveyor (& Mapping) |
| .. Civil Engineer | .. Personal Analysis | .. Telephone Engineer |
| .. Advertising Manager | .. Business Law | .. Telegraph Engineer |
| .. Business Manager | .. Lawyer | .. High School |
| .. Financial Manager | .. Machine Shop Practitioner | .. Fire Insurance Expert |
| .. Sales Manager | .. Photoplay Writer | .. Wireless Radio |
| .. Cert. Pub. Accountant | .. Mechanical Engineer | .. Undecided |
| | .. Shop Superintendent | |

Name.....
Address.....
Occupation.....

VALPARAISO UNIVERSITY

Founded in 1873

An unparalleled opportunity

Departments—Education, Arts and Sciences, Engineering, Pharmacy, Law, Pre-Medicine, Home Economics, Public Speaking, Music, Manual Training, Preparatory, High School, Commerce, Stenography and Typewriting.

LOW COST of LIVING

Under University supervision, the cost of board and room, as well as tuition, is exceptionally low. Detailed figures are available in our catalog. The University is governed by a board of trustees—all influential men, eager for the students' welfare. It is not operated for profit. Valparaiso is beautifully situated, 44 miles from Chicago. **FIFTY-FIRST YEAR OPENS OCT. 1, 1923**

Address President for free catalog

Box 11, University Hall VALPARAISO, IND.

ELECTRICAL men with training are in demand. For more than a quarter of a century this school has been training men of ambition and limited time, for the electrical industries. Condensed course in **ELECTRICAL ENGINEERING** enables graduates to secure good positions

and promotions. Theoretical and practical Electricity, Mathematics, Steam and Gas Engines, Mechanical Drawing. Students construct dynamos, install wiring and test electrical machinery. Course with diploma, complete



Thoroughly equipped fireproof dormitories, dining hall, laboratories, shops. Over 3000 men trained. Write for catalog. 31st year begins Sept. 26, 1923.

BLISS ELECTRICAL SCHOOL

104 TAKOMA AVENUE, WASHINGTON, D. C.

AVIATION INFORMATION FREE

Send us your name and address for full information regarding the Aviation and Airplane business. Find out about the many great opportunities now open and how we prepare you at home, during spare time, to quality. Our new book "Opportunities in the Airplane Industry" also sent free if you answer at once.

AMERICAN SCHOOL OF AVIATION

Dept. 1196 3601 Michigan Ave. CHICAGO

Wrestling Book FREE



Learn to be an expert wrestler. Know scientific wrestling, self-defense, and jujitsu. Develop a splendid physique, and have perfect health. Join this popular school and learn by mail. The famous world's champions—the marvelous

Frank Gotch and Farmer Burns

offer you a wonderful opportunity. Wrestling is easily and quickly learned at home by mail. Men and boys write now for splendid free book. Learn all the science and tricks. Be able to handle big men with ease. Accept this wonderful offer NOW. Send for free book today, stating your age.

Farmer Burns School of Wrestling, 1776 Railway Bldg., Omaha, Neb.

HOW TO BECOME A PROFESSIONAL PHOTOGRAPHER

EARNING \$35 TO \$125 A WEEK



Three to six months' course. Motion Picture, Commercial, Portraiture. Practical instruction. Modern equipment. Ask for Catalog No. 49.

N. Y. INSTITUTE OF PHOTOGRAPHY
NEW YORK CHICAGO BROOKLYN
141 W. 36th St. 630 So. Wabash Ave. 505 State St.



"BECOME A LIGHTNING TRICK CARTOONIST"

MAKE MONEY CHALK TALKING. SEND \$1.00 FOR SHARPLY PROGRAM OF TRICK DRAWINGS WITH INSTRUCTIONS BY A PROFESSIONAL CARTOONIST. SATISFACTION GUARANTEED. CIRCULAR FREE. BALDA ART SERVICE, Q1, OSHKOSH, WIS.

HOME LOVERS' BARGAIN BOOK FREE

Showing Over 10,000 Furniture Bargains

All selections loaned free for a month. Take a year to pay if satisfied, paying little by little almost as you please. SPIEGEL, MAY, STERN CO., 1108 W. 35th St., Chicago

A Better Job Now!

Why take small pay from uncertain jobs? Why be buffeted around from this to that, and not know whether you are going to have a job tomorrow or not? You can change all that. Learn a trade. Know autos—how to repair them, and take advantage of the countless opportunities to make big money. Pave the way for a business of your own—a business that can make you independent for life. You can do it with a few weeks' training at the Michigan State Automobile School—the great auto-trade school in the heart of the auto industry.

Be a Trained Man—Successful!

Fellows just like you step out and make great successes. Trained men wanted all the time—everywhere! More than 12,000,000 autos, trucks and tractors in use. All need service and repairing. 50 million tires, millions of batteries to be kept in commission. More men needed for good jobs. More garages—more electric service stations—more tire-repair shops—welding shops—battery stations needed. This means amazing opportunities for the men who start now. Fit yourself to win a good job, or to start a business of your own. Very small capital is needed. You are right on the threshold of big money if you decide now to make this your business.



Come to the Auto Center

Learn Autos in a Few Weeks by Factory-Endorsed Methods

Come to Detroit, where autos are made. Come to the Michigan State Automobile School where you get first-hand experience and knowledge. Great auto factories endorse and recommend M. S. A. S. training. *The Packard Motor Co.* says: "We have no hesitation in recommending the M. S. A. S. in every particular. *The Hudson Motor Co.* says: "The best equipped and most efficient school in America." Others say the same. Their executives have investigated this School and know that it is the only one which they can endorse. Learn the business thoroughly on latest equipment. M. S. A. S. equipment is up-to-date, all in good order, all for students actually to learn and practice on. Visit the great Detroit auto-plants. Get first-hand knowledge and a quality-training that means certain success, if you do your part.

Get All Facts—Mail Coupon Today!

Decide now to grasp this opportunity. If you like autos—and are mechanically inclined—there are big-money jobs—a business of opportunities waiting for you. Classes always open. Your enrollment includes Life-Membership with privilege to come back at any time to brush up on the latest equipment, and get new money-making ideas. Investigate! Let us show you what we can do for you. Mail the coupon for big 100-page catalog.

MICHIGAN STATE AUTOMOBILE SCHOOL

A. G. ZELLER, President
309 Auto Bldg. 3729 Woodward Ave.
DETROIT MICHIGAN

FREE

CATALOG
MICHIGAN STATE
AUTO SCHOOL

Mail Coupon To Day

MICHIGAN STATE AUTOMOBILE SCHOOL
309 Auto Bldg., Detroit, Mich.

Gentlemen:—Send FREE and without obligation, your 100-page catalog, and Auto School News, giving complete information and showing the opportunities and advantages of a Factory Endorsed Detroit-Training to make the most money.

Name.....

St. or R. F. D.....

City..... State.....

The Factory Endorsed School



High School Course in Two Years!

You Want to Earn Big Money!

And you will not be satisfied unless you earn steady promotion. But are you prepared for the job ahead of you? Do you measure up to the standard that insures success? For a more responsible position a fairly good education is necessary. To write a sensible business letter, to prepare estimates, to figure cost and to compute interest, you must have a certain amount of preparation. All this you must be able to do before you will earn promotion. Many business houses hire no men whose general knowledge is not equal to a high school course. Why? Because big business refuses to burden itself with men who are barred from promotion by the lack of elementary education.

Can You Qualify for a Better Position

We have a plan whereby you can. We can give you a complete but simplified high school course in two years, giving you all the essentials that form the foundation of practical business. It will prepare you to hold your own where competition is keen and exacting. Do not doubt your ability, but make up your mind to it and you will soon have the requirements that will bring you success and big money. **YOU CAN DO IT.**

Let us show you how to get on the road to success. It will not cost you a single working hour. Write today. It costs you nothing but a stamp.

American School

Dept. H674, Drexel Ave. and 58th St., Chicago

American School

Dept. H674, Drexel Ave. and 58th St., Chicago
Send me full information on the subject checked and how you will help me win success.

- | | |
|------------------------------|----------------------------|
| Architect | Lawyer |
| Building Contractor | Machine Shop Practice |
| Automobile Engineer | Photoplay Writer |
| Automobile Repairman | Mechanical Engineer |
| Civil Engineer | Shop Superintendent |
| Structural Engineer | Employment Manager |
| Business Manager | Steam Engineer |
| Cert. Public Accountant | Foremanship |
| Accountant and Auditor | Sanitary Engineer |
| Bookkeeper | Surveyor (& Mapping) |
| Draftsman and Designer | Telephone Engineer |
| Electrical Engineer | Telegraph Engineer |
| Electric Light & Power | High School Graduate |
| General Education | Fire Insurance Expert |
| Vocational Guidance | Wireless Radio |
| Business Law | Undecided |

Name.....

Address.....

Please Mention Popular Mechanics

WE TEACH COMMERCIAL ART

Meyer Both Company, the largest Commercial Art Organization in the World, offers you an unusual opportunity for practical training, based upon twenty-three years of success. This nationally known organization each year produces and sells to advertisers over 15,000 commercial drawings. Meyer Both instruction is the difference between successful fact and experimental theory. This well paid profession equally open to men and women. Home study instruction.

Get Facts Before You Enroll in Any School

Ask the Advertising Manager of the leading newspapers in your city, anywhere in the United States, Canada, England or Australia about the Meyer Both Company—let them tell you about us. Write for our illustrated book telling about the success of our students—for one-half the cost of mailing—four cents in stamps.

MEYER BOTH COMPANY

Department of Art Instruction
Michigan Ave. at 20th St., Dept. 16 CHICAGO, ILL.

Note—To Art and Engraving Firms: Secure practical artists among our graduates. Write us.

Music Lessons

UNDER MASTER TEACHERS

At Home

Any Instrument

Write, naming course you are interested in: Piano, Harmony, Voice, Public School Music, Violin, Cornet, Mandolin, Guitar, Banjo or Reed Organ—and we will send FREE CATALOG. SEND for it NOW!

University Extension Conservatory, 822 Sigel-Myers Bldg., Chicago

Complete Conservatory Course by Mail

Wonderful home study music lessons under great American and European teachers. Endorsed by Paderewski. Master teachers guide and coach you. Lessons a marvel of simplicity and completeness.

LAW High-Grade Instruction

By Correspondence
Prepares You for the Bar—Est. 1892

University Methods.

Standard Text-Books. Approved by Bench and Bar. Graduates practicing in every state. Send today for Free Catalog and Rules for Admission to the Bar.

Chicago School of Law
520 Reaper Block Chicago, Ill.



Wonderful, new device, guides your hand; corrects your writing in few days. Big improvement in three hours. No failures. Complete outline FREE. Write C. J. Ozment, D-34, St. Louis, Mo.

TRI-STATE COLLEGE OF ENGINEERING

Makes you a Civil, Mechanical, Electrical or Chemical Engineer in two years, 48 weeks each. No entrance examinations. High School Diploma not required. Compact courses made up of essentials only. Expenses low. 100 M. Street, Angola, Indiana
FOR CATALOG ADDRESS

LEARN WATCH REPAIRING

Be a watchmaker—you can learn this profitable trade by correspondence in a few weeks in your own home by the DeSelms Chart System. After you complete the course you will know a watch from A to Z. You will know just what the matter is and how to repair one. When you graduate you will be a practical watchmaker and repairer and competent to fill any position. Positions for our graduates. Ask for our Free Book. It explains our system and terms.

THE DeSELMS WATCH SCHOOL
23 Perry Street ATTICA, INDIANA



FREE RAILROAD FARE

**Learn
Electricity
in 3
Months**

**Earn
\$150
to
\$400
per
Month**

In the Great Shops of



Student Winding Stator

Make this the most profitable and enjoyable summer of your life. Come to Chicago, the greatest summer resort city in the country on beautiful Lake Michigan, and the greatest electrical center in the world. We pay your railroad fare from any place in the United States. See the country at our expense. Become a skilled electrical expert in the great shops of Coyne.

Complete Electrical Training in Three Months

No books or useless theory—everything is practical. You are trained on \$200,000 worth of electrical equipment. Everything from door bells to power plants. You work on motors, generators, house wiring, autos, batteries, radio, switchboards, power plants—everything to make you an expert ready to step right into a position paying from \$45 to \$100 per week. We give you practical training in Circuits, House Wiring, D. C. A. C., Armature and Stator Winding, Drafting, Auto Truck and Tractor Electricity,

Battery Building and Repairing and Radio. In addition, you receive Free, a Life Scholarship which enables you to stay as long as you want or come back for further training at any time without charge.

Radio Course FREE

Besides paying your railroad fare, we include free a course in Radio—the marvel of the age. You can build your own radio receiving set.

Earn While You Learn

Our employment department helps you get a job to earn a good part of your living expenses.

Send Coupon NOW!

This is the greatest offer ever made by a school and it is for a limited time. Don't delay a single minute. Send the coupon in right away for our big free catalogue and full particulars of this wonderful offer. Act now!

B. W. COOKE, Pres.

COYNE ELECTRICAL SCHOOL,
Dept. 13-56, 1300-10 W. Harrison St.,
CHICAGO, ILLINOIS

Dear Sir:—Please send me free your big catalogue and full particulars of your special offer of free railroad fare.

Name.....

Address.....

Great Summer Resort City

Chicago, on beautiful Lake Michigan, is the Nation's summer playground. Free bathing beaches, beautiful parks, excursion boats and the great Municipal Pier, zoos, ball parks, everything you need for an enjoyable summer.



COYNE
Electrical School

Indorsed by Electrical Industry

Dept. 13-56

1300-10 W. Harrison St.
CHICAGO, ILLINOIS

Let Me Put PEP into You!



STRONGFORT, the Perfect Man

Let me show you what it means to be filled with energy, initiative, vim and vigor! No man who isn't physically fit can get half the joy out of life. You can't achieve anything worth while if you are only half a man—weak—sickly—anaemic—cursed with chronic ailments and weaknesses that make living a misery. You can't make a success of anything if you have allowed your vital forces to ebb away. You know it, down in your heart, as well as I do, that some day, sooner or later, you will have to do something to pull yourself out of the slough of physical failure and weakness. The longer you put it off, the worse your condition will be. **DO IT NOW.**

STRONGFORTISM

The Modern Science of Health Promotion will build up your Body and Brain and make a real red-blooded man out of you, no matter what your condition is or what caused it. I guarantee it.

Mark the subjects on the free consultation coupon (write other weaknesses on extra line) on which you want special confidential information and send with 10c to help pay postage, etc., on my free book—"Promotion and Conservation of Health, Strength and Mental Energy." It contains a priceless message for every man who earnestly desires to be strong, healthy, vital. Send for my free book. Right Now. TODAY.

LIONEL STRONGFORT Physical and Health Specialist
 Founded 1895 Dept. 519, Newark, New Jersey

FREE CONSULTATION COUPON

Mr. Lionel Strongfort, Dept. 519, Newark, N. J.—Please send me your book, "PROMOTION AND CONSERVATION OF HEALTH, STRENGTH AND MENTAL ENERGY," for postage on which I enclose a 10c piece (one dime). I have marked (X) before the subject in which I am interested.

- | | | |
|-------------------------|----------------------|-------------------------|
| .. Colds | .. Catarrh | .. Weak Eyes |
| .. Asthma | .. Blackheads | .. Gastritis |
| .. Hay Fever | .. Insomnia | .. Increased Height |
| .. Obesity | .. Short Wind | .. Heart Weakness |
| .. Headache | .. Flat Feet | .. Poor Circulation |
| .. Fear | .. Stomach Disorders | .. Skin Disorders |
| .. Thinness | .. Constipation | .. Neurasthenia |
| .. Rupture | .. Biliousness | .. Despondency |
| .. Lumbago | .. Torpid Liver | .. Round Shoulders |
| .. Neuritis | .. Indigestion | .. Lung Troubles |
| .. Neuralgia | .. Nervousness | .. Weaknesses (Specify) |
| .. Flat Chest | .. Poor Memory | .. Muscular Development |
| .. Deformity (Describe) | .. Rheumatism | .. Great Strength |
| .. Diabetes | .. Pimples | |
| .. Female Disorders | .. Falling Hair | |

Mention other ailments here.....
 Name.....
 Age..... Occupation.....
 Street.....
 City..... State.....

Learn Watchwork, Jewelrywork and Engraving.

A fine trade commanding a good salary, and your services are always in demand. Address **Morological**, Dept. P, Bradley Institute, PEORIA, ILL., for our latest catalog.

WANTED

RAILWAY POSTAL CLERKS \$1600 to \$2300 Year

MEN — BOYS 18 UP SHOULD MAIL COUPON IMMEDIATELY

Steady work. No layoffs. Paid Vacations

Common education sufficient: Travel—See the country

The Key to Success

Stop Forgetting

Make Your Mind a File—Not a Pile

The Key to Success is the ability to remember. I can make your mind an infallible classified index from which you can instantly select thoughts, facts, figures, names, faces. Enables you to concentrate, develop self-control, overcome bashfulness, forgetfulness, address an audience. Easy. 20 years' experience developing memories of thousands.

Write Today for free booklet, "How to Remember," and Copyrighted Memory Test, and how to secure Free my \$3.00 book, "How to Speak in Public."

DICKSON MEMORY SCHOOL
 Dept. 7851 Evanston, Ill.

BE AN ARTIST

We can teach you **DRAWING** in your own home during your spare time.

Our 18 years of successful teaching prove our ability. 10 Courses in Commercial and Illustrative Drawing. Teachers Normal and Applied Art. Endorsed by high art authorities. Students trained by members of our Faculty are filling high-salaried positions. Artist's Outfit **FREE** to Enrolled Students. Write today for Art Year **FREE** Book.

OUR HANDSOME ART YEAR BOOK

SCHOOL OF APPLIED ART

APPLIED ART BLDG. NO. 2 BATTLE CREEK MICH.

FREE BOOK LEARN PIANO

This interesting Free Book shows how you can become a skilled player of piano or organ at quarter usual cost. It shows why one lesson with an expert is worth a dozen other lessons. Dr. Quinn's famous Written Method includes all of the many important modern improvements in teaching music. Brings right to your home the great advantages of conservatory study. For the beginner or experienced player. Endorsed by great artists. Successful graduates everywhere. Scientific yet easy to understand. Fully illustrated. All music free. Diploma granted. Write today for free book, **Quinn Conservatory, Studio PM69, 593 Columbia Road, Boston 25, Mass.**

STAMMER NO MORE

Kill the fear of stammering. Re-education the key. The widely famed Hatfield Method fully outlined in an accurate, dependable, worthwhile book—"HOW TO STOP STAMMERING." It has inspired thousands. Free copy today.

THE HATFIELD INSTITUTE, 109 N. Dearborn, Chicago, Ill.

Buchstein's Fibre Limb

is soothing to your stump—strong, cool, neat, light. Easy payments. Braces for all deformities.

D. BUCHSTEIN CO., 113 6th St. S., MINNEAPOLIS, MINN.

Send for Catalog Today

FRANKLIN INSTITUTE, Dept. A178, Rochester, N. Y.

Write: Send me without charge, (1) Sample Railway Postal Clerk Examination questions; (2) List of government jobs now obtainable; (3) Send free illustrated book, "How to Get Government Jobs."

COUPON.....
 Name.....
 Address.....

Price cut to

\$1.97

Plus Actual Postage

BOXING Jiu-Jitsu Wrestling

This great course sold for \$5. Sales grew fast—so we cut the price to \$3.85. That boosted our enrollments still higher. Now Marshall Stillman says, "Cut the price to \$1.97."

Think of it!—Over 80 complete lessons in Boxing, Jiu-Jitsu and Wrestling for only \$1.97. The greatest secrets of the ring, the best blows and guards used by the top-notchers—the Jack Dempsey Triple, the Benny Leonard Triple, The Fitzsimmons Shift. All the fine points of feinting, ducking, clinching, breaking-ground, judging distance and timing. Three rounds of shadow boxing, combining all the best blows used by professionals. Instructions on how to train, with questions and answers. The International Sporting Club Rules for Boxing. Muscle-building and other special exercises for development.

Wrestling and Jiu-Jitsu also—how to subdue an armed opponent, how to break a strangle hold, the Gotch Toe Hold, the Stecher Scissor Hold, etc. All for \$1.97.

There are over 240 illustrations in this great course. It is finely printed on good paper. With the course you get FREE a history of 69 great Prize Fighters with their pictures and "inside" stories.



10-Day Trial—Send No Money

Simply fill in and mail the coupon. When you have the course in your hands, deposit 97 cents plus actual postage with the postman. Use the course for 10 days—try it out thoroughly. At the end of ten days, either send us the small balance of \$1 in final payment, or return the course, and we'll send your deposit back at once. Mail the coupon now.

COUPON

Marshall Stillman Association,
Dept. 1223-J, 42nd St. and Madison Ave., New York

You may send me on approval the Marshall Stillman Course. I will deposit 97 cents (plus actual postage) with the postman, with the understanding that if, after 10 days, I wish to return the course, I may do so and my money will be instantly refunded. If I keep the course I am simply to send you \$1 in final payment.

Name.....

Address.....

Canadian and foreign orders must be accompanied by cash (\$1.97 U.S. funds) subject to money back guarantee if not entirely satisfactory.

You Can Easily Learn to Play Any Music on the

HAWAIIAN GUITAR

Just As Hawaiians Do—Native Instructors Teach You QUICKLY!

Here's Proof of our Remarkable Course

Buchanan, Va.
First Hawaiian Conservatory of Music, Inc.

It has been two months since I have finished your course on the Hawaiian Guitar and I can play anything I wish. The course was all that could be desired and I am perfectly pleased with my playing ability since finishing your course.

Respectfully yours,
Louise R. Hammond

Keester School,
214 So. Franklin St.,
Chicago, Ill.

First Hawaiian Conservatory of Music, Inc.

I shall certainly be very glad to recommend your course whenever the chance is mine to do so. Mr. W. R. Johnson has not phoned me yet, and if he does not phone in a day or so, will write him. Am sending a letter to Miss Helen Sivik today which I think may help to secure her enrollment, and I shall be glad at any time to write a personal letter to anyone whom you may suggest.

Your former student,
W. L. Walker

In Half an Hour You Will Be Playing "ALOHA". Soon You Will Be Winning Praise Everywhere Playing "Stumbling", "Three O'Clock in the Morning", "Hot Lips" and ALL Popular Music as Well as the Beautiful Hawaiian Melodies

Here's the chance you've been waiting for—the opportunity to play popular music quickly on the most enchanting instrument of the age—the Hawaiian Guitar. No previous musical knowledge necessary.

ONLY FOUR MOTIONS TO LEARN

and these you acquire in a few minutes. No troublesome scales or runs, you begin to play harmonious chords immediately! We don't care if you never saw a note of music in your life, we guarantee to teach you to play just as the Hawaiians do!

We Furnish Everything—a Beautiful Hawaiian Guitar, Picks, etc., and 52 Pieces of Music FREE!

You have always wanted to play some instrument, so we have made it unusually easy for you by furnishing everything—a beautiful Hawaiian Guitar, complete Conservatory Course of instruction and 52 pieces of especially selected music.

No Other Course Teaches as Quickly and Easily

This is the only Conservatory Course where you get the personal instruction of Native Hawaiian Experts—Frank Ferrera, Walter Kolomekn, Lawrence Kalaluki and Carl Seville, famous the world over and the most noted makers of phonograph records, supervise your playing.

Mail Coupon for Details of FREE Offer

Don't wait another minute—clip, fill in and mail the coupon NOW and get full details of our remarkable offer to teach you how to play the Hawaiian Guitar just as the Hawaiians do.

Special Arrangements for Lessons if You Have Your Own Instrument

FREE

This \$15
Hawaiian
Guitar

You will be delighted with the fine tone of this splendid Hawaiian Guitar

First Hawaiian Conservatory of Music, Inc.,
Desk 43 233 Broadway (Woolworth Bldg.), New York.

Send me at once details about your 52 easy lessons and FREE Hawaiian Guitar offer!

Name.....

Address.....

Town..... State.....

Print name and address clearly.

Special Courses under famous Teachers. Tenor-Banjo, Violin, Banjo-Ukelele and Ukelele. Fine Toned Instruments **FREE!**



"\$1,000 Saved!"

"Last night I came home with great news. Our savings account had passed the thousand dollar mark!

"A few years ago I was making \$15 a week and it took every cent to keep us going. Then one day I realized why I wasn't being advanced—I couldn't do anything in particular. I decided right then to invest an hour after supper each night in my future, so I wrote to Scranton and arranged for a course of special training.

"Why, in a few months I had a whole new vision of my work! An opening came and I was promoted—with an increase. A little later another raise came—I could save \$25 a month. Then another—I could save \$50 each pay day. So it went.

"Today I am manager of my department. We have a thousand dollars saved—and there is a real future ahead!"

For 31 years the International Correspondence Schools have been helping men and women everywhere to win promotion, to earn more money, to have happy prosperous homes, to know the joy of getting ahead in business and in life.

You, too, can prepare right at home in spare time for the position you want in the work you like best. All we ask is the chance to prove it. Choose your career from this coupon and mark and mail it now.

TEAR OUT HERE

INTERNATIONAL CORRESPONDENCE SCHOOLS

Box 5543-D, Scranton, Penna.

Without cost or obligation, please tell me how I can qualify for the position or in the subject before which I have marked an X:

BUSINESS TRAINING COURSES

- | | |
|---|---|
| <input type="checkbox"/> Business Management | <input type="checkbox"/> Salesmanship |
| <input type="checkbox"/> Industrial Management | <input type="checkbox"/> Advertising |
| <input type="checkbox"/> Personnel Organization | <input type="checkbox"/> Better Letters |
| <input type="checkbox"/> Traffic Management | <input type="checkbox"/> Foreign Trade |
| <input type="checkbox"/> Business Law | <input type="checkbox"/> Stenography and Typing |
| <input type="checkbox"/> Banking and Banking Law | <input type="checkbox"/> Business English |
| <input type="checkbox"/> Accountancy (including C.P.A.) | <input type="checkbox"/> Civil Service |
| <input type="checkbox"/> Nicholson Cost Accounting | <input type="checkbox"/> Railway Mail Clerk |
| <input type="checkbox"/> Bookkeeping | <input type="checkbox"/> Common School Subjects |
| <input type="checkbox"/> Private Secretary | <input type="checkbox"/> High School Subjects |
| <input type="checkbox"/> Business Spanish <input type="checkbox"/> French | <input type="checkbox"/> Illustrating <input type="checkbox"/> Cartooning |

TECHNICAL AND INDUSTRIAL COURSES

- | | |
|--|--|
| <input type="checkbox"/> Electrical Engineering | <input type="checkbox"/> Architect |
| <input type="checkbox"/> Electric Lighting | <input type="checkbox"/> Blue Print Reading |
| <input type="checkbox"/> Mechanical Engineer | <input type="checkbox"/> Contractor and Builder |
| <input type="checkbox"/> Mechanical Draftsman | <input type="checkbox"/> Architectural Draftsman |
| <input type="checkbox"/> Machine Shop Practice | <input type="checkbox"/> Concrete Builder |
| <input type="checkbox"/> Railroad Positions | <input type="checkbox"/> Structural Engineer |
| <input type="checkbox"/> Gas Engine Operating | <input type="checkbox"/> Plumbing and Heating |
| <input type="checkbox"/> Civil Engineer | <input type="checkbox"/> Chemistry <input type="checkbox"/> Pharmacy |
| <input type="checkbox"/> Surveying and Mapping | <input type="checkbox"/> Automobile Work |
| <input type="checkbox"/> Metallurgy <input type="checkbox"/> Mining | <input type="checkbox"/> Navigation |
| <input type="checkbox"/> Steam Engineering | <input type="checkbox"/> Agriculture and Poultry |
| <input type="checkbox"/> Radio <input type="checkbox"/> Airplane Engines | <input type="checkbox"/> Mathematics |

Name.....
Street..... 3-27-23
Address.....

City..... State.....

Occupation.....

Persons residing in Canada should send this coupon to the International Correspondence Schools Canadian, Limited, Montreal, Canada.

Please Mention Popular Mechanics

Learn to Write

I Teach by Mail

I can make a good penman of you at your home during spare time, no matter where you live or how poorly you now write. My simplified system is shown thousands the way to good penmanship during the past twenty-five years—it CAN and WILL do the same for YOU.

My beautifully illustrated 32-page Book
"How to Become a Good Penman" FREE!!

It contains many beautiful specimens of penmanship showing what others have accomplished by the Tamblin System, with testimonials and general information about our courses. (Your name elegantly written on a card if you enclose stamp for postage.) Ladies taught successfully as well. Write Today. Address
F. W. TAMBLIN
 418 Ridge Bldg. Kansas City, Mo., U. S. A.

F. W. Tamblin

Factory to Rider

Saves \$10 to \$25 on the Ranger Bicycle you select. You can have your choice of 44 Styles, colors and sizes. Delivered free on approval, express prepaid, for 30 DAYS' FREE TRIAL.

12 Months to Pay if desired. Possession and use at once on our liberal year to pay plan. Parents often advance first payment.

Tires best quality, at factory prices, express prepaid. Lamps, wheels and equipment, low prices. Send No Money, do business direct with makers.

Mead Cycle Company
Dept. 106 Chicago

Write today for free Ranger Catalog, factory prices and marvelous easy payment terms



MUSIC LESSONS FREE

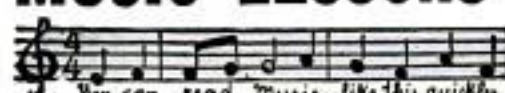

IN YOUR OWN HOME

You can read music like this quickly
Piano, Organ, Violin, Mandolin, Guitar, Banjo, etc.
 Beginners or advanced players. One lesson weekly. Illustrations make everything plain. Only expense about 2¢ per day to cover cost of postage and music used. Write for FREE booklet which explains everything in full.

AMERICAN SCHOOL OF MUSIC, 51 Lakeside Building, CHICAGO

LEARN WATCHMAKING AND ENGRAVING



Earn while learning. Most practical watch school. Individual instructions. Graduates in great demand. Book free. Chicago School of Watchmaking, Dept. 20, 4840 Lincoln Ave., Chicago

PIMPLY SKIN made WELL

When a few applications of this wonder-working lotion has cleared faces of pimples, **FREE BOOK** **Clear-Tone** the face or body, barbers itch, eczema, enlarged pores, oily or shiny skin, you can realize why CLEAR-TONE has been tested and approved in over 100,000 Test Cases. The simplicity of the treatment, and *The Story of How I Cured Myself* are all explained in my free booklet, "A Clear-Tone Skin." Write for your copy today and learn of the results gotten by thousands of men and women.
E. S. GIVENS, 128 Chemical Bldg., Kansas City, Mo.



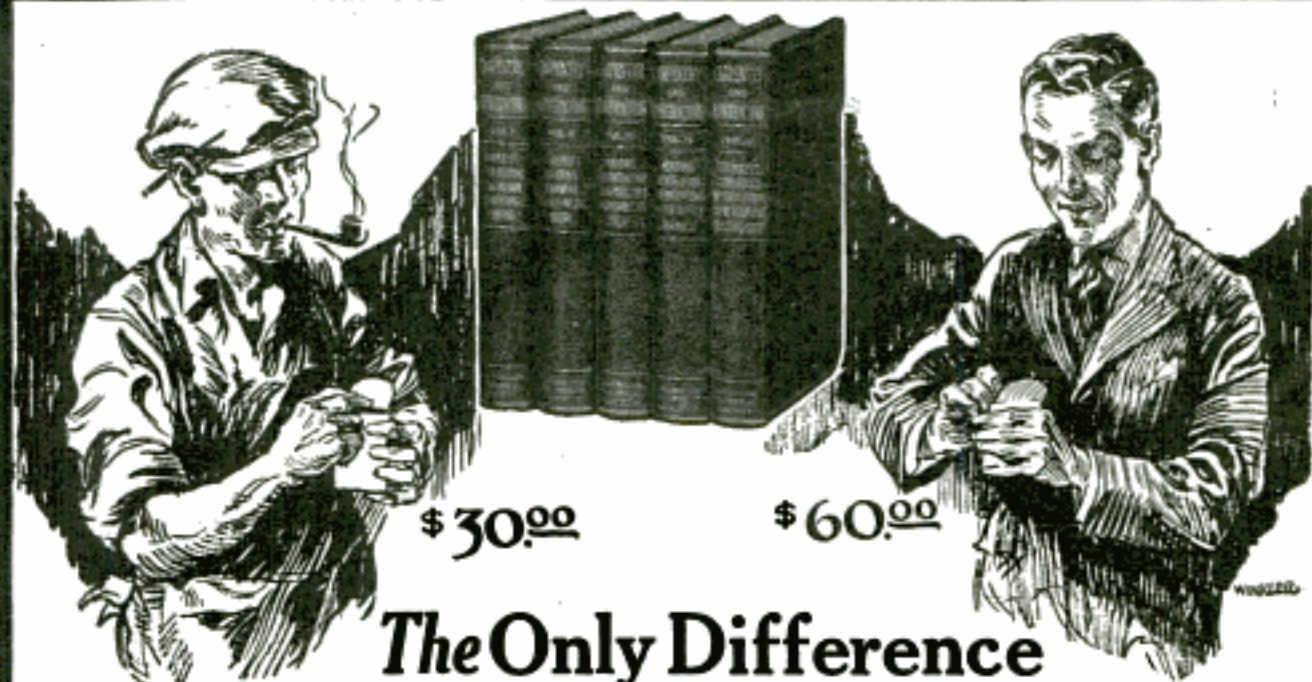

The Only Difference Between Them Is a Set of Books

One earns \$30 a week—the other \$60. A year ago they were equal in skill, and both got the same pay. But one stood still, while the other was ambitious to get a bigger, better job. He read our "Carpentry and Contracting" and it told him a thousand things he never knew before—gave him ideas—better ways of doing things—enabled him to do jobs successfully—by so doing helped him to solve the problems that came up in his daily work. The big boss was quick to notice his progress. Today he has a better job and a man's size income. He is the boss himself.

FREE Consulting Membership

A resident consulting staff of 17 practical experts is waiting to solve for you any building or contracting troubles that you may have. A letter or a wire to the American Technical Society will bring you an immediate answer and the solution to your problems. This advisory staff of practical building men plus your library of Carpentry and Contracting will enable you to handle successfully any building job. These men know all the latest methods and the newest and best ways of doing things. Let this pay-raising consulting staff be YOUR SILENT PARTNER. Use this service daily if necessary.

This free consulting membership offer is good for a limited time only and can be withdrawn without notice

Free Examination 6 Months to Pay

Send the coupon for these pay-raising Carpentry and Contracting books TODAY. You will receive the whole set, by express collect, for a week's FREE examination and use. If you don't think they are worth twice the money, notify us to take them back at our expense. If you like them send us only \$2.80 in seven days and \$3 each month until \$19.80 is paid, or cash with order \$17.80. Remember, sending the coupon does not obligate you to buy.

**American
Technical Society**
Dept. G-619
Chicago, Illinois

With the big building boom sweeping across the country, there is a demand for more and better carpenters, plasterers, painters, masons, plumbers—every branch of the building trade is crying for good men at BIG WAGES. Now is the time for you to "cash in"—you can earn more if you learn more. Every man in the shop or on the job should have this set of

Carpentry and Contracting

Five big, wonderful volumes, bound in black flexible binding that will last a lifetime, 2138 pages of practical wisdom and more than 1,000 blue prints, plans, pictures and diagrams, prepared by 25 well-known experts.

Here are a few things this set of books will tell you:

Estimating	Blue Print Reading	Concrete Work
Drafting	Use of Steel Square	Stair Building
Drainage	Heating and Ventilating	Plumbing

Why not spend a little of your spare time at home fitting yourself for a much better job and a fatter pay envelope? Read this FREE trial offer and easy payment plan.

© A.T.S. 1923

AMERICAN TECHNICAL SOCIETY, Dept. G-619
Chicago, U. S. A.

Please send me a set of Carpentry and Contracting, for seven days' FREE EXAMINATION, shipping charges collect. I will examine these books thoroughly, and if satisfied, will send \$2.80 within seven days and \$3 a month until I have paid the special price of \$19.80. If I decide not to keep the books, I will return them within one week at your expense. It is understood that if I keep the books I am entitled to a FREE Consulting Membership in the Building division of the Society.

Name.....

Address.....

Reference.....

(Please fill out all lines, give local merchant, banker or employer as reference.)

Get a Job Like These

Earn \$3500 to \$10,000 a Year

in the Big Pay Field of ELECTRICITY



20 Years Old— Makes Almost \$500 a Month

Harold Hastings of Somers, Conn., says: "The profit on my electrical business amounts to \$475 a month. My success is due entirely to your instruction. You make your men just what you say—Electrical Experts. No man will ever make a mistake enrolling for your course."



Dickerson Gets \$7,500 a Year

"I earned \$30 a week when I started with you—\$50 a week when half through your course. Now I clean up at the rate of \$7,500 a year. Thank you a thousand times for what you did for me. Electricity pays big on the farm." Herbert M. Dickerson, Warrrentown, Virginia.



\$20.00 a Day for Schreck

"Use my name as a reference and depend on me as a booster. The biggest thing I ever did was answer your advertisement. I am averaging better than \$500 a month from my own business now. I need to make \$12.00 a week."

A. Schreck,
Phoenix, Ariz.



Pence Earns \$9,000 a Year

W. E. Pence, Chehalis, Wash., says: "Your course put me where I am today. Mr. Cooke—making \$150 a month doing automobile electrical work—think of it—\$9,000 a year. Besides that I am my own boss. My wife joins me in thanking you for what you did for us."



\$30 to \$50 a Day for J. R. Morgan

"When I started on your course I was a carpenter's helper, earning around \$5.00 a day. Now I make from \$30 to \$50 a day and am busy all the time. Use this letter if you want to—I stand behind it."

J. R. Morgan,
Delaware, Ohio.

It's your own fault if you don't earn more. Blame yourself if you stick to your small pay job when I have made it so easy for you to earn \$3500 to \$10,000 a year as an electrical expert. Electrical Experts are badly needed. Thousands of men must be trained at once. One billion dollars a year is being spent for electrical expansion and everything is ready but the men. Will you answer the call of this big pay field? Will you get ready now for the big job I will help you get? The biggest money of your life is waiting for you.

I Will Train You at Home

I will train you just like I trained the five men whose pictures you see here. Just like I have trained thousands of other men—ordinary, everyday sort of fellows—pulling them out of the depths of starvation wages into jobs that pay \$12.00 to \$30.00 a day. Electricity offers you more opportunities—bigger opportunities—than any other line and with my easily learned, spare time course, I can fit you for one of the biggest jobs in a few short months' time.

Quick and Easy to Learn

Don't let any doubt about your being able to do what these other men have done rob you of your just success. Pence and Morgan and these other fellows didn't have a thing on you when they started. You can easily duplicate their success. Age, lack of experience or lack of education makes no difference. Start just as you are and I will guarantee the result with a signed money back guarantee bond. If you are not 100% satisfied with my course it won't cost you a cent.

FREE—Electrical Working Outfit and Tools

In addition to giving my students free employment service and free consultation service, I give them also a complete working outfit. This includes tools, measuring instruments, material and a real electric motor—the finest beginners' outfit ever gotten together. You do practical work right from the start. After the first few lessons it enables you to make extra money every week doing odd electrical jobs in your spare time. Some students make as high as \$25 to \$35 a week in spare time work while learning. This outfit is all FREE.

Mail Coupon for FREE BOOK

—the Vital Facts of the Electrical Industry

The coupon below will bring you my big free electrical book—over 100 interesting pictures. The real dope about your opportunities in electricity—positive proof that you, too, can earn \$3500 to \$10,000 a year. Send for it now. Along with the book I will send you a sample lesson, a credit check allowing you a \$45.00 reduction, my guarantee bond and particulars of the most wonderful pay-raising course in the world. Send the coupon now—this very second may be the turning point in your life. Send it while the desire for a better job and more money is upon you, to

L. L. COOKE, Chief Engineer

Chicago Engineering Works
Dept. 16 2150 Lawrence Ave., Chicago

The Cooke
Trained Man
is the Big
Pay Man

L. L. COOKE, Chief Engineer, Chicago Engineering Works,
Dept. 16 2150 Lawrence Ave., Chicago, Ill.

Without obligating me in any way send me the "Vital Facts," your Free Book, Sample Lessons and particulars of your Free Outfit Offer, Free Employment Service, and proof that you can fit me for a big-pay electrical job.

Name.....

Address.....

CLASSIFIED ADVERTISEMENTS

WORLD'S BEST WANT AD MEDIUM

Advertisements in this section, 25 cents per word, each insertion, minimum 10 words, payable in advance. To be inserted under proper classification in October issue, copy should be in our office August 18th.

ADVERTISING AGENCIES

25 WORDS—355 Rural Weeklies, \$14.20. Ad-Meyer Agency, 4112-M Hartford, St. Louis.

ADVERTISING, Display, in this or other Magazines; Newspapers; Magnetic Trademark; Illustrated Booklet. Write The Capital Advertising Company, Inc., Munsey Building, Washington, D. C.

To secure agents or salesmen or for selling farms and reaching investors, use classified (want) ads in largest newspapers and magazines. Price list No. 30 sent free. Ankrum Advertising Agency, 20 W. Jackson Blvd., Chicago, Ill. The largest classified advertising agency in the U. S.

FOR ADVERTISERS

INCH display 100 magazines thrice \$8. Beck, 5401 Alaska, St. Louis.

ADVERTISE in 24 Big Sunday Newspapers, 25 words \$15.00. Catalog listing 1,000 leading Dailies, Weeklies, Magazines, 4c stamps. Union Advertising, Baltimore Bldg., Chicago.

AUTOMOBILE SUPPLIES

DISTRICT Representatives on fast selling automobile and hardware accessory. Calcos Steel & Iron Co., Philadelphia, Pa.

AUTOMOBILE accessory, 21,000 sold. Write for list. 897 Milwaukee St., Menasha, Wis.

UNITED Air Cleaner, attached to the carburetor of your engine, lengthens life of pistons, rings, cylinders, and other engine mechanism by keeping out all grit and road dust. Cleans the air automatically. Requires no attention or adjustment. No oil or filtering medium. Lasts forever; nothing to wear out. Type for all engines. When you send for circular give name and year of car, so we can quote exact price. Also dealer's name and address. United Mfg. & Distributing Co., 3707 Cottage Grove Ave., Chicago, Ill.

REPAIRING Ford Cars, Trucks and Tractors in the most proper and efficient way is explained in a new 229-page book by the former director of the Ford Motor Co. Service School. This information is otherwise unavailable outside of the Ford plant. Written more especially for the mechanic and repairman. Price \$2, postpaid. Popular Mechanics Book Dept., 200 E. Ontario St., Chicago.

EMERGENCY Fan Belts for 490 Cherokees. You can replace your broken belt in 30 seconds with this new automatic tension belt. Snaps on over pulleys by hand. Don't risk burning up your motor when your fan belt tears. Always carry Emergencies. Easy to install—a blind man could put one on after dark. Two belts in neat side pocket carton, \$1.00 postpaid. Joe V. Bomig, 1216 Union St., Allentown, Pa.

8-HOUR Battery Charging with Constant Potential Pays Big. Easy Payments. Profits Pay. Postal brings details. Hohartson, Troy, Ohio.

AUTOMOBILE parts, guaranteed new for all cars. Save money; get our wholesale prices on gears, shafts and bearings. State make of car, model and parts wanted. Parts shipped immediately from stock. We refund your money, including transportation charges, if not satisfied. Mechanics Gear Co., 3708 No. Halsted St., Chicago.

AUTOMOBILE Parts—Used parts for most any car at half factory list prices. Allen, Briscoe, Buick, Cadillac, Chalmers, Chevrolet, Dodge, Dort, Grant, Hudson, Humble, Oakland, Overland, Oldsmobile, Rec. Studebaker and many others. Send list of parts wanted. Maxwell Bros., 4106 Olive St., St. Louis, Mo.

LIBERTY Air Compressors, for garages, tire-shops, filling stations, also paint spraying equipment. Air Compressor & Equipment Co., 1437 Carroll Avenue, Chicago, Ill. Distributors wanted.

SOMETHING new in Car Bumpers—Twin Compression Spring Type—Housed. Patent Pending. Cash or Royalty. For particulars and Details, E. Nasiri, 16 Oakland St., Brooklyn, N. Y.

MAGNETO Recharger; State Rights free. State Distributors. Reliable, 328 Jay St., Utica, N. Y.

AUTOMATIC Air Compressor, quietest, most compact outfit on market. No noisy breaking belts. Motor and pump one unit. Thousands garages, filling stations, tire shops, using. Most economical to operate. Absolutely dependable. \$35 cash, balance terms. Iron Chad satisfaction or Money-back guarantee. Write for details. Hohart Brothers, Troy, Ohio.

AUTO parts—Save 25-90%. New gears, axles, bearings, springs, radiators, magnetos—4,000 models. Bankrupt supplies, retooling outfits. Brightman Auto Exchange, 321 Windsor Ave., Hartford, Conn. Largest in the East.

TOURIST Auto Sleeping Beds—Camp Equipment, Vanderpool's, Springfield, Ohio.

AUTOMOBILES

PATENTS Procured. Send sketch or model today for examination, prompt report and advice. No charge for preliminary advice. Write for free Booklet and blank form on which to disclose your idea. Highest references. Promptness assured. Clarence A. O'Brien, Registered Patent Lawyer, 562 Southern Building, Washington, D. C.

AUTO Trails Maps, Pocket Size—Hand McNally Official; Most Popular Road Guides, 21 Maps, covering 21 touring districts, each complete in itself. Featuring marked auto routes with explanation of markers; all main traveled auto roads; mileage between towns; city maps of larger towns; reliable information concerning hotels, garages and service stations. Price 35c ea., postpaid. Send for further particulars. Popular Mechanics Book Dept., 200 E. Ontario St., Chicago.

PATENTS—Write for our free illustrated Guide Book and Evidence of Conception Blank. Send model or sketch and description of your invention and we will give our opinion of its patentable nature. Highest references. Prompt service. Reasonable terms. Victor J. Evans & Co., 185 Ninth, Washington, D. C.

DYKE'S Automobile Encyclopedia, 13th edition, new, greater than ever, entirely rewritten and rearranged. Contains greatest array of automobile facts ever published in one volume. Separate books containing same information cost \$21. Over 1200 pages and 4100 illus. Cloth \$8. Flex. Amer. Monaco \$7.50 postpaid. Popular Mechanics Book Dept., 200 E. Ontario St., Chicago.

FOR FORD OWNERS

FORD Car Repair Book Sent Free. This complete and well illustrated valuable book explains in a simple way how to overcome Ford car troubles; Repairing, Economical Winter Driving, Cold Weather Car Starting, Equipment for Fall and Winter, Curving Piston Ring Troubles, Carburetor Adjustments and Repairs, Connecting Rods, Timers, Transmission Troubles, and practically every phase of Ford car driving, repairing and equipment. Send 25c coin for three months' trial subscription and get the valuable repair book free. Ford Owner and Dealer Magazine, 533 Montgomery Bldg., Milwaukee, Wis.

UNDERSLING with "RKO" Swing Lo Irons. See "Red-4-Kut" ad, page 143.

CLAHOLME power delivery systems more than double power and traction, reducing upkeep. An essential demanded by every Ford driver. Low priced, easily applied in original housings. Aggressive dealers, garage owners or owner drivers can make big money in exclusive territory. Quick turnovers and large sales. Claholme Universal Joint Corp., 25 Broad Street, New York City.

FORD Owners! Learn About Wonderful New Power Maker. Practically eliminates spark lever—stops misfiring—adds power and speed—saves gas and is waterproof. Price is low. Ask for booklet and learn about Free Trial Offer. A. B. M. Co., Box 2, Brightwood, Mass.

FORD cars get 20-40 per cent increase in power and mileage. No tapping. Guaranteed Automatic Vaporizer. Order now, price \$3.00. Agents wanted. R. A. Reid, 19 Burget Ave., Medford, Mass.

MOTORCYCLES, BICYCLES & SUPPLIES

LARGEST stock of new and used motorcycle parts and accessories in the world at your disposal via Uncle Sam's mail. Write for quotations. Motorcycle Parts Mfg. Co., 2030-36 Wabash Ave., Chicago, Ill.

EIGHTEEN valuable trade secrets for Bicycle Repairmen, Gun and Locksmiths. Regular price \$5.00. Now \$2.95. Nelson Carter, Shreveport, La.

NEW Rogers Side Cars with extension axles. Fit any motorcycle, \$59.50; also used bargains. Erickson, 438 W. 79, Chicago.

SEND for our Bargain Bulletin and Money Saving Message. It will save you money on Motorcycles, Side Cars, Motor Wheels, Repair Parts, and Accessories. Some used parts at less than half. Cleveland and Ace Motorcycles our specialty. See our ad on page 137. American Motor Cycle Co., 2043-5-7 W. Chicago Ave., Chicago.

1920 HARLEY-DAVIDSONS, \$90; 1919, \$65; 1917, \$55; 1915, \$40. Guaranteed. Money refunded if not satisfied. Circular free. Wisconsin Creole Sales Co., 726 National Ave., Milwaukee, Wis.

USED parts for all motorcycles, cheap. State wants, Schuck Cycle Co., 1922 Westlake, Seattle, Wash.

WONDERFUL bargains in reconditioned motorcycles. Priced as low as \$35. Sidecars from \$25 up. Everyone expertly rebuilt and guaranteed in absolutely first-class condition. Don't delay. Send 2c for new big catalog showing 1923 bargains. Western Supplies Co., 539 Hayutin Bldg., Denver, Colo.

'19 INDIAN 3 Speed \$75.00. '20 Indian 3 Speed \$95.00. '21 Indian 3 Speed \$125.00. Howard A. French Company, Baltimore, Md., Washington, D. C.

SEND for big list of slightly used motorcycles on the easy payment plan. Howard Cycle Co., Trenton, N. J.

DON'T buy a Bicycle Motor Attachment until you get our new catalogue and prices. Also runs washers, pumps and shop machinery. Shaw Mfg. Co., Dept. 27, Galesburg, Kans.

AVIATION

PRACTICALLY New nine-cylinder Gnome aeroplane motor, \$75.00 cash. P. O. Box 762, Mobile, Ala.

PATENTS Procured. Send sketch or model today for examination, prompt report and advice. No charge for preliminary advice. Write for free booklet and blank form on which to disclose your idea. Highest references. Promptness assured. Clarence A. O'Brien, Registered Patent Lawyer, 561 Southern Building, Washington, D. C.

TEN lessons in the air, of twenty minutes each, will make you a pilot, by our advanced method of training. This, together with our five-week shop course at \$100.00, makes America's oldest aircraft factory the most popular flying school. Work after class hours guaranteed. Heath Airplane Co., Chicago, Ill.

THE American School of Aviation announces a new correspondence course in Mechanics of Aviation. A thorough training in Practical Aeronautics. American School of Aviation, Dept. 188-B, 3901 Michigan Ave., Chicago, Ill.

BIGGEST, best catalogue Model Aeroplanes, Parts and Supplies; 5c Postpaid. Ideal Aeroplane Co., 72½ Green St., New York.

INVENTORS desiring patents should write for our Free Illustrated Guide Book and Evidence of Conception Blank. Send model or sketch for our opinion of its patentable nature. Highest references. Prompt service. Reasonable terms. Victor J. Evans & Co., 187 Ninth, Washington, D. C.

SEND 10c for our latest aeronautical catalog listing a complete line of airplane goods at reduced prices. Propeller catalog 4c; Ford or Motorcycle motored airplane catalog, 4c each. Heath Airplane Co., Chicago, Ill.

WELDING

ELECTRO plating Generators. Make money doing Plating Work. Priced reasonable. Terms if desired. Write us, Hohartsons, Troy, Ohio.

WELDING Encyclopedia—A complete instruction book on all welding processes; oxyacetylene, electric arc, electric resistance and thermit. Welding of all weldable metals fully discussed. 326 pp., 375 ill. The accumulated experience of the welding brains of America is yours for \$5. Money back if not satisfied. Popular Mechanics Book Dept., 200 E. Ontario St., Chicago.

BOOKS AND PERIODICALS

FIRE-PROOF Homes. Directions for building good, substantial fire-proof homes at reasonable cost. Head de Linde's book on building. It may save you much costly labor and material and avoid mistakes. This book also contains directions for manufacturing Tombstones and Monuments from white cement. Price one dollar. Peter de Linde, Zion, Ill.

LEFAX—"Facts on Leaves." You make your own handbook, loose-leaf. From our complete list of Lefax data sheets you select only those that you actually need, then fill in your own notes or diagrams on extra blank sheets which come in 100 different styles. These in loose-leaf binder make up a book covering your individual needs. Send for complete information and price list to Popular Mechanics Book Dept., 200 E. Ontario St., Chicago.

INDUSTRIAL Alcohol. Wright's book everybody wants. Full directions for making with drawings of necessary apparatus. \$2.50 postpaid. Spon & Chamberlain, 120 P. M. Liberty Street, New York, N. Y.

HYPNOTISM astounds, controls others. Wants gratified. 25 easy lessons \$1.10. "Mindreading" (any distance). Wonderful. \$2.10. Popular Institute, 81014 Belmont, Chicago.

ELECTRICIANS' Examination book of questions and answers, with diagrams, symbols, tables, notes and formulas, for preparation for license. \$1.25. Address Reade Pub. Co., 296 Broadway, New York.

"LIGHTS, Colors, Tones and Nature's Finer Forces," covering Vibrations; Odic-Auras; Cold-lights; Radio; Inventions; 270 pages. Satisfaction guaranteed; \$2.00. Circulars Free. M. Stevens, Publisher, 242 Powell, San Francisco.

OUR valuable catalog of over 500 practical books arranged for easy reference under 80 different subject headings will be sent free on request. Popular Mechanics Book Dept., 200 E. Ontario St., Chicago.

BIG money in writing photoplays, stories, poems, songs. Send today for free copy America's leading writer's magazine, full of helpful advice on writing and selling. Writer's Digest, 708 Butler Building, Cincinnati.

YOU should have our New Illustrated List of Practical Books. Free. Spon & Chamberlain, 120 P. M. Liberty Street, New York, N. Y.

NOVELTIES, CURIOS, ETC.

SURPRISE Package, 6 Latest novelties 50c. Money returned if dissatisfied. McHenry's, 15 Queen St., Niagara Falls, N. Y.

KIRBY Bridge Pad Holder with refillable ball pencil with eraser and score pad for \$1.00. Attaches instantly to edge of card table with two places for pencil. Holder and Pencil enameled in either red, yellow or black. Kirby Company, Middletown, Conn.

PICTURES AND POSTCARDS

JOIN Live Postcard Club; Membership Lists, including catalog, 10c. Harvey Teeple, Decatur, Ind.

JOIN the Old Reliable Card Club, Membership 10c. Riverside Club, Frederick, Md.

GAMES AND ENTERTAINMENTS

VENTRILQUISM taught almost anyone at home. Small cost. Send 2c stamp today for particulars and proof. George W. Smith, Room M-729, 125 N. Jefferson Ave., Peoria, Ill.

GREATEST mind reading act ever sold. Not a toy. Easily mastered. Cannot be detected. Postpaid for \$1.00. The Benwills Co., P. O. Box 797, Macon, Ga.

200 KINDS Iron, wood and wire puzzles, leader and illustrated list 10c. Western Puzzle Works, St. Paul, Minn.

MAGIC TRICKS, BOOKS AND JOKERS' NOVELTIES

TRICKS, magic, novelties, puzzles, cards, books. Catalog free. C. Fenner, 2401 Jefferson, Louisville, Ky.

GOOD Books on Tricks, Magic, Puzzles, etc.—Houdini's Paper Magic, \$2.50—Houdini's Miracle Mongers and Their Methods, \$3—Walker's Conjuring Tricks, \$2—Hoffman's Later Magic, \$2.50—Goulden's More Tricks and Puzzles, \$1—Mass.eyne and Devant's Our Magic, \$2.50—Elbiquet's Supplementary Magic, \$2—Elbiquet's Text Book of Magic, \$1.00. Prices postpaid. Popular Mechanics Book Dept., 200 E. Ontario St., Chicago.

MAGIC—Tricks, Books and Supplies. For Amateurs as well as the great professionals. Anyone can learn through our instructions. Feature Acts in Mind Reading, Spiritualism, Rope Ties, etc. Large Illustrated Professional Catalog, 10c. Chicago Magic Co., 140 S. Dearborn St., Dept. B, Chicago, Ill.

FREE Trick for stamp. Wooley Novelty Co., Peoria, Ill.

TRICKS, puzzles, jokes, magical apparatus, plays, stage supplies, mind-reading, sensational escapes. 169-page illustrated professional catalog, 10c. Oaks Magical Co., Dept. 548, Oshkosh, Wis.

EVERYTHING in Magic, Four Catalogs 15c. Glimagico, Morgan Park, Ill.

MAGIC Disappearing Writing Pad. You simply write anything at all on the top sheet of the pad; then lift; Presto! the writing vanishes. Mystify your friends. Great fun. Price 25 cents postpaid. Popular Mechanics Book Dept., 200 E. Ontario St., Chicago.

STAMP COLLECTING

100 DIFFERENT stamps, 12c. McQuitty, Box 747, Muskogee, Okla.

SNAPS—200 different stamps, 10c; 60 different United States Stamps, 12c. With each order we give free our price list of sets, packets, albums, etc., and our pamphlet which tells "how to make a collection properly." Queen City Stamp Company, Room 36, 604 Race, Cincinnati, Ohio.

FREE—50 varieties or set to approval applicants sending 2c. Richard P. Lamprecht, Valparaiso, Ind.

BEST one cent approvals in America. F. P. Hand, 1117 So. 40th St., Philadelphia, Pa.

1000 UNITED STATES and Foreign Postage Stamps mixed—for stamp collectors, 25 cents. C. W. Parker, 77 Kensington Heights, Meriden, Conn.

FREE—15 South American stamps to approval applicants enclosing postage. References. Southwestern Stamp Company, Dallas, Texas.

\$3.00 FOR 12c! 100 different Neurope, catalogued \$2.10; triangle stamp, Red Cross set, airplane set, perforation gauge, millimetre scale, fine wallet, 5 approval sheets, 250 hinges, scarce packet from Nyassa, Abyssinia, etc., price lists and approvals—all for 12c! Atlanta Stamp Co., Box 532, Atlanta, Ga.

BIG Variety Packet Foreign Stamps free for 2c postage. Gray Stamp Co., Station E., Toronto, Canada.

1000 DIFFERENT Stamps \$1.55; 500, 55c; 300, 25c. Micheal, 5353 Calumet, Chicago.

10c EACH, 50 different Austria, 20 Czecho-Slovakia, 20 Lichtenstein, 25 Poland. Fred Unken, 630 79th Street, Brooklyn, N. Y.

UNIVERSAL Packet, 100 varieties, all over the world, 10 cents. Covert Stamp, 29 State, Rochester, N. Y.

STAMP'S Free—War Stamps, Surcharged, Unissued Pictorials, British, French Colonials, 2c postage. Midland Stamp Co., Toronto, Canada.

WONDERFUL Bargain; Germany 1922, Munich Exposition Stamps complete, unused, only 10c. Nickles, 122 Florida, Washington, D. C.

200 DIFFERENT stamps ten cents to approval applicants only. K. C. Stamp Co., Lee Bldg., Kansas City, Mo.

1000 ALL Different Stamps for \$1.30 postpaid. 500 all different British Colonials for \$4.25 postpaid. New Wholesale list just issued. Send for price lists. Alois von Jakobovics, Monticello, N. Y.

ODD Moments—Odd Stamps. Approvals for postal. Odd Stamp Co., Sunset Heights, Asheville, N. C.

FREE—New Europe, 20 diff. to applicants for my 1c, 2c and 3c approvals. Send reference and get extra premium. Chas. Schmidt, 3221 Benner St., Wissinoming, Philadelphia, Pa.

FREE—100 different stamps to approval applicants. References required. Head Stamp Co., 1232½ Oakland, Milwaukee, Wis.

100 FOREIGN Stamps free to approval applicants. J. A. Platen, Fertile, Minn.

\$9 VALUE 15c. Packet of scarce stamps from South and Central America, including Cuba, Hayti, Salvador, Venezuela, Uruguay, having catalog value of over \$9.00. Price to new applicants for Fenway net approvals 15c. Fenway Stamp Co., Fenway Station, Boston, Mass.

FREE set to applicants for 50c approvals. Dorval Stamp Co., Gloversville, N. Y.

50 DIFFERENT United States 10c; 10 Nyassa 1901 25c. Seldenberg, Merton, Wis.

FREE, Dollar Stamp Free to applicants for my 60c approvals. Norman Shultz, Colorado Springs, Colo.

STAMP'S sent on approval at 75% discount. Reference required. Emory Renoll, Hanover, Pa.

STAMP'S, 50 Varieties, Africa, Brazil, Peru, Cuba, Mexico, etc., 10c. 50 different U. S., 25c; 1,000 mixed, 40c; 1,000 hinges, 10c. List free. C. Stegman, 5948 Cote Brillante, St. Louis, Mo.

158 GENUINE Foreign Stamps Mexico War Issues, Venezuela, Salvador and India Service, Guatemala, China, etc., only 10c. Finest approval sheets 50 to 60%. Agents Wanted. Big 72-p. Lists Free. We Buy Stamps, Estab. 29 yrs. Hussman Stamp Co., Dept. 54, St. Louis, Mo.

FRENCH Colonies Free—Beautiful Picture set, including Native Chiefs, Tigers, Pictorials, 2c Postage. Empire Stamp Company, Toronto, Canada.

24 VARIETIES Cuban stamps, 10 cents. List of 6,000 low-priced stamps free. Address Chambers Stamp Co., 111P, Nassau St., New York City, N. Y.

STAMP'S, 20 unused, all different, free. Postage 2c. Mention paper. Quaker Stamp Co., Toledo, O.

PACKET of 23 stamps, no two countries alike. Packet hinges. Set of \$1 and \$2 U. S. Rev., all for 5c. Mention paper. Miami Stamp Co., Toledo, Ohio.

20 UNUSED stamps free. All different. Postage, 2c. Flak Stamps, Toledo, Ohio.

FOREIGN Stamp Collection Sent Free. Cornish Company, Schenectady, N. Y.

105 CHINA, etc., stamp dictionary, list, 2c. Album (500 illustrations), 3c. Bullard, Sta. A, Boston.

FREE—Nyassa Set, also one set Neurope, for a request for my 1, 2 and 3c net approvals also the higher-priced desirable stamps at 50% discount and better. You will find many good British Col. on my sheets and books. None better. Chas. T. Egner, 4821 Frankford Ave., FK'D, Philadelphia, Pa.

EXCHANGE Stamps of all Countries. Membership fee, 25 cents. International Stamp Club, 4002 Brooklyn Ave., Seattle, Wash., U. S. A.

100 DIFFERENT New Europe Free. to approved applicants, sending 2c postage. Anselink Co., 2410 Prairie St., Milwaukee, Wisconsin.

RARE COINS

OLD U. S. Silver Coins Cheap. Old bust type dimes dated before 1838, 25c. Old half dollars with lettered edge, dated before 1830, 75c. Columbian Half Dollars with bust of Columbus (sold at \$1 in 1893), price 75c. Five foreign coins, 1 over 100 years old, and my large 50 page Illustrated Coin Catalog for only 20c. Our catalog free with any order for above coins. All kinds of Coins and Bills for sale. R. Max Mehl, Numismatist, Mehl Bldg., Dept. P, Fort Worth, Texas. Largest Rare Coin Establishment in the United States.

FOREIGN Money. 100,000 German marks \$2.00. 100,000 Austrian kronen \$3.00. 1,000,000 Russian rubles \$1.00. 10,000 Polish marks 75c. 20,000 mark German 5% bond \$1.00. Craig Dare, 440 53th St., Brooklyn, N. Y.

CALIFORNIA gold, $\frac{1}{4}$ size, 27c. $\frac{1}{2}$ size, 53c. 3c piece and catalogue, 10c. Address Norman Shultz, Colorado Springs, Colo.

OLD Coins. Large Fall selling catalogue of coins for sale, free. Catalogue quoting prices paid for coins, 10c. William Hestlein, 101 A Tremont St., Boston, Mass.

WE paid \$2,500 for one silver dollar to Mr. Manning of Albany, N. Y. We buy all rare coins and pay highest cash premiums. Send 4c for large Coin Circular. It may mean much profit to you. Numismatic Bank, Dept. H, Fort Worth, Texas.

FOR BOYS

MOVING Picture Machines free. Particulars, Nite Mail Order Supply, 609-27th, Denver, Colo.

BOOKS — "Ventriloquism," "Toymaker Book," "Boy Electrician," 10c each, all for 25c. G. Elsen, Bowling Green, Ohio.

CAMERAS AND PHOTO SUPPLIES

JUST Published—Our new complete 128-page catalog and bargain book of new and used cameras and supplies. Our goods are guaranteed finest quality obtainable. We have thousands of satisfied customers. Write at once for this bargain bulletin, just hot from the press. Address Central Camera Co., 124 S. Wabash Ave., Dept. E-78, Chicago, Ill.

NEW—The Artograph Distance Indicator. (Patent pending.) Insures correct focus, prevents disappointments and waste of film—indispensable to amateur photographers. Sent prepaid upon receipt of price, \$3.00; worth it in one day's use—product guaranteed. Mail order dept., The Artograph Screen Co., 500 Fifth Ave., New York.

BARGAINS in slightly used guaranteed cameras, kixlaks, lenses, etc. No list published. Write stating exactly what you want. We can furnish anything and save you money. Empire Loan Bank, 649 No. Clark St., Chicago, Ill.

KODAK Films—Special trial offer; your next kodak film developed, 5c—prints, 2c each. Moser & Son, 1917 St. James Ave., Cincinnati.

MODERN Photography in all its branches now taught by mail. New Successful Method. Students earning \$300.00 while learning. Big Opportunity. Write for particulars and unusual offer open for short time. Dept. 3435 International Studios, Inc., 3801 Michigan Ave., Chicago.

SPECIAL Trial Offer: Any size Kodak film developed for 5c; prints 3c each. Overnight service. Get a Free Auto. Ask for details, Roanoke Photo Finishing Co., 209 Bell Ave., Roanoke, Va.

MAKE money with your camera. Lancaster, Box 967, Los Angeles, Calif.

HAVE You a Camera? Write for Free sample of our big magazine, showing how to make better pictures and earn money. American Photography, 790 Camera House, Boston, 17, Mass.

MOTION PICTURES

MOVIE Films for Toy Projectors, 100 feet, \$1.00 postpaid; 800 feet, \$3. Dealers Supplied. Films rented for homes, churches and schools. Home Projector, \$25. Cameras \$50. Ray, 328 5th Avenue, New York, N. Y.

FILMS: Special Features—Comedies—Cartoons—Dramas and Serials. Lowest Prices. Bargain List Free. Monarch Theatre Supply Co., Dept. 81, Memphis, Tenn.

MOVIE Film: For Home Use. Send \$5.00 Cash or Money Order and we will ship you postage prepaid, Big 1,000-foot Reel. Complete stories with best screen stars. Dramas—Comedies—Features—Westerns. Special—only while they last. Monarch Theatre Supply Co., Dept. P, 724 So. Wabash Av., Chicago.

FILMS For Sale—\$2.50 per Reel up. Address Queen Feature Service, Birmingham, Ala.

REMARKABLE value: Light Weight Professional Motion Picture Projector, Mazda Illuminated, with 1,000 feet of film, \$37.50. Send for photograph. DeFranco Importers, 109 No. Dearborn St., Chicago, Illinois.

JUST in time to get in on the big money to be made! Bass will start you in the Motion Picture Making Business, enormous profits making Industrial Films, News Weeklies, etc. Catalogue and full information free! The Cinema Handbook, 575 pages, for \$3.00 postpaid. Bass Camera Company, 195 No. Dearborn St., Chicago, Ill.

AMERICA'S Greatest Fortunes made in the Motion Picture Business. We furnish Complete Theatre Equipment on easy payments. Openings everywhere. Catalog Free. Monarch Theatre Supply Co., Dept. F—724 South Wabash Ave., Chicago.

\$35.00 PROFIT nightly. Small capital starts you. No experience needed. Our machines are used and endorsed by government institutions. Catalog free. Atlas Moving Picture Company, 482 Morton Bldg., Chicago.

FREE to Writers—A wonderful little book of money-making hints, suggestions, ideas; the A B C of successful story and play writing. Absolutely Free. Just address Authors Press, Dept. 12, Auburn, New York.

ONLY \$98.00 starts you in this business. Wonderful opportunities for making Fortunes. Details Free. Monarch Theatre Supply Co., Dept. 46, Memphis, Tenn.

\$\$\$ FOR Ideas. Photoplay plots accepted any form; revised, criticized, copyrighted, marketed. Advice free. Universal Scenario Corporation, 917 Western Mutual Life Bldg., Los Angeles.

MAKE money writing photoplays; details free to beginners. No correspondence course. Producers League, 230 Wainwright, St. Louis.

SCENERY TO RENT

SETTINGS for Opera, Plays, Minstrelk. Flush Drops. Address Amelia Grain, Philadelphia.

EDUCATIONAL AND INSTRUCTION

PRACTICAL Courses in Photo-Engraving are offered by Wentworth Institute, in cooperation with national and local associations of Engravers, at its School of Graphic Arts. The instruction covers work of all the divisions in the industry, and important related subjects. The Day Course starts on September 24, 1923, the Evening Course starts on October 1, 1923. Entrance interviews for the Day Course will be held on September 18 and 19, 1923, at 8:30 a. m., for the Evening Course on September 21 and 22, 1923, at 7:30 p. m. For particulars write to the Wentworth Institute, Boston 17, Mass.

STUDENTS of the Steam Engine—Get this book, "The Slide Valve Simply Explained." 83 pp. Illustrated. Paper cover. 25 cents postpaid. Popular Mechanics Book Dept., 200 E. Ontario St., Chicago.

USED books and educational matter bought, sold, exchanged. Bulletin free. Instruction Correspondence Exchange, 1969 Broadway, New York.

PATENT Drafting. Book teaching this artistic high salaried business for 50 cents. Box 858, Schenectady, N. Y.

SPANISH. Spontaneous Method. You and I correspond in Spanish. Free particulars. Hedin, 3509 Franklin Avenue, Saint Louis.

START a Real Estate Office of your own. Earn from \$2500 upwards. Our course of 21 lessons tell you how. Booklet M, on application. Frederick Jenkins, Corlaer Heights, Schenectady, N. Y.

LEARN Press Photography—Markets unlimited. Write Hedger Studios, Clariton, Iowa.

SHOW-CARD Writing, a pleasant, profitable profession, quickly and easily learned by our new simple "Instructograph" method. No canvassing or soliciting. We show you how, no matter where you live. Full particulars and booklet free. American Show Card System Limited, 203 Adams Building, Toronto, Canada.

LEARN the operating principles of the Corliss Engine from this book, "The Corliss Engine and Its Management," 92 pp. Illustrated. Paper cover. 25 cents postpaid. Popular Mechanics Book Dept., 200 E. Ontario St., Chicago.

POSITIONS secured everywhere by brief and thorough shorthand course by mail, at small cost (Pitman and Gregg). Positions paid month \$135 to over \$250. Absolutely guaranteed. A few minutes in spare time accomplishes it. W. H. Dillon, 20 years reporter and principal of Boston School of Shorthand, Wilcox Bldg., Los Angeles, Calif.

SHORTHAND in 100 hours. Most rapid readable system. Introductory booklet free. Memoscript Institute, Roanoke, Va.

WORLD-ROMIC System, Masterkey to All Languages. Primers, 23 languages, \$1.94 each language: English, French, German, Italian, Portuguese, Spanish. Pronunciation-Tables, 102 languages, 80c each language. Languages Publishing Company, 8 West 40th Street, New York.

BE a Laboratory Expert. Earn \$300.00 to \$500.00 a month. Study Microbiology, Bacteriology, Laboratory Technology, Sanitation. Interesting Extension and Residential Courses. Diplomas and Degrees granted. 71-piece Urinalysis Outfit Free to students. Write for Free 48-page Prospectus Today. Int'l Physicians and Surgeons College of Microbiology, Room 955, 550 Garfield Ave., Chicago, Ill.

ARE You between the ages of 18 and 25, single and employed? Have you a common school education? Can you follow instructions? Are you honest? If so, a rare opportunity awaits you. Send 10c for postage, etc. (coin only). Mattox Twone Institute, Dept. C, 3292 Sacramento Street, San Francisco, Calif. "Watch Us Grow."

"WHAT to Invent for Profit" free. Patent News-N, Washington, D. C.

BIG money distributing samples and tacking signs. No experience. Instructions \$1.00 bill. G. Barney, 137 Briggs St., Syracuse, N. Y.

YOU can use a business profession of your own and earn big income in service fees. A new system of foot correction; readily learned by anyone at home in a few weeks. Easy terms for training; openings everywhere with all the trade you can attend to. No capital required or goods to buy, no agency or soliciting. Address Stephenson Laboratory, 1 Back Bay, Boston, Mass.

DOUBLE Entry Bookkeeping mastered in 60 hours with 8 keys; guaranteed; diplomas. Our graduates lead in bookkeeping, auditing, accountancy, balance sheets, and financial statements. International Bookkeeping Institute, Dept. 8, Springfield, Mo.

WRITE articles, stories, news, in spare time for newspapers and magazines. Big pay. Copyright book free. Press Syndicate, 552, St. Louis, Mo.

BIG Money in writing photoplays, stories, poems, songs. Send today for Free copy America's leading writer's magazine, full of helpful advice on writing and selling. Writer's Digest, 603 Butler Building, Cincinnati.

ARTIFICIAL Marble, sanitary flooring instructions, ornamental casting, concrete plaster, papier-mache decorations, garden furniture, statuary, Rubber-moulds, Electrometallurgy, particulars and 200 illustrations free. Chris Mahler, Box 122, Huntington, N. Y.

STUDY Bacteriology, Hygiene, Public Health. Laboratory technologists make good income. Interesting course, can be mastered at home or school in a few months. Also courses in Arts and Sciences, Chronographic, P. G. Pharmacy, etc. 15th year. Diplomas conferred. Free announcement. National University of Sciences, 2923 So. Michigan Blvd., Chicago.

USED books and educational matter bought, sold, exchanged. List 1,000 items free. Students' Exchange, 47-A West Forty-second Street, New York, N. Y.

SHOW-CARD writing a pleasant, profitable profession easily and quickly learnt by our new, simple graphic block system. Artistic ability not necessary. We teach you how. Distance no object. Full particulars and booklet free. Wilson Methods, Limited, Dept. M, 84, East Richmond, Toronto, Canada.

KELP'S Calculator and Short-Cut Arithmetic shows the answer as quickly as a watch shows the time to all problems likely to occur in office, store, shop, bank, farm or factory. Price, pocket case, paper, 35 cents; cloth 50 cents; leatherette \$1. Desk size, cloth, \$1.50 postpaid. Popular Mechanics Book Dept., 200 E. Ontario St., Chicago.

USED educational books sold, rented, bought and exchanged. Bargain list free. Lee Mountain, Pisgah, Ala.

TELEGRAPHY

TELEGRAPHY—Both Morse and Wireless—taught thoroughly and quickly. Tremendous demand. Big salaries. Wonderful opportunities. Expenses low; chance to earn part. School established fifty years. Catalog free. Dodge's Institute, H St., Valparaiso, Ind.

RADIO OUTFITS AND SUPPLIES

SIX detailed designs for constructing latest type radio sets, 25c. Satisfaction or money back. M. B. Sleeper, Inc., E-88 Park Place, New York.

RADIO Books, catalogue free. R. Dobbin, 146 West 27th Street, Indianapolis, Ind.

ATTACH a United Vernier to your plate condenser and bring in stations that have always defied you. Makes tuning at least twice as fine. Clarifies signals. Fits any rotary plate condenser by drilling one hole in plate. Price postpaid \$2.50. We also sell United Plate Condensers with this wonderful new vernier. 43-plate—\$6.50. 23-plate—\$5.00. 11-plate—\$5.50. United Audio Frequency Transformer is a wonder-worker. Use with old or new tubes. Each \$4.50. Give name and address of your favorite radio dealer when you write. Circular free. United Mfg. & Distributing Co., 9707 Cottage Grove Ave., Chicago.

RADIO Generators—500 volt 100 watt \$23.50. High speed motors—Federal phones \$16.50. Battery chargers \$12.50. Motor Specialties Co., Crafton, Pa.

JAY-CEE Storage Batteries \$11.50 to \$16.50, according to size. Eighteen months guarantee. Jay-Cee Battery Co., 801 South 14th Street, Newcastle, Ind.

BUILD Hazeltine Neutrodyne Receivers. 32-page illustrated book—complete assembly, adjusting and tuning information for building four and five tube "neutrodyne" receivers. Full size panel drilling templates. Listen in to broadcasted radio concerts from stations thousands of miles away. This book tells how. Send 50c and your book will come in the next mail. Kimball Houton Stark, 1581-V Jerome Ave., New York City.

FREE—Complete price list of radio parts. Write Aitken Radio Co., 504 Superior St., Toledo, Ohio.

TRADE SCHOOLS

BIG Money in the Painting Trade. Be your own Boss—Learn Sign Painting—Auto Painting—Decorating—Paperhanging—Graining—Marbling—Pictorial Painting—Card Writing, in a few weeks. Write for Special Summer Rates Now. Chicago Painting School, 148 West Austin Ave., Chicago, Ill.

BUSINESS OPPORTUNITIES

MAKE Money at Home—making toys. We show you how. Send \$1 for complete working drawings and instructions. DeKalb Designing Co., Decatur, Ga.

\$200 TO \$500 will start a cash business. Free information; Dept. M. Paul Kaye, 149 Bway, New York.

STOP Flooding! Be Successful. Operate a Tire Repair Shop. Make big profits in any locality. We teach you and furnish complete equipments \$100.00 up. Book of Opportunity free. Hayward's, 1305 South Oakley Avenue, Chicago.

STATE manufacturing rights for sale. Valuable patent. Fortune for you. Machinery unnecessary. Dr. Schmidt, Blanton, Fla.

BE a Laboratory Expert. Earn \$300.00 to \$500.00 a month. Study Microbiology, Bacteriology, Laboratory Technology, Sanitation. Interesting Extension and Residential Courses, Diplomas and Degrees granted. 71-piece Urinalysis Outfit Free to students. Write for Free 48-page Prospectus Today. Int'l Physicians and Surgeons College of Microbiology, Room 971, 550 Garfield Ave., Chicago, Ill.

EARN \$10 daily silvering mirrors, plating and refinishing metalware, autos, chandeliers, bedsteads, headlights. Outfits furnished. E. Decie Laboratories, 1133 Broadway, New York.

SILVERING Mirrors! My exclusive French Tartaric method opens enormously profitable business. Booklet free. H. Barstow, 514 28d Street, Oakland, Calif.

AN unusual opportunity for some one. Our client, a successful manufacturer, well-established with hardware and grocery trade, wants to make or sell some article of merit. Has abundant capital and good business organization. Write giving full description. Porter-Eastman-Byrne Company, 22 West Monroe Street, Chicago, Ill.

PATENTS Procured. Send sketch or model today for examination, prompt report and advice. No charge for preliminary advice. Write for free Booklet and blank form on which to disclose your idea. Highest references. Promptness assured. Clarence A. O'Brien, Registered Patent Lawyer, 581 Southern Building, Washington, D. C.

SIOP Machines; Headquarters for Premium Machines. 1916 Germantown Ave., Philadelphia.

GO into the Crispette business. Everybody likes Crispettes. You can make a lot of money. We start you. Write for facts. Long Bakins, 1959 High St., Springfield, Ohio.

668 WAYS to Make Money—2,716 Formulas in "Encyclopedia Business Opportunities," 3 volumes; price, \$3; yours for \$1. Order at once. Ideal Book Shop, 5501-VK, North Rober, Chicago.

SELF-CONFIDENCE brings success. Particulars free. Robert Knox, Box 728, San Francisco, Calif.

WANT man with \$1,000, in each state, take lease on fastest road-building invention of the age. Share millions spent on good roads. Address, J. P. Copeland, Wolfe City, Texas.

FORMULAS, Trade Secrets—Different, dependable. Catalog free. B. Thaxly Co., Washington, D. C.

PATENTS Procured; trade marks registered. A comprehensive, experienced, prompt service for the protection and development of your ideas. Preliminary advice gladly furnished without charge. Booklet of information and form for disclosing idea free on request. Richard B. Owen, 30 Owen Bldg., Washington, D. C., or 2278-B Woolworth Bldg., New York.

PUBLISH Magazine of Your Own; Start Mail Order Business and Advertising Agency. Sample magazine and plan 10c. Harvey Teeple, Decatur, Ind.

I HAVE over 100 stores paying \$5 monthly. You can do the same in your city. Month practice qualifies. Midnight Alarm System, 2870 Algonquin, Detroit.

ATTENTION! "Get Acquainted." Cash for your property. Farm, Hotel or Retail Store, no matter where located; confidential service. Hayes' Business Agency, Cincinnati, Ohio.

SILVERBLACK Foxes \$300. Muskrats, Skunks, Time payments, Arthur Schumacher, Lockland, O.

"GET into the Specialty Manufacturing Business" or "Why Work for Others?" may sound good to you, but you won't succeed in that business unless you possess Formulas that are absolutely reliable, the same required by leading manufacturers supplying the Best. Don't be bunked into buying a Collection of cheap "Formulas" and expect to succeed. Send today for my valuable literature and Formula Lists and Real Money-Makers in the Specialty Manufacturing Business. 26 years supplying the Best. Miller, Chemist, 805 De Leon St., Tampa, Fla.

"HOW to Sell Patents" free. Patent News-H., Washington, D. C.

\$4 HOURLY removing superfluous hair permanently; \$30 needed. B. Zilka, Fairview, Mass.

\$3,000 TO \$6,000 Yearly. Want it? Others are making it. Send check or money order today for our invaluable books "How to Sell Real Estate," \$3.00—and "How to Conduct Real Estate and Insurance Business," \$1.50. Absolute satisfaction guaranteed. Free catalogs. Realty Book Co., Dept. 52, Cleveland, Ohio.

DOLLARS yearly in your spare time. Indoors or outdoors. I'll show you how. Particulars free. PM Meta, 313 East 89th, New York.

GENUINE Big-money stunt. Legitimate, mutual, inexpensive. Amo Keumer, Eastbay, Olympia, Wash.

"WHAT to Invent for Profit" free. Patent News-C., Washington, D. C.

BECOME a Landscape Architect. Dignified, exclusive profession not overrun with competition. Crowded with opportunities for money-making and big fees. \$5,000 to \$10,000 incomes attained by experts. Easy to master through our correspondence methods. Established 1916. Get information today. American Landscape School, 36-K, Newark, N. Y.

FOR \$3.00 you can start making and selling Fly Ejecting Window Screens. Frank Rohner, Palo Alto, Calif.

ENTER a new business. Earn \$3,000 to \$6,000 yearly in professional fees making and fitting a foot specialty, openings everywhere, with all the trade you can attend to; easily learned by anyone at home in a few weeks, at small expense; no further capital required, no goods to buy, job hunting, soliciting or agency. Address Stephenson Laboratory, (1) Back Bay, Boston, Mass.

INCH Display Advertisement 161 Magazines Thrice \$15. Year \$50. Page \$100. Wood's Popular Services, Atlantic City, N. J.

LEARN the collection business. Good income, quick results. Interesting booklet, "Skillful Collecting," free. National Collectors Assn., Long St., Newark, O.

MAIL Order Business is your opportunity. Breniser's Famous Handbooks teach how to start small, grow big. Sell merchandise, service, ideas; enormous profits. Spare time to begin. Get complete set, 11 books, \$3.00, and be posted. Breniser, 335 Walnut, Philadelphia. Descriptive Catalog and big batch interesting mail order information, 25c. None free.

RAISE guinea pigs. Pay better than poultry or rabbits; easy to raise; little space required. We guarantee market. Particulars and booklet how to raise free. Cavies Distributing Co., 3102 Grand Ave., Kansas City, Mo.

WE Start You in Business, furnishing everything; men and women, \$30.00 to \$100.00 weekly operating our "New System Specialty Candy Factories" anywhere. Opportunity lifetime; booklet free. W. Hillier Ragsdale, Drawer 4, East Orange, N. J.

EXCEPTIONAL Opportunity for Sales Manager capable of handling state distribution. Marvelous new Adding Machine. Retail \$15. Work equals \$350 machine. Tremendous possibilities. Unlimited profits. Write quick for details. Lightning Calculator Co., Dept. B., Grand Rapids, Mich.

"SCHEMER Magazine," Alliance, Ohio, prints big profit schemes; one subscriber making \$25,000 from three; another \$10,000 from one. Try your luck. Year, only \$1.00; three months, 25c.

GOOD money easily earned at home spare time silvering mirrors; no capital. Free instructive book tells how. Patterson & Co., Brooksville, Ky.

MARBLE mixing instructions, covering wood or cement flooring 1/2 inch thick, fire-proof, waterproof, low cost, sanitary, all colors. Particulars, 200 illustrations, free. Chris Mahler, Box 122, Huntington, N. Y.

\$50 WEEK evenings—I made it. Mail Order business; booklet for stamp tells how. Sample and plan, 25c. Free 12 articles worth \$3. Algeo Scott, Cohoes, N. Y.

CHEMISTRY

YOUR chemical problem solved and working process furnished Five Dollars. Write me. W. Stedman Richards, Consulting Chemist, address Box 2102, Boston, Mass.

FORMULAS AND TRADE SECRETS

MAKE cast iron or aluminum solder. Each formula 25 cents. A. Bevan, 5304 Lorain Ave., Cleveland, O.

BE licensed operating engineer and electrician. You can increase your income on the side, without investing money, in any locality using my trade secrets. Money refunded if dissatisfied. Hundred dollars' worth of valuable information mailed for 50c, stamps accepted. Address, Engineer—A. Wensit, 3108 Canal St., Chicago.

BEST Grade English Complexion Clay. Guaranteed formula and complete detailed instructions for making, postpaid 25c. Fletcher, Box 383, Jefferson City, Mo.

800 FORMULAS 25c: Luminous Paint—Resilvering Mirrors—Renewing Dry Batteries—Mechanics Soap—Gas Tonic—Carbon Remover—Puncture Plugger, 20c each. Entire collection 50c. Catalog Free. Ideal Book Shop, 5501-FK, North Robey, Chicago.

FORMULAS—Best that Chemical Science can devise. Not "Better Sort" Formulas, but Guaranteed Reliable processes in all lines. Stamp brings Valuable Literature and Latest Summer Sellers from an Analytical Chemist. Miller, Chemist, 897 De Leon, Tampa, Fla.

FORMULAS: Source of supply. Bulletins. Special Money-Making Courses. Byron, B27, Sta. 1, New York.

500 FORMULAS: resilvering mirrors, valuable collection, 25c. Universal, 4049-EK, North Whipple, Chicago.

500 VALUABLE Formulas, 25c: Formula Literature, 2c. Harvey Toepke, Decatur, Ind.

10,000 SELECTED chemical, technological and practical recipes and processes, including hundreds of so-called trade secrets for every business, alphabetically arranged in one large volume of 800 pages. Price \$4 postpaid. Popular Mechanics Book Dept., 200 E. Ontario St., Chicago.

1,000,000 FORMULAS, 1016 pages, \$2. 500 Formulas Free if you order quick. Ideal Book Shop, 5501-MK, North Robey, Chicago.

20,000 FORMULAS, 557-page volume, \$1.30. Universal, 4049-YK, North Whipple, Chicago.

FORMULAS—Guaranteed, Catalog free. Bestoval Laboratories, 4919-FK, North Whipple, Chicago.

TWENTIETH Century Wonder. Extract all nutrition from fruit and grain into liquid food instead of canning fruit. Send \$1.00 fee formula. Math J. Schmitt, Box 332, Emporia, Kans.

VALUABLE manufacturing secrets. Every one a money maker. Postpaid, \$1.00. Your money back if not satisfied. S. Vignola, Ph. G., 135 Meadow St., Pittsburgh, Pa.

5,000 RECIPES, \$1.25. Best formulas and processes for every business, trade or occupation are in "Yeoman's Guide." Many never before published. Worth \$1.25 each, 530 pages, paper cover \$1.25. Cloth \$2.00, postpaid. Book catalog free. Wells and Edwards, N852 George, Chicago.

AGENTS WANTED

RIGHT this way to the \$1,000 per month class. Step right into the Alexander Sales training course. Free to our men. The material in this course has trebled the production of specialty men. You sell motion picture publicity—and you earn big money—as you learn to make more money. Vigorous national expansion campaign now on. Do you like hard work for big results? Write now—right now. Alexander Film Company, 3389 Broadway, Denver.

AGENTS Wanted—Something New—Fire Fighter sells easily. Makes a spectacular demonstration; car owners, homes, factories, stores, practically buy on sight. Our men make \$10.00 to \$50.00 a day; exclusive territory. If you wish to establish a business of your own with unlimited possibilities for making big money, write us today. Fyr-Fyter Co., 103 Fyr-Fyter Bldg., Dayton, Ohio.

AGENTS—New Interlock guaranteed hosiery for men, women, children. All styles, colors. Full line. Guaranteed to satisfy or replaced free, 12 months demand—make \$5 to \$12 a day. Full or spare time. Samples to start you. Parker Mfg. Co., Sample 678, Dayton, Ohio.

SELL Lunch Cocoa to stores, etc.; absolutely pure, good profits. Greenhood Chocolate Co., Gilman St., Somerville, Mass., Desk 6.

NO Dull Times Selling Food. The greatest, surest and safest business in the world today is selling Federal Pure Food Products, and here is your opportunity to get into this business. You can make \$3,000, \$5,000, \$10,000 or more per year—the only limit is your ability to take care of the business. People Must Eat, and our food products are the fastest selling, surest and quickest repeat order getters in the world. Sell on sight in every home where food is used. Repeat orders immediate and every week thereafter. We supply you with effective Free Advertising Matter, Free Samples and a Free Course in Salesmanship. We also have over 100 high-grade beautifully packaged Toilet Preparations. Your future will be a financial success. A Real Big Business All Your Own. Every New Customer adds a great deal to your weekly income. Your business once established has a market value just like a store and can be easily sold. The greatest money-making opportunity of your lifetime because you risk absolutely nothing, as we guarantee your sales, and we will not let you fail. Remember! Guaranteed! Best products, biggest sellers, surest repeat orders. No capital or experience is required. We furnish capital and everything necessary for you to become a Federal Distributor. Exclusive territory will be given honest men or women who will write at once asking us to send our "Success Guaranteed" proposition. Address, Federal Pure Food Company, Dept. A, Chicago, Ill. Largest inventors of and packers of Pure Food specialties in the world. Reference, any bank, Dun or Bradstreet rating agency, Express or Railway Company in America.

AGENTS—Sell Orangeo Powder; makes delicious drink. Send 15 cents for package, makes gallon, 10 packages, postpaid, \$1.00. Orangeo Co., 6338 N. Maplewood St., Chicago, Ill.

AGENTS—Unusual opportunity; \$2.70 profit on every \$4.50 sale; 30 sales daily easily made. Every home and office a live prospect. Re-orders. Write today for exclusive territory. Holan Receiver Hobbler Corporation, Dept. A, 516 West 41st Street, New York.

MAKE \$31.00 Profit—Cost You \$1.50. Complete Gold Monogramming Outfit. Transferred Instantly on Automobiles, Trunks, Bags, Windows. Experience unnecessary. Free Samples. Nutlife (A) Monogram, Hartford, Conn.

\$40-\$200 A WEEK. Genuine Gold Letters for store windows. Easily applied. Free samples. Liberal offer to general agents. Metallic Letter Co., 438-D, North Clark, Chicago.

WONDERFUL invention—Eliminates all needles for phonographs. Saves time and annoyance. Preserves records. Lasts for years. 12,000,000 prospects. \$15.00 daily. Free sample to workers. Everplay, Desk 923, McClurg Bldg., Chicago.

AGENTS—\$50 a week taking orders for guaranteed hosiery for men, women and children. Must wear 12 months or replaced free. All styles and finest line of silk hose. Write for sample outfit. Thomas Mfg. Co., Class 262, Dayton, Ohio.

\$5 TO \$15 daily easy—Introducing New Style Guaranteed Hosiery. Must wear or replaced free. No capital or experience required. Just show samples, write orders. Your pay in advance. We deliver and collect. Elegant outfit furnished, all colors and grades, including silks, wool and heathers. Mac-O-Cheo Mills Company, Desk 2580, Cincinnati, Ohio.

\$10 DAILY and more to real workers. Marvelous new polishing cloth sells like hot cakes to homes, merchants, everybody. Over 100% profit. Popular price. Big repeater. Samples 25c. Write for Money-Making sales plan, Denmac Co., 347-E, Madison Ave., New York.

SELL "Amen" Shirts. Wonderful opportunity, big profits. Made-to-measure and stock shirts; finest materials. Write for details. Menzies Shirt Co., 479-A, East Tremont Ave., New York.

SHEEP Wool Moccasins, Polishers, Dust-ers, Box 26, East Boston, Mass.

AGENTS: C. T. A. prices lower than ever. Suits \$18.00, made to order, any size or style. Orders easy to get. Big profits. Amen's outfit free. Sample suit at cost. Write Chicago Tailors Ass'n, Dept. 418, Sta. C, Chicago.

AGENTS—Free offer captivates customers. 20 First Day—\$20.00 Profit, 100 celebrated necessities. National Products Co., 835 Grand St., St. Joseph, Mo.

FORTUNE Maker—Thread-Cutting Thimble. Live wires only. Sample, 15c. Automobile Mfg. Co., 3753 Monticello, Chicago.

AGENTS: Get into the tailoring game. Make \$75.00 to \$125.00 a week and up right from the start. No experience necessary. We teach you and supply finest Selling Outfit, \$10 to \$20 a day profits easy. You get paid every day. Write quick. Address Dept. 565, Goodwear Chicago, Inc., Chicago.

YOU can sell every merchant in town our changeable signs. Large profits; easy sales. Write for territory now. Changeable Sign Co., 581 East 162nd, Cleveland.

AGENTS—\$4.25 Profit on every sale of Nibco Service Set. Needed in every home and building. Get particulars quick. A. A. Silver-Chamberlin Company, Clayton, N. J.

EARN \$10 daily silvering mirrors, plating and refinishing metalware, autoes, chandeliers, bedsteads, headlights. Outfits furnished. R. Dectle Laboratories, 1133 Broadway, New York.

\$75.00 A WEEK selling specialty articles to men. Every man is a prospect. Write for details today. Kit Strop Co., Dept. 422, 20 W. Jackson Blvd., Chicago.

AGENTS: \$75.00-\$100.00 weekly taking orders for popular price-smashing raincoats. \$3.98. Largest commission advanced. Prompt shipment. We collect. Free coats. Eagle Raincoat Co., 555 Mid City Bank Bldg., Chicago.

YOU can earn \$30 cash extra every week during your spare time and get your own clothes free besides, taking tailoring orders. We are the only house that pays double. No experience necessary. Real cloth samples will be sent free. Write today before you forget. Est. 1896. A. E. Stern, Sales Mgr., 161 W. Harrison St., Dept. 827, Chicago.

MEN'S Shirts. Easy to sell. Big demand everywhere. Make \$15.00 daily. Undersell stores. Complete line. Exclusive patterns. Free samples. Chicago Shirt Manufacturers, Franklin and Van Buren, Factory 113, Chicago.

AGENTS: \$100.00 weekly selling established quality raincoats at \$3.95. Pay advanced. We deliver. Free coats. Hydro Raincoat Co., 3510 Polk, Dept. 108, Chicago.

AGENTS: \$15 a day. Latest improved portable talking machine. Does more than machines costing five times its price. Built-in just like a suitcase. Fully guaranteed. Pay you daily. Write Perry-Ludlow Co., S-1962, Dayton, Ohio.

MAKE \$75.00 a week and up selling our fine made-to-measure, all-wool suits at \$31.50 retail, direct to wearer. Biggest values—positively sell on sight. Biggest commissions, paid in advance. We attend to delivery and collections. 6x3 swatch samples furnished free. W. Z. Gibson, Inc., Dept. W-41, 161 W. Harrison St., Chicago.

AGENTS: Stop wishing, work—you can make \$10 daily selling articles everybody needs. Particulars free. Write B. & G. Rubber Company, Dept. 335, Pittsburgh, Pa.

PORTRAITS, photo pillow tops, frames, sheet pictures, medallions, merchant's signs, water-proof and tea aprons, guaranteed hose, toilet requisites, luminous crucifixes; catalog, 30 specialties free. 30 days' credit. Jas. C. Bailey Co., Desk M-9, Chicago.

AGENTS, Salesmen, Demonstrators, you will have the devil's own time trying to find a better seller than "Zippe." If there was such a thing we'd have it. Splendid profit on 50c "Go Getter" repeat article that sells on ten second demonstration. Works While You Watch It. Demonstrates value, while others waste time making claims. New Discovery! Greatest Scientific Triumph of the age. It's the berries. Haven't room to tell our story here. Write immediately. Karam-Smith Co., 669 Clark St., Ft. Wayne, Ind.

AGENTS—\$15 a day—Easy, quick sales—Free Auto—Big weekly Bonus—\$1.50 premium Free to every customer. Simply show our Beautiful 7-piece Solid Aluminum Handle Cutlery Set. Appeals instantly. We deliver and collect. Pay daily. New Era Mfg. Co., 803 Madison St., Dept. 21-B, Chicago.

WANTED—Tailoring salesmen, make \$60 to \$125 per week. Biggest merchants in many towns have started with our line. We are the largest made-to-measure tailoring house in the country, furnishing elaborate sample equipments, including 500 all wool fabrics and guaranteed absolute satisfaction, perfect fit, best workmanship, or no sales. Write me for line and all accessories to be sent free. Tell us all about yourself. Address E. F. Mitchell, Sales Manager, Box 483, Chicago, Ill.

AGENTS: New Reversible Raincoat—Not sold in stores. Two coats in one. Guaranteed waterproof or money back. You take orders. We pay you daily. No experience necessary. Sample furnished. Parker Mfg. Co., Coat 1178, Dayton, Ohio.

27,000 RECORDS guaranteed with one Everplay Phonograph Needle; new—different; cannot injure records; \$15.00 daily easy. Free sample to workers. Everplay, McClurg Bldg., Desk 26, Chicago.

TAILORING Agents: We've got a wonderful line of tailor made suits to sell at \$18 and up. Beautiful assortment of fabrics, \$10 to \$25 cheaper than retail. No experience needed. Our free suit offer is a wonder. Write American Woolen Mills Co., Dept. 1849, Chicago, Ill.

AGENTS: Big profits, no competition. Make \$5 to \$15 daily selling our beautiful Scripture Text Calendars. Agents now selling from 10,000 to 50,000 yearly. Write now. Address Messenger Publ. Co., Dept. 116, 314 W. Superior St., Chicago, Ill.

GFP Free Sample Outfit! Earn \$3,000 to \$5,000 a year selling the most complete line guaranteed Hosiery and Underwear in America. No experience needed. You can become District Manager and have others working for you—if you act quick! Write today. Malloch Knitting Mills, 539 Grant St., Grand Rapids, Mich.

AGENTS—Big money, \$8 to \$16 a day. Aluminum handle cutlery set. Brand new. You display and take orders. We deliver and collect. Pay you daily. Sample free. Try it out. Jennings Mfg. Co., Dept. 1668, Dayton, Ohio.

AGENTS, \$54 a week; travel by auto, install New Stove Converter in country homes. Wonderful invention. Cook and bake all year without coal or wood. No gas or electricity needed. We furnish the auto. Sample free. Thomas Mfg. Co., Class 2562, Dayton, Ohio.

AGENTS—Steady Income. Large manufacturer of soaps, perfumes, toilet articles and pure food products, etc., wishes representatives in each locality. Manufacturer direct to consumer. Big profits. Honest goods. Whole or spare time. Cash or credit. Send at once for particulars. American Products Co., 4686 American Bldg., Cincinnati, Ohio.

AMAZING auto necessity. Retail \$4.00. Your profit \$2.50. Territory going. Write Super, 1306 Fenwick, Milwaukee, Wis.

GENUINE Gold Leaf Letters anyone can put on store windows. Guaranteed to never tarnish. Large profits. Enormous demand. Free samples. Write today. Metal Letter Co., 438-A North Clark, Chicago.

300% PROFIT: Whirlwind Seller. Tremendous repeater, "Kleanrite." Marvelous Discovery. Washes clothes without rubbing. Premiums for customers. Sells 25c. You make 15c. Free samples make easy sales. Write quick. Bestever Products Co., 1941-K9 Irving Park, Chicago.

TAILORING Agents: Get our powerful proposition, \$35.00 suits for \$21.85, including a good profit for you. Big swatch line of samples in handsome carrying case. Hustlers make \$75 a week. Territory going fast. Write at once. State experience. Klueberbocker Tailoring Company, Dept. 220, Chicago, Ill.

A SALE in Every Home: The Burn's Guaranteed Bread Knife. Cuts warm bread or cold bread—cuts it without leaving a crumb. All you have to do is to let people try the knife. They will buy. We guarantee the sale and a good profit. Write now. Don't delay. Some one is going to sell this knife in your community. J. M. Pitkin and Co., 522 Commercial Block, Newark, New York State.

BIG Fast Profits for Agents. Repeater Six Fuse Plugs sell on sight wherever there is electricity. Do away with lighting troubles. Welcomed everywhere. Get details. Sample 25c. Moss-Schuyler Manufacturing Company, Inc., 10-A, Detroit, Mich.

ACTIVE Men, Women, let us start you in business and make you independent. You can earn \$25 to \$50 weekly with Menthol Ointment; works like magic; repeat orders come fast. Folder, sample sent free. Horner Manufacturing, 578, Pittsburgh, Pa.

SELL "Instant Shine" Metal Polishing Cloths to stores and users. Details 25c. Sample free. Instant Shine Polish Co., Utica, N. Y.

HEATING with oil is in its infancy. Get in while the getting is good. Our burners make good. Agents wanted. Exclusive rights. Economy Oil Burner Co., 718-721 Second St., Webster City, Iowa.

AGENTS—Earn \$75.00 to \$100.00 weekly selling "Sun Bright" Pure Aluminum guaranteed Cooking Utensils direct to housewife. Prices 25 to 50% lower than retail. Write today for particulars and state what territory you want. Rand Distributing Co., Inc., Direct Factory Rep., 35 So. Dearborn St., Chicago, Ill.

PATENTS Procured. Send sketch or model today for examination, prompt report and advice. No charge for preliminary advice. Write for free Booklet and blank form on which to disclose your idea. Highest references. Promptness assured. Clarence A. O'Brien, Registered Lawyer, 562 Southern Building, Washington, D. C.

FORMULAS, Trade Secrets—Different, dependable. Catalog free. S. Thaxby Co., Washington, D. C.

EASIEST Seller on Earth. Senior Knife and Scissor Sharpener. Sells like wildfire upon a minute's demonstration. 150 to 350 per cent profit. Sample 25c. Particulars free. A trial will convince you. Senior Mfg. Co., 602 Commonwealth Bldg., Pittsburgh, Pa.

WONDERFUL hand soap powder sells everywhere. Send 20c for samples and sales plan. Kansas Laboratories, Scott City, Kan.

GOLD Leaf Sign Letters; make and sell; profits exceed 1,000%; immense demand; particulars free. Johnston Co., Quincy, Ill.

PERMATUBE, the permanent dry automobile spring lubricant. Application lasts one year. Easy sales, large profits. Write for territory. Agents sample \$1. Permatube Co., 4350 Fifth Avenue, Chicago.

BE first to sell two new patented necessities for Ford Cars. Territories now being allotted. Big opportunity for man who knows Ford Cars to get in a real business on the ground floor. All applicants must give selling experience. Autoquip Mfg. Co., Inc., Rochester, N. Y.

INSTANT Rubber Weld. Repairs largest punctures without cement or heat. Lenn's profit one day, \$56. Write quick. Free sample; territory going fast. Touriste's Pride Mfg. Co., Desk T, Minneapolis, Minn.

INCREASE your sales! See advertisement page 122 this issue. J. B. Simpson, Inc.

BIG Profits Selling New \$3.50 Automatic Adding Machine. Absolutely accurate. Fully guaranteed. Quick sales. Ten daily easy. No competition. Pocket size. Business people everywhere positive customers. Thousands being sold. Tremendous demand. Here's high-grade money-maker. Bassett Co., 1458-W, Hollywood Ave., Chicago.

SELLS at every house. ½ pint Mystol Vanilla Flavor 50c and you make 35c. Express prepaid and guaranteed. Live salesmen wanted. Mystol Mfg. Corp., Glens Falls, N. Y.

SELLS on sight—All Purpose Cream and Mother's Laundry Tablets. Big Money. Accept no proposition until you investigate. Samples free. Credit given. Hansen Co., 3749-P, Maple Square, Chicago.

AGENTS, Mail-Order men, beginners: Valuable inside information; 300% profit. Nite Mail Order Supply, 609—27th, Denver, Colo.

AGENTS, \$100 weekly selling fancy knitted ties, Sample 25 cents. Raymond's Mfg. Co., 31 East 132nd Street, New York.

SELLS Like Hot Cakes; Big Profits; New Ironing Wax Pad and Asbestos Rest; Clamps Board; Perfumes Clothes; Outfit 10c. Yankee Mfg's., 380 Atlantic Ave., Brooklyn, N. Y.

AGENTS for new carbonless oil burner for small residences. Inexpensive, economical. Exclusive territory. Yankee Burner Co., 4824 Armitage, Chicago.

WANTED: Agents and royalty manufacturers, men's carved clip hatcomb. Fits behind sweatband. Seven inch wire auto hatholder. Sample 25c. Geo. T. Robinson, Calhoun, Ky.

AGENTS make as high as \$1,000 month with amazing new invention; spare-time workers \$25 a day easy. Read pages 60 and 61, then act quick.

YOU can do what John Hackett did. He made 14 sales in 16 calls with Hair Bitters, the hair remedy. \$1.00 profit per sale. Free goods plan shows how. Automobile free to hustlers. Write Beriault Corp., 4311-P Ravenswood Ave., Chicago.

AGENTS sell made to measure gabardines, whipcords, \$14.50; reversible raincoats; \$75-\$100 weekly. Outfit free. Standard Raincoat, Dept. 5, 129 West 17th St., New York.

AGENTS and Salesmen: Something different, \$40.00 suits sell for \$23.50. Union made. No extra charges. Good commission. Old well-known line. Established reputation. Complete equipment furnished. Commissions paid daily. No experience necessary. Good men make \$100.00 weekly. Stars make more. Territory going fast. Write Elliott Bradley, Inc., 1028 West Van Buren, Dept. PM, Chicago.

BIG Money in Emblem Goods. \$25.00 daily easy. Wall and Auto emblems; pins, buckles and leather goods sell on sight. Sales guaranteed. Get free sample and cash bonus plan. Kler Emblem Co., Dept. PM9, Como Bldg., Chicago.

AGENTS: \$60.00 weekly selling newest sensation; Leather Link Belts going over big. Easy quick sellers. Big profits. Write quick. Victory Belt Co., 1774 Wilson, Chicago.

AGENTS and District Managers wanted everywhere for our Ideal Exhaust and Pet Cock Whistles, also Glare Shields. Men with autos preferred. Exclusive territory given. Address Interstate, 192 Market St., Newark, N. J.

SALESMEN calling on automobile owners: \$2 to \$5 hour, extra. New patented accessory. No installing. No capital required. Manager, 319 Quincy Bldg., Denver, Colo.

ASTRONOMY and Astrology; explains eclipses, horoscopes, zodiac, signs, sun, moon, stars etc. Copy 15c. Leroy Watts, 1431 Martindale, Indianapolis, Ind.

AGENTS: \$12 daily easy, introducing Ladies' Sweaters in silk, wool and artificial silk; 12 colors. Latest novelties. Going like wildfire. You simply show samples we furnish, take orders, we deliver and collect. Your pay daily. Mac-O-Chee Mills Company, Form 1109, Cincinnati, Ohio.

RIGHT Dollars for seven hours! Peck's Rivets quickly mend leaky kitchenware. Sell everywhere on sight. Samples free. Box 25c. Peck Company, Medina, N. Y.

CLEARMIST for Windshields, prev nts accidents during foggy or rainy weather. One man in Columbus, O., sold 55 gross in 60 days. 200% profit on small investment. Write for Wonder selling plan. Dept. 13, C. L. Wisegar, Mfr., West Fort Ann, N. Y.

AGENTS (both sexes): We manufacture and control new household article. Fast seller. Big profits; exclusive territory. Write now. Connolly, 123 Liberty St., New York.

AGENTS—If you have formerly sold felt rugs, write for our new proposition concerning new goods. It's a winner. Newark Felt Rug Company, 27-C Bergen Street, Newark, N. J.

\$15.00 DAILY easy selling Unbreakable Amurold Coats, kind can hit with hammer, saw wood with teeth, etc. Top-notch sellers with agents. Streetmen selling over \$100.00 worth Saturday afternoon and evening. You can do as well. Terms and convincing proof free. Oliver Gandy, Crisfield, Md.

AGENTS—\$10 to \$15 daily possible selling a line of factory-priced rubber goods specialties for women direct from manufacturer. Free catalogue. American Rubber Products Co., Dept. 908, Pittsburgh, Pa.

SELL Something nine out of ten women will buy because it saves double its cost the day it is bought. 50c each. \$2.00 profit on \$3.00 sales. Premier Mfg. Company, Dept. 813, Detroit, Mich.

SELF-threading Needles find sales in every home. Fine side line. Easily carried. Big profits. Sample free. Prentice-Lee, 145 East 23rd St., New York.

IDEAL Side-line: \$1 Check Protector. 200% profit. K. Home, 1957 Warren, Chicago.

AGENTS—Everywhere—to sell Women's and Children's shoes direct to wearer. Quality guaranteed. We deliver. A. B. Condon, Sales Manager, The Allen Shoe Co., 110 Summer St., Boston, Mass.

SPECIALTY Salesmen or State Distributors to sell Keystone E-Z Steering Post Bushings. This is a money maker. Requests big. Keystone Sales Co., Pacific Bldg., San Francisco, Calif.

YOUR big opportunity. Make \$1 an hour. Everybody enjoys music. Particulars free. Crocker-Steinkamp Music Publishers, Quincy, Ill.

WONDERFUL Seller. Big Profits. Harper's Ten Use Cleaning Set washes and dries windows, scrubs, mops, cleans walls, sweeps, etc. Complete set costs less than brooms. Can start without investing a cent. Write Harper Brush Works, 111-A St., Fairfield, Iowa.

START and Operate Your Own Business and acquire financial independence. Openings everywhere. Either men or women. We furnish everything and show you how. Big explanatory book "The Open Door to Fortune" Free. Ask for it now. National Scientific Laboratories, 16A, Richmond, Va.

FOUR \$7.50 Sales to Merchants Net you \$20.00 Daily. Sayers Systems, 2815 Sheffield, Chicago.

SELL Patterns and Instructions for Making Cloth Working Gloves. Demand Unlimited. Sample 25c. Information Free. Chas. Whitehead, Cochranton, Pa.

SELL Madison "Better Made" Shirts direct from our factory to wearer. No capital or experience required. Easily sold. Big profits. Write for Free Samples. Madison Mills, 503 Broadway, New York.

\$100 TO \$300 a week. Men with slight knowledge of motors who can reach car owners can earn \$200 weekly without making single sale. If they can also make sales, profits may reach \$25,000 yearly. Only proposition of its kind ever offered. A. E. Phillips, 1904 Broadway, New York.

"HOW to Sell Patents" free. Patent News-O, Washington, D. C.

THE Agents Guide—Tolls where to buy almost everything. Copy 30c. Sealed. Wilson, Publisher, Box 74, Madison Square Station, New York.

AGENTS: We pack Beauty creams, face powders, perfumes, toilet preparations, with your label. Repeat orders guaranteed. Big profits. Write Chemist, A-944 No. Clark, Chicago.

AGENTS—W. F. Omels, a former trash salesman, made over \$5,000.00 during 1922 selling our \$1.50 kitchen specialty. He is now a district manager. We are offering you the same proposition—an opportunity as big as you want to make it. You can do what Omels did. Write today to M. H. Tyler Mfg. Co., Manager's Desk, Muncie, Ind.

MOST Wonderful Seller, 96c profit every dollar. No stock to carry. License unnecessary. Sample free. Mission Factory PM, 519 No. Halsted, Chicago, Ill.

PORTRAIT Agents—\$50,000 Profits I made canvassing. My valuable Free book explains all. Guaranteed Prints, Portraits, Frames, Photo-Pillow-tops, Sheet Pictures, shipped all over the world. Samples free. Picture Man Friedman, Dept. S-H, 673 Madison, Chicago.

GENUINE Big-money stunt, Legitimate, mutual, inexpensive. Amo Keumer, Eastbay, Olympia, Wash.

SUCCESS in Business and Personal Affairs! Read character by handwriting and features. Conlin System. Low price for entire course. Write, H. E. Conlin, Dept. B, 21 St. John's Place, Buffalo, N. Y.

ANY man handy with paint brush or light tools can start new mechanical business on nearly nothing; needed everywhere; nearly all profit; experience not required. John Braceland, 1457 So. Ninth, Philadelphia, Pa.

EASY, pleasant work for Mechanics. Shop Men, Clerks, during spare hours; will add many dollars to their salaries. Also want persons who can give full time. Big wages assured. Novelty Cutlery Co., 67 Bar St., Canton, O.

FREE Sample. "Rain Shield Wiper." Retail \$1.00—Costs (25c). Sold. Clear and Rainy Days. No Cloth—No Paste—No Attachment. (1) Rub keeps Windshield Clear (48) Hours. Experience unnecessary. NuLife (H) Corporation, Hartford, Conn.

POLMET Polishing Cloth cleans all metals; retails 25c; sample free. Gale & Co., Inc., 15 Edinboro St., Boston.

THESE Advertisements of mine have appeared in Popular Mechanics for sixteen years. Hundreds of Successful Manufacturers today owe their success to my formulas and valuable information. Majority started with practically nothing. You can do the same—write today for my valuable literature relative to my Guaranteed Manufacturer's Formulas for making Non-Thermal Ice-Saving Cakes, Delicious Beverages for Home, Bottlers and Fountain sale. Pure Food Products, Non-Alcoholic Flavors, Laundryite Washing Marvel, Zest, greatest Stain remover, Sta-Comed, Marvel Hair Curler, and latest Toilet specialties. Mexican Yucca Soap, Laundry Suds, Flynox, Sensol, and all latest disinfectants. Amazon Tire Repair, Toy Rubber Balloons and all latest selling goods in all lines. Don't compare these with "junk" commonly offered. Analytical work carefully done. Highest references. Miller, Chemist, Tampa, Fla.

AGENTS clear \$50.00 weekly selling Opaline Portraits. Expense money advanced. Credit given. Big line now ready. Samples and Catalog free. Consolidated Portrait Co., Desk 2, Chicago.

AUTOMOBILE Safety Device. Sells at Sight. Men making \$10 a day alone, \$50 with subagents. No competition. Exclusive contracts. Lindl, 306 M & M Bank Bldg., Milwaukee.

MAKE money silvering mirrors, all kinds plating, knives, spoons, auto headlights. Outfits furnished. Free booklet. International Laboratories, Dept. 25, 311 Fifth Avenue, New York.

CALIFORNIA Rosebuds selling like hot cakes. Agents coining money; new stuff. Big profits. Catalog free. Mission Factory PM, 519 No. Halsted, Chicago, Ill.

RAINCOAT Agents. Get Our Prices. Sell made-to-measure raincoats. We deliver and collect. Outfit free. World Raincoat Co., 659 Morris Park Ave., New York.

EVERYBODY uses extracts. Sell Duo Double Strength Extracts. Complete line household necessities. Big repeaters. Write today. Duo Co., Dept. El, Attica, N. Y.

IF you need good live agents—fellows who can get the business—ask me how others are doing it. I'll gladly render the necessary assistance. Geo. F. Baker, Mgr. Classified Advertising, Popular Mechanics Magazine, Chicago.

\$8.00 TO \$20.00 per day. A wonderful seller. Any man, woman, boy or girl can make big wages Selling Crimp Grip Clothes Line Fasteners. It is a perfect rope holder and can be used for many purposes. Crimp Grips are a simple, time-saving device. They last a life time and will not rust; it holds the line tight, and saves time on wash days. Every buyer is a booster. Send 50c for Mounted Sample and one pair of Crimp Grip Clothes Line Fasteners. Write for particulars. Crimp Grip Company, Belvidere, Ill.

WANT Distributing Agents everywhere for Hanslick, the new original powdered handsoap. Removes grease, grime, ink, paint, and most anything from the hands without injury to the skin. Every mechanic and auto-owner, everybody who gets his hands dirty will be a customer. A great opportunity for a hustler to get in business for himself. Full information free. Send 10 cents, coin or stamps, for liberal sample can. Solar Products Company, 122 West Lake Street, Chicago.

AGENTS—Send for sample "Fretnot"—the wastaway wonder. Be convinced you can do a whirlwind business. You can clear at least \$20 to \$100 weekly, according spare or whole time. You don't have to talk; if she doesn't buy at sight, leave sample; she will be looking for you long before you are able to make the rounds again. Samples furnished free. Premiums for your customers. Exclusive territory guaranteed to agents who can produce. Credits given. Don't call. P. M. Moster & Sons, 29 E. Jackson Blvd., Chicago.

AGENTS—Best seller: Jen Rubber Repair for tires and tubes; supersedes vulcanization at saving of over 800 per cent; put it on cold, vulcanizes itself in two minutes, and is guaranteed to last the life of the tire or tube. Sells to every auto owner and accessory dealer. For particulars how to make big money and free sample, address Amazon Rubber Co., Amazon Bldg., Philadelphia, Pa., Dept. 565.

OUR Ex-Cel Luminous Crucifix "shines brilliantly in the dark." Sells on first demonstration. Big profits. W. G. Hannan Co., Dept. B, 57 E. 18th St., Chicago.

AUTO owner tire agent wanted each locality to use and take orders for handmade Mellinger fabric and cord tires; guarantee (over 8,000 and 12,000 miles (no seconds); shipped prepaid on approval; get your tires free; no capital or experience required; make \$100 to \$300 weekly. Write for wholesale prices and sample kit. Address, Mellinger Tire Co., Dept. 100, Kansas City, Mo.

AT Last—World's Greatest Adding Machine. Almost human. Retail \$15; work equals \$30 machine. \$500 monthly easily made, demonstrating to stores, offices, garages, factories. Simple, easy; adds, subtracts, multiplies, divides automatically. Speedy, accurate, durable, handsome. Five year guarantee. Tremendous demand; amazing profits. Liberal trial offer. Protected territory. Write quick. Lightning Calculator Corp., Dept. F, Grand Rapids, Mich.

GREATEST Sensation! Eleven piece toilet article set selling like blazes at \$1.75, with \$1.00 dressmakers' shears free to each customer. Spring rush on. Foster Reid Co., 38 Winslow Bldg., Station C, Chicago.

REX India Fibre Broom: One of the biggest sellers on market. Outlasts five ordinary brooms—price no higher. 100% profit. Rex Fibre Products Company, 145-C New Jersey Ave., Brooklyn, New York.

BIG Money and Fast Sales. Every owner buys Gold Initials for his auto. You charge \$1.50; make \$1.35. Ten orders a day easy. Write for particulars and free samples. American Monogram Co., Dept. 40, East Orange, N. J.

"\$10 A DAY and More," our new book, shows clearly how you may gain sure success and large profits selling Guaranteed Hosiery and Underwear, factory to family. It is Free. Write today. C. & D. Company, 41-E, Grand Rapids, Mich.

LIVE man to distribute for great "Foot Ointment," hand or nail. Odor sells it. Solemail opportunity. Write now. The Elder Co., 294 Parkdale, Buffalo, N. Y.

AGENTS—\$3 per hour and more! Sell Iron Board Covers, Rubber Aprons, Shopping Bags, Embroidered Aprons, Satteen Coverall Dresses. Free Sample offer! American Braiding Company, Dept. P, 329 W. Monroe, Chicago.

MAKE \$25 to \$50 Week representing Clow's Famous Philadelphia Hosiery, direct from mill—for men, women, children. Heavy pair guaranteed. Prices that win. Free book: "How to Start" tells the story. George Clow's Company, Desk 31, Philadelphia, Pa.

YOU can be your own boss with our Key-Check outfit. Good for \$5 a day stamping names on pocket key checks, fobs, etc. Sample check with your name and address, 20 cents. Press Die Works, Dept. M, Winchester, N. H.

AGENTS: Big Money Monogramming by Transfer Method, Catalog Showing Over 50 Styles and Particulars Free. Motorists' Accessories Co., Mansfield, Ohio.

PORTRAIT and Medallion Agents—Our Goods Will Make You Big Profits; delivery guaranteed; prompt shipments; low prices; send for latest catalog. Adam J. Kroll & Co., 602 Blue Island Ave., Chicago.

EARN big money fast applying gold initials to autos. Every owner buys—\$1.35 profit on \$1.50 sale—particulars and samples free. Write quick. Lithogram Co., Dept. 17, East Orange, N. J.

MAN in each town to plate auto parts, reflectors, bathroom fixtures, refinish beds, mirrors, chandeliers; by new method. No capital or experience required. Simple plan of manufacturing at home starts you in big money-making business. Outfit furnished. Free particulars and proofs. Gun Metal Co., Ave. H., Decatur, Ill.

AGENTS: Big profits. Best and cheapest window letters made. Easily applied. Dime brings five samples. Particulars free. Stalbright Co., 1115 Second Ave., New York.

AGENTS—Stamping names on Pocket Key Protectors; sample Check with your name and address, 25c. Stamping Outfits, Emblem Checks, Check Fobs, Name Plates. Hart Mfg. Co., Desk 2, 303 Degraw St., Brooklyn, N. Y.

AGENTS—Clever Invention! Inkspoon makes every pen a fountain pen. Fast office seller; big profit, demand increasing everywhere. Exclusive territory offered. Sample free. H. Maral Company, Tribune Bldg., New York, N. Y.

DUSTLESS Sponge Cloth. New Invention. Details (5c)—Costs (16c). (1) Rub Cleans, Polishes Automobiles, Pianos, Furniture. NuLife (A) Sponge, Hartford, Conn.

AGENTS—N-R-G Laundry Tablets, the old reliable moneymaker for live agents. Millions sold—used in many homes—sales waiting for you. Clothes washed spotlessly clean in 10 minutes without rubbing. Free samples. N-R-G Company, 732-A N. Franklin, Chicago.

SELL Necessities. Everybody needs and buys the "Business Guide." Bryant cleared \$800.00 in July. Send for sample. It's free. Nichols Co., Box 4-B, Naperville, Ill.

\$100 WEEKLY. Agents, Crew Managers. Absolutely new article selling big to housewives. No capital required. Commissions paid in advance. No collections. No delivery. Exclusive territory. Write quick. Pioneer Corp., 6391 Yale Ave., Chicago, Ill.

AGENTS make 500% profit handling Auto Monograms, New Pictures, Window Letters, Transfer Flags; Novelty Signs. Catalog Free. Write Hinton Co., Star City, Ind.

GET Our Free Sample Case—Toilet articles, perfumes and specialties. Wonderfully profitable. La Derma Co., Dept. A, St. Louis, Mo.

AGENTS—Good salary and commission selling "Ratskill," new rat and mouse exterminator; ready for use; no bait required; non-poisonous; rodents die outside premises; no odor. Empire Specialties Co., 1549 N. Wells, Dept. 301, Chicago, Ill.

AGENTS—Crew men, novelty men. Gloo-Pen, a 50c muckage fountain pen; everybody buys on demonstration. Write for big profit plan. Gloo-Pen Co., 75 (FF) Front St., New York.

WANTED—Representatives to sell Automobile necessity. Kills headlight and sun glare. Write for sample. Dept. P. The Clark Products Co., Springfield, Ohio.

PORTRAIT Agents—If you are looking for a better grade of work, we can satisfy you. Our enlargements have that finished appearance together with perfect likeness, which makes it a pleasure to deliver, and best of all our prices are not high. Export work a specialty. W. G. Hannan Co., Dept. A-5, 57 E. 18th St., Chicago.

PORTRAIT Agents and Others. Get Big Profits. Sell Perry Photo Medallions. You charge \$2.98; make 400% profit. \$10 daily cash. Big exclusive line. 4-day service. Perry Photo Novelty Corporation, Section 18, 360 Bowery, New York.

WE start You Without a Dollar. Soaps, Extracts, Perfumes, Toilet Goods. Experience unnecessary. Carnation Co., Dept. 201, St. Louis.

AGENTS make a dollar an hour. Sell Mendets, a patent patch for instantly mending leaks in all utensils. Sample package free. Collette Mfg. Co., Dept. 494-B, Amsterdam, N. Y.

AGENTS—Sell Patented Cigar Lighters and Cigar-Case Moisteners. Big Profits. Start making money at once. Write for circulars, cuts and sales plan. Drake Mfg. Co., Dept. M, Milwaukee, Wis.

BRANCH Sales Managers for city and county. Experience unnecessary. Recent developments eliminates all competition. Undersell anybody by 1/2—enormous demand—liberal profit-sharing plan and bonus. Arma Co., 711 North Sedgewick, Chicago.

LARGE corporation wants a Service Man in every town to paste up its signs on store-keepers' windows. Excellent opportunity for reliable party. Steady work. No experience necessary. We also have attractive proposition for agents and salesmen. Guarantee Sign Service, 361 West Superior, Chicago.

AGENTS make \$10 daily—Big line guaranteed extracts, food products, perfumes, toilet goods, household necessities. No capital or experience needed. Free sample case and instructions. Write for amazing offer. Perkins Products Co., Desk 6, Hastings, Neb.

AGENTS: Big Returns, fast office sellers; particulars and samples free. One Dip Pen Co., 2 Daily Record, Baltimore, Md.

NEW Business, Re-dye rugs on floor. Fibertint applied with brushes. Nine colors. \$1.00 box dyes 9x12 rug. Sample for small rug 10c. Agencies granted. Texply Co., Inc., 15-A, Somerville, N. J.

HIGH-GRADE SALESMEN WANTED

SALESMAN—A live, up-to-date line of chinaware which appeals to every dealer and which has been making friends for 25 years; liberal commission and every reasonable help from home office; state experience and reference with your application. The Salem China Co., Salem, Ohio.

SALESMEN—Nationally advertised, patented device, no competition; now in use by leading industrial and city departments; every office and home a live prospect; splendid opportunity for hustlers to go into permanent, substantial business for themselves; repeat business runs high; extra large profits. Hoban Receiver Holder Corporation, Dept. B, 516 West 41st Street, New York.

TAILORING Salesmen, add to your sales and profits. Sell boys' suits as well as men's. Make double profit on every sale. Get our complete outfit of men's and boys' suits. The greatest line in America. \$8.45 and up for boys' two-piece suits, \$28.50—\$26.50—\$29.50 and up for regular \$50.00 men's suits made-to-measure. Guaranteed quality. Our salesmen making \$75.00 week easy. Complete sample outfit in carrying case free. Write quick for full particulars—exclusive territory. Wright & Co., Dept. B-201, 500 S. Throop St., Chicago.

SALESMEN \$75.00 weekly selling our vacuum windshield match boxes and Glare Shades to advertisers. Samples 35c. The William Black Company, Ferry Street, Pittsburgh.

\$60-\$200 A WEEK. Genuine Gold Letters for store windows. Easily applied. Free samples. Liberal offer to general agents. Metallic Letter Co., 438-B North Clark, Chicago.

SALESMEN and Distributors for our Nationally Advertised line of Motorene Oils and Columbia Paints. We desire men of real ability who can establish a going business in their communities. This is an opportunity to establish a permanent business which will pay from \$2,000 to \$5,000 a year. Central Petroleum Company, Cleveland, Ohio.

"ZIM'S Peerless." Quickest seller; surest collector. Biggest—best Collector System published. Details \$7.50. Creditors' Association, E-312 McKnight Bldg., Minneapolis, Minn.

REPRESENTATIVES wanted, every county immediately. Four pair ladies' silk hose \$5.00, 60% commission, other numbers. Lexington Co., P. M., Lexington, Ky.

SALESMEN—Opportunity for high grade men to create permanent business. Profits generous. This is a real business not hand-to-mouth selling. Write. Crown, Richmond, Ind.

SPECIALTY Salesmen or State Distributors for high grade Automotive Lines. Stable Merchandise. Big sellers to all dealers. Wire or write for our proposition. Rodenfeld Manufacturing Co., Richmond, Ind.

SELL Tailoring—the quickest selling, most profitable line in the selling field. Our one-price line shows more than 100 all-wool fabrics for tailored-to-measure suits and overcoats, all at one amazing low price. Every order pays you good profit, cash in hand. Tailoring experience not necessary. We furnish handsome selling outfit and most effective selling helps. Write at once. Goodwear Chicago, Inc. Dept. 566, Chicago.

PHOTO medallion salesmen: Earn \$100 to \$200 every week selling P. & G. Photo medallions. No investment—free equipment. Guaranteed 4-day service—send for sales plan and free 1923 catalogue with 102 beautiful designs, including clock and religious medallions. Pullin & Goldstein, 259 Bowery, Dept. A, New York.

EARN Money at Home. \$35.00 to \$50.00 a week increased income selling our 123 line of personal greeting cards. Full or spare time. Weekly payment. Samples free. Selling experience unnecessary. Get details. John A. Hertel Co., Dept. D-9, So. Clinton, Chicago.

WORLD'S Fastest Selling Auto Accessory! County distributors wanted; write today. G. L. W. Spring Oiler Co., San Diego, Calif.

\$4.00 PROFIT on Every \$5.00 Sale. "Free Sample."—New Specialty. (Money Getter.) Every Storekeeper, Doctor, buys quickly. Experience unnecessary. Territories open. Drawer 395, Hartford, Conn.

SPECIALTY Salesmen: Sell boys' suits. Easily make \$50.00 to \$75.00 week. Guaranteed quality. Profits in advance. We deliver. Prices 25% less than retail stores. Complete sample outfit—free. Write for full particulars quick—get exclusive territory. The Boys Store, Wright & Co., Dept. B-191, 500 S. Throop St., Chicago.

INCREASE your sales! See advertisement page 122 this issue. J. B. Simpson, Inc.

SALESMEN and District Managers: Hundred Thousand Dollar Corporation wants capable salesmen to sell established, constantly used repeating specialty to Hotels, Restaurants, Lodges, Dairies, Theatres, Garages, Schools, Hospitals, Institutions, etc. No dull seasons. Protected territories. Permanent, highly paid positions leading to District Managerships. Exceptional opportunity for live men with ability to organize District Sales Forces. Write at once, stating experience and territory desired. The Colcraft Company, 997 West 70th Street, Cleveland, Ohio.

\$150 WEEKLY selling our product to Bakers. Big repeat business after first order. Big opportunity for live salesmen. Mystal Corp., Glens Falls, N. Y.

SALESMEN make us high as \$1,000 month with amazing new invention; spare-time workers \$25 a day easy. Read pages 60 and 61, then act quick.

SELL our beautiful engraved stationery, etc. Liberal commission. Northside Engraving Co., Valley at Troy, Dayton, Ohio.

TAILORING Salesmen—Sell all-wool suits and overcoats to retail \$28.50 and up; fit and workmanship guaranteed, \$5 to \$12.50 profit. We have opening for salesmen, merchants, barbers, cleaners, foremen, etc. We ship free, prepaid, large swatch line 250 all-wool samples. Write today for exclusive agency. Jay Rose & Co. Dept. M70, 413 S. Wells, Chicago.

\$742 LAST month for Beck of Buffalo, introducing latest advertising plan; nothing else like it; every merchant wants it; easy sales; no deliveries; no collections; specialty salesmen write quick for offer. National Adv. Service, P. O. Box 33, LaGrange, Ind.

SALESMEN—If \$500 to \$1,500 monthly interests you, write quick. Taylor made \$2,000 first 30 days. Specialty Mfg. Co., 123 S. Jefferson St., Chicago.

\$5 PROFIT selling \$7.50 necessity. Write for sample. Merchants Ass'n, Minneapolis, Minn.

SIDELINE Salesmen Wanted; sell coal to your trade in carload lots. Earn week's pay in an hour. Washington Coal Co., Stock Yards Station, Dept. J, Chicago.

SALESMEN: Secure exclusive protected territory, high class, permanent business, worth \$10,000 yearly. Only small capital needed; no risk. Address Box 1336, New Haven, Conn.

CALIFORNIA Rosebuds selling like hot cakes. Agents coining money. Absolutely new. Big profits. Catalog free. Mission Factory 8P, 519 No. Halsted, Chicago, Ill.

SALESMEN Can make \$5.00 a day selling our Calendars, Pencils, Signs, Advertising Novelties, Yardsticks, Whistles, etc. Liberal terms. Sells entire year. Fine side line. Local and traveling agencies. Model Calendar Co., Dept. 226, South Bend, Ind.

TAILORING Salesmen: Make more profit. Get our complete outfit made-to-measure suits. 160 fabrics. Six wholesale prices \$18.00 to \$39.00. Fix your own selling prices. Make all the profit you want. Undersell all competition. Lower prices than any other line—big profits for you. Guaranteed quality by firm established 1885. Write for full particulars. Fred Kauffmann, The American Tailor, 1360 W. Harrison St., Chicago, Dept. B-11.

A WONDERFUL Seller! Any man, woman, boy or girl can make big wages. Some agents make from \$8.00 to \$20.00 per day. Crimp Grip Clothes Line Fasteners are a simple, time-saving device for holding a rope—also used for many other purposes. It pays for itself quickly in time saved on wash days. No knots—it fastens and releases quickly. Every home a prospect. Every housewife who uses Crimp Grips—and there are thousands of them—is a booster. There is but one Crimp Grip. Write for particulars, or send 50c for one pair and a mounted sample, with full particulars to agents, Crimp Grip Company, Belvidere, Ill.

SALESMEN—Sideline pays five to ten dollars a day taking orders for Specially printed gummed advertising and Match Box Stickers. Write for proposition, samples, etc., today. **Beardsley's Printery, Rock Island, Ill.**

BEST Seller: Jem Rubber Repair for tires and tubes; supercedes vulcanization at saving of over 800%; put it on cold, vulcanizes itself in two minutes, guaranteed to last life of tire or tube; sells to every auto owner and accessory dealer. Get particulars how to make big money and free sample. **Amazon Rubber Co., Philadelphia, Pa., Dept. 510.**

TRAVELING Salesmen calling on retail stores wanted by large manufacturer to sell wonderful line of business-boosting articles. Year round, fast selling, main or side line. If not earning \$150 weekly, address **Elmsar Works, 222 Charles St., Ironville, N. Y.**

SALESMEN—Become Independent. Own your business; experience unnecessary; selling our \$7,500 Accidental Death, \$50 Accident, \$25 Sick Weekly Benefits; \$12.50 yearly; other amounts proportionate. Guaranteed steady income from renewals. \$250,000 deposited Insurance Department. Registration Dept. A, Newark, N. J.

WERE You Ever Offered a Grocery Store? Our Proposition is Better. You can handle Sugar, Flour, Canned Goods, Dried Fruit, Coffee and entire line of Groceries, as well as Paints, Roofing, and Automobile Oils, with no rent to pay; no money invested; take large orders from samples. Goods are guaranteed and proven quality. Selling experience not necessary. Steady, profitable work for "workers." Address **Hitchcock-Hill Co., Dept. 200, Chicago, Ill.** Reference: Any Bank or Express Co.

HELP WANTED

U. S. GOVERNMENT positions, \$1,400 to \$2,300 year. Men 18 up. Become Railway Mail Clerks—City Mail Carriers—Post Office Clerks—Rural Carriers. Steady work, No layoffs. Life positions. Paid vacation. Influence unnecessary. Common education sufficient. Specimen examination questions and list positions obtainable—free. Write immediately. **Franklin Institute, Dept. A-3, Rochester, N. Y.**

THE Field Museum of Natural History has openings for a few men who wish to become museum preparators. An interest in the subject is expected, also manual dexterity, or at least an aptitude for some mechanical or artistic work. Address, **Recorder, Field Museum, Chicago.**

MAKE money writing Photo-plays; details free to beginners. No correspondence course. **Producers' League, 230 Wainwright, St. Louis.**

ALL men, women, boys, girls, 17 to 60, willing to accept Government Positions, \$117-\$190, travelling or stationary. Write **Mr. Oment, 101 St. Louis, Mo.,** immediately.

GOVERNMENT Railway Mail Clerks start \$133 month; expenses paid. Specimen questions free. **Columbus Institute, Dept. E-2, Columbus, Ohio.**

LOCOMOTIVE Firemen for railroads nearest their homes—everywhere; beginners \$150-\$250 monthly. **Railway Association, Desk M-1, Brooklyn, N. Y.**

INCREASE your sales! See advertisement page 122 this issue. **J. B. Simpson, Inc.**

SILVERING Mirrors, French plate. Easily learned; immense profits. Plans free. Address, **Wear Mirror Works, Excelsior Springs, Mo.**

AGENTS, Distributors, capable of organizing sales force, make from \$3,000 to \$10,000 yearly; the best and fastest selling automobile accessory on the market; sells 4 to 8 at a time. Write for particulars. **Continental Co., 912 7th Ave., New York City.**

EARN \$10 daily silvering mirrors, plating and refinishing metalware, auto, chandeliers, bedsteads, headlights. Outils furnished. **E. DeLoe Laboratories, 1133 Broadway, New York.**

EARN \$110 to \$250 monthly, expenses paid, as Railway Traffic Inspector. Position guaranteed after 3 months' spare time study or money refunded. Excellent opportunities. Write for Free Booklet CM-46, **Standard Business Training Inst., Buffalo, N. Y.**

RELIABLE Men and Young Men Wanted Everywhere to distribute free samples and almanacs, etc. No selling or soliciting. No experience or capital needed. Permanent business opportunity at big pay. Do not fail to write us at once for contracts and details. **American Advertising Association, File AA-1, 6930 North Clark St., Chicago, Ill.**

VACANCIES constantly, U. S. Government positions, \$85-\$250 month. Men-women 18 up. Steady. Vacations. List positions free. Write today sure. **Franklin Institute, Dept. A-20, Rochester, N. Y.**

MEN Wanted. Learn Automotive Electricity. Best paying trade today. More positions than we can fill. Many graduates making \$309.00 per month. Taught by mail or personal attendance. You can make money spare time working for us. We pay you liberally and render valuable assistance. Your chance to start a business for yourself without capital. Write for particulars. **Johnson's Automotive Electrical School, Dept. B, 729 Broadway, Denver, Colo.**

35 WEEK, Men 15 up. Become automobile experts. Earn while learning. Write **Franklin Institute, Dept. A, 401, Rochester, N. Y.**

INVENTORS desiring to secure patents should write for our book "How to Get Your Patent," tells our terms and methods. Send sketch for our opinion of its patentable nature. **Randolph & Co., Patent Attorneys, 620 P. Washington, D. C.**

YOU are wanted, U. S. Government jobs, \$117 month. Steady. Vacancies constantly. List free. Write immediately. **Franklin Institute, Dept. A20, Rochester, N. Y.**

AGENTS: \$130 to \$375 monthly easy, introducing New Guaranteed Hosiery. Must wear or replaced free. You simply show samples furnished you and take orders. We deliver and collect. Promotions to General Agency made from active workers. Steady repeat business. Cotton, lisle, silk, heather, wool hosiery for all the family. Spare time satisfactory. No experience required. No capital needed for stock. Your pay daily. **Mac-O-Chee Mills Company, Desk 2699, Cincinnati, Ohio.**

BE a Finger Print Expert. Demand increasing. Write for special free offer, **American Finger Print System, 1966 Broadway, New York.**

EARN your portrait; easy home work. **Black Studio, D36, Los Angeles.**

\$1,600-\$2,300 YEAR. Steady. Railway Postal Clerks. List positions free. **Franklin Institute, Dept. A-20, Rochester, N. Y.**

WRITE articles, stories, news, in spare time for newspapers and magazines. Big pay. Copyright book free. **Press Syndicate, 553, St. Louis, Mo.**

OUR genuine gold window sign letters are an excellent money-making proposition for handy men. **Slann Sign System, Bethune Ave. E., Detroit, Mich.**

SALESMEN, we pay larger commissions than any other Brush House in the Country to men selling our line of Sanitary twisted in wire Brushes. **Sanitary Wire Grip Brush Co., 15 Mercer St., New York.**

\$60-\$200 A WEEK. Genuine Gold Letters for store windows. Easily applied. Free samples. Liberal offer to general agents. **Metallic Letter Co., 438-C, North Clark, Chicago.**

GOVERNMENT wants Railway Mail Clerks, \$132 month. Steady. List positions free. Write immediately. **Franklin Institute, Dept. A-20, Rochester, N. Y.**

WANTED: Railway Mail Clerks—\$1,600 to \$2,300. Exams everywhere. Write today for full information. **Patterson, Civil Service Expert, Box 4025, Rochester, N. Y.**

HOTELS Need Trained Men. Nationwide demand for high-salaried men; past experience unnecessary. We train you by mail and put you in touch with big opportunities. Big pay, fine living, interesting work, quick advancement; permanent. Write for Free Book, "Your Big Opportunity." **Lewis Hotel Training Schools, Room 351, Washington, D. C.**

BE a Finger Print Expert—Opportunities opening everywhere. Write **National System, 186 East 79th, New York.**

STORIES, poems, plays, etc., are wanted for publication. Good ideas bring big money. Submit manuscripts or write **Literary Bureau, 522, Hannibal, Mo.**

ART AND ADVERTISING

CARTOONISTS—Improve your style by following the work of the greatest cartoonists found in the bound volumes of **Cartoons Magazine, Eight volumes, each covering six months, Jan.-June, 1917, to July-Dec., 1920, inclusive, 1200 cartoons, 900 pages to a volume, 7 by 9 1/2 in., 3 in. thick. New books, durable and attractive binding. Sold separately at \$2 per vol. postpaid. Supply limited. Send at once. **Popular Mechanics Book Dept., 200 E. Ontario St., Chicago.****

INFORMATION

CHEMICAL Processes, Analysis, Research, Technical Information. Consulting Chemist, **Madison, Maine.**

MAILING LISTS

2400 COUNTY Agricultural Agents, 1360 Home Demonstration Agents, \$8 thousand. **Morrison, Box 586, Atlanta, Ga.**

TYPEWRITERS AND SUPPLIES

UNDERWOOD Typewriters at far less than manufacturers' price; rebuilt, all worn parts replaced, guaranteed good as new. Cash, installment payments. Write for Catalog 1516. **Shipman-Ward Mfg. Co., estab. 1892, Montrose and Ravenswood Ave., Chicago, Ill.**

TYPEWRITERS, all standard makes, \$10 up. Fully guaranteed. Free trial. Write for complete lists. **Northwestern Typewriter Exchange, 329 West Goethe St., Chicago.**

BLACK Ribbons, any visible machine, 33c each. **Typewriter Supply, 7927-29 Colfax Ave., Chicago.**

TYPEWRITERS, All Makes, Save one-half. Thoroughly Rebuilt in our factory by the famous "Young Process." Fully guaranteed. Free trial. We handle all standard makes. Cash or sold on easy terms. Write for Catalog. **Young Typewriter Co., Dept. 502, Chicago, Ill.**

ADDING MACHINES

NEW \$3.50 Automatic Adding Machine. Adds, Subtracts, Multiplies. Absolutely accurate. Capacity 9999,999.99. Fully guaranteed. 75,000 pleased users. Makes adding easy, positive, quick. Eliminates Mistakes. Saves Time. Postpaid, \$3.50. **Bassett Co., 1458-V, Hollywood Ave., Chicago.**

FREE Trial. Marvelous new Adding Machine. Adds, Subtracts, Multiplies, Divides, automatically. Work equals \$350.00 machine. Price only \$15.00. Speedy, durable, handsome. Five-year guarantee. Used by largest corporations. Write today for catalog and free trial offer. **Lightning Calculator Co., Dept. E, Grand Rapids, Mich.**

DUPLICATORS AND DEVICES

STENCIL Duplicator—Two Dollars, Note Size—Letter, Three-fifty. Prints Typewriting—Handwriting. On Approval. **Primos Specialty Co., M-3, Primos, Pa.**

YOU can make 50 to 100 copies of a letter, notice, etc., at a cost of three cents on a Hoyer Quality Duplicator. Write for free trial offer. **The Hoyer Duplicator Co., 14 S. Wells St., Chicago, Ill.**

"MODERN" Duplicators save Time, Labor, and Money. Gets Business, Reproduces Typewritten or Panned Letters, Drawings, Lessons, Music, Menus, Bids, Notices, Specifications, Maps or anything in one or more colors. Prints Two per minute. Special Sale On 30 Days' Free Trial, \$2.25 up. **Booklet Free. J. E. Durkin-Reeves Co., Pittsburgh, Pa.**

BUSINESS SERVICE

INCORPORATE. Our lawyers do the work, saving you time, annoyance and money in incorporating under the most liberal laws of Arizona. Laws and forms free. **Southwestern Securities & Investment Co., Box D488, Phoenix, Ariz.**

PRINTING, ENGRAVING AND MULTIGRAPHING

GUMMED Labels! Rubber Stamps! Interesting Samples Free! **Edward Harrison, "Printing," Baltimore.**

CALLING Cards. Fifty best quality calling cards sent upon receipt of 25c. Prompt service. Send your order today. The Norcity Print, 11 Stillman St., Boston, Mass.

GUMMED Labels—1,000, \$1.00; 3,000, \$2.00. Send for Samples. Jacobus Printing Company, 1627 Madison St., Chicago.

WE print everything. Stationery, Booklets, Catalogs, Circulars, Samples. Commercial Press, Batavia, Ohio.

200 HAMMERMILL Bond letterheads, size 6x7, and 100 envelopes to match, neatly printed in blue ink, with your name and address, only \$1.00 postpaid. Leo Spillane, Red Lake Falls, Minn.

150 EACH Letterheads and Envelopes, \$1.50. Jacobus Service, Irvington, N. J.

1000 HAMMERMILL Bond letterheads, Mailed \$3.50. Express and Standard Corporation, Newport City, Va.

100 LETTERHEADS and 100 Envelopes \$1. Hedin, 3509 Franklin Avenue, Saint Louis.

200 HAMMERMILL Bond Letterheads, Envelopes, Billheads or Business Cards, \$1.00 postpaid. Race Printing Company, Hudson, N. Y.

250 LETTERHEADS, 250 white envelopes, printed and mailed, \$3.00. Samples printing free. Sunco, Mohawk, N. Y.

PRINTING Outfits—Presses, type supplies, type novelties. Send stamp for catalogue. Model Press, York, Penna.

QUALITY Printing! Reasonable Prices! Tell us your wants and let us quote our Money-Saving prices. Best Work. We print anything. Ernest Fantus, 525 South Dearborn Street, Chicago.

PRE-USED Printing Presses. Type and supplies. List for stamp. Popular Barrens, Richland, Pa.

1,000 LETTERHEADS or Envelopes, \$3.00. Sent Prepaid. Samples Free. Moulton Press, Morrisville, Pa.

225 BOND letterheads, envelopes, billheads, cards, \$1.25 each. Combination, \$4.00. Economic Press, Leonia, N. J.

FOR MEN

LEARN to Swim—complete instructions 50c. Mercatus Co., Box 361, Indianapolis.

ARE you old at forty? See our advertisement on page 143 of this issue. The Electro Thermal Company, 2125 Main St., Steubenville, Ohio.

BOATS AND LAUNCHES

BOWBOATS—easily made. Blueprint list free. Weashe-Uco, West Market, Detroit, Mich.

"HOW to make your boat leakproof." Send for booklet. L. W. Ferdinand & Co., 152 Kneeland St., Boston, Mass.

OPTICAL GOODS

BAUSCH-LOMB Microscope. Triple objectives, including oil immersion. Guaranteed like new, \$69.00. Send for complete description and photograph. Sackheim, 649 N. Clark St., Chicago.

FOR THE HOME

BEAUTIFUL Oil Paintings, famous California scenery. Painted by instructor of eastern art school. Sizes 6x12, \$4.00; 8x14, \$6.00. Other sizes on request. Josephine Manchester, 2230 Pacific Ave., San Francisco, Cal.

ANTIQUES AND WAR RELICS

INDIAN Baskets, Blankets, Wampum, Mata Wholesale, Catalogue, Gilham, Kelseyville, Calif.

PHONOGRAPHS AND RECORDS

BUILD your own phonograph. We furnish everything. Catalog free. American Phonograph Co., 3515 North Crawford, Chicago.

BUILD Your Phonograph. Quality phonographs. Quality Serravallo motor and motors of other types. Electric Motors, tonearms, reproducers, amplifiers, case material, accessories. Free blueprints and building instructions. Big saving. Wonderful results. Prompt delivery. Catalog mailed for ten cents. Hoosier Manufacturing & Supply Co., 213 Baldwin Block, Indianapolis, Ind.

MUSIC AND MUSICAL INSTRUMENTS

SAXOPHONISTS: Get free circular about New Saxophone Book. Virtuoso Schools, Buffalo, N. Y.

COMPLETE, easy self-instructors—harmonic, Violin, Piano, Drum, Ocarina, Ukulele, Accordion, Saxophone 25c each. G. Elsen, Bowling Green, Ohio.

C. G. CONN. Silv. Pl. B; Tenor Sax. with case, good as new, \$72.50. Save half or more on saxophones or other musical instruments. Write, stating exactly what you want; no list published. Empire Loan Bank, 619 No. Clark St., Chicago, Ill.

MUSIC rubber stamps, burning brands, adjustable stencils, rubber type catalogue 25c. W. Karstadt, Dayton, Ohio.

CORNETISTS—Trombonists—Saxophonists—Clarinetists. Send for "Free Pointers No. 2." Name instrument. Virtuoso School, Buffalo, N. Y.

VIOLINS—Deep, Mellow, Soulful—on credit. Easy terms for wonderful instrument. Get details today. Gustav F. Henning, 2421 Gaylord St., Denver, Colo.

WRITE Songs. Big money and reputation. Write for information. J. Gordon Pub. Co., 201 N. Hoyne Ave., Chicago.

I WANT song poems. Casper Nathan, Garrick Theatre Building, Chicago.

PATENT ATTORNEYS

INVENTORS should write us for our book, "How to Obtain a Patent," which clearly sets forth what may be patented and the necessary steps to protect an invention; it describes the procedure in patent office and tells about assignments, licenses and trade marks, and gives many useful facts about patents which every inventor should know; many persons well versed in patent matters have pronounced the book the best of its kind they have ever read; it is written so you can understand it; copy free upon request. Talbert & Talbert, Patent Lawyers, 481 McGill Bldg., Washington, D. C.

PATENTS promptly procured. Personal, careful and efficient service. Highest references. Moderate fees. Send sketch for model or actual search and advice. George P. Kimmel, Master of Patent Law, 54-L, Loan and Trust Bldg., Washington, D. C.

INVENTORS: Record invention legally before disclosing to others. Our Invention-Record and Data Sheet shows how. Sent free and valuable information given on patent procedure, costs, etc. Report on patentability includes copies of patents nearest your idea. O'Connell & O'Connell, Jenifer Building, Washington, D. C.

PATENTS and Trade-marks obtained. Prompt service. Write for our new book on patents. Established in 1889. D. Swift & Co., 349-7th St., Washington, D. C.

To proceed properly and safely, send sketch and description for personal advice in your particular case and estimate of costs. H. F. Lowenstein, Registered Patent Attorney, McLachlen Building, Washington, D. C.

MONROE MILLER, Ouray Building, Washington, D. C., patent attorney, mechanical and electrical expert. Best quality of work and results. Moderate charges.

MILLIONS spent annually for ideas! Hundreds now wanted! Patent yours and profit! Write today for free books—tell how to protect yourself, how to invent, ideas wanted, how we help you sell, etc. American Industries, Inc., 500 Kresge Bldg., Washington, D. C.

PATENT application filed on partial payment plan. Trade-marks, copyrights, etc. Milo B. Stevens & Co., 655 F St., Washington; 352 Monadnock Bldg., Chicago. Estab. 1844.

INVENTORS—Send for form "Evidence of Conception" to be signed and witnessed. Form, fee schedule, information free. Lancaster and Alwine, 221 Ouray Bldg., Washington, D. C.

PATENTS—Before disclosing an invention the inventor should write for our blank form "Record of Invention." This should be signed, witnessed and returned to us together with model or sketch and description of the invention and we will give our opinion as to its patentable nature free. Our Three Books mailed free to inventors. Our Illustrated Guide Book, "How to Obtain a Patent," contains full instructions regarding patents. "List of Patent Buyers" sent free, contains unsolicited letters from manufacturers and others who are constantly writing us regarding the purchase or leasing of meritorious patents. Victor J. Evans & Co., 934 Ninth, Washington, D. C.

PATENTS—Booklet and full instructions without obligation. B. P. Fishburne, Registered Patent Lawyer, 331 McGill Bldg., Washington, D. C.

PATENTS Procured. Send sketch or model today for examination, prompt report and advice. No charge for preliminary advice. Write for free booklet and blank form on which to disclose your idea. Highest references. Promptness assured. Clarence A. O'Brien, Registered Patent Lawyer, 561 Southern Building, Washington, D. C.

PATENTS Procured; Trade-marks Registered—A comprehensive, experienced, prompt service for the protection and development of your ideas. Preliminary advice gladly furnished without charge. Booklet of information and form for disclosing idea free on request. Richard B. Owen, 30 Owen Bldg., Washington, D. C., or 2276-R, Woodworth Bldg., New York.

LACEY Patent Sense. See page 158.

EDWARD C. SASNETT, formerly a Principal Examiner U. S. Patent Office, Personal service, 516 McGill Bldg., Washington, D. C.

SEND sketch for search report. Get my latest book on Patents. H. L. Woodward, 714-9th St., Washington.

MONTHLY Payments, moderate patent cost. Disclosure blank free. Sterling Back, Washington, D. C.

INVENTORS desiring patents, read the free treatise, "Reducing Inventions to Property Rights." Lester E. Barrett, 629 F Street, Washington, D. C.

INVENTORS: Send sketch or model of invention for opinion concerning patentable nature and exact cost of patent. Book "How to Obtain a Patent," sent free. Tells what every inventor should know. Established twenty-eight years. Highest references, prompt service, reasonable charges. Address Chandler & Chandler, 438 Seventh, Washington, D. C.

PATENTS, trade marks, copyrights. Prompt, personal, reliable service. Over 20 years' active practice. Write for terms. Book free. Address E. G. Siggers, N. U. Bldg., 918 F St., Washington, D. C.

PATENTS. Booklet free. Highest references. Best results. Promptness assured. Send model or drawing for preliminary examination. Watson E. Coleman, Patent Lawyer, 624 F Street, Washington, D. C.

"INVENTORS' Guide" free on request; gives valuable information and advice for all who have original ideas or improvements. Frank Lehmann, Registered Attorney and Engineer, 15-P Park Row, New York.

PATENTS. My fees in installments. Advice book free. Frank Fuller, Washington, D. C.

BOOK on inventions, patents, trade-marks, sent free, advice given; excellent references. Twenty-three years' experience. Robb, Robb & Hill, 1348 Hanna Bldg., Cleveland, Ohio, 811 McLachlen Bldg., Washington, D. C.

BEFORE or after filing application for patent on your invention it will pay you to read over my "Inventor's Advisor No. 2," free for asking. M. Labiner, Registered Patent Attorney, 3 Park Row, New York.

FOR INVENTORS

I SELL Patents. Established in 1909. A service for the inventor that serves Bankers, Lawyers, Patent Attorneys, Corporations, Mechanics, men in every walk of life, are my clients. Why not you, if you have a patent to sell? Charles A. Scott, 773PM Garson Avenue, Rochester, N. Y.

PATENTS—"How to Obtain a Patent" is the name of a book which every inventor should have. It will be sent free upon request, and will tell you what you want to know about patents. It contains the whole story. It describes the different parts of the application and explains in simple language the prosecution before the Patent Office. It tells about joint applications, reissues, assignments, licenses, interference, infringements, process patents, design patents, trade-marks, and prints and labels. If you are interested in patents either as an inventor, manufacturer or owner of a patent you will enjoy reading this book which was written by a lawyer who has had twenty-five years' experience in patent matters. If you have an invention and will send us a sketch, model or photograph of it we will promptly make a search of the Patent Office records and advise you whether or not, in our opinion, your invention is patentable, our charge for this service being \$5.00. We feel that our experience of twenty-five years has fitted us to render prompt and efficient service which will merit your confidence. Write today. Talbert & Talbert, 464 McGill Building, Washington, D. C.

HAVE \$5,000.00 cash to invest with services in exceptionally good patent. Kindly forward full particulars first letter. Martins, 905 Mulberry Street, Scranton, Pa.

PATENTS. Is yours for sale, write for offer. Western Distributors, De Soto, Ia.

INVENTORS, if you're not fully experienced on patent matter, better learn from one who is. My facts will prove valuable assistance. Adelard Plouffe, 38 South St., Woonsocket, R. I.

PATENTS Procured. Send sketch or model today for examination, prompt report and advice. No charge for preliminary advice. Write for free Booklet and blank form on which to disclose your idea. Highest references. Promptness assured. Clarence A. O'Brien, Registered Lawyer, 562 Southern Building, Washington, D. C.

PATENTS Procured; Trade Marks Registered. A comprehensive, experienced, prompt service for the protection and development of your ideas. Preliminary advice gladly furnished without charge. Booklet of information and form for disclosing idea free on request. Richard B. Owen, 39 Owen Bldg., Washington, D. C., or 2276-R, Woodworth Bldg., New York.

PATENT Sense—"The book the inventor keeps." Free. See Lacey ad, page 158.

DON'T waste money on ideas. Before patenting secure my opinion as to patentability, including copies of nearest patents, based on search of pertinent U. S. Patents, for \$5. Send sketch. Ralph Burch, Registered Patent Lawyer, Jenifer Building, Washington, D. C.

TO sell your Patent, Write me; experienced handling, immediate action. Address Arthur S. Billings, Suite 401 Dekum Bldg., Portland, Ore.

UNPATENTED ideas can be sold. I tell you how and help you make the sale. Particulars free. Write W. T. Greene, Jenifer Building, Washington, D. C.

INVENTORS—Send your ideas for manufacturing development in our modern sheet metal and angle-iron fabricating plant. Those pertaining to dust collecting or ventilating preferred. Liberal payment for accepted inventions. Kirk & Blum Manufacturing Co., 2851 Spring Grove Ave., Cincinnati, O.

PATENT Application Blanks free to inventors. Patent News-D, Washington, D. C.

INVENTORS' Educator: 900 Mechanical Movements, 50 Perpetual Motions. How to procure and sell patents. Mechanical Movements greatly assist inventors, suggest new ideas. Explains how to select an attorney and avoid Patent Sharks. Price \$1.50. Postage Free. Albert E. Dieterich, 621 Ouray Building, Washington, D. C.

PATENTS. Write for free illustrated guide book. Send model or sketch and description for free opinion of its patentable nature. Highest references. Prompt attention. Reasonable terms. Victor J. Evans & Co., 157 Ninth, Washington, D. C.

GET your own patents. Application blanks, complete instructions \$1. Cutting Sons, Campbell, Cal.

"**INVENTORS' Guide**" free on request; gives valuable information and advice for all inventors. Frank Ledermann, Registered Attorney and Engineer, 15-F Park Row, New York.

PATENTS. If you have an invention which you wish to patent you can write fully and freely to Munn & Co. for advice in regard to the best way of obtaining protection. Please send sketches or a model of your invention and a description of the device, explaining its operation. All communications are strictly confidential. Our vast practice, extending over a period of seventy-seven years, enables us in many cases to advise in regard to patentability without expense to the client. Our Handbook on Patents is sent free on request. This explains our methods, terms, etc., in regard to Patents, Trade Marks, Foreign Patents, etc. "Scientific American" contains Patent Office Notes. Decisions of interest to inventors and particulars of recently patented inventions. Munn & Co., Solicitors of Patents, 623 Woolworth Bldg., New York; Scientific American Bldg., Washington, D. C.; 801A Tower Bldg., Chicago, Ill.; Hobart Bldg., San Francisco, Calif.

MODEL Making and experimental work; Modern Shop; expert workmen. Manufacturing. Lamson Electrical & Mfg. Co., 625 W. Jackson, Chicago.

HAVE You an invention? If so, write for our free book, "How to Get Your Patent," tells our terms and methods. Send model or sketch for our opinion of its patentable nature. Randolph & Co., Dept. 144, Washington, D. C.

INVENTORS, write for free copy of Modelcraft. R. G. Clyne, St. Louis, Mo.

PATENTS FOR SALE

FOR Sale, my Patent Combination Try and Mitre Square. A boon to carpenters and mechanics. Inquire, Randolph A. Wells, 524 Market St., Kenosha, Wis.

FOR Sale, New improved Stop Signal for Automobiles and Trucks. Operates automatically. Will not wear the battery down. Write for sample. A. J. Boyd, Box 10, Auburndale, Mass.

PROPOSITION for men of big business. Untold treasures can be recovered from ocean depths with the aid of Phillips patent salvage ship. Investigate. F. G. Phillips, 620 Woodland Drive, Vancouver, B. C.

INCENSE Burners, 13512; Cow Tail Holders, 13716; Flashlight Attachment for Guns, 13839; Harrow, 13534; Animal Hoop, 13620; Vehicle, 13980. Talbert & Talbert, McGill Bldg., Washington, D. C.

FOR Sale—Patent pending. Metal railroad tie. Free specifications. H. M. Jennings, Afton, Texas.

UNIQUE table of many uses. For sewing, games, carols, nut-cracking, etc. Outright or royalty. A. M. Hannon, Wabek, No. Dak.

AUTOMOBILE Towing Dolly, adjustable for width and height, center extension for lifting cars, preparatory to blocking. Speedy and practical. Outright sale desired. C. T. Jacobson, 48 Tehama St., San Francisco, Calif.

INVENTION for Sale. Patented and patent pending. Outright or cash and royalty. Guard attachment for spraying machine. Protects stock machinery and general surroundings while spraying calcimine, cold water, paint, or white-wash. Description on request. John Paschall, 1411 W. Madison St., Chicago, Ill.

FOUNTAIN Manicuring Instrument; Sponge Filled Absorbent Pad; Writing Board; Gift Novelty; Refrigerator without drain pipe or drip pan. M. V. Bauer, 661 McLachlen Bldg., Washington, D. C.

WONDER Lock, no duplicate keys; high class use only. Banks, Mailboxes, Lockers, Automobiles. Sale or Royalty. C. M. Shigley, Wesley Block, Columbus, Ohio.

OUTRIGHT or Royalty: Washer halves. Snaps, forming complete Washer instantly. No need removing nut. Manufactured cheaply. Patent 1,452,492. E. H. Carpenter, Baird, Texas.

YOU have a worth-while patent, haven't you? Why don't you tell our two million readers about it? Most of them are specially interested in patents and new inventions. Ask me to tell you how other inventors successfully sold their patents. Geo. P. Baker, Manager, Classified Advertising, Popular Mechanics Magazine, Chicago, Ill.

PATENTS For Sale: To sell, buy or obtain patents write Patent News—P. Washington, D. C.

PATENT on Cream Separator disc washer—cheap. Wonderful labor-saving device. Clayton Tanks, Elroy, Wisc., Route 1, Box 34.

SURVEYING INSTRUMENTS

NEW and used surveying instruments direct from factory. Satisfaction guaranteed or money refunded. Wisler, 619 Broadway, St. Louis.

MODELS AND MODEL SUPPLIES

MODEL Making Supplies—2"—4" diameter special thin brass tubing for Model Boilers, 10c—20c per inch. Machined ends, per pair, 2", 75c; 4", \$1.50. Miniature machine screws, 3/32" up. Finished Boiler Fittings. Catalogue 20c. Bathe Mfg. Co., Dept. D, 5214 Woodland Ave., Philadelphia, Pa.

MODELS, Tools, Patterns, Castings. Instrument work. Send sketch for estimate. Lowest terms. Arthur Schmidt, 394 Canal St., New York City.

PATENTS Procured. Send sketch or model today for examination, prompt report and advice. No charge for preliminary advice. Write for free Booklet and blank form on which to disclose your idea. Highest references. Promptness assured. Clarence A. O'Brien, Registered Patent Lawyer, 562 Southern Building, Washington, D. C.

WE Build Models, design, develop, and manufacture articles in large or small quantities. Homeyer Machine Products & Mfg. Co., 1885 E. 17th St., Cleveland, Ohio.

OUR factory will make your models, manufacture your articles as well as build your tools, dies and fixtures. Standard Die & Specialty Co., 817 W. Washington Blvd., Chicago, Ill.

MODEL Making and experimental work; Modern Shop, expert workmen. Manufacturing. Lamson Electrical and Mfg. Co., 625 W. Jackson, Chicago.

DIES, Tools and General Manufacturing. Models, and Manufacturing of new inventions our specialty. Logan Machine Co., 222 S. Clinton St., Chicago, Ill.

WE make working models for inventors and do experimental work and carry a complete stock of brass gears and model supplies. Send for catalogue. The Pierce Model Works, Tinley Park, Ill.

BEFORE ordering your model write for free copy of Modelcraft. R. G. Clyne Engineering Co., St. Louis, Mo.

INVENTORS—Write for our free illustrated guide book and Evidence of Conception Blank. Highest references. Prompt attention. Reasonable Terms. Victor J. Evans & Co., 165 Ninth, Washington, D. C.

RACING 2 and 3 cylinder poppet valve engines, original steel boilers. Special plant; engine, boiler, torch \$22.50. Send 10c in stamp for catalogue. Model Machine Shop Co., 417 East 71 St., New York City.

FOR MANUFACTURERS

MANUFACTURERS: Can sell your products—good market. South American. Bank references. Rowe, Casilla 2620, Buenos Aires, Argentina.

WANTED—Someone to manufacture and sell Tire Tester, Something new. Unnecessary to remove gauge until tire is inflated. For particulars write: Sladik, 5119 West Lake St., Chicago.

SPECIAL labor saving machinery, Jigs and Fixtures and other production tools, Punches and Dies for all kinds of metal stampings, Gauges, manufacturing and machine work to order. Simplex Tool Company, Woonsocket, R. I.

WANTED—Metal Stamping and Model work taken on contract basis. We are ideally located and equipped to develop patents. Meyers Company, Box 326, Bedford, Ind.

MANUFACTURING

UNUSUAL opportunity—new factory well equipped for dies, stampings, die-casting, screw-machine and wire products. Plating, Enameling, Burnishing. Quotations to responsible parties. Metal-Craft Manufacturing Co., Box 259, Chicago.

EXPERIMENTS developed, dies, models and manufacturing, machine designing. Estimates and information promptly given. Address Schroer Bros. Machine Works, 512 East 25th Street, Kansas City, Mo.

LONG established manufacturer of auto accessories which are daily sold by practically all wholesale and retail accessory houses will consider manufacturing and distributing new automobile products, capable of equally wide sale through same channels. Patented articles preferred. Address Auto Accessory Manufacturer, 1512 North American Bldg., Chicago, Ill.

SCREWS, nuts, screw machine products, all metals. Autoscrew Works, 355 West Broadway, New York City.

WE design and build special machinery. Send for free copy of Modelcraft. R. G. Clyne Engineering Co., St. Louis, Mo.

SPECIAL labor saving machinery, jigs and fixtures and other production tools, punches and dies for all kinds of metal stampings, gauges, manufacturing and machine work to order. Simplex Tool Company, Woonsocket, R. I.

IRON, Brass, Aluminum Castings, Models, Patterns, Light Manufacturing. Welch Brothers Co., North Chicago, Ill.

PATTERNS, wood and metal. Models, tools and dies. Brass, bronze, aluminum and iron castings. Screw machine work, production work of all kinds. Write Modern Machine & Pattern Co., Terre Haute, Ind.

WIRE Goods, all kinds, made to order. Cooley Mfg. Co., 524-530 N. Western Ave., Chicago.

IF you want dies and metal stampings write us. Lyons Machine Works, Lyons, Ia.

MACHINERY, TOOLS AND SUPPLIES

MACHINE No. C-193; One 3ft. Linderman Glue Jointer complete without motors. Price \$1500. Machine No. C-17; One 14x36 R. H. Horizontal Corliss Engine valve, skeleton frame, 1ft. x 6ft., outdoor shaft, rigid pillow block groove, V rope shears for 1" rope. Price \$1000. Machine No. C-364; One 11x12 Ames Automatic Engine, side crank single valve. Price \$1000. Machine No. C-367; One Type S, 50 k.w. 240 to 250 volts, 275 r. p. m. Sprague Generator with Cutler-Hammer Field Regulator. Price \$1000. Attention! Purchasing Department, Kollogg Switchboard & Supply Company, Chicago.

NO. 1 Arcade Molding Machines, \$200.00, No. 2 Arcade Molding Machines, \$225.00. The Wehrle Co., Newark, Ohio.

THE Bulking Drift Bolt Puller, an especially designed tool for withdrawing driftbolts, is operated with a crowbar. Useful in bridge building, car repairing, wharf and dock work. Price, 60 cts. each. Order direct from Electric Steel Foundry, Portland, Ore.

FOR Sale—One 150 hp. Russell Automatic, four valve, left hand, steam engine. Tangeye bed, side crank, sliding valves, automatic governor, iron fly wheel 22"x8". Excellent condition. If interested write for further particulars. Goshen Sash & Door Company, Goshen, Ind.

IMPACT Testing Machine, \$200.00, Toledo Postal Scale, \$25.00. The Wehrle Co., Newark, Ohio.

CONCRETE Building Block Machines and Molds. Catalogue free. Concrete Machine Co., 303 South Third St., St. Louis, Mo.

ELECTRICAL

X-RAYS simply Explained. An excellent and practical book on radiography for only 25 cents, postpaid, 93 pages, illustrated. Paper covers. Popular Mechanics Book Dept., 200 E. Ontario St., Chicago.

WHOLESALE Prices Motors and Electrical supplies, including sockets, tape, sockets, switches, wire, conduit, cleats, lams, porcelain goods. Illustrated Catalog free. Hyre Electric Co., 633-1114 S. Dearborn St., Chicago.

LEARN How to Wind D. C. Armatures. Engineering students will find in this book by W. E. Hennig a simplification of a difficult yet important subject. Mathematical and technical discussions have been avoided as far as possible. Contains all diagrams heretofore scattered in many books, 205 pp. illus. in colors. Cloth binding. Price \$3.50 postpaid. Popular Mechanics Book Dept., 200 E. Ontario St., Chicago.

ELECTRICAL Experimenters—Here is the book you have been waiting for: "How to Make Things Electrical." 256 articles, 427 pages, 353 illustrations. Price \$2 postpaid. Popular Mechanics Book Dept., 200 E. Ontario St., Chicago.

ENGINES, MOTORS AND DYNAMOS

MOTORS, G. E. $\frac{1}{4}$ hp., \$16.50; $\frac{1}{2}$ hp., \$22.50. Generators, 8v, 10 amp., \$15.00; 32v, 500 watt, \$30.00. Write for catalog. Motor Specialties Co., Crafton, Pittsburgh, Pa.

ALTERNATING Current Motor Bargains. Reliable Makes only, including new $\frac{1}{4}$ H. P.—\$13.00; new $\frac{1}{2}$ H. P. General Electric \$29.00. Westinghouse, Crocker-Wheeler, Wazner, Emerson, Century motors, special prices. All guaranteed for one year. Buy now before prices advance. Motors repaired and exchanged. Hyre Electric Co., 633-FX South Dearborn St., Chicago.

FOR MECHANICS

1,000,000 INDUSTRIAL Facts, Calculations, Receipts, Processes and Trade Secrets for every business are contained in the 1016-page book "Moore's Universal Assistant and Complete Mechanic," 500 Engravings, Cloth. Price \$2 postpaid. Popular Mechanics Book Dept., 200 E. Ontario St., Chicago.

PATENTS—Write for our free illustrated guide book and Evidence of Conception Blank. Send model or sketch and description of the invention for our opinion of its patentable nature free. Highest references. Prompt attention. Reasonable terms. Victor J. Evans & Co., 184 Ninth, Washington, D. C.

FOR THE SHOP

POPULAR Mechanics Shop Notes are published annually in book form; price 50 cents postpaid. The latest volume containing all notes in the magazine during 1922 is ready. Better send \$1 today for the two latest issues and get acquainted with these wonderful aids in your work. Back volumes are in great demand and we can supply 15 of them at 50c each. Altogether they make an encyclopedia of mechanical information that is priceless to the owner. Popular Mechanics Book Dept., 200 E. Ontario St., Chicago.

BLACKSMITHS

BLACKSMITHS, Listen: Any Handy man can make more money doing hard jobs easy. Forging and welding solid, with Toy's Modern Methods of Blacksmithing. Hardening and tempering to a standard with colored tempering charts. All for one dollar. Samples Free. W. M. Toy, Sidney, O.

FOR SALE—MISCELLANEOUS

FISHING Reel, Aluminum Folding Star Type. A Success. Albert Jenks, Thackery, Ohio.

BUY—Exchange—Sell! Many of our readers hate for sale or exchange the article you are looking for—and lots of them are looking for the very items you want to turn into cash. Get together! Let our two million readers know your wishes—they'll help you! Send your ad today to Geo. F. Baker, Manager Classified Advertising, Popular Mechanics Magazine, Chicago.

GASOLINE Lamps and Lanterns. Catalog Free. Little Wonder Light Co., Terre Haute, Ind.

WANTED—MISCELLANEOUS

WANTED—Complete file of Popular Mechanics Magazine for the years 1902 and 1903. Must be in good condition. Will pay \$5.00 for full sets of either year. Address, Geo. F. Baker, Room 304, Popular Mechanics Bldg., 200 East Ontario, Chicago, Ill.

JEWELRY wanted. Send anything, cash waiting. Cook Smelting Works, 691 Congress East, Detroit, Mich.

WILL buy, sell and exchange for you anything you have in Jewelry, Diamonds, Pearls, Rubies, Gems, Platinum, Silver, Etc. Quick returns. Wiegand & Co., Irvington, N. J.

CASH sent immediately for old gold, silver, platinum, watches, diamonds, magnet points, unused postage stamps and other valuables. Merchandise returned if payment unsatisfactory. Busch Products, 144 Fifth Avenue, New York.

MAIL us your old jewelry, gold, silver or platinum, diamonds, trinkets, etc. Liberal payment will be rushed return mail. If not satisfactory return money within ten days—we'll return goods our expense. Universal Exchange, 69 Canal St., Boston, Massachusetts.

WANTED—State contracts. Kitchen specialties. Mail complete detailed offers. United Supply House, Lyons, Iowa.

WANTED, Copies of Popular Mechanics Magazine of October 1922 in good condition. Will pay 25 cents per copy. Address Room 311, Popular Mechanics Magazine, 200 East Ontario St., Chicago, Ill.

MAIL us your discarded Jewelry, Gold Crowns and Bridges, Watches, Diamonds, Silver, Platinum, and Old False Teeth. Money promptly mailed. Goods returned if offer refused. United States Smelting Works (The Old Reliable), Dept. 71, Chicago.

REAL ESTATE AND FARM LANDS

\$400 SECURES 120-acre Farm, 9 cows, horse, 4 acres oats and Hungarian, acre corn and potatoes, large vegetable garden, hay, 100 poultry, hog, furniture, full implements included to settle quickly; convenient two railroad towns; fine 7-room house, big barn, Price \$3000, only \$400 needed. Page 308 Big Catalog. Strout Farm Agency, 156P Nassau St., New York City.

WANTED—I want farms for cash buyers. Describe and state price. R. A. McNow, 312 Wilkinson Bldg., Omaha, Neb.

PECAN-Orange Units, Easy terms, Big returns. Write Dept. B, Suburban Orchards Co., Ocean Springs, Miss.

FOR Sale—Silver-Lead properties with good titles located in western part of State of Zacatecas, Mexico. Chalchihuites District, within twelve miles of railroad station. Cheap labor and transportation. For detailed information and description of properties, address A. T. Biting, Chalchihuites, Zacatecas, Mexico.

LANDSEEKERS! Attention! \$10 to \$50 down starts you on 20, 40, 80 acre tracts; near thriving city in lower Michigan; balance long time. Investigate this opportunity. Write today for free illustrated booklet giving full information. Swigart Land Company, P-1259 First Nat'l Bank Bldg., Chicago.

ATTENTION!! You can have a business of your own. Establish and operate New System Real Estate Business, brokerage and insurance agency in your community. Office at home. Earn \$5,000 year. Representatives wanted everywhere. Send stamp free booklet. Hayes Realty Association, Cincinnati, Ohio.

FOR Sale—Three full sections in McKenzie County and two sections in Billings County, North Dakota. Each section contains land suitable for crops, balance for cattle. Each section has valuable deposits of lignite which some day will alone be worth many times the present value of the land. This part of the state is developing very rapidly, with good schools within easy access. As owner cannot use this land himself, will sell one or more sections at a price which almost anyone can afford to pay. Address W., care Popular Mechanics, 200 East Ontario St., Chicago.

SELL your property quickly for cash, no matter where located. Don't pay big commissions. Particulars free. Real Estate Salesmen Co., Desk B., Lincoln, Neb.

DOGS

RUSSIAN Wolfhounds. We are the world's largest importers, breeders and most successful exhibitors of wolfhounds and can supply your wants. Once a wolfhound owner, always one. Valley Farm Kennels, Stamford, Conn.

IRISH Terriers—\$35 up. Garrett, 1563 Logan Ave., Youngstown, Ohio.

Only 50 days Between You and Big Money in **AUTOMOTIVE ELECTRICITY**



Four Times His Former Salary

"I was making \$40 a week as Head Bookkeeper when I took up your training. Last week I made \$170, and hardly a week passes in which I don't make at least \$160. No labor either. I locate the trouble and the mechanics do the work."

"HENRY L. LUDLOW, Indiana."

**Come to Chicago
or Train at Home
for this New Field
that Covers 78% of
**AUTOMOBILE
TROUBLES****



Makes \$1000 a Month

"I trained with you 7 weeks. Then I started right to work with a big garage. Averaged about \$310 a week. After 8 weeks I opened my own shop. Find it easy to get any price I choose to charge. Clearing over \$1000 a month. W. G. ELLERD, Neb."

YOU'D probably be willing to take a four year college course if you could earn \$132.00 a week when through. But you don't have to. **FOR YOU CAN BE READY IN FIFTY DAYS** to earn that much and more, just like any number of my former students are doing. Get my book that gives the facts and figures.

Big Jobs Open

This fascinating new profession is clamoring for men. Garage and Repair Shop Owners can get all the ordinary mechanics they need. Mechanics can learn in a shop, but Auto-Electrical Experts are study-trained. That's why shops can't get the man who knows automobile electricity. And yet they have to have him. Auto-owners will no longer pay for 10 hours' service while an ordinary mechanic fiddles around trying to find what is wrong. When you consider that 78% of all automobile troubles are electrical troubles you'll realize why the car owners are combing the market for experts. My **free** book will give you some surprising facts.

No Experience

Best of all, you can get in this big pay profession in 50 days—without knowing about electricity or automobiles beforehand. If you can read and write, you can succeed. We teach you everything in a practical, brass tacks way, which my book explains fully.

Amazing New Way to Train

When the government needed Auto-Electrical Experts for the war there was no time to waste. Men had to be trained 100% right and sent out almost overnight. The man who invented the 50-day method was the man to whom Uncle Sam went for help. Results were amazing. Never before had such a thing been accomplished by anyone. A complete, practical, thorough training in 50 days. So remarkable that after the war, and at a great cost, it was made available to Ambu students only.

Ambu has even improved on the original plan by **not admitting more than 20 men to a class. No other school does this** and the smaller the class the more you learn.

When my graduates are grabbed up at big salaries; when men like Ludlow jump from a \$40 a week bookkeeping job into an income of \$175 a week as Automotive Electrical Expert; when fellows who want to be their own boss, like Ellerd, clean up \$1000 a month; everybody simply **HAS** to agree that Ambu Training can't be beat. Get my book and see the proof.

Get Out of the Grease

I know what a demand there is for my graduates. I know what remarkable earnings they are making. I know how employers are glad to get their services. I have hundreds of letters that show how Ambu graduates "make good." I'll send you copies of them; tell you to write these former pupils; let them tell you what a fascinating, easy profession it is. In my free book I show you how you can get paid big for **headwork**, not handwork; how you keep out of the grease, lifting, labor, etc., which the ordinary mechanic has to do.

Get FREE Book

Everything is explained in a remarkable eye-opening book that will be a revelation to you. It shows how my graduates are equally expert whether they come to classes here in Chicago or **LEARN IN SPARE TIME AT HOME**.

Get it at once. It is free. If you act quick you'll also be able to take advantage of a most unusual short-time offer I am making. Mail coupon today.

C. J. BUCKWALTER, Pres.

AMBU ENGINEERING INSTITUTE

Dept. 19, 2632 Prairie Ave.

CHICAGO



Continued from Page 44

COLLIES for Sale. Training Book 35c. Sunnybrae Kennels, Bloomington, Ill.

POULTRY

PIGEON Keeper—Biggest and Best illustrated monthly magazine. Sample copy 15c. American Pigeon Keeper, 736-P Cornelia Ave., Chicago, Ill.

PLANS for Poultry Houses. All styles. 150 illustrations; secret of getting winter eggs, and copy of "The Pull Egg Basket." Send 25 cents. Inland Poultry Journal, Dept. 74, Indianapolis, Ind.

PERSONAL

YOUR Horoscope, Business, Character, Changes, Friends, Enemies. Send birth date and ten cents (stamp) for remarkable test reading. Zanya, C-202 W. 105th St., New York.

FREE—Information of a scientific nature that has brought happiness through perfect health to thousands. No charge; no obligation. Enclose stamp for reply. C. O. Wood & Co., Colorado Springs, Colo.

YOUR greatest asset is Personality. Add to your stock. Success Tips and Self-Revealing chart 10c. Thomson-Heywood, Dept. PM, Chronicle Bldg., San Francisco, Calif.

ARE you bashful, self-conscious, easily embarrassed? These troubles overcome. Send dime for particulars. C. Veritas, 1160 Broadway, New York, N. Y.

UNUSUAL Horoscope—Six pages covering full year. Includes extensive reading, Astro-Analysis, valuable daily guide and special forecasts for each month, scientific, complete. Try it. Send birthdate and 50c. Money returned if dissatisfied. Prof. Helles, Box 5, Fordham Station, New York, N. Y.

PLEASANT Root easily, inexpensively overcomes tobacco habit. Send address. Franklin Steles, Mohawk, Fla.

ARE You Old at Forty? See our advertisement on page 143 of this issue. The Electro Thermal Company, 2125 Main Street, Steubenville, Ohio.

YOUR name cards, artistic samples 10c (silver). Prince, 130 W. 101, New York.

TOBACCO Kills Manly Vigor. Quit easily. Cigarettes, chewing, smoking, snuff conquered or no charge. Small sum if satisfactory. Stops craving; harmless. Full treatment on trial. Perkins Co., 34-A, Hastings, Neb.

FREE—Stop using tobacco. We will give free information how to conquer habit easily and permanently. Results guaranteed. Anti-Tobacco League, Box K, Omaha, Neb.

TOBACCO or Snuff Habit, cured or no pay. \$1.00 if cured. Remedy sent on trial. Superba Co., TP, Baltimore, Md.

MISCELLANEOUS

STARTING a Company? Save expenses and taxes by organizing on the popular Common Law plan under a pure Declaration of Trust. No experience required to fill in Demaree Standard Forms, issue shares and begin doing business at once. Genuine Demaree Forms are nationally known, approved by attorneys and utilized by successful concerns throughout the United States. Send for large free pamphlet (C-53) containing valuable information that you may need. C. S. Demaree, legal blank publisher, 708 Walnut, Kansas City, Mo.

ARE You Old at Forty? See our advertisement on page 143 of this issue. The Electro Thermal Company, 2125 Main Street, Steubenville, Ohio.

CUTS anybody can make. Simple, cheap process. \$1. Specimens, particulars, 2c stamp. M. Day, Windfall, Ind.

CONCRETE Handbook. New, for the Amateur. We have just published a book describing 173 ways of using concrete in the home, shop and on the farm, with full directions for doing these things yourself with ordinary tools. 138 illustrations. It is "written so you can understand it." Price 50 cents, postpaid. Popular Mechanics Book Dept., 200 E. Ontario St., Chicago.

LOCKSMITHS—Send \$1. get valuable chart for cutting tumbler padlocks keys. Globe System, 278 Washington St., Newark, N. J.

ARTIFICIAL Eyes, \$3. Booklet free. Denver Optic, 559 Barclay, Denver, Colo.

POCKET Maps. We will send you a reliable and comprehensive Rand-McNally indexed pocket map, tourists' and shoppers' guide of any state in the union, Canadian provinces, Alaska, Mexico or Central America, postpaid, upon receipt of 35 cents; also a splendid pocket reference map of practically any foreign country at 50 cents postpaid. Popular Mechanics Book Dept., 200 E. Ontario St., Chicago.

INCORPORATION in Arizona Completed in One Day. Any capitalization, least cost, greatest advantages. Transact business anywhere. Laws, by-laws and forms free. Stoddard Incorporating Co., Dept. 2, Phoenix, Arizona.

HOMEOPATHIC and Biochemic preparations sent postpaid to all parts of the world. Manual and booklets free. Halsey Bros. Co., 111 N. Wabash Ave., Chicago, Illinois. Established 1855.

ART Metal Workers—You will find our book "Metal Work and Etching," a complete manual on making book ends, desk sets, pad corners, paper knives, letter openers, stationery racks, rocking blotters, desk calendars, arts and crafts jewelry, etc.; 96 pp. illus. Price 50 cents postpaid. Popular Mechanics Book Dept., 200 E. Ontario St., Chicago.



MECHANICAL DENTISTRY

THE IDEAL VOCATION FOR MEN WHO ARE MECHANICALLY INCLINED

Dentistry needs more Mechanical Dentists. For men who like mechanical work, Mechanical Dentistry offers an exceptional opportunity to rise above a limited income into professional work with professional earnings.

TRAIN 3 MONTHS—THEN EARN \$35 TO \$125 A WEEK

The Dental Profession is constantly calling for graduates of the four great schools of this institution. Salaries from \$35 to \$45 a week to start, with advancement up to \$125 a week. Many positions are unfilled for weeks because of the great shortage and the demand.

ESTABLISH A BUSINESS OF YOUR OWN

Work with a Surgeon Dentist, in a Dental Laboratory, or establish a business of your own with unlimited earning possibilities. Dental experience or special education not required.

FREE 36-PAGE ILLUSTRATED CATALOG

Contains illustrations of students "Learning by Doing" actual practical work through individual instruction, day and evening sessions. Describes the great field and demand, and how you can "Earn While Learning." Investigate—Write today for Free Catalog No. 2.

BODEE DENTAL INSTITUTE

Founded 1892—No Correspondence Courses

NEW YORK
136 West 52d Street

PHILADELPHIA
1305 No. Broad Street

BUFFALO
1225 Main Street

BROOKLYN
15 Flatbush Avenue

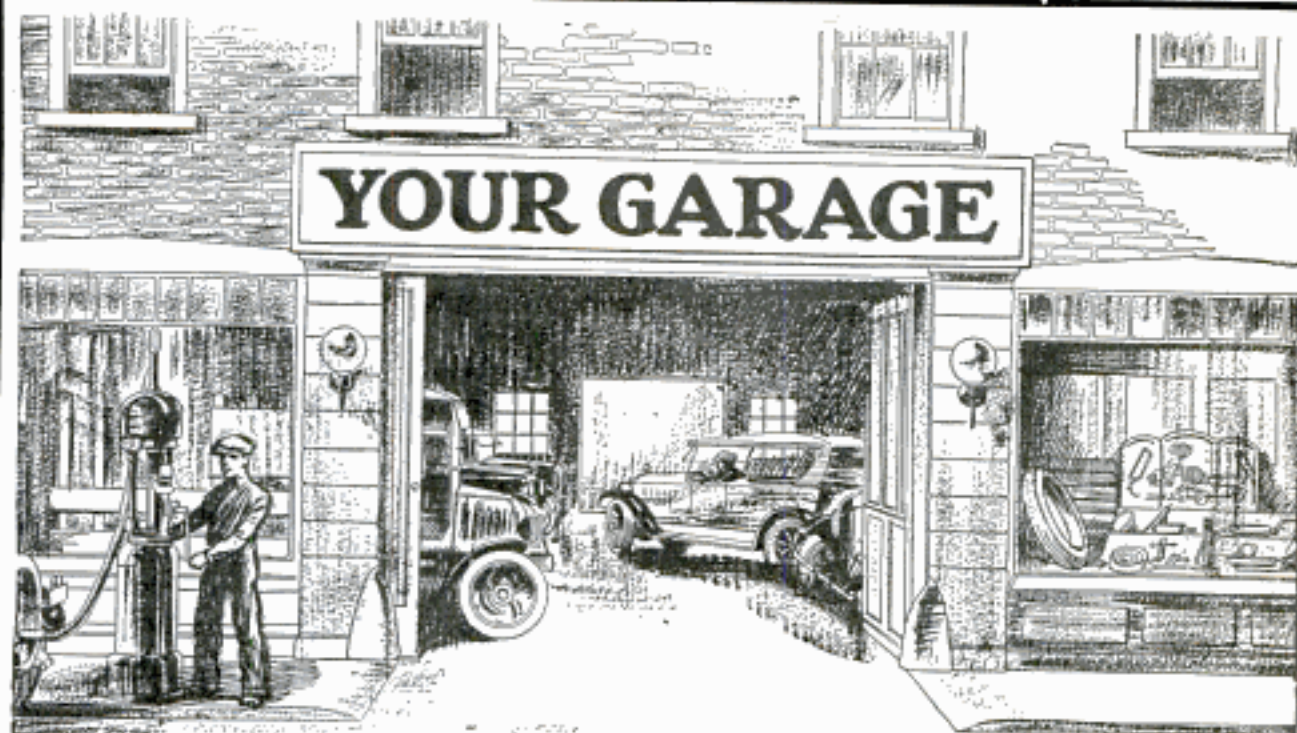

Get Into Business for Yourself

Learn Automobile Engineering in Your Spare Time

You don't have to continue to work for someone else all your life. As an automobile expert you can start a business of your own in America's fastest growing industry. You can run your own garage and have other people work for you. And you can bank the profits.

Know the Game and Earn Big Money

Men who know all about automobiles are earning big money these days. Yet the automobile business is still young and the real earnings are just ahead. Today there are over 12,000,000 automobiles in the United States. 3,000,000 new cars will be made this year. Experts say that by 1927 there will be over 17,000,000 cars running in this country.

Think what a wonderful future the automobile engineer has. Think how well off will be the wise men—the men who plan for the future and prepare themselves for this big-pay field of work.

Know All About Automobiles and Earn Big Pay

These are just the books for the man who wants to know all about automobiles and fit himself for a big-paying job. They are interesting from start to finish and crammed with information. A little regular reading in them during spare hours will soon equip you for the automobile business. Then after you get into the auto game, you'll still have them for reference.

Let These Books Solve Your Daily Problems

To the man now engaged as a mechanic or shop foreman, these books will give a world of help. They dig deep into the technical angles and theories and explain them in everyday words. If you have trouble on any point, you'll find the answer in these books. They are the work

of fifteen auto experts who know from experience, the problems and difficulties of the shopman.

FREE Consulting Membership

A resident consulting staff of 18 practical experts is waiting to solve for you any auto, tractor or motorcycle troubles that you may have. A letter or a wire to the American Technical Society will bring you an immediate answer and the solution to your problems. This advisory staff of practical automobile men plus your library of Automobile Engineering will enable you to handle successfully any auto job. These men know all the latest methods and the newest and best ways of doing things. Let this pay-raising consulting staff be YOUR SILENT PARTNER. Use this service daily if necessary.

This free consulting membership offer is good for a limited time only and can be withdrawn without notice.



**American
Technical
Society**

Dept. A-619
Chicago, U.S.A.

© A. T. S. 1923

AMERICAN TECHNICAL SOCIETY, Dept. A-619
Chicago, U. S. A.

Please send me a set of Automobile Engineering for seven days' FREE EXAMINATION, shipping charges collect. I will examine these books thoroughly, and if satisfied, will send \$2.50 within seven days and \$3 a month until I have paid the special price of \$21.80. If I decide not to keep the books, I will return them within one week at your expense. It is understood that if I keep the books I am entitled to a FREE Consulting Membership in the Automotive Division of the Society.

Name.....

Address.....

Reference.....

(Please fill out all lines, give local merchant, banker or employer as reference.)

I GUARANTEE YOU A POSITION



PHILLIP STATE BANK OF CHICAGO
Capital \$200,000.00 Surplus \$40,000.00
Reserves over \$1,500,000.00
Chicago, Illinois

TO WHOM IT MAY CONCERN

This is to certify that Mr. E. A. Shock has deposited in this bank \$1000.00. Out of this special fund this bank is authorized and does hereby guarantee to return to any of Mr. Shock's students at any time within 90 days after the completion of the course, all moneys the student has paid if Mr. Shock has not fulfilled his obligation as agreed.

Very truly yours,
PHILLIP STATE BANK,
Geo. F. Swilley,
Vice-President.

**Big
Pay**

Succeed!

To make money, get into a field where money is made—and men are wanted. Today there is such a field—a big, profitable field that has been barely scratched. Men are succeeding in it and making money and uncounted opportunities for great success are still open. The Finger Print profession is the field that offers you this opportunity. Finger Printing is beyond the experimental. It is recognized as the one positive means of identification.

Be a Finger Print Expert

Finger Print Experts earn big money and occupy the respected position of the professional man because their work is conspicuous and essential. There are no lay-offs nor shut-downs in the Finger Print profession. Everything you do counts for yourself. Daily, just a handful of men are trying to answer the demands of the thousands and thousands of instances where the Finger Print Expert is vitally needed. Trained Finger Print Experts share in big incomes, fame and importance. For years my time has been devoted to the Finger Print profession. I will teach you how to become a Finger Print Expert. My course of study is simple, easily understood and I guarantee to assist you in securing a position. Read the letter from the Phillip State Bank. You can study during your spare time. No special education is needed. My simplified course makes everything clear.

Secret Service Course

In addition to my complete course in Finger Prints, I will also supply you free and without extra charge, a complete course in Secret Service. Study of this will equip you for all-round work. It gives you knowledge essential to the successful Finger Print Expert. Remember this course is free with my course in Finger Prints. It, alone, is worth the cost of my complete course in Finger Prints. But this offer, as in my Position offer and Free Professional Outfit offer, is limited. Men are needed at once. Unless you act at once, you may lose this remarkable free offer.

Actual Secret Service Reports

FREE To all who write for complete information at once, I will send, free, copies of actual Secret Service reports. These reports give inside facts of amazing cases of interest to you. Send for them and my complete explanation at once. I will tell you fully what you can expect as a Finger Print Expert and I will help you succeed. Today—write for this information and my guaranteed-position offer.

U. S. SCHOOL OF FINGER PRINTS
Dept. 13-58 7003 N. Clark St.
CHICAGO, ILL.

**Send
Coupon**

U. S. SCHOOL OF FINGER PRINTS
Dept. 13-58 7003 N. Clark St., Chicago, Ill.

Please send me Free information about your Finger Print Course, Free Course in Secret Service together with Guaranteed-Position Offer, Free Outfit, Secret Service Reports and Special Low Prices.

Name.....

Address.....

City.....State.....Age.....

\$100 a Week for Spreading Good News

Big pay for helping us to introduce a wonderful new device called NU-HEAT, in your community. Takes one part of coal oil and TWENTY parts air and turns them into hot, brilliant gas, cheaper than city gas. 3 times the heat of coal. Fits in any range, heater, furnace. No more building fires. A twist of the wrist brings heat in few seconds. No high-priced coal, no chopping wood, no dirt, dust, soot or smoke to ruin furniture or impair health. Government Experts, Domestic Scientists, Architects, etc., recommend it. Tell your friends about it; they'll be grateful; make many new friends who'll thank you for the information. And you get paid for it. Earn \$50 to \$100 a week, full or spare time, as others are doing. Write for exclusive territory and free sample case offer.

WADE HILL MFG. CO., Dept. 940, ST. LOUIS, MO.



FREE LIST OF Government Positions Obtainable

Men and Women 17 to 45 Years
Salary \$1600 to \$2600

Write today for Booklet and List

UNITED BUSINESS TRAINING ASS'N
214 Dinan Bldg. DETROIT, MICH.

TO
CORRESPONDENCE
SCHOOL
STUDENTS &
GRADUATES



Write for FREE Book
The Secret Door

It contains a vital message for you. Sent absolutely FREE. No obligation.

NU KAPPA SIGMA
5 Bungalow Court, Newark, N. J.

FREE
\$20



Violin, Hawaiian Guitar, Ukulele, Guitar, Mandolin, Cornet, Banjo-Ukulele, Tenor Banjo or Banjo
Wonderful new system of teaching note music by mail. To first pupils in each locality, we give a \$20 superb Violin, Mandolin, Ukulele, Guitar, Hawaiian Guitar, Cornet, Tenor Banjo or Banjo absolutely free. Very small charge for lessons only. We guarantee success or no charge. Complete outfit free. Write now. No obligation.
SLINGERLAND SCHOOL OF MUSIC, Inc., Dept. 214, CHICAGO, ILL.



Electrify Your Pay Envelope

No line of work—no trade on earth gives the regular two-fisted fellow such a chance to get ahead in the world and make a bunch of money as *Electricity* does! BIG Pay—fascinating work—quick and easy advancement in a field still new!—in a field where science is discovering new electrical uses every day—where new jobs are opening up faster than trained men can be found to fill them—where the young man who dreams of a business of his own, of men working for him, of being his own boss—can realize that ambition more quickly and easily than anywhere else! Why just think of it!

As Electrical Specialist You Earn \$75.00 to \$200.00 a Week

No matter who you are, where you live or what your education is, you can climb right into this field and make good! Do you know that the common untrained garden variety of electrician makes from \$75 a week up? That the man who's onto his job, who knows his business, who as a certified electrical specialist can boss the job, gets from \$10,000 a year up? Fact! And between these two extremes are literally hundreds of thousands of jobs! Everyone of them is waiting to be filled by a better trained man. And we can make you that man!

You Can Start Right Now!

Our simplified and condensed Course in Practical Electricity taken at home—during spare time—will put you on the ladder!—will train you for the career of a successful Electrician—do it in less time, with greater thoroughness, at lower cost and with a more binding, all-in-your-favor guarantee of RESULTS than any home study Course ever written. No college education needed. No high school. Just the ability to read, write, figure and THINK!

22 Electrical Experts Will Be at Your Elbow to Help

Not merely one man with a biased one-man viewpoint! 22 men—experts—succeed themselves. But find out about the hundreds who have taken our training in preference to all others and made good. About the FREE DRAFTING COURSE, alone worth \$50—the FREE Electrical Library, 4 wonderful volumes worth \$30—the FREE Demonstration and Experimental Outfit, including a real, not a makeshift, electrical motor and Wheatstone Bridge, the most valuable outfit ever offered with a home study course.

Send the Coupon

Brings full details—enables you to quickly decide whether you want to be an electrical expert at a big salary or stay where you are. Never can you start at a better time than now.

American School
Drexel Ave. & 58th St.
Dept. E-674, Chicago, Ill.
©A.S.1923

FREE ELECTRICAL COUPON

AMERICAN SCHOOL,
Dept. E-674, Chicago.

Please rush all information relative to your Course in Electricity. This in no way obligates me.

Name

Address.....

*How
Much Are
You Making
Today?*

Now You Can Learn a Trade in 8 weeks in New York



Are you making \$50 a week? Are you going to be making \$75 a week a year from now? If you aren't, or if you are not sure of your future, every word of this advertisement is meant for you. It points the way for you to realize your ambition. It shows the way to prosperity, to happiness and to independence. How? It shows you how you can get into the automobile business after 8 weeks of training and how you can become an expert with an expert's salary.

Learn the Automobile Trade

The automobile business is an open, a big paying and an interesting field. Men of experience are constantly needed and right now thousands of jobs paying upward of \$200 a month or more are going begging while the ideal men to fill them fool around with \$25 and \$30 a week jobs that offer a limited future! Those men are poorly paid, not because they have not the brains but simply because they lack the energy to ACT. The automobile repair man or electrician is sure of his job. He does not have to wait for promotion and advancement at the boss's whim—because the boss needs him more than he needs the boss.

How You Can Do It

There was a time when a man had to serve years as an apprentice in order to learn a business. He usually started by "sweeping out." But those days are gone. Now, all the information the apprentice got in years you can get in a few weeks, right here in New York. For 14 years Stewart institutions have been making automobile men. For 14 years the Stewart School has been recognized as the leading school by automobile companies all over the East.

Personal Instruction

At the Stewart School men are not pushed thru and turned out as so many factory products. Each man is taught in the way he learns the quickest—and the best. **YOU STAY WITHOUT EXTRA COST UNTIL YOU SATISFY YOURSELF YOU HAVE LEARNED EVERY DETAIL.** Eight weeks is the minimum time required. **SEND FOR OUR FREE BOOK AND LEARN ABOUT OUR GUARANTY.**

Pay As You Learn!

You can finish your course in about 8 weeks of fascinating work. That means eight weeks of practical work with tools spent among the pleasant and inspiring surroundings in New York. Find out about our easy payment plan. If you want to earn living expenses while learning our Employment Department will take care of you.

Decide Now

Make up your mind now to investigate the opportunities in the automobile business. Send the blank below and get our big **FREE BOOK.** You will be under no obligations. The book gives just the facts and figures you need. It shows just what chance you have in the automobile business and just how you can get in after 8 weeks in New York.

Send for Free Book Now

Where will you be 8 weeks from today? In the same old rut? Or will you be on your way toward a big job—a happy job and \$200 or more a month? Every day of delay is a day lost. With a newer, bigger future before you your time is precious—send the coupon in **now.**

STEWART AUTOMOBILE SCHOOL
225 W. 57th St., Dept. 1776, New York, N. Y.

Please send me your free book that describes your school and the opportunities in the Automobile Business. I am under no obligation.

Name.....

Address.....

City.....

State.....



George Debble's Pay Check and—YOURS!

George studied with me only a short time. Before that he could not make over \$20 a week. He left me to take a position at \$65.00 a week. This is only one instance of many. It is a common thing for my students to secure big increases in pay weeks and months before they graduate, and scores have earned enough within a short time after enrolling to pay for their course several times over.

I give my students a practical training for the big pay electrical jobs and offer every student FREE and unlimited employment service. It is my claim I have placed every student who asked me for

a job in an acceptable position—and the same service is FREE to you and all other graduates.

What Do You Earn?

If it is less than \$60.00 a week—stop and think. With the aid of my simplified plan of teaching Practical Electricity by Home Study, you can fit yourself in spare time for the highest paid jobs in this wonderful profession. My course covers all types of electrical work such as House Wiring (Pay \$8.00 a day up); Central and Sub-station Operating and Maintenance (Pay

\$2,500.00 to \$10,000.00 a year); Automobile and Tractor Starting Lighting and Ignition (Pay \$35 to \$85 a week); Electrical Jobbing and Battery Station Service (Pay \$40 weekly to \$20,000.00 a year); Illuminating Engineering; Farm Light, Heat and Power; Radio; and Motor Installation, Maintenance and Repairs (Pay \$6.00 to \$15.00 a day); and is easily and quickly mastered by any one with a common school education. The cost is small, payable in easy installments and when you graduate, I shall give you a diploma and valuable certificate of competency with the degree of E. T. or passed Electrical Technician.

Be a Registered Electrical Technician and Make \$60 to \$200 a Week

You cannot lose by my plan for my course is so clearly explained and so wonderfully illustrated with original cuts, pictures, diagrams, plans and designs, and my personal supervision of your work is so thorough and complete and painstaking that I can, and I will guarantee your success in this study; and more than that, in my reply to your letter of inquiry, I will prove that

LOSS TO YOU IS IMPOSSIBLE

I will undertake to train you until you are fitted to begin earning \$50 to \$70 a

week, and when you graduate, if for any reason whatsoever you are not more than satisfied, if you are not convinced you have received the most up-to-date PRACTICAL expert electrical man's training obtainable, I will gladly and instantly REFUND to you every cent paid me for tuition.

FREE

you make sure of receiving with your course a valuable outfit of Electrical Appliances, Instruments, Apparatus and Material with which you can do many

By acting Now, you save ONE-HALF the usual cost of tuition, and by replying at once

kinds of electrical lighting, signaling, power and installation work right at home, and even make money to help pay for your tuition. This outfit is ABSOLUTELY FREE. Make sure of getting this great outfit by securing full details of my course—NOW.

FREE REVIEW COURSE

When you finish the Home Study course, you can come in with me in my big shops for a wonderful Review Training Without One Penny extra for tuition to you.

Sample Lessons Sent—FREE
Write or Mail Coupon
at once—don't delay—do it NOW!

S. V. Smith, Chief Engineer
S. & H. Electrical Works

H. S. Dept. K. K. 4
1422 W. Monroe St. Chicago, Ill.

Chief Engineer Smith, E. T.,
1422 W. Monroe St., H. S. Dept. K. K. 4
Chicago, Ill.

Dear Sir:

Send me catalog and full particulars of your course in Practical Electricity, with sample lessons; free of charge or obligation to me.

Name.....

.....

.....

.....

September 1923
Strength

The Magazine of Good Health

Expert points on kicking
a football
Herrmann's Boxing Course
The Insulin Cure
for Diabetes

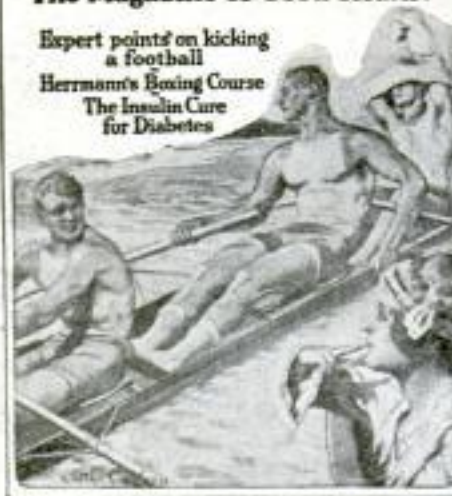

Your Body Is a Machine

and it deserves at least as much attention as you give to your motorcar or to your pet lathe.

EVERY MAN SHOULD EXERCISE

to keep the body in perfect condition. Most men neglect exercise because it is not made interesting enough.

You Should Read "STRENGTH"

because it is an *inspiring* publication devoted entirely to the physical welfare of its readers. It contains articles on every form of body-building exercise, outdoor sports, fancy dancing, diet, etc. The STRENGTH Magazine is magnificently illustrated. If you are interested in the human form divine, you will find in the pages of STRENGTH pictures of magnificently-built men and beautifully-formed women.

At present STRENGTH contains TWO GREAT SERIAL FEATURES

The First is

A Course of Body-Building Exercises

written by a college physical director who has obtained marvelous development by practicing these exercises.

The special feature in the September number is the article HOW TO KICK A FOOTBALL, written by one of the great kickers in the history of the game.

The Second is

Prof. Wm. Herrmann's Boxing Course

of which an installment appears in each number of the magazine. This is acknowledged to be the finest boxing course ever published.

The Subscription Price of STRENGTH is \$1.50 Per Year

Note Special Offer at Bottom of This Page

During this month we are making the following special offer. We are making a reduced price for a year's subscription, in combination with

The Best "Tumbling" Course Ever Issued

The Edgar Weyer Course in Tumbling and Hand-Balancing contains 193 different feats and combinations. It is copiously illustrated with special pictures showing the details of the different stunts. A sample illustration is shown here.

The price of the tumbling course if bought separately is \$2.00, but you should take advantage of the special offer.

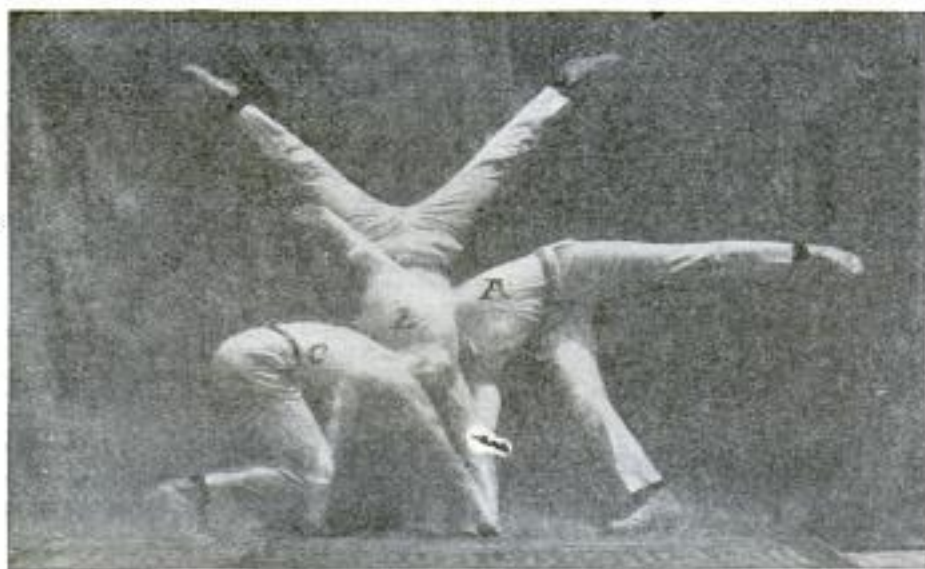

STRENGTH Magazine,
Diamond & Third Sts.,
Philadelphia, Penna.

To the man: Enclosed please find cash (money order) (check) for \$2.75, for which enter my subscription to STRENGTH Magazine beginning with the current issue, and send me immediately the Weyer Tumbling Course.

Name.....

Address.....

City.....State.....

SPECIAL OFFER

STRENGTH Magazine for one year, regular price \$1.50. Weyer Course in Tumbling, regular price \$2.00.

Our price for both is . . .

\$2.75

Mail the coupon to **THE STRENGTH MAGAZINE**
Diamond and Third Sts., PHILADELPHIA, PA.

Don't Envy Successful Salesmen—BE One!

Those fellows who are making anywhere from ten to thirty thousand dollars a year—who travel first class, stop at the best hotels, are in daily contact with prosperous business men—did you ever figure out what it is that enables them to SELL with such success?

It can't be size—or good looks!—

Otherwise keen sales executives would specialize in furniture heavers and chorus men—whereas some of the best salesmen you ever knew measure less than five feet five and are so homely that you actually feel sorry for them.

It can't be schooling—

Otherwise only college graduates would hold the records—and men like Schwab wouldn't have a chance in the world.

It can't be any special GIFT which they inherit—

For there's many a salesman straight from the land where the tall corn grows—his father a farmer and his father's father before him—who fairly astonishes the "boss" at the way he brings in the business.

If it isn't any of THESE things—then it is surely possible for ANY man of average intelligence—provided he has the courage to TRY and the willingness to LEARN—to become a successful salesman.

—For the REASON for success in selling is nothing more nor less than the knowledge and application of SALES-MANSHIP.

GET that knowledge and APPLY it—whether you are now in the selling field or not—and we predict that your income will mount and will NEVER CEASE TO MOUNT—so long as your health is good and you stay in business!

How You Can Get the Training That Will Bring Success

A bold statement, you may think—but it is based on bed-rock facts.

When LaSalle Extension University was preparing its training in Modern Salesmanship, it made a careful study, over a period of years, of the selling processes of more than a thousand outstanding salesmen engaged in selling a wide variety of products and many different types of service. These men were already rated as exceptional. Their records proved it.

Under the direction of a nationally known sales executive—himself a \$50,000 man—the particular methods which were found to yield the highest percentage of results were sifted out—and for two years, and at a time when selling was anything but "easy," more than four hundred salesmen—comprising a number of separate sales crews—were instructed to specialize in these particular selling methods.

Out of this test came unusual and often surprising results. The best men on various forces—in lines ranging from boots and shoes and electrical apparatus to motor cars and life insurance policies—thru the basics furnished them MATERIALLY INCREASED THEIR SALES.

One salesman stated that what was furnished him was responsible for the establishing of more than 100 new accounts in his territory and a large increase with his old trade.

Increases of 100% and in some cases 500% were reported.

On the strength of these findings, the identical principles and methods used by these men and proven sound and practical by the severest kind of tests, were organized and incorporated into the present training offered by LaSalle in Modern Salesmanship.

And AGAIN they are proving out—as witnessed by the following statements, typical of hundreds that have been received by LaSalle within the last few months:

"The first two texts have given me so much that I am firmly convinced that if I never learn anything more from the course, I would have a full return for the entire investment. I tell you frankly that I would not take \$25,000 for my scholarship if another could not be had."—C. J. JONES, Canada.

"From a salesman in the ranks, in two short months



my sales have shot up nearly 150 per cent, and I have received a promotion from a company I had been with only six months. I am now a district manager with eleven men working under me. Not only have my immediate sales shown an increase—and right in the middle of the summer months—but I have had a keener grasp of the principles of selling. I know the meaning of 'fundamentals' now; I know that by the application of certain definite truths, certain definite results can be attained. My effort, formerly more or less of an uncertainty, is now a certainty. Getting down to brass tacks, I know what I am doing now."

—C. RUTHERFORD, Ontario.

Send for "Modern Salesmanship"

To explain within the brief limits of a page how LaSalle training in Modern Salesmanship is conducted, or to give more than the barest hint of its value to the man ambitious to develop as a salesman, is impossible. We have therefore prepared a 66-page book entitled "Modern Salesmanship"—an interesting and compelling presentation of the present-day opportunities in salesmanship and a clear outline of the way they may be quickly realized.

No man engaged in selling—or looking forward to salesmanship as a career—should be without a copy of "Modern Salesmanship." The University will be glad to mail a copy to any man who marks and signs and mails the coupon just below this text. There is, of course, no obligation.

LASALLE EXTENSION UNIVERSITY

The Largest Business Training Institution in the World

Dept. 964-SR

Chicago, Illinois

Please send me catalog and full information regarding the course and service I have marked with an X below. Also a copy of your book, "Ten Year's Promotion in One," all without obligation to me.

Modern Salesmanship

Training for Sales and Advertising Executives, Solicitors, Sales Promotion Managers, Salesmen, Manufacturers' Agents, and all those engaged in retail, wholesale or specialty selling.

Other LaSalle Training Courses

LaSalle is the largest business training institution in the world. It offers training for every important business need. If more interested in any of these courses, check here:

- | | |
|---|--|
| <input type="checkbox"/> Business Management | <input type="checkbox"/> Modern Business Correspondence and Practice |
| <input type="checkbox"/> Traffic Management | <input type="checkbox"/> Modern Foremanship and Production Methods |
| <input type="checkbox"/> Higher Accountancy | <input type="checkbox"/> Personnel and Employment Management |
| <input type="checkbox"/> Railway Station Management | <input type="checkbox"/> Expert Bookkeeping |
| <input type="checkbox"/> Law—Degree of LL. B. | <input type="checkbox"/> Business English |
| <input type="checkbox"/> Commercial Law | <input type="checkbox"/> Commercial Spanish |
| <input type="checkbox"/> Industrial Management Efficiency | <input type="checkbox"/> Effective Speaking |
| <input type="checkbox"/> Banking and Finance | <input type="checkbox"/> C. P. A. Coaching |

Name.....

Present Position.....

Address.....



LEARN ART *from* AMERICA'S LEADERS

If you like to draw—if you are ambitious to become a highly-paid commercial artist, you are doubtless eager to obtain instruction of proven merit, and profit by the hard-won experience of leading artists.

Think of being able to learn from Charles E. Chambers, Franklin Booth, Edw. V. Brewer, Charles Livingston Bull, the famous animal painter, and Natlaek Price, an authority on posters! These and many other nationally known artists and illustrators—have contributed *exclusive* lessons to the Federal Course, which has fairly won for itself the title,

America's Foremost Course in Commercial Art

It covers every branch of commercial art in a thorough, practical and modern manner. Every step is clearly explained, and you as a student receive an individual personal criticism by a successful commercial artist on every lesson.

Hundreds of Federal students and graduates are making good in a big way. Many who are now earning \$50, \$75, and \$100 a week, at first could probably draw no better than you can. The Federal Course does not work on notes—no course can—but develops the ability of an earnest student rapidly and on a sound basis. It brings you to the earning point in a fraction of the time otherwise required. Why not investigate?

"YOUR FUTURE" Sent on Request

A beautiful book which explains every detail of the Federal Course, shows work by Federal students, and gives surprising facts regarding the demand for commercial art. If you are in earnest, send 6c in stamps with the coupon below, being sure to state your age and occupation.



Federal School of Commercial Designing

693 Federal Schools Bldg., Minneapolis, Minn.

Please send me "Your Future," for which I enclose 6c in stamps.

Name.....

Age..... Occupation.....

(Write your address plainly in the margin)

*America's Foremost School of
Commercial Art*

Please Mention Popular Mechanics

FREE FIRST LESSON RECORD

Learn to Play

Violin-Mandolin, and Banjo Mandolin without embarrassment by the *World's Most Successful Method*. Personal instructions on Records taught by the famous Prof. F. M. Schneider. Six year combined course teaches all three instruments. Simple as A. B. C. Play for money in 2 months. 30,000 have learned to play beautifully.



\$25 Instrument FREE With Course

Your choice of any one instrument given absolutely free to one pupil in each locality. Only small charge for lessons—a few cents a week. Success assured.

Write Today for Free Record

Send no money. Just ask for first lesson Record on one week's approval. We want to prove to you as we have to thousands of others the wonderful advantages of learning music the more simple and easy way by our personal instruction lessons given on Records. Write at once! TODAY!

SCHNEIDER SCHOOL OF MUSIC

Dept. B-9, 238 Vermont St., Blue Island Ill. (A suburb of Chicago)

Make \$10 a Night



Be a Drummer

Professional drummers in demand everywhere and make big money. You can quickly and easily learn to play band, orchestra and dance music through my home study course. Write for particulars today. NOW! Write for folder of special snare drum offer.

The Herman H. Rinne Correspondence School of Modern Drumming
3154 Park Ave. INDIANAPOLIS

\$38⁶⁵ Remington No. 10 Typewriter

Two dollars down, late model, all recent features, five-year guarantee, 30 day trial

LINCOLN TYPEWRITER COMPANY
298 Broadway, Dept. 133, NEW YORK

LEARN ENGINEERING

Courses, 3 months to 3 years practical technical training under experts. Not a Trade School but a practical technical college teaching electricity, steam, gas, auto-electric, armature winding, drafting, radio. Extensive laboratory and shop equipment. Degrees awarded. Day and night sessions. Enrollment free.

FINLAY ENGINEERING COLLEGE 1001 Indiana Avenue KANSAS CITY, MO.

Do You Like the great outdoors? Then

learn railway surveying through our easy new chart method in your spare time.

\$110 and expenses paid after 2 months' study, previous experience unnecessary. Later \$500. Send for free sample lesson.

BJOSTAD INSTITUTE, Dept. M, Duluth, Minn.

LEARN TO GET DOLLARS OUT OF WATCHES.

WATCH-REPAIRING, ENGRAVING, JEWELRY REPAIRING.

WRITE NOW.
ENICAR TRADE SCHOOL
530 W MONUMENT SQUARE, RACINE, WIS.



WANTED MEN AND WOMEN TO LEARN PHOTOGRAPHY!

Photographers and Photo-Engravers earn \$200 to \$500 a month. The field is uncrowded. Learn these profitable and fascinating professions. Taught by largest and best college of its kind in the world. Established over 30 years. Demand for our graduates far exceeds supply. Good positions secured. Tuition and living expenses low.

Get this FREE Book! Write today for free beautifully illustrated book describing wonderful opportunities in this field.

Illinois College of Photography, Box 493, Effingham, Ill.

These Books Helped 280,000 Men to Bigger Pay

Think of it, 280,000 men are getting Big Money because they own a set of these books. These men do not have to go to school—they need no special training—but, they got into the Big Pay Class with a set of these pay-raising reference books and the Free Consulting Membership. These books and the Membership are their Silent Partners—Always ready to help—Always at hand to advise. Every question is answered and every problem solved.

No matter what kind of work you are doing, don't you think you could learn something from twenty to thirty of the biggest experts in that line? The world's greatest experts have prepared these books to help men who want to advance into BETTER JOBS and BIGGER PAY. Each set is written in plain, every-day language that anyone can understand. There are no puzzling technical terms. They are written in a simple, understandable way that makes them doubly practical. You can put what they teach right to the test in your daily work—you can profit by them at once—you can refer to them dozens of times daily to solve some new problem—you can use their knowledge as a stepping stone to that better position you have had your eyes on for some time—and make them bring to your pockets that fatter pay envelope you have yearned for.

Reference Books That Make Happy Days of Pay Days. Select Your Own Line From This List for Week's Free Use

5 vols. Carpentry and Contracting—was \$37.50 now.....	\$19.80
12 vols. American Law and Practice (including free reading course and 250 page book of standard legal forms)—was \$97.50 now.....	49.80
8 vols. Applied Electricity—was \$60.00 now.....	29.80
6 vols. Auto Engineering—was \$45.00 now.....	21.80
9 vols. Civil Engineering—was \$67.50 now.....	34.80
8 vols. Business Management—was \$52.50 now.....	29.80
7 vols. Steam and Gas Engineering—was \$52.50 now.....	24.80
4 vols. Sanitation, Heating and Ventilating—was \$30.00 now.....	14.80
4 vols. Fire Prevention and Insurance—was \$30.00 now.....	14.80
6 vols. Modern Machine Shop Practice—was \$45.00 now.....	21.80
4 vols. Telephony and Telegraphy—was \$30.00 now.....	14.80
4 vols. Drawing—was \$30.00 now.....	14.80

Free Consulting Membership

A resident consulting staff of from 15 to 20 practical experts is waiting to solve for you any difficulty that you may have. A letter or a wire to American Technical Society will bring you an immediate answer and the solution to your problems. This advisory staff of practical men plus your working and reference library will enable you to handle successfully any job in your line. These men know all the latest methods and the newest and best ways of doing things. Let this pay-raising consulting staff be YOUR SILENT PARTNER. Use this service daily if necessary.

This Free Consulting Membership Offer Is Good for a Limited Time Only and Can Be Withdrawn Without Notice

Use Books Free for One Week—Send No Money

—just fill out the coupon. After you receive the full set of books, express collect, read them over and test them out for seven days. If you don't want them, send them back at our expense. If you decide they will do for you what they have done for more than 280,000 others, pay \$2.80 within one week and \$3 each month thereafter until the special price is paid. **This amounts to only ten cents a day.** Mail coupon NOW if you want a bigger, better job at higher wages.

Here's your opportunity, if you want to EARN MORE MONEY. Remember, we are taking all the chances—you pay NOTHING unless you are absolutely eager to after seeing the books. Isn't this about the fairest proposition you ever saw in print?

AMERICAN TECHNICAL SOCIETY

Dept. X-619

Chicago, U. S. A.

AMERICAN TECHNICAL SOCIETY, Dept. X-619 Chicago.

Please send me a set of for seven days' FREE EXAMINATION, shipping charges collect. I will examine these books thoroughly, and if satisfied, will send \$2.80 within seven days and \$3 a month until I have paid the special price of \$..... If I decide not to keep the books, I will return them within one week at your expense. It is understood that if I keep the books I am entitled to a FREE Consulting Membership in the Society.

Name.....

Address.....

Reference.....

(Please fill out all the lines, give local merchant, banker or employer as reference.)





LEARN LAW

Read law in your spare time and become a lawyer or a law-trained man in business. Great opportunities for wealth, prestige and power awaits you in the profession of law. Equally great opportunities in being a legally trained man in business. Business firms and corporations are looking for the man who knows law, for law enters into every phase of business, into every single business transaction. Gain a knowledge of law and you can command an executive position—a position of responsibility at big pay! Why don't you learn law in your spare time? Here is a real chance to get a legal training at a bare fraction of the usual cost.

\$2.80 After Examination

Make these 12 large volumes your law school. They contain all the law. A complete text, the work of the highest authorities. Prepared especially for home study with quiz questions on every subject. Every subject in commercial and professional law covered. Every point made clear. No tiresome daily lessons.

Written in interesting, fascinating form. Never before so complete and thorough a law course as this. Never before so masterly a presentation of the law in easily learned form. Already several of the leading law schools have made application for the use of these volumes as class-room texts. Splendidly bound in law Buckram, with red and black labels and titles in gold. Only 482 sets to be sold at slashed price on this special introductory offer. Act quick to get in on this offer.

Send No Money See Before You Buy

We'll ship the whole set right to your home or office for 7 days' free trial upon your simple request. If after the 7 days' free examination you are highly pleased and decide to keep them simply pay the small initial payment of \$2.80, and then only \$3.00 a month until the special reduced price of \$44.80 is paid. Regular price \$110. Think of it—a saving of \$65.20—and over a year to pay—only 75¢ a week. Offer holds good only on 482 sets.

FREE!
Reading Course

Act at once and we will include, extra and FREE, our Reading Course of 33 complete lectures in law, which will help you prepare for the bar examination. This with the books amounts to a complete course in law.

Act quick, as this cut price so rush the coupon.

NOW!!

The Johansen Corporation
618 Manhattan Bldg., Chicago

Mail the coupon now. Get the books for 7 days' trial. Decide for yourself whether you want to keep them or not.

\$7.00 required with order outside of United States.

Please send your 12-volume Home Study Course in Law for 7 days' examination, shipping charges collect. I will either send \$2.80 as initial payment and \$3 a month thereafter until \$44.80 is paid, or return the books within 7 days at your expense. (Special cash with order price \$39.80.)

Name

Address

Employed by

Please Mention Popular Mechanics



LEARN BY DOING

Every phase of all branches of

ELECTRICITY

Taught by Actual Practice

In America's foremost and oldest institution for trade training

No Books Used
Individual Instruction
Start Any Day

A SPECIAL and SEPARATE Course in Ignition, Auto Lighting and STARTER Systems. Write for FREE 64-page catalog.

THE
NEW YORK ELECTRICAL SCHOOL
44 West 17th Street, NEW YORK CITY

You too, can Earn \$71.65

In a few hours!

This MAN

MAKES

\$250.

to

\$400.

MONTHLY

"I made over \$50 weekly after leaving AMERICAN MOTOR SCHOOLS. I passed 471.00 in a few hours of my best work, 2 months after finishing course. I am an operator in my garage. I am in school from the farm and knew nothing about the motor."

J. M. GIBSON,
FAIRFAX, VA.

LEARN Automobile Mechanics. Our 8-weeks' course prepares you to START EARNING BIGGER MONEY than you ever did before, the minute you step out of school. You always command \$45 to \$100 weekly anywhere. There is work for you even in hardest times at HIGHEST PAY. We Help You Get Your First Job, Some of our pupils are placed in FINE PAYING POSITIONS WEEKS BEFORE THEY FINISH the bookless 8-weeks' course. J. M. Gibson's success is common to all of our graduates.

AMERICAN MOTOR SCHOOLS

1612-22 U St., N. W.

WASHINGTON, D. C.

Fill out and MAIL THE COUPON BELOW so we can send you CATALOG and tell you how we can train you to gain FINANCIAL INDEPENDENCE and success.

AMERICAN MOTOR SCHOOLS Dept. 1, 1612 U Street WASHINGTON, D. C.

Mail me your catalog, and tell me about your 8-weeks' course in Automobile Mechanics, by return mail.

NAME

ADDRESS.....STATE.....

WHY NOT YOU?



Garage foreman at \$75⁰⁰ a week ~ and in line for further promotion

Positions like this are waiting for men who can fill them. **AND BIGGER JOBS AHEAD.** Above the foreman, there is a better job as Service Manager. Every automobile dealer, every service station in every city in the country, needs one or more high grade foremen or superintendents. "Where can we get trained men?" they ask despairingly. *They will willingly pay big money to you if you can fill one of these jobs.* They want men who are not only good auto mechanics, but who know *shop management, modern repair methods, electric service,* and who

have a thorough understanding of the business as a whole. ■

You can get that knowledge in three months at the Michigan State Automobile School in Detroit, the Auto Center.

Men in low paid, uninteresting trades, can fit themselves for better jobs now, or a business of their own. Miners, railroad men, street car men, furniture men, barbers, laborers of all kinds, are lifting themselves out of the rut, and establishing themselves, by taking M. S. A. S. training.

I CAN MAKE YOU A BIG MONEY MAN WHETHER YOU ARE NOW A MECHANIC OR NOT

Are you mechanically inclined? If so you can develop that aptitude and make a success in the automobile business. Not necessarily as a mechanic, but as a business man—with a *foundation* of mechanical training so that you "know how" and can direct the work of others. Our training will enable you to *rise above the ranks to a position of responsibility.* Successful men are not "born," they are "made." Foresight, planning, training, is what "makes" them.

Do you know that in *one month* of this year 404,000 new automobiles were built? Notice in every city, the automobile dealers have fine establishments. "Automobile Row" is the center of activity. The automobile dealer is the biggest man in this great business. Can you begin to imagine how great the need is for *big men* to lead the business of giving service to these cars? The opportunity is simply astounding. The industry has advanced so fast that enough trained men have not been developed to hold the big pay jobs.

I can fit you for one of these jobs, and even to run a business of your own, to have a service station or be an automobile dealer. Our graduates are doing it now all over the U. S. A., and in many other countries. I can start you to success, as I

have thousands of other men. This School and its courses are endorsed by automobile manufacturers and service men.

Write to me today for full information. I want you to have a good job. I can qualify you quickly. Write to me today.

A. G. ZELLER

MICHIGAN STATE AUTOMOBILE SCHOOL
Box 6869, 3729 Woodward Avenue, Detroit, Michigan

-----Write a letter or use this coupon-----

A. G. Zeller, Michigan State Automobile School,
Box 6869, 3729 Woodward Ave., Detroit, Michigan

Tell me how I can become a big money man. My present work is.....

Full Name.....

St. or R. F. D.....

City.....State.....

I am earning \$..... My age is.....



"I Knew You'd Make Good"

"I ALWAYS felt you had it in you to get ahead. But for a time I was afraid your natural ability would be wasted because you had never trained yourself to do any one thing well. Yes, I was afraid you would always be a jack of all trades and master of none."

"But the minute you decided to study in your spare time I knew you'd make good. You seemed more ambitious—more cheerful—more confident of the future. And I knew that your employers couldn't help but notice the difference in your work."

"Think what this last promotion means! More money—more comforts—more of everything worth while. Tom, those hours you spent on that I. C. S. course were the best investment you ever made."

HOW about you? Are you always going to work for a small salary? Are you going to waste your natural ability all your life? Or are you going to get ahead in a big way? It all depends on what you do with your spare time.

Opportunity knocks—this time in the form of that familiar I. C. S. coupon. It may seem like a little thing, but it has been the means of bringing better jobs and bigger salaries to thousands of men.

Mark and mail it today and without obligation or a penny of cost, learn what the I. C. S. can do for you.

----- TEAR OUT HERE -----

INTERNATIONAL CORRESPONDENCE SCHOOLS Box 5542-D, Scranton, Penna.

Without cost or obligation, please tell me how I can qualify for the position or in the subject before which I have marked an X:

BUSINESS TRAINING COURSES

- | | |
|---|---|
| <input type="checkbox"/> Business Management | <input type="checkbox"/> Salesmanship |
| <input type="checkbox"/> Industrial Management | <input type="checkbox"/> Advertising |
| <input type="checkbox"/> Personnel Organization | <input type="checkbox"/> Better Letters |
| <input type="checkbox"/> Traffic Management | <input type="checkbox"/> Foreign Trade |
| <input type="checkbox"/> Business Law | <input type="checkbox"/> Stenography and Typing |
| <input type="checkbox"/> Banking and Banking Law | <input type="checkbox"/> Business English |
| <input type="checkbox"/> Accountancy (including C.P.A.) | <input type="checkbox"/> Civil Service |
| <input type="checkbox"/> Nicholson Cost Accounting | <input type="checkbox"/> Railway Mail Clerk |
| <input type="checkbox"/> Bookkeeping | <input type="checkbox"/> Common School Subjects |
| <input type="checkbox"/> Private Secretary | <input type="checkbox"/> High School Subjects |
| <input type="checkbox"/> Business Spanish | <input type="checkbox"/> Illustrating |
| <input type="checkbox"/> French | <input type="checkbox"/> Cartooning |

TECHNICAL AND INDUSTRIAL COURSES

- | | |
|---|--|
| <input type="checkbox"/> Electrical Engineering | <input type="checkbox"/> Architect |
| <input type="checkbox"/> Electric Lighting | <input type="checkbox"/> Blue Print Reading |
| <input type="checkbox"/> Mechanical Engineer | <input type="checkbox"/> Contractor and Builder |
| <input type="checkbox"/> Mechanical Draftsman | <input type="checkbox"/> Architectural Draftsman |
| <input type="checkbox"/> Machine Shop Practice | <input type="checkbox"/> Concrete Builder |
| <input type="checkbox"/> Railroad Positions | <input type="checkbox"/> Structural Engineer |
| <input type="checkbox"/> Gas Engine Operating | <input type="checkbox"/> Plumbing and Heating |
| <input type="checkbox"/> Civil Engineer | <input type="checkbox"/> Chemistry |
| <input type="checkbox"/> Surveying and Mapping | <input type="checkbox"/> Automobile Work |
| <input type="checkbox"/> Metallurgy | <input type="checkbox"/> Navigation |
| <input type="checkbox"/> Mining | <input type="checkbox"/> Agriculture and Poultry |
| <input type="checkbox"/> Steam Engineering | <input type="checkbox"/> Mathematics |
| <input type="checkbox"/> Radio | <input type="checkbox"/> Airplane Engines |

Name.....
Street.....
Address..... 3-27-23

City..... State.....

Occupation.....

Persons residing in Canada should send this coupon to the International Correspondence Schools Canadian, Limited, Montreal, Canada.

Please Mention Popular Mechanics

Make Money Taking PICTURES



Get \$100 for Flood Pictures
"I took pictures of a flood and sold them for \$100. I have been able to buy my house and lot from the sale of pictures."
C. M. COLE,
Washington.

\$97 in Two Days!
"I made \$285 in December. Went out two days last week on home portrait work and made \$97."
A. G. HUGHES,
Kentucky.

Tremendous, big-paying opportunities are open for ambitious men in Modern Photography. This is the picture age. Magazine and newspaper publishers buy thousands of photographs each year. Every manufacturer sends out high priced pictures of his products. Every home wants portraits. Photography is a business running into millions of dollars each year. And there is a great shortage of trained photographers.

EARN \$3,000 to \$10,000 a YEAR

Hundreds of men are earning big money and establishing their own businesses. Even during spare time, while training.

you can make \$75 a week easily—no matter where you live!

Amazing New Easy Method

I show you, at home, how to do the kind of work turned out by the big studios in New York and Chicago! I show you how to make big money within 30 days! C. M. Cole bought a home with money he had made when only half way through his training. So well do I know what I can do for you that I guarantee under bond to return every cent of your tuition if you are not thoroughly satisfied.



Professional View Camera FREE!

Write at once for Free Camera Offer—I give you, free, a splendid professional view camera. You will be astonished and delighted. This offer open for short time only—so act quick! No obligation.

INTERNATIONAL STUDIOS, Inc.
Dept. 1196, 3601 Michigan Ave., Chicago, U. S. A.

ELECTRICITY LEARN AT HOME

Send for catalog which tells how Burgess Home Training enables men and boys to get good jobs and keep them.
BURGESS ELECTRICAL SCHOOL, Dept. P9, 744 E. 42nd Street, CHICAGO

Make \$75⁰⁰ a Week and up

Make \$75.00 a week and up, selling our fine made-to-measure, all-wool suits, direct to wearer. Biggest values—positively sell on sight. Biggest commissions paid in advance. We attend to delivery and collections. 6 x 9 swatch samples—over 100 styles all one price—furnished FREE. Part or full time men write at once.

W. Z. GIBSON, Inc., 161 W. Harrison St., Dept. W-11 Chicago



BECOME A RAILWAY MAIL CLERK

Examinations soon. \$1600 to \$2300 a year. No strikes or lockouts. Common education sufficient. No "pull" necessary. Mail coupon for catalog.

Patterson Civil Service School
Dept. 89, Rochester, N. Y.

Sirs:—Send me without charge your Catalog, describing this and other fine U. S. Government positions.

Dept. 89
Patterson Civil
Service School
Rochester,
N. Y.

Name.....
Address.....

Drawing Table Free!

Yes, this is exactly what I am doing. I am giving this drafting table free to you when you enroll as my student. I do this because I want you to have the right kind of Draftsman's Working Outfit — because I want to help ambitious men and boys get ahead. This is the kind you will use when you have completed my course and have become a regular draftsman.

Complete Drawing Outfit FREE

Besides the drafting table I also furnish free the \$25.00 set of regular working instruments shown here. You get both table and instruments free if you enroll at once. I will do everything possible to help you get ahead.



Also FREE \$90 Drafting Course

To my students enrolling now I give an opportunity of getting a \$90 drafting course absolutely without cost to them. This means you need not pay me for my personal instructions or for the complete working outfit.

**Salaries up to
\$250 and \$300 a Month**

Positions paying up to \$250 and \$300 a month which ought to be filled by skilled draftsmen are vacant everywhere. There are in every part of the country ambitious men, who with practical training and personal assistance will be qualified to fill the positions. I can now take and train a limited number of students, guarantee to train them by mail UNTIL placed in a permanent position at a salary up to \$250 and \$300 a month.



Here is the Rule you get FREE

To each young man stating his age when sending a sketch as shown in box at right, I am going to mail FREE AND PREPAID the Draftsman's Ivorine Pocket Rule shown here.

Mail Coupon

Mail coupon at once for full information how you can get the table and working instruments Free, also how you can get the \$90 drafting course Free. Even if you don't send in a copy of the sketch send for this information.

**Chief Draftsman, Engineers' Equipment Co.
1951 Lawrence Ave., Div. 93-56 Chicago, Ill.**

Extra!!

Copy this Sketch
and Get Ivorine
Pocket Rule

To each young man of 16 years or older sending a sketch I will mail free prepaid the Draftsman's Ivorine Pocket Rule shown here. With it I will send you a 6 x 9 book on "Successful Draftsmanship."

There are no conditions requiring you to buy anything. You are under no obligations in sending in your sketch.



**Chief Draftsman, Engineers' Equipment Co.
1951 Lawrence Ave., Div. 93-56, Chicago, Ill.**

Without any obligation to me please mail your book "Successful Draftsmanship" and full particulars of your liberal "Personal Direction" offer to a few students. Also full information as to how I can get a \$90 Drafting Course Free.

Name

Address

Age

Mr. B. M. Oliver, of St. Louis, Heating Expert, has invented a New Kind of Heat which gives Three Times the Heat of Coal.



DON'T BURN COAL!

Amazing New Invention Does Away With Dirty Coal and Wood. Gives Three Times the Heat in Any Stove or Furnace

NO longer is it necessary to pay exorbitant prices for coal and wood—or to face the uncertainty of actual coal strikes and shortages. No longer is it necessary for any woman to give her best strength and energy in endless back-breaking servitude to a hot, mussy heater, cook stove or furnace.

No more dirty, heavy coal and wood to carry and lift—no more clouds of ashes to breathe, or back-breaking scuttles to empty—no more fires to build, bank or watch—no more heating problems—no more cold rooms in Winter—no more frozen, bursted furnace pipes—no more suffering from lack of quick fires in uncertain Fall and Spring—and no more worries about coal shortages, poor quality or high prices. An amazing invention ends all this forever and makes any type of cook stove, heater or furnace, an automatic heater that can be regulated to any temperature by simply turning a valve.

The wonderful invention of Mr. B. M. Oliver, fuel expert of St. Louis, has now been perfected so that there is a model that can be installed in any coal or wood stove in one minute's time, and then actually gives 3 times the heat of coal if wanted—or can be regulated to a tiny flame by the simple turn of a little valve. And at a cost any family can afford, any hot air, hot water or steam furnace can be converted into an automatic oil burning plant, without noisy motors, without electrical connections, without any moving parts.

Cheap, Clean, Simple

Mr. Oliver calls his invention the Oliver Oil-Gas Burner because it uses 95% air and only 5% oil (the cheapest fuel there is), turning them into an actual gas that burns with an intensely hot, clean flame. No wicks, no smoke, no odor.

Fits All Stoves Without Change

Mr. Oliver's wonderful invention is made in 16 models to fit any kind of cook stove, heating stove or furnace. No holes to drill, no bolts to fasten, no changes whatever. Simply sets in firebox. Absolutely safe. It lasts a lifetime.



Sizes to fit all heating stoves. Gives warm room at once — no waiting for fires to come up.

No wonder housewives are clamoring for this wonderful device. No wonder Mr. Oliver receives letters like these: Mrs. W. N. Spencer, of Conn., writes, "The Oliver in my heating stove works like magic. It is wonderful to have quick heat and no work." Mr. Elijah McCleave, of Va., says, "It works fine. All my friends want one. I will get their orders." A letter from Mr. S. K. Pedro, of S. Carolina, says, "Beats all other burners seen in this country. A sensation." Mr. Geo. Flynn, of Michigan, writes, "It is cleaner, cheaper, hotter and steadier than coal or wood. Only costs me \$5 for two months."

Perfect Heating Guaranteed

Now, once and for all times, do away with household dirt and drudgery. The Oliver in your stove, heater or furnace saves hours of work, thousands of needless

steps. Already Oliver burners are installed in over 150,000 homes. Their performance has been so thoroughly

tested that Mr. Oliver will absolutely guarantee perfect heating for any Oliver burner you install.

Coupon Brings Free Low Price Introductory Offer

Send immediately for the Free Attractive Booklet, "New Kind of Heat," which tells all about this amazing new invention, shows exactly how it works, and how it is different from all other

burners. The coupon below will bring you this information absolutely free, without obligation. And if you mail the coupon at once you will be in time to receive Mr. Oliver's very Low Introductory Price. You should have your Oliver installed immediately. By acting quickly, by sending in your name at once you will be entitled to Mr. Oliver's Special Low Price whether you buy now or later. So get this coupon in the very first mail.

Agent Makes \$215.00 in One Day—More Agents and Distributors Wanted

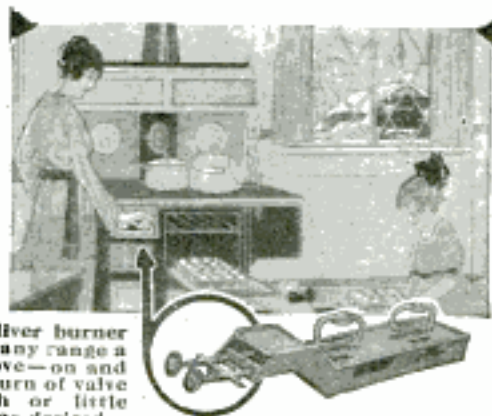

The Oliver burner makes any range a gas stove—on and off at turn of valve—much or little heat as desired.

Mr. Oliver is also looking for agents, salesmen and distributors. Oliver agents are making fortunes. F. B. Bentley, of Phila., says, "Ye gods! some seller. I made \$215 today." J. Carnegie, S. Dakota, writes, "Making \$1,000 a month." A. M. Russell, Conn., \$258 per week. Mrs. Selder, Kans., made \$100 a month, spare time only, in her own home.

If you want to earn \$50 a week spare time, or \$200 a week full time, write for FREE Sample Case Sales Plan. If you can swing a whole territory and want \$15,000 to \$50,000 and more a year, wire for sales plan. Address Mr. Oliver personally at address below.

OLIVER OIL-GAS BURNER CO.

2014-I Oliver Building St. Louis, Missouri
Canadian Distributor 2014-I Oliver Bldg., Toronto, Ont.
"Oldest and Largest Manufacturers of Oil-Gas Burners in the World."

It Brings Free Low Introductory Price Offer!

OLIVER OIL-GAS BURNER CO.,
2014-I Oliver Bldg., St. Louis, Mo.

Gentlemen: Send me your free book, "New Kind of Heat," and your Special Low Price Introductory Offer. I am interested in a burner for

Coal Range Heating Stove Furnace
(Specify Steam, Hot Water or Hot Air.)

Name

Address

City..... State.....

If interested in selling in full time or spare time, check in square here.



There's a Difference in Auto Schools Just as There is a Difference in Automobiles

ANY automobile is only as good as the service it can give the owner. Likewise, any auto school is only as good as the service it can render you in increasing your earning ability.

Some automobiles are manufactured in volume. Thousands, yes, even millions of cars are turned out by single factories in a year's time.

Some automobile schools conduct their business along these very same lines. Thousands of students are graduated each year in somewhat the same mechanical manner in which automobiles are manufactured.

The *Quality* automobiles—there are only a few—are manufactured in limited numbers. These are the cars that are made with mechanical precision that assures years of perfect service and satisfaction. These are the masterpieces of motordom—the *quality* cars.

National Automotive is an Automotive Training Institution conducted on a quality basis. Volume is not considered. Only a limited number of students can be trained because each student must have the individual instruction from expert Automotive Instructors in order to qualify. The men that graduate from National Automotive are the **AUTOMOTIVE EXPERTS**. The men who **KNOW** every branch of automotive engineering. The men who get the important big-pay jobs. The men who make a success in the automobile business.

National Automotive Is a Quality School

You know there is only one Packard; you know there is only one Cadillac. Likewise, there is only one National Automotive—the *quality* school.

National Automotive, the first automobile school in America, has, since its inception in 1905, firmly adhered to the principle of quality.

Quality at National Automotive means more than you yourself might think. It means specialized, individual instruction in every branch of automotive engineering by experienced automotive experts. It means the

finest school and most modern equipment that money can buy; hundreds of thousands of dollars have been expended to make training facilities ideal at National. It means an efficient system of training that will qualify you in the shortest possible time as an automotive expert capable of holding a big-pay job. This is our famous system of practical shop training, which has been perfected only after nearly twenty years of hard work, thought, study and conscientious effort. Quality is the reason that today, National Automotive stands so high in the field of automotive training schools.

An Auto Book Sent FREE to You

Space here is too limited to even begin to tell you of the many special advantages offered at National Automotive.

For your information, we have incorporated into a beautiful 84-page book, the story, with illustrations, facts and figures about National Automotive; about the opportunities as they are today in the automotive industry. Also stories from real life that tell how other men just like yourself have learned an auto trade and almost at once established themselves in the business world—as mechanics, electricians, battery men, etc., at big pay, or as owners of garages, tire repair shops or service stations.

Send for this free book today, and learn that there is a difference in auto schools, just as there is a difference in automobiles.

NATIONAL AUTOMOTIVE SCHOOL,
Dept. 52, 4004 S. Figueroa, Los Angeles, Calif.

Please send me your free book which explains the difference in automobile schools.

Name.....

Address.....

City..... State.....

If I Can Offer You a Job that pays \$100⁰⁰ a week and up, from the start, even to a man without any experience, are you interested? Then write me—today.

I will take on 1000 more agent-salesmen

this season and train and develop them myself and I can almost guarantee each one of these men will earn this one season at least \$2500—or at the rate of \$5000 and upwards a year. I want these men to show our beautiful samples of Fall and Winter All Wool Goods and take orders for Men's Finest Made-to-Measure Suits and Overcoats, customer to have his choice of any material in the entire line, all at the one low price of \$31.75, guaranteed equal in every way to suits and overcoats that sell generally at from \$50.00 to \$60.00.

They sell like hot cakes. Orders come easy. Men never saw such values—\$60 All Wool Made-to-Measure Suits and Overcoats at \$31.75—perfect fit and satisfaction guaranteed—choice of more than 100 different All Wool fabrics, and all at the one low price. It is a high-class, permanent business. Your customers are so well pleased they tell their friends and your income grows from season to season. You get your pay the minute you take the order—the cash goes in your pocket. You get the order almost as soon as you show your samples—people never saw such values.

Only 1000 more agencies

to be established this season—then all our sample lines will be placed. If you are interested, don't delay your application. Write me today sure.

No money or experience is needed

We have plenty of agents making big money who never took an order before. We furnish everything necessary and explain about taking measures which is simple and easy! We take all the risk and guarantee the customer perfect fit and satisfaction or refund the money. I will furnish each Goodwear agent this handsome, compact sample case and outfit as illustrated, with large 6 x 9 inch swatch samples, beautiful portfolio of fashions printed in colors, business cards, price lists, stationery, sales manual, (a real course in salesmanship), etc., etc. The most effective selling outfit ever put out. And I will give my men co-operation and assistance and make every man a sure-fire money-making success.



Even your spare time will do. Full time is better, but even if you have just spare time to give this work you can make fine profits. I will be glad to send you full particulars.

TAILORING AGENTS EVERYWHERE

No matter what line you now have, write me and get the full facts about the wonderful money making, quick selling, one price Goodwear line. Other salesmen and agents, you who are now selling groceries, books, magazines, toilet goods, raincoats, shirts, kitchenware—no matter what you are working at—I advise you to write me at once and see how much better proposition I can offer you.

Write today sure—don't put it off, you can start off quick as you get your outfit. Send me a letter or a postal, just say, "Write me full particulars," or mail the coupon. **Do It NOW!**

To LOUIS S. SCHWARTZ, Manager
GOODWEAR CHICAGO, Inc., Dept. 568, Chicago

Send at once, all free, all details of your proposition.

Name.....

P. O. State.....

St. & No. R. F. D. Box.....



More than 50 handsome Style Models similar to the above, but printed in full colors—just one of the many features of the GOODWEAR Line that helps you to sell it so effectively and so profitably.



COPYRIGHT, PACIFIC AND ATLANTIC PHOTOS, INC.

Flood of Lava from Mt. Etna Spreading Death and Destruction over Surrounding Country; Thousands were Made Homeless by the Recent Activity of the Volcano in Italy.—See Page 434

Popular Mechanics Magazine

REGISTERED IN U. S. PATENT OFFICE

WRITTEN SO YOU CAN UNDERSTAND IT

Vol. 40

SEPTEMBER, 1923

No. 3

2766

Romance of the Typewriter Revealed on Its Fiftieth Anniversary

ALTHOUGH it has freed the world from pen slavery, facilitated the tremendous growth of modern business, and opened the doors of opportunity to women, the typewriter is only 50 years old.

While it has knit the world closer together and its influence has been felt in the shaping of language and even of human thought, the man still in his fifties can distinctly remember when this "new-fangled" writing machine was only an object of curiosity.

Its birthplace was a little machine shop in the outskirts of Milwaukee where three middle-aged, thoughtful, and hard-working men, looked upon as "cranks" by their neighbors, labored upon pet inventions of their own.

One of them, a printer and "newspaperman" by trade, was engaged in developing a machine for numbering serially the pages of blank books. In this work, he had interested the second, while the third put in his time trying to invent a mechanical "spader" to take the place of a plow.

Chance caused the three to drop the inventions on which they

had been working and to pool their interests in a new and greater undertaking. According to the story of one of them, the idea arose out of a remark made when the paging machine was nearing completion:

"Why cannot such a machine be made that will write letters and words and not figures only?"

As a result of the remark they designed the "Pterotype," but it was never perfected. Model after model was built until 25 or 30 had been turned out, and finally, in 1873, a machine was constructed which was deemed sufficiently perfected for actual manufacture.

It wrote only capital letters and was a

very primitive-looking affair. The carriage was returned by a curious foot treadle, which, however, demonstrated its uselessness and was soon displaced by the now familiar hand-carriage return. Nevertheless, the fundamental principles of construction embodied in this first typewriter still survive.

The public took to the new invention rather gingerly. There was prejudice against printed letters to begin with. Many



First Typewriter Put on the Market in 1873 with Curious Foot Treadle to Return Carriage

Clipping from the Kansas City Star
Kansas City, Mo. June 15, 1923

Cont. Mrs. Frances S. Coleman, 327
83,5 Montgall Ave., Kansas City, Mo.

2766
328

POPULAR MECHANICS



Primitive-Looking Machines, the Forerunners of the Modern Typewriter That has in a Few Brief Years Freed the World from Pen Slavery and Opened the Doors of Business to Women

First played at Olympia

Hilds Country Club. AIRPLANES IN GOLF MATCH DROP BALLS ON GREEN

2893 Airplanes and field glasses are the only things needed by airmen taking part in aerial golf games, to "drive" the ball to

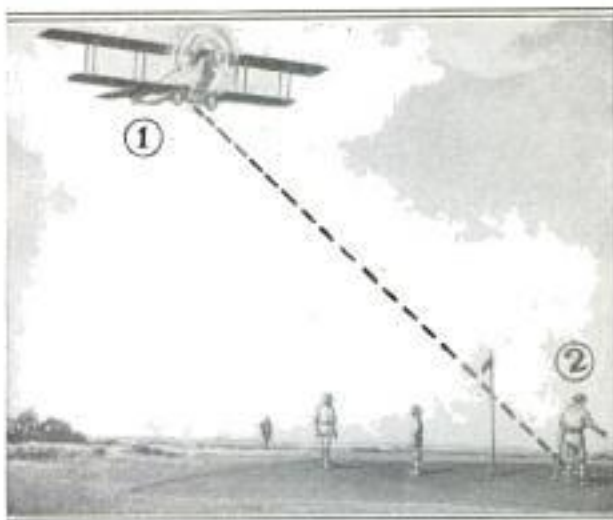

Ground Players Score the Holes After Balls have been Dropped by Aerial Golfers

the putting green. Two men are necessary for a team, one, ascending in the plane, locates the greens through his glasses, dropping the balls upon them, if possible. Then they are placed in the holes by a few strokes by the ground player. As many balls are carried by the flier as there are holes on the course.

2999 AUTO FENDERS ADD BEAUTY TO BODY OF CAR

Entirely changing the appearance of an automobile, front fenders have been made by a western inventor that are part of the body, inclose the headlights, and serve as part of the radiator shell. The lines flow into the body of the car, leaving no corners to catch dirt and making it easy to clean. Distinctive in appearance, the fender gives beauty of line.

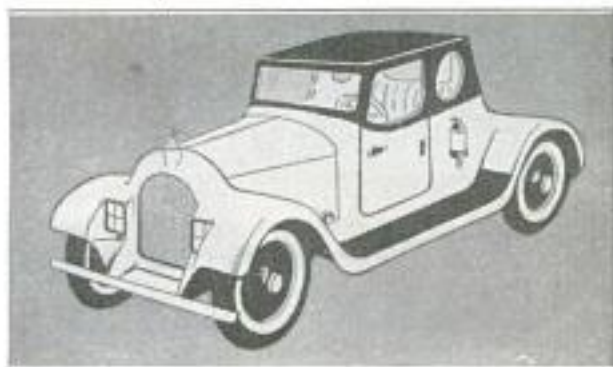

Automobile Equipped with Fender That Appears to have been Molded onto Body

correspondents resented them as an insinuation against their ability to read and write. The story is classic of the Kentucky mountaineer who returned his first typewritten letter to the man who wrote it with the words indignantly scribbled on the margin, "You needn't print no letters for me, I kin read writin'."

Lack of public interest was painfully in evidence at the Centennial Exposition in Philadelphia in 1876, where two of the greatest inventions of modern times made their first appearance—the telephone and the typewriter. While the telephone was the center of attraction, the typewriter stood in an obscure corner among the exhibits and was viewed largely as a "freak" invention.

access 2936

BATHING MACHINE IS DRIVEN IN WATER BY PEDALS

Bicycle pedals, connected by a chain with the propeller of a bathing boat used this season in a middle-western city, develop a speed of six miles per hour, the inventors say. This is equal to the rate of an ordinary small motorboat. The rider, wearing a swimming suit, sits in



Copyright, International Newsreel Corp. Rider Operating Bathing Boat by Pumping Bicycle Pedals That are Connected by Chain with Propeller

the center of the boat as he pumps the pedals with little more effort than in riding a bicycle, controlling the rudder with the hands. By changing the size of the gears, he can cut down or increase speed. In rough water the boat rides the surface well, being made stable by the weight of the bather, though tipping over does no harm.

Estimates place the amount of oxygen in the earth's atmosphere as 1,000 times greater than that present in the air surrounding the planet Venus.

Inventors, Rudolph Johnson } Chicago
William C. Wallace }
no street address given

Chicago Journal, June 27, 1923

Mr. Sarkis H. Dumbulian
Route J. Box 199
Albino, Calif.

In use by Mr. Beeman, Mrs. Miss
 330 8 Kearny POPULAR MECHANICS 5752 Wabash
 San Francisco Calif. av. Chicago

**WHEEL BRUSHES THE SHOES
 OF PASSING SHOPPERS**

As an added attraction to his establish-
 ment, a California cobbler has placed a



Shoppers Take Advantage of This Progressive Shoe-
 maker's Invitation to Have Their Shoes Cleaned

machine outside his show window to brush the shoes of any who care to avail themselves of it. A wheel of stiff bristles, revolving on a shaft driven by machinery inside the store, is raised high enough from the sidewalk so that the foot can be inserted under it and pressed against the brush, whisking the dust off in a few seconds. The noon hour seems to be its busiest time, a line of people often waiting for a chance to use it.

**SCALE SAVES FARMER'S TIME
 BY DOING HIS FIGURING**

If he knows the length of a field, a farmer can find with a pocket scale, recently marketed, the number of rows and tenths of a row to an acre in planting any distance from 6 inches to 7 feet apart. By one movement of a sliding index in a paper cover the correct figures are obtained. The same calculator converts bushel prices into prices per 100 pounds. It also includes a breeding scale for cattle, sows, mares, and ewes. Another type is made for the lumberman for measuring board feet.

Columbia Novelty Co.,
 Portage, Wis.

**HOLDER FOR ICE IN PITCHER
 KEEPS CONTENTS CLEAN**

So that ice will not come into contact with liquids in a pitcher recently patented, it is placed in a compartment in the center of the utensil. Drinks are cooled as effectively as if the ice were floated in them and are more sanitary because melted ice does not mix with them. A cap fits over the container.



**AUTO CHAINS IN FOOTREST
 SAVE SPACE IN CAR**

Serving as a rigid, durable footrest, a kit for skid chains is being marketed as one of the latest automobile accessories. Compact and neat in appearance, the device not only adds to the passenger's comfort but provides a concealed yet safe and handy place for the chains, keeping them until needed. As the cylinder is closed at both ends, there is no danger of their being lost. It is easily installed on the floor of any make of car, and in an

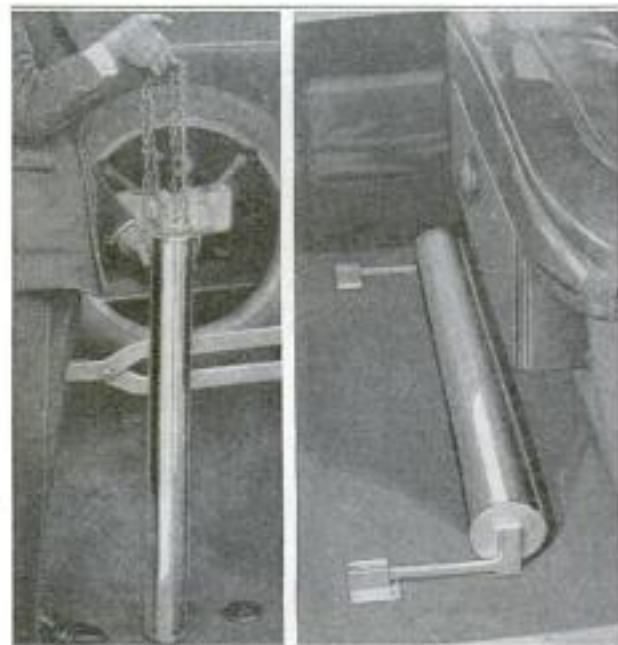

Skid Chain Kit as It Appears While being Used
 as a Footrest

emergency the holder may be used to carry water.

Maggs Automotil
 Equipment Co.,
 Box 57, Canton, Ohio.

2943

Emb. Miss Lane Elwyn
 Arlington Hotel San Francisco Calif

3004

2981

3053

Copyrighted material

LIPS STRETCHING TO EYES
ADORN AFRICAN WOMEN 287

In Africa, where many curious things are done in the name of tribal custom, there is a province where women stretch their lips with wooden disks, because it is fashionable to have large lips. When, at the age of 5 or 6 years, a native girl is engaged to marry, a ceremony is held for the first lip piercing. Her future husband thrusts a straw through her lips, where it remains for three months, when a round piece of wood is put in its place. Every three months thereafter a larger disk is used until, when the girl has become a young woman, the wood is as large as an ordinary plate. After about 7 years of this treatment the lips are so enlarged that the girl has difficulty in eating. Many then take only liquid food. Big lips, some so large that they can be pulled up over the eyes, are a mark of

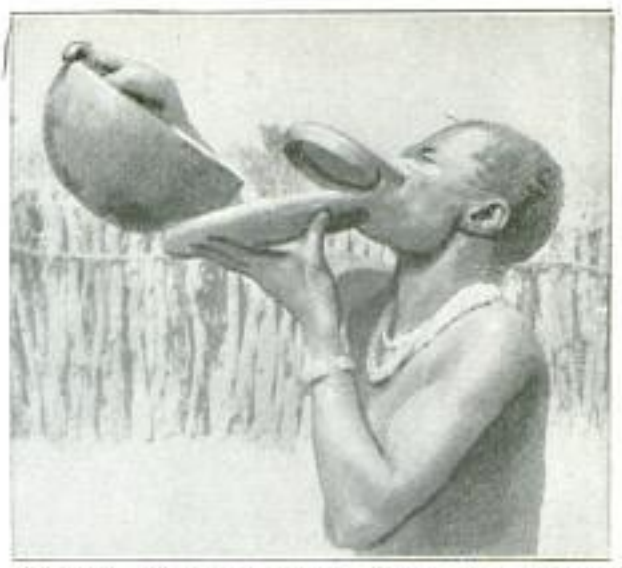

Prevented from Eating Solid Foods, This Woman Pours Liquids into Her Distorted Mouth

beauty. French officials in control of the province are making efforts to have the practice stopped, it is said.

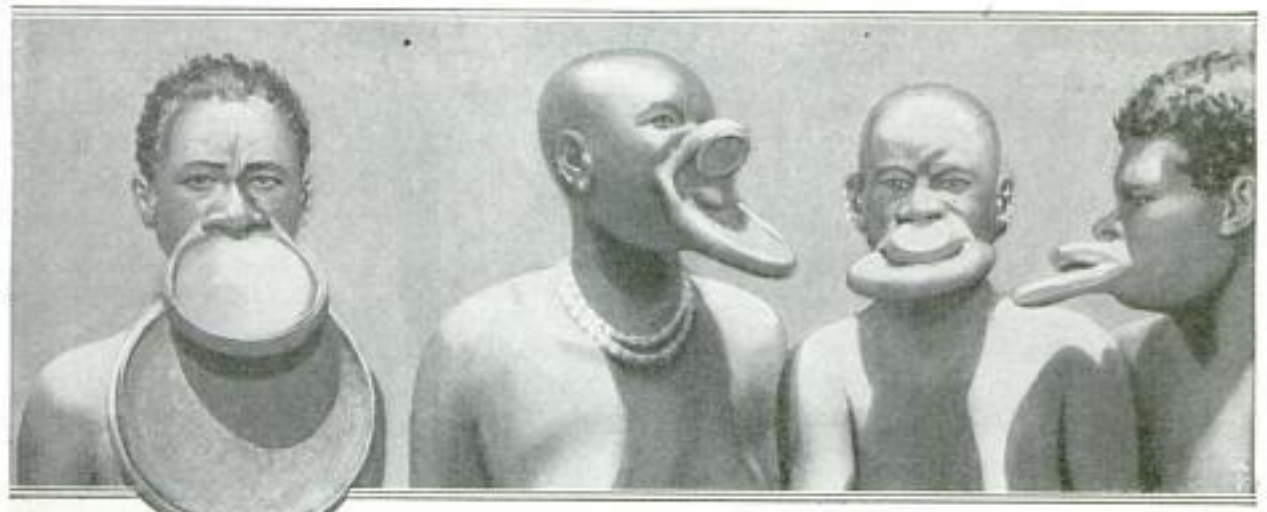

These African Women Greatly Admire Lips Enlarged to the Size of Dinner Plates. As Stretching Progresses They Begin to Droop, Often Reaching Almost to the Waistline

UNCLE SAM COLLECTS GEMS
FOR PRICELESS EXHIBIT 2989

For 40 years Uncle Sam has been collecting jewels until there is now one of the finest collections of precious gems in the world in the national museum. Through the exhibits there displayed, it is shown that practically every known gem is to be found somewhere in the United States. No longer need the jewel collector hie himself to South Africa for diamonds, since the diamonds are to be found in Arkansas, North Carolina, Kentucky, Georgia, Ohio, Wisconsin, Colorado, and California. Montana leads in the production of sapphires and also of rubies, while others of the same family,

especially the true emerald, which is often more valuable than diamonds of equal size, is found in North Carolina, and New Mexico. The topaz collection is remarkable for its size and the great range of colors shown. While the largest and richest of the blue variety of the topaz comes from Russia, Colorado has produced a marvelous reddish-brown stone, that cannot be excelled, while the clear varieties from New England and Utah are as lovely as a diamond. Many lands have given garnets, but the finest are from New Mexico. Nevada's opals have become important in the commercial world. Fresh water pearls come from the mussel and are found in the rivers of Arkansas, Indiana, and Tennessee.

Ant. Miss Edna M. Coleman,
5604-14th St, N.W. Copyrighted material
Washington, D.C.

600 N. Michigan Ave
2819 Chicago
RIGID AUTO SHADE PROTECTS DRIVER FROM THE SUN

To guard the automobile driver from the sun, rain, and wind, a rigid shade has been made that rolls up like an ordinary



Rigid Automobile Shade to Protect the Driver from Sun's Rays, Wind, and Rain

curtain. Hidden between the two folds of waterproof fabric composing the curtain, is an extension steel arm that keeps it from shaking in the wind, and holds it rigidly in any position. Used on the driver's side of a closed car, the window may be left open, the shade giving protection from both the wind and the sun, or rain. It also is made in a smaller size for a visor to shade the eyes.

287 SAFE POCKET BLOWTORCH MADE FOR HOME USE

So small that it may be carried in a pocket, a compact, safe blowtorch for use in the home, garage, and shop, is being made. Burning all forms of alcohol,



Alcohol-Burning, Self-Acting Blowtorch, Handy for Mending Kitchen Utensils or for Vulcanizing

it generates a pointed flame of intense heat capable of soldering large pieces of metal. It has many other uses, such as

vulcanizing tires, removing paint, or melting materials. A thumbscrew regulates the flow of alcohol, and thus controls the length of the flame. Unlike the gasoline blowtorch, it does not have to be pumped and heated, but is self-acting, the touch of a lighted match starting it into immediate operation. A liquid solder, dispensed from a tube, is made for use in connection with the device, although it will melt that substance in either wire or bar form.

290 TOWER CAR RAISES CAMERA ABOVE HEADS OF CROWD

Crowds will no longer make it necessary for the newspaper photographer to climb trees and poles with his camera to get pictures of interesting scenes, if he is carried about by an auto equipped with a tower, now in use by a daily newspaper. By pressing a button, the driver can automatically elevate a small platform supported on two legs that slide through the roof of the car, carrying the camera man



With This Tower Car, the Newspaper Photographer is Assured Good Views for His Pictures

above obstructions and giving him a clear field for his work. After the picture has been taken, the tower lowers in the same manner.

3030 FOUNTAIN PEN SUPPLIES LIGHT FOR WRITING IN DARK

For writing in dark places, a fountain pen is made, equipped with a small flashlight on a clip fitting over the stem, and supplied electric current from a pocket-size battery. A push-button switch operates the light which casts a ray around the pen point.

Emb. Edwin Sarruse,
The Farragut,
Washington, D.C.

The American Printer, June 5, 1923

The Solderall Co.,
127 Essex Ave.,
Newark, N.J.

POWER OF IDOLS STILL GREAT IN MANY LANDS

Great as have been the strides of civilization in the last hundred years, a very large portion of the world still is inhabited by men in a primitive stage, who fear and pay homage to strange idols of wood and stone. During some 25 years of roaming in out-of-the-way places, a Canadian has gathered together a unique collection of these heathen deities. One is a wooden carving of a crocodile from New Ireland, one of the South Sea islands. Another is the deity of the water paid homage to by the Solomon Islanders. To it they dedicate their canoes on launching, often making human sacrifices as part of the ceremony.

Then there is the special house built for the head devil of the Fijians and also the devil himself. The head god of the Battaks, an aboriginal tribe in Sumatra, who is supposed to subsist entirely upon human

bodies, also forms part of the collection. In obtaining six various-sized chalk figures, the collector nearly lost his life. These belonged to the New Irelanders, a primitive tribe of Papuan blood, who

are ancestor worshippers. When a member of a chief's family dies, one of these images is made from the chalk found in the Rossel Mountains. It is brought very secretly to the chief's house and placed in a chapel. The spirit of the deceased is then supposed to enter the figure and remain ever after. Among other idols in the collection are a god of ancient Mexico; three heads of coconuts carved in odd designs by natives of British New Guinea, and carvings of the rhinoceros hornbill made by the sea Dyaks, and

representations of a fish, the Bonito, that is held sacred in the Stewart group of islands.

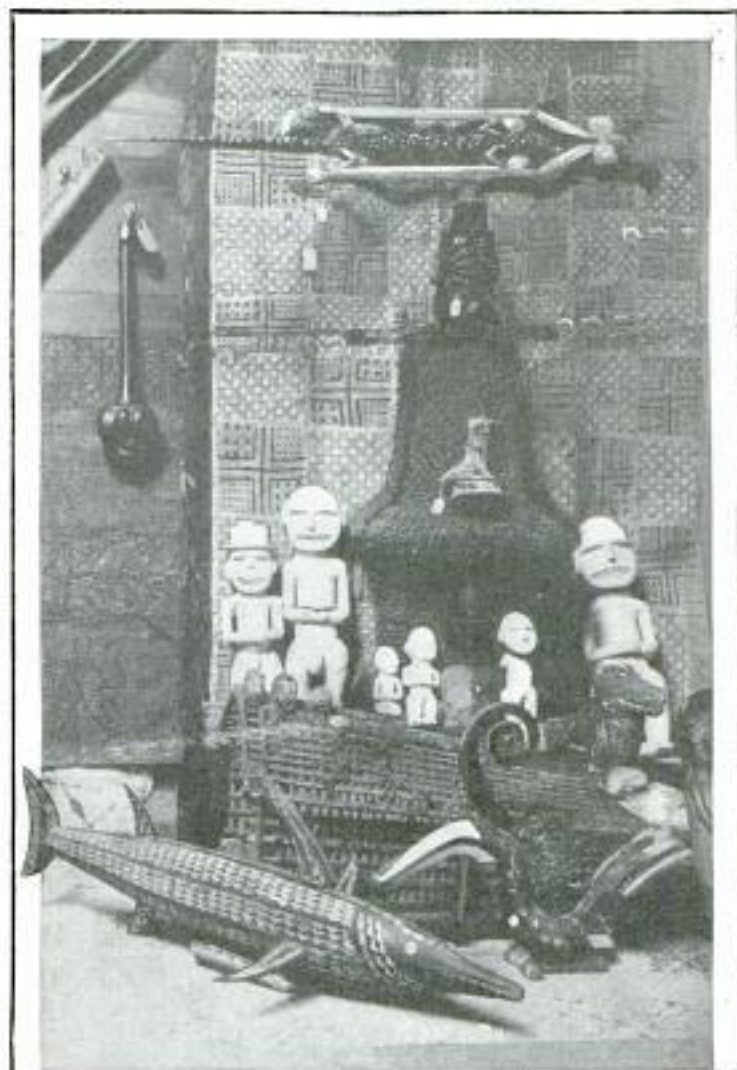

COPYRIGHT, FRANCIS DICKIE
 Idols and Charms Credited by Their Worshipers with Possessing
 Marvelous Powers of Good and Evil
Box 1090, Vancouver, B.C., Canada.

INSECTS' SENSE OF COLOR IS SHOWN BY TESTS

While naturalists have long known that insects have a highly developed sense of smell, recent investigations have indicated that they also have keen color preferences. For instance, the mosquito prefers navy blue to 16 other shades, and positively shuns yellow. Flies have no liking for pale blue, but will settle thickly

on white objects. Both flies and mosquitoes will respond to light and darkness. Colors of flowers attract many insects, but the more effective bait is their perfume. So pronounced is this excitement to odors that a scientist has asserted that it could be adapted to rid the cotton-growing states of the boll-weevil pest. He has suggested that the male boll weevil could be lured into traps by reproducing from coal tar certain fumes.

*New York Times
 7/8/23*

2701

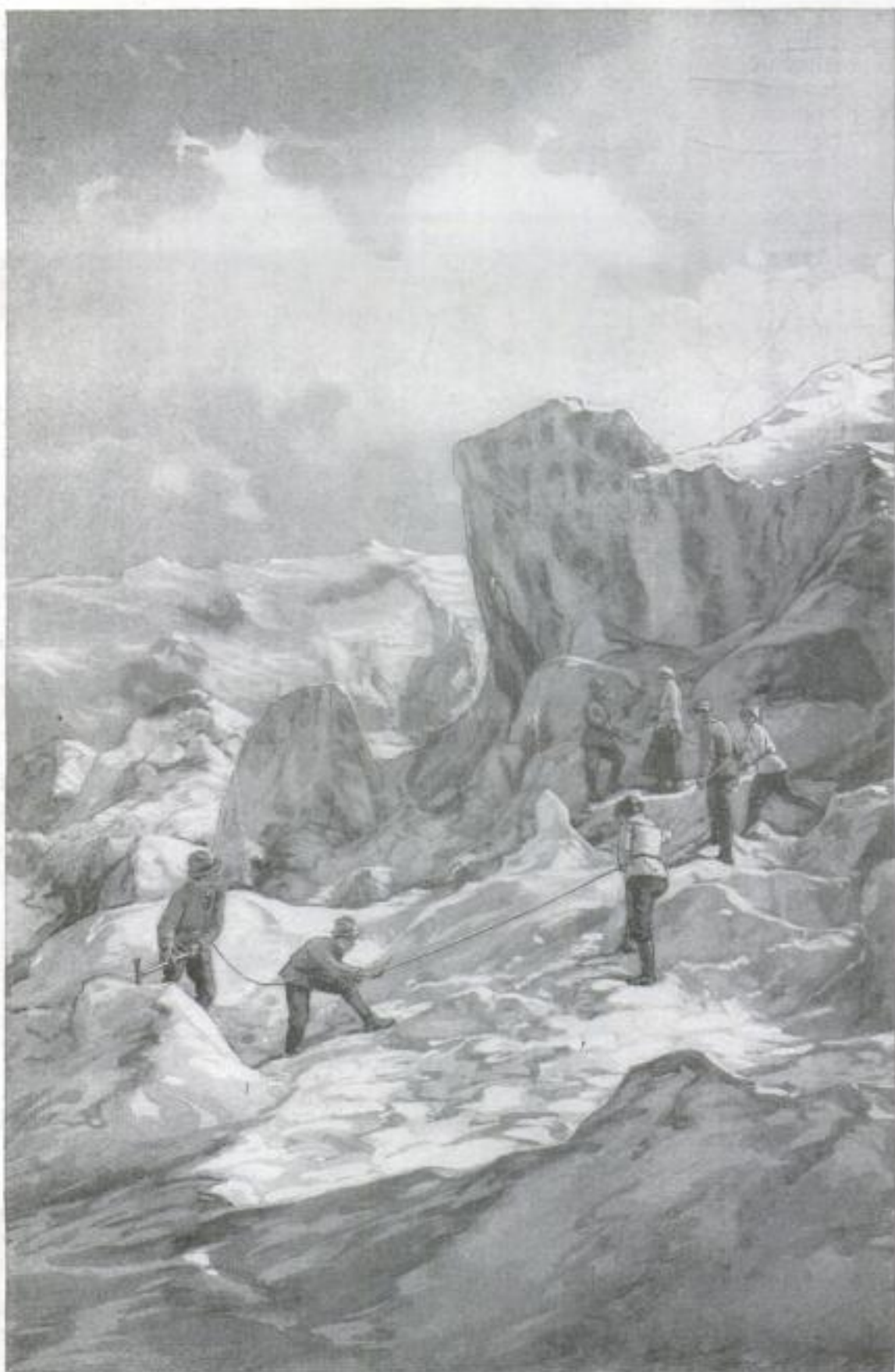

Hardy Mountain Guides and Party of Tourists Braving Hidden Perils to Conquer Alpine Peak: All are Tied Together So They may Not be Separated if Engulfed by a Snowslide.

Wide World Photos

2990 Broadcasted by Station W.P.U.

Teacher

POPULAR MECHANICS
Crosley Mfg. Co., Cincinnati, Ohio

335

SWIMMING LESSONS ARE GIVEN BOYS BY WIRELESS

Guided by a voice from the air, a class of boys and girls at a public beach recently were taught how to swim. Just as though the tutor were present, the youngsters obeyed instructions that came to them by means of a radio set placed near the edge of the pool. Fitted with an amplifier, the commands of the absent teacher carried to all parts of the

big outdoor tank, although he was talking to them from a broadcasting station some distance away. Preliminary lessons were given by the instructor in person, but after his charges had mastered the essentials of the sport, the wireless took his place. Guards were stationed in the vicinity to look out for the safety of the children during the lessons.

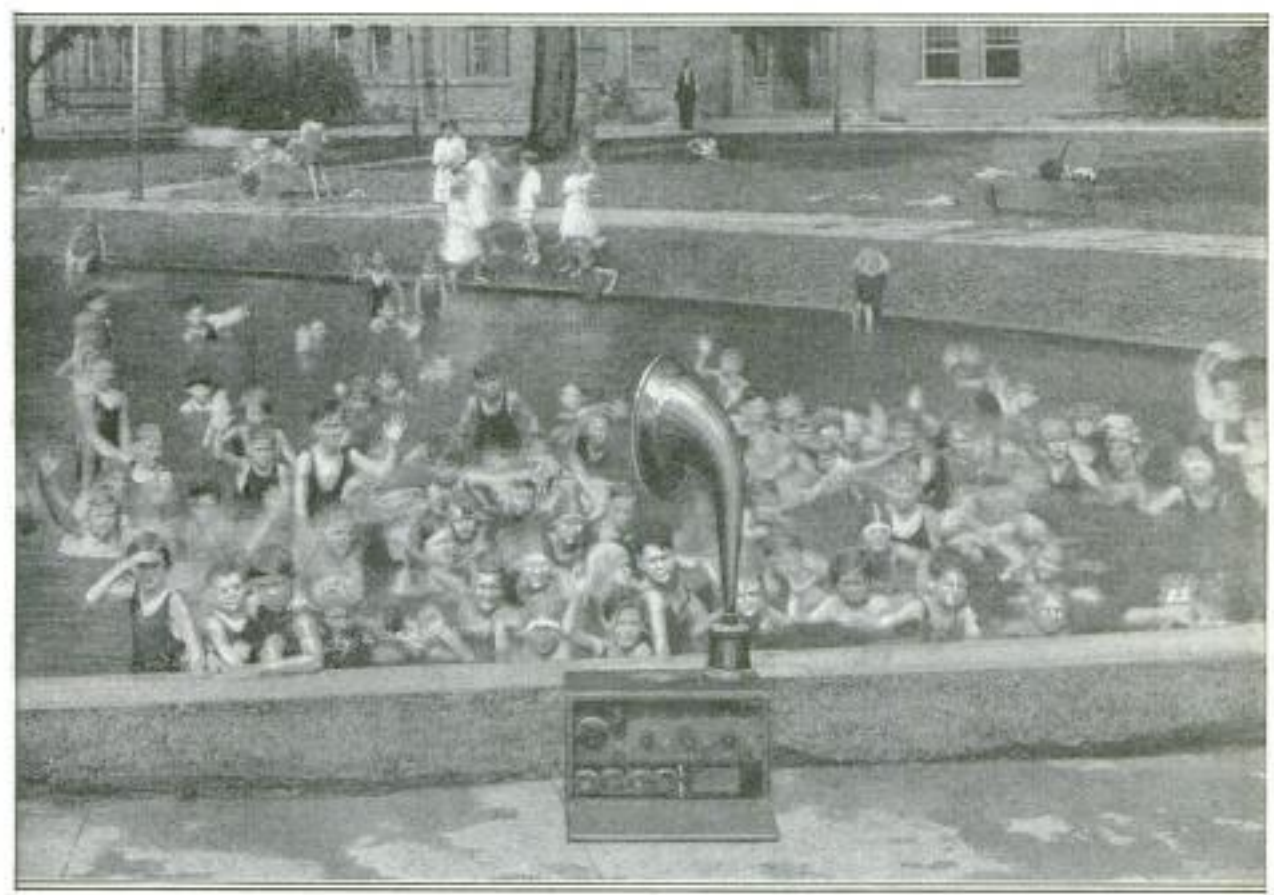

Youthful Beginners Receiving Instructions in the Art of Swimming by Radio from Their Instructor Who is Addressing Them from a Near-By Broadcasting Station.

2731

HEROISM OF ALPINE GUIDES SAVES LIVES OF MANY

Although they risk their lives daily amid snow-capped peaks, icy precipices, and treacherous glaciers, deeds of heroism by alpine guides are so common that they pass almost unnoticed. Cut off from the outside world, they are reared from the cradle to follow their hazardous profession, a heritage from generations of hardy mountaineers. Brought up among heights famed throughout the world for their beauty and grandeur, practically their only means of livelihood is guiding the thousands of tourists who flock to the great Swiss resorts every year. One of the

greatest proofs of the bravery of the guides is that, despite the many hidden perils of the winding mountain trails, serious accidents and loss of life are almost unknown. It is an honored tradition that these climbers must always be ready to sacrifice themselves to save those in their charge, and this is a code that is never violated. Usually they act in pairs, one in front and the other in the rear, with several travelers in between, all of them being tied together by long ropes about their waists. This is done, so that, even if several of the party are engulfed by a sudden snowslide, they may not become separated. Thus mountain climbing develops nimbleness and all-around strength.

Wide World Photos.

Emb. Maurice E. Pelgrims Deaso Camera Co.

336

POPULAR MECHANICS

Antwerp's Belgium
CART DRIVEN BY DOG POWER
IS AN AID TO INVALID

2849

As a means of travel about the streets of his neighborhood, a disabled Belgian war veteran has employed his dog to fur-



Geared Handlebars Help This Belgian Soldier's Dog to Pull His Homemade Carriage

nish power for propelling a cart of his own making. The animal is harnessed so as not to obstruct the rider's view of the road ahead. A set of handlebars geared to the wheels assists in driving the vehicle and at the same time serves for steering. The carriage is built of light materials, moving at a speed of five to six miles an hour without great exertion. Placed behind the cart, the animal stops or starts at a command from its master.

DIESEL ENGINE FOR AUTOS
TO INCREASE MILEAGE

Through the use of a Diesel-type engine, recently tested in the West, in automobiles, motorists see the hope of ending fuel and ignition troubles, and the attainment of long mileages impossible today. While this design of power plant has been used previously on boats, it has not heretofore proved practical in small units. Its advantage is that it readily burns heavy fuel oils, and has no spark plugs, coils, or ignition system of any kind. The mixture is ignited by the heat of the air compressed by the piston. This temperature is so great that the fuel injected into the cylinder is instantly fired. At present the average consumption of "gas" in the United States is more than 10,000,000 gallons daily and the supply is limited by the fact that only about 20 per cent of the crude oil is available as gasoline. To supply the deficiency it has been necessary to "crack," that is, to distill under pressure, some of the heavier oils into motor fuel. This has resulted in fouling of plugs and carbon troubles.

With the Diesel engine these handicaps would be done away with as it is designed to take advantage of the greater latent energy in the heavier oils.

RANGE FINDERS FROM GUNS
USED AS TELESCOPES

2867

Cut from the guns used in Europe during the war, small range finders are being marketed for use as monoculars for bird and nature study. They come in attractive leather cases with straps to go over the shoulders. Although roughly finished, the places where they have been sawed from the rifles still being visible, they are provided with fine lenses adjustable to the eye.



With leather case and shoulder strap

WARDROBE TRUNK HAS DOORS
ON TOP AND AT SIDES

2937

Doors on the top and at the sides, hangers for several suits or dresses, six drawers that slide sideways into the



Trunk That Has Doors at Top and Sides and Several Drawers That can be Locked Separately

trunk, and an unusual provision for laundry are some of the features of a wardrobe trunk recently put on the market. There is no danger of scratching a floor when the side doors are opened, as they swing out 2 inches above the trunk base.

G. H. Luggage Shop,
106 S Wabash
Chicago

Boylehem Shipbuilding Corp. 2836
San Francisco Calif

Copyrighted material

*Dist. Harry Levy Service Corp.,
130 W. 46th St. New York.
POPULAR MECHANIC*

PAPER MOVIE FILMS TO END THE DANGER OF FIRE *2830*

For the use in homes, churches, schools, and other places outside of the theater, a portable motion-picture projector has been developed that uses inexpensive, noninflammable paper films. It is said that this machine eliminates all danger of fire, and that it is so simple it may be operated by a child. Besides being used for movies, it also may be employed as a magic lantern, showing solid objects on the screen in either plain or natural colors without altering it in any way. This feature is expected to prove of value in teaching botany, engineering, and chemistry. The device projects the pictures by reflection instead of, as in the ordinary projector, by penetration of light through the film. Rays from the lamp are thrown on the picture or object at an angle from the front, in-

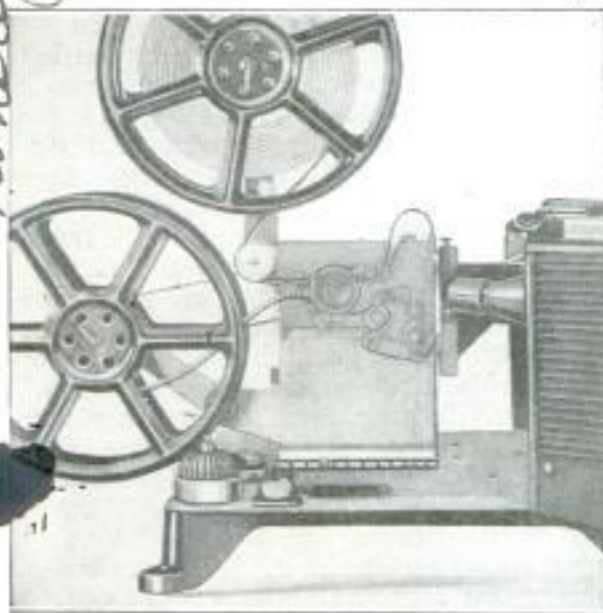

Portable Motion-Picture Machine That Uses Paper Instead of the Usual Celluloid Films

stead of behind the film. The object is thus reflected forward onto the screen. Light is provided from any standard electric-lamp fitting.

SCRAP TIN TURNED INTO TOYS

Out of 100 tons of scrap tin from salmon canneries of British Columbia, that has been piled in huge dump heaps in recent years, are to come armies of little tin soldiers, numbers of horses, miniature trains, jumping jacks, and other child's toys. American toy makers recently purchased the waste for use in their business.

no information as to users.

SAFETY SEAT PREVENTS FALLS WHILE WASHING WINDOWS

For preventing falls while washing windows in the home, a safety seat has been made which swings on two chains



Seat Swing for Preventing Accidents to Those Washing Outside Surfaces of Windows

attached to hooks in the window frames. A strap stretched between the chains supports the worker's back in comfort, at the same time acting as a guard against loss of balance, leaving the body free for movements required in the cleaning.

ANIMAL SO SMALL IT LIVES IN A DROP OF WATER

So tiny that it can be seen only by aid of a magnifying glass, an animal, heretofore unknown, has been discovered by an eastern scientist. By means of whip-lash strokes of hairlike projections covering its body it can move rapidly about in a drop of water. The little creature feeds chiefly on germs and other animals living in the water. It measures about one two-hundredths of an inch long and is less than one-fourth as wide.

Toy balloons won the distance records in a recent Paris, France, balloon race in which they were matched against real gas bags. Every one of the larger craft was reported to have been greatly out-distanced.

English product. Trade name. Kinereflex.

displayed at International Exhibition of 1904, New York

294 7
discovered by Prof. L. S. Woodruff

1 Photo from Wide World Photos.

What the World Offers the College Man

229 1043 rd St.
New York City

Rewards of Farming and Teaching Professions Prove Attractive to Increasing Numbers of Graduates

2844 1 Photo from Pacific & Atlantic Photos. New York

WITH a record-breaking increase reported in the numbers of young men, seeking admission to universities throughout the country, the question of what the future holds for the graduate is more frequently heard than ever before.

college training was worth while, the answer in every case was:

"Yes!"

Many, however, qualified their answers by declaring that, while a degree was desirable, it was not absolutely essential to success in any line except, possibly, in medicine.

Agriculture, transportation, industry, and business are all calling for trained men in constantly increasing numbers. Law, medicine, chemistry, electrical and mechanical engineering are offering a wider range of opportunities. College-trained men are being sought everywhere.

"It all depends on the man," said one. "Take two men of equal intelligence and let one enter college and another go into business. At the end of four years the one with the practical experience will command a much higher salary, but usually the college man will advance more rapidly when he starts because he has a broader vision, greater ability to assimilate knowledge, and more confidence in himself."

And yet it is pointed out that Lincoln got all his knowledge of the law by the light of a log fire at nights at home. Edison was a train "butcher." Marshall Field clerked in a country store. One of the country's greatest steel men began life as a water boy, and numberless high railway executives started as telegraph operators, section hands, and in lowly clerical positions.

How conditions are changing in the world of industry was also reflected in a canvass of the 34 highest executives of an eastern railway. It was found that 27 of them were college graduates. Just a little more than a decade ago, these figures were almost reversed, it being the rule rather than the exception for the executives to come up from the ranks.

With these and countless other examples before them, many persons are inclined to question the value in dollars and cents of a full college course. "Does it really pay?" "Is it years wasted during what should be the period of easiest mental growth and manual training—time spent in obtaining a foothold on the ladder of success and the building of firm foundations for future achievement?"

Inquiries regarding the salaries paid college men at the start revealed that two of the most profitable openings were for agricultural graduates and school-teachers. Young farm supervisors were in demand at salaries ranging from \$2,400 to \$3,600 a year, while teachers received from \$1,500 to \$3,000.

These were the questions put by Popular Mechanics to a score of successful executives and employers in one of the largest industrial centers of the country. Most of them had never even finished high school, but when asked whether a

Even higher pay was offered teachers who qualified both in scholarship and ability to act as instructors and as coaches of high-school basketball or football teams.

Wages Paid in One Industrial Center

Occupation	Salary to start	Income after four years	Education required
Doctor.....	None	\$3,600	5 years college
Lawyer.....	\$900 to \$1,200	\$3,600	6-7 years college
Dentist.....	\$1,800 to \$2,500	\$3,800	5 years college
Mechanical Engineer.....	\$1,440 to \$1,800	\$3,400	4 years college
Electrical Engineer.....	\$1,440	\$3,000	4 years college
Bricklayer.....	\$1.25 per hour	4 years apprentice
Plumber.....	\$1.15 per hour	4 years apprentice
Plasterer.....	\$1.25 per hour	4 years apprentice
Farmer.....	\$2,400 to \$3,600	4 years college
School-Teacher.....	\$1,500 to \$3,000	4 years college
Musician.....	\$3,900

[These figures are not intended to represent general averages. They were compiled after a careful canvass among employers in one of the largest industrial centers of the country and the sums are given only to indicate the general trend of wages in certain lines. As far as the trades are concerned, the figures are for employes.—Editor's Note.]

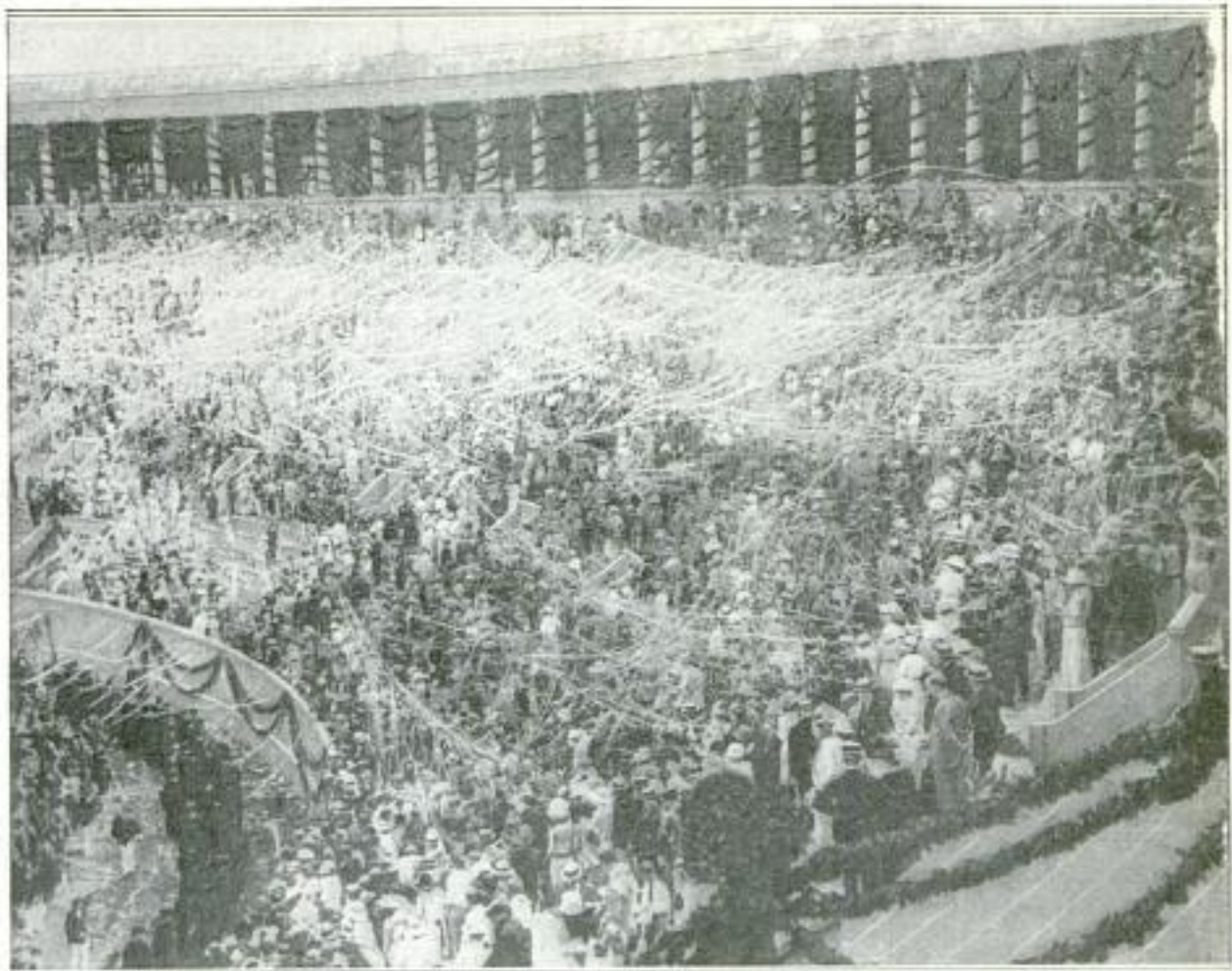

Confetti Battle That Marks the End of the College Year at Harvard and the Beginning of the Struggle for Fame and Fortune on the Part of the Graduates

On the other hand the young doctor, who entered a hospital as an interne after his graduation, received nothing but his board and room for the first year, while dentists who went to work as assistants received an average of about \$1,800.

In the engineering lines, many of the larger companies have apprenticeship courses. Students begin these during the summer vacations while they are in school, thus cutting down the period required considerably.

This system also is being adopted by many of the great commercial organizations in training executives, the effort being made to add practical experience to the theoretical knowledge gained at college.

In picking men, employers have expressed considerable preference for those who have worked their way through school, believing that this training has resulted in greater self-reliance, and has developed ingenuity and imagination.



Melting-Pot Graduation Class, Composed of Children Born in 10 Different Countries, Who Received Their Diplomas Recently from a High School in a Middle-Western City

Dr. E. W. Payne,

340 *Optometric* POPULAR MECHANICS

Fresno, Calif.
EYE DEFECTS ARE CORRECTED BY EXERCISING SCALE

299 Exercising the eyes to restore proper muscular balance and thus obviate the

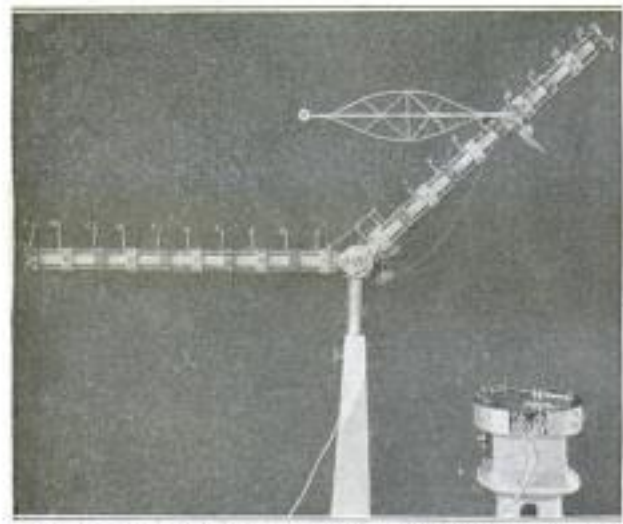

Machine Designed to Remove Muscular Defects of Eyes by a System of Drills

necessity of glasses in many cases is the object of a machine recently invented. Consisting of two long arms and a pendulum that moves either in an arc or a circle, the device provides more than

1,600 exercises. Each bar carries a number of small bulbs that may be lighted in a variety of methods and a series of letters, figures, and tiny mirrors. An electric attachment automatically controls its operation. Failure of the eyes to function properly at any angle is easily determined and then the exercises are outlined accordingly. The apparatus is supported on a pivot so that it may be turned, raised, or lowered at will.

RAY'S OF LIGHT CARRY VOICE THROUGH AIR TO PHONE

3046 Light waves were used to carry the human voice to a telephone receiver in a recent test in Europe. Selenium, a mineral that is very sensitive to changes in light reflected on it, was the principal aid. A beam was cast on a concave mirror which also received vibrations from a speaker's voice. Rays from the mirror were reflected on a selenium cell connected with an ordinary telephone receiver. As words were spoken the intensity of the light changed. The mineral cell carried these vibrations to the phone. At the test it was possible to send messages in only one direction.

University College, London, England.

3014 **JAPANESE SHRINE IS BUILT OF GOLD AND GEMS**

Creative power and imagination of the most skillful artists, metal workers, and weavers of a Japanese city recently engaged in the making of a small shrine, called mikoshi, borne on the shoulders of youths on festival days. At a carnival young men carried through the streets

the 5,000-pound shrine, of delicately fashioned gold, silver, pearls, and coral on which artists worked for three years. Built at enormous expense, it was carried away after a few hours, not to reappear for five years, when the festival will be re

peated.



Youths Bearing Sacred Burden Shown Once Every Five Years. At Right: Shrine That is Built of Gold and Gems, Including 6,000 Pearls

Cont. N. Sakata, #10 Eschome, Idamachi, Kojimachi-Ku, Tokyo, Japan

Mr. J. J. ...
Mr. L. Jones & Co. Nashville Tenn.
Mr. Beckman Place New York
Mr. Reginald ...
Mr. ...
 Dr. W. John M. Nelson *Atlantic + Pacific*
 17 N. La Salle *Chicago*
 POPULAR MECHANICS *Photos.*
 25 Park Place *341*

EAR MUFFS HOLD HAT ON WITH HIDDEN SPRING 28 50

Ear muffs have been patented that attach to an invisible steel spring worn inside of the hat band.



When not in use, they are small enough to carry conveniently in the vest pocket. Attached in an instant, they fit so closely to the head that the hat cannot be blown off, allowing the owner to warm his hands in his pockets. Made of attractive material, the muffs have proved a great convenience in changeable climates because of the ease with which they may be attached.

SHEARS WITH FIXED BLADE GIVE MORE ACCURACY 3003

Resembling an ordinary pair of scissors, a device for cutting satin, silk or other fabrics has been invented that is designed to increase accuracy and deftness. Only one blade is movable. As the upper part of the instrument is pressed down upon the cloth, the lower section rests firmly on the table top, giving the operator a solid support. Thus it may be guided easily along the outlines of a pattern. The shearing power is multiplied by the addition of an extra joint between the thumb and the upper knife edge. It is intended for the use of tailors.

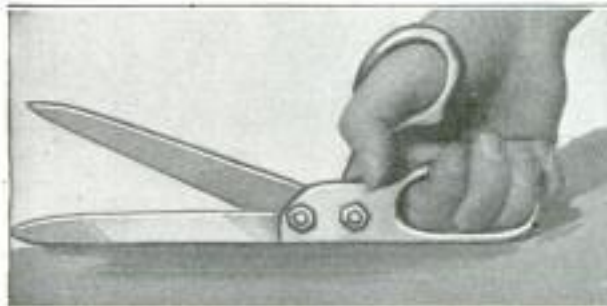

Shears with Lower Blade That Rests on Table, Made to Increase Accuracy

Ice-cream making takes 3.39 per cent of the 99,000,000,000 pounds of milk produced annually in the United States.

EMOTIONS TESTED BY MACHINE AND ACCURATELY RECORDED 2933

First used as an aid to science, a machine has been found of value in testing and recording emotions. It is said



Device That Records Emotions was First Intended to Test and Describe Heart Action

to describe all impulses accurately. Strapped to the wrist of a subject, a rubber tube carries the vibrations of the heart beats or emotion, to a delicate needle, fitted with a marking point. While undergoing the test, a person becomes unduly excited, the needle records the fact on a revolving roll of paper.

RED-CROSS FIRST-AID KIT BUILT LIKE KNAPSACK 3013

From a hunter's small knapsack, with a few changes in the pockets, there is being made a kit for American Red-Cross workers to carry when they are at disasters. Though small and light, the pack contains a complete first-aid kit, flashlight and extra battery, shears, pencils, writing paper, candle, a street guide, and other articles. In a middle-western city it is now being used by first-aid workers. Because the case is made of a heavy waterproof material, there is no danger of injuring the contents by rain.



Shown at meeting of American Medical Association, San Francisco

Publicity Dept. Chicago
 Chapter American Red Cross
 Copyrighted material
 No. 511-58
 Washington Chicago



COPYRIGHT, UNDERWOOD & UNDERWOOD

Hand-Made Oriental Tapestries Prized for Beauty of Design and Rare Workmanship Often Receive Their Finishing Touches at the Hands of Children Working with Needle and Yarn

Carpet 2695

WEAVING PICTURES FOR OUR FLOORS

Creating designs of beauty and weaving them into carpets and rugs have been the means of earning an existence for many people since earliest times. In the Oriental countries the traveling rug weaver still finds plenty to do in the way of producing tapestry work for his countrymen. While he sets up his weaving frame and does his work by hand, the tapestry makers of the United States and Europe employ huge machines that turn out strong and beautifully ornamented fabrics that serve to make home cozy and attractive.

The machine-made rug or carpet, while of the best of materials, is not quite so costly as the hand-made article. Designed by men and women who have been trained in special schools, the entire fabric is carefully planned before the materials are given to the machine for weaving and finishing.

Cotton, hemp, wool, and often silk yarns are used in making the different grades of tapestries. The warp, or longitudinal thread, forms the main body.

Where a heavy pile face is to be put into the fabric, two wefts are needed.



COPYRIGHT, UNDERWOOD & UNDERWOOD
Beginning a Masterpiece, the Tapestry Weaver Inspects Each Thread as It is Placed in Position by His Helpers



Revolving Knives Trim the Pile of Machine-Made Carpets to a Velvet Finish

One of these forms the ground, while the other is so looped about the warp that a thin wire with a knife-edge quickly cuts the looped yarn, allowing the two ends to rise vertically from the surface. After weaving, the finished material is

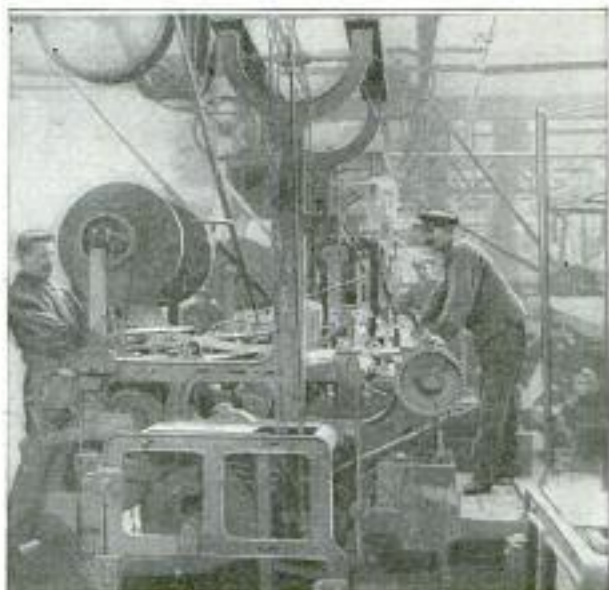

Automatic Rug Looms Now Perform Marvelous Work Designed for Them by Accomplished Artists

or background of the woven fabric. The number of warps used determines the width of the finished article. The weft forms most of the design, serves as a ground for the pattern, and determines length. Mechanical fingers pass the weft over and under the warp, knotting and looping it to give a close, durable finish.

then run through the shearing machine, where a series of brushes loosen the fibers of the pile so that the shearing knives in passing over them will leave an even velvetlike finish to the surface.

In many of the crude forms of rug weaving the body is first woven by hand on a wooden weaving frame which stands before the worker or is placed level with the ground. Removing the body from the frame, the weaver then knots in the design, using a needle and colored yarns to get the desired scheme.

Old hand-woven tapestries are today as highly prized as the rarest jewels, and much time and study are given to their collection by dealers throughout the world.

AIR PATROL OVER SAHARA GUARDS DESERT PEACE

Protecting travelers and safeguarding peaceful natives in a country three times the size of France, is the work of the aerial police in Algiers. Before this flying unit was organized, an army of thousands of men was kept there to defend the territory and to put down uprisings of rebels and roving bandits. Many soldiers were killed in these fights, but since the airplane squadron took up the patrolling, not one man has been lost. In most cases the sight of the flying machine is enough to quell any trouble, but in the

event that it is not, exploding bombs which the airmen carry quickly settle the disturbances. Until the French government occupied the region, the towns were frequently attacked and raided by warlike tribes of desert men. Strong, high walls were built around the houses and cities to aid in their defense.

ROGUES' GALLERY OF PESTS IS KEPT FOR FARMERS

For the benefit of farmers and fruit growers, government scientists keep a rogues' gallery that rivals in completeness that of any criminal institution in the world. There are recorded great numbers of insects that are ruinous to plant life. Each year the department sends out experts to hunt down "criminal" pests and to broadcast the methods of getting rid of them. Recently, after following a trail that led him over a great portion of Mexico, one of the scientists returned with specimens of the little-known fruit fly. It sometimes spoils shipments of Mexican fruit into the United States and in some sections has done great damage to crops, although it is not feared as much as its relative, the Mediterranean fly, since it does not thrive in certain localities. It bores into fruit while it is on the tree, causing it to fall to the ground and rot. Its eggs are laid in the ground.

*Philadelphia Public Ledger
June 23, 1923*



Aerial View from French Military Patrolling Plane, Showing Sahara Desert Village: High Stone Walls have been Built around the Houses to Repel Attacks of Warlike Tribesmen

2558

Written by Jacques Boyer,

POPULAR MECHANICS

5 Fcs.

34
Rue Saint Paul,
Paris, France

Exploring a New World Underground



Rushing Rivers, Golden Minarets and Rainbows of Dazzling Beauty are Found Thousands of Feet below the Surface of the Earth Where Torrents Whisper Never-Ending Tales of a Dead World

FACES DEATH TO EXPLORE WONDERS BENEATH SURFACE OF EARTH

Scientist Finds Strange World of Darkness and Hidden Beauty

BY JACQUES BOYER

*Paris, France
101 bis Rue Saint Paul*

BURIED beneath thousands of feet of solid earth, a new world of darkness, of burning lakes, enchanting gardens, rushing rivers, golden minarets, and rainbows of dazzling beauty, has been found.

After many dangerous and futile attempts, the dark and silent abysses, where for countless ages the skeletons of strange animals have lain undisturbed, have been penetrated by man and forced to yield up many of their secrets.

Chasms without bottom, cataracts of great magnitude, splendid grottoes and rushing torrents whisper never-ending tales of a weird and dead world of spectral shapes and fantastic designs which for ages has been lying untouched almost beneath the feet of the living.

These wonders have at last been revealed through the daring of a French scientist, Edouard Alfred Hartel, who has devoted his life for the past forty years to subterranean explorations. His first investigations were at the mysterious holes of Dargilan and Padirac, which the natives for countless generations had maintained were inhabited by the devil and at the bottom of which was hell itself. Later he organized an expedition to enter fourteen gigantic crevices on the Plateau of Causses, into

which no human being ever before penetrated, although tradition has it that many beasts and men have disappeared therein.

One of his most fear-inspiring experiences was the trip into the grotto of Rabanel in France. So far as known, no human being had ever before dared to venture into its depths. Soon after this he succeeded in charting the great subterranean river of Sorgnes, near Sarzac.

It was on one of these expeditions that M. Hartel discovered the lake of fire. He was equipped with ropes, ladders, candles, ribbons of magnesium, matches, hammer, knives, a thermometer, a barometer, a gas mask and other scientific equipment.

Around his neck was strapped a small telephone so that he could keep in con-

stant communication with companions on the surface. The wire connections on the telephone ran through the rope by means of which he was lowered into the darkness.

Before the descent commenced, soundings were taken to indicate the depth, and thermometers lowered to find the temperature. Slowly and with great caution the explorer is lowered by half a dozen men at the mouth of the pit so as to avoid the jagged rocks lining the sides. Then over the wire comes a faint cry:

"Let 'er go!"

This indicates to the anxious watchers above that he has arrived safely on a ledge or at the bottom of the pit and is ready to follow some gallery into the eternal darkness beyond.

Silence follows. It is broken by the ringing of the telephone and the cry from the depths:

"Hold on to your rope! Hold on fast! I'm arriving at a bad passage."

An agonizing interval intervenes before the bell rings again and the distant voice says:

"I am adjusting the gas mask. Suffocating odors."

Ten minutes have elapsed. Suddenly a strong jerk on the rope. The telephone rings and a voice cries:

"Have lost the rope ladder! Candle went out. Have reached the bottom of the first pit."

A few seconds later he calls, "Light once more! Walking on dead animal carcasses recently fallen! Skeletons of all sizes five feet deep!"

Then he searches for the end of the rope ladder. After a few minutes he locates it and the telephone rings: "Let 'er go! Have reached the mouth of the second pit!" Silence. The journey is taken up again and now the rope registers 1,500 feet below. Again telephone rings:

"It's getting very cold! Damp! and mist! 1,800 feet. I have reached a large lake! Strange sight, burning incense. The abominable odor is getting stronger."

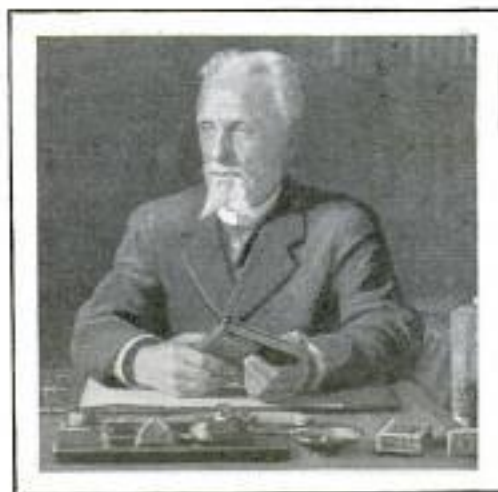

Edouard Alfred Hartel

BOONS ON EDWARD ALBERT HARVEY'S EXPLORATION

Pr

37

905-06

Harvey

and

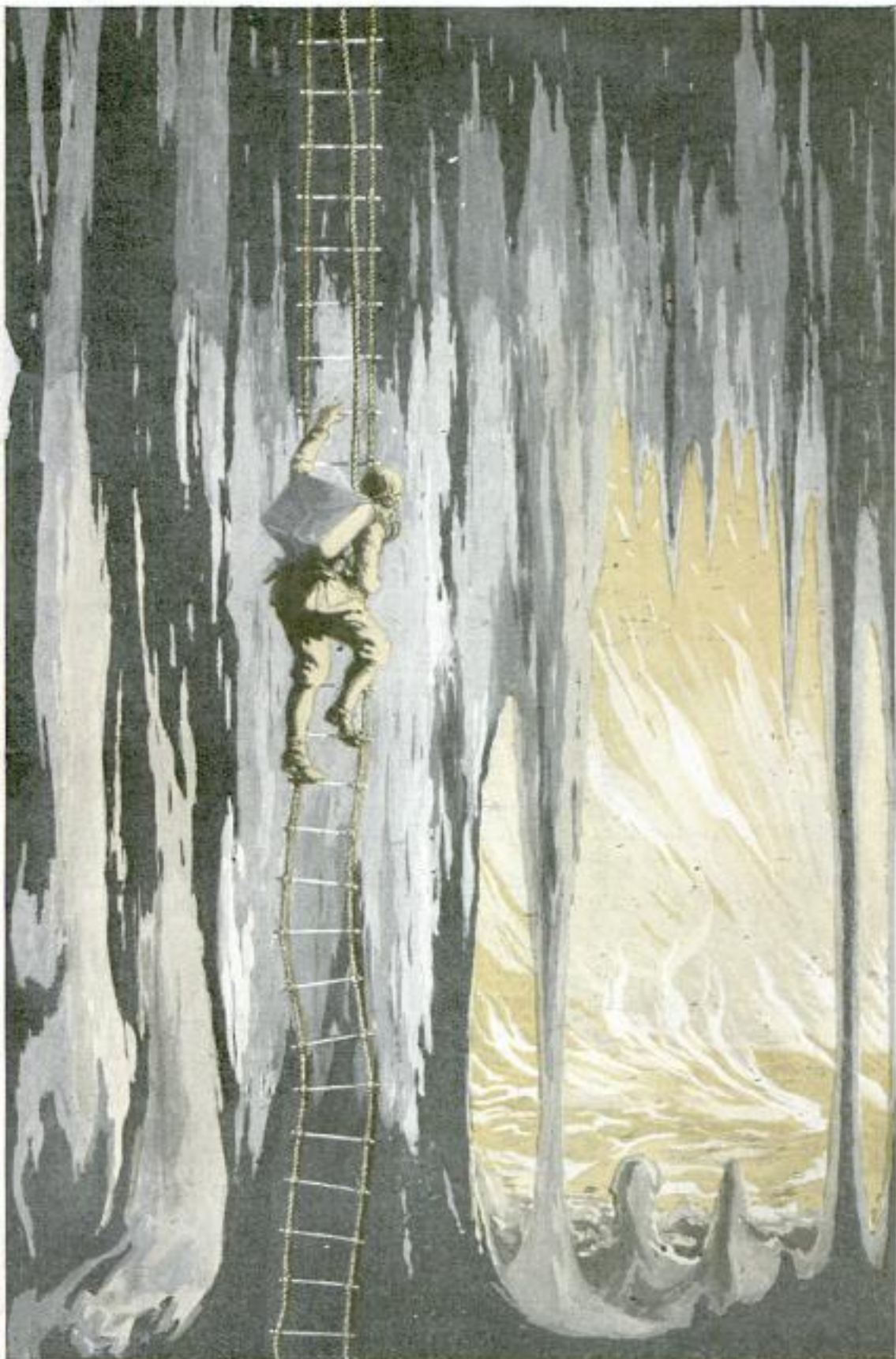

Blazing Lake of Fire Found Far beneath Earth's Surface by Daring Explorer Who Risked His Life to Catch a Glimpse of Wonders Never Before Viewed by Human Eyes

2558
 Then the ascent is taken up by means of the rope ladder. The explorer is out once more in the world of the living, exhausted and hungry for fresh air. Next day preparations are made for the exploration of the underground lake already discovered by the head of the expedition. A specially constructed canoe which holds three to four persons is lowered.

Explorers Use Canoe

Now the descent is no longer hazardous since the first risk has always fallen on M. Hartel's own shoulders. The explorers are armed with every scientific instrument necessary for the survey. First, the head of the explorers' party, then follow his assistants. One by one, they are slowly lowered down the pit with the canoe trailing behind.

On and on goes science, never satisfied, always ready to risk more and more, in order to unfold to the outside world the great hidden mysteries of enchanting gardens, innumerable minarets of stalagmites, rainbows of wonderful colors, and never-ending tales that are buried underneath thousands of feet of earth.

The romance of Hartel's underground explorations occupies 10 large volumes. On several occasions his life has been in great danger. Once he and his two companions lost their frail boat while making a survey of the underground river Padirac. Their candles went out and fell into the ice-cold water.

On another occasion he made the exploration in the famous Gaping-Ghyll cave of Yorkshire in England. No one dared to accompany him, so he decided to go down alone and left Madame Hartel at the telephone receiver. Sitting on his swing, he began to descend. On his way he received several baths from dripping fountains above his head, but succeeded in reaching the bottom.

Telephone Line Fails

After making a thorough examination, he came back to the phone. "Hello! Hello!" No answer. The microphone was put out of order by the water! For almost half an hour he kept shouting to his wife and his aids. Finally he was heard and was pulled back half dead.

A few years later he was invited by the Russian government to make explorations of an underground thermal river in the Caucasus. Here he was taken out, almost asphyxiated from sulphuric

fumes. He has, also, made valuable observations in America. In 1912 he visited and explored the great Mammoth Cave, Yellowstone Park, and the Grand Cañon.

Born at Pontoise in 1859, the future scientist in his early life showed his appreciation of nature's beauty. His curiosity as to strange phases of nature was aroused when his parents took him upon a vacation in the Pyrenees, in 1866. Later he studied in Italy, Switzerland, Austria, and England. However, his father, a lawyer, took him into his office as a partner where he practiced law for twelve years.

Yet this did not prevent him from making frequent expeditions for scientific explorations in southern France and neighboring countries. His real work began when he made the acquaintance of a famous Alpine adventurer who, in 1882, had revealed to the public, for the first time, the wonders of the Tarn and of the Cèvennes caves.

Many Obstacles Encountered

In exploring the uncharted grottoes, innumerable difficulties are encountered. It is necessary first to make a topographical and geological survey of the surroundings, at least 650 feet around the mouth of the abyss. This takes several hours. Then soundings are taken to determine the depth. For this, special instruments attached at the end of the rope are lowered down to take the temperature.

The subterranean outfit consists of several ropes, ladders, large candles, ribbons of magnesium, matches, elephant horn, hammer, knives, a thermometer, a barometer, several balls of string, a compass, topographic papers, gas masks, and other scientific instruments, first-aid packs, rum and chocolate.

Each member of the exploring party must wear the following outfit: strong laced shoes, gaiters, woolen clothes with numerous pockets, wide pantaloons, a blouse of strong material that will not easily tear by contact with sharp ledges. A cap made of boiled leather, to deaden the shock of falling rocks, and a knapsack complete the outfit.

In making the descent, the explorer installs himself on a piece of board, about half a yard long and tied in the middle by the end of the rope. A dozen men hold the rope at the mouth of the cave while another unwinds it as the explorer descends into the cave.

2558

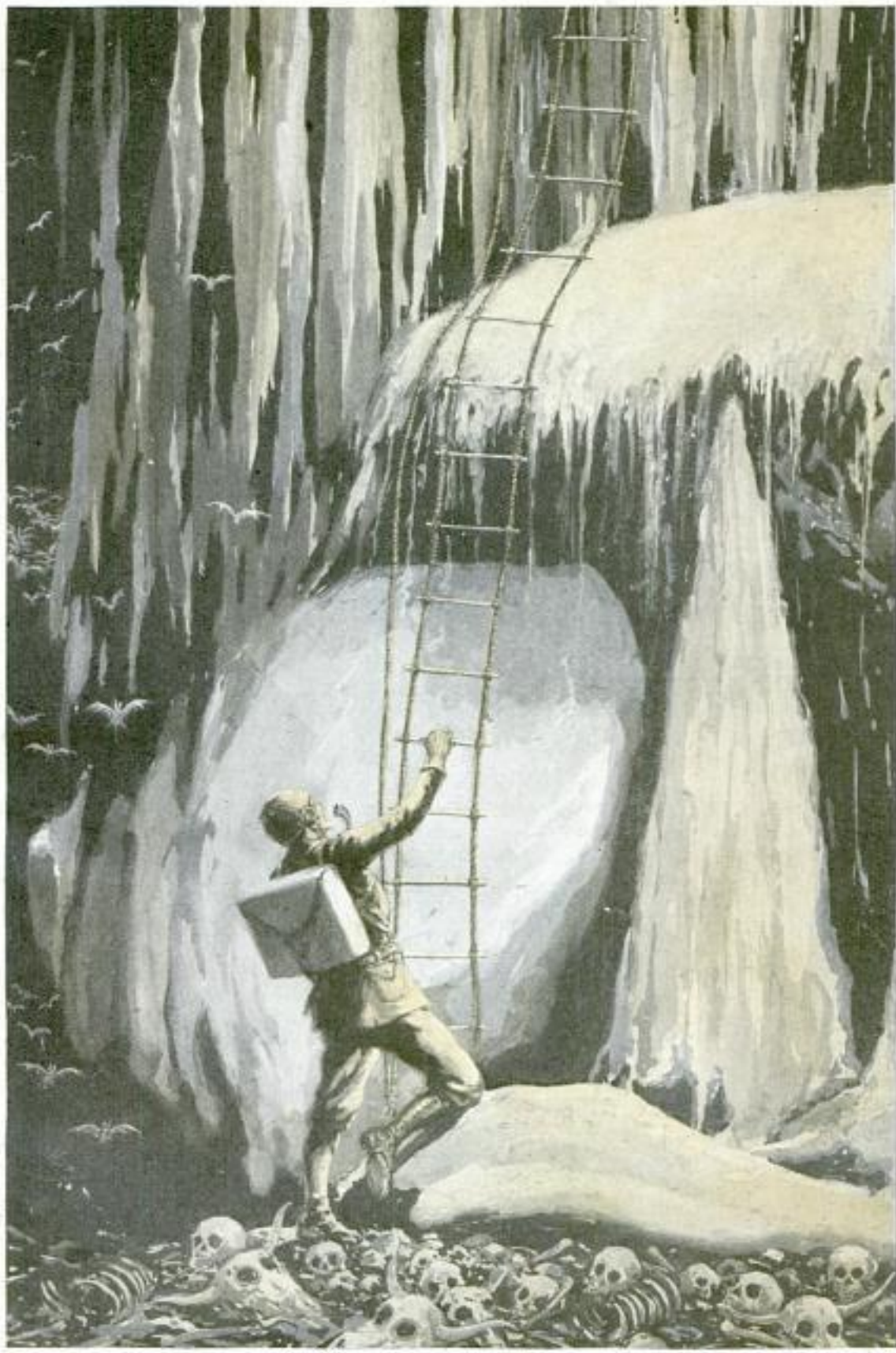

Telephone is Used by Explorer on Hazardous Trips into Caverns Thousands of Feet Underground, to Keep in Touch with His Companions on the Surface and Give Them Instructions

Illustrations & service, New York.

POPULAR MECHANICS

PICTURE TRAINS ADVERTISE COMMUNISM.

By sending trains of picture cars into the rural districts, the Russian government is attempting to educate in the principles of communism more than 100,000,000 people who, heretofore, have

propaganda and educational designs illustrating the communistic doctrines. In trying to "sell" this form of government to the peasants, the Soviets probably have become the world's largest advertisers, as



One of the Propaganda Trains being Used by Russian Government in Gigantic Advertising Campaign - Spread Doctrines of Communism among Country's Great Mass of Citizens

shown little or no interest in politics. Painted on the sides of the railroad cars by the nation's most skilled artists, are

the blazoned cars are not the only means of advertising it is using in its campaign, although perhaps the most unusual.

GASOLINE MADE FROM COAL BY DISTILLING PROCESS

With a system of distillation of coal recently developed, it is now said to be possible to obtain as much as 10 gallons of gasoline, as well as other gases and oils, from a single ton of soft coal. Under the old method, which requires 2,400 degrees of heat as compared with 1,050 or 1,100 necessary in the new process, little gasoline was recovered and other gases were destroyed. A plant for distilling coal in the new way is being erected in Canada by an automobile maker. In addition to gasoline, it is reported, a single ton of coal will yield 3 gallons of creosote oils, in some cases 6 or 8 gallons of lubricating oils, 60 pounds of pitch, 12 pounds of fertilizer, and 7,500 cubic feet of gas. And the left-over, 1,500

pounds of broken-up coal, may be pulverized for industrial fuel or made into briquettes for domestic use. It is said that the semicoke is similar to anthracite coal, high in heat value, smokeless, and moderate in ash.

SUGAR-SOAKED SPONGE USED AS TRAP TO KILL ANTS

Soaking a sponge in sweetened water is an easy way to get rid of ants. Serving as a trap, it may be placed where the insects play, and when they have crawled into the pores to eat, it may be dropped into hot water, thus killing them. As it is durable, the process may be repeated as many times as desired, making it inexpensive as well as effective. On the lawn or in the garden, the lure may be put near their holes.

*Watherville
Antarist, Canada.*

I invented Clalfeh, same thing as Dova

Plant operated by Henry Ford

*newspaper
Copyrighted material
Clipping*

*for
rd,*

to

t

1-

out

or

te

ing

RADIO ON A WALKING CHAIR KEEPS BABY AMUSED 2768

To help keep her baby amused, an eastern mother has installed a radio set on the child's walking chair. Aerials are mounted on a pole and the telephone receivers placed over the head in the usual way. Any station desired may be "tuned in" and the child left to enjoy the concert or stories from the air. Meanwhile, the child is able to push itself about and be entertained, and the cares of the mother are lightened.



Baby being Entertained by Specially Constructed Wireless Outfit While Learning to Walk with Aid of Chair

WEALTH FROM OLD MINE

Believing that all the ore had been removed, owners of an iron mine in the Missouri Ozarks abandoned it 33 years ago, and the 17,000-acre tract surrounding the shaft was turned into a stock farm. Bought for a "song" a few years ago, the mine now is producing over 1,000 tons a day.

Owned by Leonard Dusky, Pres. of the City of Chicago, Ill. Co., Chicago.

WRITING IS SENT OVER WIRE BY PHOTO PROCESS 2772

In the exact handwriting of the sender, messages are being sent over telegraph wires in France at the rate of from 75 to 100 words in three minutes. Written on any kind of paper, a special ink is used that leaves a solid deposit and a slightly raised elevation when dry. This document is wrapped on a cylinder that revolves the message under a needle similar to that of a phonograph. Every time

the point passes over one of the raised lines of the message, an electric current is interrupted. Every momentary stoppage of the current at the sending station causes a beam of light to be directed against a similar cylinder at the receiving end, carrying a piece of sensitive paper. When finished, the photographic blank is removed and developed, giving an autographic reproduction of the original message. The apparatus is now installed in several stations operated by the French government and has proved successful.



Transmitting Autographic Messages by Wire. Using Photographic Process of Recording the Movements of a Beam of Light Directed against Chemically Treated Paper

Written by Jacques Boyer, Paris. Copyrighted material

General Electric Co, Pittsfield
 Massachusetts
 Giuseppe Facciolli, of abm.

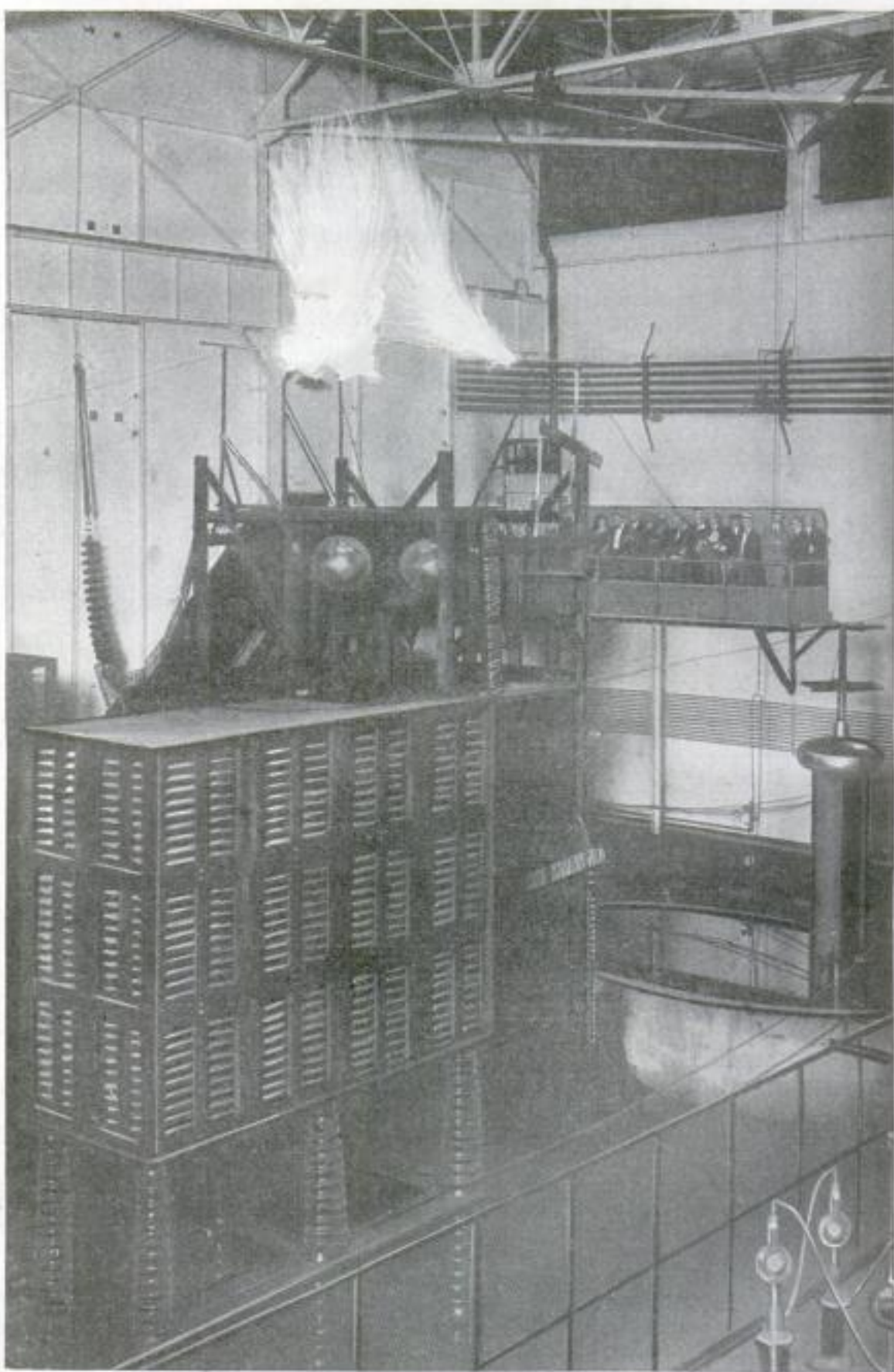

Man-Made Lightning being Produced in Laboratory, and Mass of Electrical Apparatus for 2,000,000-Volt Arc That Made Possible Notable Experiment before Group of Distinguished Scientists

Pacific & Atlantic Photos, New York
 Wide World Photos, 92
 Copyrighted material

~~Barnes-Crosby Co.~~
~~226 W. Madison~~
~~Chicago~~

MAN-MADE LIGHTNING BOLT
WRECKS TOY VILLAGE

With a 2,000,000-volt arc of sputtering man-made lightning scientists in an eastern city recently destroyed a miniature village in a steel house built for the test. Directing the bolts at will, they struck first the miniature church tower and then the store. To make the event more realistic, the roar of thunder went with the flash and even rain was produced. Success of this experiment is said to mark a step toward the control of heavier charges of current than have ever been handled, and also protect humanity and power lines and acquire a natural source of electric energy from the air. With great power at their command, scientists believe they may be able to make coal, diamonds, and other things now found only in the crucibles of nature's laboratory.



Artificial Bolt of Lightning Destroying Miniature Church and Store during Test

MEDICINE FROM "OIL BIRDS"
USED IN PERU WILDS

Anteaters that use their tails for umbrellas, birds so fat that natives catch them for their oil, blood-sucking bats, a tribe of Inca Indians that cannot live in an altitude less than 12,000 feet above sea level, and a colony of outlaws where there were no laws or taxes, were found in the little-explored tropics of Peru by a naturalist and his wife who spent 14 months in that country collecting specimens for a museum. In the domain of the outlaws, they visited a mammoth cave inhabited by the "oil birds" and captured some to put with their collection. Oil from the feathered creatures is used by the natives as food and medicine. Eighteen hundred specimens were in the store that they brought back with them recently, in addition to 20 live animals.

Edmund Heller,
Field Museum,
Chicago

VANISHING SEATS AND TABLE
FOR DINING IN KITCHEN

Seats and a table that vanish into the wall when not in use have been designed to turn a kitchen alcove into a cozy dining room for four persons.

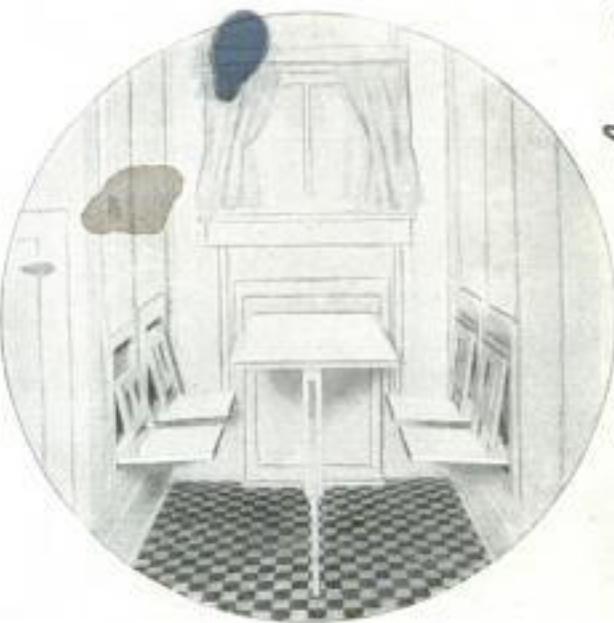

Folding Seats and Table Designed to Turn Kitchen into a Dining Room and Save Space

When the chairs have been folded away, the table may be used for ironing and other purposes. Besides saving space for small apartments, the arrangement makes a most attractive breakfast room and saves many steps for the housewife.

CRINKLE HAIRPIN STAYS PUT,
AND CANNOT BE LOST

One hairdressing with a two-way crinkle hairpin, recently put on the market, lasts from morning until bedtime. The wavy bend on one side of the pin is from left to right, and on the other side from front to back, so that there is a firm grip on the hair, holding it securely even when motoring in a high wind. Though it cannot slip, because the sides hold in different directions, it is easy to take out and will not catch or snarl the hair.



Journal American Medical Association, 532 N. Dearborn, Chicago, N.Y.
What is known as a "rocking shoe" has been devised recently by an army surgeon to aid persons with injured legs or ankles to recover their ability to walk.

4141 Clarendon Ave. Chicago
Assistant Surgeon James
Patrick P. Isroco
U. S. Public Health Service

Mr. Washmitt. Endicott Co.,
Andrews - Ind.

Hairpin Co.,
Appleton, Wis.

Copyrighted material
James
6/24/23

John D. Isaac

MOVIE OF FIFTY YEARS AGO MADE TO SETTLE BET

Twenty-four ordinary cameras, placed together in a row to make pictures of a running horse, are said to be the forerunner of the movie. To see whether a trotting horse at any time has all four feet in the air, a battery of cameras was set up at a race track in the West nearly 50 years ago. As the ^{horse} ~~stiff~~ passed, its

weight pressed a series of buttons on the track, forming an electric contact that exposed the plates, one after the other. These showed that at regular periods the horse entirely left the ground and also gave an idea that resulted in the movie camera. The experiment was made to settle a bet of \$25,000, it is said.

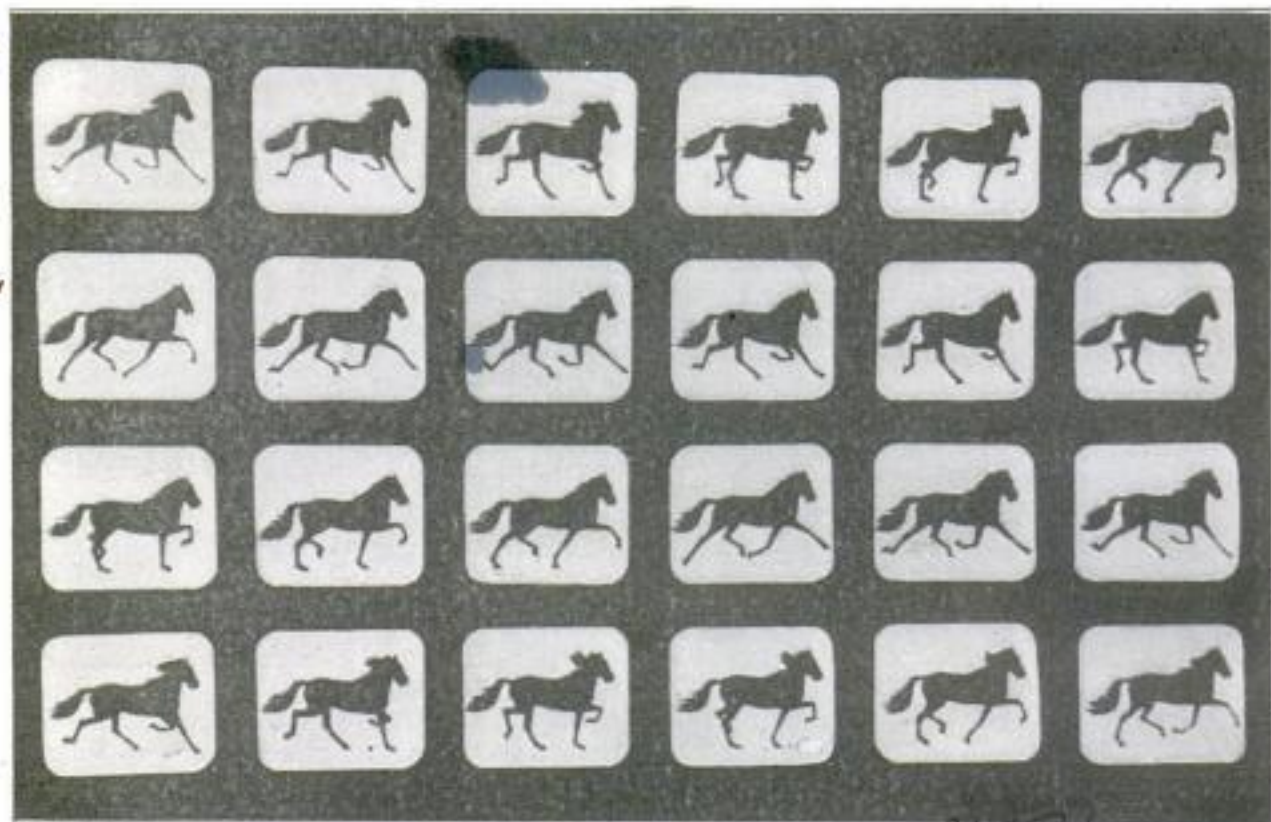

Twenty-Four Photos Made 50 Years Ago with Cameras Placed Side by Side, Showing That at Regular Intervals a Trotting Horse Has Four Feet off the Ground

COUNT STEPS OF HOUSEWIFE TO CUT DOWN WORK

How to make apple pie in eight steps or a whole dinner in 80, was shown the housewife in a recent test in which the domestic-science demonstrator wore a pedometer attached to her ankle. A badly arranged kitchen, the experiment showed, causes the housewife to walk an extra two miles a day. From the morning bacon and eggs to the dessert for the evening dinner, the demonstrator wore the device, which registered each step taken. As a result, a unit combining all the features of a kitchen stove, cabinet, sink, china closet, and refrigerator has been made, designed to save many steps. Fitted for use as a table, the top of the ice box, covered with porcelain, has one end connected with the sink.

"BABY" AIRPLANE ABLE TO FLY EIGHTY MILES AN HOUR

A "baby" airplane, weighing about 500 pounds with its pilot and load of fuel, performed successfully in a recent test flight, when it is reported to have climbed to an altitude of 1,200 feet. Having a wingspread of only 20 feet, it is said to be considerably smaller in that respect than the miniature French plane that was exhibited in the East not long ago. It was invented by an American aviation engineer and is equipped with a two-cylinder, 14-horsepower motorcycle engine, which, its designer asserts, will drive the craft at a maximum speed of 80 miles an hour. With the motor throttled down, the inventor believes that the machine can travel 1,200 miles on a single filling of its gasoline tank.

Designed by Livingston School, Montgomery, Ala.

Warden City, N.Y.

Curtis Corporation

Small
Built by Harvey C. Mumford, Chief Project Engineer

GEESE WEED COTTON FIELDS, REPLACING HUMAN LABOR

2824
Geese have partly solved a labor-shortage problem that cotton growers in two lower-Mississippi states were facing. Due to the northward migration of workers, farmers found it increasingly difficult to obtain help to weed their fields. Experiments were made with geese, and it was found that they freed the ground of all undesirable vegetation without harming the cotton plants. As a result, planters are now using a goose to an acre to perform a task that was formerly done by human beings.

STOVE AND ICE BOX BUILT FOR SMALL KITCHENS

2842
Designed to increase the efficiency of a small kitchen and reduce the housewife's labor, a unified equipment is being made that consists of a refrigerator and a four-burner gas stove. They stand on opposite sides of the sink. Over the burners of the range is a closet for cooking utensils. A drawer that fits alongside the broiler holds the cutlery, while directly beneath it is a compartment that may be used for many purposes. Jars for spices and coffee are fastened to the back of the cabinet. Smoke is carried away through a blind flue. Additional shelves

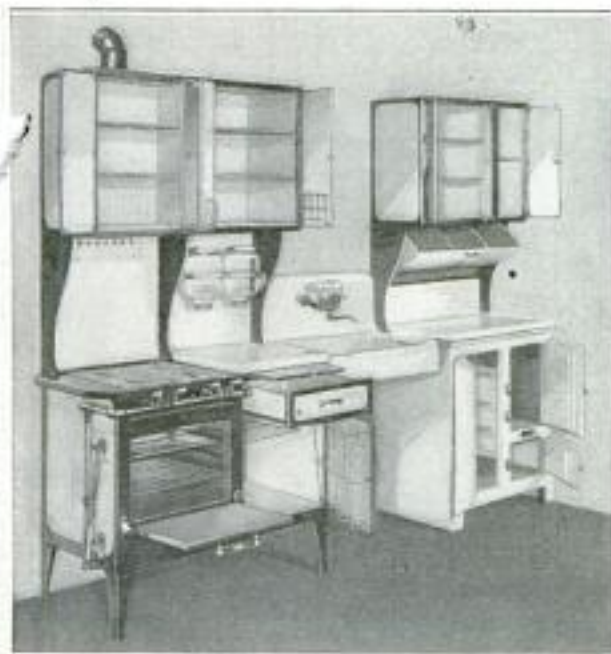

Efficient Arrangement of Stove and Refrigerator Saves Space and Labor for the Housewife

and a flour bin are attached to the ice chest, the top of which serves as a table or drainboard for dishes. Both units are enameled in white, and appear compact.

The Cabranette Corp. of Chicago
308 N. Michigan, Chicago

THREAD STILL SPUN BY HAND ON AN ANCIENT WHEEL

2823
Still in use for spinning the cotton thread used in making socks, stockings, and other necessary household articles,



Aged Woman Who Daily Spins the Cotton Thread She Uses on an Old Hand-Made Wheel

an old hand-made wheel is used by an aged Alabama woman who lives on the land her grandfather bought from the Indians in 1829. She declares that her hand-made product is far superior to the best output from modern machines.

HUMAN HAIR MADE INTO CLOTH RESISTS HEAVY PRESSURE

2894
Tons of human hair are being turned into cloth by a southern factory to supply the demand of cotton-seed oil mills of that section for a fabric that will withstand, for a time at least, a pressure of 4,000 to 4,500 pounds a square inch. Only that made from hair is strong enough. Formerly it was woven from camel's hair, but the price of that product went to such high levels as to prohibit its use. After a series of tests, a method was devised for weaving human hair in specially constructed machines. The search for a sufficient supply to keep the factory going ended in China, where buyers found a veritable army of coolies ready to sacrifice their long queues for American money. Bound in huge bales, the hair arrives at the factory ready for weaving, having already been inspected and sterilized on the way over from the Orient. Combed and carded, it is twisted into threads and fed into the looms, where it is woven into rolls of cloth 1/2 inch thick, the bolt weighing 400 pounds.

American Press Cloth Co. Columbia, S. C.

Cont. W. L. Moore, 70 E. Elm St.
Chicago

POPULAR MECHANICS

356

2603

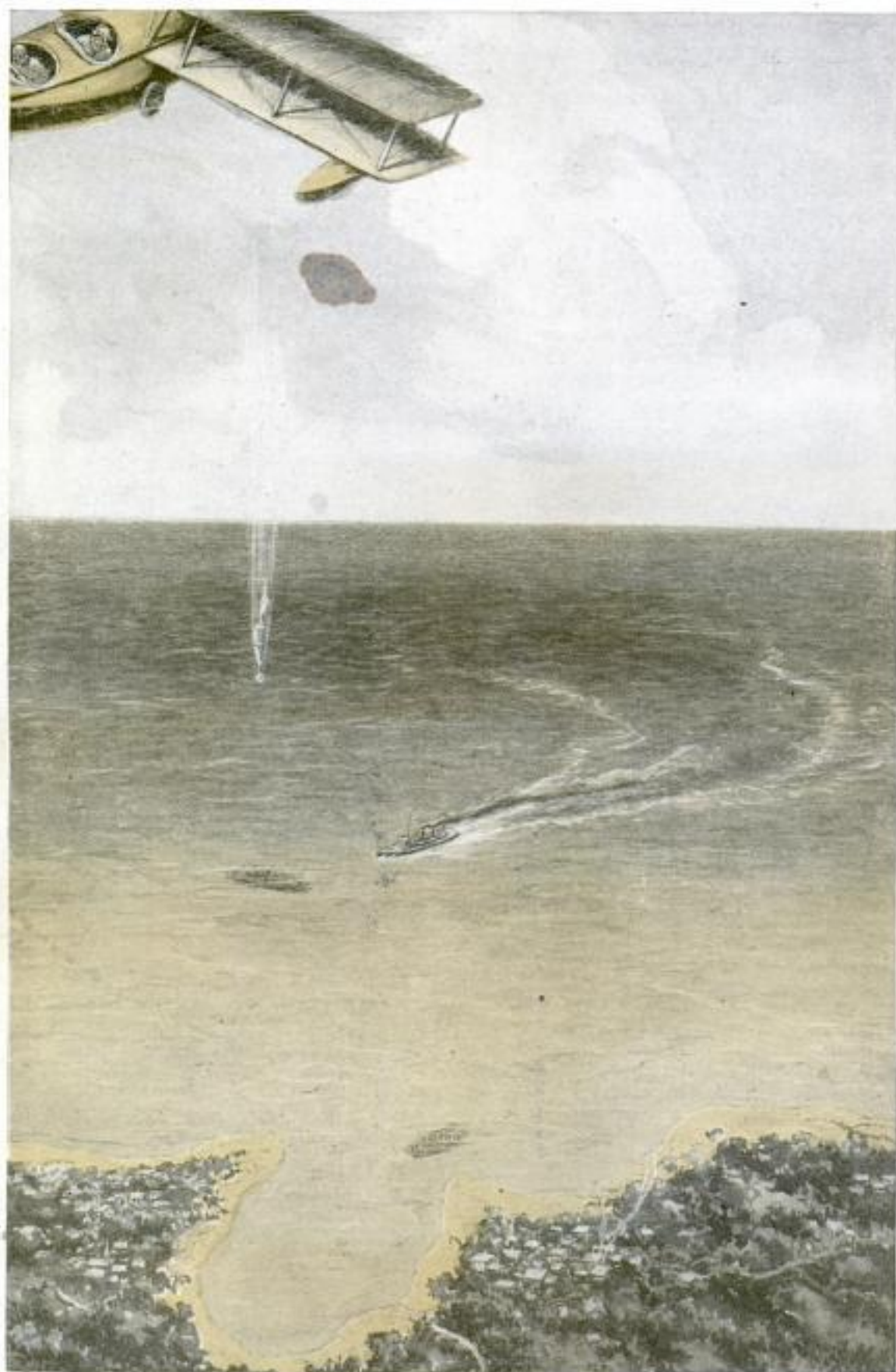

Peering into Depths of Lake from Skies in Search of a Sunken Ship So That Its Valuable Cargo of Coal, Worth About \$50,000, may be Salvaged

Salvage

News Events Photo
Service World Bldg
357
New York City

**HUNT LOST TREASURE SHIP
WITH AIRPLANE'S AID**

2603

Driven from its course by a fierce winter storm and swept by flames which forced the crew to take to the boats, the steamer "O'Connor" sank in the northern end of Lake Michigan. The vessel, of considerable tonnage, was loaded with hard coal, valued at approximately \$50,000. In the hope of being able to salvage this rich cargo, a search was begun to locate the exact position of the vessel. Yet, after two months of ceaseless effort, the lake held fast the secret of the ship's resting place. During the war, aircraft had been used in spotting submarines. Light penetrates to a great depth and, providing the bottom is of a contrasting color, any object which comes between it and the surface is clearly visible from a position directly overhead. So preparations were made to use this development of science in maritime salvage. Carrying a pilot and observer, the plane circled over the lake at a height of 500 feet. Miles were covered and the skeletons of two wrecks were found, but they proved not to be the ship sought. So the mystery of the last berth of the "O'Connor" remains unsolved.

**AIR CHAMBER SAVES DIVERS
STRICKEN AT WORK**

2821

As a first-aid appliance to save the lives of divers stricken at their work, a large steel tank, in which they are placed, is filled with compressed air to

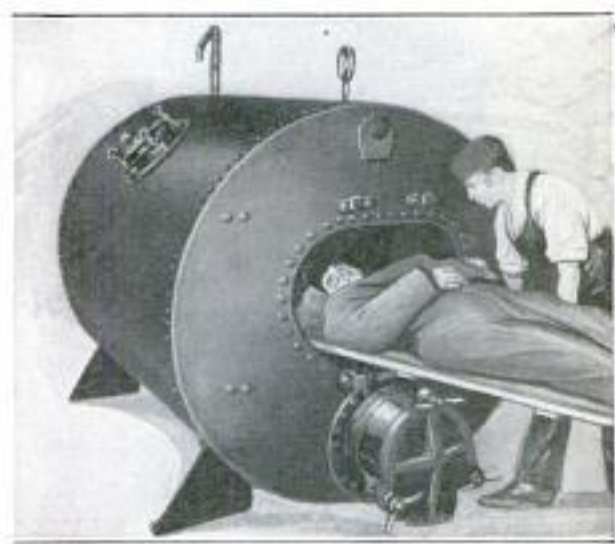

Diver, Overcome by Long Stay under Water, Placed in Air Chamber for Reviving

break up and drive out bubbles of gas that cause them to become paralyzed or unconscious. The pressure is started at 30 pounds and increased or decreased as the patient needs it. Even though a constant supply of air is pumped below to a diver at work, the great weight of the water and too long periods underseas frequently overcome him, making quick action necessary to prevent his death.

**POCKET FILTER FOR CAMERA
LENS IS ADJUSTABLE**

2864

For taking photographs with cloud effects, an adjustable filter that will fit almost any lens has been made. When in use, it is held in place by two small springs, fitting over the regular lens. Pictures taken through the filter require a slightly longer exposure, but give every detail of the cloud banks in the background. Sunsets on the water are also most effectively reproduced.



Pass Camera Co,
109 N. Dearborn, Chicago

Acetylene gas, purified and mixed with oxygen, is reported to have been successfully used as an anesthetic, with results as satisfactory as those produced by either chloroform or ether. It is administered through an air-tight mask, placed over the face.

**RUINS OF ANCIENT BABYLON
YIELD WAR GOD'S TEMPLE**

2889

Traces of structures erected during an early Babylonian period that are expected to add greatly to the known history of that time and to rival in importance the discoveries in the tomb of King Tutankhamen at Luxor, Egypt, have been found in Mesopotamia by the expedition of an American museum. Already stamped bricks of Samsuiluna, seventh king of the first Babylonian dynasty (2080-2043 B. C.), have been unearthed and translated, as well as tablets inscribed during the reign of Samula-Il'u, the second king of that line (2211-2176 B. C.), and the temple built by him to the war god Ibaba. Experts regard those preliminary finds as proof that the excavators have approached strata that conceal remains of the earliest Babylonian civilization. They expect to find many relics of historical value later.

Discovered by H. Weld Blundell expedition to Mesopotamia

**DISHWASHER FITTED IN SINK
SAVES TIME AND LABOR**

Operated by a small electric motor, a device is now being made that washes and

28/14

*Chicago Hardware
7 Laundry Co., 299
W. Randolph
Chicago*

Sani-sink



No Need for Housewife to Put Hands in Water When Using This Dishwasher

dries dishes in five minutes or less, without the housewife putting her hands in the water. Only a slight pressure on a push button is necessary to start and stop the machine. Fitted in a basin at one end of the kitchen sink, the apparatus forces water rapidly over the dishes. After they have been rinsed by a spray of hot water, another part of the machine dries them. As all revolving parts are inclosed, it lends itself readily also to the washing of light table linens, and, because of its simple construction, it may easily be kept sanitary. One day's dishwashing for a family of six to eight persons, it is estimated, costs less than 15 cents for power for the machine. All parts that are contained within the basin may be removed when not in use, thus providing additional sink space.

☛ Sand-blast dust is being used as a covering for newly laid asphalt by highway authorities of an eastern state. It is obtained from dirt arresters in iron foundries.

**LOCOMOTIVE READY TO RUN
27 45 IS CARRIED ON SHIP**

Because the president of a South American republic was in a hurry to receive a railroad engine being made for him in the United States, the huge locomotive was quickly put together and then, ready for the tracks and hanging from

a giant crane on a scow, it was moved to the side of a ship and lifted on deck. It is said this was the first time such a big engine had been placed on board ship ready to run. Usually the engines are taken to pieces before being sent by water. So great was the weight of the engine that the scow almost sank while it was being carried to the ship.

*Baldwin Locomotive Works,
Eddystone, Pa.*

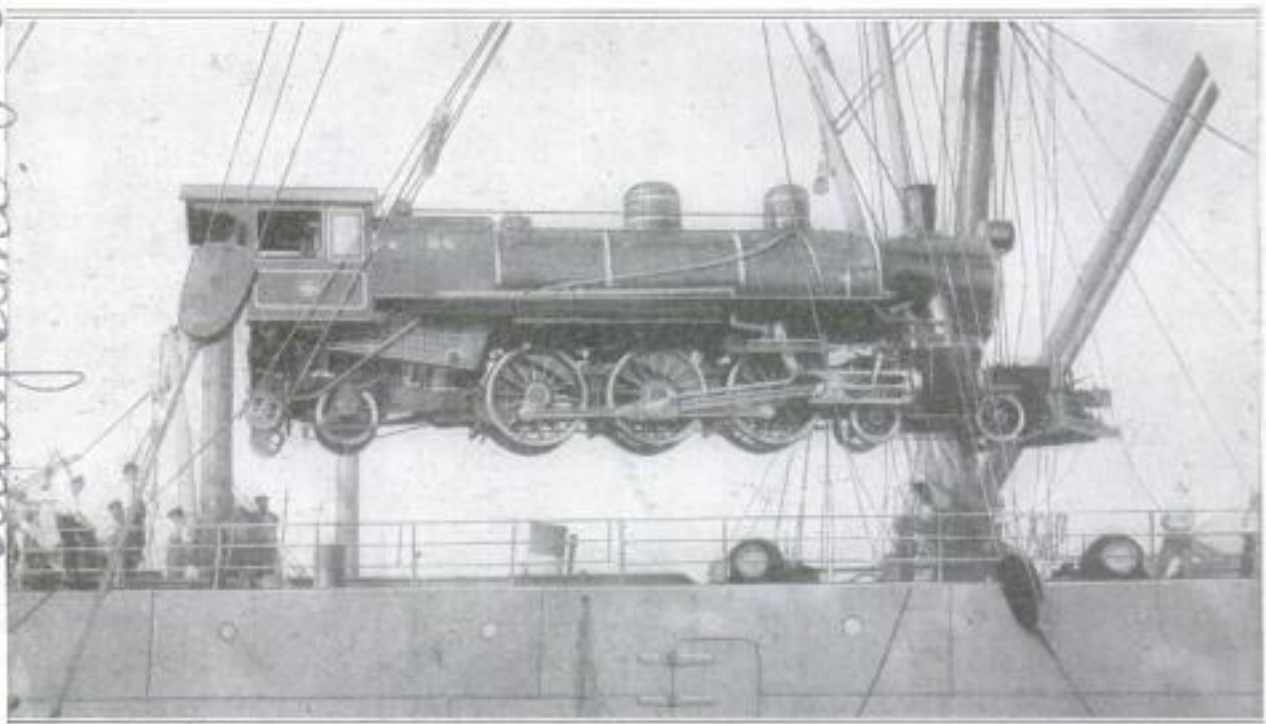

Placing 75-Ton Engine on Ship's Deck with Crane That Carried It from Shore: Usually Locomotives are Taken Apart before being Shipped, but There Was No Time in This Case

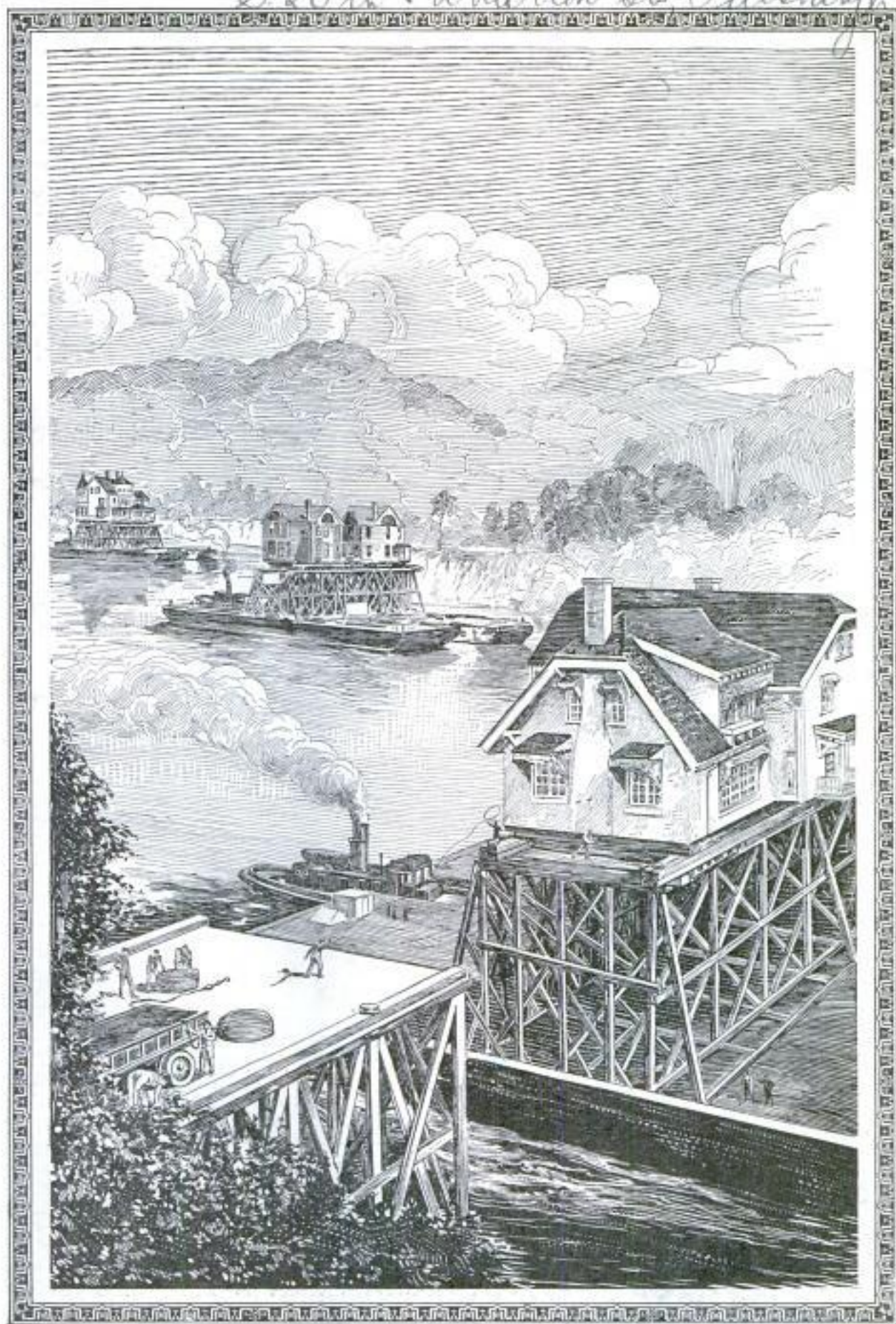

Houses being Moved across River on Barges to Make Room for the New State Capitol at Charleston, West Virginia: They were Elevated to Avoid the Necessity of Lifting Them Up an Embankment:

Von Lengerke + Gutwiler,
100 S. Wabash
Chicago

The American
Printer, June 5,
1923

**KNAPSACK WITH POCKETS HAS
A PLACE FOR EVERYTHING**

With several pockets, all of which are covered by flaps, a knapsack of waterproof material, large enough to hold all



Knapsack with Pockets to Separate Food from Clothing and with Double Straps for Back

that a camper needs for a lengthy journey, is on the market. Because the sides are made in a telescopic shape and the material is a rubberized fabric, there is no possibility of rotting, the makers say. Two straps for the back are used, the idea already having been adopted by the U. S. government for tests with mail carriers' sacks. The extra pockets provide a separate space for food.

**LENS ENDS USE OF A CLOTH
OVER SCREEN OF CAMERA**

Held to the ground-glass screen of a camera by suction, a small pocket lens has been made, to do away with the necessity of using a cloth covering over the head when viewing the image of the picture to be taken. By applying the eye to the lens, the entire image can be seen as well as though it



were viewed under the cloth usually used to cut off the light. When not in service, it may be detached and placed in the vest pocket.

Price \$1.75

**PRINTING OF ONE DOLLAR BILL
TAKES MONTH AT MINT**

More than \$20,000,000 in greenbacks and \$1,000,000 in stamps are made by the United States government every day. Such great care attends the printing of notes that 30 days are necessary to complete the processes to which one single bill—\$1 or \$10,000—is subjected. Although millions of dollars pass through the plant daily and are left openly on desks, not a single guard is placed over the money, nor are employes searched as they leave the building. Instead, a rigid system of accounting is enforced, the notes being counted 15 times and the stamps 10 before being sent out. Should a shortage be discovered the plate printer and those who handled the bills must replace the amount of the missing notes. Most of the greenbacks are one and two-dollar notes. The \$10,000 note is the largest made, but there are only a few of them in circulation. Stamps, requiring less attention than the bills, come from the presses at the rate of 40,000,000 a day. While most of them are ones and twos, the government turns out some at \$5.

**MAT FOR AUTO RUNNING BOARD
SECURES FOOTHOLD**

To prevent slipping by those entering and leaving automobiles in wet or icy weather, is the purpose of a rubber mat



Metal-Cove-ed Rubber Tread for Automobile Running Boards Offers Firm Grip to Step

studded with knobs protruding through holes in a polished aluminum plate which is attached to the running board by four screws. The nibs extend sufficiently above the metal to give a secure grip to the sole of the shoe, avoiding any ice or water that might gather on the surface of the plate.

Hollaway Motor Co. Toledo, Ohio

Great interest is being displayed by physicians in a new drug, known as tryparsamid, which is claimed to have proved a cure for paresis.

Baso Camera Co. 109
N. Dearborn, Chicago

SICK-ROADS CURE IS SOUGHT BY UNCLE SAM

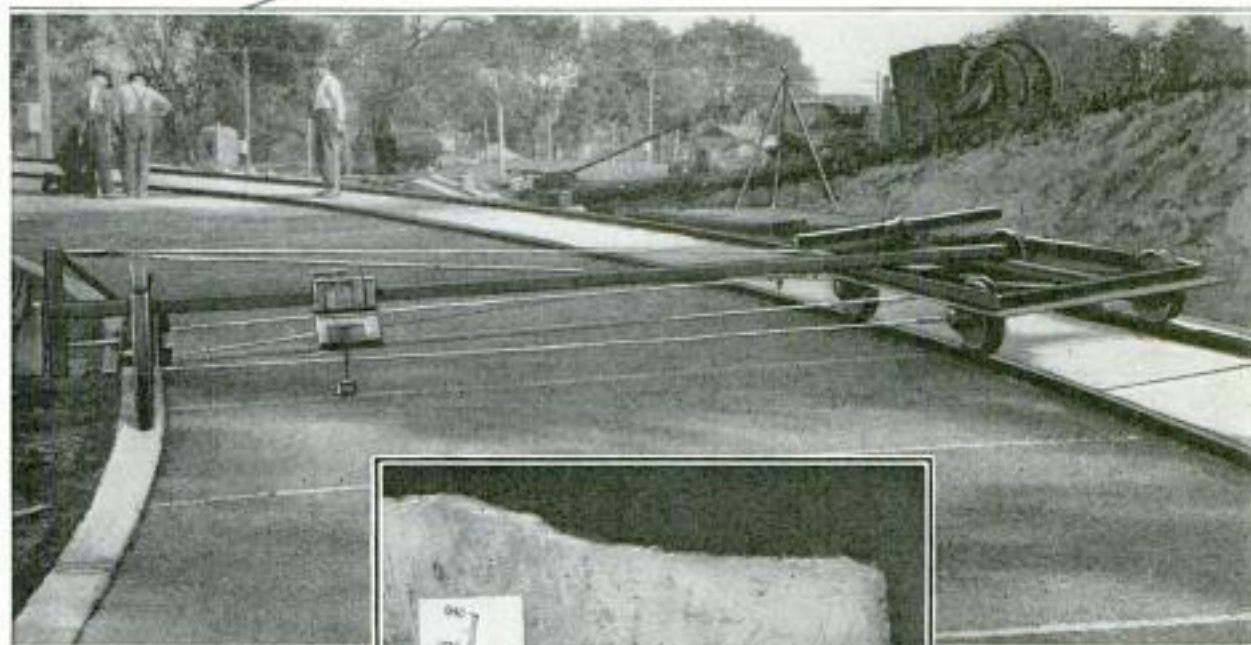

Apparatus for Testing Road Pavements of Various Materials

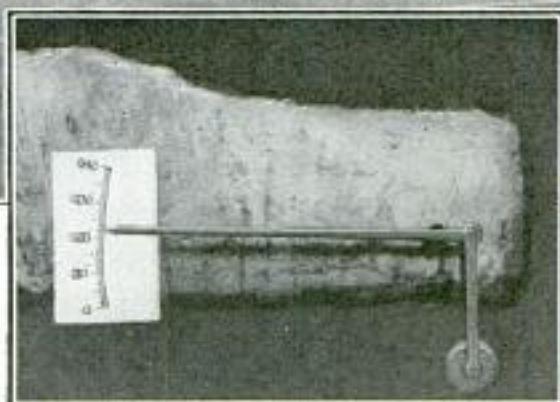

Left: This Instrument Indicates Warping of Surface

To study the causes of wavy road surfaces, the government has built a circular track, 15 feet wide and 180 feet in diameter, divided into sections, each of which is paved with a different kind of tar or asphalt on a concrete foundation. An electrical device furnishes the wear and

heat to curl and bend the materials, after which a measuring machine on cables supported by wheels is passed to and fro over the surfaces to show to what extent they have sunk or risen.

WORMS DYE THEIR OWN SILK IN UNFADING COLORS 2909

By injecting dyes into their cocoons, a French scientist is reported to have caused silkworms to spin colored threads. Not only the ordinary shades, but the tones and hues that are made from combining various tints, are produced by the little workers receiving treatment by this process. Silk is usually dyed after it has been wound and twisted into floss, but the new method is expected to grow it in colors that will not fade.

foods will be scorched or burned, because they are cooked in their own juices. In this way flavor and healthful mineral salts are retained. A vent in the top allows excess steam to escape. When open, it provides a way to brown the roast, without heating up an oven.

WATERLESS COOKER IS SAFE AND IMPROVES FLAVOR 2883

Meat and vegetables may be cooked without water in an aluminum kettle now being sold. A triple bottom of steel, aluminum, and asbestos makes this possible. When the cooker is placed over a low flame, the housewife can go about her other work without fear that her



Kettle That Cooks without Water over Low Flame, and without Attention of the Housewife

Similar cooker made by
 West Bend Aluminum Co.,
 West Bend, Wis.

Sold by Van Lengerke & Antoine
 130 S. Wabash, Chicago

2981

Adventures in Asiatic Paths

BY SVEN HEDIN

Sven Anders Hedin, noted authority on those little-known lands, Tibet, Turkestan, Mongolia, and central Asia in general, has spent a great part of his life—he is now 58 years of age—in exploring these strange lands. These journeys, performed at times amid extraordinary hardships and always at the immediate risk of lingering and terrible death at the hands of savages or by starvation, have won for him high honors and a world-wide reputation and fame. A noted scientist, a daring adventurer, a fluent writer—he is author of numerous valuable and weighty books. Doctor Hedin is an honorary or active member of nearly every scientific society in the world; is a member of the nobility of Sweden, to which he was raised in recognition of his work by the king; is the bearer of honorary degrees from most of the famous universities of the civilized world; is the personal friend of potentates and rulers, and is now on his way to Asia for another daring journey through the wild interior where he has found strange buried cities, grotesque and terrible customs, and where he has several times been forced to travel long distances on foot without water or food.—Editor's Note.

I HAVE traveled over 24,000 miles in Asia's beaten and unbeaten tracks, and in doing so have had adventures without number. In what follows I will tell the readers of the Popular Mechanics Magazine a few of the things I have seen and experienced in the interior of the largest continent on our globe.

I will start with my very first entrance in Asia. It was several decades ago, late in the summer. I was to drive from Vladikavkaz to Tiflis, a distance of 120 miles. I hired a strongly built Russian wagon, which is drawn by a "troika," the typical Russian three-horse team. Merrily the bells are tinkling in the bell collar worn by the middle horse, which is trotting along, hitched in between the shafts on either side. Over the horse's neck bends a wooden yoke, through the iron rings of which the reins pass. He is strapped so close to the harness that he cannot run in a gallop. But the two horses on the sides are galloping and turning their heads outward and downward, while the center horse is carrying his head high. The animals are accustomed to occupying this position, and it is a truly magnificent sight to watch a troika speeding along.

The road is level and good at first, but soon it begins to lead upward. We have reached the region of the mountains, whose dark-hued, steep walls are looming up before our eyes and hemming in our way more and more on either side. However, this road with its solidly ballasted bed and its cement rails

is evidently well built. It is traversing the Caucasian province of Georgia or Grusia and is called the Grusinian military way. It cost enormous sums of money.

When the czar dedicated it he said: "I thought I should travel on a way of gold, but I see that it is nothing but gray stone."

In grotesque curves it winds around the mountain sides and passes through valleys and glens. Up it leads and then down again. In the wildest rush we may whisk down a precipice; then suddenly there comes a sharp turn to the right. We cannot see where we are going, but we have an uncomfortable feeling as if horses, carriage, and everything would be flung into the gorge below before another minute has passed. But again we spin around a corner, so abruptly that the carriage is resting on the two outer wheels. Thank goodness! We have escaped this trap, too, and we now see a stretch of the road ahead, until the zigzag course begins again.



Dr. Sven Hedin

In winter the traveling is done in sleighs, but then the road is dangerous. Many spots have an evil reputation for avalanches. Where the snowslides are wont to shoot down from the mountains, stone tunnels have been built with walls 10 feet thick. Over these the snow masses of the avalanches will glide without injuring the travelers.

As a young student I once had a merry trip from Bagdad, the city of the caliphs and of the Arabian Nights, to Kerman-



Nature's Wildest Moments are Experienced amid the Blinding Rainstorms of the Himalaya Regions. At Such Times the Frightened Caravan must be Guarded against a Stampede

shah in western Persia. I was alone and had no servant, and of the traveling fund there remained only 200 Persian "krans," or \$39. I was too proud to borrow money and thought I should succeed in pulling through without anybody's aid. In the bazaars I met an Arabian caravan, which was carrying goods on to Kermanshah, 50 miles. I hired from the leaders a mule for one-fourth of all I owned.

It was early in June and the heat was intense, so the merchants traveled only at night. The tinkling of the bells had a drowsy effect, and from time to time I fell asleep while seated in the saddle. Traveling this way, of course, I could not see anything of the landscape, and the third night I succeeded in persuading an old Arab to accompany me to Kermanshah in daylight. When the merchants heard us talking about this, they would not under any condition permit us to leave the caravan, so I had to escape by stealth on the hired mule, together with the old Arab, who demanded 25 krans daily wages. One dark night, just as the moon had set, we rode slowly ahead of the caravan. After awhile we increased our speed and got away farther and farther from the others. The sound of the bells gradually died away in the distance, and we were surrounded by the stillness of the night.

We advanced at a quick trot until we had reached such a distance that the others could no longer overtake us. There we reposed until the morning; then we resumed our journey, following the path of the large caravans. From time to time, itinerant company is sighted, most of them being pilgrims, partly living and partly dead. They are all on their way to Husein's grave at Kerbela, not far from Babylon. The men are riding on horseback, the women are sitting in wooden baskets, two of which are always carried by one camel or mule. In such a basket, called "kajeveh," the woman is squatting with crossed legs on soft cushions. She has a roof of white cloth over her head, which is upheld by arched laths, and in front of her are curtains so that she can at her option hide herself from curious looks. Women of rank make use of litters called "tak-terevan," which are borne by two mules. This style of journeying is more comfortable; the lady can lie down to sleep while the mules are traveling.

And then the dead persons that are carried to Kerbela! Wealthy Persians often set aside a certain amount of

money in their wills to have a grave bought near the Holy Mosque in Kerbela, under the dome of which the martyr Husein is resting. Another sum is allotted for transporting the body. When the rich man has died, his body is wrapped in white rugs with tightly fastened cords, and around everything dark-colored blankets are wrapped, which in turn are kept closed as securely as is possible with the aid of strings and cords. But as it is more convenient and less expensive to place two bodies on each mule, the deceased must wait until a comrade can be found for this last journey. It may even happen at times that an entire caravan of bodies is accumulated to be conveyed together to the "Holy City." I have met several such funeral caravans in Persia. If the wind comes from the direction in which they are approaching, a frightful odor will announce them even from quite a distance.

Another smell to which it is necessary to become accustomed when traveling on Persian roads is the one which is spread far around by rotting carcasses of camels, horses, or mules.

In the meantime I continued with my Arab the journey to Kermanshah. After I had paid him for the mule I did not have so much as a copper coin left in my pocket. In the small town not a soul was European, and I had hundreds of miles to cover before I could reach the nearest place where lived any persons from my country.

However, I had heard of a wealthy Arabian merchant by the name of Aga Muhamed Hassan, a resident of Kermanshah, who was doing business over all the Near East. I directed my steps to his house and was admitted in the large room where he was sitting on precious rugs and casting up his accounts with his assistants. It was not easy to make clear to him where Sweden was situated, but when I said that I was from the country of Charles XII, Aga Hassan's face brightened and he said: "Then you must stay as my guest for six months." I thanked him for his kindness, but explained to him that I had to continue my journey, after having rested for a few days. A magnificent house in genuine Persian style was placed at my disposition; I was given two gentlemen attendants and two servants who were constantly sitting to wait for my orders. I was offered the finest Persian dishes of rice and chicken, grapes and melons, wine and tea, and at night I slept in a charming garden, where limpid water

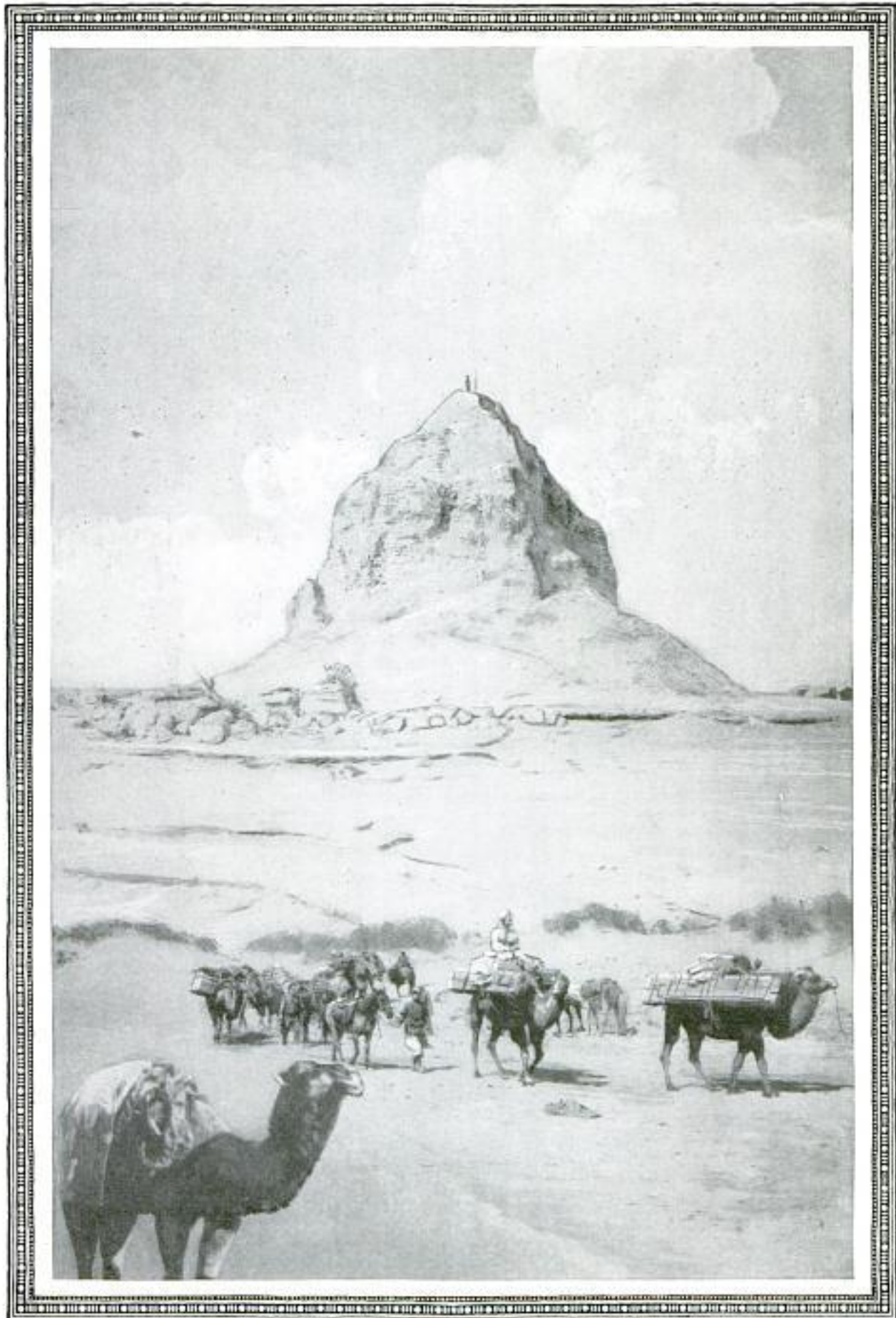

Camel Train Passing an Old Signal Tower That Once Warned Peaceful Caravans of the Presence of Fierce Desert Tribes Infesting the Barren Wastes of Central Asia

2789

POPULAR MECHANICS

was murmuring in marble basins, where fountains transparent as gossamer were

Over most of this plain, the surface is level, but the loamy ground has a granular texture. In this part of the country it will often rain in the winter, and the loam will then become soft like soap, the camels will limp, fall down, and finally refuse to rise again.



Yaks, Animals Resembling the Buffalo, Transport the Heavy Burdens of the Tibetan Traveler across the Mountainous Countries of Central Asia. Rude Rock Cairns Mark the Way

playing in the moonlight, and where roses and lilacs were luxuriously spreading their fragrance. In the stable there stood precious Arabian thoroughbred horses, ready to carry me to the villages and antiquities I wished to visit.

But I had no money! I was a beggar, a tramp and had all the trouble in the world to keep up the appearance of a gentleman as long as possible. This masquerade could last only so long. One day the truth would surely become known. So I made a virtue of necessity and told one of my gentlemen attendants that I did not own one cent.

He was taken aback for a moment, but then he answered: "Money! You may have as much of it from Aga Hassan as you wish," and when the hour of parting came, he presented me with a pouch full of silver coins, which I carried stuffed into my saddle bag, as I, on a newly hired horse, continued my journey both day and night towards Teheran, the capital city of Persia. In this way I once covered as much as 90 miles in one day, which is the speediest ride on horseback I have ever made; this became possible only by changing horses five times.

In 1906 I traveled 1,400 miles on a Bactrian camel through all of eastern Persia to the border of Baluchistan. I had bought 14 camels and had six Persian servants. In the easterly part of the country there is a vast desert, called Kevir, which consists of salt and loam.

Many caravans have perished in this way. Notwithstanding this danger, I ventured upon crossing Kevir. I had with me two men and four camels. Just as we were about to start from the southern edge, it began to rain, so we had to wait. The loam dried only slowly. A caravan of merchants came along, and we decided to continue in the trail trodden out by its camels. The distance across the desert is 84 miles. When the expedition has been started, it is necessary to proceed without camping until the northerly edge has been reached. In all this malicious tract there is no shrub, no grass-blade.

We had covered far over one-half of the road when the sky darkened again, and presently it started once more to rain. We speeded the camels and their bells sounded briskly—almost like a churchbell sounding the fire alarm. No path was to be seen; what faint trace of it may have existed for a brief while was quickly blotted out by the next shower, and then tramped up again by the next caravan. It was drawing toward evening. The sky was clear only in the west. The sun was just setting; it glowed like a cannon ball. The entire western horizon was burning red, as if a steppe fire were raging, and the fiery gleam was reflected by the barren, level ground. The long lines of camels of the merchant caravan proceeded solemnly; laden with their bales of merchandise

2789



Crossing a Valley of the Himalayas: On the Mountain Side is a Caravan of Yaks, Beasts That Scorn Roads, Preferring to Travel among Rocks of Jagged Steepnesses

they offered a fantastic sight. Their red outlines presented a striking contrast to the threatening background in the north.

We hastened northward so as not to remain sticking in the loam, which was softening more and more from the rain. According to a Persian superstition, the desert is the mansion place of evil spirits. Whoever remains behind, falls a victim to these fiends. Such a one listens and hears the tinkling of the bells, but believes that it comes from the opposite side. He turns there and is lured farther and farther into the desolate tracts, drawn irresistibly onward, with the sound of the bells in his ears all the time, until at last he falls dead from exhaustion, amidst the scornful laughter of the ghouls.

But I, too, was about to be inveigled by such a specter: black-winged sleep was fluttering around me, as I was sitting benumbed, half unconscious, on my riding camel. What a night! Would it never come to an end? The bells are ringing as if they wanted to announce a morning service, and still no dawn.

The rain continues splashing against the ground. The gait of the camels becomes more limping. Thump! There

one of them is lying in the mire; he must be raised. But soon another one falls. We urge them on frantically. The bells are ringing with a weird sound, like knells when a funeral procession passes. To keep sitting on the camel is too trying for my nerves; I alight and start to walk.

The night is pitch-black. The rain continues coming down. The loam continues loosening underneath our feet. The treads of the camels continue sounding their dull measure, the bells their rhythmic play. If the bells stop, we are the prey of the desert spirits. We have to free the camels from their burdens; we must sacrifice the goods and seek to save the animals. If the rain keeps up any longer, the camels are lost and the men must seek to save their own lives.

However, the genii of the desert relent. With the night still hovering around us, the caravan stops all of a sudden. "What has happened?" I asked. "We are at the Devil's Gutter," answers a voice in the darkness. We stumble over a bed filled with salt water. On its other side, tamarisk is growing and the ground consists of sand. The camels no longer limp. We are saved.



292*

Gautier
1923

JUNGLE REVEALS BURIED CITY LARGER THAN OLD ROME

Buried for years in the jungle fastness of the island of Ceylon in the Indian Ocean, an ancient city, a contemporary of Rome but much greater in extent, has been unearthed by explorers. The founding of Anuradhapura, as the royal city was called, was in 437 B. C., according to decipherable characters that cover some of the ruins, and its desertion took place late in the ninth century, about 1,200 years later. Excavations have revealed that the splendid structures of the city proper covered many square miles, although its actual boundaries have not yet

been reclaimed from the jungle. Throughout the parklike domain, now the feeding ground for hundreds of cattle, were found remnants of the culture of the period—marble bathing pools, towering monuments, and thousands of fallen columns, hand-hewn and hand-placed, that once supported canopies and upper floors. Some still rest on wide marble platforms. One of the interesting features of that vanished civilization is the "dagoba," a memorial structure, evidently inspired by the worship of some religion. Four of those rival present-day skyscrapers in height. One, probably the highest, towers an estimated 280 feet in the air from a base 252 feet in diameter.

Christian Science Monitor

6/29/23 copyrighted material

Com. Florence J. Clark *d.w. E.A. Sperry Jr.*
McGregor, Iowa. *Sperry Gyroscope Co.*
 POPULAR MECHANICS ³⁶⁹
 40 Flatbush Ave. E. E. T.

**SAND NEEDED FOR GLASS
MINED WITH WATER** 2942

Hydraulic mining for sands used in glassmaking has almost entirely replaced hand labor. Manufacturers of glass require hard sands usually found in rocky hills and cliffs. Along the Mississippi River banks in Iowa, the diggers direct streams of water at the rate of 1,200 gallons a minute against the stony ledges, washing them away and carrying the sand into settling tanks where it quickly passes to the bottom. The water is then drained off, and the sand dropped into large bins for shipment. 2882

**TINY FOLDING STOVE HEATED
WITH CANNED ALCOHOL**

About 6 inches square and, when folded, almost flat, a small stove is being made for camping, motoring, and yachting, as well as for use in the dining room, kitchen, bedroom, nursery, or porch of the home. Small cans of denatured alco-

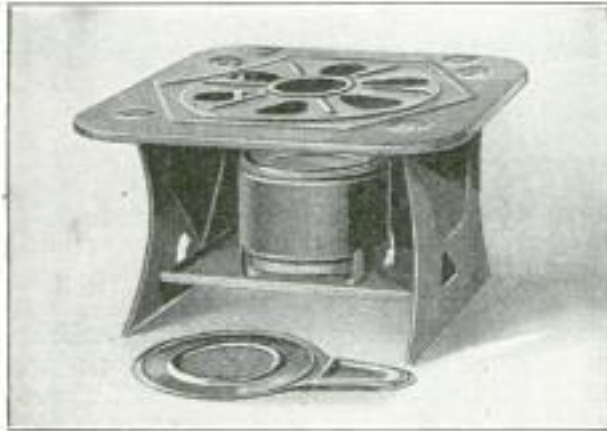

Small Folding Stove, That Uses Canned Alcohol for Heat, Handy at Home or in Camp

hol furnish the heat. To shut off the flame a metal plate is placed over the top of the can. For quickly heating the baby's milk, water for shaving, almost any kind of cooking, the stove can be set up anywhere. It is light and also inexpensive.

Don Lengerke
Antoine, 130 S. Wabash
Chicago

RADIO MESSAGE SAVES SHIP 2953

Stranded for eight days on an island in the Mediterranean, a steamship was dragged out of the sands by vessels responding to a distress message sent out by an amateur radio operator. The vessel was on its way to Constantinople, when it ran aground.

Radio News Bulletin
July 17, 1923

**WAY SHIP BEHAVES AT SEA
STUDIED BY MACHINE** 2881

Every roll, pitch, rudder movement, course steered, and the time made by a ship at sea, are automatically recorded

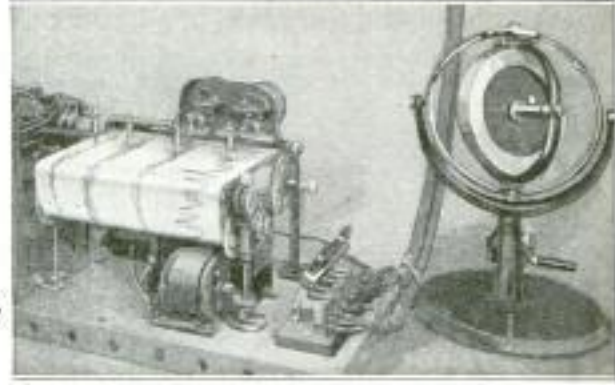

How Every Movement of a Ship at Sea is Recorded by Moving Pencils on Rolls of Paper

by a recently invented machine. This will enable marine architects to study a vessel's behavior under all conditions and to better designs of hulls and rudders. In a test over a 6,000-mile course, a complete log of a big freighter's action was kept. Electrically operated devices set down the rudder movements. The roll and pitch recorders depend on the operation of a gyroscope that maintains its position regardless of the movement of the ship. All of the records are made on rolls of paper moving over drums under a moving pencil.

**AIR-FILLED RUBBER TOYS FLOAT
AND KEEP NEW** 287

Gaily painted toy fish, turtles, frogs, ducks, clowns, and dolls are being made of rubber so they can be blown up to any size desired. As they float in the water, they can be used at the beach, in the bathtub, or about the house. The size can be changed by blowing more air into them, providing an almost endless fascination for the children.



When deflated, many may be carried in the pocket or handbag.

Seamless Rubber Co., d.w. Haven, Conn.

*Cont. Percy Lingore, State Supervisor
 of Vocational Rehabilitation*
 370 POPULAR MECHANICS *March*
 2957 **BLIND TAUGHT TO FIX SHOES ON MACHINES**

For teaching blind men shoe repairing, a training school equipped with modern electrical machinery has been established by one of the state institutions. After the students have completed the course, which takes about three months, and can

turn out a good quality of work, they are permitted to go into business for themselves, or enter the employ of other shoe repairers. The instructor, who is blind, teaches his pupils to operate the various machines used in the work.

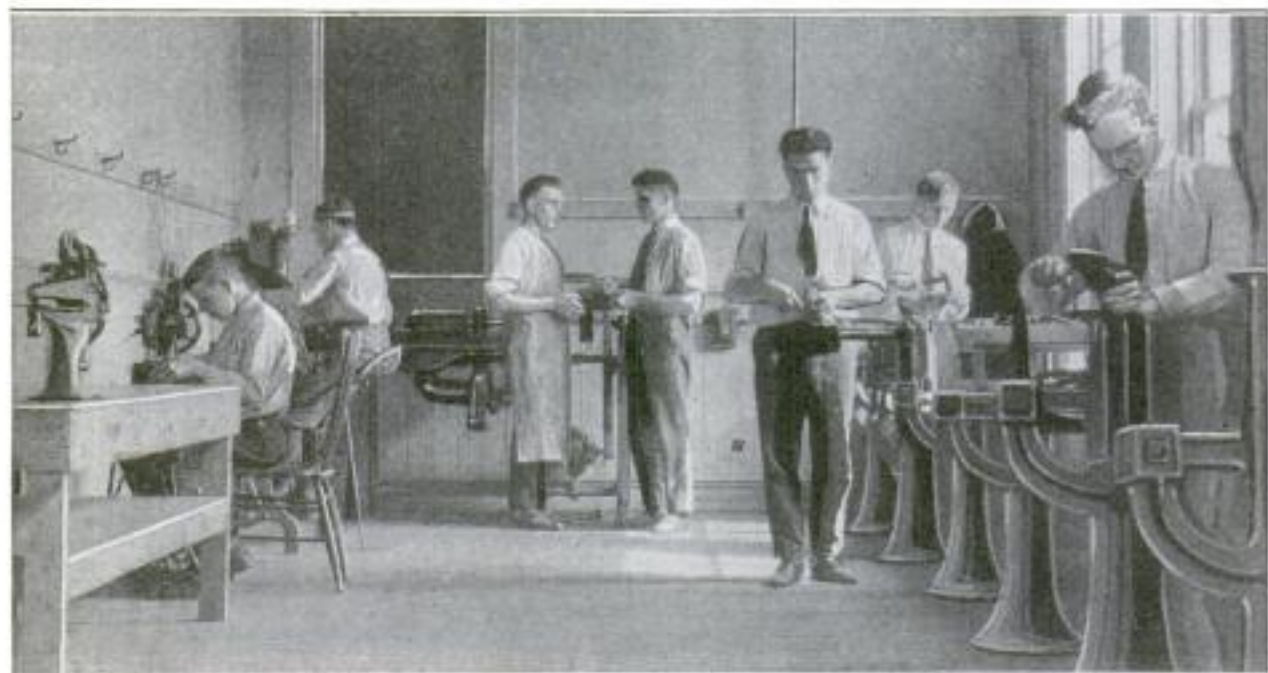

Teaching Operation of Modern Shoe-Repairing Machinery to Blind Students in Vocational Training

**WHOLE LABORATORY IN BOX
 FOR AMATEUR CHEMIST**

Playthings having a practical value are in demand by young people, who want

own motor to haul it on metal rails, charged with electric current, wood-blocks for toy houses have given way to steel girders and beams that erect small bridges and buildings. Youthful students of chemistry may now look into its secrets with the help of a small chemical set having retort, pestle, glass tubes, and vials of salts and acids for mixing into gases and liquids, that change form and color as their different parts are added. Knowledge as well as pastime is assured the young amateur possessing it.



Both Study and Amusement are Offered Young Students by This Chemical Laboratory Set

to do the things that interest grown-ups. A train of toy cars must have its

**FLOOD OF BOGUS ANTIQUES
 BROUGHT FROM EUROPE**

For years past museums and art collectors have been made victims of clever imitations of valuable antiques, sometimes made by modern workmen plying their trades within short distances from where the articles are put up for sale, according to the testimony in a trial in the East recently. Old-style furniture, patterned after that in use two or three centuries ago, is given appearance of genuineness by having its surface treated with chemicals to create the color of age.

*Chicago Park,
 July 1923*

*Marshall Field & Co.
 Chicago*

POPULAR MECHANICS *Co Cheap side E.C.*
London England

PACIFIC'S BOTTOM IS CHARTED BY TIMING SOUND WAVES

Charting the bottom of the Pacific ocean between United States and Australia is the task of a navy cruiser using a delicate apparatus to measure the time required for sound to pass from the surface of the water to the ocean's bed and return. Records are taken every five miles while the boat is moving. Knowing the speed of sound through water and the time elapsing between sending and returning of a signal serves to compute the depth.

300 5

CAR WASHER FITTED TO HOSE REGULATED BY TRIGGER

Attached to an ordinary garden hose like a nozzle, a device has been made for washing automobiles and other machines that ejects either a spray or jet of water through a heavy bristle brush. Without screws or bolts, the force of the water is controlled by a trigger fixed to the forepart of a ribbed handle. By pressing half-way down on it, the stream is forced through the cup-shaped top of the apparatus and changed into a fine spray for washing windows. Another attachment throws a 50-foot stream that cleans mud from the wheels.

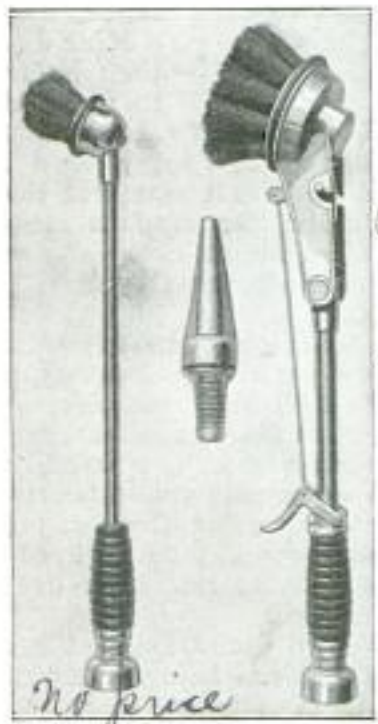

No price

2914

RARE BIRD'S PICTURE TAKEN

What is considered to be the first photograph of the Kirtland warbler, acknowledged by scientists to be one of the rarest birds in North America, was obtained recently in northern Michigan, the only spot in the world where the bird is known to nest. It summers and winters on the Bahama Islands. Only one nest is reported to have been seen before by naturalists.

2930

Photographed by - James Mc Millinray Michigan Conservation Commission

PIPE SHAPED LIKE A CIGAR FOR OUTDOOR SMOKING

Made in the shape of a cigar, a pipe has been designed for motorists, golfers, and sportsmen. Tobacco is placed in a

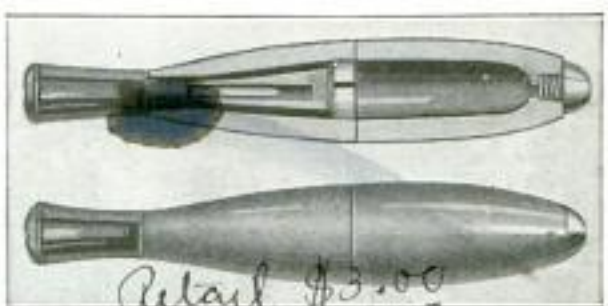

Pipe Shaped Like Cigar to Protect Tobacco from Wind and Rain

Retail \$3.00
\$2.00

bowl, where it is protected from the wind and rain. It may be lighted and kept going even in a strong gale. As it is separated into several pieces, it is quickly taken apart for cleaning. The mouth-piece is of amber, but the pipe resembles a cigar both in shape and color, although it is long enough to assure a cool smoke. Lacking the curve of an ordinary pipe, it is easily carried in the pocket.

Star Finder
Star Finder
Star Finder

STAR FINDER TRACES COURSE OF FAR-OFF PLANETS

Costly telescopes and other expensive devices are made unnecessary for the amateur student of astronomy by the use of a constellation finder having an arrow mounted over a circular chart to locate star groups seen with ordinary field glasses.



A slide, with an opening through which readings are visible, is moved around an upright dial, printed with the names of the planets, to the day and hour, at the same time turning the arrow to point into the midst of the group shown by the chart. The pointer also shows the actual paths taken by the planets in their journeys across the sky. After a little study and practice, any star can be easily found and followed.

Armin HeGENER, 121 New York, 335 Broadway

Price \$7.50
W. W. Hancock, Chicago
Watry

Twenty Years Ago in Popular Mechanics



"The modern steamship of today offers about every convenience and accommodation that it is possible to provide. On the finest of these vessels the passengers have the freedom of the immense decks that cover the entire vessel. Cabins and smoking rooms are thoroughly well lighted."

Comment of Two Decades Ago

TWENTY years ago, according to the files of *Popular Mechanics*, engineers were discussing the possibility of joining the Atlantic and Pacific oceans with a canal in either Panama or Nicaragua.

Nine days were required then by the fastest liners to make the voyage from

New York to London that now takes considerably less than a week. Of these old boats, it was said that, "It seems as though the modern steamship of today offers about every convenience and accommodation that it is possible to provide."

That ocean vessels would be built with fast passenger elevators, swimming pools, tiled baths, massive, pillared dining rooms, daily newspapers, was never even conceived as a possibility in 1903. That opera music and concerts by notable artists given hundreds of miles away on the shore would be enjoyed by ocean travelers, was not even dreamed of by inventors.

Two decades ago, the discovery of the X-ray was being hailed as the latest marvel of science, electric headlights were being tried on some of the fastest railway express trains. The 100th birthday of the first locomotive was being observed in all parts of the country. Chicago began the use of its first subway, the tube being 100 miles long and designed for freight only.

Forecasting the coming triumph of the radio, Swedish engineers announced that they had succeeded in sending wireless messages for a distance of 28 miles, and a Belgian inventor exhibited a device designed to transmit the picture of the person talking over a telephone wire.

The possibility of telephoning without wires was considered but idle speculation.

"Comforts" of Ocean Travel in 1902



Former "Queen of the Desert"



"Umbrella Sail" Used in 1903

Contrasted with the Luxuries of Today

"Radio concerts, daily newspapers, banks, Pompeian swimming pools, sumptuous libraries, luxurious dining rooms, fast elevators, tiled baths, comfortable cabins, vast expanses of promenades, hot and cold running water, and all the conveniences of a first-class hotel or club."

What Liners Now Offer

AS a graphic example of the increase in speed and safety of travel during the past 20 years, a trip around the world in 1902 required 54 days.

Just a few years before, however, Jules Verne had written of what was then considered an impossible feat, "Around the World in Eighty Days." Just recently this trip has been made in 34 days, and this time is expected to be further reduced with the growing use of airplanes.

With the automobile in its infancy two decades ago, a queer craft running on wheels and propelled by sails was built to "skim the lifeless sands of the dreaded Mohave Desert." It was declared to be capable of carrying several persons at a speed of from 50 to 80 miles an hour, and plans were made for it to supplant the camels used in the great Sahara.

With the coming of the tractor, this strange ship on wheels has been forgotten, its place being taken by an automobile attached to a so-called endless tread.

Another strange craft was the boat fitted with an umbrella, or cyclone, sail. This was expected to increase the speed and to remove the danger of capsizing as the wind pressure did not tend to tilt the craft.

Although the device attracted wide attention at the time, it also has been forgotten with the coming of the fast motorboats, many of which have run at a speed of more than 60 miles an hour.

And yet within the memory of men now alive it took longer to go from Kansas City to San Francisco than it does now to encircle the globe. During the days of the prairie schooners in '49, this journey took over three months, while recently an airplane flew from New York to San Diego in 24 hours.



Dining Room on Ocean Liner



Tractor for Desert Travel



Type of Modern Speed Boat

Pacific & Atlantic Photos
 25 Park Place
 POPULAR MECHANICS
 New York

371
 2786

THRILLS OF OBSTACLE GOLF RIVAL REAL GAME



Playing obstacle golf on the lawns offers all of the delicate problems of ordinary games with more hazards and less driving. The plays have no limit of variety, as more difficult obstructions than the usual courses are equipped with can be built into spaces of smaller area.



Balls similar to those now used on the regular green are driven to the obstacle by lightweight clubs, and there, lifted, or knocked, to carry them above a hurdle or through a keg having no bottom. Small bridges may be built over pools for the players.



FUTURIST ART GIVES WEIRD EFFECT TO BUILDING

Twisting walls, six stories high, lend a fantastic appearance to an apartment building in Europe. Bulging outward at each floor, the sides of the building serve as a sun shield for the windows below

and also keep off the rain. The roof is covered with tiles of various colors. This unusual style of architecture is called "Catalonian." It is used somewhat in southern Europe.



Fantastically Designed Apartment Dwelling, the Sloping, Twisting Walls of Which Serve to Protect the Windows from Sun and Rain While Many-Hued Roof Tiles Add to the Weird Effect

LIONS TAMED BY ELECTRICITY INSTEAD OF WITH WHIP

As a more effective means of training lions that eventually perform in the rings of a circus, lion tamers are reported to favor an electrically charged wire instead of the whip. When a beast has just begun its education, it often attempts to attack the instructor when his back is turned. Formerly the trainer's security was in keeping a sharp watch over his shoulder and striking out with the heavy piece of leather when the animal jumped at him. But now a charged wire is stretched across the cage, and when the beast touches it, it receives a lesson that leaves a deeper impression than a blow.

placed that of the sun and instead of rain there was water from the fire hose. For a week the blaze smoldered, and during that time firemen continuously played a stream of water over the debris. Then 50 bales burst their strong bonds and, from the seeds contained in them, plants

FIRE MAKES COTTON SPROUT MORE THAN INCH A DAY

How plants will grow even in seemingly hopeless spots was recently demonstrated when fire partly destroyed an eastern warehouse in which 200 bales of cotton were stored. Heat from the flames re-



Fire Duplicates Feat of Nature in Causing Plants to Sprout from Bales of Cotton

sprouted. Within three days, they reached a height of more than 3 inches.

Engr. Edwin Jarvis
 of the Farragut, Washington
 1916

Com. Walter E. Burton
 1922 Florida Ave.
 Kenmore, Ohio
 Copy printed material

2913

SIPHON CARRIES WATER UNDER RAILWAY TRACKS

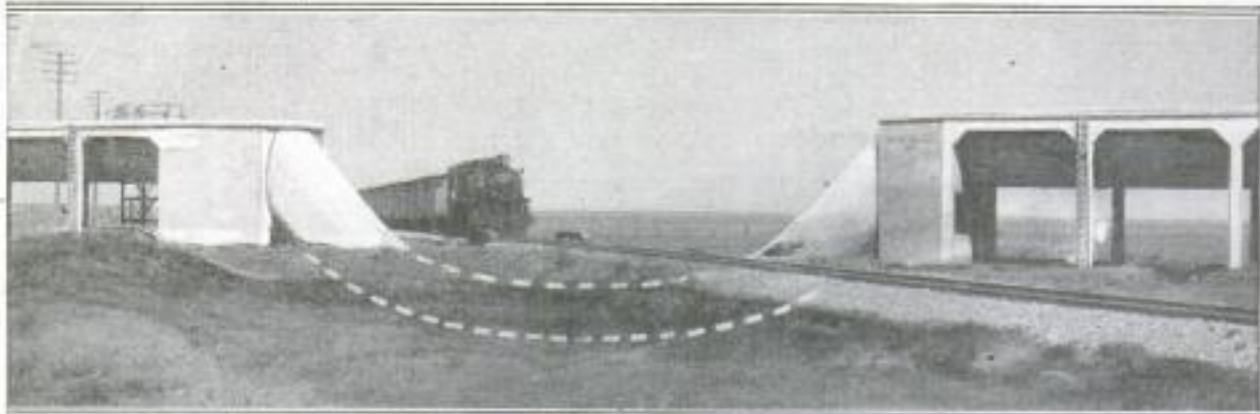

Inverted Siphon, Connecting Opposite Ends of Flume, Carries Water beneath Railroad Tracks, as Height of Curved Shell did Not Provide Sufficient Clearance for Crossing above Ground

To irrigate hundreds of thousands of acres of land in the West, water is being brought for 2 miles over a reinforced-concrete trestle, 60 feet high.

At one point, the rushing torrent is carried down into the ground through a siphon to enable it to cross the tracks of a railway at a speed of 12 cubic feet per second.

Hailed as a remarkable feat of engineering, the aqueduct is a curved shell suspended between heavy girders. Twisting like a huge snake across the landscape, it suddenly vanishes into the earth only to re-

appear on the other side of the tracks. Here, tapered ends at the inlet and outlet of the tube give an increased velocity to the flow with but a slight total loss of "head." There was no interruption

of traffic while the flume was being constructed. In building the aqueduct approximately 25,000 cubic yards of concrete and 4,000,000 pounds of reinforcing steel were used at a total cost of 650,000 dollars.

It carries water from Lake Newell across a valley between the Bow and Red Deer rivers to the Bassano irrigation project east of Calgary, Canada.

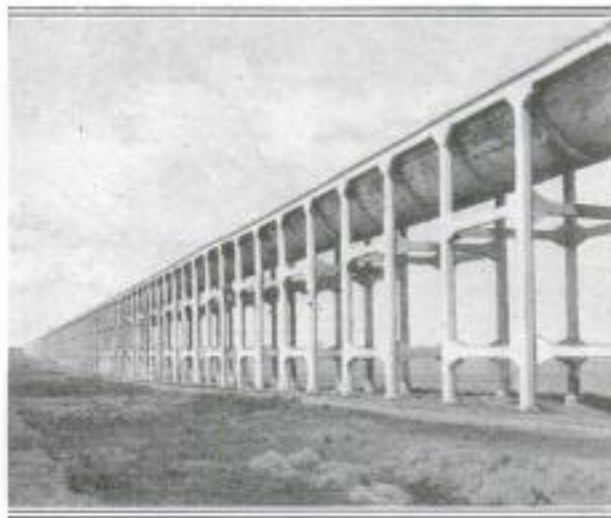

Huge Aqueduct of Irrigation Project, Supported by Concrete Trestle across Surface of Two-Mile Wide Valley

SILVER FOXES BRED ON RANCH TO OBTAIN RICH FURS

Because of the killing of fur-bearing animals, a silver-fox ranch has been established on Long Island within sight of New York City. In a five-acre inclosure, rigidly guarded, are kept 100 pairs of the beautiful animals. A number of their offspring are marketed yearly. Some are sold for breeding purposes while others are killed, painlessly, for their pelts. Protected from the dangers of life in the open and carefully attended, the animals develop furs of better quality, it is said. Mother foxes, often nervous in captivity, frequently disown their

young and then their places are taken by cats, but dogs rarely seem willing to "mother" young foxes. The industry has grown to such an extent that most of the skins that now find their way to market come from ranches that are scattered all over the United States. While the average prices paid for skins last season ranged from \$150 to \$370, a single fox for breeding purposes, with a fine pedigree, sometimes sells for as much as \$2,000.

Energy equal to the muscle work of 5,400,000 men employed in three eight-hour shifts, it is claimed, will be generated by a steam turbine now being made by an American firm.

Huntington Fox Trap Co.
near Huntington, L. I.

**GOLDEN COLD-LIGHT FILTER
MAKES MOVIES SAFE**

Coated with pure gold, a filter has been made that removes 90 per cent of the heat from light rays used in projecting motion pictures, thus eliminating the danger of fire when the machine slows down or suddenly stops. By its use it is possible to halt the unwinding of a highly inflammable film and throw "still" pictures on the screen. The device consists of two small glass disks, with the gold-sprayed sides cemented together, thus making a single lens. Fitted above the projection aperture while a reel is being run off, it automatically drops into place when the machine loses speed or halts. While it reflects objects as readily as an ordinary mirror, it is transparent when held to the light. Rays filtered through it have a slight greenish cast, but not sufficient to blot out the picture. For years scientists have been searching for a means to take heat from light rays.

**DIAL TELLS HOW HOT IT IS
WITHOUT MERCURY**

Without the aid of mercury, a recently devised thermometer works from a coiled metal spring expanding and contracting under changes of temperature, revolving a dial horizontally behind a pointer. The scale, printed in large figures, may be seen at a considerable distance, making a convenient article for desks or walls. Ornamental designs are used to meet various requirements.



The Thermo. Dial Laboratories, Newark, N. J. \$4.00.

To make pictures of wood in a catalog more realistic, publishers in a middle-western city have printed them with varnish, giving the exact coloring of various stains and shellacs advertised.

**SEA SCOUTS USE COLUMBUS
CARAVEL FOR TRAINING**

Sea scouts of a middle-western city are using a reproduction of the old Columbus caravel "Santa Maria," as their flagship.



Made thirty years ago for an exposition, it is an exact model of the ship in which Columbus sailed to America more than four centuries ago. On the decks 15 and 16-year-old boys study navigation, the manual of

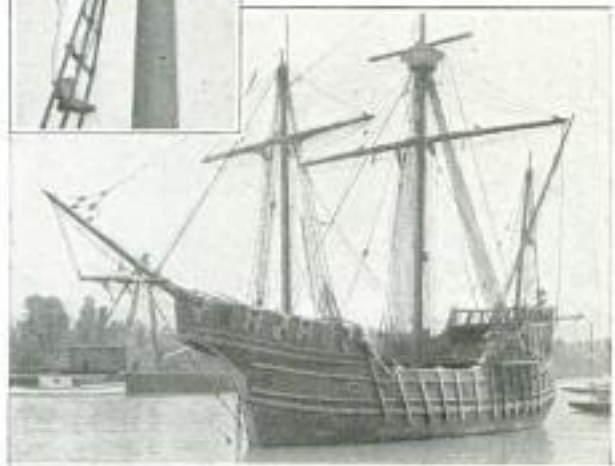

Replica of Ship in Which Columbus Discovered America, That is Now Used for Training Sea Scouts

arms, seamanship, and other subjects in the sea-scout program. The old caravel is a picturesque contrast to the modern motorboats and yachts that surround it. Its rigging is kept in repair for practice exercises during the scouts' drills.

**ROMANS PADDLE INDIAN CANOE
ON THE HISTORIC TIBER**

From the streams and lakes of the North American continent, which it has plied for centuries, the American Indian canoe has recently found its way to the waters of the historic Tiber of Italy. Within recent months canoeing has become a favorite sport of the Romans, and on Sunday many of the frail craft, guided by the descendants of the founders of Rome, mingle with power boats, sculls, shells, and skiffs that crowd the yellow waters of the river. Although the Italians as yet have not attained the perfection of the Indian in handling the canoe, the demand for it has become so great that a factory near Rome is turning them out by the scores, using a dozen American-made conveyances as models.

Chicago Park

7/7/23

British Columbia Canada
SPIRITS OF DEPARTED SPEEDED WITH WEIRD RITES

2919

ONE of the most interesting subjects afforded a traveler in many lands off the beaten path of civilization is the



COPYRIGHT, FRANCIS DICKIE
Resurrected after One Year, This Native's Remains
Repose Aloft near His Old Home

on top of a near-by high mountain where it is cold. Until recently these people made human sacrifices of slaves at times when living relations wished to send a message of importance to a dear departed, the soul of the slave supposedly carrying the message. Missionaries are now trying to stop this practice.

In another part of Borneo, the bones of the dead are taken up after about a year and are carefully laid beside the things the deceased most cherished in life. The gathered whole is then placed in a beautiful little house, six by four feet in size, which is a mass of very fine carving. The house is then reared high in the air on the top of a stout pole which is made firmly fast in the ground near the dead man's home.

Although separated by thousands of miles, the Dusans and the Eskimos still bury their dead somewhat in the same manner, while the Dusans and the Stapsans, living near each other on the same island, have not one thing in common in their burial custom.

various ways in which primitive people honor the spirits of the departed.

Tribes living within a few miles of each other are often found to have practices totally at variance, while races separated by thousands of miles do things almost in the same way.

Among the Eskimos, when a man dies he is wrapped in his best furs and laid upon the tundra or prairie at some selected spot. Then a cairn of stones is built over him. Upon this is placed all the cooking utensils, weapons, and the boat he used in life.

For three days after death, the spirit is supposed still to remain within the body. During this time the deceased's nearest relative, usually his eldest son, comes for a short time each day and talks to the spirit to keep it from getting lonely. A tall pole is also erected over the grave from the end of which blow in the breeze bits of cloth, skin, or moss that keep away evil spirits. At the end of the third day all the dead man's possessions may be sold to white men or Indians, if such be in the vicinity, but on no account to other Eskimos.

In North Borneo, the dead are buried in the earth. Over each grave is erected a substantial and neat little house in which are placed the possessions of the deceased, particularly clothes, as the Dusans believe the other world to be



COPYRIGHT, FRANCIS DICKIE
Natives of a Borneo Tribe Protect Graves with
Houses Containing Articles of Clothing

8058 FOREST OF FOSSIL TREES
MILLION YEARS OLD

What is regarded as the earliest recorded fossil forest has been unearthed in New York State. Experts estimate that it is about 300,000,000 years old, and that it belongs to the Devonian period. Already 40 of the stone-tree butts removed from the excavation have been placed in the state's museum. Stumps were found in the rocks at two levels, one 60 feet above the other. Only a short distance below the lower forest, the rocks are said to bear true marine fossils. Authorities now believe that the western Catskill Mountains region was formed millions of years ago.

Sacoma Ledger
7/9/23
Copyrighted material

Discovered by Dr. A. S. Spinnons, formerly instructor in Zoology,

CITIES OF RARE BIRDS FOUND IN GULF-COAST WILDS

3056

Miles from human habitation, in an isolated and wild section of the Gulf coast of Texas, enormous cities of birds were found recently. Some were of species not known to exist anywhere in the United States, except in limited numbers. Among these was the white-face, glossy ibis, the American cousin of the sacred bird of Egypt, whose gorgeous bronze plumage was used as a decoration for women's hats until laws were passed forbidding the practice. Living in another colony were the wood ibis, commonly called the American stork; the rare white-face ibis, sought by naturalists for years; and the roseate spoonbill, noted for its brilliant feathers.

ELECTRIC HEAT IN FURNITURE IS CONVENIENT AND SAFE

2892

Electrically heated screens, mirrors, panels, and hangings for theaters have been designed recently. Low-temperature elements are used so as not to injure the furniture in any way or to mar its appearance. In one instance a tapestry screen with four wings, each 5 feet by 2 feet, was equipped so as to give a temperature of from 75 to 105°. Efforts are being made to adapt this system to



Electrically Heated Screen in Which Hidden Elements Raise Temperature to 105 Degrees

domestic purposes generally, as it is claimed that it is safe and convenient.

*Isrierson, Ltd,
London, England*

POPULAR MECHANICS

University of Texas.

379

CANTERING WOODEN HORSES RACED BY CHILDREN

2534

Combining amusement and healthy exercise, a wooden horse that canter has been made in Europe. It is strong, flex-



PHOTO BY COURTESY OF THE SKETCH
Wooden Horses That Canter being Raced by Children, the Latest Sport in London Parks

ible, and compact, and can easily be carried when not in use. The toy has won wide popularity among children, who may be seen with it in the parks every day, holding amateur races.

FLY MOVES TOY PIG'S EARS IN TRYING TO ESCAPE

3024

In attempting to escape, flies, which have been imprisoned in the body of a toy pig, cause its ears to move. Two flies are necessary to work both ears at the same time.

One of the rubber legs may be withdrawn to permit the entrance of a live fly that has been captured. The ears immediately respond to the activities of the prisoners. As the flies are invisible, the movements of the legs and ears cause much curiosity.



*American novelty Supply House
1418 Augusta St.
Chicago*

*104
Mr. L. N. Cleader
Berkhamstead, Hertf., England
Clayton's Military Stores
29 E. 2nd Street, Chicago*

Copyright material

Thrills Made to Order in the Movies at the Risk of Life and Limb

Stars of the Silver Screen Often Called Upon to Face Death as Result of Demand for More Realism in Pictures

HANGING by the heels on a 6-inch ledge with the street cavern yawning 12 stories below is no trick at all—in the movies.

Missing a foothold on the edge of a tall brick precipice and being caught by the hands of a clock 10 floors above the earth, however, contains almost as many thrills for the actor as it does for the spectators.

For these are the days of realism in pictures, the result of a ceaseless demand on the part of a public long accustomed to seeing speeding automobiles plunge over steep cliffs, death-defying leaps into a raging surf, and airplane crashes, for more thrills.

While only a few years ago most of the "stunt" pictures were the result of trick photography, double exposure, and splicing of the film in the cutting rooms, today the highest-priced stars of filmdom are often called upon to risk their lives.

In other cases "doubles" are employed to take the place of the star for the more hazardous undertakings. Dressed and made up to resemble the actor, they brave death in leaps from speeding trains to airplanes, jump over cliffs, and ride motorcycles into locomotives with no chance of winning either fame or glory for themselves. They are the unsung heroes of the movies.

Many risks, however, are taken by the stars. In one instance, during the filming of a western melodrama, the heroine was called upon to plunge into an icy mountain torrent and float downstream

toward a cataract. Camera men and the director trailed along in a boat behind so that a close-up of her face in the water could be obtained.

It had been found by experiment that the current would carry

floating objects to a sand bar just above the falls, and a watcher was stationed

there to pull her from the water as she swept past. But, instead, the current swept her to the other side of the stream and she would have been dashed over the falls

to certain death had not her secretary managed to grab a bit of her dress and draw her to the shore. One of the strongest bits of realism ever shown on a screen probably, was the expression of hopeless horror on the face of the victim as she realized her danger. This was caught by the camera in the boat.

Considerable hazard often is eliminated by the use of wires that protect the actor against falls. These cannot be seen when the picture is shown on the screen. In the comedies, also, many other tricks are employed. One is a rest at the back of an automobile that holds the actor out parallel to the road and makes him appear to be stretched out like a ribbon.

To do this two pictures are taken and spliced together. In the first, he chases after the automobile and catches the rear seat with his hands, throwing his feet into the air. Then the automobile goes back, the actor takes his place on the rack and it covers the same course. Later the films are cut and joined at the point where he first leaped into the air.

In making a picture of a man climbing the side of a building and doing apparently perilous stunts many floors above the street, a real building was selected and a circus performer employed to double for the actor in the "long shots." Then a fake building was built on top of the real one. The "set" was built in far enough so that the roof would break any fall and also would provide a platform for the camera. By "shooting" at a proper angle, however, the drop to the street looked straight down.



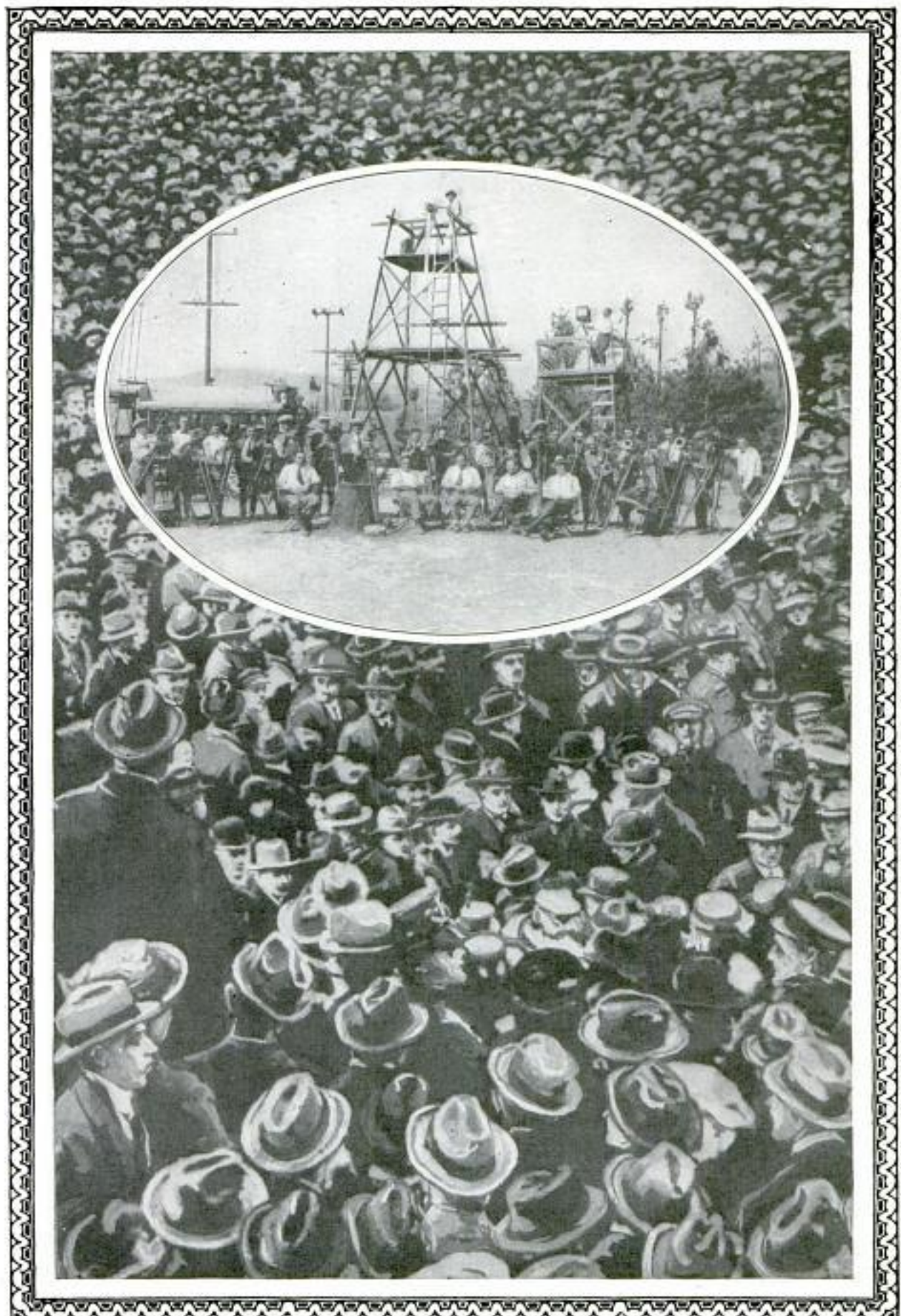

In Making the Great Moving-Picture Features, Whole Armies of Actors are Called into Motion, the Voice of the Director being Carried to Them by Radio-Magnifying Devices



Leaping from a Balcony into the Rear Seat of an Automobile Is Just One of the "Stunts" Demanded in the Movies from High-Salaried Stars



Real Athletic Ability and Constant Training on the Part of Stars is Required to Meet the Demand of the Public for More Speed and Thrills

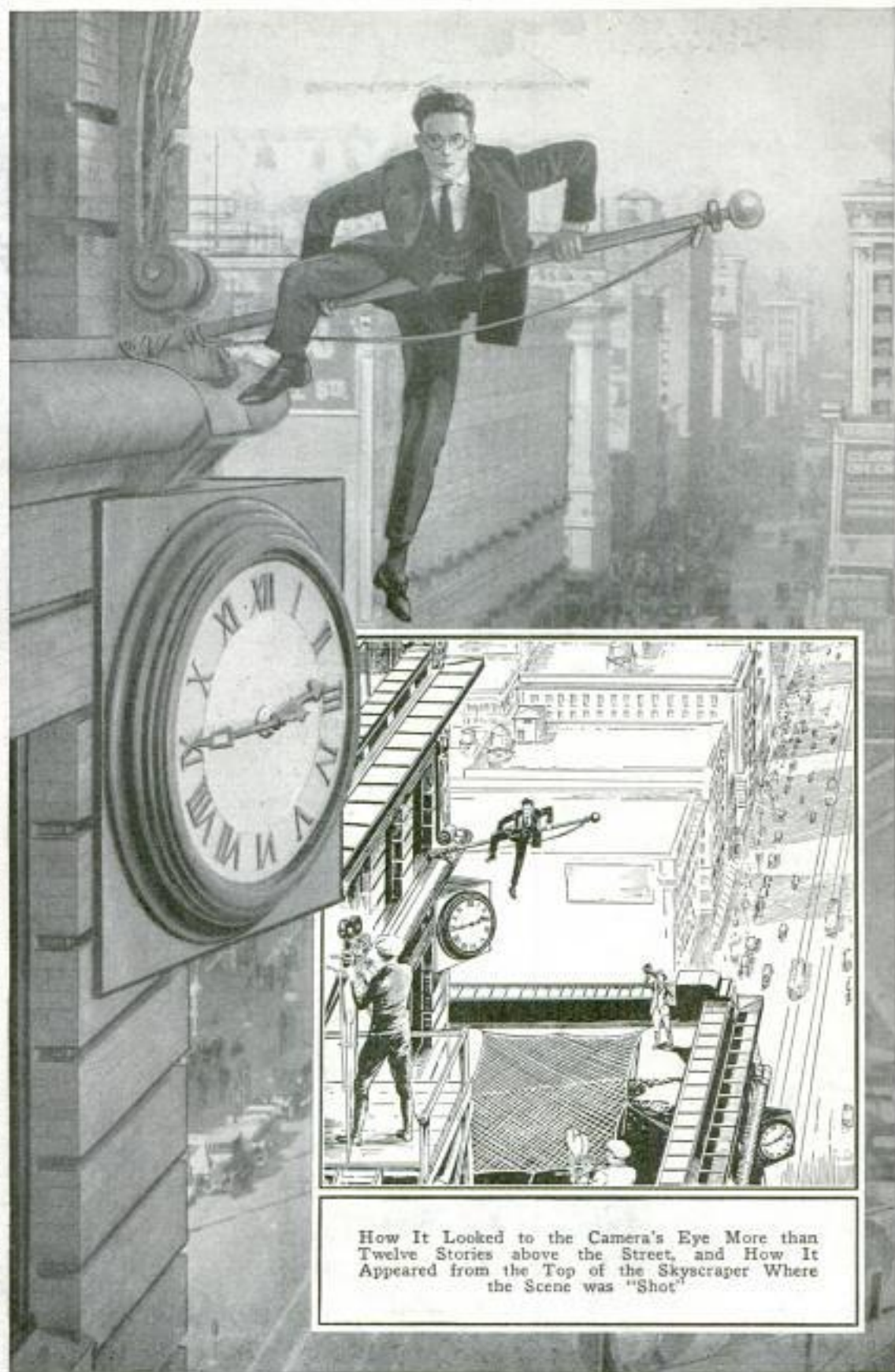

How It Looked to the Camera's Eye More than Twelve Stories above the Street, and How It Appeared from the Top of the Skyscraper Where the Scene was "Shot"



Although the Lives
of Movie Stars are
Carefully Guarded,
They Often are
Called Upon to Risk
Death in Response
to the Public's Dem-
and for Realism,
Accidents Upsetting
the Best Planned
Precautions



CAMERA MEN AND STARS SHARE IN SAME PERILS



While the Camera Men Never Appear on the Screen, They Often Take the Role of Unsung Heroes in the Taking of the Pictures, As They Have to Follow the Stars and at the Same Time Carry Their Heavy Tripods to Obtain Effective Views

2932

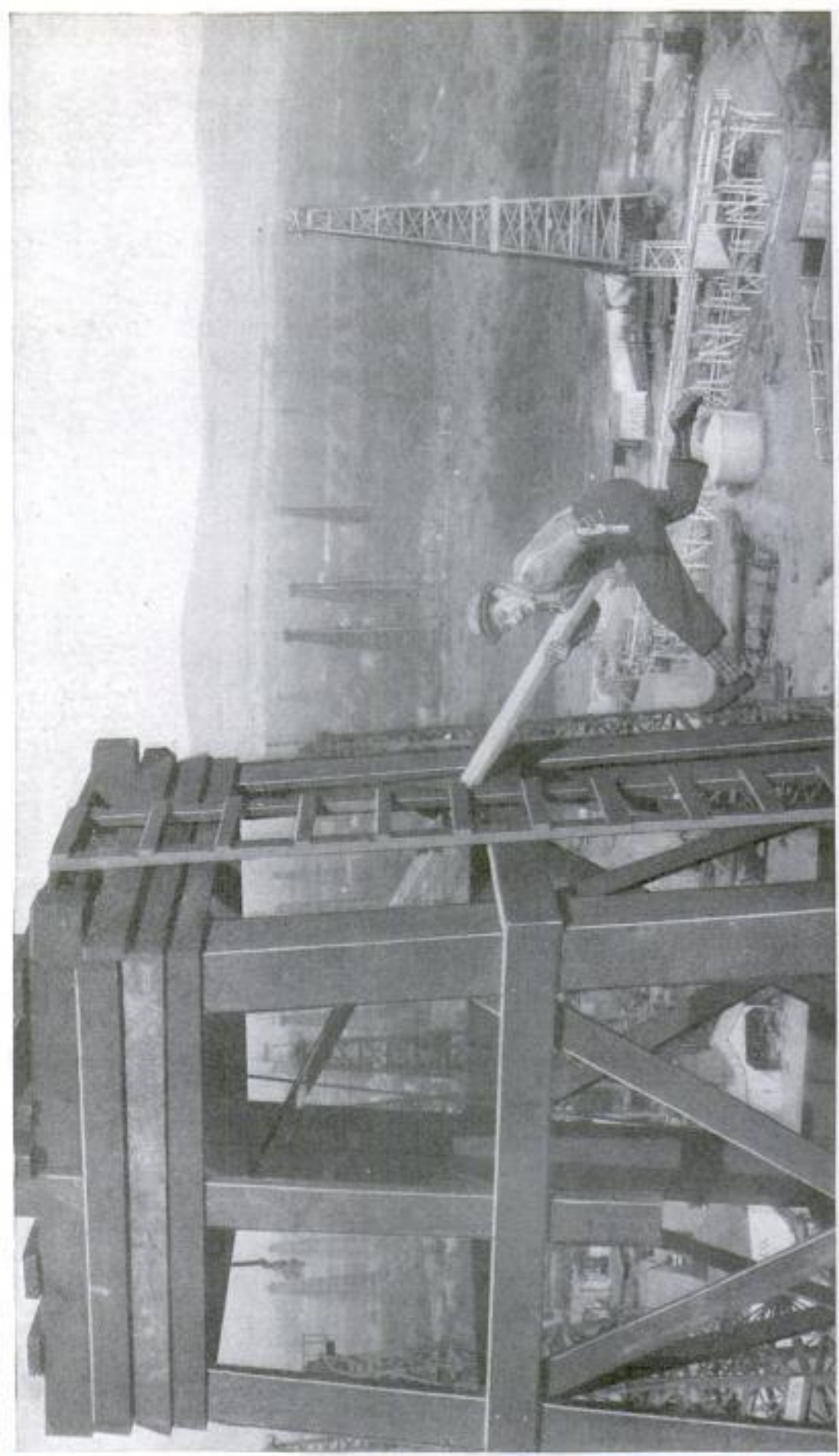

Fine Wires and Nets That do Not Appear in the Completed Picture When It is Thrown on the Silver Screen, Often Enable Actors to Perform Seemingly Impossible Feats. Trick Photography and Double Exposure are Seldom Used, as These Devices have Become So Familiar to Audiences That They are Usually Detected

2732

MOVIE CAMERA'S EYE PENETRATES OCEAN'S DEPTHS

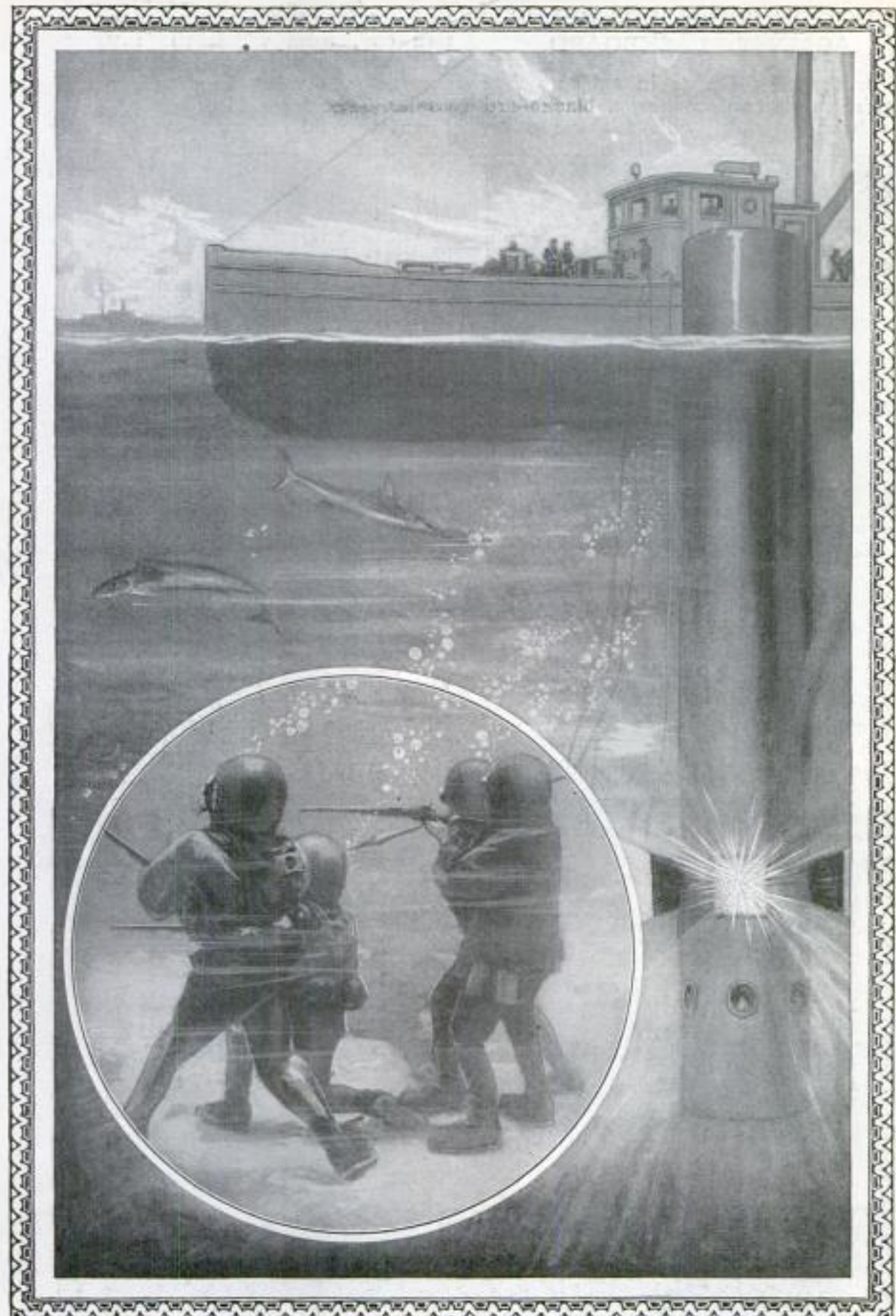

In Long Tubes Swung from Boats, Operators Film Scenes Far beneath the Surface of the Sea, Electric Lights Supplying the Necessary Illumination for the Actors in Diving Suits

Golden Compass Co.
Elkhart, Ind.

388

POPULAR MECHANICS

SUCTION CUP HOLDS RULER AGAINST BLACKBOARD

2855

For teaching classes in subjects that require accurate drawings, a blackboard has been provided with a drawing set

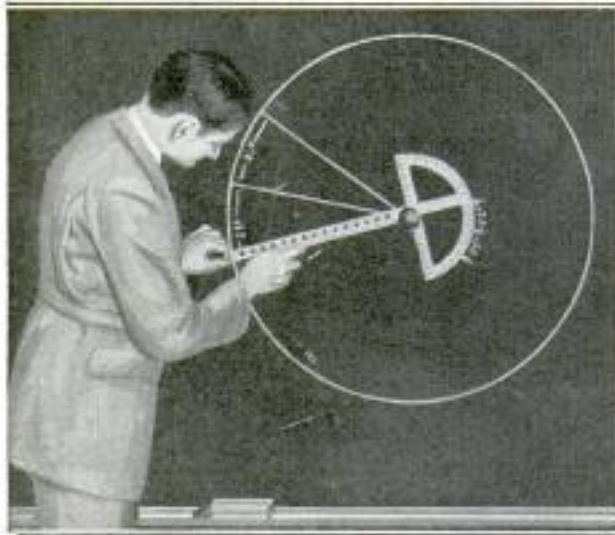

Drawing Set Attached to Blackboard by Suction Cup to Aid Teachers and Lecturers

that can be instantly attached by a suction cup, from which the instruments swing on a pivot, permitting the use of protractor, divider, T-square, rule, and angles. The force of the suction is sufficient to hold the set to the surface of the board for 15 minutes, when the outfit may be removed or replaced at the same point. Being vertical, this device may be seen from any part of a room, and makes it easier for the lecturer to illustrate his subjects.

NELSON'S SHIP TO SAIL AGAIN

3036

Work of reconstructing and restoring Nelson's famous flagship, the "Victory," that successfully led the attack on the ships of Napoleon in Trafalgar Bay in 1805, has been started at Portsmouth, Eng. It was on the deck of this vessel that Nelson, mortally wounded by a shot from an enemy gun, issued his memorable command: "England expects every man to do his duty." He died a few hours before the battle ended.

Christian Science Monitor
7/6/23

2896 WATER BICYCLE SAVES DROWNING PERSONS

To aid life guards in rescue work, a floating frame supported in the water between two air tanks, enables them to reach danger points quickly. Half submerged, the rider drives a propeller by

working pedals with his feet, traveling at greater speed than swimming would permit. The body of the victim may be easily thrown across the front of the tanks and carried to shore.

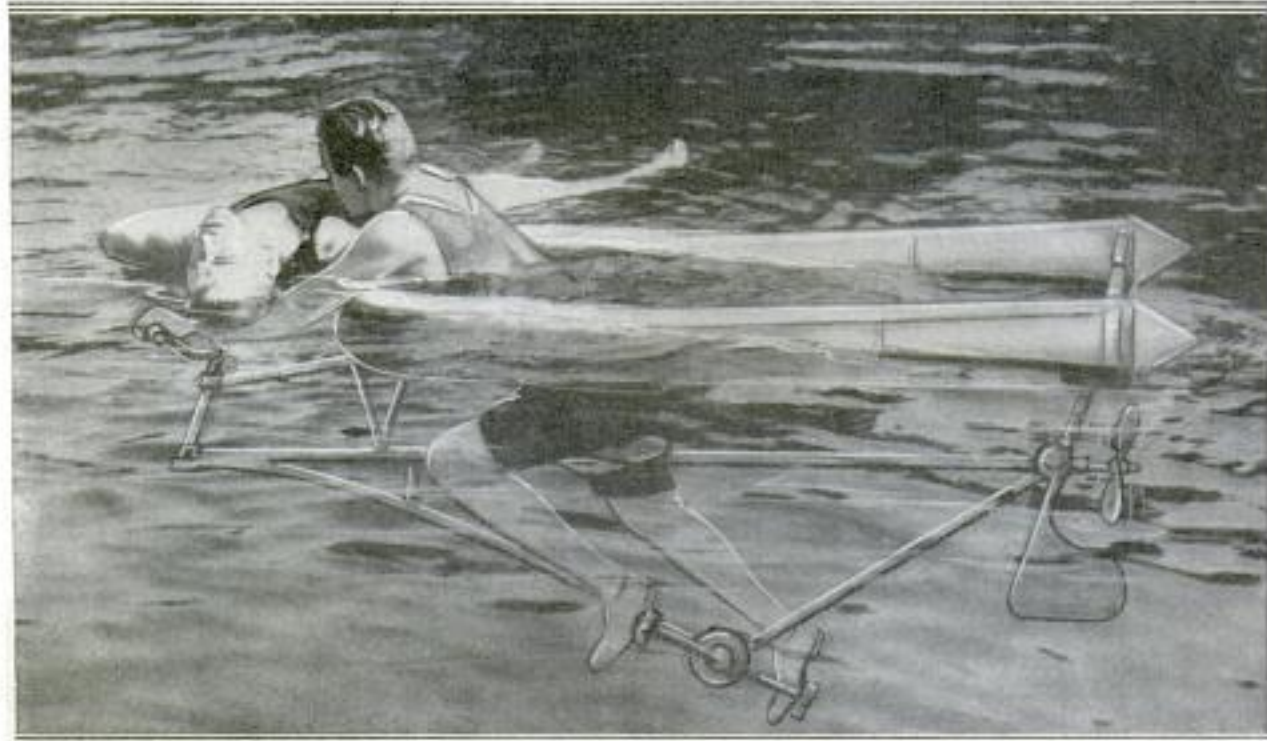

Guard Making Rescue from Life-Saving Device Driven by a Propeller Worked with Pedals: The Victim is Placed on the Floating Tanks and Rushed to Receive First Aid

data missing

Mr. Francis Luckie
Iderist Bay
B.C., Canada.

MANY SEA LIONS ARE SLAIN TO PROTECT FISH 3033

Armed with machine guns and rifles, a ship sent out by the Canadian government destroyed several large colonies of sea lions which fed on fish inhabiting the waters around a group of islands. By launching small boats, the vessel's crew were able to surround numerous herds of the monsters, driving them on to high rocks where heavy gun fire killed them. It was estimated that every one of the animals shot meant a saving of several hundreds of dollars' worth of valuable fish each year.

2934.

FOOT POWER CARRIES WATER TO CHINA'S MILLIONS

Because labor in some parts of China is cheaper than gas or electricity, the ancient method of drawing water by foot pumps is still practiced. Treading coolies provide the motive power for raising buckets of water, two men by working

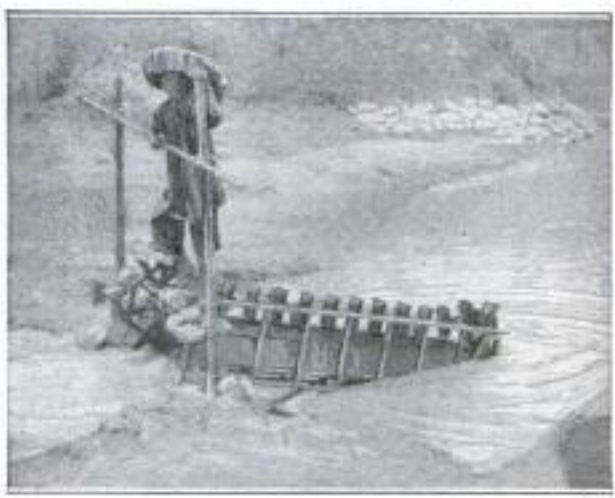

Two Men Who Walk All Day Long, Never Moving Forward, Merely to Draw Water

all day without rest supplying a small village. Despite modern ideas in many of the large cities of China, this crude way of pumping water is generally used throughout the country.

International News 3006

SKELETON OF DINOSAUR FOUND

Practically a complete, fossilized skeleton of a dinosaur, a huge animal living thousands of years ago, has been found by an expedition traveling through Asia. Working in what is believed to have been a river bed, the searchers discovered the bones at a depth of three feet.

Discovered by American Museum of Natural History

HEADS CARVED IN DIRT BANK SHOW SKILL OF SCULPTOR

Carvings of life-size heads on the side of a mud bank show the skill of a west-



Work of Sculptor in Mud Bank That He Paints White So It will Stand Out in Relief

ern artist who has made some remarkably realistic reliefs of noted persons. Many of his figures are larger than life size. These were made while he stood on a large stepladder. Painting the figures white with an ordinary brush makes them stand out in relief and visible from a long distance.

SPRINGS ON JEWELERS' LENS HOLD IT ON SPECTACLES

So that jewelers' lenses may be used conveniently by those having to wear spectacles, they have been fitted with springs that attach to the glasses. Instantly detachable, they do not interfere in any way with the ordinary vision. Also, they require no effort to hold them in place. To watchmakers and others,

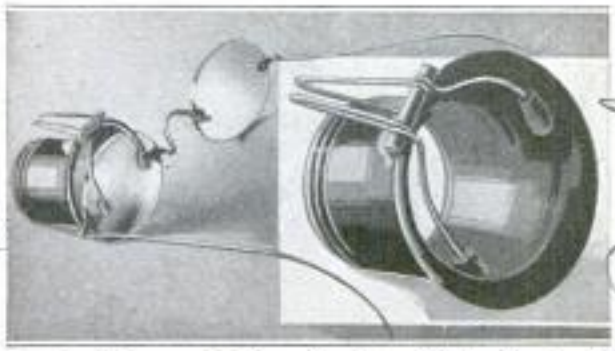

Jewelers' Lenses Made to be Attached to Spectacles by Almost Invisible Spring Clips

whose work has impaired their eyes, the attachment has proved a great convenience, besides relieving them of the strain caused by holding the glass in position.

297 N. Madison Ave. Pasadena, Calif.

Mr. J. D. Gump, 2322 Victoria Ave., Los Angeles, Calif.

390

Miss Martha V. Bauer
601 No. POPULAR MECHANICS
Washington, D. C.

2845

FOUNTAIN MANICURE STICK CARRIES OWN POLISH

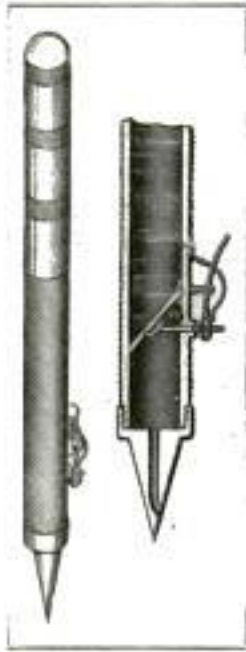

For supplying its own liquid nail polish or cuticle oil, a patented manicure stick with a hollow stem, opened and closed by a small spring device on the side worked by the thumb, feeds any desired quantity to removable orangewood points having holes drilled through them. Interchangeable tips with screw threads may be attached for different kinds of work, to the end of the barrel, which is about the size of the ordinary fountain

pen and may be carried in the vest pocket or purse, or kept on the dressing table.

RICH MINE OF PLANT ROOTS YIELDS PAPER AND FOOD

On a river in southwestern France there was discovered recently a deposit of almost 1,000,000 tons of fiber made from roots of a plant called "molinia," which, when mixed with molasses, makes good cattle food. When dried it replaces

wood wool for packing fruit, and is also used for paper making. The fiber provides bedding for animals, too. Sixteen feet thick and spreading over 32 acres, the deposit is said to be one of the largest in the world. It is removed with pitchforks to the cars on a small railway, built specially to haul it away. Under the valuable fiber bed are 5,000,000 tons of plastic clay for pottery and tiles.

X-RAY IS AN AID TO STUDENTS IN STUDYING ANATOMY

In order that students may receive practical experience, instructors of an eastern college this year will use X-ray photographs as an aid to their anatomy classes. By studying the human framework directly from the pictures, the pupils will learn the subject more quickly and in addition gain a more thorough idea of the practice of surgery. Experts assert that the X-ray gives a positive reproduction and thus is a great aid in diagnosis of ailments. Modern methods have virtually eliminated the danger of burns from its rays.

Phila. Public Ledger 7/2/23

Although well-preserved wood was taken from the tomb of King Tutankhamen recently, supposed to have been sealed about 3,000 years ago, scientists believe that modern preservatives are equal in effectiveness to the substance used by the Egyptians.

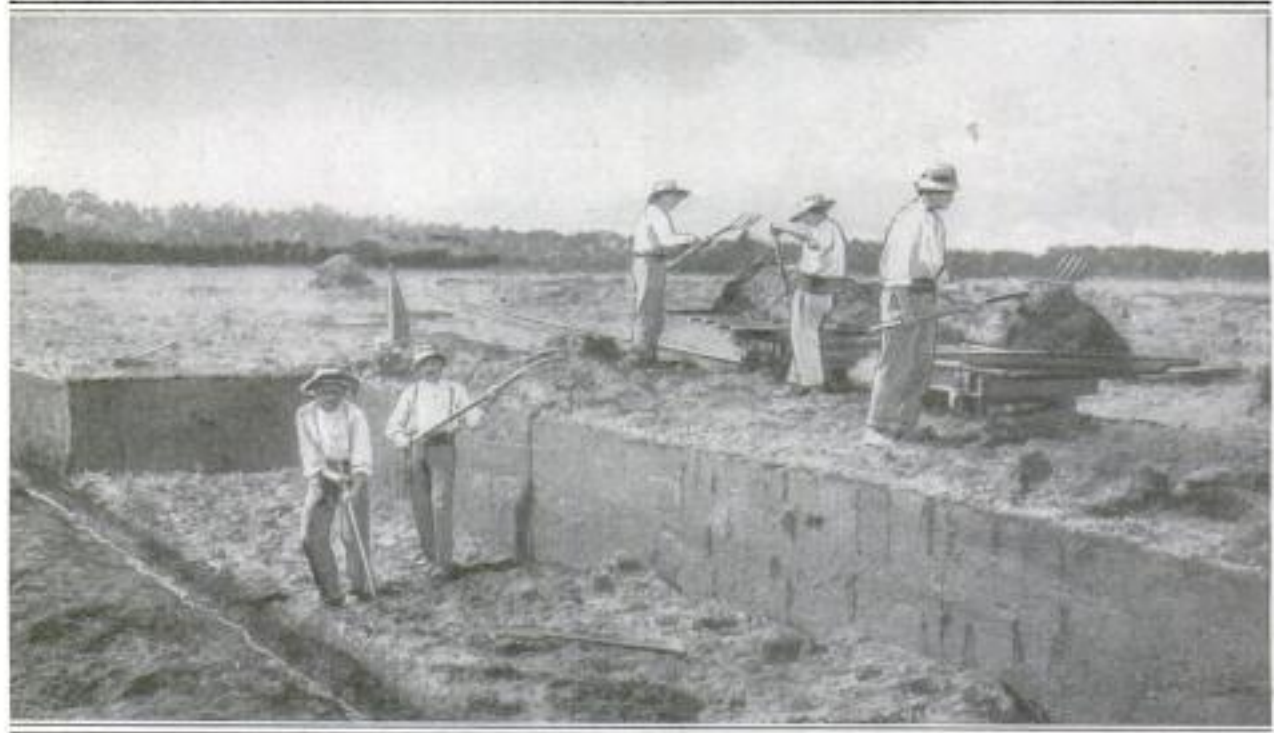

Removing Fiber of Roots of Plant Used for Cattle Food, Paper Making, and Fruit Packing

Wide World Photos
229 W. 43rd St.
New York

Used at Woman's Medical College

HUMAN "CHECKERS" USED IN GAME ON BEACHES

Exciting sport for both the spectators and the players is provided by a game known as "beach checkers" that has proved popular on the Pacific coast. Usually girls are used as the "checkermen," but men may play it also. In many

ways it resembles leapfrog, the contestants being forced to jump over any opposing player who is holding them back. The action takes place on a huge checkerboard laid out on the sands with white squares of cloth.



Human "Checkers" being Used in Game Played on Beaches with Squares Laid Out in Sand: The Contestants are Required to Jump over Opposing Players as in Leapfrog

LONG-LOST MINE IS FOUND IN THE MEXICAN WILDS 282

Hidden for centuries as a result of a cave-in, the main ore body of the famous Bondora mine of Mexico, reputed to have produced millions of dollars' worth of silver and lead in the latter part of the 18th century, is said to have been re-discovered by an American prospector. Records indicate that it was first found in 1766 by goat and sheep herders, and that it was worked until 1786 when the shafts collapsed, causing the rich vein to be lost from sight. A city of 16,000 inhabitants had grown up around the mountain where the riches were stored,

Discovered by Sam. Hortner American mining prospector

but that has long since vanished, only the crumbling walls and fallen stones of its houses now remaining. A young Spaniard, who went to Mexico to forget disappointment in a love affair, is said to have been the first owner of the property.

WASHINGTON ELM IS DYING 283

America's historic elm, under whose branches George Washington accepted command of the army of '76, is reported to be dying and beyond saving. For many years, tree surgeons have made strenuous efforts to prolong its life. It stands near Harvard University, at Cambridge, Mass.

Located in Quang Boun mountains 25 miles S. E. of Lampagos, Mexico.

*International
 Prof Charles S. Sargent
 Penamint Tree Robert
 Cambridge, Mass.*

ALL the magic colors of the rainbow are being made to order on butterfly farms in France. From the almost invisible eggs and crawling, ugly caterpillars to the marvelously tinted specimens treasured by collectors, they are bred and cared for as painstakingly as the



Many-Hued Specimen

rarest plants or the most valuable race horses.

Seeking to turn out shades that will rival nature's wonders, scientists are now trying to find a way to determine the color of the butterfly before its birth through experiments in crossbreeding that already have met with partial success. While previously only a pastime for amateurs, the study of the butterflies has now become the serious work of scientists.

Often a single rare specimen has been sold for \$3,000, the delicate body and wings being preserved with a varnishlike substance and used as a decoration for a hat or dress by women. They are also in great demand by collectors, and enable experts to study the formation and shading of colors.

Farms devoted to the cultivation of the insects provide plenty of trees, such as apple and pine, with abundant leaves, which form the chief food of the caterpillars. Great care is taken when the eggs start to hatch. They are placed on branches which are stuck in vases filled with water, while a protecting gauze prevents the feeble young insects from drowning. As soon as the leaves are devoured, fresh branches are provided. The room in which the eggs are hatched is well ventilated and an even temperature is maintained. After two weeks, they are removed to the open air. There protection is provided against birds, a sort of sleeve being placed over the branches.

When they reach the size of full-grown caterpillars, the protecting sleeve is removed. At this stage the danger from birds is remote, due to the extreme fat of the caterpillars, which is disliked by their feathered enemies. Soon the insects retire in cocoons or wrap themselves up in leaves. These later are collected and stored in well-ventilated receptacles, and the evolution into a beautiful butterfly is the next stage.

It has been found that a butterfly may change its coloring because of the action of heat and cold and, perhaps, electricity in the air. These changes are as follows: from light to dark brown, turning almost black. Other changes are due to the way in which the scales are arranged, tawny yellow sometimes turning so pale that it will look almost white. Red, yellow, white, brown, or black, as well as blue and violet, are so arranged that they are capable of displaying many shades.

Generally it has been found that the lighter shades indicate feebleness, while the darker forms show physical strength. With these lessons in mind, experts turn to their laboratories and apply in many ways a practical, scientific knowledge both of breeding and of colors.

To the eye, the wings of a moth seem to be covered with minute particles of dust that rub off on the slightest touch. But closer observation shows that they are coated with thousands of tiny scales, that



Female Silkworm Butterfly

overlap one another in the fashion of shingles on the roof of a house. In those are the pigments, that together make the gorgeous colorings.

Nature has designed the colors to make the butterflies almost invisible while they are feeding or resting on flowers or trees, to protect them from their enemies, the birds.

2679



Collecting for Study



Shielding the Young



Pressing the Wings



Marking for Records



Gorgeously Winged Female of the Peacock Moth Depositing Its Eggs on the Tender Leaves of a Tree That Furnishes Food to the Young When They have Hatched

2783 NAVY TESTS GUARD LIVES OF AIR-CRAFT CREWS

To protect the lives of airmen, the navy puts every scrap of material used in building its airplanes and dirigibles to many tests. Hundreds of inspectors are constantly employed in this work and many special machines have been made to insure accuracy. When the great dirigible "ZR-1" was being built at Lakehurst, N. J., every wire was tested by pressure gauges before and after being installed, to insure its strength and that

tanks. Any excess of heat would cause undue expansion of the gas. Government experts also are seeking to produce helium gas in quantities at a low enough price to render it satisfactory for aircraft use. Facilities have been perfected for making the same quality of helium gas that was produced during the World War in limited amounts, at a cost of \$1.500 a cubic foot, for 7 cents a cubic foot. Hydrogen gas costs $\frac{1}{4}$ cent a cubic

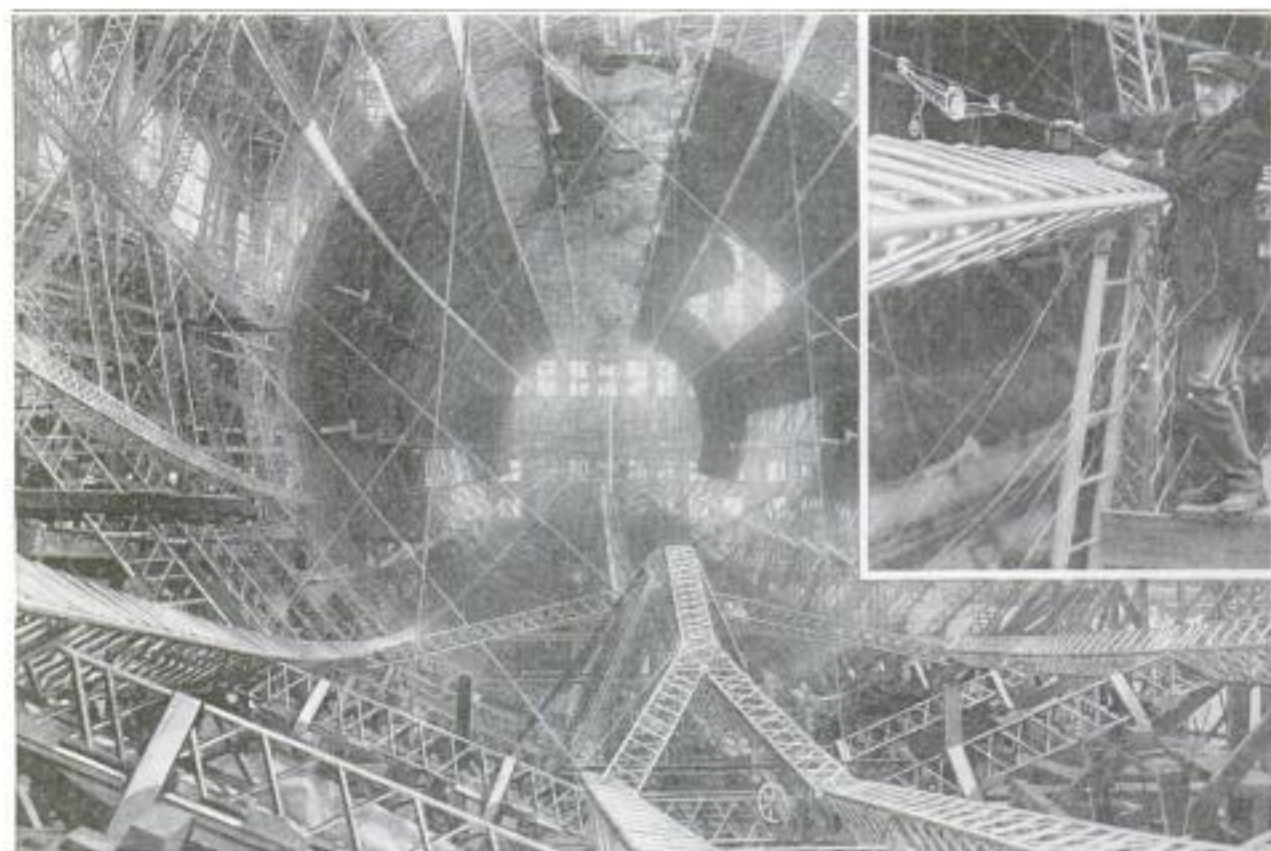

Naval Dirigible being Given Finishing Touches in Preparation for Its First Flight, While Guide Wires are Tensioned to Safeguard Lives of Crew

the tension put upon it was not too great. Chemically treated linen that was stretched over the steel ribs of the craft also was tried in special machines before it was put in place. Realizing that some hidden flaw may result in loss of lives, every effort is made to assure the soundness of the material used. In testing cloth, strips are suspended in a wooden framework and exposed to the weight of one load applied in a lengthwise direction at the same time as four variable loads are also pulling on the same sample in the other direction. An aluminum preparation is painted over the cloth to give it a surface that will reflect sunlight and thus eliminate the penetration of objectionable heat into the gas-storage

foot. Helium is a noninflammable gas, while hydrogen is highly explosive.

CHAIR IS TURNED INTO BED FOR SMALL APARTMENTS

For use in small apartments, where bedroom space is limited, a luxurious chair that may be turned into a full-sized bed, has been made. Concealed from view in the back rest, are the box springs and soft mattress which pull down in a few seconds when it is desired to use them for sleeping. The bottom and arms slide out and support the footboard, giving it stability. Combining the features of both in a single piece of furniture, it results in a great saving of space.

Adams Chair Bed Co.,
8th floor, Republic Bldg,
Chicago.

MOISTURE-PROOF POWDER
IS ALSO SMOKELESS *2808*

Damp-proof, flashless, and smokeless, a powder for use in small firearms and artillery has been developed recently by the army experts. Possessing all the driving power of the old type, it will do away with a great portion of the care taken to keep ammunition dry under conditions of modern warfare. During tests, it was completely submerged in water without harm.

Folding into a small compact package, a baby's chair has been patented recently that may be used as a swing in an auto-

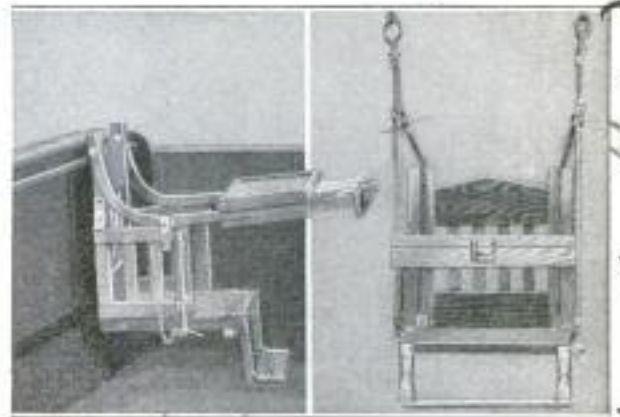

Folding Chair Combined with Swing, for Baby's Use in Auto or at Home

FOLDING CAMP STOVE COOKS
MEAL FOR TEN PERSONS *2869*

When cooking on a small folding camp stove recently invented, the sportsman keeps cool because he is shielded from the heat by a metal plate. The stove, though large enough to prepare a meal for 10 persons, is folded flat when not in use, being an inch thick, a foot wide, and a trifle longer, and all parts are attached so that there is nothing to be lost. Because the screen over the fire is made of a dozen separate sections, it is not neces-

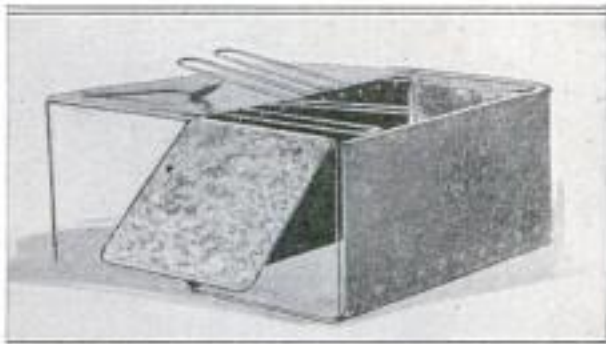

Camp Stove. That Is Large Enough for 10 Persons, but may be Folded into Small Space

sary to lift the entire top when putting in more fuel. Attached to the stove is a metal plate which can be set up as a table top for warming dishes. *2780*

WOOD GLOVES TO PROTECT
HANDS FROM WRINGER

To protect the hands of women who use a wringer, wooden gloves have been made so that the fingers cannot be drawn between the rollers. The gloves fit tightly over the fingers and a double rubber cap with flexible, water-tight finger holes, keeps the water out, preventing scalding. They also enable the clothes to be handled properly, without the usual danger, so that buttons are not torn off or the fabrics injured.

mobile, on the lawn, or in the house. By fixing a hinged wooden arm to the car door, a tree, or between two table chairs, it may be suspended only a few inches above the floor or the ground. It can be used for a high chair, as it may be utilized as such simply by clamping it to the backrest of any ordinary dining-room chair. A small drawer, underneath the part that locks the child in the seat and also serves as its table, holds a knife, fork, spoon, and napkin.

CONCRETE ROAD "BLOWS UP,"
WRECKING AN AUTO *2846*

Due to expansion caused by intense heat of the sun, a piece of concrete road is reported to have "exploded" recently just as an automobile was passing over it, throwing the car into the ditch. Several other similar incidents are attributed to differences in the top and bottom material, resulting in unequal expansion. The force exerted may be so powerful as to hurl broken blocks of concrete into the air, leaving large holes much like those made by charges of dynamite. In one case the upheaval left a gap 3 feet wide in the highway. Brick and wood-block paving, also, have been known to expand from heat or moisture, buckling with a sudden upward movement.

Heat is measured in British thermal units, known to engineers as "B. T. U." One of these is about the amount of heat given off by a match in lighting a cigar.

Van Lengerike & Antoinette
130 S W Abach. Chicago

Cont. Polland. office
Chicago Evening Post
6/21/29

Mr. A. E. Stetwiler
4012 Cottage Grove Ave.
Chicago

Data missing
 U. S. agent. W. B. Fox & Bros,
 396 21 Warren,
 POPULAR MECHANICS

Aermantus + Supreme

2791 **SKIMMED MILK MADE INTO ARTICLES OF BEAUTY**

New York City

Combining beauty with utility, a material is being made from skimmed milk by a process recently brought to the



Articles of Great Beauty and Worth That were Made from Skimmed Milk

United States from England. As it is noninflammable, odorless, and can be drilled, glued, and dyed, it has a multitude of uses as a substitute for ivory, ebony, amber, tortoise shell, horn, and other similar products. Besides, it may be used as an almost perfect imitation of many natural products of great price, among them being Chinese jade and lapis lazuli. A brilliant polish is easily obtained and it can be bent, pressed, and, to some extent, molded, or machined. As it is a nonconductor of electricity, it may be used in making decorative radio and lighting fittings. Also it has been found valuable for ships' cabins, handrails, automobile fixtures, and in the making of beads, buckles, buttons, jewelry, fancy ornaments, cigarette holders, combs, brushes, carriage handles, parts of furniture, pencils and penholders, organ stops, and piano keys.

SICK CURED WITH GASES FIRST USED IN WAR

2790

Deadly gases developed during the war are now being used to cure disease. Grip, colds, and the "flu" are quickly checked by chlorine gas, say army chemists. Mustard gas is being used to combat tuberculosis, while paresis, and other diseases, are being treated with some success with "lewisite," a gas of arsenic and acetylene. This was invented for use by American troops.

FLOATING AIR-CRAFT DEPOT IN MIDDLE OF OCEAN

2666

Linking of the sea, air, and land is seen in a proposed depot, far out at sea where airships and planes may pause for supplies and passengers during transatlantic flights. Under the plan, the stations would be made like floating platforms with masts similar to those of a ship to which lighter-than-air craft might be moored. Anchored in position, but free to swing with the wind, platforms would be provided for the arrival and departure of airplanes plying between the United States and Europe. Such a depot, it is urged, would serve as a place of refuge in case of severe storms, or for emergency repairs or supplies. In addition, powerful lights would be provided for the guidance of sky travelers.

WINDOW WIPER GIVES CLEAR VISION FOR MOTORMEN

2784

Cleaning the window as it swings, an automatic device is being made to give street-car motormen a clear view in stormy weather, thus lessening the danger of accidents. Operated by compressed air, a long arm, fitted with a rubber blade, rests against the window pane and moves in a wide arc across the glass, sweeping away either snow or rain. It is operated by air supplied from a tank underneath the car and is similar to an automatic

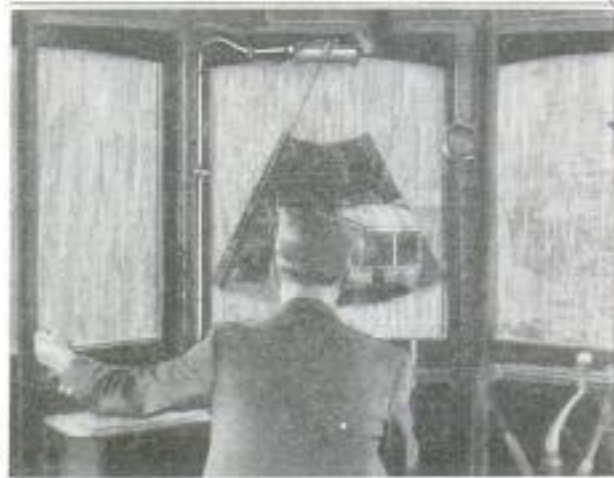

Automatic Window Cleaner, Operated by Air, Gives Motorman Clear View in Stormy Weather

automobile-windshield cleaner now in general use. The cleaner is expected to reduce accident claims.

Grief, poverty, and business failures are given as the chief causes of 80,000 suicides in Germany last year.

Erinoid, Ltd., Lighthell Mills, Stroud, Gloucestershire, England.

Holberch Auto Specialty Co. 67914 Lake Ave. Cleveland Ohio

Revised 2nd Edition Chicago 6/15/23



Battleship Designed to Serve as a Supply Station in the Middle of the Ocean for Transatlantic Aerial Voyagers, and as a Carrier for Dirigibles and Airplanes

2706 MAKING FLOOD OF MONEY KEEPS MINTS BUSY

With the value of paper money so low in many European countries that sometimes a basket full of it is needed to make an ordinary purchase, printing presses and engravers have been known to work overtime to turn it out. The material on which it is printed does not last long under the wear of handling, and the sup-

ply must be replaced regularly. As the face value becomes less, a greater amount is necessary, requiring more speed on the part of the printer. Throughout the countries of North and South America plenty of gold, silver, and copper coins are in the hands of the people, although many banknotes and bills are to be seen.



Mexican Government Mint Working Overtime to Produce Sufficient Silver and Copper Coins to Supply the Needs of the Citizens, Who Dislike the Use of Paper Money

2806 NATURE'S TRAP YIELDS BONES OF PREHISTORIC MONSTERS

Death traps of nature, as the asphalt pits of a western state are known, have given up skeletons that have enabled scientists to add to their knowledge of prehistoric animals. Ages ago strange birds and beasts that long since have vanished, in seeking to cross what appeared to be solid ground, would become mired in the sticky substance. Floundering about in an attempt to pull themselves free, they would attract the attention of an enemy. Both then would become trapped, and, in time, would slowly sink from sight. Thus nature has provided scientists with a record, although perhaps incomplete, of creatures that no longer exist. Working in the pits, experts have uncovered many well-preserved skulls of the saber-tooth

tiger. The teeth, from which the animal was given its name, extended about 5 inches below the lower jaw. In those pits, many skulls have been found, among them that of another member of the cat family, which measured 19 inches through the cheek bones. Skeletons of the giant sloth, buffalo, horses, and wolves also have been taken from the deposits.

2777 STRAPS ON STEPS OF AUTO KEEP LUGGAGE SAFE

To secure baggage on the running board of an auto, small reels, containing straps, are fastened to the bottom of the step. When not in use, the straps are wound up in the reels, which protect them from mud and water. Besides, they leave the running board clear and are always ready when wanted.

Vertical handwritten text on the right margin: Alliance, Chicago, Wm. H. ... Co., Windsorfield, Wm. H. ... Co., Chicago Agent.

News & index June 21, 1923

Chicago Motor News June 1923 Copyrighted material

New York Times
June 21, 1923

San Antonio

AIR MADE FRESH BY OZONE SUPPLIED BY MACHINE

2825

Machine-made ozone, that invisible quality in the air that gives it freshness and life, is being used to aid in solving ventilating problems in schools and other places where large numbers of persons are brought together. Breathing robs the air of its healthfulness. Ozone, which is "concentrated" oxygen, supplies that element. By recent experiments in two schoolhouses of equal size, investigators determined that by generating this substance by electric motors and adding it to the air supply, health is guarded. In schools where the regular system of ventilation was employed, absences because of illness were three times as great.

2797

WOMAN PAINTS STUFFED FISH SO THEY APPEAR ALIVE

Painting every spot, stripe, and fin of stuffed fish in colors rivaling those of nature, is the work of a woman scientist employed by the government. When placed in exhibition jars, the specimens outdo their living brothers in beauty. In



Woman Artist Who Makes Drawings of Fish and Other Water Creatures for the Government

addition, this artist makes drawings of almost invisible water creatures magnified many hundred times, and paints shells, queer dwellers in the ocean depths, and specimens of deep-sea life.

Ⓢ Weighing 20¾ carats, a diamond of a rich brandy shade, has been found in an African mine. It is said to be the largest of its kind in the world and is valued at 50,000 dollars.

TRAVEL CASE KEEPS CLOTHES FIT ON LONG TOURS

2794

Smart in appearance and easily handled, a travel case is being made with special compartments for everything needed by



Specially Designed Traveling Kit with Compartments to Keep Clothes in Good Condition

the traveler and special hangers to keep two men's suits in perfect press. Covered with black-enameled canvas, with reinforcement trimming strips of tan leather, the inside is lined with black-and-white-checked linen. Brown straps hold the different articles of wearing apparel in place.

Though smaller than many suitcases, it packs systematically, in specially designed compartments, a dozen collars, 12 ties, the same number of handkerchiefs and hose, seven shirts and undergarments, two pairs of pajamas, a bathrobe, and a pair of shoes.

Owing to the systematic way in which everything is stowed away, and to the shape of the carrier, clothes are kept in perfect condition.



Wm. J. Winfield Machinery Co. Marshall Field & Co. 7th St. Dept. Chicago

Done by Mrs. E. Bennett Beecher for National Museum & U. S. Bureau of Fisheries

100
2677

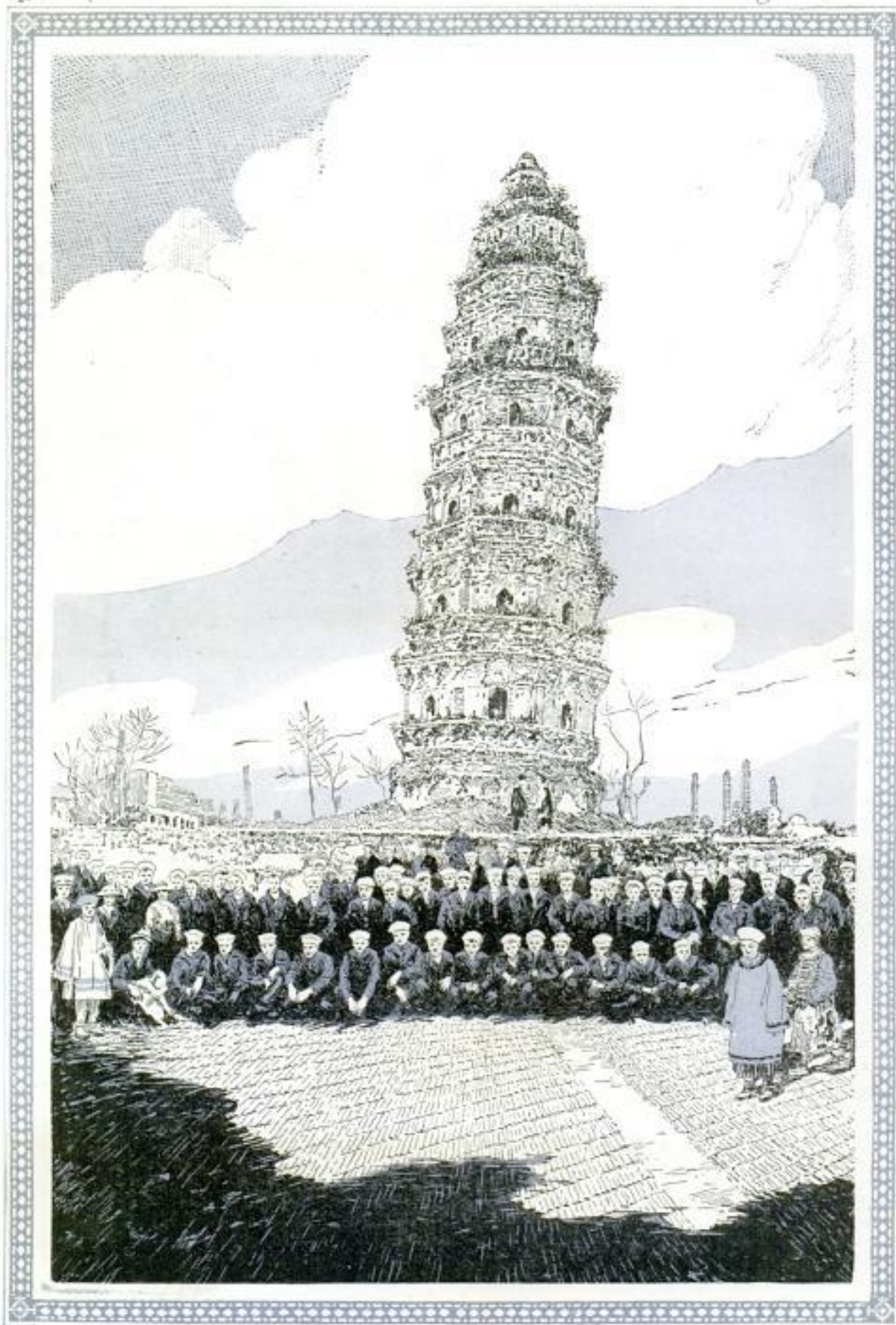

Pagoda, Known as the Leaning Tower of China. That Houses Strange Idols and Treasures of Painters' and Carvers' Art Representative of an Ancient Civilization

MYSTICISM OF THE FAR EAST IS BUILT INTO PAGODAS

In Asia, where life is a never-ending drama of contrasts, a strange blend of shops, slums, and palaces, out of which rise, like tall, tinted flowers, numberless pagodas, blue-tiled as the sky above and capped with gold, stand as monuments to a civilization that was old before Rome was born. In their shadows kings, khans, emperors, empresses, and priests have feasted and laughed and whispered and died for a thousand years. From walls 14 miles long and 100 feet high so that good spirits, who all fly at night at the 100-foot level, may not be inconvenienced in getting into Peking, may be seen the "Little Tired Pagoda" that lived far away in the north until it started to walk to the city, but grew weary just outside the gate of its dreams. Near by is a tower with a bell that harbors the soul of the maker's daughter, who jumped into the blazing metal so that her father should be saved from the emperor's wrath, leaving her embroidered shoe in her nurse's hand. And, "Hai!" say the mothers of Peking, as a low moaning follows the deep boom of it, "Hai, there is Ko Ngai who cries for her shoe!"

2835

ELECTRIC LAMP KILLS FLIES, MOTHS, AND OTHER PESTS

To kill flies, moths, and mosquitoes, an electric lamp has been made that takes advantage of the strong attraction light

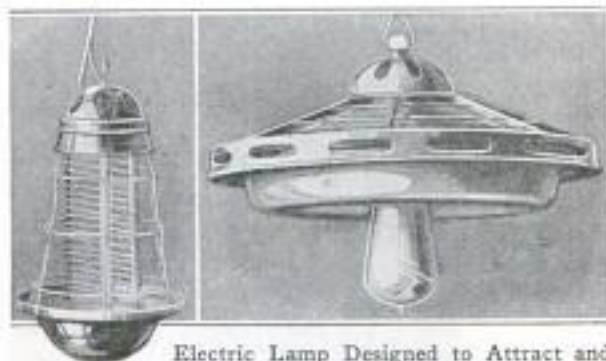

Electric Lamp Designed to Attract and Kill Insect Pests and Retain Them

possesses for these and other insects. The device is made in several forms, each providing a container to prevent the dead insects from falling to the floor. When filled, the trays are easily removed for cleaning. Fluttering about the hot globe until they come into contact with it and are killed, the insects are caught in the container beneath as they fall. The trap does not interfere with the illumination.

Svedish invention

2820 FEAR OF KNOTS IN TIMBER CAUSES MILLIONS WASTE

Knots have little effect upon the carrying capacity of timbers, according to government experts. Tests are said to have proved that builders in the past have

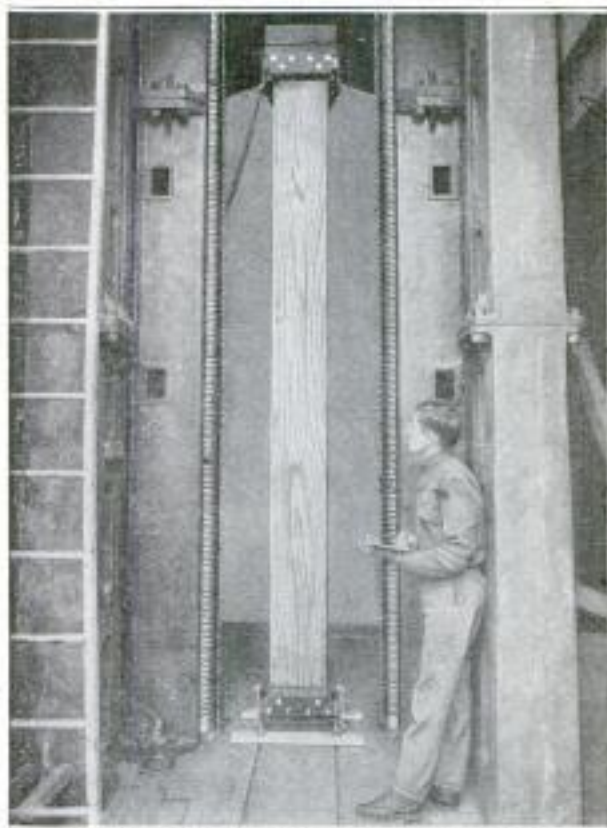

Giant Testing Machine, That Exerts Great Pressure, Determines Strength of Heavy Structural Beams

wasted millions of dollars by excessive use of lumber in underestimating the strength of wooden columns. For instance, a piece of southern yellow pine, 30 feet long and a foot square, will hold as much as 432,000 pounds, while the same-size column of Douglas fir will sustain a maximum of 406,300 pounds. Two-foot chunks of wood were used in the knot experiments that are said to have demonstrated that those imperfections have little relation to the column strength. Forty-five feet high and weighing 150,000 pounds, the machine used in the research is powerful enough to exert a pressure of 1,000,000 pounds. Pressure is applied by two vertical screws, driven by a 5-horsepower motor. The pressure exerted is measured by a weighing beam, after the fashion of an ordinary pit scale.

For scouring and cleaning aluminum dishes, cakes of soap mixed with steel wool are being made.

Sears & Roebuck, Chicago

Forest Products Laboratory Madison Wis.

PASSENGER AIR LINERS HAVE PRIVATE CABINS

With furnishings equal to that of the best hotels, the de-luxe models of air-planes for service between Berlin and

London have been completed, and pas-sengers are now passing through the air between the two capitals with all the comforts of home. Though not as large as those on ocean liners, the airship cabins have all the appointments to be found at sea. It is estimated that sav-ing of time in the trip between London and Berlin by air makes the trip actually cost less than it does by the land and water route.

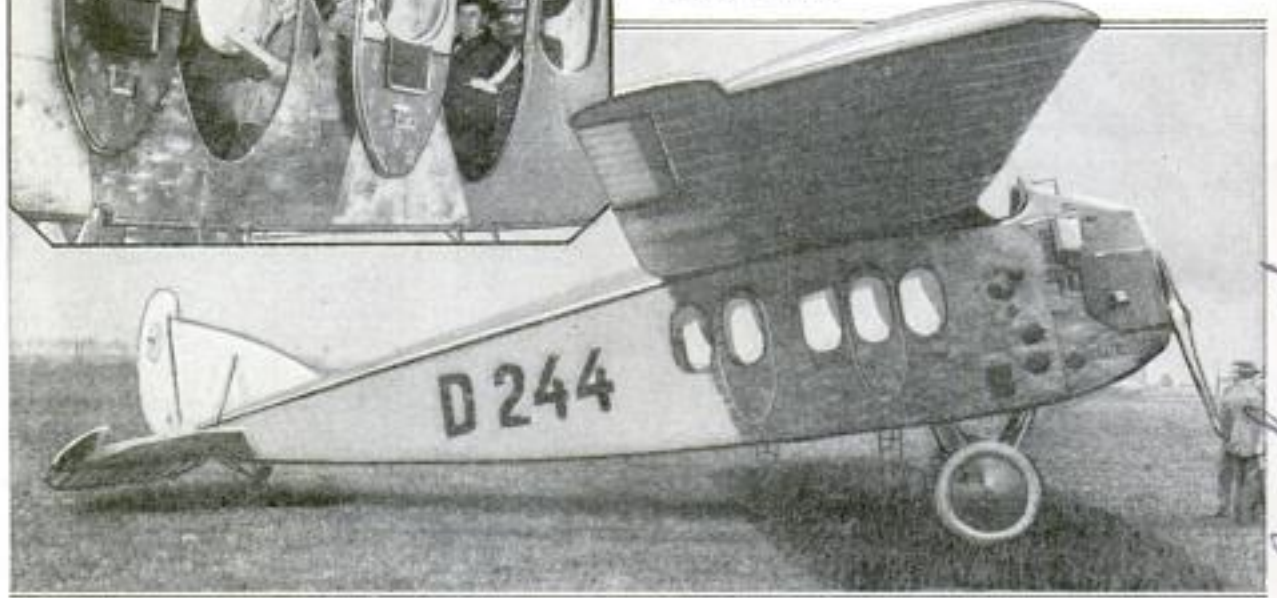

Passengers in Cabin of First Passenger Plane to Run between Berlin and London: Though Service in Europe Started Early after Armistice, the German-British Route was Not Opened Up until Recently

DOT OF LIGHT TELLS TIME FOR PHOTO EXPOSURE

By turning a scale until a dot of light is seen, the exact time and shutter opening for taking a photograph is given on



an expo-sure meter so small it may be slipped into the vest pocket. No figuring is neces-sary, and nothing is left to the judgment of the user, as the device is almost automatic. It is held between the eyes, and the light and scale are turned until a blue spot is seen on the glass. The figures at the top then give the time for the exposure.

Complete with instruction card & leather case - \$2.50.

HELICOPTER STAYS IN AIR FOR FIFTEEN MINUTES

Rising 20 feet from the ground and hovering in the air for 15 minutes, a British helicopter is declared to have proved a success in recent tests. Although the details were closely guarded by the government, it is known that the machine carried passengers and a "military load" weighing 1,000 pounds. Efforts will be made at once to adapt the craft for lateral flights as well as vertical.

Dr. W. Louis Brennan,

COLD ROBS FROGS OF CROAK

Thousands of croakless frogs are marketed annually by a man in a middle-western city. He rears and fattens them in his back yard, in water-filled concrete trenches. By fitting the ditches with a refrigerating plant, he fools them into believing that it is winter and thus stops their croaking. New stock is obtained from near-by creeks and marshes.

Emil Neuenfeldt, Ashkosh - Wis.

2865 Bass Camera Co. 109 N. Dearborn Chicago

England
Warborough

2761

2857

Copyrighted material

Detroit News
June 26, 1923

Cloning Infg. Co.
1375 W. Lake
Chicago

PLANE REFUELED IN MID-AIR THROUGH RUBBER HOSE 288

Refueling an airplane in the air has been successfully accomplished. It was done in two minutes while two planes were rushing along, one above the other, at a speed of 90 miles an hour. Flying 40 feet above, the supply craft with its load of gasoline dropped a steel-wire-incased rubber hose to the one beneath it, through which the fuel passed into that machine's tank. Because of the hazards, the feat was not attempted until after the airmen had practiced it many times. A few drops of gasoline on the hot exhaust pipes might have resulted in a disastrous explosion.

AUTO LIGHTS UNDER FENDERS REMOVE STRONG GLARE 283

By having all of its rays strike directly on the road ahead, an automobile lamp attached by a single bolt to the underside of the front fender inside the wheel, does away with blinding glare of ordinary high-powered headlights that frequently annoy those driving at night. Its shaft of light, thrown for 300 feet, is low enough to avoid the eyes of approaching motorists and cyclists, and clearly shows the road from both directions, preventing many accidents and making dimming unnecessary. A bracket allows the level of the light to be raised or lowered with ease.

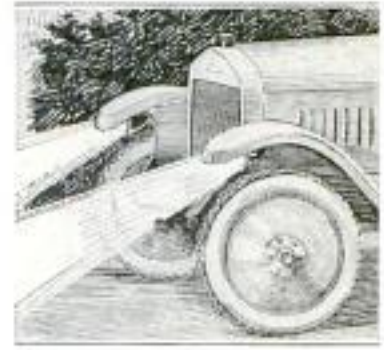

X-RAY USED FOR EIGHT HOURS IN CANCER TREATMENT 282

In seeking a sure cure for some forms of cancer, German scientists have applied a powerful X-ray to the patients for continuous periods of eight hours. It is claimed that this long exposure kills the germ cells, while the healthy tissue remains unaffected. Only one treatment is given, during the length of which the sufferer is kept on a surgeon's table while the physician watches from behind a screen. Lead glass, or shields, that the rays will not penetrate, afford protection for the attendants. A current of 200,000 volts is employed in the treatment.

With a mixture of half sawdust and the remainder chalk and chemicals, a scientist is reported to have made artificial wood by subjecting the combination to heavy pressure. It can be used as ordinary lumber, and is said to be as tough as oak, and rot-proof. It also withstands more heat than real timber.

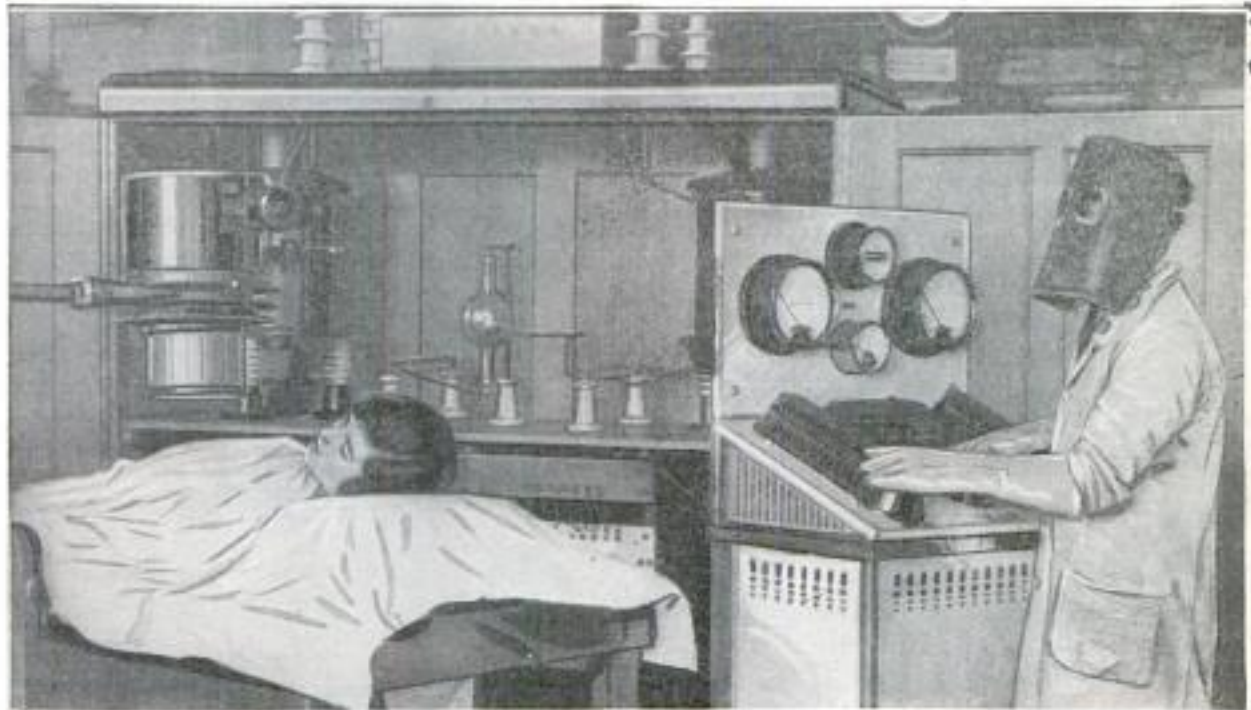

Cancer Victim being Exposed to the Action of High-Powered X-Ray during Single Eight-Hour Treatment, Used to Combat the Disease by Scientists in Europe

Prof. Wintz
Earlanger, Germany

N.Y. Times - June 26.
Inventor - Scientist named
Kullermond. Christiania

**BOAT BUILT OF OLD SCRAPS
IS MOVED BY GAS**

2676

Curious-looking junks in Chinese ports are rivaled by some of the boats plying the River Po, between the Alps and Apennine mountains, in northern Italy. One such craft was built by a fisherman from metal and boards found in a scrap heap. While in appearance it is crude, a small motor pushes it along at a speed that seems a rapid pace in comparison with the boats moved by oars. As the course of the Po is marked by sand bars and shallows, fishermen are kept constantly on the alert. At some points though, where high banks confine the channel, its bed is above the surface of the surrounding land. From farms along the river the roughly made boats present an odd appearance as they move back and forth with their cargoes. There are still evidences of canals and roads built along the winding Po in old Roman days, but save for the occasional use of an engine, there is little difference between the types of boats used on this stream then and now.

**BLOND RACE FOUND IN SAHARA
BY DANISH SCIENTIST**

2803

Preliminary reports from a Danish scientist, now on his way home from an expedition to the central and western parts of the Sahara Desert, tell of his visits among the Tuaregs, whose ruler has his headquarters on the Ahaggar mountain plateau in Morocco. In the villages of these nomadic Arabs he found a blond race, of whose existence unconfirmed tales have been current for a long time. This people bears every mark of being a remnant of some northern tribe that may have invaded Africa long before historic times. The scientist describes them — both men and women — as possessing great beauty and being very careful of their fair complexion. The men, he says, wear dark veils for this purpose, use rouge and powder, and bedeck themselves with ornaments. The women, on the contrary, go unveiled and do not seem to be as vain as the men. Agriculture, goat and sheep herding are their occupations, but the women do not work, having black servants even for household duties. They live in mud huts and are fond of "parties," at which music, singing, and storytelling form the chief entertainment.

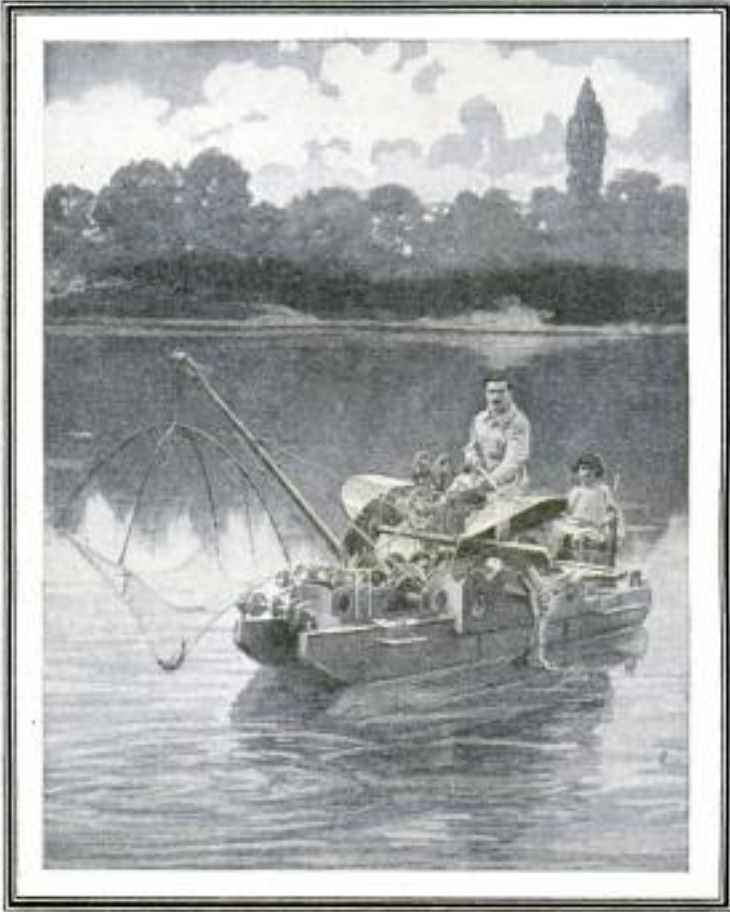

Strange Boat, Built from Scraps Found on Junk Pile and Propelled by Small Motor, Used in River-Fishing Trade

**SWIMMING POOL IS WARMED
BY A HEATING PLANT**

By the installation of a large heating system, a mid-west city has solved the problem of keeping its municipal swimming pool sufficiently warm for bathing even on cool days. In a recent test, the plant raised the temperature of the pool 11° in 10 hours. As a result, it is expected that the swimming season will be considerably lengthened.

☛Cancer is not yielding to research and radium treatment, according to figures compiled recently by an insurance company. The mean average of cancer deaths, throughout the United States, according to this report, is more than 90 per 100,000. Eighty-five per cent of those are persons over 40 years of age.

Suggested heater made by
Warner Corporation
East Chicago, Ind.

At Glen Oak Park,
Peoria, Ill.

**VICTIMS OF GAS ARE SAVED
BY RESPIRATOR MASK**

To save the lives of persons overcome by gas, a mask has been made so that a constant stream of fresh oxygen is fed into the lungs and then exhausted into the air, the process being similar to that of breathing.

Lung and heart specialists, after tests in France, declared that the apparatus seldom will fail in bringing an asphyxiated person back to life, unless the victim is already dead.

Although chiefly intended for use in factories, where the danger from suffocation is often encountered, as in illuminating-gas, carbon-dioxide, and electric-battery plants, the device also is being used in mines and on beaches.

Prompt application of artificial respiration is necessary when a victim is stricken. First aid is of great help in retarding the poisonous effect of the fumes on the blood. This usually requires stretching the patient flat, rubbing the spine, and moving his arms and legs vigorously until an oxygen tank can be applied.

Under the method now in general use, however, inhalation and exhalation by the

patient is done through a single connection with the tank. The result is that, when pure oxygen enters into the lungs by inhaling, it becomes at once stale by coming into contact with the poison in the patient's system. This impure air returns and mixes with pure oxygen by the action of exhalation, and is taken back and forth into the lungs.

This is prevented in the new apparatus, as the mask is fitted with two valves and a pneumatic rubber cushion, attached to the face by a strap. The cushion creates a vacuum, preventing the oxygen from leaking through facial irregularities. One of the valves is connected with the oxygen tube, while the other discharges impure air thrown off by the action of exhalation. Both valves open and close automatically. While the patient inhales, the first valve opens and lets the oxygen flow into the lungs, at the same time allowing the other one to close, thus shutting off outside air. In exhaling, the former closes and the latter opens to let impure oxygen escape. Since the victim breathes nothing but pure oxygen, the chances of reviving him are increased more than 50 per cent, it is claimed by those who have conducted many tests on victims of gas and smoke.

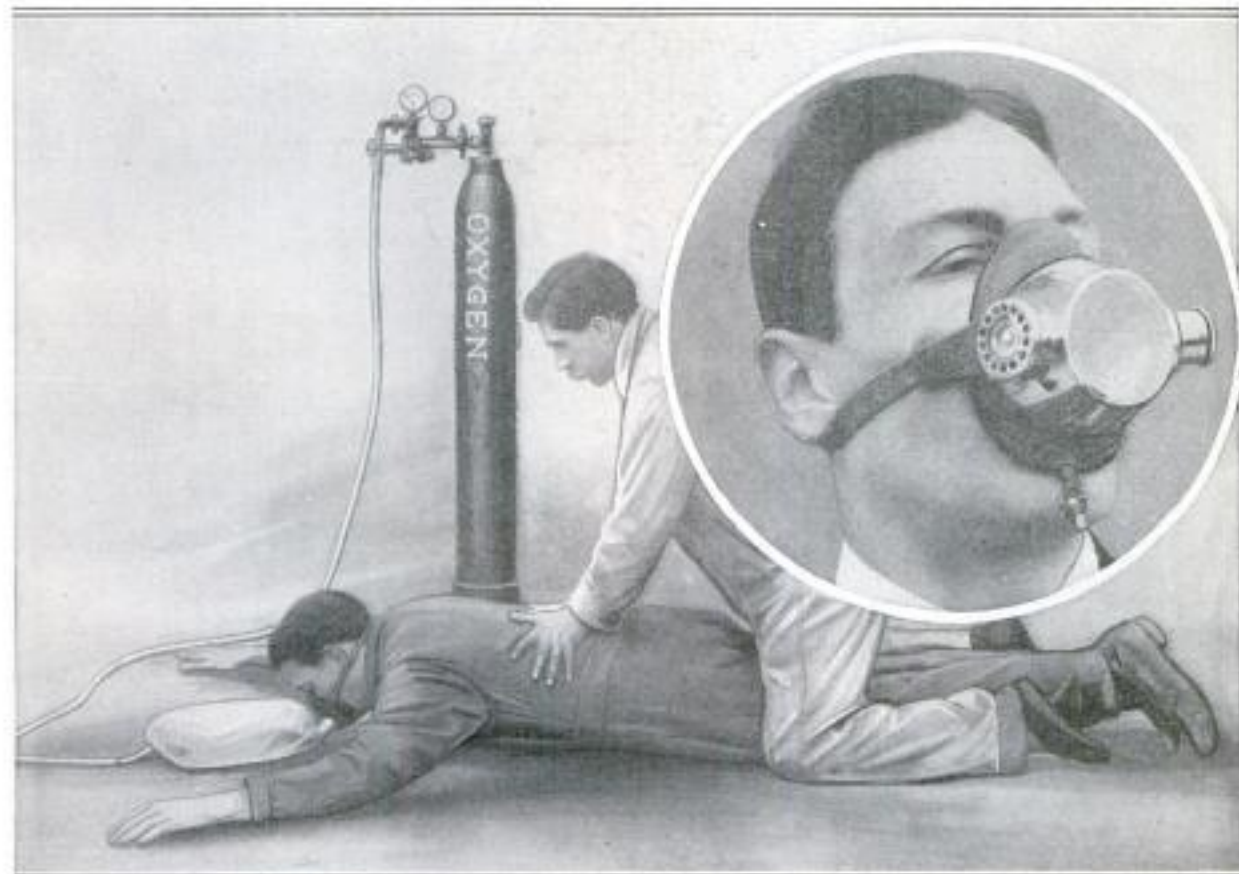

Mask Used to Save Lives of Persons Overcome by Gas: Insert Shows Valves through Which Oxygen Enters and Impure Air is Discharged from the Patient's Lungs

2724

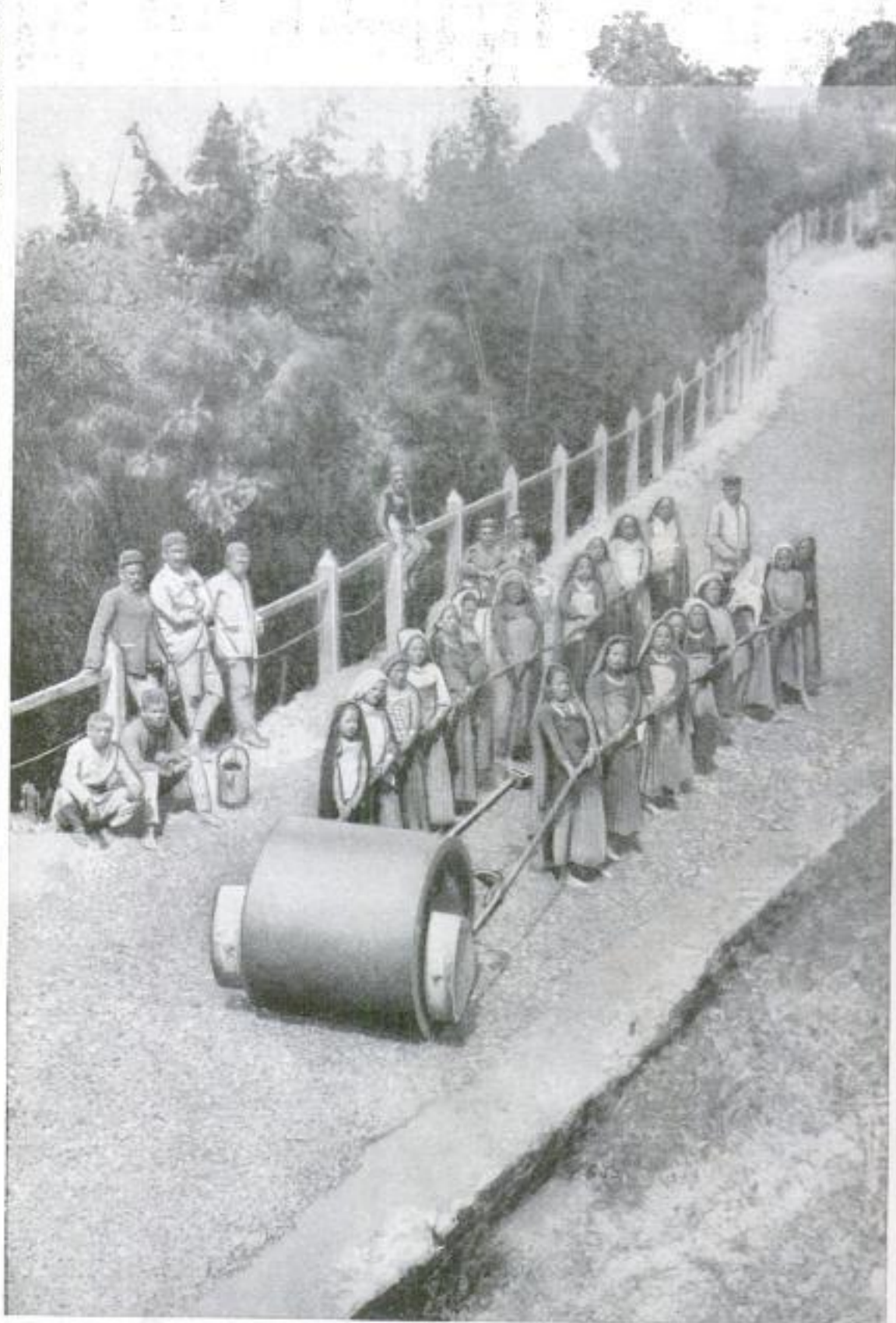

Women of India, Heavily Garbed, Working on the Mountain Roads of Northern Bengal, Hauling a Heavy, Crudely Made Roller up a Steep Grade While the Men Look On

COPYRIGHT, UNDERWOOD & UNDERWOOD

TRADITIONS OF INDIA HOLD NATIVES IN SLAVERY ²⁷²

Bound by traditions handed down for countless generations, the natives of India prefer the methods of the past to the comforts of modern civilization. Held in check by their religious beliefs and the caste organization of society, they battle against every effort to introduce labor-saving devices. In one instance, the effort of an English company to install an incline railway to carry passengers and freight up a steep height almost caused a revolt. "What can we do if there is nothing for us to carry?" demanded the natives, who had been acting as beasts of burden. Even after months of argument, they remained unconvinced that the object was not to rob them of their means of livelihood, and so today the road, that was built despite their protests, carries only passengers, while freight is still transported on human backs. Women are often used to carry heavy burdens and in the making of roads. The men seldom engage in manual labor.

2862

TOY DUCKS SEALED IN GLOBE HALF FILLED WITH WATER

For the amusement of children, celluloid globes are being made in which toy ducks float about. The balls are half filled with water and are decorated in fantastic tints and flowery figures. They are sealed in the middle and will stand considerable abuse without breaking or leaking. They come in many different colors and some have fish inside instead of the ducks.



Marshall Field & Co., Chicago

MOVABLE JOINT WON'T LEAK

2880

Having but four parts, a flexible pipe joint has been made of brass. The greater the pressure of water, air, or gas on its rubber seal, the tighter it becomes and the less the opportunity for leakage. As the seal is inflated and not expanded, it automatically takes care of either high or low pressure.

Fiero Supply Co.,

201 Merchants Exchange Bldg., St. Louis, Mo.

Capt. George H. Paul
90 W. Ellsworth
2851 Old Chicago
407

OLD MORMON CASTLE KEPT AS FRONTIER-DAYS RELIC

One of the few remaining relics of the vanishing frontier in Utah, the famous old Windsor Castle, built many years ago

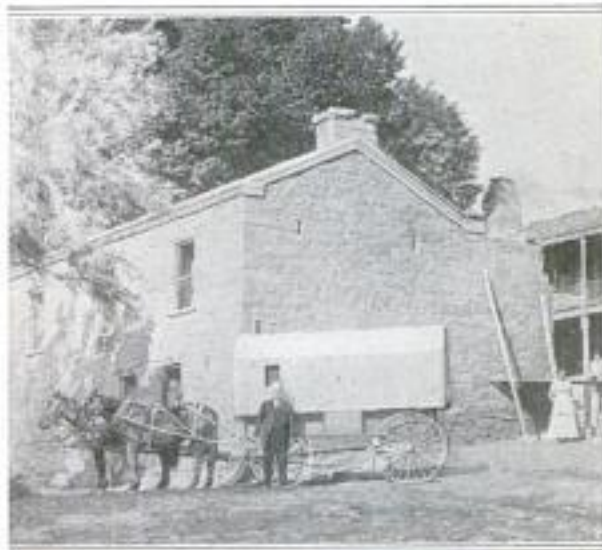

Mormon Castle, Relic of Vanishing Frontier, That has been Marked as Historical Site

by Brigham Young of the Mormon Church, is to be preserved. This substantial structure of sandstone was in reality a fortress, strong enough to withstand a siege. Loopholes were provided in the walls at strategic points. In the valleys round about were quartered vast herds of cattle, and naturally the castle was the headquarters for the interests of the church. Now the tract of land on which it stands has been set aside by the government and will be known as the Pipe Spring National Monument. All features of historical interest will be preserved.

286A

TWO WHEELS SHARPEN KNIFE AND SCISSORS BLADES

Sharpening of knives and scissors is made easy by a device consisting of two grinding wheels placed close together on a small holder.



The blades are moved back and forth between the two, giving them a razor-like edge. Protection is afforded for both hands as the blades cannot slip while being ground.

Van Lengerke & Antoinette
100 Wabasha
Chicago 33

286 TURNING "IVORY NUTS" FROM TREE INTO BUTTONS

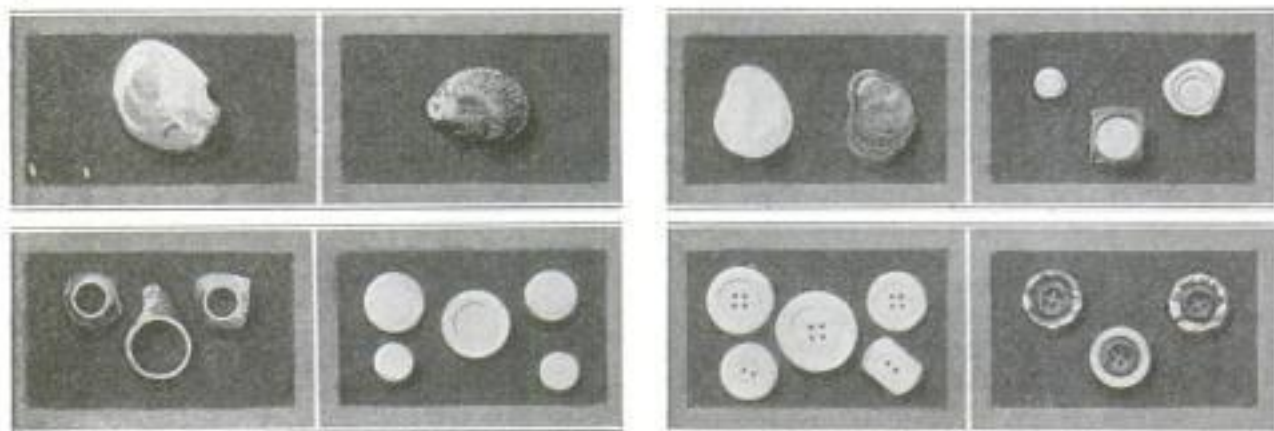

Buttons are made from the "ivory nut" of a palmlike tree growing along river banks in South America and Panama. After being dried, the shells are cracked and the kernels cut into slabs. Sometimes tons of nuts must be cut up before there is even a small supply of pieces large enough for overcoat but-

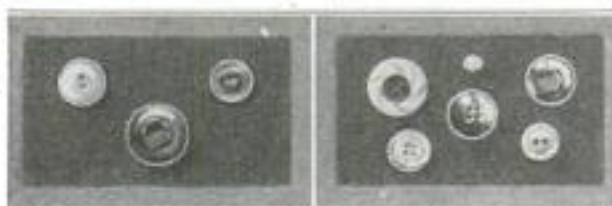

From Left to Right, the Slow Evolution of an "Ivory Nut" into Buttons

tons. A turner makes blanks of them for various-sized buttons and then holes are drilled by machine. To open the pores for coloring matter, they are first softened in water and then dyed and polished by ivory waste and chalk in a moving cylinder. Bright, dull, satin, and polished finishes are given.

285 2 LIGHTS MARK STOLEN AUTO AS WARNING TO POLICE

As a warning to police that the car has been stolen, lights on the front and rear license plates have been made to burn when the car is in motion unless they have been shut off by the owner's key. By pressing a pedal at the driver's seat, the ignition system is locked, a



Red Cross over License Plate That Is Warning the Auto is Stolen; Only Owner's Key Removes It

large red cross appears over the license plates, and these are each marked by two small lights. The cross cannot be re-

moved until unlocked by the driver's key. If a thief breaks the motor lock and drives away, the flaming red marks over the license plates give a silent alarm.

2921 GROUND PHONE TO HELP SAVE THE LIVES OF MINERS

From a war-time instrument, the geophone, a sound-ranging apparatus, has been developed by government experts into a peace-time device that may be used effectively in locating entombed miners, mine-fire areas, and to reduce accidents resulting from blasting. It was first invented by the French to detect enemy underground operations. Later improvements have increased its sensitiveness, and tests have indicated that under certain conditions it will register the pounding of a sledge hammer through 3,000 feet of solid rock; 2,000 or more feet through coal; 500 feet through mine "cover," and 300 feet through clay. Built on the principle of a seismograph and mechanical in action, the machine consists of a flat iron ring, from the center of which is suspended a lead weight fastened with a bolt through two metal disks. A rubber tube conveys the vibrations to the ear.

Geophone.

Auto Lucerne Lock Corp. New York
138 W. Broadway, New York

July 1, 1927
New York Times

2905

BEHIND THE SCENES IN A GREAT MUSEUM



Priceless Treasures of Art and Nature Brought from All Parts of the World are Prepared by Skilled Artists and Then Carefully Guarded

By J. T. EDWARDS JONES, *Editor of Publications,*
Field Museum, Chicago

HIDDEN away behind the priceless treasures to be found in a great museum are the workshops of the skilled artists who restore to lifelike form specimens of strange beasts and birds gathered from all parts of the world. While hardy adventurers are risking their lives on jungle trails and at outposts of civilization gathering material, these scientists, working with microscopes and strange tools, reconstruct a prehistoric monster from a single bit of fossil, and give a semblance of reality to a dried piece of fur that would almost deceive Nature herself.

Tawny lions, striped tigers and zebras, spotted leopards and jaguars, giraffes, black, brown, grizzly, and white bears, antelopes of all sizes and colors, buffaloes, and foxes of many hues, are represented in a veritable Noah's ark of exhibits gathered together by explorers so that wild life may be studied in the midst of civilization and without the hardships of perilous trips to strange lands.

Under the skilled hand of the hidden artisans, these treasures in furs, made to assume the appearance of life, are shown in their natural surroundings, stalking their prey, guarding their young, engaged in mortal combat with an enemy or in the endless search for food. Animals seen in a zoo generally are poor prisoners who have adapted themselves to a hope-

less level of an inane and artificial existence, while those in a museum have been so skillfully restored that they actually seem to live and breathe, with all the sleek strength and beauty of life.

To obtain these results requires that the worker be something of a wizard, an artist, a mechanic and, of course, a zoölogist. While the methods employed are generally those of a sculptor, the modern taxidermist is rigidly confined to the exact lines laid down by nature. Absolute accuracy in every detail is required, nothing being left to the imagination. In form, color, the arching of a neck, the raising of a cautious foot, and in the background, bits of trees and brush, all as nature, and not man, planned it.

First comes the tanning and preparation of the hide, an art in itself. Machines known as "kickers," consisting of two huge, mechanical legs worked by electricity, dance a jig on the tough pelt until it is softened and turned into leather. It is then placed in a cleaning machine, containing a quantity of sawdust, and revolved until it is thoroughly cleansed. Then it is placed in storage, where it remains until the time when the taxidermist is ready to resurrect the animal to an appearance of life.

The old-fashioned process of "stuffing" is a thing of the past, and the replacement in the older museums of specimens

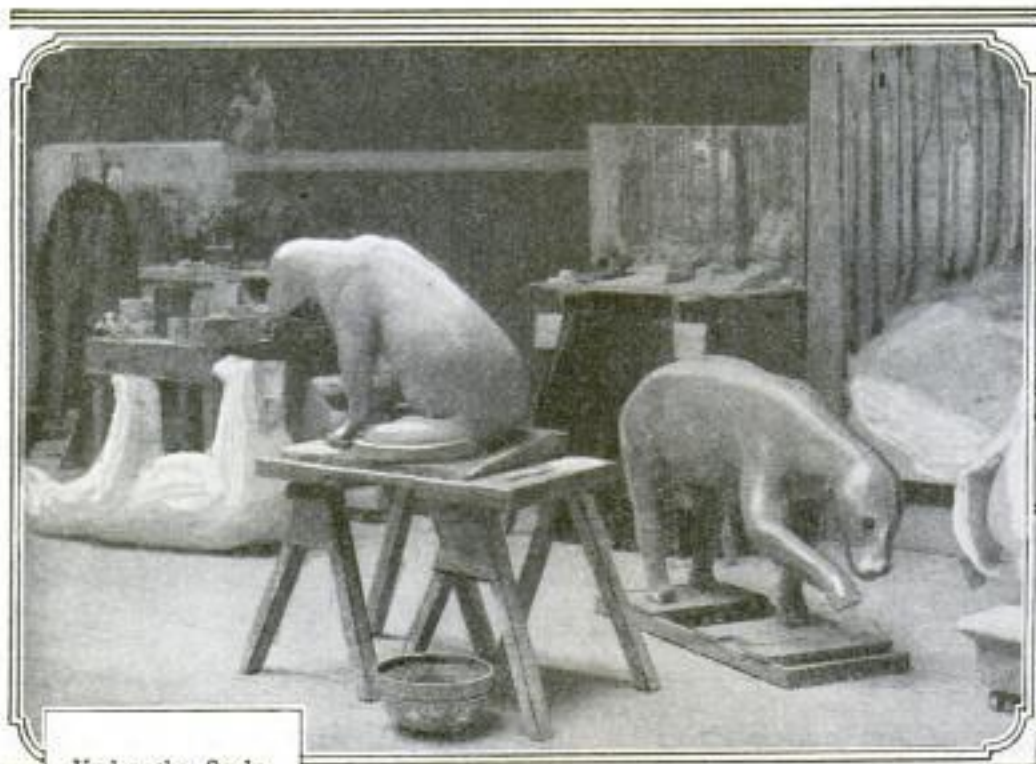

Under the Sculpturing Hand of the Taxidermist the Plaster Mold Grows toward the Animal's Natural Form



Papier-Mâché and White Cement Supply the Ferocious Countenances That Glare from Glass Cases at Museum Visitors



Selecting Eyes from Among Thousands to Fit the Expression of the Finished Specimen Before It is Exposed to Public View

by the new process represents a considerable item of annual expense. Like a sculptor, the modern taxidermist generally experiments and crystallizes his ideas into a small clay model before he ventures on the actual work. Having accomplished this, he prepares a "core" on which to model the beast.

If available, the leg bones and skull are used to insure exact proportions. If not, he builds up the clay body in characteristic attitude to measurements taken in the field. After the model is finished, it must be reproduced in some lighter and stronger material. For this purpose, a plaster mold in several pieces is taken

and a cast made by building it up, layer by layer, of burlap and plaster, or fine wire netting

the services of the artist who adds realistic accessories in the form of vegetation, trees, and rocks which merge into the background. Having thus secured a natural scene, the case is ready to take its place in the exhibition halls.

Bird taxidermy is an art by itself. The skin is first relaxed by a thorough damping, and then cured with chemicals. An artificial body is made of cork or wood wool with a neck of wrapped tow fitted into the skin. The head, wings, and feet are securely wired, and the bird made to adopt the position it would assume in life. This part is purely mechanical, the difficulty lying in the proper adjustment of the feathers, the pose, and the expression.

In the case of reptiles, a cellu-

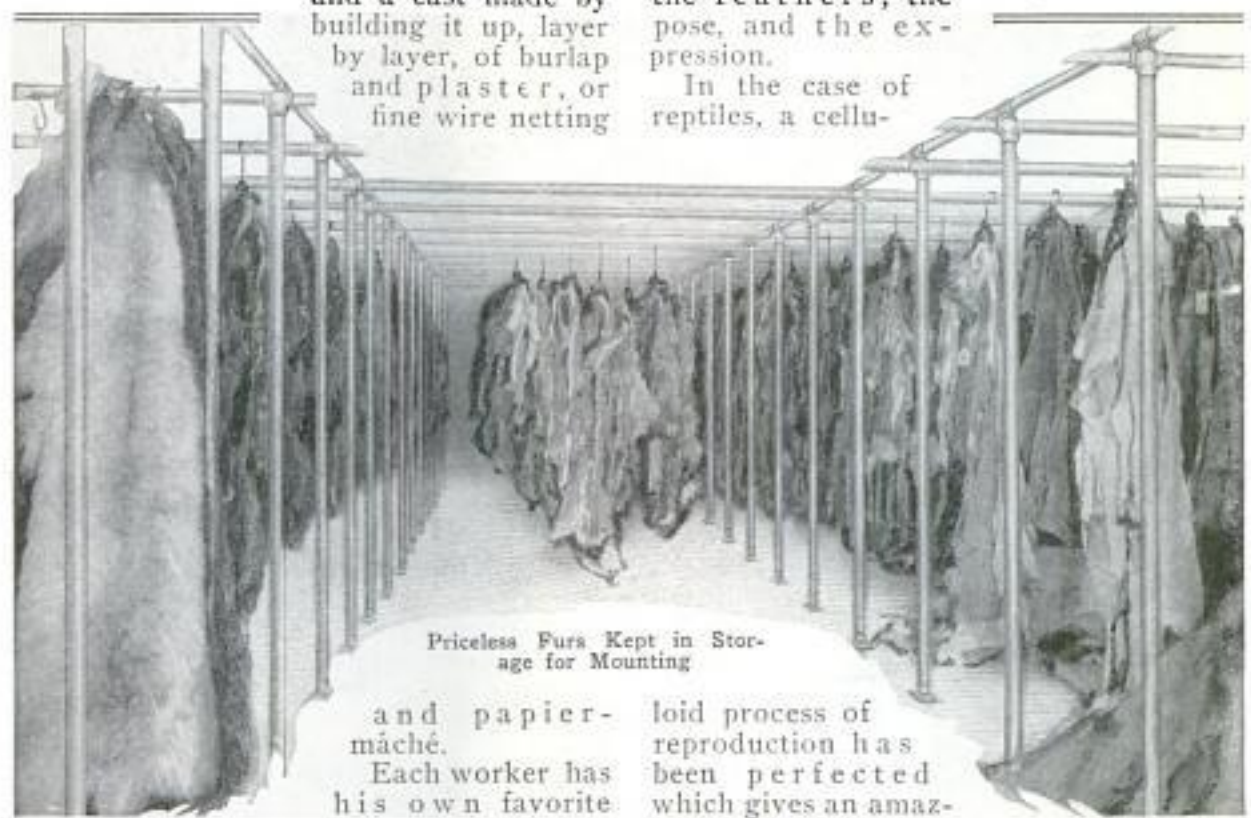

Priceless Furs Kept in Storage for Mounting

and papier-mâché.

Each worker has his own favorite methods, but all

result in a light, strong duplicate, called a manikin. Over it, the skin, that first has been poisoned against moths and vermin in a sealed room, is drawn and permanently adjusted. Lastly, the muzzle and nostrils are carefully molded in papier-mâché and the eyes are set.

It now remains to mount the animal, to do which a study must be made of its anatomy, habits, and characteristic attitudes in the wild state. A klipspringer assumes its natural poses only on rocks. A sloth cuts an impossible figure apart from its beloved tree, and bears, for instance, must be represented as they really appear on their native heath, with a proper background.

For this work the taxidermist requires

laid process of reproduction has been perfected which gives an amazingly lifelike appearance to the models. While the details of the process are kept secret, the plaster mold plays a prominent part in the operation. The result is a practically unbreakable model.

Fishes placed in the exhibits also are plaster casts, taken from molds. Usually the natural fins and tails are utilized. The greatest difficulty is in the coloring, the artist being forced to reproduce the infinite shades and colors of nature.

After the specimens have been placed on exhibition, they are guarded as carefully as the crown jewels of a European kingdom. In many cases, they are displayed only under artificial light, as it has been found that daylight and the sun's rays have a destructive influence.

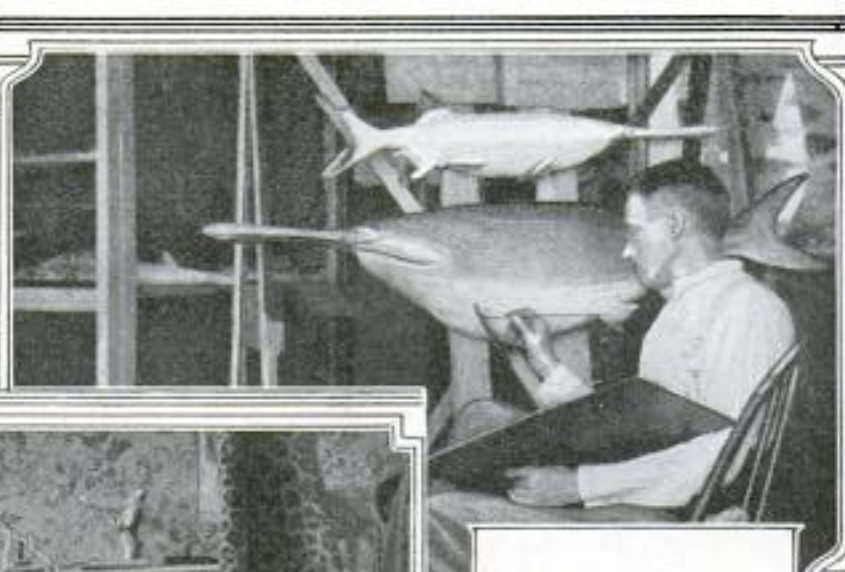

On Plaster Casts, the Artist's Brush Creates Tinted Scales and Silver Skins That Graced the Living Fishes in Their Deep-Sea Homes



Accurate Copies of Their Bony Frameworks must be Made Before Plaster Casts of the Animals can be Built in Life-like Poses



Preparation of Feathered Subjects Presents Difficult Tasks in the Arrangement of the Plumage, Characteristic Expressions, and Attitudes of the Birds

2905

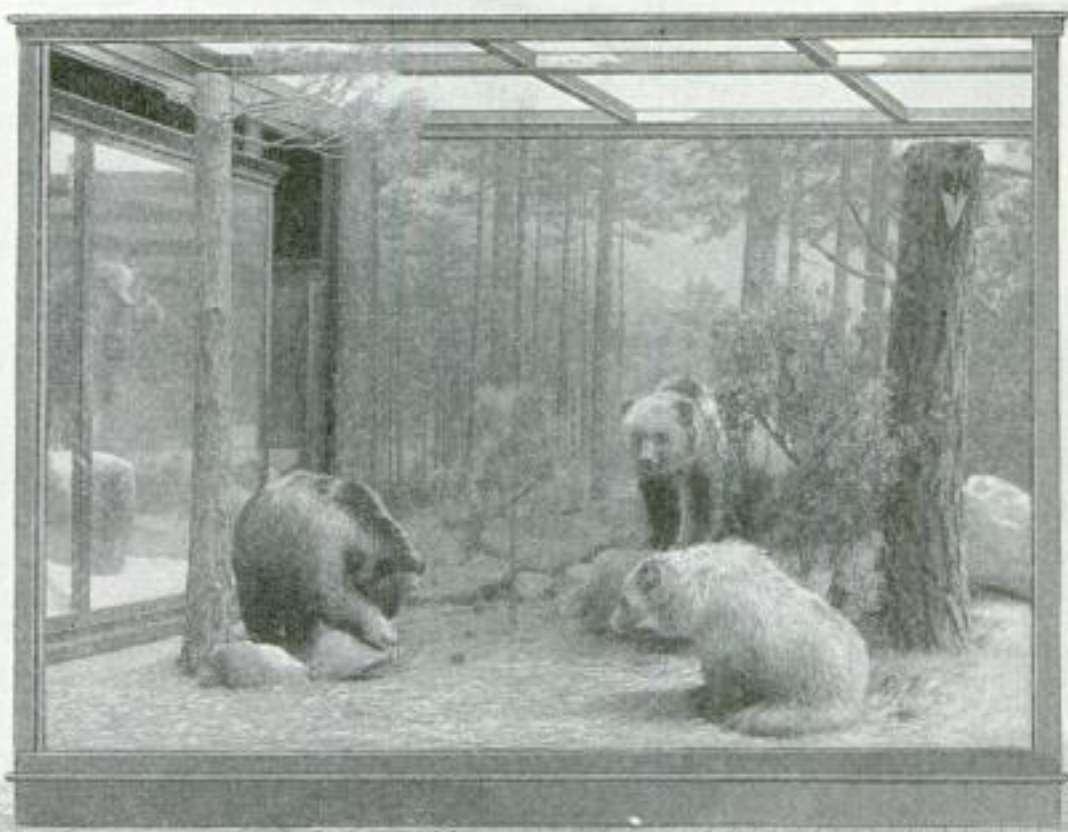

Shaggy Forest Beasts Taken from Their Native Haunts and the Lap of Nature, to Repose, Serene and Life-like, in a Museum, through Skill of Taxidermists

As the furs are almost priceless, glass cases in which they are kept are constantly guarded, day and night, against thieves and fire. In addition, they are chemically treated to protect them from moths and insects.

* The glass cases in which the mounted specimens are kept are tightly sealed, and there the animals remain in their natural surroundings, posed in characteristic pursuits, so lifelike that the visitor pauses to watch the next act in the drama.

2992

GEAR WITHOUT COGS HAILED AS ENGINEERING MARVEL

Defying many of the known laws of mechanical engineering, a small piece of steel mechanism was tested recently at an eastern technical school. Without a single cog or tooth, the apparatus, which is in the form of a shaft, was connected to a 5-horsepower motor and speeded up to 17,000 revolutions a minute. The other end, however, was turning only five times an hour, but was able to lift a weight of 10 tons. Simple in construction, the device consisted of the driving shaft that fitted into the end of the driven shaft, turning freely in it on ball bearings. Instead of resting on a journal, the outside, or driving shaft, turns between three or four rollers, one or two of which are larger than the others. These run inside

of a steel ring, slightly off center. As the inner rollers turn on the high-speed shaft, the outer ring becomes the driving gear. Difference in the diameters of the parts establishes the rate of reduction in speed and increase in power.

OLD AUTO TIRES ARE BURNED TO SAVE GRAPE CROPS

Worn-out auto tires are used in some western vineyards serving the same purpose as smudge pots, which prevent damage by frosts. Tires bought from a junk dealer for about \$30 per ton are saturated on the inside with oil. They are placed about the vineyard in piles of three or four and, when lighted, they furnish enough heat not only to ward off frost but also to save the grower trouble and expense of a second pruning.

Exhibited at Machinery Hall, Pittsburgh Carnegie Library, July 1, 1923

Dr. W. George Smith
Morrisson, 609 Chamber of Commerce
Pittsburgh, Pa.

The Inside Engineer World
July 1, 1923

2843 "LOST CAUSE" MEMORIAL WORK IS STARTED

After seven years of planning, the carving of a huge memorial to the Army of the Confederacy, out of the solid granite

mounted before the work could be started. One was the placing of a guiding design on the steep weather-worn



Bald Face of Granite Mountain Top in Georgia from Which is being Carved Out the Heroic Figures of the Former Leaders of the Confederate States

side of Stone Mountain in Georgia, was begun recently. With appropriate cere-



Governor Delivering Address at Ceremonies That Marked Start of Confederate Memorial

monies, a well-known sculptor applied the chisel to the figure of Gen. Robert E. Lee, which, with that of Jefferson Davis, "Stonewall" Jackson, and other Confederate leaders, composes the first section. Many difficulties had to be sur-

mounted before the work could be started. One was the placing of a guiding design on the steep weather-worn side of the mountain. That was finally accomplished by the use of a large magic lantern, the pictures of models, greatly enlarged, being projected on the surface that had been coated with a sensitive substance which reproduced them. Those illustrations were then made permanent by chemical baths. Suspended hundreds of feet above the ground in harness chairs, the artisans will chisel out the



How Sculptor is Swung from Chair So He can Work on Side of Mountain

Von Lengerke & Antoine
 130 S. Wabash
 2884 FOR TWO PERSONS
 Chicago

huge figures, using power-driven cutting instruments for the less delicate modeling. Tons of rock must be cut away before the first group will have been completed. Stone Mountain, 1,686 feet above sea level, was the scene of many hard-fought skirmishes during the Civil War. In the territory surrounding it, one of the most remarkable campaigns of the war, in point of strategy, was carried on in 1864. It ended in the battle of Atlanta in which General McPherson, one of the most capable Union commanders, was killed.

GUN SHOTS ICE CREAM INTO SHELL HOLDER

With a gun-shaped filler, worked by a trigger, ice cream is shot into crisp, tasty cake shells covered with chocolate, a product recently introduced as a soda-fountain novelty. The cylinder container, wrapped in wax paper to prevent leaking in hot weather and to keep the fingers clean, is held in one hand, while the other dips the gun into ice cream, presses the barrel close to the filler, and then shoots

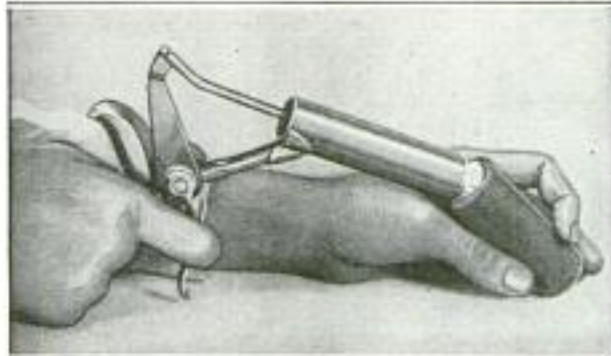

Plunger of Gun Pushing Ice Cream into Cake Shell Covered with Chocolate

the cream by pulling the trigger. A plunger pushes the ice into the cake, thus packing it firmly.

TAXI METERS USED IN ROME

Before the time of Julius Cæsar, ancient Romans were called upon to travel about in hired chariots for which they paid by a crude method of counting distances, according to recently discovered records. The "taxicab" had a device like an hour-glass, by which a pebble was dropped into a bowl for about every 5,000 feet traveled. At the end of the journey, the driver would count the stones, thus arriving at the amount of fare to be paid by the passenger.

Chicago Tribune
 7/2/1923

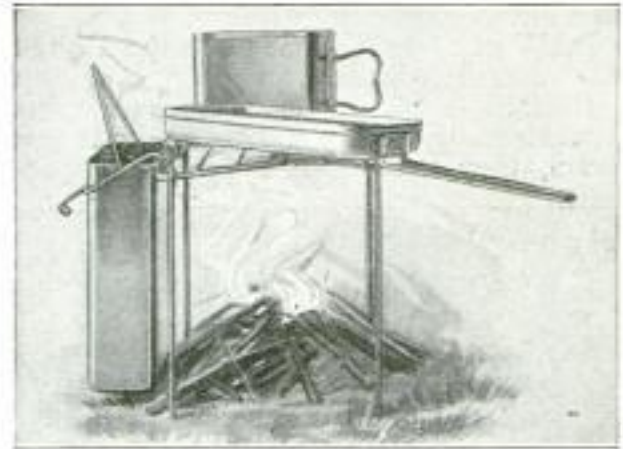

Mess Kit That Fits in Pocket, Containing Frying Pan, Kettle, Cup, Pail, Grid, and Broiler

for cooking over an open fire. This set is large enough to prepare a meal for two persons. For picnics, a set, slightly larger, but containing two cups, two frying pans, a kettle holding four cups, and a grid big enough to hold all pans and kettles, has been devised.

LIES SHORTEN SIGHT SO DEVICE DETECTS THEM

By examining the eye with an apparatus, called the retinoscope, an eastern scientist seeks to show whether a person is telling a lie. He bases the test on a theory that lying is a mental strain resulting in temporary nearsightedness.



Testing the Eye with Lens, That is Aimed to Show Whether Person is Telling Falsehood

The detector indicates whether the subject's vision is changed by questioning.

Dr. H. W. Bates, Ophthalmologist

SCIENCE RIVALS NATURE IN MAKING EYES

Artists, Working from Painted Copy, Bring Out Thousands of Tints and Shades
So as to Almost Defy Detection

BY A. N. MIRZAOFF

269 Leland Ave
Plainfield, N.J.

OUT of every 300 people in the United States, it is said, one is wearing an artificial eye, but, owing to improvements in their manufacture during the past few years, they are difficult to detect, per-

ing of the colors. Enamelled gold was tried later, but proved too heavy to be held in the eye cavity. Pieces of leather on which artists reproduced the iris and pupil on a white background, attaching them to velour-covered wires that fastened over the ears, also were tried.

At the beginning of the 18th century, the perfectly shaped glass eye, having the brilliancy of the natural organ, made its appearance, resulting in the present article that does everything but see.

These are blown out of glass by artists, working from a painted copy of the natural eye, so that every detail may be exact. The workbench of the eye maker is a riot of colored glass tubes and slender sticks of crystal, from which he gets the thousands of tints that combine to make up the shades.

For the eyeball, a white or opaque tube



Hollow Crystallike Stems are Attached to Melted Glass for Inflating the Bubble

fectly matched, and are moved by the muscles of the eye socket.

The first glass eyes are believed to have been made and sold in the city of Venice in the year 1580, by a Florentine jeweler, who painted glass balls with enamel, covered with a thin sheet of polished lead to prevent irritation and fad-



Ground Shades for the Iris are Traced from Sticks of Brightly Colored Glass



Globes Blown from Tubes of Opaque Glass Form the Balls of Artificial Eyes

is selected, and from it a small globe is blown by means of a torch and blowpipe. Tipping and revolving the ball downward in the flame, tends to cause the molten glass to flow toward the bottom, forming a thicker, tapering wall at the front, where the ground tone of blue, gray, or brown, is traced in a circle from one of the colored sticks of crystal. Into the center of this the pupil is inserted.

Few natural eyes are of solid colors, the iris generally being made up of slight brushlike lines and dots, radiating out-

Artificial eyes can be supplied by any optician

EYES OF THE ANCIENTS

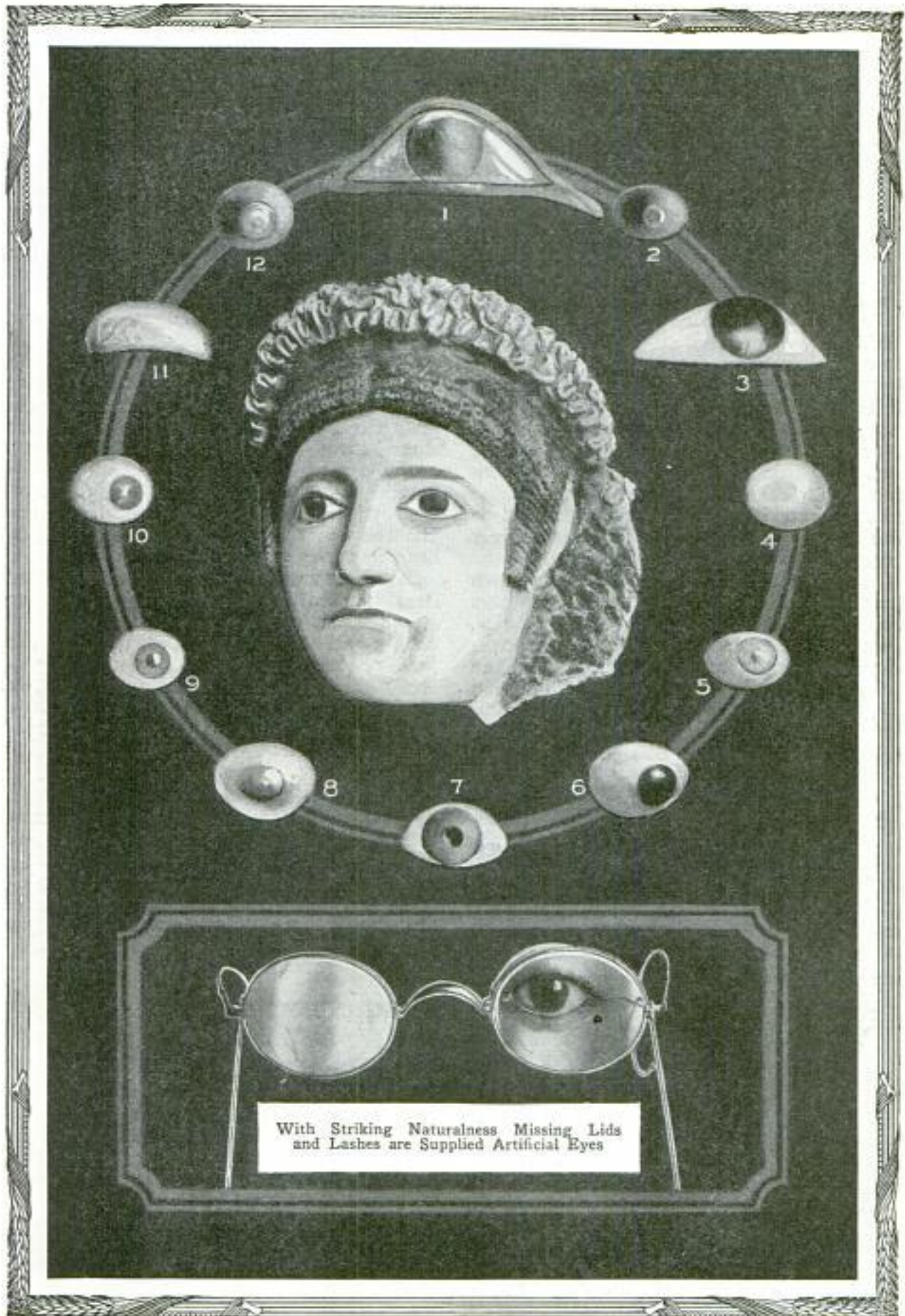

Above: Funeral Mask with Artificial Eyes; Also Orbs as Follows: No. 1, Wood; 2, from Mummy; 3, Ivory; 4, Lead; 5, Early Chinese; 6, German; 7, Enamel; 8, Old Glass; 9, Seventeenth-Century Glass; 10, Venetian; 11, Marble; 12, Silver

ward from the pupil. These the worker imitates with threads of glass he has first drawn out over the torch, touching their ends to the globe as he slowly revolves it to insure evenness, afterward putting in the tiny veins so often seen scattered over the white of the normal eye. Shaping the "reform" eye, as it is called, and coating it with a covering of clear crystal to blend the colors and give it natural brilliancy, must be done before the stem is withdrawn for sealing the shell at the back, finishing a task that requires less than an hour.

In a well-equipped establishment an artificial eye can be fitted with as much ease, and in the same space of time, as is required for a pair of shoes, some dealers carrying from 50,000 to 100,000 in all the ordinary color combinations. For those that are made to order, not more than two or three days is necessary to turn out a perfect match, for although most of the materials are imported, as well as the stock eyes, a scarcity of them rarely happens under normal conditions.

Many manufacturers keep one or two duplicates of the eyes of their customers constantly on hand for emergencies, since their delicate construction exposes them to frequent breaking under the handling of the wearer, and the action of the acids of the body. Instances of artificial eyes exploding are known, but seldom with any injury to the socket, the

vacuum on their interior drawing the broken pieces inside the shell.

Loss of the eye is often accompanied by destruction of all or parts of the lids, which are now reproduced on the artificial eye in glass, colored to match the skin and worn as a spectacle. A drooping or paralyzed lid can be supported in normal position, by a small shelf of clear crystal built across the eye. After a natural eye has been removed, temporary globes are inserted into the cavity for a period of two months to enlarge it for the regular one that follows.

Accounts of the ancient peoples show that as early as the days of the Egyptian emperors, attempts to reproduce the human eye in mummies and statues were made by embalmers and artists. From buried tombs along the banks of the Nile, there have been taken bodies having crudely made artificial eyes, formed of plaster or wax and precious stones, covered with white-enameled shells of silver and other metals, pierced by holes to represent the pupils.

Many, found in the same locality, had eyes of baked and painted clay, or rounded out of marble, studded with colored gems. A funeral mask made in the first century contained a pair of perfectly shaped eyes in imitation of nature's work, evidence of man's untiring efforts to produce by his own hands the masterpieces of creation which surrounded him.

STEERING JERKS AND SHOCKS LESSENER FOR AUTOISTS

To make small automobiles steer as easily as large cars, a device has been made to increase the leverage. It helps in preventing accidents by giving

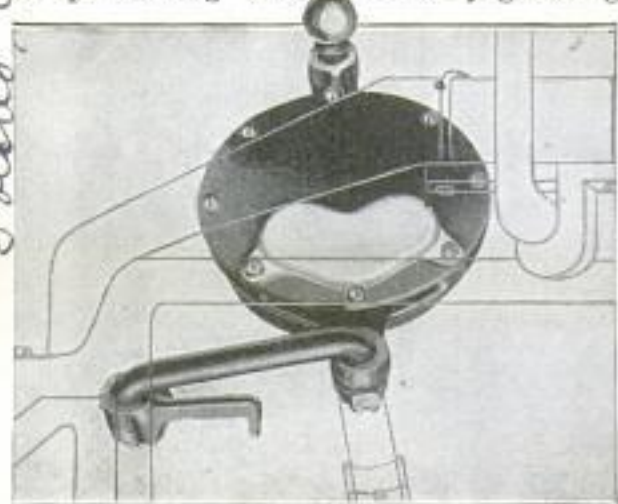

Steering Device for Small Cars That Eliminates Shocks and Operates in a Bath of Oil

the driver better control under all conditions, as it holds the machine to the road and will follow ruts. Fitting directly into the steering post, it acts as a stabilizer and equalizer, and all vibration is absorbed before it can reach the hands. No dirt can get into the moving parts, which operate in oil.

MILLIONS OF GOLF BALLS ARE USED IN U. S.

Because of the growing popularity of the game, experts estimate that 13,200,000 golf balls will be bought this year in the United States compared with 12,000,000 in the preceding 12 months. About one-quarter of the supply comes from England and Scotland. Between September, 1922, and April 30, 1923, American dealers imported from those two countries 1,927,697 of the little white pellets, valued at \$792,641. With those figures as a basis, trade authorities judge that the total of importations this year will be 3,140,000 balls, with a value of \$1,297,000.

Hord

International

2872

2891

3007

The Rollaway Motor Car
S. L. Dadd, Ohio.

2800

TEN TONS OF HANDS BUILT FOR SCENE IN MOVIE



Plaster Hands, Each of Which Is Larger than a Man, That were Made for Giant Sphinxes, Used during the Taking of a Motion Picture in the West

To complete a motion-picture scene on the sand dunes of California, 10 tons of hands were made. They were attached to 24 giant sphinxes as large as any of the original statues to be found in Egypt. Although mere skeletons in outline,

viewed through the eye of the camera or on the silver screen by audiences, they cannot be distinguished from the originals from which they were designed. When the picture is completed, the great setting will be wrecked by dynamite.

2894

PLANE FOR SEA OR SKY HAS DETACHABLE WINGS

For aviation school or pastime purposes, a seaplane, seating three passengers, is changed in 32 seconds to a ground-landing machine, by replacing the pontoon floating frame with a wheeled undercarriage. Only two fastenings are necessary to hold the lower structure to

the plane. Turning a handwheel beneath the body withdraws eight bolts holding the wings, which are two pieces, in sockets at the sides. Tests showed that six men can convert the machine from land craft to a water plane in 65 seconds. The cockpit covers are removable.

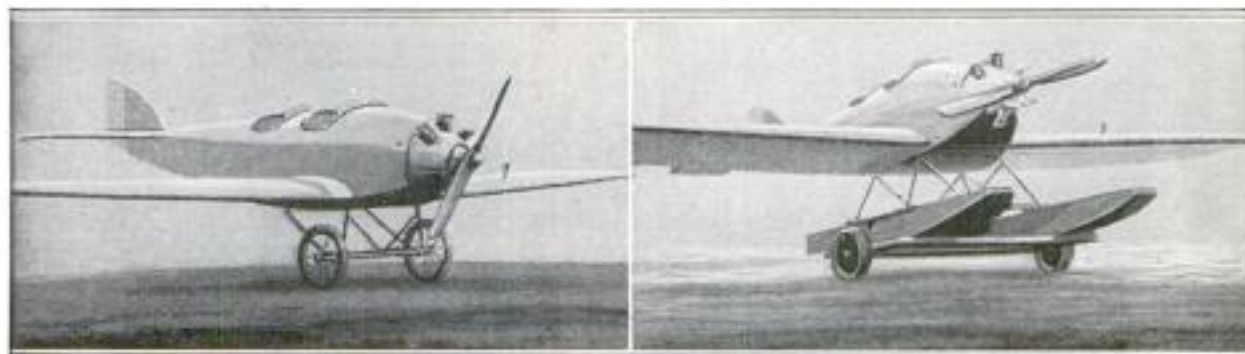

Convertible Seaplane That can be Dismounted from Pontoon Float and Equipped with Wheeled Undercarriage for Land Maneuvering in Little More than a Half Minute

Ernst Heinkel Flugzeugwerke,
Warnemünde, Germany

**MAN-MADE NORTHERN LIGHTS
ARE CREATED BY A GAS**

3045

With a gas, called krypton, the flaming display of the northern lights was produced on a small scale by European scientists in a recent test. They were studying the aurora borealis to learn why it is present only in the polar regions. Krypton was thus discovered. It was found that the characteristic green lines of this gas were the same as those of the aurora, and it was suggested that the color of the lights is due to this gas in the polar regions. How it collects in the north is unsolved, but scientists believe it may result from the difference in the temperature of the gases that make up the earth's atmosphere.

*Laduna Product Corp. 3425 Laies new York
Emb. George H. Paul
900 Ellsworth Bldg.
Chicago*

**COTTON SHIPPED BY AIRPLANE
IS WORN THE NEXT DAY**

3040

In a test recently made, a bale of cotton weighing 500 pounds, carried by airplane from a southern city, reached a mill in a New England state the same day it was shipped, in time to be started through the machines. Woven into cloth, and separated into pieces, sewed and trimmed, it was sent to another distant city where it was worn by guests of a convention the next day.

**LUMINOUS DIAL TELLS DRIVER
WHEN FUEL IS SHORT**

2955

With the condition of his oil and gasoline supplies clearly shown at night by a gauge in front of him, the motorist does not need to guess at the amount in the tank or leave his seat to read the register at the back of his car. The new recorder consists of



two tubes of glass filled with the liquids placed upright against a white scale, having a phosphorescent glow at night. The levels of the fluids correspond to those existing in the supply tanks of the car.

¶ In September, 1864, the first Bessemer steel was made in America at an experimental plant in Wyandotte, Mich.

**FARE BOX PRINTS TRANSFER
AND REGISTERS COIN**

3010

Transfers are given passengers as they pay fares into it by a collecting box recently designed for street cars, that can

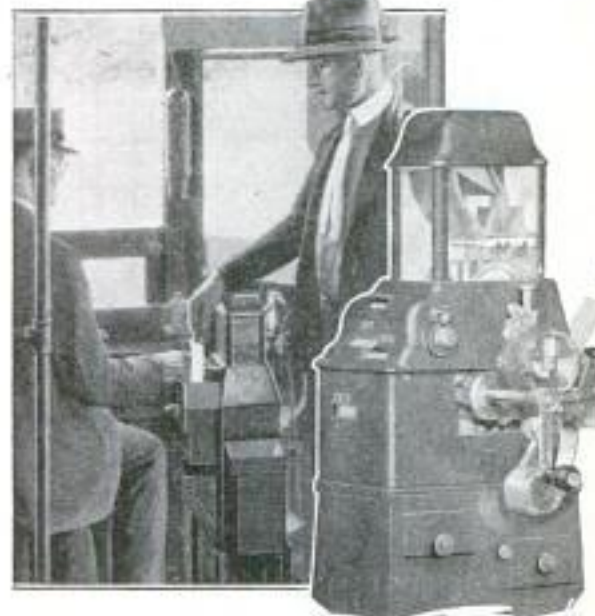

With a Single Operation Fares are Taken and Transfers Delivered by This Machine

be operated by hand or electric motor. Paper tickets are separated from other fares, canceled, and carried into a locked box, while coins are totaled and metal checks counted, before passing to a drawer where they may be reached by the operator and used for sales or making change. By the same movement that records the fare, the transfer can be delivered, stamped in large figures with the hour and date of issue, conductor's badge number, and street-car lines over which it is to be used. Number of transfers issued, collections for each trip, and day's totals are shown on different dials at the side of the box.

3057

**WAX OF WEEDLIKE SHRUB
TURNED INTO VARNISH**

Selling wax from a weedlike shrub that grows wild and needs no cultivation is becoming a thriving industry of the South and Mexico. Large shipments are being made to foreign countries. Factories that refine it from the stems operate to full capacity the year around and cannot get enough plants to fill the demand. It is used as a base for varnish, fillers, polish, talking-machine records, and waterproofing materials. The cost of the shrub is very small.

Candelilla plant

*Chas. Lord Clayburgh, Patent
Attorney, Dayton, Ohio.*

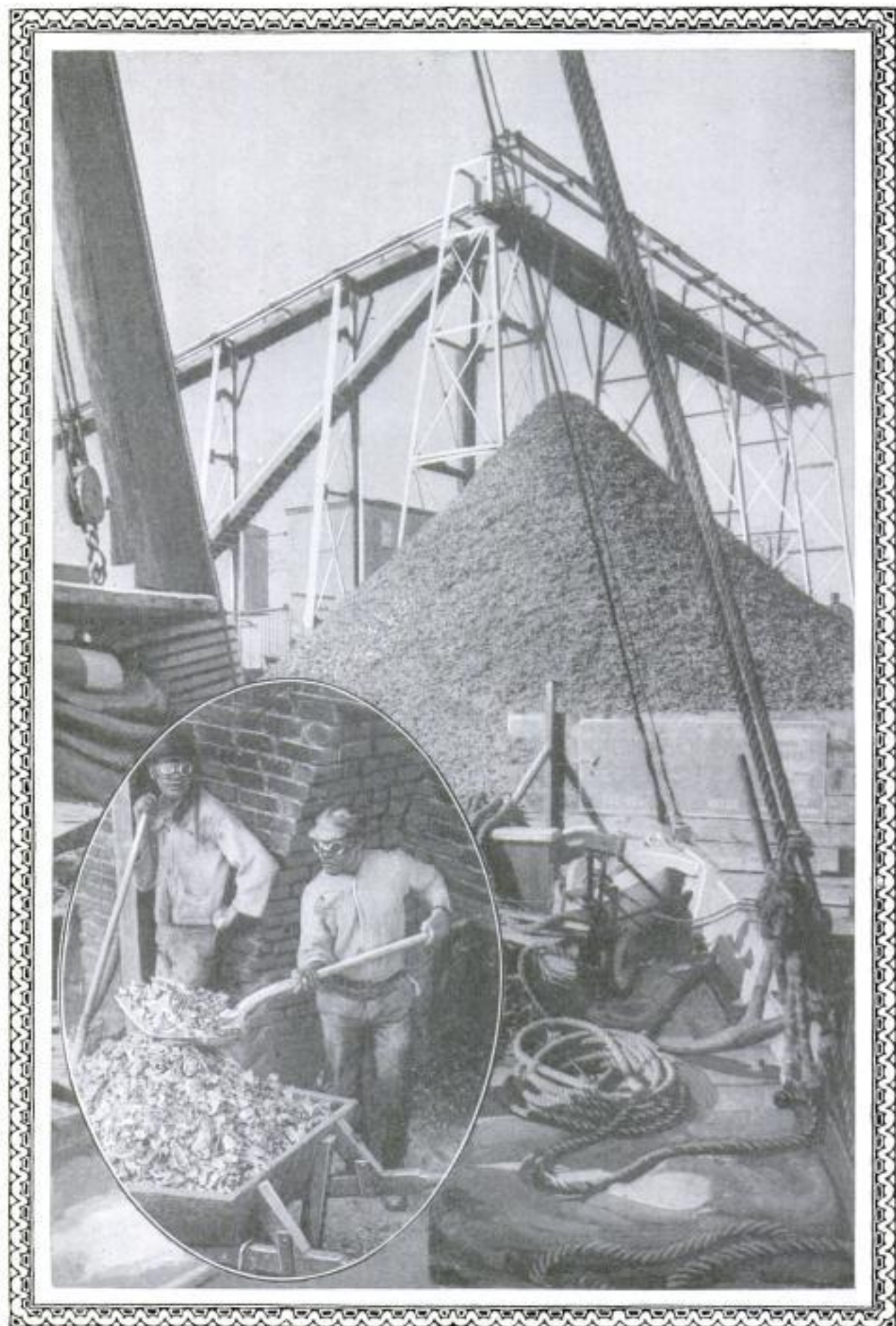

Copyright, Underwood & Underwood

Belt Carriers Taking Shells from Fishermen's Boats and Adding Them to the Small Mountain of Shells to be Burned and Then Ground into Powder for Fertilizer; Insert: Shoveling Shells into Kiln

OYSTER SHELLS BRING RICH CROPS FOR FARMERS 2725

Burning and grinding oyster shells into a powder to make plants grow, is a growing industry of the South. A recent scarcity of nitrates forced farmers to look for some other fertilizer, and they adopted the oyster. To use something that lives at the bottom of the sea, the food of a starfish, for improving land seemed impossible at first, but in the powdered shells were found qualities that enriched the soil and so they are now being widely used. The shells are burned on a grate over a roaring fire. They are hauled by wheelbarrow to a conveyor which carries them to the place called a pulverizer, where they are mashed and ground into fine dust, ready for the farmer. This recently developed industry has brought oyster hunting to a state where it is said to be more profitable than any other kind of fishing.



COPYRIGHT, UNDERWOOD & UNDERWOOD

Removing Shells to the Kiln

SPARKS CAUGHT IN WATER PREVENT FOREST FIRES 2781

For eliminating forest fires started by sparks from logging engines, a device is being made for use in large lumber camps



Fire Protector being Used on a Logging Engine in a Big Lumber Camp

industry—the apparatus catches the sparks as they are shot upward and forces them through live steam into a tank of water, without impairing the engine's draft. Simple in construction, the arrester is supported on the roof of the structure covering the engine, provision being made for cleaning it when it becomes clogged with cinders.

PLAGUE OF LOCUSTS RETURNS AFTER SEVENTEEN YEARS 2810

With a plague of locusts sweeping over Africa, many sections of the United States have reported a return of the periodical pest. After 17 years underground, grubbing among roots, the insects make their appearance in the world, living for one month in a winged state, and then die leaving millions of eggs behind. One curious fact in the life of the locust is the way in which it changes skin after coming from the ground. It climbs the tree, on whose roots it has been feeding and, fixing itself firmly to the bark, waits for the shell to split along the back. Then the winged insect appears. After laying its eggs in small branches, the pests cut the twigs nearly through so that eventually they will fall. Having made this provision for the future, they depart from their brief hour in the upper world. Grubs born from the eggs burrow at once into the earth and stay there for 17 years. Although they injure vegetation, the locusts do not harm human beings.

Newspaper clipping

where the fire hazards are great. Fitted over the vent of a donkey engine—the type most commonly used in the logging

*Anderson Draft Regulator Co.
Eugene, Oregon. Attention J. C. Anderson*

2108 TRADE GUNS FOR IVORY IN AFRICAN MARKET

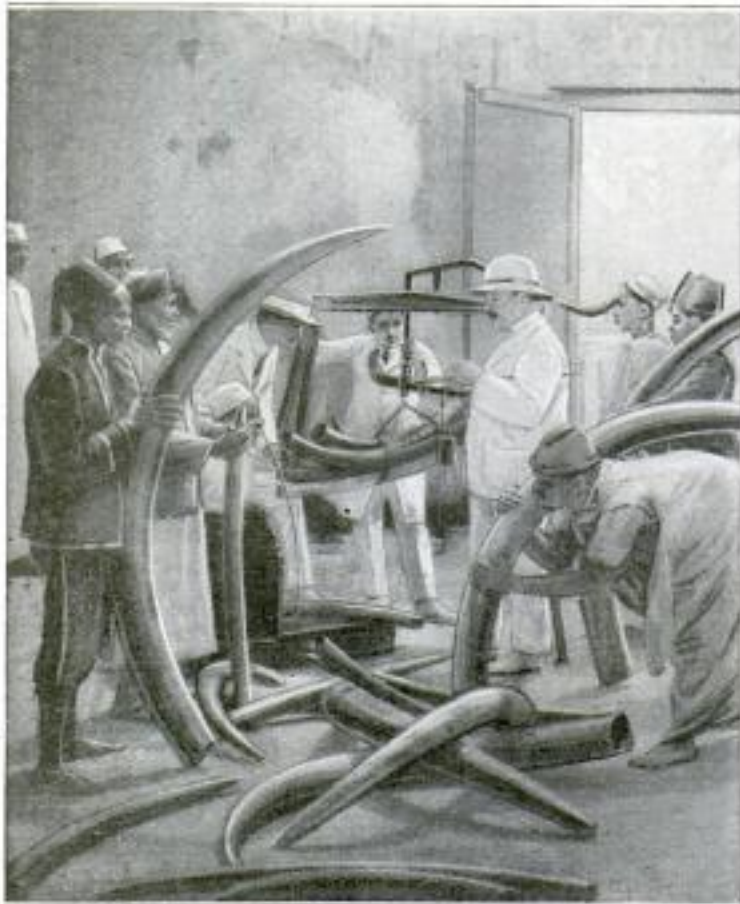
 COPYRIGHT, UNDERWOOD & UNDERWOOD
 Where White Men Bargain with Natives for Elephant Tusks in
 Ivory Market of Central Africa

One of the most picturesque sights in central Africa is the ivory market, where white men barter with natives for elephant tusks, giving in exchange guns, and other things the natives fancy. Traders sell them to makers of pool and billiard balls, toys, models, and works of art. Piano keys are made of ivory not only from the elephant but from certain whales, walrus, and the hippopotamus, too. An idea of the enormous number of elephants killed so that ultimately the white man may play pool is shown by the fact that only three of these balls can be made from the average small tusk. Some of them are of huge size, weighing 150 pounds and being 9 feet in length. The skilled hunter often gets tusks without the danger of shooting an elephant, because he knows where to find animals that have died a natural death. Shrewd business ideas of the trader, and the native's longing for what the white man offers, have combined to make the ivory market one of the chief industries of central Africa.

 2144 RECORD-SIZE LACE CURTAIN
 BIGGER THAN CITY LOT

Showing the lace maker's art, a curtain 150 feet long and 50 feet wide has been made in one piece at a famous mill in England. It is said to be the largest one-piece curtain ever made. The average home lot is smaller than this big exhibit of the skill of modern workers

at a trade that is many hundreds of years old. In the hall where it hangs, there was placed more than 100 years ago one of the first machines for lace making, an apparatus that turned out bobbinet, opening a new era in the craft. At first the products were crude, but today there is said to be little difference between the handwork and manufactured pieces.

 COPYRIGHT, CLARKE & HYDE
 Lace Curtain, One-Fourth of City Block in Length, Said to Be Largest Single Piece Ever Made, Shows
 Skill of Modern Craftsmen in Ancient Art

Swastika Photos. 35 S Dearborn
 Copyrighted material
 Chicago

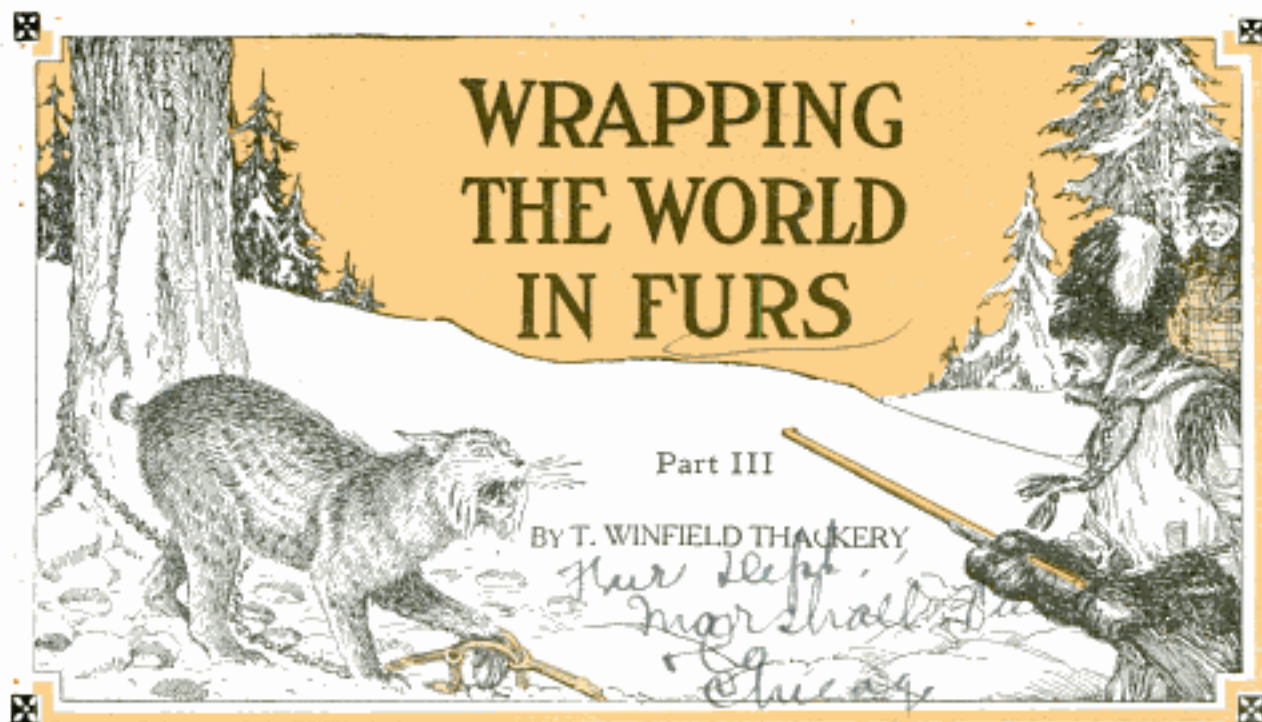

FURS from remote antiquity have formed at once the protection of man from the cold and the insignia of royalty and power. They have been the price of ransoms for royal captives, the gifts of emperors and kings, and the peculiar badge of the power of government. Today they hold the same valuation, but because of the spread of democracy throughout the world, they are no longer the possessions of the rich alone. By their abundance, and the cheapness of some kinds, furs in the last hundred years have come within the reach of the man of moderate means.

The story of furs can be read in the travels of Marco Polo, as when he grows eloquent in describing the marvelous furs of the Khan of Tatar; in the lament of the early churchmen who said that the introduction of furs into the life of Rome and Byzantium was evidence of "barbaric and depressing luxury"; in the romantic history of the French occupation of Canada; in the tale of the early settlements of America; in the records of the Hudson's Bay Company, and in the annals of the trade of today.

A great many misconceptions are entertained by the general public as to the fur business. There are many strange superstitions afloat which need correction.

As an example, many people believe that the skins of the unborn Persian lamb are used for the trade. This is an error, for such pelts would be entirely

too delicate to be worked up into furs or to wear well. Occasionally, in severe winters, broadtail—as the lambs are called—are born prematurely and few of such pelts come into the market. While all the "secrets" of the fur trade could not be described in anything short of a large library, a few of the more interesting facts may not be out of place here.

With the exception of Alaska sealskin and some other fine furs, the majority of pelts are treated in the same way after the animal is killed. The majority of fur bearers are trapped or snared, shooting them usually spoiling the coat. When the skins have been carefully removed, as soon after death as possible, they are tacked out, most of them fur outwards, and, without being exposed to the sun, are allowed to dry in a moderately warm, shady place. With the exceptions already mentioned, all raw skins come to the market dried in this simple manner.

In preparing the furs for the market a furrier or skin merchant must have a good eye for color, for the difference in value due to the color and variety is very great. Furthermore, he must know whether a skin will turn out to be soft and strong after dressing, and whether the raw pelt is in the best condition when he buys it.

Now, while the dressing of fur turns the skin into leather, the process is not the same as when ordinary hides, such as

[This is the third of a series of three articles by Mr. Thackery, dealing with the absorbing subject of furs—where they come from, curious and interesting facts about the animals that bear them, and how the skins are prepared for the market. Mr. Thackery is a Chicagoan and director of the fur division of the largest retail store in the world. His articles, therefore, bear the stamp of unquestionable authority.—Editor.]

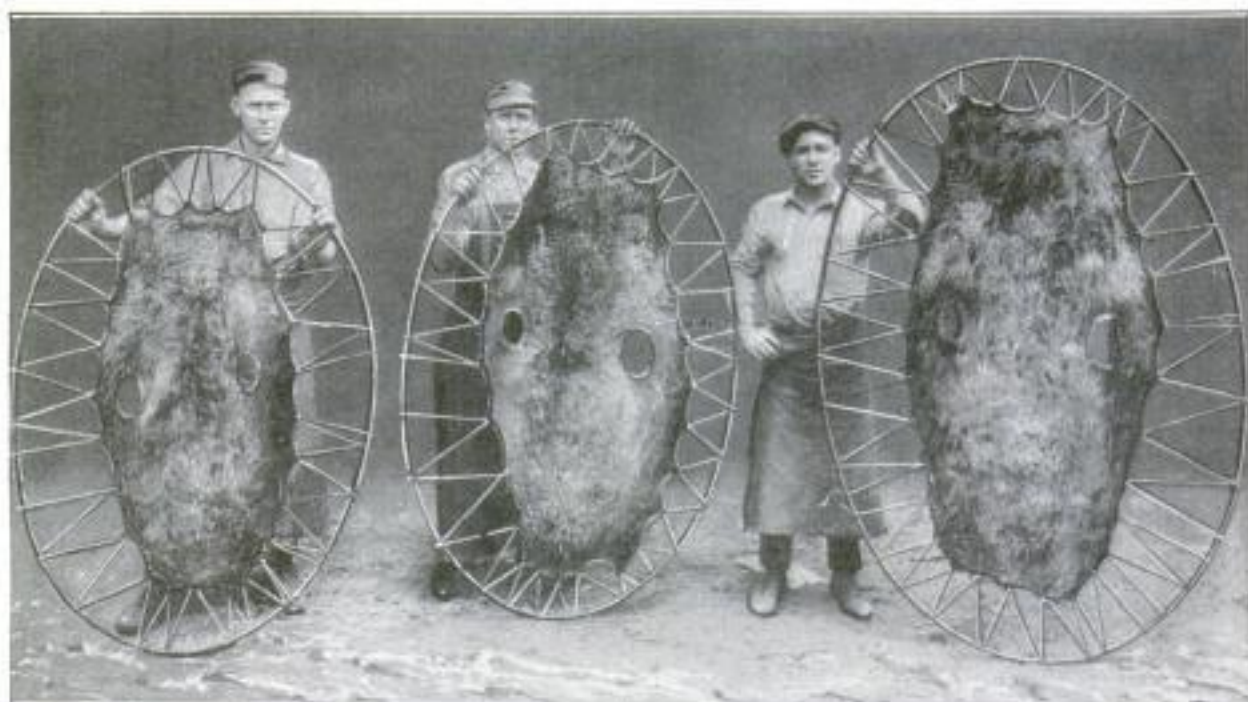

After the Removal of the Blubber and Some of the Long Hairs, the Skins are Washed and Then Put on These Light Frames So That in Drying They do Not Shrink. They are Then Placed in a Heated Chamber

cowhide, are prepared for the market. In the latter case tannic acid is used. On a fur skin this process would destroy the fur itself and harden the skin. In a moment we shall see how sealskins are

prepared, but other pelts of less value are generally placed in an alkali bath as the first step, then, working by hand with a blunt wooden instrument, the moisture in the pelt is worked out and



Skins are Received at the Rear of This Room. They are Then Passed On to the Sorters Who Judge the Value, Determining the Price Paid the Trapper

the superfluous flesh removed. Special grease is then rubbed in and the skin is run through a series of machines from which it emerges in condition to be cut up and made into garments. A great many natural furs have to be dyed before being made into scaris, wraps, and the like.

For example, the caracul lamb, and indeed all lambs, are naturally a rusty black, brown, or white in color and, with few exceptions, are dyed a jet-black in manufacture. It may surprise many to know that most so-called Hudson Bay sables are naturally a medium brown and many are quite yellow.

The various processes through which the sealskin passes from the time the animal is killed, on the far-off Pribiloff Islands, as described in this series of articles heretofore, until the beautiful fur is displayed in shop windows, exceed more than 100 in number and are very interesting, both to the women who eventually wear the skins and to the men who ultimately pay for them.

As will be recalled, we found the barrels of salted sealskins leaving the Pribiloff Islands by boat for Seattle, Wash. From there they are shipped by train to St. Louis where they are placed in cold storage at a moderately low temperature.

The skins must be kept in a wet, salted state until they are put into the process of manufacturing, for they contain a great deal of oil which would burn the skins through evaporation if allowed to dry out.

The first thing that is done in a dressing operation is to grade the raw skins according to age, quality, length, and

thickness of the fur and the condition of the skin itself. On the living seal, as on most animals, the fur is the soft silky hairs close to the skin. It is protected by what is called the "overhair," really longer stiff bristles. This overhair serves to protect the downy fur and keeps it from becoming matted down on the animal. For commercial purposes this overhair must be extracted from the skin, for it is not pleasant to the touch and, in most cases, is not very beautiful. Therefore, one of the first steps in dressing sealskin, after the surplus oil and blubber

is removed from the pelt and fur in special washing machines, is to "unhair" the skins. This requires great skill and fine judgment on the part of the workmen in order that these long guard hairs may be taken out by the roots without damaging the soft "underfur," or the skin itself.

The skin next moves to the leathering department where, after being worked into condition, seal oil—which is made from the blubber that was taken off the skin in

the first place—is applied to the back of the pelt and the whole is put into a machine which transforms the raw pelt into leather.

Scientists have been baffled in trying to discover exactly why it is that by merely kicking the skin about it is turned into leather. Some sort of chemical change takes place, but just what this is, or how it comes about, is not known. When the white man first came to America he found the Indians changing raw skins into leather simply by putting natural grease on them and then rubbing them up and down in their hands or

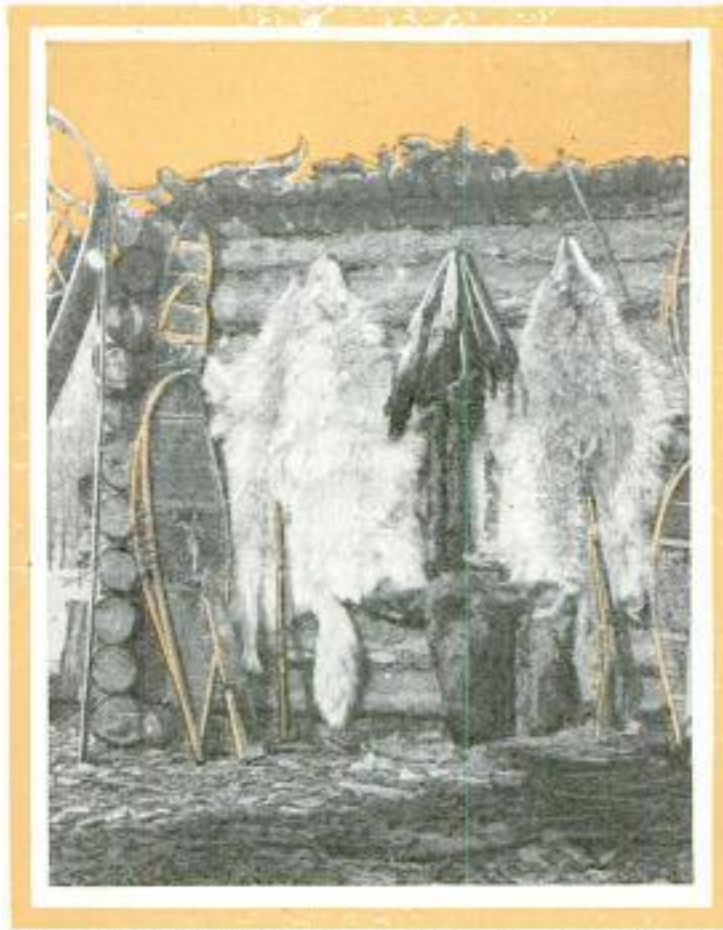

Skins and Working Tools of the Trapper Stacked Up by His Lonely Cabin in the North Woods

pounding them in a mortar. When the explorers went to the Far North they found the Eskimo women putting the seal blubber onto the skins and then chewing the latter in their mouths, thus producing leather. Many of the older women's teeth even today are worn down to the gums from this constant chewing of skins.

Taking their cue from this, the white men at first used to throw the skins into a big tub, and after adding enough grease or oil, jump up and down on them with their bare feet until the leather was made. From this it was a simple step to make machinery which, even today, simply kicks the skins around. Of course, it should be understood that



Scraping the Long Hairs from a Sealskin with a Dull Knife

every furrier does not use this kicking process. Many still use acid. The processes here and later described are those used by the Fouke Fur Company of St. Louis, which handles all the Alaska sealskins for the account of the United States Government.

After the skin has been turned into leather, the surplus oil and dirt is removed from the pelt by tumbling it about in sawdust. The oil is absorbed by the sawdust and thus removed.

The skins are now ready for dyeing. This is a very complicated process and requires from three to four weeks, during which time the skins are handled every day. The dye is put on by hand with a scrub brush. This requires very



Fur Buyers at a "Floor Sale": So Expert Are They That a Glance Tells Them the Value of the Pelts



Tiger Skins Are among the Most Prized of Possessions: Tall Jungle Grass Makes Hunting Them a Highly Dangerous Pursuit

great skill. As it is known, the natural color of the seal is a very light, unclean-looking brown. In putting on the dye, the workmen are so expert that they are able to color almost exactly half of the depth of the fur a rich chocolate brown and the top half another shade of brown so deep that it looks jet-black. Anyone familiar with the appearance of fur when it is "soaking-wet" will appreciate the skill of a workman, who, with a heavy scrubbing brush, can put on the dye so that it sinks in exactly as he wishes it. Also, his art is made the greater in that the fur is, of course, not equally deep all over the skin. For instance, under the flippers of the seal the fur is only a fraction as long as it is in the middle of the back; yet a sealskin expertly dyed will show the hairs evenly colored throughout.

After being dyed and again cleaned the skin is cut down to the proper thickness. This is necessary because those who manufacture the skin into garments find that natural variations in thickness make skins hard to match up and sew together. The method formerly used to accomplish this was "hand-shaving," but a machine has been invented to do this.

Next comes a most interesting step. As might be supposed, there are small guard hairs growing out in the skin of the animal when it is killed. These are short, stubby bristles hidden by the fur itself. If they are allowed to remain in the skin they interfere with its soft, even appearance and the silky "feel" of the fur. Because these hairs are covered by the fur they could not be removed at the time the first stiff guard hairs were taken out. A wonderful machine has been invented which actually runs in through the soft fur and cuts off these stubby bristles. This feat is accomplished by an ingenious arrangement of air blowers, combs, and knives, and is a secret process.

To prepare the sealskin for the market requires four months, and from start to finish the skin is worked on nearly every day and a good many nights. Extra care must be taken in certain steps because if the skin is allowed to remain damp or wet it is liable to rot in a single night. No one can see or feel the exquisite fur and dainty, soft, light-finished pelt, without sensing its charm. The skin eventually is just like chamois and a big one may be drawn through a man's good-sized finger ring. It takes an average of six skins to make one coat for a woman.

After preparing the skins for the market the Fouke Fur Company, which alone is allowed to kill the seals on the Pribi-

loff Islands, must sell them at auction. They then go to the manufacturer who makes them up as he sees fit.

The art of the furrier is an old one and the workers must really be artists. Many factors go into "Wrapping the World in Furs." For instance, it is a recognized law among high-class furriers that furs should be simply arranged, that is, that an article of wearing apparel should consist of only one fur, or of two furs of a suitable contrast. Illustrative of this, it may be explained that a brown fur, such as sable, marten, mink or beaver, will match well with a black fur, while those of a white or gray nature, such as ermine, chinchilla, blue or silver fox, or gray squirrel, will look well when set on seal or black furs, such as Persian lamb, astrakhan or caracul.

For a long period of years, furs made into garments were most imperfectly tailored. It is only comparatively recently that new methods, in which America led the way, have resulted in a fur garment as accurately and gracefully fitted as velvet or other cloth. Fur-sewing machines have been on the market since 1890. There are, however, certain parts of garments, such as the putting in of sleeves, which are best sewn by hand.

Another branch of the fur business is that which has to do with hats, cloths and shawls. The best felt hats are made from beaver and muskrat wool and the cheaper kinds of nutria, hare, and rabbit wools. For weaving, the most valuable pieces are taken from Angora goats.

Fur skins do not always appear as they were in life. Most gray squirrels seen on the streets come from Russia, where, after the dressing process, the backs of the squirrels are made up separately from the under and thinner parts of the skin. The smaller and uneven pieces of heads and legs are made up into linings.

The most of the odd-shaped pieces from the heads, legs, sides, and paws of all animals are exported to countries where cheap furs are in the biggest demand. A good many other skins, such as foxes and ermines and others having specially handsome markings, are sliced up and the manufactured neckpieces may often be in several-pieced sections sewn together.

In all, there are more than 100 kinds of skins known to the fur market; this, of course, does not include varieties of the same species of animal. Even the house cat is pressed into service. The best of these latter come from Holland, but although in color, weight, and warmth they

are very good, the fur is apt to become loose and fall off. They are used mostly for coat lining.

Dog skin also is used, though the only ones used in civilized countries are those imported from China. These are heavy and coarse and only used in the cheaper trade, chiefly for rugs. All kinds and conditions of goats give their skins to the trade. The Chinese export thousands of skins in black, gray, and white, mostly made into rugs of two skins each.

Most monkey fur once belonged to the black monkey taken on the west coast of Africa. The hair is very long and bright, with no underwool, but having a white belt at the base of the hair. It is interesting to learn that monkey fur was in great demand and very fashionable in England back in 1850. Also it appeared in fashion marts in America in 1890. For the next 30 years they were mostly bought in Germany, but as we now see, they are again in fashion in this country.

The kangaroo is another animal whose fur is acceptable to the trade. The best of the lighter weights of kangaroo fur are often not strong enough to stand wearing in a coat. A variety, however, coming from a species of the animal, which is known in Australia as the swamp wallaby, is dyed to imitate skunk skin and looks very well.

The very limited number of musk oxen may be one of the reasons why these skins are not in greater use. The ani-

mals have a very dense coat of fine, long, brown wool, with very long dark-brown hair on head, flanks, and tail, and in the center a peculiar pale, oval marking. There is no other fur so thick, and were it not so scarce it would be greatly used for robes and greatcoats.

Most people being used to seeing the brown of the muskrat fur probably do not know that a very few thousand skins of the Russian muskrat are annually imported. This is a very pretty silvery-blue and silky fur, which, did it not have the odor of musk, would probably be one of our most valuable skins. Raccoon furs are a common sight, but perhaps it is not generally known that the animal itself is a kind of wild dog, and while having a close relationship to the bears, is not more than a cousin many times removed.

A word or two in conclusion may well have to do with the care of furs. Most people do not know how to best preserve their furs. Sunlight encourages the development of moth eggs and also tends to bleach the fur; therefore, continuous exposure to strong sunlight, especially in the warmer months of the year, is to be avoided. When furs are wetted by the rain they should be allowed to dry in a current of air without exposure to sun or fire; this after they are well shaken. Where cold storage is not available when one wishes to put up furs for the summer, they should be well shaken, then packed in linen and kept in a perfectly cool, dry place.



Dyeing Sealskins by Brushing on the Color with Ordinary Scrub Brushes: Note How Skins are Folded; They are Not Allowed to Rest Otherwise

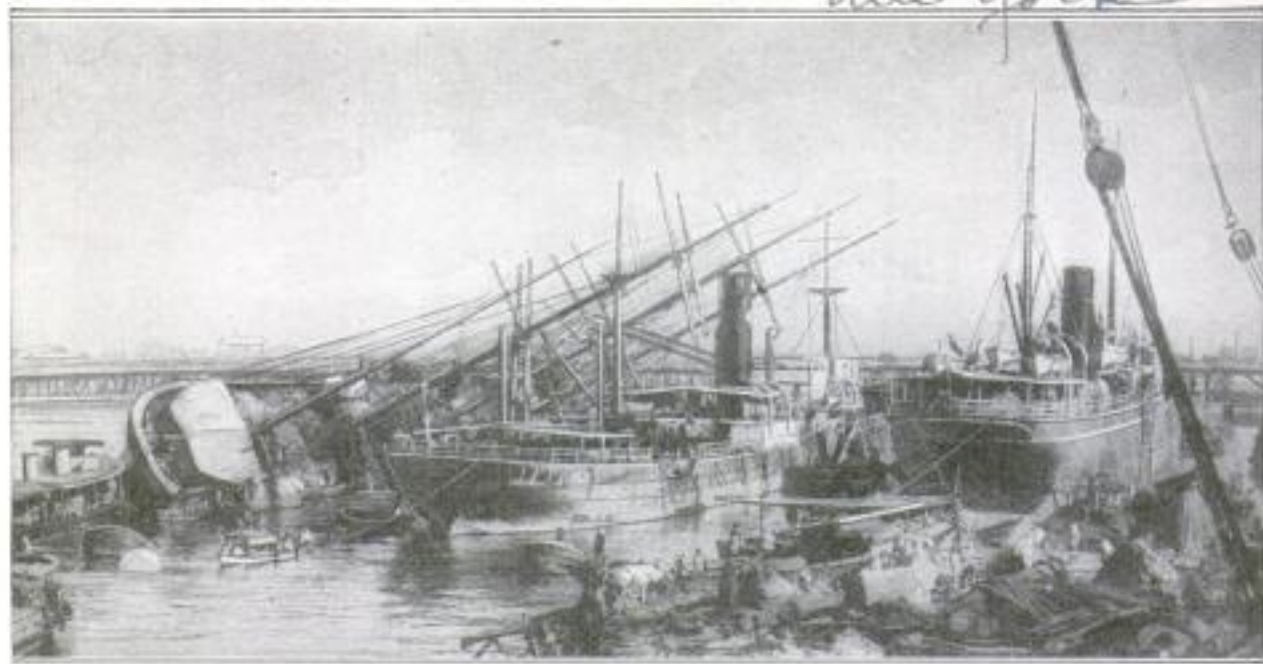

Catastrophe to Sailing Craft Awaits in the Least Suspected Waters, as This German Schooner, Which Keeled Over at Calcutta While being Cleaned, Bears Mute Witness

SAILORS FEAR PERILS OF PORTS MORE THAN SEA

Hidden dangers lurking in crowded ports are more feared by sailors generally than the hazards of the sea. When far from land, the seaman may avoid many mishaps by skillful handling of his vessel or by fleeing before storms too severe to be faced. But tied up to a dock or at anchor in a busy bay where there is no room to maneuver, the constant menace from fire, collision, sudden shifting of the cargo that might upset the ship at its dock, and other perils that cannot be foreseen or provided against, must be faced. Anchors may drag or mooring lines part under the strain put

upon them by strong winds, setting the vessel adrift to smash itself among other shipping. Unexpected sand bars in rivers and harbors are another danger dreaded by mariners. In tropical seas, tidal waves, swept before terrific storms, roll far up the rivers and invade the gulfs, crushing everything in their path and leaving the beaches piled high with wreckage. As a result, sailors the world over never feel so safe as when their ships are at sea with land far in the distance. Aided by warning devices, the approach of bad weather is known hours ahead, nearness of icebergs floating from frozen seas is foretold, while hidden reefs, shoals, and rocks are shown on the captain's chart, enabling him to avoid them.



Salvaging Cargo from Hold of Ship That Capsized in the Harbor: Its Tangled Rigging and Masts Struck a Neighboring Steamer, Thus Preventing a More Serious Accident

MUSIC NOTES DEFY MECHANICAL TYPESETTING

Little-Known Trade at Which There Are Only 75 Workers
in the United States

BY GEORGE BARNARD

NO one has yet succeeded in perfecting a machine which will set up type for sheet music. Newspaper stories occasionally laud an alleged success. But according to that rare survival, the music typesetter, the trade is still waiting for something practical to supersede its old-fashioned but effective methods.

There are ways of reproducing musical scores without setting them up in type. In fact, lithography and engraving have practically supplanted the old method. But for certain classes of work the old style is still supreme, and is putting up a gallant fight against extermination. The musical notation in most hymn books is produced by means of movable type. The advantage of the use of type in this connection is that the words are made to coincide more exactly with the notes to which they are related; and as the hymn-book page is smaller than an ordinary song sheet, it is difficult by means of engraving to inscribe the words sufficiently clearly in so small a space.

But hardly any song sheets are printed by the movable-type process nowadays, and as the demand for hymn books is small, in comparison with the total production of musical scores, the survivors in the old musical-typesetting industry are few and far between. It is estimated that there are fewer than 75 men in the whole of the United States who are com-

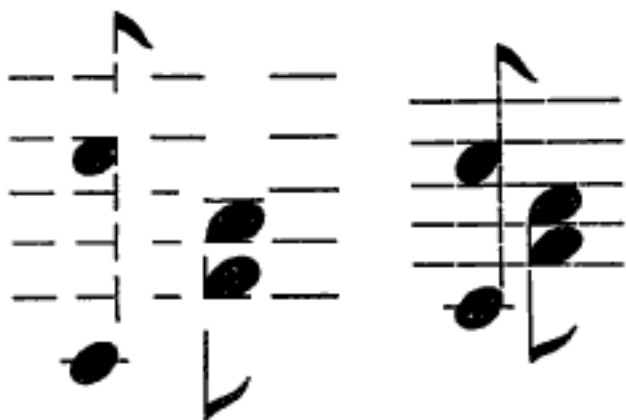

At Left, an Analysis of the Individual Pieces of Type Indicated in the Diagram at Right

petent to set up music type. There are perhaps 10 shops in the whole country in which this kind of work is done; and throughout the rest of the world the music-type printer is proportionately rare. In New York there are probably

only two or three concerns which set up music type. In Chicago there are two, Cincinnati still claims one, and there are two or three elsewhere in America.

The art of the music typesetter will probably die in the not far distant future, unless some one comes along



One Hundred and Sixteen Pieces of Type were Used in These Two Bars of Music

with a machine—at present inconceivable—that will give type-set music an advantage over the engraved kind. In one music-typesetting shop, for instance, there are no apprentices—a significant fact. Boys do not rush in to learn such a trade. Apart from the fact that the future is uncertain and the opportunities small, the work itself requires considerable application and is difficult to learn.

Some of the troubles which beset the man who strives to perfect a machine, after the fashion of the linotype, to set music notes, will be seen from a consideration of the task before him.

In the mechanical setting of ordinary type each line is set separately, as most people know, and one line has no relation (so far as the exact position of the individual letters is concerned) to the line above or below it. One character is simply read in its relation to other letters in the same horizontal line, and they do not even have to join on to one another. A linotype machine works from one end of the line to the other. It cannot set one character exactly above another character except by minute and laborious calculation on the part of the operator. Unless a "music linotype" were fitted with hundreds of thousands of keys, and corresponding matrices, it would have to be able to set one character above another, as well as one character beside another, and it would have to do both with extraordinary precision.

A study of the accompanying diagrams

will best explain the intricacy of the task of setting music type. A page of music, composed of music type, is a mosaic made up of little pieces of metal which singly are meaningless. A single note with its stem is never merely one piece of type. It is usually made up of three pieces, and sometimes of more. The lines must, of course, be set up, as well as the notes and other characters, and they must all fit together exactly.

The number of pieces of type in a given space will vary according to the intricacy of the musical passage. Three hundred distinct pieces of type in a single line of music is a fairly low average, or 3,000 in a medium-sized page of a hymnal.

A music compositor's output will vary according to the copy. On average copy, the setting of two pages of hymn-book music is considered a fair day's work for one man.

Music type is of standard type height. Its other dimensions are not measured by the "point system" known to printers, but one kind is distinguished from another by names which formerly were used in connection with ordinary type before the point system came into vogue: "excelsior," "agate," "nonpareil," "diamond," and so forth.

An ordinary printers' "composing stick" is used by the music compositor. Of course he has to set the type from right to left, as it will reverse in printing. But whereas an ordinary compositor merely places pieces of type side by side, the music compositor has to build in two directions at the same time.

A font of music type is contained in cases very similar to the printers' alphabetical case, but the number of characters in a font is considerably greater. A font of music type usually contains over 3,000 characters. Some of the characters differ only slightly from others, some sections of "line," for instance, being just a hair's breadth longer than other sections. Yet, so expert does a music compositor become that he cannot only set music type as easily as another man can manipulate the alphabet, but he can distribute the type into the proper departments of the "case" with the greatest facility.

As the demand for music type is so small, each printer who handles this class of work has to supply his own matrices when ordering from a type foundry. It now costs about \$7 a hymn-book page to set up music type. Yet, in the long run, it is cheaper to produce music by this method than it is to work with engraved plates.



A B C D E F# G# A A G F E D C B A
 These Strange-Looking "Notes" Find a Place in the Music Setter's Type Case Used in the South, and are Not Generally Understood by the Rest of the World

2801
VOLCANO IN FRESH OUTBREAK DESTROYS MANY HOMES

Inactive since 1911, Italy's Mt. Etna recently broke forth anew in violent eruptions, with rivers of molten lava streaming down its sides and across the countryside from five new mouths. Thirty thousand persons were made homeless and much property was destroyed. For a year prior to this outbreak, the volcano had shown signs of becoming active. Through that period, dense clouds of smoke poured from its crater, accompanied by heavy rumblings. Familiar with the disasters that have attended past outpourings of the fiery masses, the natives fled in terror. Sun-obscuring clouds of black smoke filled the air for miles, and white-hot lava spread over the surrounding territory, enveloping everything in its path. Be-

fore one wave of lava cooled, another and greater one was pushing it forward. Mount Etna's recorded eruptions, numbering over 80, have resulted in the death of more than 100,000 persons. Sixty thousand were killed in 1693, when an unusually severe earthquake occurred at the same time as an eruption.

2804
GRAPES PROTECTED BY BAGS

Heavy paper bags are being used to shield grapes from birds, harmful insects, and damaging rot during the growing season. Thus the yield and quality are increased. Slipped over the bunches, the protectors are fastened securely to the vines, and remain until the fruit has ripened. While thick enough to shed moisture, the material of which they are made does not exclude air or the sun's heat.

*Pacific Atlantic Photos
 International*

*Mitchell's
 518 Market Street
 Philadelphia, Pa.*

Prof. Barry Macnelt
Professor of Physics

POPULAR MECHANICS
Lehigh University, Lehigh, Pa.
LUMINOUS CLOUDS TO LIGHT
BOTTOM OF THE OCEAN 2809

Luminous clouds of artificial light are used in experiments being made to find a method for taking photographs and moving pictures of the ocean's floor, where the "Lusitania" and many other ships, some laden with treasure, lie buried out of the reach of divers. By spraying the water with a chemical designed to reproduce the phosphorescence of waves, a scientist believes it may be possible to light up the sea sufficiently to take pictures of objects, many fathoms below the surface. At present, beyond a depth of 50 feet, it is virtually impossible to see more than 10 feet in any direction.

ELECTRIC LANTERN IS CLEAN,
SAFE, AND CAN'T BLOW OUT

Resembling in form the old oil type, an electric lantern is being made that is clean, safe, and can't blow out. The battery is carried in the bottom and the lamp replaces the usual wick, being protected by heavy glass globe. Always ready for use, it is not affected by jolts and jars, and will burn steadily for a long time. When the battery is exhausted, it can be replaced in less time than it takes to fill the old-style lantern.



The battery is carried in the bottom and the lamp replaces the usual wick, being protected by heavy glass globe. Always ready for use, it is not affected by jolts and jars, and will burn steadily for a long time. When the battery is exhausted, it can be replaced in less time than it takes to fill the old-style lantern.

FIRE FIGHTERS SHOOT WATER
THROUGH LOOPS IN TEST 2847

During a recent field day held by the London fire department, target shooting with streams of water was one of the



Shooting the Target with a Stream of Water during a London Contest

popular events. A strong head of water was used, making it difficult to manage the nozzle and direct the stream through a small hoop at a distance. With long practice, firemen become as skilled in handling a high-pressure hose as does the marksman with his rifle, often reaching difficult spots with heavy streams of water, even in the face of winds. Perched at the tops of long ladders, balancing the weight of the hose, many veterans can direct water onto distant parts of a fire.

RADIO IS TAUGHT IN SLEEP
BY PHONES ON EARS 2888

Teaching the novice how to send and receive radio code messages more speedily by giving him instructions while he sleeps, is a method recently adopted and said to be proving successful at a naval air-training station. Before retiring at night, the student puts an ordinary headset of telephone receivers over his ears. All night long skilled operators send messages, usually ten words a minute in excess of the student's capacity. The next day in his conscious hours, it is reported, the beginner is able to transcribe communications at the speed they came to him during his sleep, and to send code words faster than the day before. Some committed to memory passages of literature flashed to them while they slept.

NIAGARA FALLS TO BE LIGHTED
BY SUBMERGED ELECTRICS 2858

Added grandeur to the play of water over Niagara Falls is expected to result from the installation of submerged electric lamps to replace the system of flood lighting now used to illumine the falls at night. Built after the fashion of a depth bomb, metal containers, with white or colored water-tight electric globes set in the tops, will be anchored by cable underneath the cascade. The bulbs will point upward so that the colored rays will be reflected upon the tumbling water.

Similar one made by Embury Mfg Co, Warwick, R.I.

do not know about this suggested

International Newsreel
Chief Radio Mate Thimney & Station, Pensacola, Fla.

Detroit Free Press
June 24, 1929

New York Times
6/25/29



Batteries of Searchlights Played on Its Dazzling Lacework of Crystal Gems and Pyramids of Water Jets, Produce Marvelous, Changing Color Effects from This Electric Jeweled Fountain

FAIRY CITY OF FUTURE FORECAST AT EXHIBIT

Dreams that the builders and architects of today hope to see realized in the city of the future were displayed at an exposition in the East recently. Overhead thoroughfares supported on great arches between towering skyscrapers, double-decked streets, moving sidewalks bordered by a maze of show windows, stores connected by artistic bridges and covered promenades, will serve to crowd the lives of the citizens. Airships landing at lofty stations will carry the business man and the shopper to the down-town district, where they will be lowered to the

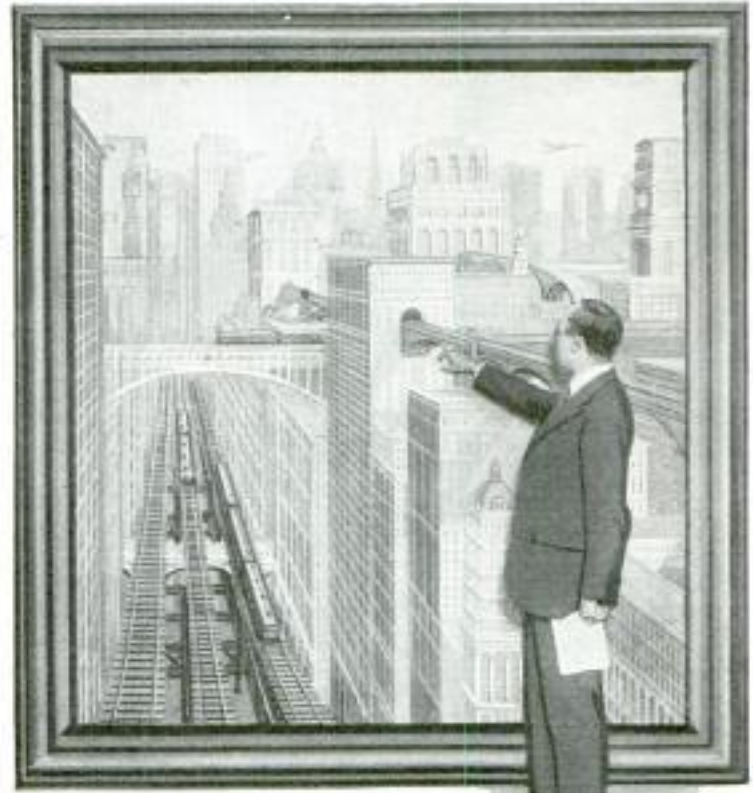

Artist's Conception of How Traffic will be Handled in American Cities of the Future.

streets by speedy elevators. Electrified railroads will enter underground and unload passengers at subterranean depots from whence cars traveling through wide subways will take them to different points of the city. Radio equipment in every office and home will serve to keep the inhabitants advised of the daily happenings in distant parts of the world. A sea of light, radiating from powerful hidden bulbs, will make the night as bright as day. One of the exhibits that attracted much attention was a jeweled electric fountain of elaborate design and beautiful effect.

VANISHING RACE OF INDIANS VISITED BY EXPLORERS 2879

In the southernmost inhabited land, Tierra del Fuego, lives an almost extinct tribe of Yaggan Indians, called "Firelanders," who speak a rich, beautiful language containing 32,000 words, and who worship only one god, whom they call "Watainourva," signifying "The Ancient in Heaven." For more than a century the "Firelanders" have been pictured as barbarians, without education, moral sense, or religion, and as cannibals who ate their aged parents. But two priests, who spent months with them and were made members of the tribe, have returned recently to contradict those reports. Their investigations also have enabled them to make a valuable contribution to science on the habits of the people. Like most primitive races, the Yaggans reach their educational heights in religious functions, which often last for weeks. During those ceremonies the young mem-

bers are initiated into the traditions of the tribe. For the last 30 years, because of the rapidly decreasing membership, only one part of the rites, known as the "Coxans," has been observed, although the second portion, the "Kina," was performed for the two explorers. In 50 years, their ranks have decreased from 2,000 to not more than 70. As only a few plants thrive in that cold region, the natives obtain most of their food by hunting and fishing. 2856

"WORMHOLES" SOLD IN EUROPE

Exporting wormy oak for manufacture into "antiques," may soon develop into a thriving and profitable industry, according to government experts. One consignment of faulty timber that was sent abroad recently found no sale until it was offered to an "antique"-furniture manufacturer. He bought it at a premium because the worm-made holes eliminated the necessity of boring them.

McCutcheon-Lesson Service
64 W. Randolph, Chicago

Chicago Tribune June 24, 1923

Perfected at Kiel, Germany.

POPULAR MECHANICS

Pacific & Atlantic Photos, Inc.
25 Park Place, New York.

438

2785

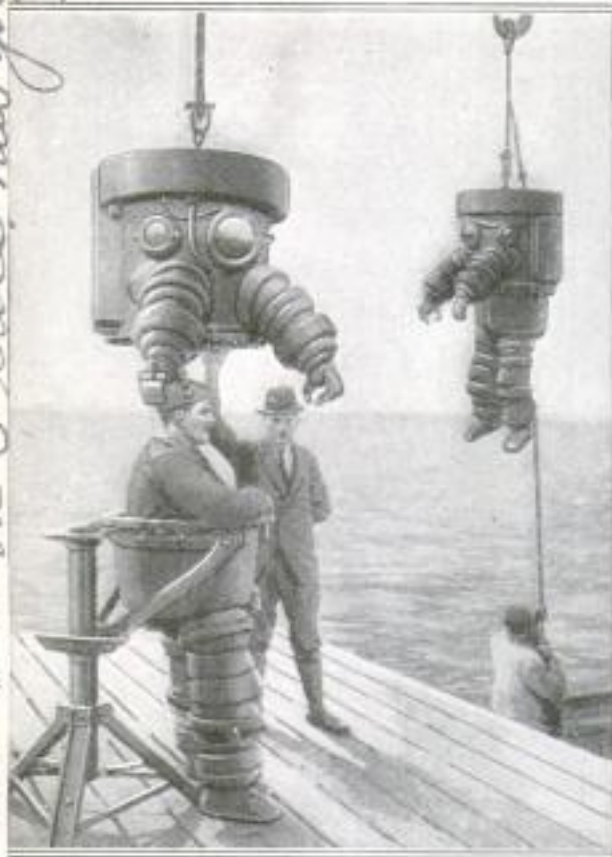

Diver Wearing Queer Suit in Which He Walks through Dark Realms under the Sea

TREASURES OF SEA SOUGHT IN STEEL-CLAD SUITS

To explore the depths of the sea, a queer-looking apparatus with an air chamber that the diver regulates has been made in Europe. It is intended for use in entering sunken ships and will allow the wearer freedom of action at a depth of 1,000 feet, it is claimed. In the darkness found far beneath the surface, an electric light guides the wearer, and a telephone keeps him in communication with the boat from which he is lowered. Search for hidden treasure lying at the bottom of the sea will be made by use of this diving suit.

NEW YORK TO CHINA FLIGHT

2798 BY PLANE IS PLANNED

Plans for an airplane flight from New York to Peking, China, were announced recently. To avoid flying over the Pacific Ocean, the route would be by Alaska, as only a comparatively small expanse of sea separates that territory from the eastern hemisphere. Thus the hazards of flying over open water would be greatly reduced.

AIRMEN FIND CYCLE RACE HARDER THAN FLYING

Although their sense of balance had been trained by years of flying, 100 French airmen recently found cycle skating was more difficult than piloting an airplane when they took part in a race

in Paris. Many accidents resulted, although all of the fliers were ardent bicycle riders who, despite their air duties, have never wholly forsaken their training on wheels. To the majority, the sport was new. Yet the contest was close enough to be exciting, and it attracted a great crowd of spectators.



Although Untrained in the Sport, French Airmen, Taking Part in a Novel Cycle-Skating Race in Paris, Carried the Contest to an Exciting Close

Wide World Photos

Copyrighted material

St. Louis Free Press
June 15, 1923

These Are for Everyday Use But— Can You Name Them?

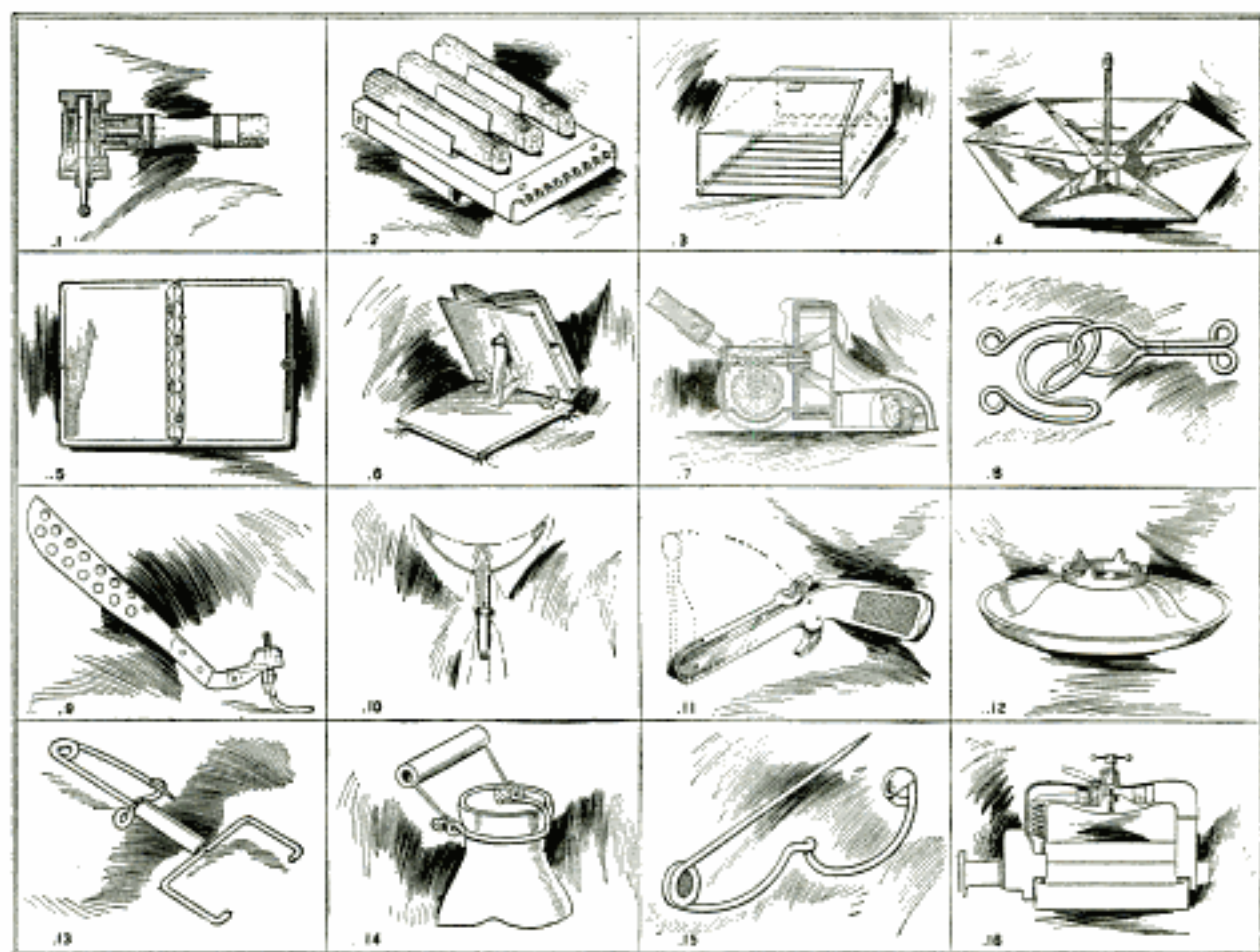

JUST to help you, the use for which the articles are intended is as follows:

No. 1 in a profession and for painful work. No. 2 on the farm. No. 3 in the home. No. 4 for out-of-doors. No. 5 by men. No. 6 in the home. No. 7 in the home. No. 8 on clothing. No. 9 in the home. No. 10 as a part of men's attire. No. 11 anywhere, but especially in the home. No. 12 in the home. No. 13 by women. No. 14 in a business. No. 15 on clothing. No. 16 in the home.

Popular Mechanics Magazine offers no prizes for correct answers to these problems, but offers them for the interest it believes its readers will find in attempting to determine the nature of the various articles shown.

If you think you have the right answers you can find out by comparing them with the correct list which will appear in Popular Mechanics Magazine for October.

TOY PLANE HELPS TO TRAIN ANTI-AIRCRAFT GUNNERS

To teach aiming with anti-aircraft guns, a miniature airplane on a 30-foot



Model Plane, Mounted on Tower, at Which Student Gunners Aim during Indoor Practice

tower is moved about the floor of an eastern armory. The target is raised and lowered by the driver of the electric truck on which the tower is mounted. Effective practice in aiming is thus provided the student gunners, who try repeatedly to get the range, but never fire. Not until they have passed rigid tests are they allowed to quit the indoor lessons for some aerial warfare on the field. Night practice is made more realistic by playing searchlights on the airplane.

GATE AND WINDING STAIRS LEAD UP TO GARDEN

In solving the problem of how to reach his home and garden, which are elevated about 12 feet above the street level, an eastern man has built a winding stairway leading to a platform. The top overlooks the sidewalk and highway, and is on a level with the house. It is supported by iron pillars and is reached through an attractive gateway.

No information

TENTED CITY IN DESERT BUILT FOR MOVIES

During the filming of a movie based on a Bible story, a tented city in a western desert was the home of several thousand actors, and 4,000 animals, including camels, elephants, lions, horses, dogs, mules, and pigs. More than 600 tents were occupied by the cast, said to have been the largest ever assembled. Men, women, and children of all classes mingled in the mob scenes out on the sand, 200 miles from the city where they had been recruited. For several weeks clerks, bankers, attorneys, butchers, club women, and scrub women lived together in the desert colony, all engaged in the same task of acting before the movie camera.

MOTOR WHEELS DO WORK OF SWITCH ENGINE

For railroad sidings where there are more cars to be moved than can be handled with a crowbar, and yet not enough to keep a switch engine busy, an eastern inventor has brought out a jack mounted on two wheels, placed one behind the other. It may be driven by a small gasoline motor, or run by hand with a crank. The machine will work

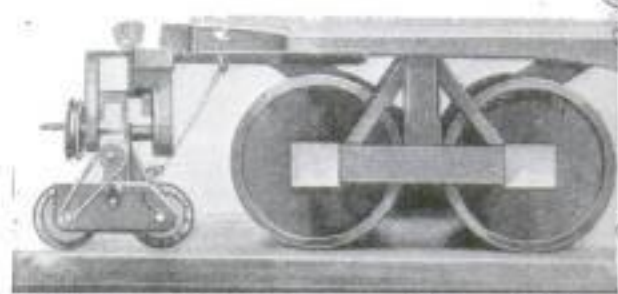

Freight Cars being Moved to Shipping Platforms without Small Bars or Locomotives

on either of the rails, and may be attached to the end of any kind of a car in a few seconds. It gets its hold on the track from the pressure caused by screwing the top upward against the load, and can be made to travel at speeds of from 1/2 to 10 miles per hour.

The Popular Mechanics' Bureau of Information offers its free service to all readers of our magazine. Names and addresses of manufacturers and dealers in articles described, and any other details in our possession, will be promptly furnished by addressing the bureau.

Mr. Charles H. Robertson, Philadelphia, Pa. 2107

748

2770

2779

258

ONE-MAN FISH NET SPREADS LIKE A HUGE FAN

Throwing a net at fish and catching entire schools of them by closing it with a cord is a new water sport in the South. The net is held in one hand by the sportsman, who wades into the water. It is thrown over a school of fish. Down over the water the net spreads like a huge fan, the weighted edges quickly sinking. Pulling of a cord closes the bot-



Throwing Net into Air, Where It Spreads like Huge Fan and Then Sinks around School of Fish

tom so that the fish are unable to escape. The net is dragged to shore, where the catch is taken out by releasing the cord. Skill is required to use this net because the fish must not be alarmed by the approach of the fisherman. If properly used, the one-man net will catch as many fish as can be lured into the ordinary one seined by two persons.

2778
CHANGE GOLF-CLUB WEIGHT TO SUIT THE PLAYER

To enable the weight of a golf club to be instantly adjusted to suit the player, one manufacturer has inserted removable pieces of lead in the head of the stick. As changes may be made during the game, this does away with the need of carrying several drivers or brassies in the bag so as to have a variety to select from in meeting various situations. Slight

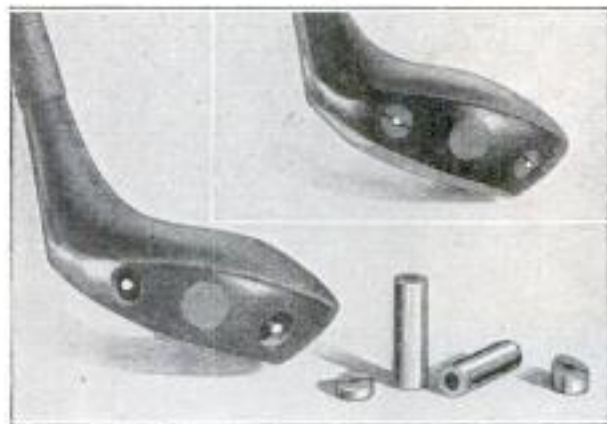

Golf Club with Removable Weights in Head So That It may be Changed to Suit Player

changes in the weights of the clubs also have proved useful when the player feels out of form.

A. S. Spalding & Bros.
211 S. State
Chicago

2739
PENCILLIKE SCALE SOLVES ENGINEERS' PROBLEMS

In a few seconds, with the movement of two sliding tubes scarcely larger than a pencil, a rapid calculator has been made to solve engineering problems. Easily carried in the pocket, it will do the work of a 66-inch slide rule and will give the roots and powers of all numbers without limit, even of fractions. Also, it will answer many other mathematical calculations, proving of value to all who have figuring to do. When solving a problem involving the volume of cylinders, only one movement of the tube is needed, and it will also figure the costs for various weights. The scale is made like a watch charm and when folded may be carried in the pocket like a pencil.

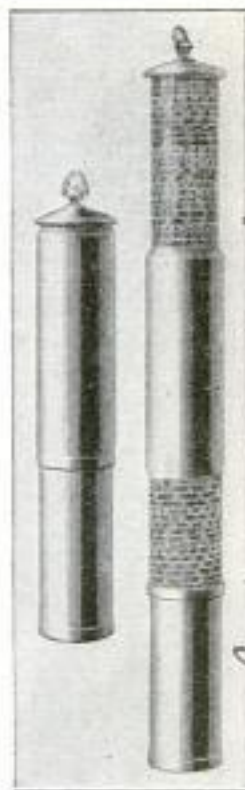

Price not known
U.S. agent not known

Carbic Ltd., 51, Holborn Viaduct, London, England.

2308

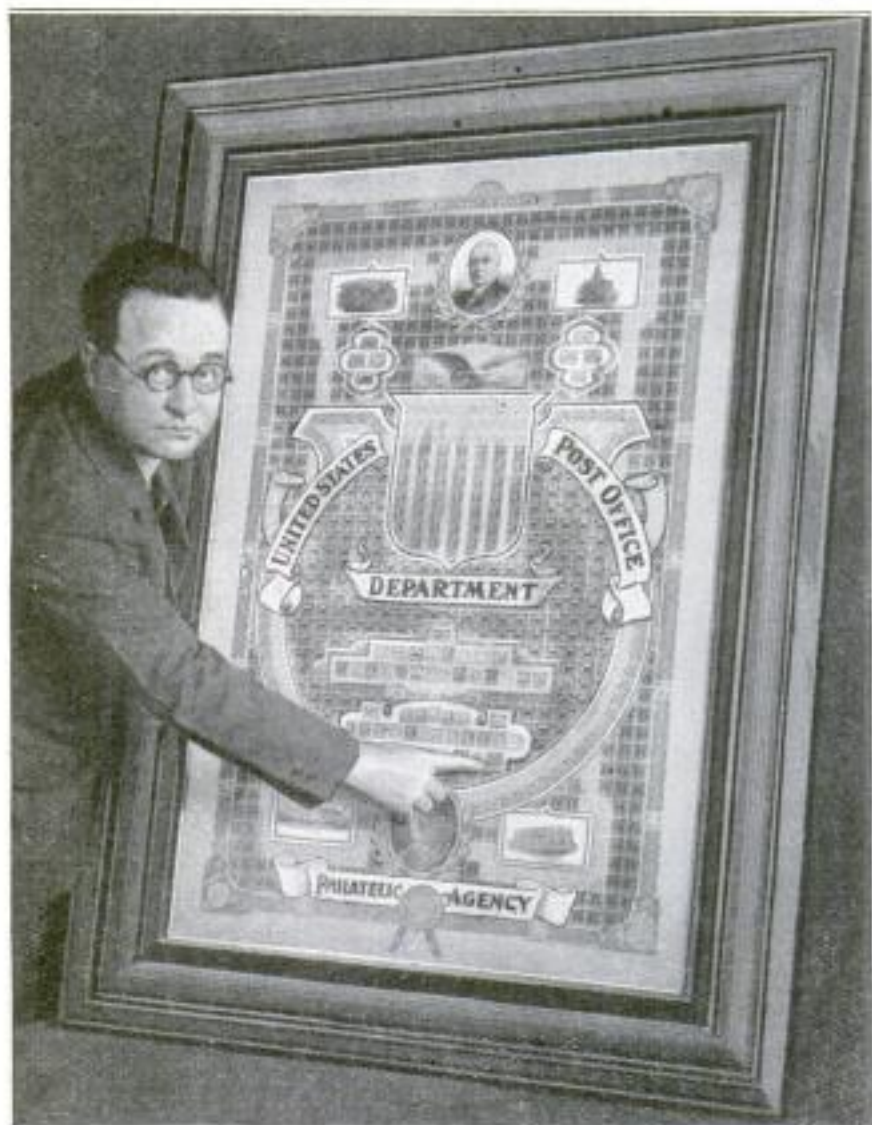

Assistant Postmaster-General Glover is Shown Pointing to the Die Proof of the Famous 24-Cent Stamp, Made in Error with an Inverted Airplane

COPYRIGHT, UNDERWOOD & UNDERWOOD

Assistant Postmaster-General Glover sailed for London recently, bearing with him a priceless stamp collection prepared by the Bureau of Printing and Engraving. The collection is arranged on a huge plaque, and consists of rare stamps laid out to represent the American shield. The trip was being made for the purpose of entering the collection in the International Stamp Exposition, to be held in the Royal Horticultural Hall in London.

**TRADE-MARKING
 A CITY**

Red and white labels, attached to commercial and municipal stationery, are being used to help stock growers distribute their cattle. Business boosters devised the labels, which are adorned with the picture of a top, on which appear the words "Watertown, Wisconsin," while a legend above reads, "On the Top," and another below, "It will Never Stop."

*Elmer Keynor
 Watertown, Wis.*

2130

HOTHOUSE BUILT ON ROOF OF BUILDING

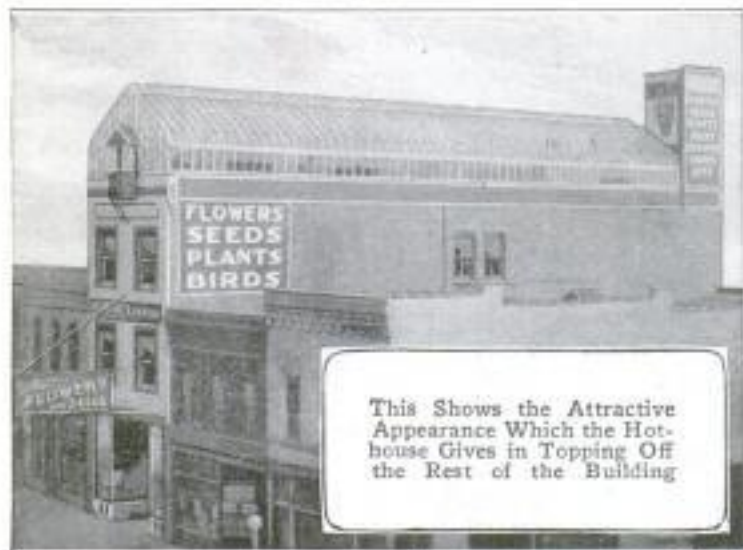

Hothouses are usually low-lying structures, built at a distance from the business section of a city, but one enterprising florist has erected his on the roof of his business establishment, where it is reached by an elevator. In addition to the advertising value of this arrangement, the feature possesses the advantages of economy and convenience, saving additional lot space and combining his business in one structure. The hothouse is 20 by 92 feet, steam-heated and storm-proof, and is accessible to customers. Curved glass windows are used on the side edges.

*James Seed & Floral Co.,
 400 E. Lincoln
 Springfield, Ill.*

New York Times
Billings
6/7/23
**CIVIL-WAR VESSEL FOUND
 BY DREDGE IN RIVER** *2795*

Rusted shells recently pumped from the bed of the Mississippi River by a gravel dredge in Louisiana, are believed to be the remains of a federal war vessel commanded during the Civil War by George Dewey, later Admiral Dewey. The vessel was disabled in an attack on Port Hudson in the river fighting of 1863. Struck by a volley of shells, it floated down the river and finally burned and sank. The ship was attached to the fleet of Admiral Farragut.

**MODEL HOUSES ARE MAILED
 TO POSSIBLE BUYERS** *2774*

Sending little "sample" houses to home builders, is the plan of salesmanship being used by London architects. These models are complete in every detail and are designed to inspire pride of ownership in the person to whom they are mailed. Facing a housing shortage, rivaling that of any American metropolis, many residents of London have bought home sites in the city's suburbs and are confronted with the problem of selecting the type of home to be built. To



COPYRIGHT, UNDERWOOD & UNDERWOOD
 One of the Model Houses Architects Mail on Approval to English Home Builders

help them, the architects have started the new industry of building models that are mailed to possible buyers.

AUTO FUEL FROM SAND *2572*

Automobile fuel and other valuable products are being taken from tar sand in Canada. Besides the gasoline, paraffin, lubricating oil, and asphalt are obtained. Nearly all gasoline and oils used in the Dominion have been brought in from the United States.

*near Edmonton
 Alta. Canada*

Photograms 1298 2711
acc. New York 413
**SWIMMING GLOVES WITH WEBS
 LIKE A DUCK'S FOOT**

By using the principle of the duck's webbed feet, gloves are being made that make swimming much easier. The web



Gloves, Patterned from Duck's Foot, That Help in Making Speed through the Water

between the fingers spreads as the hands move backward, giving a greater pressure against the water. On the forward stroke, the fingers are closed and the glove offers no more resistance than the naked hand. Besides giving more speed, the gloves afford greater security, as it is easier for the swimmer to keep afloat because of the additional leverage.

Arch. E. F. Sport
**ELECTRIC HOUSE OF FUTURE
 TO BANISH DRUDGERY** *2793*

In a home fitted with every known electrical appliance that was shown recently at a southern exposition, housewives saw the coming of a new era of comfort and convenience. Iceless refrigerators, dishwashing machines, stoves that could be set to start cooking at any time desired and which would automatically shut off the heat and keep the food warm when the meal was done, odorless incinerators in the basement connected with the kitchen by a chute, and vacuum cleaners, all operated at the touch of a button, doing, as if by magic, work that would require hours of back-bending toil. Walls built on the principle of a vacuum bottle would keep the rooms cool in summer and save heat in winter. Wide expanses of windows abolished the dark corners that so often are breeding places for germs. Beautifully tinted walls and floors were made of cement and concrete, so durable that they could be cleaned with a hose.

W. E. Clemens, Pres.,

*Electric League
 of New Orleans, La.*

*Justice A. Clarke,
 of Sammel, Harghies & Bond Co.,
 of Incennes, Ind. claims to be inventor.
 June 14, 1923
 New Orleans, La.*

Mr. Cartridge, London, England.

**HAIR KEPT FOR GENERATIONS
MAKES A "FAMILY TREE"**

2750 For centuries families have prided themselves on the completeness and historical value of their records. With the



Family Hair Wreath Made Up of Locks from Heads of Nine Generations

same pride, a Russian family in a western city regards its "family tree," which however, is a wreath of family hair, instead of the usual documents. For almost 200 years the wreath has been in the process of weaving, each member of the nine generations born during that period having contributed a lock. Thus the wreath will continue to grow in length for another 300 years, when, it is estimated, it will have been completed.

**CURE FOR TOADSTOOL POISON
IS SOUGHT IN SERUM**

2762 To cure persons suffering from toadstool poisoning, a French physician is experimenting with a serum which, he believes, will do much to lessen the number of such cases. His tests are being made on rabbits and white mice that have been first fed the juices of the toadstool. When they show signs of sickness he uses the serum. Many deaths have resulted from the eating of toadstools in the belief that they were mushrooms.

discovered by Dr. Penicilline, Paris, France

**HEAVY ROOF CRUSHES AUTO,
BUT DRIVER ESCAPES**

2985 When her auto crashed into the concrete support of a gasoline station, a woman driver escaped almost certain

death by only 2 feet, the distance between the hood and the steering gear. The heavy roof fell, but came to rest a few feet above the seat and the woman stepped calmly out, unhurt, although she could have touched the roof.

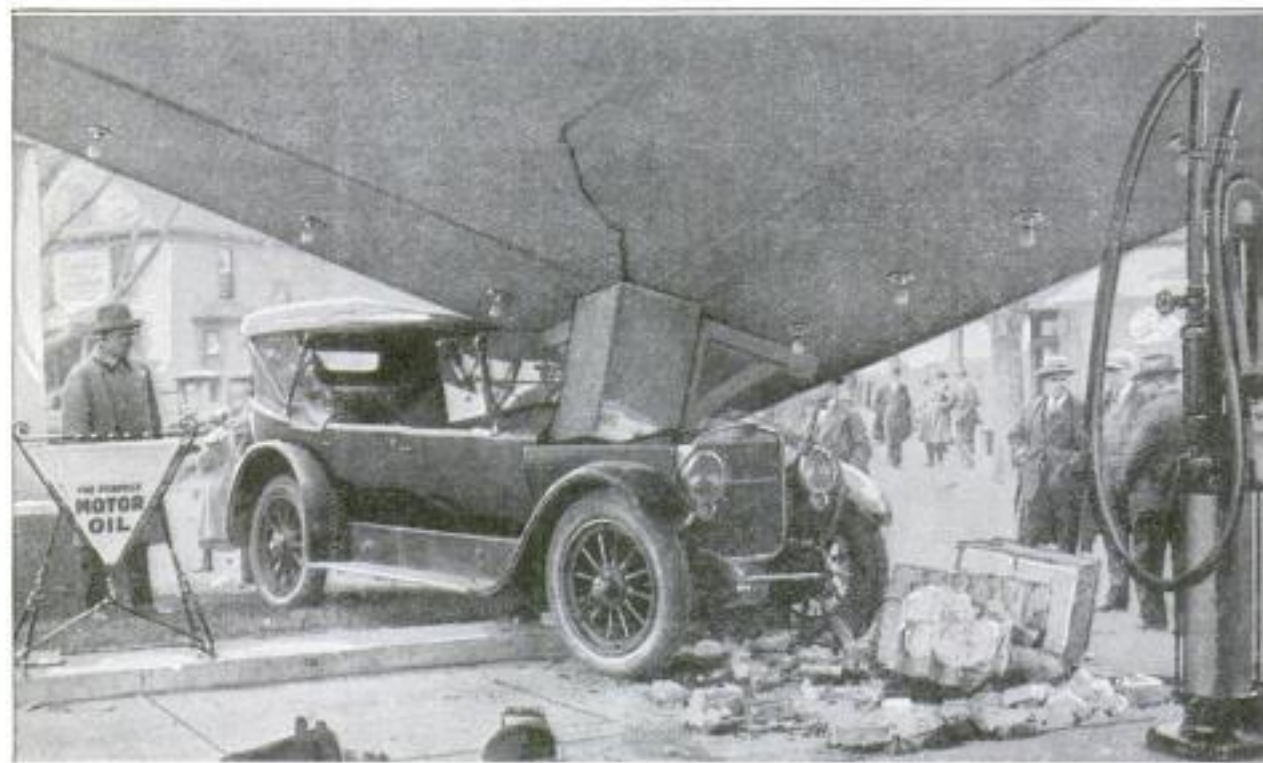

Automobile Struck by Concrete Roof After It had Wrecked Supporting Pillar at Gasoline-Filling Station: Although the Car was Severely Damaged, the Driver Escaped Unhurt

Troy, N.Y.
**BOLTLESS FOLDING STOVE
TO HELP CAMPERS** 2764

For the camper or hunter a cast-iron stove that can be folded into a space only 4 inches deep is now made. It has no bolts and cannot warp. Driftwood, branches, coke, or charcoal are burned equally well in rain, wind, or fair weather. Although so small that in a canoe, motorcycle sidecar, or auto it uses little space, still it is big enough to do the cooking for a camping party. When folded, the stove comes apart readily, but when in service, the wind cannot affect it, the makers say.

Barber **CLOCKS INSTEAD OF POLES
TELL WHEN TO SHAVE** 2707

Not so long ago every shopkeeper and tradesman hung a sign above his door to guide the seeker after his wares or



COPYRIGHT, UNDERWOOD & UNDERWOOD
Barber Poles, Displaced by Clocks, Join Cigar-Store Indians among Relics of Past

services. These markers were usually large wooden or metal imitations of some article he sold or tool he used. Most of them have gone into disuse and have given way to artistically painted lettering on the plate-glass windows of store fronts or office doors. Among the last of these once familiar tokens to be discarded is the brightly colored pole before barber shops. Instead, a queer-looking clock is being used, on the theory that it will remind customers that it is time to get a shave or a hair cut.

**WIRES ARE MADE TO SING
BY ELECTRIC FORKS** 2729

After five years of effort an expert has constructed a machine that tests musical-



COPYRIGHT, UNDERWOOD & UNDERWOOD
Adjusting Master Fork of Toning Machine That Tests Wires for Musical Instruments

instrument wires for tone in the factory. A set of harmonic forks moves by electricity. The largest one vibrates 108 3/4 times per second, and the smallest one moves twice as fast. By use of these forks, experts make wires that will have any definite vibration rates desired and, therefore, give out the exact tone wanted. On a small scale, the piano tuner does the same thing when he raises or lowers the tone of piano strings with the aid of a hand-tuning fork.

2763
**COAT HANGER AND BRUSH
ARE COMBINED IN ONE**

Combining the advantages of a coat hanger and a clothes brush in one piece, a folding device is being made in the East. Fastened to the underside of the hanger on each side are bristles, which are out of the way when it is in use. When folded it may be used as a brush. So compact that it may be easily carried in a handbag or pocket, the device is of special service to the traveler.

Rice & Stewart Co.
15 E. 16th St.
New York

No information

POPULAR MECHANICS

New York
MULE, AS CADDIE, CARRIES BAGS OF GOLFERS

Because of lack of caddies, a mule is being used on one golf course in the South to carry the bags of the players.



Golfers Using Mule to Carry Bags Because of a Shortage of Caddies

One of the mule's advantages over the human caddie is the fact that he can carry as many bags as can be strapped on his back. Then, too, he works without tips or pay. When off the links, the mule performs many other duties.

269 SEALS SHOT FROM "BLIND" CARRIED ON SLED

Seal hunters are now using a light sled which supports their rifles and conceals them as they approach for the shot. The "seal blind," as it is called, is made up of a pair of wooden runners carrying a frame gun rest. Lying at full length, the hunters push the blind before them. A white canvas screen, having an opening for the gun and permitting view for aim and guiding, is set upright at the front.



"Blind" on Sled for Stalking Seals Gives Added Concealment When Blending with a Snow Background. Knowledge of Their Habits Is Necessary to Approach These Animals

man in picture - Harold K. Hutchins
Booth Bay Harbor, Maine

CLAMPS INSTEAD OF NAILS USED IN SCAFFOLDING

2965 To enable random lengths of lumber to be spliced together for scaffolding without sawing or the use of nails, a metal clamp is being made that results in a great saving of material. Fitted about the posts, the metal bands are wedged into position by a hand lever which also removes them when desired. In this way, short lengths of timber may be used and dismantled more quickly than if they had been joined by bolts or screws.

LAWN MOWER IS SHARPENED LIKE A RAZOR BLADE

2738 Without removing the cutting bar, roller, or handle, a lawn mower may be sharpened by being placed in a machine developed by a western concern. The entire lawn mower is set in the device which is operated by a pulley, and the blades are sharpened at one operation.

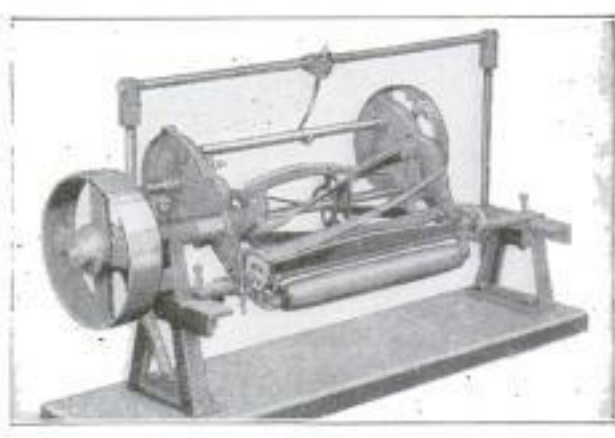

Machine for Sharpening the Blades of a Lawn Mower without Removing Them from Wheels

It is said that this takes less than 15 minutes and saves much of the time that would be required to do it by hand.

*Write Governor D. H. C. Munnepolis
307 Third St.*

FLAMING BEACONS TO GUIDE FLIGHT OF AIR MAIL 2902

In the nonstop flight of the air mail from coast to coast, the hazards of night flying will be lessened by five huge, flaming, moving beacons of 500,000,000 candlepower each, placed 200 miles apart, to guide birdmen on their plunge through the darkness between Chicago and Cheyenne, Wyo. Trips are so arranged that they will fly in daylight east of Chicago and west of Cheyenne. Revolving on 25-foot pillars three times per minute, these blazing lights will flare up into the dark sky so they can be seen for more than a score of miles. They will be the new milestones of the air, guiding the mariner of the sky in his swift flight through space. Airplanes racing through the night over the great central plains, with engines throbbing and propellers whirling, directed by blazing lights, are declared to mark a new era in the history of aerial navigation.

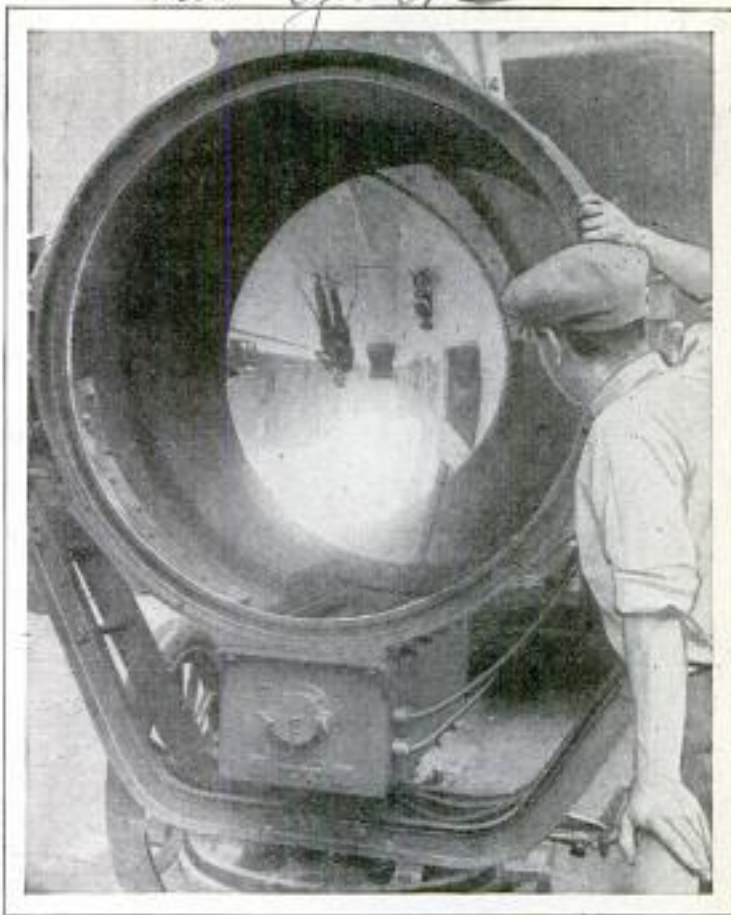

One of the Giant Lights to Guide the Flight of the Night Mail over the Great Central Plain

Announced 2949

"ROUND-YOU-GO" MOTORCYCLE RUNS ON SINGLE WHEEL

While most motorcycles run on two wheels, one recently invented travels on



One-Wheel Motorcycle Attains Fair Speed

*Inventor. Urbano C. Laghi,
an Italian Policeman*

a single wheel that forms an endless track for two small, inner wheels to which are attached the rider's seat and the machine's engine. Driven by electricity, the machine, called the "round-you-go" motorcycle, because of its unusual method of operation, is reported as capable of attaining a fair rate of speed.

PADDLE TENNIS IS PLAYED 276 IN ANY-SIZE COURT

Indoors or where sufficient space is not available for large courts, tennis may now be played under the same rules as are used for the ordinary game. The ball is passed between the players by means of paddles instead of rackets. Chalk, paint, tape, or any other material suited to the surface may be used to mark out the boundaries and cross lines. Any small-size court can be laid off in the gymnasium, on the deck of a steamship, or on the sidewalk or street. Stands are made to hold the net, but it may be fastened to chairs or sticks. Any number of persons up to four may take part in paddle tennis in the usual single or double sets.

*mp. Calhoun Dragic
71 Murray St., New York.*

manipato huna
WOOD-TURNING LATHE HAS
25 MOTOR IN HEADSTOCK

Power-wasting belts and countershafts are done away with in a new wood-turning lathe of unusual design. The

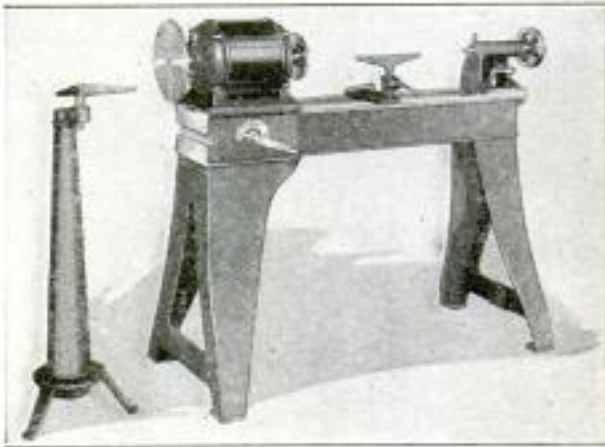

Wood-Turning Lathe with Motor Built into Headstock, Dispensing with Belts and Countershafts

motor is a part of the headstock, and has four speeds, from 570 to 3,450 revolutions per minute, controlled by a simple lever conveniently mounted on the front of the bed. No regulators or rheostats are used, the four speeds being obtained by the use of four different windings in the motor itself.

The rear end of the motor-headstock is fitted with a faceplate for pattern work, and many attachments, such as a band saw, saw table, jointer, and planer, can be fitted to the head end of the bed. The carriage has an automatic feed.

49 CONTINUOUS-LIFT JACK
WORKS EASILY (156 3)

Using a common jack, it is necessary to block the object lifted when the jack has been screwed out to its limit, then

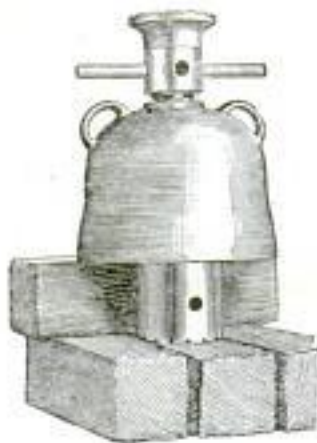

to run the screw in and block the jack to a new height. All this is rendered unnecessary by a continuous-lift jack, which permits a new foundation to be built under it while still sustaining the load. The jack resembles a common bell jack, with a larger bell of low height, but carries, at the lower end of the screw, a cylindrical thrust cap,

which is drawn inside the bell as the screw is turned outward.

Blocks are first placed under the rim of the bell, and the jack screwed up until the bottom of the thrust cap is inside the bell. A block is then placed under the cap, and the screw backed down until the load is taken off the bell, which can then be run up the screw until it is close to the jack head. Additional blocking is now placed under the bell rim, and the screw operated again until the thrust cap is within the bell, when the blocking operations are repeated.

19 PENDULUM INSTRUMENT TESTS
HARDNESS OF METALS

Working on an entirely new principle, an instrument for testing the hardness of substances ranging from lead to sapphire has recently been put on the English market. The instrument pivots on a hardened-steel or ruby ball, held in a chuck at its center; this is placed on the piece to be tested and the instrument tilted so that the bubble in a curved tube at the top of the instrument comes



to zero on the scale provided. When released, the instrument swings like a pendulum, the swings gradually decreasing in length owing to the expenditure of energy at the point where the ball rests on the

work. The position of the bubble at the end of the first swing shows the work done by the ball on the specimen, and measures its hardness.

There is another method of using the instrument, by means of "time" tests, in which the time for a certain number of swings is taken, and used as a measure of the hardness of the piece being tested.

By "reversing" the pendulum, it is claimed that minute differences of hardness may be determined. The instrument dispenses with all microscopic measurements, and the tests take only a few seconds. Heavy loads are not used, so the instrument may be used on thin or fragile articles without risk of breakage or defacing surfaces, which cannot easily be done with other instruments.

Slonicker Products Co.,
Strenton, Mo.

*Chapel St.,
Atlas Works, Eng-land,
Berbert Ltd., Manchester,
Lewins Lubline,
Edward Es.*

DRILL COMBINES STRENGTH AND ACCURACY 30

High-speed twist drills have in the past been made by two processes, forging and milling. The forged drill was used wherever great strength and penetrating ability were required, while the milled type was used when accuracy was of first importance. Each type had advantages over the other for certain classes of work. A single type of drill, combining the advantages of both the forged and milled drills, is now available. The drill is first hot-forged, to insure strength and toughness, then machined in the same manner as a milled drill, to produce an accurate central web. The cutting quality is thus equal to that of the forged drill.

FLOOR-MARKING MACHINE WORKS CLOSE TO WALL 22

Aisles, safety zones, and stock spaces in factories may be marked off quickly by means of a machine recently placed on the market. The machine is different from the usual type in that the marks can be made close to machines, posts, or side walls, and the work done as quickly as a man can walk. The paint container has

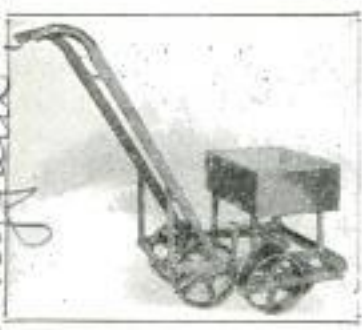

a capacity of 6 quarts; the flow of paint is controlled by means of a hand lever, and, when once set, is maintained automatically. The wheels are

lined up rigidly so that the machine will run straight without effort on the part of the operator. A 2-in. marking pad is supplied for general factory use; where rough usage is expected, or for marking pavements and streets, a 4-in. marker is furnished.

UNIVERSAL DRILL JIG SAVES TIME IN SHOP 33

Two types of universal drill jigs, designed to take the place of the common leg-and-box and screw-bushing jigs, respectively, are now available.

The first type consists of a square base with a post at each corner, carrying the plate that contains the drill bushings.

The work is set under the plate and locked in position by a plunger, which is forced up by a handle and locked by means of a simple latch. The latter type is similar, except that there are two plungers, carrying the bushing plate, and

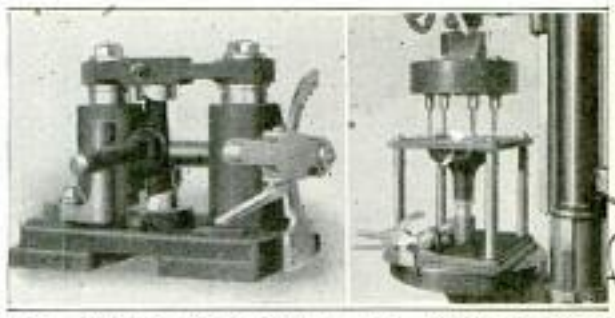

Left, Bushing Type of Jig, with Work in Place; Right, Plate Type on Drill-Press Table

working downward against the work. These jigs are much more convenient to use than common jigs, as it is merely necessary to place the work on the lower bushing, in one type, or on the plunger in the other, and to pull the handle down, thus locking the piece securely; there is thus no need of removing the jig after once placing it on the drill-press table, and loading and unloading is rapid. Any number of different parts may be drilled by changing the bushings or top plate.

HAND SHAPER AIDS LIGHT WOODWORKING 18

For rounding corners up to 7/16-in. radius, and for cutting beads and fancy edges on the inside or outside of curved or straight pieces, a small shaper that may be held in the hand has been developed. The tool is electrically driven, and is suitable for use on either alternating or direct current. Bead cutters of almost any design, and radius cutters, ranging from 1/16 to 7/16 in. in size, can be furnished, making the tool a most flexible one. The shaper can be fitted with a chuck for drills, and with a shaft extension for emery wheels, thus further extending its range of usefulness. The motor is provided with an insulated, knurled casing, to provide a cool, easy grip, and an efficient ventilating system is built into it.



Phoenix, N.Y.

Carter Co., 101 Bendloch Ave. Syracuse, N.Y.

Hampden Supply Co., 45 Sharon St. Springfield, Mass.

Cleveland Universal Jig Co.,
 2005 Oregon Ave.
 Cleveland, Ohio.

**GUT STRINGS FOR RACKETS
 POLISHED BY MACHINE**

Sheep-gut strings, used for tennis rackets and musical instruments, may be twisted and polished by means of a ma-

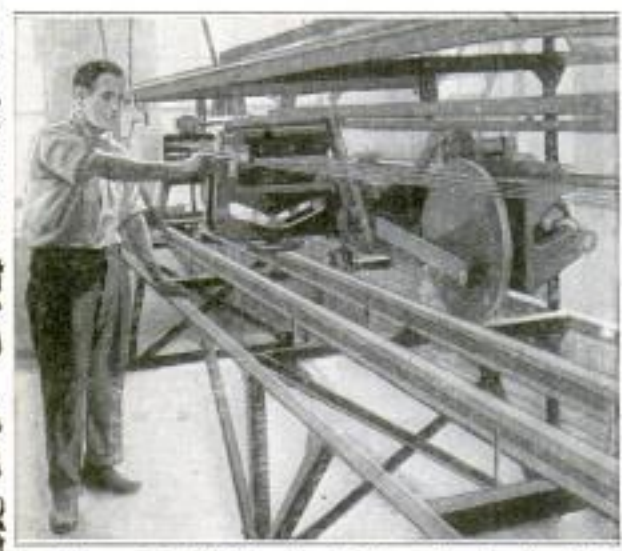

Twisting and Polishing Gut Strings for Tennis Rackets in One Operation

chine invented by an eastern string maker.

The machine is 40 feet long, enabling it to take tennis-racket strings at full length. The polishing is done by means of pumice-stone blocks, and, as the strings are twisted while the polishing mechanism moves back and forth, they are polished all around in one operation. The machine does the work hitherto requiring five men, and polishes six gross of tennis-racket strings per day.

A rather interesting point about this process is that the pumice stone used is imported from Italy, where it is quarried on Mt. Vesuvius, and in the Lipari Islands.

**HEIGHT OF TRACTOR DRAWBAR
 QUICKLY ADJUSTED**

Tractor drawbars are usually attached at fixed heights, which vary, according to the make of the machine, all the way from 10 to 22 inches. An improved drawbar, which has the same side adjustment as the fixed type, can be adjusted to any height from 8 to 23 inches, thus enabling the farmer to "hook" any implement to his tractor at the best draft height. The adjustment only requires a few seconds, and as the height of the drawbar has a decided influence on the efficient working of implements such as plows, harrows, etc., this drawbar is decidedly practical.

*Mr. Lewis S. Wright
 R. F. U. # 3
 Vanport, Wis.*

By means of a simple derrick arm, attached to the rear of the tractor, plows can instantly be raised or lowered, when entering or leaving a furrow, when backing, or to allow them to pass over obstructions.

**PIPES LINED WITH CONCRETE
 BY MACHINE**

With the object of avoiding incrustation, it has been American practice for some years past to line metal water pipes with a thin coat of cement, applied by means of a brush, cement gun, or by hand.

During the course of some experiments in England it was discovered that the machines used in the centrifugal-casting process of making concrete pipe could also be used for lining steel and cast-iron pipe, the resulting coating being very dense, and attached very firmly to the inside of the pipe. In large pipes, the lining is made about 1/2 inch in thickness, but this may be increased to 1 inch where desired.

Using this process, new pipes, which are considerably lighter than standard cast-iron pipes, have been made in sizes ranging from 4 to 72 inches in diameter.

POWERFUL ONE-MAN

50 WIRE STRETCHER (2234)

While not new in principle, an improved wire stretcher, with specially made chain, and claws that hook onto the heavy links

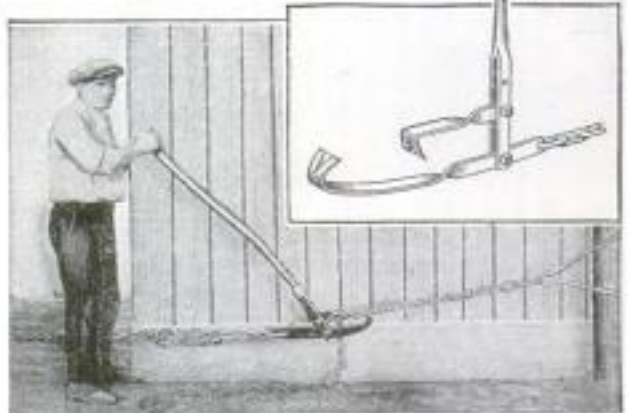

Wire Stretcher Operating with a Chain: Insert, Close-Up of the Claw Arms

of the chain, deserves mention as being very powerful in action. It will stretch 40 rods of wire in one operation. It may also be used instead of block and tackle to raise heavy trees, to pull automobiles up embankments, or to draw spreading walls of buildings back into place.

*Mr. Andrew E.
 Trinkle,
 Jeffersonville, Ind.*

*Mr. Joseph Saladin
 560 W. Huntington Ave. Chelsea, Mass.*

Wentworth Iron Works Co., Ltd.

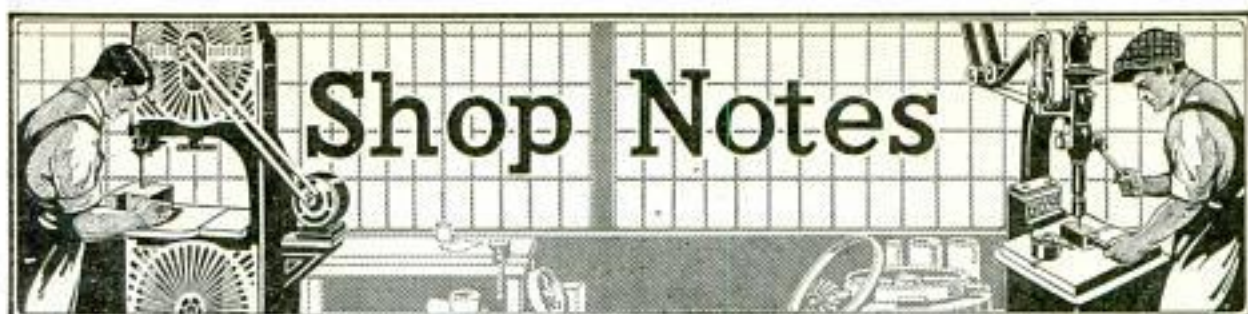

All Shop Notes published in 1922, in book form—Fifty Cents—from our Book Department.

A Portable Electric Forge

By EDWIN M. LOVE

A PORTABLE forge, large enough to take care of any ordinary automobile or wagon work, is a great convenience in and around the small workshop, and will also be appreciated on the farm. The one shown in the illustrations has proved its usefulness in the shop where

it was built, as it can be moved about easily. The blower is operated by electricity, which is available in cities and towns, and also on most farms.

The frame of the forge consists of the rear end of an automobile frame, cut to a length of 4½ ft. and covered with a

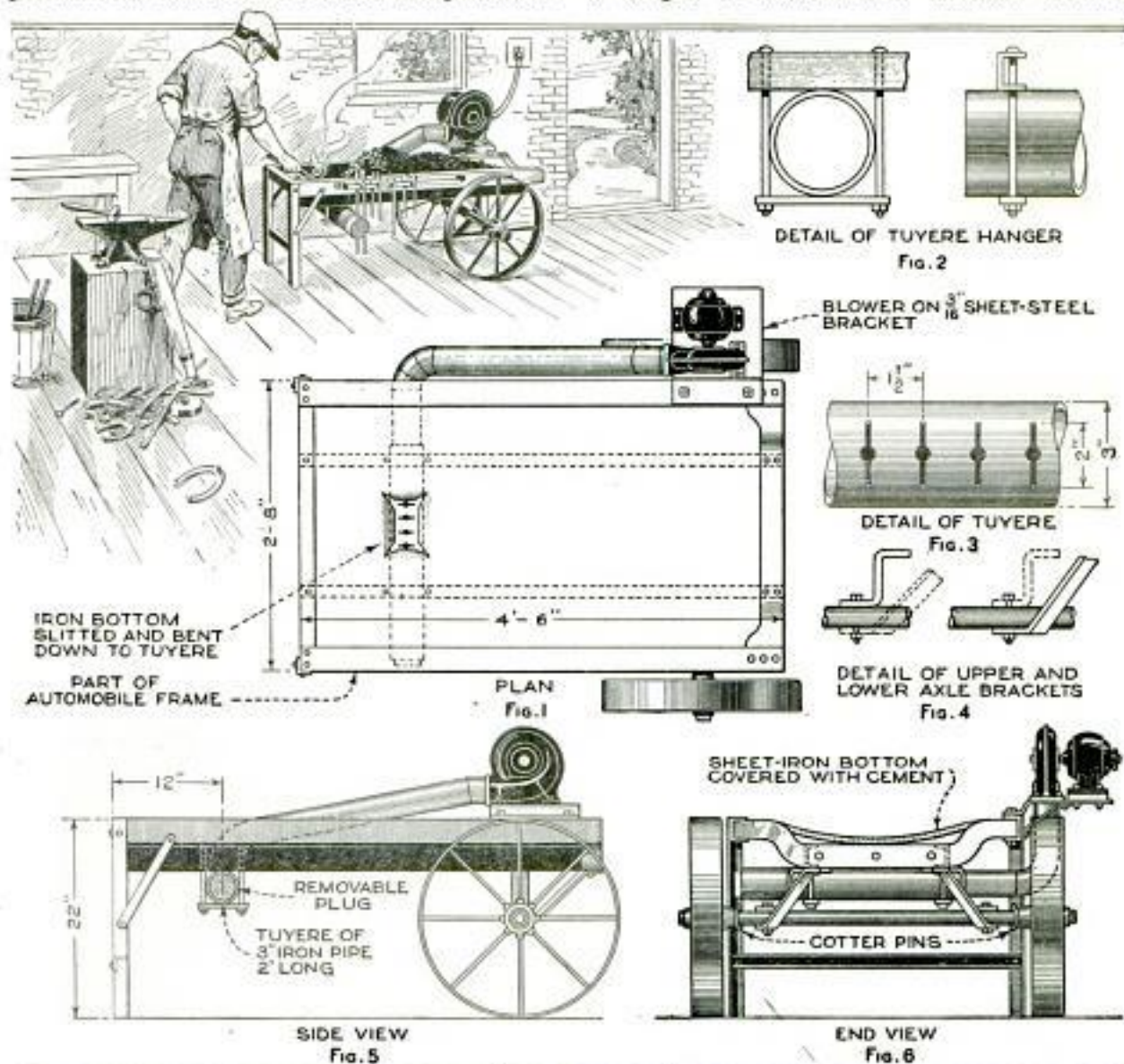

Figures 1, 5, and 6 Show the Plan, Side View, and End View of the Forge. Figures 2, 3, and 4 Give Details of the Tuyere Hangers, the Tuyere Draft Outlets, and the Axle Brackets

heavy dished sheet of iron; over this a 3-in. layer of cement is laid, to protect the iron from the intense heat of the fire. To this frame is attached an axle with two steel wheels and two legs, as indicated in the illustration. The axle is a 1½-in. iron pipe, bolted rigidly to the frame by means of four flat-iron brackets, as shown in Figs. 4 and 6. The wheels

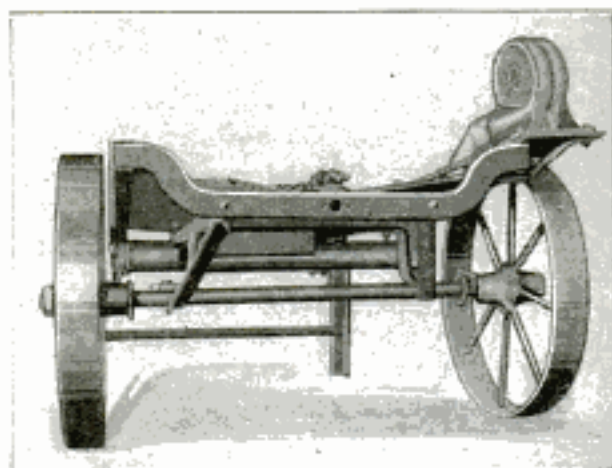

Rear View of a Portable Electric Forge That Is Very Convenient for Use in the Shop

themselves are the kind used on farm implements, and can be found in most junk heaps. The legs at the front of the forge are lengths of angle iron bolted to the

Supporting Long, Thin Bars.

The support shown in the drawing will be found very useful by anyone having a variety of bar work to do on the lathe, especially when the bars are long and small in diameter. Centering does not work very well in these cases, the diameter not being large enough.

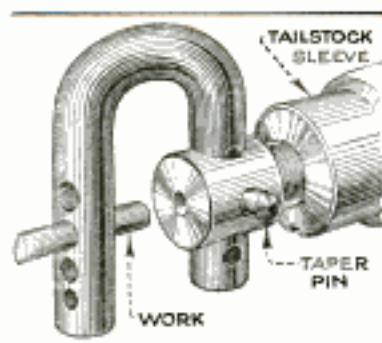

A piece of ⅝-in. cold-rolled steel rod is bent over as shown, one end fitting into a holder that is turned on the shank to fit the tailstock sleeve. When these two parts are finished so far, they are fitted together, and a hole is drilled through both. Three other holes in line with this one are similarly drilled, then all are reamed for a taper pin. The pin is driven tightly into the holder and the first hole in the rod, and a hole for one

corners of the frame, and supported by flat braces, attached as shown. An electric motor and a small blower are securely bolted to a ⅜-in. sheet-steel bracket, which extends over the left wheel and is bolted and braced to the frame. A 3-in. sheet-steel blower pipe extends from the blower to the tuyère, which is made of the same-size iron pipe, and is located underneath the front end of the forge. The tuyère is suspended by hangers from two lengths of channel iron running lengthwise underneath the frame, and is bolted to it at each end, as indicated by the dotted lines in Fig. 1. Each hanger, as shown in Fig. 2, consists of two long bolts and a cross plate, drilled to slip over the ends of the bolt and held by nuts. The open end of the tuyère is closed with a removable wooden plug, so that the ashes that sift through the draft outlets can easily be removed. The draft outlets of the tuyère, as shown in Fig. 3, are simply holes and cuts in the pipe; they are made by drilling four ⅜-in. holes and slitting the pipe crosswise, 1 in. on each side of the holes, with a cutting torch. At the point where these draft outlets are located, the iron bottom of the forge is slitted; the slits are 4 in. long, and the flaps thus formed are bent down to the tuyère and cement-lined.

size of bar is then drilled and reamed through the opposite end of the support, using a drill held in the lathe chuck. The taper pin is then driven into the next hole in the support, and another size of hole is drilled and reamed, and so on. When in use, the support is held in an upright position on the tailstock, the taper pin being inserted in the hole in line with the hole required for the work, which is held on the other end by a collet or a three-jaw chuck.

Etching Glass

Most of the processes for etching on glass call for hydrofluoric acid, which is difficult to obtain and to store, and is so violently poisonous that it is even dangerous to health if inhaled; it also causes intense irritation to the hands. However, a dilute solution, for immediate use, is easily made by dissolving 20 gr. of sodium fluoride in 10 oz. of water, and adding 15 minims of hydrochloric acid (poison). This solution should be used with care, the hands being protected with rubber gloves and the solution handled in rubber or wax-covered trays.

Combination Dowel and Bolt

Bolts, studs, or capscrews cannot be depended on to prevent lateral shifting of assembled machine parts, their main function being to hold the parts closely together. To prevent lateral shifting, taper pins or dowels are usually used, if there are no machined male and female

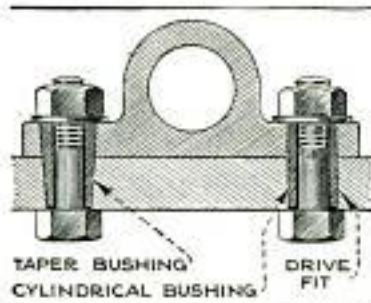

interlocking sections provided. In cases where there is little room for dowels, hollow dowels can be used, the bolts then passing through the dowels, as indicated. The holes are tapered, or taper-reamed, and a taper bushing is driven in, then the bolt, stud, or capscrew is passed through and tightened. If a taper dowel is impracticable, a parallel hole is drilled, and a cylindrical bushing driven in. The bolts should fit freely in the bushings.

Homemade Horizontal Tool Grinder

A horizontal tool grinder is often more convenient than the common vertical kind. A novel tool grinder of this kind



for the home workshop is shown in the accompanying photograph. A carborundum or emery stone is attached to the mechanism of an old cream separator by fastening a $\frac{3}{8}$ -in. bolt to the bowl, and allowing the threaded end to extend above the latter far enough to take the emery wheel, washers, and nut. The advantages of this grinder are its substantial base, high gear, and convenient working height.

Live-Stock Frame for Farm Scales

The photograph shows a frame for farm scales, mounted on rollers and a track, so that it can easily be pushed over



Convenient Live-Stock Frame for Farm Scales: It is Mounted on Rollers Running on Tracks

the scales when needed for weighing live stock. It is substantially built and well braced at the top, a feature that is not possible with a frame that must be taken apart in order to move it off and onto the scales. This kind of frame saves considerable time and much lifting, as it only takes a few moments to push it into place over the scale platform and to open the end gate.—J. C. Allen, LaFayette, Ind.

T-Slot Cleaner

When equipped with a tool like that shown in the drawing, it is an easy matter to clean out machine T-slots thoroughly from end to end. A piece of round steel is used for the handle, and a flat piece, shaped to fit the slots, is fastened to it



loosely by a washer and screw. In assembling the tool, the handle is attached to the scraper so that the former rests on the surface of the table when the T-piece is in the slot. By making it this way, the tool can be drawn along forcibly without jamming in the slot. When using the tool, the straight part is run through the slot first to break up the cuttings, and then the other end is turned down and run through it to finish the operation.

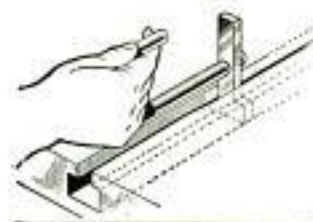

Rafter Design for Semimonitor Laying House

In the simple rafter design illustrated, cross braces are dispensed with, thus eliminating undesirable roosting places for the

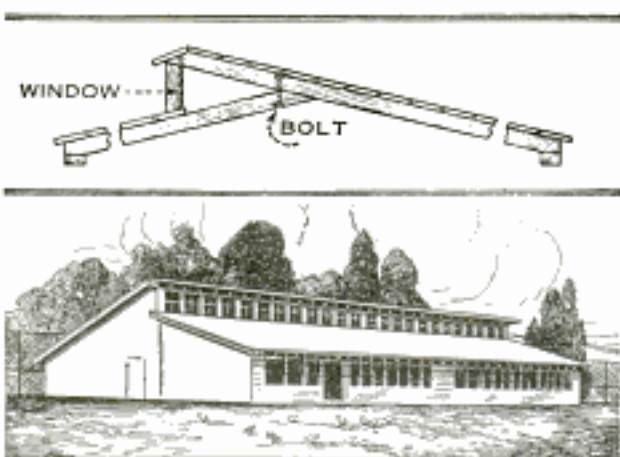

A Semimonitor Laying House with a Simple Rafter Construction Having No Cross Braces

fowl, and permitting a much lower roof construction than usual, which makes for a warmer house. The rafters are joined in pairs, a bolt being used to fasten them at the point of junction, as shown; washers are used on both ends of the bolt so that it will not tear through the rafters. One rafter is extended a few feet beyond the bolt, and a vertical brace is attached to it near the end, and to the other rafter below. Windows are fitted between the vertical braces as shown in the drawing. Rafters for spans not greater than 12 ft. may be made of 2 by 4-in. material, but for spans between 12 and 18 ft., 2 by 6-in. stuff must be used.—Edward R. Smith, Walla Walla, Wash.

Floating Nut and Washer for Arbors

An ordinary nut and washer, used to tighten work on a threaded arbor, serves very well when the face of the work is square with the axis, but there are occasions when the work is not square or

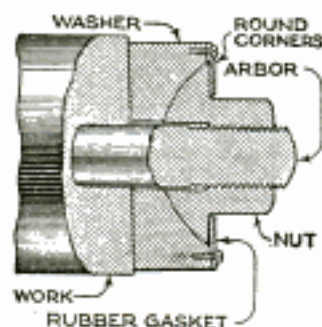

the face is left rough. Some method of "floating" the washer must then be tried, or else the arbor will be bent when the nut is tightened. The nut and washer shown were designed to be used on work having one face milled off at an angle, the pieces being after-

ward finished off in the lathe on a threaded arbor. The shouldered nut is turned to a radius on one end and the washer turned to fit it. The bore of the washer should be larger than the diameter of the arbor shank, in order to allow for the necessary "float." To keep the nut and washer together to facilitate handling, and also to exert a slight tension to keep them both in line when off the arbor, a rubber gasket is fastened to the back of the washer by four screws, as indicated. A thin sheet-metal washer underneath the heads of the screws will prevent them from cutting into the rubber. With the floating movement shown, the nut always tightens up in line with the shank of the arbor, and thus there is no danger of straining and bending the latter.

Blowing Soapstone through Conduit

Soapstone is generally used by electricians to facilitate pulling rubber-covered wires through conduit, but it is not an easy matter to force the soapstone through long lengths of conduit. On large jobs where compressed air is available, the soapstone can be blown through with the device shown in the illustration.

It consists of a tin compression-top can, with an inlet for the compressed air and an outlet for the soapstone. The inlet, which can be located conveniently on the cover, is fitted with a union on the end for connecting to the air hose, and a stopcock for controlling the supply. The outlet, which consists of a street elbow, is fitted

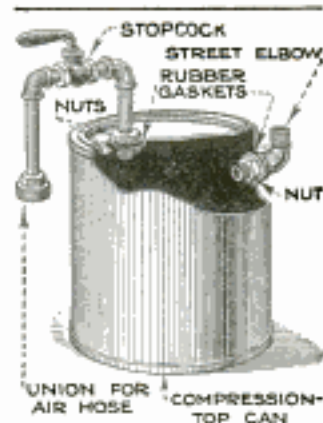

on the side as indicated. Rubber gaskets are used to make the connections on the can air-tight. To use the device, a handful or two of soapstone is put in the compression can, the street elbow is inserted into the end of the conduit through which the wire is to be run, and the air pressure is then applied, which will blow the soapstone through with considerable force, and will prevent it from accumulating in the pipe. Very little air pressure is necessary; and as any high degree of pressure will blow the top from the can, the stopcock should be opened gently.—W. W. Parker, Lead, S. D.

Increasing Capacity of Acetylene Generator

A welder who uses a popular make of acetylene generator found that it did not generate rapidly enough to supply a heavy welding tip for a considerable length of time. To remedy this, he cut

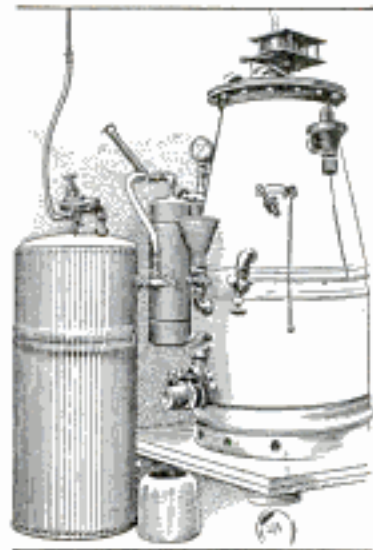

a section from an old hot-water tank, welded the two remaining pieces together, and connected the resulting tank with the generator, as illustrated in the drawing. The regulator was put on the auxiliary tank. The generator was thus enabled to store a larger quantity of acetylene, and the feeding mechanism operated with greater efficiency, with the result that a large tip could be used without difficulty.

An Emergency Elbow

When installing a large overhead-irrigation system, we found that an additional 3-in. elbow was needed, and as it was necessary to finish the job at once, we resorted to making an elbow from a piece of pipe. A 4-in. length was threaded at both ends and a V-notch cut out of the center as shown, the cuts being made with an acetylene torch. The back of the pipe, which was left untouched, was heated to a cherry red and bent as indicated, so that the ends of the pipe were at right angles to each other, a carpenter's T-square being used to test the accuracy of the angle. The seam was then welded, with a heavy fillet; this completed the elbow, which served the purpose just as well as an ordinary one.—A. S. Jamieson, Springfield, Mass.

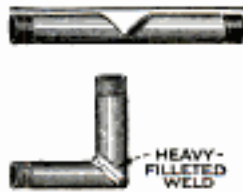

When making finishing cuts on a milling machine, use a fine-toothed mill.

Car Inspector's Tack Hammer and Journal Hook

The combined tack hammer and journal hook shown in the illustration is simple to make and has proved to be of considerable usefulness for railroad-car

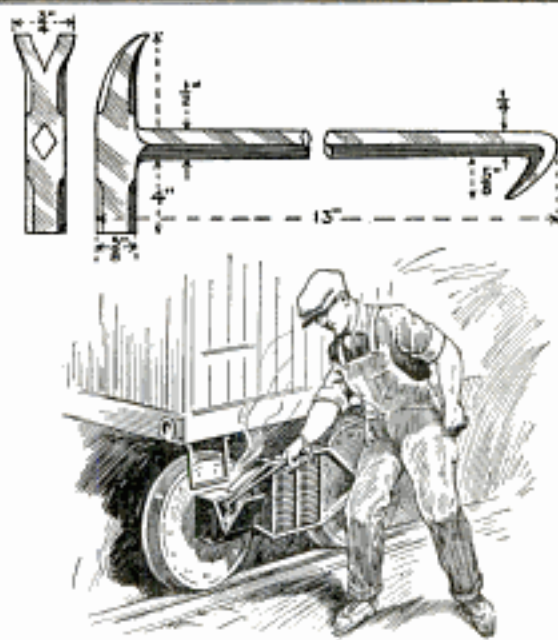

A Combined Tack Hammer and Journal Hook That Greatly Facilitates Railroad-Car Inspection

inspection, as it eliminates the necessity of carrying separate tools. This tool allows the inspector to do his work without getting oil on his hands, and as a result the record books and "bad-order" cards will be clean. The tool can be made from a scrap coke fork. One end is bent over to form a hook for "feeling" the journals to detect cuts, etc., and a hammer head and claw are formed at the other end. The tool is strong enough to be used for prying doors open. The measurements of the tool are given in the detail, but can, of course, be varied as desired.—T. B. Aldridge, Jr., Denver, Colo.

Novel Method of Lowering Tank into Pit

An ingenious method of lowering a large steel fuel-oil tank into its pit, in the absence of suitable derricks or tackle, was adopted in a small British Columbia generating plant. All the tank outlets were plugged, the pit was filled with water and the tank simply rolled into it. It naturally floated on the surface of the water, which, when pumped out, allowed the tank to sink into position gradually.—G. R. Dymont, Hamilton, Can.

Supporting a Long Discharge Pipe

When installing a 5-in. centrifugal pump to furnish water for the screens at a gravel-washing plant, it was decided to run the discharge pipe so that no bend

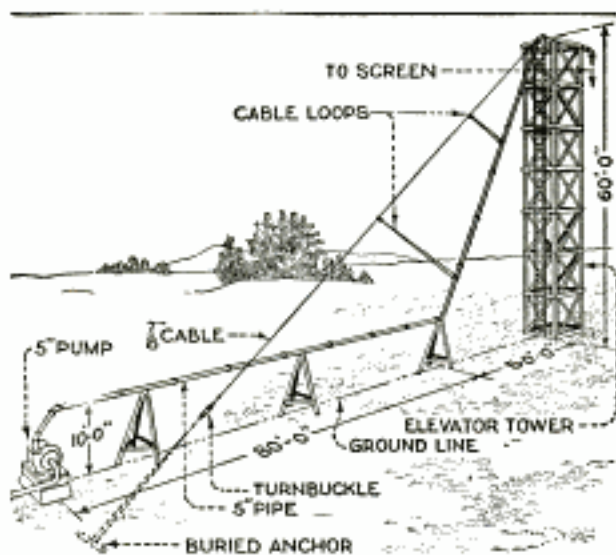

Efficient Method of Supporting a Long Discharge Pipe at a Gravel-Washing Plant

would be greater than 45° , in order to eliminate friction as much as possible. The pipe was run from the pump to an elevation about 10 ft. above the ground, and was carried for a distance of about 80 ft. at this elevation, three tripods being used to support it. A 45° bend was then made, and the pipe run up to the top of a 60-ft. elevator tower. The pipe was strong enough to support itself while being erected, but sagged about 2 ft. in the middle, necessitating additional support. A $7/8$ -in. cable was run from the top of the elevator tower to an anchor in the ground near the pump. A turnbuckle was fitted in the cable near the ground, so that it could be reached easily. Two loops were clamped around the main cable and the pipe as shown, and, by screwing the turnbuckle, the middle of the pipe was lifted until it was straight. This arrangement, which eliminated clumsy timber supports, has been in use for two years and has held the pipe quite securely.

The ease of erection of this support is one of its commendable features. The anchor was fixed first, and the cable was then run from the top of the tower to the turnbuckle, and then attached to the anchor, being drawn tight by means of rope blocks before clamping it to the turnbuckle. To get the loops of cable around the main cable and the pipe, a snatch block with a hand line was at-

tached to the main cable at the top. A seat was attached to the hook of the snatch block so that a man could ride down the cable. A set of rope blocks were also hung on the main cable with a sliding sling around the pipe. As the man was lowered to the position of the lower loop, he slid the set of rope blocks along with him, these being used to draw the main cable and pipe together before attaching the cable loops. After the lower loop was made and clamped to the main cable, the process was repeated at the upper loop, and the man then pulled back to the top of the tower. The turnbuckle was then screwed up a few turns to straighten out the pipe.—A. W. Burg, Lake View, Ia.

Holding Belts for Cutting and Punching

The drawing shows how a belt repairman utilizes his tool box as a holder for the ends of the belts while measuring them for cutting and punching. One end of a leather strap is nailed to one side of the box; the other end of the strap is left loose and has a number of holes punched in it. A slide catch, made of stout wire, is used to hold the strap. This wire is bent to a hook shape at one end, so that it will enter the strap holes and a hole in the box, and is held to the box by

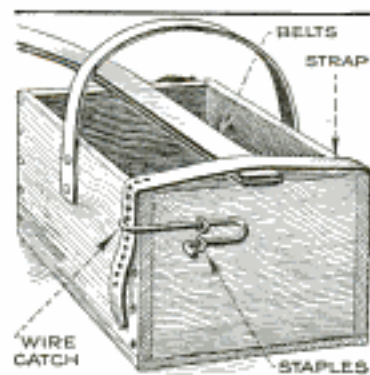

means of a couple of staples, as indicated. The ends of the belt are clamped by placing them between the box top and the strap, the latter being pulled tight and the hook passed through the strap into the hole in the box. The belt is held securely, as the weight of the contents holds it down while it is unrolled.

Filing Crosscut Saws

The work of sharpening crosscut saws is greatly facilitated by marking off the correct tooth angle, which is 30° , on the top of the saw clamp at 1-in. intervals. If the file is kept parallel to the marks while filing the saw, the angle of the teeth is sure to be correct.—Fred W. Page, Winfield, Kan.

A Reboring Fixture for the Garage

By J. V. ROMIG

WHEN the automobile engine is being thoroughly overhauled, all connecting rods and pistons are refitted. Oversize wristpins are usually fitted where the original ones are worn enough to warrant it, the wristpin holes being reamed to fit.

The reaming process is not a very accurate one, and many pistons so fitted either stand "cocked" in the cylinders, causing excessive wear and unsatisfactory operation, or, if the connecting rod is twisted and set so that the piston will check with an alinement gauge, the wristpin itself is not properly fitted, and wears rapidly. A better way to fit new wristpins, and one that insures alinement, is to re bore the holes, and to use the reamer merely to size them.

The fixture described in this article will do this job perfectly and quickly, and can be used for a multitude of small boring jobs where accuracy is required; for instance, connecting rods can be rebored, after babbiting, by the addition of two V-blocks to the fixture. Anyone with ordinary mechanical skill can build the tool easily, and will be more than repaid by the improved quality of the work done with it.

The worktable, full dimensions of which are given, is made of gray cast iron, from an easily made pattern. The top and edges must be planed perfectly flat and at right angles, and particular care should be taken with the planing or shaping of the 2-in. side groove, and the 2 $\frac{1}{4}$ -in. top groove, to insure that they are square with all surfaces.

The table is mounted on a 3-in. pipe column, which screws into a threaded hole in a boss on the underside of the table casting. The base of the column is a pipe flange, by means of which the

machine is bolted to the bench. All parts should be screwed up tightly.

Two slots are cut through the front of the table, as shown, for the passage of the boring-head clamp bolt, and holes for $\frac{1}{2}$ -in. studs drilled and tapped in the surface of the table. Holes for $\frac{3}{8}$ -in. screws are drilled and tapped in the back edge of the casting, to hold the braces.

The boring-bar head is a bronze casting, 9 $\frac{1}{2}$ in. long over all, and is machined as shown in Figs. 1, 2, and 5. The arms are bored and threaded for the 1 $\frac{1}{4}$ -in. boring bar; this job is best done by clamping the head to the faceplate of a lathe, after shaping. The arms are then drilled and tapped for the adjusting

screws and slitted, as shown in Fig. 2. The boring bar, which is made of steel, is now turned, bored, and threaded, as shown in Fig. 3. The thread pitch is 32 per inch, and the screw should be fitted accurately in the arms of the head. As will be noted, there are two boring bars, a main bar and an auxiliary one. The main bar is 9 $\frac{1}{2}$ in. long, and is turned down

to 1 $\frac{1}{8}$ in. diameter for about $\frac{3}{4}$ in. at each end. At the nose end, a $\frac{3}{8}$ -in. square hole is machined for the tool bits, and at the other, a $\frac{5}{8}$ -in. round hole for the crank handle. The latter is made of $\frac{5}{8}$ -in. cold-rolled steel, turned down to $\frac{1}{2}$ in., except for the ball end and the center portion, which latter is left $\frac{5}{8}$ in. in diameter to fit the hole in the bar. A setscrew hole is drilled and tapped in this $\frac{5}{8}$ -in. section for the clamp screw.

The tools are clamped by means of a $\frac{5}{8}$ -in. tool pin, sliding in the hollow bar, and pushed against the bits by means of the tool-clamp screw just mentioned. One end of the pin is spotted to receive the pointed end of the screw.

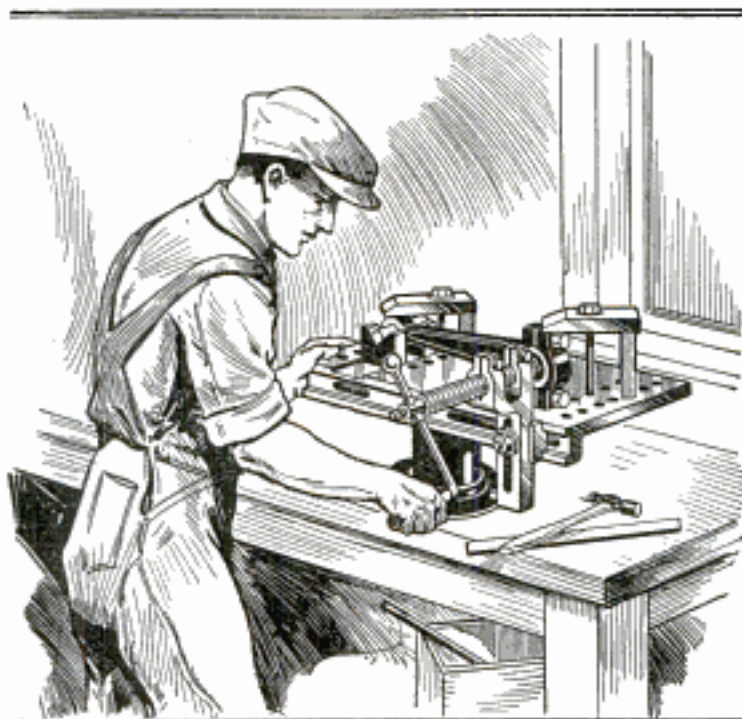

Reboring a Connecting-Rod Big End with a Portable Hand Fixture: Note How the Rod is Clamped

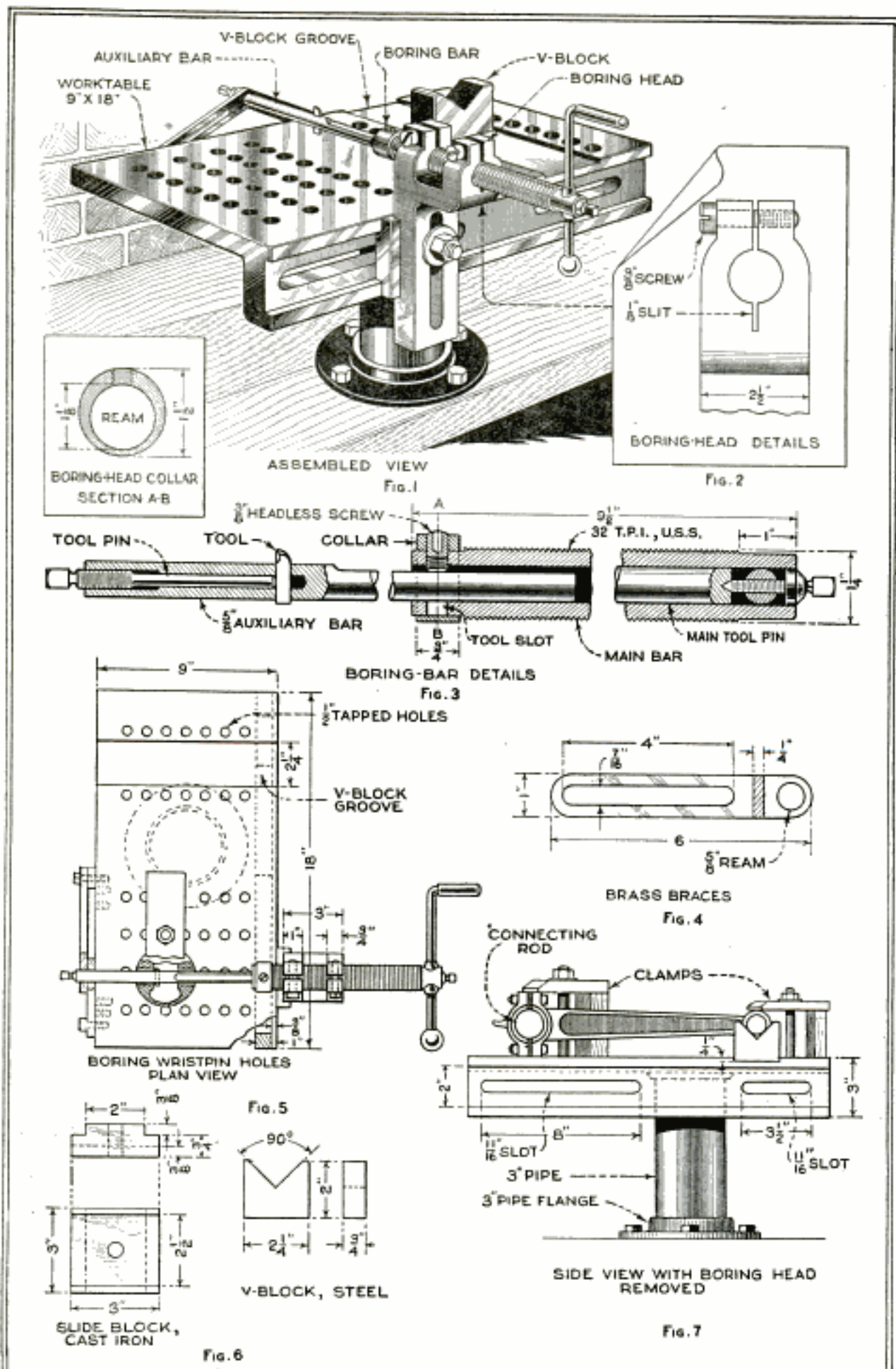

Figure 1 Shows the Fixture Completely Assembled; Figure 2, Details of the Boring Head; Figure 3, Main and Auxiliary Boring Bars; Figure 4, Braces for Auxiliary Bar; Figure 5, Set-Up for Boring Wristpin Holes; Figure 6, Dimensions of Blocks, and Fig. 7, Method of Reboring Connecting Rods

When boring wristpin holes, it is necessary to use an auxiliary bar, which is shown in position in Fig. 1, and in detail in Fig. 3. This bar telescopes into the larger one, the main tool pin first being removed, and is locked in position by the special collar shown in the detail. The headless setscrew in the collar is run through the tool-bit hole in the main bar and tightened on a flat milled on the auxiliary bar. The tool in this bar is also clamped by a tool pin, which, in this case, is a part of the clamp screw.

When boring a piston of large diameter, it is necessary to adjust the bar for each hole. The use of the auxiliary bar also necessitates the making of the brass or bronze braces shown in Fig. 4. These are fitted as indicated in Figs. 1 and 5, and keep the bar true and steady.

The feed is secured by the action of the threaded bar, turning the crank to the right feeding the bar forward, and to the left, backward. If it is desired to cut on the backward movement, the tool, of course, must be reversed. When the work is clamped close to the head, quite heavy cuts can be taken in the softer metals.

The method of boring wristpin holes is indicated in Fig. 5. To insure ac-

curacy when sizing, after the holes are rebored, a shell reamer should be used, held on the boring bar. For connecting rods, two V-blocks should be made, hardened and finished by grinding so as to be as accurate as possible; these must fit snugly, without any side play, in the groove in the table top. When reboring a connecting-rod "big end," a wristpin is slipped through its bearing and laid on the V-blocks, one being placed on each side of the bearing. The rod is then clamped down, as indicated in Fig. 7, and bored, using only the main bar, with the assurance that all bearings will be square.

When boring the wristpin bearing for an oversize pin, the same method is followed, using a mandrel in the big-end bearing. As the feed is $\frac{1}{32}$ in., the tools used should be ground with a flat top, slightly over $\frac{1}{32}$ in. wide, so that the tool marks will overlap.

Bushings that are too small in the bore can be rebored by clamping them in one of the V-blocks; the machine can also be used for most work that cannot be handled in the drill press because of the lack of large drills, and, as no power is necessary, it may be carried close to the work, and clamped or bolted to any convenient bench.

Suction Cleaner for Machinery

A handy suction cleaner for use around machines, such as knitting and paper-perforating machines, weaving looms, etc., is a great convenience. A cleaner of this kind can readily be made to operate on compressed air, if constructed as shown in the illustration. It is made from a discarded benzine can and a few standard $\frac{1}{2}$ -in. pipe fittings. The bottom

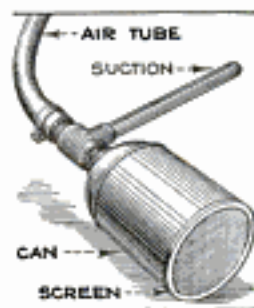

of the can is cut out, leaving a margin of about $\frac{1}{4}$ in., to which is soldered a piece of fine brass screen. The cap of the can is removed and a short nipple soldered in its place. A tee is screwed on the nipple, and a length of pipe, about 1 ft. long, into the tee, this pipe being flattened at one end so that the opening will be about $\frac{1}{8}$ or $\frac{1}{16}$ in. wide. It is not essential to have the pipe straight; it may be bent to any convenient shape, and its length may also vary to suit the user. Another short nipple is screwed into the tee, as

shown, to permit the attachment of the air hose. The rapid passage of air from the hose through the can creates a strong suction in the pipe, and the dirt and scraps of light material are easily picked up and deposited in the can. Where fine dirt or dust is to be cleaned up, a cloth bag, such as a mailing bag, is tied over the bottom of the can to retain the fine particles. Unscrewing the connection at the tee permits the contents of the can to be shaken out.—H. I. Wheeler, Westwood, Mass.

Comfortable Handles for Buckets

I have found that a short length of flexible metallic tubing, such as is used by electricians, provides a comfortable handle for a bucket. It is slipped over the wire handle with which the bucket is equipped. On a job where we had several heavy paint buckets to carry, all of them were fitted with these handles, which made the job very easy on the hands. Pieces of waste tubing can be picked up around almost any new building where the wiring is being installed.—Reuben Stafford, Jr., Washington, District of Columbia.

Making Window of Dark Room Light-Proof

The method of making the window of the dark room light-proof shown in the drawing should prove of interest to pro-

When the shade is up, the hinged strips are open; when it is desired to darken the room, the shade is drawn down, fastened by means of the lower buttons, and the hinged strips closed and clamped tightly by means of the side buttons.

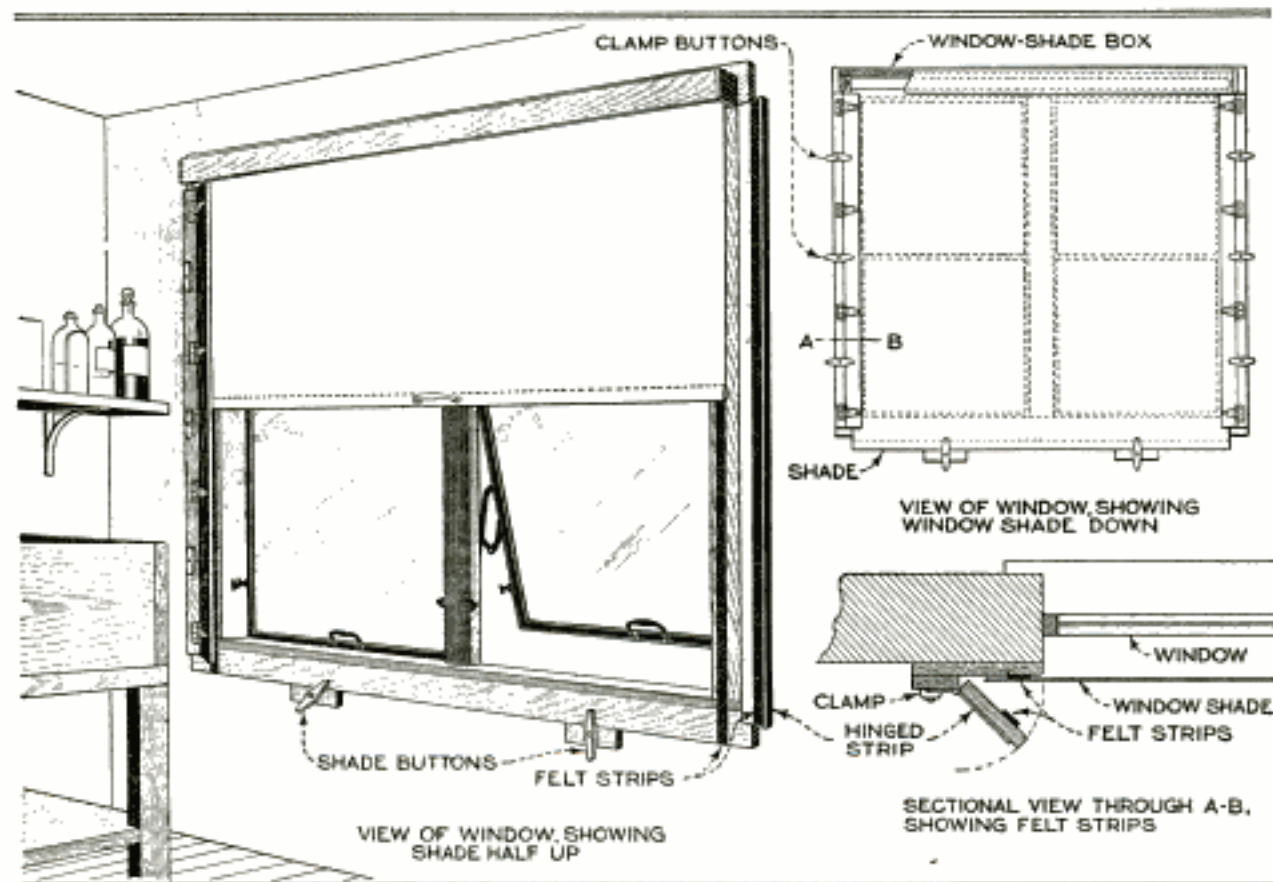

Method of Making the Dark-Room Window Light-Proof of Interest Not Only to the Professional, but Also, Because of Its Simplicity, to the Amateur Photographer

fessional photographers, or even to the amateur, as it is a very simple one. This is the method used in Popular Mechanics' dark room, and has proved entirely satisfactory.

Strips of wood, $\frac{1}{2}$ in. thick by 5 in. wide, and as long as the window frame, are fastened to the wall on either side of the window, as shown. On the outside of these strips, $\frac{3}{4}$ by $1\frac{3}{4}$ -in. strips are nailed, and $\frac{1}{2}$ by $3\frac{1}{4}$ -in. strips attached to them by hinges. The 5-in. and hinged $3\frac{1}{4}$ -in. strips are faced with felt, as shown in the sectional view, the window shade, when down, being gripped tightly by the felt. Wooden turn buttons are used to clamp the hinged strips when closed, and two other buttons, mounted on strips of wood fastened to the wall below the window, are used to hold the lower end of the shade tightly against the wall. The shade roller is inclosed in a light-tight box, as shown in the perspective and front views.

The free working of the shade is thus not interfered with in the least, while it is perfectly light-proof in use.

Soldering Tinfoil

When making fixed condensers for use in radio work, it is often desirable to solder leads to the tinfoil sheets. This is difficult to do because the solder does not readily adhere to the tinfoil, and because the foil melts so easily. This difficulty can be avoided by placing the foil on a sheet of copper, and using a flux made of vaseline, paraffin, and sal ammoniac. The vaseline and paraffin, in equal parts, are heated and mixed together. While the liquid mixture is still hot, half the total bulk of sal ammoniac is added. The whole is then thoroughly mixed and allowed to cool. The flux thus made is effective, providing, of course, the work is thoroughly clean.—Leroy Western, Plainfield, N. J.

Tail Center for Wooden Arbors

The use of a wooden arbor is at times necessary in woodworking and pattern making, for special work; emery and

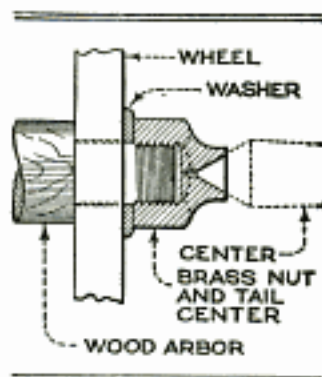

sand paper wheels are also usually mounted on wooden arbors. However, workmen sometimes hesitate to use one because the wood around the tail center has a tendency to split open while revolving at a high rate of

speed, which loosens the arbor and is, of course, dangerous. This danger can be eliminated by screwing a combined brass nut and center on the end of the arbor. The nut is made of hexagon brass stock, threaded to screw on the wooden end, and is center-drilled to fit the lathe center, as indicated in the illustration.

Pipe Fitter's Vise Support

Pipe fitters usually do their work before the inside of the building is finished, and, consequently, it is often a problem

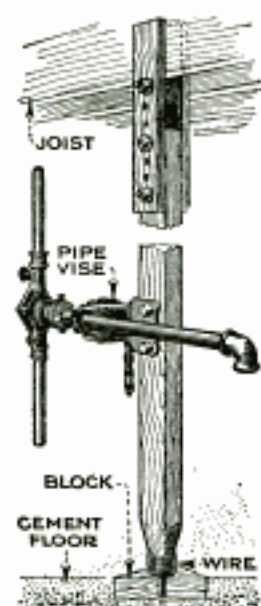

to find a suitable place for the pipe vise, particularly in the basement. The arrangement illustrated makes it possible, however, to use a pipe vise wherever the floor joists are exposed, anchorage being obtained by a pin driven into the wire-wound foot of the upright. A 2 by 4-in. stick is used for the upright, with two pieces of 1½-in. boards bolted to opposite sides, for clamping the device to an overhead floor joist. The pin in the

bottom end is made from ¾-in. rod, and is allowed to project about 3 in., fitting into a small hole drilled in the joist. In the basement, a hole may be chipped in the floor, and a wood block fitted to take the pin, as shown, or a small hole drilled right in the floor. In either case, it is a simple matter to fill up the hole.

Clamp for Cylinder Grinder

A mechanic, finding that the regular clamps furnished on his cylinder-grinding machine did not hold the cylinder block

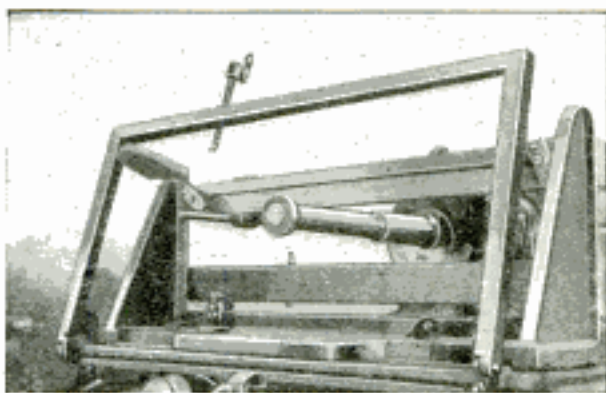

An Additional Clamp on a Cylinder-Grinding Machine to Prevent Vibration

solidly enough to prevent a slight vibration—which tended to produce imperfect cylinder walls—constructed the clamp shown in the photograph to overcome the difficulty.

It consists of a U-shaped frame, made by welding together 1-in. iron bars, and hinged to lugs bolted to the grinder carriage. A hole is drilled and tapped in the horizontal bar to receive a setscrew fitted with a crank handle. When the cylinder block has been placed in readiness for grinding, the clamp is swung to a suitable position over the block and the setscrew is screwed down against it. Since the clamp has been used, vibration marks and spoiled cylinders have been eliminated.

A Sprinkler Guard

The moving stairway in a large department store ran close to a line of sprinkler piping, and the sprinkler-head links were often accidentally broken or brushed by parcels carried by persons using it, or tampered with by meddlers. To prevent this, a simple guard was made and placed over each head within reach of the stairway. The guards consisted of a clamp made of sheet metal, fitting around the base of the head, and provided with a number of U-shaped wires, soldered into holes drilled in the upper edge of the clamp, as shown.



Since installing these, no further trouble has been experienced.

Lifter for High Drawers

In stores where an increase of stock of small parts makes it necessary to put in drawers above the original ones, if lack of floor space does not permit addi-

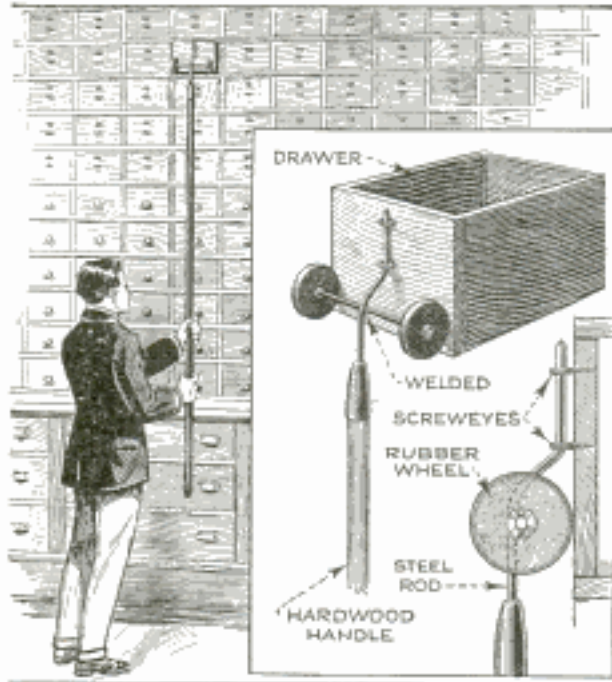

Handy Drawer Lifter for Reaching High Drawers in Stores Where a Rolling Ladder is Not Fitted

tional cabinets, or it is not desired to install these, a rolling ladder is commonly used. However, a good substitute for a rolling ladder is a drawer lifter of the kind shown in the drawing. This even has advantages over a rolling ladder in that it does not take so much space, and as several may be provided if necessary, no time is wasted in waiting for the ladder until some one else has finished using it farther along the shelves.

It consists of a strong hardwood handle on which is fitted a short length of steel rod, bent to the shape shown. A crosspiece of the same size steel rod is welded across the first piece, and small rubber wheels are fitted at each end, these being kept in place by means of cotter pins and washers. In use, the bent rod is slipped into screweyes driven into the front of each drawer, and it is then an easy matter to pull the drawer out and lower it. The length of the handle depends on the height of the upper line of drawers.—L. H. Georger, Buffalo, N. Y.

☛ Steam, rising from water at its boiling point of 212° F., has a pressure equal to that of the atmosphere, or 14.7 lb. per square inch.

An Offset Screwdriver

For working in very close quarters, an offset screwdriver of the type shown in the drawing will be found very useful. It consists of a handle carrying a head that has four narrow blades formed on it. Each blade is set at an angle of 45° with the two on each side of it, so that in using the tool, it is only necessary to move the handle slightly before one blade can be engaged in the groove of the screw. Where headroom is limited, and a screwdriver cannot be used, this tool will be found to remove the screw much more quickly than the common close-quarters screwdriver, which has but two blades, set at right angles to each other at opposite ends of the handle.



A Good Cabinet Scraper

The illustration shows an easily made wood scraper that has been found very practical for cabinetmakers and other woodworkers. It consists of a wooden handle, shaped square, with slightly rounded corners and edges. The head is square and has a tongue formed on it as indicated. The scraper blade consists of the end of an old plane bit, and is attached to the handle by means of a

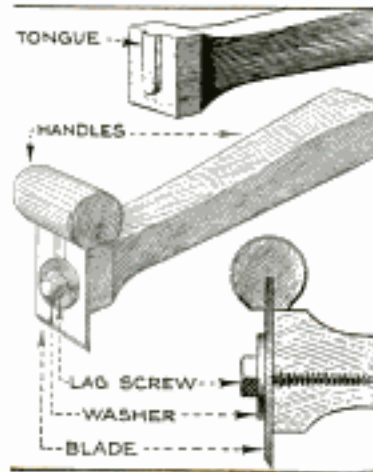

lag screw or round-head screw driven into the end, a hole being first drilled in the handle, to prevent splitting. If a lag screw or round-head screw is not at hand, a nut can be countersunk to take the head of a flat-head screw, and the two soldered together. To protect the cutting edge of the blade, a short piece of round hardwood, about 1 in. in diameter, and slotted to fit the blade snugly, is provided. This piece is used as a hand rest when using the scraper, being then attached to the top of the blade, as shown.—M. E. Dugan, Kenosha, Wis.

Rotary Blower Made from a Tin Can

BY HOWARD GREEN

A ROTARY blower that will suffice for the small shop or laboratory can be made with nothing but ordinary tools, except for the wooden end disks, which should be turned in a lathe for best results. However, if the disks are carefully sawed out, even the lathe will not be needed.

The rotor is made from a sheet-metal cylinder, for which purpose a strong tin can may be used; if an extra good job is desired the cylinder may be built up of heavy sheet metal, using wooden ends. A $\frac{1}{2}$ -in. hole is made in each end of the can, $\frac{7}{8}$ in. from the center, and the holes are reinforced by riveting or soldering on washers with a $\frac{1}{2}$ -in. opening; both holes should line up exactly. A piece of $\frac{1}{2}$ -in. shaft is fitted through the holes, leaving

forming a discharge passage at the top. The wooden ends must be spaced, so that the rotor can turn freely, with about $\frac{1}{32}$ in. of end play. The rotor is put in place before the casing is finally assembled. The discharge opening should be curved, as shown in the section, to provide an easy passage for the outgoing air.

The leather flap valve is an exceedingly important part of the blower; leather that is fairly thick, but very soft and pliable, usually gives the best results. It is attached to the lip of the discharge opening with small rivets, as indicated. It will be observed that there is a little clearance between the rotor and casing so that the former can pass the flap at each revolution without sticking.

The rotor should be counterbalanced

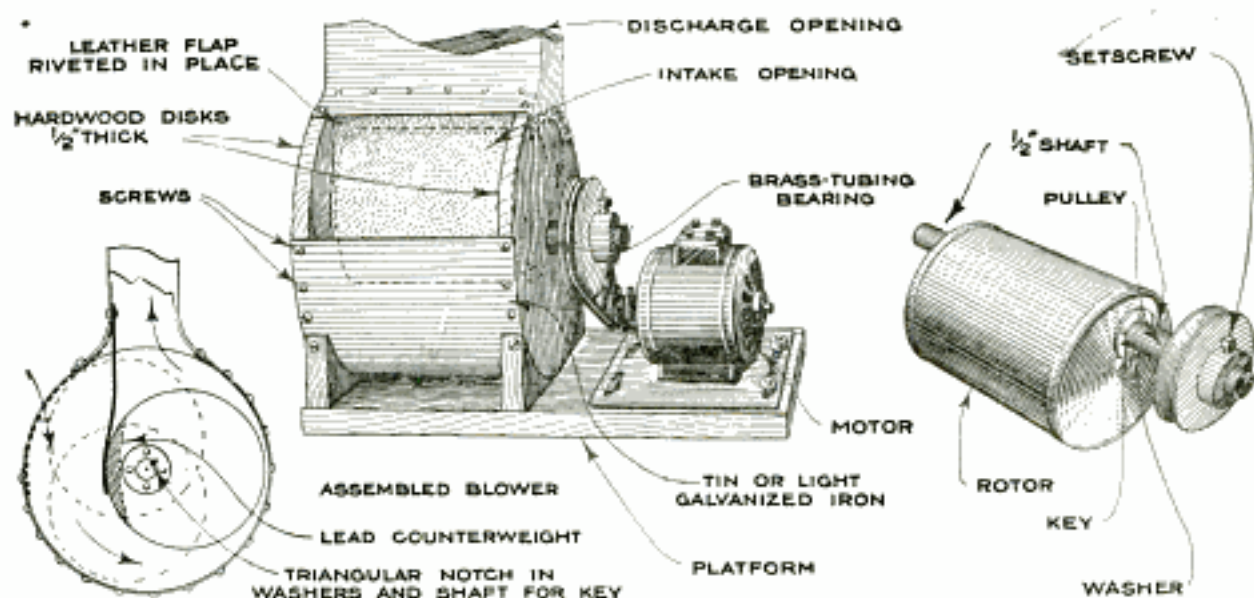

Where a Fairly Large Volume of Air at Low Pressure is Required in the Small Shop, a Blower Made from a Tin Can and Some Scrap Materials will do Satisfactory Work

about $1\frac{1}{4}$ in. projecting at one end and 2 in. at the other. Triangular notches are filed in each washer and corresponding grooves are cut into the shaft, so that a piece of brass wire can be forced into each of the small keyways thus formed; the shaft is then soldered or brazed to the can, and the outside ends of the keys cut off flush with the washers.

The casing requires two disks, about $6\frac{1}{4}$ in. in diameter and $\frac{1}{2}$ in. thick; holes are drilled at their centers for the short lengths of brass tubing that form the rotor-shaft bearings. The bearings are forced tightly into the holes, and oil holes drilled in them. The housing is then made from sheet metal, as shown in the drawing, and screwed to the disks, leaving a large opening for the air intake and

so that it will run smoothly. When it has been finished, rig up the end disks of the casing temporarily so that the shaft can be put in place and rotated. Attach strips of lead temporarily to the outside of the rotor, at the point nearest the shaft, and run the rotor at a speed of about 250 or 300 revolutions per minute to see how it balances. Try pieces of different weights until one is found that allows the least vibration and seems to balance the rotor properly. When the right weight has been found, melt the lead and pour it through a hole in the end of the can so that it will settle and solidify at the point nearest the shaft. The lead will stick in place if, before the rotor is assembled, the inside is cleaned and coated with a little soldering paste.

Give the leather flap a good rubbing with light graphite grease on the side that comes into contact with the rotor, and coat the surface of the latter in the same way, without using too much of the lubricant. The best operating speed will have to be ascertained by experiment, and as the leather valve works itself into shape and acquires pliability, operation will be improved. Sometimes it will be found that a very light strip of wood tacked across the bottom of the leather

will help somewhat. Such blowers can be made in any size, but if made with a housing much smaller than $6\frac{1}{4}$ in. in diameter, the results will be hardly worth while, although it can be made a little smaller and still do fairly good work. It is not intended for high speed; in fact, if driven too fast it will not work well. The operating speed depends largely upon the action of the leather valve, which refuses to function properly beyond a certain speed.

Steady Rest for Tapered Work

The steady rest shown in the drawing will be found a considerable improvement on the ordinary one furnished with a milling machine, which is rather limited

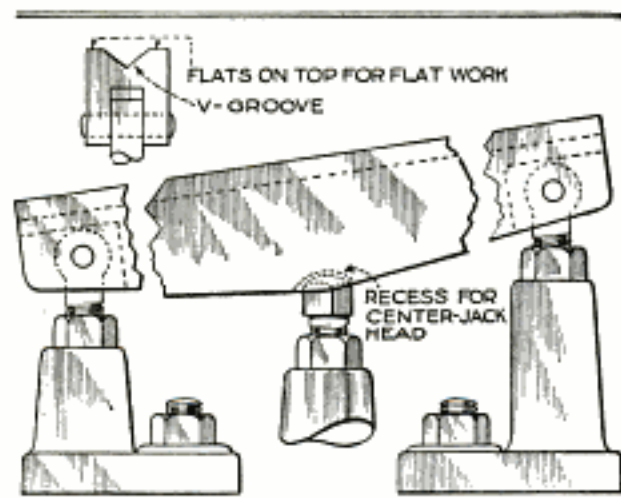

A Steady Rest on a Milling Machine That has been Found to Be of Considerable Usefulness for Tapered Work

in its use. It consists of a truss-shaped beam, mounted on end jacks as shown, and having a recess cut on the underside to fit on the center-jack head; several center jacks can be used, and the beam made long enough to suit any length of work. A V-shaped groove is cut in the top side, for round work, and the flats are used for flat work. The rest may also be used for grinding.—Henry S. Laraby, New Haven, Conn.

Cheap Concrete Forms

By using tar paper to face forms for rough concrete work, a cheaper grade of wood can be used for making the forms, and the total expense of the forms considerably reduced. They are covered with a single layer of tar paper, and the concrete can be poured in without the danger of its running out through knotholes or cracks. It is also much easier to remove

the forms, since the cement will not stick to them as it will to wood forms in which the joints are not tight. This method is particularly adapted to horizontal floor or sidewalk slabs.

Micrometer Attachment for Height Gauge

In checking a drill jig that had a number of holes in line with each other, I found that a quick method of discovering errors in the location of the holes was to use a micrometer attachment on a vernier height gauge. The micrometer head is fitted into a steel bracket, shaped as shown, and clamped to the gauge in place of the regular blade. When the micrometer thimble is at zero, the end of the spindle is exactly in line with the top of the gauge jaw, thus eliminating any additional calculation. A

standard pin is fitted in the first hole, and the height gauge is set so that the micrometer spindle touches the top side of the pin. The reading

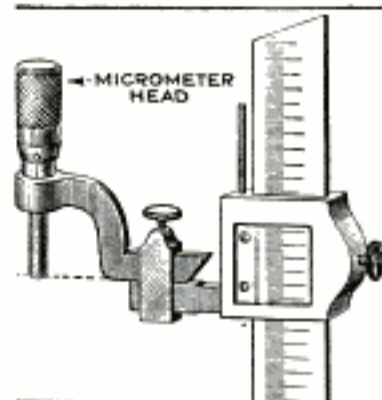

of the thimble is carefully noted. Having the correct height established in this way, the pin is set into the next hole and the height gauge is slid along so that the micrometer spindle is located above the pin. The spindle is then turned down against the top side of the pin as before. If the reading is the same in both cases the holes are in line; if not, the amount of error is at once apparent. In this way all the holes can be carefully measured.—Alexander Malcolm, Providence, R. I.

Fastening Pulley to Small Motor

A small pulley that is not subject to heavy load can be held on the motor shaft without a key or a setscrew. The entire length of the shaft outside of the motor is threaded and the pulley is fitted

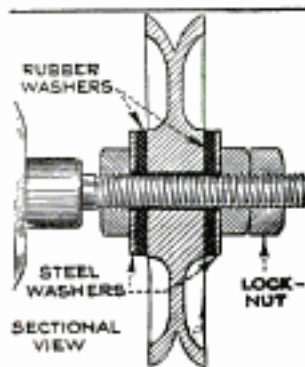

on the shaft between two rubber washers. These are forced tightly against the face of the pulley by means of nuts screwed on the shaft. Thin steel washers are, of course, used between the nuts and the rubber washers, and a locknut is provided, to prevent the other nuts from loosening. With this arrangement the pulley will not slip unless placed under an abnormally heavy load.

Improving Lathe Tailstock Clamp

In a popular engine lathe the tailstock is clamped to the ways by means of two bolts, which pass through the base of the tailstock and extend down through a clamping bar that bears on the lower edge of the lathe bed. As these bolts are held loosely at their upper ends, there is a decided tendency for the clamping bar to bind when the tailstock is moved along the ways, unless the bolts are loosened far enough to allow the bar to clear the lathe bed, which necessitates several part turns of the nuts.

This trouble has been overcome by installing a guide piece as shown in the illustration. It consists of a flat piece of steel, $\frac{1}{4}$ in. thick and $1\frac{1}{4}$ in. wide, with two small holes drilled through it to receive screws that fasten it to the base of the tailstock, and two larger holes which are a snug fit for the bolts. With the addition of this guide piece, a quarter turn on the nuts is sufficient to permit the tailstock to be moved easily.—Edwin Kilburn, Spring Valley, Minn.

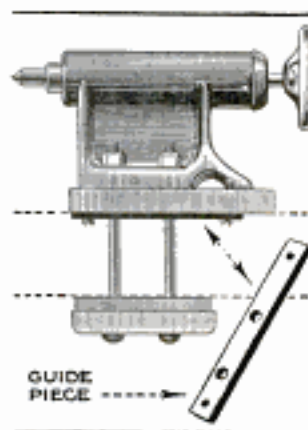

Preventing Stream Erosion

Along many streams it is necessary to hold the bank back in some efficient and cheap manner, otherwise the ground will



Method of Building an Inexpensive Wall to Prevent Erosion of Streams Having Low Banks

gradually slump down into the stream, due to the washing away of the banks. An excellent method of preventing this is shown in the illustration.

A woven-wire fence is erected where the new water edge is to be made, the fence posts being driven into the bed of the stream. Brush and saplings are then deposited as indicated, the branches pointing away from the water, and the butts inserted into the fencing. Earth is thrown on the brush to make the wall solid, and in a short time the new bank is knit together by marsh grasses and rushes.

Removing Dust from Batch Hopper

During the construction of a large power house, the concrete foreman constructed a square sheet-metal hood and chimney over his batch hopper, to remove the cement dust. A $\frac{1}{2}$ -in. pipe, connected to the compressed-air supply, was arranged so that it pointed up the center of the hood, and, when the air was turned on, a strong suction was created in the chimney, which caused the dust to be drawn up. The expense of this attachment was about \$10, which was more than repaid by the cleanliness of the mixing room and the increased efficiency of the men.—Aaron Evans, Rockport, Wash.

Large Homemade Pulleys

Most mechanics in out-of-the-way places find that when they need a pulley,

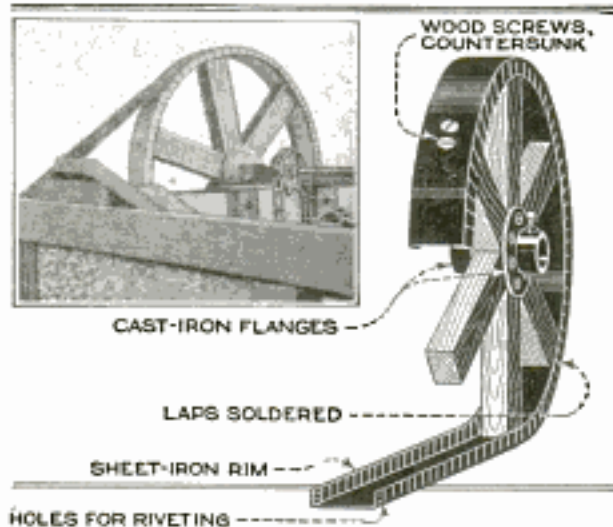

Large Pulleys That Are Light but Rigid can Readily be Made in the Out-of-the-Way Workshop

they cannot wait to have it cast, or until one can be delivered, but must have it at once. One resourceful mechanic constructs his own pulleys, when necessary, from wood and sheet metal, as shown in the illustration.

Two cast-iron flanges, specially made for this purpose, and a number of which are kept on hand, form the hub of the pulley, wooden spokes being bolted between them, and a sheet-iron rim of sufficient thickness provided on the outside. The flanges are fitted with setscrews to lock the pulley to the shaft. The spokes are beveled at the inner ends to fit together properly at the hub, and are rounded at the other end to conform to the curvature of the rim. The rim is made of a strip of sheet iron, the length being equal to the circumference of the pulley, plus 2 in. for the lap. Cuts are made along the edges by means of a hacksaw, and the strip is bent along the cuts as indicated. If the sheet metal is light, the pieces cut should be made to overlap each other when the strip is bent around the spokes, but if it is heavy, the cuts should be V-shaped, and of such size that their edges will fit closely together when bent. Solder is then run over the flange to fill the openings between the laps, making the rim rigid. If this is done neatly, and the rim given a coat of paint, the cuts cannot be seen. The ends of the rim overlap about an inch, and are riveted together. The rim is attached to the spokes by means of flat-headed wood screws, the holes being countersunk in the rim.

Most of the pulleys made in this manner have been about 2 ft. in diameter, with a 3-in. face, and for these 6-in. flanges, 2 by 3-in. spokes, and 22-gauge rims have been used. Because of their lightness and rigidity, these pulleys are much preferable to those made of cast iron or wood for slow speeds, especially when they are very large and are to be used on a light shaft.—Jonas Byberg, Silverton, Ore.

Bench Block for Straightening Rods

For straightening brass or copper rods, the bench block shown in the drawing will give excellent results. This device was used for straightening a number of 1/2-in. brass rods that had previously been used on tank work and were bent to a semicircular shape. It is made from a square block of steel, drilled diagonally, the hole being made a trifle larger than the diameter of the rods, and part of the

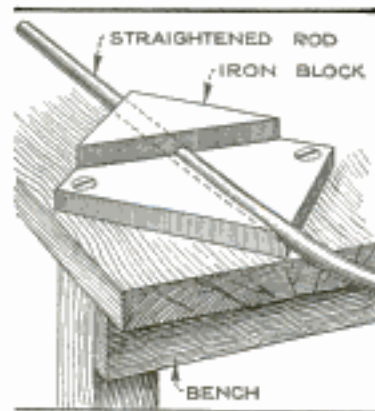

block is cut away to half its thickness as shown. Holes are drilled in opposite corners for screws to hold the block to the bench. The bent rods are inserted in the hole as

far as possible, then tapped down with a lead hammer and pushed through farther, until the rod passes through the hole.

Before this form of block was made, an ordinary flat block was used, but too much time was required to get the rods straight, as they warped in different directions when struck with a hammer, and it was necessary to go over each one several times. In the case of the block shown, however, the straightened part of the rod remains straight, as it is supported in the hole, and therefore it will be quite straight after it has passed through.—Harry Moore, Montreal, Can.

Satin Finish for Goldplated Work

To satin-finish gold, the articles must first be scratch-brushed with a revolving brush made of fine steel wire, the brush being driven at high speed. The brush and work are kept wet with bran water,

which is made by immersing in a gallon of boiling water a bag containing $\frac{1}{2}$ lb. of bran; the bag must be well squeezed to be sure that the water is made "strong." The water is placed in a drip can suspended above the wheel, and a tin or cardboard guard is mounted above the wheel to prevent splashing. After scratch-brushing, the work will show a satin or dulled finish; it is then dipped in hot ammonia water, after which it is plated, using a rather weak current. Bicarbonate of soda and water is afterward used, on a handbrush, to clear the color of the work, which is apt to become rather foggy in the plating bath.

Homemade Jack for Erectors

Machinery erectors and other machinists frequently require jacks smaller than the average, which are often too high to

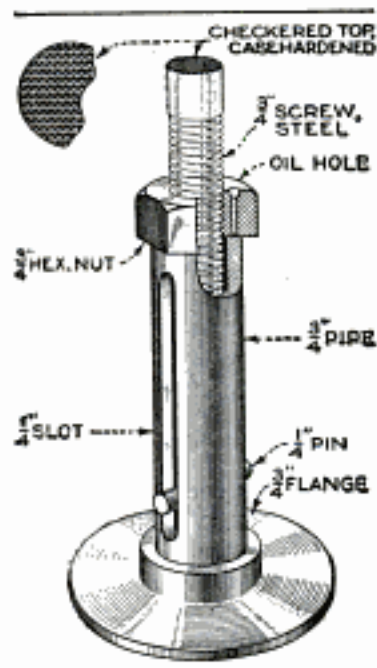

be used to advantage. A set of several small jacks will make erecting and assembling work easier, and will quickly pay for the time spent in making them. The body of the jack shown in the drawing is made from $\frac{3}{4}$ -in. extra-heavy pipe, such as used for hydraulic and high-pressure purposes, fitted at the bottom with a floor flange. The pipe is screwed into the flange flush with its lower face, so as to make a firm and continuous supporting surface. The elevating screw is made from $\frac{3}{4}$ -in. round steel, threaded to within an inch of the head, which is checkered and casehardened to give a good non-slipping surface; the checkering can be done before casehardening by making deep cuts at right angles to each other with a three-cornered file. The screw is drilled and fitted with a $\frac{1}{4}$ -in. pin, which slides in a slot cut in opposite sides of the pipe and prevents the screw from turning. A good casehardened hexagon nut is used to raise and lower the jack.

Cutting Gear Teeth on the Shaper

Gears that had a number of broken teeth filled in by welding were machined

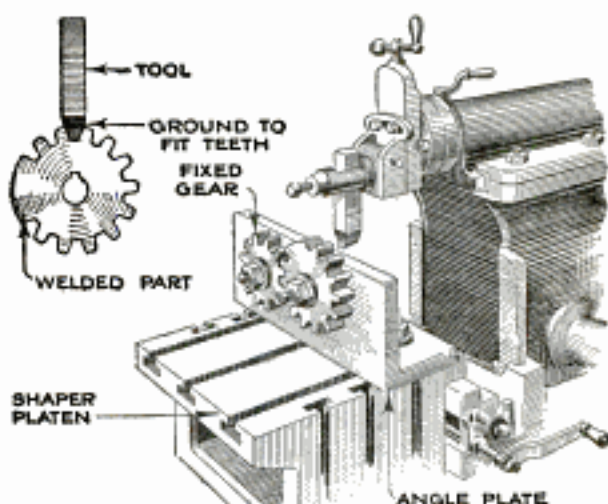

Machining New Teeth in a Damaged Gear Repaired by Welding

on a shaper by means of the method shown in the drawing.

An angle plate was set up on the table of the machine, and a cutting tool was made, using an unbroken section of the gear as a template. The welded gear was placed against the angle plate and secured by a center bolt. A pinion was then bolted to the plate, so as to mesh with the unbroken teeth of the gear to be machined, with one of the good tooth spaces of the gear at the top. The gear was then brought up to the tool to locate the correct position of the shaper table. The welded section was now set under the tool and the cutting commenced, using only the vertical feed. The small pinion meshing with the larger gear was bolted solidly to the plate and was not disturbed until the work was done. As each tooth was cut, the work was turned by detaching it and turning it one tooth, so that a fresh surface of the new metal was brought in front of the cutting tool.

Melting Sulphur

Sulphur is often used to anchor bolts in cement or stone floors, but as it catches fire so easily when melted over an open flame, its use is somewhat inconvenient. This difficulty can, however, be avoided by first melting some lead, and then partly immersing the sulphur vessel in the molten lead. The sulphur will be melted in a short time, and there it will not catch fire, unless the temperature of the lead is allowed to exceed 625° Fahrenheit.

Facing Valves on Drill Press

A novel method of refacing valves is shown in the illustration, a drill press and a hand grinder being used to do the work. A cupped emery wheel is fitted on the grinder, and the valve face is ground with

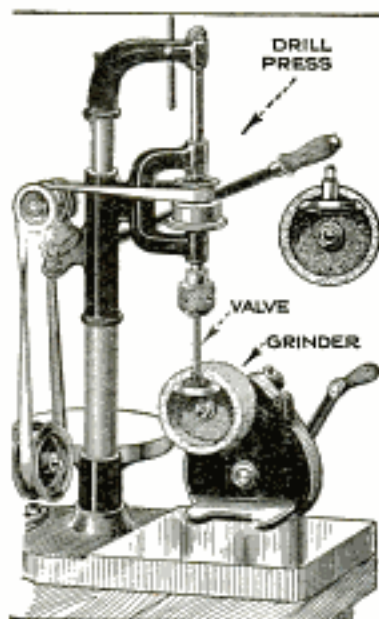

the inner surface. This makes the face round, which, by many mechanics, is considered superior to a flat face, as it seats more readily and uniformly, and the smaller contact surface removes all carbon particles that become lodged on the seat.

The grinder is revolved with one hand while the drill-press spindle is lifted to bring the valve face in contact with the inside surface of the emery wheel. In grinding, only the smallest possible amount of metal is removed from the valve, and therefore the valve must not be held on the wheel for any considerable length of time.

Miter Nailing "Jack"

The miter nailing "jack" shown in the illustration is used for holding the mitered end of a piece of wood while the other end is being nailed as indicated,

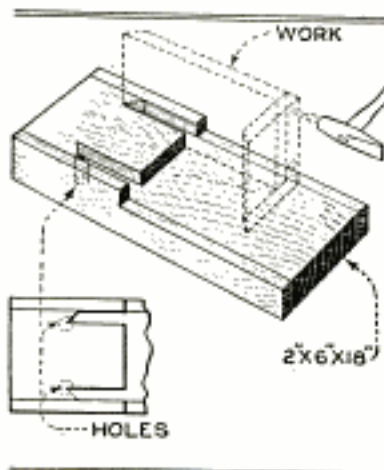

the object of the jack being to avoid bruising the beveled edge.

The base of the fixture is made of 2 by 6-in. wood, about 18 in. long. A piece of $\frac{7}{8}$ -in. wood is then cut with recesses for the beveled edge of the work,

and this piece is nailed solidly to the base near one end, as shown. Strips are

then nailed to the sides to complete the slots in which the mitered pieces are placed while nailing. Small holes, drilled through the base at the points of the slots, prevent the accumulation of sawdust and dirt in the points. The dotted lines show the position of the work when nailing.—F. M. Arthur, Bethune, S. C.

Long-Range Cotter-Pin Puller

The cotter-pin puller shown in the illustration was devised by an automobile mechanic, and has been found to be of considerable assistance in removing cotter pins from places where it is difficult or impossible to use pliers or other tools. This tool can be used without the preliminary work of straightening the ends of the cotter pins, and also without the danger of scratching and bruising the hands.

The body of the tool consists of a length of steel tubing of about $\frac{3}{8}$ -in. inside diameter. A $\frac{3}{8}$ -in. steel rod that slides freely inside of the tubing is filed or forged to a hook shape at one end,

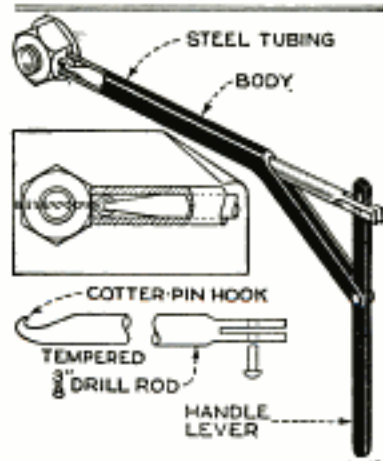

as indicated, and the other end is slotted and drilled for a small pin. One end of the tubing is cut and bent to form a support for a handle lever, which is pinned loosely to the end of the rod. The lever is also pivoted on the support extending from the tubing. In use, the body of the tool is held against the side of the nut while the rod pulls the cotter pin, the handle providing a good leverage.

Locating Squares on Shaft Ends

When cutting a square on the end of a shaft, take a square-nose tool and cut down a short length on the shaft end, in the lathe, until its diameter is equal to a side of the square. This enables the mill-

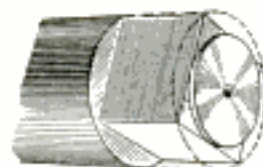

ing cutter or shaper tool to be fed down to the correct depth at once, without further measuring.



The "California Cooler"

BY W. DRAPER BRINCKLOE

THE "California cooler" is well known on the Pacific coast, and should be better known elsewhere in the country. It is used to keep vegetables and other perishable foodstuffs fresh and sweet, and in the cool climate along the sea coast works very well. It consists of

supposed to keep the food fresh, and, as a matter of fact, does so quite successfully.

For use farther east, however, this simple construction must be modified; as the outside air is often very hot, the cooler must be arranged to take cool

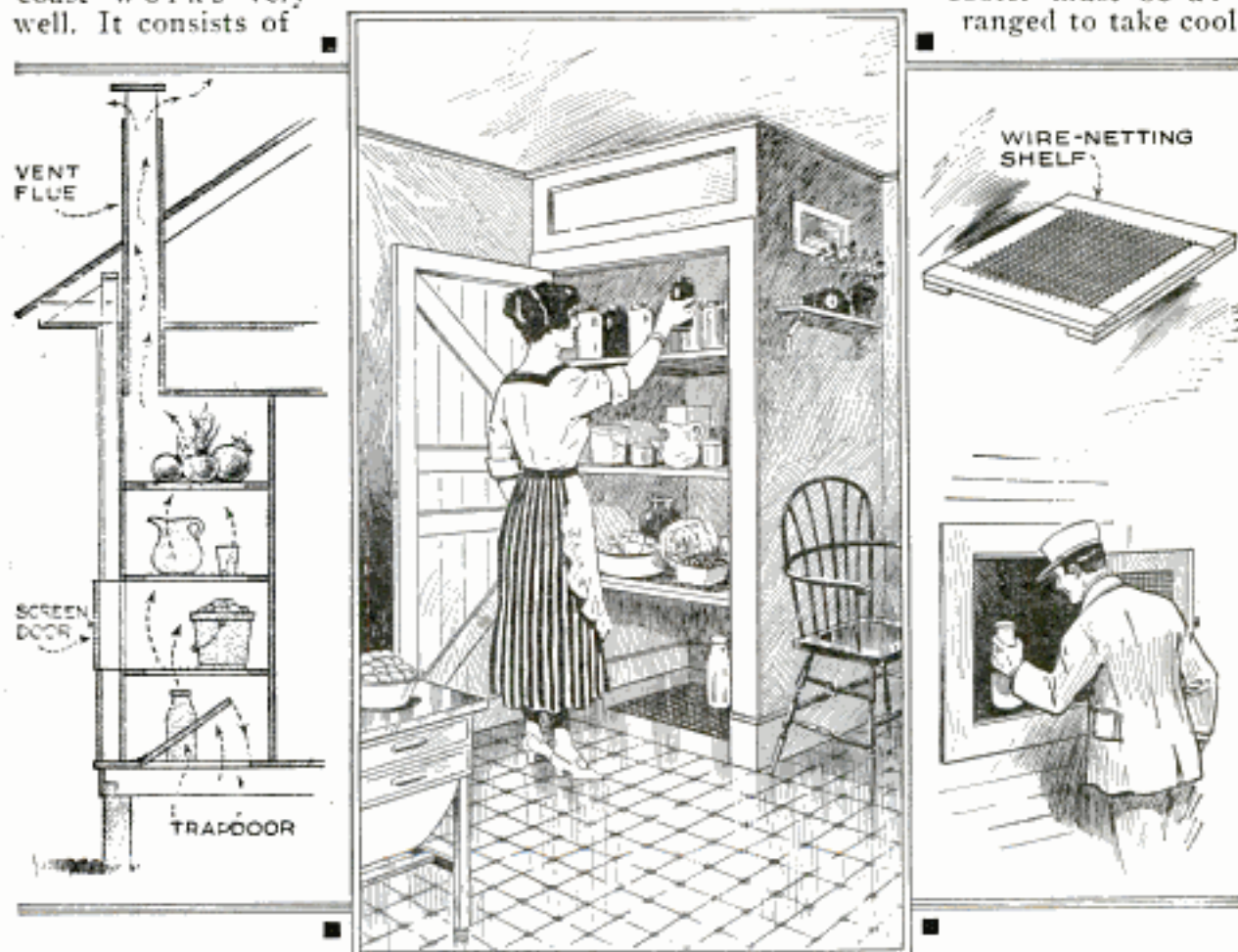

Left: Cross Section of California Cooler, Showing Arrangement of Trap and Screen Doors, Shelves, and Vent. Right: Detail of Shelf, and Appearance of Screen Door and Casing

nothing more than a simple closet, fitted with screen-wire shelves, with a small screened opening in the house wall, near the bottom, and another at the top. Fresh air enters the closet through the lower opening, and passes out of the upper one; the constant current of air is

air from the cellar, and to make it pass through fairly rapidly.

A closet, of matched boards and of any size convenient, is built in one corner of the kitchen, on an outside wall. From the top, a sheet-metal or wooden flue is run above the roof, as shown in the left-

hand drawing. This is better than merely cutting a hole in the side wall, as, when the flue is heated by the sun, the air within it rises more rapidly, drawing the cool air in at the bottom. The vent is usually made 4 in. in diameter or 4 in. square; in the drawing, it is shown passing through a low attic, but in my own bungalow it runs up through a second-story room, behind a wallboard partition.

Near the bottom of the closet, an opening, about 8 in. wide and 12 in. high, or any other convenient size, is cut through the wall. This is cased in, and a small screen door fitted in place with spring hinges. In the bottom of the closet, an opening is cut through the floor, and fitted with a small trapdoor, about 12 in. square. The trapdoor opening, as well as the opening in the vent, should be covered with fly-screen wire.

The shelves are made of heavy galvanized cellar-window wire netting, tacked to 1 by 2-in. wooden frames, and resting on cleats screwed to the inside of the closet.

In cool weather, the trapdoor is kept closed, and the air taken from the outside. When the outside air becomes too hot, the trapdoor is opened, and the screen-door frame filled with a piece of wallboard or thin wood, cut to fit nicely and held in place by turn buttons.

The cold closet will not do away with the refrigerator by any means, but I have found that for a large part of the year it enables one to get along without ice very well. If milk bottles are wrapped in a wet cloth and set in the cooler, the current of air causes rapid evaporation and keeps them quite cold. Fresh meats are put in closed kettles, and the kettles wrapped in wet cloths; fruits and vegetables do not require this, as the cellar air keeps them cool enough.

Milk and grocery deliveries can be made through the outer door, and for the milk especially this is a decided advantage, as it is placed in a cool place at once, not left in the hot sun as usual. All told, the constructor of a California cooler will not regret it.

Emergency Lens Shade

All motion-picture cameras are provided with lens shades, which is the reason that the operators can obtain such

effective scenes "shot" against the sun. Amateur photographers will profit by using such a shade. One can easily be made from a card or piece of paper of a dark color, preferably black. Cut a piece to suitable size and make a slit in the end equal to exactly half

of the circumference of the lens tube. Open the slit and slide the shade over the lens as shown. To cover the entire lens, use two cards.

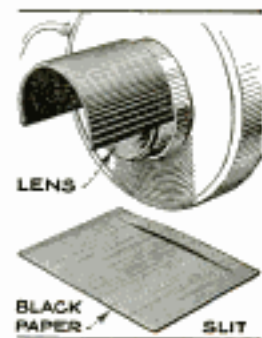

Bucket Used as Heater

During cool weather in spring and fall, when it is not necessary to use a furnace, but some heat is necessary to take the "chill" from the room, oil and gas cookstoves are frequently used. Although these provide considerable heat, it does not radiate properly, but rises to the top of the room. This difficulty can be avoided by placing an ordinary metal bucket, with holes punched

in the bottom to permit air circulation, in an inverted position over the burner. The heat given off by the stove will then radiate from the sides as well as the top, causing a more even distribution of the warmth.—Joe H. Hudner, Bautista, Calif.

Fly Exit on Screen Door

Despite care in keeping screen doors shut, flies will gain entrance, and will collect on the inside of the screen where they have no means of escaping until the door is opened and they are driven out.

If a slot is cut or planed along a short length of the top edge of the screen-door frame, as shown in the illustration, the flies, which constantly crawl from the bottom to the top of the door, will be attracted by the strip of light and will crawl through the slot to the outside, but as the inside of the slot is not so well lighted, they will not return. It is still better, if possible, to cut a few slots where the screen joins the frame, which can be accomplished with a little more trouble. The planed surface is then painted a dark color.—Harold E. Benson, Boulder, Colo.

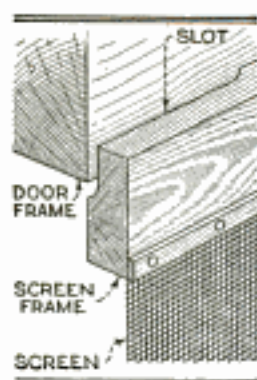

Soldering with Alcohol Lamp

A very convenient method of soldering the wire connections on radio sets, or on any other delicate work, is to use a piece of copper wire heated by the flame of a small alcohol lamp. The lamp can be

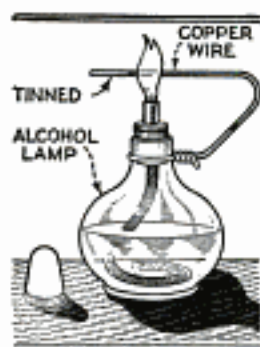

purchased for about 40 cents at any physicians' or dentists' supply house.

The length of copper wire, which should be No. 14 gauge, is thoroughly cleaned, twisted around the neck of the lamp with a pair of pliers, and bent to pass through the upper

part of the flame, leaving about $\frac{3}{4}$ -in. of the end projecting beyond the flame. This end is tinned in the usual way, and used as the soldering bit. Experiments will determine how far the tip must extend from the flame to obtain the best results. The device insures a hot point of constant temperature, and because of its size, it is much more efficient than a soldering iron for small work.

Saving the Gatepost

Careless drivers often neglect to allow sufficient clearance between the wagon and the gatepost when driving in a large load, and as a result the post is often struck and loosened, or it may even be broken.

To prevent this, a farmer mounted an old wagon wheel on a 2 by 4-in. timber and spiked it on the top of the fence post, so that the tire projected about 3 in. beyond the post, as shown. The wheel was



bolted to the timber, a thimble from an old wagon axle being used for the wheel to turn on, and a large washer and nut on the upper end prevented the wheel from being lifted up. When a load passes through the gate too close to the post, it strikes the wheel, and the wheel keeps it clear of the post.

Easily Made Wagon-Box Derrick

On the average farm it is seldom that more than one set of wagon trucks is kept for the different boxes and racks, and this naturally necessitates frequent

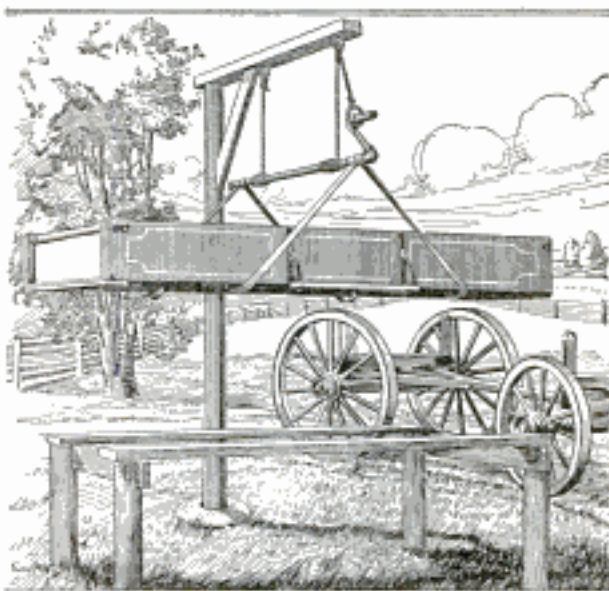

Simple Derrick Used for Hoisting Wagon Boxes and Racks: It can Easily be Operated by One Man

changes to meet the seasonal requirements. The task of lifting the boxes is usually beyond the strength of one man without some mechanical assistance. For this reason the revolving derrick shown in the illustration was designed. With it one man or boy can easily remove a box or rack from the truck and place another in position.

The standard of the derrick is a 6-ft. oak post, set in a cement base; the post fits loosely in the base so that it can be easily turned, the socket being filled with hard grease to facilitate swinging. A 6-ft. arm projects at the top and is supported by a stout brace. Two strong ropes are attached to the arm with eyebolts, as shown, and a windlass, made of $1\frac{1}{4}$ -in. pipe, is suspended from the ropes, the ends of the ropes being securely attached to holes drilled in the windlass. The hooks are made of heavy tire iron, bent and sharpened at the lower ends to hook under the box, and with eyes forged in the upper ends to hang on the pipe. A short length of rope with an iron ring is tied to one of the eyebolts, and is used to hold the pipe crank, to prevent it from unwinding.

☐ A waterproof glue is made by dissolving gelatin in hot water, to the consistency of thick cream, and adding a tablespoonful of acetic acid to each pint.

Miniature Photography

There are many cases where miniature photographs are better than none at all, and if the photographer is running short of films and is carrying a pair of field glasses along with him, he can, after an

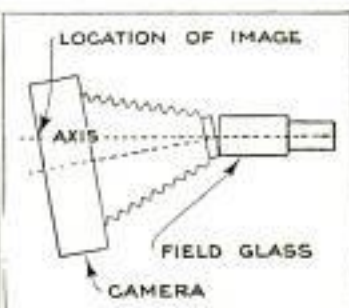

Taking Pictures through the "Wrong" End of a Field Glass to Obtain a Number of Miniature Negatives

experiment or two, get a considerable number of negatives on the space that would ordinarily be a single $3\frac{1}{4}$ by $5\frac{1}{2}$ -in., or similar, negative.

First focus the field glasses on a distant object in such a manner that the image seen seems to be at a distance. This is termed "focusing for parallel rays," and is most easily done by looking at the distant object with the unaided right eye, while at the same time looking with the left eye through one barrel of the glass, which is also directed at the distant object. Focus the glass until the left eye sees the image of the object just as distinctly as the right eye sees the object directly. This focus may be marked once for all by making a scratch on the draw tube of the glass to mark the position.

In practice, the focusing device of the camera is set for 100 ft., and the draw tube of the field glass is set at the scratch. The objective, or large lens, of the field glass is held firmly, in proper alinement, against the lens or lens mounting of the camera, with the small end of the field glass directed toward the view to be photographed. The exposure—time or snap—is made in the usual manner. Upon development the result will be a miniature photograph of a size proportional to the power of the field glass. All the light entering the camera will fall upon a small circular area of the plate or film, on the axis of the lens system, the rest of the film being untouched by light. This fact

makes it possible, after an exposure, to turn the film forward by an amount equal to the diameter of the miniature negative and then make another exposure for a new picture.

The illustration shows how two such exposures were made using a film shift of 2 in., which was larger than necessary. In the case of this particular camera (postcard size), it is quite possible to take nine of these miniature photos on the $5\frac{1}{2}$ -in. strip of film normally devoted to one photograph. A little dexterity in holding the axis of the camera lens system at a slight angle to the axis of the field glass, as shown in the diagram drawing, will enable one to take three of the miniature negatives without shifting the film at all, one where the axis of the camera lens system strikes the film, and one on each side of this spot. This scheme may be followed for each shift of the film so that upon development one has three rows of miniatures extending from end to end of the film, resulting in a possible 150 exposures on an ordinary six-exposure film.

Care should be taken, however, not to tilt the glass much; a slight movement only is required, and too much will admit light between field glass and lens, fogging the film.

Aerating Well and Cistern Water

The water in cisterns and slow-running wells is apt to become more or less stagnant. This can be remedied by aerating

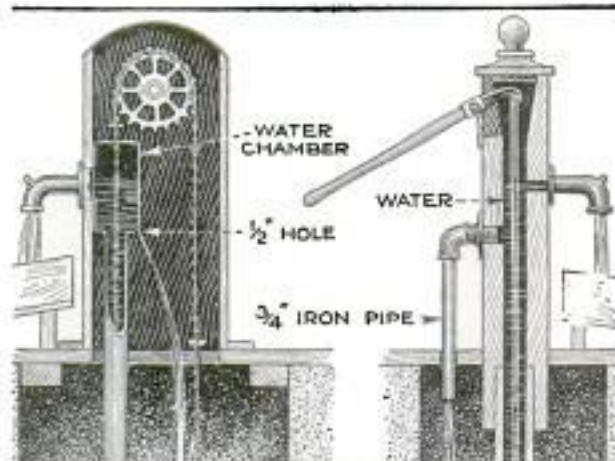

Simple, but Effective Method of Aerating Well and Cistern Water That Tends to Become Stagnant

a part of the water in the manner shown in the illustration.

In the case of a chain pump, a $\frac{1}{2}$ -in. hole is punched in the bottom of the water chamber toward the rear, as indicated, so that part of the water will

escape through it and fall back into the cistern. While falling, the water is broken into drops, and these absorb some of the oxygen of the air, which purifies the water and improves its taste.

A similar method can be used on an ordinary plunger pump, by drilling a hole about 4 in. below the level of the spout and screwing a $\frac{3}{4}$ -in. nipple into it. An elbow and a length of $\frac{3}{4}$ -in. pipe are fitted onto this nipple, so that part of the water will be returned to the well.

Quickly Detachable Binding Posts

On electric switchboards and panels where wires must be changed frequently, quickly detachable binding posts of the kind illustrated are much better than the ordinary kind, on which the nuts must be screwed down so tightly, to prevent them from being jarred off by vibration, that a wrench must be applied to loosen them, which, of course, consumes considerable time.

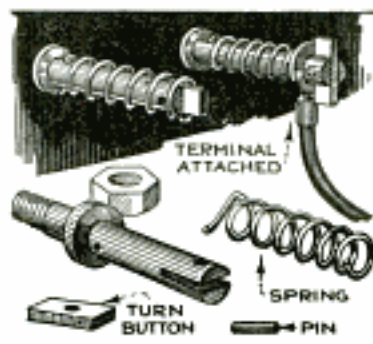

The binding post shown consists of a short, shouldered copper rod, threaded at one end and slotted at the other. The threaded end is pushed through the hole in the panel, and a nut is screwed on from the opposite side. A washer is then slipped on from the slotted end and also a coil spring. The inner end of the spring is pushed through a small hole, drilled through the post near the shoulder, as indicated. A brass turn button, which must not be wider than the diameter of the post, is riveted loosely in the slot, so that it can be turned around to either of the two positions shown in the upper details. It is then an easy matter to attach or remove the terminal of a conductor by turning the button parallel to the post. The coil spring keeps the lug tight against the button, assuring good contact, and as it can be compressed considerably, several conductors can be attached to the same post.

☞ To freshen the appearance of the leather chair seats, bags, etc., that are shabby from wear, rub them with the well-beaten white of an egg.

Serviceable Camp Stove

The drawing shows a serviceable camp stove that can be made at small expense, and that will give excellent service. It



A Serviceable Camp Stove, Made from a Steel Oil Drum, and Equipped with a Chimney

consists of a half of a metal oil drum, the head being used as the stove top. A square hole is cut in the side, near the bottom, to serve as a door through which the fuel is supplied. Just below the top, and opposite the fuel opening, a 4-in. hole is cut, and a sleeve is welded on so that a 4-in. elbow and a length of stovepipe can be added, thus providing a chimney. —C. K. Meller, Fargo, N. Dak.

Improving Auto-Door Straps

The leather or fabric straps used on automobile doors, to prevent them from swinging open too far, sometimes cause trouble by bending the wrong way and jamming between the door and door frame, thus preventing the door from being closed, and also straining the hinges or loosening the screws. To overcome this, fold the strap and sew a hem at its center, as indicated in the illustration. This will cause the strap to be bowed outward, and prevent any further trouble. The hem should not be so large that it will shorten the strap much.

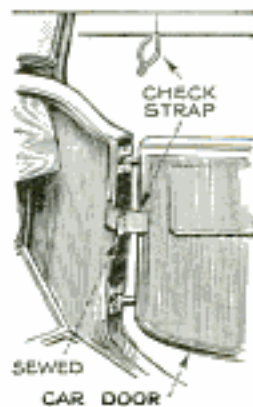

Photographing Objects Full Size

When it is desired to photograph small pictures or other objects in natural size, a short-focus lens can be used, but, as this gives greater distortion, it is much better to lengthen the bellows, which should be double the focal length of the lens used; that is, if a camera with a 7-in.

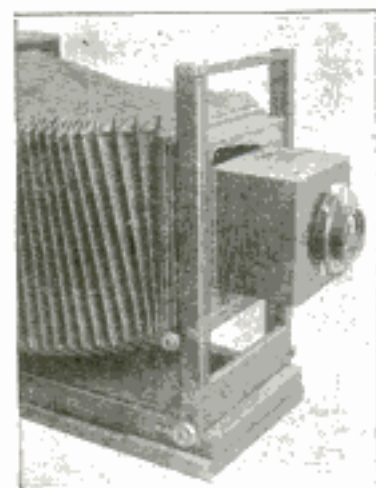

lens is used, the bellows must be extended 14 inches in order to record the image in natural size.

The best method of increasing the focal length is to use a "cone," which is merely a tight-fitting box attached

to the lens board, the lens being removed from the latter and fitted to the cone. The cone may also be fitted to the lens-board opening; if fitted to the lens board itself, the latter should have as large an opening as possible, so that the rays from the lens will not be cut off from the edges of the plate. If the cone is made sufficiently long, objects can even be photographed enlarged.—J. G. Pratt, Washington, D. C.

"Pushmobile" Brake

On a toy "pushmobile," the usual brake is a short lever, operated by hand and pressing on one wheel. An improvement upon this, consisting of two brake levers, with leather-faced blocks attached

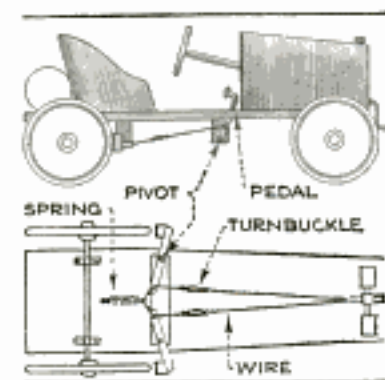

at the ends, and a pedal to operate them, is shown in the illustration. The brake levers pivot at their centers on a block attached to the underside of the car. A coil spring, connected to the inner ends of both levers, and attached to the underside of the car as shown, holds the outer ends away from the wheels. Two

wires are attached to the brake beams at the same points as the coil spring, and are connected to the pedal. Turnbuckles are used on the wires to take up the wear of the brake surfaces. Pressure on the pedal applies the brakes to the wheels, and the coil spring disengages the blocks from the wheels the moment the pedal is released.—Harold E. Benson, Boulder, Colo.

Broken Windshields Make Plate-Glass Shelves

Pieces of plate glass, cut from broken windshields and mounted on brackets made of pipe and fittings, form attractive and sanitary shelves.

The glass is cut to the desired proportions and the edges are ground down. Three holes are drilled and countersunk in the glass to receive flat-head screws. The holes are drilled with an old three-cornered file, held in a breast drill, a mixture of emery and water being used as an abrasive. The holes are countersunk by means of a piece of steel ground to a 60° point, used with the same abrasive. It is surprising how quickly the drilling is accomplished. Care must, of course, be taken to feed the drill lightly, so as not to break the glass.

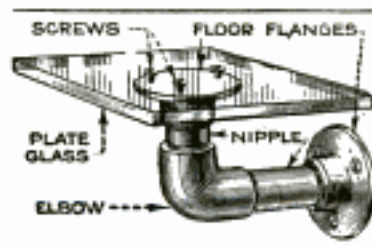

The bracket consists of two floor flanges, two short nipples and an elbow, all nickelplated and arranged as shown. The glass is screwed to one flange and the other flange is attached to the wall. When attaching the shelf to the bracket, a piece of thin felt should be used between the flange and the glass to absorb any uneven pressure of the screws.

Insulating Paint

The sealing composition found on storage batteries makes a good insulating paint. If placed in a container and set in hot water, it will melt readily, and can then be applied with a paintbrush. Nearly every car owner has an old storage battery available for this purpose, but if not, the composition can be obtained from a battery-service station at small cost.—C. M. Wilcox, Torrington, Conn.

Building a Four-Passenger Hand Car

BY GEO. A. NURS

THE four-passenger hand car described in this article will provide a great deal of healthy exercise and fun for the boys building it, and as most of the parts are made of wood, and are designed to be made with simple tools, a group of boys should not encounter any great difficulty in its construction.

The main member is a 12-in. oak plank,

1 in. thick. The exact length will depend to some extent upon how long it is desired to make the baggage compartment, and whether or not a headlight is desired, but the plank should not be less than 9 ft. long. Four 3 by 5-in. slots are cut along the center line of the plank, as shown in the detail of the board, and a hole to fit a $\frac{3}{4}$ -in. pipe is bored at the

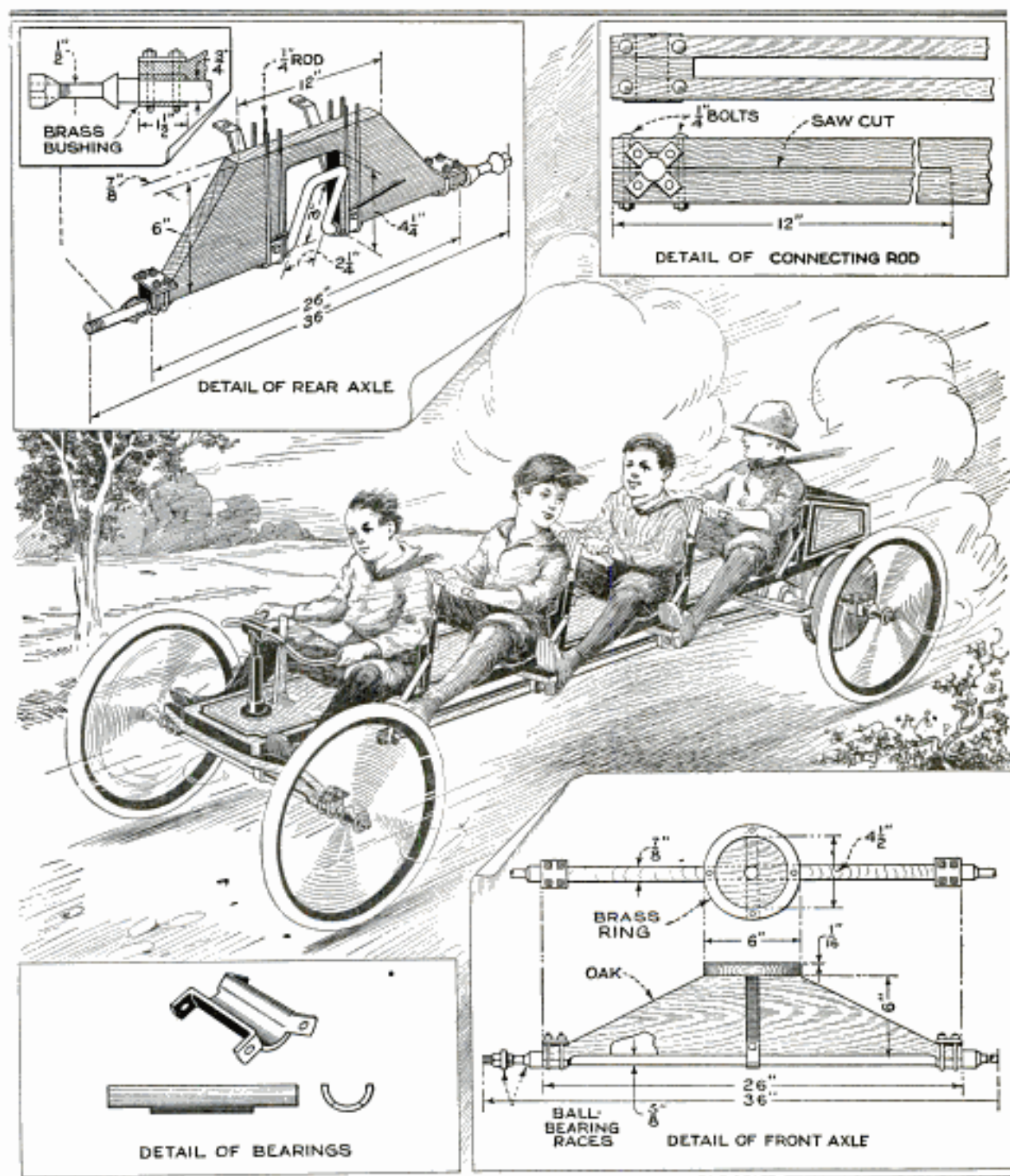

Full Details of Front and Rear Axles of Hand Car, Construction of Connecting Rod, Method of Making Bearings, and Perspective View of Car in Action

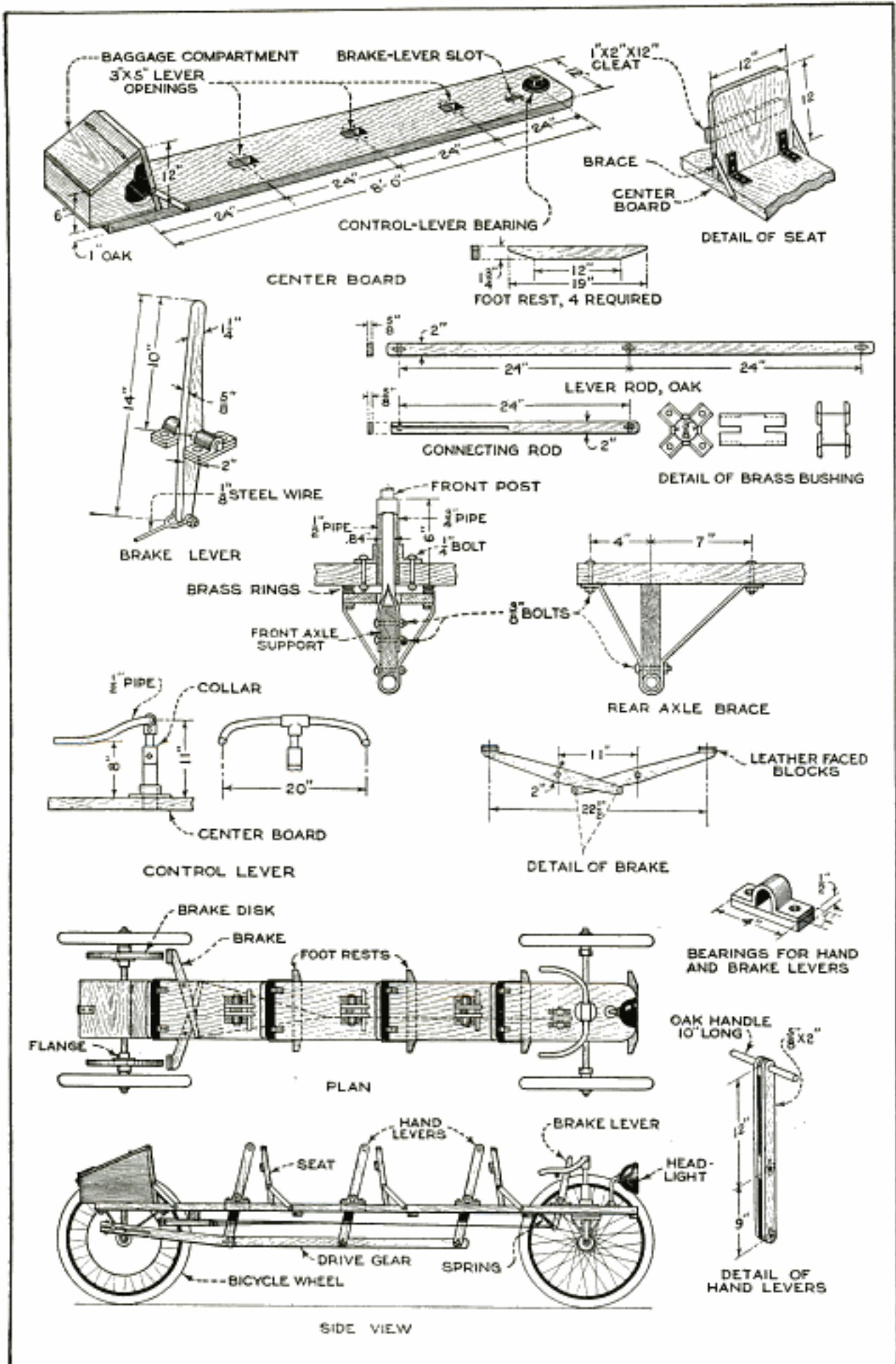

Top, Details of Main Board, Showing Baggage Compartment, Method of Bracing Seats, Sizes and Details of Lever and Connecting Rods and Their Bushings; Center, Cross Sections of Front and Rear Axles, and Details of Steering Post, Brake, and Lever Bearings; Below, Plan and Elevation of Car and Detail of Hand Levers

forward end, on the center line of the front axle. The axle centers are 8 ft. apart. The axles are made and attached first; it will probably be beyond the skill of the boy to make his own axles, but any blacksmith will turn them out if given a copy of the drawings. The rear axle is made from $\frac{3}{4}$ -in. iron or steel, with a crank of 3-in. throw, $2\frac{1}{4}$ in. wide, forged in the center. It is turned down at the ends to $\frac{1}{2}$ in. diameter, threaded, and fitted with the cone nuts that hold the wheels firmly in place. These nuts can be obtained from any cycle-supply house. The axle runs in bushings made of brass tubing, which are held to the wooden axle frame by U-bolts; these bolts are also best made by the blacksmith, as well as the flat-iron axle braces.

The front axle is made of $\frac{5}{8}$ -in. round steel, fitted in the same manner as the rear axle, but the front wheels can be allowed to run freely on the axle and provided with regular bicycle ball bearings, if desired; in this case, no brass bushings will be necessary, the axle being tightened firmly against the axle bracket. On top of the axle bracket or support, a 6-in. disk of wood is fastened, and a brass ring screwed to this, as indicated. This ring bears against a similar one screwed to the underside of the main board. This arrangement permits the front axle to be turned easily if the rings are kept oiled. The method of pivoting the front axle should be closely studied. A piece of $\frac{3}{4}$ -in. pipe is threaded into a floor flange, which is bolted to the main board; the end of the pipe passes through the hole in the board. A $\frac{1}{2}$ -in. pipe passes through the $\frac{3}{4}$ -in. pipe, and is split at the lower end, drilled, and bolted to the axle support; this forms the steering post, and is fitted with a collar that bears on the end of the $\frac{3}{4}$ -in. pipe. The upper end of the post is fitted with a tee, and the handlebars, also of $\frac{1}{2}$ -in. pipe, are screwed into this after being bent to shape.

The drive arrangement is very simple, and all parts are made of oak, bushed with brass tubing for bearings. The pieces of tubing are sawed at the ends to form ears, as shown in the details, drilled, and the ears bent so that they can be bolted to the levers and connecting rod. The end of the long lever rod fits between the ends of the connecting rod, and is attached to it by a $\frac{3}{8}$ -in. pin, fitted with washers and cotter pins. The hand levers are connected to the lever rod in a similar manner.

The construction of the brake is quite

clearly shown in the drawings; as the brake is only used for emergency stops, all ordinary stopping being done by gradually slowing up on the hand levers, the brake disks may be omitted, and the brake levers allowed to act directly on the rear wheels. If brake disks are used, they should be turned and fitted with floor flanges, setscrewed to the shaft. This will necessitate lengthening the shaft by an amount equal to twice the thickness of one disk and flange. The rear-brake levers may be connected to the hand-brake lever by light rods, in which case a spring on the hand lever will release the brake, or by heavy steel wire, which will require a spring to be fitted to each rear-brake lever. The details of the bearings for the hand and brake levers are quite clearly shown; they are bolted to the main board as shown in the plan and side elevation.

Where greater speed is required than can be obtained with the direct drive, a gear drive can be fitted. A small pinion gear with about 15 teeth is keyed or pinned to the rear axle, the crank being omitted, and a gear with about 75 teeth is mounted in bearings in front of it so that the teeth will mesh. This gear should be provided with a $\frac{3}{4}$ -in. pin, screwed into it 3 in. off center, and the connecting rod shortened and fitted on the pin. This will give a much greater speed than the direct drive.

The seats should be padded with burlap, stuffed with excelsior, and tacked to the board. For long trips, an acetylene or electric bicycle headlamp and an oil tail lamp should be carried, fastened to the main board by simple brackets.

A Three-Piece Mattress

An ordinary mattress, cut into three equal pieces as shown in the drawing, and with the cut edges rebound with canvas and strong waxed thread, will be found of advantage in the sick room. Each piece is very easily handled, making the job of airing the bed much less laborious than with the full-size mattress. In addition to this, if the three pieces are interchanged often, the formation of lumps or hollows is prevented, as the weight is evenly distributed over the mattress, thus adding greatly to the comfort of the patient.

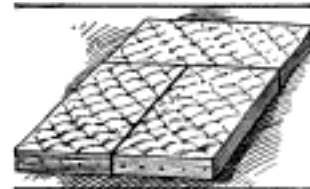

Making a Diving Springboard

A springboard for the swimming pool or the "old swimming hole" that actually has "spring" to it, is made by connecting

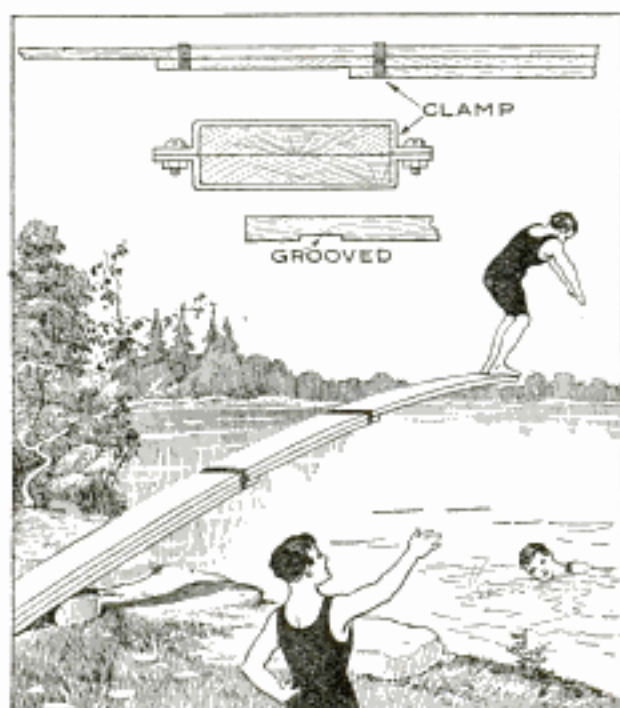

A Highly Satisfactory Diving Springboard Made by Bolting Three Planks Together

three boards somewhat after the manner in which the leaves of an automobile spring are assembled. In this way the spring obtained is much greater than that produced by any single board.

The top board is the longest, the next is about 3 ft. shorter, and the lowest one is about 4 ft. shorter than the second. The inner ends of the boards are set flush, and all three are fastened together throughout with screws, and at the points illustrated with iron clamps, which should be as unyielding as possible and made with sufficient space between the ends so that the boards can be clamped together tightly. The clamps are fitted into grooves cut on the underside of the bottom and middle boards, but the upper surface is not countersunk.—Robt. P. Lincoln, Minneapolis, Minn.

Turf-Cutting Tool

A single-bladed chopping knife can be made into a turf cutter for edging lawns around walks and flower beds. It is only necessary to remove the wooden handle with which the chopper is provided, and to drive the tang into a longer handle, which may be the handle from an old spade, or similar implement.

Using Badly Worn Phonograph Records

Some of the older phonograph records in every collection have become concave, and, from constant use, much of their original quality has been lost. One of these can be used to improve the playing of other records, however. To the convex side of the record, four felt or leather washers, just thick enough to keep the record out of contact with the turntable, are glued at equal distances. The record, so fitted, is then placed on the turntable, and the record to be played placed on top of it. This arrangement will slightly increase the volume of sound and also bring out the low tones more distinctly.—James E. Noble, Portsmouth, Ontario.



Plug-Type Aerial-Ground Switch

In order to use a radio set without running a permanent wire into the house from the aerial, an arrangement similar to the one shown in the drawing can be used. The lightning switch, which is of the single-pole, single-throw type, is opened or grounded as the plug is attached or removed. The switch is arranged on the outside of the building.

A hole is drilled through the window casing or wall, in line with the switch blade; this hole should be $\frac{13}{16}$ in. in diameter and a $\frac{3}{4}$ -in. porcelain insulating tube inserted into it. A second tube, $\frac{3}{8}$ in. in diameter and 2 in. longer than the first, is fitted with a strong spring switch clip small enough to pass through the larger tube. The wire running from the clip through the smaller tube should be regular high-tension automobile-ignition cable, and a flexible cord, which reaches to the instruments, is soldered to this. It

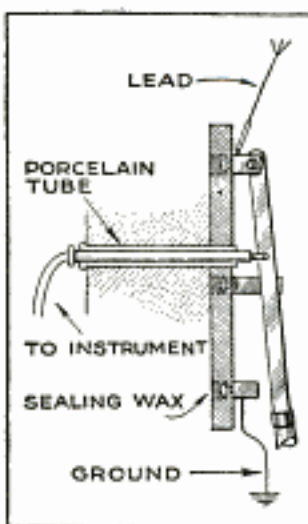

will be seen that when the inner tube is pushed through the outer one from the inside, the clip will make contact with the switch blade and at the same time push it out, breaking the ground connection. Upon pulling the plug in, the aerial is automatically grounded, but there is no metallic circuit into the house. A stop is provided to prevent the switch blade from being pushed out too far.—Edwin J. Bachman, Fullerton, Pa.

How to Make a Bed of Boughs

Thousands of men who camp in the woods sleep on twig beds, but it is safe to say that comparatively few know the proper way of making such a bed, so that it can be slept on comfortably. The mere cutting of a mass of branches and covering it with a blanket does not make for that enviable comfort so much talked of by old campers. A single thick branch will cause a sleepless night, not to mention what an armful unevenly distributed will do. There is only one way of making a



twig bed that is worth while. The twigs selected should have stems not thicker than $\frac{1}{4}$ in., while smaller ones would be still better. Take a canvas or blanket, go to a tree, cut off a supply, and bring it in. Two men working at the job will

soon have the bed ready for the night. The head of the bed should be higher than the foot, and the drawing shows how the twigs should be arranged at an angle, with the butts of the stems resting on the ground. In this manner the thick matting of the twig tops will keep the body from coming into contact with the sticks. When completed, stretch the covering blanket over the boughs. It should be mentioned that it is a good idea to fasten straps or cords at the four corners of the covering canvas or blanket; these can be tied to the tent pegs and drawn tight. Balsam-fir and cedar twigs are the best materials to use for the purpose; branches from most other trees are practically useless.

Basket on Pole Hives Bees Safely

A Wisconsin beekeeper, whose general farm work allows very little time for capturing the swarms that escape his



An Effective and Timesaving Device for Hiving a Swarm of Bees That have Escaped

apiary, has found the method illustrated both easy and quick. The device used for the work, he claims, has saved him many hours of labor as well as numerous painful stings.

The device is simple to make. It consists of a circular rim and a supporting fork made of $\frac{1}{4}$ -in. iron rod, and a cone-shaped screen-wire basket attached to the rim as shown. A stout cane fishpole is used for a handle, making the device light and easy to handle.

When the bees swarm, they usually alight in one of the trees of the orchard, and often at such a height that it is almost impossible to capture them. As soon as the swarm is located and fairly settled, the basket is raised under the swarm and shaken so that most of the bees will drop into it. Of course, many bees escape but they will return to the swarm and cluster on the outside of the basket. When all is quiet again, the basket is lowered in front of an empty hive and the bees are induced to enter their new home without much trouble.—G. E. Hendrickson, Argyle, Wis.

☛ A wastebasket, fastened to the side of the desk chair, keeps the basket in one place and prevents upsetting.

Thermostat Control for Carburetor Needle Valve

By adding a simple thermostat, the needle valve of an automobile carburetor may be regulated automatically without

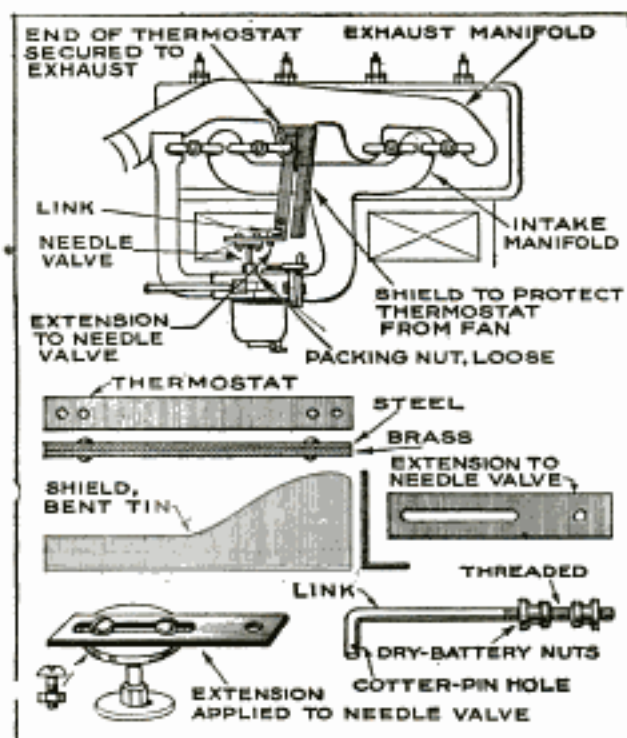

An Automatically Controlled Carburetor Needle Valve That Opens and Closes as the Engine Heats or Cools

attention on the part of the operator. The thermostat operates an extension on the needle valve, opening it slightly when the engine is cold and closing it when the engine warms up. The thermostat is made by riveting two pieces of dissimilar metals together, in this case strips of brass and steel. Metal, about $\frac{1}{8}$ in. thick by $\frac{1}{2}$ in. wide, is suggested. Owing to the fact that one of these metals expands considerably more than the other when heated, the thermostat will form the arc of a circle. By fastening one end of the thermostat securely in the manner shown, the opposite end is made to operate the carburetor.

On a common type of light car the upper end of the thermostat can be fastened underneath one of the manifold clips, and the lower end connected to the needle valve by an extension rod, fitting into an adjustable extension fastened to the top of the needle-valve wheel. By making the connecting link adjustable, various settings can be tried until the best effect is obtained. With the light-car engine, the needle valve should be opened a quarter turn for starting, and then turned back as the engine becomes warm; and approximately the same

rule will apply to similar types of carburetors. With a heat-controlled regulator of this type, the thermostat must be shielded from the direct blast of the fan by means of a shield, cut from a piece of tin and fastened under the thermostat.

Breaking Force of Water from Hose

A great disadvantage in irrigating a garden with an ordinary hose is the washing away of the ditch or furrow banks, owing to the force of the water as it issues from the hose. This trouble can easily be overcome by taking two cans, one somewhat smaller than the other, and arranging them as shown in the illustration. A hole is made in the bottom of the larger one, to receive the end of the hose, and the



small can is placed inside the larger, with its open end toward the hose. Both cans are fastened together by means of a wire, run through them as shown. In use, the arrangement is placed in a ditch, the hose is fastened in place, and the water is turned on. The water strikes the end of the small can, is deflected back, and issues in a slow, broad stream from the opening between the cans.

Nonslip Feet for the Tripod



Those who do much photographing in the home experience considerable trouble in keeping the tripod from slipping on linoleum or hardwood floors. By pushing an ordinary fuller ball from a faucet over the point on each leg of the tripod, no further

trouble will be experienced, as the rubber balls will hold the tripod securely on any surface.—K. H. Hamilton, Chicago, Ill.

Increasing Wave Length of Receivers

BY F. L. BRITTIN

THE National Radio Conference recently held in Washington has made radical changes in the wave lengths on which the various broadcasting stations are permitted to operate, with a view to clearing the air for public benefit. The new wave lengths allotted to broadcasting stations that are now operating below 3,150 meters, can be divided into three classes, namely: Class A, which includes those stations not using more power than 500 watts and which are to operate on wave lengths between 288 and 300 meters; Class B, which includes stations

to enable them to receive stations operating on wave lengths greater than those for which their sets were originally designed. Most receiving sets now in use were built to tune to wave lengths from 200 to 500 meters, when using the average type of aerial, and in these cases it is only necessary to make minor changes in order to enable the operator to tune to maximum signal strength.

If a very short aerial is used, an inductance is necessary in the aerial circuit, controlled by means of a variable condenser connected in series with the

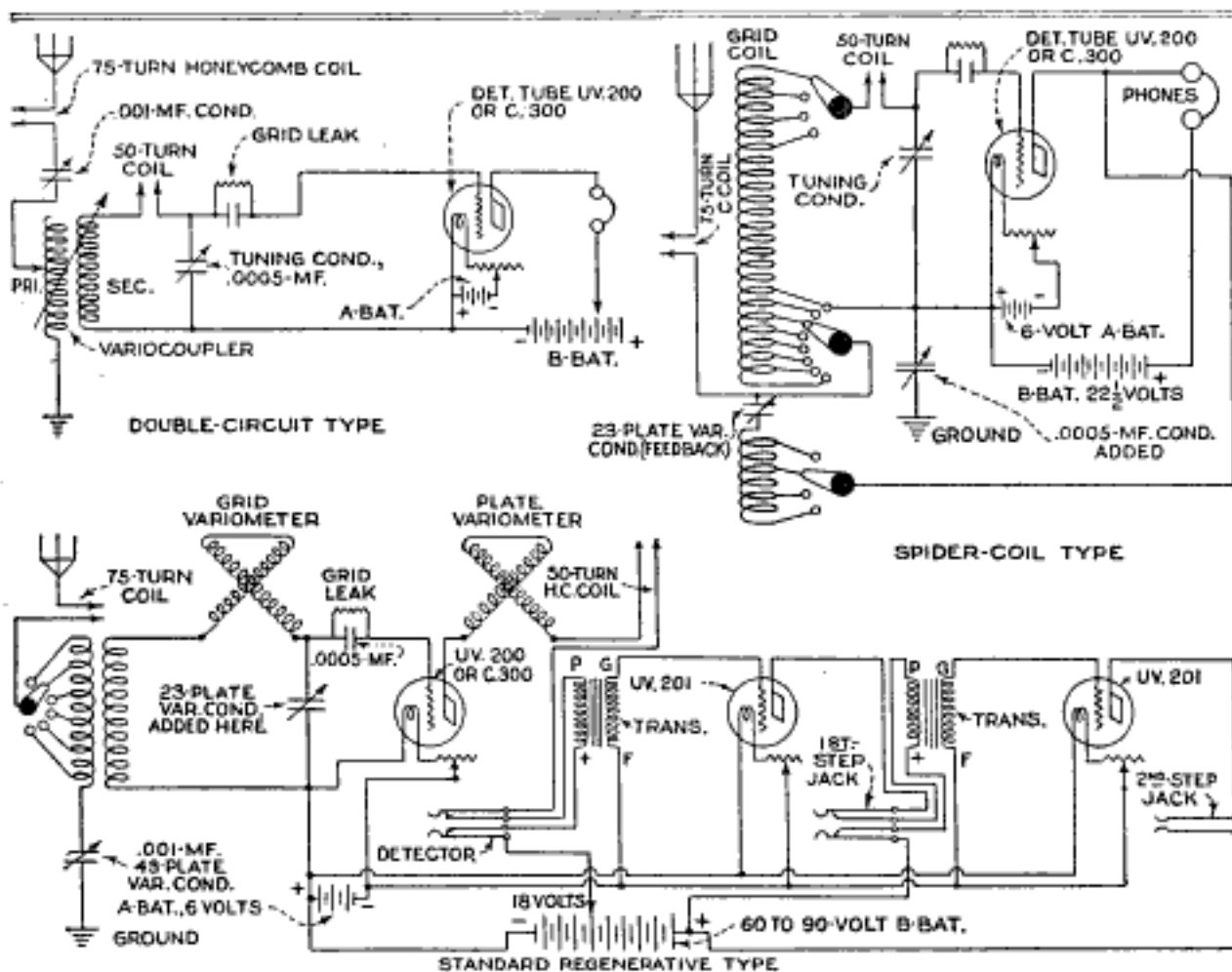

The Addition of Honeycomb Coils and Variable Condensers to the Common Types of Radio-Receiving Instruments Allows Them to be Tuned to the Longer Wave Lengths That are Now Used

using power from 500 to 1,000 watts, to use wave lengths from 300 to 545 meters, and Class C, which includes stations that are operating on a 360-meter wave length and that will be permitted to continue using this wave length.

On account of these new rules, many amateur radio fans are confronted with the problem of making the proper changes in their receiving instruments,

aerial. Honeycomb coils are excellent inductances to use for this purpose, as they are small, compact, and easy to install. Another method of adjusting the antenna circuit to longer wave lengths is to place a variable condenser across the tuning inductance. The condenser should have a capacity of .0005 mf., which is generally known as the 23-plate size, and be of the vernier type.

On the double-circuit type of receiver, using a variocoupler, a 75-turn honeycomb coil is placed in the aerial circuit between the aerial and the primary of the variocoupler, and a 50-turn honeycomb coil is connected in the secondary circuit, this coil being placed in the lead running from the secondary tuning condenser to the secondary winding of the variocoupler, as shown in the upper left-hand diagram. A method of switching out this coil must, of course, be provided in order to permit tuning to the shorter wave lengths. In the case of a single-circuit receiver, using a tuning coil and a variable condenser in the aerial or ground circuit, a 75-turn honeycomb coil is placed in the aerial circuit.

With a regenerative receiver of the spider-coil type, the wave length can be increased by placing a 75-turn coil in the aerial circuit between the aerial and the coil, and a 50-turn coil in the secondary or grid-coil circuit, between the switch

and the variable tuning condenser, as shown in the upper right-hand diagram. A .0005-mf. variable condenser is also placed in the ground lead to assist in tuning.

In the case of a standard type of regenerative receiver, consisting of a variocoupler and two variometers, a 75-turn honeycomb coil is placed in series with the aerial circuit, and a 50-turn coil in series with the plate variometer; a 23-plate condenser is also connected across the grid variometer and the secondary winding of the variocoupler, as shown in the lower diagram.

The circuit diagrams show exactly where to connect the honeycomb coils and condensers. Switches must be provided for cutting out the coils when they are not required. These switches can be mounted on the panel in any convenient position. Single-coil mountings are now on the market, and they can be attached to either the front or rear of the panel.

Doorstop Made from Hook

It is frequently necessary, when sweeping, scrubbing, or moving pieces of furniture in and out of the house, to provide



some means of holding the screen door open. A simple and effective stop can be made from a screen-door hook. The hook is straightened out as indicated and screwed into the lower part of the door, a screwhook being driven in near it, for the hook to rest in when not in use. When it is desired to hold the door open, the hook is lifted from its place with the toe, and allowed to drop down so that the point digs into the floor.

Blackening Metal Parts of Camera

Interior metal parts of cameras must be colored a dead black to prevent light reflections. Brass parts can be painted with a solution of copper nitrate, followed by an application of nitrate-of-silver solution, after which the metal is heated until the color is deep enough. Zinc is placed in a fixing solution of hyposulphite of soda and chrome alum, which

will turn it a dark green. Both metals can be lacquered by heating and applying shellac or hard-drying varnish, if used on the outside of the camera.

Combined Oil Funnel and Container

A combination funnel and container which is of considerable convenience, is shown in the illustration. Any ordinary metal funnel can be used for this purpose, providing it is large enough to hold about a quart of oil. A strip of flat spring steel is riveted to the side and bent over as indicated so that the loose end comes over the center of the funnel; a hole is drilled through this end. A short length of round wooden rod, and a cork that just fits into the wide part of the neck, are both drilled lengthwise to receive a long bolt, then attached to the end of the handle as shown. Pressure on the handle forces the cork into the neck of the funnel, closing it, and allowing the funnel to serve as a container or carrier for the oil. When the liquid is to be discharged, the pressure on the spring is released, and the cork is pulled out of the neck.

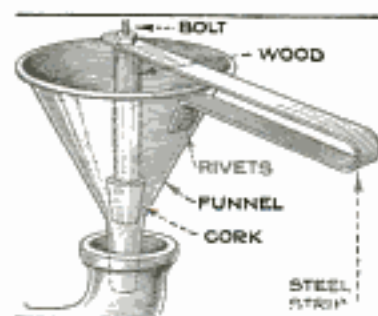

Handy "Built-In" Shoe-Polish Box

Convenience and usefulness are combined in the "built-in" shoe-polish box shown in the photograph. It provides space for keeping the polishes and brushes, and when opened, serves as a footrest as well. Being small in size, it can be installed in any suitable place in a wall, as it slips between the studs, which are usually spaced 16 in. apart.

Build the box of 1-in. stock, 12 by 18 in. inside measurements, gaining the top and bottom pieces into the jambs. The depth should be such that after the back, which is made of panel veneer or other suitable thin stock, is nailed on, the front of the frame will be flush with the plaster when the box is set in place. The shelves and partitions indicated in the photograph should be set back from the front edge of the frame $\frac{3}{8}$ in. so as to form stops for the door, which measures $1\frac{1}{8}$ by 12 by 18 in.

The door pivots on a piece of $\frac{1}{2}$ -in. gas pipe, $13\frac{3}{4}$ in. long. The ends are carried in holes bored in the side jambs, $2\frac{1}{2}$ in. from the bottom and $1\frac{1}{2}$ in. from the front. Ordinary pipe straps screwed to the inside of the door act as hinges. A stop must be so placed inside the frame that the door, when open, slopes forward at a convenient angle for the foot.

Case the box to match the trim of the

room, bringing the inner edges of the casing flush with the inside of the box. It has been found that the most convenient height for the box is about 1 ft. from the floor, measuring from the bot-

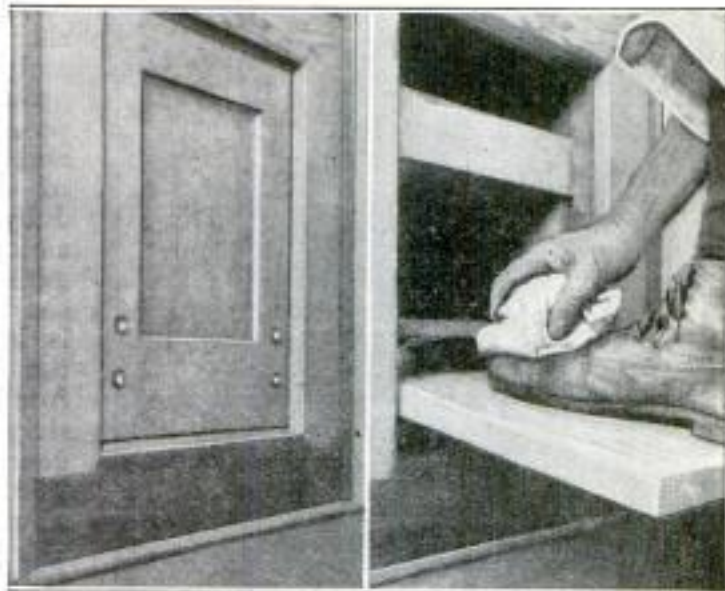

Convenient Box for Shoe Polish and Brushes: The Door Opens to Serve as a Footrest While Polishing

tom of the box. The edge of the lower casing will then bear against the top of the baseboard.

If the box is to be installed in a house already built, cut out the plaster and laths between two studs until the height of the opening is 20 in. Cut two lengths of 2 by 4-in. wood and nail these between the studs, above and below the opening, so that the casing nails may be driven into them.

Homemade Ink-Bottle Holder

A serviceable ink-bottle holder that can easily be made from a block of wood and some ordinary pencil erasers, is shown in the illustration. A block of $\frac{3}{4}$ -in. wood, about 4 in. square, is obtained, and a circle, a trifle larger

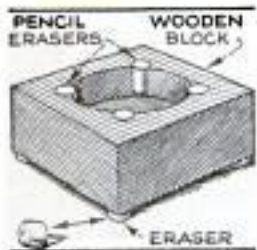

than the bottom of the ink bottle, is scribed on one side of the block, in the center. Then another circle, with a radius $\frac{3}{8}$ in. larger and concentric with the first, is scribed on the

block. The circles are divided into four equal parts by scribing diagonal lines from corner to corner of the block. At

the points where the lines intersect the outer circle, punch marks are made, and holes, a trifle smaller in diameter than the rubber tips of pencils, are drilled with the punch marks as centers. The large hole for the ink bottle is then drilled to the desired depth.

Pencil erasers are forced into the four holes drilled for them. As is apparent, they serve to hold bottles of slightly varying diameters snugly. Pieces of pencil erasers are attached to the underside of the holder with small brads to serve as feet and prevent marring of the finish of the desk or table. Two coats of black shellac give the holder a good finish.

☛ To test turpentine, place a drop or two on a piece of white paper. If pure, no trace or stain will be left.

"Propping" Pear Trees with Twine

A successful California fruit grower has found ordinary binder twine a good substitute for the wooden props ordi-



Binder Twine as a Substitute for Wooden Props Ordinarily Used to Support Fruit-Tree Limbs

narily used to support heavily loaded branches of pear trees. The twine is wound around the tree as if it were a huge bundle of grain. This is done after the fruit is well set on the trees, but before it is large enough to bend the limbs. The work of tying up the trees is conveniently done by two persons. One carries a ball of twine and a forked stick to hold the twine at any desired height while moving around the tree, and the other, mounted on a stepladder, ties up the branches. It is frequently necessary to wind the twine around the tree several times at different heights.—W. L. Salvage, Beaumont, Calif.

Saving Radio Tubes

After completing a radio set and hooking up the batteries, it is highly advisable to apply a voltmeter to the filament terminals of the sockets before inserting the tubes, with the rheostats first off and then turned to operating position. If the voltmeter indicates more than the filament voltage of the tube, look over the wiring and see if the B-battery lines are connected across the filament lines, and make the proper changes. Under no conditions should the tubes be subjected to a higher voltage than that for which they are designed, as the filaments will be burned out very quickly.

Stop for Garage Doors

The usual method of "propping" the garage doors to hold them open may be dispensed with by providing an automatic stop of the kind shown in the illustration. A short post is sharpened at one end and is driven into the ground near the open position of the door, and two short strips of wood, about 1 by 3 by 8 in. in dimensions, are hinged together at one end as shown. A coil spring is fastened between the strips to raise the free end of the upper

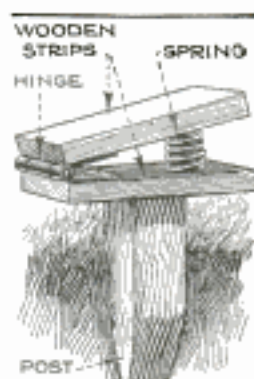

strip, the ends of the spring being stapled down. The lower strip is nailed to the post so that the hinged end points toward the door when the latter is opening. When the door is swung open, the bottom strikes the inclined plane of the upper strip and, after depressing it, slips over the end; the spring then lifts the strip and prevents the door from closing. A stake should be placed beyond the stop to keep the door from swinging open too far. When driving the post into the ground, care should be taken that the post is sunk deeply enough into the ground so that the door will be sure to slip over the strips.

Convenient Drying Rack for Negatives

The drawing shows a convenient rack for drying negatives. It is made of sheet zinc or brass, and can be hung on the wall, or placed on the bench or table. It is made of sheet metal, cut to shape, with the wide end formed to make a shallow tray, while the long strip is bent at right angles to the tray. Cuts are made in the strip as indicated and the parts so formed bent out to an angle of about 45°.

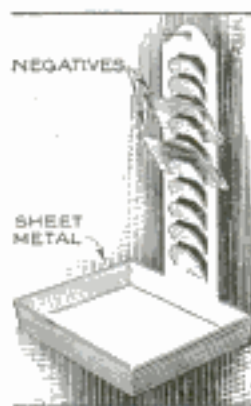

A small hole is drilled at the top of the rack so that it can be hung on the wall. Plates must be placed in the rack with the emulsion side up, or the film surface will be scratched, ruining the negative, and all sharp edges must be rounded off smooth.

Musical Instruments from Cigar Boxes

BY W. F. CORD

CIGAR boxes, which may generally be obtained for the asking from any tobacconist—who will be glad to get rid of them—can be used to make very passable violins and mandolins. Of course, it is not expected that a "fiddle" of this variety would possess the tone of a Cremona or Stradivarius, but, in the hands of one knowing how to play such an instrument, very creditable results may be attained.

The drawing shows the dimensions and appearances of the various necks in case it is desired to make them at home. However, if the best results are desired, it is recommended that these, as well as the bridges, tailpieces, strings, and simi-

box, to make it stronger. When the neck has been completed, drill two or three holes through the block and box into the neck for screws; then glue the neck in place, and screw it on tight. Next fasten the fingerboard in place, drill a hole in the rear end and rear block, and glue into it a small peg to hold the tailpiece. The bow is also made of poplar, and the hairs can be obtained from a long-tailed horse or bought from a music store; ordinary thread can even be used, where it is not possible to obtain horsehair, or to purchase a bow.

For the mandolin, a box about $5\frac{1}{2}$ or 6 in. wide, $2\frac{3}{4}$ to $3\frac{3}{4}$ in. deep, and $9\frac{1}{2}$ in. long, will be best. The lid, as in the

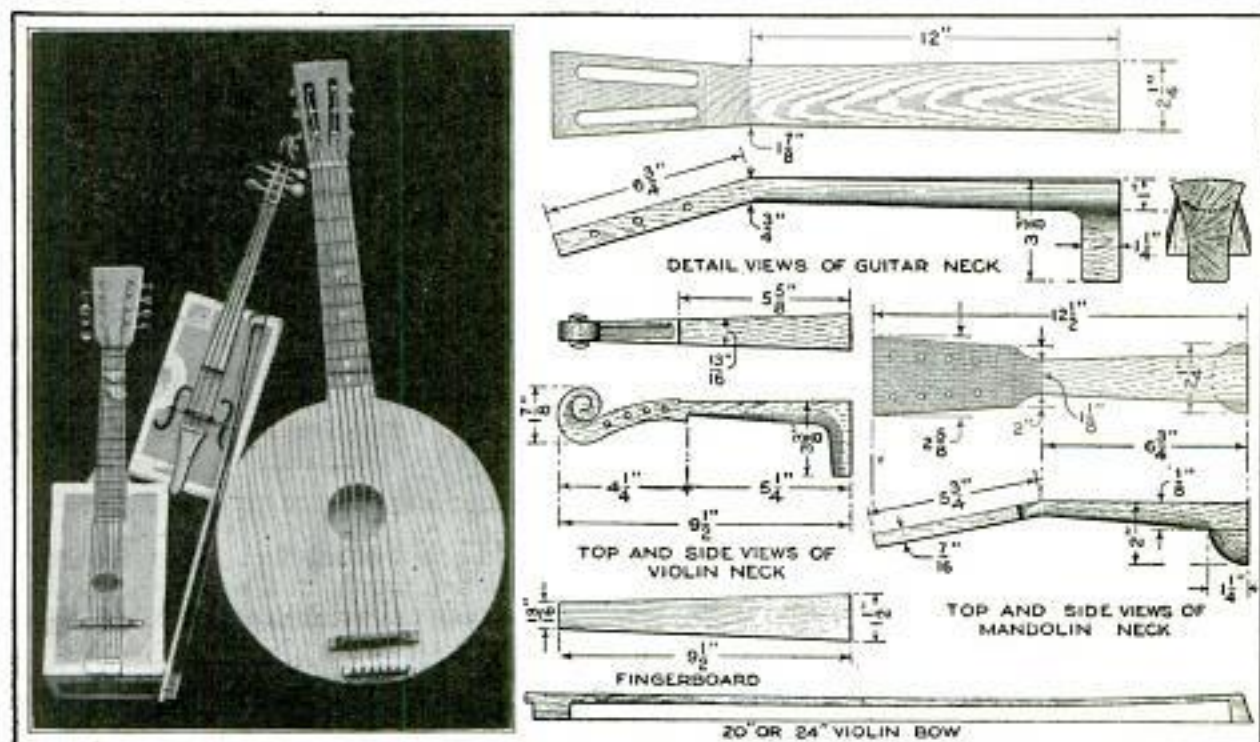

Violin, Mandolin, and Guitar That are Made from Cigar and Cheese Boxes by the Addition of Suitable Necks and Fittings: Anyone Who can Play a Standard Instrument of Either Kind can Produce Music from These

lar fittings, be purchased from a music-supply house. If made at home, poplar should be used.

The cigar-box violin should be made from a box about 3 in. deep, 5 in. wide, and from $9\frac{1}{2}$ to 13 in. long, according to the person for whom it is made. Let the lid form the back of the instrument, but do not nail it down until the work has been completed. Glue a block, $\frac{3}{8}$ in. wide by $2\frac{1}{2}$ in. long and the same depth as the box, in the end to which the neck is to be fastened, and a smaller block at the opposite end. Cut the F-shaped sound holes in the top and then drive in a few more nails around the edges of the

violin, forms the back and is not fastened down until the remainder of the work is done. The sound hole, which is about at the center of the box, is $1\frac{1}{4}$ by $1\frac{3}{4}$ in. in size. Glue a piece of wood, $\frac{1}{4}$ by $\frac{5}{8}$ in. in dimensions, across the box, midway between the sound hole and the end of the box, to keep the bridge and fingerboard from pressing in the top. A block, $\frac{3}{8}$ in. wide by 3 in. long, and the same height as the box, is glued inside at the neck end. The neck is made as indicated in the drawing, and is attached to the box as described for the violin.

The guitar is made from part of a cheese box instead of a cigar box. A box

made from a single piece of wood, instead of one made up from three-ply veneer, should be selected. Cut the rim down to $3\frac{1}{4}$ in. in width, and attach the neck at the point where the ends meet, after fastening a $\frac{3}{4}$ by $3\frac{1}{4}$ by $3\frac{1}{4}$ -in. block on the inside. The neck, when in place, must stand above the rim a sufficient distance so that, when the top is applied, the neck will be flush with the top. After the neck has been fitted, as described above, the top and bottom can be put on; these pieces may be sawed from pine, poplar,

or almost any kind of lumber, about $\frac{1}{8}$ in. thick. The sound hole is a little above the center and is $2\frac{3}{4}$ in. in diameter. The top is glued and nailed to the rim and is reinforced by three $\frac{1}{4}$ by $\frac{5}{8}$ -in. strips that are glued edgewise across the underside of the top to prevent it from being pressed in. It is also advisable to glue two or three such strips on the bottom before it is attached. A lug, $1\frac{1}{4}$ in. long by $1\frac{1}{2}$ in. wide, is left on the bottom cover, and fastened to the underside of the neck.

Homemade Hog Oiler

An easily constructed hog oiler, made from a wheel taken from an old wheelbarrow, is shown in the photo. The

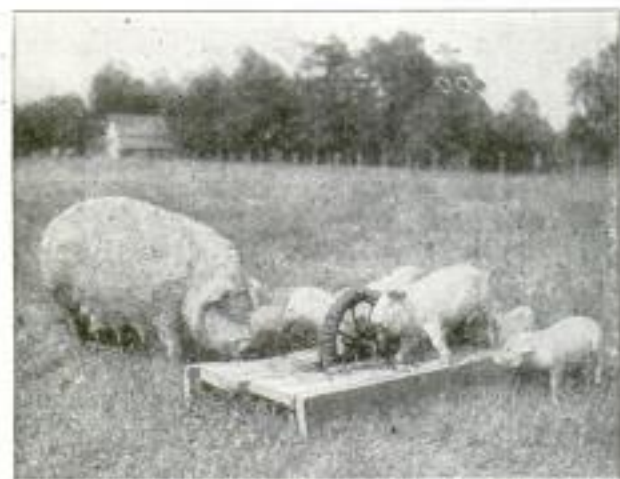

Effective Hog Oiler, Made from an Old Wheel Covered with Burlap Sacking

wheel, covered with burlap, is mounted in its original bearings on the wooden base that contains the oil trough. The wheel turns as the hogs rub against it, thus continually taking up a fresh supply of oil. This treatment keeps the hogs free from lice and other vermin.

Making Sparrows Useful

If a small quantity of cracked corn is thrown on the heads and under the stalks of cabbage plants, the sparrows will gather up the corn, and, while getting down through the leaves after the small grains, will also eat the cabbage worms.

Some corn is first scattered near the patch to attract the birds, and the grain is then thrown in and around the head of the cabbage plants about every two days; if the patch is a large one, every three or four days will do. The sparrows will not eat the cabbage, but will get the green worms.—Joe Dunn, Meyerdale, Pa.

Vacuum Cleaner "Blows" Organ

In a church where an ordinary reed organ with pedal-operated bellows was used, it was desired to install an electric blower. As the reeds of such an organ are sounded by suction, the air being exhausted from the wind chest by the bellows, it was found that a common vacuum sweeper could easily be made to do the work. A small hole was cut in the wind chest, and the end of the vacuum-cleaner hose inserted, the connection being made air-tight. The cleaner itself was set in the basement where it could not be heard while running. The result was entirely satisfactory, the cleaner doing the work just as well as an expensive electric blower.—Phil H. Brehmer, Rutland, Vt.

Attaching Caster to Oil Stove

The addition of casters to an oil stove, which is ordinarily not fitted with them, increases its convenience considerably, as it can then be moved about more easily.

A piece of 1-in. hardwood is cut to a circular shape and a hole is drilled through it as shown, so that the leg of the oil stove fits in the hole snugly. The bottom of the hole is closed with a cardboard disk, a flat-top caster is placed in position underneath it, and the caster screws pushed up through the cardboard.

Melted lead is poured into the hole in the block from above, and this, when cool, will hold the screws securely.

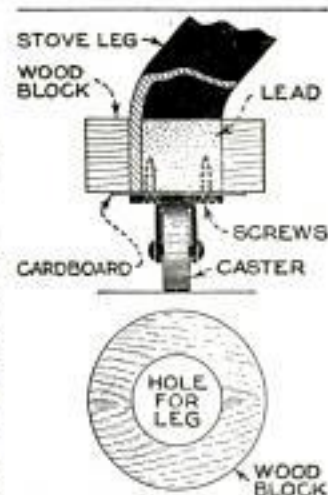

Using Camera Finder as Range Finder

Any small camera finder, having a ground glass, can be used as a range finder by marking two horizontally converging lines on the ground glass as shown in the illustration. Distances of 6, 10, 25, and 50 feet from the camera are marked off on the ground, and, with

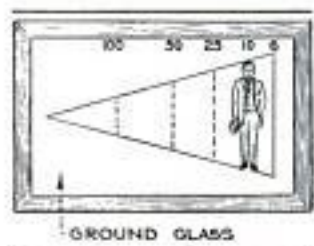

a person of average height standing at these points successively, his position is marked on the ground glass at the points where the images of head and feet

touch the upper and lower lines. Vertical lines are drawn between the points thus located and the distances marked on. If the finder is too small for many figures, the lines marked can be the same as those on the focusing scale, and the numbers dispensed with. Thereafter, when making a snapshot, it is only necessary to find the line corresponding in height to the person to be photographed in order to know the correct distance to set the scale.

Package Fasteners

When it is necessary to send a package at unsealed-mail rates, and a supply of regular parcel-post package seals is not on hand, perfectly satisfactory ones can readily be made from two 4-in. strips of 1-in. gummed paper, such as is used for sealing packages. Fold over about $\frac{3}{4}$ in. at one end of each strip and insert a flat-headed brass paper fastener, as shown, in one of

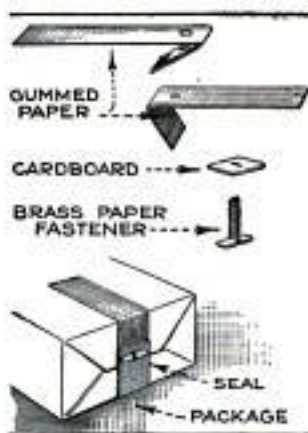

the strips, and a small piece of cardboard in the other. Then stick the ends down to hold the fastener and cardboard in position. Punch a hole or cut a slit through the piece of cardboard for the fastener to pass through, and then fasten the strips to the package as shown, so that it can be opened for inspection by the postal authorities.—Leighton Powell, San Francisco, Calif.

Temporary Wire Fences

The photograph shows the construction of a temporary fence for "hogging down" corn or other forage crops on a



Temporary Wire Fence That can be Set Up or Taken Down in a Very Short Time

farm. Each stake is made from a length of pipe, which is flattened at one end so that it can be easily driven into the ground. A number of holes are drilled in the pipe, in pairs, at equal distances apart, and a small loop made of wire is inserted into each. The wire fence is then stretched in the usual way, and a long straight piece of heavy wire is slipped down through the small loops to hold the fence in place. With this arrangement the fence may be put up or taken down in a very short time.

When Felloe Bolts Become Loose

Bolts that are used to hold demountable rims in place on the felloe have a tendency to loosen, partly from screwing them up tightly, and partly from running stresses. A simple repair is as follows: Remove the bolts, and plug the holes with wooden dowels, then drill new holes half-way between the old ones. The size of these holes should be such that the bolts must be driven in.

Combination Window Boxes and Sills in Concrete

When remodeling his building, an owner included the concrete combination window boxes and sills shown in the il-

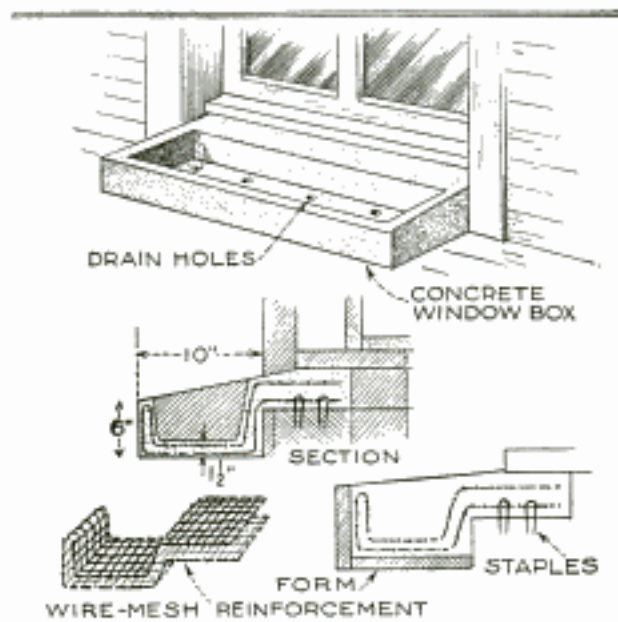

Combination Window Boxes and Sill in Concrete That Is More Durable than the Wooden Sill

lustration, adding considerably to the appearance of the house, and insuring permanent sills. The construction is simple and durable, the concrete being reinforced with wire mesh, doubled as shown, and stapled to the plate under the sill. A wooden form was made, 6 in. deep at the front, 10 in. wide and as long as the window frame, lightly nailed in position, and the concrete, a mixture of 1 part cement to 2 parts sand, poured. The interior was cut out and troweled smooth while the concrete was still plastic, and $\frac{1}{2}$ -in. drain holes made through the bottom. The form was not removed until the concrete had set, and the sill was kept wet for a week, before any weight was placed on it.

When the Crankcase Oil Runs Low

Owners of automobiles provided with the splash system of oiling will appreciate the kink given below, when a low supply of oil in the crankcase threatens to "freeze" the pistons and burn out the connecting-rod bearings.

Pour a quart or two of water into the crankcase. As oil is lighter than water, it will rise to the top, and will be splashed up by the crankshaft and connecting rods as usual. By doing this the car can be run to the nearest supply station, where the crankcase can be drained and refilled.

Special Wrench for Removing Grease Cups

The wrench illustrated was devised to remove grease cups of the screw-cap type, such as used on automobile axles, the threads on the outside of the cup preventing the use of a pipe wrench because

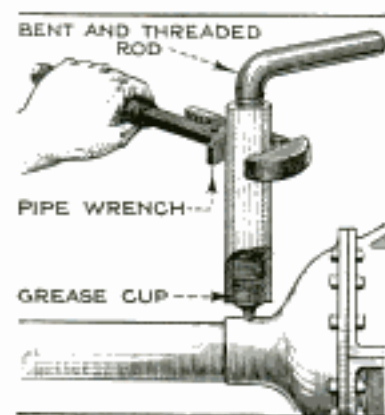

of the damage to the thread, and the hexagons on the lower parts being usually so much worn or so placed, as not to allow a wrench to be used. The tool consists of two parts: a short

length of pipe, tapped through its entire length with the same thread as the grease cup, and a rod, threaded to fit in the pipe, and bent as shown, to facilitate turning it. In use, the pipe is first screwed onto the grease cup, after which the rod is screwed down tightly against the cup, thus locking it securely in the pipe. A pipe wrench is then used in the manner indicated to unscrew the cup.

Mirror an Effective Lure for Fish

While the bait shown in the illustration makes use of a mirror, it is the greed of a fish that leads to its capture rather than its vanity, for, seeing the bait attractively reflected in the mirror as well as the image of what seems to be another fish, it becomes a question of which one gets the worm first. While glass mirrors can be used they are open to the objection that applies to all glassware—they break. Consequently a concave mirror made of polished metal, such as the bowl of a silver tablespoon or large measuring spoon, is better, and the results equally satisfactory, the convex side being blackened. The hook is fastened on a line passed through a hole in the edge of the mirror and drops to the center, where it can be baited in the usual way.—J. W. Matley, New York City.





That's the Way

To teeth you envy
Just combat the dingy film

When you see glistening teeth—as you do everywhere now—remember how folks get them.

Leading dentists the world over are urging a fight on film. Millions now employ the method. And wherever you go you now see the results.

If you have not yet found that method, ask for this ten-day test.

Why teeth discolor

You feel on your teeth a viscous film. It clings to teeth, enters crevices and stays. If you leave that film, it becomes discolored by food or tobacco stains. Then it forms dingy

coats. Tartar is based on film. That's why teeth grow cloudy.

Film also holds food substance which ferments and forms acid. It holds the acid in contact with the teeth to cause decay.

Germs breed by millions in film. They cause many serious troubles, local and internal. Thus film is the teeth's chief enemy.

Now easy to combat

Dental science, in late years, has learned how to fight that film. It has found two film combatants. One acts to curdle film, one to remove it, and without any harmful scouring.

Able authorities proved these methods effective. Then a new-type tooth paste was perfected to apply those methods daily.

That tooth paste is called Pepsodent. Careful people of some fifty nations are employing it today.

It also does this

Pepsodent does two other things which research proved essential. It multiplies the alkalinity of the saliva. That is there to neutralize mouth acids, the cause of tooth decay.

It multiplies the starch digestant in the saliva. That is there to digest starch deposits which may otherwise ferment and form acids.

With many diets, those things are essential. To countless homes they now are bringing a new dental era.

Do this and see

Pepsodent results are quick and apparent. They are seen and felt, so no one can doubt them. And they mean so much—whiter, cleaner, safer teeth—that you should find them out.

Send the coupon for a 10-Day Tube. Note how clean the teeth feel after using. Mark the absence of the viscous film. See how teeth whiten as the film-coats disappear.

You will know in a week what this way means, both to you and yours. Cut out coupon now.

Avoid Harmful Grit

Pepsodent curdles the film and removes it without harmful scouring. Its polishing agent is far softer than enamel. Never use a film combatant which contains harsh grit.

Pepsodent PAT. OFF.
REG. U.S.

The New-Day Dentifrice

A scientific tooth paste based on modern research, now advised by leading dentists the world over.

10-Day Tube Free 1243

THE PEPSODENT COMPANY,
Dept. 182, 1104 S. Wabash Ave., Chicago, Ill.
Mail 10-Day Tube of Pepsodent to

.....
.....

Only one tube to a family.



Construction Day by Day

So great and so constant is the growth of demand for telephone service that the Bell System invests throughout the country an average of three-quarters of a million dollars every working day for new telephone plant.

New aerial lines are always under construction or extension, new subways are being dug and cables laid, larger building accommodations are under way, more switchboards are in process of building or installation, and added facilities of every description being mustered into service to care for the half million or more new subscribers linked to the System every year.

This nation-wide construction, this large expenditure of funds, could not be carried out efficiently or economically by unrelated, independent telephone organizations acting without co-operation in different sections of the country. Neither

could it be carried out efficiently or economically by any one organization dictating from one place the activities of all. In the Bell System all the associated companies share common manufacturing and purchasing facilities which save millions of dollars annually. They share scientific discoveries and inventions, engineering achievements, and operating benefits which save further millions. But the management of service in each given territory is in the hands of the company which serves that territory and which knows its needs and conditions.

By thus combining the advantages of union and co-operation with the advantages of local initiative and responsibility, the Bell System has provided the nation with the only type of organization which could spend with efficiency and economy, the millions of dollars being invested in telephone service.



" BELL SYSTEM "
**AMERICAN TELEPHONE AND TELEGRAPH COMPANY
 AND ASSOCIATED COMPANIES**

One Policy, One System, Universal Service, and all directed toward Better Service



Make Big Money

Get into business for yourself

Charles——, of Iowa, writes me:

"Dear Mr. Jewett:

I had \$5000 last year when I began with your cars in this town of 5000 people. Today I am worth \$10,000, have a real business, and drew more last year than I ever earned on a salary."

\$5000 to \$50,000 a year for you handling Paige and Jewett cars

This advertisement is addressed to every man in America whose ability, ambition and clean record qualify him to succeed in business for himself. No previous automobile experience is necessary—just real good business men are wanted. We have openings right now for such men. In your own town or near by, such an opportunity likely exists—even if we have a dealer or distributor already established. Read every word of this advertisement. Then write me personally. Although we have nearly 2000 Paige and Jewett dealers and distributors, I can find a place for you—if you can measure up to our requirements—to grow rich in business for yourself.

The World's Most Profitable Opportunity

Paige and Jewett dealers frequently start with as little as \$5000 capital. With this they do \$50,000—\$75,000—even \$100,000 a year business. Our liberal financing plan makes large capital of less consequence than character and energy. Handling Paige and Jewett you need little, because you turn your capital faster than in any other retail business. Profits come from small margins on big volume, which is good business. And this fastest growing of all industries needs good business men, able salesmen, small capitalists. It offers them the world's most profitable opportunity to get into business for themselves.

Henry R.——, of Ohio, writes me:

"Dear Mr. Jewett:

"You used to be in the coal business, and you told me, when I started handling your car in this coal-mining town 10 years ago, that it looked like pretty lean pickings to you. You remember I had only \$5000. So I thought I would write you that my January 1st statement shows I am worth \$100,000, and I have made every penny of it handling your cars in this town you thought wasn't a good field to sell in."

Paige and Jewett—the Ideal Foundation

Your success as an automobile dealer depends upon the quality of your car and the stability of the manufacturer behind it. Read our advertisements about the Jewett car. Read them thoroughly and see if you know any car that can match the Jewett in quality and performance at anywhere near the price. In less than a year after the Jewett was introduced—we sold more than 25,000 cars—to date over 50,000—a world's record, we believe, for a new car at this price. You can sell such a fine six-cylinder car at \$1065. A Six at the price of a Four. The Jewetts in use have proved themselves—the public have accepted and are demanding Jewett. And so soundly is it built that need for service is rare. Paige cars, too, are in demand. For Paige is one of the four largest selling top-quality Sixes—competing with the finest, yet selling for only \$2450. We are spending over a million dollars yearly, telling the public of Paige and

Jewett, in magazines, farm papers and newspapers. This tremendous advertising campaign is building trade for you. Think of the people around you—interested in Paige and Jewett—waiting for YOU to show the car—PROFIT waiting for you.

Paige-Detroit Motor Car Company has been in business over 14 years. The same officers that are responsible for its success are still guiding it. Last year we did over \$38,000,000 in business. This year we are doing even more. Naturally our dealers share in this prosperity. Until now—our present dealers could take all the cars we could make. Now with greatly enlarged factories and a production of 500 cars a day, we are opening territory that we could not supply with cars before. This means adding to our prosperous dealer family. This also means your opportunity to make big money.

Have You These Qualifications?

Ambition, energy, clean record, managerial ability, the ability to lead. To a few men with such qualifications, we offer an opportunity to make big money—own their own business—be independent. Even if we already have a dealer or distributor in your locality there may still be an opportunity for you to build a profitable business where your success is measured by your own energy. Capital alone is not sufficient—you must have the above qualities. Previous automobile experience is not important. In one Middle West town are three young men who started handling our cars five years ago. Today their business is valued at \$200,-

000 and they draw handsome incomes. Our records show many even greater successes. They started with the same capital we have set as a minimum for you to start with.

If you are a good manager or salesman—if you feel that you are the type to succeed in business for yourself—if you have \$5000 or more to establish yourself in a business of your own—then this is an unequalled opportunity for you. Write me personally outlining your business experience and stating how much you can invest in YOUR business. Address me personally, please.

H. M. JEWETT, President

PAIGE-DETROIT MOTOR CAR COMPANY, DETROIT, MICH.

Manufacturers of Paige and Jewett Motor Cars

(608-A)

Radio Catalogue Free—

**Write us
a post card—**

and we will send you free this 52 page catalogue of radio sets and parts. It also contains explanation of radio terms, map and list of broadcasting stations and much radio information, including an explanation of successful hook-ups and circuits.

You will be amazed at the low prices Ward's quote. A complete set for \$32.50 equalling sets at \$60.00 elsewhere—a \$23.50 set that under favorable conditions has a radius of 500 miles and more.

This catalogue contains everything for the expert and amateur. Complete sets and every improved part for building sets, all the most up-to-date devices—at the lowest possible prices.

Headquarters for Radio

Montgomery Ward & Co. is headquarters for Radio, selling everything direct by mail without the usual "Radio-profits." Why pay higher prices? Ward quality is the best and the prices will often save you one-third. Everything sold under our Fifty Year Old Guarantee—Your Money Back if You Are Not Satisfied. Write today for your copy of this complete 52-page Radio Book.

Write to the house nearest you. Address Dept. 6-R
Chicago Kansas City St. Paul Portland, Ore. Fort Worth

Montgomery Ward & Co.

The Oldest Mail Order House is Today the Most Progressive



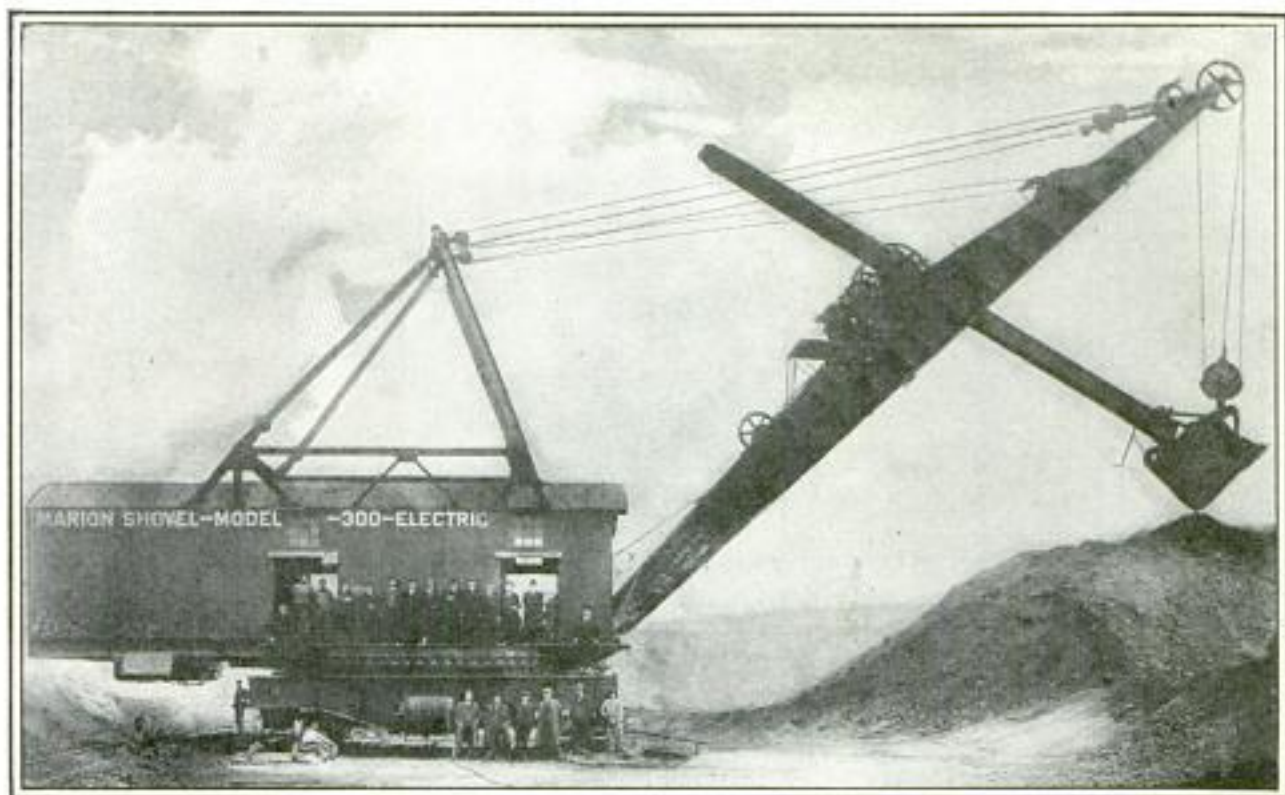

The largest one-man shovels in the world, equipped with General Electric motors, take eight dump cartloads at a bite, and can take a bite a minute.

Its shoulders never tire



General Electric Company makes many different types of motors, some small enough to wind a clock, some large enough to operate these giant shovels; but *all* designed to help electricity do more for human service at a lower cost.

A giant worker—excavating over three hundred thousand cubic feet a day! In three days, six hours and thirty-six minutes, it could handle material equal in cubic contents to the Washington Monument.

Think for how many centuries the world wasted its most precious possession—human lives—in labor that electricity can do!

GENERAL ELECTRIC



One Month's Earnings

G. B. George.....	\$780.00
A. B. Knapp.....	816.00
B. B. Budd.....	520.00
E. G. Pick.....	605.00
K. H. Holden.....	502.00

Many of our men who have been with us six months or more are averaging over \$100.00 a week selling Simpson's

All Wool Tailored Suits--Overcoats To Order **\$31⁵⁰**

We furnish 6x9 swatches of cloth—a real selling outfit, compact, easy to carry, easy to show and easy to sell. You'll find heavy weight blue, gray and brown serges, and Frenchback worsteds, winter weight suitings, in all colors and patterns, *mostly worsteds*, but with a good showing of cassimeres, tweeds and cheviots. You'll find a dozen topcoatings, and a wonderful assortment of overcoatings, including Meltons, standard kerseys, rug backs, through and through weaves, etc. Our fabric assortment is very fine. Remember, they are all one price, \$31.50 suit or overcoat, all wool, tailored to order, any style, at no extra charge, and satisfaction guaranteed always. We ship by express, subject to examination, if so instructed.

Commissions Paid Daily You Collect Deposit

We ship C. O. D. for the balance. Tailoring men write. We give protected territory. No deposit required on samples. We will train inexperienced men, with satisfactory references. You can do well right from the start, and when experienced, average \$100.00 a week and up. Write us fully, in strict confidence. No references investigated without your permission.

It pays to sell a quality product with which you can build up a steady, permanent business. Actual figures based on experience of our men show that after six months' work, from 35 to 65% of your business will be from previous customers or on leads furnished by them. Sales to old customers or to people recommended by your customers, are easy to make. If the line you now handle doesn't bring you a heavy percentage of repeat orders, drop it and tie up with a line that will.

We believe ours is the easiest selling tailoring line in the United States. The fabrics are unusually attractive and the quality very fine. Every suiting is pure virgin wool. The linings and workmanship are very fine. The fit is seldom equalled and never excelled even at much higher prices. Our fall line is better than any other line in our history—in spite of the fact that prices on wool have gone skyrocketing.

Salesmanager J. B. SIMPSON, Inc.

Dept. 616

831-843 W. Adams St.

CHICAGO, ILL.

A marvelous new fuel so cheap that coal at \$5 a ton is by comparison expensive!

**COAL
\$5 TON**

Amazing New Fuel You Make at Home

A Remarkable Gas You Can Burn in Any Coal Range, Heater or Furnace—Better and Cheaper than Coal—Convenient as City Gas.

The Gloria Light Company of Chicago, Ill., oldest and largest concern of its kind in the world, has perfected a marvelous new gas that you can make right in your own home, and use in your coal range, heating-stove or furnace instead of coal or wood, and which is more efficient for cooking and heating than either coal or city gas, and so cheap that coal at \$5 a ton is by comparison expensive!

Now that this remarkable gas has been achieved, no home anywhere has to put up with the drudgery and expense of coal for fuel. Any stove that will burn coal or wood can be quickly adapted to Oxo-Gas with no alterations in the stove.

The New-Day Fuel for Cooking and Heating



Heating with Oxo-Gas beats heating with coal and costs a lot less.



Make your furnace an Oxo-Gas Burner. Save work and coal money, enjoy greater comfort

The only ingredient you have to buy for the making of Oxo-Gas is kerosene—common everyday coal oil, as easily procurable as sugar at any corner grocery, at a few cents a gallon. A unique invention, a simple device called the Oxo-Gas Heating appliance, fixed in your stove in a few minutes, takes the kerosene, and vaporizing it, mixes it with oxygen (4% kerosene and 96% oxygen) and makes and burns Oxo-Gas, the cheapest and most efficient fuel ever made for man.

Do not confuse the Oxo-Gas appliance with the various oil burning devices with which the market is flooded. It differs in principle, in design, in construction, in performance.

It is a device that really makes a gas, and burns this gas as a gas—as cleanly and silently as any city-gas stove, but much more efficiently in the heat created. The burners of the Oxo-Gas are lava discs—an exclusive patented feature. These discs are rendered semi-incandescent under the heat of the gas. This intensifies the heat by refraction from 20% to 30%, which gives you a hotter fire than coal, wood or city gas—a fire that cooks quicker and one you can instantly turn off when through, when you want a cool kitchen.



Let your coal range be an Oxo-Gas Burner. Cook as with city gas.

2 Cents to Cook a Meal

With Oxo-Gas you have heat where wanted, and as long as wanted. Heat you can regulate to perfection for any and all cooking and baking and heating—heat for every purpose, with no coal scuttle drudgery and no smoke, soot or ashes. And just think—one gallon of kerosene will make enough Oxo-Gas to heat a range or heating stove eight to ten hours. The average cost of kerosene being from 8 to 12 cents a gallon, the cost of cooking or heating with Oxo-Gas is but 1½ to 2 cents an hour. 2 cents worth of gas to cook a meal!

Write for Free Book

Wherever this remarkable gas is introduced it creates a sensation. Already more than one hundred thousand homes throughout the country are now using this new marvel-fuel. You owe it to yourself to learn all about it!

Write today for our free book on Oxo-Gas. Gives you all the facts—tells you how Oxo-Gas is made, how used in any coal range, heater or furnace; what it costs, etc.

Besides cook stoves, heating stoves and furnaces, Oxo-Gas appliances may be had for Hot Water Reservoirs, Garages, Camps, Yachts, Shipmates, Water Still, Hot Water Coils, Pressing Machines, Revolving Bake Ovens. Indicate on the coupon the particular use for Oxo-Gas you're interested in and we will send you full information, postpaid and free, with no obligation. Clip and mail coupon now.

GLORIA LIGHT CO.

101-107 N. May St. CHICAGO
Branches in 40 American and Foreign Cities

AGENTS WANTED

Some choice territory for Oxo-Gas agencies and distributorships still open to thoroughly responsible parties. Your own locality may yet be unassigned. If you can qualify, we offer you a genuine opportunity to make \$10,000 a year and more. Just write and ask us for our agent's proposition and we will discuss the matter with you either by mail or in person.



THE GLORIA LIGHT CO.,
101-107 North May St., Chicago, Ill.

(102)

Gentlemen: Please send me free book on Oxo-Gas, the new-day fuel for cooking and heating. (Check particular appliance you're interested in.)

() Cook Stove and () Garages () Hot Water Coils
() Heaters () Camps () Pressing
() Furnaces () Yachts () Machines
() Hot Water () Shipmates () Revolving
Reservoirs () Water Still Bake Ovens

Name.....

Address.....

City..... State.....

The Greatest Improvements Yet Made in Radio

New Erla Reflex Circuits

Using 2 and 3 Tubes



Unequaled range and power, over a waveband of 200 to 900 meters, are assured by Erla radio transformers. AB 1, 2, 3, \$4. Reflex 1, 2, \$5



Exclusive telescoping rim of Erla bezels fits any $\frac{1}{8}$ " to $\frac{1}{4}$ " panel. Made in bright nickel or dull enamel, in 1" and $1\frac{1}{2}$ " sizes. List, 20c

JOBBERS—Erla research facilities maintain leadership of Erla products. Write for terms and discounts.

Tube for tube, the new Erla two and three-tube reflex circuits demonstrate a degree of efficiency never heretofore attained. Elaborate six and seven-tube circuits fail to equal their range and volume.

Constructed on the same fundamental principle as the famous Erla Duo-Reflex circuit, the most powerful single-tube circuit ever built, they record a tremendous advance in radio apparatus construction.

With the three-tube circuit, nation wide reception is obtained through a loud speaker, and the two-tube circuit is but a step behind. Either circuit is operated successfully with an indoor antenna. Also economical dry cells can be advantageously used.

Guaranteeing the successful operation of these circuits, and the keystone of their amazing range and power, are Erla synchronized radio reflex and audio reflex transformers. Through their employment, the difficulties experienced until now with reflex circuits are entirely overcome, assuring absolute stability, with unequaled sensitiveness and amplification.

Further improvement results from the use of the new Erla fixed crystal detector, designed especially for reflex work. No adjustment is required with this crystal, and it is proof against jolt and jar, giving perfect rectification at all times.

Complete diagrams and descriptions of Erla one, two and three-tube reflex circuits are presented in Erla Bulletin No. 14. Ask any leading radio dealer, or write us, giving your dealer's name.

Electrical Research Laboratories
Dept. J 2515 Michigan Ave., Chicago



Perfect synchronization and standardization of Erla audio transformers guarantees success in reflex work. Ratios— $3\frac{1}{2}$ and 6 to 1. List, \$5



Erla is the only fixed condenser guaranteed to test to the exact capacity for which it is marked. Made in eleven sizes, 35c to \$1 each



Present types of detectors are antiquated by the new Erla crystal rectifier. No adjustment required. Proof against jolt or jar. List, \$1

ERLA

The MONARCH Jr. Lathe is Priced Within Your Means

Most efficient machine tool you can have in home workshop, repair shop or garage too. Turns out, with 1000th-inch accuracy, all small wood and metal parts that other lathes will. *Experimenters, inventors, mechanics* enthusiastic over it. Completely equipped; auto-safety devices; semi-quick change gear.

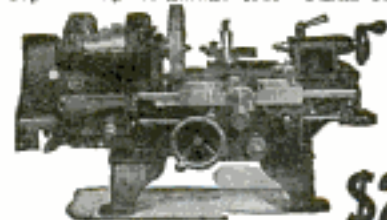

\$245 9 in. Lathe—
2 1/2 ft. Bed—
with Bench Legs

Also built with bed lengths up to 5 feet. Made in 11-inch swing size too, at slightly higher price.

THE MONARCH MACHINE TOOL CO.
400 Oak Street SIDNEY, OHIO

Drive 100 Tacks and Save \$25

on your next Top or Seat recovering. Ford's \$5.20 to \$10. Chevrolet's \$7.96 to \$16. All other cars \$9.95 to \$22. Our **Plate Glass Lights** enhance the value of your car. **Side Curtains \$5.25 up.** **Seat Covers \$2.00 to \$22.** Quality and fit the best. Our instructions make it easy to apply. Send for samples. Our prices include delivery at your door. Eastern orders shipped from Ohio. **Auto Equipment Co., 1055 So. Broadway, Los Angeles, Calif.**

\$5.20 up
Delivered

Our BUREAU OF INFORMATION will answer all questions regarding articles appearing in this magazine.

AGENTS

For the Biggest Money-Making
Selling Proposition You Ever Saw

See Pages 60 & 61



21 Jewel Santa Fe Special Sent on Approval

Without one penny of advance payment let us place in your hands to see, to examine, to inspect, to admire, to approve a real masterpiece in watch creation.

Our determination to this year double our sales of the world famous Santa Fe Special and Bunn Special Watches prompts this matchless offer.

While other watch dealers are raising their prices, asking you for larger monthly payments, and making payment terms harder for you to meet, we are offering you our new model Santa Fe Special, no advance in price, no money down, easier terms and smaller monthly payments. WE realize the war is over and in order to double our business we MUST give you pre-war inducements, better prices, easier terms, and smaller payments.

Page Twelve of Our Watch Book is of Special Interest to You!

Ask for our Watch Book free—then select the watch you would like to see, either the famous Santa Fe Special or the 6-position Bunn Special, and let us explain our easy payment plan and send the watch, express prepaid, for you to examine. No money down.

SANTA FE WATCH CO.

96 Thomas Bldg. Topeka, Kans.

REMEMBER—No money down—easy payments buys a master timepiece—a 21 Jewel guaranteed for a lifetime at about half the price you pay for a similar watch of other makes. No money down. A wonderful offer.



*No
Money
Down*
TAKE ADVANTAGE OF
OUR GREAT WATCH OFFER.

SANTA FE WATCH CO.

96 Thomas Bldg., Topeka, Kans.

Please send prepaid and without obligation your Watch Book free, explaining your "No Money Down" Offer on this Santa Fe Special Watch.

Name.....

Address.....

*Mail
Coupon
Today*



Price \$512.00

16" x 8' Quick Change Gear Lathe

SOUTH BEND LATHES

for the MACHINE SHOP for MANUFACTURING for the TOOL ROOM

Over 30,000 Satisfied Users

SIZE	Standard Change Gear	Quick Change Gear
9" x 3' Lathe.....	\$ 211.00.....	\$ 241.00
11" x 4' Lathe.....	248.00.....	288.00
13" x 5' Lathe.....	304.00.....	354.00
15" x 6' Lathe.....	376.00.....	431.00
16" x 8' Lathe.....	452.00.....	512.00
18" x 10' Lathe.....	656.00.....	721.00
21" x 12' Lathe.....	933.00.....	1016.00
24" x 14' Lathe.....	1254.00.....	1353.00

Send for new Catalog No. 81, which gives prices on the entire South Bend Lathe Line
South Bend Lathes can be purchased from Machinery Dealers in all principal cities.

South Bend Lathe Works
555 East Madison St. South Bend, Ind.
New York Sales Room, 166 Centre St.

Established
in 1906



Lathe Builders
for 17 years

Make A Gas Range out of Your Old Stove in Five Minutes



FOR HEATING STOVES

The Standard Oil Burner fits any heating stove. Heats your living rooms in a few minutes on the coldest day. Think of keeping your home at an even, healthful temperature all day, without constant filling, shaking and poking.



IDEAL FOR FURNACE

The Standard Oil Burner can be installed in any hot air, pipeless, steam or hot water furnace. So simple and safe a child can light and regulate it. Clean, even heat all over the house, all the time.

Think of it! Your old coal or wood stove can be made into a regular gas range in less time than it takes to tell you about it. You don't have to alter your stove one bit. You don't even have to bore a hole or insert a bolt. Just set a marvelous new kind of burner in your fire box, attach it to a tank of coal oil by means of a copper tube, turn a valve, strike a match, and instantly you have a heating flame as steady, reliable and easy to adjust as city gas, at one-third the cost.

WHY HOME-MADE GAS IS CHEAP

The burner mentioned above is the Standard Oil Burner, a wonderful device that mixes 96% air and 4% kerosene (common coal oil) to form a gas whose heat is two or three times as great as that from coal or wood, and as convenient and easily controlled as city gas. You get instant heat at the turn of a valve. There's no waste of fuel or time in starting a fire. Light it only when you need it—no need to "keep the stove going" to save building a new fire, like you do with coal and wood. No need to sweat and slave in a hot kitchen all summer.

SPECIAL PRICE AND 30 DAYS' TRIAL

to the first user of a Standard Oil Burner in your community. Act quickly and get the benefit

**SAVES HOURS
OF DRUDGERY**

The Standard Oil Burner saves you all the exhausting, disagreeable work of carrying heavy buckets of coal, splitting firewood and hauling dirty ashes. Burning gas does away with smoke, soot and dirt—makes your housework easy and lessens your weekly wash. Your meals are prepared quicker. With the Standard, you don't have to stay in the kitchen constantly while food cooks. A turn of the valve regulates the heat. Once installed, you'll wonder how you ever did without a Standard.

of this generous offer. Make this trial on our absolute Money-Back Guarantee.

FREE BOOKLET

Use Coupon to get our attractive Booklet, HOME HEATING.

STANDARD OIL BURNER CO. Dept. 12-A
103 North Main St., St. Louis, Mo.

Agent Made \$200 in One Day

The Standard sells like hot cakes. A demonstration means a sale nearly every time, because the Standard fills a long-felt need. Everybody wants one. In a single day I made \$200. Wm. J. Finlay, Agent Webster Groves, Mo.

AGENTS WANTED

Big money is being made by our agents selling Standard Oil Burners. Start Now. Sells easier in Spring than any other season. Part time or full time work. Exclusive territory. We give you every help in selling. Write today for money-making proposition.

ONE USER WRITES:

I find the use of coal oil in the Standard 51% cheaper than coal, and 64% cheaper than gas. In convenience, cleanliness and comfort coal does not compare with it.

Standard Oil Burner Co. Dept. 12-A
103 North Main St., St. Louis, Mo.

Send me details of your 30 days' Trial Offer, with special Price and Money-Back Guarantee. Also send me your Free Booklet, HOME HEATING. This puts me under no obligation.

Name.....

Address, Box or R. R.....

P. O..... State.....



Carries Great Messages Around the World

THAT statement adequately expresses what is perhaps the greatest influence of radio in developing and bettering human fraternal interest, not only between the people of one community, of one country, of one state, or even a single nation, but between all nations and all peoples of the world.

Be these messages from government leaders—from the heads of the world's greatest educational institutions or from those who stand foremost in the arts of the world—they will serve to bring the human race into closer contact.

In the past ages great orators and writers, famous poets and musicians have swayed the destinies of nations, and have been instrumental in the rise and downfall of mighty empires.

In the future these same influences of similar great minds will, through radio, create a better understanding and a greater fraternal spirit between the people of the nations.

It is the vacuum tube that has made possible this broad and far reaching application of radio telephony, and that plays the most important part in the operation of your receiving set.

Cunningham Vacuum Tubes, standard for all makes of receiving sets—built by one of the world's largest manufacturers with unlimited resources—are the product of years of manufacturing experience and the creative genius of the engineers of that great scientific organization, the Research Laboratory of the General Electric Company.

Patent Notice: *Cunningham tubes are covered by patents dated 11-7-05, 1-15-07, 2-18-08, and others issued and pending. Licensed for amateur, experimental and entertainment use in radio communication. Any other use will be an infringement.*

Cunningham Radio Tubes

C-301A—6 Volts $\frac{1}{4}$ amp. Amplifier.....	\$6.50
C-299 —3 Volts .06 amp. Dry Battery Det. & Amp.....	6.50
C-300 —6 Volts Gas Content Detector.....	5.00
C-11 —1.1 Volts .25 amp. Dry Battery Det. & Amp.....	6.50
Special Base	
C-12 —Similar to C-11 with standard base....	\$6.50

E. J. Cunningham Inc.

Home Office: 248 First Street, San Francisco, Calif.
154 W. Lake Street Chicago, Ill. 30 Church Street New York City, N. Y.

Cunningham National Tube Week
Sept. 24 to Oct. 1, 1923
\$5000 in Cash Prizes to Radio Dealers



The Add-A-Unit Way of Building a Radio Set Saves a Lot of Time and Money and Gives Remarkable Results.

Start with the *RPM Variometer and Variocoupler Units*. Add a *RPM Detector Unit* and have a fine working set for headphone reception—at less than half the cost of buying a ready made set.

Then add as many of our amplifying units as you wish, for loudspeaker service, or for increasing range and power of your set.

Or, start with the *RPM Coupled Circuit Tuner* unit (which takes the place of both Variometer and coupler) hooked up to the *RPM Detector Unit*.

Other units in our Add-A-Unit line include Amplifier, Variable Condenser, loading Coil and Base.

No panels to buy or to drill; no shopping round for dials, knobs, contact points, spaghetti wire, etc., as each unit is complete with its own panel.

Simple Hookup Diagram furnished with each purchase. We also sell RPM units *unmounted* for either panel or base mounting.

RPM Radio Units are fine examples of radio engineering, embodying the best materials and workmanship.

Send for illustrated circular.



Radio Products Mfg. Co.
667 West 14th St. Chicago, Ill.



SAVE 50% OF THE USUAL COST

Buy a **World Battery** for your auto or radio set, save the difference and get a *written 2 year guarantee*.

Auto Prices:	RADIO PRICES:
6 Volt	6 Volt 60 Amps. \$10.00
11 Plate \$13.25	6 " 80 " 12.50
6 Volt	6 " 100 " 14.50
13 Plate 15.25	6 " 120 " 16.00
12 Volt	
7 Plate 18.00	

SPECIAL 2-VOLT STORAGE BATTERY \$5.00 Will ship C.O.D. subject to inspection or will allow 5% discount for cash with order. Write today—Now.
For W. D. 11 and W. D. 12 tubes. Will run 200 hours on one charge. **WORLD BATTERY CO., Dept. 6, 1219 So. Wabash Avenue, Chicago, Ill.**

Sell coal to your trade

IN CARLOAD LOTS

Earn week's pay in an hour Sideline salesmen wanted.

Washington Coal Co., Stock Yards Sta., Dept. AG, Chicago



"Read'em" Binding Posts

With knobs that won't come off

Anyone can "read 'em." All popular styles—Antenna, Ground, Fones, A and B Battery plus and minus—abbreviations of different names engraved on knobs. Ask your dealer for "Read 'em"—the kind for real Radio fans. If your dealer does not have them, write direct.

The Marshall-Gerken Co.
Manufacturers

Dept. H. Toledo, Ohio

The 1924!

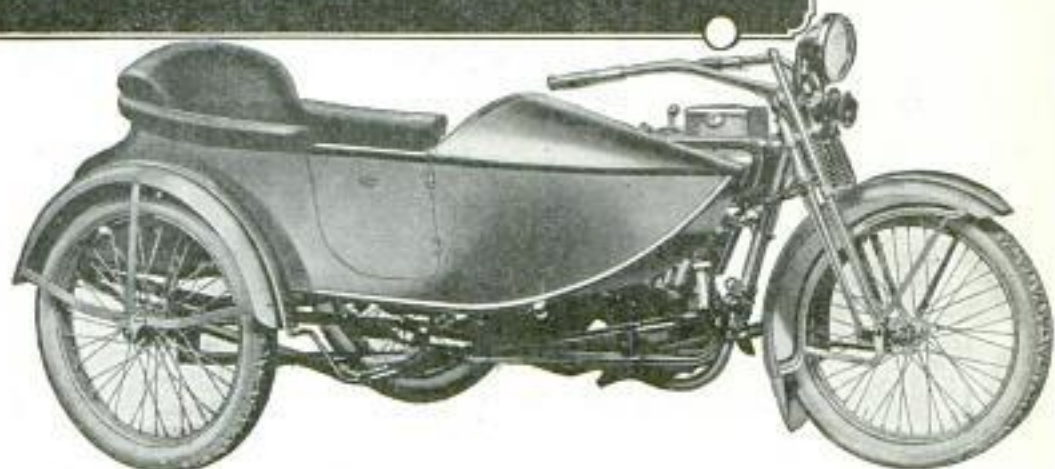

**Light Alloy Pistons!
Alemite Lubrication!
Olive Green Finish!**

SPEEDIER, peppier than ever (aluminum alloy pistons) — easier to care for (Alemite-equipped)—handsomer than ever (olive green, maroon striped)—that's the 1924 Harley-Davidson! And the new side car — just wait till its ful-floteing, semi-elliptic springs float you over roads that look rough!

Motorcycling—with a 1924 Harley-Davidson — is the Greatest Sport on Wheels. You have never felt such a surge of smooth power as the alloy-pistoned Harley-Davidson motor delivers. In acceleration and sustained high speed it's a marvel.

The Alemite equipment (first on any motorcycle) is a great improvement. It makes the weekly "once over" a clean, handy few-minutes job that's thorough.

Ask your dealer for a "1924" demonstration. Ask him about his Pay-as-You-Ride Plan — most dealers offer one. Mail the coupon (below) for new Harley-Davidson catalog, showing 1924 models, **IN FULL COLOR.**

HARLEY-DAVIDSON MOTOR CO. Dept. P. MILWAUKEE, WIS.

Harley-Davidson
The Motorcycle

Money-making sales opportunities in open territories Write for particulars.

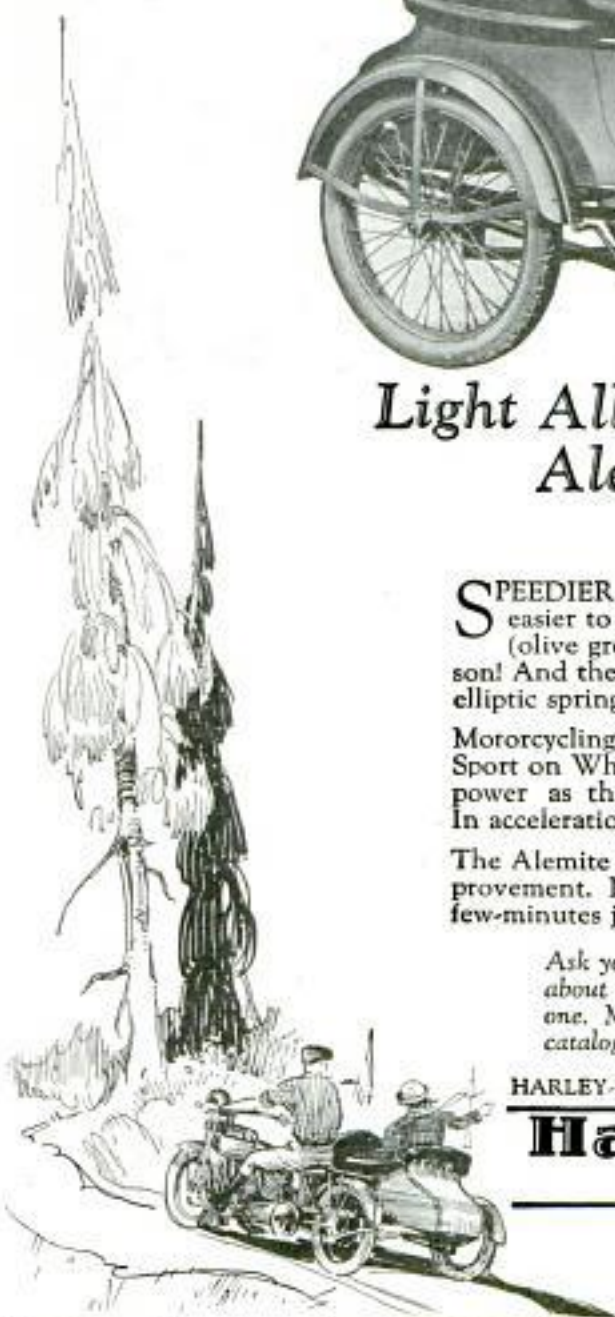

Harley-Davidson
Motor Company
Milwaukee,
Wisconsin
Dept. P.

Gentlemen:—

Send me free, postpaid, new catalog showing 1924 Harley-Davidsons in full color.

Name _____

Street or
P. O. Box _____

City _____

State _____

"JUST A THOUGHT"—NOT A PATENT

You are interested in other people's ideas—that is why you read this magazine.

One of America's great Industries is interested in YOUR ideas—that is why we buy this space.

You have heard of "**Pressed Metal**". It refers to *any* useful article that can be made by *stamping* from sheets of steel, brass, aluminum, copper or any practical metal, instead of by castings or other methods.

Pressed Metal is one of the greatest blessings that American mechanical genius has given the world. Its range of USEFULNESS, ECONOMY and CONVENIENCE to everybody is so great that, with a present volume of about \$20,000,000.00 a year, it has barely begun to meet its possibilities.

The **Pressed Metal** industry includes many of the largest high-class manufacturing concerns in the United States, and through the Pressed Metal T. E. C., welcomes the co-operation of every bright mechanical mind in the country, on a cash basis.

SELL US A PRACTICAL IDEA

of some new and useful WAY to utilize Pressed Metal in place of other materials. The undersigned will promptly pay cash for every acceptable suggestion approved by our Engineering Advisory Board. Free book gives you the facts.

DO NOT SEND US PATENTS OR MODELS. JUST

Write for the Free Pressed Metal Booklet

It tells all the conditions and the amounts to be paid for the successful ideas, and also how to protect yourself against misappropriation of your creative thoughts by others. WRITE TODAY. (A post card will do, but please make it easily legible so it can be properly filed and acknowledged.) Address

PRESSED METAL TRADE COUNCIL

27 QUINCY STREET, SUITE 1701, CHICAGO



ONLY
\$ **3**
DOWN
and you
keep this
typewriter



DIRECT
to you
from our
Factory

Big Saving
In Price

Yes, we will ship you this Genuine Underwood

Rebuilt in our own factory just like new for
ONLY \$3 down—NOT ONE CENT MORE

Until you have tried the machine 10 full days at our expense



Our Factory

EVERY MACHINE is fully guaranteed. New parts wherever needed. New enamel, new nickel, new lettering, new platen, new key rings—a complete, perfect typewriter. Impossible to tell it from a brand new Underwood either in appearance, durability or quality of finished work.

An up-to-date machine with two-color ribbon, back spacer, stencil device, automatic ribbon reverse, tabulator, etc. In addition we furnish FREE waterproof cover and special Touch Typewriter Instruction Book. You can learn to operate this Underwood in one day.

Big Book FREE

Our big handsomely illustrated catalog will be sent free on request. It tells you all about the advantages of owning a STANDARD SIZE UNDERWOOD; how and why this machine will last for years, saving many dollars not only in the purchase price but in its operation.

Send in the coupon and let us send you this beautifully illustrated book FREE without any obligation whatever.

Shipman-Ward Mfg. Co.
"Typewriter Emporium"
2126 Shipman Bldg.
Montrose and Ravenswood Aves., Chicago

Write Right Now

and learn how it is possible for us to ship you this Underwood Typewriter upon our free trial plan and our direct-to-you money saving methods. Get the full details now—just sign the coupon and mail today. Get all the facts—then decide.

No Obligation

—to buy. You don't have to order. Just sign the coupon, send it to us and we will mail you our big catalog absolutely free.

Send the
Coupon
Today

10 Days'
Free Trial

You have ten full days in which to try the typewriter before deciding whether you want to keep it. Give it every test—see for yourself—make the Underwood prove its worth to you. Don't take our word for it—put the Underwood before you and see if you don't think it the greatest typewriter bargain ever offered.

You will be amazed at the liberality of our offer, the beauty and all around excellence of our typewriters.

This is the genuine Underwood Typewriter. We offer you the same three models of the Underwood Typewriter being made and sold by the manufacturers today. Standard 4-row single shift keyboard. Absolutely visible writing—the full line of typewriting is visible at all times. All the improvements and attachments that any high grade typewriter ought to have.

Big Saving to You

Our plan of selling to you direct makes possible enormous savings, which are all for your benefit. Send in the coupon and we will send you prepaid our big catalog, including "A Trip Through Our Factory." This shows how the Shipman-Ward Rebuilt Underwood is the best that can be produced at our Special Price.

don't have to do a thing to get our big Free catalog and complete details of our amazing

You

typewriter offer except to sign and send in the coupon. There is no obligation.

**FREE TRIAL
COUPON**

SHIPMAN-WARD MFG. CO.
2126 Shipman Bldg., Chicago

Please send me FREE, all charges fully prepaid, your BIG NEW catalog of UNDERWOOD TYPEWRITERS and complete details of your FREE TRIAL Offer.

It is understood that I am under no obligation whatever and that this is to be sent without one cent of cost to me.

Name.....
Street.....
City..... State.....

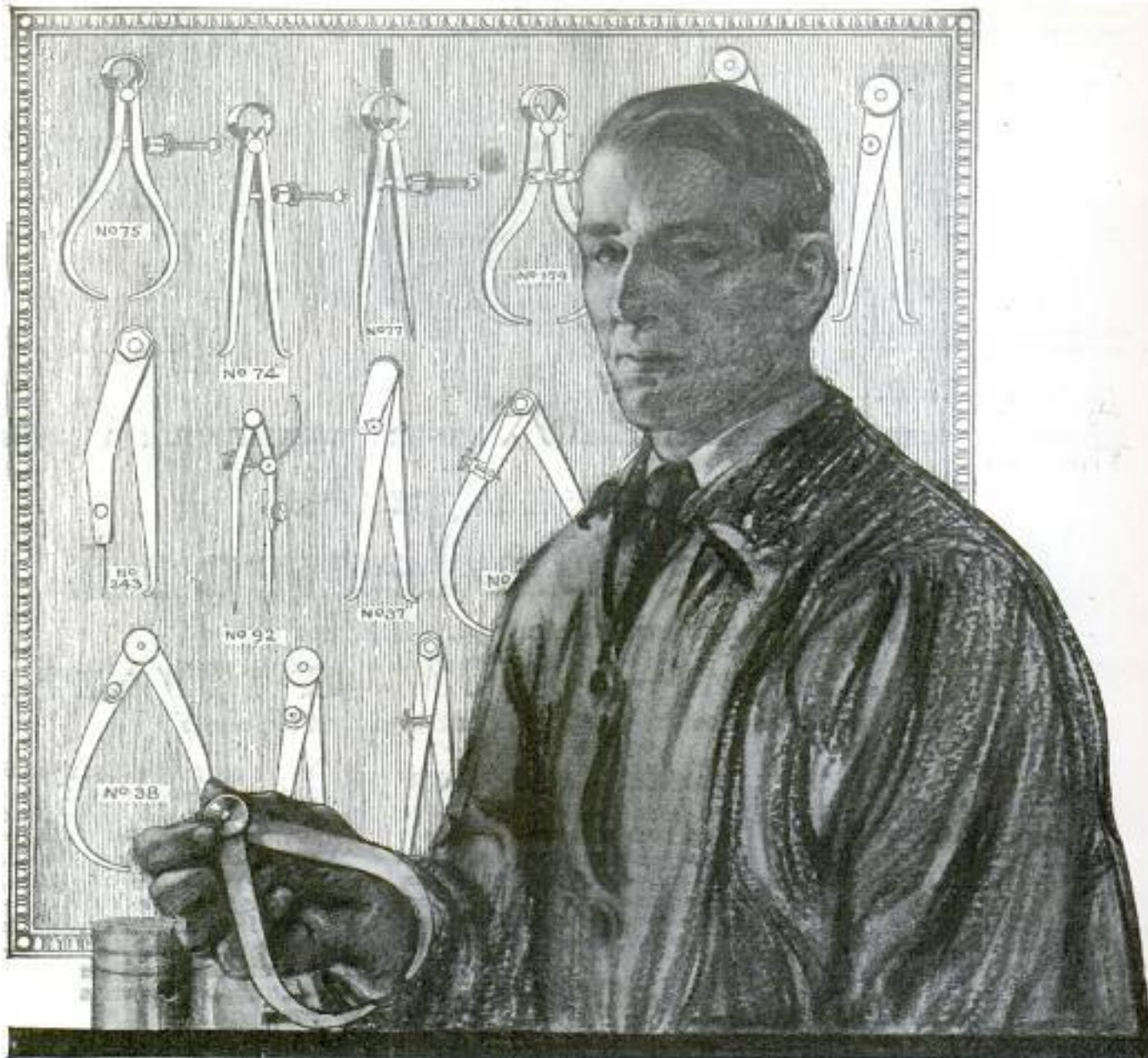

You Can't Beat a Starrett Caliper

Starrett Calipers and Dividers are famous everywhere for their fine workmanship, reliable accuracy and the sensitive "feel" so necessary for precise measurements.

Whatever your work, if you have a need for Calipers or Dividers you can find exactly what you want in the Starrett line. Designs, special features, sizes, prices, etc., are all fully covered in the Starrett Catalog No. 22 AP. We will be glad to send you a copy if your hardware dealer can't supply you.

THE L. S. STARRETT CO.
The World's Greatest Toolmakers

ATHOL, MASS.
Manufacturers of Hacksaws Unexcelled

Use Starrett Tools



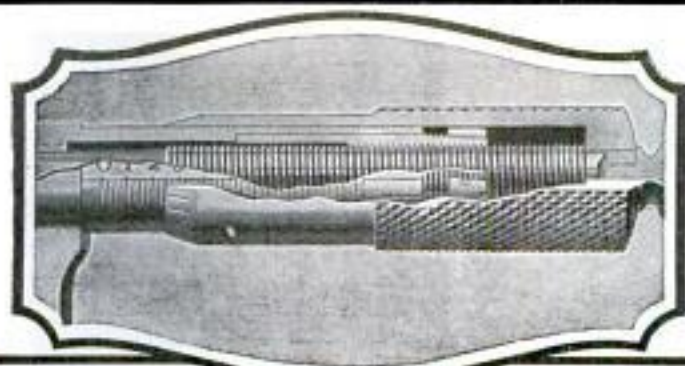

A Precision Measuring Screw— The first point of superiority of Brown & Sharpe Micrometers

1

Watch for point 2.
It will appear soon
in this magazine.

IN the accuracy of the measuring screw lies the first point of superiority of Brown & Sharpe Micrometer Calipers. Years of experience in the manufacture of precision tools, combined with special machinery developed in our own plant to meet the particular requirements of the work, give the measuring screws of Brown & Sharpe Micrometers their superior accuracy.

Ask your dealer to show you a Brown & Sharpe Micrometer, and feel the ease and smoothness with which the screw turns. The closeness of fit between the screw and the nut insures smooth, uniform action of the screw throughout its entire length.

Mechanics have recognized the superior accuracy of Brown & Sharpe Micrometers for over 70 years, and rely on their dependability and lasting qualities for good work and long service.

*Our No. 28 Small Tool Catalog lists over
400 styles of Brown & Sharpe Micrometers.*

BROWN & SHARPE MFG. CO.
PROVIDENCE, R. I., U. S. A.

BROWN & SHARPE TOOLS

Great Diamond Ring Bargain

Perfectly cut, genuine blue-white Diamond held aloft on six white gold prongs. Gentleman's 14K Green Gold, hand-carved mounting, trimmed with artistic scroll designs of White Gold.

Send No Money—Ring sent FREE for your approval. If entirely satisfied pay only \$10, then \$5 a month for ten months until the total price of \$60 has been paid. If not satisfied, return. Money refunded immediately.

Free Gift Book shows thousands of other bargains in Diamonds, Watches, and Jewelry. Send for copy No. 63-P.

\$ **5⁰⁰**
A Month



Buy
Today
10
Months
TO PAY

THE HOUSE OF QUALITY
CAPITAL \$1,000,000.
LW-SWEET INC.
1650-1660 BROADWAY, NEW YORK



"I thought the 'Yankee' No. 30 was the perfect screw-driver — but the

'YANKEE' Quick-Return No. 130 improves on perfection''

That's what a foreman carpenter said about this new "YANKEE" Spiral Ratchet Screw-driver. Spring in handle brings it back automatically for next push. Holds bit in screw slot. All you do is push.

Fine for cramped places or one-hand jobs. Right- and left-hand ratchets and rigid adjustment. Furnished with 3 sizes of bits. Ask your dealer to show you No. 130.

No. 130 Standard Size (illustrated)

No. 131 Heavy Pattern No. 135 Light Pattern

Some other "YANKEE" Tools

Ratchet Hand Drills	Ratchet Tap Wrenches
Ratchet Breast Drills	Automatic Push Drills
Ratchet Chain Drills	Plain Screw-drivers
Ratchet Bench Drills	1½ to 30 in. blades

Dealers everywhere sell "YANKEE" Tools

Write for Free Book

Illustrations and descriptions tell all about the entire line of ingenious "YANKEE" Tools that save your time and your muscles.



NORTH BROS. MFG. CO., Philadelphia, U. S. A.

"YANKEE" TOOLS

Make Better mechanics

Help Wanted

We require the services of an ambitious person to do some special advertising work right in your own locality. The work is pleasant and dignified. Pay is exceptionally large. No previous experience is required, as all that is necessary is a willingness on your part to carry out our instructions. If you are at present employed, we can use your spare time in a way that will not interfere with your present employment—yet pay you well for your time.

If you are making less than \$150 a month, the offer I am going to make will appeal to you. Your spare time will pay you well—your full time will bring you in a handsome income.

It costs nothing to investigate. Write me today and I will send you full particulars by return mail and place before you the facts so that you can decide for yourself.

ALBERT MILLS, Gen. Mgr. Employment Dept.
8681 American Bldg., CINCINNATI, OHIO

CLIMAX TROMBONE OUTFIT \$5.25 Down—then pay only \$5

per month for six months! Climax Trombone; perfect slide action; EASY BLOWING; handsomely engraved bell; polished brass; beautiful, sonorous tone; complete with side-opening, flannel-lined Koratol case; professional mouthpiece, lyre, mute; self-instructor. *Money-back Guarantee!* ORDER NOW!

For sale by your Music Merchant.

LYON & HEALY, 73-75 Jackson Blvd., CHICAGO, ILL.



Earn \$50 a day

Selling
men's
gas-mask

Goodyear Raincoats

\$1.90 each, in dozen or gross lots. Sample sent upon receipt of \$2.15. Agents wanted (Write for our 6 best sellers).

GOODYEAR RUBBER M'FG CO.
Dept. A. 34 East 9th Street, New York City



The Hand That Rocks The Cradle
Can Also Swing The Brush

WHITING-ADAMS BRUSHES

Insure even tempers on odd jobs.

Send for Illustrated Literature

JOHN L. WHITING-J. J. ADAMS CO., Boston, U. S. A.
Brush Manufacturers for Over 114 Years and the
Largest in the World



ALVAN CLARK TELESCOPES

Famous throughout the world as the highest grade Astronomical and Terrestrial Instruments. Now bringing to you at a reasonable price, these wonderful instruments—a source of pleasure and education—for the home—the school—the college. Send for circular and prices.

ALVAN CLARK & SONS CO.
Makers of the great "YERKES" and "LECK" Telescopes
55 Henry Street Cambridge, Mass.



IRON GLUE

10¢-15¢ SIZES
AT ALL 5 AND 10 CENT STORES
QUICK TO STICK
SOLD TO HOLD

MCCORMICK & CO., Baltimore

HANDS ALL PAINT?

You can remove it quickly with

GIT HAND PASTE

18 OUNCES



10¢ at F. W. Woolworth Co., McCrory and other stores

Accurate Measurements

Interlox

MASTER SLIDE RULE

Inside or outside, made instantly. Rule slides in and out; no slow folding. Strong; brass trimmed. Any length, 2 to 8 feet, 20¢ per lineal foot. If not at dealer's, sent postpaid.

MASTER RULE MFG. CO., Inc., 441-43 East 138th Street, New York City

Dealers and Agents: request attractive proposition.



SARGENT PLANES

make it easier to do the careful, finished work you can be proud of. The Sargent Auto-Set Bench Plane is best for all-round work. The Pocket Plane and Steel Block Plane add the finishing touches to your handiwork. At hardware stores everywhere.

SARGENT & COMPANY, 49 Water St., New Haven, Conn.

\$3 Cash Buys Typewriter

Balance Only \$5 Monthly
Save 35 to 60% on all standard makes—Underwood, Royal, Remington, etc. Every machine thoroughly rebuilt and **GUARANTEED**. Try five days at our expense before you buy.

WRITE at once for Free Descriptive Circular and Special Low Prices.

5 DAYS FREE TRIAL

WYNN TYPEWRITER EXCHANGE 11 Reliance Bldg., Kansas City, Mo.



Fix it with BERNARD PLIERS



When the
Gas
Range

balks, or leaks, or acts cantankerous, a pair of Bernards quickly restores it to normalcy. Bernards are handy things to have around. They do a hundred jobs, and do them all perfectly. They grip tenaciously and cut cleanly. Insist on Bernards. At good Hardware Stores.

Booklet "P" Free on Request



BERNARD PLIERS

Wm. SCHOLLHORN CO.
NEW HAVEN, CONN.



PARALLEL JAWS OUTSIDE CUTTER

THE SCREWDRIVER THAT HOLDS THE SCREW

As Good as a Third Hand in Assembling anything from a Watch to an Automobile



Appeals Especially to Radio amateurs and professionals. A wonderful (patented) Improvement.

Jobbers, Dealers and Agents. Favorable discounts

\$1.25 **THE COBURN TOOL CO., 114 Bedford St., Boston**

BURN YOUR NAME ON TOOLS WITH ARKOGRAF

Protect your tools from theft. Write any name, engrave any design on metal with electricity like writing on paper with pen or pencil. Complete outfit \$3.50, prepaid anywhere. Interesting descriptive circular free. Write today. Agents Wanted. Arkograf Pen Company 1007 Van Building Portland, Oregon



This Beautiful
DIAMOND RING \$ **1**
DOWN



WIN HER WITH THIS BEAUTIFUL DIAMOND
10 Days' Free Trial
 Send only \$1.00 and this beautiful Diamond Ring will come to you **without "red-tape" or delay.** If not convinced it is the **greatest Bargain in America,** send it back and your \$1.00 will be returned. Only if pleased, pay \$3.15 a month until our **Special Bargain price of only \$32.50** is paid.

10 months to pay—A few cents a day.

Million Dollar Bargain Book

FREE Send for it today. It pictures thousands of amazing bargains. Address Dept. 1776

J.M. LYON & CO. INC.
 2-4 Maiden Lane, New York



It is the well known quality of **CRESCENT** machines that justifies you in selecting one of them each time you have need for wood working machinery. The **CRESCENT** line is better than ever and will always give you satisfaction in every particular. Ask today for catalog of hand saws, saw tables, jointers, shapers, planers, borers, planers and matchers, swing saws, disk grinder, cut off table, hollow chisel mortiser, variety wood worker, Universal wood workers.

THE CRESCENT MACHINE CO., 83 Columbia Street, Leetonia, Ohio

\$25 A DAY
Clear Profit

—every day you work. Make \$5,000 to \$10,000 a year in the Floor Surfacing Business with the American "Universal" method. Work for yourself. Experience, special training or large investment unnecessary.

New Field; Big Profits
 Better floors are demanded everywhere. American "Universal" electric machine, doing work of six men, assures **BIG PROFITS** in this new uncrowded field. Every floor,—old or new,—in town or city, is your prospect. Work easy to get. Profit possibilities unlimited. Positive guarantee and 5-day trial offer protects you. Write today for complete details.

AMERICAN FLOOR SURFACING MACHINE CO.
 522 S. St. Clair St., TOLEDO, OHIO





FREE Book on Saws

This new book gives you all the latest information on metal-cutting. It tells how to speed up the work and get longer and better service from your saws. Gives complete information on selecting the right saw for every job. Shows Atkins metal-cutting saws and machines, and explains their use. Also contains scores of helpful hints and tables. It is valuable to every man who uses or buys saws for metal-cutting. Send for it NOW.

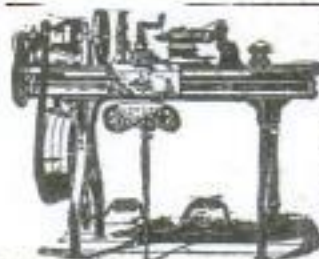

Enclose 10 cents and tell us what metal you cut and we'll send you an Atkins Non-Breakable Hack-Saw Blade.

E. C. Atkins & Co., Inc.
 Dept. P. Indianapolis, Ind.
 Makers of "Silver-Steel" Saws and Tools



LATHES

9 to 18-inch Swing

List price \$175 and up according to size. When ready to buy send for Lathe Catalog and prices.

W. F. & John Barnes Co.
 100 Ruby Street, ROCKFORD, ILL.



TOOL CHESTS

for Machinists & Toolmakers
 Every tool arranged in order. No up-to-date mechanic should be without one. A Gerstner Case costs no more than some tools, and will last a lifetime. Catalog free.

Gerstner & Sons
 717 Columbia Street DAYTON, OHIO

AGENTS 500% PROFIT

\$60 - \$200 per week. Free samples **GOLD SIGN LETTERS** for store and office windows. Anyone can put them on. Big demand everywhere. Liberal offer to general agents.

METALLIC LETTER CO., 4338 N. Clark, Chicago

FASTEN IT WITH AN AJAX EYELET FASTENER

Binds Paper, Cardboard, Leather, Cloth
 It Saves Time by Punching the hole, feeding the eyelet and clinching it in one operation. Order from your Stationer

Machine Appliance Corp.
 Dept. P. M. BROOKLYN, N. Y.



"UNITED"

Radio Instruments Will Multiply the Joy of Your Radio Evenings

Our new million dollar plant with its unequalled equipment of precision tools and our staff of trained radio experts have enabled us to develop condensers and transformers which offer

- 1—Finer tuning, under more perfect control.
- 2—Clearer reception, from any distance,
- 3—Welcome freedom from discordant noises.

"United" Audio-frequency Amplifying Transformer Magnetically shielded, Ratio 5 to 1. Price \$4.50.

"United" Variable Condensers, with new Vernier Dial Adjuster

43 plate \$6.50	5 plate \$5.00
23 plate 6.00	3 plate 4.75
11 plate 5.50	Postpaid

Try your Dealer First. If he does not carry the line, remit to and give us his name and address.

UNITED MFG. & DISTRIBUTING CO.

9705 Cottage Grove Ave.
Chicago, Ill.

New York Office:
50 Church St., New York, N.Y.
San Francisco Office:
709 Mission St.
San Francisco, Cal.

**FREE RADIO BOOK**

An easily understood explanation of Radio, written by Powell Crosley, Jr., President of Crosley Mfg. Co., Cincinnati, and The Precision Equipment Co., Cincinnati.

WRITE TODAY FOR THIS BOOKLET

Crosley Manufacturing Co.

915 Alfred Street Cincinnati, O.

CHARGE YOUR BATTERY

(RADIO OR AUTO)
at HOME for a NICKEL
The HOMCHARGER

POPULARLY PRICED—PAYS FOR ITSELF
SEND FOR THE AUTOMATIC ELECTRICAL
DEVICES CO.
FREE BOOK 129 W. THIRD ST. - CINCINNATI, OHIO.

Rings Bells Without Batteries

Avoid the annoyance of having bells out of order. At a nominal cost you can install this little device which will ring electric bells, buzzers, annunciators, electric heat regulators, door-openers, etc., from the same current that lights your home.

Air-Way
Bell Ringer Transformer

Connects direct to lighting-current, and eliminates forever the use of troublesome dry batteries. Does not use enough current to register on meter. Buy it from any electrical dealer, or we will send it anywhere postpaid upon receipt of price. Your money back if you are not satisfied.

JOBS, DEALERS, AGENTS—Write for selling proposition.
AIR-WAY ELECTRIC APPLIANCE CORPORATION
Toledo, Ohio



ONLY \$2.00
Canada \$3.00

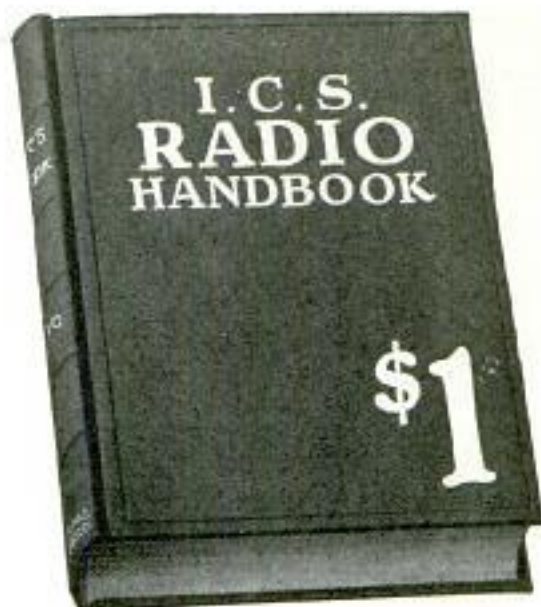

At last! A practical authoritative book on
RADIO

562 pages. Price only \$1

Compiled by HARRY F. DART, B.S.E.E.

Formerly with the Western Electric Co., and
U. S. Army Instructor of Radio

Technically edited by F. H. DOANE

THE most complete book of its kind ever published. Written, compiled and edited by practical radio experts of national reputation. Packed with concise, sound information useful to every radio fan—from beginner to veteran hard-boiled owl. Hundreds of illustrations and diagrams to make every point clear. Note this *partial* list of contents:

Different types of receiving and sending hook-ups, electrical terms, condensers, oscillating circuits, coupled circuits, induction coils, antenna systems, electric batteries, generators and motors, protective devices, crystal detectors, arc generators, transmitters, filters, wavemeters, radio experiments, International and Morse codes, commercial receiving sets, tables and data, radio transmitting and broadcasting stations (with call letters), Radio License Regulations, etc.

Send \$1 to-day and get this 562-page I. C. S. Radio Handbook before you spend another cent on parts. Money back if not satisfied.

TEAR OUT HERE

INTERNATIONAL CORRESPONDENCE SCHOOLS

Box 5545-D, Scranton, Penna.

I enclose One Dollar. Please send me—post-paid—the 562-page I. C. S. Radio Handbook. It is understood that if I am not entirely satisfied I may return this book within five days and you will refund my money.

Name.....

Address.....

Please Mention Popular Mechanics



"Been on a
vacation
Bill?"

"No, Jim - I've
stopped smoking.

Gained six pounds in a
week. You know how I
used to smoke—a pack-
age of cigarettes and a
cigar or two a day—it
sure had some hold on
me. But I'm cured—

took a scientific home tobacco treatment
—fixed me up in two weeks.

"Wasn't hard on me at all—noticed
improvement the first day—I feel like a
new man. It didn't interfere with my
work—didn't leave any druggish after-
effects—the money I saved in the last
two weeks has paid for the treatment
alone.

"Why don't you take it! It has cured
men like you and me for over forty years
—it is a doctor's individual prescription
that sure fixes you up. Just send the cou-
pon for full information NOW. No obli-
gation. All correspondence is strictly
confidential."



A Doctor's
Prescription

The Keeley Institute, Dwight, Ill.

Please send me, without any obligation on my part,
your free booklet which will tell me how to rid myself of
the tobacco habit.

Name.....

Town.....

Street..... State..... P. M. - 9

SEND NO MONEY
2 GENUINE DIAMONDS $\frac{4}{100}$ Each

Solid Gold

\$25

14 kt. White Gold Top,
Gold Emblem Inlaid
in Genuine

Hope Ruby

Can be had in all initials
(Old English); also in all
lodge emblems. Send size
of finger and ring will be
sent for inspection.



B G M S W Any Letter

This Reg. Trade Mark
guarantees you genuine diamonds.

Buffalo Jewelry Mfg. Co., "The Mail-Order House"
Dept. P, Brisbane Bldg., Buffalo, N. Y.

Good Profits for
Demonstrator
Agents



EVEN spare time
earns big money!

Never such a chance
to turn sport into profit!

You get a new demon-
strator at factory price.

All year we send you prospects.

Only one agent in a locality—so write
today for reservation of territory. This is Ole
Evinrude's fast 3 HP light twin cylinder out-
board motor—sold only under name of "Els."

ELTO OUTBOARD MOTOR COMPANY

Dept. AA, Manufacturers Home Building, Milwaukee, Wis.

Different from all others—the
NEW BENJAMIN

AIR RIFLE



Made on a different princi-
ple from all other Air-Rifles.

The Benjamin is really a strong air-
pump used to compress the air in the
air chamber to any degree of power
desired. From one to six strokes of
the pump give all the force necessary.
Each additional stroke gives increased
power. The Benjamin works on the
same principle as all air-drills and
air-hammers—with this difference:

You control the shooting force as you de-
sire. Look at this block of hardwood. It
shows how Benjamin power is regulated as
you wish.

You can't have accidents with a Benjamin.
It's safe, always, because you control the
power. The Benjamin never loses shooting
force, and has no springs to get out of order or
shake your aim. Write us for an interest-
ing folder about this wonderful air-gun.

If your dealer does
not handle yours, send
direct to factory—

(PRICE \$5)
POSTPAID

BENJAMIN AIR-RIFLE & MFG.
CO., 615 N. Broadway, St. Louis, Mo.

Ask your
dealer for
demon-
stration.

Pacific Coast
Representatives
THAYER &
BOWER
Los Angeles
Calif., and
San Francisco
Calif.



FREE
To Machinists

POPULAR MECHANICS
MAGAZINE

has prepared a table of decimal
equivalents of the fractions of an
inch, a copy of which will be mailed
free to any machinist or auto repair-
man upon application. The table is
16½ in. wide by 23 in. long, printed
on good, heavy paper, and will
prove of great value in any shop.

There are no strings to this offer; simply
send us your name, and the address of the
shop or garage in which you work, and the
table will be forwarded at once, carefully
wrapped, and postpaid.

Address

The Editor, Shop Notes Dept.
Room 512, Popular Mechanics Bldg.
200 East Ontario Street, Chicago, Ill.

200,000

"ALL-AMERICAN"

**Amplifying Transformers
Radio and Audio Frequency**
now in use by satisfied customers! We are proud of this record.

The care and attention we have given in specializing in the manufacture of Radio and Audio Frequency Transformers has had its reward. Sales each year are many times those of the year previous.

Ask your friends and your dealers for their choice of Transformers. We know their answer will be unanimously

"All-American"

To help you get the most enjoyment from your radio set we have compiled a book of Hook-ups containing twenty-five reliable circuits and a quantity of other useful information. This book is FREE. Send 2c stamp for postage.



Radio Frequency Transformer



Audio Frequency Transformer

RAULAND MFG. CO.
200 No. Jefferson St., Chicago, Ill.

FREE Radio Catalog

Our big stocks of standard makes of radio sets, parts and supplies enables us to make prompt shipment from stock. Play safe—buy standard equipment from a reliable house. No cut price material.

Send \$1.25 for Univernier for close tuning—mention size of Condenser or Variometer shaft; \$2.00 for 6-phone plug

JULIUS ANDRAE & SONS CO.

In business since 1860

116 Michigan St. Milwaukee, Wis.

Are You All Primed?

We can supply you with Masonic books of reference, study, history, etc. Also fine aprons, regalia, novelties, jewelry and supplies.

Send for Free Catalogue X

REDDING & CO.

Publishers and Manufacturers

Dept. 25 9 West 23rd Street, New York

ELECTRIC SOLDERING IRON

EVERY RADIO FAN has been looking for this iron for both radio and home use. Operates on A. C. or D. C. current.

GUARANTEED one year. Sent anywhere in U.S. or Canada Parcel Post prepaid on receipt of money order for \$2.28.

FANS Send 2c stamp for our list of RADIO BARGAINS

RADIO BARGAINS

17 N. LA SALLE ST.—CHICAGO

Look for
this Label



Ask your
Dealer

**Improve Your Present Set
or Make a New One Better**

By Using

**BRANSTON Lateral Wound
Honeycomb Inductance Coils**

(Licensed under Deforest Patents)

Ask your "Old Timer" Radio friend why sets using Honeycomb Coils are Best.

Send 4c in stamps for Series 1 "Hook-Up" Circular showing five good Honeycomb coil hook-ups and Catalog of famous Branston Radio materials. Write today. Give us name of your Radio Dealer. If he can't supply you, let us know.

CHAS. A. BRANSTON, Inc., 819 Main St., Buffalo, N. Y.
In Canada—CHAS. A. BRANSTON, Ltd., Toronto, Ont.



BRANSTON
RADIO

**SIGNAL RADIO**

Signal Radio Apparatus has long endured strenuous service by government, professional, and commercial users, as well as by beginners. Costs no more than experimental kind.

Send for Catalog.

SIGNAL ELECTRIC MFG. CO. 1910 Broadway
Menominee, Mich.

SQUAB BOOK FREE!

Squabs are selling at highest prices ever known. Greatest market for 25 years. Make money breeding them. No mixing feed, no night labor, no yowling to attend. Start small, grow big. Start now. Read how our customers will square for \$12 a dozen. We have been established for 23 years. Better look into this. Let us send you, at no cost to you, our big, illustrated free book telling how to make money breeding squabs. Address

Plymouth Rock Squab Co., 634 HSt., Melrose Highlands, Mass.

SALENA PATENT
NICKEL DETECTOR
CUP AND BINDING
POST

**RADIO
DETECTOR**

SLIDING HARD
RUBBER KNOB



NICKEL HOLDER
AND BINDING
POST
SOLID
COMPOSITION
BASE

This is the smallest and lowest priced detector on the market. It does a variety of things as well and better than many \$5.00 detectors. Has composition base; all metal parts nickel-plated; furnished complete with salena crystal. Study illustration and notice new features. Note particularly patent nickel detector cup and binding post. Size 1 1/2 x 1 3/4 x 1 1/2 in. Sent prepaid anywhere. Price complete

50c

If you build your own radio set you must have the RASCO catalog containing 100 illustrations and 60 vacuum tube connection diagrams—the greatest collection published in any catalog. Catalog contains the greatest assortment of parts and raw materials in U.S. Send 10c in stamps or coin for this catalog. "Radio Man's" RADIO SPECIALTY COMPANY, 98 E. Park Place, N. Y. City



DELTA ELECTRIC BICYCLE LAMPS

Delta Electric Bicycle Lamp Protects You—Front and Rear!

Night Bicycle Riding is dangerous. Especially if not equipped with a light. The Delta is the best made and best priced. Delta No. 80 throws a powerful white light one hundred feet ahead and a powerful red light far in the rear—warning approaching motorists.

Fits any bicycle instantly—under axle nut front left side. Complies with all laws.

Ask your dealer or sent prepaid for \$2.25 complete (less battery).

DELTA ELECTRIC COMPANY
100 Delta Block Marion, Indiana

Standard Makers of Bicycle Lamps, Electric Lanterns, Automobile Spotlights, Radio Head Sets, Flashlights and Flashlight Batteries.

New York San Francisco
Winnipeg



SEND for the INTERNATIONAL CATALOG

FOR FORD—
PRICES FROM
\$27.65
UP.

Factory to Consumer direct—Pay only one profit.



Our net price list. Full line of accessories for Fords at Wholesale Prices.

Save big money on bodies by buying direct from factory.

INTERNATIONAL BODY WORKS, Dept. 7, 914 W. Ohio Street, CHICAGO, ILL.

Cut Ford Lighting Repair Bills

To replace wiring burned out in a Ford by a short-circuit, costs around \$8. You can positively prevent damage to your electrical system by installing a "Union" Fuse Block. Then, when a wire grounds, a fuse blows. And the fuse can be replaced for a few cents.

Flickering lights, blown lamps and all other troubles caused by loose wires or by speeding the motor, are eliminated with this device.

Permits use of standard single-filament lamps for bright and dim lights.

Sent postpaid for \$1.50 if not at your dealer's. Money back if not satisfactory. Easy to install. No extra wiring.

Write for booklet.

CHICAGO FUSE MFG. CO.

1503 West 15th Street, CHICAGO

Eastern Branch: New York

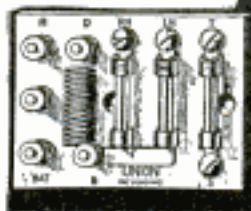

Easy to Build this SHAW Cycle Car

Here's a REAL Automobile

with a Real Motor that any handy man or boy can build. The SHAW Speedster carries two passengers anywhere. Power supplied by famous 2½ H. P. Shaw Motor. If you have a Shaw Motor get plans. If not, we supply everything.

Write for FREE particulars or send 25c (stamps accepted) now for Easy-to-follow plans. Write today!

Shaw Mfg. Co.
Dept. 3-1
Galesburg,
Kansas



MOTOR REPAIR BOOK FREE



Why spend dollars for motor and household repairs when a few cents' worth of **SMOOTH-ON CEMENT No. 1** will do? Write for this FREE book and learn how Smooth-On can save you many dollars. Sold by Hardware and General Stores in 6-oz. tins 30c (by mail, add 6c); also in 1-lb., 5-lb. and larger sizes.

SMOOTH-ON MFG. CO.
Dept. 37-1, Jersey City, N. J., U. S. A.

SMOOTH-ON IRON CEMENT No. 1 For Motor and Household Repairs

You Can Save \$35.00



\$4.45 and up Parcel Post Paid

Recover your old auto top frame yourself. Custom tailor made to fit all makes and models of cars. Any person that can drive a car can put it on. Roof and quarters sewed together, with rear curtain, fasteners, welts and tacks complete. Give name, year and model number of your car and we will send you catalog with samples.

LIBERTY TOP & TIRE CO., Dept. E-7, Cincinnati, O.

Beautiful HOUSES \$900 and BUNGALOWS

CAN BE BUILT FOR AND UP This and many others in my new book, Building Plans for Modern Homes, will save you hundreds of dollars. One of the most complete and comprehensive books of plans ever published by any architect. New edition just off the press. Nearly 500 floor plans and photographs of bungalows, Colonial houses, etc., costing from \$200 up; gives sizes and cost to build.



FREDERICK H. GOWING ARCHITECT

Sent postpaid for \$2.00 101 Tremont St., BOSTON, MASS.

HANES ATHLETIC UNDERWEAR

is guaranteed absolutely—every thread; stitch and button. We guarantee to return your money or give you a new garment if any seam breaks.

Trade Mark P. H. HANES KNITTING CO. WINSTON SALEM, N. C.



EVINRUDE WILL

To insure delivery of a new SPORT TWIN, order from your dealer at once. Send for catalog.

EVINRUDE MOTOR CO., 207 Erie Blvd., Milwaukee, Wis.

BE OVERSOLD

The Secret Service!

Liquid

Will stop all leaks *permanently* anywhere in radiator or cooling system in from 5 to 10 minutes.

Simply pour contents of a can of

RADIATOR NEVERLEAK

into the water in your radiator. That is all that is necessary. This marvelous liquid will search out every leak and seal it at once.

We absolutely guarantee that it cannot clog or injure the cooling system in any way. It must give entire satisfaction or we will refund your money.

Write for free "Secret Service" booklet.

BUFFALO SPECIALTY CO.

357 Ellicott St. BUFFALO, N. Y.

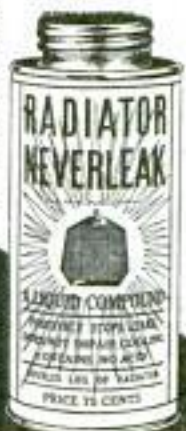

No job too difficult



MOSSBERG Chrome Manganese Steel Wrenches and Tools

That out-of-the-way nut or bolt is easy for Mossberg Wrenches and Tools. No matter how difficult the job there is a Mossberg Wrench big enough—small enough—good enough to handle it without trouble.

Select any Mossberg Wrench or Tool for examination—at the nearest dealer. They look strong—they are stronger than they look—their construction is of the sort that enables them to stand up under the hardest work. *Chrome manganese steel is used throughout the entire line.* One piece solid construction gives added strength.

Take Mossberg Speed Braces—for instance—they take hold of a nut or bolt, handle it easily and leave it clear—no burrs, no roughing up. You'll like their sturdy efficiency—their ability to stand not only use but *abuse*.

Special sets—small and large—for all kinds of work.

Look for the Mossberg trade mark. It represents value and quality.



Chrome Manganese Steel
Solid Socket "Tee"
Handle Wrench.



Chrome Manganese
Steel Indestructible
Speed Brace Wrench.

FRANK MOSSBERG CO.
Lamb Street Attleboro, Mass.

Please Mention Popular Mechanics

Auto Supplies

Knowing *HOW* to buy is merely knowing *WHERE*

This is Chicago's Great Wholesale House.

AUTO SUPPLIES AND MOTOR PARTS

WHOLESALE ONLY

Dealers send today for this big money-saving book

ACCELL AUTO ACCESSORIES COMPANY

1307-A South Michigan Avenue

CHICAGO

Steady Work

in a fast growing business with Vanderpool Latest Improved Vulcanizer. Made in America.

Ask for Catalog

Vanderpool Co., Dept. 9P, Springfield, Ohio

F. H. DIBB, Agent for British Isles,
26 Fairfield Rd. Winchester, England



INSYDE TYRES

Inner Armor for auto tires. Prevent blowouts and punctures. Double tire mileage. Easily applied to any tire between casing and tube. Details free. Agents wanted. Liberal profits. Amer. Accessories Co., Tire 26 Cincinnati, O.

MOTORCYCLE BARGAINS

Save 25% to 65%

on Slightly used and Rebuilt Motorcycles, Side Cars, Johnson Motor Wheels, Evans Power Cycles, Bicycles. Send for Free Bargain Bulletin and Money Saving Message. Being hundreds of Bargains in used, rebuilt and new machines, supplies, accessories, etc.

AMERICAN MOTOR CYCLE CO.
Dept. 922 2047 W. Chicago Avenue, CHICAGO



S-A-F-E-T-Y

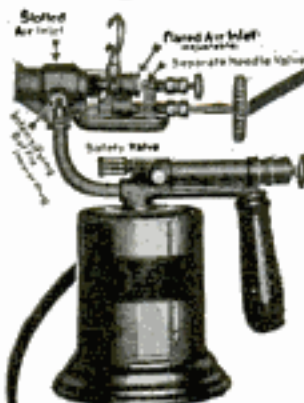

in the Price too

Examine the one piece, one opening tank. Note the dual system of fuel control. Study the heat intensifying baffle. Grip the handle. Use the pump. Operate the air release and try to find a safety valve on any other. \$8.25 at your dealer's or direct, postpaid. Order one now. You need it.

Every man who knows Blow Torches recognizes in the Turner a real, a practical, a SAFE and SECURE job that can be purchased as reasonably as the kind he has been fearful to use.

TURNER BLOTORCH

Safe as a Candle

has won a world of friends in the homes and workshops throughout the country. Its very outer appearance just radiates quality and when one inspects its ingeniously designed features, amazement is expressed at the price, so strikingly low.

Volume sales plus volume production is the answer. Turner precision shop methods on a highly organized scale gives you greater durability, greater efficiency, and **Positive Safety** at an honest price.

Go to your dealer today

THE TURNER BRASSWORKS

Industry Ave., SYCAMORE, ILL.

The World's Largest Exclusive Manufacturers of Blow Torches, Fire Pots and Braziers.

Buescher-Grand TRUMPET

Especially easy to blow, with an improved bore and new proportions. With the mute in, it blows so softly and sweetly that it will not annoy anyone. A splendid home instrument.



The Buescher-Grand Cornet is exceptionally easy to blow, yet possesses a tone of wonderful volume. It is the same instrument with which the greatest cornetists of America have made their reputations.

Send today for Free Book, mentioning instrument in which you are interested.

BUESCHER BAND INSTRUMENT CO.
Makers of Everything in Band and Orchestra Instruments
2593 Buescher Block ELKHART, INDIANA

Clear-Tone FOR PIMPLES

Your skin can be quickly cleared of Pimples, Blackheads, Acne Eruptions on the face or body, Enlarged Pores, Oily or Shiny Skin. \$1,000.00 Cold Cash says I can clear your skin of the above blemishes.

FREE WRITE TODAY for my FREE Booklet—"A Clear-Tone Skin"—telling how I cured myself after being afflicted for fifteen years.

E.S.GIVENS, 129 Chemical Bldg., Kansas City, Mo.

GET FACTORY PRICES ON GALVANIZED ROOFING



EDWARDS "REO" Metal Shingles

Absolutely rust-proof—edges as well as sides. Not the space of a pin point exposed to weather. Also fire and lightning proof. Reduces insurance. Outlast building. Need no repairs—end all roofing expenses. Easy to lay—one man can do the work—hammer and nails only tools needed. Lay over old shingles if desired. Patent Interlocking Device makes water tight seams—all nail heads covered—no rust or leaks possible.

Exclusive "Tightcote" Process
Put all Edwards Galvanized Roofing in a class by itself. Bend, twist, strike it with a hammer as much as you like—you can't loosen or scale off the galvanizing—due to our "TIGHTCOTE" process which practically makes zinc covering a part of the metal sheet. No other galvanized roofing can withstand this test.

FREE Roofing Book

Don't buy roofing until you get our big free book, describing Edwards famous "Tightcote"



THE EDWARDS MFG. CO.
900-950 Pike St. CINCINNATI, O.



FREE Samples & Roofing Book

How Would You Like To Grow Hair in a Month?

Getting bald, hair falling and fading? If you want to grow new healthy hair right away I will send you absolutely Free a sample of the famous Alexander Glandahair. No cost, no obligation, just send name to ALEXANDER LABORATORIES, 5104 Gateway Station, Kansas City, Mo.

21 Jewel Burlington

\$1 Down

Adjusted to the Second—Temperature—Isocronism—Positions—21 Ruby and Sapphire Jewels—Cased in a \$5 year Gold Strata Case. Only \$1 down will bring you this masterpiece. Write today for free book to

Burlington Watch Company
19th Street & Marshall Boulevard
Dept. 13-56, Chicago, Ill.

AGENTS: We Pay \$9.00 a Day

taking orders for Reversible Raincoat. Two coats in one. One side handsome black raincoat—other side fine dress coat. Takes the place of an expensive overcoat. Guaranteed water proof. Latest style. Not sold in stores.

\$50.00 A WEEK GUARANTEED FOR 2 AVERAGE ORDERS A DAY

No experience necessary. No capital required. All you do is to take the orders. We deliver by Parcel Post and do all collecting. Commission paid same day your orders are booked. Work full time or spare time. Easy to get orders on account of two coats for the price of one. Get started at once. Big season now on. Send for sample coat to wear and show.

THOMAS MFG. CO., R-2648, DAYTON, O.

No more burning
smarting
shaves

YOU get
real shav-
ing comfort—*always*
—if you use Ingram's
Therapeutic Shaving Cream.
No irritation—no stinging after
effects.

This cream has an exclusive medicinal prop-
erty that soothes the most sensitive skin—heals
annoying little cuts—leaves your face smooth and
cool. No need to use a lotion.

Get a jar from your druggist today—50c. If he is not sup-
plied, send us 50c together with his name
and address. We will mail you a jar of
Ingram's Therapeutic Shaving Cream,
and without charge a full-sized tube of
Ingram's Zodenta for the teeth

Frederick F. Ingram Co.
97 Tenth Street,
Detroit, Mich.

Also
Windsor,
Ont.

There
is Comfort
In Every Jar



REMINGTON
PORTABLE TYPEWRITER
Dealers and Branches Everywhere

You can play a
CONN

Easiest of all instruments to play, the
Conn saxophone is also hailed best
by famous stars.

Play popular tunes in short time.
Big money, lots of fun for you.

Free Trial—Easy Payments.

C. G. Conn Ltd., Elkhart, Ind.

931 Conn
Building

CONN
SAXOPHONES
CLARINETS
TRUMPETS
TROMBONES

CULTIVATE YOUR MUSICAL BUMP

SEND NO MONEY

If You Can Tell it from a
GENUINE DIAMOND Send it back

To prove our blue-white MEXICAN DIAMOND cannot be told from
a GENUINE DIAMOND and has same DAZZLING RAINBOW
FLIR, we will send a selected 1 carat gem in ladies Solitaire Ring.
(Cat. price \$5.25) for Half Price to introduce, \$2.63, or in Gentle
Heavy Youth Solitaire Ring (Cat. Price \$5.00) for \$2.50. Our finest
12k Gold Filled mountings. GUARANTEED 20 YEARS. SEND NO
MONEY. Just mail postcard or this ad, State Size. We will mail at
once. When ring arrives deposit \$1.63 for Ladies ring or \$2.25 for
Gents with postman. If not pleased return in 2 days for money back
less handling charges. Write for Free catalog. Agents Wanted.

MEXICAN DIAMOND IMPORTING CO., Dept. ET, Las Cruces, N. Mex.
(Exclusive controllers Mexican Diamonds)

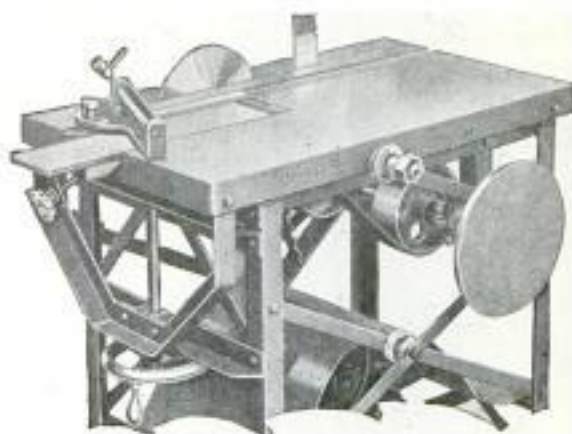

JUST what you've wanted! A real variety wood-
worker for small shops. This Parks Cabinet Shop
Special includes 8-inch rip and cross-cut saw, 4-inch
jointer, borer, sander, and universal motor. Shaper,
lathe and band-saw may be added. Strong, durable,
guaranteed 10 years. Handiest woodworker ever
designed, at a startling low introductory price. Price
with motor \$140 to \$210—depending on attach-
ments desired. Send for bulletin C-S.

THE PARKS BALL BEARING MACHINE CO.
1500-1540 Knowlton St. Cincinnati, O.
Canadian factory: 200 Notre Dame East, Montreal, Canada

PARKS
WOODWORKING MACHINES

KEITH'S \$2.50 OFFER



A new, big Plan
Book, showing 112
designs and floor
plans of artistic
homes in frame,
stucco, and brick,
your choice of bun-
galows, cottages or
two-story houses (and
8 months' subscrip-
tion to Keith's Mag-
azine—all for \$2.50.

Keith's Magazine for over 20 years an authority on
planning, building and decorating
homes—25c a copy on newsstands. With its help and Keith's
Plans you can get the most distinctive, comfortable and satisfactory
home with greatest economy.

3 big plan books (\$36 plans) and Keith's for 12 months—\$4.50
KEITH CORPORATION, 114 NORTH 7th STREET BLDG., MINNEAPOLIS, MINN.

The Real Metal Solder in Paste Form

SOLDERALL

Introducing Our New
SOLDERALL BLOW TORCH
of Heavy Solid Brass

Indispensable in the Home, Garage
and to the Electrician. For solder-
ing Radio, House Wiring, Jewelry,
Ignition, Kitchen Utensils, etc.



SOLDERALL CO. Dept. P Newark, N.J.

Outdoor UMBRELLA AUTO TENT

UNITED STATES TENT & AWNING CO. PRODUCTS



Special Features

- Patent Pending
- Light weight
- Sturdy frame
- Water proof and wind proof
- Up or down like an umbrella
- Center height 8 ft., at eaves 6 ft.; maximum head-room; also with rear lean-to which tubes full sized double camp bed.
- Two windows opened or closed from inside.
- Made and guaranteed by the manufacturers of largest line of parasols in the country and recognized leaders in the tent and awning world.

The Best Outing You Ever Had

Save hotel bills. Know the happiness and health of camping in secure comfort. Write for Free Book. The "OUTDOOR" is made of lightest grade U. S. Army Shelter Tent Cloth, absolutely water proof and wind proof. Up or down like an umbrella. Center height 8 ft.; at eaves, 6 ft.; maximum head-room; also with rear lean-to which tubes full sized double camp bed. Two windows opened or closed from inside. Made and guaranteed by the manufacturers of largest line of parasols in the country and recognized leaders in the tent and awning world.

"Outdoor" Portable Cottages
Summer House—Lawn Cottage—Play House—Outdoor Sleeping—Exclusive construction features. Portable, yet substantial; convenient, economical.

Free Book of Camp Equipment
Give particulars of the "OUTDOOR" line. Write for it today. The "OUTDOOR" Tents and Cottages are up-to-date with new exclusive features. Don't confuse with ordinary tents. Samples of our tent cloth sent free.

U. S. TENT & AWNING CO., 213 N. Desplaines St., Chicago, Ill.



No mixing
No Spreading
No Mess
No Trouble

Just crumble up a
Rat Bis-Kit

about the house. Rats and mice will seek it, eat it, die outdoors. Easiest, quickest, cleanest way. 25c and 35c. All druggists or general stores.

THE RAT BISCUIT COMPANY
Springfield Ohio

MINT VENDING MACHINE

Pays \$10 to \$20 Day Profit
Pays Rent for Store Owner

Install one in your store or any public place and get this easy money. Requires no attention. Always works. Machine's profits pay the rent. Write us about rebuilt penny and nickel machines. Finished like new. In excellent running order. Pay their cost in 10 days.

Write or wire today for full particulars. \$25 down payment. Balance C. O. D. Export orders full down payment. Mints \$15 per case, 1,000 5 cent packages. Single boxes, 100 5 cent packages, \$1.50.

SILVER KING NOVELTY CO.
400 Williams Bldg. Indianapolis, Ind.



Business Cards that get you IN



YOUR name, business, address and phone number are important factors to a favorable and quick audience with the man you are trying to reach. No one should be without a good business card. They create immediately the impression of your importance and "GET YOU IN."

BOOK FORM CARDS

Carried in "Wear Well" Cases are distinctive, beautifully lettered in either Roman or Gothic in process, Engraved effect, without use of expensive dies or plates. Used by officials and salesmen of the largest concerns in U. S.

Send \$2.00 cash with order for 100 cards and "Wear Well" cover. Give name, address, city and business (4 lines) \$2.00 for 250 or \$4.50 for 500 cards. 10c each additional line.

Note smooth edges and when detached

of cards held firmly by cover binder in case

Modern Card Co., 49 E. 11th St., Chicago
Enclosed please find..... for which send me.....
Book Form Cards and "Wear Well" Cover.
My name is.....
City..... Phone No.....
Street address..... State.....
Additional lines at 10 cents per line:
.....
You may have your club or business on your cards for the additional 10 cents.

We Pay \$7 a day taking orders for Can't Clog Coal Oil Burner

Most perfect burner ever invented

Intense blue flame. Can't clog up. Turns any coal or wood stove into a gas stove. Heats oven to baking point in 10 minutes. Cheapest fuel known. Low priced. Sells everywhere. Nothing else like it. Not sold in stores. Write quick for sample.

PARKER MFG. CO., BURNER 878, DAYTON, OHIO



Ride A Ranger

The finest bicycle ever built. 44 styles, colors, sizes; made in our new factory. SAVE \$10 to \$20 by direct from the factory purchase. Delivered free on approval, express prepaid, for 30 Days' Free Trial. 12 MONTHS to PAY, if desired. Tires best quality at factory prices, express paid. Lamps, wheels, horns, equipment and repairs at unusually low prices. Send No Money, do business direct with makers.

Write today for free Ranger Catalog, factory prices and marvelous easy payment terms

Mead Cycle Company
Dept B108 Chicago



CAMERAS

Over a Hundred Styles and Sizes
Send for new 1923 illustrated catalog showing newest models and latest reduced prices.
IT'S FREE
10 days' free trial given
Seneca Camera Mfg. Co.
300 Central Ave., Rochester, N. Y.



Six Machines in One

Combines bench saw, sander, drill, grinder, polisher and buffer for working in wood and soft metals

Boice Pony Bench Machine

—a precision machine especially adapted to rapid and accurate work. Handies 4" and 5" grinding wheels, 6" saws, 6" and 8" sand disc and $\frac{3}{8}$ " chuck. Saws 1 $\frac{1}{2}$ " wood. Mountable on separate base with motor. Height 10". Weight 31 lbs. Top 10" x 12" easily removed. All metal construction. Easily driven by $\frac{1}{4}$ or $\frac{3}{4}$ H. P. motor. Especially suited for Private Shops, Laboratories, Shipping Depts., Printers, Cabinet and Pattern Makers, Furniture Repairmen, etc. Machine sold with a money-back guarantee. Our line includes 4" bench jointers, 14" bench band saws, bench drills, $\frac{1}{4}$ and $\frac{3}{4}$ H. P. Ball-Bearing motors, and larvor motor driven bench saws. Write for descriptive literature and prices on Boice Pony Bench Machines and the above Boice-Built Bench Machines and Motors.

W. B. & J. E. BOICE, Dept. P.M. 9, Toledo, O.

Prices Reduced



On All Standard Make
Typewriters
Lowest Prices in Years

We will ship any make you choose for one week's trial, Underwood, Royal, L. C. Smith, Remington, Oliver, etc.

Easy Terms Pay less than rent each month and own a typewriter. Guaranteed good as new. Perfectly rebuilt by experts—the famous "Young Process."

Send for our free trial offer and new low price list now. Write today.

Young Typewriter Co.

World's Largest Dealers in Standard Typewriters
654 W. Randolph St., Dept. 1109, CHICAGO, ILL.

\$4.00 Adding Machine

The Gilson Adder will do your figuring easily, quickly and with absolute accuracy. Capacity 109,999,999 or \$1,099,999.99. It adds, subtracts, multiplies and divides and automatically carries from one column to the next. Made with aluminum case and steel operating parts, size 3 $\frac{1}{2}$ " x 6" x $\frac{3}{4}$ ". Written Two-Year Guarantee. Catalogue Free. Price, postpaid, \$4.00.

Your money back if you are not satisfied.

Gilson Slide Rule Co., Niles, Mich.

GUM
1¢ a
pack

Chewing Gum 1¢ per pack

Full size—5 stick packs—spearmint, peppermint and fruit flavors. \$5.00 for 500 packs. Suitable for Premium or Scheme purposes. Deposit required. Prompt shipments.

HELMET GUM MAKERS, Cincinnati, Ohio



Do Your PRINTING

Cards, circulars, labels, tags, book, menus, paper, Press, \$12. Larger \$35. Job Press \$150 up. Save money. Print for others. BIG PROFITS. All easy, rules sent. Write factory TODAY for press catalog, TYPE, cards, paper. THE PRESS CO. D-37, MERIDEN, CONN.



DIVINE RED DEVIL Water Motors

Simple—strong—durable. Wonderful little workers for all sorts of household and shop uses. Thousands in use. For all light power purposes. Attaches to faucet.

Two sizes: 4"—\$4.25
6"—\$6.75

The higher the water pressure the more work they do.
Send today for catalogue.
Divine Water Motor Company
Utica, N. Y.

21 Jewel ~ Extra thin STUDEBAKER The Insured Watch.

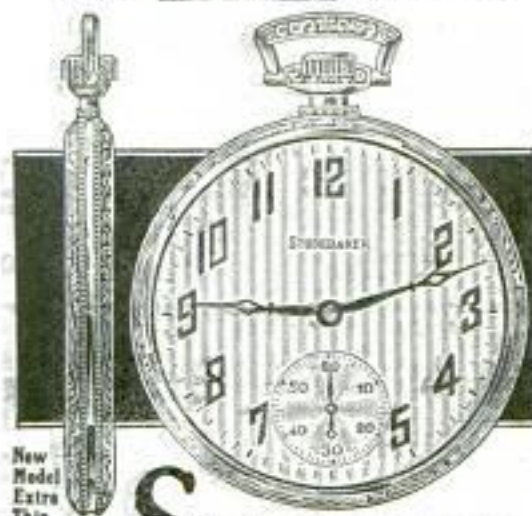

New
Model
Extra
Thin

SENT FOR

\$1.00 DOWN!

Only \$1.00! The balance in easy monthly payments. You get the famous Studebaker 21 Jewel Watch—Insured for a lifetime; a choice of 54 new Art Beauty Cases; adjustments, including heat, cold, isochronism and 5 positions—direct from the maker at lowest prices ever named on equal quality.

Write today for FREE BOOK of Advance Watch Styles.

Gold Chain FREE!

For a limited time we are giving away FREE with every Studebaker Watch a beautiful pattern Studebaker Watch Chain. Write now while offer lasts.

Mail Coupon for FREE Book of Advance Watch Styles

Send at once and get a copy of this book—FREE! See the newest, beautiful, advance styles in Studebaker Art Beauty Cases and Dials. Read how you can buy a 21 Jewel Studebaker Insured Watch direct from the maker—save big money—and pay for it on easy monthly payments.

Write! for our free book. It will post you on watch styles and watch values. Send coupon at once. Get Free chain offer today while it lasts.

Studebaker Watch Co.

Dept. 229, South Bend, Ind.

STUDEBAKER WATCH CO.

Dept. 229, South Bend, Indiana

Please send me your Free Book of Advance Watch Styles and particulars of your \$1.00-down offer.

Name

Address

City State

Please Mention Popular Mechanics



**Ford
Auto
FREE!**

We have a plan whereby our active workers can get a Ford without cost, in addition to their big cash earnings. Get the plan—quick!

"I have averaged \$7000

Per Year for Three Years—Have Made Over \$90 PROFIT in One Day"

That is the statement of Frank DePries, one of our live-wire representatives. Keeton of Mississippi made \$252 on his first sale. Vickers of Alabama made \$118 in one week. Conant quit a \$6,000 job to come with us.



DePRIES

AGENTS WANTED

We need more men like these, because the demand for our Super Fyr-Fyter is growing by leaps and bounds. Sells to garages, stores, factories, schools, homes, hotels, auto owners. Approved by the Underwriters. If you are willing to work and ambitious to make some real money, get our plan. You need no experience, as we train you without cost for the work. No great capital required. Good territory going fast. Better write us at once.

THE FYR-FYTER COMPANY

1730 Fyr-Fyter Bldg.,

Dayton, Ohio

DIAMONDS-WATCHES
LOFTIS
BROS. & CO. 1115
on CREDIT

"Jeannette" Diamond Ring
"Sylvia" Diamond Ring
DIAMONDS WIN HEARTS

GENUINE DIAMONDS, BLUE WHITE, PERFECT CUT

Rich 18-K Solid White Gold Mountings, pierced and carved.

Wonderful Values at **\$75 \$100 \$150 \$200**

When ordering rings shown above, give name and price

We import Diamonds direct from European markets and sell direct to you by mail. You save all middlemen's profits.

SEND FOR FREE CATALOG Select as many articles as you wish and have all charged in one account. Sent prepaid for your Free Examination. Catalog explains everything. Send for it today.

Rectangular Wrist Watch



18-K Solid White Gold, 17 Jewels, \$35
14-K Solid White Gold, 15 Jewels, \$29

Bargains in Diamonds, Jewelry, Pearls, Watches. **MONEY BACK IF NOT SATISFIED.**

See Catalog for other popular styles in Wrist Watches, Unusual Values.

Credit Terms on all articles: One-fifth down, balance divided into equal payments within eight months.

LOFTIS
BROS. & CO. EST'D 1858

NATIONAL CREDIT JEWELERS
DEPT. D-594
108 N. State Street, Chicago, Ill.
Stores in Leading Cities



Design No. 303

Plans \$18.00

California Bungalow Books

"Home Kraft" and "Draughtsman" each contain Bungalows and Two Stories. "Plan Kraft" Two Stories. "Kozy Homes" Bungalows. \$1.00 each—all four for \$3.00. De Luxe Plans \$1.00.

DELUXE BUILDING CO.

516 Union League Bldg., Los Angeles, Calif.

Moore Push-Pins
Glass Heads—Steel Points
Moore Push-less Hangers
To hang up things
Ask your dealer to show them
Sold Everywhere **10¢** per packet
Moore Push-Pin Co.
Wayne Junction Philadelphia

SELF-FILLING INK PENCIL

"INDEPENDENT"

Guaranteed Improved Fountain Pen. Eliminates fatigue. Promotes efficiency. Writes uniform. A business necessity.

\$2 By Mail

Meets all requirements... Self-filling, non-leakable, safety cap. Attached clip. Smooth writing gold style point.

Your Name in Gold—25 Cents Extra

AGENTS WANTED

J. C. ULLRICH & CO., 161 Washington St., New York

\$1 NOW

STROPS ANY SAFETY Razor Blade Perfectly 100 Shaves per Blade
Nickel Steel Stropper, Leather Strap and Hanger, all postpaid for \$1. Or C. O. D.
Money-Back Guarantee.
TOMSON STROPPER CO.
Dept. 1275, KANSAS CITY, MO.

Sell Shirts

Sell Madison "Better-Made" Shirts, Pajamas, and Nightshirts direct from our factory to wearer. Nationally advertised. Easy to sell. Exclusive patterns. Exceptional values. No experience or capital required. Large steady income assured. Entirely new proposition. **WRITE FOR FREE SAMPLES.**
MADISON SHIRT CO., 803 B'way, N. Y. City

Those who wear them say:
ERICKSON LEGS are Wonderful
because they do not chafe, overheat or draw end of stump.

Established 1892



If you have had a recent amputation send for new booklet on **TEST LEGS** for beginners.
E. H. ERICKSON CO.
38-A Washington Av. N.
MINNEAPOLIS • MINN.



The Present

W. L. DOUGLAS

\$7.00 & \$8.00 SHOES FOR MEN AND WOMEN
ALSO MANY STYLES AT \$5.00 & \$6.00

ESTABLISHED 1876

W. L. DOUGLAS SHOES ARE ACTUALLY DEMANDED YEAR AFTER YEAR BY MORE PEOPLE THAN ANY OTHER SHOES IN THE WORLD



They are made of the best and finest leathers, by skilled shoemakers, all working to make the best shoes for the price. The quality is unsurpassed. The smart styles are the leaders in the fashion centers of America. The wide range in kinds, styles and prices provides suitable shoes for every occasion, business, travel and motoring. Shoes of equal quality cannot be bought elsewhere at anywhere near our prices.

Why pay high prices for shoes? Try W. L. Douglas \$8.00 shoes, the shoes that hold their shape. If you had your shoes made to order you couldn't get more perfect shoes; they are exceptionally good value. Frankly, is it not worth while in these days of high cost of living for you to save money on your footwear when the opportunity offers?

For thirty-seven years W. L. Douglas name and portrait have stood for a high standard of quality and dependable value. For economy and satisfactory service, wear shoes that bear this trade mark. Ask your dealer for W. L. Douglas shoes. Look for W. L. Douglas name and the retail price stamped on the sole. Refuse substitutes.

IF NOT FOR SALE IN YOUR VICINITY, WRITE FOR ILLUSTRATED CATALOG SHOWING HOW TO ORDER SHOES BY MAIL. POSTAGE FREE.

TO MERCHANTS: If no dealer in your town handles W. L. Douglas shoes, write today for exclusive rights to handle this quick-selling, quick turn-over line.



W. L. Douglas
 President
 W. L. Douglas Shoe Co.
 128 Spark Street, Brockton, Mass.



Are YOU Old at 40?

A very common cause of early old age is the disturbed condition of an important gland. Even big, strong men are not exempt from this common and serious irregularity, interrupted sleep, mental depression, etc., are so often due to this gland. Sold for over five years upon a money-back-if-not-satisfied plan. Do not confuse it with massage, medication, violet rays, etc. No obligation. Write for your copy of the FREE BOOK today.

Our plainly written, interesting and educational

FREE BOOK

"Why Many Men are Old at Forty" may bring a priceless message to you. It tells of a simple, sensible way by which thousands have corrected this prostate gland condition. It tells how sciaticas, backaches, foot pains, interrupted sleep, mental depression, etc., are so often due to this gland. Sold for over five years upon a money-back-if-not-satisfied plan. Do not confuse it with massage, medication, violet rays, etc. No obligation. Write for your copy of the FREE BOOK today.

THE ELECTRO THERMAL CO. Thermalaids
 2125 Main Street, Steubenville, Ohio

Beats 10c Gasoline

INCREASES POWER AND MILEAGE 40%



Amazing auto invention. Wonderful new carburetor. Guaranteed to reduce gasoline bills from one-half to one-third and increase power of any motor from 30 to 50 per cent.

SENT ON 30 DAYS' TRIAL

Fit any make of car. Put on in a few minutes. Fords make as high as 34 miles to a gallon of gasoline. Other cars show proportionate increase.

Take advantage of our special 30-day trial offer. Name your car. AGENTS WANTED

AIR FRICTION CARBURETOR CO. Dept. 3980 DAYTON, OHIO



"Lighting Fixtures"

READY TO HANG

(Direct from Manufacturers)

Completely wired, including glassware. New designs. Send for catalogue No 24.

Send for DEALERS' proposition.

ERIE FIXTURE SUPPLY CO.

STA. A.

ERIE, PA.

MAKE YOUR FORD INTO THIS SPORT CAR—SAVE \$50 to \$150 WITH Red-i-Kut Life-Size Patterns \$6.40 COMPLETE

Popular Red-i-Kut life-size patterns and piece-by-piece instructions show you how you can easily convert your Ford into this FAST, SAUCY, SPORT CAR as thousands have done. With easily obtained materials. No need to lay up the car. The "Pat" with pressed metal streamline rear. Life-size patterns for each part of the body so you can't go wrong and

CONICAL DISK WHEEL PATTERNS Only \$1.00 delivered. Order now while we can make good delivery, and really enjoy the happy summer days in your "Pat." Keen, Classy, Up-to-the-minute. You can build it. Over 11,000 in use. Order Now.

"Red-i-Kut" Steel Set Complete for "Pat" \$9.51. Ed. West \$11.98 The Ace of Fords—"Have finished my 'Pat.' It's some jazz boat. I go where others fail. I can run thru mud as high where others can't go on low. I am so proud. I am called the 'Ace' of Fords. For I skip by them all kind of like a rabbit."—Cal Fortness, Columbia, Ky. "Swing Lo" Underlating Irons, no frame cutting kind, \$7.01. Send 5c coin for new manual of other distinctive sport body patterns from \$2.50 up—"Red-i-Kut" Steel Underlating Irons, "Jiffy" Taps and "Gossam" Windshields. Don't delay—Order Right Now. Kuempel Co., 40 Kuempel Bldg., Gottenberg, Iowa



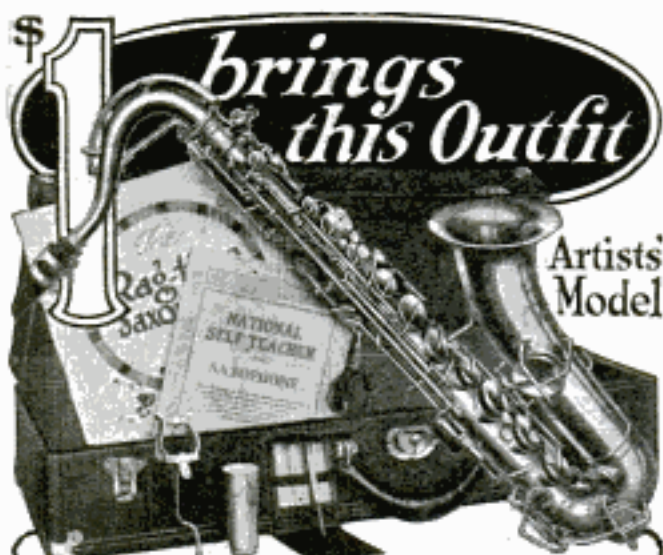

\$1 brings this Outfit

Artists' Model

Standard "C Melody" SAXOPHONE

Learn to play Saxophone! The easiest instrument to learn, it is also the most popular! Pick out tunes in an hour, as quickly as with one finger on the piano. And there's no faster way to **make extra money** than playing Saxophone at dance or church or theatre. Makes you a social favorite, always welcome everywhere!

10 MONTHS TO PAY! The Standard "C Melody" Saxophone is the supreme grade "made in Elkhart." Choice of famous artists and teachers. The 1923 model with "bevelled sockets" makes all other Saxophones "out of date." Sent to you for 6 days' trial, to prove to you its ease of blowing, simplified fingering and golden tone can't be equalled at any price. Complete 12 piece outfit direct to you from factory at only \$1 down and **\$8.00 a month**. Small first payment. Sensational cut in price during this sale, no interest, no tax, not one cent extra:—Saxophone, \$10 case, self-instruction system, book of music, reed, strap, pearl keys, etc., everything you need. Quality that enables you to buy **once** for a life-time.

CATALOG FREE! Tells you how you can secure the greatest of Saxophones on easy terms at less than cash prices! Write today for this free book and complete information of our sensational offer! Standard Music Co., Dept. 1322 P. O. Box 503, Chicago



SEND NO MONEY for this 3 ft. long distance brass bound 5 section telescope. On arrival pay postman \$1.85 plus few cents postage. **Guaranteed or Money Back!** Send today! Ferry & Co., 75 W. Van Buren, Dep. 1777, Chicago

TWO BEAUTIES
\$6.75 \$11.75
Watches you're proud to own

PRETTIEST watches that ever snugly hugged a fair feminine wrist. You'd think they were the highest priced watches, but by selling in enormous quantities, we cut prices. Ladies Watch of 14K White Gold filled, 25 years guarantee on tonneau shape case—richly carved—6 jewel imported movement; charming hand-made dial; sapphire crown; gross-grain ribbon and clasp. One year guarantee.

A SENSATIONAL OFFER AT \$6.75
Also available in rectangular case at \$11.75.

Send No Money. We Prepay Postage
Pay postman. You take no risk—money back promptly if not satisfied. These are good time keepers. Write today for yours.

Precious Wares Co.
ART JEWELRY
389 FIFTH AVE., DEPT. 619
NEW YORK CITY



\$6.75

\$11.75



Harris Homes Beautiful PERMANENT BUILT

Your Home Is Within YOUR Reach When You Buy From Us!

A mighty organization of thirty great departments ready to serve you. Managed by experienced buyers, designers and practical builders. We have vast stocks bought at huge quantity price savings which are now at your command. Our sole aim and purpose is—

To help you get a home that will prove entirely satisfactory at a price that will mean a substantial saving in actual dollars of your money.

The combined efforts of these great departments in experimenting and testing materials and methods of construction have produced for you a **GUARANTEED** home, expert machine cut, bundled and marked—the last word in building economy!

Not One Penny in Advance

So sure are we of the superior excellence of our material and our **GUARANTEED Ready-Cut System** that we will ship you any **HARRIS HOME** without the payment of one cent down. Our Plan Book explains our liberal terms fully.

FREE Plan Book

FREE Plan Book

for you, contains our **FREE PLAN OFFER** and photographic reproductions, with floor plans and specifications of 100 beautiful homes. Write for full particulars now!

Our Specialties: Guaranteed Ready-Cut Lumber, Mill Work, "Pre-set-Up" Bolt-Together Houses, Plumbing, Heating, Electric, Siding, etc., etc., and Building Material of all kinds.

HARRIS BROTHERS CO.

Dept. PE-7, 1349 W. 35th St., Chicago

SENSATIONAL SALE

GUARANTEED TYPEWRITERS



Limited quantity fully guaranteed standard make typewriters. Five Days' Free Trial. Lowest prices ever offered. Easy monthly payments. Send today for FREE booklet of Valuable Typewriter Information and Special Sale Bulletin.

SMITH TYPEWRITER SALES CO.
300-360 Grand Avenue, CHICAGO, ILL.



Build This Phonograph Yourself

TREMENDOUS SAVING IN COST

Easy, fascinating work with our **SIMPLIFIED PLANS**. We furnish blue prints, diagrams, motor, cabinet pieces, ready-built horn, etc. You don't need to be a cabinet maker. A few hours assembling and you will have a fine instrument at one-quarter the regular retail price. **AGENTS MAKE MONEY** making and selling these instruments. Write today for full details and our **FREE OFFER**. Address

LUPERL PHONOPARTS CO.

2648 W. Chicago Ave. Dept. 5 CHICAGO, ILLINOIS

BIG MONEY!



BIG MONEY IN SPARE TIME for one man in each locality making embossed show cards and price tickets for stores and others. Easy, quick work. No training needed. New embossing machine does it all. 400% profit. Signs sell on sight. T. W. Cushing of Chicago sold \$75 first call. S. D. Downes averaged \$15 a day for 6 months. Many sell \$5 to \$20 daily. No speculation. Before you invest a penny we send you free sample cards to show merchants and convince yourself they sell at sight. Write today.

PRAEMAFIX CORPORATION OF AMERICA

Dept. 600 Geneva, N. Y.



You can have disc wheels, too

You can have steel disc wheels on your coaster wagon, just as Dad has on his car. And with over-sized rubber tires, too—sturdy, fat, solid rubber tires which ride easily and as swiftly as a racer.

Most boys like the wheels this way. But you can also get disc wheels with steel tires or wood wheels with steel tires, if you prefer.

Substantial steel disc wheels are only one of the many features which make a boy as proud of his Auto-Wheel as Dad is of his automobile. Just look at the other features.

Auto-Wheel Coasters and Auto-Carts

Besides disc wheels with rubber tires (3 largest have over-size tires) the other features are: steel-tired disc or wood spoke wheels, (all wheels interchangeable); self-contained roller bearings, hound brace, hand brake, special hub cap and locking pin, sides mortised and nailed.

Write for Catalog which shows all models of the Auto-Wheel and also all models of the Auto-Cart, the Auto-Wheel's junior companion for your little brother and sister. If you send the names of three local coaster wagon dealers, telling which ones sell the Auto-Wheel, we will give you a year's subscription FREE to the "Auto-Wheel Spokesman," a dandy little magazine for a boy like you.

Auto-Wheel Coaster Co., Inc.
North Tonawanda, N. Y.

SPORT BODIES for FORD and CHEV. 490 at \$34.50

Life-size paper patterns—You can build your own body at small cost. We are man-



UP
UNDER
SLUNG
PARTS
Per Set
\$6.75

ufacturers and our quantity production enables us to quote exceptional low prices. Our unique shipping methods save you 73% in FREIGHT CHARGES. Send at once for free particulars on Central Bodies. Our Book: "HOW TO BUILD A FORD RACER" sent anywhere on receipt of 25c in cash or stamps. WRITE TODAY!

Central Auto Supply Co. Dept. 126 Louisville, Ky.

Ukulele Free!

Genuine Koa Wood
Finish Hawaiian Ukulele. Sweet ringing
tone. Given free with Short-Cut
Ukulele Instruction Course.

Clip this Ad

Learn to Play by our amazing new copyright course. No months of practice—just one hour.

Send No Money

for course and FREE Ukulele outfit. On arrival deposit with postman only \$2.95 plus a few pennies postage. We guarantee complete satisfaction or money refunded. Send now.

FERRY & CO, 75 W. Van Buren, Dept. 1778 Chicago, Ill.

N - O - W

YOU CAN FILL YOUR FORD
WITHOUT LIFTING CUSHIONS
and Have a Perfect Gasoline Gauge
IN PLAIN
SIGHT

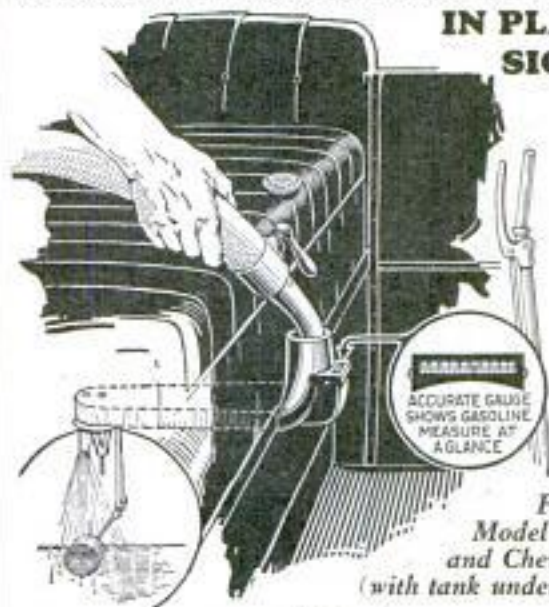

For All
Model Fords
and Chevrolets
(with tank under seat)

The Kirstin Fil-O-Meter

A GASOLINE FILLER AND GAUGE COMBINED



The Kirstin Fil-O-Meter attaches like this on any Ford or Chevrolet tank in 10 minutes.

PRICE

\$5.00
Except Sedans \$6.00

Money Order, Check or Sent C. O. D.

With the Kirstin Fil-O-Meter in place the Ford or Chevrolet (tank under seat) fills like a regular car. No lifting cushions—no fuss, muss or inconvenience. An accurate gasoline gauge is always in plain sight, showing just how much gas is in the tank at all times. No more guessing or measuring with messy measuring stick.

**ATTACH IN 10 MINUTES
Without Help of Mechanic**

Anyone can attach the Kirstin Fil-O-Meter in 10 minutes. No cutting or drilling in tank. Fil-O-Meter sets right in old tank cap opening. Then your Ford or Chevrolet fills outside the seat, taking full flow from the filling hose. **The Fil-O-Meter is out of the way.** Weighs less than 2 lbs., is strongly made of pure aluminum and will last a lifetime.

10 Day Money Back Trial

Order a Fil-O-Meter now. Put it on your car and try it 10 days. If not satisfactory, return it and your money will be immediately refunded. Be sure to specify Year and Model of your car.

MAIL THIS ORDER NOW

A. J. KIRSTIN CO., 12 First St., Escanaba, Mich.

Gentlemen: Please send me a Kirstin Fil-O-Meter for Ford, Chevrolet, year model with understanding that I will put it in use on my car and if not perfectly satisfied after ten days' trial I can return it and get my money back.

Money Order enclosed Check enclosed Send C. O. D.

Name

Town State

SALESMEN—DEALERS Do you want our big proposition?

Please Mention Popular Mechanics

\$400⁰⁰ ONE DAY!

Ira Shook of Flint Did That Amount of Business in One Day

Making and Selling Popcorn Crispettes with this machine. Profits \$269.00. Mullen of East Liberty bought two outfits recently, and is ready for third. Iwata, Calif., purchased outfit Feb., 1920. Since, has bought 10 more—his profits enormous. J. R. Bert, Ala., wrote: "Only thing I ever bought equaled advertisement." J. M. Pattilo, Ocala, wrote: "Enclosed find money order to pay all my notes. Getting along fine. Crispette business all you claim and then some." John W. Culp, So. Carolina, writes: "Everything going lovely. The business section of this town covers two blocks. Crispette wrappers lying everywhere. It's a good old world after all!" Kellogg \$700 ahead end of second week. Mexiner, Baltimore, 250 in one day. Ferrin, 380 in one day. Baker, 3,000 packages, one day.

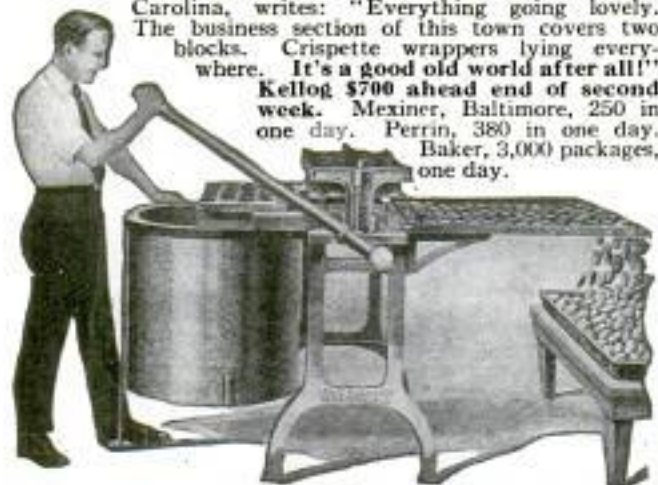

WE START YOU IN BUSINESS

Little capital, no experience. Furnish secret formula.

Build a Business of Your Own

The demand for Crispettes is enormous. A delicious food confection. Write me. Get facts about an honorable business, which will make you independent. You can start right in your own town. Business will grow. You won't be scrambling and crowding for a job. You will have made your own place.

Profits \$1,000 a Month Easily Possible

Send post card for illustrated book of facts. Contains enthusiastic letters from others—shows their places of business, tells how to start, when to start, and all other information needed. It's free. Write now.

LONG EAKINS COMPANY

928 High Street

Springfield, Ohio

Taxidermy Book FREE

Mount Birds

We teach you by mail to stuff and mount all kinds of Birds, Animals, Game Heads. Also to tax skins and make rugs. Be your own taxidermist. Decorate your home with your beautiful trophies or increase your income selling specimens and mounting for others. Easy, quickly learned in spare time by men and women. Highest endorsements by thousands of students. Write today for our great free book "How to Mount Birds and Animals" Free—write today. N. W. School of Taxidermy, 9776 Elwood Bldg., Omaha, Neb.

YOU CAN SELL

Agents! IDEAL FIBER CUTTER

The Kitchen Convenience every housewife wants.

\$1.50 House-to-house agents average \$40.00 to \$100.00 weekly.

an hour for full or spare time Write for free book, "Coining Cash," and read how other agents are making big money. Don't put it off. Write at once. NOW!

M. H. TYLER MFG. CO., Factory No. 2, Muncie, Ind.

Pleasure and Profit With a "KING" Saxophone

IT'S so easy to learn to play the famous KING saxophone! A few weeks' practice and you can play popular music—then join a band or orchestra and make good money playing for dances and other entertainments.

"KING" Band Instruments and Saxophones are easiest to play because they are built acoustically correct. Scientific design, finest skilled workmanship, careful supervision at each phase of construction make "KINGS" the most perfect instruments in the world. The tone quality is impossible to duplicate. Leading bands and orchestras insist upon "KINGS." Let us send you one for 10 days free trial.

Free Trial—Easy Payments

"KING" Band instruments and Saxophones are fully described in beautifully illustrated circulars. Write today for complete information about our ten days free trial and our easy payment plan on any instrument. Ask for bargains in rebuilt instruments—old ones taken in trade.

THE H. N. WHITE COMPANY
5211-43 Superior Avenue, Cleveland, O.

RANGER \$5 a Month

Finest bicycle built—44 styles, colors and sizes. Factory to Rider prices FREE delivery, express prepaid on 30 days Free Trial. Cash or easy pay'ts.

TIRES

lamps, wheels and equipment at half usual prices. Send no money. Write today for big catalog, special Factory Prices, free trial plan and marvelous offers.

MEAD CYCLE CO. Dept. B108 CHICAGO

Tire Agents Wanted

Use and Introduce Mellinger Cord Tires

12,000 Miles Guaranteed!

Lowest Wholesale Prices in America. Shipped prepaid on approval. Make big money all or part time. No capital or experience. Sample sections furnished.

FREE TIRES FOR YOUR CAR to one user in each locality. Simply send some today for valuable book; tells how thousands have gone into big business. SPECIAL AGENTS' OFFER. Wholesale Prices and FREE SAMPLE KIT.

MELLINGER TIRE & RUBBER CO.
\$600,000 Capital. Dept. 517, Kansas City, Mo.

"LYON BODIES" \$27⁵⁰

For Fords, Chevrolets and Dodges

SEND NOW For Our 1923 "Book of Bargains"

Containing a full line of bodies and accessories at exceptionally low prices. Buy direct from the factory.

AUTO TIRE SALES CO., Dept. P 12
1346 S. Michigan Ave. CHICAGO Body Division



Preferred equipment

The number of CRESCENT wrenches, pliers and screwdrivers bought by car owners within the last five years indicates that more than half of America's automobiles are "Crescent Tool equipped." Crescent tools are "first choice" with millions of users.

Crescent Tool Company
The "CRESCENT WRENCH People"
JAMESTOWN, N. Y.

CRESCENT TOOLS

TAILORING SALESMEN

We Pay You Salary and Commissions

Greatest money-making line in America. Made to measure suits, overcoats, one price, \$33.65, express prepaid, all wool, all wool linings, hand tailored, finest workmanship. No extra charges for style or overize. Bigger advance commissions, weekly salary besides. Protected territory. Apply at once.

GREAT WESTERN TAILORING CO.
837-841 W. Jackson Blvd. CHICAGO, ILL.

FREE —a book that tells how to get better results with radio tube sets. Address
WILLARD STORAGE BATTERY COMPANY
CLEVELAND, OHIO

\$2 Brings This Genuine
DIAMOND RING



SET IN PLATINUM

Think of it — seven brilliant genuine diamonds massed in setting of solid platinum so closely together that only close inspection will distinguish it from a \$750 solitaire.

FREE ROYAL CATALOG

Illustrates thousands of special offers in Diamonds, Watches and Jewelry from our \$2,000,000 stock. Write Dept. 961.

10 DAYS' REE TRIAL

Simply send \$2; if you can duplicate this diamond ring for less than \$65 your deposit will be refunded. Guarantee based on original mark ring. After trial, pay balance \$1.00 a month for ten months. Price only \$68.50.

ROYAL DIAMOND & WATCH CO.
35-37-39 Maiden Lane - New York

8 TESTS

That Prove the Safety of Every Investment

YOURS - FREE

At last there is available to every investor, whether large or small, a concise, scientific guide to making investments that may be relied upon to ensure the maximum of safety. Eight specific tests may be given to prove the safety of every investment. Unless an investment will pass every one of these 8 tests it is lacking in some element of safety. No person should invest money in any form of security without knowing and applying these eight tests.

Over a period of 38 years, George M. Forman and Company have handled the investments of thousands of individuals without the loss of a single dollar to any customer — this record could have been made only by the application of these tests to every investment. In a booklet, "How To Select Safe Bonds," you will find exactly what these 8 tests are and much additional information of interest in connection with your investments. You will find how you can still get an attractive yield with safety in the face of declining interest rates.

Mail Coupon for Book

Fill out and mail the coupon at once for this interesting booklet. There is no obligation. It will not only show you how to test every investment for safety, but will also give you information that will enable you to secure, with absolute safety, a larger income from your investment. Mail Coupon now.

GEORGE M. FORMAN & CO.
105 W. MONROE ST. CHICAGO
38 Years Without Loss to a Customer

GEORGE M. FORMAN & CO.
Dept. 449, 105 Monroe St.
Chicago, Illinois

Please mail me without cost or obligation a copy of your booklet "How to Select Safe Bonds." No solicitor is to call on me.



Name.....
Address.....
City.....State.....

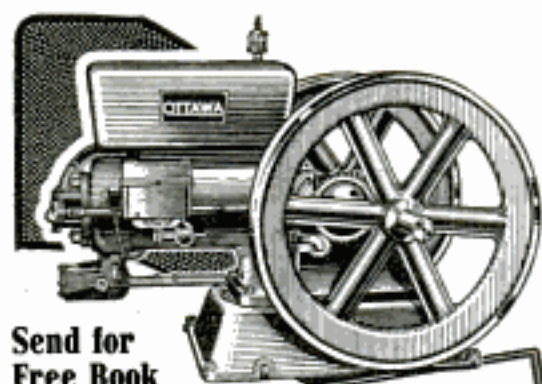

Send for
Free Book

**OTTAWA Prices
Save You More!**

If you are going to need an engine, send at once for Special Factory-to-You Sale Offer. All styles and sizes at wonderful money-saving prices. Send a postcard at once for full particulars!

Direct From Factory to You

All sizes — 1½, 2¼, 3¼, 5, 7, 10, 12, 16, 22 H-P. Kerosene, Gasoline.

FREE! Send postcard today for new Free Book—"How to Know Better Engines."

OTTAWA MFG. CO.
534-K King St., OTTAWA, KANS.
Desk 534-K Maple Bldg. PITTSBURGH, PA.

*How to
KNOW
BETTER
ENGINES*

EASY NOW TO RID YOUR PLACE OF FLIES

Flies are worse than ever before this hot weather, buzzing, irritating humans and animals, spreading disease and filth everywhere.

Now, through the discovery of E. R. Alexander, well known scientist, you can instantly rid your place, home, barn, farm, livestock of these pests.

Just spray a little Rid-O-Fly around and flies drop dead; kills nothing but bugs, flies, motus, mosquitoes, chiggers, etc. Not a poison—harmless, non-irritating to stock, no unpleasant odor. But the pests won't come back as, in addition to killing it is strong repellent.



Rid-O-Fly is an organic chemical that works like magic and is guaranteed to give absolute satisfaction. In three minutes you can clear a kitchen or dining room of flies, and when used on livestock, cows give more milk, stock contented, animals do double work. No more disease carriers, no more fevers or infection.

Think how easy to make this simple amazing test.

SEND NO MONEY

Just send name and address. Dr. Alexander will send you a \$3.00 supply of RID-O-FLY and a fine large household sprayer worth one dollar absolutely free. Pay postman only \$1.25 and a few cents extra postage. Use right away; if not delighted two big Kansas City banks guarantee your money back without delay. The chemical alone is worth more than the price asked, so to get the valuable free sprayer be sure to write today and this introductory offer will be mailed at once. Address ALEXANDER LABORATORIES, 1559 Gateway Station, Kansas City, Mo.

Please Mention Popular Mechanics

SAVE COAL

**Make 10 tons do the work
of 12 to 20 tons**

Lack of air over the surface of the fuel bed in your furnace is costing you extra money for coal and is reducing the amount of heat you should get.

There is a simple scientific device that remedies this condition; that gives you quick steady heat and more of it; that reduces your coal bills 20 to 50%. This device is the CROWN FUEL SAVER.

The CROWN FUEL SAVER fits the feed door of any heating plant. It provides by means of natural draft, the supply of super-heated air necessary to burn the rich gases that rise from the surface of the fuel bed. (See illustration.) These gases ordinarily are lost, going up the chimney as "smoke." The CROWN prevents this unnecessary waste of fuel. This means a tremendous increase in heat and a corresponding reduction in smoke.

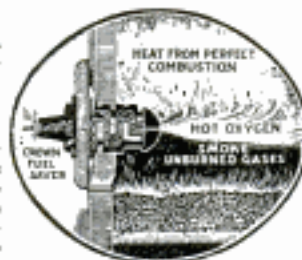

Have a CROWN put on your heating plant now. Requires no attention. Any mechanic can install it easily and quickly, without injury to the feed door.

Write for our booklet—"Making the coal bill look like 30 cents" and for details and price of CROWN. As the CROWN comes in 4 sizes, give name and make of furnace and approximate size of grate.

CFSCO, 15 N. 10th St., Richmond, Ind.

DISTRIBUTORS WANTED

The CROWN is the fastest selling specialty on the market. Offers opportunity to get into a profitable business. Write or wire for distributors proposition.

AGENTS

For the Biggest Money-Making
Selling Proposition You Ever Saw

See Pages 60 & 61

"I Would Not Part With It for \$10,000"

So writes an enthusiastic, grateful customer. In like manner testify over 100,000 people who have worn it. Conserve your body and life first.

The Natural Body Brace

Overcomes **WEAKNESS** and **ORGANIC AILMENTS** of **WOMEN** and **MEN**.

Develops an erect and graceful figure. Brings restful relief, comfort, energy and pep, ability to do things, health and strength. Does away with the strain and pain of standing and walking; replaces and supports misplaced internal organs; reduces enlarged abdomen; straightens and strengthens the back; corrects stooping shoulders; develops lungs, chest and bust; relieves backache, curvatures, nervousness, ruptures, constipation, after effects of Flu. Comfortable and easy to wear.

Costs You Nothing to Try It

Write today for illustrated book, free, with full information and measurement blank. Address

HOWARD C. RASH, Pres. Natural Body Brace Co.
223 Rash Building SALINA, KANSAS



For
Children
Also

SAWS AS MUCH AS 10 MEN!

One man, now, can saw 15 or more cords of wood each day with the OTTAWA Log Saw. No more back-breaking work with a cross-cut saw; no more lugging logs to a circular saw, for it's easy to take this power saw to the wood. Over 26,000 in use. Thousands making big money sawing wood for neighbors and to sell. Coal is high and may be higher—wood is in good demand for fuel. Send your name on a post card today for full particulars about the—

Faster sawing; easier moved—easy to start in any weather. 4 H. P. Kerosene Engine—you need plenty of power. Shipped quick from nearest to you of nine branch houses.

OTTAWA 4 in 1

- 1—Cuts Down Trees
2—Saws Logs
3—Buzzes Up Branches
4—Does Belt Work

LOG SAW

Get Big Special Factory-to-User Offer!

Send at once for big 32-page Free Book telling all about this remarkable one-man outfit. Let me show you how it will save you all hard work, provide cheap fuel for yourself and to sell, and pay back its cost in a short time. Cash or Easy Terms.

30 Day Trial 10 Year Guarantee. Send your name and address on a post card. Write today.

OTTAWA MFG. CO.
1742-M Wood St., Ottawa, Kans.
Room 1742-M Magee Bldg.
Pittsburgh, Pa.

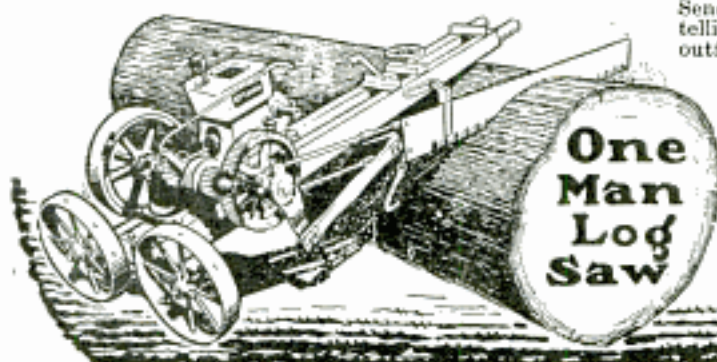

Tobacco

Special Bargain Introductory offer on Kentucky's Finest Good Old Melon Sweet Green River Smoking Tobacco. Two big 1-lb. cans, \$2.00 value for only \$1.00 postpaid. Satisfaction guaranteed or money back.

OWENSBORO TOBACCO CO., Dept. 130, Owensboro, Ky.

Starting a Company?

Save expenses and taxes by organizing on the popular, COMMON LAW plan under a pure DECLARATION OF TRUST. No experience required to fill in DEMAREE STANDARD FORMS, issue shares and begin doing business at once. Genuine DEMAREE FORMS are nationally known, approved by attorneys, and utilized by successful concerns throughout the United States. Send for large, free pamphlet (D-53) containing valuable information that you may need. C. S. DEMAREE, legal blank publisher, 708 Walnut, Kansas City, Missouri.

AGENTS—Here It Is

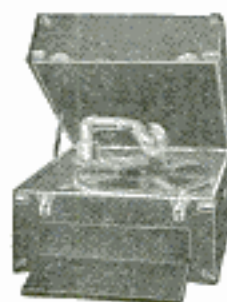

Something new. Wonderful invention. The Serenola does more than machines costing 10 times its price. Taking the country by storm. Orders taken for over a thousand a week. Big demand. Easily carried with you anywhere. Built in just like a suitcase. Fully guaranteed. Low price. Must satisfy customers or money back.

Easy to Take Orders

Biggest, best and most profitable proposition we have ever offered. Big money on every order. No capital needed. No collecting. Pay you every day. Get started at once. Some of our representatives making from \$7 to \$21 a day. No competition. Territory given. Don't pass up this wonderful opportunity.

PERRY-LUDLOW CO., S. 448 DAYTON, O.

Easy Now to Make and Repair ELECTRICAL APPLIANCES \$1.00 Prepaid

Genuine NICHROME WIRE

This resistance wire is the business end of standard electrical appliances. 27 feet guaranteed up to 660 watts, 110-120 volts, 6 amps. With this you can make or repair your own electrical ranges, furnaces, soldering irons, toasters, curling irons, waffle griddles, etc. Complete package with copper and mica washers, nuts, screws and full instructions sent prepaid for One Dollar, or order C. O. D. and pay fee cents extra postage. **Allied Factories Corporation, 1007 Cox Cola Bldg., Kansas City, Mo.**

General Utility Motor

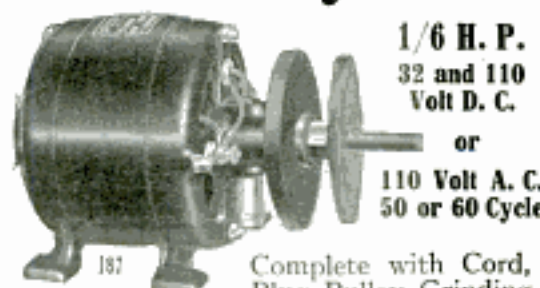

1/6 H. P.
32 and 110
Volt D. C.

or

110 Volt A. C.
50 or 60 Cycle

Complete with Cord, Plug, Pulley, Grinding and Buffing Wheel. Can be used for cleaning and polishing silver, sharpening knives or for operating sewing, washing or other household machine.

PRICE \$17.95 Satisfaction Guaranteed or Money Refunded

PETER BROS. MFG. CO.
ALGONQUIN, ILL.



"Our Vacation's Not Over!"

"We're continuing our vacation every evening and week-end on our INDIAN Motorcycle.

"We whizz out into the country after supper—riding it to business means getting home much earlier.

"Friend Wife says the carfare saved during the week makes our Saturday and Sunday trips cost almost nothing.

"We're sure storing up enough fresh air and energy to keep us peppy all winter.

"And we're having the fun of riding, while we're paying for our INDIAN. Just a little each week—so small we hardly notice it."

INDIAN Scout, the most popular middle-weight, \$250; electrically equipped, \$285. F. O. B.

INDIAN Big Chief 74, ideal for heavy duty side car work, \$345. F. O. B.

HENDEE MANUFACTURING CO.
SPRINGFIELD, MASS.

Ask your dealer—or write us, Dept. P-9, for free booklet and easy, ride-as-you-pay plan.

Indian Motorcycle

Please Mention Popular Mechanics

ONLY \$ **200** DOWN
10 MONTHS TO PAY

48.00 PER MONTH
4.60 PER MONTH

30 DAYS FREE TRIAL

LOOKS LIKE **1½ CT. DIAMOND \$600.**

Choose the ring you like best; give finger size, and send only \$2.00 deposit to show your good faith. We will send the ring without any delay or red tape. If you like it, pay only \$4.60 each month for ten months. Total price only \$48.00 for either ring. If you return it within 30 days, we will return your money.

THESE RINGS WORTH 50% MORE
Former price \$75.00. The sparkling, blue-white, perfectly cut, genuine diamond solitaire is set in an 18 kt. solid white gold ring. In the cluster ring, seven perfectly cut, blue white, genuine diamonds are set in solid platinum.

WRITE FOR JEWELRY CATALOG No. 679
It brings a big jewelry store right into your home
STERLING DIAMOND & WATCH CO.
(Established 1879. \$1,000,000 Stock)
63 PARK ROW, Dept. 679, NEW YORK, N. Y.

TYPEWRITERS



\$50 buys a brand new Corona, the Personal Writing Machine. Latest model with many improved features.

Write for free booklet No. 8.

Corona Typewriter Co., Inc.
GROTON, N. Y.



PILLIOD Tool Cases Excel

Machinists, Tool Makers and Carpenters find them most satisfactory in construction, appearance, service and price. Immediate shipment.

Booklet describing 20 styles on request.

THE PILLIOD LUMBER CO.
Dept. 1 Swanton, Ohio

New 300 Candle Power Lamp

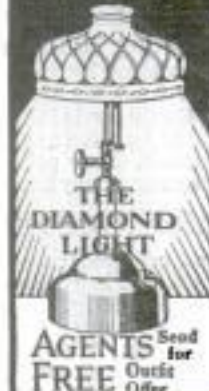

Make \$60 to \$100 a Week

Introducing this wonderful new lamp. Gives soft, brilliant light; restful to eyes; ideal illumination.

Burns Kerosene or Gasoline

Clean, odorless, economical. Burns 96% air, 4% fuel. Absolutely safe. Lights with match. 100 times brighter than wick lamps. Patented. Greatest improvement of age. Table lamps, hanging lamps, lanterns.

Work all or spare time. You simply take orders. We deliver by Parcel Post and do collecting. Commissions paid same day you take orders. No experience necessary. Get started at once. Big season now on. Write today for catalog and special agents' offer.

THE AKRON LAMP CO.
109 Lamp Bldg. Akron, Ohio

Send for
FREE Offer



HEAT!
THE NEW WAY

Amazing
Invention
Does Away With
Coal and Wood

No Wood no Coal

NOTE
SCIENTIFIC
APPLICATION
OF AIR TO FLAME

Fits Any Stove

Twice the Heat at Half the Cost—On or Off with the Turn of a Valve.

Think of having instantly all the heat you want IN ANY STOVE without building fires; without kindling, ashes, dirt, or odors. Think of having—at the touch of a finger—a fire that is three times hotter than coal—or just enough to simmer a kettle. A fire that stays where you want it—high or low.

THREE TIMES HOTTER THAN COAL

Think of the wonderful cooking and baking you can do with such a fire, think of the better health and comfort the family will enjoy when you can keep every room in your home at just the heat you want, warm and cozy, day and night, in any weather. These are but a few of the advantages enjoyed by users of a remarkable new invention—

INSTANT-GAS—CHEAPER THAN COAL

A scientific combination of 96% superheated air and 4% kerosene (common coal oil)—the cheapest and safest fuel known. It is produced by an amazing invention which, in one minute, can be slipped into the fire-box of any coal or wood stove. All the convenience of gas at half the cost.

Start with the Turn of the Valve

Turn high or low to suit, heat your home, do your cooking and baking, and then stop with another turn of the valve. A child can operate it. Instant-Gas gives a clean, steady, dependable fire. No ups and downs to give the family influenza and pneumonias, no running out into the cold to fetch coal or wood, no fallen cakes or sodden biscuits from an unsteady oven. Saves cleaning bills, doctor bills, wall paper and curtains.

Works in Any Stove—Old or New

No holes to drill, no injury to stove, installed in a few minutes, makes old stove work like new, and makes a new stove last twice as long. Lasts a lifetime. For many years the markets have been flooded with oil burning devices—but a scientific improvement in the application of oil burning principles makes the Instant-Gas Oil Burner the one great, outstanding success of its kind. Yet it costs

no more than inferior out-of-date makes. Money-back guarantee gives you absolute protection.

TRY IT IN YOUR HOME FOR 30 DAYS FREE

Test the Instant-Gas for yourself, try it in your own stove at our risk for 30 days, see for yourself how much superior Instant-Gas is to any other fuel, how much money it saves, how easy it is to turn on and off, how much cleaning and scrubbing it saves, how much warmer you can keep your home, and how much better cooking and baking you can do. Join the hundreds of thousands of Instant-Gas users who have gained health and strength by cutting their work in half and doing away with the heavy, dirty, back-breaking coal and wood. Mail coupon today for 30 day trial offer and amazing new book "Scientific Oil Burning." No obligation. Special low introductory price to those who mail coupon at once. Mail yours today.

AGENTS Oil burning is the rage. People everywhere are turning to this remarkable new method of heating and cooking. \$60.00 a week sales plan for beginners and spare time workers. \$5,000.00 to \$10,000.00 a year easy for real producers, who can handle big territory. Write at once for details and be ready for big Fall and Winter sales.

INTERNATIONAL HEATING CO.

119 South 14th Street, Dept. 310, St. Louis, Mo.
Manufacturers of scientific heating equipment.

Mail this Coupon for Amazing Free Book

International Heating Co.,
119 South 14th Street, Dept. 310, St. Louis, Mo.

Without any obligation whatever to me, mail me, post paid, your Free Book entitled "Scientific Oil Burning," together with your special introductory price and 30 day trial offer to those who act at once.

Name.....
Address.....
City and State.....

If interested in making from \$60.00 to \$200.00 a week] as agent, like Lacey of Mass., mark X in this square.

RAISE BELGIAN HARES
New Zealand Reds—Flemish Giants—American Blues.
BIG PROFITS, WE PAY \$1.50 TO \$6 EACH.
Also Cavies, Mink, Skunk, Fox, Muskrat, Etc.
Easily raised anywhere. **FREE!**
Illustrated book "COMMON SENSE RABBIT RAISING," quarterly journal, and copy of America's leading small stock magazine, all for 12 cents. Address Outdoor Enterprise Co., 1005 E. 51st St., KANSAS CITY, MO.

MADE TO YOUR MEASURE

Suit \$14.95

NO EXTRA CHARGES

Postage Prepaid

SEND NO MONEY We make this special offer to prove the wonderful value, style and fit of Progress tailoring. We will tailor to your special order one of these fine suits, send it to you postage prepaid and guarantee absolute satisfaction for only \$14.95. We have other equally striking bargains in the finest made-to-order suits at from \$14.95 up to \$39.50.

AGENTS WANTED Earn \$20 to \$35 extra every week, taking orders from your friends and neighbors for our high-class tailoring. NO EXPERIENCE NECESSARY.

Big Sample Outfit FREE

Drop us a line today and we will send you absolutely free, our big assortment of woolsen samples, style book and special wholesale prices, on our made-to-measure suits.

THE PROGRESS TAILORING CO., Dept. W-145, CHICAGO

\$7.50 Value for \$4.50 Metal Bottom Tool Bag

"Maderite," the most convenient general utility bag ever built for mechanics, plumbers, steamfitters. Built for extra heavy service. Non-rusting, galvanized bottom—waterproof duck body. Handles and shoulder straps of heavy haler style webbing. Nickel plated buckles. 20 in. long—6 in. wide. Sold with a Money Back Guarantee. At all dealers, or send \$4.50 direct.

A. BRUNS & SONS, 50 Ralph Avenue, BROOKLYN

5 SIZE AUTOMOBILE TAP AND DIE SET, ONLY \$3.00

DIRECT FROM THE FACTORY TO YOU!

Our No. 12 Automobile Set furnished in our highly finished chestnut box contains 5 each taps and dies (1-4, 5-16, 3-8, 7-16 and 1-2"), in the S. A. E. thread, 1 die stock, and one tap and reamer wrench.

Our No. 11 Set is the same as No. 12 except that the thread is U. S. S. instead of S. A. E. You are purchasing a splendid set at a very low figure.

Send us your order at once and be one of our many satisfied customers.

Let us also send you one of our circulars illustrating our full line of Handy Tools.

WORCESTER STEEL PRODUCTS CO., Dept. T, 25 Union Street, Worcester, Mass., U. S. A.

Free *Latest BOOK on* HEALTH and BEAUTY

VIOLET RAYS



Only \$1.00 DELIVERS now *to Your Home*

ONLY \$1.00 brings this complete, scientific Violet Rays outfit to you. Treat yourself and family at home, save delay, costly doctors and medicines. Thousands use Violet Rays at home to relieve pain and sickness. The identical outfits doctors have bought from us for years and with which they successfully treat many ailments.



QUICK RESULTS—No Medicine

Violet Rays work quickly, it's scientific, goes after the cause. That's why results are quick, permanent. Dr. Duncan, Kewanee, Ill., writes, "Violet Rays is the finest thing I ever used to relieve pain, treatments are so pleasant all my patients like it." Use it yourself at home, you save Doctor's bills.

BEAUTY AID

Brings natural, magnetic beauty of health, no dieting, exercise or drugs. FREE book tells in detail how high priced beauty specialists use it to improve scalp and skin.

EARN CASH

Men, women, without experience earn liberal profits in spare time showing Violet Rays to neighbors. Proves results first demonstration. Sells on sight. Get attractive offer and wholesale prices now.

SEND FOR FREE BOOK

Explains how Nikola Tesla discovered Violet Rays, how it works, why it heals. Tells what doctors and plain folks accomplish in conquering pain, disease and nervous trouble with Violet Rays.

Reveals **Marvelous Scientific Discovery** Shows charts of human body, explains where pains start, how to banish them. Offered FREE for a limited time only, to introduce Violet Rays. Send for FREE copy.

Mail Coupon—Send No Money

VI-REX ELECTRIC COMPANY
326 West Madison St., Dept. 29, Chicago

Please send me without cost or obligation your free book describing your VI-REX Violet Ray outfits, and details of your \$1.00 offer.

Name _____
Address _____
City _____ State _____

SAVE MONEY
Get This Book

HANDY MAN BOOK

Install Your Own
PLUMBING & HEATING
NEW EASY WAY - SAVE HALF

25c
Reg. Price 50c

Brings you this big Plumbing and Heating Encyclopedia-Catalog. Write for your copy today without fail.

Guaranteed Heating Plants

Our Handy-Man Book shows how. Big 256-page well-bound encyclopedia of Plumbing and Heating Outfits, Systems, Supplies, Fixtures and Accessories—10,000 items—illustrated. Hundreds of floor plans, elevations, diagrams, trade secrets, money and trouble-saving kinks, etc. "How to save coal in heating," "Easy repair methods." Every householder, contractor, farmer, mechanic, institution needs this book. Shows how to save wages, work and materials.



Hot Water Boiler

BIG HANDY MAN BOOK

Tells how we help you plan and install. From rough sketch or description we supply working plans and clear instructions. We loan the tools needed. Any handy man can install. This is the place to buy on money-back guaranty. Plumbing Outfits and Supplies; Water Systems; Hot-Air, Water or Steam Heating Plants; Radiators, Pipes, Boilers or Septic Disposal Tanks.

Send 25c for Yours Today

We have spared no effort or expense to complete this remarkable and instructive book. To keep from sending it broadcast to disinterested persons, we request a deposit of 25c, which will be refunded on your first order—or send for our FREE Bulletin. Write today and save half.



Pipeless Furnace

HARDIN-LAVIN CO.

50 Years
at 4547-57
Cottage Grove Ave.,
CHICAGO



Bathroom Outfit

NO JOKE TO BE DEAF

—Every Deaf Person Knows That I make myself hear, after being deaf for 25 years, with these Artificial Ear Drums. I wear them day and night. They are perfectly comfortable. No one sees them. Write me and I will tell you a true story, how I got deaf and how I make you hear.



Medicated Ear Drum
Pat. Nov. 3, 1906

Address
GEO. P. WAY, Artificial Ear Drum Co. (Inc.)
80 McCreedy Building, 2631 Woodward Avenue, Detroit, Michigan

BIG PROFITS AGENTS—SALESMEN

\$20 to \$40 daily selling and applying
Gold Transfer Letters

\$1.40 profit on \$1.50 sale—six letters on side doors of automobiles, motorcycles, toilet articles, store and office windows, etc. Our Mr. Saunders made \$700 selling and applying letters and emblems in 15 days. \$125 profit on \$5 outfit. Send money order today.

Monogram Letter Co. 196 Market Street
NEWARK, N. J.

Swear Off Tobacco

Tobacco Habit Banished Let Us Help You

Quick Results

Trying to quit the tobacco habit unaided is often a losing fight against heavy odds, and may mean a serious shock to your nervous system. So don't try it! Make the tobacco habit quit you. It will quit you if you will just take **Tobacco Redeemer** according to directions.

It doesn't make a particle of difference whether you've been a user of tobacco for a single month or 50 years, or how much you use, or in what form you use it. Whether you smoke cigars, cigarettes, pipe, chew plug or fine cut or use snuff—**Tobacco Redeemer** will positively remove all craving for tobacco in any form in a few days. Your tobacco craving will usually begin to decrease after the very first dose—there's no long waiting for results.

Tobacco Redeemer contains no habit-forming drugs of any kind and is marvelously quick, scientific and thoroughly reliable.

Not a Substitute

Tobacco Redeemer is in no sense a substitute for tobacco, but is a radical, efficient treatment. After finishing the treatment you have absolutely no desire to use tobacco again or to continue the use of the remedy. It helps to quiet the nerves, and will make you feel better in every way. If you really want to quit the tobacco habit—get rid of it so completely that when you see others using it, it will not awaken the slightest desire in you—you should at once begin a course of **Tobacco Redeemer** treatment for the habit.

Results Absolutely Guaranteed

A single trial will convince the most skeptical. Our legal, binding, money-back guarantee goes with each full treatment. If **Tobacco Redeemer** fails to banish the tobacco habit when taken according to the plain and easy directions, your money will be cheerfully refunded upon demand.

Let Us Send You Convincing Proof

If you are a slave of the tobacco habit and want to find a sure, quick way of quitting "for keeps" you owe it to yourself and to your family to mail the coupon below or send your name and address on a postal and receive our free booklet on the deadly effect of tobacco on the human system, and positive proof that **Tobacco Redeemer** will quickly free you from the habit.

Newell Pharmacal Company
Dept. 300 St. Louis, Mo.

Free Book Coupon

NEWELL PHARMACAL CO.,

Dept. 300

St. Louis, Mo.

Please send, without obligating me in any way, your free booklet regarding the tobacco habit and proof that **Tobacco Redeemer** will positively free me from the tobacco habit or my money will be refunded.

Name.....

Street and No.....

Town..... State.....



Tobacco Tells on
Nervous System



Tobacco Ruins
Digestion



Tobacco Stunts
Boy's Growth



Tobacco Robs
Man of Vitality



Tobacco Steals
from You the
Pleasures, Com-
forts, Luxuries
of Life





SHOP WORK with a

CARNES ARTIFICIAL ARM

FOR nearly ten years a Carnes Artificial Arm has kept Mr. Pahhe Yaze of Lawrence, Kan., on the payroll as a draftsman and machinist at a good salary. Thousands of other mechanics, artisans, office workers, farmers and laborers owe their independence to this improved arm.

Life-Like in Action and Appearance

The Carnes Arm cannot be detected from the natural except by close inspection. Its user can dress himself, use knife, fork, pen, pencil and keys; pick up large or small objects, carry grips—in fact, do virtually everything that was possible before. He can bend the elbow of the Carnes Arm, bend and turn the wrist and open and close the fingers at will, even if the amputation is at the shoulder.

192-Page Book FREE. A book of 192 pages, profusely illustrated with photographs showing what can be done with this remarkable invention, will be sent free to any person interested. Send for it now.

CARNES ARTIFICIAL LIMB CO.,
208 Carnes Bldg., Kansas City, Mo.

F-F BATTERY CHARGER CHARGES AT HOME

\$15

RADIO "A" & "B" & AUTO STORAGE BATTERIES Overlight For Few Cents From Any 110 Volt A. C. Lamp Socket. COMPLETE PORTABLE AUTOMATIC. No Skill Required. WILL PAY FOR ITSELF. 7 TYPES at POPULAR PRICES.

TYPE 6 charges 6 Volt Battery At 6 Amperes \$12
TYPE 12 charges 12 Volt Battery At 6 Amperes \$18
TYPE 8 charges RADIO "B" Batteries Up to 120 Volts \$18
TYPE A-B is a Combination of TYPES 6 & 8 \$20
TYPE 166 charges 6 Volt Battery At 12 Amperes \$20
TYPE 1612 charges 12 Volt Battery At 7 Amperes \$20
TYPE 1626 is a Combination of TYPES 166 & 1612 \$28

SHIPPING WEIGHTS COMPLETE 10, 12, 15 lbs. PURCHASE FROM DEALER, or Order CHARGER C. O. D. ORDER now, or WRITE for Free CHARGER Bulletin 24

FRANCE MFG. CO., CLEVELAND, OHIO

Custom-Made Tops Less Than Half Price

SEND NO MONEY

You can attach them easily. Full instructions sent. Complete tops with beveled plate glass, tacks, fasteners and welts. Free delivery 1,000 miles. For all rates; special prices on Maxwells, Overland Fours, Dodges and Chevrolts. Describe your car. Samples and money-saving Bulletin free.

S-C PRODUCTS CO., 758 Nicholas Bldg., Toledo, O.

DIAMONDS

\$195 PER CARAT

From 1-6 Carat to 2 Carats

Former Price, \$325.

You Save 40 per cent

30 DAYS FREE WEAR

Genuine, sparkling blue white diamonds set in 18 Karat solid white gold rings. CATALOG FREE

It gives valuable information about diamond weights and grades which you should know before buying, and offers a jewelry store full of bargains to select from. Money back guarantee bond with each diamond.

B. GUTTER & SONS ESTD. 1879
172 NASSAU ST., Dept. 1109 New York

Please Mention Popular Mechanics

STOP USING A TRUSS

Do Away With Steel And Rubber Bands

FREE TRIAL



TRADE MARK

STUART'S ADHESIVE PLAPAO-PAD

Inner surface is made adhesive to secure the PLAPAO-PAD firmly to the body, keeping the PLAPAO continually applied and the pad from slipping. No straps, buckles or springs attached. Soft as velvet—easy to apply.

It's the Non-Slipping, yet Non-Rigid Pad and What is Within It That Counts

PATD APRIL 6 1909

FREE to 5,000 Truss Sufferers

To the extent of 5,000 sufferers who may apply I will send, ABSOLUTELY FREE, a sufficient quantity of the Plapao to positively convince them that this is the only logical, commonsense way of treating rupture. Plapao is a highly astringent medication placed within the Plapao-Pad and being absorbed through the skin, creates a wonderful feeling of relief and at the same time tends to strengthen the weakened muscles and thus permanently close the rupture opening. The process of recovery is natural, so you'll have no use for a truss—you can throw it away forever! Old and young have testified under oath that the Plapao-Pads cured their rupture—many of them long-standing, aggravated cases—without delay from work. Patent allowed in U. S. and foreign countries. Awarded Gold Medal at Rome and Grand Prix at Paris.

Send No Money—for a sufficient quantity of the Plapao is sent without charge to enable you to give it a thorough test; you pay nothing for this trial now or ever. Write for it and full information today. Address: Plapao Laboratories, Block 1427 St. Louis, Mo.

DEAFNESS IS MISERY



I know because I was Deaf and had Head Noises for over 30 years. My invisible Antiseptic Ear Drums restored my hearing and stopped Head Noises, and will do it for you. They are Tiny Megaphones. Cannot be seen when worn. Effective when Deafness is caused by Catarrh or by Perforated, Partially or Wholly Destroyed Natural Drums. Easy to put in, easy to take out. Are "Unseen comforts." Inexpensive. Write for Booklet and my sworn statement of how I recovered my hearing.

A. O. LEONARD, Suite 226, 70 5th Avenue, New York City

MOVIES In Your Home

Our marvellous, practical Movie Machines sell as low as \$5.00—and what's more, we have wonderful films at lowest prices—with a new film exchange service. DON'T MISS THIS!

Write NOW for Free Catalogue

PARAMOUNT MFG. COMPANY
Box 1371, Dept. M2, Boston, Mass., U.S.A.

NO MORE BALD HEADS



WHEN our VACUUM CAP is used a few minutes daily. We accept no pay until you have tried the Cap 30 days and are satisfied. The Vacuum Cap is an appliance that draws the blood to the Hair Roots and starts a new healthy crop of hair. It stops Dandruff, stops the hair from falling out.

Bought by Doctors and men who know that it is the only reasonable HAIR GROWER known to science. No Drugs Used. Write for application blank, testimonials, and booklet on "HAIR," sent sealed in plain envelope. FREE.

THE MODERN VACUUM CAP CO.
N 559 BARCLAY, DENVER, COLO.

PATENTS TRADE-MARKS AND COPYRIGHTS

SPECIAL OFFER — Free Opinion as to Patentable Nature

Before disclosing an invention, the inventor should write for our blank form "Record of Invention." This should be signed and witnessed and if returned to us together with model or sketch and description of the invention, we will give our opinion as to its patentable nature.

Our Three Books Mailed FREE to Inventors

OUR ILLUSTRATED GUIDE BOOK

HOW TO OBTAIN A PATENT

Contains full instructions regarding Patents, Trade-Marks, Foreign Patents. Our Methods, Terms, and 100 Mechanical Movements illustrated and described; Articles on Patent Practice and Procedure, and Law Points for inventors.

OUR TRADE-MARK BOOK

Shows the value and necessity of trade-mark protection and gives information regarding Trade-Marks and unfair competition in trade.

OUR FOREIGN PATENT BOOK

We have direct agencies in all foreign countries and secure foreign patents in the shortest possible time and at the lowest cost.

LIST OF PATENT BUYERS SENT FREE

IDEAS WANTED: Send for LIST OF PATENT BUYERS containing unsolicited letters from Manufacturers and others WISHING TO BUY meritorious patents. There is a great demand for NEEDED INVENTIONS. We endeavor to assist OUR clients in the commercial development of their inventions.



Highest References—Prompt Attention—Reasonable Terms

---FREE COUPON---

VICTOR J. EVANS & CO., Patent Attorneys

NEW YORK OFFICES
1007 Woolworth Building

CHICAGO OFFICES
1114 Tacoma Building

PHILADELPHIA OFFICES
714-715 Liberty Bldg.

PITTSBURGH OFFICES
514 Empire Building

SAN FRANCISCO OFFICES
Hobart Building

MAIN OFFICES: 765 9TH STREET, N.W., WASHINGTON, D. C.

Gentlemen: Please send me FREE OF CHARGE your books as described above.

Name..... Address.....



PATENTS

Seventy-six Years of Practice

THE firm of Munn & Company filed its first application for a patent in 1846, and for seventy-six years has endeavored to keep pace with the inventive genius of the United States.

An experience of many years is at your disposal. If you have an invention which you wish to patent, send your sketches or model together with a description of your device, explaining its operation, and you will receive prompt, courteous attention.

Write for our Handbook on PATENTS

A full and complete booklet on Patents, Designs, Trade-Marks, Foreign Patents, Copyrights, Labels and Patent Office Practice with an explanation about our methods, terms, etc.

All communications strictly confidential.

Keep in touch with the inventions of the world by reading

SCIENTIFIC AMERICAN

The MONTHLY MAGAZINE with a special appeal to every man of inventive genius. Recent rulings of the Patent Office, descriptions of the latest patented inventions, legislation and court decisions affecting patents, are noted in this authoritative publication.

MUNN & COMPANY

Patent Attorneys

672 Woolworth Building, New York City

Scientific American Building, Room 2
625 F Street, Washington, D. C.

Suite 801, Tower Building, Chicago, Ill.
601 Hobart Building, San Francisco, Cal.

Please Mention Popular Mechanics

Can You

think of a simple, practical idea that will fill one of the many requests we have on file for new inventions? It may mean a fortune for you. Thousands of things are needed **right now**. Your brains can help. Send today for our great new book—

"Inventions and Trade-Marks, Their Protection and Exploitation"

and learn more about making money from ideas than you ever knew before. It tells many things that are wanted, too.

**A postal will do—
It is free**

We Help Our Clients

without charge, to get the dollars out of their ideas—having facilities none others possess. Advice free. Don't delay—get the book at once.

American Industries, Inc.
200 Patent Dept.
WASHINGTON, D. C.

**Patents
Advertised
For Sale Free**
in Invention and
Manufacturing Supplement

Published for the man with an idea. Send for free sample copy. One year's subscription, 50c.

U.S. PATENTS



**SEND FOR
THIS FORM**

DON'T LOSE YOUR RIGHTS TO PATENT PROTECTION

Before disclosing your invention to anyone send for blank form "EVIDENCE OF CONCEPTION" to be signed and witnessed. A sample form together with printed instructions will show you just how to work up your evidence and establish the same before filing application for patent. As registered patent attorneys we represent hundreds of inventors all over the United States and Canada in the advancement of inventions. Our schedule of fees will be found reasonable. The form "Evidence of Conception," sample, instructions relating to obtaining of patents and schedule of fees sent upon request. Ask for them—a post card will do.

PATENTS AND TRADE MARKS

LANCASTER & ALLWINE

480 Ouray Bldg. Washington, D. C.
Originators of forms "Evidence of Conception."

PATENTS

EXPERIENCE **SERVICE**

CLARENCE A. O'BRIEN
PATENT ATTORNEY

REGISTERED IN UNITED STATES PATENT OFFICE.
 MEMBER OF THE BAR OF
 SUPREME COURT OF UNITED STATES, COURT OF APPEALS DISTRICT OF COLUMBIA,
 SUPREME COURT DISTRICT OF COLUMBIA, UNITED STATES COURT OF CLAIMS.
 PRACTICE CONFINED TO PATENTS AND TRADE MARKS.

PATENTS

SCIENCE
INVENTION
INDUSTRY

ECONOMY
EFFICIENCY
INITIATIVE

Any new article, machine, design or improvement thereof, or any new combination of parts or improvements in any known article which increases its efficiency or usefulness, may be patented, if it involves invention.

If You Have Any New Ideas
 which you feel are useful, practical and novel, *take prompt action toward protecting your rights.* If you have invented any new machine, or new combination of parts or improvement, or new process or design, **SEND DRAWING, MODEL OR DESCRIPTION** of it for information as to procedure to secure protection.

Write Today for Blank Form "RECORD OF INVENTION" to be returned to me with drawing, description or model of your idea. Promptly upon receipt by me of your idea I will write you fully as to procedure and costs. No charge for the above information.

All Communications Are Held in Strict Confidence
 My personal, careful and thorough attention is given to each case. I offer you efficient, reliable and prompt service—based upon practical experience. *Highest references.* Write today for free book "How to Obtain a Patent." This book will give you valuable information, and it may save you much time and effort. *Send for it NOW.* My practice is devoted exclusively to United States and foreign patents and trade marks. Very probably I can help you. Write today.

CLARENCE A. O'BRIEN, Registered Patent Attorney
 1701 Southern Building WASHINGTON, D. C.

CLARENCE A. O'BRIEN, 1701 Southern Bldg.,
 Patent Attorney, Washington, D. C.
 Please send me your free booklet, "How to Obtain a Patent" and blank form "Record of Invention" without any obligation on my part.

NAME.....
 ADDRESS.....
 (WRITE PLAINLY)

HOW TO OBTAIN A PATENT

PATENTS

Booklet Free

Highest References

Promptness Assured

Best Results

Send drawing or model for preliminary examination

ALL BUSINESS GIVEN PROMPT AND PROPER ATTENTION

WATSON E. COLEMAN, Patent Lawyer, 624 F St., Washington, D. C.

PATENTS

To the Man with an Idea

I offer a comprehensive, experienced, efficient service for his prompt, legal protection and the development of his proposition.

Send sketch, or model and description, for advice as to cost, search through prior United States patents, etc. Preliminary advice gladly furnished without charge.

My experience and familiarity with various arts frequently enable me to accurately advise clients as to probable patentability before they go to any expense.

Booklet of valuable information and form for properly disclosing your idea free on request. Write today.

Richard B. Owen, Patent Lawyer
9-303 Owen Building, Washington, D. C.
2276-E. Woolworth Bldg., New York City

Have You An Invention?

If so the WORLD PROGRESS will show you how to **PROTECT AND PROFIT FROM YOUR IDEAS** Sample copy free. One year's subscription \$1.00. Send for free book,

"WHAT TO INVENT"

containing SUGGESTIONS TO INVENTORS as to Inventions Needed. We invite manufacturers to address us regarding inventions they want.

WORLD PROGRESS PUB. CO., Inc.
Room 203 Victor Bldg. WASHINGTON, D. C.

PATENTS

Trade-Marks, Copyrights and Patent Litigation

Write for advice and instructions how to proceed, costs, etc. Hand Book with illustrations of 100 Mechanical Movements sent free on request.

ALBERT E. DIETERICH

Patent Lawyer and Solicitor

Successor to Fred G. Dieterich & Co. 621 Ouray Bldg., Washington, D. C.

INVENTORS

who derive largest profits know and heed certain simple but vital facts before applying for Patents. Our book *Patent-Sense* gives those facts: free. Write **Lacey & Lacey, 646 F St., Washington, D. C.** ESTABLISHED 1869.

QUIT TOBACCO OR SNUFF RUINING YOUR HEALTH WASTING YOUR MONEY

Harmless treatment quickly overcomes craving for cigars, cigarettes, pipe, chewing or snuff. Sent on trial. Costs \$1.00 if it cures, nothing if it fails. Used by over 400,000 people. **Superba Co. H-2 Baltimore, Md.**

PATENTS If You Have an Invention and Desire to Learn How to Secure a Patent

Send for our Guide Book, **HOW TO GET A PATENT**, sent Free on request. Tells our terms, methods, etc. Send model or sketch and description of your invention and we will give our opinion as to its patentable nature.

RANDOLPH & CO.
600 F St., N.W., Washington, D. C.

NAME.....

STREET.....

CITY.....STATE.....



Get This Wonderful Ring. If You Can Tell It From a Genuine Diamond Send It Back

These amazing, beautiful CORODITE diamonds positively match genuine diamonds in every way—same blinding flash and dazzling play of living rainbow fire. They alone stand the diamond tests, including terrific acid test of direct comparison. Lifetime experts need all their experience to see any difference. Prove this yourself.

Wear a Corodite Diamond 7 DAYS FREE

Make this test. You risk nothing. Wear a genuine Corodite and diamond side by side on the same finger for 7 days. If you or your friends can tell the difference, send it back; you won't be out a single penny. That's a fair enough. If you keep the ring, price printed here is all you pay. No installments. Remember, Corodites also have the same setting as genuine stones.

SEND NO MONEY Keep your money right at home. Just send name, address and number of ring wanted and size as shown by slip of paper. Ring sent to end around finger joint. Your ring will come by return mail. When ring arrives deposit amount shown above with postman. If you decide not to keep ring after 7 days' wear, send it back and your money will be immediately returned. Send today.

E. RICHWINE CO.

19 West Jackson Blvd., Dept. 601, Chicago, Illinois
Sole Importers Genuine Corodite Diamonds

PATENTS Secured

Prompt service. Avoid dangerous delays. Send for our "Record of Invention" form and Free Book telling How to Obtain a Patent. Send sketch or model for examination. Preliminary advice without charge. Highest Reference. Write TODAY.

JACOBI & JACOBI, 410 Ouray Bldg., Washington, D. C.

PATENTS C. L. PARKER

Formerly Member Examining Corps, U. S. Patent Office

PATENT LAWYER

MCGILL BLDG.

WASHINGTON, D. C.

Patents, Trade Marks, Copyrights, Patent Litigation

Handbook for Inventors, "Protecting, Exploiting and Selling Inventions," sent free upon request.

GEARS ALL KINDS SMALL

The most accurate made and prices reasonable. We carry a complete line of gears in stock for immediate shipment. Can also quote on special gears of all kinds. Send us your inquiries. WRITE FOR CATALOGUE.

CHICAGO STOCK GEAR WORKS
105-109 S. Jefferson St., CHICAGO

PATENTS

Send us sketch or model for patentability opinion and exact cost of patent. Our book "How to Obtain a Patent," sent free on request. It tells how to apply for Patents, Trade Marks, Foreign Patents, Copyrights, etc.; gives information on Patent Procedure; tells what every inventor should know. Thousands of inventors, who are our clients, are our references.

Chandlee & Chandlee, 25 Years' Experience.
455 7th St. Washington, D. C.

DEVELOP YOUR INVENTIVE ABILITY

Invention Is a Science

Let Great Inventors teach you how to invent, develop, patent and market your ideas; amazing new course teaches science of invention by mail

Every man, woman, and child is born with creative imagination. Some develop this faculty to a greater degree than others, and those who develop it to the greatest extent are successful inventors. Invention is an orderly process of the mind, which combines two or more known facts to produce a new fact. Anyone who develops the right mental process can become an inventor. Every successful inventor has this type of mind, developed by constant experience over a period of perhaps



Raymond Francis Yates

author of the New Course in Inventive Science, in collaboration with 15 other inventors. Mr. Yates is known through the country as Editor of scientific magazines, writer of hundreds of articles and inventor of many practical devices and machines.

Edison says: "Invention should be taught as a profession." Every inventor realizes the hopelessness of groping in the dark for the habits of thought and methods of work required for successful invention. Trying to invent without knowing the fundamental requirements of invention is like trying to build a bridge without knowing engineering.

Don't Waste Ideas! Every man at some time or other has an idea for something he would like to invent, but his mind doesn't know how to work. He doesn't know what to do about it—doesn't know how to think along inventive lines—and soon someone whose mind is trained along inventive lines invents just the thing you may have thought of.

WRITE FREE BOOK FOR

A wonderful book explaining this wonderful new course in detail has been written and will be sent free to those genuinely interested. This book explains the course in detail, and proves that anyone can become an inventor who trains his mind—it may be the beginning of a fortune for you. If you have ever had an idea for an invention, or if you would like to become a spare-time or professional inventor, and if you would like to know what to invent, send in your name at once on the coupon NOW!

Only a limited number of these books are available for free distribution.

Bureau of Inventive Science, 39 Wisner Bldg., Rochester, N. Y.

many years. Heretofore those who succeeded in the field of invention had to discover all the principles themselves. But, now, just as any student of medicine, law, or engineering can take full advantage of all the recorded experience in these fields of study, so can YOU take the same kind of short cut to the habits of thought, and the methods of work required of successful inventors.

Little Inventions Win Fortunes

Fortunes have been made by men who have thought of a "little" idea in a flash. The man who invented the bottle top, the man who invented the crimped hairpin, the man who invented the thin lead automatic pencil, the man who invented the snap fastener—all these men, perhaps, got their ideas in a flash, and founded their fortunes as a result of a single idea. But in every case their minds operated in accordance with the scientific laws of successful invention.

BUREAU OF INVENTIVE SCIENCE
Dept. 39, Wisner Building
Rochester, N. Y.

Please send me your free book "The Science of Invention."

Name

Address

City

State

Great *New*



Invention for seekers of Health Power Beauty

Elco Health Generators at last are ready for you! If you want more health—greater power to enjoy the pleasures and delights about you, or if more beauty is your desire—write! Ask for the book on these inventions which has just been prepared. It will be sent to you without cost. It tells you how Elco Health Generators aid you in leaving the lethargy and hopelessness of bad health and weakness behind forever. Re-vitalize yourself. Bring back energy. Be wholly alive. Write today!

10 Days Free Trial—Write for Free Book!



These great new inventions generate Violet Ray, Vibration, Electricity and Ozone—combined or separate

Free Trial

They operate on the electric light in your home or on their own motive power at less than 50 cents per year. Elco Health Generators are positively the only instruments which can give you in one outfit Electricity, Violet Ray—Vibration and Ozone—the four greatest curative agents. Send the coupon below. Get the Free Book NOW!



For All These:

Paralysis	Catarrh
Pimples	Insomnia
Palling Hair	Skin Diseases
Headache	Hay Fever
Lumbago	Neuralgia
Nervousness	Deafness
Rheumatism	Pain
Sore Throat	Development
Anthema	Neuritis
Black Heads	Obesity

Mail Coupon for FREE Book!

Do not put this paper down without sending the coupon. Don't go on as you are with pains and with almost no life and energy. You owe it to yourself to be a better man or woman. You wear, put here to enjoy life—not just to drag through it. So do not rest another day until you have put your name on the coupon here. That will bring the whole story of these great new inventions. Do it today—now.



Lindstrom & Company

442-448 N. Wells Street, Dept. 13-56, Chicago, Ill.

Please send me your free book, "Health—Power—Beauty" and full information of your 10-day Free Trial Offer.

Name _____

Address _____

Please Mention Popular Mechanics

\$4
NO MORE

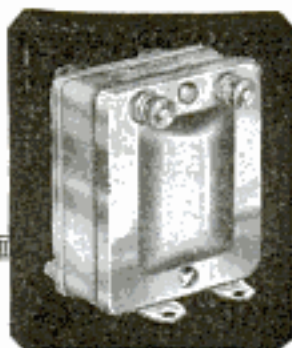

\$4
EVERY WHERE

NATIONAL AUDIO TRANSFORMERS

Are Giving

PERFECT SATISFACTION

on thousands of sets. Use them on your set—with any type of tube. Better Transformers are not made. Highest grade materials and workmanship. Approved by experts everywhere. At your dealer. If not, order direct, mentioning his name. Dealers: Write for sales proposition.



NATIONAL TRANSFORMER MFG. CO.
154 Whiting Street, Dept. 910, Chicago, Illinois



WRITE TODAY for Our 168-PAGE FREE BOOK on **Deafness**

and learn how Perfect Hearing is now being restored in every condition of deafness or defective hearing. Our "Little Wireless Phones for the Ears" require no medicine, but effectively replace what is lacking or defective in the natural ear drums. They are simple devices, which the wearer easily fits into the ears, where they are invisible. Soft, safe and comfortable.

WILSON EAR DRUM CO., Incorporated
1285 Inter-Southern Bldg. LOUISVILLE, KY.



MOTORCYCLES

RELIABLE STANDARD MAKES that you can **DEPEND ON.**

Enjoy the glorious experience of going wherever you like—whenever you like. The price is within your means—35% to 50% less than others. These machines are slightly used, thoroughly overhauled or rebuilt. Send for catalogue.



MYEROW BROS.,
258 Columbus Ave., Boston, Mass.

Make Your \$1.49 Go Farther**Hair Clippers**

\$1.49

SAVE barbers' bills. You can cut hair, so everyone will think the barber did it. Three hair cuts and you've paid for these clippers. Finest American make neck shaver. Cuts very close, select-tool steel blades highly tempered.

Light weight, full polished and nickel plated. Exactly the same clipper sold almost everywhere for \$2.50, sometimes more. No. 10 P. M. Size 00 Hair Clippers, postage prepaid..... **\$1.49**

\$1.98 Focusing Flash Light

\$1.98

At last, a flash light which you can focus to any way desired. Throws a long light for distance or big broad light for close up. Well made ribbed fibre case, nickel ends, Mazda bulb with concentrated filament. Regular \$2.75 value. No. 11 P. M. Flash Light, postage paid..... **\$1.98**

Six Tools For \$1.69

Postage Paid

Heavy Rosewood Handle equipped with finely tempered knife. Each tool can be locked solidly in end of handle. Complete set consists of tool holder handle, punch $\frac{1}{8}$ " chisel, screw driver, combination file and screw driver and saw blade. These are all tempered and made for real service. Attractive genuine leather case. Just fits the hip pocket. Would be a wonderful value at \$3.00. No. 12 P. M. Tool Set, postage prepaid..... **\$1.69**

You can now buy from us by mail at the same low prices you would pay in our stores. Our guarantee is your protection.

Perfect Satisfaction or Money Refunded

SELL SELF SYSTEM

849-851 Washington Blvd., CHICAGO, ILL.

RADIO PARTS

At wholesale prices.
Send for price list.

SYPHER MFG. CO., TOLEDO, OHIO

THE TRINITY LOUD SPEAKER

The only device of its kind in the radio field.

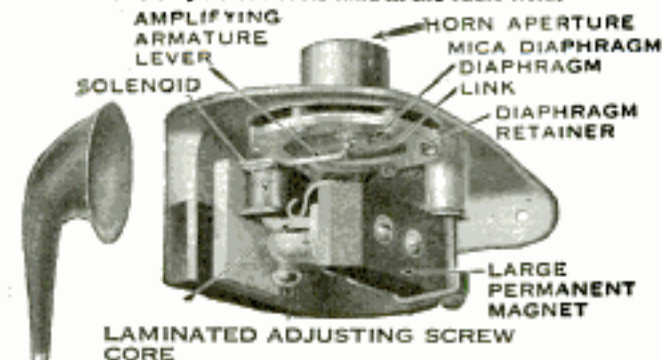

TYPE B \$12.50

Study the illustration carefully and you will understand why it produces full, clear natural tones with perfect reproduction of all vocal and instrumental music. May be used with phonograph or built into your set.

TRINITY RADIO CORPORATION
168 DARTMOUTH ST., BOSTON, MASS.

Type A1, \$25.00
21" Fibre Horn

BOYS

Learn

ELECTRICITY

There is a wonderful opportunity right now for boys who like electricity. Boys who are ambitious and will train themselves in spare time can step into positions just as soon as they are ready. Good salaries are offered to start with splendid chances for rapid promotion.

For 31 years the International Correspondence Schools have been training boys for success in electricity and over 300 other subjects. They will help you prepare right at home for a position in the line of electrical work you like best—or in any other work that appeals to you. Thousands of boys, through I. C. S. training, have stepped into fine jobs, but never were opportunities so great as now.

Let the I. C. S. help you. Choose the work you like best in the coupon below, then mark and mail it today. This doesn't obligate you in the least, and it will bring you information that may start you on a successful career. This is your chance. Don't let it slip by. Mark and mail this coupon now.

----- TEAR OUT HERE -----
INTERNATIONAL CORRESPONDENCE SCHOOLS
Box 5241-D, Scranton, Penna.

Without cost or obligation, please tell me how I can qualify for the position or in the subject before which I have marked an X:

BUSINESS TRAINING COURSES

- | | |
|---|---|
| <input type="checkbox"/> Business Management | <input type="checkbox"/> Salesmanship |
| <input type="checkbox"/> Industrial Management | <input type="checkbox"/> Advertising |
| <input type="checkbox"/> Personnel Organization | <input type="checkbox"/> Better Letters |
| <input type="checkbox"/> Traffic Management | <input type="checkbox"/> Foreign Trade |
| <input type="checkbox"/> Business Law | <input type="checkbox"/> Stenography and Typing |
| <input type="checkbox"/> Banking and Banking Law | <input type="checkbox"/> Business English |
| <input type="checkbox"/> Accountancy (including C.P.A.) | <input type="checkbox"/> Civil Service |
| <input type="checkbox"/> Nicholson Cost Accounting | <input type="checkbox"/> Railway Mail Clerk |
| <input type="checkbox"/> Bookkeeping | <input type="checkbox"/> Common School Subjects |
| <input type="checkbox"/> Private Secretary | <input type="checkbox"/> High School Subjects |
| <input type="checkbox"/> Business Spanish | <input type="checkbox"/> Illustrating |
| <input type="checkbox"/> | <input type="checkbox"/> Cartoning |
| <input type="checkbox"/> | <input type="checkbox"/> French |

TECHNICAL AND INDUSTRIAL COURSES

- | | |
|---|--|
| <input type="checkbox"/> Electrical Engineering | <input type="checkbox"/> Architect |
| <input type="checkbox"/> Electric Lighting | <input type="checkbox"/> Blue Print Reading |
| <input type="checkbox"/> Mechanical Engineer | <input type="checkbox"/> Contractor and Builder |
| <input type="checkbox"/> Mechanical Draftsman | <input type="checkbox"/> Architectural Draftsman |
| <input type="checkbox"/> Machine Shop Practice | <input type="checkbox"/> Concrete Builder |
| <input type="checkbox"/> Railroad Positions | <input type="checkbox"/> Structural Engineer |
| <input type="checkbox"/> Gas Engine Operating | <input type="checkbox"/> Plumbing and Heating |
| <input type="checkbox"/> Civil Engineer | <input type="checkbox"/> Chemistry |
| <input type="checkbox"/> Surveying and Mapping | <input type="checkbox"/> Automobile Work |
| <input type="checkbox"/> Metallurgy | <input type="checkbox"/> Navigation |
| <input type="checkbox"/> Steam Engineering | <input type="checkbox"/> Agriculture and Poultry |
| <input type="checkbox"/> Radio | <input type="checkbox"/> Mathematics |
| <input type="checkbox"/> | <input type="checkbox"/> Airplane Engines |

Name.....
Street.....
Address.....
City..... State.....

Occupation.....
Persons residing in Canada should send this coupon to the International Correspondence Schools Canadian, Limited, Montreal, Canada.

Please Mention Popular Mechanics

TRADE MARK REG.
WURLITZER
SUPREMACY IN MUSICAL INSTRUMENTS

Try It In Your Own Home

You may now have any known musical instrument for a week's free trial in your own home. Play it as much as you wish. See how easy it is to learn. There is no obligation to buy—no expense for the trial. You may return the instrument at the end of a week if you decide not to keep it.

Wurlitzer instruments are known the world over for unusual tone quality and excellence of workmanship. They are used by the greatest musicians, bands, and orchestras.

Easy Payments

If you decide to buy, the Wurlitzer plan makes it easy for you to own the instrument you want. Payments are conveniently arranged in small monthly sums—a few cents a day will pay.

Special combination offers on complete outfits—velvet lined case, all accessories, self-instructor, etc.—everything you need at practically the cost of the instrument alone.

Send For Free Catalog

The greatest musical catalog ever published—over 3000 articles—every known instrument described and illustrated—many of them shown in full colors. Gives you lowest prices and all details of the Wurlitzer plan.

Send This Coupon

The Rudolph Wurlitzer Co., Dept. 1776
117 E. 4th St., Cincinnati 329 So. Wabash Ave., Chicago
120 W. 42nd St., New York 250 Stockton St., San Francisco

Send me, absolutely free, your new illustrated catalog of musical instruments. Also tell me how I may try any instrument in my own home at your expense, and how the Wurlitzer plan makes it easy for me to buy. No obligation.

Name

Address

City.....State.....

Instrument

(State instrument in which you are interested.)

Copyright 1923, The Rudolph Wurlitzer Co.



"Red Devil" Rapid Boring Auger Bits are 33 $\frac{1}{3}$ % easier boring, have 10% greater clearance, and bore with or against the grain of any wood. Style 2400—10/16 in., shown here, 75c.

Red Devil

REG. U.S. PAT. OFF.

Hack Saw Blades Cut Faster—Last Longer

"RED DEVIL" Tungsten steel Hack Saw Blades are designed for hard work and long wear.

The sharp, milled teeth are carefully, evenly set at just the right pitch to give a smooth, easy, rapid cut no wider than is necessary.

"Red Devil" Tungsten steel Blades have hardened teeth and flexible backs, giving you the advantage of an all hard blade without the danger of breaking. They bite into the hardest metals—make difficult cutting jobs easy.

"Red Devil" Hack Saw Frames work best with "Red Devil" Blades. Be sure the blades and frames you buy are stamped "Red Devil."

"Red Devil" Hack Saw Blades are on sale at all good hardware stores. If not in stock, send dealer's name, and 75c for 1 dozen Red Devil Hack Saw Blades, No. 1239—10-inch size.



SMITH & HEMENWAY CO., Inc.

Manufacturers of "Red Devil" Tools
260 Broadway New York, N. Y.

"Red Devil" Glass Cutters—the glaziers' standard tools of the world. "It's all in the wheel." Made in 40 styles. No. 024 shown here, 20c.



Please Mention Popular Mechanics

From Oliver Factory

\$44⁵⁰

**New
3-Bank
Standard
Keyboard**

The greatest typewriter value ever heard of! The real Oliver No. 9 model—remade, renewed, readjusted—at a *fraction* of the price for *any* new standard machine!

This is the typewriter so many large corporations have adopted exclusively on its efficiency record; speedy, almost *indestructible*, and lowest first-cost. Does the most letter-perfect work known. Standard three-bank keyboard; has every convenience and short-cut the typist can name. A *beautifully* made and finished machine.

A Guaranteed Typewriter at a Bargain Price

These are all factory remakes; not a worn part used. Built, adjusted and tested by the same men producing all Olivers. They carry the same factory *guarantee*! The enormous demand for newest Oliver models makes this astounding offer possible. Costs you less than to try and do with an old, worn machine that has merely been tinkered and cleaned!

SAVE \$50 Before buying any typewriter, large or small, users should investigate this exchange Model 9 Oliver at \$44.50! Sold on small monthly payments, too. *Mail us coupon.*

**Genuine
Re-Made
Model
Nine**

**Easy
Terms**

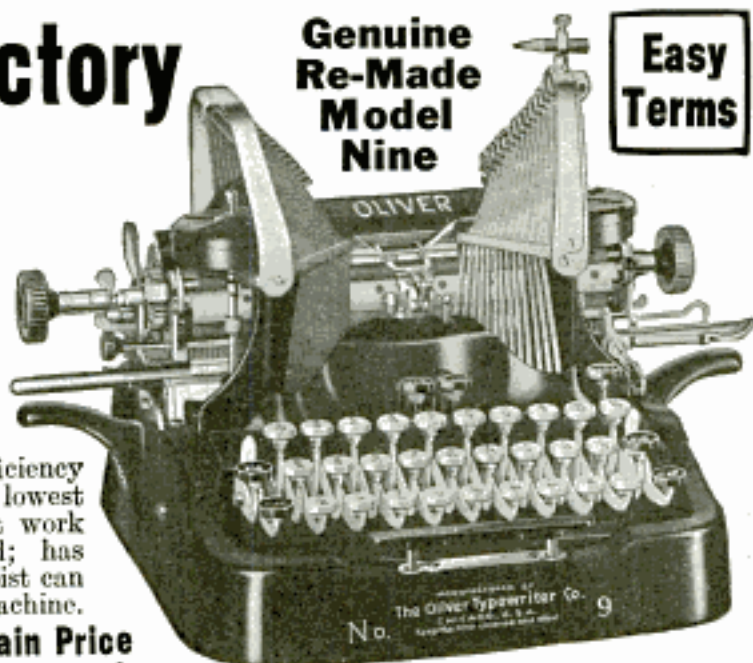

SPECIAL OFFER COUPON

OLIVER TYPEWRITER COMPANY

(Rebuilt Machine Dept.)

109-C Oliver Typewriter Bldg., Chicago

Please send FREE and without obligation complete information on rebuilt standard Oliver typewriters, and tell me how I may arrange for a free trial of the actual machine.

Name

Address

GREEN AUTOMATIC MACHINE



ADD TO YOUR INCOME

WITH LITTLE EFFORT
\$5 to \$10 A DAY MADE
EASY WITH

New Improved Green Automatic Machine

Sharpens, Honors and Strops all kinds of safety razor blades, in one operation, from four to six blades per minute. For both Quality and Quantity, this machine is in a class by itself. There is nothing like it on the market. Let us send you our descriptive literature explaining everything, including the "AMERICAN" Key Cutter—cuts square, angular or round slots.

AMERICAN SHARPENING MACHINE CO. (Inc.), Dept. 9, 114 W. Washington St., CHICAGO



AGENTS

For the Biggest Money-Making
Selling Proposition You Ever Saw

See Pages 60 & 61

Ford Car Goes 66 Miles on One Gallon Gas

Other makes do equally as well. Wonderful Vapor Humidifier. One FREE to Car Owner to introduce. Give make, Walter Critchlow, Suite 341, 716 Madison, Chicago.

Miracle
Tooth Beautifier

25¢

For 100 Guaranteed Years
For Four Corners and Beyond
MIRACLE TOOTH BEAUTIFIER
is the most effective tooth
whitener ever made. It is
safe, pleasant, and does
not harm the teeth in any
manner.

For More After-Care
Remember to Buy
MIRACLE TOOTH BEAUTIFIER
with every bottle of
Tooth Beautifier.
It is the only product
of its kind, and is
the most effective
tooth whitener
ever made.

New Easy Way to Make Money Fast

**Make \$75.00 to \$150.00 A Week.
All Time or Spare Time**

MIRACLE TOOTH BEAUTIFIER amazes nation. Makes yellow, discolored, or tobacco-stained teeth as white as snow. Eliminates tartar. Just a clear liquid, absolutely harmless. Teeth shine and glisten like polished ivory. Everybody wants MIRACLE TOOTH BEAUTIFIER. Recommend it to their friends. Not an ordinary tooth paste or powder. It's a new scientific discovery. Nothing else like it. Sells like hot-cakes.

\$50 to \$200 Weekly Easily Made

You don't need selling experience. You can make Big Money right from the start. All you have to do is place the cards and collect your profits. Territory going fast. Write today for complete details. Better still, mail \$1.50 for sample card. Don't delay.

MARCH PRODUCTS COMPANY
Dept. 24 2162 N. California Ave., CHICAGO, ILL.

**Just Place Card on Dealer's
Counter, Collect Once A Week**

All you have to do is place a card (containing 18 bottles) on the counter of drug, cigar and candy stores. Card brings in \$4.50. Dealer keeps \$1.50. Pays you \$3.00. You pay us \$1.50, making \$1.50 per card profit for yourself. Many stores sell first card in two hours. Drug-gists call it fastest seller in history.

Send \$1.50 for Sample Card

Place it on a druggist's counter. Watch it for a day or two. See how fast MIRACLE TOOTH BEAUTIFIER sells. Then grab your territory. If not satisfied, return card and we'll refund your \$1.50. Order several cards now if you want to get started quick.

ONLY \$2 DOWN

FAMOUS-21-JEWELLED ILLINOIS RAILROAD WATCH BUNN SPECIAL

**\$5.50
A Month**

PENN. TERMINAL



GRAND CENTRAL



We guarantee this watch to pass railroad inspection on any railroad in the United States. The requirements for passing railroad inspection are so severe that only the very finest watches can pass them. This watch is adjusted to six positions, although railroad requirements call for only five. A full description of the movement will be given if desired. Better still, order it on trial.



GUARANTEED 25 YEARS

This famous Bunn Special movement is put in a 25 year gold filled case that will wear like solid gold for more than 25 years. We guarantee it against any defect in material or workmanship. These movements are built to give a lifetime of satisfactory service just as the two famous Terminals pictured above were built to last for generations.

30 DAYS' TRIAL: 10 MONTHS TO PAY

You can test this watch in your own pocket for 30 days with the distinct understanding that if you return the watch we will return every penny you paid. Order it now or write for any additional information desired. Get our big catalog.

STERLING DIAMOND & WATCH CO.

Established in 1879

63 Park Row Dept. 1108 NEW YORK

STERLING DIAMOND & WATCH CO.

63 Park Row, Dept. 1108, New York.
Gentlemen: Please send the famous BUNN SPECIAL, 21 jewelled Illinois Watch, as described above, to me on 30 days free trial. I enclose \$2.00 deposit to show my good faith. If I am not satisfied and return the watch within 30 days, you will return my money. If I keep the watch I will pay you \$5.50 every month for ten months until the total price of \$57.50 is paid. Title to this watch remains with you until I have paid you in full. It is understood that you fully guarantee this watch to be as described. Please send your catalog.

YOUR

NAME _____

LOCAL

ADDRESS _____

CITY &

STATE _____

Please Mention Popular Mechanics

ONLY \$1.80

for this strength-tested, pocket-size, 3-blade screwdriver.

SIMORE LIGHTNING CHANGE SCREWDRIVER

Blades selected and produced by gravity, and they lock into position with just a turn of the knurled cap at the base of the blade. When finished a thumb's touch releases the blade which disappears instantly into the handle.

CHANGES BLADES Instantly—Automatically
No loose blade, no lost blades, always ready for use. Once you try it—you won't be without it. SEND NOW money order or check for \$1.80.

The Simon & Skidmore Mfg. Co.
Dept. 49 Santa Ana, Calif.



Guaranteed satisfaction or money refunded

GREAT
2 IN 1
LAMP

A FLOOD OF LIGHT Indoors or Out

This great 2-in-1 (lamp and lantern) solves the lighting problem for millions who want a light brighter than gas or electricity. Requires no wiring or piping. Lights with matches. Smokeless, compact, handsomely nicked. Durable, economical — burns 97% air.

Remove
Shade for
Outdoor
Use
—
300
Candle
Power
—



AGENTS—BIG MONEY

QUICK There's a way that brings quick and certain sales of this brilliant combination Handy-Lite. It's building profitable business for our agents in spare time.

Write for supreme selling secret and attractive agency proposition
ENTERPRISE TOOL AND METAL WORKS, Dept. 39
2441-9 No. Western Ave. Chicago, Ill.

Burns 97% Air

Build Your Own PHONOGRAPH

IT'S EASY WITH OUR HELP

A few hours' interesting work saves over half and gives you a machine to suit your ideas. We furnish motors, tone arms, case material, blue prints and full instructions. Plays any record. Make fine profit building phonographs for your friends.

Write today for our **FREE** Blue print offer.

GET YOUR **RADIO SUPPLIES** FROM US

Choraleon Phonograph & Radio Co.
923 1st St., Elkhart, Ind.



SAVE
OVER
HALF

\$75.00 CASH WEEKLY also Guaranteed Salary

A sure income; pleasant, easy work, demonstrating Violet Rays. Experience not essential; the demonstration makes the sale for you. Many buy on sight; this marvelous, scientific device brings health, happiness and beauty to all. Endorsed by leading doctors, specialists and plain folks.

Men and Women

earn big money, spare time or all time. We guarantee salary to experienced producers. Commissions very liberal, paid in cash. We deliver and collect. Exclusive territory to workers. A push-over for quick money, steady income.

VI-REX CO. 326 W. Madison - Chicago
Dept. W-9

\$215 In One Day

Salesmen Reporting Biggest Sales They Ever Made on Amazing New Invention Everyone Wants

HERE'S an amazing new invention that is banishing forever the muss, dirt and drudgery of coal and wood fires—saving housewives from roasting kitchens in Summer, giving ready heat in uncertain Fall weather and three times the heat of coal in Winter. Set it in any fire-box of any coal range. Presto! In one minute you have an actual gas stove. Then just the turn of a valve gives as much or little heat as needed.

No Experience Needed for Big Money

Besides its other points the Oliver burns 95% air and 5% oil, the cheapest fuel there is. With everybody raving about the price of coal and the probable shortage, sales of Oliver Burners are breaking all records. You don't need to be a high powered salesman to make money on a proposition like this. The Oliver's amazing features sell it for you.

Now you know why W. H. Drew of Michigan made \$85.00 in one day; why L. Zueher of Ohio made \$21.50 in three hours; why A. M. Russell of Connecticut has averaged \$660.00 for the last 6 months; why one order sent by P. M. Ford of Iowa gave him a profit of \$846.25.

Quick Sales—Big Profits

Every agent we appoint makes big money. You, can too. We have a number of definite territories which we are ready to dispose of to those who act quickly.

Coupon Brings Full Offer

Mail this coupon now for our offer. We are not making any extravagant claims about this. We don't have to. We want to give you the facts. Writing will not obligate you in any way. But hurry. Send the coupon at once if you want to get in on this big money, whirlwind all-season seller.

OLIVER OIL-GAS BURNER & MACHINE CO.
2048-U Oliver Bldg. ST. LOUIS, MO.

BLANK CARTRIDGE PISTOL

Protection
Against
Burglars,
Tramps,
and Dogs



PRICES
50c
\$1.00
Post-paid

Well made and effective; modelled on latest type of Revolver; appearance alone is enough to scare a burglar. When loaded it may be as effective as a real revolver without danger to life. It takes standard .22 Cal. Blank Cartridges obtainable everywhere. Price 50c. Superior quality \$1.00 postpaid. Blank Cartridges, by express, 50c per 100. Johnson Smith & Co., 1218 Washington Ave., Dept. 950, Racine, Wis.

JOY—ADVENTURE—ROMANCE

LINGER NO LONGER



BY THE
FIRESIDE

8-16
Overhead Valves
Selective Transmissions

Sport Fenders Underlung
Sport Fenders for
Standard Fords

You must seek them out in the City's White Lights; under the Country's Blue Sky; by the Rippling, Murmuring Waters. Get Busy! Buy a Ford and equip it with a Beautiful FORD-SPEED Sport Body and find the road to Happiness. We offer nine smart models to choose from \$29.00 up. Full line Racing Specialties to help you go faster. Free Catalog.

This Month's Specials

	Price	Now		Price	Now
Discs, set of 5, flat	\$12.00	\$ 5.95	Underlung Fictures	\$12.50	\$ 9.95
Force Feed Pump Older		2.50	Warm Steering Gear	30.00	16.00
Power & Speed Camshaft	10.00	11.95	Crank Case Motor Arm		
3 1/2 or 2 1/2 Gears	12.50	6.50	Support	6.00	2.95

SATISFACTION OR MONEY BACK guarantee, 50% with order, balance on delivery
D. A. FORD SPEED & POWER EQUIPMENT MFRS., 250 West 54th St., New York

Salesmen are Making Fortunes

"Am making \$1000 per month. I have made big money before but did not expect so much. Your Burner is just the thing."
J. Carnegie, S. D.

"Am sending today for 7 Oliver's. This is one day's orders (\$85 profit). Selling like beer in a dry town."
W. H. Drew, Mich.

"Send following weekly hereafter: 10 No. 1; 8 No. 2; 4 No. 5." Berger's Weekly Profit on order, \$258.50.

R. Berger, Ont.
"I made \$43 last night selling Oliver Burners."
N. B., Chelan, Wash.



F. W. Bentley of Phila., says: "Ye Gods—some seller! I made \$215 today!"

Oliver Oil-Gas Burner & Machine Co.,
2048-U Oliver Bldg., St. Louis, Mo.

Please send me full facts about how I can make big money representing you in my territory. Also your plan, if I wish to make big money in my spare time.

Name.....

Address.....

City.....State.....

CAR OWNERS SAVE MONEY — Make Big Profits!



FOR ALL SIZES

Cut your own tire bills—and make good money selling National Tirefiller to others. A proven success for 12 years. Eliminates tubes, punctures and blowouts. Increases tire mileage 30 to 50% and still outwears several casings. Easily inserted; easy riding. Over 300,000 enthusiastic users. Big sales possibilities. Some good territory still open. Driver agents make good profits. Mail coupon today for proposition.

National Rubber Filler Co.,
232 College St., Midlothian, Texas.

Please send me your agent's proposition and full information on National Tirefiller.

Name.....

Address.....

MAIL
THIS
Now

Saxophone Book FREE

Every music lover should send for a copy of this interesting book on the history and development of the Saxophone.

It tells which Saxophone takes violin, cello and bass parts, and many other things you would like to know. Also illustrates first lesson. Send coupon for your free copy.

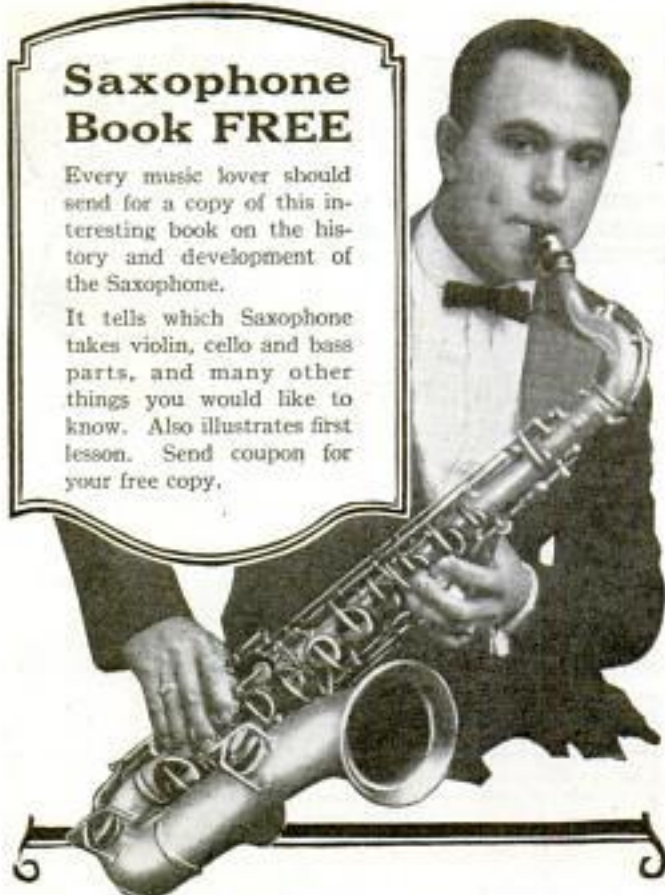

Saxophone Players in Big Demand

For Bands and Orchestras, for church, lodge and school musical affairs, for social and home entertainment, the Saxophone is the most popular instrument and one of the most beautiful. A good Saxophone player is always popular socially and enjoys many opportunities to earn money. Saxophone players are always in demand for dance orchestras. Every town should have a Saxophone quartette or orchestra.

BUESCHER Saxophone

Easiest of all wind instruments to play and one of the most beautiful. With the aid of the first three lessons, which are sent free (upon request) with each new Saxophone, the scale can be mastered in an hour; in a few weeks you can be playing popular music. Practice is a pleasure because you learn so quickly. You can take your place in a band within 90 days, if you so desire.

Free Trial—Easy Payments

You may have six days' free trial of any Buescher Grand Saxophone, Cornet, Trumpet, Trombone or other instrument. Easy terms of payment can be arranged. Mention the instrument interested in and a complete catalogue will be mailed to you free. (95)

Buescher Band Instrument Co.

Everything in Band and Orchestra Instruments

2595 Buescher Block Elkhart, Indiana

Buescher Band Instrument Co.
2595 Buescher Block, Elkhart, Ind.

Gentlemen: I am interested in the instrument checked below:
Saxophone.....Cornet.....Trombone.....Trumpet.....
(Mention any other instrument interested in)

Name.....

Street Address.....

Town.....State.....

Please Mention Popular Mechanics

Free!

Get My New Book of Factory Prices

ON
FURNACES,
STOVES and RANGES

Let me show you how to save \$40 to \$200 on the finest quality pipe or pipeless furnace ever made. Sold direct to you at **Factory Prices—\$59.95 and up.** Easy to install. Easy payments. Quick shipments. Safe delivery. 300 days' approval test. More than 600,000 pleased customers. Mail a postal or letter today—get my new Factory to Family Bargain Book—FREE.



A Kalamazoo Direct to You

W. S. Dewing
"The Direct-to-You Man"
KALAMAZOO STOVE
COMPANY

391 W. Rochester Ave.
Kalamazoo, Mich.



Automobile Repairshop Short Cuts

Over 1500 time and labor-saving kinks, methods and devices from more than 1000 of the best garages, service stations and repairshops in the U. S., covering engine, clutch, gearset, running gear and body repairs. 256 Pages, 9x12, 1500 Figs. Cloth. Price, \$3.50 postpaid.

POPULAR MECHANICS BOOK DEPARTMENT
200 E. Ontario Street, Chicago

Popular Mechanics Books

Each one of the following books has been published by Popular Mechanics and is characterized by the same careful editing and authoritative presentation of the subject matter as is the magazine itself. All are unusually good values for the prices asked.

THE BOY MECHANIC—Book One 480 Pages—700 Articles—800 Illustrations.....	\$2.00
THE BOY MECHANIC—Book Two 480 Pages—1000 Articles—905 Illustrations.....	2.00
THE BOY MECHANIC—Book Three 480 Pages—800 Articles—802 Illustrations.....	2.00
MISSION FURNITURE, HOW TO MAKE IT, Part 1 128 Pages—30 Designs, Illustrated.....	.50
MISSION FURNITURE, HOW TO MAKE IT, Part 2 128 Pages—32 Designs, Illustrated.....	.50
MISSION FURNITURE, HOW TO MAKE IT, Part 3 128 Pages—36 Designs, Illustrated.....	.50
WOOD-WORKING FOR AMATEUR CRAFTSMEN 128 Pages—125 Illustrations.....	.50
ARTS-CRAFTS LAMPS, HOW TO MAKE THEM 96 Pages—16 Designs, Illustrated.....	.50
LAMPS AND SHADES IN METAL AND ART GLASS 128 Pages—18 Designs—64 Illustrations.....	.50
METAL WORK AND ETCHING—96 Pages—Illustrated	.50
ELECTROPLATING—112 Pages—62 Illustrations...	.50
PRACTICAL COURSE IN MECHANICAL DRAWING 160 Pages—157 Drawings.....	.50
HEAT—128 Pages—Illustrated.....	.25
KINGDOM OF DUST—128 Pages—40 Illustrations..	.50
HOW TO MAKE DEVICES FOR OUTDOOR WINTER SPORTS—64 Pages—Illustrated.....	.25
SHOP NOTES FOR 1923 224 Pages—544 Articles—436 Illustrations.....	.50
SHOP NOTES SET—15 Vols.....	7.50
CONCRETE HANDBOOK 96 Pages—173 Articles—138 Illustrations.....	.50
PATTERN MAKING—224 Pages—312 Illustrations...	1.00
POWER GAS AND THE GAS PRODUCER 192 Pages—Illustrated.....	1.00

Above prices are postpaid

POPULAR MECHANICS BOOK DEPT.
200 East Ontario Street CHICAGO, ILL.

NEW!



Every Man Likes To See—Every Man Wants
A KRISS KROSS STROPPER
 UNDER OUR
NEW SALES PLAN

Selling is 100% easier and you may

MAKE \$2 to \$500 or More

From One Small Sale, Without Any Further Effort on Your Part

*Strops All Safety Razor Blades
 Diagonally Just Like the Barber.*

**Distributors looking for
 Opportunity, Write
 M. H. RHODES, Pres.**

HERE AT LAST IS A REAL SHAVING COMFORT

Just show a Kriss Kross Stropper to any man. He will instantly reach for it. He can't help wanting to operate it. The way the blade automatically raises and reverses itself—bringing the other side to the leather, appeals to the mechanical instinct of all men and causes them to "sit up and take notice." Every man wants the Kriss Kross on sight because he instantly knows it is the first stropper ever made that has the right principle in stropping—the barber's diagonal stroke and adjustable pressure for dull or sharp blades. Our men have already established records of five sales in four minutes on one canvass, to 33 sales in one day. As this Adv. was being written we received a letter from an auditor who contracted to put in part time. He wrote: "Enclosed you will find eight orders taken today, my first trial, in less than 15 minutes."

Instead of frowning they smile. Many exclaim: "What'll they get up next!" You'll enjoy selling it! One salesman wrote: "The man who can't sell it can't sell anything."

No experience or capital necessary to start your own business. This is your chance to get into something really big. Millions of people have been sold safety razors and they need a stropper. You have practically no competition. Page 253 Popular Mechanics, August issue, is one of many things now coming out to help the stropper business. Our 4500-word Sales Manual tells you all about how to sell Kriss Kross. We can't give you full details of our NEW SELLING PLAN and how you may make \$2 to \$500 or more from one small sale, but just write us and we'll give you full details. We'll send a stropper with sample outfit for remittance of \$2.50 with your inquiry from this Adv.

RHODES MFG. CO.

4230 Cozzens Avenue

ST. LOUIS, MO.

Summer Home in Maine

A gentleman's estate of 175 acres on the Maine coast, with frontage on a lake 9 miles long; master's house; large bungalow; caretaker's house; large garage; barns; private electric light and inexhaustible water works, and every modern improvement. Forty acres very large trees. Golf and yacht clubs only a few minutes away; good markets in the town.

The scenery of mountains, lake and ocean is pronounced one of the best five in New England. House and bungalow both completely furnished; steam heat.

Place will be sold at a great bargain as owner can no longer use it.

Address OWNER

206 East Ontario Street. CHICAGO, ILL.

A New Book on Concrete For the Home, Farm and Factory

Describing 173 Ways of Using Concrete. Full directions for doing these things yourself with ordinary tools—138 Illustrations.

POPULAR MECHANICS'

CONCRETE

HANDBOOK NUMBER ONE

At the very outset it should be understood that while this book contains much that is of interest to the professional concrete worker, the clear directions and great variety of work covered make it especially suited to the needs of the amateur.

Shows you how to make such things as

Concrete Fence Posts on the Farm	Concrete Garden Furniture
Cheap Concrete Miner	(5 articles)
Concrete Forge	Concrete Tile
Concrete Boat Landings and Docks	Concrete Sidewalk Flagging
Garden Seats of Concrete	Horse Stalls of Concrete
Molds for Making Concrete Blks.	Concrete Block Milk House
Watering-Troughs in Concrete	Sanitary Drinking Fountain
Forms for Concrete Gate Posts	Concrete Curbs and Gutters
Rural Mail Box Post	Faultless Concrete Sidewalks

And practically any other requirement in concrete.

PRICE FIFTY CENTS POSTPAID

Popular Mechanics Book Dept.
 200 East Ontario Street, CHICAGO

\$5000⁰⁰— Agents to call on Established Trade
Big Profits—Permanent Business

**And a
 Business
 of your
 own**

**AGENTS-SALESMEN! OLD TIMERS OR NEW BEGINNERS!
 FULL TIME OR PART TIME WORKERS!**

We have a proposition to offer that puts you in a permanent—growing business of your own where your profits are limited only by the time and effort you give to it. Full time workers who sell our complete line of men's made-to-order suits and overcoats—Raincoats and Boys' clothes make \$5000 a year easy.

Double Sales—Double Profits The greatest line of men's made-to-measure suits and overcoats in America. Fine foreign and domestic fabrics—lowest prices \$23.50 — \$26.50 — \$29.50 RETAIL. Boys' suits with two pair of pants—\$8.45 to \$14.75. Prices always 20% to 30% less than local stores. Sales easy to make—every man—every boy buys on sight. You make double profit because every man who buys a suit or overcoat will buy one for his boy also.

**Sell Men's made to Measure Clothes
 — Boys' Suits too!**

COMPLETE SAMPLE OUTFIT FREE

We furnish complete sample outfit of 160 finest styles for men—more than 50 styles for boys. Neat carrying case and everything needed — to make full success you do not invest one penny in merchandise—you have a larger stock of goods to sell from than any store in town and lower prices. Folks buy quick, the minute you show them your complete line and low prices.



Advance Profits

You get your profit the minute you make your sale. Customer pays you a deposit with order—you put this in your pocket—it's your profit—you send us the order—we ship goods to your customer c. o. d. for wholesale price—you have no deliveries to make—no collection and your profits are from \$4.00 to \$10.00 on every sale.

UNLIMITED FIELD—CUSTOMERS WAITING

Every man and every boy in your locality is a live prospect for a suit or overcoat. You sell them easy when you have our complete line because we sell real men's \$45.00 suits for \$29.50—boys' suits that retail everywhere for \$15.00 we sell for \$8.45. We have been in business since 1885—more than 37 years and have thousands of satisfied customers who are waiting for our representatives to call on them.

Do You Measure Up?

We want \$5000.00 a year men to take hold of our proposition. Men who stand for honesty and integrity in their community. Hard hitting men—the kind who want a permanent ever growing business of their own. To such men we offer the chance of a lifetime. Unlimited field for sales and profits—old customers waiting to buy—our active help in getting new customers—the highest grade of goods and service. No experience is necessary—we teach you every step—full instructions are included in our selling outfits.

Now Is The Time To Line Up

Our Fall and Winter sample outfits are ready. Orders are being taken every day by our present representatives —profits being made—customers writing us to have our representatives call to see them. Every day's delay means profit lost to you and the possibility that the territory you want may be taken. Write us today for more information and a copy of our free booklet "The Secret Memorandum Book."

WRIGHT & CO., Dept. A101, Congress, Throop and Harrison Sts., CHICAGO, ILL.



BRILLIANT SEARCH LIGHT

HUNTERS, FARMERS AND MECHANICS' Powerful Carbide Head Light, Bull's Eye Type, Long Range. Illustrated Catalog on request.
 BRILLIANT SEARCH LIGHT MFG. CO., 509 South Dearborn Street, Dept. P, CHICAGO, ILL.

FREE Book of Newest Styles just out. Women's, men's, children's clothing on credit and at bargain prices, less than cash prices everywhere. Very latest fashions; best materials. Open a charge account with us. Buy on credit and save money! Dress in newest styles. Send for Style Book absolutely FREE today! Elmer Richards Co., Dept. 1775, W. 35th Street, Chicago



Are You Reaching for the Truth?

**I will tell you
 FREE**

Under which Zodiac Sign were you born? What are your opportunities in life, your future prospects, happiness in marriage, friends, enemies, success in all undertakings and many other vital questions as indicated by ASTROLOGY, the most ancient and interesting science of history?

Were you born under a lucky star? I will tell you free, the most interesting astrological interpretation of the Zodiac Sign you were born under.

Simply send me the exact date of your birth in your own handwriting. To cover cost of this notice and postage, enclose ten cents in any form and your exact name and address. Your astrological interpretation will be written in plain language and sent to you securely sealed and postpaid. A great surprise awaits you!

**Do not fail to send Birthdate and to enclose 10c.
 Print name and address to avoid delay in mailing.**

Write now — TODAY — to the

ASTA STUDIO, 309 Fifth Ave., Dept. 138, New York



WIDWEB

Quality First

How Did Your Garters Look This Morning?

Hurried on in the morning—tossed off at night—your garters are perhaps not so carefully scrutinized as are other articles of apparel. Keep them fresh and lively—the added comfort will repay you. Try "Wideweb" Bostons.

George Frost Company, Makers, Boston

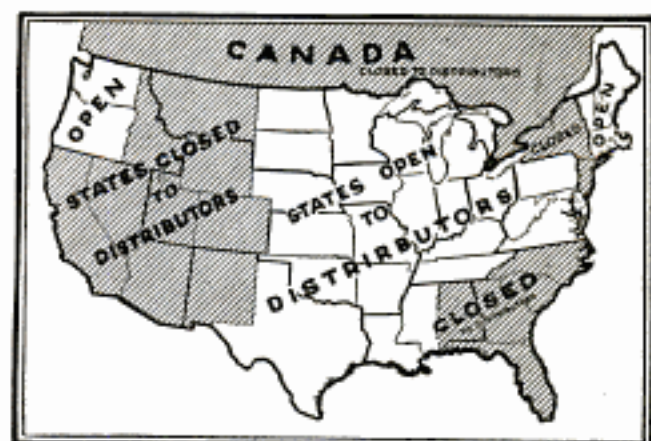

\$10,000 to \$25,000 Yearly to Distributors

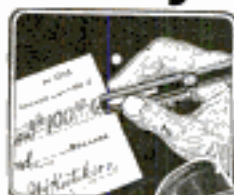

Selling famous Security Check Protecting Fountain Pen. Opportunities available in states not shaded on the map.

A new distributor started with an order of 1000 pens, "that will last me a month," he said. Ten days later he wired, "Send 1500 more quick!" Two weeks after that he wired again for 2000. His first month's profit was \$4,500.

Agents Make \$5,000 A YEAR

A dozen pens often sold in a single office in a half-hour. A hundred customers in a single office building. Nine men out of ten buy. Not sold in stores. Side line men make \$20 to \$35 a week. Full time men make \$50 to \$100 a week. Tell us territory you wish—we will put you in touch with Distributor.

HOW IT OPERATES

\$16,000 was lost last year on "ruined" checks—made out "Away from the office". \$37,000,000 was lost or stolen on lost checks cashed through changing payee's name to "bearer" or "cash". The Security Check Protecting Fountain Pen prevents both kinds of loss. The revolving steel cutting wheel, concealed in cap, scores amount, name, date, number, memoranda, etc. and fills the cuts with acid-proof red ink. Defies crooks. Gives more complete protection than expensive machines.

PRICES according to sizes:

No. 300	\$3.50
No. 400	4.00
No. 600	5.00
No. 800	7.00

(No. 800 is red and black)

SECURITY PEN CORPORATION

Formerly Kritikson Bros., Inc.

Dept. 69 910 W. Jackson Blvd., Chicago

Security Pen Corporation

Dept. 69, 910 W. Jackson Blvd., Chicago, Ill.

Gentlemen: I am interested in your proposition from the standpoint of

Distributor

Agent

I enclose letter giving my past experience, references, etc. (Please give me complete information without obligation on my part.)

NOTE: If you wish to see the Security Pen before taking further action, send check or money order and specify the pen wanted. A complete demonstrating outfit furnished free with sample pen.

Name.....

Address.....

City.....State.....

Please Mention Popular Mechanics

WE WANT AGENTS

to sell a new inner tube, invented by B. J. Milburn, of Chicago. Has been developed to a point where it is guaranteed to travel at least 10,000 miles without a puncture or blowout. Same price as other tubes. Has stood test in which 5,000 ten-penny nails have been driven into it, without loss of air. We want wide distribution by agents and offer a wonderful money-making proposition. See our ad also on page 158, August issue Popular Mechanics. Write B. J. MILBURN, 337 West 47th Street, CHICAGO, ILL.



JOIN This Free Association for Agents The Agents National Clearing Association

This is a free association for agents. It is formed to benefit every agent—to show him how to sell goods better and to place before him better goods to sell. Send for our free booklet, "AGENT SELLING," and take note of our ad on page 151 of the August issue of Popular Mechanics Magazine. If you wish to increase your earning power, get in touch with us at once.

Agents National Clearing Association
(Formerly Agents Co-operative Association.)
Dept. 9, 210 E. Ohio St. Chicago, Illinois

Our BUREAU OF INFORMATION will answer all questions regarding articles appearing in this magazine.

Address Bureau of Information, Popular Mechanics Magazine, Chicago

WIZARD VAPORATOR YOUR MOTOR NEEDS ONE Saves Money Three Ways

1. WIZARD VAPORATOR is Bunsen burner principle adapted to an internal combustion engine, which means CLEAN motor, CLEAN valves, CLEAN COMBUSTION and 1 to 4 Miles MORE ROAD WORK per gallon. It is Automatic and Noiseless.
2. REMOVES CARBON with kerosene and water—Flashes Cylinders and Valves of Running motor with STEAM, Blows Carbon Out harmlessly through exhaust. Saves motor—Saves repairs.
3. PRIMER: Starts balky motor quickly—Saves time, Saves the battery, Saves a broken arm or jaw. GO when you wish.

Don't argue—Get the Facts. Thousands "Sold"—Glad Users Everywhere. Easily put on ANY motor—Saves cost every few weeks. Complete Outfit with Carbon tube, Primer can and directions in handsome box.

Only \$4.00 Prepaid

General Agents and Representatives Wanted

all or part time. We treat you 100% O. K. Easy Work—Big Field—Your Own Boss—\$12 upwards daily—Get Busy—Write Quick.

WIZARD MANUFACTURING COMPANY, 453 Central Ave., Rochester, N. Y.



The tracks shown in the August issue were those of a chipmunk.

Can you guess the tracks in this issue? See if you can discover what animal made these tracks. The answer will appear in the October issue.



Stevens' "Favorite."
Retail price, inc. tax,
\$9.75. 24-inch take-
down. .22 long rifle,
.22 short, .25 Stevens
and .32 long rim-fire.
A favorite for three
generations.

No
guess work
here!

If you have the skill
your Stevens'll do
the work

ASK some boy in your
neighborhood who
owns a *Favorite* or
Visible Loading. He'll tell
what a Stevens can do.

Or better still—ask some man. Plenty of men in your town own a Stevens. Ask one. He's probably owned his Stevens for years, and it's certain that it's as sturdy and true as it was the day he bought it.

For a Stevens slings a bullet hard and dead true—and will keep on doing it for years.

It's the Stevens special process of reaming—the final boring cutting a depth of less than one thousandth of an inch.

The barrel is accurate—and it stays accurate.

You can afford a Stevens. Look at the price of the rifle shown here. Where can you beat this?

Ask at your dealer's or write direct for our interesting catalog.

J. STEVENS ARMS COMPANY
Dept. 542 CHICOPEE FALLS, MASS.

Owned and operated by the Savage Arms Corporation

Stevens

13th Edition A NEW AND GREATER DYKE'S AUTOMOBILE ENCYCLOPEDIA

Entirely rewritten—rearranged and new illustrations from beginning to end. Mr. Dyke devoted almost two years of constant application to rewriting this book. We are confident that you will agree with us that it is the best book in the world today on the automobile, truck and tractor.

A PRACTICAL BOOK ON THE AUTOMOBILE FOR EVERYBODY

Over 1,200 Pages. Over 4,100 Illustrations
Over 14,000 Lines of Index

This book teaches the underlying fundamental principles of each and every part of an automobile—mechanical and electrical—in a simplified manner, and that is why the largest auto schools are using it as a textbook. Auto owners, students and repair men say that it contains the greatest array of automobile facts ever published in one volume.

This book will teach you to become an expert automobile repairman and also an electrical expert. You will understand fundamental principles, diagnosing troubles, testing, adjusting and repairing. If you were to purchase separate books on the subjects covered the lot would cost about \$21.00. The price of Dyke's book is

Cloth Binding, \$6. }
Flexible American } Postpaid
Morocco, \$7.50 }

Complete table of contents mailed
free upon request

Popular Mechanics Book Dept.
200 E. Ontario St., Chicago



The Household Painter

Intended for the use of the Household, with Full Directions for Painting, Decorating, Papering, Calcimining, Whitewashing, Stenciling, Wood Finishing, Wood Staining, Varnishing, etc. Cloth binding, Illustrated.

Price \$1.25 Postpaid

POPULAR MECHANICS BOOK DEPARTMENT
200 E. Ontario Street, Chicago

The Essentials of Lettering

By
French and
Meiklejohn

is a book of practical usefulness. The instructions throughout aim at the snap and swing of professional drafting. 94 Pages. Size 9x6. 120 Illustrations of high grade. Price, \$1.50 postpaid.

POPULAR MECHANICS BOOK DEPARTMENT, 200 E. Ontario Street, CHICAGO

Mathematics Made Easy by ROPP'S CALCULATOR AND SHORT-CUT ARITHMETIC

Shows the Answer as Quickly as a Watch shows the Time to all Problems likely to occur in the Office, Store, Shop, Bank, Farm, or Factory.

Over 2,000,000 Sold



Explains and simplifies every principle in Arithmetic, Mechanics, and Mensuration.

PRICES
POSTPAID
Desk Size...\$1.50
Leatherette, Pocket Size...\$1.00
Pocket Size,
Cloth...\$0.50
Pocket Size,
Paper...\$0.35

Popular Mechanics Book Dept., 200 E. Ontario St., Chicago

GODELL-PRATT

1500 GOOD TOOLS

**“Let me bore a hole—
then you won't split the wood,”
says Mr. Punch**

“When you want to put in a screw, don't start it with a few sharp cracks of a hammer. You're sure to run into trouble. Let me bore a hole first. Then the screw will go in easily and neatly—and you won't split the wood.”

Mr. Punch, the Automatic Drill, is equipped with eight different size drill points, ranging from 1/16 to 11/64 inch. Just pick the size point you want—you'll find it in

the handle—fit the point into the chuck, and Mr. Punch bores the hole.

Any man who tinkers with tools will find Mr. Punch, the Automatic Drill, as necessary as a hammer and saw.

All exposed metal parts are polished, nickel plated, and buffed. Length, 10 inches; weight, 8 ounces.

Sold by good hardware stores everywhere. If your dealer hasn't it, write us.

Other good tools you should have

Among the 1500 Good Tools that Goodell-Pratt make are many that should be on your work bench now. You need them.

Write for Catalog No. 15, which illustrates and describes the entire line. It's filled with the kind of information every amateur mechanic needs.

GODELL-PRATT COMPANY, Greenfield, Mass., U. S. A.

Toolsmiths



**Mr. Punch—
the Automatic
Drill, No. 185
Price, \$2.50**

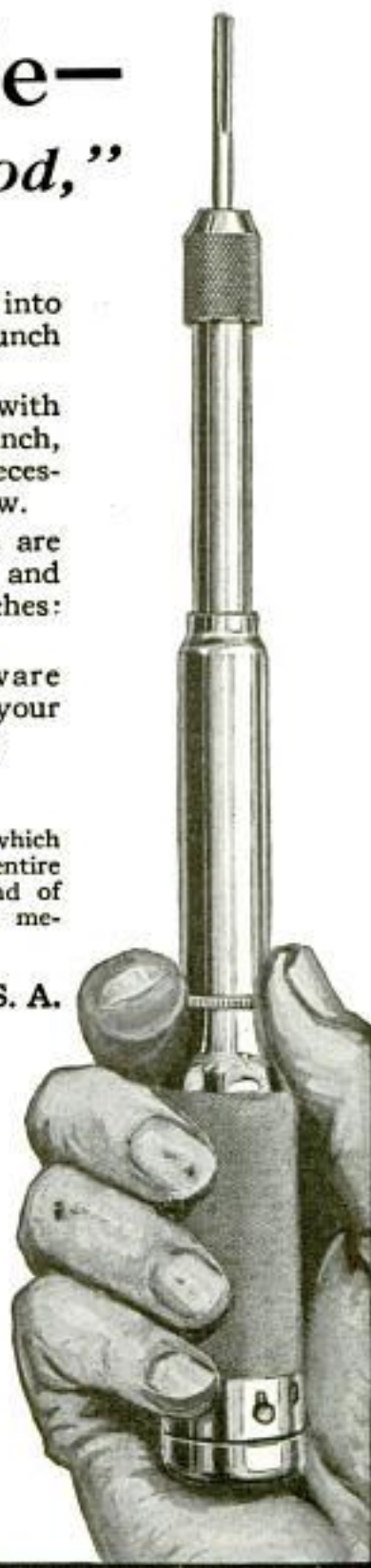

FROST-RADIO

THERE are a lot of good reasons why you should specifically ask for Frost-Radio when purchasing head fones, receiving transformers, tuning coils, plugs, jacks, jac-boxes, extension cords and microphones. One reason is that Frost-Radio offers you greater value for your money than any other line.



See Your Dealer

Your dealer knows Frost-Radio. Ask him about this famous line of apparatus. Have him show you the big Frost-Radio Receiving Transformer shown below, retailing for \$8.50. It is a finely

built piece of apparatus, with hardwood base and frame, mahogany finished. All metal parts are brass, nickel plated and hand buffed. Coils are silk-wire wound. Wonderfully selective. This and other Frost-Radio Apparatus is at your dealer's. See it today.

\$8⁵⁰

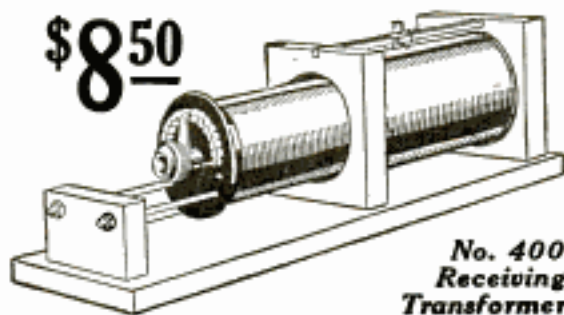

HERBERT H. FROST, Inc.

154 West Lake Street, Chicago
30 Church Street, New York

Please Mention Popular Mechanics

The Eztoon Dial



The necessity of fine tuning is recognized by every radio fan.

Here is a micrometer movement with a ratio of 40 to 1. It is two dials in one. The outer dial for finding the station, the center vernier dial tunes him in—clear and sharp—cutting out all interference.

When used on a condenser gives much closer tuning than a vernier plate. Attractive in appearance; it is easily attached to any variometer condenser, rheostat, variocoupler and tickler on all types of receivers. Fits either $\frac{1}{4}$ " or $\frac{3}{16}$ " shaft.

Sold Under Positive Guarantee
Shipped Parcel Post, C. O. D.

3 in. Dial, \$2.00; 4 in. Dial, \$2.25

Attractive discounts offered to recognized manufacturers, jobbers and dealers. Write today.

Butler Manufacturing Company
3234 W. Washington St., Indianapolis, Ind.

AGENTS: Make \$4,500

Next Few Months



\$15.00 a Day
Guaranteed for
Only Three
Sales a Day

Sell THURSTON OIL-GAS BURNERS

Sizes for any coal or wood Range, Heater, or Furnace. No changes to make in stove. Just set it in—Start it off. No tools needed to install. Use in any Worn Out or New Stove. Clean, intense, even blaze. Great for baking. Three times heat of coal at half the cost. No more coal or ashes to carry. No dirt, soot, or drudgery. Absolutely safe. \$15 a day a snap for hustlers. Popular price seller. Written guarantee. Sample free plan. Get yours free. Write.

Thurston Mfg. Co., 10 Dicky Bldg., Dayton, O.



MARVEL 8 Tires
ONLY PLY

GUARANTEED 10,000 MILES

IN WRITING!

Look at the section here's the only 8-ply tire at so low a price. More mileage built into these tires, so you will get 10,000 to 20,000 miles out of them on any kind of road. **No Money No Deposit** Sent to you for Free examination on request. **Written Guarantee** Send guarantee with every tire. Better than Standard makes, but only half price. **Brand New, direct from factory. Order today!**

SIZE	TIRE	TUBE
30x3 1/2	\$ 9.85	\$1.35
32x3 1/2	12.50	1.50
31x4	14.75	2.00
32x4	16.50	2.10
33x4	16.75	2.20
34x4	17.50	2.30
32x4 1/2	19.75	2.50
33x4 1/2	20.75	2.60
34x4 1/2	21.75	2.70
35x4 1/2	22.50	2.80
36x4 1/2	23.50	2.90
38x5	23.75	3.00
35x5 1/2	24.50	3.10

Pay on delivery plus express or parcel postage.
AMERICAN TIRE CO. 1461 So. Michigan Blvd.
Dept. P102 CHICAGO

NEED A BOOK

on some practical subject and ?
don't know where to find it ?

Popular Mechanics Book Department maintains a service you will appreciate.

Send to-day for our valuable free catalog listing over 500 books on the following subjects:

Agriculture	Glass	Photography
Architecture	Heating and Ven-tilation	Physics
Arts and Crafts	Hydraulics	Plumbing
Automobiles	Inventions	Poultry
Aviation	Iron and Steel	Printing
Blue Prints	Leather	Radio
Boats	Locomotives	Railways
Bookbinding	Machine Shop Practice	Refrigeration
Books for Boys	Masonry	Rope Work
Building	Mathematics	Rubber
Business	Mechanical Engi-neering	Sheet Metal Work
Carpentry	Mechanics	Sign Painting
Cement and Con-crete	Metallurgy	Soap Making
Ceramics	Millwrighting	Soldering
Chemistry	Mineralogy	Steam Engineering
Civil Engineering	Mining	Surveying
Cleaning	Model Making	Taxidermy
Compressed Air	Motion Pictures	Textiles
Dictionaries	Motorcycles	Toys
Drawing	Navigation	Tractors
Electricity	Paints and Paint-ing	Upholstering
Engraving	Pattern Making	Watch Repairing
Finger Prints	Patents	Water Power
Formulas	Photo-Engraving	Welding
Furniture Making		Windmills
Gas Engines		Wireless
Geology		Woodworking

If you don't find what you are looking for in the catalog, write us a letter explaining the particular subject you are interested in and we will tell you of any books that may be available.

POPULAR MECHANICS BOOK DEPT.
200 East Ontario Street, CHICAGO

Don't Wear a Truss

BE COMFORTABLE—Wear the Brooks Appliance, the modern scientific invention which gives rupture sufferers immediate relief. It has no obnoxious springs or pads. Automatic Air Cushions bind and draw together the broken parts. No salves or plasters. Durable. Cheap. Sent on trial to prove its worth. Never on sale in stores as every Appliance is made to order, the proper size and shape of Air Cushion depending on the nature of each case. Beware of imitations. Look for trade-mark bearing portrait and signature of C. E. Brooks which appears on every Appliance. None other genuine. Full information and booklet sent free in plain, sealed envelope.



MR. C. E. BROOKS

BROOKS APPLIANCE CO., 126-H State St., Marshall, Mich.

Diamonds Here at 60% of Market Price

Never in three quarters of a century have we offered such amazing bargains. Hundred of money-saving opportunities in latest Diamond Bargain List, equalling those shown here.

Here's why we can offer such remarkable values: This 75 year old firm—rated at over \$1,000,000.00 capital—the largest and oldest diamond banking institution of its kind in the world has made loans on Diamonds, Watches, and other jewels in excess of \$25,000,000.00.

Why Pay Full Prices Costs Nothing to See

Thousands of unpaid loans. Must sell now. Diamonds, Jewels, Watches and other Gems of unusual qualities—at an entirely different price basis—viz: loan values not market values. At our risk we send you any bargain you wish for absolutely free examination. No red tape. No obligation. Don't buy unless satisfied you can not match the bargain at 60 per cent more. *Diamonds of desirable quality at \$125 per carat. Yes, some even lower priced—also, finest gems obtainable at higher per carat—but proportionately low bargain prices. Our bargains have guaranteed loan values also, unlimited exchange privilege at full price.*

Latest List Diamond Loans

Send at once for latest list. Thousands of unpaid loans and other special advantage bargains described in full detail with exact weight, color, quality, etc. Get details of Free Examination offer. No obligation. List is free.

Mail Coupon Now

Only Opposite Post Office

Without obligation, send me free, your latest Bargain List of Diamonds, Watches and other jewelry.

Name.....

Address.....

City..... State.....

Jos. DeRoy & Sons,
1912 DeRoy, Bldg., Pittsburgh, Pa.

For Weddings, Graduations, Etc.

\$38.50
1/2-1/6 Ct. Perfectly Cut

\$186
1-3/32 Ct. Blue White

\$55
5/2 Ct. Show Cluster

\$62
1/4 Ct. White Gold

HIGHER EDUCATION

HOME STUDY

Courses in English, Spanish, Mathematics, Chemistry, Drawing, Education, Business and in 35 other subjects are given by correspondence. Begin any time.

The University of Chicago

32nd Year

Division 4, Chicago, Ill.

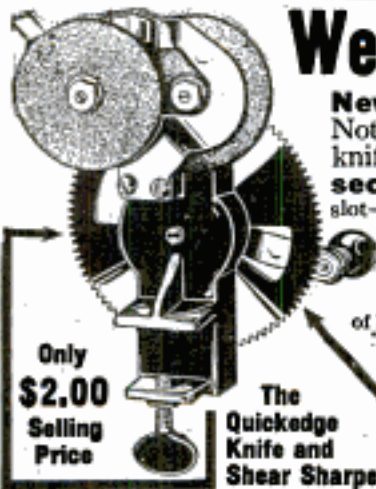

Only
\$2.00
Selling
Price

The
Quickedge
Knife and
Shear Sharpener

We Want Agents at \$50 to \$90 a Week

New Invention—Just out. Needed in every home every day. Patented. Nothing else like it. Low priced—**Sells on sight.** Sharpens any kitchen knife, paring knife, carving knife, bread knife, or shears and scissors in ten seconds. Mechanical masterpiece. A child can use it. Just put knife in slot—turn crank—sharpens both sides at once automatically. **We want representatives at once—men and women hustlers. Get this position where profits start first day.**

No Experience Necessary—200% Profit

Make as much money next week as these men are making now. J. C. Lewis, of Kansas, says: "I have sold one hundred sharpeners in four days." Hobart Kerr, of Md., writes: "The women can hardly wait till they get them." Herbert Cain, of Ky., sold nine after supper. At the end of the first day, J. W. Gordon, of Pa., writes: "I sold two dozen and I sold to every one I saw." Wm. G. Hall, of N. J., says: "I think it is great. I sold six in about one-half hour. The machine is a mighty fine proposition. I am a mechanic and I know what I am talking about." **You can make this money. WRITE TODAY. TERRITORY FREE. Get busy at once.**

QUICKEDGE SHARPENER CO., 109 Sharpener Bldg. Jackson, Mich.
159 West Pearl St.

"If anyone would ask me what kind of bicycle tires I would recommend I would say Vitalics by a long shot. Those tires are real tires. My set of Vitalics will be 5 years old this Sept. and they are not worn out yet."

*Yours truly
Proctor Disbro
17920 Canterbury Road
Cleveland, Ohio*

FREE
A Vitalic Bike Cap to boys who will write for it

"Vitalics by a Long Shot"

PROCTOR DISBRO'S experience with Vitalics is not unusual. Thousands of boys have written us their approval of Vitalic tires. They wear and wear and stand up under the hardest kind of usage. Vitalics can be depended upon. They have been the choice of boys and men for over ten years. No tires equal Vitalics. Big bicycle makers like Excelsior, Iver Johnson and others put nothing except Vitalic tires on their finest wheels.

"Tougher than Elephant Hide" is a slogan that describes Vitalic qualities exactly.

CONTINENTAL RUBBER WORKS
1948 Liberty Street Erie, Pa.

VITALIC Bicycle Tires

"TOUGHER THAN ELEPHANT HIDE"

Boys: Tell your father or big brother that he can now get Vitalic Cords for his automobile with the same "Tougher than Elephant Hide" quality.

Please Mention Popular Mechanics

A BETTER Engine For Less Money

Only
Engine
Sold on
Lifetime
Guarantee

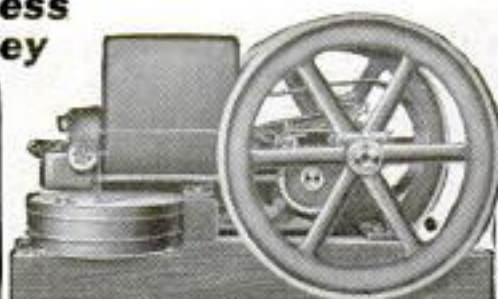

THE NEW WITTE

Throttling Governor

Easy to install—Easy to handle—Gives more power than rating—Increase or decrease speed at will—Run on cheap fuel, Gasoline, Kerosene, Distillate or Alcohol—Steady speed on variable load—Starts without cranking—So simple a boy can understand it.

Adaptable to any power job anywhere

Comes complete—Battery equipped. BOSCH Magneto at small cost extra. All other sizes and styles at proportionate low prices.

WRITE FOR CATALOG

2 H.P. — Pulls 3
\$45.00
At K. C.
Pbr. \$48.50
Price \$57

3 H.P. — Pulls 4
\$69.50
At K. C.
Pbr. \$75.50
Price \$87

5 H.P. — Pulls 6½
\$99.00
At K. C.
Pbr. \$107
Price \$123

WITTE ENGINE WORKS (Write Nearest Address)
1748 Oakland Avenue, KANSAS CITY, MO.
1748 Empire Building, PITTSBURGH, PA.
1748 Fremont Street, SAN FRANCISCO, CAL.

LONG RANGE RIFLE

SINGLE shot hunting rifle of finest blue, case hardened steel, modelled after famous Springfield rifle. Bolt action, take-down model 36 inches over all. Shoots 22 calibre long, extra long and short cartridges. Special at \$4.95

Front and rear sights; automatic shell ejector.

PAY POSTMAN ON DELIVERY plus postage. Money back if Not Satisfied.

CONSUMERS CO., Dept. 3-CB
1265 Broadway, New York

FREE Send for free catalog of other bargains in sporting goods.

LEARN TO PITCH

Lessons by "MATTY," WALSH, WHITE, JOHNSON, RUCKER, WOOD—PITCH THE FADE-A-WAY, SPITTER, KNUCKLER, SMOKE BALL, etc. Clearly described and illustrated by 56 Pictures. Entire COURSE OF LESSONS sent p. p. for **25c**

J. C. DORN, 721 S. Dearborn Street, Dept. 65, CHICAGO, ILL.

Every boy loves boats and trains

Send 10 cents to The Ives Manufacturing Corporation, Bridgeport, Conn., for complete catalog of Boats and Trains.

IVES TOYS MAKE HAPPY BOYS



Small Steam Engines and Boilers

Gas and Gasoline Engines
1/8 H. P. Up

Pumps, gears, model makers' supplies. Sent postpaid (2 dimes preferred) or 20c stamps.

Modern Engine & Supply Co.
331 Monadnock Bldg., Chicago



Genuine "RADIOLA"

Made by Westinghouse for the Radio Corporation of America

Formerly \$207⁵⁰ Now \$ **99⁵⁰**



Regenerative Receiver and 2-Step Amplifier

The first occasion in the history of the radio business of a set designed and built by the highest authorities in the industry being offered at such a low price.

Only
\$ **5⁰⁰**

Puts It In Your Home

Think of it! This marvelous regenerative receiver and 2-step amplifier, at the price of \$99.50, complete with tubes, batteries, head-phones, and wiring equipment,—and on top of that, easy payments and free trial. Only a limited number are to be had at this price. Don't miss your chance.

The Perfected Radio —At Last

So simple to tune that it is just the thing for the beginner. Yet so perfect that it will delight the most hardened "radio fan" who has long been searching for the ideal circuit. Its long range will bring in stations never heard before, so loud and clear that a loud speaker will delight the whole family. Wonderfully selective. With it interference, internal noises and annoying body capacity are forgotten.

WD 12 Tubes and Dry Cells Reduce Upkeep to Almost Nothing

Equipped with 3 of the latest type of dry battery tubes. WD 12 tubes use only $\frac{1}{4}$ ampere. Most perfect tube both for detecting and amplifying. Battery expense reduced to the absolute minimum.

Outfit Complete—No Accessories to Buy

Remember, this is not a price on the bare set alone, as radio sets are usually sold. You get everything you need to install your set and start operating without the investment of one more penny. Just \$5 is all you send. Get your outfit and start enjoying it. Even a free trial is yours if you take advantage of this unprecedented offer.

This is the satisfactory way to buy. Seize this first and last chance to get a Radiola at less than half former price. Have a set that all your friends will envy. Pay a little each month as you enjoy it. The greatest radio season yet known is here. Get ready!

Send Coupon for SPECIAL Offer Circular!

Just mail the coupon. That's all. No obligation. Find out all about the greatest radio bargain ever offered. Act at once and be sure of your chance. No more at this price when these are gone. Send the coupon NOW!

BABSON BROS. 19th and Marshall Blvd.
Dept. 13-56 Chicago

Babson Bros., Dept. 13-56
19th Street and Marshall Blvd., Chicago, Ill.

Send me your special offer of a Radiola Outfit at \$99.50 for only \$5.00 down and Free Trial.

Name

Address



NEW AUDIO FREQUENCY TRANSFORMER

Price, Mounted Only

6 to 1 Ratio Transformer - -	\$4.50
(with Red Label)	
3 1-2 to 1 Ratio Transformer - -	4.00
(with Blue Label)	

Built by Transformer Experts

The new Thordarson Audio Frequency Amplifying Transformer is a product of a company having 28 years' concentrated experience in the development and manufacture of power transformers for a multitude of varied commercial and experimental purposes.

Designed in the Thordarson Laboratories and constructed entirely in the Thordarson plant, its unequal performance in both volume and pure tone production has brought new and finer entertainment to thousands of discriminating radio amateurs and experimenters.

THORDARSON

Scientifically—
Electrically—
Mechanically—
Correct



VARIABLE CONDENSER

13 plate .00025 M. F. - - -	\$2.00
with vernier, knob and dial - -	3.50
23 plate .0005 M. F. - - -	2.50
with vernier, knob and dial - -	4.00
43 plate .001 M. F. - - -	3.00
with vernier, knob and dial - -	4.50

Flexible—Selective—Accurate

No finer variable condenser is built than this new Thordarson. Precision in tuning and reliability under all atmospheric conditions marks it as a worthy product of Thordarson genius and engineering skill.

After exhaustive competitive tests leading manufacturers of receiving sets are now specifying the new Thordarson transformers and condensers. Our friendly suggestion is that to increase the selectivity and volume of your set, and to reduce distortion, insist on Thordarson products. Interesting radio facts and specifications of our equipment are contained in our new circular. Write for your free copy.

THORDARSON

ELECTRIC MFG. CO.

Huron and Kingsbury Streets

Chicago, Ill.

Hand Forged
Razor Steel
Blades, No. 57



A GENUINE \$2 KNIFE
FOR
\$1.18 POSTPAID

Direct at Factory Prices

This \$2 KNIFE \$1.18 Postpaid

Hand Forged Razor Steel Blades

Handy shaped Blade makes this knife best for mechanics, sportsmen and farmers; light but strong; re-sharpened easily. Stag handle. German silver finish; blades file tested, hand forged from razor steel and warranted.

Sample \$1.18 3 for \$3.00 Postpaid.

Send for our 100-page List and "HOW TO USE A RAZOR" **FREE**

MAHER & GROSH CO., 106 A St., Toledo, Ohio

Motorists—Garagemen—Workmen

Protect Your Clothes With the 10-second Two-in-One



As a
Driving
Coat

KOVER KWICK

As a
Work
Suit

← The Same Garment →
Just Snap the Snappers

Either a Long Driving Coat or a 2-leg All-protecting suit. Not an overall. To take off—one pull and all fasteners are open. Made of strong Khaki.



\$3.95

SEND NO MONEY

Just write on a card—"Send me a 10-second Kover Kwick." State chest and height. We'll send it C. O. D., postpaid. Money back if not satisfied.

Agents Wanted

Sell Kover Kwicks direct to wearer. Thousands of motorists, garagemen, farmers and workmen are wearing this Nationally advertised garment. Steady money for you. Write for details.

KAY MILLS, 520-530 N. Broadway, CINCINNATI, OHIO

Cleans Up Fortune Quickly

Amazing New Plan Pays Big Profits!

Howard Montell was just making a bare living six months ago. Had never saved a penny. Now he has almost \$5000 in the bank and his weekly earnings are enormous. Any one may use his method. No capital needed.

"Six months ago I was disgusted with everything," says Montell. "The high cost of living kept me working like blazes to get the bare necessities—and I couldn't save a penny.

"I had sold specialties for years but I couldn't get a line that had any outstanding features that would give me an edge on competition. Something like that is absolutely needed if a man is to be a 'five-figure' man.

"But that is all changed now. I have nearly \$5000 in the bank and I am living high, too.

"All because I'm selling something EVERY housekeeper wants and AT A LOWER PRICE FOR A BETTER ARTICLE with an enormous commission. You can't beat that combination I've made as much as \$500.00 in a single week."

His Method

Every housekeeper knows that Science recently found an easy, inexpensive, effortless way to make every range, heater or burner an oil burner by a remarkable device which is inserted in any stove in a minute. This takes one part of kerosene (the cheapest fuel known) and mixes it with 20 times its bulk of AIR—nature's FREE fuel—and makes an intensely hot gas even cheaper than City gas.

This cuts housework in half. No more coal to buy—No more worrying about scarcity or high prices—No more wood to haul or chop—No more ashes to carry out—No more coal dust to create dirt or ruin furniture and curtains—No more freezing in cold rooms on "blizzardy" mornings while BUILDING a fire! For you don't BUILD a fire with the new device. Just a twist of the wrist and you HAVE a fire in a few seconds—an intense cheerful fire that heats the coldest rooms in a few minutes.

Devices for making this wonderful gas out of cheap oil and FREE air sold like wild-fire even before this latest improvement.

Another Discovery

Then just six months ago, came a device known as NU-HEAT—Montell took this up almost as soon as it came out. Later discoveries had shown how to eliminate certain parts. This made the new device,

NU-HEAT, far more efficient than the first devices and at the same time much cheaper. The new idea was patented at once and then sold at such a low price that almost every woman could



A twist of the wrist brings a fire in a second—a warm house on arising—a hot oven in a jiffy. Models for each type of range, heater and furnace.

own one. Everybody wanted a gas-making device—and the new one was within the easy reach of practically every housekeeper.

Now you can see why Montell is cleaning up a fortune.

And he isn't the only one. Men who never sold a dollar's worth of goods before are now selling 6 out of every 10 people they call on. While men who have sold other products, and whose earnings averaged about \$25.00 to \$50.00 a week, find it just as easy to make from \$100.00 to \$200.00 a week with this device. Spare time agents make big money also.

Build a Fortune

Investigate this wonderful plan. See why a call on your very next prospect can easily mean Ten Dollars for fifteen minutes' pleasant conversation! If you can see twenty people in a day—and that should be easy—you should sell twelve. Figure your profits, working six days a week or spare time.

Mail the coupon now. The wonderful story of NU-HEAT and NU-HEAT profits will come to you at once without cost or obligation on your part.

WADE HILL MANUFACTURING CO.
Dept. 939 St. Louis, Mo.

WADE HILL MFG. CO., Dept. 939,
St. Louis, Mo.

Send me full details showing how I can make a big income, without capital, selling NU-HEAT in full or spare time. Explain your amazing new selling plan that makes it easy for every home to own one, the personal co-operation you give, and your free sample case offer.

Name.....

Address.....

City..... State.....

These Others Have Found This An Easy Way to Build a Fortune!

\$100 the First Week

"I've made \$100.00 my first week. Now one customer tells others and I get enough 'requests to call' to keep me busy, so I expect soon to double this." — Arch B. Thayer, Michigan.

Business Forced on Her

"I didn't start out to be a saleswoman. I put a NU-HEAT in my stove and was so delighted with it I began to brag about it. Many of my friends asked me to get burners for them and of course I collected the commissions. That started me. Now I make more than my husband and that's saying a lot for he's the best lawyer in the county." — Mrs. Laura M. Marston, Tenn.

Worth \$100,000 to Him

"I wouldn't give up the work for \$100,000.00. For I'm earning at the rate of \$15,000.00 a year and that is interest on a quarter-million." — Harley Jackson, Massachusetts.



"Good-bye, Boys!"

"Today I dropped in for a last word with the boys at the office. And as I saw Tom and Dave there at the same old desk it came to me suddenly that they had been there just so the day I came with the firm four years ago.

"When I started here I was put at a desk and given certain routine things to do. But after a few months I began to realize that I was nothing but a human machine—doing things that any one could do.

"So I wrote to Scranton and arranged for a spare-time study course that would give me special training for our work. Why, do you know, it gave me a whole new interest in our business! In a few months I was given more responsibility and more money. Since then I've had three increases. Six months ago I was put in charge of my department, and now my big chance has come—I'm to be manager of our Western branch at \$5,000 a year! It just shows what spare-time training will do."

If you want to make more money, show your employer you are trying to be worth more money. If you want a bigger job, show him you are willing to prepare for it.

There's a simple, easy way to do it. For 31 years the International Correspondence Schools have been training men and women right in their own homes whenever they had a little time to spare. More than 180,000 are studying now. Ten thousand are starting every month.

Can you afford to let another priceless hour pass without finding out what the I. C. S. can do for you? Here is all we ask—without cost, without obligating yourself in any way, mark and mail this coupon.

TEAR OUT HERE

INTERNATIONAL CORRESPONDENCE SCHOOLS
Box 5544-D, Scranton, Penna.

Without cost or obligation, please tell me how I can qualify for the position or in the subject before which I have marked an X:

BUSINESS TRAINING COURSES

- | | |
|---|---|
| <input type="checkbox"/> Business Management | <input type="checkbox"/> Salesmanship |
| <input type="checkbox"/> Industrial Management | <input type="checkbox"/> Advertising |
| <input type="checkbox"/> Personnel Organization | <input type="checkbox"/> Better Letters |
| <input type="checkbox"/> Traffic Management | <input type="checkbox"/> Foreign Trade |
| <input type="checkbox"/> Business Law | <input type="checkbox"/> Stenography and Typing |
| <input type="checkbox"/> Banking and Banking Law | <input type="checkbox"/> Business English |
| <input type="checkbox"/> Accountancy (including C.P.A.) | <input type="checkbox"/> Civil Service |
| <input type="checkbox"/> Nicholson Cost Accounting | <input type="checkbox"/> Railway Mail Clerk |
| <input type="checkbox"/> Bookkeeping | <input type="checkbox"/> Common School Subjects |
| <input type="checkbox"/> Private Secretary | <input type="checkbox"/> High School Subjects |
| <input type="checkbox"/> Business Spanish <input type="checkbox"/> French | <input type="checkbox"/> Illustrating <input type="checkbox"/> Cartooning |

TECHNICAL AND INDUSTRIAL COURSES

- | | |
|--|--|
| <input type="checkbox"/> Electrical Engineering | <input type="checkbox"/> Architect |
| <input type="checkbox"/> Electric Lighting | <input type="checkbox"/> Blue Print Reading |
| <input type="checkbox"/> Mechanical Engineer | <input type="checkbox"/> Contractor and Builder |
| <input type="checkbox"/> Mechanical Draftsman | <input type="checkbox"/> Architectural Draftsman |
| <input type="checkbox"/> Machine Shop Practices | <input type="checkbox"/> Concrete Builder |
| <input type="checkbox"/> Railroad Positions | <input type="checkbox"/> Structural Engineer |
| <input type="checkbox"/> Gas Engine Operating | <input type="checkbox"/> Plumbing and Heating |
| <input type="checkbox"/> Civil Engineer | <input type="checkbox"/> Chemistry <input type="checkbox"/> Pharmacy |
| <input type="checkbox"/> Surveying and Mapping | <input type="checkbox"/> Automobile Work |
| <input type="checkbox"/> Metallurgy <input type="checkbox"/> Mining | <input type="checkbox"/> Navigation |
| <input type="checkbox"/> Steam Engineering | <input type="checkbox"/> Agriculture and Poultry |
| <input type="checkbox"/> Radio <input type="checkbox"/> Airplane Engines | <input type="checkbox"/> Mathematics |

Name.....
Street.....
Address.....

3-27-23

City..... State.....

Occupation.....

Persons residing in Canada should send this coupon to the International Correspondence Schools Canadian, Limited, Montreal, Canada.

Please Mention Popular Mechanics

The Music Pals of the Nation

"Everyone a Gibsonite" Central High School Boys Mandolin Orchestra, Kalamazoo, Mich. Garnet Davis, Directress.



New friends, new pleasures, new and interesting experiences, invitations galore—dinners, dances, week-end parties, outings,—are some of the good things playing a Gibson brings into your life.

Gibson
Instruments

are easily learned in spare time without previous knowledge of music. A few weeks of pleasant, interesting study and you'll be able to play. And there's no other joy in life quite equal to hearing music you make on your own instruments.

\$5.00 Monthly buys a Gibson. The ultimate in construction, finish, tone quality and volume. Built like a violin. Adjustable bridge, non-warpable trust rod neck and thirty other exclusive Gibson features. **Guaranteed for life.** Non-Gibson instruments exchanged.

Make \$25 to \$200 weekly, selling, playing, teaching. Own a high class, exclusive business. We furnish stock, advertise, help sell, carry accounts. Gibsons easily sold on confidential credit plan.

Send for **FREE** catalog, **FREE** music and information about Mandolin, Mandola, Mando-cello, Mando-bass, Guitar, Harp-guitar, Mandolin-banjo, Tenor-banjo, Cello-banjo, Guitar-banjo. If interested in Agency, check here..... **Teacher..... Clip, check and mail this ad today.** Address all mail to Kalamazoo.

Gibson Mandolin-Guitar Co.

1589 Parsons St.
Kalamazoo, Mich.

Foreign Dept.
25 Broad St., N. Y. City



Get This
NEMCO BOOK of
3000 Bargains
From Your Dealer

FREE See your dealer today and insist upon getting the Big NEMCO Bargain Book. See how much money you can save on automobile accessories and guaranteed repair parts—in fact, everything your car needs. Also special bodies for Fords and Chevrolets. Lowest prices anywhere. All parts of Standard quality. Save postage, freight and expressage by buying direct from the dealer in your town.

If your dealer does not have this money-saving book send us his and your name and address and you will get a copy by return mail without cost. No obligation to us or your dealer. You will be astonished at the low prices. **EVERY ARTICLE GUARANTEED.**

NEW ENGLAND MILLS COMPANY

849-851-853-855
W. Washington Blvd.
CHICAGO, ILLINOIS



DEALERS:

If you have not already received your NEMCO Books write us today on your business stationery. This book will help you get more customers and increase sales to your present ones.



BULLDOG Pipeless Furnace

The Only Furnace That Comes Completely Erected!
Fits Any Basement—Install It Yourself!

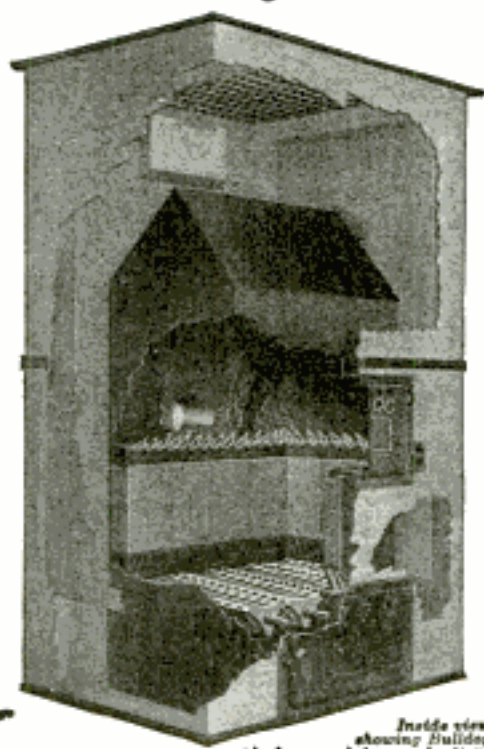

Inside view showing Bulldog pipes, smokeless combustion.

Our patented extensible casing is made to fit any basement. Save the usual installation cost of \$25 to \$40. No mechanical skill needed—nothing but a hammer and a saw!

The **only** furnace with the "Gable-Top" radiator, receiving all the direct rays of the fire.

The **only** furnace with the square construction giving absolutely straight and free passage of air.

Complete combustion of all gases by super-heated air saves you 25% on your coal bill.

The **only** furnace with the oblong fire-pot, burning wood to much better advantage.

Here is the latest and greatest advance in home heating yet devised. The Bulldog is *different!*—and *better!* Find out about it today!

\$10

**Puts The
 Bulldog
 in YOUR
 Home!**

Heat your home right. Take advantage of this special offer. Only a small amount down—the balance in easy monthly payments—and you can have the wonderful Bulldog Pipeless Furnace in your

home. Remember, it comes completely erected—absolutely gas tight and factory inspected. Factory connections in both East and West. We ship from nearest point.

Heat Your Home Right

Why use stoves? They mean dirt and ashes in your living room—constant attendance—one room too hot—another too cold—your face toasted while your back is chilled. *Let the Bulldog heat your home right!* Remember your wife and kiddies. Keep them warm and comfortable all the time. *It's easy!* For only a little

more first cost than the stove, and no more cost for up-keep, you can have a Bulldog Pipeless Furnace that will give you a constant complete circulation of pure, moist, warm air through every part of your home. With the Bulldog in your home you'll have winter comfort such as you never had before!

Send Coupon for Free Book

Learn some amazing facts about the laws of nature! Learn how you can have all the heat you want—where you want it—and when you want it—and yet **save money!** Learn how our amazingly low price has been made possible by standardization. **Get your wife and kiddies the best there is. You can do it easily! FIND OUT! MAIL THE COUPON TODAY!**

Babson Bros. 19th St. and California Avenue
 Dept. 13-56 Chicago, Illinois

Babson Bros. 19th St. and California Ave.
 Dept. 13-56 Chicago, Ill.

Without obligating me in any way, please send me your free catalog and \$10 down offer on the Bulldog Pipeless Furnace.

Name _____

Address _____

AGENTS Here it is at last!

**Outfit
FREE!**

Complete SAAL equipment for your own car or a sample to carry, FREE! We supply everything you need without charge. We disclose the methods of our most successful Agents, to show you the way to make \$20 or more a day!

\$20 a Day, easy!

You've been looking for this easy to sell BIG PROFIT line! Now is the season. Mail the coupon, get the facts, send for your Free Outfit, start cashing in at once! Even men without previous selling experience are making money taking orders for SAAL SYSTEMS—the wonderful new method of lubricating automobiles with HEAVY OIL, instead of grease. Get into this business—no capital needed. Be your own boss. We will show you how to be a SUCCESS.

SAAL Heavy Oil System of Chassis Lubrication

The Only
100%
Lubrica-
tion

HEAVY OIL 2000 lbs. Hydraulic Pressure

Patented construction of SAAL "Oil Shooter" forces heavy-oil with a ton of force thru the most stubborn bearing. Only a car owner can properly appreciate the pleasure of using a lubricating system where he can see the oil "come out of the other end"—where he can feel the squeakless, velvety comfort of 100% Lubrication. Try it in the steering and get a real surprise!

\$2,500,000 Company and 6 Factories Back You to Win!

Why not hook-up with this 23 year old company which can show you how to make real money with less work and effort than you ever made it before? If you have only average ability and the determination to succeed, will supply the product, the capital, the selling plan—will deliver and collect—all you supply is your time!



"\$200 a Week" Says Mattson

Mattson of California started in June. He calls himself an everyday fellow. No previous record of success, little or no selling experience. His average profits are already over \$200 a week! He says anybody can sell "SAALS."

ABIG BUSINESS of Your Own Without Capital

We equip you to sell motorists, dealers, lubricating service stations, farmers, factories, repair shops, etc. We tell you and show you how to build up a big, permanent, profitable business of your own. We stay with you until you are a financial success. Here, we believe, is your big opportunity. Grab it while your territory remains open!

H.G.SAAL CO. Dept. 601
1800 Montrose Ave.
CHICAGO, ILL.

Mail
Coupon
To-
day!

Illustration shows how SAAL "Oil Shooter" lubricates steering and wheel bearings. SAAL fittings replace the old grease cups—no mechanic needed. Carry the "Oil Shooter" under the hood in holster which is supplied with complete outfit.

\$5 Ford
Sizes
\$8 for all
big cars

H. G. SAAL CO.,
Dept. 601, 1800 Montrose Ave., Chicago

Please send me complete information about your offer to Agents, Free Outfit and the big money-making opportunity selling "SAALS."

I have a car. I have no car.

Name

St. No. or R. F. D.

City State

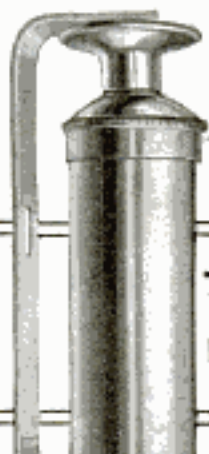

Carry
SAAL
"Oil
Shooter"
in
Holster
under
hood

ELECTRICITY

Needs You To Boss Jobs Like This



Be a **Certificated Electrical Expert**
EARN \$3500 to \$10000 a Year

Some Features of My Course That Have Revolutionized Home Study Training

1. Practical Instruction—no useless, high-sounding theory.
2. Free Electrical Outfit—Finest outfit ever sent out for home experiment.
3. Free Employment Service.
4. Free Consulting Service.
5. Free Engineering Magazine.
6. Free use of my Electrical Laboratory.
7. Extra Courses Free—Radio—Electrical Drafting.
8. Spare time work—Special earn-while-you-learn lessons.
9. Reduced prices on all Electrical Supplies.
10. Cash Refund Guarantee Bond.

These features are all explained in my big Free Book.

IT'S a shame for you to earn less than \$100 a week when trained Electrical Experts are in such great demand. You ought to get more. You can get more.

Cooke Trained "Electrical Experts" earn \$70 to \$200 a week. Fit yourself for one of these big paying positions. Get into a line of work where there are hundreds and hundreds of opportunities for advancement and a big success.

What's YOUR Future? Today even the ordinary Electrician—the "screw driver" kind—is making money—big money. But it's the trained man—the man who knows the whys and wherefores of Electricity—the "Electrical Expert"—who is picked out to "boss" ordinary Electricians—to boss the Big Jobs—the jobs that pay up to \$10,000 a year.

AGE or LACK OF EXPERIENCE No Drawback

You don't have to be a College Man; you don't have to be a High School graduate. My Course in Electricity is the most simple, thorough and successful in existence, and offers every man regardless of age, education or previous experience, the chance to become, in a very short time, an "Electrical Expert," able to make from \$70 to \$200 a week.

I Give You a Real Training As Chief Engineer of the Chicago Engineering Works I know exactly the kind of training a man needs to get the best positions at the highest salaries. Hundreds of my students are now earning \$3,500 to \$10,000. Many are now successful ELECTRICAL CONTRACTORS.

Your Satisfaction Guaranteed So sure am I that you can learn Electricity—so sure am I that after studying with me, you, too, can get into the "big money" class in electrical work, that I will guarantee under bond to return every single penny paid to me in tuition, if, when you have finished my course, you are not satisfied it was the best investment you ever made.

FREE — Electrical Working Outfit — FREE

I give each student a Splendid Outfit of Electrical Tools, Materials and Measuring Instruments absolutely FREE. I also supply them with Drawing Outfit examination paper, and many other things that other schools don't furnish. You do PRACTICAL work AT HOME. You start right in after the first few lessons to work at your profession in a practical way—make extra money while you learn.

Get Started Now—Mail Coupon I want to send you an Electrical Book and Proof Lessons both FREE. These cost you nothing and you'll enjoy them. Make the start today for a bright future in Electricity. Send in coupon—NOW.

L. L. COOKE, Chief Engineer, Chicago Engineering Works,
Dept. 516, 2150 Lawrence Avenue, Chicago, Illinois

L. L.
Cooke,
Chief
Engineer

Chicago
Engineering
Works

Dept. 516, 2150 Lawrence Ave., Chicago, Ill.

Dear Sir:—Send at once the "Vital Facts" containing Sample Lessons, your Big Book, and full particulars of your Free Outfit and Home Study Course—all fully prepaid, without obligation on my part.

Name

Address

The "Cooke" Trained Man is the "Big Pay" Man

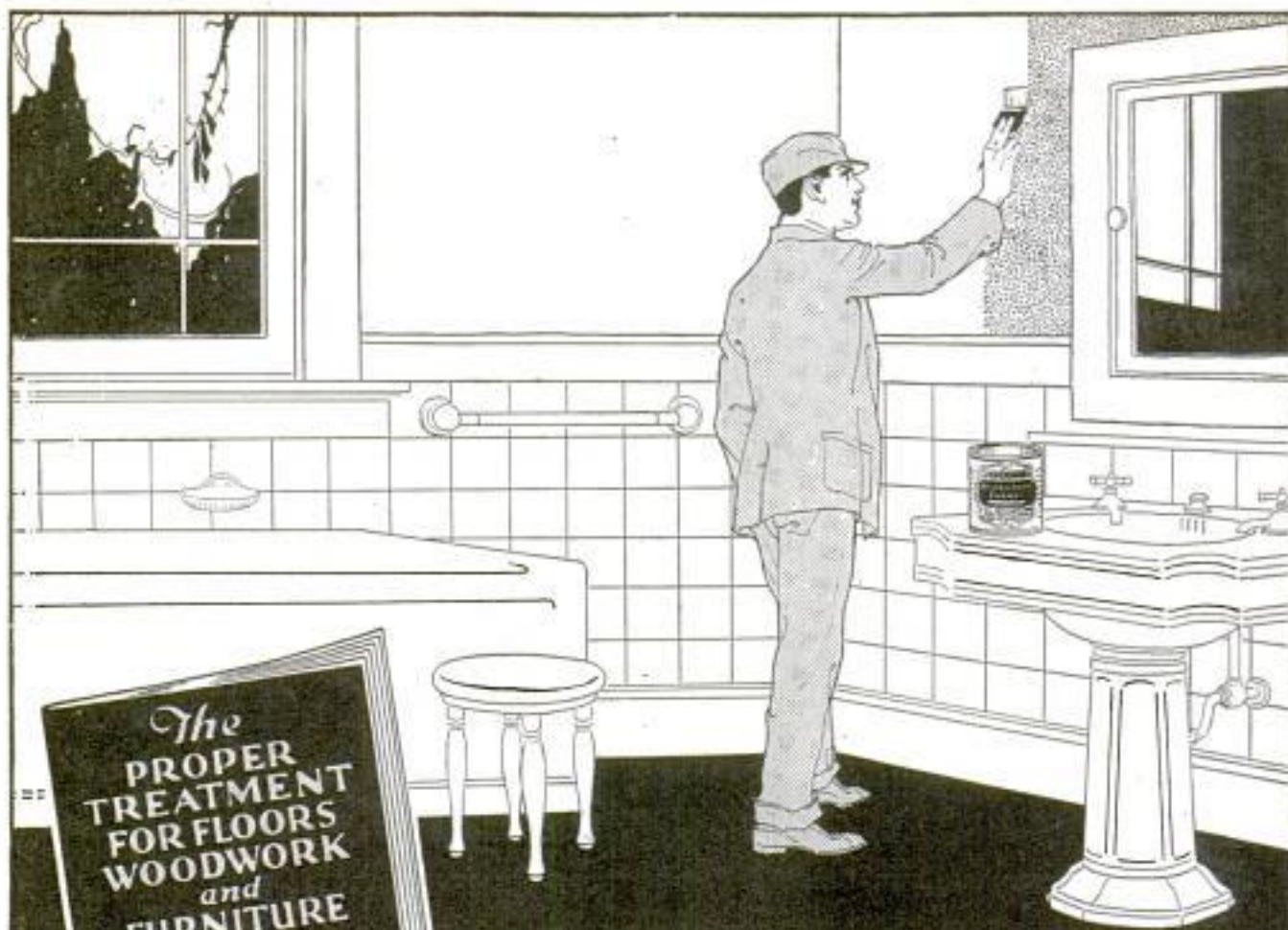

This Beautiful Book on Wood Finishing **FREE**

GIVES complete instructions for finishing all wood—hard or soft, old or new. Explains just what materials to use and how to apply them. Tells how inexpensive soft woods may be finished so they are as beautiful and artistic as hard wood. This book is the work of experts—illustrated in color. Gives covering capacities, includes color charts, etc.

JOHNSON'S ENAMEL

Johnson's Perfectone Undercoat and Enamel is the ideal finish for wood, plaster and metal. It will not chip, check, crack, peel or change its color. Gives a beautiful,

germ-proof porcelain-like finish which is impervious to hot soapy water, iodine, ammonia, etc.

Fill out and mail coupon for a free copy of "The Proper Treatment for Floors, Woodwork and Furniture."

S. C. JOHNSON & SON, Dept. PA9, Racine, Wis.
Please send me, free and postpaid, your Instruction
Book on Wood Finishing. The best dealer in paints

here is.....

My Name.....

My Address.....

City and State.....

S. C. JOHNSON & SON

"The Wood Finishing Authorities"

Dept. PA9, RACINE, WIS.

Canadian Factory—Brantford

HERE IS THE TEST

Check the form you believe correct. Then compare with the correct answers in panel below.

1. Would You Write—

Between you and I	or	Between you and ME
I DID it already	or	I HAVE DONE it already
WHO shall I call	or	WHOM shall I call
It's just AS I said	or	It's just LIKE I said
The river has OVERFLOWED	or	The river has OVERFLOWN
I WOULD like to go	or	I SHOULD like to go
I LAID down to rest	or	I LAY down to rest
Divide it AMONG the three	or	Divide it BETWEEN the three
The wind blows COLD	or	The wind blows COLDLY
You will FIND ONLY one	or	You will ONLY FIND one

2. How Do You Say—

evening	EV-en-ing	or	EVE-ning
ascertain	as-cer-TAIN	or	as-CER-tain
hospitable	HOS-pi-ta-ble	or	hos-PIT-able
abdomen	AB-do-men	or	ab-DO-men
mayoralty	MAY-or-al-ty	or	may-OR-al-ty
amenable	a-ME-na-ble	or	a-MEN-able
acclimate	AC-cli-mate	or	ac-CLI-mate
profound	PRO-found	or	pro-FOUND
beneficiary	ben-e-fi-shEE-ary	or	ben-e-FISH-a-ry
culinary	CUL-i-na-ry	or	CU-li-na-ry

3. Do You Spell It—

superCede	or	superSede	or	repEition	or	replition
recElve	or	recIEve	or	sepArate	or	sepErate
reprElve	or	reprIEve	or	aCoModate	or	aCCoMModate
donkEYS	or	donKIES	or	traffiCing	or	traffiCKing
factorIES	or	factorYS	or	ACSeSible	or	ACCeSSible



SHERWIN
CODY

Is Your English a Handicap? This Test Will Tell You

THOUSANDS of persons make little mistakes in their everyday English and don't know it. As a result of thousands of tests, Sherwin Cody found that the average person is only 61% efficient in the vital points of English. In a five-minute conversation, or in an average one-page letter, from five to fifty errors will appear. It is surprising how many experienced stenographers fail in spelling such common words as "business," "abbreviate," etc. It is astonishing how many business men use "who" for "whom" and mispronounce the simplest words. Few persons know whether to use one or two "c's" or "m's" or "r's," whether to spell words with "ie" or "ei," and when to use commas in order to make their meaning absolutely clear. Make the test shown above, now. See where you stand on these 30 simple questions.

New Invention Improves Your English in 15 Minutes a Day

Mr. Cody has specialized in English for the past twenty years. His wonderful self-correcting device is simple, fascinating, time-saving, and incomparably efficient. You can write the answers to 50 questions in 15 minutes and correct your work in 5 minutes

more. You waste no time in going over the things you know. Your efforts are automatically concentrated on the mistakes you are in the habit of making, and through constantly being shown the right way you soon acquire the correct habit in place of the incorrect habit. There is no tedious copying. There is no heart-breaking drudgery.

FREE—Book on English

A polished and effective command of the English language not only denotes education, but it wins friends and impresses favorably those with whom you come in contact. Many men and women spend years in high school and years in college largely to get the key to social and business success. And now a really efficient system of acquiring an unusual command of English is offered to you. Spare-time study—15 minutes a day—in your own home will give you power of language that will be worth more than you can realize.

Write for this new free book, "How to Speak and Write Masterly English." Merely mail the coupon or a letter, or even a postal card. You can never reach your greatest possibilities until you use correct English. Write to-day for the free booklet that tells about Mr. Cody's simple invention.

Mail this coupon or postal **AT ONCE**

Sherwin Cody School of English

59 Searle Building
Rochester, N. Y.

ANSWERS

<p>1.</p> <p>Between you and me I have done it already Whom shall I call It's just as I said The river has overflowed I should like to go I lay down to rest Divide it among the three The wind blows cold You will find only one</p>	<p>2.</p> <p>EVE-ning as-cer-TAIN HOS-pi-ta-ble ab-DO-men MAY-or-al-ty a-ME-na-ble ac-CLI-mate pro-FOUND ben-e-FISH-a-ry CU-li-na-ry</p>	<p>3.</p> <p>supersede receive reprieve donkeys factories repetition separate accommodate trafficking accessible</p>
--	---	---

SHERWIN CODY SCHOOL OF ENGLISH

59 Searle Building, ROCHESTER, N. Y.

Please send me at once your Free Book, "How to Speak and Write Masterly English."

Name _____

Address _____

City _____

State _____

MEN WANTED!

I am teaching trades to men who want to get out of white collars and into overalls. Who want to quit being wage slaves whose job a strike or bad business or employer's whim can terminate without warning. Who want a chance to be independent, make real money and own their own business. I refer you to sixty thousand men who found the way to success by sending for my catalog.

Earn \$50 a Week and Up!

If you are looking for work at \$50 a week and up, if you would like to get into something sure and solid that will give you success and independence, and can put in a few weeks this summer in TRAINING, write me today.

With over TWELVE MILLION automobiles running the demand for mechanics, demonstrators, chauffeurs, truck drivers, garage men, etc., is greater than ever before. Countless opportunities in cities and towns and even remote places. I estimate there are 20,000 Sweeney trained men owning their own garage or business.

send
this now

EMORY J. SWEENEY, President
Dept. 1104, Sweeney Bldg.
Kansas City, Mo.

Send me free, without any obligation on my part, your 64-page catalog and Special Offer!

Name

P. O.

City



The white-collar worker contemplating a shift into a manual trade will find, with a little investigation, that the trades themselves are shifting. Yesterday he would have tackled something like carpentering, bricklaying, plastering, painting or type-setting. Today he finds a demand for men who understand automobiles, internal-combustion engines, electricity, oxy-acetylene cutting and welding, and other crafts of comparatively recent development. Ten or fifteen years ago many of them did not exist. They have come into existence with the growth of internal-combustion power and the changed character of building.

—Saturday Evening Post
May 26

“The White Collar
Shifts Into
Overalls”

Sweeney System of Practical Instruction

is the ONLY WAY to learn if you want to save time and money and be properly trained. You get this at the WORLD'S greatest trade school, the MILLION DOLLAR SWEENEY SCHOOL and you get it nowhere else. 8 weeks practical training with Tools, not books!

FREE RAILWAY FARE

If you will come now I will help by paying your railway fare from any point in the U. S. to the Sweeney School. I will also tell you about my New Offer—a wonderful opportunity for you! The first step is to send for my Free Catalog. **Get all the facts.**

FREE Simply send name today for my big 64-page catalog. Shows hundreds of pictures of men at work in the school. Tells all about wages, profits, opportunities in auto and tractor business. Explains step by step how you learn. Interesting letters from graduates telling how they made good. Shows how men come from all over the world to this big school. Makes you want to join the crowd. Tells everything you want to know. No cost, no obligation. Clip the coupon, or a postcard will do. Get the catalog now—that's the first step. Don't put it off one minute. No colored students accepted.

E. J. SWEENEY, President

LEARN A TRADE

Sweeney

AUTOMOTIVE & ELECTRICAL SCHOOL
1104 SWEENEY-BLDG-KANSAS-CITY, MO

erial