

25 Cents

POPULAR MECHANICS MAGAZINE

WITH WHICH IS INCORPORATED THE ILLUSTRATED WORLD

WRITTEN SO YOU CAN UNDERSTAND IT

REGISTERED TRADE MARK, GREAT BRITAIN, No. 410426

REG. U. S. PAT. OFF.

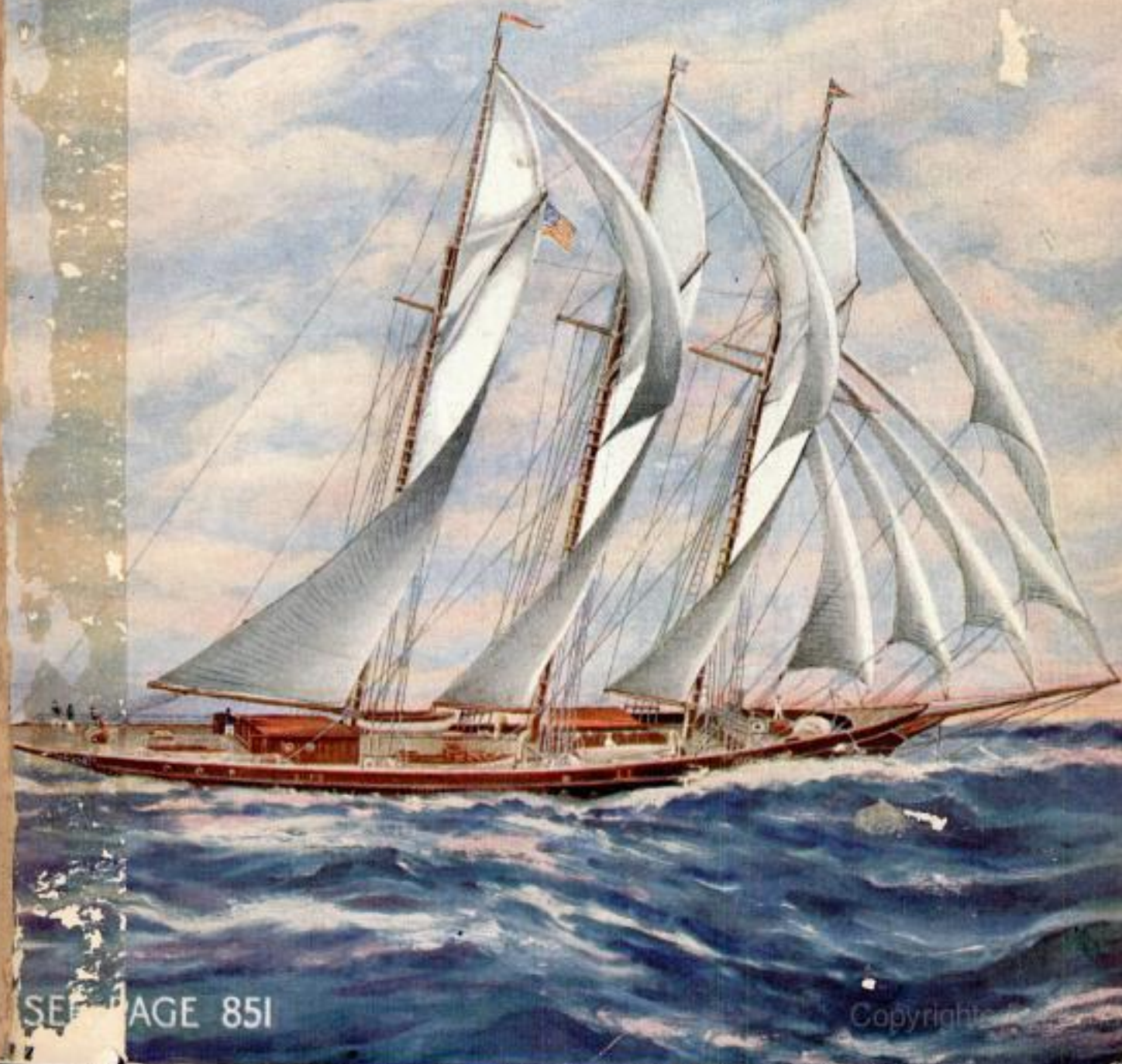

SEE PAGE 851

Copyright



Guaranteed for Life

FREE 10-Piece Kitchen Set
White Enamelled

Wonderful 32-Piece Aluminum Set consists of 2 Bread Pans; Doughnut Cutter; 2 Loose Bottom Jelly Cake Pans; Combination Tom-kettle and Rice Boiler with lid; Sausage Set with lid; Dipper; Colander; Measuring Cup; Percolator; 2 Flo Pans; Complete Caster Set; Tea or Coffee Strainer; Fry Pan; also cooker set of 5 pieces—makes 11 useful combinations: Preserving Kettle; Groves Kettle; Combination Cooker; Casserole; Pudding Pan; Tubed Cake Pan; Colander; Roaster; Corn Popper; Steamer Set; Double Boiler.

No Money Down!

Just mail the coupon and we send this 32-piece Aluminum Cooking Set, and the 10-piece Kitchen Set Free. When the goods arrive, pay only \$2.00 on the Aluminum Set. Nothing for the Kitchen Set—it is FREE. Use both sets 30 days, and if not satisfied send them back and we will refund your money and pay transportation both ways. If you keep them, pay for the Aluminum Set, only a little every month.

FREE 10-Piece Kitchen Set
Not a penny to pay for this set. You get it absolutely free with Aluminum Set.
Potato Masher
Mixing Spoon
Measuring Spoon
Ice Pick
Egg and Cream Beater
Can Opener
Vegetable & Pan Brush
Fork
Egg and Cake Turner
Wall Rack
All have white enameled handles and hang on wall rack—keeping them conveniently at hand.

Complete 32-Piece Aluminum Set and FREE Kitchen Set

Hartman's special, selected set of heavy gauge Aluminum Ware—a complete cooking outfit, light to handle, easy to clean, always bright as silver. Will never chip, crack or rust. We guarantee it for life. 32 utensils—everything for baking, boiling, roasting, frying. And—absolutely free—a Combination Kitchen Set, 10 utensils with pretty white handles.

Nearly a Year to Pay

You pay only \$2.00 and postage on arrival (on the Aluminum Set—not a penny to pay at any time on the Kitchen Set). The balance a little every month.

Order by No. 417EMA7. Price for Aluminum Set, \$17.95. No money down. \$2 and postage on arrival. Balance \$2 monthly. 10-Pc. Kitchen Set is Free.

HARTMAN Furniture & Carpet Co.
Dept. 5516 CHICAGO, ILLINOIS

Copyright, 1928, by Hartman's, Chicago

FREE BARGAIN CATALOG and FREE GIFTS

This great 358-page book offers the world's greatest bargains in home furnishings, jewelry and farm machinery—all sold on easy monthly payment terms and 30 days' free trial on everything.



Wonderful Gifts
Catalog explains how you can get Glassware, Lemonade Sets, Silverware, Tablecloths, Napkins, etc., free with purchase. Send for it today.

HARTMAN FURNITURE & CARPET CO.
Dept. 5516 Chicago, Ill.

Send the 32-piece complete Aluminum Cooking Set No. 417EMA7 and 10-piece Kitchen Set. Will pay \$2 and postage on the Aluminum Set on arrival. Kitchen set is free. I am to have 30 days' free trial. If not satisfied, I will ship both sets back. If I keep them, I will pay you \$2 monthly until the price of the Aluminum Set, \$17.95, is paid. Title remains with you until final payment is made.

Name.....
Occupation.....
R. F. D., Box No.
or Street and No.
Post Office..... State.....
(If your shipping point is different from your post office, fill in line below.)
Send shipment to.....

21 Jewel Burlington

Just Out

Latest Designs in Watch Cases beautifully illustrated in our booklet. Send for **FREE** Copy.

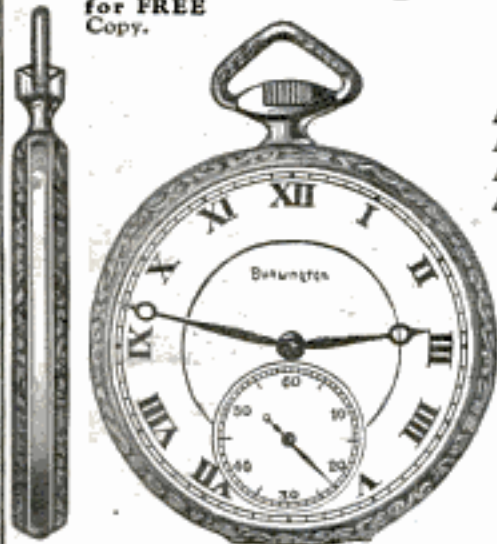

Adjusted to the Second
Adjusted to Temperature
Adjusted to Isochronism
Adjusted to Positions

21 Ruby and Sapphire Jewels
25 Year Gold Strata Case
Your Choice of Dials
(Including Montgomery R. E. Dial)
New Ideas in Thin Cases

Only \$**100**
Down

Only One Dollar Down will buy this masterpiece of watch manufacture. The balance you are allowed to pay in small, easy, monthly payments. The Burlington — a 21-Jewel Watch — is sold to you at a price much lower than

that of other high-grade watches. Besides, you have the selection of the finest thin model designs and latest styles in watch cases. Don't delay! Write for the **FREE** Watch Book and our **SPECIAL OFFER** today.

Write While This Special Offer Lasts

Get the Burlington Watch Book by sending this coupon. Find out about this great special offer which is being made for only a limited time. You will know a great deal more about watch buying when you read this book. You will be able to "steer clear" of the over-priced watches which are no better. Remember, the Burlington is sent to you for only One Dollar down, balance in small monthly payments. Send the coupon for watch book and our special offer **TODAY!**

Burlington Watch Company

Dept. A-935, 19th Street and Marshall Blvd., Chicago
Canadian Address: 62 Albert Street, Winnipeg, Manitoba

Burlington Watch Company

Dept. A-935, 19th St. and Marshall Blvd., Chicago
Canadian Address: 62 Albert St., Winnipeg, Manitoba

Please send me (without obligations and prepaid) your free book on watches with full explanation of your \$1.00 down offer on the Burlington Watch.

Name _____

Address _____

This One



61P1-P7D-JZ74

Here's a "dandy" Free Text
Book for "Home Carpenters"

12 WORKING DRAWINGS
 VOL. 36
CYPRESS
 POCKET LIBRARY
 "THE WOOD ETHERAL"

"SHORT CUTS" TO
 GOOD CARPENTRY

"Short Cuts to Good Carpentry"—
 (Vol. 36, Cypress Pocket Library)

48 pages of authoritative instruction (simple, clear and stimulating) fully illustrated and with big Supplement, 24 x 36 in. with detailed Working Drawings that show how to make twelve "hard jobs" easy, safe and economical of both labor and Lumber. Read what "Rural Life," (Rochester, N. Y.) says of

"SHORT CUTS to
 GOOD CARPENTRY"

"It is a guide book for the man or boy who can handle a saw or hammer and wants to know how to use them to the best advantage."

Ten topics pertaining to the house and 4 about barns. Sent free with our compliments.

WE TRUST YOUR
 OWN JUDGMENT
 and SELF-INTEREST to
 INSURE CYPRESS on YOUR job.
 "The Wood Eternal" keeps values
 going up by keeping the place from
 running down."

BOX SILL
 CONSTRUCTION

SELF
 SUPPORTING

BARN
 FRAMING

ROOF TRUSS

CORNICE
 DETAIL

CYPRESS SHINGLES

JOIST

2x4



When planning a Mansion, a Bungalow, a
 Farm, a Bleeding-Porch or just a Fence, remember—
 With CYPRESS you BUILD, BUT ONCE... TRY IT.

Let our "ALL ROUND HILL'S DEPARTMENT" help YOU. Our resources are at your service with Reliable Counsel.

SOUTHERN CYPRESS MANUFACTURERS' ASSOCIATION

1219 POYDRAS BLDG., NEW ORLEANS, LA., or 1219 GRAHAM BLDG., JACKSONVILLE, FLA.

(Please address nearest office)

INSIST ON TRADE-MARKED CYPRESS AT YOUR LOCAL DEALER'S. IF HE HASN'T IT—LET US KNOW

Popular Mechanics Magazine

200 E. Ontario Street, Chicago, U. S. A.

H. H. WINDSOR, Editor

London: Hachette & Co.,
16-17 King William Street, Charing Cross, W. C. 2

Paris: Hachette & Co.,
111 Rue Reaumur

Melbourne, Australia
The Australasian News Co.

ISSUED MONTHLY

SUBSCRIPTION:

SINGLE COPY, 25 CENTS

In United States and its possessions, also Canada, Cuba, and Mexico, per year, postpaid . . . \$3.00

To all other countries in the Postal Union 3.50

All subscriptions are discontinued at expiration. Please examine the date printed on your wrapper.

Entered as Second Class Matter Sept. 15, 1903, at the Post Office at Chicago, Illinois, under Act of March 3rd, 1879.

Entered as Second Class Matter at the Post Office Department, Canada.

Published monthly by POPULAR MECHANICS CO.

Copyright, 1923, by H. H. Windsor. Copyright in Australia.

Vol. 39

Contents for June, 1923

No. 6

Airplane Fighting Wheat Rust Traps Germs.....	821	Culvert, Egg Shaped, Is Self-Cleaning.....	874
Airplane, Hospital, Designed for Surgical Work....	807	Dam Repaired While Mills Run, by Horace E. Thomas.....	856
Airplane Landing Field Marked to Aid Airmen.....	875	Dissecting Scope Is Compact and Efficient.....	914
Airplane Records and Styles, New, Appear in Field of Aviation.....	844	Drilling Tool, Convenient, Is Motor Driven.....	846
Arc Welding Device Lowers Voltage.....	888	Dust, Tons of, Travel in Sky.....	922
Asphalt Pavement Melting Machine, Portable.....	870	Eclipse, Crocker Pictures Show Sun Streamers on.....	825
Automobile Aids Sinking of Mine Shaft.....	896	Egg Candler Machine Uses Acetylene Gas.....	910
Automobile Axles, Broken, Emergency Device Repairs	930	Electricity—Striking Electrical Effect on High Voltage Line.....	831
Automobile Cam Gear Increases Steering Leverage..	932	Electrotype Plates, Machines Routs, Three at a Time	834
Automobile Device Registers Quantity of Oil and Gas in Tank.....	918	Elevated Railway, "Silent," for Philadelphia, by Wm. A. McGarry.....	877
Automobile Gasoline Gauge Holds Reserve Supply... 898		Elevator, Simple Bucket, Stores Farm Grain.....	926
Automobile License Plate Carrier Fits Various Sizes	900	Emery Wheel Attachment Faces Valves.....	890
Automobile Parking Light Works by Clock.....	937	Explosions, Supercamera Gauges Speed of.....	899
Automobile "Safety First" Guard Rail Envelops Car	941	Explosions—What Goes Up—Comes Down, by Francis W. Wilson.....	830
Automobile Sleigh Has Helical Rear Wheels.....	913	Farming Experiment, Novel, for War Veterans.....	860
Automobile Spring Lubricating Tool Shaped like Hatcher.....	902	Fire Ladder, Turntable, Extends from Truck.....	848
Automobile Steering Attachment Improves Control.. 925		Flooring, New Fiber, Has Fireproof Qualities.....	917
Automobile Steering Wheel Lock Easily Installed... 917		Flowers, Sleeping, Give Clue to New Anesthetic.....	900
Automobile, Streamlined, Cuts Head Resistance.....	883	Forest Disease Fought by Air, Land, and Water, by Francis Dickie.....	908
Automobile Trailer, Mammoth, Has Freight Car Capacity.....	928	Forest Surrounds Homes of City on Plain.....	919
Automobile Washing Device Keeps Soap Solution Uniform.....	866	Gas Mantle Burners, Double, Give Improved Light.. 861	
Automobiles, Endless Tread, Successful in Norway.. 927		Gas Range Burners Light Automatically.....	864
Automobiles, Steam, Pilot Ignition Designed for... 920		Glass and Metal Welded by Simple Method.....	922
Aviation, Japan Quietly Making Advances in.....	864	Grandstand, Iowa, of Steel Assures Permanence.....	861
Band Saw, Portable, Cuts Wood and Metals.....	836	Grapefruit Cutting and Coring Device.....	938
Bank Alarm, Electric, Protects from Holdups.....	940	Gravel, Suction Dredge Gets from Bathing Pond.... 941	
Barber Shears, Comb on, Intended for Home Use... 943		Grinder, Automatic, for Lawnmower Blades.....	894
Baseball Glove Protects Throwing Hand of Catchers	858	Gulf Stream Prevents Mail from Reaching Lightship	912
Bean Harvester Threshes in Same Operation.....	855	Gun, New Tear Gas, Is Effective Weapon.....	932
Bearing, New Roller, Special Sleeve Features.....	912	Helicopter Rises 20 Feet with New Motor.....	926
Blowtorch, Gasoline, Has Fool-Proof Features.....	855	Helium, New Method of Purifying Provides Aid for "Z.R.-1," by John W. Kean.....	826
Blueprint Drier Features Copper Cylinder.....	909	Hens Register Eggs with New Device.....	891
Boat Model, New, Oxford Racing Crew may Use... 838		Highway, 6,500 Mile, Last Link in, Completed, by E. M. Webber.....	886
Boat—Rowboat, Knock Down, Simple and Compact. 911		Hoe, Double Bladed Garden, Has Sharp Edges.....	942
Boiler, New, Designed for Liquid Fuel.....	897	Hotel Has Underground Parking Space for Guests, by H. S. Grassman.....	899
Brushes, Rotary, to Aid Housewives.....	871	Household Devices.....	934
Bundling Machine Makes Scrap Metal Bales.....	828	Hydroelectric Plant Runs without Attendants.....	874
Bungalow, New Circular, Saves Space and Steps... 854		Ice Cake Machine Cuts into Standard Weights.....	865
Bungalow, Pupils Build within School.....	835	Island, New, Reported Found Near French Indo-China.....	924
Butter Vanity Cases Now Used in German Cities.. 912		Kettles, Miniature Copper, Made from Coins.....	876
Caisson Hoist Facilitates Foundation Work.....	847	Label Stickers for Amateur Radio Panels.....	852
Canal, New Dutch.....	821	Lake, Owens, Drying Up of, Reveals New Wealth.. 893	
Card Index, Simple, Intended as Calendar Memo File	942	Lamp Lock, New, Attaches to Brass Sockets.....	918
"Cash Register," Giant, Aids University Campaign.. 908		Lamp, Table, Radio and Phonograph Sets in.....	879
Check Protector Weighs Only Half Pound.....	922	Lazy Tong's Lift Valve Springs Easily.....	841
Children's Picture Page.....	943	Light, Red Finger, to Aid Night Signaling.....	847
Civic Features.....	920	Magnet, Oil Well, Recovers Lost Equipment.....	898
Clock, One Hand, Aids in Avoiding Errors.....	868	Magnet Turns Stirring Rig inside Closed Dish.... 926	
Clock, World's Time, for Radio Purposes.....	875	Mail Box Sentinel Detects Letter Thieves.....	853
Clutch, New Type Friction, Ends Jerk.....	883	Mansion, Old New Hampshire, to be Moved to New York.....	859
Coal Mining in Alabama with Stream of Water.... 891		Map, Air Service Prepares, for Airmen's Use.....	876
Coal Ships, Roller Mounted Towers Unload.....	879	Map Surveys, Precise, by Aerial Photography.....	896
Coconut Festival Staged in Solomon Islands.....	859	Microscope, Pocket, for Field Work.....	858
College, Yale, Branch of, Successful in China.... 936		Milk Company Uses Redeemable Metal Tokens.....	942
Concrete Walls, Colored Figures Add Life to, by Arthur Jones.....	860	Milking Machine Valve Prevents Infection.....	866
Cookstove, Collapsible, for Camp Use.....	912		
Copper, Noncorrodible, Cast under Hot Water.... 937			
Cotton Gin, New, Uses Two Sets of Saws.....	842		
Cottonwoods, Sprayed, Shed No Cotton.....	852		

[Continued on Page 4]

[Contents—Continued]

Milling Machine, Automatic, for Production Work.....	915
Money, Worn Out, Turned Back into Paper.....	925
Monument, Southern "Mammy," Planned at Capital.....	918
Mop Cabinet, Metal, for Shaking Out Dust.....	896
Motion Picture Laboratory, Federal, Completely Equipped.....	867
Motion Pictures, First "Pullman" Car Featured in.....	829
Motion Pictures, Paraffin as Floating Ice for.....	900
Motor, New, for Temperature Control Apparatus.....	837
Mussel Culture to Aid Pearl Button Industry.....	853
Nozzle, Gas Burning, Avoids Flashback.....	842
Nozzle, Water Propelled, Cleans Sewers.....	925
Office Buildings, Concrete, Completed in Dallas.....	907
Oil Filter Alarm Warns of Clogging.....	936
Oil Heater Uses Separate Combustion Chamber.....	888
Oil Tank Fire Quickly Put Out with Curtain of Water, by Chas. W. Geiger.....	884
Oil Well Fire Shoots 200 Feet into Air.....	838
Oils, Viscosity of, Electric Treatment Raises.....	856
Olympic Games' 1932 Session Awarded to Los Angeles.....	907
Onion "Set" Planter Saves Tedious Labor.....	890
Oxygen Breathing Apparatus Works Automatically.....	868
Peach, New Variety of, Developed.....	852
Pearl Fishing Off Western Australia.....	880
Peat Digging, Hydraulic Dredging Method Applied to.....	940
Peeling Machine, Portable, for Small Restaurants.....	858
Photographs, Air, Made Obliquely in Canadian Survey.....	887
Phonograph with Keyboard Picks Out Records.....	908
Photography—Portraits, Novel, Made by Multiple Exposure.....	865
Pier, Large Vancouver, Nearing Completion, by Henry C. Copeland.....	904
Pine, Leaning, of Rome Leans More than Tower of Pisa.....	841
Pipe Line, Water Supply Intake, Floated into Position.....	882
Pistol, Army .45, may be Changed.....	942
Prize Offers.....	883
Popular Mechanics New Home, by H. H. Windsor.....	823
Pump Has High Vacuum and Pressure Combined.....	934
Pump, Trench Force, Has Convenient Features.....	944
Punch, Simple Metal, Has Self-Contained Dies.....	897
Pushcart, Child's, Carried like Brief Case.....	860
Radio Headset Has Wide Resistance Range.....	878
Radio Message, Mayor's, Hundreds Answer.....	938
Radio News Sent to China.....	838
Radio Receiving Set, Portable, Easily Installed.....	861
Radio Station, Dutch, Spans 12,000 Mile Gap.....	928
Radio Transmitter, Diaphragmless, Aids Broadcasting.....	836
Rail Bending Device Makes Old Rails Usable.....	932
Railroad Sleeping Car Headboards, Permanent, Aid Privacy.....	834
Railroad Sleeping Car Leakage Makes Perfect Ventilation.....	828
Railway, New Australian, Taps Rich Lands.....	861
Rhubarb, Freezing before Forcing Improves.....	878
Rice Field Waste Benefits Sugar Refining.....	910
River's Menace Changed into a Utility.....	854
Roadbuilding Expedition, British, Penetrates India's Last Frontier.....	862
Rubber Bands, Machine Cuts, from Old Inner Tubes.....	940
Salvaging Caissons, Deep Sea, Tested Successfully on Sunken "Eagle" Boat.....	839
Saw—Handsaw, Students', Has Twelve Sets of Teeth.....	901
Science Notes for Daily Use.....	924
Screwdriver, Durable, Has Insulating Handle.....	918
Screwdriver, Ratchet, Has Pistol Grip.....	939
Seal, "Plant Trees," as Civic Emblem Plan in Nebraska City.....	902
Seaplane Lays Efficient Smoke Screen.....	853
Selenium "Eye," Wonderful, by R. C. Folger.....	839
Sewer, Leaking, Wrecks City Street.....	831
Ship—French Liner Built on New Power Plan.....	842
Ship "Leviathan," Well Known Skipper to Command.....	910
Ship—Ocean Liner, Wall of Water Rocks.....	841
Shipwreck Victims may Walk Ocean to Safety.....	827
Sleds, Ox Drawn, Thresh Egyptian Grain.....	846
Snake Breeding, Commercial, in California, by Arche M. Dunning.....	929
Snakes, Hundreds of, Killed by Road Crew.....	908
Snow, Twin Rotary Blowers Shoot, from Highway.....	849
Soil Pulverizer, Tractor, Digs like Gopher.....	927
Sound Wave "Filter" may Eliminate Noises.....	939
Spindle Machine, Multiple, Aids Production.....	870
Spiritism—Spirit Pictures and a Speaking Skull, by J. L. Peabody.....	817
Spruce Haul, Record, Claimed in Maine.....	906
Steam Boiler Signal Instrument Charts Water Level Record.....	907
Steam Condensers, High Pressure Streams to Clean.....	933
Steam Flow Recorder for Small Plants.....	859
Steel Heating Device Shows Critical Point.....	923
Steeplechase—Over the Top—and Down.....	913
Stones, Heavy, Homemade Device Handles.....	829
Street Car, English Railless, Has Six Wheels.....	896
Street, Granite Concrete, Is Widest in World.....	925
Street Lamps, Parisian, Have Built-In Mail Boxes.....	902
Subscription, Novel, Appeals in Hawaii.....	910
Sugar Cane Trailer Trucks Replace Oxcarts.....	871
Sun's Rays and Flask Burn Finish on Office Desk.....	849
Surfacing Machine Uses Abrasive Belts.....	828
Tank Capacities Measured by Portable Instrument.....	878
Tape, Micrometer, Measures Diameters.....	876
Tar Pouring Kettle Has Adjustable Nozzles.....	864
Telephone Lineman Uses Hanging Chair.....	919
Telephone System, Italy's, Again in Private Hands.....	902
Tennis Scoring, French Have New System of.....	828
Tiles, Precast, Make for Economical Building.....	838
Tire Deflater Leaves Both Hands Free.....	940
Tire Rim Remover, New, Unusually Powerful.....	944
Tool, Combination, Is Handy and Efficient.....	905
Totem Post, New, Added to Harvard Museum.....	894
Trail, Overland, Wheel Rutted Rocks Recall Days of Trees, Million of, for California's Highways, by H. H. Dunn.....	827
Trees, Queer, of the Island Continent.....	837
Truck Cab Top Lowered to Clear Low Bridges.....	876
Turnbuckle, New Expansion, Has Positive Lock.....	874
Vegetable Handling Device, Mechanical.....	915
Viaduct, Concrete, Makes Altamont Pass Safe.....	909
Wagon Quickly Fills and Dumps.....	914
Water Heater, Tank, Uses No Coiled Tubes.....	923
Water Service Box Has Safety Features.....	846
Welding Outfit, Portable, Generates Own Gas.....	912
Winch Designed to Attach to Front of Tractor.....	923
Window Sashes, Adjustable, for Any Weather.....	938
Wire Strap Tying Machine.....	900
Wood—Plywood, Steel Reinforced, Appears in England.....	868
Wrench Combination Tool Has Strong Grip.....	822
Writing Pad, One Sheet, Lasts "Indefinitely".....	820
Yacht Club Float, Launched in Chicago.....	850
Yacht, Latest, Added to New York Yacht Club Fleet.....	851

SHOP NOTES

Automobile Cylinder Blocks, Tool Holds for Preheating.....	950
Automobile Runways, Concrete.....	945
Beehive, "Sun Porch" for.....	960
Blueprints, Rack for Drying.....	947
Bolts and Screws; Tight, Removing.....	961
Cable Ends, Method of Handling.....	959
Coal Dealer Window Display.....	960
Couplings, Gasoline Line, Cementing.....	949
Explosives, Method of Tamping.....	958
Fence Post Attachment Made of Pipe.....	947
Flux for Brazing.....	957
Gas Torch, Homemade.....	961
Gauge, Height, Made from Planer Gauge.....	848
Gauge, Internal Limit.....	846
Gold, Green, Plating Solution for.....	961
Hoist, Serviceable Homemade.....	962
Hose Connections, Tight, How to Make.....	959
Hospital, Sleeping Porches for.....	949
Locomotive Brasses, Extractor for.....	948
Milling Cutters, Setting to Depth.....	956
Milling Machines, Oil Distributor for.....	960
Planer, Wood, Safety Guard for.....	956
Post Holes, Shield for.....	950
Pump Cylinders, Method of Pulling.....	949
Punching, Guide and Die for.....	963
Quarry Floor, New Method of Lowering.....	946
Radius Finding Tool.....	949
Scriber Set in Fountain Pen.....	956
Sewer, Flushing by Water Pressure.....	948
Steam Engine, Small Horizontal, How to Make.....	951
"Steamboat," Improved, for Tracing.....	961
Steps, Concrete, Protecting Edges of.....	956
Tool Chest Drawers, Slide for.....	946
Trammel, Improved.....	957
Troughs, Wall, for Poultry Feed.....	957
Truck Attachment for Handling Armatures.....	947
Valves, Globe, Reseating.....	959
Willows, Removing from Open Drain.....	958
Workbench Drawer, Trick Lock for.....	948
Workbench Top, Container Holders in.....	957
Wrench, Spanner, How to Make.....	949

AMATEUR MECHANICS

Automobile Hood, Method of Holding.....	922
Automobile Radius Rods, Shock Absorbing.....	928
Baby Swing, Adjustable Hanger for.....	974
Barrel, Tumbling, Provides Sport for Bathers.....	981

DRAKE'S PRACTICAL MECHANICAL BOOKS

THEY WILL RAISE YOUR PAY—

ORDER ON 5-DAY TRIAL

The books listed below will perfect you in your chosen trade — pave the way to the big positions. Written in non-technical language—easy to read and understand. *Every book covers its subject completely. An entire course of instruction condensed into one volume.* Your choice sent postpaid — you benefit 5 days — money refunded in full if not entirely satisfactory. Order direct from this page.



Automobile Books

- Automobile Ignition, by ManlyLeatherette \$2.00
 Automobile Starting and Lighting, by Manly.....Leatherette \$2.00
 Brookes' Automobile Handbook.....Leatherette \$2.00
 Ford Motor Car, Truck and Tractor, by Manly.....Cloth \$1.50
 Starting and Lighting Troubles, Remedies and Repairs, by ManlyLeatherette \$3.00
 Automobile Battery, Care and Repair, by Manly.....Leatherette \$2.00
 Automobile Catechism and Repair Manual.....Leatherette \$1.50
 Tires and Vulcanizing, by TuffordCloth \$2.00
 Gas and Oil Engine Handbook.....Cloth \$1.50
 Automobile Upkeep and Care, by Manly.....Cloth \$1.50
 Motorcycle Handbook, by ManlyCloth \$1.50

Shop Practice Books

- Sweet Metal Workers' Manual.....Leatherette \$2.00
 Oxy-Acetylene Welding and CuttingCloth \$1.25
 Slide Rule and Logarithmic TablesLeatherette \$2.00
 Handbook for Millwrights.....Cloth \$2.00
 Modern Blacksmithing.....Cloth \$1.25
 Machine Shop Practice.....Cloth \$2.00

- Mechanical Drawing and Machine DesignCloth \$2.00
 Pattern Making.....Cloth \$1.50

Carpentry Books

- Cloth Binding
 Modern Carpentry, 2 vols.....\$3.00
 The Steel Square, 2 vols.....\$3.00
 Wooden Boat and Shipbuilding.....\$1.50
 Modern Estimator\$1.50
 Timber Framing\$2.00
 Builder's Architectural Drawing.....\$2.00
 Concrete\$1.50
 Practical Bungalows\$1.00
 Low Cost Homes.....\$1.00
 Roof Framing, by Van Gusbeek.....\$1.50
 Stair Building and Hand Railing\$1.50

Electrical Books

- Practical Applied Electricity....\$2.00
 Alternating Current\$1.50
 Electric Motor Control Systems.....\$1.50
 Wiring Diagrams and Descriptions\$1.50
 Electrical Tables and Data.....\$1.50
 Armature and Magnet Winding.....\$1.50
 Modern Electrical Construction.....\$1.50
 Modern Electric Illumination.....\$1.50
 Electricians' Operating and Testing\$1.50
 Motion Picture Operation.....\$1.50
 Drake's Electrical Dictionary.....\$1.50
 Electric Motors, D. & A.....\$1.50
 Electrical Measurements and Meter Testing\$1.50
 Drake's Telephone Handbook.....\$1.50
 Easy Experiments.....Cloth \$1.25
 Wireless Telegraph and Telephone Handbook.....Cloth \$1.25
 Telegraphy Self-Taught.....Cloth \$1.25

Steam Engineering

- Swingle's Handbook for Steam Engineers and Electricians.....Leatherette \$4.00
 Examination Questions and Answers for Marine and Stationary Engineers.....Leatherette \$2.00
 Steam Boilers.....Leatherette \$2.00
 Swingle's Catechism of Steam, Gas and Electrical EngineeringLeatherette \$1.50

Painting Books

- Scene Painting and Bulletin ArtCloth \$4.00
 A Show at Sho' Cards.....Cloth \$4.00
 Sign PaintingCloth \$4.00
 Strong's Book of Designs.....Leatherette \$4.00
 Strong's Art of Show Card WritingCloth \$4.00
 Signist's Alphabets.....Cloth \$1.50
 Modern Painter's Cyclopaedia.....Cloth \$2.00
 Automobile Painting.....Cloth \$1.50
 Estimates, Costs and Profits, Painting and Decorating.....Cloth \$1.50
 New Hardwood Finishing.....Cloth \$1.50
 The Amateur Artist.....Cloth \$1.50
 New StencilsCloth \$1.25
 Chalk Talk and Crayon PresentationCloth \$1.25

Farm Books

- Farm Mechanics.....Cloth \$1.25
 Farm Buildings.....Cloth \$1.25
 Farm Engines.....Cloth \$1.25
 Traction Farming.....Cloth \$1.50

Business and Reference Books

- Better Business Letters.....Cloth \$1.00
 Better Business English.....Cloth \$1.00
 Better Advertising.....Cloth \$1.00
 Finger Prints Simplified.....Cloth \$2.00
 Practical Bricklaying.....Cloth \$1.25
 Practical Instruction for DetectivesCloth \$1.00
 Practical PlumbingCloth \$1.50
 Hot Water Heating.....Cloth \$1.50
 Elementary Chemistry.....Cloth \$1.50
 Courses in Civil Service.....Cloth \$1.50
 Cyclopaedia of Recipes.....Cloth \$1.50
 American Star Speaker.....Cloth \$1.50

Modern Languages

- By Prof. P. S. Allen, U. of Chicago
 French without a Teacher.....Cloth \$1.25
 Spanish without a Teacher.....Cloth \$1.25
 German without a Teacher.....Cloth \$1.25
 Everyday French.....\$1.25
 Everyday Spanish.....\$1.25

ORDER DIRECT FROM THIS PAGE—ON OUR MONEY-BACK PLAN

The books listed above are only a few of the many in our catalogue, which you will receive promptly after filling out and mailing us the attached coupon. For quick action order direct from this page—cross name of each book wanted and send in with price quoted. We prepay postage and send the books on our money-back plan.

FREDERICK J. DRAKE & CO.

PUBLISHERS

1008 Michigan Ave., Chicago

Drake Books Are For Sale at All Book Stores

FREDERICK J. DRAKE & CO.
 1008 Michigan Avenue
 Chicago, Ill.

GENTLEMEN:—Please send me free, postage paid, your illustrated catalogue which lists and describes over 100 Practical Mechanical Books for Home Study.

My name is

and my address

Mail Coupon For Free Catalogue
 Your Guide to Home Study

Agents

"Ye Gods, -some seller! I made \$215 to-day"
-writes Bentley



The Oliver Oil-Gas Burner does away with coal and wood. Burns 95% air—5% oil. Turns any range into an oil-gas stove. Just like using city gas. Gives much or little heat by simply turning valve. Think of the appeal you can make in every community. Heat only when wanted—that means doing away with sweltering kitchens in summer. Cheaper than coal or wood—absolutely safe. No fires to make, no ashes, dirt, smoke, chopping, carrying coal and wood. Easy to install. Doesn't change stove. Easy to demonstrate—slips in or out of stove in one minute. Show any woman how to have a cool kitchen and sale is made. Big demand all year. Make you more money this summer than ever before. The big season is on.

Free Sample Case Offer and book "New Kind of Heat" Write for them now.

OLIVER OIL-GAS BURNER CO.
Oldest, largest Manufacturers Oil-Gas Burners in the world,
2014-R Oliver Building,
ST. LOUIS, MO.

Read what these Oliver agents say:

\$660 a month
"Have averaged \$660 profit a month for last six months."
A. M. Russell, Conn.

\$1000 in 4 weeks
"Am making \$1000 per month. I have made big money before, but did not expect so much. Your Burner is just the thing."
J. Carnegie, S. Dak.

Buy car with profit
"Have earned enough in one month to buy me a new auto."
S. W. Knappen, Col.

Sells like beer in a dry town
"Am sending today for seven Oliver's. This is one day's orders (\$85 profit). Selling like beer in a dry town."
W. H. Drew, Mich.

\$43 in one evening
I made \$43 last night.
N. B. Chelan, Wash.

ELECTRICITY LEARN AT HOME

Send for catalog which tells how Burgess Home Training enables men and boys to get good jobs and keep them.
BURGESS ELECTRICAL SCHOOL, Dept. PG, 744 E. 42nd Street, CHICAGO

JUST OUT

THE AUTOMOBILE PAINTERS' MANUAL

By G. F. WOLF, A. Y. P. E., Founder of The Detroit Auto Painting School

For the auto painter, garageman and auto owner. Written to give precise information, pertaining to the Painting, Striping, Monogramming and Lettering of an automobile. Covers the subject of color mixing—color blending—and tinting with a hundred and fifty different shades. Considered by experts, the book of the hour. Self instructional and self educational. Also contains numerous and various styles of alphabets, monograms and initials. Special introductory offer. Edition limited. Post Paid \$1.50.

BETROIT AUTO PAINTING SCHOOL, 426 Superior Street, Dept. P, DETROIT, MICH.

"THERE'S MONEY IN IT"

LEARN TELEGRAPHY AT HOME

MORSE AND WIRELESS

TEACH YOURSELF

in half usual time, at trifling cost, with the wonderful Automatic Transmitter, **THE OMNIGRAPH**. Sends unlimited Morse or Continental messages, at any speed, just as an expert operator would. Adopted by U. S. Government, and leading Universities, Colleges and Telegraph Schools. 3 Styles. Catalog free.

OMNIGRAPH MFG. CO., 16-22 Hudson St., NEW YORK

If you own a Radio Phone Set—and don't know the code—you are missing most of the fun.

WANTED

RAILWAY MAIL CLERKS

\$1600 to \$2300 Year

MEN—BOYS 18 UP SHOULD

MAIL COUPON IMMEDIATELY

Steady Work. No Layoffs. Paid Vacations
Common education sufficient:
Travel—See the country

[Contents—Continued from Page 4]

Berries, Shipping by Mail.....	980
Boat Trailer for Auto.....	978
Buffet Doors, Novel Sliding.....	966
Canoe, Method of Towing.....	968
Clothes Drying Rack, Simple.....	974
Cupboard Stepladder, Convenient.....	980
Door Latch, Self-Acting.....	969
Dust Container Made from Bag.....	967
Fence, Recess in, for Auto.....	967
Fish Lure, Glass Bowl Containing Minnows as.....	964
Fly Trap for Dairy Barns.....	969
Fountain Pen, Method of Repairing.....	974
Gasoline Tank Cap, Retainer for.....	965
Gun, "Safety First," Shoots Rubber Bands.....	975
Heater, Kerosene, Converted to Use Gas.....	975
Heater, Kerosene, Heating Water with.....	980
Hose Spraying Attachment for Garden.....	967
Lawn Canopy, Improved, How to Make.....	963
Lawn, Edging with a Blowtorch.....	969
Onions, Transplanted, Grow to Double Size.....	966
Percolator Faucet, Improved.....	966
Photography—Lamp Shade for Dark Room.....	973
Poultry Nest Prevents Roosting on Its Edge.....	965
Radio Detector and Two Step Amplifier for Dry Cell Tubes.....	976
Rugs, Old, Method of Renewing.....	979
Saws, Rusty Crosscut, Cleaning.....	972
Shut-In, Employment and Information Bureau Business of.....	970
Spool Holder for Sewing Room.....	966
Statoscope, Homemade.....	962
Stones, New Method of Piling, on Cleared Land.....	965
Storage Battery Acid, Preventing Damage from.....	973
Stumps, Burning Out Effectively.....	981
Trousers Made to Fit in High Boots.....	968
Water Filter and Cooler, Simple.....	964
Weed Pulling Fork for Hoe.....	975
Window Sash Weights, Improved.....	967

"HELP WANTED"

U. S. CIVIL SERVICE



RAILWAY MAIL CLERKS WANTED

Free List of Government Positions Open

MEN AND WOMEN 17 TO 45 YEARS

Salary \$1600 to \$2600

UNITED GOVERNMENT TR. ASS'N.
214K Dinan Bldg., Detroit, Mich.

Please send me free booklet and list of Gov't. positions open.

Name.....

Address.....

City..... State.....

WANTED

RAILWAY MAIL CLERKS

\$1600 to \$2300 Year

MEN—BOYS 18 UP SHOULD

MAIL COUPON IMMEDIATELY

Steady Work. No Layoffs. Paid Vacations
Common education sufficient:
Travel—See the country



FRANKLIN INSTITUTE, Dept. S177, Rochester, N. Y.

Sirs: Send me without charge, (1) Specimen Railway Mail Clerk Examination questions; (2) List of Government jobs obtainable; (3) Tell me how I can get a Gov't position.

Name.....

Address.....

Let These Guides

Solve Your Problems



Electricity at your finger ends

HAWKINS ELECTRICAL GUIDES IN TEN VOLUMES

3500 PAGES

4700 PICTURES

\$1 A VOLUME

\$1 A MONTH

Send No Money--Send Only This Coupon

Know the facts in Electricity. They mean more money and better position for you. Hawkins Guides tell you all you need to know about Electricity. Every important electrical subject covered so you can understand it. Easy to study and apply. A complete, practical working course, in 10 volumes. Books are pocket size; flexible covers. Order a set today to look over.

LEARN ALL ABOUT

Magnetism—Induction—Experiments—Dynamoes—Electric Machinery—Motors—Armatures—Armature Windings—Installing of Dynamoes—Electrical Instrument Testing—Practical Management of Dynamoes and Motors—Distribution Systems—Wiring—Wiring Diagrams—Sign Flashers—Storage Batteries—Principles of Alternating Currents and Alternators—Alternating Current Motors—Transformers—Converters—Rectifiers—Alternating Current Systems—Circuit Breakers—Measuring Instruments—Switchboards—Wiring—Power Stations—Installing—Telephone—Telegraph—Wireless—Bells—Lighting—Railways. Also many Modern Practical Applications of Electricity and Ready Reference Index of the ten numbers.

SHIPPED FREE

Not a cent to pay until you see the books. No obligation to buy unless you are satisfied. Send Coupon now—today—and get this great help library and see if it is not worth \$100 to you—you pay \$1.00 a month for ten months or return it.

THEO. AUDEL & CO.,
72 Fifth Ave., New York City

Please submit me for free examination, HAWKINS ELECTRICAL GUIDE, (Price \$1 a number). Ship at once prepaid; the 10 numbers. If satisfactory, I agree to send you \$1 within seven days and to further mail you \$1 each month until paid.

Name

Occupation

Employed by

Home Address

Reference

PSM June '23.

\$80 Drafting Course Free

There is such an urgent demand for practical, trained Draftsmen that I am making this special offer in order to enable deserving, ambitious and bright men to get into this line of work. I will teach you to become a Draftsman and Designer, until you are drawing a salary of \$250.00 a month. You need not pay me for my personal instruction or for the complete set of instruments.

\$250 a Month Starting salary according to my agreement and guarantee. Draftsmen's work is pleasant and profitable. Positions are open paying \$3,600.00 a year in the best surroundings. They are open everywhere. Thousands of men are needed who have just the kind of training I will give you. You can get this training during spare time in your own home.

Mail the Coupon

for my valuable book — "Successful Draftsmanship." It explains how YOU can become a Successful Draftsman in a short time. The book is free at present, so write **AT ONCE**.

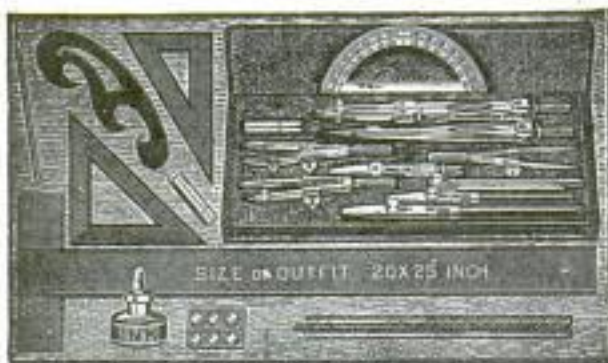

Free Course Offer Coupon Chief Draftsman Dobe

1951 Lawrence Ave. Div. A-135 Chicago
Without any obligation to me please mail your book, "Successful Draftsmanship" and full particulars of your liberal "Personal Instruction" offer to a few students. It is understood I am obligated in no way whatever.



Name _____

Address _____

Chief Draftsman Will Train You Personally

on practical Drafting-room work **Until** you are competent and **Until** you are in a permanent position at a salary paying at least \$250 per month. This is an exceptional opportunity for a few selected ambitious men, between the ages of 16 and 50 whom I will train personally.



Send the Coupon or a letter and let me tell you how you can become a Draftsman in your spare time and earn a good salary. Don't delay — send the coupon at once.

I Guarantee
To instruct you until competent and in a permanent paying position at a regular Draftsman's salary of at least \$250 per month and guarantee to furnish you free complete Draftsman's working outfit at once from the set.

FREE—this \$25.00 Draftsman's Working Outfit

 These are regular working instruments, the kind I use myself. I give them free to you if you enroll at once. **Send the Free Coupon today.**

Earn While Learning

You can be earning a handsome income while learning at home. This is a special offer I am making. Absolutely no obligations of any kind in sending coupon. But you must write at once, as I limit the number of my students.

Mail the FREE Coupon at once for my book—"Successful Draftsmanship," also list of open positions and for the free offer to be earning good money at once while learning at home. This offer is limited and in order to benefit thereby — **act at once.**

Chief Draftsman Dobe
1951 Lawrence Ave., Div. A-135, Chicago, Ill.



How to Box 40c

By Terry McGovern, James J. Corbett, J. Gardner Smith, M. D., Arthur P. Keeley and Gus E. Keeley.

How to Box to Win. How to Build Muscle; How to Punch the Bag and How to Stand, Walk or Run.

This interesting book written by experts is known also as "The Book of Health and Strength." It will greatly assist everyone in keeping fit, in putting them in condition to master a strenuous undertaking either physical or mental.

62 Illustrations. Size 6 1/2 x 11 in. Paper copy .185 pages
SHREWSBURY PUBLISHING CO.
5525 West Lake Street, Chicago, Ill.

PRACTICAL ELECTRICAL EDUCATION

Learn by the thorough approved scientific methods which our seventeen years of specialisms enable us to give you.

A. C. and D. C. Armature Winding, Wiring and Testing, Practical Electricity, Drafting, Electrotechnics, Commercial Engineering, Electrical Engineering with B. S. Degree. "Earn While You Learn," Radio Broadcasting WIAO, Every Day. Next term opens **June 25th**. Write for 72 P. H. catalog. **It's Free.** Mention Age, Education and Course interested in.

SCHOOL OF ENGINEERING OF MILWAUKEE
PM-6, Marshall Street, Milwaukee, Wis.



FREE BOOK LEARN PIANO



This Interesting Free Book

shows how you can become a skilled player of piano or organ at **quarter** usual cost. It shows why one lesson with an expert is worth a **dozen** other lessons. Dr. Quinn's famous Written Method includes all of the many important modern improvements in

teaching music. Brings **right to your home** the great advantages of conservatory study. For the beginner or experienced players. Endorsed by great artists. Successful graduates everywhere. Scientific yet easy to understand. Fully illustrated. **All music free.** Diploma granted. Write today for free book. Quinn Conservatory, Studio PH55, 596 Columbia Road, Boston 25, Mass.

Make \$10 a Night

Be a Drummer Professional drummers in demand everywhere and make big money. You can quickly and easily learn to play band, orchestra and dance music through my home study course. Write for particulars Today, NOW! Write for folder of special snare drum offer.
The Herman H. Rinne Correspondence School of Modern Drumming
3154 Park Ave. INDIANAPOLIS

\$200 A MONTH After 8 Weeks in New York

Learn the auto business in New York. One graduate writes, "after 8 weeks in your school, I took a job that paid me \$60.00 a week." You can do it, too. Here you get personal instruction that enables you to get and hold a big paying position. Day and evening classes. Pay as you learn.

Free Automobile Book Write for our beautifully illustrated catalog. It shows views of New York and the Stewart School. It tells about the automobile business, its future and how you can qualify for a big job after 8 weeks in New York. Send for it today—it's free.

STEWART AUTOMOBILE SCHOOL
225 W. 57th St. Dept. A117 NEW YORK

COLUMBIA SCHOOL OF DRAFTING
Specializing in training of professional Draftsmen—Mechanical, Architectural and others; personal instruction; complete course 3 to 9 months. For information address Local Dept. 2003, R. C. Clafin, Pres., 14th and T Sts., N. W., Wash., D. C.

RADIO FOR THE AMATEUR

Building, Installing and Operating Stations for Radio Communication are presented in convenient form in **Practical Amateur Wireless Stations**

An experience book containing the best suggestions of thirty-three experimenters compiled by the editor of Wireless Age.

It blazes a clear-cut trail to the practical achievement of an amateur wireless station.

Where a method is described, it is one which the author of the chapter has worked out and tried himself; and the same is true whether dealing with a single piece of apparatus or a complete station.

136 Pages—115 Illustrations
Size 6x9. Price 75c postpaid

Popular Mechanics Book Dept.
200 E. Ontario St. Chicago



Be a RADIO EXPERT

Radio Needs Trained Men

Radio is becoming the world's most popular source of entertainment! Radio experts now needed everywhere to construct, install, repair and sell radio outfits. **Big money for trained men!**

Learn in Spare Time

The Radio Training Association of America will train you easily and quickly. Association operated by many of America's most prominent radio leaders. **FREE**—employment service to all members!

EARN \$50 TO \$350 A WEEK

Millions of dollars being spent in Radio. Become a radio expert and make from \$50 to over \$350 a week—in spare time or full time. No need to leave town or to give up present work.

Send for Free Information

You too can make **big money** in radio. Write today for facts on how you can become a Radio Expert in a few weeks and at extremely low cost, and become a life member of this association with full privileges. Mail postcard or letter today. Address

Radio Training Association of America
Dept. 15E Washington, D. C.



WANTED MEN AND WOMEN TO LEARN PHOTOGRAPHY!

Photographers and Photo-Engravers earn \$200 to \$500 a month. The field is uncrowded. Learn these profitable and fascinating professions. Taught by largest and best college of its kind in the world. Established over 30 years. Demand for our graduates far exceeds supply. Good positions secured. Tuition and living expenses low.

Get this FREE Book! Write today for free beautifully illustrated book describing wonderful opportunities in this field.
Illinois College of Photography, Box 463, Effingham, Ill.



THE PRACTICAL Automobile, Wagon, House and Sign Painter

By W. F. White
Postpaid \$1.00

This book is written for the man who wishes to paint his automobile, or his home, or wagon. It will tell the inexperienced just how to do it, and it will tell him how to mix paints. It also contains many painters' recipes and trade secrets of great value. Bound in Cloth—157 pages—Size 5 x 7 1/2.

Postpaid \$1.00

SHREWSBURY PUBLISHING COMPANY
5525 West Lake Street Chicago, Illinois

Five Pictures Show You How to Be a Mechanic!

STUDY the pictures in the order they appear. These pictures tell the story of how a young man—just like YOU—succeeded in life.

I will start with No. 1. Here you will see the man who doesn't spend all his time reading the sporting news; he is serious and ambitious. He is looking to the future. He is not going to stay in a rut all his life. He wants money, respect, and a real position in life. This man, just like you are doing now, is reading one of my advertisements. I write and sign all my own advertisements, just as I meet face to face the men who come to my school—The Million Dollar Sweeney Trade School.



He answers the advertisement promptly.

Now look at No. 2. This, Bud-die decided to investigate the auto-motive business. He wanted to see if it did not offer him wonderful possibilities. He believed the trained man could succeed; he was curious and eager to know more about the amazing Sweeney System, so he answered the advertisement. He just sent me his name and the day I got his letter, I sent him the big 64-page Sweeney catalog. You see him now reading the Sweeney catalog. This is the most important step of all—the first step—to get the catalog. This man is reading how 60,000 men made good, how they learned to be expert mechanics. He is reading how Wilson and Powell left the Sweeney School and now "wouldn't take \$10,000 for our business, and we owe it to you." How Elbert Pence built up a \$25,000 yearly garage business at Clearmont, Missouri; how men are trained in eight weeks to be competent repairmen, auto and tractor experts, mechanics, garage owners, salesmen, etc.; how the wonderful Sweeney System as applied with the immense resources of this Million Dollar School



Reading the fascinating Sweeney catalog

teaches them by training hand and eye and brain; how everything is here not only to teach them, but to make them comfortable, dormitories, swimming pools, free lockers, reading rooms, one of the finest equipped trade schools in the world. Now I want you to get the catalog and see the actual pictures of men at work in the school.

Number 3 shows this man at work in the Sweeney School, tak-

ing the eight weeks' course. Please note he is working in overalls, with his hands; he is not reading a book; he is happy and contented because he is learning rapidly. He knows he will soon be a real trained man. He is one of over 1,000 men working like bees. He likes the men around him; he likes the school; he likes the expert instructors who show him how to do things that he couldn't learn in years tinkering around a shop or garage.

Now I call your attention to picture Number 4. This young man has completed his course and decided to go to work right away. He took a job as a repairman at \$1.25 per hour. There are plenty of better jobs open. The demand for trained men is way in excess of the supply. Sweeney graduates are eligible to positions as motor experts, \$125.00 a month; chauffeurs, \$150.00 a month; trouble shooters, \$3.00 per hour; tractor engineers, \$15.00 a day; demonstrators, \$150.00 a month; salesmen, \$3,500.00 a year; garage managers, \$3,000.00 a year.

Some men go back home and open their own repair business; some go to work in the big garages; some have a variety of plans, but all practical, and I'm glad to talk over and advise with my students, if they are in doubt. But don't forget this: "Trained men command the good jobs."

Please look at Picture Number 5. It shows my student in business for himself. He has opened his own shop and garage. He has a business that will fix him for life. He is on mighty good terms with the banker, the president of the local commercial club,

all the successful men in his town.

Now, my friend, apply this to your own case. Make step for step like the man whose progress I have illustrated. But the first thing you want to do is to send for my catalog now. Investigate what Sweeney has actually done, my positive record of success. It costs you nothing to get this valuable free book. I am making a special summer offer that will save you a lot of money and I will also pay your fare to K. C. Write me today and learn something greatly to your advantage. Do it now.

Earnestly yours,

EMORY J. SWEENEY

LEARN A TRADE-
Sweeney
AUTOMOTIVE & ELECTRICAL SCHOOL
1190 SWEENEY BLDG. KANSAS CITY, MO.



At work in the Sweeney School



Takes a job at \$1.25 per hour



Success attained. Owns his own business

EMORY J. SWEENEY, President
1190 Sweeney Bldg., Kansas City, Mo.
Send me free your 64-page catalog and Special Summer Offer!

Name.....

Address.....

I'm Coming.....

I pay your
Railway
Fare
from any
point in
the U. S.
to Kansas
City

What the Old Timer said to Charley

by
C.L. Hardy



“ONLY a few years ago, Charley, the man whose name you see on that door was just where you are today.

“I remember the day he came to work for us. He didn't know much about the business. But he was always asking questions—always anxious to learn.

“And by and by we got to noticing that Billy Stevens was getting ahead of some of us old fellows who had been around here for years.

“I can remember as clearly as though it were yesterday, the day Billy showed old Tom Harvey how to figure out the pitch of some new bevel gears we were making on an important contract.

“Tom told me afterward how respectful Billy was—nothing fresh, or ‘I know it all’ about him. He just made a suggestion and showed Tom a quicker way to start the problem and a shorter, surer way to finish it.

“One day I said to him—‘Where'd you get hep to all that fancy figuring, Bill?’ We were eating lunch and he was reading some little book he always carried. He looked up at me and said innocently: ‘Oh, I just picked it up!’ I knew different than that, so I quizzed him until he told me the whole story.

“‘Did you ever notice the old men around the shop,’ he asked—the men with families who drudge along day in and day out—never getting anywhere?’ I admitted that I had noticed quite a lot of them.

“‘Well,’ he said ‘I made up my mind I wasn't going to spend my whole life in a humdrum job at small wages. So I took a home-study course with the International Correspondence Schools that would give me special training for this business.

“‘I tell you frankly that I never dreamed it would be so fascinating and so helpful in my work. I'm making mighty good money—twice as much as formerly—and I'm going to have even a bigger job around here some day.’

“Well, Charley, that boy went straight on up. The members of the firm heard about his studying in his spare time and encouraged him to keep on. You see where he is today.

“And I—I'm still plugging along at the same old job—struggling to make both ends meet. I had just as good a chance as Billy Stevens, but I let it slip by. Yes, I let it slip by.

“Now, Charley, you've got to want your training bad enough to go get it. That's as far as I can help you; you've got to do the rest yourself.

“I've seen a lot of young men come into this business. Those who went ahead were always those who trained themselves for the job ahead. You can do the same thing.

“Start now! It will take only a moment to sign and mail that coupon. It doesn't obligate you in any way. But it's the most important thing you can do today. Some day I know that you will come to me and thank me for what I'm telling you.”

----- TEAR OUT HERE -----
INTERNATIONAL CORRESPONDENCE SCHOOLS
Box 5523-D, Scranton, Penna.

Without cost or obligation, please tell me how I can qualify for the position or in the subject before which I have marked an X:

BUSINESS TRAINING COURSES

- | | |
|---|---|
| <input type="checkbox"/> Business Management | <input type="checkbox"/> Salesmanship |
| <input type="checkbox"/> Industrial Management | <input type="checkbox"/> Advertising |
| <input type="checkbox"/> Personnel Organization | <input type="checkbox"/> Better Letters |
| <input type="checkbox"/> Traffic Management | <input type="checkbox"/> Foreign Trade |
| <input type="checkbox"/> Business Law | <input type="checkbox"/> Stenography and Typing |
| <input type="checkbox"/> Banking and Banking Law | <input type="checkbox"/> Business English |
| <input type="checkbox"/> Accountancy (including C.P.A.) | <input type="checkbox"/> Civil Service |
| <input type="checkbox"/> Nicholson Cost Accounting | <input type="checkbox"/> Railway Mail Clerk |
| <input type="checkbox"/> Bookkeeping | <input type="checkbox"/> Common School Subjects |
| <input type="checkbox"/> Private Secretary | <input type="checkbox"/> High School Subjects |
| <input type="checkbox"/> Business Spanish <input type="checkbox"/> French | <input type="checkbox"/> Illustrating <input type="checkbox"/> Cartooning |

TECHNICAL AND INDUSTRIAL COURSES

- | | |
|--|--|
| <input type="checkbox"/> Electrical Engineering | <input type="checkbox"/> Architect |
| <input type="checkbox"/> Electric Lighting | <input type="checkbox"/> Blue Print Reading |
| <input type="checkbox"/> Mechanical Engineer | <input type="checkbox"/> Contractor and Builder |
| <input type="checkbox"/> Mechanical Draftsman | <input type="checkbox"/> Architectural Draftsman |
| <input type="checkbox"/> Machine Shop Practice | <input type="checkbox"/> Concrete Builder |
| <input type="checkbox"/> Railroad Positions | <input type="checkbox"/> Structural Engineer |
| <input type="checkbox"/> Gas Engine Operating | <input type="checkbox"/> Plumbing and Heating |
| <input type="checkbox"/> Civil Engineer | <input type="checkbox"/> Chemistry <input type="checkbox"/> Pharmacy |
| <input type="checkbox"/> Surveying and Mapping | <input type="checkbox"/> Automobile Work |
| <input type="checkbox"/> Metallurgy <input type="checkbox"/> Mining | <input type="checkbox"/> Navigation |
| <input type="checkbox"/> Steam Engineering | <input type="checkbox"/> Agriculture and Poultry |
| <input type="checkbox"/> Radio <input type="checkbox"/> Airplane Engines | <input type="checkbox"/> Mathematics |

Name.....
Street.....
Address.....

3-27-23

City..... State.....

Occupation.....

Persons residing in Canada should send this coupon to the International Correspondence Schools Canadian, Limited, Montreal, Canada.



**Just Like a Movie—
“From Rags to Riches”**
By the Magic of the

Coyne “Job-Method” Drafting Course

ONLY a few months ago an underpaid laborer—or worse, out of a job. Today, a high-priced Draftsman, confident, successful, facing the future without fear. Look at the picture! You'd almost rather be the Draftsman than the Boss! YOU—no matter what your job today, no matter how limited your schooling—can RE-MAKE yourself by learning Drafting the *new* way—President Cooke's “Job-Method.” An every-day occurrence—no magic after all!

Jobs Open \$300 a Month

Every factory, big or little—every railroad, every automotive plant, shipyards, the U.S., State, County, and City governments, the Army and Navy, everywhere you turn Draftsmen are in demand at \$200 to \$500 a month. Before machines, buildings, anything can be built a Draftsman must draw the plans!

Mechanics, Builders

Men in any mechanical line can smash ahead to bigger pay and better jobs when they can not only read blue-prints but create them! “Loan me a part of your spare time”—says President Cooke, “and by my new ‘Job-Method’ I'll make you an Expert Draftsman quick!” The “Job-Method” gives you actual JOBS to do from the very first “lesson.” The “Job-Method” makes hard jobs easy and pleasant.

Mail Coupon for FREE Two Books

The new “Job-Method” course of Drafting trains you for the big-pay job. Most complete Drafting instruction ever offered for home-study. To supply the enormous demand for Cooke-trained Draftsmen, the great Coyne School now offers special inducements to ambitious men everywhere. Coupon brings 2 free books, free draftsman's pocket rule and complete information. Mail it today!

COYNE
HOME STUDY DEPT.

E. W. Cooke, President

Address Home Study Dept. 302
552-598 So. Throop St. CHICAGO



Bennett Wellington Cooke
President of the Coyne Trade and Engineering School, “greatest institution of its kind in the World.” Mr. Cooke has an international reputation for turning out big-job big-pay Draftsmen.

Draftsman's Pocket Rule FREE!

Receive pocket rule free to every man who's interested in Drafting. Coupon brings it. DON'T WAIT. SEND TODAY!

Coyne Trade and Engineering School

E. W. Cooke, President

Home Study Dept. 302

552 to 598 So. Throop Street Chicago

Without obligating me in any way please send me Draftsman's Pocket Rule, and your 2 books, “Drafting, the foundation of Industry” and “Learn Drafting by the Job-Method”—all absolutely free. Also complete information of your rapid home-study Drafting course, free Radio offer and free Instruments.

Name

St. No.

City

State

NEW, Complete Radio Course FREE!

The famous “COYNE course in Radio, admitted by experts to be the most practical and up-to-date ever produced. Includes construction, installation, operation. Actually teaches you to build your own set. This 445 course absolutely FREE. Act quick, while this opportunity remains open.

FREE!

Draftsman's “Professional” Instruments and complete outfit. Supplied without one cent of cost to every “Job-Method” student. Coupon brings details of this great free offer.



MEN-I Will Make You AUTOMOTIVE ELECTRICIANS



"I Teach You a New Easy Way

No longer is it necessary for you to spend years studying electricity—or to be a college graduate to get a big pay job. I have discovered and perfected an amazingly easy way by which any one can become an Automotive Electrician in a few weeks. Ambu graduates are holding down the best jobs in the country—stepping right out of the school into \$75 a week jobs. Yet I guarantee to teach you in 8 short weeks here in Chicago—or right in your own home in spare time. This is no idle talk. I can prove every word I say. I will give you the name and address of my graduates—they will tell you what they are making. And you don't have to worry about getting a job. My employment department will give you Free Service. Write me at once, or mail the coupon. You might as well have one of these jobs and be an Automotive Electrical Expert and get the big pay that is waiting for you."

—C. J. BUCKWALTER,
President

Wonderful New Field Pays \$75 to \$100 a Week After Few Weeks Training

If you want big money, here's your chance. Don't study for months and months learning some business that may not pay you as much as you want to earn. Here is a wonderful new field—Automotive Electricity—the highest paying branch of both the Electrical Field and the Automotive Industry, and there are not enough men by half to fill the thousands of jobs that are waiting—jobs that pay \$75 to \$150 a week. Just think of it! 78% of all automobile repairs are electrical. Yet, not one out of 50 garage men know enough about electricity to cash in on this field. No matter what you now know about automobiles, this is your big chance. For, by an amazingly new, easy method which I have discovered I will make you an automotive electrician in a few weeks of interesting study and equip you to take any of these big pay jobs you want.

Thousands of Men Wanted

Other branches of electricity are crowded. Men are out of work. Ordinary automobile mechanics cannot find jobs. But the demand for men who know Automotive Electricity is so tremendous that the men I train are snapped up the minute they finish my new, easy method of learning.

NO EXPERIENCE NEEDED

You don't have to be experienced. You don't have to know a thing about automobiles or electricity. You don't even have to have a high school education. No matter what you are doing now, no matter what your age, education or occupation, I will fit you in a few weeks to instantly locate any electrical trouble on any make or model of car and have your repairs made while the average man is fiddling around looking for the trouble.

BIG FREE BOOK

This big Free book about Automotive Electricity has started hundreds of men on the road to success and big pay in this amazing new field. Bletcher of Chicago earns \$100 a week. William Bass, of Louisiana, doubled his salary in two weeks. Ellerd makes \$1000 clear profit every month. Ludlow increased his income four times. Every one of these men started out by sending for this book. This is your opportunity. Send for this big book immediately. Don't delay your success a minute.

Jobs Waiting—Hurry

Learn at once all about this amazing new, easy way of becoming an Automotive Electrician. See for yourself what a tremendous future is ahead of you. See what my other graduates are doing. See how you can quickly get one of these big pay jobs with a real man's salary. A special limited time offer is now being made—so mail the coupon at once for the Free book and full details.

C. J. BUCKWALTER, President

Ambu Engineering Institute
Dept. 16, 2632 Prairie Ave. CHICAGO, ILLINOIS



**Ambu
Engineering
Institute**
Dept. 16
2632 Prairie Avenue
Chicago

Please send me FREE Book and complete information on Automotive Electricity. Tell me of the rich rewards which await me in this uncrowded field. I am interested in your

- Home Study Course
 Residence Course

Name

Address

City State

TIRE AGENTS WANTED \$4000 A YEAR

I'll Show You How to Make More Money Taking Orders for Mellinger Tires

Without risking one cent, I'll start you as I have started so many others in a business of your own. All or part time. The **Mellinger Plan** is revolutionizing the tire business. No capital or experience needed.

I Guarantee Your Profits

The Mellinger Plan literally guarantees your profits. My **Big Free Book** tells you all about it. No matter what you are doing, where you live, let me put this remarkable money making plan in your hands.

12,000 MILES GUARANTEED!

Lowest Wholesale Prices in America!

Mellinger Super Quality Cord Tires, always considered the best cord tires made, are now even better. The use of Ethyl-cured Rubber gives marvelous tough tread, wears down so slowly it reminds you of steel, yet so pliable that it feels like pure gum. Bead reinforced with two chafing strips; combed Egyptian cord; a double layer of cushion rubber; cured 2½ hours on air bags. These high grade features on the **Mellinger Cord** cost more, yet you pay less than for ordinary unguaranteed tires and I give a **Guarantee Bond for 12,000 miles.**

FREE

For a little of your time in showing and recommending Mellinger Tires, I will make you a surprising offer that will give you a set of tires FREE. If you are in dead earnest I will send you the **Master Salesman Kit**, containing everything. As one Agent says, "It's like taking a prospect through the factory. The Kit sells the prospect and I take the Order."

Positive Proof for You

Be the first from your locality to get the **Mellinger Plan** and positive proof that you can make big money. I say it's your big opportunity—a big business—hosts of friends and customers—I don't ask you to risk one cent. Send the coupon today. My **Big Free Book** explaining everything will be in your hands in a few days.

Mellinger Tire & Rubber Co.
1704 Grand Ave.,
Kansas City,
Mo.

FREE BOOK TELLS HOW!

Mr. B. L. Mellinger, Pres.,
Mellinger Tire & Rubber Co.,
1704 Grand Ave., Kansas City, Mo.

Without obligation, send me details of the Mellinger Plan, Free Book and Wholesale Prices and how, without investing any money, I can become your authorized agent.

Name

Address

INSTRUCTION BOOKS, MUSIC



These books are illustrated and gotten up to make the method of self-teaching so simple that any one without any knowledge of music could learn to play any of the following:

SAXOPHONE - 25c	MANDOLIN - 25c
ACCORDEON - 25c	PIANO - 25c
BANJO - 25c	UKULELE - 25c
GUITAR - 25c	VIOLIN - 25c

The above prices are postpaid. Any above 5 titles, \$1.00, postpaid.
J. C. DORN, 725 So. Dearborn St., Dept. 17, Chicago

AUTO MECHANICS NEEDED

We have more positions available than graduates to fill them. Write today for catalog.

Address Dept. 328

AMERICAN MOTOR SCHOOLS, Inc., Washington, D. C.



LEARN TO PITCH

Lessons by "MATTY" WALSH, WHITE, JOHNSON, RUCKER, WOOD—PITCH THE FADE-A-WAY, SPITTER, KNUCKLER, SMOKE BALL, etc. Clearly described and illustrated by 56 Pictures, Entire COURSE OF LESSONS sent p. p. for **25c**

J. C. DORN, 721 S. Dearborn Street, Dept. 65, CHICAGO, ILL.

MECHANICS FOR YOUNG AMERICA

Plain and complete directions for building boats, water motors, wind mills, searchlight, burglar alarm, ice boat, water bicycle, cabin, camps, kites, etc. 6x9 in. Illustrated. 25c, postpaid.
Popular Mechanics Book Dept., 200 E. Ontario St., Chicago.

PATTERN-MAKING for Those Who Should Know



Compiled by G. H. WILLARD, a pattern maker of many years' experience, for those who wish to increase their pay—or those who wish to enter this well-paying occupation. Filled to the covers with helpful shop-kinks and actual working information. Practical instructions written in plain language, which anyone can easily read and understand. Learn at home—in your spare time. Bound in cloth, 224 pages, 312 illustrations, diagrams and working drawings, etc.

Tells About Pattern making as a trade—The Tools—Wooden Joints—4 chapters on Turning—2 chapters on the Circular Saw—2 chapters on Machine Tools—3 chapters on Simple Tools—Crooked Patterns—2 chapters on Large Pattern Work—Cross-Head Guide patterns—Sweep work—Pipe work—Stove pattern work—Molding—Machine Work—Molding Pattern Work.

CORE MAKING AND MOLDING

Part II explains the simple and complicated problems in core making and molding which every good pattern maker should know. **Tells about**—Core making, simple and complex—principles in Molding—Loam Patterns—Loam Molds.

Everyone following this trade or intending to enter it should have this remarkable book. The price is so low that anyone can afford to buy it. Those who have it, wouldn't be without it.

Price Prepaid \$1 This book will be sent postpaid to any address upon receipt of purchase price. Send today. Take advantage of this remarkable offer NOW—before it is too late.

POPULAR MECHANICS BOOK DEPT.
200 E. Ontario St., CHICAGO

MEN! YOU CAN NOW

STUDY AUTOS AT HOME

The twelve years of training experience of this school is now open to you without leaving your home or job. You can fit yourself now for the advancement you have wanted, or prepare to start a business of your own.

Study at Home, or in Detroit—(or Both)

The M. S. A. S. Home Study Course is written so you can learn the business entirely at home. But it includes the privilege of coming to Detroit to take our practical course also, with actual experience in our laboratories and shops. You can start at home and continue your training here later if you wish to. If you plan to come to Detroit later, but can't come now, start now at home and have that much advantage. That will save part of room and board expense when you do come. It's a wonderful opportunity for you to make your start now toward success. Remember that this is the only Home Study Course put out by a factory endorsed school. It is also the only Home Study Course giving you the privilege of continuation in a real practical school.

Earn \$125 to \$500 Per Month

The Automobile Business is THE Business to get into. Over 12 million cars to overhaul and repair. Millions of batteries, electrical systems, and tires to repair and replace. Thousands of good garages are needed. Can you think of a better business for a man to get into? You can get started now—at home. You don't need to wait until you've saved up enough to come to Detroit for three months.

Very Easy Terms—Nothing to Wait for Now

No matter what your situation is you can take this course, on the astonishingly easy payment plan. You pay as you go and you take no chance. We give you a signed absolute guarantee to give your money back if you are not satisfied with the Course. You are the sole judge of whether you are satisfied or not.

Auto Factories Say:

Studebaker: "We do not know a better automobile school than the M. S. A. S." *Maxwell:* "We heartily recommend the M. S. A. S." *Hudson:* "You will make no mistake by entering for a course." *Buick:* "Course is thorough and complete in every detail." *Packard:* "Have no hesitancy in recommending it in every particular." *The Automobile Journal:* "The M. S. A. S. is the greatest institution of its kind."

Get Started Now

Now—when you are working—is the time to prepare and train yourself for times when you may be out of a job. Have a good trade that you can work at anywhere any time. That's the automobile business. With 12 million cars to keep running, a trained man can always get a good job or open a shop of his own.

Don't Say You Never Had An Opportunity!

Here's a golden one placed right before you, and everything made easy for you to take it. Write for full particulars today. The coupon is the first step to success. Mail it to us now.

MICHIGAN STATE AUTOMOBILE SCHOOL

HOME STUDY DEPARTMENT

26 Auto Bldg., DETROIT, MICH.

The Automobile Center



The Factory Endorsed School

FREE CATALOG
MICHIGAN STATE
AUTO SCHOOL

Mail Coupon To Day

MICHIGAN STATE AUTO SCHOOL
26 Auto Bldg., Detroit, Mich., U. S. A.

Please send me particulars of your Home Study Automobile Course.

Name.....
(Print or write plainly)

St. or R. F. D.....

City..... State.....



HOW MUCH do ARTISTS EARN?

WOULD you like to earn \$100 a week as a commercial artist? If you like to draw, you should develop your talent, for well-trained artists earn \$75, \$100, \$150 a week, and oftentimes much more. Beginners who can do practical work soon command \$50 a week.

The Federal home-study course develops your talent on a sure foundation by the **quickest possible method**, and makes the work truly a pleasure. It is the **original, practical** course in commercial art, created by men with more than 25 years' experience in the field, and after 8 years of unequalled success today stands supreme as America's Foremost Course in Commercial Designing. It contains **exclusive** lessons from leading American artists, gives you individual personal criticisms on all lessons and teaches you the methods that make your drawings worth real money.

Send Today for "YOUR FUTURE"

If you are sixteen years old or more, and in earnest about your future, send today for this book. It is beautifully illustrated, tells every detail about the Federal Course, gives you convincing proofs of its merits and shows work done by Federal Students. Fill out and mail the coupon NOW, kindly stating your age.



COUPON

Federal School of Commercial Designing
631 Federal Schools Bldg., Minneapolis, Minn.
Gentlemen: Please send me "YOUR FUTURE" without charge or obligation.

Name

Age ... Occupation

Write your address plainly in margin.

Please Mention Popular Mechanics

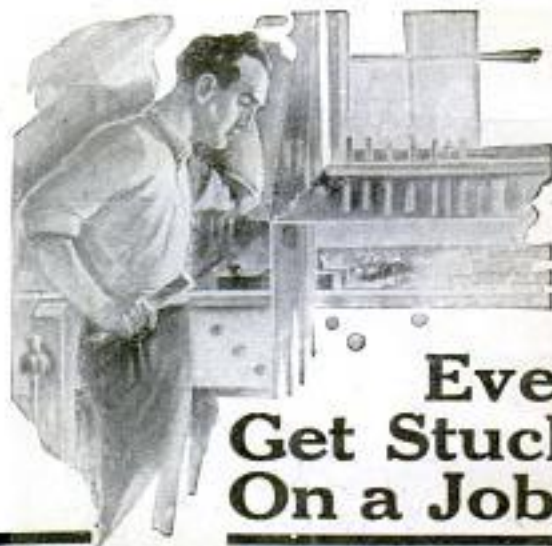

Ever Get Stuck On a Job?

SHOPNOTES FOR 1923

The latest volume of Popular Mechanics series of year books tells

544 Easy Ways to Do Hard Things

of daily use to every mechanic. Among the many useful articles are Shop Crane—Testing Motors—Power Hammer—Arbor Press—Air Compressor—Turret Lathe—Bench Punch—Concrete Mixer—Bench Grinder—Drag Saw—Concrete Tile.

224 Pages—436 Illustrations
Price 50 Cents, Postpaid

Nine of the volumes of Shop Notes issued previously are also obtainable at 50 cents per copy postpaid.

POPULAR MECHANICS BOOK DEPT.
200 E. Ontario St., Chicago

Every Welder Should Have The Welding Encyclopedia

It is America's most complete and authoritative reference and instruction book on welding. It gives you a vast fund of expert knowledge on all forms of welding, conveniently arranged, fully illustrated by drawings and photographs and written in language you can understand. It has the approval of the leading manufacturers in the trade. You need this book in your shop.

326 Pages—375 Illustrations—Clothbound

Edited and Compiled by the Editors of the Welding Engineer with the help of many experts in the welding trade

CONTENTS

Illustrated encyclopedia covering all words, terms and trade names used in welding—Oxy-acetylene Welding—Aluminum, Steel, Cast Iron, Copper, Brass, Bronze, Full instructions for welding each of these metals.—Electric Arc Welding—Electric Resistance Welding, includes Butts, Line, Percussion and Spot Welding—Thermit Welding—Use and Misuse of Oxy-acetylene Equipment—Boiler Welding—Heat Treatment of Steels—Rules and Regulations—Charts and Tables, including temperature color chart—Condensed Catalogs and Buyers' Index.

The Accumulated Experience of the
Welding Brains of America
Yours for \$5.00

Absolute Refund Guarantee—If, after having ordered and examined this book, you are not satisfied with same, return it to us and your money will be refunded.

Popular Mechanics Book Dept.
200 E. Ontario St. Chicago



**Your One Chance to Earn
The Biggest Money of Your Life!**
Millions Can Sell Goods
— but Don't Know It!

**It's a Crime to Slave
for Low Pay —
When It's So Easy To Earn Big Money**

**Blame Yourself
If This Message Doesn't Bring
You A Big Salary Increase**

**The Book That Has Shown Thousands
the Way to Amazing Salary Increases**

Proof of Every Statement In This Amazing Free Book!

You have seen these statements before. Some of them sound startling, but in looking at the proof you will learn facts that will amaze you—facts that may possibly start you on the way to a prosperous future.

YOU have read our announcements time and again. Your interest has been aroused. Then why is it that you have never exerted yourself enough to fill in and mail the coupon, to see for yourself the proof that we offer, Free!

Hundreds of others are now capitalizing on the urge that prompted them to send for the amazing free proof contained in our 64-page book "Modern Salesmanship." They are earning more money than ever before, realizing every reasonable hope and ambition through what they learned in this remarkable book. Many of them are making phenomenal successes in the selling field—earning from five to ten times as much as they formerly earned.

Hundreds who sent for this book once believed, as you may now believe, that salesmen have to be "born" to their task. But these men now have a two-listed grip on prosperity.

These men are virtually their own bosses. They travel—live in daily contact with big business men—they enjoy salaries formerly denied them—their families live better and they are making big money in a profession that is more like a fascinating adventure than work.

READ

Charles Berry of Winterset, Mo., stepped from \$18 a week a position making him \$600 the very first month.
P. Overstreet of Dennison, Texas, read this amazing book, got a job on the Capital Police force and in six weeks earned \$800.
F. Wynn, Portland, Me., an ex-service man, earned \$4.37 in one week.
Geo. W. earns of Oklahoma City and in this book a way to multiply his earnings from \$60 a month to \$524.00 in two weeks.
C. W. Campbell learned in it how he could quit a boring job on the railroad to run \$1,632 in thirty days.

The fact that you are reading this announcement is proof that you are anxious to increase your earning power. While you may think you can't increase it in this way, you surely would spend two cents to find out. So why not send for PROOF of how you can quickly fulfill your ambition. It comes to you free—with no obligation—and after you have studied the amazing evidence you will know beyond all doubt that here is a sure and certain way for you to make the money your ambition dictates.

Take any ten average men who are in blind alley jobs at low pay. Analyze each case

without prejudice. You will find that everyone of them is solely and entirely to blame for his poor earning power. Every one of them at one time or another has had a golden opportunity! They either failed to recognize it, or, recognizing it, lacked the energy or courage to follow it up. But now comes your chance—your one big opportunity. What are you going to do with it?

Write for Your Copy Now

This book, "Modern Salesmanship," explains how thousands have quickly succeeded in the selling field—how it is easy to make big money once you are in the possession of the Secrets of Selling—how you can quickly get these fundamental secrets, apply them and achieve a quick and permanent success. AT LEAST—read the book. Then decide for yourself. And while this important matter is before you fill the coupon and get it into the mails—today.

**National Salesmen's
Training Association**

Dept. 12G
53 W. Jackson Blvd., CHICAGO, ILL.

NATIONAL SALESMEN'S TRAINING ASS'N.

Dept. 12G, 53 W. Jackson Blvd., Chicago, Illinois

I am willing to investigate the opportunity you offer without cost to myself. Please mail me Free Proof that I can become a Master Salesman and qualify for a good sales position. Also send your illustrated book "Modern Salesmanship" and particulars of membership in your Association and its Free Employment Service.

Name.....

Address.....

City..... State.....

Age..... Occupation.....





Be Master of a Real Job

Then you can walk confidently into the office or the plant, knowing you are needed and appreciated—that you have a future bringing more power, better pay, bigger leadership. You won't have to "cool your heels" in waiting rooms looking anxiously for a job at "almost anything."

Good Advice from One Who Climbed

R. H. McElroy, one of the vice-presidents of the Standard Oil Company, who climbed to a \$30,000 salary from a clerical position says (*N. Y. Times*, July 2, 1922): "Any young man who has the right stuff in him, who is willing to work at his job and study after working hours, who will keep his eyes open . . . can achieve the same success." In a letter to us, Mr. McElroy adds: "The correspondence and evening schools provide a splendid opportunity for the young man of limited time and means to prepare himself for a brilliant future."

After a quarter-century of experience in aiding men to become their Bigger Selves, the United Y.M.C.A. Schools offer this tested service by mail, so that wherever you may be, whatever you may need or whatever your hours are, you can get this valuable aid.

Some of our 300 Correspondence Courses

Technical Courses		
Agricultural Courses	Farm Management	Rural Engineering
Architecture	Foremanship	Shop Courses
Automobile Courses	Highway Engineering	—Blacksmith—Machine
Building Construction	Mechanical Engineering	—Foundry—Pattern
Civil Engineering Courses	Plumbing	Steam Engineering
Concrete Engineering	Public Husbandry	Structural Drafting
Drafting Courses	Radio Engineering	Surveying
Electrical Courses	Radio Telegraphy	
Commercial and Other Courses		
Accountancy	Business English	Insurance Courses
Advertising	Business Finance	Mathematical Courses
Applied Psychology	Business Law	Physical Directors Training
Banking	English Courses	Public Speaking
Business Letters	Foreign Languages	Salesmanship
Bookkeeping	Grammar School Courses	Shorthand and Typewriting
Business Arithmetic	High School Courses	Slow Card Writing
Business Administration	Illustrating	Traffic Management

Mark and mail the coupon for our friendly counsel.

Without obligating me, please advise regarding the course in.....

Name.....

Full Address.....

Dept. 74-Ju

Please write plainly

United Y.M.C.A. Schools
Correspondence Instruction *The most Service for the least Money*
347 Madison Ave. New York City, N.Y.

Please Mention Popular Mechanics

Be A Practical Electrician

YOU can qualify in three months for a real job by the Sweeney System of Practical Experience. You don't need to be an engineer or scientist to install, operate and repair all kinds of electrical machinery. We teach with tools. You learn by actually working on our \$150,000 special equipment in this world famous Million Dollar Trade School where we have turned out 55,000 trained mechanics.



E. J. SWEENEY,
President

FREE Simply send name today. Get our Special Offer and interesting Electrical Catalog. Free radio course. Free Railway fare to Kansas City. Big opportunities in Electrical industry for young men. Colored students not accepted.

WRITE US AT ONCE

LEARN A TRADE—
Sweeney
AUTOMOTIVE & ELECTRICAL SCHOOL
3 SWEENEY BLDG. KANSAS CITY, MO.

BE AN EXPERT
Penman

I TEACH BY MAIL. You can become an expert penman right in your own home by my method. Small Cost. All that is required is some of your Spare Time. Write for my book, "HOW TO BECOME AN EXPERT PENMAN." It contains specimens and tells how others became expert writers by the TEVIS METHOD. Your name written on a card if you enclose stamp. FREE BOOK. Write today. T. M. TEVIS, BOX 25K, CHILlicothe, MO.

STAMMER
If you stammer attend no stammering school till you get my large FREE book entitled "STAMMERING, Its Origin and the Advanced Natural Method of Cure," bound in cloth and stamped in pure gold. Ask for special tuition rate and a FREE copy of "The Natural Speech Magazine." Largest, best equipped and most successful school in the world for the cure of stammering; stuttering, etc. No sing-song or time beat. Write today. The North-Western School, 2317 Grand Ave., Milwaukee, Wis.

IT'S EASY TO PLAY THE
TENOR-BANJO

THIS
\$15.00
TENOR BANJO
FREE

No Previous Musical Knowledge Necessary. Play Music Your First Lesson. Wonderful Method Only 5 minutes and you master them quickly. After a short period of easy practice you will be playing all the popular hits, just as you have heard experts play them on the stage, in Dance Orchestras—everywhere! It is the most popular instrument of the age and you can quickly learn to play it. Prof. Barker will teach you to chord and harmonize exactly as he does in an amazingly short time! And remember we furnish your tenor banjo free. Write for details of our course and free offer. Address

First Hawaiian Conservatory of Music, Inc.
Desk 60, 233 Broadway (Woolworth Bldg.) N. Y.



5,000,000 Men Are After the Routine Jobs—

*Break Away From
This Competition—*

Command Big Pay!

When business slackens, can your employer "let you go"—and tomorrow hire almost any routine man from this army of 5,000,000 men and find him competent to take your place?

Observe that when a business trims its crew, it is almost never the *big-pay* men who walk the plank.

Not only are the specialists retained—the Accountants, Production Managers, Traffic Managers, and, in fact, the managers of any of the important departments of a business—but they are frequently promoted. Other concerns are in need of their ability, and come bidding for their services.

Many of these men who today are going rapidly ahead were no better off than you, several years ago. Today, while others walk the streets, these men walk into the better jobs.

There is no mystery about their swift advancement. There is a way that's interesting and practical whereby any man of average intelligence can get the training that will put him in the big-pay class. Literally thousands of ambitious men have found this way in the LaSalle Problem Method. They have chosen the line of work that most appealed to them—then, right in the quiet of their own homes, without losing an hour from work or a dollar of pay, they have solved the problems they today are meeting in the better jobs.

Situations which they face today are identical with those they faced in spare-time study. They have been shown exactly how to meet them—guided every step of the way by some of the ablest business men, in their respective fields, in America.



Read these statements, typical of over 1,000 which we will send you in booklet form and which represent but a small part of the many thousands of similar letters in our files:

"The most efficient and most rapidly promoted men in our whole organization are LaSalle-trained."

"Promoted to General Manager."

"Now a director in two banks."

"From bookkeeper advanced to chief accountant—salary increased 500%."

"Passed bar examination with highest grade, in competition with many resident school graduates."

"The Problem Method increased my income \$2,500 a year."

"Passed C. P. A. examination. You will be interested to know that 50% of the successful candidates were LaSalle-trained men."

An analysis of the letters from 1,193 LaSalle members reporting definite salary increases during 3 months' time shows an average increase per man of 89%.

While the axe hangs over every business office, it's the time of all times to free yourself forever from the treadmill jobs.

Mark on the coupon the training that attracts you, sign and mail it to the University. It will bring you full information, together with particulars of our convenient-payment plan; also your free copy of the inspiring book—"Ten Years' Promotion in One."

Break away from the crowd of routine pluggers. Find out today what YOU must do to put yourself among the men who command big money. Mail the coupon NOW.

INQUIRY COUPON

LASALLE EXTENSION UNIVERSITY, Dept. 664-R CHICAGO, ILLINOIS

Please send me catalog and full information regarding the course and service I have marked with an X below. Also a copy of your booklet, "Ten Years' Promotion in One," all without obligation to me.

- | | | | |
|---|--|--|---|
| <input type="checkbox"/> Business Management | <input type="checkbox"/> Law—Degree of LL. B. | <input type="checkbox"/> Banking and Finance | <input type="checkbox"/> Expert Bookkeeping |
| <input type="checkbox"/> Modern Salesmanship | <input type="checkbox"/> Commercial Law | <input type="checkbox"/> Personnel and Employment Management | <input type="checkbox"/> Business English |
| <input type="checkbox"/> Higher Accountancy | <input type="checkbox"/> Industrial Management Efficiency | <input type="checkbox"/> Modern Foremanship & Production Methods | <input type="checkbox"/> Commercial Spanish |
| <input type="checkbox"/> Traffic Management | <input type="checkbox"/> Modern Business Correspondence and Practice | | <input type="checkbox"/> Effective Speaking |
| <input type="checkbox"/> Railway Station Management | | | <input type="checkbox"/> C. P. A. Coaching |

Name..... Present Position.....

Address.....

LEARN CARTOONING the Right Way



Have your ability trained by the school that has developed many famous cartoonists.

If you like to draw—if you find pleasure in picking up a pencil and paper and trying to make sketches or cartoons, don't regard it merely as a hobby. Have your ability developed and earn a good income as a cartoonist.

Hundreds of nationally known cartoonists, such as Branner of the Chicago Tribune; Blosser, who draws "Freckles and His Friends"; Gene Byrnes, creator of "Reg'lar Fellers"; Thiele of the Sioux City Tribune; Fung, of the Seattle Times and others equally well known, took the Landon Course at home, in their spare time, and fitted themselves for their present positions at salaries ranging from \$50 to \$200 and more per week.

Have YOUR talent developed by the same method

What the above mentioned boys did you can do, with the same training. The Landon method of teaching makes cartooning easy to learn. By means of an extensive series of Big picture charts all the necessary details of ORIGINAL drawing are explained step by step, in a clear and simple manner.

FACTS that determine the superiority of the Landon School:

1. Landon School Students are securing the best cartooning positions which open up everywhere.
2. The picture chart method of instruction was originated and is used exclusively by the Landon School.
3. From the very beginning, the Landon Course teaches ORIGINAL drawing. No copy work.
4. Individual attention and criticism of student's work. Personal coaching whenever necessary.
5. Specialized instruction on how to originate cartoon ideas. This is an exclusive feature of the Landon Course.
6. Practical assistance in securing positions for students and help in marketing their work.
7. The price is within reach of everyone who is ambitious to succeed. Easy payments can be arranged.

Write today for full information about the Landon Course, and sample chart by means of which you can test your own ability. Find out what the possibilities are for YOU in this interesting profession. Please state your age.

The Landon School
838 National Bldg. Cleveland, Ohio

FIRE! FIRE!! FIRE!!!

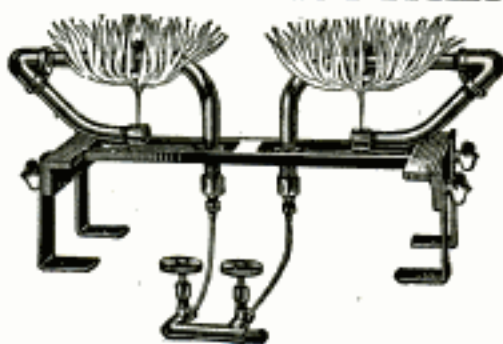

GAS-FIRE MADE FROM AIR

mixed with a little kerosene in any type cook stove, heating stove or furnace. COAL AT \$5.00 A TON would not compare with GAS-FIRE in cheapness, cleanliness, convenience, efficiency.

AGENTS \$50.00 TO \$250.00 WEEKLY

HEAT APPLIANCE CORP.

109 N. May Street

Chicago, Ill.

LEARN WATCH REPAIRING



You can learn by our modern and original system of instruction every part of the Watch Repairing Trade at home as good or better than at a shop. You can earn money while learning and secure a well paying position or start in business after completing our course of instruction. Good watch repairers are always in demand and earn from \$30 to \$70 per week. For particulars apply to the Wisconsin School of Watch Repairing
166 Mason St., MILWAUKEE, WIS.

MUSIC LESSONS FREE

IN YOUR OWN HOME

You can read Music like this quickly

Piano, Organ, Violin, Mandolin, Guitar, Banjo, etc. Beginners or advanced players. One lesson weekly. Illustrations make everything plain. Only expense about 5¢ per day to cover cost of postage and music used. Write for FREE booklet which explains everything in full.
AMERICAN SCHOOL OF MUSIC, 50 Lakeside Building, CHICAGO

Can you afford to

STAMMER?

or STUTTER?

It rules many chances for promotion. Send postage for large free book "The Correction of Stammering and Stuttering." Methods successful for over a quarter-century. THE LEWIS INSTITUTE, 33 Lewis Bldg., 77 Adelaide St., Detroit, Mich., U.S.A.



\$133 to \$192

MONTH

**Men — Boys
18 or Over**

Mail Coupon
Today Sure!

FRANKLIN INSTITUTE
Dept. 9179, Rochester, N. Y.

Kindly send me, by return mail free information telling how I can get into the U. S. Gov't service as Railway Mail Clerk (\$1690 to \$2300 a year), or as City Mail Carrier or Post Office Clerk (\$1400 to \$1800 a year).

Name

Address

I Pay Your Railroad FARE

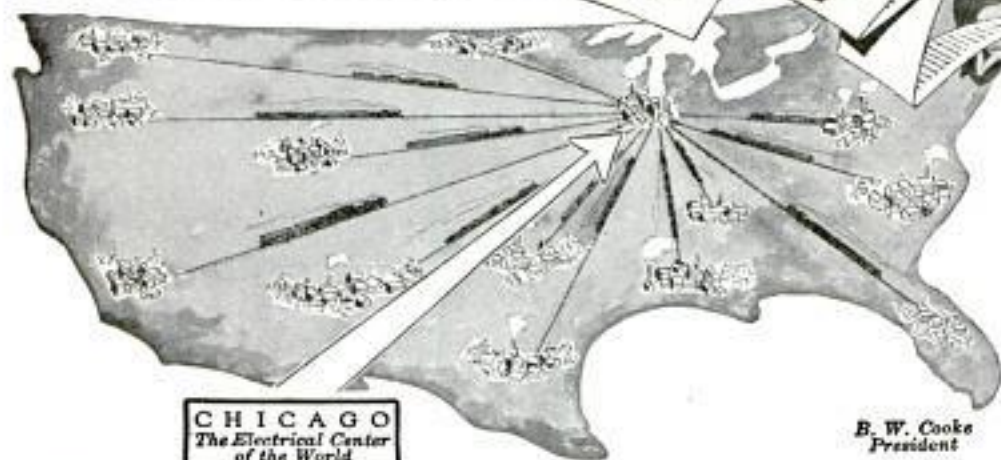

B. W. Cooke
President



Come to Chicago—the Electrical Center of the World—I pay your railroad fare from any place in the United States. Grasp this opportunity to see the country at my expense. Don't stick in one spot—travel—get experience. Come to Coyne—learn electricity in 3 months. Fit yourself for a big paying job. The largest electrical school in the country specializing in electrical instruction ONLY.

Learn Electricity in 3 Months

Get a complete training so you can make big money as Power Plant Operator, Superintendent, Telephone man, Construction worker, auto, truck or tractor electrician, battery man, radio expert, or you can go into business for yourself as electrical contractor, dealer, auto ignition or battery expert and make from \$3,000 to \$20,000 a year. Hundreds of our graduates today are making big money and you can do the same if you grasp this opportunity—act now.

Great Shops of Coyne

No books or useless theory. You are trained on \$100,000 worth of electrical equipment. Everything from door bells to power plants. You work on motors, generators, house-wiring, autos, batteries, radio, switch-boards, power plants—everything to make you an expert ready to step right into a position paying from \$45 to \$100 a week.

RADIO COURSE FREE. We include the following free with the regular course:

- (1) A complete course in auto, truck and tractor electricity and storage batteries. Greatest outlay of auto, electrical and battery equipment in the country.
- (2) Course in Radio—the marvel of the age. Constructing, installing and operating. Build your own wireless telephone set.
- (3) Life membership in the Coyne school. Stay as long as you wish and return for further training at any time in the future.

Earn While You Learn! We help students to secure jobs to earn a good part of their expenses while studying.

Send Coupon

Don't delay a minute—send that coupon right now for our big free catalog and full particulars of Free Railroad Fare offer. Remember this special offer is limited so act now!

COYNE
Electrical School
Endorsed by Electrical Industry

1300-1310 W. Harrison St., Dept. A-135

B. W. Cooke, Pres.

Coyne Electrical School

1300-1310 W. Harrison St., Dept. A-135 Chicago

Dear Sir: Please send me free your big catalog and full particulars of your special offer of Free Railroad Fare and two extra courses.

Name

Address



Student Winding a Stator

Only 8 weeks to get a big job in auto & tractor business

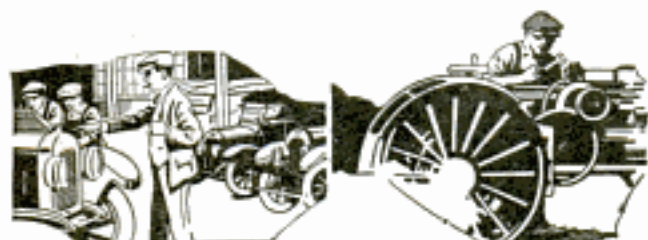

Louis Beimer at 24 was made foreman over men many years older. That's not luck—it's Rahe training.

Emanuel Rushfeldt, Alberta, says: "Earning \$10 a day and only 20 years old."

Big Firms Need Trained Men

The Auto and Tractor Business is on the boom. Thousands of trained men will be needed during the next few months. I get calls every day from Garages, Battery Stations, Auto Repair, Welding Shops and other successful concerns for Rahe men. When the big fellows need high grade men they know where to come for them. They want Rahe trained men who know the work from A to Z.

My Training Unusual

Scientific tool training—that's the secret. You do things here according to the latest engineering standards. Thousands of dollars have been spent in modern tools and equipment. That's why my men are at home in the biggest shops in the country. If you want to succeed the way Beimer and Rushfeldt and the rest have—qualify by the same method.

I'll Pay Your Railroad Fare and Board You

In order to fill the openings that now exist, I am making an offer no one has ever made before—Free railroad fare, Free board. But even that is not all. I'll tell you about the rest in my letter. Write me at once.

Rahe AUTO & TRACTOR Schools

CINCINNATI Dept. 904 CHICAGO
Ninth and Walnut 4445 Grand Blvd.

My big illustrated training book tells how others are succeeding. It tells many things you ought to know about Autos and Tractors. Write for it and my short time offer NOW. It soon expires.



ACT NOW
RAHE AUTO & TRACTOR SCHOOLS,
Dept. 904 (address label saved you) 4445 Grand Blvd., Chicago, Ill.
Without any obligation, send me your big free book "The Evolution of Transportation." Also information regarding special temporary offer.

Name _____ Street _____ City _____ State _____

Please Mention Popular Mechanics

COMMERCIAL ART

A Big Field for Men and Women

Be a Creative Commercial Artist. Don't be the "tell me what to do" kind. Creative artists are worth from \$100.00 to \$500.00 per week and more. Our academy is the only school basing its instruction upon the actual practices of the Master Commercial Artist. By analysis of Commercial Art Master Pieces we find the methods of the artist. By constructive instruction we teach these principles, developing the student step by step, until he is producing high grade Commercial Art.

The 1923 edition of our course embodies all up to date Commercial Art Practices. Large Commercial Art houses, employing hundreds of artists, have endorsed us as their training school. Students finishing half of this unusual course can secure and hold desirable positions. Four month students can begin to sell drawings.

Home study or class room instruction. Both day and evening classes. Get our big beautifully illustrated book telling all about Commercial Art and the opportunities it presents as WE TEACH IT. Send 6 cents in stamps for a copy.



"STAMMERING

Its Cause and Cure"

You can be quickly cured if you stammer. Send 10 cents, coin or stamps, for 288 page cloth bound book on Stammering and Stuttering. It tells how I cured myself after Stammering and Stuttering for 20 years. BENJAMIN N. BOGUE
6930 Bogue Building, 1147 N. 111 St. Indianapolis

Music Lessons

UNDER MASTER TEACHERS

At Home

Any Instrument

Write, naming course you are interested in: Piano, Harmony, Voice, Public School Music, Violin, Cornet, Mandolin, Guitar, Banjo or Reed Organ—and we will send FREE CATALOG. SEND FOR IT NOW!

University Extension Conservatory, 785 Maple-Noyes Bldg., Chicago

Complete Conservatory Course by Mail

Wonderful home study music lessons under great American and European teachers. Endorsed by Paderewski. Master teachers guide and coach you. Lessons a marvel of simplicity and completeness.

HOW TO BECOME A PROFESSIONAL PHOTOGRAPHER

EARNING \$35 TO \$125 A WEEK

Three to six months' course. Motion Picture, Commercial, Portraiture. Practical instruction. Modern equipment. Ask for Catalog No. 49.

N. Y. INSTITUTE OF PHOTOGRAPHY
NEW YORK CHICAGO BROOKLYN
141 W. 36th St. 630 So. Wabash Ave. 505 State St.

LEARN WATCH REPAIRING

Be a watchmaker—you can learn this profitable trade by correspondence in a few weeks in your own home by the DeSelms Chart System. After you complete the course you will know a watch from A to Z. You will know just what the matter is and how to repair one. When you graduate you will be a practical watchmaker and repairer and competent to fill any position. Positional or our graduates.

Ask for our Free Book. It explains our system and terms

THE DeSELMS WATCH SCHOOL
23 Perry Street ATTICA, INDIANA



How Do You Look in a Bathing Suit?

The good old swimming days are here. Oh boy! But it's great to rip off the old shirt, into your suit and take the splash. But what a shock to some of the poor girls when they see their heroes come out with flat chests and skinny arms instead of the robust frames they expected to see.

You Can't Fool Them

Don't try to make excuses. You should have knobs on your arms like a baseball. A fine protector you would make, when you can't even fight your own battles. What are you going to do? She is going to find you out.

Look Your Best

It's not too late. I can save you yet. It means hard work and plenty of it, but think of the results. In just 30 days I am going to add one full inch to your biceps. Yes, and two inches on your chest in the same length of time. But that's only a starter. I am going to

broaden out those shoulders and put real pep into your old backbone. You will have a spring to your step and a flash to your eye, showing you to be a real, live man. Before summer is past you won't recognize your former self. You will have a physique to be really proud of. This is no idle talk, fellows. I don't promise these things. I guarantee them. Come on and make me prove it.

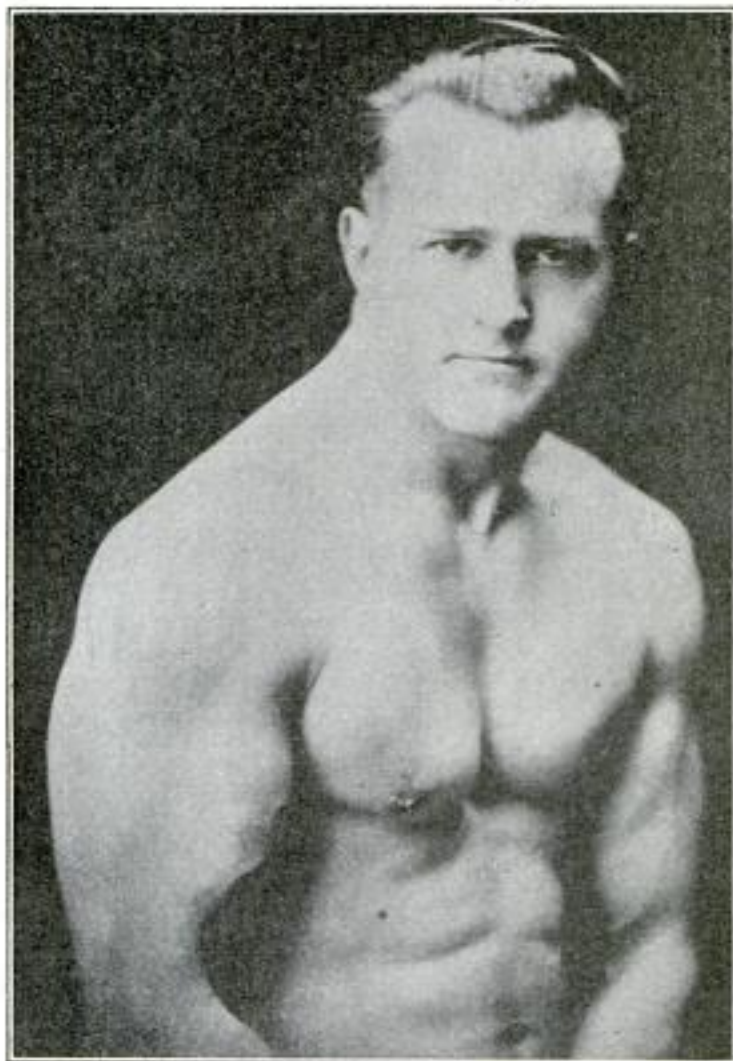

EARLE E. LIEDERMAN as he is to-day

Send for My New 64-Page Book, "MUSCULAR DEVELOPMENT"

It contains forty-three full-page photographs of myself and some of the many prize-winning pupils I have trained. Some of these came to me as pitiful weaklings, imploring me to help them. Look them over now and you will marvel at their present physiques. This book will prove an impetus and a real inspiration to you. It will thrill you through and through. All I ask is 10 cents to cover the cost of wrapping and mailing and it is yours to keep. This will not obligate you at all, but for the sake of your future health and happiness, do not put it off. Send today—right now, before you turn this page.

EARLE E. LIEDERMAN

Dept. 2006

305 Broadway NEW YORK CITY

EARLE E. LIEDERMAN

Dept. 2006, 305 Broadway, New York City

Dear Sir:—I enclose herewith 10 cents for which you are to send me, without any obligation on my part whatever, a copy of your latest book, "Muscular Development." (Please write or print plainly.)

NAME.....

STREET.....

CITY.....STATE.....



\$2500 Reward for the Conviction of—

WHO murdered John Blake? The country was stunned by the crime mystery of the year. A rich reward was offered. There were clues a-plenty. Circumstantial evidence pointed to a dozen men. But the District Attorney didn't dare bring anyone of them to trial. Then the Finger Print Expert stepped in.

With feverish excitement the crowd in the courtroom listened. Judge, jury, attorneys and onlookers leaned forward in strained silence, eager to catch every word. The young Finger Print Expert in the witness chair was the center of attraction, as with calm assurance, he gave the evidence that convicted the murderer, and brought him the \$2500 reward.



I Can Make YOU a Finger Print Expert

I have trained hundreds of the men now prominent in the Profession. For instance, there's Harry Passano, Chief of the Iowa State Bureau. He had no previous experience—no college or high school education. He was just a country photographer. I trained him.

T. G. Cooke, President
I can do the same for YOU. You may study right at home—in your spare time.

Right NOW is the time to start. More trained men are needed to fill the positions created almost daily. Salaries are high. Chances for big rewards are frequent. The Finger Print Expert is respected and deferred to by all. I am offering you a big opportunity. Will you take it?

Professional Finger Print Outfit—Free

A professional outfit, just like the Finger Print Expert uses in court, in the laboratory and at the scene of crime, is yours FREE with this famous course of training. Also a course in Secret Service Intelligence is FREE to you if you enroll early. Mail the coupon for my free book telling all about the exploits of finger print detectives and full information about this wonderful profession, and your opportunity as a Finger Print Expert.

T. G. COOKE, President

UNIVERSITY OF APPLIED SCIENCE

1920 Sunnyside Ave. Dept. A-135 Chicago, Ill.

University of Applied Science,
1920 Sunnyside Avenue, Dept. A-135 Chicago, Ill.

Gentlemen: Without any obligation whatever, send me your new, fully illustrated, FREE book on Finger Prints and your offer of a FREE course in Secret Service Intelligence and the Free Professional Finger Print outfit.

Name.....

Address.....

City and State..... Age.....

Please Mention Popular Mechanics

I Teach by Mail

I can make a good penman of you at your home during spare time, no matter where you live or how poorly you now write. My simplified system has shown thousands the way to good penmanship during the past twenty-five years—IT CAN and WILL do the same for YOU.

My beautifully illustrated 32-page Book
"How to Become a Good Penman" FREE!!

It contains many beautiful specimens of penmanship showing what others have accomplished by the Tamblin System, with testimonials and general information about our courses. (Your name elegantly written on a card if you enclose stamp for postage.) Ladies taught as successfully as men. Write Today. Address
F. W. TAMBLIN
418 Ridge Bldg. Kansas City, Mo., U. S. A.

ELECTRICAL men with training are in demand. For more than a quarter of a century this school has been training men of ambition and limited time, for the electrical industries. Condensed course in Electrical

ENGINEERING

enables graduates to secure good positions and promotions. Theoretical and practical Electricity, Mathematics, Steam and Gas Engines, Mechanical Drawing. Students construct dynamo, install wiring and test electrical machinery. **IN ONE YEAR**
Course with diploma, complete



Thoroughly equipped fireproof dormitories, dining hall, laboratories, shops. Over 3000 men trained.

Write for catalog. 31st year begins Sept. 26, 1923.

BLISS ELECTRICAL SCHOOL

104 TAKOMA AVENUE, WASHINGTON, D. C.

STAMMER NO MORE

Kill the fear of stammering. Re-education the key. The widely famed Hatfield Method fully outlined in an accurate, dependable, worthwhile book—"HOW TO STOP STAMMERING." It has helped thousands. Free copy today.

THE HATFIELD INSTITUTE, 109 N. Dearborn, Chicago, Ill.

LEARN TO GET DOLLARS OUT OF WATCHES.

WATCH-REPAIRING, ENGRAVING, JEWELRY REPAIRING.

WRITE NOW.
ENICAR TRADE SCHOOL
830 W. MONUMENT SQUARE, RACINE, WIS.

LAW

Learn law with only institution giving same course by correspondence as was given for years at resident classes of this college. **DEGREE OF LL. B. CONFERRED.** One year business law course prepares you for success in business. Law trained business men in demand. Three year university course covers preparation for bar examination.

Money back guarantee if not satisfied. Low fee, easy terms, includes complete 1321 thirteen volume library, text material and all expenses. Write for **FREE BOOK.**

Hamilton College of Law
431 So. Dearborn St., Dept. 60A Chicago

CAN YOU DRAW?

Earn Money Drawing Pictures

Opportunity to increase your earnings. Learn to do it once and make pay. **"MONEY HUNTERS FOR THE ARTIST"**—book instructs you. How and What to Draw and Where to Sell. List of Markets, etc. For the artist in the country as well as the city. Satisfaction guaranteed. Send \$1 TODAY for copy or send stamp for particulars.



NOVEL ART STUDIOS, Dept. D, 7 East 42nd Street, NEW YORK CITY



A Big Raise in Salary!

Is Very Easy to Get, If You Go About It in the Right Way

You have often heard of others who have doubled and trebled their salaries in a year's time. You wondered how they did it. Was it a pull? Don't you think it. When a man is hired he gets paid for exactly what he does, there is no sentiment in business. It's preparing for the future and knowing what to do at the right time that doubles and trebles salaries.

Remember When You Were a Kid

and tried to ride a bike for the very first time? You thought that you would never learn and then—all of a sudden you knew how, and said in surprise: "Why it's a cinch if you know how." It's that way with most things, and getting a job with big money is no exception to the rule, if you know how.

We Will Show You How

Without loss to you of a single working hour we can show you a sure way to success and big pay. A large number of men in each of the positions listed are enjoying their salaries because of our help—we want to help you.

Make check on the coupon against the job you want and we will help you to get it. Write or print your name on the coupon and send it in today.

American School

Dept. G.A-74 Drexel Ave. and 58th St., Chicago

American School, Dept. G.A-74 Drexel Ave., and 58th St., Chicago

Send me full information on the subject checked and how you will help me win success.

..... Architect
 Building Contractor
 Automobile Engineer
 Automobile Repairman
 Civil Engineer
 Structural Engineer
 Business Manager
 Cert. Public Accountant
 Accountant and Auditor
 Bookkeeper
 Draftsman and Designer

..... Electrical Engineer
 Electric Light and Power
 General Education
 Vocational Guidance
 Business Law
 Lawyer
 Machine Shop Practice
 Photoplay Writer
 Mechanical Engineer
 Shop Superintendent
 Employment Manager

..... Steam Engineer
 Foremanship
 Sanitary Engineer
 Surveyor (& Mapping)
 Telephone Engineer
 Telegraph Engineer
 High School Graduate
 Fire Insurance Expert
 Wireless Radio
 Undecided

Name..... Address.....

EARN ^{up to} \$400 ^{per Mo.}

LIVING EXPENSES PAID



Prepare for well-paid HOTEL Position

waiting for you

Fit yourself for a position leading to rapid advancement in the most fascinating business in the world—full of big opportunities for the trained employee.

BIG PAY Fine Chance for Advancement

Beginners earn \$80 to \$200 a month; meals and often

Many Employees WANTED

By Leading Hotels

- 2 Room Clerks \$175-200 Mo.
 - 1 Steward \$375-425 Mo.
 - 1 House Cashier \$175 Mo.
 - 1 Manager \$10,000 Yr.
 - 1 Housekeeper \$175 Mo.
 - 1 Storeroom Bookkeeper \$150 Mo.
 - 1 Asst. Manager \$225 Mo.
 - 3 Mail Clerks \$125-150 Mo.
- Partial list. Many positions with room and meals.

rooms furnished. Trained men earn more—advance more rapidly, because they have the experience of successful men to guide them.

WE TRAIN YOU

We have successfully trained thousands by mail for higher positions—better pay. We will do the same for you—no previous experience necessary. We will teach you how to fill any hotel position—the true fundamentals of the hotel business—all in your spare time, of a few minutes each day for a few weeks.

A Position Is Waiting for YOU

When you graduate, you don't have to look for a position. Positions will look for you. Hotels are looking to us for trained employees. *They welcome our graduates.* Will you be one of the sought-for men and women to fill the positions such as listed in our bulletin, which you should send for?

Send Coupon Today!

**STANDARD
BUSINESS
TRAINING
INSTITUTE**
Carlton Court
Buffalo, N. Y.

Secures Position Before Graduating

The question that worried me the most, and has worried the majority of your prospective students, I presume, was 'Will they be able to get me a job?' Actions speak louder than words, and your actions surely spoke loud. I had not been under your instruction even two months before you placed me here at the _____ That fact is most doubly significant when I consider that previous to the day I started your instruction I had not one single hour of any kind of hotel experience.

(Signed) Raymond W. Zippich.
Note: Mr. Zippich's address sent on request.

Standard Business Training Inst.
Carlton Court, Buffalo, N. Y.

Send me free booklet H-166 giving full information about Hotel Operation and Management Course, also employment bulletin listing positions open.

Name

Street

City

Please Mention Popular Mechanics

ELECTRICITY

Learn and Earn

Be An A1
Electrician

Make Real Money

Electricity in any way it is followed is a real money-maker for the man who has had this standard training.

Electricity is the CREAM of the automotive business.

It is one thing the average auto mechanic is weak on.

We are especially equipped to teach this business RIGHT, as well as all branches of the automotive business. The very best ideas, coupled with years of experience, have been combined in working out a continuous and well-rounded system of practical training, made as simple as it is humanly possible to make it.

Write for Big Free Catalogue Today

Iowa State Auto and Electrical School
739 Nebraska St. SIOUX CITY, IOWA

Learn to PAINT SIGNS and SHOW CARDS

Big field—unlimited possibilities—increasing demand for men with creative ideas. Our course develops ability and originality. Work intensely interesting.
EARN \$25 TO \$75 WEEKLY

You can do it if ambitious. Successful graduates everywhere. Our course thoroughly covers every phase of work. Our graduates command big salaries. Write for catalog, samples, guarantee and Free Quilt Offer.
Detroit School of Lettering, 630 D. S. L. Bldg., Detroit, Mich.



HIGHER EDUCATION

HOME
STUDY

Courses in English, Spanish, Mathematics, Chemistry, Drawing, Education, Business and in 35 other subjects are given by correspondence. Begin anytime.

The University of Chicago

31st Year

Division 4, Chicago, Ill.

LEARN Wrestling Secrets at Home by Mail



Yes, learn the secrets of World's Champions—how to wrestle expertly—how to handle big men with ease—how to win. Be athletic, be strong, be healthy. Learn how to defend yourself.

Farmer Burns

the world's most scientific wrestler, who trained the undefeated Champion Frank Gotch—who also trained six other World's Champions, will now train you. Investigate today his wonderful methods—the secrets of Champions. Every man and boy in the world, no matter what age, needs this information on SCIENTIFIC WRESTLING—PHYSICAL CULTURE—JU-JITSU—SELF DEFENSE.

Free Book Send your name and age and get my splendid 22 page illustrated wrestling and athletic book—absolutely free—no obligations of any kind. Write NOW.
FARMER BURNS, A177 Ry. Exchange Bldg., Omaha, Neb.

You Can Easily Learn to Play Any Music on the HAWAIIAN GUITAR

Just As Hawaiians Do—Native Instructors Teach You QUICKLY!

Here's Proof of our Remarkable Course

Buchanan, Va.
First Hawaiian Conservatory of Music, Inc.

It has been two months since I have finished your course on the Hawaiian Guitar and I can play anything I wish. The course was all that could be desired and I am perfectly pleased with my playing ability since finishing your course.

Respectfully yours,
Louise B. Hammond

Koester School,
214 So. Franklin St.,
Chicago, Ill.

First Hawaiian Conservatory of Music, Inc.

I shall certainly be very glad to recommend your course whenever the chance is mine to do so. Mr. W. R. Johnson has not phoned me yet, and if he does not phone in a day or so, will write him. Am sending a letter to Miss Helen Sivik today which I think may help to secure her enrollment, and I shall be glad at any time to write a personal letter to anyone whom you may suggest.

Your former student,
W. L. Walker

Special Courses under famous teachers. Tenor-Banjo, Violin, Banjo-Ukulele and Ukulele. Fine Tuned Instruments

FREE!

In Half an Hour You Will Be Playing "ALOHA". Soon You Will Be Winning Praise Everywhere Playing "Stumbling", "Three O'Clock in the Morning", "Hot Lips" and ALL Popular Music as Well as the Beautiful Hawaiian Melodies

Here's the chance you've been waiting for—the opportunity to play popular music quickly on the most entrancing instrument of the age—the Hawaiian Guitar. No previous musical knowledge necessary.

ONLY FOUR MOTIONS TO LEARN and these you acquire in a few minutes. No troublesome scales or runs, you begin to play harmonious chords immediately! We don't care if you never saw a note of music in your life, we guarantee to teach you to play just as the Hawaiians do!

We Furnish Everything—a Beautiful Hawaiian Guitar, Picks, etc., and 52 Pieces of Music FREE!

You have always wanted to play some instrument, so we have made it unusually easy for you by furnishing everything—a beautiful Hawaiian Guitar, complete Conservatory Course of instruction and 52 pieces of especially selected music.

No Other Course Teaches as Quickly and Easily
This is the only Conservatory Course where you get the personal instruction of Native Hawaiian Experts—Frank Ferrera, Walter Kolomoku, Lawrence Kalaiuki and Carl Seville, famous the world over and the most noted makers of phonograph records, supervise your playing.

Mail Coupon for Details of FREE Offer
Don't wait another minute—clip, fill in and mail the coupon NOW and get full details of our remarkable offer to teach you how to play the Hawaiian Guitar just as the Hawaiians do.

Special Arrangements for Lessons if You Have Your Own Instrument

FREE

This \$15
Hawaiian
Guitar

You will be delighted with the fine tone of this splendid Hawaiian Guitar



First Hawaiian Conservatory of Music, Inc.,
Desk 42, 233 Broadway (Woodworth Bldg.), New York.

Send me at once details about your 52 easy lessons and FREE Hawaiian Guitar offer!

Name.....

Address.....

Town..... State.....

Print name and address clearly

AVIATION Information FREE

Send us your name and address for full information regarding the Aviation and Airplane business. Find out about the many great opportunities now open and how we prepare you at home, during spare time, to qualify. Our new book "Opportunities in the Airplane Industry" also sent free if you answer at once.

AMERICAN SCHOOL OF AVIATION

Dept. 119A 3601 Michigan Ave. CHICAGO

BE A NEWSPAPER ARTIST!



Win fortune and fame. MANUEL ROSENBERG COURSE IN NEWSPAPER ART tells you how. 71 Lessons and 150 illustrations. Drawing made easy. Complete instruction in layouts, lettering, illustration, cartooning and sketching. Ten years' experience as staff artist of important American dailies. Send \$5 or order c. o. d. today. Your money refunded if you do not agree that this is the greatest art course value ever offered.

MANUEL ROSENBERG, Butler Bldg., P. M., Cincinnati, O.

Whatever Your Question;—be it the pronunciation of Bolshevik, the spelling of a puzzling word, the location of Murman Coast—the meaning of blighty, ace, tank, ukulele, etc., this Supreme Authority—

WEBSTER'S NEW INTERNATIONAL DICTIONARY

contains an accurate, final answer 400,000 Words, 2700 Pages, 6000 Illustrations.
Regular and India-Paper Editions. G. & C. MERRIAM CO., Springfield, Mass.

Write for specimen pages, prices, etc. and FREE Pocket Maps per Popular Mechanics



WANTED—RAILWAY MAIL CLERKS

\$133 to \$192 a Month for Life

Every second week off with full pay—no "lay offs" because of strikes, poor business, etc.—sure pay—rapid advancement to higher positions. City and country residents stand same chance. Common sense education sufficient—no political influence.

DON'T DELAY—ACT AT ONCE

Send Coupon today—sure. Every day's delay means so much less chance of appointment from the next examinations—so write at once.
FRANKLIN INSTITUTE, Dept. S181, ROCHESTER, N. Y.

Take the First Step for a U. S. Government Job
Use Coupon Before You Lose It

COUPON

FRANKLIN INSTITUTE, Dept. S181, Rochester, N. Y.
Kindly send me, entirely free of charge, (1) A full description of the position checked below; (2) Specimen examination questions; (3) Free copy of copyrighted book "Government Positions and How to Get Them;" (4) A list of U. S. Government Jobs obtainable; (5) Tell me how to get the position here checked.

..... Railway Mail Clerk (\$1600 to \$2300) Customs Positions (\$1100 to \$2000)
..... Postoffice Clerk (\$1400 to \$1800) Internal Revenue (\$1100 to \$2000)
..... City Mail Carrier (\$1400 to \$1800) Rural Mail Carrier (\$1800 to \$2600)
..... Income Tax Auditors (\$2940 to \$3900)

Name.....



"There's One Man We're Going to Keep"

"Ed Wilson, there, is one of the most ambitious men in the plant. I notice that he never fools away his spare time. He studies his International Correspondence Schools Course every chance he gets.

"It's been the making of him, too. He hasn't been here nearly so long as Tom Downey, who was laid off yesterday, but he knows ten times as much about this business.

"I'm going to give him Tom's job at a raise in salary. He's the kind of man we want around here."

HOW do you stand in your shop or office? Are you an Ed Wilson or a Tom Downey? Are you going up? Or down?

No matter where you live, the International Correspondence Schools will come to you. No matter what your handicaps or how small your means, we have a plan to meet your circumstances. No matter how limited your previous education, the simply-written, wonderfully-illustrated I. C. S. textbooks make it easy to learn.

This is all we ask: Without cost, without obligating yourself in any way, put it up to us to prove how we can help you. Just mark and mail this coupon.

TEAR OUT HERE

INTERNATIONAL CORRESPONDENCE SCHOOLS Box 5524-D, Scranton, Penna.

Without cost or obligation, please tell me how I can qualify for the position or in the subject before which I have marked an X:

BUSINESS TRAINING COURSES

- | | |
|---|---|
| <input type="checkbox"/> Business Management | <input type="checkbox"/> Salesmanship |
| <input type="checkbox"/> Industrial Management | <input type="checkbox"/> Advertising |
| <input type="checkbox"/> Personnel Organization | <input type="checkbox"/> Better Letters |
| <input type="checkbox"/> Traffic Management | <input type="checkbox"/> Foreign Trade |
| <input type="checkbox"/> Business Law | <input type="checkbox"/> Stenography and Typing |
| <input type="checkbox"/> Banking and Banking Law | <input type="checkbox"/> Business English |
| <input type="checkbox"/> Accountancy (including C.P.A.) | <input type="checkbox"/> Civil Service |
| <input type="checkbox"/> Nicholson Cost Accounting | <input type="checkbox"/> Railway Mail Clerk |
| <input type="checkbox"/> Bookkeeping | <input type="checkbox"/> Common School Subjects |
| <input type="checkbox"/> Private Secretary | <input type="checkbox"/> High School Subjects |
| <input type="checkbox"/> Business Spanish <input type="checkbox"/> French | <input type="checkbox"/> Illustrating <input type="checkbox"/> Cartooning |

TECHNICAL AND INDUSTRIAL COURSES

- | | |
|--|--|
| <input type="checkbox"/> Electrical Engineering | <input type="checkbox"/> Architect |
| <input type="checkbox"/> Electric Lighting | <input type="checkbox"/> Blue Print Reading |
| <input type="checkbox"/> Mechanical Engineer | <input type="checkbox"/> Contractor and Builder |
| <input type="checkbox"/> Mechanical Draftsman | <input type="checkbox"/> Architectural Draftsman |
| <input type="checkbox"/> Machine Shop Practice | <input type="checkbox"/> Concrete Builder |
| <input type="checkbox"/> Railroad Positions | <input type="checkbox"/> Structural Engineer |
| <input type="checkbox"/> Gas Engine Operating | <input type="checkbox"/> Plumbing and Heating |
| <input type="checkbox"/> Civil Engineer | <input type="checkbox"/> Chemistry <input type="checkbox"/> Pharmacy |
| <input type="checkbox"/> Surveying and Mapping | <input type="checkbox"/> Automobile Work |
| <input type="checkbox"/> Metallurgy <input type="checkbox"/> Mining | <input type="checkbox"/> Navigation |
| <input type="checkbox"/> Steam Engineering | <input type="checkbox"/> Agriculture and Poultry |
| <input type="checkbox"/> Radio <input type="checkbox"/> Airplane Engines | <input type="checkbox"/> Mathematics |

Name.....
Street.....
Address..... 3-27-23
City..... State.....

Occupation.....
Persons residing in Canada should send this coupon to the International Correspondence Schools Canadian, Limited, Montreal, Canada.

SHORTHAND IN ONE MONTH

Wonderful, Easy System—The BOYD
Writers hold World's Record

100 to 150 words a minute in 30 days guaranteed. Big demand for trained Stenographers and Private Secretaries. Learn a profession that pays big.

What Students Say:
"Your Course is Wonderful."—M. R. W.
"It beats all other Systems."—F. Z.

The Boyd can be learned in one-sixth the time of other systems. It is the NEW WAY in Shorthand. Dictation first week—in 30 days you are ready for a position. Send today for Catalog and Money-Back Guarantee.

CHICAGO HOME-STUDY SCHOOLS
802 Reaper Block Chicago, Illinois

BE AN ARTIST

We can teach you **DRAWING** in your own home during your spare time.

Our 19 years of successful teaching prove our ability. 10 Courses in Commercial and Illustrative Drawing. Teachers Normal and Applied Art. Endorsed by high art authorities. Students trained by members of our Faculty are filling high-salaried positions. Artist's Outfit FREE to Enrolled Students. Write today for Art Year Book.

OUR HANDSOME ART YEAR BOOK "FREE" to YOU!

SCHOOL OF APPLIED ART

APPLIED ART BLDG. NO. 2 BATTLE CREEK MICH.

If I Can Show

how you can make \$75 a week without money or experience and get your pay daily, selling Men's \$50 Suits for \$29.75 would you investigate? Write **LOUIS SCHWARTZ, Mgr., Park Tailoring Company, Dept. 628, Chicago**

Wonderful, new device, guides your hand; corrects your writing in few days. Big improvement in three hours. No failures. Complete outline FREE. Write C. J. Ozment, D-34, St. Louis, Mo.

WHY NOT spend Spring, Summer and Fall gathering butterflies, insects? I buy hundreds of kinds for collections. Some worth \$1 to \$7 each. Simple outdoor work with my instructions, pictures, price-list. Send 10c (not stamps) for my illustrated Prospectus before sending butterflies.

Mr. Sinclair, Dealer in Insects, Dept. G, Ocean Park, Calif.

BE A JAZZ MUSIC MASTER

PLAY PIANO BY EAR

Play popular song hits perfectly by ear. Hum the tune, play it BY EAR. No tedious, ding-dong daily practice—just twenty brief, entertaining lessons which you can master At Home in Your Spare Time. Send for the FREE BOOK. It tells how to start if you want musical ability at which friends will marvel. **NIAGARA SCHOOL OF MUSIC, Dept. 661 Niagara Falls, N. Y.**

Send for this Free Book

The Glory of a Man is His Strength!



LIONEL STRONGFORT

Dr. Sargent, of Warsaw, declared that "Strongfort is unquestionably the finest specimen of physical development ever seen."

without a copy of this wonderfully instructive book. It's absolutely free. Just mark the subjects on the free consultation coupon (write other ailments on extra line) on which you want special confidential information and send with 10c (one dime) to help pay postage, etc. You will get your copy at once and with it a message of renewed life—renewed hope—renewed success—that will mean all the world to you. Send for my free book—**Right Now, TODAY.**

LIONEL STRONGFORT

Physical and Health Specialist

Dept. 348 Founded 1895 Newark, New Jersey

Special Notice.—Lionel Strongfort, the World's Famous Athlete and Physical and Health Specialist, has achieved wonderful results with the Principles of Strongfortism. Thousands of pupils throughout the world have testified to the benefits gained under his guidance. He enjoys an excellent reputation in his profession and can be depended upon to do exactly as he promises.

To be a **real** man, you must be strong, healthy, vigorous, vital—overflowing with power and force and possessed of the determination and endurance to do a man's work in this world and win the success and happiness that every red-blooded man wants.

Make Your Fondest Dreams Come True

Every man worthy of the name dreams of the day when he will achieve his ideals and ambitions. Can you make your dreams come true? Have you the power and personality to win recognition and financial success? Are you physically fit to fight the battles of life and forge up to the front with the winners? Answer these questions frankly and then resolve to make yourself over into a real 100% man.

Be an Ideal of Red Blooded Manhood

Nobody Loves a Weakling. No one has any use for a weak, sickly man—always ailing and complaining—always discouraged and despondent, burdened down—held back—retarded with pimply face, bleary eyes, nasty, irritable disposition, indigestion, dyspepsia—crippled with flat chest, rheumatism, and the numerous other results of neglect, etc. (see consultation coupon). You can't expect your wife, your parents, your friends and associates, in the home, in business or society to put up with you much longer. Everybody is attracted to healthy, successful men—nobody wants a complaining failure around. The future looks dark and gloomy to you—but cheer up—there is a way out—you can save yourself with

STRONGFORTISM

The Modern Science of Health Promotion

The Principles of **Strongfortism** are based on my discovery—that internal muscular harmony and strength is the key to lasting, abundant Health and Vitality. The Heart, Lungs, Stomach, Bowels and other vital organs function through virtue of the contracting power of the muscles contained in their structures. Circulation, Digestion, Assimilation and Elimination are largely the result of internal muscular action. The **Strongfort Methods** go to the very cause of all ailments and weaknesses and by scientifically strengthening and developing the important internal muscles, provide 100% results when other methods disappoint.

Once you accept **Strongfortism**, you enter a new life. The results are immediate and positively thrilling. You feel the rich blood racing through your body—you feel new strength and power developing in every organ and structure—you acquire new poise and a magnetic personality. **Your success with Strongfortism is guaranteed.**

Take the First Step Now

Don't put it off—don't fool yourself with the idea that you will get better sometime. You won't get better. You will surely get worse and the longer you delay in building up your body the longer it will take to make a real man of you. For your own sake make up your mind, **NOW.** Don't delay another minute.

Write for my FREE BOOK

The truth about the scientific application of Nature's corrective forces is clearly and frankly explained in my famous book, "**Promotion and Conservation of Health, Strength and Mental Energy.**" It contains a priceless message for every man and woman, boy and girl. No one should be

FREE CONSULTATION COUPON

ABSOLUTELY CONFIDENTIAL

Mr. Lionel Strongfort, Dept. 348, Newark, N. J.—Please send me your book, "**PROMOTION AND CONSERVATION OF HEALTH, STRENGTH AND MENTAL ENERGY.**" for postage on which I enclose a 10c piece (one dime). Send me special information on subjects marked (X) below, as well as those I may write on extra line, without obligation.

- | | | |
|-------------------------------------|---------------------------------------|---|
| <input type="checkbox"/> Colds | <input type="checkbox"/> Catarrh | <input type="checkbox"/> Debility |
| <input type="checkbox"/> Asthma | <input type="checkbox"/> Blackheads | <input type="checkbox"/> Weak Eyes |
| <input type="checkbox"/> Hay Fever | <input type="checkbox"/> Insomnia | <input type="checkbox"/> Gastritis |
| <input type="checkbox"/> Obesity | <input type="checkbox"/> Short Wind | <input type="checkbox"/> Increased |
| <input type="checkbox"/> Headache | <input type="checkbox"/> Flat Feet | <input type="checkbox"/> Height |
| <input type="checkbox"/> Fear | <input type="checkbox"/> Stomach | <input type="checkbox"/> Heart Weakness |
| <input type="checkbox"/> Thinness | <input type="checkbox"/> Disorders | <input type="checkbox"/> Poor Circulation |
| <input type="checkbox"/> Rupture | <input type="checkbox"/> Constipation | <input type="checkbox"/> Skin Disorders |
| <input type="checkbox"/> Lumbago | <input type="checkbox"/> Biliousness | <input type="checkbox"/> Neurasthenia |
| <input type="checkbox"/> Neuritis | <input type="checkbox"/> Torpid Liver | <input type="checkbox"/> Despondency |
| <input type="checkbox"/> Neuralgia | <input type="checkbox"/> Indigestion | <input type="checkbox"/> Round Shoulders |
| <input type="checkbox"/> Flat Chest | <input type="checkbox"/> Nervousness | <input type="checkbox"/> Lung Troubles |
| <input type="checkbox"/> Deformity | <input type="checkbox"/> Poor | <input type="checkbox"/> Weaknesses |
| <input type="checkbox"/> (Describe) | <input type="checkbox"/> Memory | <input type="checkbox"/> (Specify) |
| <input type="checkbox"/> Diabetes | <input type="checkbox"/> Rheumatism | <input type="checkbox"/> Muscular |
| <input type="checkbox"/> Female | <input type="checkbox"/> Pimples | <input type="checkbox"/> Development |
| <input type="checkbox"/> Disorders | <input type="checkbox"/> Falling Hair | <input type="checkbox"/> Great Strength |

Mention other ailments here.....

Name.....

Age..... Occupation.....

Street.....

City..... State.....

"I'm at the Top of the Pole"



That's as high as I can climb in my present job."

So wrote an ambitious lineman to the United Y. M. C. A. Schools. He didn't want to climb poles all his life, so he enrolled for a practical course of home study to help him to a higher position in his chosen field of work.

He is making progress. He feels that ahead of him are the larger responsibility, the leadership, the higher pay and the better privileges, comforts and associations that are sure to come to the man who puts more into his head.

Have you gone as high as you can with what you now know? Do you need more knowledge to climb higher? Face these big questions.

During the last three years our friendly counsel has been given to more than 35,000 men who have enrolled for the United Y. M. C. A. Schools' correspondence courses—a new type of instruction from competent instructors that emphasizes service on all your problems.

Some of our 300 Correspondence Courses

Agricultural Courses
Architecture
Automobile Courses
Building Construction
Civil Engineering Courses
Concrete Engineering
Drafting Courses
Electrical Courses

Technical Courses

Farm Management
Foremanship
Highway Engineering
Mechanical Engineering
Plumbing
Podstry Husbandry
Radio Engineering
Radio Telegraphy

Rural Engineering
Shop Courses
—Blacksmith—Machine
—Footdry—Patterns
Steam Engineering
Structural Drafting
Surveying

Commercial and Other Courses

Accountancy
Advertising
Applied Psychology
Banking
Better Letters
Bookkeeping
Business Arithmetic
Business Administration

Business English
Business Finance
Business Law
English Courses
Foreign Language
Grammar School Courses
High School Courses
Illustrating

Insurance Courses
Mathematical Courses
Physical Directors' Training
Public Speaking
Salesmanship
Shorthand and Typewriting
Show Card Writing
Traffic Management

If you want to climb higher, send the coupon for our friendly counsel.

Without obligating me, please advise regarding the course in.....

Name.....

Full Address.....

Dept. 2-Ju

Please write plainly

United Y.M.C.A. Schools

Correspondence Instruction *The most Service for the least Money*

347 Madison Ave. New York City, N.Y.

Please Mention Popular Mechanics

WE TEACH COMMERCIAL ART

Meyer Both Company, the largest Commercial Art Organization in the World, offers you an unusual opportunity for practical training. If you like to draw develop your talent. Study this practical course—taught by this nationally known organization with twenty-two years success—who each year produces and sells to advertisers over 15,000 commercial drawings. Our teachers give you the double advantage of being instructors of proven ability, as well as artists in this widely known organization. Meyer Both instruction is the difference between successful fact and experimental theory. Commercial Art is a highly paid, intensely interesting profession, equally open to men and women. Home study instruction.

Get Facts Before You Enroll in any School.

Ask the Advertising Manager of the leading newspapers in your city, anywhere in the United States, Canada, England or Australia about the Meyer Both Company—let them tell you about us. Write for our illustrated book telling about the success of our students—for one-half the cost of mailing—four cents in stamps.

MEYER BOTH COMPANY

Department of Art Instruction

Michigan Ave. at 26th St., Dept. 16 CHICAGO, ILL.

NOTE—To art and Engraving Firms: Secure practical artists among our graduates. Write us.

Learn Photography at HOME

Make \$75.00 a Week on the Side

Establish yourself as a Photographic Expert quickly—during your spare time—under a leading photographer. I'll show you how to start your own business—or command a large salary. Send for my unusual offer—it's only temporary. Act at once. A postal will do. H. R. VANT.

INTERNATIONAL STUDIOS, Inc.
Dept. 119A, 2601 Michigan Ave., Chicago, U. S. A.



POSITION GUARANTEED

I Want You

The Finger Print profession wants men immediately. Big pay, interesting work, no lay-offs or shut-downs. I will teach you quickly to become a trained Finger Print expert. I guarantee a position and back it up with a \$1,000 bank deposit. Write at once for full explanation and details about my free Secret Service course, free Secret Service reports and special low price. Offer is limited. Write at once. No obligation. U. S. SCHOOL OF FINGER PRINTS, Dept. A-135, 7003 N. Clark St., Chicago.

FREE

Clear-Tone FOR PIMPLES

Your skin can be quickly cleared of Pimples, Blackheads, Acne Eruptions on the face or body, Enlarged Pores, Oily or Shiny Skin. **\$1,000.00 Gold**

Cash says I can clear your skin of the above blemishes. **WRITE TODAY for my FREE Booklet—"A Clear-Tone Skin"**—telling how I cured myself after being afflicted for fifteen years.

FREE

E.S. GIVENS, 128 Chemical Bldg., Kansas City, Mo.

Repair Any Auto ^{OR} Auto Truck

Examine These **FREE** NEW AUTO BOOKS

Be an expert auto repair man. You can have the skill that makes every complicated trouble as easy to fix as taking out a spark plug. Learn every detail of all makes of cars and trucks. Know exactly how to find what's wrong and how to make all repairs quickly. These great new Auto Books show you how.

Make Money Repairing Autos

Over 9 million cars are in operation and thousands of men are needed to keep them in good going condition. There are more jobs open than there are good men to fill them. Never before have expert auto repair men been in such great demand and made so much money. Now is your great money-earning opportunity in the auto repair business. Every mechanic, every chauffeur, every car owner needs this great New Library of Automobile Engineering.

Tells About
Explosion Motors,
Welding, Motor Construction and Repair,
Carburetors and Settings, Valves, Cooling,
Lubrication, Fly-Wheels, Clutch Transmission, Final Drive, Steering Frames, Tires, Vulcanizing, Ignition, Starting and Lighting Systems, Shop Kinks, Public Garage Design, Equipment and Operation, Electrics, Storage Batteries—Care and Repair, Steam Cars, Motorcycles, Commercial Trucks, Glossary, More than 100 blue prints Wir'g Diagrams.

75c a Week If You Decide to Buy

Let us send you the complete six-volume set of Automobile Engineering for one week's examination. Read the simple directions for repairing every automobile trouble. Six thick volumes 5½x 8¾ inches, flexibly bound and stamped in gold, 2,650 pages, 2,100 illustrations, wiring diagrams, etc. Everything in plain, every-day language simple to understand. If you decide to keep them, send only \$2.80 in seven days, and \$3 a month thereafter until the special introductory price of \$21.80 has been paid. The regular price is \$45.00, so you save \$23.20 by acting at once.

Send No Money

Don't send a penny! Your name and address in the coupon brings the six books to you at once for seven days' trial.

Mail Coupon NOW

American Technical Society
Dept. A19A Chicago, U. S. A.



Starting and Lighting



Welding

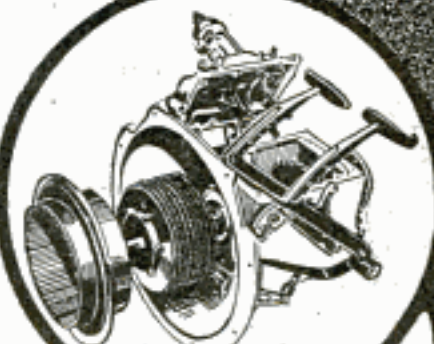

Transmission

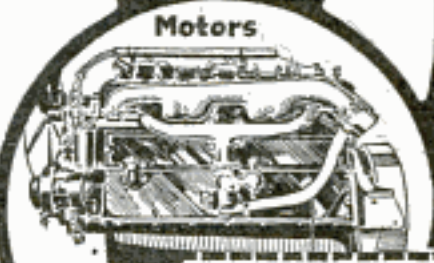

Motors

AMERICAN TECHNICAL SOCIETY

Dept. A19A Chicago, U. S. A.

Please send me the six-volume set of Automobile Engineering for seven days' examination, shipping charges collect. If I decide to buy, I will send \$2.80 within seven days and balance at \$3.00 a month until \$21.80 has been paid. Then you will send me a receipt showing that the set of books are mine and fully paid for. If I think I can get along without the books, I will return them, after 7 days, at your expense.

To insure prompt shipment fill out all lines.

Name

Address

Employed by



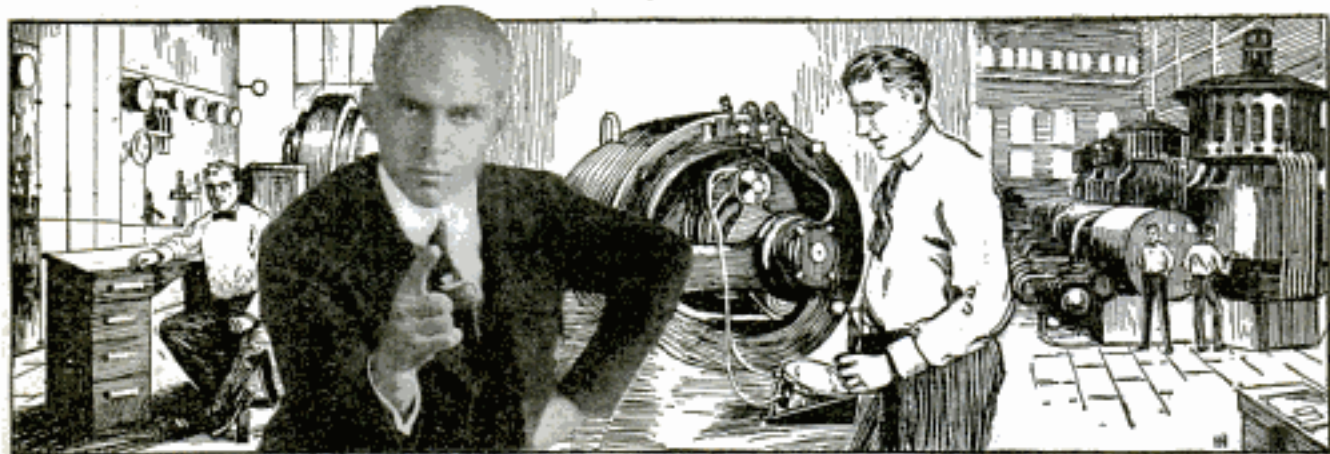

Electricity Needs You I WILL TRAIN YOU AT HOME

Stop right here. This is YOUR opportunity! Electricity is calling you, and the Electrical Business is in for a tremendous increase. But it needs more trained men—at big pay. By my **Home Study Course in Practical Electricity** I can train you for these positions.

Earn \$70 to \$200 a Week

You've always had a liking for Electricity and a hankering to do electrical jobs. Now is the time to develop that talent; there's big money in it. Even if you don't know anything at all about Electricity you can quickly grasp it by my up-to-date, practical method of teaching. You will find it intensely interesting and highly profitable. I've trained and started hundreds of men in the Electrical Business, men who have made big successes. **YOU CAN ALSO**

Be a Big Paid ELECTRICAL EXPERT

What are you doing to prepare yourself for a real success? At the rate you are going where will you be in ten years from now? Have you the specialized training that will put you on the road to success? Have you ambition enough to **prepare** for success, and get it?

You have the ambition and I will give you the training, so **get busy**. I am offering you **success** and all that goes with it. Will you take it? I'll make you an **ELECTRICAL EXPERT**. I will train you as you should be trained. I will give you the benefit of my advice and 20 years of engineering experience and help you in every way to the biggest, possible success.

**CHIEF ENGINEER
COOKE**
Chicago Engineering
Works
Dept. 1-a, 2150 Lawrence Av.
CHICAGO, ILL.

Dear Sir: You may send me entirely free and fully prepaid, a copy of your book, "How to Become an Electrical Expert," and particulars about your **Home Study Course in Electricity**.

Name.....

Address

CityState

Valuable Book Free My book, "How to Become an Electrical Expert," has started many a man on the way to fortune. I will send a copy, free and prepaid, to every person answering this advertisement.

Act Now! Good intentions never get you anywhere. It is action, alone, that counts. **NOW IS THE TIME TO ACT.**

L. L. COOKE, Chief Engineer

**CHICAGO
ENGINEERING
WORKS**

2150 LAWRENCE AVENUE
Dept. 1-a Chicago, U. S. A.

FREE! BIG ELECTRICAL OUTFIT

A fine outfit of Electrical Tools, Instruments, Materials, etc., absolutely **FREE** to every student. I will also send you **FREE** and fully prepaid—Proof Lessons to show you how easily you can learn Electricity and enter this splendid profession by my new, revised and original system of Training by Mail.

Radio Course FREE!

Special newly-written wireless course worth \$45.00, given away **free**. Full particulars when you mail coupon below.

Earn Money While Learning

I give you something you can use **now**. Early in my **Home Study Course** I show you how to begin making money in Electricity, and help you get started. No need to wait until the whole course is completed. Hundreds of students have made several times the cost of their course in spare time work while learning.

CLASSIFIED ADVERTISEMENTS

WORLD'S BEST WANT AD MEDIUM

Advertisements in this section, 25 cents per word, each insertion, minimum 10 words, payable in advance. To be inserted under proper classification in July issue, copy should be in our office May 25th.

ADVERTISING AGENCIES

TO secure agents or salesmen or for selling farms and real-estate investors, use classified (want) ads in largest newspapers and magazines. Price list No. 30 sent free. Andrus Advertising Agency, 20 W. Jackson Bldg., Chicago, Ill. The largest classified advertising agency in the U. S.

FOR ADVERTISERS

FREEBURN, Hicksville, Ohio: Plans, Layouts for Advertising copy, Designs, Engravings, State wants, Sketches free.

INCH Display 100 magazines, thrice \$8. Beck Agency, 5492 Alaska, St. Louis, Mo.

INCH Display in 50 magazines \$2.00. Thrice \$5.00. Kleese, East 89th, New York.

1 WHITE booklets, folders, letters, complete follow-up for manufacturers, mail-order dealers. Long experience. Write for prices. L. Taylor, Box 43, Freeport, Ill.

ADVERTISE in 24 Big Sunday Newspapers, 25 words \$15.00. Catalog listing 1,000 leading Dailies, Weeklies, Magazines, 4c stamps. Union Advertising, Baltimore Bldg., Chicago.

AUTOMOBILE SUPPLIES

MR. RADIATOR Repair Man, why pay big prices for radiator cores when you can buy our radiator core equipment and make your own cores? We make radiator core machines, lock seamers, cutoff shears, adjustable digging frames, radiator test plugs, etc. Write for details to Radiator Engineering Co., 626 Nesselwood Ave., Toledo, Ohio.

WE buy and sell anything. Simon Supply Company, St. Louis, Mo.

GUARANTEED Non-Corrosive Battery Terminal. Fits any Standard Battery. Sell Jobber or Dealer. Liberal Commission. Atchison Specialty Co., Atchison, Kan.

AUTO Parts at cut prices! All kinds of new and used, for all cars. Engines, Clutches, Transmissions, Axles, Radiators, Magnets, Generators, Batteries, Shafts, Gears, Bearings, Springs, etc., etc. If you have never known the House of Warslawsky, you had better write us and get acquainted. Think of buying the Osgood lens for 35c per pair, and rims for any car at \$2.00 each. Windshields from \$8.00 to \$10.00. Spotlights \$1.75. Welding outfits at a low price. Specify make and model of car when writing. Warslawsky & Co., 1935 S. State St., Chicago, Ill.

DRIVE 100 Tacks and save \$25.00. See advertisement, page 134.

PROTECT your rights—Write for "Record of Invention" and booklet about Patents. Prompt personal service. Advice without charge. J. Reaney Kelly, 612-G, Columbian Building, Washington, D. C.

LET us show you how to save 30% of your gasoline. Send your name and address; we'll do the rest. Southwestern Research Laboratories, Oklahoma City, U. S. A.

"HANDY-KAN" Portable Commode, with removable waxed paper lining. Patent pending. Indispensable to the motorist. For children or adults. Price \$6.00. Send for circular. Henry P. Jones, 41 Arkansas St., Buffalo, N. Y.

8-HOUR Battery Charging with Constant Potential Pays Big. Easy Payments. Profits Pay. Postal beings details. Hohartco, Troy, Ohio.

USED parts for Dodge, Dorr, Maxwell, Overland, Oldsmobile, Oakland, Allen, Chevrolet, Studelaker, Case, Hupmobile, Pullman and Ford. 50 to 75% from Est. Auto Tire & Parts Co., Cape Girardeau, Mo.

CHALMER'S Parts—State year, etc. Christian, 8 Prospect Place, Somerville, Mass.

SILENT Timing Gears is what you need to take the rattle out of your motor. Money back if not satisfied. Auto Tire & Parts Co., Cape Girardeau, Mo.

PRONTO Series Gap Spark plugs. Guaranteed Life of Motor and to shoot through oil. No porcelain. All mica. 100% Government test. Particulars gladly furnished. Pronto Mfg. Co., Omaha, Neb.

8-HOUR Battery Charging with Constant Potential Pays Big. Easy Payments. Profits Pay. Postal beings details. Hohartco, Troy, Ohio.

AUTOMATIC Air Compressor, quietest, most compact outfit on market. No noisy breaking belts. Motor and pump one unit. Thousands garages, filling stations, tire shops, using. Most economical to operate. Absolutely dependable. \$35 cash, balance terms. Iron Clad satisfaction or Money-back guaranteed. Write for details. Hobart Brothers, Troy, Ohio.

STANLEY, Steamers Owners get "List" Acme Boilers, Burners, vaporizers, superheaters; everything for your Steam Automobiles. "Doc" Paine, 1238 Santa Fe, Denver, Colo.

AUTOMOBILE Parts. All cars and trucks, motor parts, clutch parts, universal joints, axle shafts, gears, ball, roller, and thrust bearings, timing chains and gears. State make, model and parts wanted. Special prices. All new parts. In stock. Merrin Motor Parts Co., 1728 Michigan Ave., Chicago, Ill.

AUTOMOBILE Parts—Used parts for most any car at half factory list prices. Allen, Heisroe, Buick, Cadillac, Chalmers, Chevrolet, Dodge, Dorr, Grant, Hudson, Hupmobile, Oakland, Overland, Oldsmobile, Iro, Studelaker and many others. Send list of parts wanted. Maxwell Bros., 4106 Olive St., St. Louis, Mo.

AUTOMOBILE parts, guaranteed new for all cars. Save money; get our wholesale prices on gears, shafts and bearings. State make of car, model and parts wanted. Parts shipped immediately from stock. We refund your money, including transportation charges, if not satisfied. Mechanics Gear Co., 3708 No. Halsted St., Chicago.

LIBERTY Air Compressors, for garages, tire-shops, filling stations, also paint spraying equipment. Air Compressor & Equipment Co., 1437 Carroll Avenue, Chicago, Ill. Distributors wanted.

AUTO parts—Save 25-90%. New gears, axles, bearings, springs, radiators, magnets—1,000 models. Bankrupt supplies, retopping outfits. Brightman Auto Exchange, 521 Windsor Ave., Hartford, Conn. Largest in the East.

AUTOMOBILE owners, garagemen, mechanics, send today for free copy America's most popular motor magazine. Contains helpful articles on overhauling, repairing, ignition, carburetors, batteries, etc. Automobile Digest, 563 Butler Bldg., Cincinnati.

PRONTO Series Gap Mica Spark Plugs. Guaranteed life of motor. Positively shoots through oil. 100% Government Air Mail Service test. Real dealers and distributors write. Pronto Mfg. Co., Omaha, Neb.

USED parts for Dodge Brothers Cars. 50% from list. Satisfaction Guaranteed. Harris Motor Car Company, Cape Girardeau, Mo.

MAGNETO Recharger: State Rights free. State Distributors. Reliable. 328 Jay St., Utica, N. Y.

25c IN coin brings you latest spark plug cleaner on the market. Cleaner, gauge and file, all in one. 1/2 and 3/4 A. C. Champion and others of like type. Dealers wanted. Frederick Wambach, Greenwich, Conn.

AUTOMOBILES

AUTOMOBILE owners, garagemen, mechanics, send today for free copy America's most popular motor magazine. Contains helpful articles on overhauling, repairing, ignition, carburetors, batteries, etc. Automobile Digest, 563 Butler Bldg., Cincinnati.

REPAIRING Ford Cars, Trucks and Tractors in the most proper and efficient way is explained in a new 220-page book by the former director of the Ford Motor Co. Service School. This information is otherwise unavailable outside of the Ford plant. Written more especially for the mechanic and repairman. Price \$2 postpaid. Popular Mechanics Book Dept., 200 E. Ontario St., Chicago.

PATENTS—Write for our free illustrated Guide Book and Evidence of Conception Blank. Send model or sketch and description of your invention and we will give our opinion of its patentable nature. Highest references. Prompt service. Reasonable terms. Victor J. Evans & Co., 185 Ninth, Washington, D. C.

PATENTS Procured. Send sketch or model today for examination, prompt report and advice. No charge for preliminary advice. Write for free Booklet and blank form on which to disclose your idea. Highest references. Promptness assured. Clarence A. O'Brien, Registered Patent Lawyer, 562 Southern Building, Washington, D. C.

DYKE'S Automobile Encyclopedia. 13th edition, new, greater than ever, entirely rewritten and rearranged. Contains greatest array of automobile facts ever published in one volume. Separate books containing same information cost \$21. Over 1,200 pages and 4,100 illus. Cloth \$8. Flex. Amer. Morocco \$7.50 postpaid. Popular Mechanics Book Dept., 200 E. Ontario St., Chicago.

FOR FORD OWNERS

EIGHT Overhead Valve Cylinder Heads, complete with manifolds, plugs and wires, \$65. Speedster and racing Eight Valve Heads extra price. We guarantee more power, more speed and more motor efficiency, than can be had in any other Eight Valve Head for Fords. Type B Sixteen Valve Head, finest rocker arm system on any motor. Type BB, most powerful Sixteen Valve Cylinder Head made. Type C, fastest Cylinder Head in the world, carrying four carburetors, and special high speed camshaft. Actual speed test on Ford racing car with Type C Head, over one hundred miles per hour. We will double the pulling power of your Ford truck and insure you 2-ton truck instead of 1-ton truck. For touring cars, hill climbing and road service beyond the wildest dreams of the owner. Largest manufacturer of power and speed specialties in the world. Doing business in fifty foreign countries and every state in the Union. No matter what you want in power and speed specialties, write us. If you are interested in Cylinder Heads, undersliding parts, high speed camshafts, water accelerators, roller bearings, shock absorbers, steering device, wire wheels, fabric or cord tires, counterbalances for crankshaft, or single-piece counterbalanced crankshaft, one solid forging, worm and gear steering gears, nickel steel racing gears, any ratio, Ford replacement gears, carburetors for speed or general service, power and speed pistons, Tripod-like connecting rods, 2, 4, and 6 forward speed transmissions, high tension magnets, racing bodies, pressure feed oiling systems, large capacity radiators, oil pumps, safety goggles, racing helmets, 100-mile speedometers, stop watches, vacuum tanks, wheel discs, pressure feed gas system—then you need our folders. A postal card brings you the great money-saving power and specialty folders. We want an agent in every city and town in America. If you own a Ford car write for our special agency proposition. It will surely interest you and increase your bank account this year. Write today. Address Laurel Motors Corporation, Anderson, Ind.

DRIVE 100 Tacks and save \$25.00. See advertisement, page 134.

AVOID "turning turtle," leaving the road, locking over center. You can steer safely and easily out of ruts, through mud, sand, snow and on center-crowned roads, with a Sprague Worm Steering Gear. Same type as used on all larger cars. Prevents bumps in road from turning front wheels aside; gives you control of steering. Also absorbs shock, vibration and strain on arms and shoulders. Makes a far better and safer car. Easily, quickly installed; no holes to bore; outlasts car. Guaranteed to satisfy you. Write for particulars. Union Sales Co., Dept. 2, Omaha, Neb.

FORD Owners, Attention! Forget the low gas peril; homemade accessory will carry your car over any hill using the last drop of gasoline. Send \$1 (bill) for complete description and details of construction. The Havo Co., box 239, Peckskill, N. Y.

FORD Car Repair Book Sent Free. This complete and well illustrated valuable book explains in a simple way how to overcome Ford car troubles; Repairing, Economical Winter Driving, Cold Weather Car Starting, Equipment for Fall and Winter, Carving Piston Ring Troubles, Carburetor Adjustments and Repairs, Connecting Rods, Timers, Transmission Troubles, and practically every phase of Ford car driving, repairing and equipment. Send 25c coin for three months' trial subscription and get the valuable repair book free. Ford Owner and Dealer Magazine, 529 Montgomery Bldg., Milwaukee, Wis.

SIMPLEX Starter \$20. Easily attached. Guaranteed. Agents. American Simplex Co., Anderson, Ind.

SPEEDSTER Fans. Don't fail to see "Red-I-Kut" ad. Page 145.

FORD Owners save money—time—trouble. Read about Sun Automatic Timer on page 134.

PULLMAN Sleeper in your Ford. Wonderful bed. Different. Free Circular. Quality Company, Robinson, Ill.

FORDS run 40,000 miles without 1c engine, carbon or ignition expense. Full information \$1.00. I have nothing to sell. J. C. Eppers, Clifton Heights, Pa.

FORDS run 34 miles on gallon gasoline. Other cars show proportionate saving. Wonderful new carburetor. Starts easy in coldest weather. Fits any car. Attach yourself. Money back guarantee. Sent on 30 days' trial. Agents wanted. Air Friction Carburetor Co., Dept. 3221, Dayton, Ohio.

MOTORCYCLES, BICYCLES AND SUPPLIES

BICYCLE Repairing, Gun and Locksmithing. 18 valuable articles, \$5.00 C. O. D. Nelson Carter, 513 Millam St., Shreveport, La.

USED Motorcycles fully guaranteed like new, \$25 to \$100. Motorcycle tires, \$3. Auto tires, \$3. Bicycle tires, \$1. Bicycles, \$5; tandem, \$10. Disk Talking Machines, \$9. Records for all Talking Machines, 25c. Send stamps for catalogues. Denlinger Price Cutter, Rochester, N. Y.

SEND for our Bargain Bulletin and Money-Saving Message. It will save you money on Motorcycles, Side Cars, Motor Wheels, Repair Parts and Accessories. Some used parts at less than half. Cleveland and Henderson Motorcycles our specialty. See our ad on page 134. American Motor Cycle Co., 2043-5-7 W. Chicago Ave., Chicago.

1921 HARLEY-DAVIDSONS, \$135; 1920, \$115; 1919, \$100. Indian Scouts, \$125. Guaranteed. Money refunded if not satisfied. Circular free. Wisconsin Cycle Sales Co., 728 National Ave., Milwaukee, Wis.

WONDERFUL bargains in reconditioned motorcycles. Priced as low as \$35. Sidecars from \$25 up. Everyone expertly rebuilt and guaranteed in absolutely first-class condition. Don't delay. Send 2c for new big catalog showing 1923 bargains. Western Supplies Co., 539 Hayutin Bldg., Denver, Colo.

LARGEST stock of new and used motorcycle parts and accessories in the world at year disposal via Uncle Sam's mail. Write for quotations. Motorcycle Parts Mfg. Co., 2030-30 Wabash Ave., Chicago, Ill.

GOOD Used Motorcycles, Large Stock, prices low, Lists free. Seeber-Hofheims, Buffalo, N. Y.

USED parts for all motorcycles, cheap. State wants, Schuck Cycle Co., 1922 Westlake, Seattle, Wash.

'19 INDIAN 3 Speed \$75.00. '20 Indian 3 Speed \$95.00. '21 Indian 3 Speed \$125.00. Howard A. French Company, Baltimore, Md., Washington, D. C.

SEND for big list of slightly used motorcycles on the easy payment plan. Howard Cycle Co., Trenton, N. J.

DON'T buy a Bicycle Motor Attachment until you get our new catalogue and prices. Also runs washers, pumps and shop machinery. Shaw Mfg. Co., Dept. 27, Galesburg, Kans.

MOTORCYCLE cylinders reground, fitted with new pistons and rings, \$6.00. Guaranteed. Muncie Piston Co., Muncie, Ind.

AVIATION

AIRPLANES; Wings; Motors, 28 to 200 h. p.; Motor Parts; Propellers, new or slightly used. Prices about one-eighth of original cost. Photo of airplanes, Six Cents. Aviators' Leather Coats, Used, \$10.00 to \$15.00. Smith Machinery Co., 403 Grogan Bldg., Houston, Texas.

AIRPLANES, Flying Boats, Motors, Supplies, New 99 H. P. LeRhone Rotary Motor, \$100; OX5 90 H. P. Motor, \$250; New OX5 Motored Standard 2 Pass. airplane, \$390; 150 H. P. Hispano motored Standard airplane, 3 Pass., \$1,250; 26x4 new wheels, \$5; slightly used Goodyear Cord casing, \$3, and new tube, \$1; NAK Resistal non-shatterable Goggles, \$5; Jumbo Resistal non-shatterable Goggles, \$3.50; Leather Helmet, \$4.50; ladies' size, \$5.25; OX5 propellers \$12. Floyd Logan, 716 W. Superior, Cleveland.

FOR Sale: Curtiss 90, \$100. Wm. Mullen, Duff Bldg., New Bedford, Mass.

BUILD your own aeroplane. Materials cut to fit or assembled. Easy terms. A. Angeles, East Seattle, Wash.

AEROPLANE Flying School, unlimited instructions. Pilots license guaranteed. Write for information. New classes, May-15, June-15. Ohio State Flying School, 117 West Pearl Street, Cincinnati, Ohio.

A REAL proposition for real ambitious young men who want to learn to fly. Week with pay while you are learning. Ten lessons in the air, of twenty minutes each, will make you a pilot by our advanced method of training. This, together with our five-week shop course at \$100.00, makes America's oldest aircraft factory the most popular flying school. Heath Airplane Co., Chicago, Ill.

SAILPLANE: Files without motor; efficient; inexpensive, easy to build and fly. Working drawings \$1.00. Propellers \$12.00. 15 HP. motors \$70.00. Burke Aircraft Co., Dusters Grove, Ill.

SEND 10c for our latest aeronautical catalog listing a complete line of airplane goods at reduced prices. Heath Airplane Co., Chicago, Ill.

LEARN to Fly Now with Partridge, Inc., teaching since 1913, on Aero Club of Illinois Field. Send 5 cents for booklet. 430 S. Michigan Ave., Chicago, Ill.

"SPORTPLANE," knockdown, \$150. Sportplane propellers, \$8 each. Curtiss OX5 Motor, \$135. Hallscoff 100 horsepower motor, \$135. Flying Instruction, complete course, \$164. Aviation Engineering Co., Lawrence, Kan.

HEATH propellers represent the most efficient method of aerial drive. Each propeller individually designed for the particular work to be done, as laid out by America's oldest aeronautical engineers. Propeller catalog 4c. Heath Airplane Co., Chicago, Ill.

INVENTORS desiring patents should write for our Free Illustrated Guide Book and Evidence of Conception Blank. Send model or sketch for our opinion of its patentable nature. Highest references. Prompt service. Reasonable terms. Victor J. Evans & Co., 187 Ninth, Washington, D. C.

HIGGEST, best catalogue Model Aeroplanes, Parts and Supplies; 5c Postpaid. Ideal Aeroplane Co., 72½ Green St., New York.

THE American School of Aviation announces a new correspondence course in Mechanics of Aviation. A thorough training in Practical Aeronautics. American School of Aviation, Dept. 1863, 3601 Michigan Ave., Chicago, Ill.

WELDING

WELDING Encyclopedia—A complete instruction book on all welding processes; oxyacetylene, electric arc, electric resistance and thermit. Welding of all weldable metals fully discussed. 326 pp., 375 Ills. The accumulated experience of the welding brains of America is yours for \$5. Money back if not satisfied. Popular Mechanics Book Dept., 200 E. Ontario St., Chicago.

ELECTRO plating Generators. Make money doing Plating Work. Priced reasonable. Terms if desired. Write us. Hobartsons, Troy, Ohio.

BOOKS AND PERIODICALS

NEW Book—Where to Buy Ten Thousand Things at Wholesale. (Groceries, clothing, everything imaginable.) Worth \$10 per copy to anyone, says Professor Abbott. Price 60c prepaid. G. O. Shaver, Publisher, Pm. 20, Oil City, La.

BOOKS. All Kinds. Lists. Please mention reading preference: Fiction? General Literature? or Science-Instruction? Higen's, A2441 Post Street, San Francisco, Calif.

LEFAX—"Facts on Leaves." You make your own handbook, loose-leaf. From our complete list of Lefax data sheets you select only those that you actually need, then fill in your own notes or diagrams on extra blank sheets which come in 100 different styles. These in loose-leaf binder make up a book covering your individual needs. Send for complete information and price list to Popular Mechanics Book Dept., 200 E. Ontario St., Chicago.

COUE'S "Self Mastery," 50c. "Power of Will," \$3.00. "Master Key," \$2.50. Complete (New). All for \$3. Phipps, 1014 Belmont, Chicago.

SUCCESS-O-METER keeps you on your toes mentally and physically. Send only \$1 for this fascinating course on Mind, Body and Personality. Address, Lock Box 1513, Washington, D. C.

LIGHTS, Colors, Tones, and Nature's Finer Forces. Marvellous Scientific Discoveries. 270 Pages, Includes—Vibrations; Odies; Cold-lights; Radioactivity. Illustrated, \$2.00. Satisfaction Guaranteed. Table Contents free. Department—Mechanics—Stevens Publishers, 242 Powell, San Francisco, Calif.

1,000,000 INDUSTRIAL Facts, Calculations, Receipts, Processes and Trade Secrets for every business are contained in the 1,016-page book "Moore's Universal Assistant and Complete Mechanic," 500 Engravings, Cloth. Price \$2 postpaid. Popular Mechanics Book Dept., 200 E. Ontario St., Chicago.

BOOKS—Summer Special—10 books fiction or assorted, good condition. Send no cash—pay postman only \$3. Judy Book Store, 1330 Madison, Chicago.

FOUR Poppy Baseball Tales, Illustrated, Quarter. Libby, 93 High, Portsmouth, N. H.

YOU should have our New Illustrated List of Practical Books, Free. Spon & Chamberlain, 120 P. M. Liberty Street, New York, N. Y.

ADVANCED Machine Work, Seventh Edition, by Robert H. Smith, Massachusetts Institute of Technology; 797 pages, 896 engravings, postpaid \$3.25. A practical book for apprentices, machinists, tool-makers, auto and farm mechanics, students, teachers and engineers. Instruction is given in measuring with light waves to the millionth of an inch. Address, Industrial Education Book Co., Box 153, Back Bay, Boston.

BIG money in writing photoplays, stories, poems, songs. Send today for free copy America's leading writer's magazine, full of helpful advice on writing and selling. Writer's Digest, 708 Butler Building, Cincinnati.

CONCRETE Handbook, New, for the Amateur. We have just published a book describing 173 ways of using concrete in the home, shop and on the farm, with full directions for doing these things yourself with ordinary tools. 138 illustrations. It is "written so you can understand it." Price 50 cents, postpaid. Popular Mechanics Book Dept., 209 E. Ontario St., Chicago.

INDUSTRIAL Alcohol, Wright's book everybody wants. Full directions for making with drawings of necessary apparatus. \$2.50 postpaid. Spon & Chamberlain, 120 E. M. Liberty Street, New York, N. Y.

PLANS for Poultry Houses, All styles. 150 illustrations; secret of getting winter eggs, and copy of "The Full Egg Basket." Send 25 cents. Inland Poultry Journal, Dept. 74, Indianapolis, Ind.

PICTURES AND POSTCARDS

SEE yourself as others see you—Photo Pocket Mirror, 65c. Send Photo, Success Art Company, Cumberland Gap, Tenn.

JOIN Live Postcard Club, Membership Lists including Catalog, 10c. Harvey Teeple, Decatur, Ind.

NOVELTIES, CURIOS, ETC.

ARTISTIC name cards, samples 10c (silver). Prince, 150 W. 164th, New York.

MOON-O-LIGHT radium paint shines in darkness; 25c per bottle. Gray & Bresey, 1463 St. Lawrence Ave., Bronx, N. Y.

GAMES AND ENTERTAINMENTS

FOR Your Lawn, Country Club, Neat Obstacle Golf, Paris, Maine.

VENTRILAQUMISM taught almost anyone at home. Small cost. Send 2c stamp today for particulars and proof. George W. Smith, Room M-737, 125 N. Jefferson Ave., Peoria, Illinois.

200 KINDS Iron, wood and wire puzzles. Leader and illustrated list 10c. Western Puzzle Works, St. Paul, Minn.

MAGIC TRICKS, BOOKS AND JOKERS' NOVELTIES

CRYSTAL Gazing acts, Entertain, Mystify—Magical Card Tricks, Novelty, Jokes, Illusions, entertainment goods. Large assortment of quality goods. Buy direct. Illustrated catalog mailed free. Write today. Henney Magic Co., Berlin, Wis.

JOKERS' novelties, Greatest fun makers on earth. Catalog for stamp, C. Fenner, 2401 Jefferson, Louisville, Ky.

MAGIC Disappearing Writing Pad, You simply write anything at all on the top sheet of the pad; then lift; Presto! the writing vanishes. Mystify your friends. Great fun. Price 25 cents postpaid. Popular Mechanics Book Dept., 209 E. Ontario St., Chicago.

EUROPEAN Novelty, "See Lola dance." Sample, 10c. Schaefer Novelty Co., Newman Stern Bldg., Cleveland, Ohio.

PAPER Magic—A new book by Houdini in which are described not only a large number of tricks with paper but also the amusing and puzzling articles which may be made of folded paper and tearing of paper. Paper Puzzles are also included. 206 pages, illus. Price \$2.50 postpaid. Popular Mechanics Book Dept., 209 E. Ontario St., Chicago.

TRICKS, Puzzles, Jokes, magical apparatus, plays, stage supplies, mind-reading, sensational escapes, 168-page illustrated professional catalog, 10c. Oaks Magical Co., Dept. 548, Oshkosh, Wis.

AMAZE and Mystify your friends! New 48-page Magic Book tells how—explains 33 Mystifying Effects. Sent with Catalogue of 300 Tricks and Novelty, only 6c. Write today. Lyle Douglas, Station A, Dallas, Texas.

EVERYTHING in Magic, Four Catalogs 10c. Glimaggio, Morgan Park, Ill.

FREE—Our Catalog of Puzzles, Tricks, Games, Jokes, Novelty, Wright & Son, 601-G Ind. Ave., Peoria, Ill.

STAMP COLLECTING

50 DIFFERENT United States 10c; 10 Nyassa 1901 25c. Seidenberg, Merion, Wis.

UNITED STATES, 100 varieties \$1.00; Danzig, 37 varieties 65c; Hinges, per package 15c, Approvals, First Class References or Cash Deposit Required, C. Osborn, 486 Park Ave., Weehawken, N. J.

BEST one-cent approvals in America, F. P. Hand, 1117 So. 60th St., Philadelphia, Pa.

START a Stamp Collection—70 different stamps from 70 different foreign countries, including Africa, Asia, Australia, Europe, West Indies, etc. Our pamphlet which tells "How to make a collection properly," and price list of albums, packets and sets, all for only 16 cents. Queen City Stamp Co., Room 36, 601 Race St., Cincinnati, O.

TRY my Hi-grade Approvals, One cent each—Worth it! Premiums free! Ulric Childress, Winthrop, Mass.

100 RARE and valuable foreign stamps, all different, and big catalog, 7c. Stanton, Niantic, Conn.

200 DIFFERENT stamps, list ten cents to those ask for 50% discount approvals. K. C. Stamp Co., 838 Lee Bldg., Kansas City, Mo.

PACKETS—100 diff. stamps, 8c; 200, 18c; 500, 75c; 1,000, \$1.40; 100 diff. Hungary, 15c; 30 Greece, 25c; 300 New Europe, 45c. Set of stamps free to approval applicants sending reference. Yonkers Exchange, Yonkers, N. Y.

FREE, Dollar Stamp Free to applicants for my 60% approvals. Norman Shultz, Colorado Springs, Colo.

MONTENEGRO, 1907, complete set, 12 varieties only, 15c, or 1910 set, 12 varieties for 80c. Finest selections on approval only on request, B. L. Voorhees, 25 N. Dearborn St., Chicago.

STAMPS sent on approval at 70% discount, Reference required. Emory Benoit, Hanover, Pa.

UNIVERSAL Packet, 100 varieties, all over the world, 10 cents. Covert Stamp, 39 State, Rochester, N. Y.

100 DIFFERENT foreign—No English, French, German, Canadian, cheap, unused European, ten cents, R. Lehr, 1309 Foulkrod St., Philadelphia, Pa.

FREE—Fifty Different Neuros to Approval Applicants. Postage 2c. 1,000 Hinges, 10c. Sunflower Stamp Company, Hutchinson, Kan.

ZAMBESIA, Zanzibar, Abyssinia, Herzegovina, Allenstein Stamps, Menageric collection, hinges, 10c. Liberty, 3974 Arsenal, St. Louis, Mo.

APPROVALS! 1/2 catalog, Rare Hayti, Cataloging \$1, free to applicants, Penna. Stamp Co., Manor, Pa.

NEW Rumanian "Coronation Issue" (5 varieties) 15 cents. Sets, Singles on approval, F. Buffham, Lake Ave., Racine, Wis.

FREE! World's smallest stamp. Approvals, Postage 2c. Cannon, 1414 Carey, Davenport, Iowa.

300 DIFFERENT Stamps, 25c; 200—15c. Micheal, 5602 Prairie, Chicago.

105 DIFFERENT stamps, including German airplane, Plume, Danzig, Ukraina, and approvals 10c. James Musick, 4440 Natural Bridge, St. Louis, Mo.

\$3.00 FOR 12c!! 100 different Neuros, catalogued \$2.10; triangle stamp, red-cross set, airplane set, perforation gauge, millimetre scale, fine wallet, 5 approval sheets, 250 hinges, scarce packet from Nyassa, Abyssinia, etc., price lists and approvals—all for 12c!! Atlanta Stamp Co., Box 532, Atlanta, Ga.

TEDDY ROOSEVELT, 5c Blue; also 50 different French Colonials for 2c; Jacob Fischer, 1539 North Lawler, Chicago.

STAMPS, 50 Varieties, Africa, Brazil, Peru, Cuba, Mexico, etc., 10c. 50 different U. S., 25c; 1,000 mixed, 40c; 1,000 hinges, 10c. List free, C. Stegman, 3948 Cote Brillante, St. Louis, Mo.

100 FOREIGN Stamps free to honest approval applicants. Address J. A. Flatten, Fertile, Minn.

200 DIFFERENT New Europe, mostly unused, including Czech-Slovakia, Danzig, Latvia, Ukraina, Airplanes, etc., postpaid for 12c to new applicants for Fenway Net Approvals. "Ask any boy who's had them." Address, Fenway Stamp Co., Box 84, Fenway Station, Boston, Mass.

LIKE Triangular Stamps? To introduce our Sudden Service Approvals we'll send triangular Plume, set China ships, large \$1.00 United States revenue, also packet 50 foreign, millimetre scale, perforation gauge, ruler and bargain lists for only 9c! Fennell Stamp Company, Dept. P, Fullerton Bldg., St. Louis, Mo.

158 GENUINE Foreign Stamps Mexico War Issues, Venezuela, Salvador and India Service, Guatemala, China, etc., only 10c. Finest approval sheets 50 to 60%. Agents Wanted, Big 72-p. Lists Free. We Buy Stamps, Estab. 29 yrs, Hussman Stamp Co., Dept. 54, St. Louis, Mo.

UNIVERSAL Packet, 100 varieties, all over the world, 10 cents. Covert Stamp, 39 State, Rochester, N. Y.

24 VARIETIES Cuban stamps, 10 cents. List of 6,000 low-priced stamps free. Address Chambers Stamp Co., 111P, Nassau St., New York City, N. Y.

FREE! Sectional Loose Leaf Postage Stamp Album at the rate of 8 pages each month given with subscription to our monthly Journal. Send two-cent stamp for prospectus. United Stamp Co., 140 N. Dearborn St., Chicago, Ill.

STAMPS, 20 unused, all different, free. Postage 2c. Mention paper, Quaker Stamp Co., Toledo, O.

PACKET of 23 stamps, no two countries alike. Packet hinges. Set of \$1 and \$2 U. S. Rev., all for 5c. Mention paper. Miami Stamp Co., Toledo, Ohio.

20 UNUSED stamps free. All different. Postage, 2c. Fisk Stamps, Toledo, Ohio.

105 CHINA, etc., stamp dictionary, list, 2c. Album (500 illustrations), 3c. Bullard, Sta. A, Boston.

FRENCH Colonies Free—Beautiful Picture set, including Native Chiefs, Tigers, Pictorials, 2c Postage, Empire Stamp Company, Toronto, Canada.

FOREIGN Stamp Collection Sent Free, Cornish Company, Sebectady, N. Y.

BIG Variety Packet Foreign Stamps free for 2c postage, Gray Stamp Co., Station E., Toronto, Canada.

APPROVALS, Better Grade, William Stone, 172 Sherman Ave., New York City.

STAMPS Free—War Stamps, Surcharged, Unused, Pictorials, British, French Colonials, 2c postage. Midland Stamp Co., Toronto, Canada.

1,000 DIFFERENT, \$2.00; 500, 75c; 325, 50c; 225, 25c. Fred Onken, 639 79th Street, Brooklyn.

FREE—50 varieties or set to approval applicants sending 2c. 500 different 60c. Richard F. Lamprecht, Valparaiso, Ind.

RARE COINS

\$2 TO \$500 each paid for hundreds of Old Coins. Keep all Odd or Old money. It may be very valuable. Send 10c for New Illustrated Coin Value Book, 4x6. Get posted. We pay cash. Address Clarke Coin Co., Ave. 2, Le Roy, N. Y.

40 OLD coins, all different, \$1.00, 30 Large U. S. Cents, all Different Dates, \$2.25; 20 old Bills, all Different, \$1.00. List Free. Claud Denney, Box 315, Dallas, Texas.

THREE old coins 10c; coins found. Dursio, 25 Mulberry, N. Y. City.

100,000 ROUBLES 25c, 10,000 German Marks \$1.00. Craig Dare, 410-55th, Brooklyn, N. Y.

SPECIAL Offer—10,000 German Marks \$1.50; 1,000,000 Roubles \$1.75. Write for free sample of foreign money, also price list. Public State Bank, Dept. 100, Chicago.

CENTS worth dollars. Do you know that coin collectors pay up to \$100.00 cash for certain old U. S. Cents—as well as high premiums for all rare coins. We buy all rare coins. Send 4c. Get large coin circular. It may mean much profit to you. Numismatic Bank, Dept. H., Ft. Worth, Texas.

POLITICAL Cent. Jackson Cent or "Hard Times" Token, issued in 1834 to 1842. Highly interesting, some with jacks, turds, etc. Get one now with my large 50-page illustrated Coin Catalog for only 20 cents. This is just a special "get-acquainted offer." H. Max Mohl, Numismatist, -Mehl Bldg., Dept. P., Fort Worth, Texas. Largest Rare Coin Establishment in the United States.

OLD Coins. Large Spring selling catalogue of coins for sale, free. Catalogue quoting prices paid for coins, 10c. William Heskett, 101 A Tremont St., Boston, Mass.

CALIFORNIA gold, $\frac{3}{4}$ size, 27c. $\frac{3}{8}$ size, 33c. 2c piece and catalogue, 10c. Address Norman Shultz, Colorado Springs, Colo.

BY return mail, four rare coins (one silver), no trash, for fifty cents, also membership endless chain of free coins. Honest dealings. Southampton Coin Exchange 5427 Nottingham St. Louis.

FOR BOYS

BOYS! Make many dandy wooden toys! "The Boy Toy-maker" outfits are complete with materials, tools and instructions. Get your set at once and start right in making toys for yourselves, for brother and sister, or sell the toys and earn money. "The Boy Toy-maker" outfits come in four sizes. Which one will you have? \$1.50, \$2.00, \$3.50 and \$5.00. Sent postpaid to your home on receipt of check or money order. M. Carlton Dank & Co., Dept. P, 2728 Atlantic Ave., Brooklyn, N. Y.

BOOKS — "Ventriloquism," "Toy-maker Book," "Boy Electrician," 10c each, all for 25c. G. Elsea, Bowling Green, Ohio.

CAMERAS AND PHOTO SUPPLIES

JUST Published—Our new complete 128-page catalog and bargain book of new and used cameras and supplies. Our goods are guaranteed finest quality obtainable. We have thousands of satisfied customers. Write at once for this bargain bulletin, just hot from the press. Address Central Camera Co., 124 S. Wabash Ave., Dept. E-70, Chicago, Ill.

TRIAL—Film developed, six prints 25c coin. Road Photos, Waupun, Wis.

SAMPLE enlargement, dime and negative (returned). Sample 6-exposure roll finished glossy, 25c silver, Brown Studio, Lake Elmo, Minn.

ICA Postcard size, Film-Plate Zeiss Tessar Lens 6.8. Brand new. Listed \$95.00, sacrifice at \$60.00. Rev. Markert, Techny, Ill.

CAMERAS, lenses, binoculars, telescopes; buy, sell, exchange. Write now; shotguns taken in trade. National Camera Exchange, LaSalle Bldg., Minneapolis, Minn.

KODAK Films—Special trial offer: your next kodak film developed, 5c—prints, 2c each. Meier & Son, 1917 St. James Ave., Cincinnati.

MODERN Photography in all its branches now taught by mail. New Successful Method. Students earning \$300.00 while learning. Big Opportunity. Write for particulars and unusual offer open for short time. Dept. 3435 International Studios, Inc., 3601 Michigan Ave., Chicago.

SPECIAL Trial Offer: Any size Kodak film developed for 5c; prints 3c each. Overnight service. Get a Free Auto. Ask for details. Roanoke Photo Finishing Co., 209 Bell Ave., Roanoke, Va.

FILM developed and six glossy prints, 20c. Photo Works, Ashton, Ill.

MAKE money with your camera. Lancaster, Box 967, Los Angeles, Calif.

FILMS, 5c each; Prints, 3c each. Any size. One hand-tinted Free with each order. Anzlykum, Bristol, Vt.

HAVE You a Camera? Write for Free sample of our big magazine, showing how to make better pictures and earn money. American Photography, 790 Camera House, Boston, 17, Mass.

MOTION PICTURES

THEATRE Supplies. Picture Machines. Opera Chairs. Carbons, Stereoscopes. Save Money. Send for Catalog. Western Motion Picture Co., Danville, Ill.

FILM: Standard Slide for Toy and Professional machines. Special Bargains—Complete subjects \$3.00 per reel. We sell everything for "The Movies." Monarch Theatre Supply Company, Dept. P, 724 S. Wabash Ave., Chicago.

FILMS For Sale—\$2.50 per Reel up. Address Queen Feature Service, Birmingham, Ala.

FILMS for Toy Projectors, 800 feet, No. 2, 2,500 Reels, \$3 and \$5; Home Projector, \$25, Motor Driven Projector, \$75; Road Show Projector, \$50; Movie Camera, 200 foot, \$55; Panorama Tripod, \$25; Ray—324—5th Avenue, New York City.

REMARKABLE value: Light Weight Professional Motion Picture Projector. Mazda Illuminated, with 1,000 feet of film, \$37.50. Send for photograph. De-France, Importers, 169 No. Dearborn St., Chicago, Illinois.

AMERICA'S Greatest Fortunes have been made in the Moving Picture Business. Small investment needed. We furnish complete theatre equipment. Easy payments. Openings everywhere. Catalog free. Monarch Theatre Supply Co., Dept. F, 724 So. Wabash Ave., Chicago, Ill.

JUST in time to get in on the big money to be made! Bass will start you in the Motion Picture Making Business. enormous profits making Industrial Films, News Weeklies, etc. Catalogue and full information free! The Cinema Handbook, 575 pages, for \$3.00 postpaid. Bass Camera Company, 105 No. Dearborn St., Chicago, Ill.

\$35.00 PROFIT nightly. Small capital starts you. No experience needed. Our machines are used and endorsed by government institutions. Catalog free. Atlas Moving Picture Company, 482 Morton Bldg., Chicago.

FREE to Writers—A wonderful little book of money-making hints, suggestions, ideas; the A B C of successful story and play writing. Absolutely Free. Just address Authors Press, Dept. 12, Auburn, New York.

\$\$\$ FOR Ideas. Photoplay plots accepted any form; revised, criticized, copyrighted, marketed. Advise free Universal Scenario Corporation, 917 Western Mutual Life Bldg., Los Angeles.

MAKE money writing photoplays: details free to beginners. No correspondence course. Producers League, 230 Waterwright, St. Louis.

FILMS: Comedies—Cartoons—Dramas—Westerns—Serials and Educational Subjects. Get our Big List and bargain prices before you buy. Monarch Theatre Supply Co., 228 Union Avenue, Memphis, Tenn.

SCENERY TO RENT

SETTINGS for Opera, Plays, Minstrels. Push Drops. Address Amelia Grain, Philadelphia.

EDUCATIONAL AND INSTRUCTION

STUDY Bacteriology, Hygiene, Public Health. Laboratory technologists make good income. Interesting course, can be mastered at home or school in a few months. Also courses in Arts and Sciences, Chiropractic, P. G. Pharmacy, etc. 15th year. Diplomas conferred. Free announcement. National University of Sciences, 2923 So. Michigan Blvd., Chicago.

USED books and educational matter bought, sold, exchanged. Bulletin free. Instruction Correspondence Exchange, 1969 Broadway, New York.

SHOW-CARD writing a pleasant, profitable profession easily and quickly learnt by our new, simple graphic block system. Artistic ability not necessary. We teach you how. Distance no object. Full particulars and booklet free. Wilson Methods, Limited, Dept. M, 64 East Richmond, Toronto, Canada.

BE a Laboratory Expert. Earn \$300.00 to \$500.00 a month. Study Microbiology, Bacteriology, Laboratory Technology, Sanitation. Interesting Extension and Residential Courses. Diplomas and Degrees granted. 71-piece Urinalysis Outfit Free to students. Write for Free 48-page Prospectus. Int'l. Physicians and Surgeons College of Microbiology, Room 955, 559 Garfield Ave., Chicago, Ill.

CARTOONISTS—Improve your style by following the work of the greatest cartoonists found in the bound volumes of Cartoons Magazine. Eight volumes, each covering six months, Jan.-June, 1917, to July-Dec., 1920, inclusive. 1,200 cartoons, 500 pages to a volume, 7 by 9 1/2 in., 3 in. thick. New books, durable and attractive binding. Sold separately at \$2 per vol. postpaid. Supply limited. Send at once. Popular Mechanics Book Dept., 200 E. Ontario St., Chicago.

USED books and educational matter bought, sold, exchanged. List 1,000 items free. Students' Exchange, 47-A West Forty-second Street, New York, N. Y.

ARE you doing work you are best fitted for? We thoroughly examine and issue certificate stating your accomplishments. Electrical, Automotive, Engineering. Particulars free. Illinois Practical Technicians' Institute, DuQuoin, Ill.

ROPP'S Calculator and Short-Cut Arithmetic shows the answer as quickly as a watch shows the time to all problems likely to occur in office, store, shop, bank, farm or factory. Price, pocket size, paper 25 cents; cloth 50 cents; leatherette \$1. Desk size, cloth, \$1.50 postpaid. Popular Mechanics Book Dept., 200 E. Ontario St., Chicago.

YOU can have a business profession of your own and earn big income in service work. A new system of foot correction; readily learned by anyone at home in a few weeks. Easy terms for training; openings everywhere with all the trade you can attend to. No capital required or goods to buy, no agency or soliciting. Address Stephenson Laboratory, 1 Back Bay, Boston, Mass.

WORLD-HOMIC System. Masterkey to All Languages, Primers, 23 languages, \$1.94 each language: Arabic, Bohemian, Bulgarian, Cantonese, Chinese, Danish, Dutch, English, Scotch English, French, German, Hungarian, Italian, Japanese, Latin, Polish, Polish, Portuguese, Rumanian, Russian, Sechuana, Spanish, Swedish, Pronunciation Tables, 94 languages, 20c each language. Languages Publishing Company, 8 West 40th Street, New York.

INVENTORS—Write for our illustrated cycle book and Evidence of Conception Blank. Send model or sketch and description for free opinion of its patentable nature. Highest references. Prompt attention. Reasonable terms. Victor J. Evans & Co., 167 Ninth, Washington, D. C.

DOUBLE Entry Bookkeeping mastered in 60 hours with 8 keys; guaranteed; diplomas. Our graduates lead in bookkeeping, auditing, accountancy, balance sheets, and financial statements. International Bookkeeping Institute, Dept. 8, Springfield, Mo.

WRITE articles, stories, news, in spare time for newspapers and magazines. Big pay. Copyright book free. Press Syndicate, 552, St. Louis, Mo.

BIG Money in writing photoplays, stories, poems, songs. Send today for Free copy America's leading writer's magazine, full of helpful advice on writing and selling. Writer's Digest, 603 Butler Building, Cincinnati.

ARTIFICIAL Marble, sanitary flooring instructions, ornamental casting, concrete plaster, papier-mache decorations, garden furniture, statuary, Rubber-moulds, Electro-metallurgy, particulars and 200 illustrations free. Chris Mahler, Box 122, Huntington, N. Y.

MATHEMATICS taught by mail. Arithmetic, Algebra, Geometry, Mensuration, Trigonometry, Logarithms, and Mechanics' courses. Harding School, 76 Brighton, Highland Park, Mich.

USED educational books sold, rented, bought and exchanged. Bargain list free. Lee Mountain, Pisgah, Ala.

"WHEAT to Invent for Profit" free. Patent News, N. Washington, D. C.

USED books and educational matter bought, sold, exchanged. List 1,000 items free. Students' Exchange, 47-A West Forty-second Street, New York, N. Y.

TELEGRAPHY

TELEGRAPHY—Both Morse and Wireless—taught thoroughly and quickly. Tremendous demand. Big salaries. Wonderful opportunities. Expenses low; chance to earn part. School established fifty years. Catalog free. Dodge's Institute, H St., Valparaiso, Ind.

RADIO OUTFITS AND SUPPLIES

FIBRE Panels any size, $\frac{3}{16}$ inch 16 square inch, delivered. Ohio Comb Co., Orville, O.

RUSONITE multipoint crystal rectifier. The standard crystal. Synthetic crystal detector sensitive over its entire surface. Extraordinary clearness and volume. Price mounted, 50c. Rusonite, 14-Karat gold supersensitive Cat-whisker. Price, 25c. Guaranteed. Rusonite Products Corporation, 15 Park Row, New York.

THE Perfect "Fishing" Record. Experienced radio operators have found a big advantage in keeping permanent records of their "catches." White & Wyckoff's Handy Radio Record is the ideal record form. It tells at a glance the code, location, ownership, wave length, date of every find. The sheets are perforated and can be taken from any part of the pad without disturbing the others. Get this Handy Radio Record and keep a convenient and systematic record of your radio results. At your dealer's or send us \$1 for 5 pads of 50 sheets each, 8"x9". Sent postpaid anywhere on receipt of price. Remit by check, cash or money order to White & Wyckoff Mfg. Co., Makers of the famous Autocrat Stationery, 110 Water Street, Holyoke, Mass.

BUILD your own Radiophone. Instruction book ten cents. Radio Service Inst., U. S. Bank Bldg., Washington, D. C.

ELECTRIC Solder Iron \$1.50. Circuits Free. David Simon, 4927 Fountain, St. Louis, Mo.

1,500-MILE Vacuum Tube Receiver \$28.50. Box 265, Williamsport, Pa.

FREE—Complete price list of radio parts. Write Aitken Radio Co., 504 Superior St., Toledo, Ohio.

PLAY Radio Golf and get a new pleasure out of your Receiving Set. Our Radio Golf outfit will enable you to keep accurate score day by day of the number of stations you hear and the total number of miles they represent away from your home; also helps you to see how your receiving is improved. Send \$1.00 today and the entire outfit will be shipped by return mail. Money refunded if not satisfactory. Radio Golf Association of America, Dept. B32, Washington, D. C.

"**BANG**," that new discovery. The Desert Cactus Cat Whisker, improves your set 100%. Mail 25 cents for set of two and details of the new 300 mile Mars Radio Crystal Receiving Set. Address, Million Article Radio Service, Box 822, Needles, Calif.

ARMSTRONG Regenerative Tuner Licensed. Using coil similar to Rheinartz. Complete \$10.00 and postage. Knocked down parts \$5.00. Catalog 10c. Address, Tresco, Davenport, Iowa.

TESTED Reelies. Transmitter Button Hook-Ups, Amplification, Loud Speakers. Free Circular. K. Electric Co., 15 Park Row, New York City.

TRADE SCHOOLS

LEARN Modern Barbering. It pays. Clean—care-free—short course. Can travel, see the World, or be your own boss. Will equip shop on payments. We have 33 branches. There is one near you. Write any address below for booklet B, telling all. (You do not need street address.) Moler System of Colleges, New York City, Chicago, Ill., St. Louis, Mo., Kansas City, Mo., Cincinnati, O., Cleveland, O., Detroit, Mich., New Orleans, La., Atlanta, Ga., Memphis, Tenn., Milwaukee, Wis., Omaha, Neb., Denver, Col.; Dallas, Ft. Worth, San Antonio, Houston, Texas, or Toronto, Ont., Canada.

LET Us Place You in a Position to earn from \$10 to \$15 per day. We make an expert painter of you in a few weeks, better than if you went to work in a regular shop. Practical training in Sign, Pictorial, Auto Painting, Decorating, Paperhanging, Graining, Marbling. Catalogue Free. Chicago Painting School, 148 West Austin Avenue, Chicago.

BUSINESS OPPORTUNITIES

CAPABLE men wanted to open branch office and manage salesmen. \$300 to \$1,000 necessary; handle your own money. Possibilities unlimited. Address Manager, 603 N. Eastway St., Baltimore, Md.

STOP Working for Wages Immediately. Trouslot, Box 1272, San Francisco.

WE start you in business manufacturing advertised food product. Exclusive license your city. Lite Lunch Co., 220 No. State St., Chicago.

BIG Money in Radio. Thousands of men needed in fastest growing industry. Best positions go to men holding Government license in Radio. Easy to qualify for this at home in spare time. Write for Free Book on radio. Describes bigger opportunities in Radio; tells how you can easily qualify for them. Address National Radio Institute, Dept. M-3, 1345 Pennsylvania Ave., N. W., Washington, D. C.

OPPORTUNITY to start lucrative business, little capital. Write Dept. M, Paul Kaye, 149 Broadway, New York.

MAKE Big Money—Very small investment, large profits, permanent business, no experience needed. Act at once. El-O-Viso Greasing System, 722 Wall St., Wichita Falls, Texas.

LEARN how to make a real success in the mail order business. Send stamped envelope for free particulars. H. Johnson, 5128 Wells St., Chicago, Ill.

START a pressing, cleaning and dyeing shop; excellent field, splendid profits. We tell you how. Write for booklet. Ben-Vonde System, Dept. C, Charlotte, N. C.

MAKE money! Start mail business. 20 Gilt-Edged Plans Free. Wolverine Bureau, 491 Washington, Muskegon, Mich.

WHY not sell us your spare time? \$1.00 per hour. \$9.85 Daily easy for full time—introducing New Style Guaranteed Hosiery—37 styles, 17 colors. No capital or experience required. Just write orders. We deliver and collect. Your pay daily, also monthly bonus. Free auto offer besides. Complete outfit furnished. All colors-grades, including silks. Mac-O-Cheer Mills Co., Desk 2536, Cincinnati, Ohio.

EARN \$70 daily silvering mirrors, plating and refinishing metalware, autos, chandeliers, bedsteads, headlights. Outfits furnished. E. Dele Laboratories, 1133 Broadway, New York City.

HAVE you found your place in life? Write for free circular on misdirected abilities. Address Robert Knox, Box 728, San Francisco, Calif.

CORPORATIONS organized, security issues formulated, prospectuses prepared—moderate fee. Blanchet & Co., 347 5th Ave., New York City.

PUBLISH Magazine of Your Own. Start Mail Order Business and Advertising Agency on \$1 Capital. Sample Plan, 10c. Harvey Teeple, Decatur, Ind.

HOW To Organize. Finance Company. Write Box 617, Schenectady, N. Y.

FREE Book. Start Little Mail Order business anywhere. Home employment earnings. Beginners Working Outfit furnished. Instruction, 500 circulars, samples, things to sell. You deal direct with manufacturers. No stock to carry. Instructive Book free. Pier, 238-A, 74 Cortland Street, New York.

RABBITS pay if kept right. Rabbitcraft shows you how. Send 50 cents for 12 months' subscription and receive free book "How to Sell Dressed Rabbits." Sample copy free. Rabbitcraft, Box P, Lamoni, Iowa.

LABORATORY Scientists are in demand. We teach you quickly and thoroughly and help secure positions. Extension and residential courses in Bacteriology, Microbiology and Sanitary Science. Taught by clear, concise, simple method. No preliminary training needed. Diplomas and degrees granted. The fascinating profession of Laboratory Scientist is recognized in business, detection of crime, disease prevention and cure. More experts needed daily. Become respected member of growing profession. Earn \$250 to \$500 a month. Students enrolling now will receive 48-piece Urinalysis outfit absolutely free. Send for free prospectus today. Physicians and Surgeons College of Microbiology, Suite 971, 550 Garfield Avenue, Chicago.

RAISE Silver Foxes. I pay \$200 to \$500 for pups. Gerald F. Todd, St. Stephen, N. B.

START Automobile Painting, Plating, etc. Profitable plans free. Borhek, 427 Carroll St., Akron, Ohio.

SWIMMING Propellers; season now. Any body can build and sell; large profits. Send 25c for plans and instructions. Novelty Wks., 822 W. 35th St., Chicago.

STOP Here—If you have \$500 available you can make \$288 a week clear and handle your own money. New proposition—strictly legitimate—requires no fixed investment of any kind. Operates anywhere. All or spare time. A business proposition that will bear close investigation. Hurry—send today for proof and details. Address Balba Corporation, Toledo, Ohio.

DEPENDABLE Solution for Raising Capital quickly, economically, successfully. Outline proposition fully for valuable 32-page free book, "There is a Way." Robert S. Hansel, Financing Specialist, Dept. 501, Fourth Avenue, Pittsburgh, Pa.

LEARN at home, make automobile specialties. New Tops; Repaint, Retrim, and clean cars. Endorsed by trade experts. Start your own shop—we teach you how. Autoremaco, Sheboygan, Wis.

SEND 25c for paying mail order plan that brings big money quickly. Bookham, 43 Court St., Room 1, Boston, Mass.

BIG opportunity. Start in business for yourself; make and sell mosquito lotion formula. 50c. Gray & Brecky, 1463 St. Lawrence Ave., Bronx, N. Y.

CHEMICAL Expert furnishes manufacturing formulas with complete working directions, resulting products possessing distinct individuality and merit. Processes perfected. All lines. No lists of worthless stock formulas. Correspondence invited. Dr. Arthur VanHoeven, 508 South Oakley Boulevard, Chicago.

I MADE \$30 a Week Home, French Breadmaking. 15 years' experience; Free Booklet tells. Ashbrook, 67, Marenco, O.

PATENTS Procured. Send sketch or model today for examination, prompt report and advice. No charge for preliminary advice. Write for free Booklet and Blank form on which to disclose your idea. Highest references. Promptness assured. Clarence A. O'Brien, Registered Patent Lawyer, 501 Southern Building, Washington, D. C.

PREPARE—Sell Your Own Products. Formulas, trade secrets. Different, dependable. Catalog free. B. Thaxly Co., Washington, D. C.

ATTENTION!! You can have a business of your own. Establish and operate New System Real Estate Business, brokerage and insurance agency in your community. Office at home. Earn \$5,000 year. Representatives wanted everywhere. Send stamp free booklet. Hayes Realty Association, Cincinnati, Ohio.

PATENTS Procured; Trade Marks Registered—A comprehensive, experienced, prompt service for the protection and development of your ideas. Preliminary advice gladly furnished without charge. Booklet of information and form for disclosing idea free on request. Richard B. Owen, 30 Owen Bldg., Washington, D. C., or 2276-B Woolworth Bldg., New York.

PROTECT your rights—Write for "Record of Invention" and booklet about Patents. Prompt personal service. Advice without charge. J. Reaney Kelly, 612-G Columbian Building, Washington, D. C.

SEE What I can do for you and what you can do for yourself manufacturing these Biggest Selling Specialties from Miller's Guaranteed Manufacturer's Formulas and detailed Simple Instructions. No Machinery Required—Investment Small, Start in Home, Office, Store or Factory, making 30-Minute White Beauty Clay, Mexican Yucca Soap, Merte's Toilet Specialties, Vanil, Fifteen Pure Food Specialties, Concentrated Summer Drinks, Washing Marrel Powder, Amazon Tire Repair, Rubber Toy Balloons, White Floating Laundry Soap, and many other largest sellers in all lines. Stamp brings all lists and valuable descriptive literature. Don't compare these high grade processes with anybody's "Bargain Collection" of cheap Recipes. 26 years supplying the Best. Highest references. Miller, Chemist, Tampa, Florida.

HAVE a business of your own; the most fascinating, best paying business-profession in the world, a foot correctionist; easy terms for training you at home in a few weeks, a new protected system that has enabled men and women to rise in one step to greater earnings than they ever thought possible; no capital required or goods to buy, no agency or soliciting. Address, Stephenson Laboratories, 1 Back Bay, Boston, Mass.

START a Lucrative Business of Your Own. We teach you how to establish and operate a successful collection business and refer items to you. Capital unnecessary. Practically no competition. Walter Sanford, Nashville, reports \$92,921.94 gross commissions last year. Joseph Cullen, Washington, sends sworn statement showing gross earnings \$8,039.07 for one month. Orrin Overholzer, Dayton, says: "I averaged nearly \$400 net commissions monthly last year. Such earnings bought my home and farm." Start now in spare time. You can succeed like 4700 others. Write today for New Plan. American Collection Service, 802 Shelby Block, Detroit, Mich.

ORANGEADE, in powder—just add cold water—most delicious drink you ever tasted. Fine for home, parties, picnics, dances, etc. Start in this business—big money easily made. Send dime for ten glass package, postpaid. 7 kinds, Cherry, Grape, Lemon, Strawberry, etc., for 70 glasses only 50c, postpaid. Morrissey Company, 4417-25 Madison St., Chicago.

"SCHEMER Magazine," Alliance, Ohio, prints big profit schemes; one subscriber making \$25,000 from three; another \$10,000 from one. Try your luck. Year, only \$1.00; three months, 25c.

MAIL Order Business is your opportunity. Brenner's Famous Handbooks teach how to start small, grow big. Sell merchandise, service, ideas; enormous profits. Spare time to begin. Get complete set, 11 books, \$3.00, and be posted. Brenner, 335 Walnut, Philadelphia. Descriptive Catalog and big batch interesting mail order information. 25c. None free.

SILVERING Mirrors! My exclusive French Tartaric method opens enormously profitable business. Booklet free. H. Barstow, 514 23d Street, Oakland, Calif.

RAISE guinea pigs. Pay better than poultry or rabbits; easy to raise; little space required. We guarantee market. Particulars and booklet how to raise free. Carver Distributing Co., 3162 Grand Ave., Kansas City, Mo.

GET into the specialty manufacturing business. Amazing profits. We will send you free book explaining our system. Write immediately. A wonderful opportunity awaits you. National Scientific Laboratories, 211 North Monroe, Richmond, Va.

FREE Advice, on How to Become Successful in Real Estate and Insurance. Particulars, Macdonald Cooperative Realty, San Diego, Calif.

MEN—Look into our proposition of Wall-paper Cleaning. Take big cleaning contracts. Unlimited field. C. Swanson & Sons, Mankato, Minn.

WE Start You in Business, furnishing everything; men and women; \$30.00 to \$100.00 weekly operating our "New System Specialty Candy Factories" anywhere. Opportunity lifetime; booklet free. W. H. Dyer Baggdale, Drawer 4, East Orange, N. J.

MODERN Photography in all its branches now taught by mail. New successful Method. Students earning \$300.00 while learning. Big Opportunity. Write for particulars and unusual offer open for short time. Dept. 2865, International Studios, Inc., 3901 Michigan Ave., Chicago.

DOLLARS yearly in your backyard. No Mushroom dope. Particulars free. Metz, 213 East 89th, New York, N. Y.

START in Business. Samples and stock 15c. Cochran, Grayville, Ohio.

CHEMICAL Expert will furnish Formulas and Trade Secrets. All Lines. Lists Free. W. L. Cummings, Ph. D., 228 Gordon Ave., Syracuse, N. Y.

OPERATE a Typewriter Exchange. Wonderful opportunities. My complete set instructions tells how. Write for full particulars. Sablin K. Elser, "The Typewriter Man," Brownsville, Texas.

EXCEPTIONAL Opportunity for Sales Manager capable of handling state distribution. Marvellous new Adding Machine. Retail \$15. Work equals \$350 machine. Tremendous possibilities. Unlimited profits. Write quick for details. Lightning Calculator Co., Dept. B., Grand Rapids, Mich.

START a cleaning, dyeing, pressing shop. Big profits. Experience unnecessary. Plans 25c. International, Dept. 19, Excelsior Springs, Mo.

"WHAT to Invent for Profit" free. Patent News-C, Washington, D. C.

LEARN the collection business. Good income, quick results. Interesting booklet. "Skillful Collecting," free. National Collectors Assn., Long St., Newark, O.

GOOD money easily earned at home spare time silvering mirrors; no capital. Free instructive book tells how. Patterson & Co., Brooksville, Ky.

\$3,000 TO \$6,000 Yearly. Want it? Others are making it. Send check or money order today for our invaluable books "How to Sell Real Estate," \$3.00—and "How to Conduct Real Estate and Insurance Business," \$1.50. Absolute satisfaction guaranteed. Free catalogs. Realty Sales Co., Dept. 52, Cleveland, Ohio.

MARBLE mixing instructions, covering wood or cement flooring 1/2 inch thick, fireproof, waterproof, low cost, sanitary, all colors. Particulars, 200 illustrations free. Chris Mahler, Box 122, Huntington, N. Y.

\$98.00 WILL establish you in Cash Business. Wonderful Opportunities everywhere for making Fortunes. Details Free. Monarch Theatre Supply Co., Dept. 46, 726 So. Wabash Av., Chicago.

START business Electric Lawn Mower Sharpening Machine. Capacity \$2.00 per hour. Write Springer, Knals, 415 South Lawrence, Kansas City, Mo.

INCH Display Advertisement 161 Magazines Thrice \$15. Year \$50. Page \$100. Wood's Popular Services, Atlantic City, N. J.

"HOW to Sell Patents" free. Patent News-H., Washington, D. C.

AUTOMATIC Fly Erecting Window Screens. Your opportunity. Your own business at a cost of a hammer, saw and \$3.00 for all the particulars. Address F. Rohner, Box 173, Palo Alto, Calif.

INCORPORATE any enterprise under common law; any capital, transact business any state, no corporation taxes; no personal liability; raise capital; keep control. Booklet free. Herbert Co., Rand-McNally Building, Chicago.

MANUFACTURE Extracts, and other necessities, 200% profit; we tell you how. Write White Manufacturing Drug Co., 1420 Laidlaw Ave., Cincinnati, O.

CHEMISTRY

YOUR chemical problem solved and working process furnished Five Dollars. Write me. W. Stedman Richards, Consulting Chemist, address Box 2402, Boston, Mass.

1,000,000 FORMULAS, 1016 pages, \$2.50. Formulas Free if you order quick. Ideal Book Shop, 5501-MF North Robey, Chicago.

FORMULAS AND TRADE SECRETS

\$1.00 FORMULA; cuts grease; cleans wood work, rugs, removes stains. Great for all mechanics. Costs 5c, sells \$1.00. Klean Kwick, 1046 S. Main, Jacksonville, Ill.

10,000 SELECTED chemical, technological and practical recipes and processes, including hundreds of so-called trade secrets for every business, alphabetically arranged in one large volume of 800 pages. Price \$4 postpaid. Popular Mechanics Book Dept., 200 E. Ontario St., Chicago.

700 PROVEN Money-Making Formulas, 30c. Address "Successful Plans Magazine," Sugar Notch, Penna.

EXPERIENCED Manufacturing Chemist, will solve your chemical problems and furnish working process, and accurate formulas for anything desired. A. Berlon, 342 East 71st St., Chicago, Ill.

500 VALUABLE Formulas, 25c; Formula Literature free. Harvey Teeple, Decatur, Ind.

3,000 FORMULAS, Money-makers, 400 pages, \$1. Bestosall Laboratories, 4049-BF, North Whipple, Chicago.

FORMULAS—Guaranteed. Catalog free. Bestosall Laboratories, 4049-BF, North Whipple, Chicago.

800 FORMULAS 25c; Luminous Paint—Resilvering Mirrors—Renewing Dry Batteries—Mechanics Soap—Gas Tonic—Carbon Remover—Puncture Plugger, 20c each. Entire collection 50c. Catalog Free. Ideal Book Shop, 5501-MF North Robey, Chicago.

MAKE first class paint without oil, product on every farm. Formula disse. Box 326, Rock Hill, S. C.

5,000 RECIPES, \$1.25. Best formulas and processes for every business, trade or occupation are in "Youman's Guide." Many never before published. Worth \$1.25 each. 530 pages. Paper cover \$1.25. Cloth \$2.00, postpaid. Book catalog free. Wells and Edwards, X852 George, Chicago.

DON'T Waste Money on "Junk." Stamp brings Valuable Literature of High-Grade, Reliable Formulas of Best Sellers in all lines. Buy from chemist and get real service. Miller, Chemist, 807 De Leon Street, Tampa, Florida.

"BEAUTY Clay." Widely advertised Beautifier. Women wild over it. 500% profit. Guaranteed Formula, \$1. Bestosall Laboratories, 4047-CB North Whipple, Chicago.

FORMULAS of the better sort. Write for our free catalog. National Scientific Laboratories, 211 North Monroe, Richmond, Va.

3,000 FORMULAS, 400 pages, \$1.00. Hillside Laboratories, 7021-AC South Winchester, Chicago.

AGENTS WANTED

AGENTS Earn \$50 to \$100 a Week selling flag holder for Auto running board. Every owner wants one, retails for 75c—Costs \$4 per dozen for flag and holder; you make \$5 per dozen. Exclusive territory. Decoration Day and July 4th big selling days. Send 50c for sample and particulars. M. P. Lamoureux, Commerce Station, Minneapolis, Minn.

BIG Money Operating 4 in one \$50 combination portable folding self-washing popcorn popper, hamburger, fruit and refreshment stand; 16 square feet table leaves, folds up size small trunk. Start in business street corners, fairs, carnivals, make mint money. Process Popper P. M. Co., Salina, Kan.

IF you need good live agents—fellows who can get the business—ask me how others are doing it. I'll gladly render the necessary assistance. Geo. F. Baker, Mgr. Classified Advertising, Popular Mechanics Magazine, Chicago.

AGENTS—District representatives. Product used by all auto repairers. Very large profits. Sample postpaid 40 cents. Anderson, 49 Whitmarsh Ave., Worcester, Mass.

AGENTS: World's greatest Necessity Specialties. Agents made \$68 a week. Valuable samples free with first mail. Ro-d-ex Co., 70-B, Council Bluffs, Ia.

300% PROFIT—Whirlwind Seller. Kleen-Bite. New Washing Discovery. Washes clothes without rubbing. Women throw away washboards. Write Quick for Free Package and Special Offer. Bestever Products Co., 1941-K6, Irving Park, Chicago.

RUBBER Goods Manufacturer offers big opportunity to men and women agents selling household and personal comfort necessities. Write Manufacturer, American Rubber Products Company, Dept. 698, Pittsburgh, Pa.

AGENTS, Distributors, Energetic Men everywhere earn \$10 daily handling the HyKon Belt; a new household necessity; sells on sight to homes, dressmaking and tailoring establishments. Be first; get this money-maker; put out sub-agents. Opportunity folder free. HyKon Mfg. Co., Alliance, Ohio.

PORTRAIT and Medallion Agents—Our Goods Will Make You Big Profits; delivery guaranteed; prompt shipments; low prices; send for latest catalog. Adam J. Kroll & Co., 692 Blue Island Ave., Chicago.

MAKE \$31.00 Profit—Cost You \$1.50. Complete Gold Monogramming Outfit. Transferred Instantly on Automobiles, Trunks, Bags, Windows. Experience unnecessary. Free Samples. NuLife (A) Monogram, Hartford, Conn.

WANTED—Men or Women to take orders from consumers for Boys' and Girls' Shoes. Whole or spare time. Quality guaranteed. We deliver. A. P. Condon, Sales Manager Allen Shoe Co., 101 Summer St., Boston, Mass.

MEN—Start a varnish polish business. Automobile, piano owners demand "Povar." Send 10c postage for free bottle. Demonstrate its merit and get year-around repeat business. Big profits. \$5 free advertising in your local paper. Povar Corp., 530 W. 58th, New York City.

ANY man, anywhere, handy with paint brush or light tools, can start needed painting and mechanical business on nearly nothing. Mostly all profit. Experience not necessary. Testimonials from mechanics from Maine to Oregon. John Braceland, 1457 So. Ninth, Philadelphia, Pa.

SHAVE Without Razor, new discovery, details free. American Pharmaceutical Co., Box 21, Station A, Cincinnati, O.

\$425.00 A MONTH made by Mr. Burt-ah selling our Spices, Extracts, Soups, etc. Write for terms and territory. Laxasia Co., Dept. 127, St. Louis, Mo.

NEW micrometer that reads in fractions. Accurate to the thousandths. Does work of fifty-dollar set. Sells for one dollar. Agents wanted. Schaap, 344 Cumberland Street, Brooklyn, N. Y.

GO Fishing with Wonder Fish Lure. Makes fish bite like hungry wolves. Box 25, Price \$1.00. Don't go thirsty while fishing; Drink Sweetheart Punches; Delicious orange or cherry flavors. Box makes over 25 glasses. Only 3c. Agents wanted. Union Co., Barnes City, Iowa.

AGENTS—Get our big sample assortment tea, coffee, extracts, spices, big line of foods, laundry and toilet soaps; thinness people eat and use daily; everything furnished. Send postal quick. Dept. A-82, Harley Computer, Dayton, Ohio.

AGENTS, Salesmen, Demonstrators, you will have the devil's own time, trying to find a better seller than "Zippe." If there was such a thing we'd have it. Splendid profit on 50c "Go Getter" repeat article that sells on ten second demonstration. Weeks While You Watch It. Demonstrates value, while others waste time making claims. New Discovery! Greatest Scientific Triumph of the age. It's the berries. Haven't room to tell our story here. Write immediately. Karam-Smith Co., 608 Clark St., Fort Wayne, Ind.

AGENTS—\$15 a day—Easy, quick sales—Free Auto—Big weekly Bonus—\$1.50 premium Free to every customer. Simply show our Beautiful 7-piece, Solid Aluminum Handle Cutlery Set. Appeals instantly. We deliver and collect. Pay daily. New Era Mfg. Co., 863 Madison St., Dept. 21-N, Chicago.

\$61.50 WEEKLY. Introducing and selling a new gas-light burner for kerosene lamps. Beautiful light. No chimney. No mantle. Samples free. Experience not necessary. Write today. Luther Mfg. Company, Dept. 482, Cincinnati, Ohio.

NO Dull Times Selling Food—The greatest, surest and safest business in the world today is selling Federal Pure Food Products and here is your opportunity to get into this business. You can make \$5,000, \$5,000, \$10,000 or more per year. The only limit is your ability to take care of the business. We print your name and address as distributor on every package, thus making sure that you will get the thousands of dollars' worth of repeat orders which will be sent to you. No dull times, for the people must eat and our food products are the fastest selling, surest and quickest repeat order-takers in the world. Sell on sight in every home where food is used—repeat orders immediately and every week thereafter. A real Big Business All Your Own. Every new customer adds a great deal to your weekly income. Your business once established has a market value just like a store and can be easily sold. The greatest money making opportunity of your lifetime because you risk absolutely nothing as we guarantee your sales, and we will not let you fail. Remember Guaranteed! Best products, biggest sellers, surest repeat orders. No capital or experience is required. We furnish capital and everything necessary for you to become a Federal Distributor. Exclusive territory will be given honest men or women who will write at once asking us to send our "Success Guaranteed" proposition. Address, Federal Pure Food Company, Dept. A, Chicago, Ill. Largest inventors of and packers of Pure Food specialties in the world. Reference, any bank, Dun or Bradstreet rating agency, Express or Railway Company in America.

THIS IS It—Fifty Fast Sellers. Everybody needs and buys. Fifty Dollars weekly easily made. B. & G. Rubber Company, Dept. 270, Pittsburgh, Pa.

AGENTS—Make money selling popular Ford Accessories; big demand; quick sales; liberal profits. Every Ford needs them. Write today. Stauber Mfg. Co., 125 S. Jefferson St., Chicago, Ill.

SAVIQUIN Washing Aid—splendid labor saver. Other specialties also. A paying repeating line for reliable agents. Knox Chemical Co., Dept. A, Rockland, Maine.

MYSTIC Writing Pad. Send 25c for Sample. Agents wanted. B. C. Simons, 4829 N. Fairfield, Chicago, Ill.

27,000 RECORDS guaranteed with one Everplay Phonograph Needle; new—different; cannot injure records; \$10.00 daily easy. Free sample to workers. Everplay, McClurg Bldg., Desk 66, Chicago.

AGENTS—Something new—everyone buys Ever-Radiant and Luminous Glass Name Plates, House Numbers, etc. You sell for \$1.75 and make \$1.45. Ten sales per day easy. Start big-paying business of your own. No experience necessary. Mail card for complete money-making plans. Address Crystal Products Co., 59 Wayne St., Big Prairie, Ohio.

PORTRAITS, photo pillow tops, frames, sheet pictures, medallions, merchant's signs, water-proof and tea aprons, guaranteed hose, toilet requisites, luminous crucifixes; catalog, 50 specialties free. 30 days' credit. Jas. C. Bailey Co., Desk M-6, Chicago.

TAILORING Salesmen: Make \$75 a week selling our strictly All-Wool Made-to-Measure Suits. You collect profits in advance and keep them. We supply finest selling outfit in America. Many exclusive money-making features. Tailoring, raincoat and side-line men, part or full time, get in touch with us immediately. Park Tailoring Co., Dept. 627, Chicago.

AGENTS: 100% profit, \$69.00 to \$100.00 a week. Wonderful new tire protector—prevents punctures and blow-outs. Installed without tools. Sells on sight. Wilson made \$100.00 first week. Territory going fast. Write at once for interesting money-back proposition. Pelletier Tire Company, 542 W. Jackson, Chicago.

WANTED—Men to put up window displays. Pleasant work, good pay, and an opportunity to learn salesmanship. Fine chance for advancement. Send full information and references to the Skat Company, Hartford, Conn.

WHY not sell us your spare time? \$1.00 per hour, \$9.85 Daily easy for full time—Introducing New Style Guaranteed Hosiery—57 styles, 17 colors. No capital or experience required. Just write orders. We deliver and collect. Your pay daily, also monthly bonus. Free auto offer besides. Complete outfit furnished. All colors—grades, including silks. Minc-O-Chest Mills Co., Desk 2566, Cincinnati, Ohio.

TAILORING agents wanted—to sell all wool suits tailored to order \$29.50, all wool tropical worsteds two-piece suits—\$19.50. Palm Beaches—\$17.50. We believe this is the best and biggest value line in America for the man who believes in pleasing his customers and getting repeat business. To such men we will gladly send full information about our selling plan. Address Sales-manager, J. B. Simpson, Dept. 552, 831 W. Adams St., Chicago.

WORLD'S fastest agent's seller, 300% Profit. Needed in every home and store. Establish permanent business. Premier Mfg. Co., 813 E. Grand Blvd., Detroit, Mich.

AGENTS—Make big money taking orders for Insude Tyres. Positively prevent punctures and blowouts. Double tire mileage, any tire, old or new. Old worn-out casings give 3 to 5 thousand miles more service. Use over and over again. Low priced. Big demand. One customer brings four others. Big money saver. Write for terms. American Accessories Co., R-678, Cincinnati, Ohio.

AGENTS—Make \$7 to \$11 a day. Brand new Aluminum Handle Cutlery Set. You take orders, we deliver and collect. Pay you daily. Full or spare time. No experience necessary. No capital. We need 1500 sales agents, men or women, to cover every county in the U. S. Demand enormous. Write quick. Jennings Mfg. Co., Dept. 1868, Dayton, Ohio.

MAKE money silvering mirrors, all kinds plating, knives, spoons, auto headlights. Outfits furnished. Free booklet. International Laboratories, Dept. 25, 311 Fifth Avenue, New York.

AGENTS: Sell biggest sensation. New; different; large profits. 12,000,000 prospects, \$12 daily easy. Free sample to workers. Higgins, Manager, Desk 623, McClurg Bldg., Chicago.

AGENTS—Something New—fastest sellers and quickest repeaters on earth. Permanent, easy, profitable business. Good for \$42 to \$58 a week. Address, American Products Co., 8434 American Bldg., Cincinnati, Ohio.

AGENTS Wanted—Something New—Fire Fighter sells easily. Makes a spectacular demonstration; car owners, homes, factories, stores, practically buy on sight. Our men make \$10.00 to \$50.00 a day; exclusive territory. If you wish to establish a business of your own with unlimited possibilities for making big money, write us today. Fry-Fryer Co., 103 Fry-Fryer Bldg., Dayton, Ohio.

AGENTS: Make \$16 a day. Take orders for Serenols. Does more than machines costing five times its price. Built in just like a suitcase. Fully guaranteed. Pay you daily. Big season just starting. Write for terms. Perry-Ludlow Co., Class 102, Dayton, Ohio.

AGENTS—\$5 to \$12 a day. Sell Interlock guaranteed hosiery for men, women, children. Full line. All styles, colors. No experience needed. Full or spare time. Repeat orders run 90%. Prepaid deliveries. Samples to start you. Parker Mfg. Co., Sample 478, Dayton, Ohio.

MAKE 300% profit applying gold initials to automobiles. Samples free. Bates, 225 Harrison Ave., Boston, Mass.

SIDE-LINE Salesmen: Big profits assured. National organization selling staple specialties to trade or consumer. Send for catalogue and winning sales plan. Ostra Corporation, 114-L East 25th Street, New York, N. Y.

WHY work for others? Make and sell your own goods. We show you how. Enormous profits. Write quick for free book explaining everything. National Scientific Laboratories, 211 North Monroe, Richmond, Va.

EARN \$10 daily silvering mirrors, plating and refitting metalware, autos, chandeliers, lightstands, headlights. Outfit furnished. E. Deste Laboratories, 1133 Broadway, New York City.

AGENTS: Housewives Everywhere Delighted with new article which removes stains from clothing, table linen, etc. Write quick for territory and sample. Can make \$2 an hour. Christy, 79-Union, Newark, N. Y.

TERRITORIAL Distributors for a specialty of genuine merit in big demand. Send references with application for territory and details. Sales manager, 3964 Grand River Ave., Detroit, Mich.

AGENTS can easily make 900-1500 packages Sweetest Sachet for \$5.00. Complete instructions 25c. J. B. Fogal Co., Astbury Park, N. J.

START your own business as our sole agent, selling 100 famous home products. All or spare time. Dr. Blair Laboratories, Dept. 524, Lynchburg, Va.

AGENTS—If you have formerly sold felt rugs, write for our new proposition concerning new goods. It's a winner. Newark Felt Rug Company, 56-C Bergen Street, Newark, N. J.

"SHUR-LOCK" for screen doors: catch and lock combined; four screws; no chiseling; guaranteed; quick seller; good profit. Pressed Steel Products Co., Plantsville, Conn.

AGENTS—\$4.25 Profit on every sale of Nibco Service Set. Needed in every home and building. Get particulars quick. A. A. Silver-Chamberlin Company, Clayton, N. J.

\$60 TO \$70 Weekly Easily Made Selling Ferranti. Keeps metals bright. What territory do you want on this new invention of wonderful appeal to everybody? Sensational seller. Sales guaranteed! Product guaranteed! Come and grow with us. A postal will do. Consolidated Chemical Works, 253F, Broadway, New York.

WANTED—District Purchasing agents, experience unnecessary. National Instrument Co., 4704 North Hamilton, Chicago.

AGENTS Sell Harper's Household Cleaning Set. Washes and dries windows, mops, scrubs, cleans walls, hangs paper, sweeps, etc. Complete Set sells for less than \$3. Over 100% profit. Can start without a cent. Harper Brush Works, 111 A St., Fairfield, Ia.

EARN big money easily with our casting Toy and Novelty forms, making Whirling Birds, Wild Animals, Crowing Roosters, Automobiles, Baseball Players, Statue of Liberty, Indians, Toy Soldiers, Cowboys, Barking Dogs, Wag-Tail Pups, Miniature castings of Capitol, Bathing Girl, Souvenirs and others. No experience necessary. We furnish you with Bronze casting Forms and necessary outfit from \$3.50 up. We buy large quantities of finished goods at highest prices. Spot cash. Send for catalogue and information free. The Improved Metal Casting Co., 342 East 145th Street, New York.

GRITO Laundry Tablets take the rub out of rubbing. Wash clothes snow-white in 15 minutes absolutely without rubbing. Tremendous Seller. Enormous profits. Big Repeater. Sample Free. Grito Soap & Mfg. Co., Dept. X, Rochester, N. Y.

GET posted—Good prices paid for butterflies, insects. See Sinclair display advertisement, page 28.

MAKE \$30.00 daily taking orders for \$3.95 Union-made raincoats. Factory prices. Largest commission. Your pay daily. We deliver and collect. American Eagle Raincoat Co., 155 No. Union St., Dept. 316, Chicago.

\$100 TO \$300 a week. Men with slight knowledge of motors who can reach car owners can earn \$300 weekly without making single sale. If they can also make sales, profits may reach \$25,000 yearly. Only proposition of its kind ever offered. A. E. Phillips, 228 West 29th St., New York.

AGENTS sell Laundry Tablets under your own name and brand. Free samples and circulars furnished with every order. Particulars free; sample, fifteen cents. Write today. Krebs A Products, College Point, N. Y.

PORTRAIT agents earn big money selling our Photo medallions, Photo medallion clocks, Religious medallions, Photo pocket mirrors, Photo buttons, Photo jewelry, and Fraternal Photo medallions. Send for free catalogue. Satisfaction guaranteed. Four-day service. Address Gibson Photo Jewelry Co., Apartment 7, 608 Grand Ave., Brooklyn, N. Y.

\$100 MADE in one week by young man in small town without capital or experience in local advertising business. Why can't you do likewise? Free book tells how. S. Meyer, 211 Seventh St., Louisville, Ky.

SELL Kwik-Kut Knives to every woman who sews, and every man who wants a very sharp knife for light cutting. Uses discarded razor blades. Big profits and quick sales. Sample postpaid 25c, refunded on first order of two dozen or more. Kwik-Kut Knife Company, 1013 Chestnut St., St. Louis, Mo.

AGENTS wanted to sell "Havana Treat" 5c cigars to stores and smokers. Profitable business. Havana Treat Cigar Co., Utica, N. Y.

OWN a Business. Make Sparkling Glass Name Plates, Numbers, Checkers-boards, Medallions, Signs. Quick Sales, big profits. Illustrated booklet Free. E. Palmer, 556 Wooster, Ohio.

FREE Sample. "Rain Shield Wiper." Retail \$1.00—Costs (25c). Sold, Clear and Rainy Days. No Cloth—No Paste—No Attachment. (1) Rub keeps Windshield Clear (48) Hours. Experience unnecessary. NuLife (H) Corporation, Hartford, Conn.

(1) RUB Metal Polish Chamol Cloth. Retail (30c)—Costs (10c). Cleans, Polishes Silverware, Brass, all Metals. NuLife (A) Metal, Hartford, Conn.

AGENTS—Make \$5.00 an hour; our beautiful silk knitted neckwear sells on sight; latest New York styles direct from mill to you; popular price; instant sales, steady all year round proposition; big repeater; your own territory open. Write today. Knit-Art Silk Neckwear Co., 298 Broadway, New York.

WHY work for others? Make and sell your own goods. We show you how. Enormous profits. Write quick for free book explaining everything. National Scientific Laboratories, 211 North Monroe, Richmond, Va.

ICELESS Refrigerators: How to make, how to sell them, and how to finance your business. Details from Sensible System, 1683 O'Farrell St., San Francisco, Calif.

ROBERT Wrench is a sensation in wrenches. It surprises everybody. Grasps pipes, nuts and bolts any size without adjusting. Over 30,000 sold. You make almost 100 per cent profit. If you call on stores, shops, garages, factories or homes, write us today for full particulars about "The Wrench With The Bull Dog Grip." Robert Wrench Co., 71 Murray St., New York.

AGENTS—Household necessities galore; food products, toilet preparations, extracts, remedies, soaps, beverages, jewelry; catalogs free. Western Products, 606 N. Oakley, Dept. AE, Chicago.

AGENTS—500% Profit. Sell on Sight New Useful Article for Phonograph. Sample 50 cents. Brown Co., Box 424, Ft. Wayne, Ind.

GOLD Leaf Sign Letters; make and sell; profits exceed 1,000%; immense demand; particulars free. Johnston Co., Quincy, Ill.

MAKE a Steady Income on Jubilee Auto Accessories. Easily sold to all garages or accessory dealers. Side wings, visors, spark plugs, oil gauge, windshield cleaners, transformers. Sell whole line or any part. We carry customers' accounts. Generous commissions. Low prices. Jubilee Mfg. Co., 23 Sta. C, Omaha, Neb.

\$2.00 AN hour Selling Peck's Rivets. Instantly mend Kitchen utensils. Other fast sellers. Sample 10c. Peck Co., Dept. A2, Medina, N. Y.

SLIDEMUP—Expanding Kuff Buttons. Great shirt savers, wonderful convenience. Sample pair \$1.00. Fifty other jewelry specialties at wholesale—Liberal credit. Flexo Comp, Sheboygan, Wis.

EXCEPTIONAL household products—Will absolutely sell on sight. Widely recommended. Write, Associated Chemical Laboratories, 63 Fulton Street, New York City.

AGENTS—\$50 a week taking orders for guaranteed hosiery for men, women and children. Must wear 12 months or replaced free. All styles and finest line of silk hose. Write for sample outfit. Thomas Mfg. Co., Class 262, Dayton, Ohio.

EVERYBODY uses extracts. Sell Duo Double Strength Extracts. Complete line household necessities. Big repeaters. Write today. Duo Co., Dept. E1, Attica, N. Y.

SELL Keyless Padlocks for quick money. Particulars free. "Noproco," 273 Highland, Milwaukee, Wis.

WILLIAMS' No Water Hand Soap, in tubes, has taken Auto owners by storm; washes dirtiest hands perfectly clean without water. Easy demonstration, quick sales, 150% profit. W. B. P. Williams, Montclair, N. J.

EARN \$10-\$30 weekly, distributing circulars. Palace Mfg. Co., Toledo, Ohio.

RUSSIAN, German, Austrian money. Sensational street sellers! Wonderful sales-boosting premiums for anybody who sells anything! Hirschewron, 847 Huntspoint Ave., New York. (Cheapest prices.)

SELL "Wire Arm Bands." 25c retail, 200% profit. Roman Arndt, 3689 Townsend, Detroit, Mich.

BIG Profits Selling New \$3.50 Automatic Adding Machine. Absolutely accurate. Fully guaranteed. Quick sales. Ten daily easy. No competition. Pocket size. Business people everywhere positive customers. Thousands being sold. Tremendous demand. Here's high-grade money-maker. Bassett Co., 1458-8 Hollywood Ave., Chicago.

AGENTS wanted in all towns and cities where milk is sold in bottles to sell new patent Cream Separator. Every woman buys. 100% profit. Send 35c for sample and confidential price list. Perfect Cream & Cap Remover Co., 459 N. Cicero Ave., Chicago, Ill.

AGENTS: Leather bill fold. Particulars free; sample 50c postpaid. Hyde Park Barstain House, 5447 Ingleside, Chicago.

\$35.00 PROFIT on \$1.50 Outfit; Gold Initials for Automobiles, Bags, etc.; Free Samples. National Monogram Co., Station D, Brooklyn, N. Y.

\$8.00 TO \$20.00 per day. A wonderful seller. Any man, woman, boy or girl can make big wages Selling Crimp Grip Clothes Line Fasteners. It is a perfect rope holder and can be used for many purposes. Crimp Grips are a simple, time-saving device. They last a life time and will not rust; it holds the line tight, and saves time on wash days. Every buyer is a booster. Send 50c for Mounted Sample and one pair of Crimp Grip Clothes Line Fasteners. Write for particulars. Crimp Grip Company, Belvidere, Ill.

SELL wall and auto emblems, and town plates. Every lodge member and auto owner buys. Big money—all or spare time. Free sample and cash bonus plan. Kler Emblem Co., 440 Como Bldg., Chicago.

AGENTS—\$100.00 weekly, selling tailored caps. Can use limited number of agents. Commissions paid daily. Wonderful sample outfit to those selected. We deliver and collect. Send application today. Kramer-Phillips Co., 453 Monon Bldg., Chicago.

PICTURE Man Friedman is giving away free \$2.00 samples and valuable book on canvassing. Prints, Portraits, Frames. Picture Man Friedman, Dept. 8-II, 673 Madison, Chicago.

AGENTS—Sell 3 in one shade, curtain and drape holder. \$20.00 daily. Sample Free. Standard Specialty Products, 25 No. Dearborn St., Suite 502, Chicago.

PATENTS Procured. Send sketch or model today for examination, prompt report and advice. No charge for preliminary advice. Write for free Booklet and blank form on which to disclose your idea. Highest references. Promptness assured. Clarence A. O'Brien, Registered Patent Lawyer, 562 Southern Building, Washington, D. C.

PROTECT your rights—Write for "Record of Invention" and booklet about Patents. Prompt personal service. Advice without charge. J. Reaney Kelly, 612-G Columbian Building, Washington, D. C.

PREPARE—Sell Your Own Products. Formulas, trade secrets. Different, dependable. Catalog free. S. Thaxly Co., Washington, D. C.

AGENTS—Sell silk knitted ties, \$5.00 a dozen. Sample 50c postpaid. Imperial Mail-Order House, 186 Collette St., New Bedford, Mass.

RED STAR Straw Hat Cleaner. Finest on market. Instantly cleans hats like new. Non-poisonous. Package and wonderful premium book 10c. Byron, Box 27, Sta. I, New York.

MAKE \$10 to \$20 a Day selling "Peanut Fluff," the best 10c candy bar on the Market. Send 25c for three large bars and instructions how to sell them. M. N. Nellin, Rockford, Ill.

MAKE good profits. Sell the Twentieth Century Polar Ice Blanket. Saves ice. Send \$1.50 for sample. Polar Ice Blanket Co., 115 1/2 Harrison St., Davenport, Iowa.

WORLD'S Greatest Ice Sellers. Needle-threaders. \$2.50 gross. Sample 10c. Also lucky charms. Pencil sharpeners. Hutter Specialties, Milton, N. Y.

LIFETIME Guaranteed metal outfit makes article costing 1c, sells 10-15c like wildfire. Price, \$7.50. Sample, 25c. New Jersey Specialty Co., 16 Bergen Sta., Jersey City, N. J.

EVERYBODY buys ice-saving cloths. Peerless Products Co., Jackson, Tenn.

DISTRIBUTORS wanted in each state for Dixie Lighting and Power Plants, Auto and Radio Batteries. Dixie Storage Battery Company, Baltimore, Maryland.

BIG money in New Bamboo self-filling Fountain Pen. Sells everywhere. Sample 75c. Write for particulars. T. Kobayashi & Co., Dept. 40, 311 River Street, Chicago, Ill.

WANT Distributing Agents everywhere for Hanslick, the new original powdered handsoap. Removes grease, grime, ink, paint, and most anything from the hands without injury to the skin. Every mechanic and auto-owner, everybody who gets his hands dirty will be a customer. A great opportunity for a hustler to get in business for himself. Full information free. Send 10 cents, coin or stamps, for liberal sample can. Solar Products Company, 122 West Lake Street, Chicago.

AGENTS—Send for sample "Fretnot"—the washday wonder. Be convinced you can do a whirlwind business. You can clear at least \$20 to \$100 weekly, according to spare or whole time. You don't have to talk; if she doesn't buy at sight, leave sample; she will be looking for you long before you are able to make the rounds again. Samples furnished free. Premiums for your customers. Exclusive territory guaranteed to agents who can produce. Credits given. Don't call. P. M. Motter & Sons, 20 E. Jackson Blvd., Chicago.

LARGE Shirt Manufacturer wants Agents to sell complete line of shirts direct to wearer. Exclusive patterns. Big values. Free samples. Address Madison Mills, 503 Broadway, New York.

AGENTS—Best seller: Jem Rubber Repair for tires and tubes; supercedes vulcanization at saving of over 800 per cent; put it on cold, vulcanizes itself in two minutes, and is guaranteed to last the life of the tire or tube. Sells to every auto owner and accessory dealer. For particulars how to make big money and free sample, address Amazon Rubber Co., Amazon Bldg., Philadelphia, Pa., Dept. 563.

AUTO owner the agent wanted each locality to use and take orders for handmade Mellinger fabric and oiled tires; guarantee bond 8,000 and 12,000 miles (no seconds); shipped prepaid on approval; get your tires free; no capital or experience required; make \$100 to \$300 weekly. Write for wholesale prices and sample kit. Address, Mellinger Tire Co., Dept. 106, Kansas City, Mo.

AGENTS make \$10.00 a day or more selling Coffield Tire Protectors. Prevents punctures and blow-outs. Doubles mileage. Easily applied, no cement or tools required. Absolute three-year guarantee. Nothing like them. No capital required. Big commissions paid weekly. No delivering. Get our proposition. Write Coffield Tire Protector Co., 275 Court St., Dayton, Ohio.

AT Last—World's Greatest Adding Machine. Almost human. Retail \$15; work equals \$300 machine. \$500 monthly easily made, demonstrating to stores, offices, garages, factories. Simple, easy; adds, subtracts, multiplies, divides automatically. Speedy, accurate, durable, handsome. Five year guarantee. Tremendous demand; amazing profits. Liberal trial offer. Protected territory. Write quick. Lightning Calculator Corp., Dept. F, Grand Rapids, Mich.

GREATEST Sensation! Eleven piece toilet article set selling like blazes at \$1.75, with \$1.00 dressmakers' shears free to each customer. Spring rush on. Foster Reid Co., 38 Winslow Bldg., Station C, Chicago.

ONLY One Policy Daily Means \$139 per Month Profit. Same on renewals. Policy pays \$5,000 death; \$35 weekly benefit for injury or sickness. Men and women both acceptable. Premium \$10 yearly. Full or spare time. Easy seller. Write quick for territory. Underwriters, Dept. R.L., 198 Market St., Newark, N. J.

\$75.00 WEEKLY with new specialty. Sells on sight to auto owners and trade. One man in Columbus, Ohio, sold 55 gross in 60 days, 100 to 200% profit on small investment. Write today for wonder-selling plan and information. C. L. Wingar, Dept. 13, West Fort Ann, N. Y.

500% PROFIT selling Genuine Gold Leaf sign letters. Guaranteed never to fade. Easily applied. Experience unnecessary. Wonderful future. Free Samples. Guarantee Sign Service, 363 W. Superior, Chicago.

WANTED—Tailoring Sales Agent—Make big money from very start—\$40.00 to \$75.00 weekly. Largest made-to-measure tailoring house, furnishing an equipment of five hundred woolsens, wants you to take orders. Satisfaction guaranteed. Biggest merchants in many towns have started with our line. If you want to establish yourself permanently in business and make big money write for full particulars, giving your experience as salesman or tailor's sales agent. H. F. Foster, Sales Manager, Lock Box 483, Chicago.

DUSTLESS Sponge Cloth. New Invention. Retail (50c)—Costs (16c). (1) Rub Cleans. Polishes Automobiles, Pianos, Furniture. NuLife (A) Sponge, Hartford, Conn.

WHY work for others? Make and sell your own goods. We show you how. Enormous profits. Write quick for free book explaining everything. National Scientific Laboratories, 211 North Monroe, Richmond, Va.

AGENTS—At last! Special machinery enables us to sell our patented curtain rods at the old price of Three Cents each. Big Spring sellers. Write Home Curtain Rod Co., Providence, R. I.

EARN big money fast applying gold initials to autos. Every owner buys—\$1.35 profit on \$1.50 sale—particulars and samples free. Write quick. Lithogram Co., Dept. 17, East Orange, N. J.

\$75-\$150 WEEKLY assured if you hustle. Sell attractive gold signs to stores, offices. Unlimited demand. Experience unnecessary. Free samples. Acme Letter Co., 363 W. Superior, Chicago.

\$10 DAILY and more to real workers. New discovery sells like hot cakes to homes, merchants, everybody. Over 100% profit. Popular price. Big repeater. Exclusive territory. Write for Money-Coining sales plan, Denmar Co., Dept. E, 347 Madison Ave., New York.

REX India Fibre Broom; One of the biggest sellers on market. Outlasts five ordinary brooms—price no higher. 100% profit. Rex Fibre Products Company, 145-C New Jersey Ave., Brooklyn, New York.

BIG Money and Fast Sales. Every owner buys Gold Initials for his auto. You charge \$1.50; make \$1.35. Ten orders a day easy. Write for particulars and free samples. American Monogram Co., Dept. 40, East Orange, N. J.

OUR Ex-Cel Luminous Crucifix "shines brilliantly in the dark." Sells on first demonstration. Big profits. W. G. Hannan Co., Dept. B, 57 E. 18th St., Chicago.

LIVE Agents make \$10 Day selling Eureka Strainer and Splash Preventer for every water faucet. Takes on sight. Widely advertised and known. Get details today. A. B. Seed Filter Company, 73 Franklin, New York.

SPECIALTY Salesmen making \$10.00 daily selling Ball Valve Non-Splash Water Filters on sight. Best canvassers' article ever put on market. Write for details. C. A. Shinn, Manufacturer, 73 Franklin, New York.

BIG Profits With Exclusive Territory—\$50 to \$100 weekly easy. More has been made repeatedly in one day's work. Wonderful invention delights householders. Automatic hot and cold water bath outfit without plumbing; only \$7.50. eager buyers everywhere. Send no money. Terms. Write today. Allen Manufacturing Co., 698 Allen Bldg., Toledo, Ohio.

PATENTS—Write for our free illustrated guide book and Evidence of Conception Blank. Send sketch or model for our opinion of its patentable nature free. Highest references. Prompt attention. Reasonable terms. Victor J. Evans & Co., 183 Ninth, Washington, D. C.

"\$10 A DAY and More," our new book, shows clearly how you may gain sure success and large profits selling Guaranteed Hosiery and Underwear, factory to family. It is free. Write today. C. & D. Company, 41-E, Grand Rapids, Mich.

LIVE man to distribute for great "Foot Outfitment," hand or mail. Odor sells it. Splendid opportunity. Write now. The Elder Co., 294 Parkdale, Buffalo, N. Y.

AGENTS—\$3 per hour and more! Sell Iron Board Covers, Rubber Aprons, Shopping Bags, Embroidered Aprons, Satteen Coverall Dresses. Free Sample offer! American Braiding Company, Dept. P, 329 W. Monroe, Chicago.

AGENTS—C. T. A. prices reduced again. Suits \$18.00 made to order, any size or style. Orders easy to get. Big profits. Sample outfit free. Write Chicago Tailors Ass'n, World's largest tailors, Dept. 207, Station C, Chicago.

MAKE \$25 to \$50 Week representing Clow's Famous Philadelphia Hosiery, direct from mill—for men, women, children. Every pair guaranteed. Prices that win. Free book "How to Start" tells the story. George Clow Company, Desk 31, Philadelphia, Pa.

AGENTS—Steady Income. Large manufacturer of Handkerchiefs and Dress Goods, etc., wishes representative in each locality. Factory to consumer. Big profits, honest goods. Whole or spare time. Credit given. Send for particulars. Address Freeport Mfg. Co., 59 Main St., Brooklyn, N. Y.

AGENTS—Genuine Gold Letters anyone can put on Store Windows. Guaranteed to not tarnish. Large profits. Enormous demand. Free samples. Write today. Genuine Gold Letter Co., 429-A North Clark, Chicago.

YOU can be your own boss with our Key-Check outfit. Good for \$5 a day stamping names on pocket key checks, fobs, etc. Sample check with your name and address, 25 cents. Pease Die Works, Dept. M, Winchester, N. H.

AGENTS: Big Money Monogramming by Transfer Method. Catalog Showing over 50 Styles and Particulars Free. Motorists' Accessories Co., Mansfield, Ohio.

AGENTS! A sale in every home for our beautiful dress goods, silks and general yard goods. Quick sales! Big profits! Large book of nearly 1000 handsome fabric samples furnished to agents. Write today. National Importing & Mfg. Co., Dept. 6N, 573 Broadway, New York, N. Y.

YOU Can Make Good Durable Paint and Varnish 50c per gallon. Write Dept. 2, Emmelmann Bros. Mfg. Co., Indianapolis, Ind.

POLMET Polishing Cloth cleans all metals; retails 25c; sample free. Gale & Co., Inc., 15 Edinboro St., Boston.

MAN in each town to plate auto parts, reflectors, bathroom fixtures, refinish beds, mirrors, chandeliers; by new method. No capital or experience required. Simple plan of manufacturing at home starts you in big money-making business. Outfit furnished. Free particulars and proofs. Gun Metal Co., Ave. H., Decatur, Ill.

AGENTS—New discovery makes all Jelly "Jell." Big profits, constant repeater. Sample free. Address, Joy-Jel Company, 805 Grand St., Joseph, Mo.

AGENTS—Stamping names on Pocket Key Protectors; sample Check with your name and address, 25c. Stamping Outfits, Emblem Checks, Check Poles, Name Plates. Hart Mfg. Co., Desk 2, 303 Degraw St., Brooklyn, N. Y.

OUR Agents make \$12 to \$20 every day and are getting it with new invention that sells to everybody. Low Price. Pocket sample. Write Edward Suren Company, 25 N. Dearborn St., Chicago.

AGENTS: Big profits. Best and cheapest window letters made. Easily applied. Time brings five samples. Particulars free. Stalbrit Co., 1115 Second Ave., New York.

LARGE manufacturer wants agents to sell guaranteed made to measure raincoats. Gabardines and Reversible top and raincoat combined. Make \$75 to \$100 weekly. Profit in advance. We deliver and collect. Outfit free. Standard Raincoat Co., 183 West 21st Street, New York, N. Y.

AGENTS, Secure exclusive agency for your city. High-class, permanent proposition, worth \$10,000 yearly. No investment, everything furnished. Address Box 1422, New Haven, Conn.

EASY, pleasant work for Mechanics, Shoemakers, Clerks, during spare hours; will add many dollars to their salaries. Also want persons who can give full time. Big wages assured. Novelty Cutlery Co., 67 Bar St., Canton, O.

SELL Necessities. Everybody needs and buys the "Business Guide." Bryant cleared \$500.00 in July. Send for sample. It's free. Nichols Co., Box 4-B, Naperville, Ill.

AGENTS—N-R-G Laundry Tablets, the old reliable moneymaker for live agents. Millions sold—used in many homes—sales waiting for you. Clothes washed spotlessly clean in 10 minutes without rubbing. Free samples. N-R-G Company, 732-A N. Franklin, Chicago.

AGENTS: Big Returns, fast office sellers; particulars and samples free. One Dip Pen Co., 2 Daily Record, Baltimore, Md.

AGENTS make \$10 daily—Big line guaranteed extracts, food products, perfumes, toilet goods, household necessities. No capital or experience needed. Free sample case and instructions. Write for amazing offer, Perkins Products Co., Desk 6, Hastings, Neb.

\$100 WEEKLY. Agents, Crew Managers. Absolutely new article selling big to housewives. No capital required. Commissions paid in advance. No collections. No delivery. Exclusive territory. Write quick. Pioneer Corp., 6301 Yale Ave., Chicago, Ill.

\$15.00 DAILY selling Radio Gas Lighter. Sells on sight. No matches or friction required. Sample, 10c. Rapid Mfg. Co., 10 E. 14 St., New York, N. Y.—Dept. P.

WHY work for others? Make and sell your own goods. We show you how. Enormous profits. Write quick for free book explaining everything. National Scientific Laboratories, 211 North Monroe, Richmond, Va.

AGENTS—Clever Invention! Inkspoon makes every pen a fountain pen. Fast office seller; big profit, demand increasing everywhere. Exclusive territory offered. Sample free. H. Marul Company, Tribune Bldg., New York, N. Y.

\$50-\$150 A WEEK. Free Samples Gold Window Letters Easily Applied. Liberal Offer to general agents. Enormous demand. Metallic Letter Co., 438 N. Clark St., Chicago.

DON'T Risk One Penny for Anyone's Formulas for information to "Make and Sell your own Goods" till I've sent you my valuable literature and many formula lists of guaranteed reliable formulas for manufacturing biggest selling specialties in all lines. Highest references. Twenty-six years supplying the best. Miller Chemist, 805 De Leon, Tampa, Florida.

SENSATIONAL new vest pocket cigar lighter. Retail \$1.00 Triple plated, fastens to watch chain. Agent's sample and particulars, 60c. C. Thomas, 5236 Harrison, Chicago.

AGENTS make 500% profit handling Auto Monograms, New Pictures, Window Letters, Transfer Flags; Novelty Signs. Catalog Free. Write Hinton Co., Star City, Ind.

SELPOLITE—Agents, Streetmen—Self-lite lights any fire while user sleeps, or any time. Perfume surprising stunts. Newly patented. Sample 25c, postpaid; money back. Particulars, Kaytwo Mfg. Co., C195 Station A, Boston, Mass.

MOST Wonderful Seller. 90c profit every dollar. No stock to carry. License unnecessary. Sample free. Mission, 2421-PM, Smith, Detroit.

GET Our Free Sample Case—Toilet articles, perfumes and specialties. Wonderfully profitable. La Derna Co., Dept. A, St. Louis, Mo.

AGENTS—Good salary and commission selling "Ratskill," new rat and mouse exterminator; ready for use; no bait required; non-poisonous; rodents die outside premises; no odor. Empire Specialties Co., 1549 N. Wells, Dept. 301, Chicago, Ill.

"HOW to Sell Patents" free. Patent News-O, Washington, D. C.

AGENTS, control territory, Ejjol Flavors, household necessities, perfumes, creams, toilet waters, famous "Edging's Herb Tablets." Jet Pharmacal Co., Allentown, Pa.

HECK-O-BRIGHT Polishing Cloths Sell Fast at 25c. Sample Free. Heckman Bros., 3123 Northwestern Ave., Indianapolis, Ind.

CLARKE made \$18 an hour selling vest-pocket windshield cleaner needed by every autoist, motorman, engineer; one rub keeps glass clear 24 hours; 60,000 sold; amazing proposition free. Security Mfg. Co., Dept. 602, Toledo, Ohio.

CALIFORNIA Rosebuds selling like hot cakes. Agents earning money; new stuff. Big profits. Catalog free. Mission, 2421-PM, Smith, Detroit.

AGENTS—Sell Neverfail Iron Rust and Stain Remover. Huge profits, Big line. Sample. Write today. Sanford Beal Co., Inc., Newark, N. Y. Dept. 6.

FORDS use kerosene and start instantly with new Super Carburetor. Seward's profit, one day, \$74.00. Write quick. 1304 Super, 1304 Fondulac, Milwaukee, Wis.

SELL "AMENZ" Shirts. Wonderful opportunity for big profits. Made-to-Measure and Stock Shirts; finest materials. Write for details. Menzlin Shirt Co., 2843-A Third Ave., New York, N. Y.

AGENTS—Crew men, novelty men. Gloo-Pen, a 50c moustache fountain pen; everybody buys on demonstration. Write for big profit plan. Gloo-Pen Co., 75 (FF) Front St., New York.

CABBAGE Cutter, 5 knives, slices 20 vegetables, finer than aluminum; never dulls. 20,000 users Cincinnati alone; endorsed by Good Housekeeping Institute. Sample 48c. Meyer Cutter Co., Orland Ave., Cincinnati, Ohio.

\$75-\$150 WEEKLY assured if you hustle. Sell attractive gold signs to stores, offices. Unlimited demand. Experience unnecessary. Free Samples. Acme Letter Co., 303 W. Superior, Chicago.

WANTED—Representatives to sell Automobile necessity. Kills headlight and sun glare. Write for sample. Dept. P. The Clark Products Co., Springfield, Ohio.

PORTRAIT Agents—If you are looking for a better grade of work, we can satisfy you. Our enlargements have that finished appearance together with perfect likeness, which makes it a pleasure to deliver, and best of all our prices are not high. Export work a specialty. W. G. Hannan Co., Dept. A-5, 57 E. 18th St., Chicago.

AGENTS: Big profits. Genuine Gold Leaf Window Letters anyone can put up. Scripts and 57 varieties. Chicago Agency Co., 842 Altgeld St., Chicago.

PORTRAIT Agents and Others. Get Big Profits. Sell Perry Photo Medallions. You charge \$4.98; make 400% profit, \$10 daily cash. Big exclusive line. 4-day service. Perry Photo Novelty Corporation, Section 16, 386 Bowery, New York.

WE start You Without a Dollar. Soaps, Extracts, Perfumes, Toilet Goods. Experience unnecessary. Carnation Co., Dept. 261, St. Louis.

AGENTS make a dollar an hour. Sell Mendets, a patent patch for instantly mending leaks in all utensils. Sample package free. Collette Mfg. Co., Dept. 604-B, Amsterdam, N. Y.

AGENTS—Clean up \$100 Weekly With "Nifty Nino." Weekly average, 100 sales-dollar profit each. 30-40 sales daily frequently made; demonstrating outfit clinches order. 30 other coin-coaxers, all daily necessities. Postal brings our unique plans. Davis Products Co., Dept. 506, Chicago.

FIFTY "Ideal" Sidelines for Mail Dealers and Agents. 500% profit. K. Home, 1957 Warren, Chicago.

AGENTS—Sell Patented Cigar Lighters and Cigar-Case Moisteners. Big Profits. Start making money at once. Write for circulars, cuts and sales plan. Drake Mfg. Co., Dept. M, Milwaukee, Wis.

FOUR \$7.50 sales to merchants net you \$20.00 daily; largest manufacturer of its kind in the World. Sayers Systems, 2815 Sheffield, Chicago.

HIGH-GRADE SALESMEN WANTED

MEN who travel medium size and small towns regularly can add \$50 to \$150 weekly to their income with the famous K. & S. line of salesboard assortments. Look up our rating in Dun's or ask your banker. Salesboard experience preferred, but not required. Write for complete information. K. & S. Sales Co., Dept. 140, 4325 E. Ravenswood Ave., Chicago.

WANTED: Aggressive salesmen in all sections of the United States and Canada to sell our White Wax Shoe Cleaning Gloves, Wire Suede Brushes and Stocking Saver. Every woman and girl is a potential user. Liberal Commission. Give age, experience and territory wanted. The E. T. Gilbert Mfg. Co., 228-30 South Ave., Rochester, N. Y.

If you can sell, you can make from \$75 to \$150 a week taking orders for our guaranteed all-wool tailored to measure suits at \$29.75. Tailoring experience not necessary. We teach you and supply you with finest selling outfit. We do all delivering. You just write orders and get your pay, cash with order. When you write, state experience and give references. Address Dept. 626, Park Tailoring Company, Chicago.

WANTED—Salesmen calling on garages and tire shops; new tire valve deflator and wrench; sells readily; sample 25 cents. Benson Satterstrom Mfgs., Hastings, Minn.

WHY not sell us your spare time? \$1.00 per hour, \$9.85 Daily easy for full time—introducing New Style Guaranteed Hosiery—57 styles, 17 colors. No capital or experience required. Just write orders. We deliver and collect. Your pay daily, also monthly bonus. Free auto offer besides. Complete outfit furnished. All colors—grades, including silks. Mac-O-Chee Mills Co., Desk 3046, Cincinnati, Ohio.

TAILORING agents wanted to sell all wool suits tailored to order, \$29.50, all wool tropical worsteds two-piece suits—\$19.50, palm beaches, \$17.50. We believe this is the best and biggest value line in America for the man who believes in pleasing his customers and getting repeat business. To each man we will gladly send full information about our selling plan. Address Sales-Manager, J. B. Simpson, Dept. 552, 831 W. Adams St., Chicago.

SPECIALTY Salesmen of the highest type to sell Butterfly Tints, a non-boiling dye, to retail stores everywhere on liberal commission basis. Butterfly Tinting Company, Minneapolis, Minn.

EARN \$10 daily silvering mirrors, plating and refinishing metalware, autos, chandeliers, bedsteads, headlights. Outfits furnished. E. Decie Laboratories, 1133 Broadway, New York City.

\$4.00 PROFIT on Every \$5.00 Sale. "Free Sample."—New Specialty. (Money Getter.) Every Storekeeper, Doctor, buys quickly. Experience unnecessary. Territories open. Drawer 596, Hartford, Conn.

SPECIALTY Salesman: Sell Hunt's Self-adjusting Gear Pullers to Garages and Machine Shops. Full time and side line men wanted. Big Pay. Write Geo. L. Hunt Mfg. Co., Escobedo, Wis.

RUMMAGE Sales—Make \$50.00 Daily. We start you. Representatives wanted everywhere. Permanent business. Wholesale. Clinton-Clark & Co., Dept. 108-A, 2703 S. Dearborn St., Chicago.

MAKE a Steady Income on Jubilee Auto Accessories. Easily sold to all garages or accessory dealers. Side wings, visors, spark plugs, oil gauge, windshield cleaners, transformers. Sell whole line or any part. We carry customers' accounts. Generous commissions. Low prices. Jubilee Mfg. Co., 22 Sta. C, Omaha, Neb.

COUNTY representatives to introduce newly patented sharpener for all kinds of safety razor blades. Sample 50c, Fastco, Box 405, Seattle, Wash.

A WONDERFUL Seller! Any man, woman, boy or girl can make big wages. Some agents make from \$8.00 to \$20.00 per day. Crimp Grip Clothes Line Fasteners are a simple, time-saving device for holding a rope—also used for many other purposes. It pays for itself quickly in time saved on wash days. No knots—it fastens and releases quickly. Every home a prospect. Every housewife who uses Crimp Grips—and there are thousands of them—is a booster. There is but one Crimp Grip. Write for particulars, or send 50c for one pair and a mounted sample, with full particulars to agents. Crimp Grip Company, Belvidere, Ill.

BEST Seller: Jem Rubber Repair for tires and tubes; supercedes vulcanization at saving of over 80%; put it on cold, vulcanizes itself in two minutes, guaranteed to last life of tire or tube; sells to every auto owner and accessory dealer. Get particulars how to make big money and free sample. Amazon Rubber Co., Philadelphia, Pa., Dept. 510.

TRAVELING Salesmen calling on retail stores wanted by large manufacturer to sell wonderful line of business-boosting articles. Year round, fast selling, main or side line. If not earning \$150 weekly, address Elmsner Works, 222 Charles St., Bountville, N. Y.

SALESMEN—Become Independent. Own your business; experience unnecessary; selling our \$7.50 Accidental Death, \$50 Accidents, \$25 Sick Weekly Benefits; \$12.50 yearly; other amounts proportionate. Guaranteed steady income from renewals, \$250,000 deposited Insurance Department. Registration Dept. A, Newark, N. J.

TAILORING Salesman, all towns, for by far best fitting, richest-looking, soft as silk, all wool, made to order men's suits (guaranteed) at wholesale price \$27.50. We deliver, collect, furnish advertising, \$30 to \$100 weekly. Tailoring experience unnecessary. Swatch outfit shipped for free examination. Wholesale Direct Tailors, Dept. 100, Buffalo, N. Y.

WERE You Ever Offered a Grocery Store? Our Proposition is Better. You can handle Sugar, Flour, Canned Goods, Dried Fruit, Coffee and entire line of Groceries, as well as Paints, Roofing, and Automobile Oils, with no rent to pay; no money invested; take large orders from samples. Goods are guaranteed and proven quality. Selling experience not necessary. Steady, profitable work for "workers." Address Hitchcock-Hill Co., Dept. 200, Chicago, Ill. Reference: Any Bank or Express Co.

GREATEST opportunity for cigar, electrical, drug, grocery and specialty salesman selling jobbers and retailers nationally advertised Humidifier. Necessary accessory for cigar cases. Something entirely new. Rapid seller. Act quick for protected territory. Herbert Hoyer, Consumers Bldg., Chicago.

EASY to sell Groceries, Paints, Automobile Oils, Roofing, Stock Food to consumers from samples, no capital or experience necessary; steady, profitable work. Commissions advanced. Satisfaction guaranteed. 50 years in business. Write for full particulars, Lovrin & Browne Co., Wholesale Grocers, 1775 S. State Street, Chicago, Ill.

SIGN Letter Agents and Painters: 500% Profit Gold and Silver Sign Letters for Stores and Office Windows. Anyone can put on. Big demand. Free samples. Metallic Letter Co., 431D N. Clark St., Chicago.

CALIFORNIA Rosebuds selling like hot cakes. Agents making money. Absolutely new. Big profits. Catalog free. Mission, 2421-8P, Smith, Detroit.

SALESMEN Can make \$5.00 a day selling our Calendars, Pencils, Signs, Advertising Novelties, Yardsticks, Whistles, etc. Liberal terms. Sells entire year. Fine side line. Local and traveling agencies. Model Calendar Co., Dept. 228, South Bend, Ind.

SALESMEN—Sideline pays five to ten dollars a day taking orders for Specialty printed gummed advertising and Match Box Stickers. Write for proposition, samples, etc., today. Beardley's Printery, Rock Island, Ill.

SELL "Rug Down" snap fasteners, keeps rugs in place, prevents slipping. Dealers quickly interested. Vest pocket sample, other quick-selling specialties. State experience, references. Empire Notion Co., 72 Madison Avenue, New York, N. Y.

SALESMEN—Managers—Most liberal proposition ever offered on sanitary brushes, mops, dusters. Quality line—quick service—co-operation. Best season now. Write quick. Modern Brush Co., 320 Lane Bldg., Davenport, Iowa.

TAILORING Salesman—Fastest selling line, suits, made to measure—\$23.50—one price, all wool. Profits in advance. Biggest old reliable house, W. D. Smith Co., established 1895, Dept. 11, Chicago.

SPECIALTY Salesman, if you are convinced that it is "Good Business" to have a fire extinguisher in the home or car when a fire starts, you can sell others. Arrange with us for exclusive territory at a very good income. McMullen Fire Extinguisher Co., 6504 Dubois St., Detroit, Mich.

"OUTOSITE" Aluminum Hip-Suspenders. (Not over shoulders.) Shirt down, pants up. No belt, no pressure. Illustrated, page 153 May Popular Mechanics. Enormous seller. Circular, mass of testimonials. Established price \$1.00. Sample pair 50c. (Two 20c.) Dozen \$4.00; gross \$40.00. Woods, Suite B, 3533 Lafayette, St. Louis.

SOMETHING original! Braids sell nine merchants—town nine stores. Exclusive features sells "Zim's Peerless" (Collect'ion System). Sells \$7.50. Creditors' Association, E-312, McKnight Bldg., Minneapolis, Minn.

\$5 PROFIT selling \$7.50 necessity. Write for sample. Merchants Ass'n, Minneapolis, Minn.

SPECIALTY Salesmen or State Distributors for Auto replacement part. Sells to all leading dealers. Big repeats. Act quick. Good proposition. Kerstone Sales Co., Pacific Bldg., San Francisco, Calif.

SALESMEN—New auto tube, seals its own punctures, fully guaranteed. Car owners buy on sight, when demonstration is shown. Harrison Mfg. Co., Hammond, Ind.

ROPP'S Calculator and Short-Cut Arithmetic shows the answer as quickly as a watch shows the time to all problems likely to occur in office, store, shop, bank, farm or factory. Price, pocket size, paper 35 cents, cloth 50 cents, leatherette \$1. Desk size, cloth \$1.50 postpaid. Popular Mechanics Book Dept., 200 E. Ontario St., Chicago.

HELP WANTED

STOP Working for Wages Immediately. Trounlot, Box 1272, San Francisco.

ALL men, women, boys, girls, 17 to 60, willing to accept Government Positions, \$117-\$190, traveling or stationary. Write Mr. Orment, 101 St. Louis, Mo., immediately.

UNEMPLOYED: Read Employment Magazine. Copy 10c, 716 Wolfe, Edkhart, Ind.

LOCOMOTIVE Firemen for railroads nearest their homes—everywhere; beginners \$150-\$250 monthly. Address Railway Association, Desk M-1, Brooklyn, N. Y.

START Silvering Mirrors, Headlights, Tableware. Replate stores, jewelry. Plans Free. Clarence Sprinkle, Dept. 28, Marion, Ind.

SALESMEN, we pay larger commissions than any other Brush House in the country to men selling our line of Sanitary twisted-in wire Brushes. Sanitary Wire Grip Brush Co., 15 Mercer St., New York.

AGENTS, Distributors, capable of organizing sales force, make from \$3,000 to \$10,000 yearly; the best and fastest selling automobile accessory on the market; sells 4 to 8 at a time. Write for particulars. Continental Co., 912 7th Ave., New York City.

AUTO Experts needed. \$45.00 week. Experience unnecessary. Sample correspondence lessons free. Franklin Institute, Dept. 8-101, Rochester, N. Y.

FIREMEN, Brakemen, Baggage-men, Sleeping car, train porters (colored), \$140-\$200. Experience unnecessary. 819 Railway Bureau, E. St. Louis, Ill.

WHY not sell us your spare time? \$1.00 per hour. \$0.85 Daily easy for full time—introducing New Style Guaranteed Hosiery—57 styles, 17 colors. No capital or experience required. Just write orders. We deliver and collect. Your pay daily, also monthly bonus. Free auto offer besides. Complete outfit furnished. All color-grades, including silks, Mac-O-Cheo Mills Co., Desk 2606, Cincinnati, Ohio.

LOOK! Men—women, 18 up. U. S. Government Jobs, \$1140-\$1800. List positions obtainable—free. Write Franklin Institute, Dept. 8-21, Rochester, N. Y.

WAKE up, in business for yourself. We furnish goods, Territory and instructions free. Bell Lighting Co., Inc., 387 Broadway, New York City.

BE a Finger Print Expert. Demand increasing. Write for special free offer. American Finger Print System, 1966 Broadway, New York.

LOOK! Men—women, 18 up. You are wanted. U. S. Government positions, \$1140 to \$2300 year. Steady work. Short hours. Life positions. Paid vacation. Work pleasant. Common education sufficient. Influence not needed. Experience unnecessary. List positions and specimen examination questions—free. Write today sure. Franklin Institute, Dept. 8-2, Rochester, N. Y.

GOVERNMENT positions, \$1,400-\$2,300 yearly. Many openings. 36-page information booklet free. Chicago Civil Service College, A-41, Kesner, Building, Chicago.

SHOES—Become our local salesman selling high-grade shoes direct to wearer. Quick seller and good commission. Experience not required. Tanners Shoe Mfg. Co., 467 C St., Boston, Mass.

MEN 18-35, Railway Mail Clerks, \$1600-\$2300. Write for particulars. Franklin Institute, Dept. 8-21, Rochester, N. Y.

GET Government, Railway Mail, Postoffice, Clerical positions. Paying \$1,400-\$2,300. Men, Women. Experience unnecessary. Full particulars free. Write G. W. Robbins, Civil Service Expert, 411 Pope Bldg., Washington, D. C.

GET posted—Good prices paid for butterflies, insects. See Sinclair display advertisement, page 28.

MEN 18-35, Become Railway Mail Clerks, \$1600-\$2300. List Government positions—free. Franklin Institute, Dept. 8-21, Rochester, N. Y.

WRITE articles, stories, news, in spare time for newspapers and magazines. Big pay. Copyright book free. Press Syndicate, 553, St. Louis, Mo.

OUR genuine gold window sign letters are an excellent money-making proposition for handy men. Slann Sign System, Bethune Ave., E. Detroit, Mich.

LARGE corporation wants a Service Man in every town to paste up its signs on store-keepers' windows. Excellent opportunity for reliable party. Steady work. No experience necessary. We also have attractive proposition for agents and salesmen. Guarantee Sign Service, 361 W. Superior, Chicago.

LANDSCAPE Architects earn big money; needed everywhere! Fascinating work. Particulars free. Address Landscape Gardener, 423 Union League Building, Los Angeles, California.

YOU are wanted! Government Jobs, Railway Mail Clerks, City Carriers, \$1100-\$2300. Steady work. List positions obtainable—free. Write immediately. Franklin Institute, Dept. 8-21, Rochester, N. Y.

EARN \$110 to \$250 monthly, expenses paid, as Railway Traffic Inspector. Position guaranteed after 3 months' spare time study or money refunded. Excellent opportunities. Write for Free Booklet CM-46. Standard Business Training Inst., Buffalo, N. Y.

MAKE money writing Photo-plays; details free to beginners. No correspondence course. Producers' League, 230 Wainwright, St. Louis.

GOVERNMENT Railway Mail Clerks start \$133 monthly; expenses paid. Specimen questions free. Columbus Institute, Dept. E-2, Columbus, Ohio.

INVENTORS desiring to secure patents should write for our book "How to Get Your Patent," tells our terms and methods. Send sketch for our opinion of its patentable nature. Randolph & Co., Patent Attorneys, 620 F. Washington, D. C.

SIGN Letter Agents and Painters; 500% Profit. Gold and Silver Sign Letters for Stores and Offices, Windows. Anyone can put on. Big demand. Free Samples. Metallic Letter Co., 431-D N. Clark St., Chicago.

WANTED: Railway Mail Clerks—\$1,600 to \$2,300. Exams everywhere. Write today for full information. Patterson, Civil Service Expert, Box 4025, Rochester, N. Y.

STORIES, poems, plays, etc., are wanted for publication. Good ideas bring big money. Submit manuscripts or write Literary Bureau, 522, Hannibal, Mo.

HOTELS Need Trained Men. Nationwide demand for high-salaried men; past experience unnecessary. We train you by mail and put you in touch with big opportunities. Big pay, fine living, interesting work, quick advancement; permanent. Write for Free Book, "Your Big Opportunity." Lewis Hotel Training Schools, Room 351, Washington, D. C.

SILVERING Mirrors, French plate. Easily learned; immense profits. Plans free. Address, Wear Mirror Works, Excelsior Springs, Mo.

BE a Finger Print Expert—Opportunities opening everywhere. Write National System, 186 East 79th, New York.

ART AND ADVERTISING

DECORATORS, Card Writers, Printers, Painters, Artists—Guide for mixing 3,000 colors. Example: Maroon—15 parts red, 2 black. Return mail, \$1.00. Fine Arts, 1125 W. 27th, Indianapolis, Ind.

TYPEWRITERS AND SUPPLIES

UNDERWOOD Typewriters at far less than manufacturers' price; rebuilt, all worn parts replaced, guaranteed good as new. Cash, installment payments. Write for Catalog A-151, Shipman-Ward Mfg. Co., estab. 1892, Montrose and Ravenswood Ave., Chicago, Ill.

TYPEWRITERS, all standard makes, \$10 up. Fully guaranteed. Free trial. Write for complete lists. Northwestern Typewriter Exchange, 329 West Geolia St., Chicago.

ADDING MACHINES

FREE Trial, Marvellous new Adding Machine. Adds, Subtracts, Multiplies, Divides, automatically. Work equals \$350.00 machine. Price only \$15.00. Speedy, durable, handsome. Five-year guarantee. Used by largest corporations. Write today for catalog and free trial offer. Lightning Calculator Co., Dept. E. Grand Rapids, Mich.

NEW \$3.50 Automatic Adding Machine. Adds, Subtracts, Multiplies. Absolutely accurate. Capacity 999,999.99. Fully guaranteed. 75,000 pleased users. Makes adding easy, positive, quick. Eliminates mistakes. Saves Time. Postpaid, \$3.50. Bassett Co., 1458-R Hollywood Ave., Chicago.

DUPLICATORS AND DEVICES

STENCIL Duplicator—Two Dollars. Prints Typewriting—Handwriting. On Approval. Primus Specialty Co., M-3, Primus, Pa.

"MODERN" Duplicators save Time, Labor, and Money. Gets Business. Reproduces Typewritten or Panned Letters, Drawings, Lessons, Music, Menus, Bills, Notices, Specifications, Maps or anything in one or more colors. Prints Two per minute. Special Sale On 30 Days' Free Trial, \$2.25 up. Booklet Free. J. E. Durkin-Reeres Co., Pittsburgh, Pa.

YOU can make 50 to 100 copies of a letter, notice, etc., at a cost of three cents on a Hoyer Quality Duplicator. Write for free trial offer. The Hoyer Duplicator Co., 182 N. Wells St., Chicago, Ill.

BUSINESS SERVICE

INCORPORATE. Our lawyers do the work, saving you time, annoyance and money in incorporating under the most liberal laws of Arizona. Laws and forms free. Southwestern Securities & Investment Co., Box D488, Phoenix, Ariz.

INCORPORATE any enterprise under common law; any capital; transparent business any state; no corporation taxes; no personal liability; raise capital; keep control. Booklet free. Herbert Company, 5 Rand McNally Building, Chicago.

PRINTING, ENGRAVING AND MULTIGRAPHING

USE Better Grade Printing. 1,000 Bond Letterheads \$6.00. We print anything. Horley Print Shop, Holgate, Ohio.

500 BOND Letterheads—500 Envelopes—\$5.00. Stationery Specialists, Sentinel, Hurleyville, N. Y.

500 BOND Letterheads \$1.85 postpaid. Grant, 1713-12th, Detroit, Mich.

PRINTING Outfits—Presses, type supplies, type novelties. Send stamp for catalogue. Model Press, York, Penna.

1,000 HAMMERMILL Letterheads or Envelopes, \$1.00. Full Line Samples Free. Quality Printshop, Marietta, Ohio.

PRINTING Special: Envelopes—Letterheads, 250 each, \$2.65 postpaid. Rodgers Hebard, Windsor, N. C.

ONE Hundred each Letterheads; Envelopes, \$1.50. Jacobus Service, Irvington, N. J.

WE print anything. Stationery, Catalogs, 1,000 small 4-page Circulars, \$5.00. Samples Hammermill Catalogs. Commercial Press, Batavia, Ohio.

BETTER Printing for Less Money. Printing users, send for free samples of thousand items. Mattax's Print Shop, Tremont, La.

QUALITY Printing! Reasonable Prices! Tell us your wants and let us quote our Money-Saving prices. Best Work. We print anything. Ernest Fantus, 525 South Dearborn Street, Chicago.

SOMETHING New: Thin-Pack Business and Calling Cards. 100 printed cards and elegant seal grain case 50c. Agents Wanted—sample case 15c. Anderson Co., Crest, Wis.

100 PRINTED white envelopes 79c postpaid. Quality Printery, Robinson, Ill.

FREE Card Case with your name hand-somely printed on case with every order of Calling Cards, 25 Cards 25c, 100 Cards 50c. Samples for stamp. Mail Order Print. Co., 2510-A S. Twelfth St., St. Louis, Mo.

PRINTING, Multigraphing, Mimeographing. Low Prices. Attractive Work. Quick Service. Adco, 444 Broadway, Albany, N. Y.

1,000 HAMMERMILL letterheads, envelopes, \$3.25; 250, \$1.25. Samples free. Froh Press, 98 Providence, Worcester, Mass.

250 LETTERHEADS, 250 white envelopes printed and mailed \$1.00. Samples printing free. Address Sumco, Mahawk, N. Y.

3,000 BEST Grade Bond Letterheads or Envelopes \$16.00. Chicago Commercial Printing Co., 1218 S. Racine Ave., Chicago.

1,000 LETTERHEADS, Envelopes or Statements \$3.50. Samples free. Johnson & Sharp, Bayfield, Wis.

QUALITY Printing at Reasonable Prices. Tell us your printing wants and we will quote prices which will save you money. Best work. We print anything from a letterhead to a catalog. Fantus Co., 525 S. Dearborn St., Chicago.

PRE-USED Printing Presses, Type and supplies. List for stamp. Popular Bargains, Richland, Pa.

QUALITY Printing—100 8x11 bond letterheads and 100 bond envelopes, \$2.00; 250 both, \$3.50; 500 both, \$5.25; 1,000 both, \$8.00 prepaidd. Model Company, Manchester, Iowa.

500 TWO-COLOR letterheads \$2.65. Samples free. "Adverpress," Station C, Milwaukee.

1,000 LETTERHEADS or Envelopes, \$3.00. Rent Prepaidd. Samples Free. Monitor Press, Morrisville, Pa.

225 BOND letterheads, envelopes, bill-heads, cards, \$1.25 each. Combination, \$1.99. Economic Press, Leonia, N. J.

FOR MEN

ARE You Old at Forty? See our advertisement on page 138 of this issue. The Electro Thermal Company, 2122 Main Street, Steubenville, Ohio.

PIPESREAM. Pipe cleaner. Patent. Sample 10c. Vinobar Co., 227-A Summit, Jersey City, N. J.

FOR SMOKERS

TOBACCO—Extra Smoking, 5 lbs., \$1.00; 10 lbs., \$1.50; 20 lbs., \$2.75. Chewing, 5 lbs., \$1.50; 10 lbs., \$2.75. Quality guaranteed. O'Conner Smokehouse, 8-149, Mayfield, Ky.

PURE Leaf Tobacco, Rich Red Color. Best Chewing, 4 lbs. \$1.25, 10 lbs., \$3.35. Smoking, 10 lbs. \$2.25. Prepaidd. O. D. Collier, Martin, Tenn. ("Collier is reliable.")—Martin Bank.)

ENJOY Life. Smoke Old Field Tobacco. Sample 10c. East Mailing Co., Paducah, Ky.

RAZORS AND BLADES

BLADES resharpened, one edge 2c; double, 3c; Regular razor only 20c. All hand honed. Address Conn Honing Co., New Britain, Conn.

BLADES, resharpened, one edge 2c; double 3c. New York Edge Co., Glen Cove, N. Y.

WANTED—Salesmen. Territory still open to handle, "Lewgald" imported razors, sheers, complete line imported cutlery. Good commissions. Lewgald Imports, Box 547, Syracuse, N. Y.

BOATS AND LAUNCHES

ROWBOATS—easily made. Blueprint list free. Weesho-Coo, West Market, Detroit, Mich.

"HOW to make your boat leakproof." Send for booklet. L. W. Ferdinand & Co., 152 Kitchin St., Boston, Mass.

12' ROWBOAT—easily made. Construction blueprint 30c. Weesho-Coo, West Market, Detroit, Mich.

12' FOLDING Rowboat—easily made. Construction blueprint 30c. Weesho-Coo, West Market, Detroit, Mich.

FOR THE HOME

GRANDFATHER Clock works, \$5.00. Build your own case; instructions free; make good profits selling your friends. Clock works with chimes for old or new cases. Write for full particulars. Clock Co., Ruffner St., Philadelphia.

MAKE Inexpensive Iceless Refrigerator. Blueprint 35c. William Quemore, Cambridge, N. J.

LEOPARD, ocelot and mountain lion rugs \$45 up. Albert Gerlach, Box 811, New Orleans, La.

CANDY

CANDY—Very choicest, 1 1/2 lbs. for \$1. postpaid. Superb hand-dipped chocolates; a pleasing variety of nuts, fruits, nougats, caramels, etc. So good your friends will ask where you got them. Aunt Mary's Chocolate Co., M-310 West Superior St., Chicago.

DIAMONDS, WATCHES AND JEWELRY

JEWELRY Engraved, initials, etc. David Simon, 4927 Fountain, St. Louis, Mo.

WONDERFUL Scientific Discovery: "Rainbow Sapphire"—changes color under every different light condition. Sample stone 25 carat. Other Sapphires from \$1 up. Mountings, Brobim Rings, Pearls. Valuable agency. Pauer (Importer), 153 Dewitt St., Buffalo, N. Y.

ANTIQUES AND WAR RELICS

INDIAN Relics, 20-page Clearing Catalog free. Grutzmacher, Mukwonago, Wis.

FOR Dons—Relics collected from Europe's Battlefields. Weapons, medals, insignia, helmets, etc. Illustrated catalogue and sample War Photographs 25c. Lieut. Welch, 2117 Regent Pl., Brooklyn, N. Y.

SOUVENIR—The death dealing Hand Grenade made into a beautifully designed Electric Boudoir Lamp at a surprisingly low price. Write for free circular giving full particulars. Art Furnishings Company, Desk 2, 1038 W. Chicago Ave., Chicago.

INDIAN Baskets, Blankets, Wampum, Mats. Wholesale. Catalogue. Gilliam, Kelseyville, Calif.

PHONOGRAPHS AND RECORDS

BUILD Your Phonograph, Quality phonographs. Quality Scenado motor and motors of other types. Electric Motors, tapestries, reproducers, amplifiers, case material, accessories. Free blueprints and building instructions. Big saving. Wonderful results. Prompt delivery. Catalog mailed for ten cents. Hooder Manufacturing & Supply Co., 313 Baldwin Block, Indianapolis, Ind.

WANTED, Machines to Repair. Davis Phonograph Shop, LaPorte, Ind.

FOR Sale—3 New Double-Faced 10" records, \$1.00, while they last. Davis Phonograph Shop, LaPorte, Ind.

BUILD your own Phonographs. We furnish everything at lowest prices. Write for Catalog. American Phonograph Co., 3515 North Crawford, Chicago.

MUSIC AND MUSICAL INSTRUMENTS

SAXOPHONISTS: Ely's Saxophone Method, 44 lessons, 340 pages. Price \$1.00. Virtuoso Schools, Buffalo, N. Y.

SONG Poem Writers. Have real proposition. Hübeler, 1110, 4040 Dickens Ave., Chicago.

VIOLINS—Exp. Mellow, soulful—on credit. Easy terms for wonderful instrument. Get details today, Gustaf F. Hennig, 2424 Gaylord St., Denver, Colo.

WRITE Songs. Big money and reputation. Write for information, J. Gordon Pub. Co., 201 N. Horne Ave., Chicago.

"MUSIC" Composed" to words. Bauer Bros. (formerly of Sousa's Band), Oshkosh, Wis.

I WANT song poems. Casper Nathan, Garrick Theatre Building, Chicago.

PATENT ATTORNEYS

PATENTS promptly procured. Personal, careful and efficient service. Highest references. Moderate fees. Send sketch for model or actual search and advice. George P. Kimmel, Master of Patent Law, 54-1, Loan and Trust Bldg., Washington, D. C.

PATENTS secured. Prompt service. Avoid dangerous delays. Send for our "Record of Invention" form and Free Book telling How to obtain a Patent. Send sketch or model for examination. Preliminary advice without charge. Highest Reference. Write today, Jacob & Jacobs, 408 Ouray Bldg., Washington, D. C.

TO proceed properly and safely, send sketch and description for personal advice in your particular case and estimate of costs. H. F. Lewenstein, Registered Patent Attorney, McLachlen Building, Washington, D. C.

PATENTS—Before disclosing an invention the inventor should write for our blank form "Record of Invention." This should be signed, witnessed and returned to us together with model or sketch and description of the invention and we will give our opinion as to its patentable nature free. Our Three Books mailed free to inventors. Our Illustrated Guide Book, "How to Obtain a Patent," contains full instructions regarding patents. "List of Patent Buyers" sent free, contains unsolicited letters from manufacturers and others who are constantly writing us regarding the purchase or leasing of meritorious patents. We have recently received a number of requests, among which are the following: 45 requests for Miscellaneous Articles in all classes of invention, 100 numerous to mention, 14 requests for Household Novelties and Specialties, 11 requests for General Novelties and Mail Order Articles, 6 requests for Automobile Accessories and Specialties, 3 requests for Small Metal Articles and Metal Specialties, 2 requests for Radio Accessories and Equipment, 1 request for Amusement Apparatus, 1 request for Refrigerators, 1 request for Tractors and Similar Machines, 1 request for Farmers' Supplies, 1 request for Games, 1 request for Toys. We endeavor to assist our clients in the commercial development of their inventions. Owing to the growth of our business we have established for the benefit of our clients, Branch Offices in New York City at 1067 Woolworth Bldg., Philadelphia at 714 Liberty Bldg., Pittsburgh, Pa., at 514 Empire Bldg., Chicago, Ill., at 1114 Tacoma Bldg., and San Francisco, Calif., at 1010 Hobart Bldg. Victor J. Evans & Co. Main Offices, 146 Ninth, Washington, D. C.

PATENTS, Trademarks, Copyrights procured; all countries; very reasonable; 20 years' experience; booklet free. H. Sanders, Registered Patent Attorney, 7 Rand "Nally Building, Chicago.

LACEY Patent Scribe. See page 140.

INVENTORS should write us for our book, "How to Obtain a Patent," which clearly sets forth what may be patented and the necessary steps to protect an invention; it describes the procedure in patent office and tells about assignments, licenses and trade marks, and gives many useful facts about patents which every inventor should know; many persons well versed in patent matters have pronounced the book the best of its kind they have ever read; it is written so you can understand it; copy free upon request. Talbert & Talbert, Patent Lawyers, 481 McGill Bldg., Washington, D. C.

TO proceed properly and safely, send sketch and description for personal advice in your particular case and estimate of costs. H. F. Lewenstein, Registered Patent Attorney, McLachlen Building, Washington, D. C.

ATTRACTIVE Offer for your general inventions. Sterling Buck, Washington, D. C.

PATENT application filed on partial payment plan. Trade-marks, copyrights, etc. Milo B. Stevens & Co., 685 F St., Washington; 352 Monachock Bldg., Chicago, E-stab. 1894.

PATENTS—Before Submitting Invention, write for information concerning procedure, cost and ability of attorney. The e promptly furnished. References to clients in your state, R. P. Fishburne, Registered Patent Lawyer, 331 McGill Bldg., Washington, D. C.

MILLIONS spent annually for ideas! Hundreds now wanted! Patent yours and profit! Write today for free books—tell how to protect yourself, how to invent, ideas wanted, how we help you sell, etc. American Industries, Inc., 500 Kresage Bldg., Washington, D. C.

PATENTS and Trade-marks obtainable. Prompt service. Write for our new book on patents. Established in 1889. D. Swift & Co., 369 7th St., Washington, D. C.

PATENTING and commercializing inventions explained by Lester E. Barrett, Master Patent Law, Drawer 530, Washington, D. C.

MONROE MILLER, Ouray Building, Washington, D. C., patent attorney, mechanical and electrical expert. Best quality of work and results. Moderate charges.

INVENTORS—Send for form "Evidence of Conception" to be signed and witnessed. Form, fee schedule, information free. Lancaster and Allicine, 221 Ouray Bldg., Washington, D. C.

INVENTORS: Record invention legally before disclosing to others. Our Invention-record and Data Sheet shows how. Sent free and valuable information given on patent procedure, costs, etc. Report on patentability includes copies of patents nearest your idea. O'Connell & O'Connell, Jenifer Building, Washington, D. C.

PATENTS Procured: Trade Marks Registered—A comprehensive, experienced, prompt service for the protection and development of your ideas. Preliminary advice gladly furnished without charge. Booklet of information and form for disclosing idea free on request. Richard B. Owen, 30 Owen Bldg., Washington, D. C.; 2276-R Woolworth Bldg., New York.

PATENTS Procured. Send sketch or model today for examination, prompt report and advice. No charge for preliminary advice. Write for free Booklet and blank form on which to disclose your idea. Highest references. Promptness assured. Clarence A. O'Brien, Registered Patent Lawyer, 561 Southern Building, Washington, D. C.

PROTECT your rights—Write for "Record of Invention" and booklet about Patents. Prompt personal service. Advice without charge. J. Reaney Kelly, 612-G Columbian Building, Washington, D. C.

INVENTORS: Send sketch or model of invention for opinion concerning patentable nature and exact cost of patent. Book "How to Obtain a Patent," sent free. Tells what every inventor should know. Established twenty-eight years. Highest references, prompt service, reasonable charges. Address Chandler & Chandler, 438 Seventh, Washington, D. C.

PATENTS, Booklet free. Highest references. Best results. Promptness assured. Send model or drawing for preliminary examination. Watson E. Coleman, Patent Lawyer, 624 F Street, Washington, D. C.

"**INVENTORS' Guide**" free on request; gives valuable information and advice for all who have original ideas or improvements. Frank Leisermann, Registered Attorney and Engineer, 15-P Park Row, New York.

BEFORE or after filing application for patent on your invention it will pay you to read over my "Inventor's Adviser No. 3," free for asking. M. Labiner, Registered Patent Attorney, 3 Park Row, New York.

PATENTS, My fees in installments. Advice booklet free. Frank Fuller, Washington, D. C.

BOOK on inventions, patents, trade-marks, sent free, advice given; excellent references. Twenty-three years' experience. Robt. Robt. & Hill, 1348 Hanna Bldg., Cleveland, Ohio, 811 McLachlen Bldg., Washington, D. C.

FOR INVENTORS

PATENTS—"How to Obtain a Patent" is the name of a book which every inventor should have. It will be sent free-upon request, and will tell you what you want to know about patents. It contains the whole story. It describes the different parts of the application and explains in simple language the prosecution before the Patent Office. It tells about joint applications, releases, agreements, assignments, licenses, interference, infringements, process patents, design patents, trade-marks, and prizes and labels. If you are interested in patents either as an inventor, manufacturer or owner of a patent you will enjoy reading this book which was written by a lawyer who has had twenty-five years' experience in patent matters. If you have an invention and will send us a sketch, model or photograph of it we will promptly make a search of the Patent Office records and advise you whether or not, in our opinion, your invention is patentable, our charge for this service being \$3.00. We feel that our experience of twenty-five years has fitted us to render prompt and efficient service which will merit your confidence. Write today, Talbert & Talbert, 464 McGill Building, Washington, D. C.

INVENTORS' Educator: 999 Mechanical Movements, 50 Perpetual Motions. How to procure and sell patents. Mechanical Movements greatly assist inventors, suggest new ideas. Explains how to select an attorney and avoid Patent Shams. Price \$1.50, Postage Free. Albert E. Dieterich, 621 Ouray Building, Washington, D. C.

FREE search of Patent Office records to determine patentability of your invention. Save \$10.00 on your patent. Particulars free. Write M. A. Johnston & Company, Washington, D. C.

PATENTS secured. Prompt service. Avoid dangerous delays. Send for our "Record of Invention" form and Free Book telling How to obtain a Patent. Send sketch or model for examination. Preliminary advice without charge. Highest Reference. Write today, Jacob & Jacobs, 408 Ouray Bldg., Washington, D. C.

INVENTORS: Patents sold, leased, promoted; experienced handling; immediate action. Address Arthur S. Billings, 101 Dekum Bldg., Portland, Ore.

I SELL Patents: Mr. Harry E. Ewing, Box 472, Unintown, Pa., placed his patent covering Anti-Battler for Auto Windows, in my charge to sell or lease. I have placed this with The Apex Tool & Stamping Co., Louisville, Ky. Have you a patent to sell? Charles A. Scott, 773 Garson Avenue, Rochester, N. Y. Established in 1900.

PATENT Sense—"The best the inventor keeps." Free. See Lacey ad, page 140.

INVENTORS—Prosecute your own patent applications under our supervision. Instructions and blanks \$1.00. Inventors Co-operative Ass'n, Station "B," Box 2175, San Francisco, Calif.

PARTICULARS on protecting, financing, selling inventions. Sterling Buck, Washington, D. C.

PATENTS Procured. Send sketch or model today for examination, prompt report and advice. No charge for preliminary advice. Write for free Booklet and blank form on which to disclose your idea. Highest references. Promptness assured. Clarence A. O'Brien, Registered Patent Lawyer, 561 Southern Building, Washington, D. C.

PROTECT your rights—Write for "Record of Invention" and booklet about Patents. Prompt personal service. Advice without charge. J. Reaney Kelly, 612-G Columbian Building, Washington, D. C.

PATENTS Procured: Trade Marks Registered—A comprehensive, experienced, prompt service for the protection and development of your ideas. Preliminary advice gladly furnished without charge. Booklet of information and form for disclosing idea free on request. Richard B. Owen, 30 Owen Bldg., Washington, D. C.; 2276-R Woolworth Bldg., New York.

PATENTS Procured. Send sketch or model today for examination, prompt report and advice. No charge for preliminary advice. Write for free Booklet and blank form on which to disclose your idea. Highest references. Promptness assured. Clarence A. O'Brien, Registered Patent Lawyer, Washington, D. C.

UNPATENTED ideas can be sold. I tell you how and help you make the sale. Particulars free. Write W. T. Greene, 186 The Atlantic, Washington, D. C.

INVENTORS: We sell patents on commission. Patent Co., Peterson, Iowa.

PATENTS. If you have an invention which you wish to patent you can write fully and freely to Munn & Co. for advice in regard to the best way of obtaining protection. Please send sketches or a model of your invention and a description of the device, explaining its operation. All communications are strictly confidential. Our vast practice, extending over a period of seventy-seven years, enables us in many cases to advise in regard to patentability without expense to the client. Our Hand-Book on Patents is sent free on request. This explains our methods, terms, etc., in regard to Patents, Trade Marks, Foreign Patents, etc. "Scientific American" contains Patent Office Notes, Decisions of interest to inventors and particulars of recently patented inventions. Munn & Co., Solicitors of Patents, 623 Woolworth Bldg., New York; Scientific American Bldg., Washington, D. C.; 801A Tower Bldg., Chicago, Ill.; Hotel Bldg., San Francisco Calif.

GET your own patents. Application blanks, complete instructions \$1. Cutting Sons, Campbell, Cal.

INVENTORS—Send your ideas for manufacturing development in our modern sheet metal and angle iron fabricating plant. Liberal payment for accepted inventions. Kirk & Blum Manufacturing Co., 2851 Spring Grove Ave., Cincinnati, O.

INVENTORS, write for free copy of Modelcraft, R. G. Clynne, St. Louis, Mo.

PATENTS. Write for free illustrated guide book. Send model or sketch and description for free opinion of its patentable nature. Highest references. Prompt attention. Reasonable terms. Victor J. Evans & Co., 157 Ninth, Washington, D. C.

HAVE You an Invention? If so, write for our free book. "How to Get Your Patent," tells our terms and methods. Send model or sketch for our opinion of its patentable nature. Randolph & Co., Dept. 144, Washington, D. C.

"INVENTORS' Guide" free on request; gives valuable information and advice for all inventors. Frank Ledermann, Registered Attorney and Engineer, 15-F Park Row, New York.

MODEL Making and experimental work; Modern Shop; expert workmen. Manufacturing, Lamson Electrical & Mfg. Co., 625 W. Jackson, Chicago.

PATENT Application Blanks free to inventors. Patent News-D, Washington, D. C.

PATENTS FOR SALE

SOIL Pulverizer—13,530-1; Combination Square—12,787-1. Talbert & Talbert, McGill Bldg., Washington, D. C.

FOR Sale—Traffic signal for vehicles. Patent pending. Write for particulars. Address Mr. B. Hoenigaling, 409 W. Johnson St., Madison, Wis.

YOU have a worth-while patent, haven't you? Why don't you tell our two million readers about it? Most of them are specially interested in patents and new inventions. Ask me to tell you how other inventors successfully sold their patents. Geo. F. Baker, Manager, Classified Advertising, Popular Mechanics Magazine, Chicago, Ill.

FOR Sale—A Silo-Door-Attachment Patent which brings the Silo Door close up to inner side of Silo Wall, by a sliding motion. Simple and easy to apply. United States and Canadian Patent Rights. Drawings on request. Write Fred Gross, 138 East Moreland Street, Columbus, Ohio.

IMPROVED Drain and Priming Cock. Are manufactured and sold both retail and thru N. E. Jobbers, for one year; gave splendid satisfaction. Want to market throughout country ourselves, thru agents or sales-agency. Would consider selling patent outright or Royalty basis. Get details. A. & J. Mfg. Co., Wolfboro, N. H.

PATENT for Sale—New Bevel Protractor for tool and die makers and draftsmen. Cash or royalty. C. Straub, 63 E. 42d St., Chicago, Ill.

FOR Sale—Cash or royalty—good, cheap funnel device to prevent hot fruits from breaking glass jars. Have Canada and U. S. Patents. Charley W. Young, 682 Julian St., San Jose, Calif.

PATENTS For Sale: To sell, buy or obtain patents write Patent News—P, Washington, D. C.

FOUR Patents Hydraulic Apparatus, Pumps; Starting with compressed air, continued its motions by means of the hydraulic pressure and vacuum. Luis G. Jimenez, M. E., 304 P. O. Box, Eagle Pass, Texas.

PATENT 1435429 Automatic Locking Device for ladders. Weight of person locks ladder to the floor at any angle. Cheap to manufacture. Wm. H. Reed, 2624 Hickory Ave., Baltimore, Md.

PATENT on Home Water-works system. Furnishes pressure from well or cistern. Cash or royalty basis. J. C. Harbison, Eldorado, Ill.

AUTOMOBILE valve tool. Combined valve and valve seat refacing tool accommodates all size valves and seats. If interested address W. E. Fehr, P. O. Box 92, Alameda, Calif.

FOR Sale—A new invention; end-gate to wagon-bed and platform hay-loader. Can be made all sizes, handy to operate. Its estimated value is fifty thousand dollars. Will sell shop rights for fifty dollars. Interested parties address G. W. Luckenbaugh, North Manchester, Ind.

AUTOMATIC Trap Nest, Separates layers from drones; safeguards eggs. Needs no attention. Outright. Canadian patent issued. U. S. pending. R. Harwick, R. R. No. 1, Sidney, British Columbia.

OUTRIGHT or Royalty Basis: Possible sales 20,000,000 annually. Retail \$3.00, mfg. profit \$1.00, user \$10.00. Refer to U. S. patent 1,447,883, March, 1923. Send offer. Ole Peterson, Turner, Ore.

PATENT For Sale—A new invention: Shoe Lace Fastener. Address G. J. Gaither, General Delivery, Washington, D. C.

MAKE no proposition! Stamped metal valve lifter for automobiles. Sells on sight. Saves time. Cost 2c. Sells 35c. Real money maker. Graff, Cherrystone, Virginia.

PATENT on monkey wrench, patented February 27, 1923. Patent No. 1,446,529, serial No. 590,559, John Villani, 311 Melrose St., Brooklyn, N. Y.

HOUSEHOLD Toy, used by all children. Big profit, cheap and easy to manufacture. Exclusive patent, no competition, unlimited field. Address Box 52, Niles, Mich.

FOR sale or royalty, a new design Potato Dipper covered by 4 patents already marketed. Great success. Circulars, testimonials and field views on request. A. Lauritzen, Charlotte, Mich.

PATENT Non-Skid Chain Fastener, and auxiliary link, which is prepared for cross links. Chris. Hanson, Box 68, Minneapolis, Minn.

ENTIRELY new invention for illuminating sign and entrance. Patented Canada. Royalty basis. Wm. H. Galvin, 1137 McAllister Street, San Francisco, Calif.

SALE or Royalty—Patent pending, 590,549. New phonograph case, novel. Manufacturing cost low. Chas. S. Todd, Miami, Fla.

FOR Sale—Toy Gun. Very simple, only four parts. Patent pending. Wm. Albee, Topeka, Kans., R. 2.

SPARK-PLUG. Cleans like a pipe; outright or royalty. Box 190, Worth, N. C.

FOR Sale: Kenyon Disc Screen. American, Canadian patents granted; British pending. Improvement can be used to all hand and power vacuum washing machines. Washes clothes thoroughly at bottom of tub with less than half the time and power. Eight Hundred Thousand machines in use. Thousands manufactured daily. John J. Kenyon, 1563 Waverly Ave., Detroit, Mich.

UNITED STATES—Canadian patents. Automobile bed; adjustable all touring cars and limousines. Fields package three x four x forty-one inches; can be used domestic purpose. Carrigan, Seventy-eight, Thirtieth Street, Milwaukee, Wis.

DRAWING INSTRUMENTS AND DRAFTING SUPPLIES

DRAWING Outfit. Newest aid to quick, accurate drawing—Golden Combination—Drawing Outfit in one instrument—\$3. Book of instructions furnished. Money-back guarantee. Golden Compass Company, Elkhart, Ind.

DRAWING Instruments—Slide Rules, highest quality—lowest prices. Direct from importer. Circulars free. Automotive Engineering Co., Castle Hall, Indianapolis, Ind.

SURVEYING INSTRUMENTS

NEW and used surveying instruments direct from factory. Satisfaction guaranteed or money refunded. Wisler, 619 Broadway, St. Louis.

MODELS AND MODEL SUPPLIES

MAKE Pirate Ship Models. 25 cents brings plans. Maas & Richter, 421 Brumder Bldg., Milwaukee, Wis.

PATENTS Procured. Send sketch or model today for examination, prompt report and advice. No charge for preliminary advice. Write for free Booklet and blank form on which to disclose your idea. Highest references. Promptness assured. Clarence A. O'Brien, Registered Patent Lawyer, 542 Southern Building, Washington, D. C.

INVENTORS—Write for our free Illustrated guide book and Evidence of Conception Blank. Highest references. Prompt attention. Reasonable Terms. Victor J. Evans & Co., 165 Ninth, Washington, D. C.

PUNCH press and screw-machine work, tool and die making, model and special machine work wanted. Have doubled our manufacturing space and added machinery. Let our factory be your factory. Quality Hardware and Machine Co., Dept. A, 6150-56 N. Clark St., Chicago.

DIES, Tools and General Manufacturing, Models, and Manufacturing of new inventions our specialty. Logan Machine Co., 222 S. Clinton St., Chicago, Ill.

MODEL Making and experimental work; Modern Shop, expert workmen. Manufacturing, Lamson Electrical and Mfg. Co., 625 W. Jackson, Chicago.

WE make working models for inventors and do experimental work and carry a complete stock of brass gears and model supplies. Send for catalogue. The Pierce Model Works, Tinley Park, Ill.

BEFORE ordering your model write for free copy of Modelcraft. R. G. Clynne Engineering Co., St. Louis, Mo.

METALS. Brass, bronze, copper, aluminum, German silver, zinc, iron and steel in rods, tubes, wire and sheets. No order too small. Jones Cut Metal Co., 58 Maspeth Ave., Maspeth, Long Island, N. Y.

FOR MANUFACTURERS

SPECIAL labor saving machinery. Jigs and Fixtures and other production tools, Punches and Dies for all kinds of metal stampings, Gauges, manufacturing and machine work to order. Simplex Tool Company, Woonsocket, R. I.

WANTED—Metal Stamping and Model work taken on contract basis. We are ideally located and equipped to develop patents. Meyers Company, Box 263, Bedford, Ind.

WANTED—Manufacturer for New-Idem Metallic Invention. E. Hedburg, Klingman, Ariz.

MANUFACTURING

PATTERNS, wood and metal. Models, tools and dies. Brass, bronze, aluminum and iron castings. Screw machine work, production work of all kinds. Write Modern Machine & Pattern Co., Terre Haute, Ind.

If you want dies and metal stampings write us. Lyons Machine Works, Lyons, Ia.

WIRE Goods, all kinds, made to order. Cooley Mfg. Co., 524-530 N. Western Ave., Chicago.

SCREWS, nuts, screw machine products, all metals. Autoscrew Works, 355 West Broadway, New York City.

LONG established manufacturer of auto accessories which are daily sold by practically all wholesale and retail accessory houses will consider manufacturing and distributing new automobile products, capable of equally wide sale through same channels. Patented articles preferred. Address Auto Accessory Manufacturer, 1400 North American Bldg., Chicago, Ill.

GEARS, tools and metal specialties. Send for price list. Weldon Machine Works, 2940 Herndon St., Chicago.

WE design and build special machinery. Send for free copy of Modelcraft. R. G. Clynne Engineering Co., St. Louis, Mo.

SPECIAL labor saving machinery, Jigs and Fixtures and other production tools. Punches and Dies for all kinds of metal stamping, Gauges, manufacturing and machine work to order. Simplex Tool Company, Woonsocket, R. I.

WE specialize on Dies, Stamping, Light Mfg. The Times Mfg., 410 Kimball St., Danville, Ill.

MACHINERY, TOOLS AND SUPPLIES

MACHINE Lathes, medium and extra heavy, Drill Presses, Planers, Shapers, Millers, Grinders, Motors, Dynamos, Freight and Passenger Elevators, 2 to 100-Horse Engines, Pumps, Blowers, Pulleys, Hangers and Shafting. All kinds of slightly used machinery and supplies. Bargains, Halpin Elevator Works, Kansas City, Mo.

CONCRETE Building Block Machines and Molds. Catalogue free. Concrete Machine Co., 303 South Third St., St. Louis, Mo.

POPULAR Mechanics Shop Notes for 1923, latest volume in the series, recently issued. Don't miss getting this one. It is one of the best we have ever published. Contains 544 valuable articles with 436 illustrations. 224 pages. Price 50 cents postpaid. Popular Mechanics Book Dept., 209 E. Ontario St., Chicago.

LIGHT Power Transmission Machinery, Bearings, Hangers, Pulleys, Reducing Gears. Send for Catalog. Winfield H. Smith, Buffalo, N. Y.

ELECTRICAL

ELECTRICAL Experimenters—Here is the book you have been waiting for—"How to Make Things Electrical." 256 articles, 427 pages, 353 illustrations. Price \$2.50 postpaid. Popular Mechanics Book Dept., 209 E. Ontario St., Chicago.

WHOLESALE Prices Motors and Electrical supplies, including sockets, tape, rosettes, switches, wire, conduit, cleats, lum., porcelain goods. Illustrated Catalog free. Hyre Electric Co., 633-RR 8, Dearborn St., Chicago.

ELECTRICITY for 10c Per Hour. Motoc Auto Generator. Operates on any make automobile. Produces electricity for Mowing Picture Machines, Theatres, Schools, Churches, Homes, Etc. Write for free particulars. Monarch Theatre Supply Co., Dept. AG, 724 South Wabash Ave., Chicago.

ENGINES, MOTORS AND DYNAMOS

SMALL Gasoline, Steam Engines, Dynamos, Motors, Storage Batteries, etc., new and secondhand. Bargain Bulletin 134 free. Dynamic Manufacturing Co., First National Bank Bldg., Chicago.

STEAM Engines, one Hp. \$18.00; 1/2, \$12.00. James Chambliss, 631 Monroe, Evansville, Ind.

GOVERNORS on used auto engines make good power plants. Circulars. Address Candee-Smith Governor Co., Springville, N. Y.

ALTERNATING Current Motor Bargains. Reliable Makes only, including new 1/2 H. P.—\$13.00; new 1/2 H. P. General Electric \$39.00. Westinghouse, Crocker-Wheeler, Wagner, Emerson, Century motors, special prices. All guaranteed for one year. Buy now before prices advance. Motors repaired and exchanged. Hyre Electric Co., 633-FX South Dearborn St., Chicago.

AUTOMOBILE owners, garagemen, mechanics, send today for free copy America's most popular motor magazine. Contains helpful articles on overhauling, repairing, ignition, carburetors, batteries, etc. Automobile Digest, 307 Butler Bldg., Cincinnati.

FOR MECHANICS

AUTO-MECHANICS: Want to make some easy money? Write for details. Box 445, Norfolk, Neb.

BLUE-PRINT Reading made easy to learn from 33 large Blue-Prints—Course, including two year Consulting Privilege, \$35.00. Limited special advertising price, \$12.00 complete. Send \$2 for first six Blue-Prints; get balance later. Address J. R. Giphart, 1628 W. Lehigh Ave., Philadelphia, Pa.

SHOP Notes Volume 17 contains 702 practical articles such as Half-ton Traveling Crane, Boring Machine, Toggle Press, Gas-Fired Forge, Oil-Gas Generator, Movable Table for Drill Press, etc.; 224 pp., 496 illus. 50 cents postpaid. Popular Mechanics Book Dept., 209 E. Ontario St., Chicago.

PATENTS—Write for our free illustrated guide book and Evidence of Conception Blank. Send model or sketch and description of the invention for our opinion of its patentable nature free. Highest references. Prompt attention. Reasonable terms. Victor J. Evans & Co., 184 Ninth, Washington, D. C.

FOR THE SHOP

SIX-INCH Bench Lathe, Small Bench Grinder, Small Bench Miller, are some of the valuable articles found in Shop Notes, Vol. 18. Full details of construction are given. In addition hundreds of other important articles make up one of the best book values recently offered the shop man. Price 50 cents postpaid. Popular Mechanics Book Dept., 209 E. Ontario St., Chicago.

BLUEPRINTS, All subjects. List Free. Laskaris Bros., Union City, Pa.

BLACKSMITHS

BLACKSMITHS, Listen: Any Handy man can make more money doing hard jobs easy. Forging and welding solid, with Toy's Modern Methods of Blacksmithing. Hardening and tempering to a standard with colored tempering charts. All for one dollar. Samples Free. W. M. Toy, Sidney, O.

BLACKSMITHS, Plumbers, etc. Here's what you have needed for years. Simple, Powerful, Inexpensive Universal Bending Machine. Bends Eyes, U's, Angles, etc. Bends 1 1/2" standard Pipe cold. Also bends Automobile Spring Eyes. Send for circular. Little Giant Bender Co., Lewiston, Minn.

FOR SALE—MISCELLANEOUS

BUY—Exchange—Sell! Many of our readers have for sale or exchange the article you are looking for—and lots of them are looking for the very items you want to turn into cash. Get together! Let our two million readers know your wishes—they'll help you! Send your ad today to Geo. F. Baker, Manager Classified Advertising, Popular Mechanics Magazine, Chicago.

TWO new Z-4 type genuine German Bosch magnetos \$25.00 each; two new Bosch motorcycle magnetos. Chas. Kaufmann, Santa Ana, Calif.

TWO new cream separators, one of one gallon capacity, one two gallon, \$15.00 and \$25.00 respectively. Chas. Kaufmann, Santa Ana, Calif.

OUR new four point art embroidery needle at \$1.00 and rug needle at \$1.50 are wonderful sellers; every lady interested; profits big. Particulars free. Ingersoll Bros., Box 978M, Houston, Texas.

FOR SALE—Printing Press, Type, Cases. Jay Hershberger, Kokomo, Ind.

MAKE one yourself or manufacture them for sale! New improved folding one or two deck camp bed, auto lunch box, porch or lawn swing. Plans and specifications \$1.00 each. Easy to make. Commercial Engineering Co., Box 289, Spokane, Wash.

COLLAPSIBLE automobile parcel carrier. Stearns and thiel proof. Theodora Burwell, 43 Irwin Ave., Middletown, N. Y.

LAMPS—One pair Atlas Studio Arc—12 amp. each, direct current 220 volt. Pair 24-inch Parabolic mirror reflector searchlights. 75,000 candle power. One page copper etching machine for photo engraving or name plate use. No reasonable offer refused. Jahn & Otter Engraving Co., 554 W. Adams St., Chicago, Ill.

SPECIALLY prepared spongecloth with full instructions how to press your own clothes \$1.00. Spongecloth Co., P. O. Box 1167, Springfield, Mass.

FOR SALE, complete set of Watchmaker's Tools at a Bargain. R. Jaegermann, 5315 Easton Ave., St. Louis, Mo.

ADDRESSOGRAPHS, Letter Folders, Multiplicators, Envelope Sealers, Duplicators, less than half price. Guaranteed. Pruitt Co., 112-B N. La Salle, Chicago.

\$120 **HAMMOND** Multiplex typewriter, very fine, 5 sets type, \$40; Oliver No. 9, like new, \$25, cash or special camera. H. Liss, LaSalle Drug Store, Minneapolis, Minn.

GASOLINE Lamps and Lanterns. Catalog Free. Little Wonder Light Co., Terre Haute, Ind.

WANTED—MISCELLANEOUS

CASH paid for ancient Indian Relics. Donald Bondeman, Kalamazoo, Mich.

I HAVE Pearl necklace, beautiful quality, 24 inch. Solid gold clasp set with diamond. Will exchange for good used camera, typewriter, or what have you? Send today. Satisfaction guaranteed. P. Blender, 4237 Kenmore Ave., Chicago, Ill.

CASH paid for old gold, platinum, diamonds, silver, etc. Goods returned if offer not satisfactory. Wichita Metal Co., Box 207, Wichita Falls, Texas.

CASH for old gold, silver, platinum points, diamonds, false teeth, Liberty Bonds, unused stamps, and precious articles. Goods returned immediately if not satisfactory. Bush Products, 144 Fifth Ave., New York.

WILL buy good patent. What have you? Gordon, 114 N. Seventh St., St. Louis.

CASH for old gold, silver, platinum points, diamonds, false teeth, Liberty Bonds, unused stamps, and precious articles. Goods returned immediately if not satisfactory. Bush Products, 144 Fifth Ave., New York, N. Y.

MAIL us your discarded Jewelry. Gold Crowns and Bridges, Watches, Diamonds, Silver Platinum, and Old False Teeth. Money promptly mailed. Goods returned if offer refused. United States Smelting Works (The Old Reliable), Dept. 71, Chicago.

REAL ESTATE

ATTENTION—"Get acquainted." Cash for your property. Farm, Hotel or Retail Store, no matter where located; confidential service. Hayes' Business Agency, Cincinnati, Ohio.

\$300 SECURES Equipped Farm, 102 Acres, Handy City. Fruit: 2-story 8-room house, barn, poultry house; only \$1200, furniture, cow, implements included, part cash. Page 152 Bargain Catalog. Address me personally. E. A. Strout, Pres., Strout Farm Agency, 150F Nassau St., New York City.

GOOD Farm Lands! Near bustling city in lower Michigan; 20, 40, 80 acre tracts; hard wood clay loam soil; \$10 to \$50 down; balance long time. Write today for big booklet free. Swigart Land Company, P-1259, First Nat'l Bank Bldg., Chicago.

37 ACRES \$35 cash \$2 monthly (take auto) 32000 acres, some highly improved, homestead map, etc., 10c. P. M. Hitchcock, Batesville, Ark.

SALE or Trade—Orchard bearing: 6500 apples, 500 cherries, 200 pears, 100 peaches; fully equipped, tractor, sprays, teams, 5-room house, 5 miles College town, 160 miles St. Louis. Big crop in sight, low estimate 15,000 bushels apples. Half cash. Other lands. Buchner, Box L, Neosho, Mo.

PECAN-Orange Units. Easy terms. Big returns. Write Dept. B, Suburban Orchards Co., Biloxi, Miss.

FOR SALE—Three full sections in McKenzie County and two sections in Billings County, North Dakota. Each section contains land suitable for crops, balance for cattle. Each section has valuable deposits of lignite which some day will alone be worth many times the present value of the land. This part of the state is developing very rapidly, with good schools within easy access. As owner cannot use this land himself, will sell one or more sections at a price which almost anyone can afford to pay. Address W., care Popular Mechanics, 200 East Ontario St., Chicago.

SELL your property quickly for cash, no matter where located. Don't pay big commissions. Particulars free. Real Estate Salesmen Co., Desk B., Lincoln, Neb.

FARMS wanted by cash buyers, various states. Describe, state lowest price. R. A. McNow, 312 Wilkinson Bldg., Omaha, Neb.

DOGS, BIRDS AND OTHER PETS

BLOODHOUNDS, Russian and Irish Wolfhounds. Catalog, Bookwood Kennels, Lexington, Ky.

COLLIES—Any color, any age; world's largest breeders; kennels recommended by Albert Payson Terhune, judge and author. Send for free illustrated circular. Jefferson White Collie Kennels, Wauseon, Ohio.

AIREDALE Terriers—All ages, reasonable prices. Farmer's Kennels, Comanche, Texas.

POULTRY

BREED Squabs, Book free, E. Rice, Melrose Highlands, 77 Massachusetts.

PERSONAL

ASK us! Any question about drafting, pattern making, foundry and machine shop practice, materials, machine designing, manufacturing answered by experts. Charges reasonable. Commercial Engineering Co., Box 289, Spokane, Wash.

ARE you old at forty? See our advertisement on page 138 of this issue. The Electro Thermal Company, 3122 Main St., Steubenville, Ohio.

YOUR Horoscope, Business, Character, Changes, Friends, Enemies. Send birth date and ten cents (stamps) for remarkable test reading. Zanya, C-202 W. 103th St., New York.

ARE you bashful, self-conscious, easily embarrassed? These troubles overcome. Send dime for particulars. C. Veritas, 1490 Broadway, New York, N. Y.

TOBACCO Kills Manly Vigor. Quit easily. Cigarettes, chewing, smoking, snuff conquered or no charge. Small sum if satisfactory. Steps craving; harmless. Full treatment on trial. Perkins Co., 34-A, Hastings, Neb.

STUDY Your Type—Do More—Be More—Have More. Self-Revealing Chart and Personal Development Guide for 10c. Write Thomson-Heywood, Dept. 985, Chronicle Bldg., San Francisco, Calif.

FREE—Stop using tobacco. We will give free information how to conquer habit easily and permanently. Results guaranteed. Anti-Tobacco League, Box K, Omaha, Neb.

TOBACCO or Snuff Habit, cured or no pay. \$1.00 if cured. Remedy sent on trial. Superior Co., TP, Baltimore, Md.

UNUSUAL Horoscope—Six pages, consisting of extensive and constructive four-page Special Horoscope and Astro-Analysis, and two-page valuable guide showing daily and monthly advice covering entire year. Send 5c and birthdate. Prof. Bolles, Box 5, Fordham Station, New York, N. Y.

MISCELLANEOUS

STARTING a Company? Save expenses and taxes by organizing on the popular, Common Law plan under a pure Declaration of Trust. No experience required to fill in Demaree Standard Forms, issue shares and begin doing business at once. Genuine Demaree Forms are nationally known, approved by attorneys and utilized by successful concerns throughout the United States. Send for large, free pamphlet (C-53) containing valuable information that you may need. C. S. Demaree, legal blank publisher, 708 Walnut, Kansas City, Mo.

ART Metal Workers—You will find our book "Metal Work and Etching" a complete manual on making book ends, desk sets, pad corners, paper knives, letter openers, stationery racks, rocking blotters, desk calendars, arts and crafts jewelry, etc.; 96 pp., illus. Price 50 cents postpaid. Popular Mechanics Book Dept., 296 E. Ontario St., Chicago.

FOR Fairs, Picnics, Parks, Beaches; Best Ride, Jazz Swing, Picture Machines, Films, F. P. Light Plant, Bottling, ice cream Machinery, carnival goods. Harry Smith, Gratz, Pa.

MAGIC Bill Book. Send 15c for magic bill book. Easy to operate when you know how. C. D. Hyde, 421 Cypress Ave., Johnstown, Pa.

SPECIALLY prepared Sponge Cloth with full instructions how to Press Your Own Clothes, \$1.00. Sponge Cloth Co., P. O. Box 1167, Springfield, Mass.

GET posted—Good prices paid for butterflies, insects. See Sinclair display advertisement, page 28.

HOMEOPATHIC and Biochemic preparations sent postpaid to all parts of the world. Manual and booklets free. Halsey Bros. Co., 111 N. Wabash Ave., Chicago, Illinois. Established 1855.

ARE you old at forty? See our advertisement on page 138 of this issue. The Electro Thermal Company, 3122 Main St., Steubenville, Ohio.

TRAPPER Nelson's patented packs for those going into the hills; best pack produced; carries larger load with less fatigue. Ask about same or send 25c for plans and make your own. Trapper Nelson Mfg. Co., Box 692, Bremerton, Wash.

5 MASTER Keys. Work like magic in emergencies or prove whether your home is burglar-proof. Test and open thousands of locks. Send \$1 today. Novel key chain free. Master Key Co., 8 Manhattan Block, Milwaukee, Wis.

INCORPORATION in Arizona Completed in One Day. Any capitalization, least cost, greatest advantages. Transact business anywhere. Laws, by-laws and forms free. Stoddard Incorporating Co., Dept. 2, Phoenix, Arizona.

ARTIFICIAL Eyes, \$3, Booklet free. Denver Optic, 539 Barclay, Denver, Colo.

CUTS anybody can make. Simple, cheap process, \$1. Specimens, particulars, 2c stamp. M. Day, Windfall, Ind.

BLUE-PRINTS, Castings, $\frac{1}{4}$, $\frac{1}{2}$ -horsepower gasoline engines, Mebel steam engines, horizontal or vertical. Blue-prints of any one, 50 cents. Order from ad. Stamp for circular, Master Model Co., Box 212A, Elgin, Ill.

\$215 In One Day

Salesmen Reporting Biggest Sales They Ever Made on Amazing New Invention Everyone Wants

SALESMEN ARE MAKING FORTUNES

"Am making \$1000 per month. I have made big money before but did not expect so much. Your Burner is just the thing."
J. Carnegey, S. D.

"Am sending today for 7 Oliver's. This is one day's orders (\$85 profit). Selling like beer in a dry town."
W. H. Drew, Mich.

"Send following weekly hereafter: 10 No. 1; 8 No. 2; 4 No. 3." Berrner's Weekly Profit on order, \$258.50.
R. Berrner, Ont.

"I made \$43 last night selling Oliver Burners."
N. B. Chelan, Wash.



F. W. Bentley of Phila., says: "Ye Gods—some seller! I made \$215 today!"

Quick Sales—Big Profits

Every agent we appoint makes big money. You can, too. We have a number of definite territories which we are ready to dispose of to those who act quickly.

Coupon Brings Full Offer

Mail this coupon now for our offer. We are not making any extravagant claims about this. We don't have to. We want to give you the facts. Writing will not obligate you in any way. But hurry. Send the coupon at once if you want to get in on this big money, whirlwind, all-season offer.

OLIVER OIL-GAS BURNER & MACHINE CO.
2048R Oliver Bldg. ST. LOUIS, MO.

HERE'S an amazing new invention that is banishing forever the mess, dirt and drudgery of coal and wood fires—saving housewives from roasting kitchens in Summer, giving ready heat in uncertain Fall weather and three times the heat of coal in Winter. Set it in any fire-box of any coal range. Presto! In one minute you have an actual gas stove. Then just the turn of a valve gives as much or little heat as needed.

No Experience Needed for Big Money

Besides its other points the Oliver burns 95% air and 5% oil, the cheapest fuel there is. With everybody raving about the price of coal and the probable shortage, sales of Oliver Burners are breaking all records. You don't need to be a high powered salesman to make money on a proposition like this. The Oliver's amazing features sell it for you.

Now you know why W. H. Drew of Michigan made \$85.00 in one day; why L. Zucher of Ohio made \$21.50 in three hours; why A. M. Russell of Connecticut has averaged \$666.00 for the last 6 months; why one order sent by P. M. Ford of Iowa gave him a profit of \$646.25.

Oliver Oil-Gas Burner & Machine Co.,
2048R Oliver Bldg., St. Louis, Mo.

Please send me full facts about how I can make big money representing you in my territory. Also your plan, if I wish to make big money in my spare time.

Name.....
Address.....
City..... State.....

Be An **ELECTRICAL** **TECHNICIAN**

GET YOUR ELECTRICAL TECHNICIAN'S CERTIFICATE THROUGH ME AND YOU WILL BE GUARANTEED THE AID OF MY ORGANIZATION TO SECURE YOU A POSITION PAYING YOU THE HIGHEST SALARY YOU EVER RECEIVED TO START

Command \$250 to \$600 Monthly

My course is designed to fit you for a position as Electrical Technician, Supervisor, Foreman or Manager of Equipment. These positions cover the electro-technical field and pay a rate of compensation running into thousands of dollars a year. Take my Home Study course and prepare yourself in spare time by this most simple, direct and inexpensive method to become an expert in *MOTOR MAINTENANCE, ARMATURE WINDING, BATTERY, SUB-STATION AND POWER HOUSE WORK, AUTOMOTIVE, AIR-CRAFT, TRACTOR AND ILLUMINATING ENGINEERING, GENERATOR, SWITCHBOARD AND HOUSE WIRING, TRANSMISSION, INSTALLATION AND LINE CONSTRUCTION*, and I will not only guarantee your

success in this study, but I will undertake to train you until you are actually earning \$3,000 a year. More than that, when you graduate and are qualified to receive your Electrical Technician

S. V. Smith,
Chief
Engineer
Home Study
Dept.

Certificate from me, if you are not more than pleased with your training, or if you are not fully convinced your earning power has been **GREATLY INCREASED**, or if you are not completely satisfied you can hold down a high-class job at the highest rate of compensation paid men of your experience—either you may come in with me and finish your training here in my plant—at no cost to you—or

I WILL GIVE YOU MY COURSE—FREE

There are no "ifs" nor "buts" about this offer. If you have a common school education and will agree to study a little evenings for a few months, I guarantee to train you to be a first-class man, or the course need not cost you one penny. Therefore, write at once or mail the coupon for full details of my truly remarkable proposition. **DO THIS NOW**—to avoid possible disappointment.

Wonderful FREE OUTFIT Offer

With this electrical course you will get free and prepaid an up-to-date outfit of electrical apparatus, instruments and appliances for doing experimental and practical work at home, and, in addition, if you reply to this ad promptly, I shall give you, as my student, a complete **EXPERT'S** training in

RADIO FREE. This is a wonderful opportunity for you, for with this splendid, up-to-the-minute **FREE** Course in Radio, (covering construction, operation and installation) and my help, it is possible for you to make \$50.00

a week and up right at home while learning. I shall supply what you need to aid you to do this without one penny expense to you and you can start **RIGHT IN**. Get details of this great offer at once. Send Coupon or Write—NOW.

S. V. SMITH, Chief Engineer

**Home Study Dept., S. & H. Electrical Works
Desk F. F. 1, 1422 W. Monroe St., Chicago**

**Desk F. F. 1,
S. V. Smith,
Chief Engineer
Home Study Dept.,
S. & H. Electrical
Works,
1422 W. Monroe Street
Chicago**

Dear Sir: I am interested in your guaranteed Home Study Course of Training in the best-paid divisions of Electricity; also how you aid me free to make money while learning. Send particulars at once free of charge.

Name.....

Address.....

MAIL THIS FOR BIG FREE OFFER



"Look At Him Today!"

"Six years ago he started in here just as you are doing. Now he's General Manager and makes more in a day than he used to make in a week. The first week he was here he began to train for the job ahead by studying in spare time with the International Correspondence Schools. Inside of six months he got his first promotion. You've got the same chance he had, young man. Follow his example. Take up some I. C. S. course right away. What you are six years from now is entirely up to you."

This is the story of thousands of successful men. They did their work well, and in spare time, with I. C. S. help, trained themselves for advancement. That's the thing for you to do. Whatever your chosen work may be, there is an I. C. S. Course that will prepare you right at home for a better position with bigger pay.

More than 150,000 men are getting ready for promotion right now in the I. C. S. way. Let us tell you what we are doing for them and what we can do for you. The way to find out is easy. Just mark and mail this coupon.

TEAR OUT HERE

INTERNATIONAL CORRESPONDENCE SCHOOLS
Box 5526-D, Scranton, Penna.

Without cost or obligation, please tell me how I can qualify for the position or in the subject before which I have marked an X:

BUSINESS TRAINING COURSES

- | | |
|--|---|
| <input type="checkbox"/> Business Management | <input type="checkbox"/> Salesmanship |
| <input type="checkbox"/> Industrial Management | <input type="checkbox"/> Advertising |
| <input type="checkbox"/> Personnel Organization | <input type="checkbox"/> Better Letters |
| <input type="checkbox"/> Traffic Management | <input type="checkbox"/> Foreign Trade |
| <input type="checkbox"/> Business Law | <input type="checkbox"/> Stenography and Typing |
| <input type="checkbox"/> Banking and Banking Law | <input type="checkbox"/> Business English |
| <input type="checkbox"/> Accountancy (including C.P.A.) | <input type="checkbox"/> Civil Service |
| <input type="checkbox"/> Nicholson Cost Accounting | <input type="checkbox"/> Railway Mail Clerk |
| <input type="checkbox"/> Bookkeeping | <input type="checkbox"/> Common School Subjects |
| <input type="checkbox"/> Private Secretary | <input type="checkbox"/> High School Subjects |
| <input type="checkbox"/> Business French <input type="checkbox"/> French | <input type="checkbox"/> Illustrating <input type="checkbox"/> Cartooning |

TECHNICAL AND INDUSTRIAL COURSES

- | | |
|--|--|
| <input type="checkbox"/> Electrical Engineering | <input type="checkbox"/> Architect |
| <input type="checkbox"/> Electric Lighting | <input type="checkbox"/> Blue Print Reading |
| <input type="checkbox"/> Mechanical Engineer | <input type="checkbox"/> Contractor and Builder |
| <input type="checkbox"/> Mechanical Draftsman | <input type="checkbox"/> Architectural Draftsman |
| <input type="checkbox"/> Machine Shop Practice | <input type="checkbox"/> Concrete Builder |
| <input type="checkbox"/> Railroad Positions | <input type="checkbox"/> Structural Engineer |
| <input type="checkbox"/> Gas Engine Operating | <input type="checkbox"/> Plumbing and Heating |
| <input type="checkbox"/> Civil Engineer | <input type="checkbox"/> Chemistry <input type="checkbox"/> Pharmacy |
| <input type="checkbox"/> Surveying and Mapping | <input type="checkbox"/> Automobile Work |
| <input type="checkbox"/> Metallurgy <input type="checkbox"/> Mining | <input type="checkbox"/> Navigation |
| <input type="checkbox"/> Steam Engineering | <input type="checkbox"/> Agriculture and Poultry |
| <input type="checkbox"/> Radio <input type="checkbox"/> Airplane Engines | <input type="checkbox"/> Mathematics |

Name.....
Street..... 3-27-23
Address.....

City..... State.....

Occupation.....

Persons residing in Canada should send this coupon to the International Correspondence Schools Canadian, Limited, Montreal, Canada.

Please Mention Popular Mechanics

DRAW THIS SUMMER

Cartoonists Trained by W. L. EVANS

MAKE MONEY

SOME of the cleverest cartoonists in America today are former students. They studied during their spare time and are now making good money. Cartoonist Evans' system of teaching is so simple, easy and practical that it is not hard to learn to draw originals. The school has a long established reputation and is recommended by well-known cartoonists because they know the students are handled right.

If you like to draw, send us a sample of your work, either a copy or an original. You may have more ability than you think. We will send you a portfolio of cartoons and full details about the school. The course is not expensive.



The W. L. Evans School of Cartooning
821 Leader Bldg., CLEVELAND, OHIO

LEARN WATCHMAKING

and become independent. Good-paying positions secured.

Easy to learn. Send for FREE CATALOG.

ST. LOUIS WATCHMAKING SCHOOL, Dept. 5, ST. LOUIS, MO.

Anyone CAN LEARN

No talent or experience necessary. Fascinating work. Pays big money. Complete instruction book tells about: Alphabets, Colors, How to Mix Paints, Show Cards, Window Board and Wall Signs, Handy trade letters, Gilding, Tricks of the Trade, also gives 100 Alphabets and Designs. Book bound in imitable red leather-gilt edges, and four full bearing Silver Card Pans. Sent postpaid \$3.00. (C. O. D. 10c extra.)
Dixie Pub. Co., 57 Rose St., Dept. 50, N. Y. City

**EARN MONEY IMMEDIATELY—
WE FURNISH EQUIPMENT TO START!!**

TRI-STATE COLLEGE OF ENGINEERING

Makes you a Civil, Mechanical, Electrical or Chemical Engineer in two years, 48 weeks each. No entrance examinations. High School Diploma not required. Compact courses made up of essentials only. Expenses low.
FOR CATALOG ADDRESS 100 M. Street, Angola, Indiana

The Key to Success

Stop forgetting—

Make Your Mind a File—Not a Pile

The Key to Success is the ability to remember.

I can make your mind an infallible classified index from which you can instantly select thoughts, facts, figures, names, faces. Enables you to concentrate, develop self-control, overcome bashfulness, forgetfulness, address an audience. Easy. 20 years' experience developing memories of thousands.

Write Today for free booklet, "How to Remember," and Copyrighted Memory Test, and how to secure Free my \$3.00 book, "How to Speak in Public."

DICKSON MEMORY SCHOOL
Dept. 795-X Evanston, Ill.

Learn to Play Violin, Mandolin Banjo-Mandolin

The NEW PHONOGRAPH WAY

To advertise the World's Most Successful Method of teaching Violin, Mandolin and Banjo-Mandolin, Prof. F. M. Schneider will give away



FREE \$25.00 INSTRUMENT

to one pupil in each locality. Your choice of any one. Only a small charge for lessons—a few cents a week your only expense. Success Guaranteed or Pay Nothing.

ALL-3-IN ONE COURSE

SCHNEIDER'S SIMPLEX SYSTEM

Gives PERSONAL INSTRUCTIONS—12 complete lessons on Records. Six-year Combined Course teaches all three instruments in one. Simple as A-B-C. You can play any of these instruments by notes in a few days. Play for Money in 2 months. 30,000 have learned to play beautifully. Some are now playing in orchestras, at weddings, parties and church socials. Be popular—save months of time this New Phonograph Way.

Get First Record FREE—5 Days' Trial

We will send you, absolutely free, the first record for 5 Days' Trial. Your request will enable us to protect you on free Instrument in your locality. See for yourself how easy and simple it is to learn to play music. Just fill out coupon and mail Today.

SEND NO MONEY—JUST SEND COUPON

Prof. Schneider, Director Schneider School of Music
238 Vermont St., Blue Island, Ill. (a Suburb of Chicago)

Please send me FREE and PREPAID, for 5 days' free trial, your first lesson Record, with complete information on course, and how I can secure a musical instrument absolutely free. If I decide not to enroll, I will return record after the five days' trial and will not be obligated in any way.

NAME

ADDRESS

CITY.....STATE.....

WRITE JOKES

Publishers pay from \$1 to \$5 apiece for jokes, epigrams and humorous stories. Tremendous demand for original material. Professional humorists earn good salaries. Our course in Humor Writing teaches you how to originate ideas for jokes, epigrams, stories. Learn in your spare time—earn in your spare time. Markets furnished.

Write for Information

AMERICAN INSTITUTE OF HUMOR
Office J, 414 Park Bldg., Cleveland, Ohio



BE AN ARTIST

Comics, Cartoons, Commercial, Newspaper and Magazine Illustration, Facial Expressions, Portraits and Fashions. Our simple method quickly develops your talent in spare time. By Mail or Local Classes. Write for terms and list of successful students. ASSOCIATED ART STUDIOS 87-B Flaxton Building, NEW YORK

Learn Watchwork, Jewelrywork and Engraving.

A fine trade commanding a good salary, and your services are always in demand. Address **Norological**, Dept. P, Bradley Institute, PEORIA, ILL., for our latest catalog.



BECOME A RAILWAY MAIL CLERK

Examinations soon. \$1600 to \$2300 a year. No strikes or lockouts. Common education

sufficient. No "pull" necessary. Mail coupon for catalog.

Patterson Civil Service School
Dept. 86, Rochester, N. Y.

Sirs—Send me without charge your Catalog, describing this and other fine U. S. Government positions.

Dept. 86
Patterson Civil Service School
Rochester, N. Y.

Name

Address

BOYS



Learn Electricity

How would you like to earn two or three dollars every evening after school and prepare yourself for a fine big job at the same time? Here's the opportunity of a lifetime for you fellows who like Electricity. Begin right now to prepare yourself for a regular man's size job in this fascinating field. Your chances for a big success are simply wonderful—the pay is big (\$70 to \$200 a week) and advancement comes swift and sure.

I Will Train You at Home

Look What This Boy Is Doing

"Although the School term is coming to a close, and I am pretty busy with my examinations, I manage to keep up with my electrical studies and work."

"I guess I forgot to tell you I am now in business for myself. My doing fine, but owe it all to you. If it had not been for your Course, I, being under age could not have secured my license in the town. But I got it, and now have all the work I can do, averaging \$20 to \$30 a week three spare time work."

"I went out on a job tonight after school, on which I made \$3 and brought home another on which I made \$2.50—\$5.50, for 4 hours' work and no material furnished by me."
ROGER BMYIE,
1215 Chestnut St.,
Greenville, N. C.

With my easily learned, spare time Electrical Course I will train you at home like I have trained hundreds of other boys who are now big successful men. It will not interfere with your school work and you can earn more than the small cost of the course doing odd electrical jobs in your spare time. The Course pays for itself. I will show you how to get this work and how to do it. Some of my boy students make \$10 to \$15 a week this way

Tools, Apparatus and Radio Course FREE

Send me the coupon below and I will tell you all about the big outfit of tools, apparatus and instruments and a new Radio Course that I am giving to my students for a limited time. I will send you my big interesting Electrical Book and a sample lesson, too—all Free. You will be tickled with the things I will send you Free. Mail the coupon right now.

L. L. COOKE, Chief Engineer
Chicago Engineering Works
Dept. 51-A CHICAGO

Use This "FREE OUTFIT" Coupon

L. L. COOKE, Chief Engineer,
Chicago Engineering Works,
Dept. 51-A 2150 Lawrence Avenue, Chicago

Send me your Free Outfit Offer, your big Electrical Book, Sample Lesson and particulars of your Electrical Course and Free Radio Course. This will not obligate me in any way

Name

Address

For use of boys 15 years old or more.

Please Mention Popular Mechanics

Copyrighted material

Get Into The AUTOMOBILE BUSINESS

The Great opportunities in this wonderful business are continuing and growing. This year will add three more millions of cars to the twelve million now in use. Think of these millions of cars to repair! Think of the millions of tires, batteries and electrical systems to keep in running order! You can quickly realize WHY the Automobile Business is THE Business to get into.

Every where you go you see the need for better garages, battery repair shops, tire shops, and welding shops to do all this work.

If you are a wide-awake, ambitious man, can you think of a better business to get into? Be a trained man, so that you can have a business of your own, and do the service work on these cars.

Make \$2000 to \$10,000 Yearly

Some of our graduates do even better. Big auto factories, garages and service stations continually ask for M. S. A. S. Trained Men. We cannot fill one-third of the calls that come to us. The man who comes to the M. S. A. S. has a FACTORY ENDORSED TRAINING which will get him a job anywhere. Prepare yourself now for one of these good jobs, or to have a business of your own.

Start Course at Home and Complete It Here

ENROLL NOW FOR OUR HOME STUDY COURSE

You can start your training without waiting until you can come to Detroit. Our Home Study Course is now ready after two years of steady work on it by our faculty. You can study autos at home under the personal supervision of our experts, then come here for shop practice later when you can. But in the meantime

you can be making a start. Send for the detailed outline of these lessons, and our 100 page illustrated catalog showing our shops and equipment. Both are Free.

Learn in The Heart of the

**MAX-
WELL—**

"We heartily recommend the Michigan State Automobile School."



Read what the auto makers say about this School, the *only* school which they endorse:

PACKARD—"Do not believe you would make any mistake in attending this school if you wish to become thoroughly experienced in the Automobile business. Have no hesitation in recommending it in every particular."

BUICK—

"We believe the Michigan State Automobile School located at Detroit would best meet your requirements as its courses in technical training are most thorough and complete in every detail."

HUDSON—

"The Michigan State Auto School is the finest institution of its kind in the country. In fact we endorse its method of instruction because it ranks highest in the standard of schools. Its equipment and personnel is second to none. This school is thought very highly of by the automobile men of Detroit. You will make no mistake by entering for a course."

STUDEBAKER—"The Michigan State Automobile School at Detroit conducts a very good school, in fact we do not know of a better automobile school than the Michigan State."

THE AUTOMOBILE JOURNAL—"The Michigan State Automobile School today is conceded by those who know, to be the greatest institution of its kind in America. It is endorsed by the leading men in the industry. A first-class automobile mechanic is in demand today and can always earn a salary consistent with his knowledge and ability. We do not hesitate to recommend the M. S. A. S."

**Be a WINNER! Get Started!
Fill out and mail the Coupon
NOW—TODAY!**

Michigan State

Dept. 306, 3729 Woodward Ave.,
Detroit, Mich.

Have a Business OF YOUR OWN

Hundreds of M. S. A. S. graduates are in business for themselves all over the world. You can have a shop of your own too. With 12 million cars to repair there is a crying need for good garages, battery repair shops, electrical service stations, tire shops, and welding shops. And it means success to train at the M. S. A. S. in Detroit, the Automobile Center.

What Our Graduates Say

Our files are full of letters from men who have taken our training Courses and are now making big money in the automobile business for themselves. Read these—they are typical of the thousands of letters we get:

"Am very busy these days—lots of repair work. Have five men working for me. I am just past twenty-one and I was seventeen when I took the automobile course at your school."
—J. B. Nelson, Worcester, N. Y.

Detroit Automobile Industry

"I have been in business now for myself about three years; we sure have a good business. There are several garages here in a little city of about 2,000 and we get all we can do all the time. We also employ two men, beside overtime, so you see we are getting our share."
—W. F. Dahnert, Neillsville, Wis.



"I am now foreman of the shop where I work, and am making good with a Capital G. I have doubled my salary and am also turning out far better work than I did before taking your course."
—Mervin B. Gill, Kimberly, Idaho.

"Since going to your school, I am making three or four times the money I was before going there, and I feel greatly obligated to you and the faculty. I have a good job with the Tazewell Motor Co., Tazewell, Va., and am making good."
—J. O. Cregar,

"It is four years last month since I finished the two courses at your school. Have not had a single job I could not master. Have saved \$100 every month since I got home. I give M. S. A. S. credit for my success."
—J. I. Mayes, Kansas.

"Have been in the garage here for 2 years and my wages have been increased 500%."
—Robert L. Beck, Picture Rocks, Pa.

"I have in charge for the Government and State of N. C. 600 trucks and 200 tractors. I am making \$250 a month and all of my expenses."
—W. L. Harrelson, Reidsville, N. C.

You Can Be As Successful As These Men

"Before entering your school was earning \$12.00 per week. I knew absolutely nothing about automobiles. Since I left your school have worked up through several positions, last one paying \$300 per month. Then decided to go into the business myself. Present earnings are \$300 per month."
—H. S. Bradley, Ohio.

"Have worked with men who had fifteen years experience, but my M. S. A. S. training put me up with them, and sometimes ahead of them. If I had it to do over again would be to M. S. A. S. ten years earlier."
—J. R. Navarre, West Va.

Train for Success—Let Us Help You—Start Now!

It's up to YOU! If you want to get ahead, you must act. Our training will positively help you. One of the great advantages in coming to the M. S. A. S. is that you get a long thorough course, learning everything in detail. Men realize now that they cannot learn the Automobile Business in six or eight weeks while studying three or four other trades at the same time. Each one must be given enough time to learn it properly. That kind of QUALITY TRAINING is the M. S. A. S. way.

Show Your Grit—Take This Opportunity

Don't say you never had a chance. A Big One faces you right now! Send for our free illustrated catalog! Decide now that you will come to the M. S. A. S. as soon as you hear from us.

Automobile School

The Only Factory Endorsed School

Courses Also in
Battery Repairing
Welding and Brazing
Tire Repairing—Machine Work

Our Money-Back Guarantee

We guarantee that a graduate of our Automobile and Tractor Course will be qualified to fill a position as assembler, demonstrator, tester, repair man, auto electrician, chauffeur, tractor operator or farm lighting service man or we will refund his tuition fee.

Send This Coupon Today!

Michigan State Automobile School
Dept. 306, Detroit, Mich.

Gentlemen: Send me your FREE Catalog telling all about the opportunities in the Auto Business, and particulars of your Home Study Course which will enable me to start my training at once.

Write or Print Name Plainly

Name.....

Street or R. F. D.....

City..... State.....



High School Course in Two Years!

Lack of High School Training has kept thousands of men and women from attaining **business and social position**. Without this training you are absolutely barred from a successful business career, from leading professions, from well-paid civil service jobs, from teaching and college entrance. In fact, all **preferred positions** are closed to you without this vital training. You can't stand this heavy handicap nor do you have to. The American School can give you the valuable training you missed.

Put Your Idle Hours to Work

You can complete our simplified High School Course within two years by spare-time study. Then you will be mentally equipped to handle a worthwhile position. This course, prepared by some of America's leading professors, will broaden your mind, give you a wider outlook and make you keen, alert and capable.

Remove Your Handicap

Whether you need High School Training or specialized instruction in your chosen line—NOW is the time to remove your handicap. You must know the **HOW** and **WHY**. Over 50,000 students owe their success to training received from the practical, money-making Courses in the coupon below. Let us tell you about this training—about the Course you are interested in. Check and mail the coupon.

American School

Dept. H.A.74, Drexel Ave. and 58th St., Chicago

American School

Dept. H.A.74, Drexel Ave. and 58th St., Chicago

Send me full information on the subject checked and how you will help me win success.

- | | |
|------------------------------|----------------------------|
|Architect |Lawyer |
|Building Contractor |Machine Shop Practice |
|Automobile Engineer |Photoplay Writer |
|Automobile Repairman |Mechanical Engineer |
|Civil Engineer |Shop Superintendent |
|Structural Engineer |Employment Manager |
|Business Manager |Steam Engineer |
|Cert. Public Accountant |Foremanship |
|Accountant and Auditor |Sanitary Engineer |
|Bookkeeper |Surveyor (& Mapping) |
|Draftsman and Designer |Telephone Engineer |
|Electrical Engineer |Telegraph Engineer |
|Electric Light & Power |High School Graduate |
|General Education |Fire Insurance Expert |
|Vocational Guidance |Wireless Radio |
|Business Law |Undecided |

Name.....

Address.....

Please Mention Popular Mechanics

LEARN BY DOING

Every phase of all branches of

ELECTRICITY

Taught by Actual Practice

In America's foremost and oldest institution for trade training

No Books Used
Individual Instruction
Start Any Day

A SPECIAL and SEPARATE Course in Ignition, Auto Lighting and STARTER Systems. Write for FREE 64-page catalog.

THE
NEW YORK ELECTRICAL SCHOOL
44 West 17th Street, NEW YORK CITY

You Can Learn How to Swim!

No matter how awkward you are in the water, **W.S.** can positively teach you to become a good swimmer. Remarkable simple course, guaranteed to teach you how to swim and attain confidence in the water. Unusual instruction system consisting of 25 lessons, every movement thoroughly explained and illustrated.

BRUCE SWIMMING METHOD, Sale 339,
30 Church St., Dept. J, New York

Sent Postpaid on receipt of \$2.00. Money refunded if not pleased.

RAISE POULTRY FOR PROFIT

We teach you how. Easily learned at home. Our guaranteed methods make success certain—indorsed by leading Agricultural Colleges. Send **TODAY** for **FREE BOOK**—"How To Raise Poultry For Profit."



National Poultry Institute
Dept. 312 Washington, D. C.

Why Good Dancers Are Popular

EVERYONE admires and wants to dance with the person who knows the latest steps. There is no need of being a wall-flower! By my remarkable new easy method, anyone can learn the newest dances at home in a few hours. Much less expensive than from a personal teacher. No music or partner needed. So simple even a child can learn quickly. 90,000 have learned dancing by mail. Your own success is guaranteed.

To prove I can quickly and easily make you an accomplished dancer, I will send you **FREE**, in plain cover, a lesson in Fox Trot, Secret of Leading, How to Gain Confidence, How to Follow and How to Avoid Embarrassing Mistakes. To help pay the cost of handling, mailing, etc., send 25c. Learn in private—surprise your friends. Act now and be a good dancer soon!

ARTHUR MURRAY, Studio 768, 290 Broadway, N. Y.



Copyrighted material

FLEXIBLE
BINDING
—
POCKET
SIZE

ENTIRE SET ONLY \$12

\$1
PER
MONTH



\$10,000. Master Set AUDEL'S ENGINEERS and MECHANICS GUIDES —

THE BOOKS YOU HAVE
BEEN WAITING FOR

4750 Pages—8754 Illustrations

Just completed—Au-del's New Master Set for Engineers
and Mechanics!

Every Engineer, Mechanic and Electrical worker will
welcome this set as a sure source of advancement and higher
pay because of the complete up-to-date information that is
thoroughly and easily explained on every branch of Engineering
and Electrical practice.

Why a \$10,000 Library? Because it would cost the reader
more than \$10,000 together with years of labor and experience
to collect, plan, arrange and prepare for his own study and
ready reference, the vast fund of knowledge printed in this
Master Set.

The entire set costs you only twelve dollars—knowledge
and instruction that has cost thousands of dollars and years
of time—yours for \$12.00—\$1.00 a month.

Study This Brief Table of Contents

Theory, Practice and Operation of
All Steam Engines, Valve Motion—
VALVE SETTING; complete infor-
mation on ALL engines and pumps—
CORLIS ENGINES and the Theory,
Construction and Operation of all
Steam Engines, including UNIFLOW
and POPPET VALVE ENGINES, and
LOCOMOBILES—Locomotive
Marine Engines; Turbines; Rotary
Engines—the Indicator—Lubrication—
PRACTICAL MANAGEMENT,
how to use Indicator—GAS, GAR-
OLINE, OIL, SEMI, and FULL
DIESEL ENGINES—Aeroplanes and
Aviation—HOW TO SELECT AN
ENGINE, working instructions, drawing
on STEAM ENGINE DESIGN,
mounting rules and formulae. Theory
and Construction of ALL Steam
Engines; Heat-Combustion; Fuel and
Flue Gas Analysis—CO₂ records—
Characteristics of Boilers—Materials

—Construction of all types of Boilers,
(THE LATEST PRACTICE)—Boiler
Construction—Mechanical Stokers
—Oil Boilers—Setting Chimneys—
Mechanical Draught—HOW TO
SELECT A BOILER—Complete in-
structions and drawings on BOILER
DESIGN based on A. S. M. E. BOILER
CODE—OPERATION, including
Installation, FILING; care and repair
of Steam Boilers—Pipes, Fittings and
Pipe Fitting—Heating and Ventila-
tion—Refrigeration—Cooling Towers
—Condensers—Distilling Apparatus
—Elevators—Cranes and Hoisting
Machinery—Ropes and Cables—Filing
—electric wiring in ALL branches;
compendium of practical electrical
engineering as an aid for engineers
and electricians in obtaining a license
—57 chapters—ready reference index,
covering entire field of Modern
Electricity.

*Helping Hand
Books that answer
Your Questions*

FREE
EXAM-
INATION



Send No Money—Send Only This Coupon

THEO. AUDEL & CO.,
72 Fifth Ave., New York City

Please submit me for free examination, AUDEL'S \$10,000
MASTER SET FOR ENGINEERS AND MECHANICS. Ship
at once prepaid, the 8 numbers, total cost \$12.00. If satisfactory,
I agree to send you \$1 within seven days and to further mail you
\$1 each month until paid.

Name.....

Occupation.....

Employed by.....

Home Address.....

Reference.....

PM June 23

Your Choice a Dime a Day

No matter what your occupation, one of the home study sets listed below will quickly fit you for a better job and bigger pay. Any set you select will be sent for seven days' examination, and if you decide to buy, you may pay the rock-bottom price at the rate of only 75c a week. But you must act now! When our present supply of paper and binding materials, bought at pre-war prices, is used up, production cost will be greater and we will be forced to increase the price.

These books are the work of recognized authorities. They are written in plain, easily understood language by recognized authorities, and contain hundreds of photographs, diagrams, tables, etc., that make difficult points as simple as A-B-C. Hand-somely and durably bound in half or full morocco leather (except as noted), and stamped in gold.

**Don't
Send
Money**

Pay-Raising Books At Greatly Reduced Prices

Business Management. 8 vols. 2500 pages, well illustrated. Was \$52.50. Now \$29.80.

Electrical Engineering—8 volumes, 4100 pages, 3300 pictures. Was \$90.00. Now \$29.80.

Carpentry and Contracting. 5 volumes, 2388 pages, 1000 pictures. Was \$27.50. Now \$19.80.

Automobile Engineering. 6 volumes, 2600 pages, 2300 pictures, diagrams, etc. Was \$45.00. Now \$21.80.

Steam and Gas Engineering—7 volumes, 3100 pages, 2500 pictures. Was \$52.50. Now \$24.80.

Law and Practice (with reading course, and standard legal forms free) 12 vols., 6000 pages, illustrated. Was \$97.50. Now \$49.80.

Sanitation, Heating and Ventilating. 4 volumes, 1453 pages, 1400 pictures. Was \$30.00. Now \$14.80.

Civil Engineering. 9 volumes, 3900 pages, 3000 pictures. Was \$67.50. Now \$34.80.

Machine Shop Practice. 6 volumes, 2300 pages, 2500 pictures. Was \$45.00. Now \$21.80.

Telephony and Telegraphy—4 volumes, 1724 pages, 3000 pictures. Was \$30.00. Now \$14.80.

Fire Prevention and Insurance. 4 volumes, 1500 pages—600 pictures. Was \$30.00. Now \$14.80.

Drawing. 4 volumes, 1578 pages, 1000 pictures, blue-prints, etc. Was \$30.00. Now \$14.80.

Shipped for 7 Days' Examination

Yes, we'll gladly ship any set right to your home or office upon your simple request. Pay only shipping charges when the books arrive. Don't send a penny until after you have used them 7 days, then remit only \$2.80 or return them at our expense. Pay balance at rate of \$3.00 a month—75c a week.

Act now—while these splendid books are being offered at 20 per cent to 50 per cent less than regular prices. This offer is open to every person within the boundaries of the United States and Canada. Grasp your opportunity—fill in and mail this coupon NOW!

American Technical Society, Dept. X19A, Chicago, Ill.

American Technical Society
Dept. X19A, Chicago, U. S. A.

Please send me set of.....

for 7 days' examination, shipping charges collect. I will examine the books thoroughly and, if satisfied, will send \$2.80 within 7 days and \$3 each month, until I have paid the special price of \$..... If I decide not to keep the books, I will notify you at the end of seven days and return them at your expense.

To insure prompt shipment fill out all lines.

Name.....

Address.....

Employed by.....



Thousands of Opportunities for Auto Experts



GREER Trained Men Earn \$50 to \$125 a Week

GREER Special Summer Course offers you chance to learn complete Automobile Mechanics in just eight weeks. Good jobs waiting for GREER graduates. The pay is BIG—\$50—\$125 a week! Opportunities in all sections of the country. Automobile business is booming. Count the cars now in use. Every one you see is a prospect for the mechanic who knows how to repair an automobile the right way.

GREER training puts you in the "Know How" class. You learn through practical experience with real motors. Course includes: Truck, Tractor and Automobile Repairing, Automobile Driving, Roadside Repairs, Primary Ignition, Electric Lighting and Starting Systems, Vulcanizing, Machine Shop Practice, Shop Management, Selling, etc.

Employment Guaranteed

Demand for men so great we can now guarantee you a job that will pay living expenses and even more while you are learning! GREER employment department flooded with openings. Then with a GREER diploma, you can quickly qualify for a permanent position at good pay, or go into business for yourself. GREER Summer Course is your special opportunity! Now you can get complete instruction at greatly reduced cost.

Write for FREE BOOK

Learn what GREER has to offer you. Our FREE BOOK "How to Succeed in the Automobile Business" tells all. Start today for a Better Job, Big pay and Permanent Employment! Mail coupon at bottom of this column.

GREER COLLEGE

of Automotive Engineering

2056 S. Wabash Avenue, CHICAGO, U. S. A.

Mail This Free Book Coupon

ERWIN GREER, President,
Greer College of Automotive Engineering,
2056 S. Wabash Ave., Chicago, Ill.

Send me your Free Book, "How to Succeed in the Automobile Business" and Special Tuition Offer.

Name.....

Address.....

Please Mention Popular Mechanics



New friends, new pleasures, new and interesting experiences, invitations galore—dinners, dances, week-end parties, outings,—are some of the good things playing a Gibson brings into your life.

Gibson Instruments

are easily learned in spare time without previous knowledge of music. A few weeks of pleasant, interesting study and you'll be able to play. And there's no other joy in life quite equal to hearing music you make on your own instruments.

\$5.00 Monthly buys a Gibson. The ultimate quality and volume. Built like a violin. Adjustable bridge, non-warpable truss rod neck and thirty other exclusive Gibson features. Guaranteed for life. Non-Gibson instruments exchanged.

Make \$25 to \$200 weekly selling, playing, teaching. Own a high class, exclusive business. We furnish stock, advertise, help sell, carry accounts. Gibsons easily sold on confidential credit plan. Send for FREE catalog, FREE music and information about Mandolin, Mandola, Mando-cello, Mando-bass, Guitar, Harp-guitar, Mandolin-banjo, Tenor-banjo, Cello-banjo, Guitar-banjo. If interested in Agency, check here Teacher?..... Clip, check and mail this ad today. Address all mail to Kalamazoo.

GIBSON MANDOLIN-GUITAR CO.
1586 Parsons St. Foreign Dept.
Kalamazoo, Mich. 25 Broad St., N. Y. City.

ARTIST'S OUTFIT FREE



Write quick for our remarkable offer. Learn NOW at home, in spare time, by our new instruction method. Commercial Art, Cartooning, Illustrating, Designing. Delightful fascinating work in big demand. \$50.00 paid for one drawing. Handsome book free explains everything. SEND FOR IT TODAY. WASHINGTON SCHOOL OF ART, Inc. 2130 Marston Bldg. Washington, D. C.

Learn Expert Auto Painting



There is Big Money in auto painting and refinishing. Our Home Study Course in Practical Auto Painting will enable you to do the finest work and earn big wages. Wonderful opportunity for new money-making business of your own.

FREE circular tells all about this big new business. Be first. Write quick.

CHICAGO COLLEGE OF AUTO PAINTING
Dept. 6, 20 E. Jackson Blvd., CHICAGO, U. S. A.

Sure Rupture Comfort

BE COMFORTABLE—Wear the Brooks Appliance, the modern scientific invention which gives rupture sufferers immediate relief. It has no obnoxious springs or pads. Automatic Air Cushions bind and draw together the broken parts. No salves or plasters. Durable. Cheap. Sent on trial to prove its worth. Never on sale in stores as every Appliance is made to order, the proper size and shape of Air Cushion depending on the nature of each case. Beware of imitations. Look for trademark bearing portrait and signature of C. E. Brooks which appears on every Appliance. None other genuine. Full information and booklet sent free in plain, sealed envelope.



MR. C. E. BROOKS

BROOKS APPLIANCE CO., 126J State St., Marshall, Mich.

Ticket to Chicago

(The Electrical Center of the World)

FREE



WE pay your railroad fare to Chicago—the Electrical Center of the World—from any place in the United States. Grasp this opportunity to see the country at our expense. Don't stick in one spot—travel—get experience. Come to Coyne—learn electricity in 3 months. Fit yourself for a big paying job. The largest electrical school in the country specializing in electrical instruction *only*.

Learn Electricity in 3 Months

Get a complete training, so you can make big money as Power Plant Operator, Superintendent, Telephone man, Construction worker, auto, truck or tractor electrician, battery man, radio expert, or you can go into business for yourself as electrical contractor, dealer, auto ignition or battery expert and make from \$3,000 to \$20,000 a year. Hundreds of our graduates today are making big money and you can do the same if you grasp this opportunity—act now.

Great Shops of Coyne

No books or useless theory. You are trained on \$100,000 worth of electrical equipment. Everything from door bells to power plants. You work on motors, generators, house-wiring, autos, batteries, radio, switch-boards, power plants—everything to make you an expert ready to step right into a position paying from \$45 to \$100 a week.

RADIO COURSE FREE. We include the following free with the regular course:

- [1] A complete course in auto, truck and tractor electricity and storage batteries. Greatest outlay of auto, electrical and battery equipment in the country.
- [2] Course in Radio—the marvel of the age. Constructing, installing and operating. You can build your own wireless telephone set.
- [3] A life scholarship in the Coyne school. You can stay as long as you wish and return for further training at any time in the future.

Earn While You Learn! We help students to secure jobs to earn a good part of their expenses while studying.

Send Coupon

Don't delay a minute—send that coupon *right now* for our big free catalog and full particulars of Free Railroad Fare offer. Remember this special offer is limited so act now!

B. W. Cooke, Pres., Coyne Electrical School
1300-1310 W. Harrison St., Dept. A-935 Chicago, Ill.

Dear Sir: Please send me free your big catalog and full particulars of your special offer of Free Railroad Fare and two extra courses.

Name

Address



Student Winding a Stator

COYNE

Electrical School

Endorsed by Electrical Industry

1300-1310 W. Harrison St., Dept. A-935 Chicago





BE A RAILWAY TRAFFIC INSPECTOR

The Most Pleasant Work I Know of

By L. P. Reifein



"I have been employed as a Railway Traffic Inspector for several months now and since the first day I began studying the course, an entire new field has been opened up to me. It is the most pleasant work that I have ever had the good fortune to be engaged in.

"I was employed as a passenger brakeman on one of the largest R. R. Companies, and when the Business Depression came into us in spring of 1921 I was suspended on account of

reduction in force. Whereas this position is permanent, and without the wonderful course prescribed, I would have never been able to be engaged in this line of work.

"This line here extends from the state line of N. H. to state line of R. I., being 15 divisions, and the ride of today will not be the one you make tomorrow. They cover the whole Eastern half of the state of Mass.

"Another great thing, you are practically your own boss, and deal only with best of men in this line of work.

"I owe a debt of thanks to the Standard Business Training Institute for the great opportunity derived from their course of study **where advancements are unlimited.**"

Position Guaranteed

Earn Up to \$250 per Month, Expenses Paid

Prepare in three months' spare-time study at home for this fascinating profession. Many opportunities for advancement; many men are needed. Steady, pleasant outdoor work; travel or remain near home.

You Take No Risk

After completing course if we do not get you a position paying at least \$110.00 a month and expenses, we refund your entire enrollment fee. Cost is moderate.

Send coupon today for full details

Standard Business Training Institute

Buffalo, N. Y.



Standard Business Training Institute

Buffalo, N. Y.

Send me, entirely free, Booklet No. D-63, giving full particulars about course in Railway Traffic Inspection.

Name

Street

City

Please Mention Popular Mechanics



Aerial Photo Taken by Dan Kiser

LEARN TO FLY

\$100 Reduction for Short Time

First class air pilots, with special training in Aviation Mechanics earn \$5,000 a year up. Operating companies' demand for specially trained Pilots, Field Managers, Superintendents and Airplane Mechanics growing every day. Mr. Dan Kiser, late of U. S. Air Mail Service and Army Flying Corps, will train you thoroughly in all branches of this profession and fit you for pilot license.

Special Rate Now in Force

For a limited time you can secure this training fitting you fully for the greatest red-blooded profession of them all at a big reduction in the cost of tuition. Write at once for particulars sent free and without obligation.

Address: **DAN KISER, Chief Engineer**

Dept. F 1, S & H Works (Aircraft Div.)

1422 W. Monroe Street

CHICAGO, ILL.

Drafting Plan Reading Building

Never before such a demand for skilled Draftsmen and Building Experts. More big jobs open than men to fill them.

TRAIN BY MAIL

Let Chicago "Tech" give you the training that brings quick advancement and a high salary. Send for information, CHICAGO TECHNICAL COLLEGE 630 Chicago "Tech" Bldg., Chicago



"BECOME A LIGHTNING TRICK CARTOONIST"

MAKE MONEY QUICK TALKING. SEND \$1.00 FOR SNAPPY PROGRAM OF TRICK DRAWINGS WITH INSTRUCTIONS BY A PROFESSIONAL CARTOONIST. SATISFACTION GUARANTEED. CIRCULAR FREE. BALDA ART SERVICE, 61, OSHKOSH, WIS.

Learn Autos and Tractors



Wonderful opportunities constantly offered trained men; we train you thoroughly to start your own business or make good money as motor expert, driver, shop foreman, etc.

7,000 Graduates making good. Catalog Free

Cleveland Automobile School, 1814 E. 24th St., Cleveland, O

LEARN WATCHMAKING AND ENGRAVING



Earn while learning. Most practical watch school. Individual instructions. Graduates in great demand. Book free. Chicago School of Watchmaking, Dept. 20, 4540 Lincoln Ave., Chicago

STAMMERERS

You can be cured by our course of natural individual lessons. Write today for free booklet, "How To Stop Stammering."

SAMUEL A. ROBBINS, Director,
Boston Stammerers' Institute, Founded, 1867
246 Huntington Ave. Boston 17, Mass.

Copy this Sketch



and Get
This Rule

FREE

I AM anxious to find men with desire to become draftsmen. With business picking up everywhere many thousands of draftsmen will be needed at salaries ranging up to \$3,000 and \$3,600 per year.

To every person 16 years or older sending a sketch I am going to mail free and prepaid the Draftsman's Ivorine Pocket Rule shown here. This will come to you entirely with my compliments. With it I will send a 6 x 9 book on "Successful Draftsmanship." If you are interested in becoming a draftsman, if you think you have or may attain drafting ability, sit down and copy this drawing, mailing it to me today, write your name, and your address and your age plainly on the sheet of paper containing the drawing.

Salaries up to

\$250 and \$300 a Month

I am Chief Draftsman of the Engineers' Equipment Co. and I know that there are thousands of ambitious men who would like to better themselves, make more money and secure faster advancement. Positions paying up to \$250 and \$300 per month, which ought to be filled by skilled draftsmen, are vacant. I want to find men who with practical training and personal assistance will be qualified to fill these positions. No man can hope to share in the great coming prosperity in manufacturing and building unless he is properly trained and able to do first class practical work.

I know that this is the time to get ready. That is why I am making the above offer. I can now take and train a limited number of students personally and I will give to those students a guarantee to give them by mail practical drawing room training until they are placed in a permanent position with a salary up to \$250 and \$300 per month. You should act promptly on this offer because it is my belief that even though you start now the great boom will be well on by the time you are ready to accept a position as a skilled draftsman. So write to me at once.

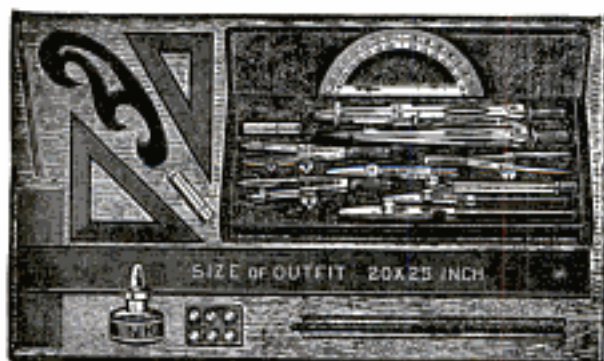

FREE

\$80 Drafting Course

To every student enrolling now I give an opportunity of getting an \$80 drafting course absolutely without cost to him. So send in your sketch today and learn all about this offer.

Mail Your Drawing at Once

— and Get an Ivorine
Pocket Rule Absolutely **FREE!**

Ambitious men interested in drafting hurry! Don't wait! This is your opportunity to get into this great profession. Accept the offer which I am making now. Send in your sketch or request for free book and free Ivorine Pocket Rule.

FREE this \$25 Draftsman's Working Outfit

These are regular working instruments—the kind I use myself. I give them free to you if you enroll at once. Don't delay. Send for full information today.

Chief Draftsman, Engineers' Equipment Co., 1951 Lawrence Av.
Div. A-935 Chicago



\$95 An Hour!

"Every hour I spent on my I. C. S. Course has been worth \$95 to me! My position, my \$5,000 a year income, my home, my family's happiness—I owe it all to my spare-time training with the International Correspondence Schools!"

Every mail brings letters from some of the thousands of I. C. S. students telling of promotions or increases in salary as the rewards of spare-time study.

What are you doing with the hours after supper? Can you afford to let them slip by unimproved when you can easily make them mean so much? One hour a day spent with the I. C. S. will prepare you for the position you want. Yes, it will! Put it up to us to prove it. Mark and mail this coupon now!

TEAR OUT HERE

INTERNATIONAL CORRESPONDENCE SCHOOLS Box 5527-D, Scranton, Penna.

Without cost or obligation, please tell me how I can qualify for the position or in the subject before which I have marked an X:

BUSINESS TRAINING COURSES

- | | |
|---|---|
| <input type="checkbox"/> Business Management | <input type="checkbox"/> Salesmanship |
| <input type="checkbox"/> Industrial Management | <input type="checkbox"/> Advertising |
| <input type="checkbox"/> Personnel Organization | <input type="checkbox"/> Better Letters |
| <input type="checkbox"/> Traffic Management | <input type="checkbox"/> Foreign Trade |
| <input type="checkbox"/> Business Law | <input type="checkbox"/> Stenography and Typing |
| <input type="checkbox"/> Banking and Banking Law | <input type="checkbox"/> Business English |
| <input type="checkbox"/> Accountancy (including C.P.A.) | <input type="checkbox"/> Civil Service |
| <input type="checkbox"/> Nicholson Cost Accounting | <input type="checkbox"/> Railway Mail Clerk |
| <input type="checkbox"/> Bookkeeping | <input type="checkbox"/> Common School Subjects |
| <input type="checkbox"/> Private Secretary | <input type="checkbox"/> High School Subjects |
| <input type="checkbox"/> Business Spanish <input type="checkbox"/> French | <input type="checkbox"/> Illustrating <input type="checkbox"/> Cartooning |

TECHNICAL AND INDUSTRIAL COURSES

- | | |
|--|--|
| <input type="checkbox"/> Electrical Engineering | <input type="checkbox"/> Architect |
| <input type="checkbox"/> Electric Lighting | <input type="checkbox"/> Blue Print Reading |
| <input type="checkbox"/> Mechanical Engineer | <input type="checkbox"/> Contractor and Builder |
| <input type="checkbox"/> Mechanical Draftsman | <input type="checkbox"/> Architectural Draftsman |
| <input type="checkbox"/> Machine Shop Practice | <input type="checkbox"/> Concrete Builder |
| <input type="checkbox"/> Railroad Positions | <input type="checkbox"/> Structural Engineer |
| <input type="checkbox"/> Gas Engine Operating | <input type="checkbox"/> Plumbing and Heating |
| <input type="checkbox"/> Civil Engineer | <input type="checkbox"/> Chemistry <input type="checkbox"/> Pharmacy |
| <input type="checkbox"/> Surveying and Mapping | <input type="checkbox"/> Automobile Work |
| <input type="checkbox"/> Metallurgy <input type="checkbox"/> Mining | <input type="checkbox"/> Navigation |
| <input type="checkbox"/> Steam Engineering | <input type="checkbox"/> Agriculture and Poultry |
| <input type="checkbox"/> Radio <input type="checkbox"/> Airplane Engines | <input type="checkbox"/> Mathematics |

Name.....
Street.....
Address..... 3-27-23
City..... State.....

Occupation.....
Persons residing in Canada should send this coupon to the International Correspondence Schools Canadian, Limited, Montreal, Canada.

Please Mention Popular Mechanics



LEARN AUTO PAINTING IN DETROIT

Earn \$50 to \$300 Weekly

Auto business on the boom. Hundreds of Auto Painters needed. Now is the time to get out of the rut. Now is the time to prepare for a better job. Over 400 men who have taken our training are making big money. You can do the same. Age or education makes no difference. Ambition and common sense is all that is necessary.

Start a Business of Your Own

Little capital necessary. Every Village, every Town and City offers big possibilities for the ambitious Automobile Painter. Custom Shops are fast following in the wake of the service station and garage. You can learn in from 8 to 10 weeks' time. We teach you in a practical, methodical way on real Automobiles, Bodies, etc. The Instructors are men who have made Automobile Painting and teaching their life's work.

Instructions are individual. You can start any time. The cost is small. **TODAY—RIGHT NOW**—write for our special offer and catalogue. No colored students accepted.

DETROIT AUTO PAINTING SCHOOL
26 D. A. P. S. Bldg., 426 Superior St., DETROIT, MICHIGAN



Be Your Own MUSIC Teacher

Learn at Home

by wonderful print-and-picture method that teaches in half usual time. Far superior to private teachers. Simple as A, B, C—a child can master it. Your lessons consist of real selections instead of tiresome exercises. When you finish one of these delightfully easy lessons you've added a new "piece" to your list. You read real notes too—no "numbers" or trick music. Method is so thorough that many of our 300,000 students are band and orchestra LEADERS.

Automatic Finger Control

Our own invention—the music marvel of all ages. Trains and guides your fingers so that they fall into proper place almost automatically.

Play by NOTE
Piano, Organ,
Violin, Cornet,
Mandolin,
Harp, Cello,
Trombone,
Flute, Clarinet,
Piccolo, Saxophone, Ukulele,
Guitar, Harmony and Composition, Banjo, Tenor Banjo, Voice and Speech Culture, Drums and Traps, Automatic Finger Control, etc.

FREE BOOK Shows You How

you may quickly become a fine player or singer through the U. S. School home study method. Write now, however before free books are exhausted. Mention your favorite instrument or whether you prefer vocal music. Please write your name and address plainly. Address

U. S. SCHOOL OF MUSIC, 76 Brunswick Bldg., N. Y. C.

Copyrighted material



He Makes \$200 Every Week

Read Grover C. Fishbaugh's Amazing Story of Success! You can easily make as much money or even more with a very small investment

Two years ago Grover C. Fishbaugh was a discouraged veterinary physician, struggling along, hardly able to make ends meet. Then opportunity knocked and today his net profits from a small investment are more than \$200 every week.

Mr. Fishbaugh saw an opportunity to make big money in becoming a lubricating specialist. He knew nothing about the motor car business at that time. He did not even own an automobile. But recognizing the demand for this kind of service he invested his

last dollar in a lubricating rack and started in a new business on a vacant lot.

The first week proved to him that his vision had been right. Within six months he had made enough money to finance the purchase of the adjoining property, remodel the building and establish a modern service station, with all the latest equipment.

Out of his profits since he has built himself an attractive bungalow and bought a good automobile.

Why Not Start in Business for Yourself! The Manufacturers of the Famous Alemite High Pressure Lubricating System Will Tell You How!

We can tell you how to go into the lubricating business and make big money like Grover C. Fishbaugh. You can start for as little as \$200. Simply fill out the coupon below and we will send you complete details without a penny of cost to you. Don't put it off another day. This is your chance to get started on the road to success.

The Bassick Manufacturing Company
2674 N. Crawford Avenue, Chicago, Illinois

The
Bassick
Mfg. Co.
2674 North
Crawford Ave.
Chicago, Illinois

I am interested in getting into the lubrication business. Please send me without any obligation or cost, complete information.

Name _____

Street _____

City _____ State _____

The New Home of Popular Mechanics Magazine: When in Chicago, Our Readers are Invited to Visit Our Building and See How the Magazine is Made and Printed. Our Location is 200 East Ontario Street, Just East of Michigan Boulevard and Only a Few Blocks North of the Loop



Popular Mechanics Magazine

REGISTERED IN U. S. PATENT OFFICE

WRITTEN SO YOU CAN UNDERSTAND IT

Vol. 39

JUNE, 1923

No. 6

2160 *national* Spirit Pictures and a Speaking Skull

Remarkable Demonstration in Broad Daylight
before the Editors of This Magazine

BY J. L. PEABODY—

EVERY one who believes in spiritistic phenomena, as well as those who are openly skeptical, cannot fail to be interested in the "spirit pictures" made by the Jesuit priest, Father de Heredia. The Jesuits, as is commonly known, study diligently for at least 13 years, take the three vows of poverty, chastity, and obedience, and then follow some particular line of study to which the rest of their lives is devoted.

This system has given the world valuable results in many fields, and literature is rich with stories of the work of these single-purposed men. Father de Heredia—a Mexican born in Mexico City, and now at Holy Cross College, Worcester, Mass.—has spent his life investigating spiritism and has followed it not so much with the mind of a scientist as with the uncomplicated logic of a boy, for that is the way, he says, to strip spiritism of the frauds commonly practiced in its name. He demonstrated recently in the Popular Mechanics photographic studio how spirit pictures could be made under "test" conditions so that the closest observer could not say

how it was done. Using the magazine's equipment, including camera, plates, and chemicals, numerous "spirit" views were produced, even to the white cloud of "ectoplasm" commonly associated with them.

To guard against plates being shifted, they were signed by persons present and Father de Heredia himself sat for some

of the views while the magazine's operator made the exposures. The results were as gratifying as any of the pictures exhibited by Sir Arthur Conan Doyle—and yet Father de Heredia did it all by trickery, and willingly explained how.

Father de Heredia discovered how to make spirit photographs quite by accident several years ago. He had been experimenting with some luminous paint

and had laid down, temporarily, an object coated with that substance. Upon picking it up, he observed that there remained a faint photographic impression upon a sheet of paper on which the object had rested. This led him to try to transfer a picture directly to a plate by first coating the picture with paint and then laying it

The Illustrated World, a magazine long and favorably known, has been merged with Popular Mechanics. Beginning with this issue, Illustrated World subscribers will receive this magazine each month until their subscription expires. Those who have been subscribers to both will have their subscription to Popular Mechanics extended by the number of months of Illustrated World still due. We welcome our new readers with the hope that they will grow to like this magazine as well as they did the other.

2160

Prof. Joseph Freud, B. 26,
625 W. Jackson Chicago

upon the sensitized surface. Results were obtained with amazing simplicity. Any picture could be transferred to an unexposed plate without affecting its appearance sufficiently for detection, and the plate could then be placed in the camera and exposed in the usual manner. The result when printed was a sharp impression of the person sitting for his portrait with an etherealized presence, or presences—according to the treated copy used—floating in a gauzy cloud near the subject, or even, transparently, across his face.

When a boy, Father de Heredia had studied magic under the renowned Herrmann. The boy's father was wealthy and maintained a private theater for his sons. Here Herrmann had given a performance which so delighted the young Mexicans that they begged to be taught the secrets of the profession. This boyish delight in clever tricks has seasoned the priest's personality and kept him very human. Magic and science are the allies which enable him to make spirit pictures under test conditions.

The priest clips his "ghosts"—a beautiful child, a gliding figure, a line of marching soldiers, an aged woman—from foreign periodicals. He always has a supply with their surfaces washed with luminous paint and freshly exposed to the light. A sitter enters the studio. Perhaps fearing fraud he has brought his own plates and chemicals—or his own camera even. He examines everything relating to his mission. The good father refuses to use the plates until the subject has written his name on them to insure that no shifting can be done. Father de Heredia watches him sign the plate, his own hand—in the palm of which is the paint-treated spirit

picture—resting lightly on one corner. The plate is then placed in the camera by the subject himself, who may even press the bulb. The sitter is eager. He insists on developing and printing the plate immediately. His eagerness increases. The print is still wet, but there—unmistakably—is not only his own likeness, but that of the aged mother for whom no normal person ever ceases to yearn.

Fortunate, indeed, for the subject, that the picture was made by the good Jesuit priest, who willingly explains how he did it.

Many and devious are the ways of



Professor Freud (Joseffy) and Father de Heredia, Quite Unconscious of the Benign "Spirit" Bending over Them

the fraudulent cabinet medium, according to Father de Heredia. A man may have a hairless chest, but what is there to prevent him from wearing a wig on his chest? Under such a wig may be concealed clouds of fictitious ectoplasm.

An examining committee is practically always restrained by delicacy from making a thorough examination of a medium. Where the medium is a woman, she must have a chaperon—and

according to the priest, any man skeptic is helpless when opposed by two clever women.

Let us pass, however, from the demonstrations of the Jesuit to a Corinthian-pillared hall where are gathered several score of people, every one of whom has suffered a bereavement that has left him groping through the hard facts of reality into the shadows of the unseen. If we had time we could read a story into each of these faces. An old man on a low rostrum at the front is announcing such hymns as "Lead, Kindly Light," and "When We Gather at the River."

A group of men at the front are



Two "Ghosts" Haunt This View of Father Kane of Loyola University and Father de Heredia. They Are Both "Luminous-Paint" Spirits, Evoked by the Jesuit Scientist in the Popular Mechanics Studio

setting up a cabinet which they have carefully examined. The medium herself is in the hands of the examining committee of women; she will soon appear in a coat and skirt borrowed from persons in the audience. The overhead lights blink out one by one. The room now is in semidarkness so that the dope-faced man at the piano looks like a death mask in the gloom. Over the rostrum one blue light



Father de Heredia, and H. H. Windsor, Editor of Popular Mechanics: The Third "Person" Is the Ghost

gleams. No one quite knows when it was switched on, but there it is like a spiritual eye to oppress any who may doubt.

The medium stumbles out of the anteroom into the cabinet, the women's committee files silently into the room. The old-man leader has instructed every one on the front seats to clasp the hand of his neighbor on the left and right. Why do some of these people grip one's hand so hard?

2160

POPULAR MECHANICS

Suddenly a voice—a gruff, loud voice—from the cabinet! It is Pedro, the medium's control. "Watch for Balsamo who lived from 1743 to 1795."

The curtains part, they are swayed by a filmy gust. Heavens! what is this? It is not the usual spiritual figure, but a skull that emerges. A horrid grinning human skull. Pedro speaks again. "Balsamo will answer questions. Three raps will mean 'yes' and two raps 'no.' Is that right, Balsamo?"

The skull opens its grinning jaws and clicks its teeth together sharply three times—meaning "yes." The people are leaning forward breathlessly.

"Balsamo, look about you"—the skull slowly turns from left to right, from right to left—"and see if you know anyone present."

"Click! click!" responds Balsamo—he recognizes no one.

"To prove that Balsamo understands what is said to him, will some one choose two figures from the chart on the rostrum and Balsamo will add them together."

The chart has all the figures from 1 to 9 and some one chooses 5 and 8. The gruesome thing responds with 13 staccato clicks, and a great sigh breathes up from the spectators.

"Is there anyone here who would like to ask Balsamo questions?" calls Pedro. The women shrink back, but a graying man calls out: "Have you ever seen John Patterson on the other side?"

"Click! click! click!" answers Balsamo, turning his hollow eyes upon the speaker, who trembles visibly.

"Can you take a message to him?"

"Click! click! click!"

"Tell him"—with a big sob—"Dad knows he was not a coward."

"Click! click! click!" answers the skull, but where is it?

It has disappeared, and the medium is staggering out into the arms of the waiting committee.

Such a seance is quite possible were Balsamo, the mechanical skull, to fall into the hands of unscrupulous persons. It is the invention of Professor Freud, otherwise known as

Joseffy, the Magician.

On the same day that Father de Heredia showed the assembled editors of Popular Mechanics Magazine how to fake spirit pictures, Joseffy exhibited Balsamo, who has been named after a Spanish magician who died in 1795. Balsamo has no visible mechanism of any kind. The head is pivoted on a small circular base and has a three-inch frill of chiffon around its neck. It was passed from hand to hand: There



"Balsamo," the Talking Skull, with Its Inventor, Joseffy, at the Left, and the Jesuit Father de Heredia, at the Right

were no connections between it and its control—Joseffy. It was then placed upon a pedestal and not only gave the performance described, but did many other things.

The skull turned either to left or right, as it was directed. Joseffy asked the time; a spectator took out his watch. It was exactly 2:06 p. m. "Click! click!" answered the skull; a pause and then six more clicks in rapid succession.

Every one responds to magic.

There were more tricks. Mind reading; answers from beyond to questions.

"Thought transference?" questioned one hesitatingly.

"Thought transference?" chuckles Father de Heredia; "no, just a trick, but I will not tell you how it ees done. It ees a great secret. Ha! Ha!"

"Ectopiffle!" laughs Joseffy, the wizard.

Inv. A. H. Sheldon
Ventura, Calif.

Chas. S. W. Winters
703 Reister National
Bank Bldg.

2038

POPULAR MECHANICS

Washington, D. C. 821

VICTIMS OF SHIPWRECK MAY WALK OCEAN TO SAFETY

A one-man life-saving device with which shipwreck victims may "walk" to land, is being offered steamship companies. It consists of two pontoons that slide back and forth alternately in a rigid frame, the operator placing a foot in each one, standing erect, of course, and grasping the handles of a steering device. As the pontoons are worked, paddles on the bottom aid the walker, folding up so as to offer no resistance on the forward slide. In windy weather a sail assists the walker.

NEW DUTCH CANAL

One of the most important canals Holland has constructed, connecting the Zuid-Willems canal, near Helmond, with Geertruidenberg, on the coast near the mouth of the Meuse, was scheduled to be opened for public traffic during May. This new waterway cuts the province of North Brabant lengthwise into two almost equal parts, gives the industrial town of Tilburg an exit to the sea, and makes possible intercommunication between this town and the important Dutch cities, Maastricht and Bosch. Its length is approximately 42 miles, its depth about 8 feet, and its surface width 71 feet. About \$10,000,000 has been spent on the project.

Christian Science Monitor
4/10/23

GERMS TRAPPED BY AIRPLANE FIGHTING WHEAT RUST

Seeking to find the source of the germs of "black stem rust," a disease of wheat, an airplane has been used within the last year to test the air above the fields. It was not known whether the rust germs were carried to the wheat-raising states

from the South by the wind or whether the barberry, a shrub of rapid growth quite common in the wheat belts, served as a breeding place for them. Glass plates, coated with a mucous substance, were mounted on the wings of the airplane, which then flew over infected fields at heights varying from 1,000 to 7,000 feet. The plates were exposed to the air for different periods of time and the results led to the conclusion that the germs were sheltered by the barberry rather than brought from the South by air currents. In one instance

6,800 spores were caught on a glass plate exposed for 65 minutes. It was also learned that the spores would germinate at heights of as much as 7,000 feet above the ground.

—
An exceptionally dry winter has so weakened Japan's electric power, through the drying up or lowering of the level of streams and lakes, that steam plants are being installed to help out.



COPYRIGHT, UNDERWOOD & UNDERWOOD
Victim of Shipwreck Operating New Life-Saving Device: Paddles on Bottom of pontoons Aid "Walker"

2140



View of the Popular Mechanics Pressroom with the Big Rotaries at Work: This Room Has a Floor Space of 10,000 Square Feet, and Every Corner of It Is as Light as Day. This Issue Is the First to be Printed in the New Building. Each Press Produces 384,000 Printed Pages per Hour, Folded and Ready for Binding, Which Is Equivalent to More than 1,000 Complete Books. All Machinery in the Building is Motor-Driven and under Instant Control by Means of Push Buttons Located at Convenient Intervals

POPULAR MECHANICS' NEW HOME

BY H. H. WINDSOR

IN occupying our new building and issuing the first copies from it, we have thought some of our readers would be interested in a few words as to how the magazine was originated and its development.

The first copy of Popular Mechanics was issued January, 1902, from one small room, by its founder and present editor. The idea had been developing in his mind for five years, suggested by reading a large number of other technical and class publications while publishing some of his own. He realized the enormous number of articles of a highly interesting and instructive character, including science, mechanics, engineering, industry, and discovery, which were expressed in technical terms that the layman could not understand, and limited to the comparatively small circulation of such publications in those days.

The Popular Mechanics idea was to secure this information at first hand and at the earliest possible moment, and concisely tell the story of these events in

language "written so you can understand it"; the "you" meaning everybody in all professions, industries, and occupations.

The first copies contained 16 pages in

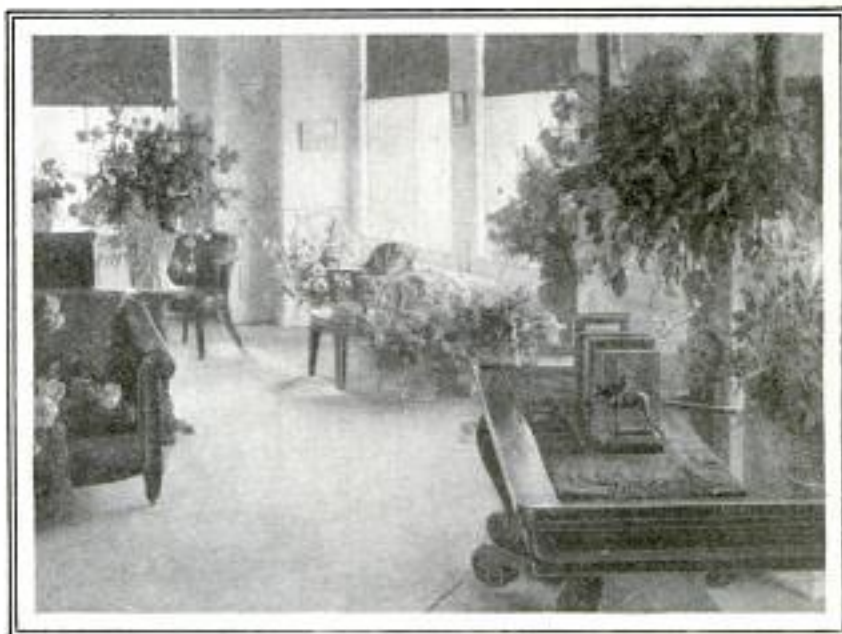

Office of H. H. Windsor, Editor and Founder of Popular Mechanics Magazine, on the Day of the Formal Opening

the form of a weekly, which two years later was changed to its present monthly-magazine size. From the first it was liberally illustrated, although at that time few publications indulged in many pictures.

A long-time policy is an absolute independence of the editorial and advertising departments. Readers frequently inquire why the name of the inventor or manufacturer of something described is almost never printed. It is to avoid even the appearance of advertising in the editorial pages.

This first small room, however, was soon outgrown, and from that day to this, the space required in which to produce the magazine has been steadily increased, until its present seven-story home became necessary in order to properly produce the publication.

The Popular Mechanics building occupies 85 by 120 feet, on a lot 120



The Office of the Vice-President, H. H. Windsor, Jr., Also Taken on the Opening Day: The Eastern End of the Room is Seen in This View

2140

by 165 feet located on the northeast corner of Ontario and St. Clair streets, Chicago. It is devoted exclusively to our offices and printing plant.

The basement of the building is used as a storage space for paper and provides room for 2,000,000 pounds.

The third floor is occupied by the advertising, subscription, and mailing departments. The general reception room is also located on this floor.

The fourth floor comprises the general administration, book, and cashier's departments. There is also a museum which is rapidly becoming of considerable interest as a permanent, fireproof resting place for what have been, in most cases, cherished family heirlooms. These are mounted on the walls or displayed in show cases, each article accompanied by a card bearing the name of the donor, with a brief description of its history. The public is invited to inspect the museum at any time during business hours.

The fifth floor is devoted to the editorial department, the bureau of information, and the library. The bureau of information gladly answers any inquiries regarding articles in the magazine, as well as furnishes any other information in its power, with absolutely no charge. The editorial department is so laid out that each writer has a room to himself.

Our art department on the sixth floor, in its arrangement and equipment, is among the finest in this country, the photographic branch being particularly complete. Something over 75,000 illustrations have appeared in our pages since the

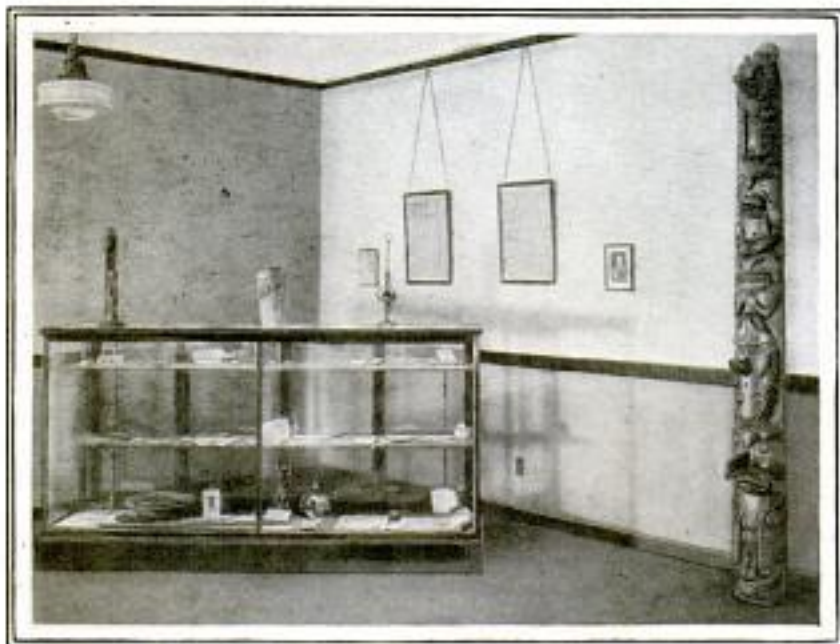

A Corner of the Museum Floor of the New Building: The Collection Has Many Exhibits of Rare Interest

The first floor is used as a pressroom and was built especially for that purpose. The height from floor to ceiling is 15 feet, which allows ample space over the presses. The presses used are rotaries.

The second floor contains the bindery where the magazine is assembled after printing, the book stitched, and the cover glued on. This is done entirely by machinery.

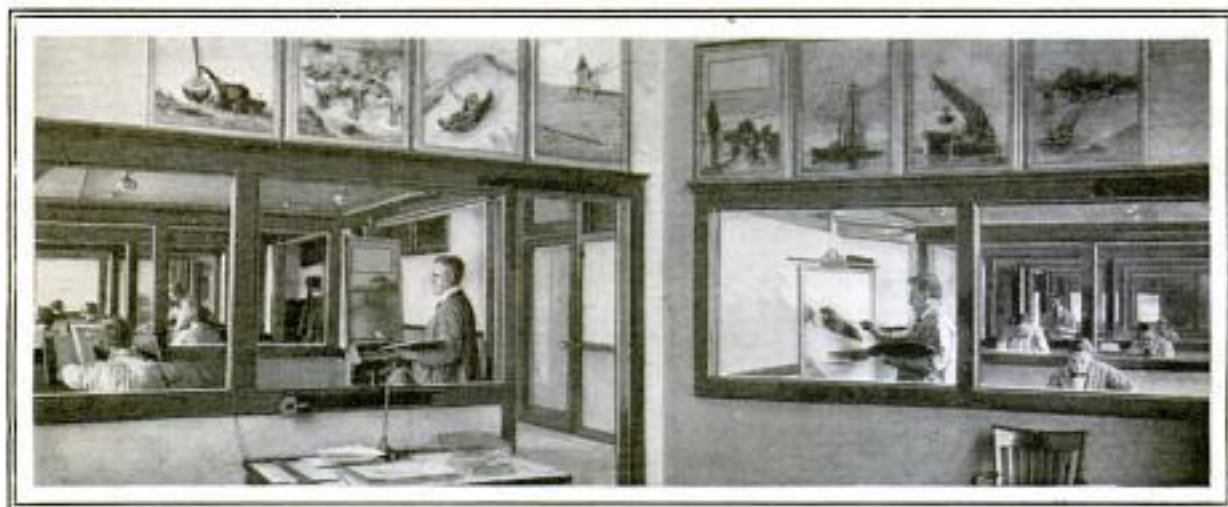

North Bay of the Art Department on the Sixth Floor, as Seen from the Art Director's Office West Bay

first copy of the magazine was published. The building is fireproof throughout, being constructed of brick, steel, concrete, and tile. It was completed in 10 months, by Marshall & Fox, the architects and builders. At the formal opening recently, over 700 guests inspected all departments.

It is the policy of the magazine not to indulge in special editions, nor to an-

nounce forthcoming features. Our effort is to try to do each month at least a little better than the one before; it should be no violation of policy to say we hope to at least live up to this endeavor. When in Chicago, our readers will find a warm welcome, and a guide to take them through all departments of the making of a magazine, should they honor us with a call.

2159

CROCKER ECLIPSE PICTURES SHOW SUN STREAMERS

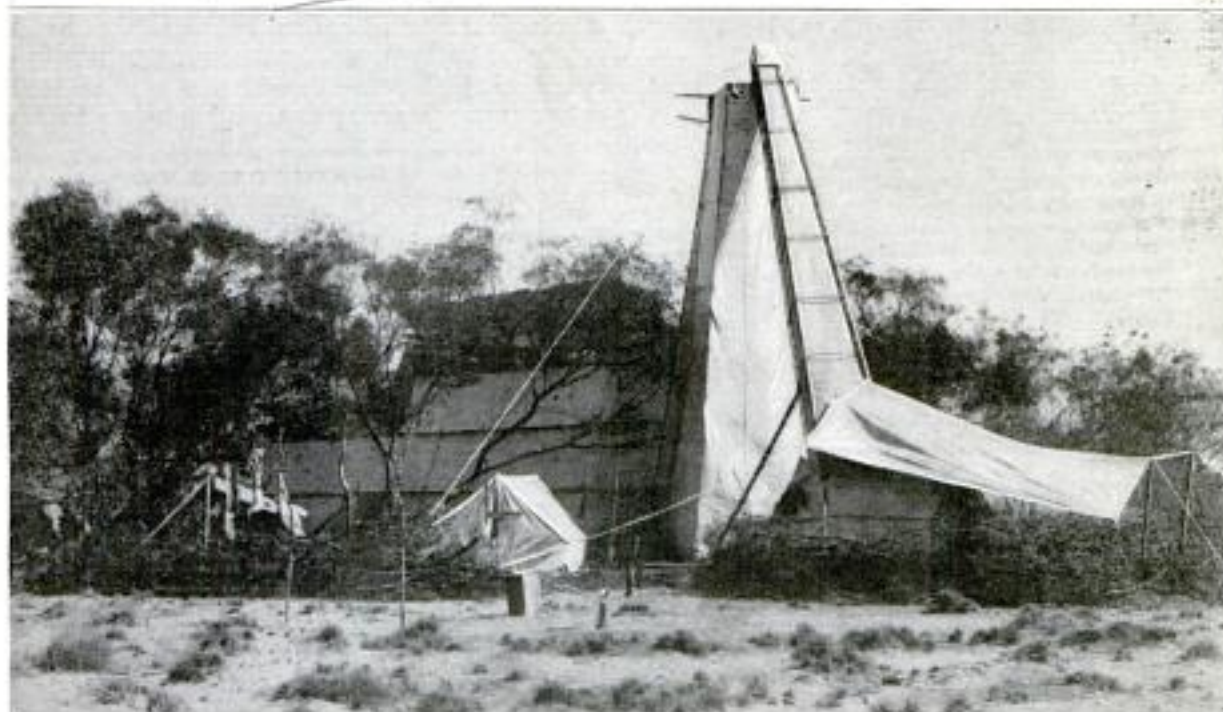

Above: The Huge Camera Erected in the Wilds of Australia by the Crocker Expedition for Photographing the Eclipse of the Sun

First photographs of the sun's eclipse last September, obtained by the Crocker expedition to Wallal, West Australia, were recently shown the public. The pictures were taken with a 40-foot camera and furnish evidence that Einstein's predictions were correct. These

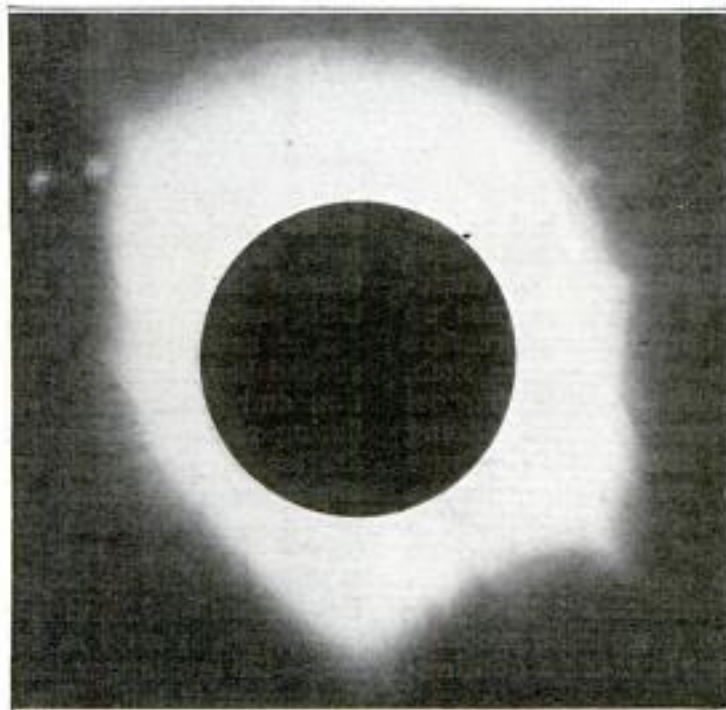

Left: Total Eclipse of the Sun as Seen by the 40-Foot Camera: The Corona Is the Band of Light Seen About the Dark Circle

photographs show the sun's corona to have been 40,000 miles wide, from which long streamers of light shot forth, one extending 2,500,000 miles from the sun's center. More than 30 stars were recognized on the camera plates and 23 of these were measured.

NEW METHOD OF PURIFYING HELIUM PROVIDES AID FOR "ZR-1"

BY JOHN W. KEAN

navigation, navy fleet, Washington D.C.

ENGINEERS of the Bureau of Mines have devised a new method of purifying helium which will be a great aid to the safe and economical operation of the "ZR-1," the navy's new American-built rigid dirigible.

In this new charcoal-adsorption method, as worked out by Doctor Moore, of the Bureau of Mines, impure helium is passed through a bed of coconut charcoal maintained at a temperature of approximately 312° below zero Fahrenheit. In passing through the cold charcoal, all of the impurities, which are principally oxygen and nitrogen, are adsorbed, and the helium that is drawn off from the apparatus is within .1 per cent of perfect purity.

The removal of the impurities is an interesting engineering and chemical process which is made possible by the adoption of liquid air for the refrigerating medium. If liquid air is held in an open container, it will boil quite vigorously and the vapor produced thereby is practically at the same low temperature as the liquid.

In the process as developed by the Bureau of Mines, this cold vapor is needed to cool the incoming impure helium and also to cool the coconut charcoal and its container. With the charcoal and the incoming impure helium at the temperature of liquid air, or thereabouts, the helium is caused to pass up through the charcoal bed under a pressure of about 15 pounds to the square inch, and under these conditions, the charcoal has the property of removing and holding all of the impurities and allows the pure helium to pass off through the apparatus. On warming up the charcoal cells, this adsorbed nitrogen and oxygen is driven off, and the cell is ready to be cooled down for another purification run. By means of a number of these cells, properly connected, the process is made a continuous one.

Helium in balloons or dirigibles is slowly contaminated by the diffusion of air into the envelope, and purification at intervals, depending upon the nature of the airship, is necessary as a measure of economy and also to conserve the supply.

At present the government plant at Ft. Worth, Tex., is extracting about 450,000 cubic feet of helium per month from the natural-gas wells in that vicinity, at a cost of approximately \$80 per 1,000 cubic feet. After the helium has been used for inflating a gas bag and has become mixed with oxygen and nitrogen and other impurities, it can be restored to its original condition at a cost of approximately \$1 per 1,000 cubic feet.

In constructing and preparing for the flights of the "ZR-1," the navy engineers are taking every precaution for safety. While the Bureau of Mines has been working on the helium problem, the National Advisory Committee for Aeronautics has been checking the plans for the big ship.

These precautions have been taken because it is fully realized that an accident to the "ZR-1" will be a very severe setback to further construction of this type of air

craft. Owing to the tragic accidents that have happened to the big airships purchased abroad, there is a feeling of distrust among people for this type.

The accidents to the ships purchased abroad have been due to faulty construction and the use of hydrogen as the inflating element. From the day the first draftsman put pencil to paper, the navy engineers determined that no accident would happen to the "ZR-1" from either of these causes.

The big ship is nearing completion at Lakehurst, N. J., and is expected to make its first flight early in July. It is 680 feet long—125 feet longer than the Washington monument is tall. The greatest diameter

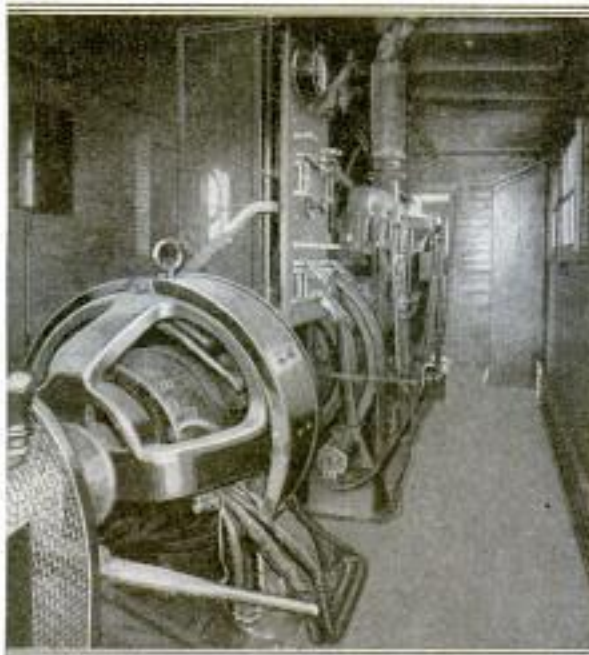

Interior of Power Car of Railroad Unit Equipped by Bureau of Mines for the Purification of Helium

Wide World Photos New York City
Underwood's Underwood, New York

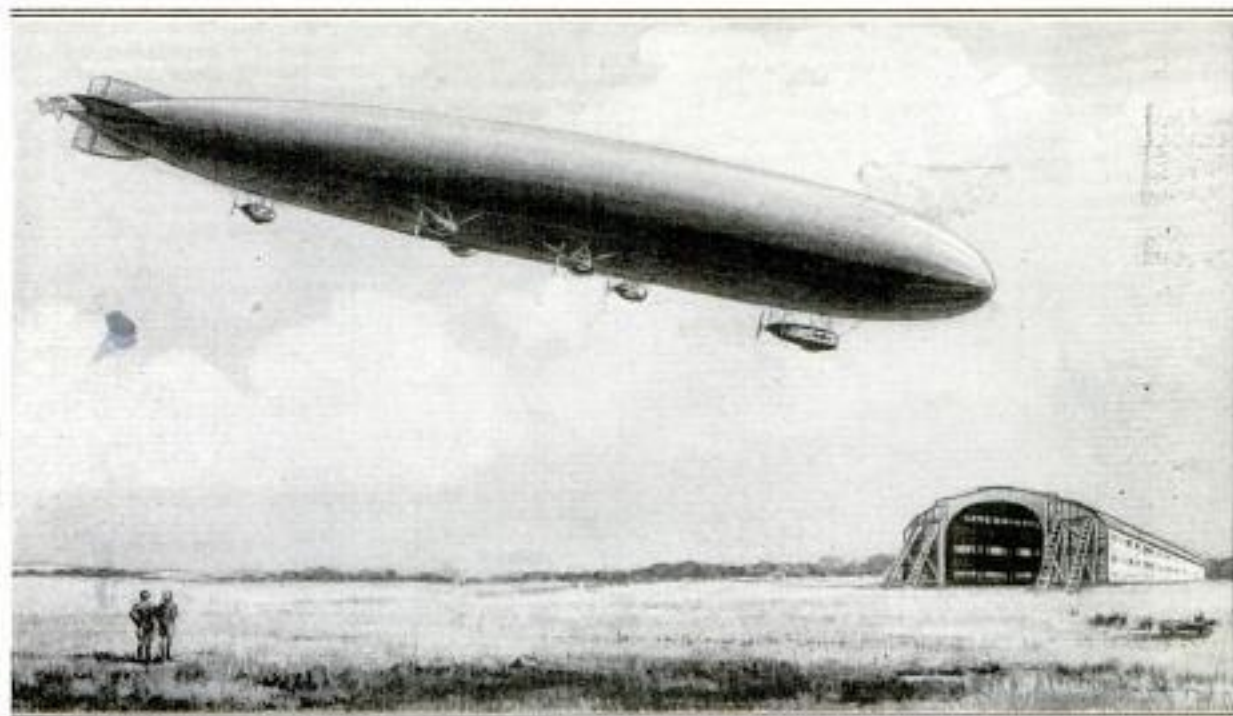

Artist's Sketch, Showing the Nearly Completed Airship "ZR-1" Making a Landing at the Naval Air Station at Lakehurst, New Jersey

is 79 feet, and the gas capacity is 2,100,000 cubic feet. This gas will be held in 20 separate gas cells or bags. A skeleton framework of an aluminum composition incloses these bags. They are lined with gold-beater's skin and, under ordinary conditions, are gas-tight. Along the keel of the ship are quarters for the crew and tanks for the water ballast and the gasoline.

Six engines of 300 horsepower each, in six separate cars swung beneath the ship, will furnish the motive power. These engines have been given continuous speed tests of eight hours' duration and are scheduled to drive the big ship at a speed of 60 miles per hour. The plans call for a continuous flight of 50 hours, which would take the ship across the United States or across the Atlantic. The "ZR-1" will be closely observed and handled with diplomacy before being called upon to make any spectacular flights.

AIR PHOTOS MADE OBLIQUELY IN CANADIAN SURVEY

In order to save time in covering the great distances of Canada, new methods of aerial photography have been adopted in making recent surveys. The photographing is done straight ahead from the nose of the machine, pictures being taken to the right, left, or to the front as desired. An advantage of this method is that it allows an area up to fifteen square miles to be shown on each picture, instead of only an area of three-quarters of a square mile as formerly. The adoption of this method followed a demand for more exact in-

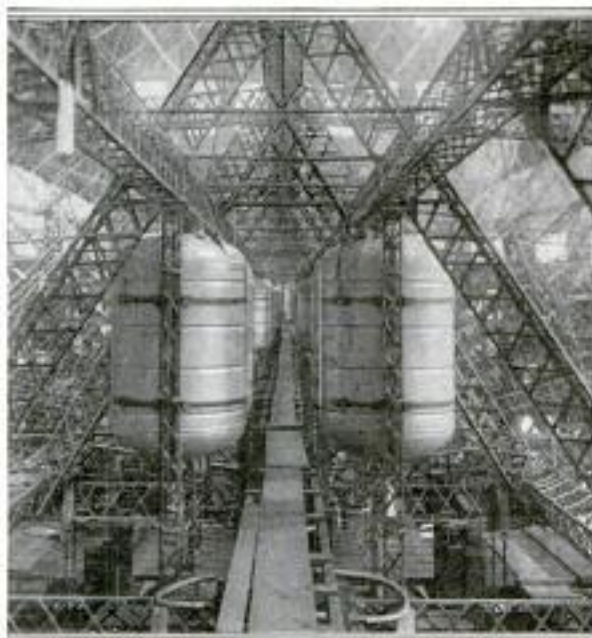

Looking through the Keel of the Partly Finished Giant Dirigible, the "ZR-1," being Built at the Lakehurst Naval Station: Note the Gasoline Tanks to the Right and Left of the Keel

formation regarding the Mackenzie River region arising since oil was discovered at Fort Norman. The work of surveying Canada has gone on slowly since the early French settlement.

**SURFACING MACHINE USES
 ABRASIVE BELTS**

Interesting features of construction are embodied in an improved type of sanding and grinding machine in-

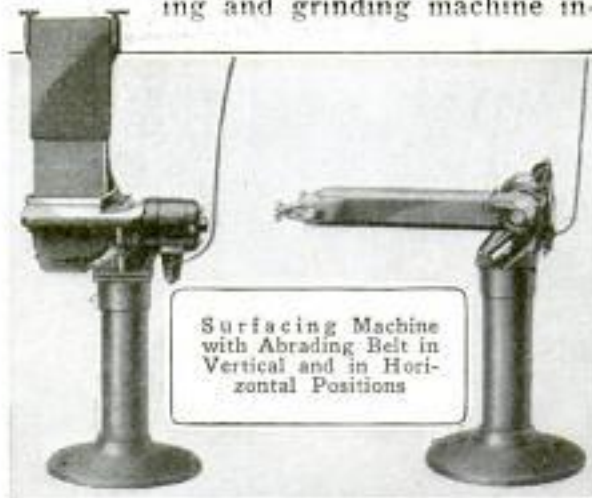

tended for small wood or metal parts. The grinding surface is an abrasive belt, easily adjustable and replaceable, which can be pivoted about its lower roller shaft and set in any position between vertical and horizontal limits. A stationary dust hood and a removable guard add to the safety of the unit. The working table, 9 by 16 inches, can be tilted up as high as 15°, and down to an angle of 45°, making it adaptable for work where faces of the material are not square with each other. The table is at a convenient height from the floor, permitting work to be handled with ease.

**FRENCH HAVE NEW SYSTEM
 OF TENNIS SCORING**

In view of the fact that the present method of scoring in the game of tennis is quite clumsy, especially in match tournaments, the French have devised a new system, the principal object of which is to end long-drawn-out contests. Instead of requiring six games to win a set, the French would have the set go to the player who first won nine games, while deuce sets—those in which neither player scores—would be done away with. Further, matches should be the best two of three instead of the best three of five sets. In this way no match could consist of more than 51 games.

Manchester Guardian 4/13/23
**BUNDLING MACHINE MAKES
 SCRAP-METAL BALES**

Circular bundles of scrap are made by a machine that has novel construction features. The scrap metal, which may consist of tangled wire, bed springs, tubing, or similar material, is wound around a revolving mandrel. As the bundle is formed, pressure is applied on its outer surface, but the full power of the machine, five horsepower, is required for only a few minutes, when the bundle is within 1 inch of the full size. Rotating disks at the ends of the mandrel absorb much of the wear that would otherwise fall on the frame. A winch is provided on the bundler, to haul the scrap from delivery wagons to the front of the machine.

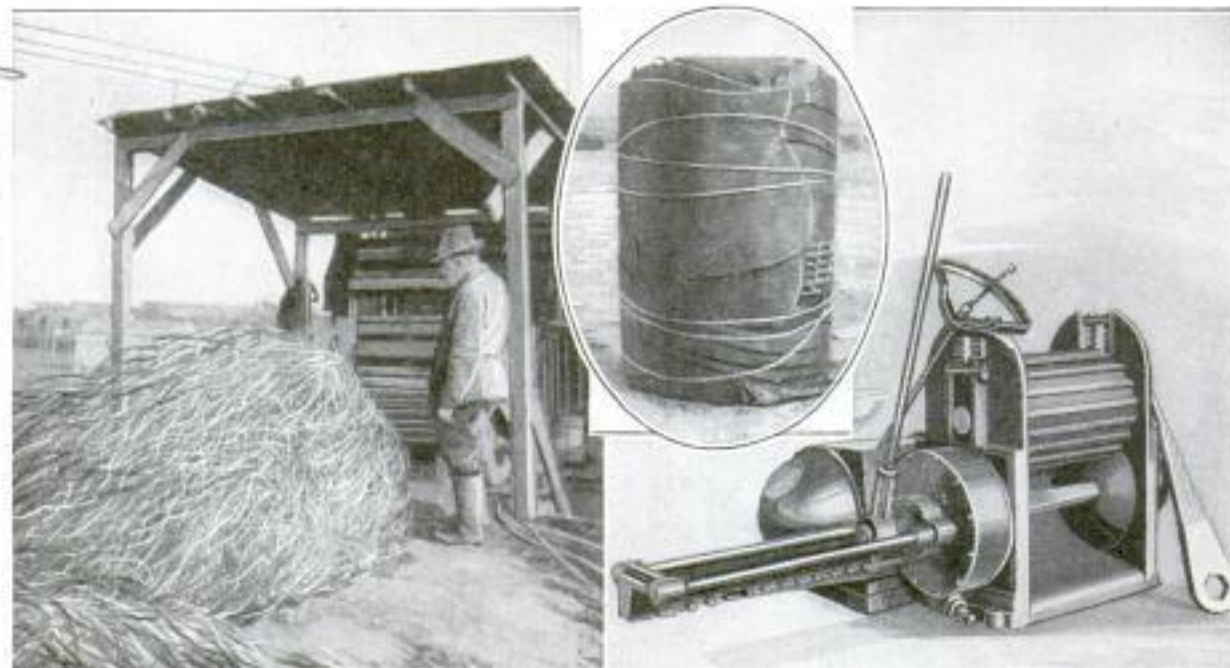

Left: A Mass of Tangled Wire being Drawn to the Machine for Bundling. Right: Close-Up of the Bundling Machine. Insert: A Bundle of Scrap after Leaving the Machine

*Samuel H. Barrett
 234 N. 13th St.
 Philadelphia, Pa.*

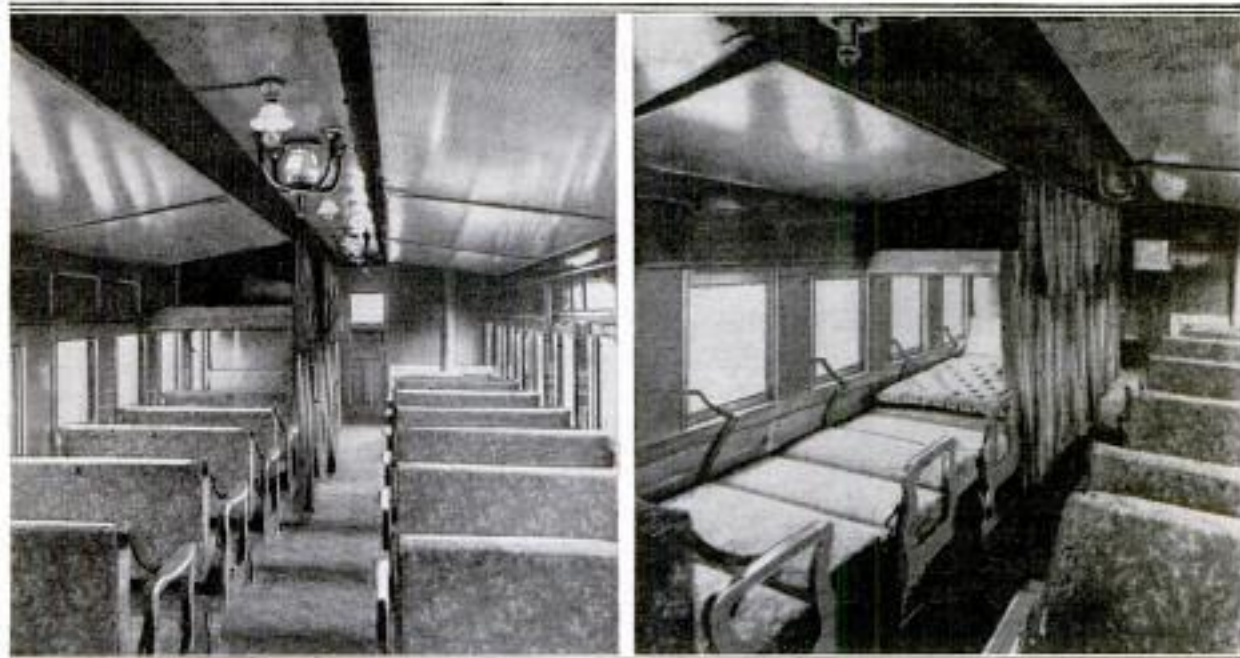

Two Views of the Interior of "Old No. 9," the First Sleeping Car: That at the Left Shows Its Daytime Guise; While at the Right It Appears with Berths Partly Made Up

FIRST "PULLMAN" CAR FEATURED IN MOVIES

In connection with an office survey of the growth of a sleeping-car concern and the great advancement made in the construction of its coaches, a moving-picture film has recently been completed. For the purpose, "Old No. 9," the original car, which made its first trip on Sept. 1, 1859, from Bloomington, Ill., to Chicago, was featured, and a story, built about the early public attitude toward the innovation, was concocted, employing the services of a number of actors. The old car carried a sign requesting passengers to "Please Remove Boots before Retiring"; seats were not cushioned; the berths were pulled down into position by means of ropes and pulleys; heat was scantily supplied by a wood-burning stove, and illumination was by candles. At night the seats and backs were adjusted so as to form one long bed, and

the sections were subdivided by curtains. A great deal of adverse comment was made at the time because of the narrowness of the aisle, which made it difficult for the women, who then wore hoop-

skirts, to negotiate its length. Similarly, the men complained because the prevalent "stove-pipe" hat was frequently knocked off by the suspended lights and the low ceiling, which latter was covered with oilcloth. The uncushioned seats were reversible. The vestibule idea not yet having been devel-



Railroad Travel in 1859 Was Not an Unmixed Blessing; Witness This Picture of the First Sleeping Car

oped, the doors at either end opened directly onto the platform. It was nevertheless termed the "Palace Car," although "Sleeping Car" was the name appearing on the outside. On its initial trip the "Old No. 9" carried only five passengers and was in charge of Conductor J. L. Barnes, who died recently.

9899

WHAT GOES UP—COMES DOWN

BY FRANCIS W. WILSON, *1416 7th St. N.W., Washington, D.C.*

IF you stood looking at a substantial brick building about 150 feet distant, and as you looked the brick walls, windows, and roof dissolved—in a split-second—into a cloud of dust and smoke which shot skyward, you would probably "register" surprise of a degree that would delight even the most exacting motion-picture director.

The building, as I first viewed it from a window of the drafting room, housed two quite substantial boilers. One of these "blew up" as I looked.

When the patter and smash of falling things had ceased, I noticed the remarkable clearness of the window glass in front of me. I put out a hand—there was no glass! The force of the explosion, acting away from the office building, had created a vacuum that sucked out every pane of glass on the side of the building I was in. Powerful as this suction must have been, I had felt no effect from it, though I stood within 3 feet of a window.

During the noon hour the bridge shop was deserted, and therefore, there was but one casualty. The fireman was alone in the power house, and not a remnant of his body could be found after the disaster.

The twin boilers had been bedded in brick masonry, and the terrain exposed to the full force of the explosion suffered a bombardment from bricks and bits of iron. Scattered about within this area were frame cottages. Fourteen bricks tore through one such house, but did not injure a woman and girl who were in it.

The oddest freak of all, from a mechanical point of view, was afforded by a piece of iron pipe which landed on an empty flat car that stood in the shop yard, half-

way between the power house and the office building. Half of its 30-inch length projected through the 4-inch-thick oak platform of the car.

The pipe landed approximately 75 feet from the site of the explosion. It might have ascended to a great height, or perhaps was projected almost horizontally. In either case it struck the car with tremendous force; otherwise it could not have cut a clean core of seasoned oak from the floor.

I measured its inclination, which proved to be about 28° from the horizontal. If it fell from a great height and struck the car at this angle, how could it punch a hole through the floor? Falling from a height, its descent would have been almost vertical, since it landed so near its starting point. In that event the result would have been to simply scoop out a dent in the floor if it landed at an angle.

If it fell with a rotary motion, the punched hole could not possibly have been neatly cut, but would have been more or less torn in the direction of the plane of rotation. If the piece of pipe were shot from the power house in an approximately horizontal direction, and with sufficient force to punch through the car floor, its trajectory would have been almost flat in the short distance traveled, and contact with the floor of the car could not have stopped its flight.

I have never arrived at a satisfactory solution of this odd problem. For a number of years I kept the core of wood which was removed from the interior of the pipe. The sheared edges were clean-cut and smooth. Fortunately nothing fell on the roof of the building in which I stood.

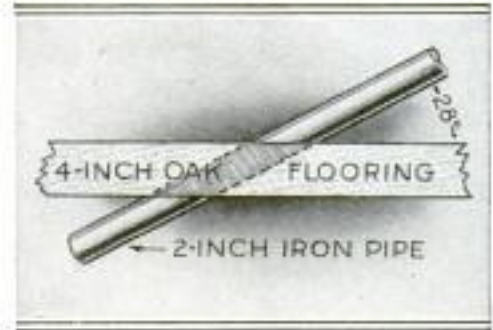

Sketch Showing How Iron Pipe Cut through Four-Inch Oak Floor of Flat Car

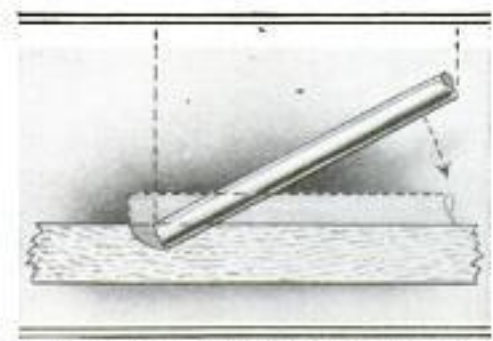

If the Pipe had Fallen Vertically, the Effect would have Been as Shown Above

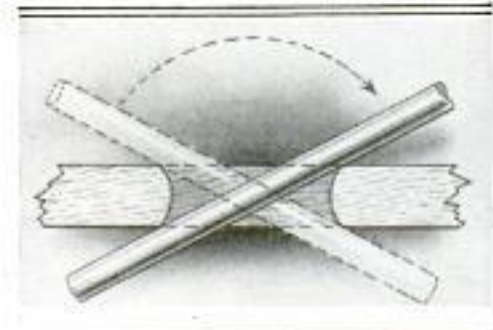

Traveling with a Rotary Motion, the Pipe would have Made a Hole Similar to This

2103

Purdue University Engineering
 Experiment Station,
 POPULAR MECHANICS
 West Lafayette, Ind.

831

STRIKING ELECTRICAL EFFECT ON HIGH-VOLTAGE LINE

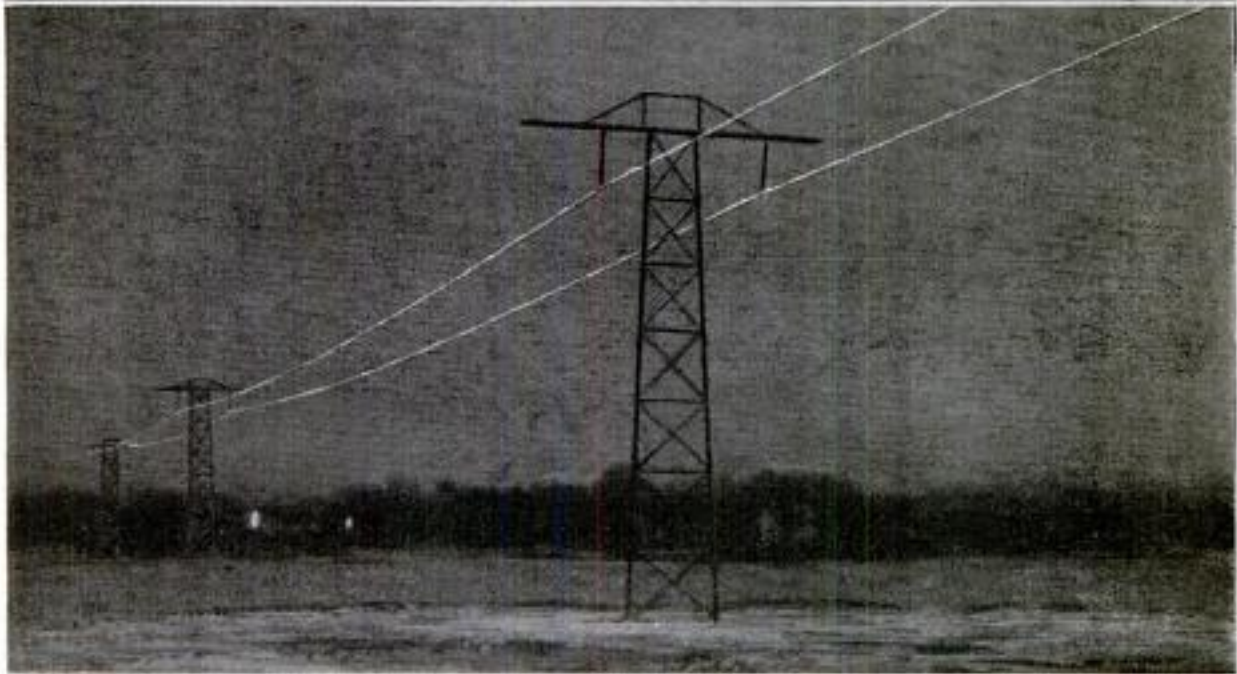

THE sleet-covered appearance of the wires in the picture is due to an electrical phenomenon known as the corona effect, which is one of the factors that work against the use of higher voltages in the transmission of electric power. The line illustrated carries 600,000 volts, and was built for studying this effect and the spacing of the conductors. It was necessary to use transformers of special design in the production of this extremely high voltage, and, similarly, insulators of special design in the construction of the line.

2/28

LEAKING SEWER WRECKS CITY STREET



A CAVE-IN of unusual proportions occurred recently in Philadelphia, letting down half a block of city street, and almost wrecking the rows of houses on either side. It was an old 14-foot brick sewer that broke down, the collapse taking place on the morning following a heavy storm. It is believed that the excessive flow of storm water increased its defective condition, so that the resulting leakage washed away large quantities of surrounding material and left the pavement slab unsupported. The noise of the cracking of the slab before it collapsed averted possible loss of life, warning, as it did, a number of boys who were playing in the street.

Cont. John J. McCarren, Jr. and
 Penn. Club, 026 Walnut St.
 Philadelphia

2053

Adm. Jesse W. Bend,
New York City

DEEP-SEA SALVAGING CAISSONS TESTED

Ship Machinery



WHILE the idea of raising sunken vessels from the floor of the sea by means of devices embodying the principle attached to—few, if any, have proved of sufficient practical value in actual operation to warrant widespread sunken ship, since divers cannot work or even live under the great pressure of such depths, and a diving bell of

Now, however, the testing out of a system, long under trial, has resulted most satisfactorily, although the recently the pontoons to reach the surface that they tore out sections of the vessel's sides— $\frac{3}{8}$ -inch plates—in their upward tractorlike machine which is supplied with air by an internal system and with electricity by means of cables from the and 12 feet high, is a steel drill. The machine is moved up to the sunken vessel and the drill applied to its sides. A on both sides, the pontoons are lowered into place. These pontoons are steel cylinders, 12 feet in diameter and 25 feet through which the air is pumped to give them their lifting power. They are braced inside the "bell." At the bottom through the valve into the caisson by the mother ship, which results in such an upward pull that only eight were Island Sound—had the plates held. The left-hand part of the picture shows the artist's conception of the action of the into the air under its impetus. On the right appears the tractorlike diving bell, the chains by which it is lowered to

Reno Marine Salvage Corp. 2053
261 Broadway

SUCCESSFULLY ON SUNKEN "EAGLE" BOAT

New York City -

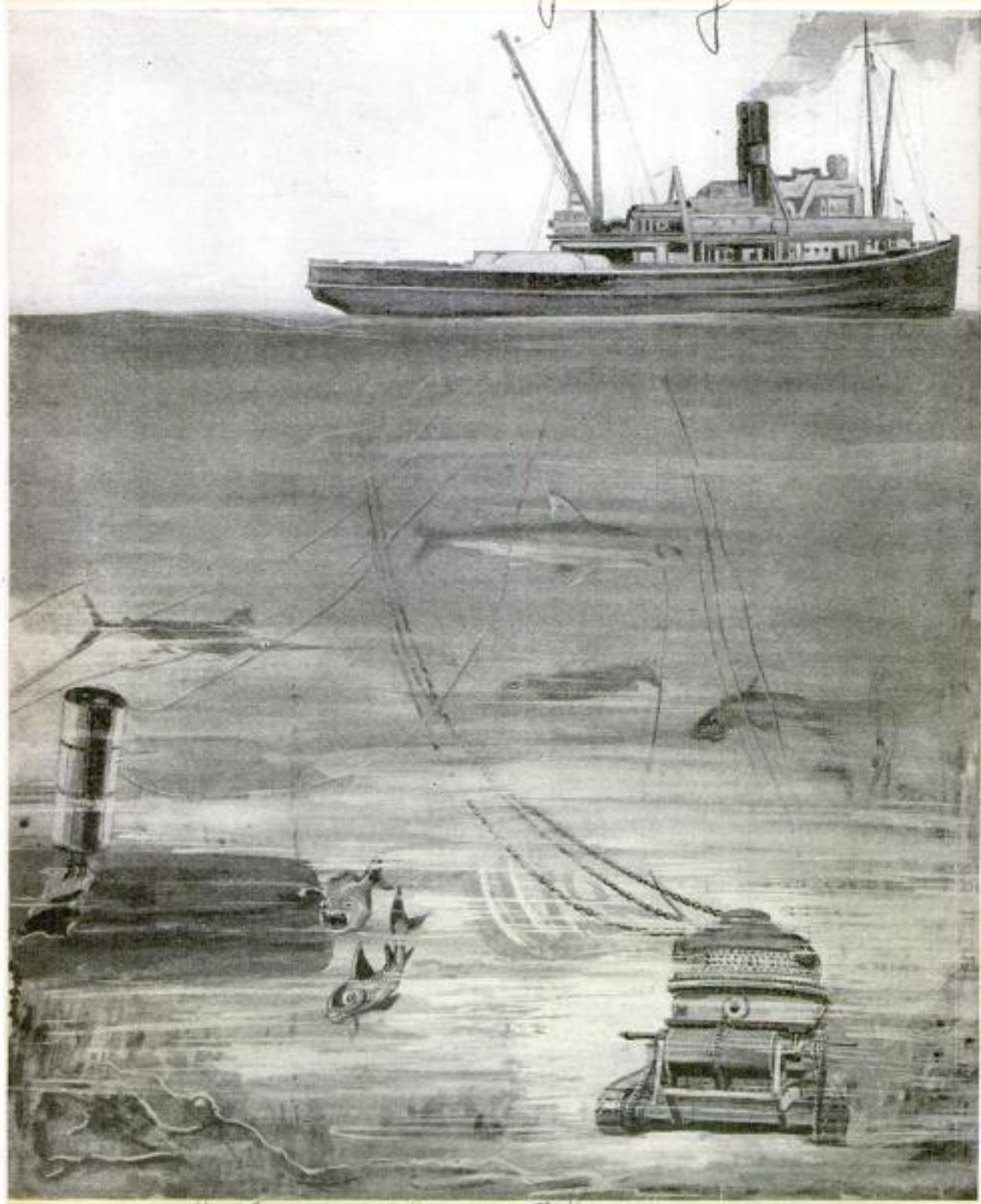

Internaval

of a balloon—a chamber filled with air, which, of course, tends to rise to the surface, pulling with it whatever it is adopted by salvagers. One of the principal troubles has been the inability to attach the apparatus to the hull of the sufficient strength could not be readily handled. This situation was brought about by the fact that so eager were surge. The difficulty in regard to pressure at the sea floor is overcome in this system by an electrically operated mother ship. Projecting from the tractor, which is operated by and carries three men in a caisson, 7 feet in diameter series of holes are bored in pairs through the plating of the ship. When a sufficient number of holes have been bored long. The cylinders are open at the lower end, while the upper end is fitted with a heavy cap carrying an air valve, are hooks attached by chains. These hooks are inserted in the holes in the boat's side. The air is then pumped used in the recent test, fully demonstrating their ability to lift the 300-ton vessel—an "Eagle" boat sunk in Long pontoons used in the test, as they tore sections of the vessel's sides loose and rushed to the surface, one leaping 25 feet the ocean floor and later raised to the mother ship's deck being seen extending upward from the top of the cylinder.

material

Railway Age 3/3/23
Pullman Company
834

H. Isoat Co. Inc
Brooklyn, N.Y.
POPULAR MECHANICS

PERMANENT HEADBOARDS AID SLEEPING-CAR PRIVACY

Seeking to increase the privacy of sleeping-car passengers during the day,

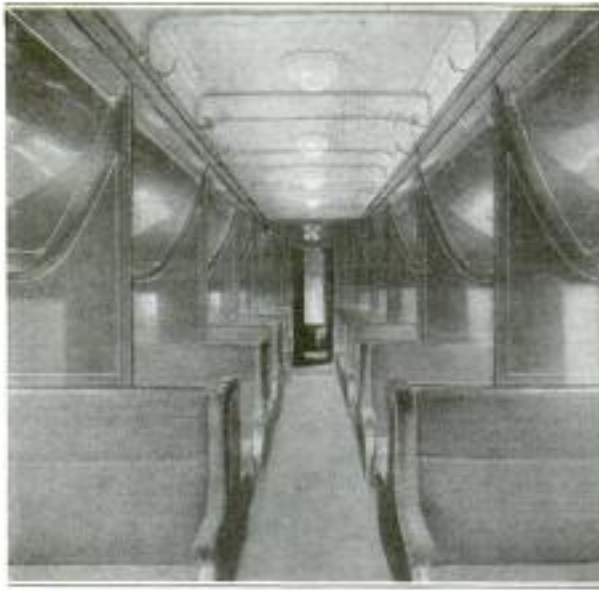

New Headboards as Installed in a Sleeping Car: At Night a Removable Half Headboard is Added

experiments are being conducted with permanent headboards erected on the principle of a rigid partition between the seats. The innovation, already installed on nearly 100 standard cars, has the further advantage of permitting the occupant of one section freely to control ventilation at his seat without causing drafts to blow on other passengers.

HIGH-VACUUM AND PRESSURE PUMP COMBINED

A small pump of unusually neat design provides, with one rotor and a single casing, high-vacuum and pressure service such as is required in surgical

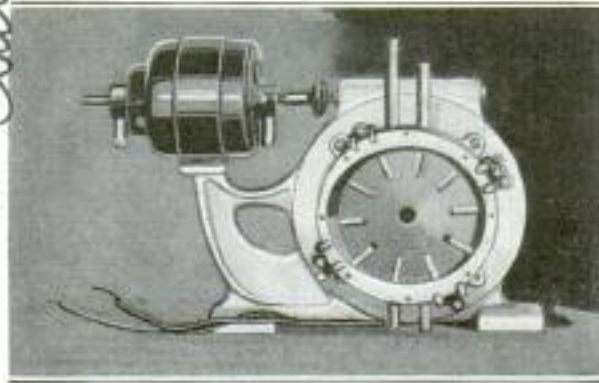

View of Compact Pump, Exposing the Rotor That Creates High Vacuum and Pressure at the Same Time

work. The circular rotor turns in an oval chamber, leaving a space on either side. In one of the spaces vacuum is created, and in the other, pressure developed. Brass plates, fitted with wedges that automatically compensate for wear, are set into radial slots in the rotor in such a manner that, under centrifugal action, a tight joint is maintained with the casing when the pump is running. The pump forms a unit with the motor, by which it is driven through a gear.

MACHINE ROUTS ELECTROTYPE PLATES THREE AT A TIME

A machine has been developed that routs out the dead metal from three electrotypes plates simultaneously. Its use is in preparing curved plates for rotary printing presses. The machine is equipped with three drums on which are mounted the plates, which must be exactly alike, and which are movable up or down and from side to side under the control of the operator. The operator guides the movement of the center one of three power-

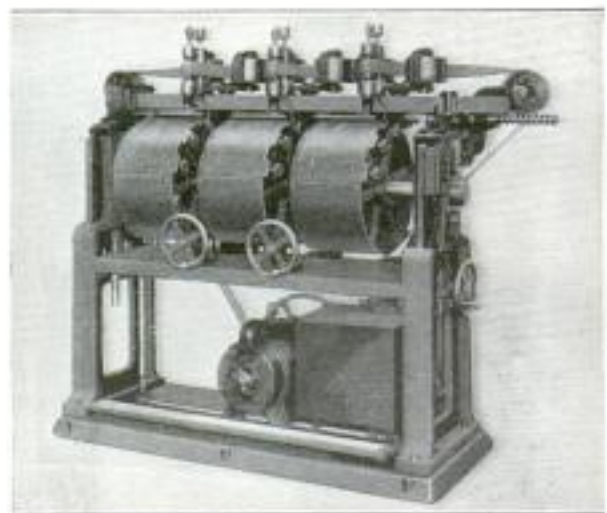

Machine Which Removes the Dead Metal from Three Curved Electrotypes Plates at Once

driven routing tools, which are mounted on spindles in such a way that the work is duplicated on the two other plates.

Engineers have disclosed, through surveys of mechanical processes in industry, that lighting is the principal source of fatigue among workers. To the influence of bad lighting these engineers lay a loss of 20 cents a day for each worker, figuring this sum as the cost of lower efficiency. This would mean a loss of about \$2,500,000,000 a year in the United States.

Friend Electric Co
625 W. Jackson Blvd. 2050
Chicago

1924 Architects. H. W. + E. B. Clarke,
Omaha, Nebr.



The Artist has Copied the Interior of Omaha's New High School in the Room Devoted to Manual Training and has Shown How a Complete Bungalow Built by the Pupils may be Moved Out of the Building to be Disposed of as a Home

PUPILS BUILD BUNGALOW WITHIN SCHOOL

IN the new Technical High School at Omaha, Neb., the pupils will be given the unique experience of building a complete bungalow, "life-sized" and ready for occupancy, the entire construction taking place within the high-school building itself. The task will be undertaken as much to demonstrate the high-grade equipment of the school as to teach the young carpenters their work.

Doors large enough to permit the pupils' structure to be moved out of the building on rollers and disposed of for a real home have been provided. Those who are authorities on the teaching of children declare that this method of instructing them arouses their interest a hundredfold as compared with that they display in building miniature houses and other articles.

The school is planned throughout on this life-sized idea. In the automobile department, a 3-ton crane has been installed to enable the students to work on real automobiles. In these shops all the tools used by mechanics in garages, and many of the new inventions, are available, so that the pupil will in reality have a thorough grounding in these trades when he finishes the course.

Other features of the building include classes in salesmanship, where all the working parts of a department store are in use, even to the cash-carrier system of overhead wires and cages.

In the auditorium, which will seat 2,000 persons, an arrangement of the moving-picture machine and screen has been made whereby there will be no distortion of the pictures shown. A cafeteria, a kitchen, an orchestra room for concerts, a library—in short nearly everything found in the lives of grown-ups—is provided in this remarkable institution.

2040 **DIAPHRAGMLESS TRANSMITTER
 IMPROVES BROADCASTING**

A new transmitter for radio makes possible the broadcasting of music and other sounds with more of the original purity.

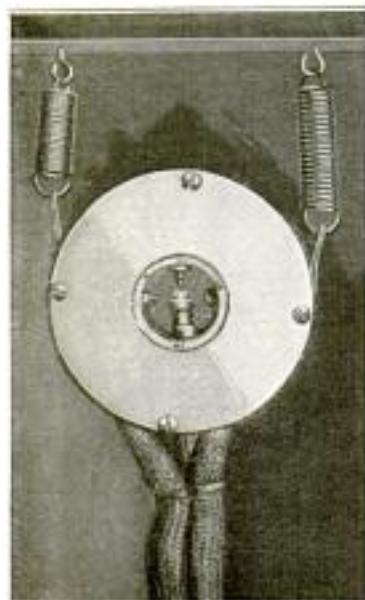

This clearness is attained by eliminating the diaphragm, which, because of its inertia, is incapable of vibrating in sympathy with all parts of the range of audible sounds. In the new transmitter the mechanical disk is replaced by a minute electrical discharge which flows between two points, separated by a very small air gap. This discharge is affected by sound waves, but, having no perceptible inertia, it responds equally well to all vibrations, whether they are caused by high or low notes. The device is about the size of a large watch, and when in operation, a point of light can be seen, caused by the flow of electric energy against one of the terminals.

2153 **PORTABLE BAND SAW CUTS
 WOOD AND METALS**

A small portable band saw has recently appeared on the market that will accommodate itself to the cutting of almost every kind of material by a quick change of blades. A change of speed is provided for cutting hard metals like iron and steel. The table, which tilts up to an angle of 45°, is mounted on a quick-acting saddle. It is designed for use on benches like those found in pattern and model shops, tool rooms, and trade schools.

2055 **AUTOMOBILE AIDS SINKING
 OF MINE SHAFT**

An interesting example of the marked contrast between the methods of modern prospectors and those of a generation or even a decade ago, is found in the work of a contractor who recently agreed to sink a mine shaft for a western syndicate at Goldtown, Calif., then the scene of a gold rush. Finding the delivery of the mining equipment he had ordered delayed, the contractor decided to use his automobile engine to aid in the work. Hitching a cable, which passed over a block and tackle, to the front of his car, he found it was easy to haul up the buckets of material from the shaft. The car faced the shaft and backed away from it in pulling up the containers, which weighed, each, 400 pounds. A smooth path was thus worn in the desert sand.



This View Illustrates the Resourcefulness of a Western Contractor, Who Used His Car for Hoisting Bucket Loads of Gold Out of a Shaft. The Method was Adopted After a Hand Windlass had been Tried and Found Wanting

Dir. Mr. Carl Sawyer,
 Goldtown, Calif.

698 Data missing

QUEER TREES OF THE ISLAND CONTINENT

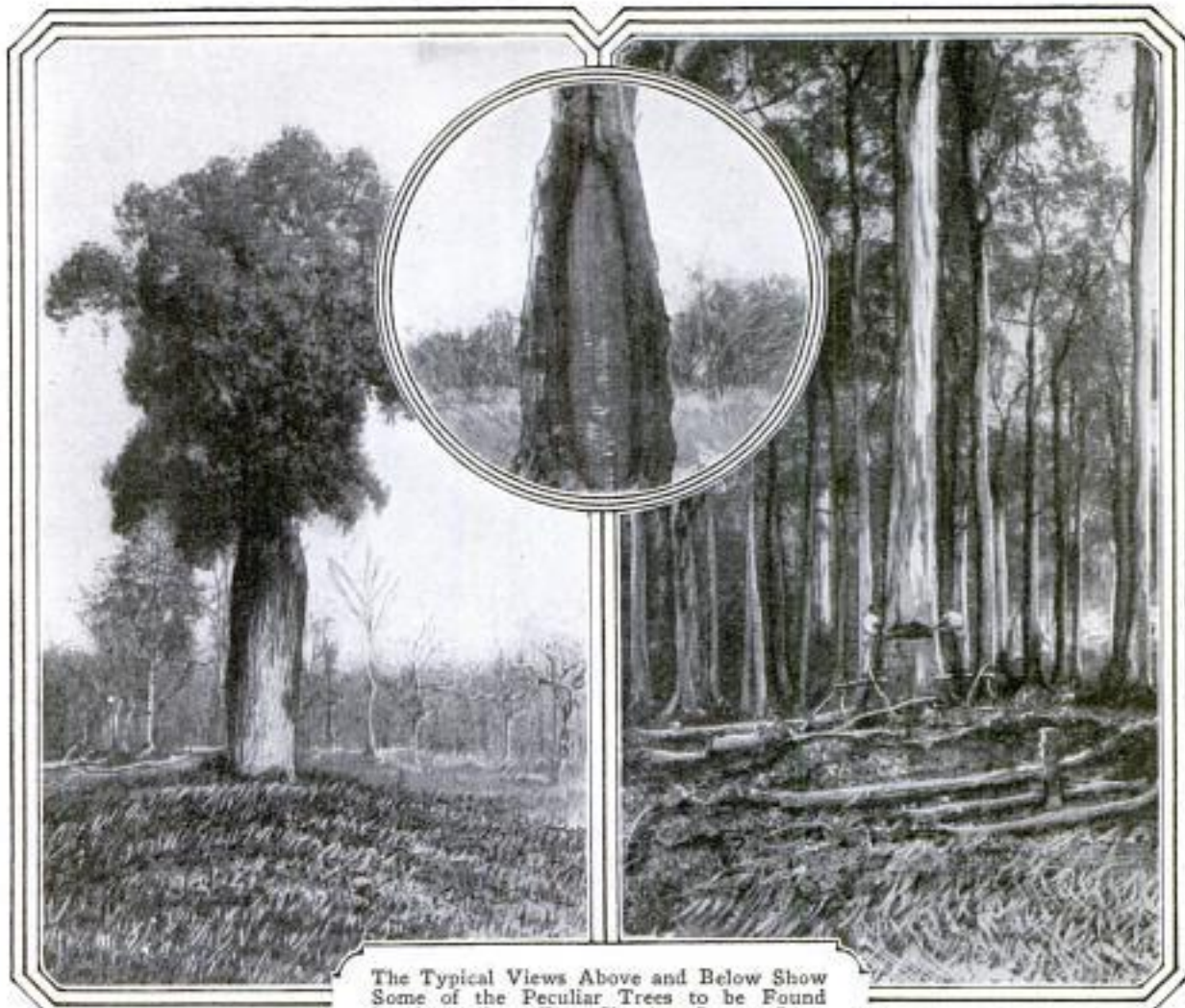

The Bottle Tree of Australia: It Is Not of Great Height, but of Very Wide Girth

The Typical Views Above and Below Show Some of the Peculiar Trees to be Found in Australia. The Circular Insert Is a View of the So-Called "Canoe" Tree, from Which the "Blackfellows" Cut Bark for Canoes. The Eucalyptus, Found in Great Numbers and Varieties, Is an Evergreen, Shedding Its Bark Instead of Its Leaves. The Grove Below Indicates the Naked Appearance of the Trunks. Note the Contrast between These Trees and the Tall Species in the Upper Right View

The "Timber Getters," Cutting Down One of the Tall Species of the Eucalyptus Family

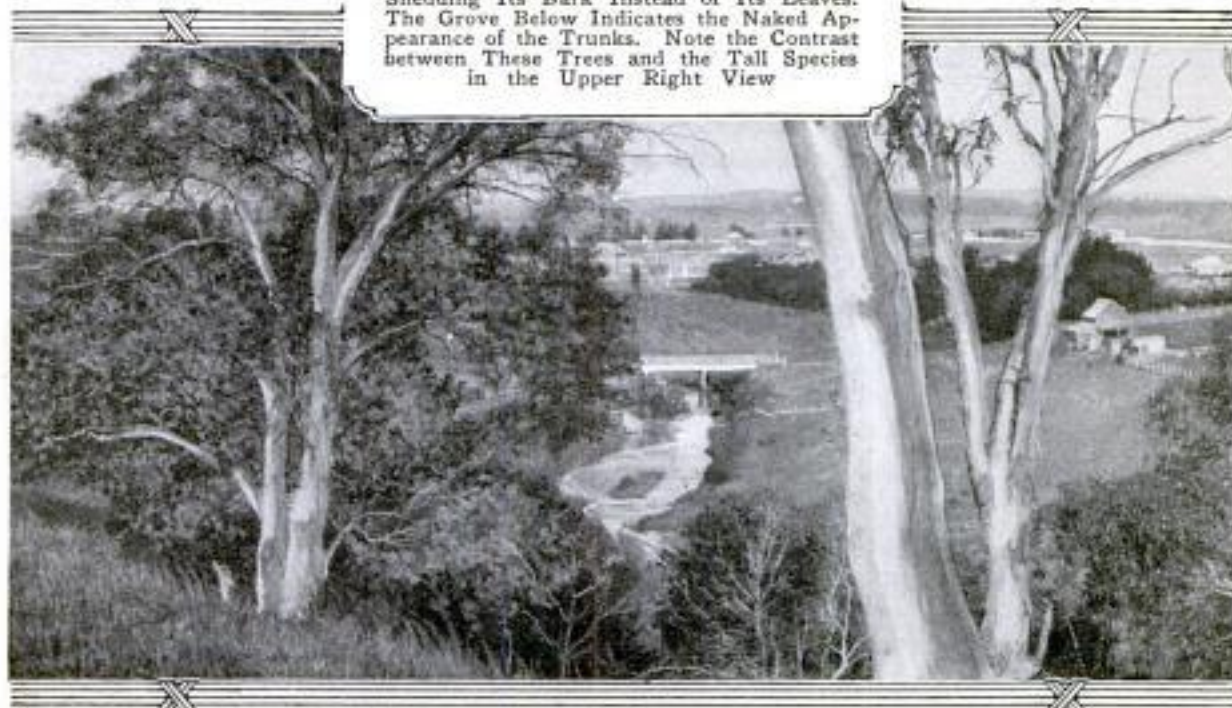

London Electrotype Agency, 1 St. Bride's
Ave. Fleet St, London, E.C. 4
England

838

POPULAR MECHANICS

2057 The Sphere

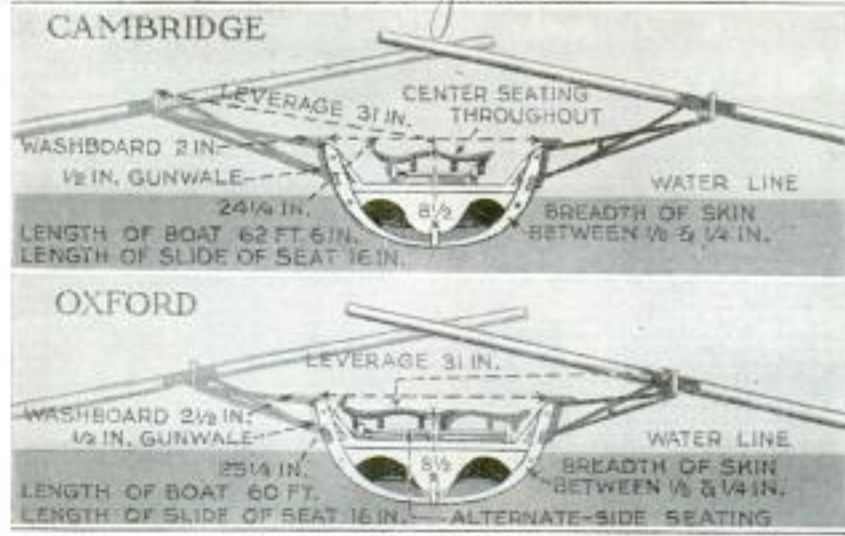

OXFORD RACING CREW MAY HAVE NEW BOAT MODEL

A new racing boat is being considered by the Oxford University rowing officials, which may supplant the design hitherto used. One of the changes considered is a greater freeboard, since it is thought the present model ships too much water. A radical change, however, is the proposal to arrange the four center seats alternately right and left, instead of in the middle.

A Comparison of the Principal Dimensions of the Oxford and Cambridge Shells: The Lower One, Oxford's, Has Alternate-Side Seating

2119
 Manchester Guardian Commercial 3/22/23
 2062
 Cmd Harold T. Blanchard
 Luchahoe, N.Y.

CHAIN OF GIANT RESERVOIRS URGED FOR RIVER SEINE

New plans are continually being made looking toward the control of the Seine in time of flood, when the rise of the waters endangers the communities along its banks, including the city of Paris. Among the latest of these is a scheme calling for the erection of 23 huge reservoirs along the banks of the river which would have a combined capacity of near-

ly 70,000,000,000 cubic feet, and it is estimated that, even should the Seine rise almost to its record flood height, the reservoirs would serve to reduce such a rise by one-half. They would also be able to hold a reserve supply of water during the dry season when the lowering of the Seine hinders shipping. Another use would be in irrigation, and by building power stations at the entrance to the reservoirs, 300,000 horsepower could be developed, it is believed.

PRECAST TILES MAKE FOR ECONOMICAL BUILDING

A new way has been found to reduce still further the cost of building construc-

tion in Berlin. L-shaped tiles are used to form hollow walls, the long legs of the



The German Method of Casting Building Blocks: Note the Economy of Placing the Forms So That the Blocks Have a Common Wall between Them

L-shaped tiles are used to form hollow walls, the long legs of the "L's" forming the wall faces, while the short legs act as distance spacers between the walls. The tiles are precast in steel forms, about 30 at a time, so that the exterior faces of each form are also the interior faces of the next adjoining one. Suitably placed lugs on each form lock with those of its neighbor, providing even spacing, preventing any shifting of the individual forms with respect to each other, and so preserving uniformity in the blocks. The blocks, of course, may be surface-treated for smoother appearance.

2091. Photo Electric Bean Separator
 Co., Ithaca, Mich.
WONDERFUL SELENIUM "EYE"

Sorts Bad Beans from Good with More than Human Accuracy

BY R. C. FOLGER

A CHAIN of 10 strands connecting the earth and the moon could be made if all the beans grown in the United States in a single year were placed end to end. Imagine having to pick out every tenth or twentieth bean from such strings! Something quite similar occurs in the sorting of beans, for the bad ones have to be picked out before marketing the product.

Owing to the high prices they have brought in recent years, beans are no longer regarded as a cheap food. One of the reasons for this is the primitive method still used for sorting beans. Rows of women seated in front of conveyors pick out the bad beans, casting the "culls," as the bad ones are called, into a box which is weighed at the end of the day to determine the pay of the women. Unfortunately, many causes beyond the control of the grower affect the quality of a bean crop; bad weather and blights often result in a high percentage of culls in every bushel.

In Michigan there was a young farmer who yearly faced this situation with a questioning mind; science had aided in finding cheaper methods for industry and for other agricultural processes; why could it not help in the sorting of beans? One year he reaped an exceptionally poor crop, the culling of which consumed about half the money he would have received

had the beans been good. He thereupon determined to build a machine that would sort beans at low cost at all times, and, even in the event of a low-grade crop, leave the grower a fair profit.

Without scientific training, Ray F. McWilliams, the farmer-inventor of this bean sorter, began casting about for something that would detect the difference between a good bean and a bad one, the latter being darker in color either wholly or in spots. He learned that a mineral (selenium) was sensitive to

changes in light reflected upon it, resulting in a similar variation in its electrical conductivity. Obtaining a selenium cell, he made experiments to learn whether he could use it for the machine he had in mind. The cell and others he later obtained, lacked the necessary sensitiveness and was too slow in reacting to light changes. Undaunted, he proceeded, with the limited resources at his command, to unravel for himself the secrets in the construction of a selenium cell, and, thanks to an accidental discovery, the end of a year found him with a cell he could use for his purpose. The new cell could detect the slightest change in color and was quick to respond to these changes. For seven years longer he worked in the development of the machine which today picks

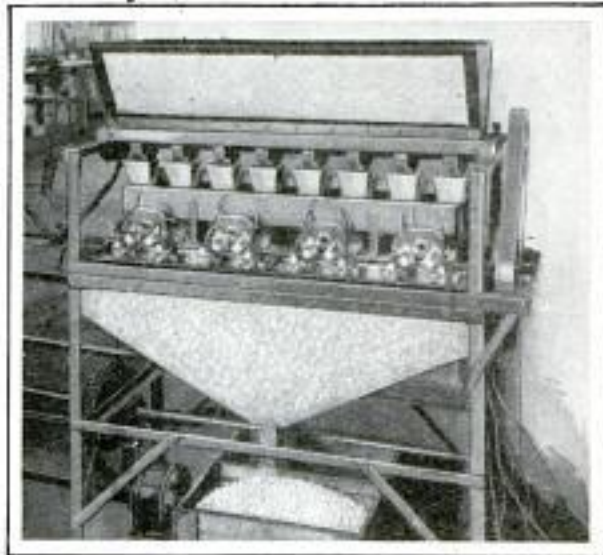

This Machine, Which is Easily Moved About by Two Men, Sorts 15 Bushels of Beans an Hour

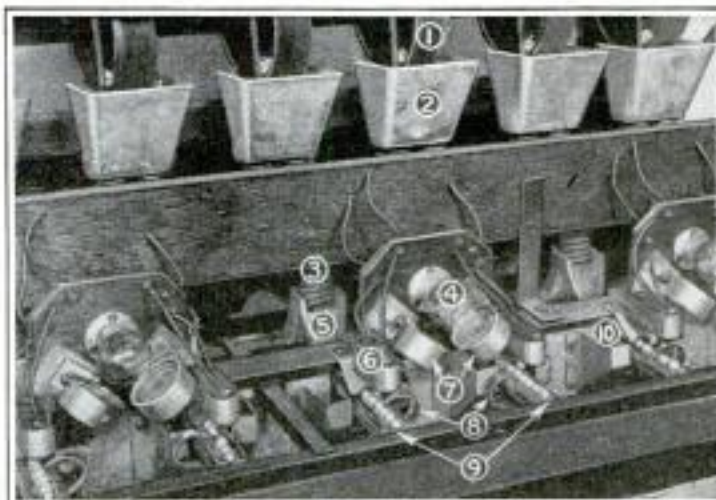

In This Close-Up, Number 1 Is Feed Roller; 2, a Small Hopper; 3, End of Flexible Spout; 4, Electric Light; 5, Hopper with Hinged Flap; 6, Selenium Cell; 7, Double Lenses; 8, Picker Fingers; 9, Small Rollers, and 10, Guides along Rollers

Mr. Williams, Ithaca, Mich.
 Ray F. McWilliams
 Ithaca, Mich.

out the bad beans from among the good ones with more than human precision.

The beans are placed in a trough at the top of the machine from which they are fed by small wheels through a series of hoppers until they pass out in single file along a pair of horizontal feed rollers.

A selenium cell is placed over each pair of rollers, and is so inclosed that it receives light only through a tube, the lower end of which is directly over the moving string of beans.

As the beans pass under the tube each one receives a flood of light from an electric bulb, which is focused on it through a double lens. When a discolored bean comes into range the selenium cell reacts to the change in color, causing a magnet to close, thus raising a finger which pushes the bad bean from the rollers, while the good beans pass on into a bin and are then ready for market.

The selenium cell is electrically connected with a pair of ordinary dry-cell batteries so as to form a circuit which

operates the electromagnet. Hinged to a support alongside the magnet is the finger, one end of which extends over the magnet, while the other curves around and over the rollers in such a manner that

its end is opposite the lower end of the tube. When a bad bean appears, the selenium cell instantly "sees" its darker color as contrasted with that of the good, white beans. It immediately sets up a greater resistance to the electrical current passing through it. This causes the magnet to act, drawing down one end of the metal finger, so that the other end is raised. In being raised, the finger pushes the bad bean off the

rollers, and it drops into a bin. The instant this is done, the change in light as seen by the selenium eye releases the magnet's hold on the finger, which returns to its first position. The good beans continue on their way down the rollers, dropping into another bin.

The machine is about 5 feet in height and length and is light enough to be easily moved by two persons of ordinary



Close-Up of Two Units of the Bean-Sorting Machine: Note the Bad Bean Picked Out by the Unit at the Left.

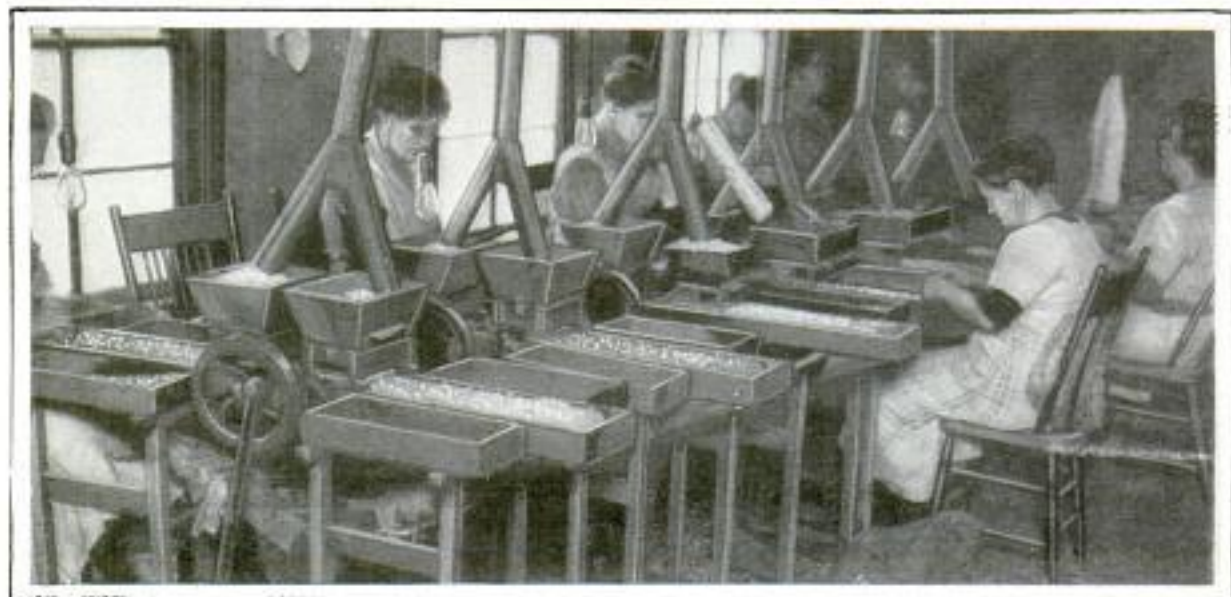

This Illustrates the Long-Practiced Method of Sorting Beans. Each Woman Operates a Treadle That Controls the Movement of a Small Belt Carrying a Stream of Beans toward Her; the "Culls" are Picked Out by Hand and Deposited in a Box alongside the Belt.

Chicago Tribune
4/18/23 P.1.

strength. Each machine is equipped with 16 cell units, which provide for a total sorting capacity of 15 bushels of beans an hour, or equal to the average work done by a dozen persons sorting by hand. The machine is driven by a 1/4-horsepower motor, and the operating cost would probably be less than the wages of one man who alone could tend a number of such machines. Another advantage of the machine is that its capacity for unsorted beans would not be affected by

2167

"WALL" OF WATER ROCKS OCEAN VESSEL

Towering 70 feet, a "wall" of water believed to have been set in motion by a submarine disturbance, nearly proved disastrous to the Pacific liner "Brush," 50 miles off the coast of Mexico recently. The captain of the ship described the approach of the strange freak of nature as an unbroken black line near the horizon when first observed by the lookout. When its nature was discerned, the ship was made ready for the onrush of water. When the wall hit the "Brush," the captain declared it was as if a huge hand had clasped the vessel and raised it into the air. There was not a breath of wind, but for six hours after the occurrence, the log of the ship shows, the "Brush" labored in swells equal to those off Cape Horn and was driven miles off its course.

2008

LAZY TONGS LIFT VALVE SPRINGS EASILY

The difficulty of lifting valve springs of an automobile engine to permit re-



moval of retaining pins, is greatly lessened by means of a set of lazy tongs recently devised for the purpose. Extending the tongs closes the jaws. These latter are then inserted under the valve. Pushing the tongs shut has the effect of opening the jaws, thereby lifting the valve. A suitable handle gives a firm grip to the user.

Inv. Joseph E. Wainwright
Brooklyn, N.Y.

how many bad ones were in the lot, whereas, in hand sorting, the more bad beans there are in a bushel, the longer it takes to sort them.

Grading of coffee beans as well as sorting the ordinary varieties of food beans can be done by the machine. It has also sorted olives according to the colors of green, red, and dark purple. Undoubtedly additional uses could be found for the machine in many other fields.

2037

LEANING PINE OF ROME LEANS MORE THAN TOWER OF PISA

There is a leaning pine tree on one of the golf links near Rome, Italy, which, unlike its famous contemporary, the lean-



The Unusual Direction of Growth Taken by This Pine Tree Adds a Queer Touch to the Landscape

ing tower of Pisa, requires a man-made support. Its curious growth has prompted much interest. To preserve its cool shade, much desired by picnickers, the municipal authorities have constructed a brick pedestal, cradled at the top to receive the curved trunk and support it.

Wide World Photos

Tests of samples of alluvial deposits in Pumpsaint, Wales, having shown a high percentage of free gold, it has been proposed that the deposits be worked by dredging.

Dr. W. C. Stacey,
Dallas,
Texas.

Manchester Guardian
4/13/23

812

POPULAR MECHANICS

1983

NEW COTTON GIN USES TWO SETS OF SAWS

By using two sets of gin saws instead of one, a Texas inventor claims to have doubled the capacity of a cotton gin. In spite of this

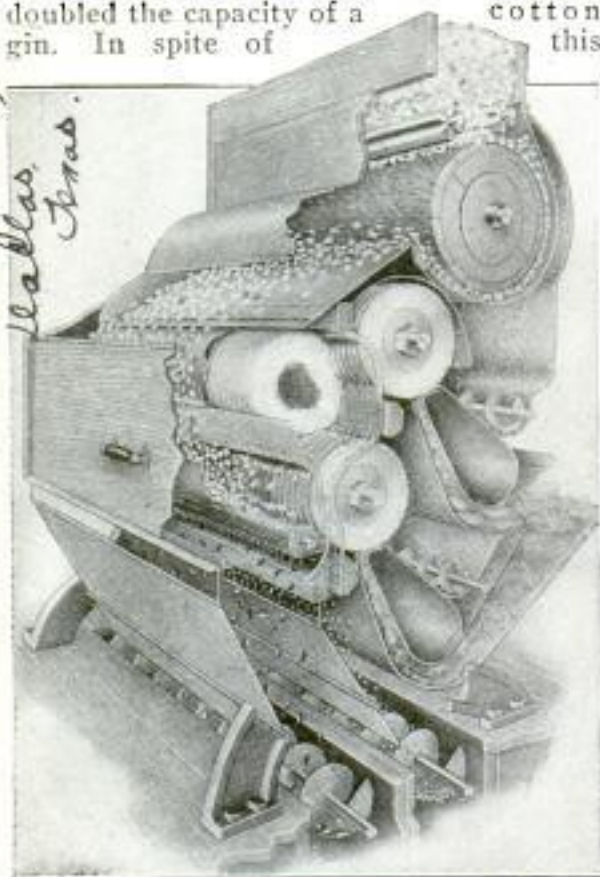

Cotton Gin with Two Sets of Saws, Which is Claimed to Give Double Capacity

greater usefulness, only 20 per cent more power is needed to run the machine. A feature of the invention is that the upper set of saws revolves 100 or more revolutions faster a minute than the lower, thereby relieving the latter of some work and enabling the handling of the longest staple cotton. Hitherto, the long-fibered cotton has been run through rollers instead of saws.

BUILD FRENCH OCEAN LINER ON NEW POWER PLAN

2/68

Both as a means of saving valuable space and considerable fuel, the new French liner "De Grasse" is to be powered by a combination of electric motors and Diesel engines, the former to be driven by the latter. There are quite a number of electric ships afloat whose current is generated by means of steam turbines, but the present case is said to be the first in which so large a ship—it will be an 18,000-ton vessel—will use Diesel engines in this manner.

Space saving will be had in that it will not be necessary to build a huge tunnel from amidships to the stern to house the propeller. The generators will be placed where convenient, and the current conveyed to the motors at the ends of shafts as short as can be practically contrived. It is a well-known fact that Diesel engines are less costly in upkeep than steam turbines.

GAS-BURNING NOZZLE AVOIDS FLASH-BACK

A new nozzle of simple design is reported to have overcome the difficulties of the flame being blown out, owing to the velocity of the outrush of air and gas being greater than that of the flame propagation. This condition is often encountered when an attempt is made to burn a premixed combination of gas and air. Around the main orifice of the new nozzle is an annular casing communicating with the main orifice by means of four small holes through which passes a small quantity of the gaseous mixture. With reduced velocity inside the casing, the small quantity of gas forms a circle of

quietly burning flame surrounding the main orifice, which is thereby heated suf-

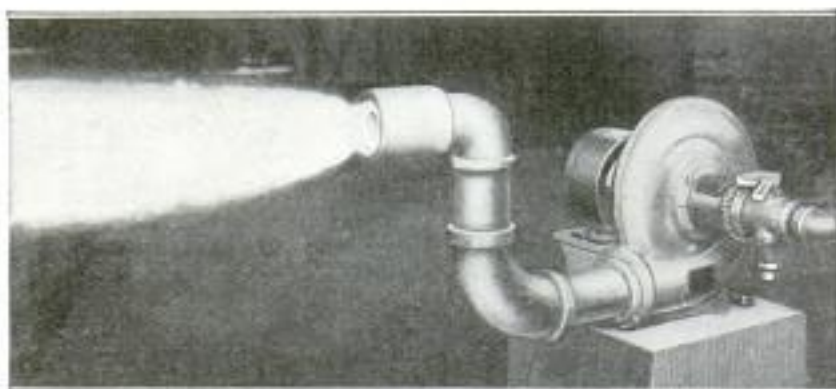

The Gas-Burning Nozzle, Here Seen in Action, Overcomes the Danger of Flash-Back and of the Flame being Blown Out

ficiently to insure ignition and complete combustion of the mixture passing through it.

S. P. Smith, c/o Maxon Furnace & Engineering Co., Muncie, Ind.

Maxon Furnace & Engineering Co., c/o Austin E. Burgess, 571 S. Marlborough St., Muncie, Ind.

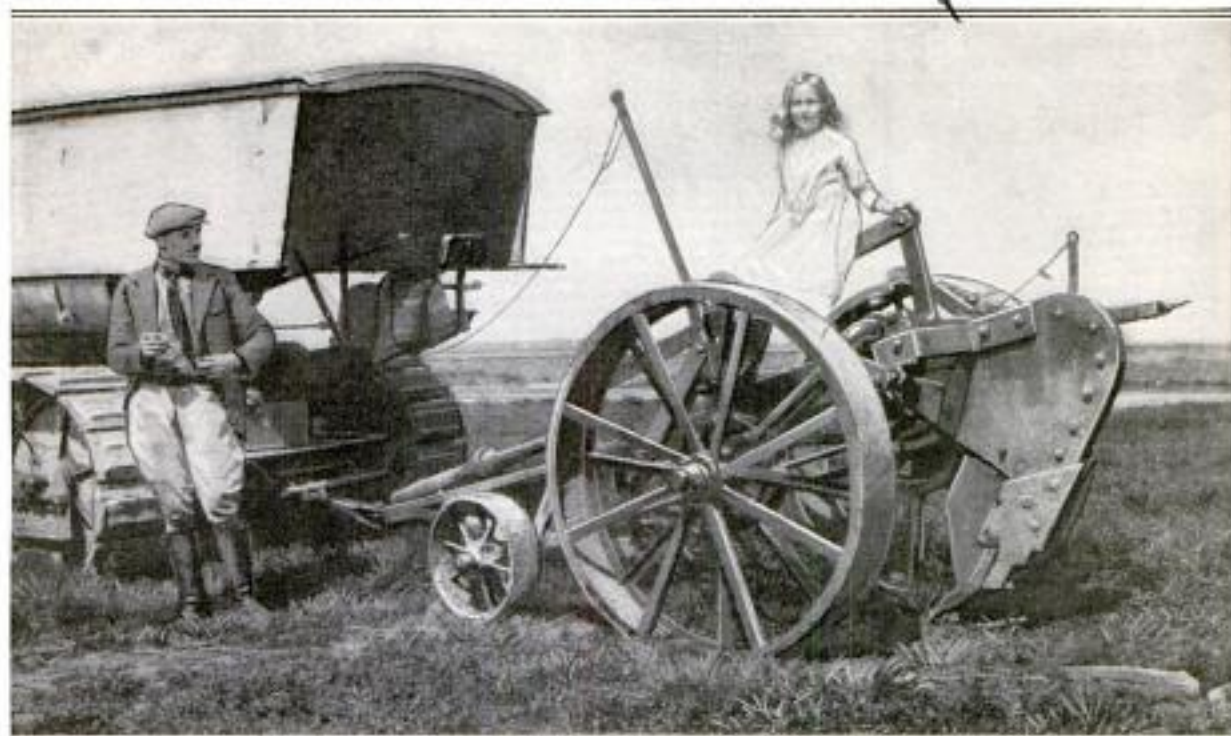

Powerful Subsoiler with Solid Billet of Annealed Steel Used for the Shank: Compare the Size of the Simple Parts of This Machine with the Girl in the Picture

SUBSOIL TILLAGE INCREASES IN CALIFORNIA

THE need of breaking up the hard soil that exists just below the soft top earth practically throughout California has led to the development of a number of powerful machines in recent years. Few farming implements have to be designed to withstand the tremendous strains that result from the resistance offered by this stubborn subsoil.

The hardpan, as this lower stratum is called, is of two kinds—natural and artificial. The former may be found at the surface or many feet below the surface, and it varies from a few inches to many feet in thickness. The artificial hardpan is the result of the farmers plowing to the same depth year after year and is appropriately called "plow sole." The danger lying in this condition is that the rain, soaking through the soft upper earth crust, drains away from the fields when it strikes the hardpan and plow sole, which it cannot soak into. Since, in California, it rains but three months out of the year, the moisture must be saved

for the remaining nine months of the growing season; thus, hardpan and plow sole, which force the rain water to drain off, must be broken up.

Deep tillage consists of two operations: chiseling and subsoiling. The former goes to a depth of from 6 to 15 inches,



Heavy-Duty, Deep-Tillage Cultivator Operating at Depth of 12 Inches: The Large Teeth Tear the Hardest Soil

whereas the subsoiling reaches down 24 to 48 inches. Often 225 horsepower is required to pull the tillage implement.

1919 Carl A. Bauer, of Dayton
Daily News, Dayton, Ohio

BROKEN RECORDS AND IMPROVED MACHINES
Verne Sampkins, 207 70 Rhode Island St
Washington D C



Above: Lieutenant Lester J. Maitland, Who Established a New Speed Record, When He Drove His Plane over the Course at an Average of 244.97 Miles an Hour.

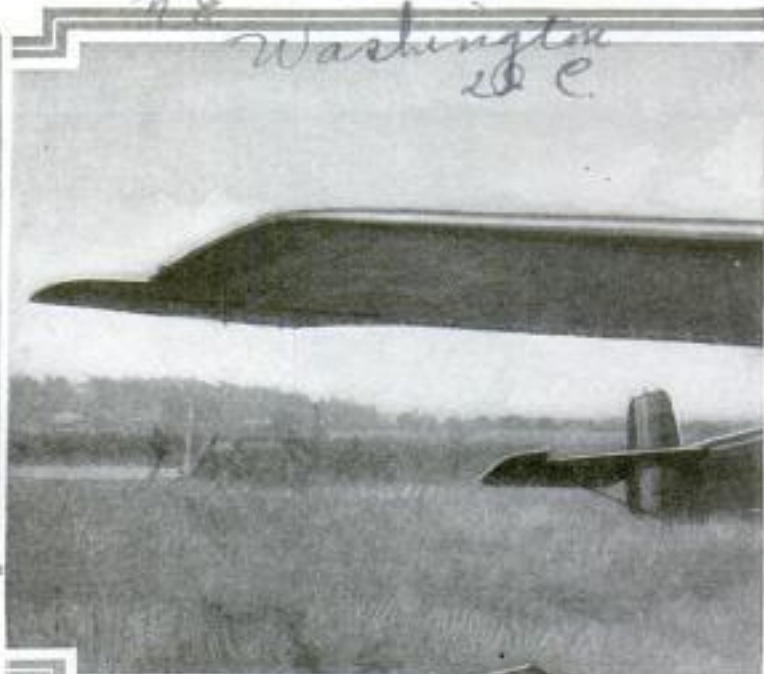

Target Glider Carried on Upper Wing of Plane: When Released by Pilot, It Descends at About 30 Miles an Hour, Thus Furnishing a Realistic Target for Anti-Aircraft and Airplane Gunners. It Weighs Only 23 Pounds.

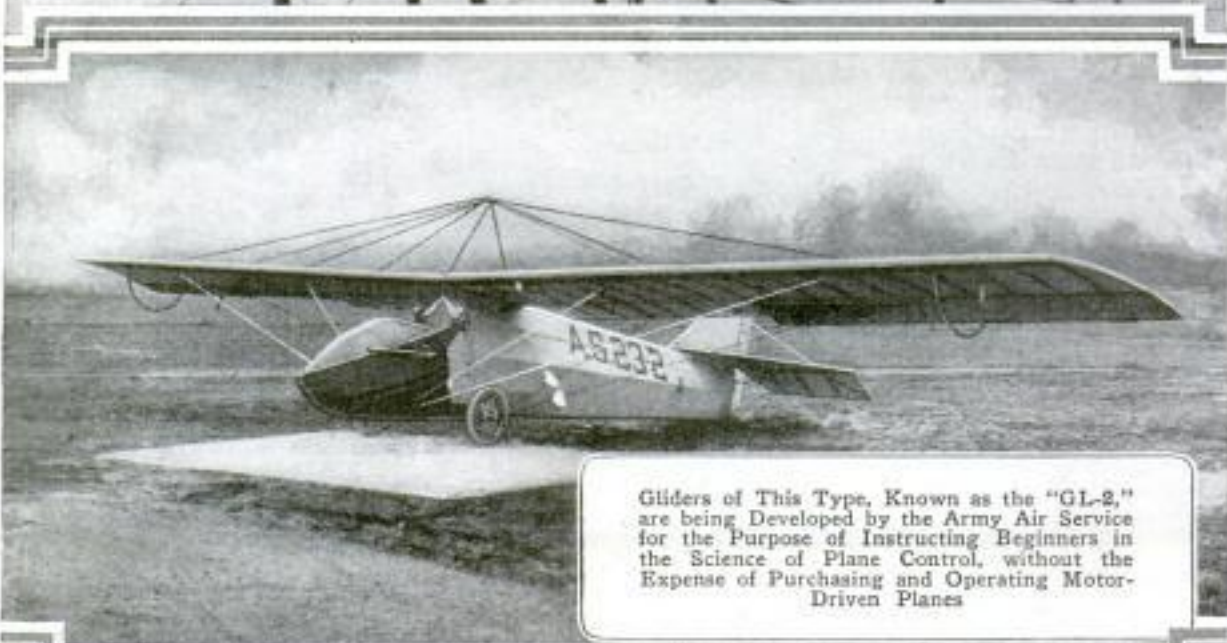

Gliders of This Type, Known as the "GL-2," are being Developed by the Army Air Service for the Purpose of Instructing Beginners in the Science of Plane Control, without the Expense of Purchasing and Operating Motor-Driven Planes.

MARK RECENT DEVELOPMENTS IN AVIATION

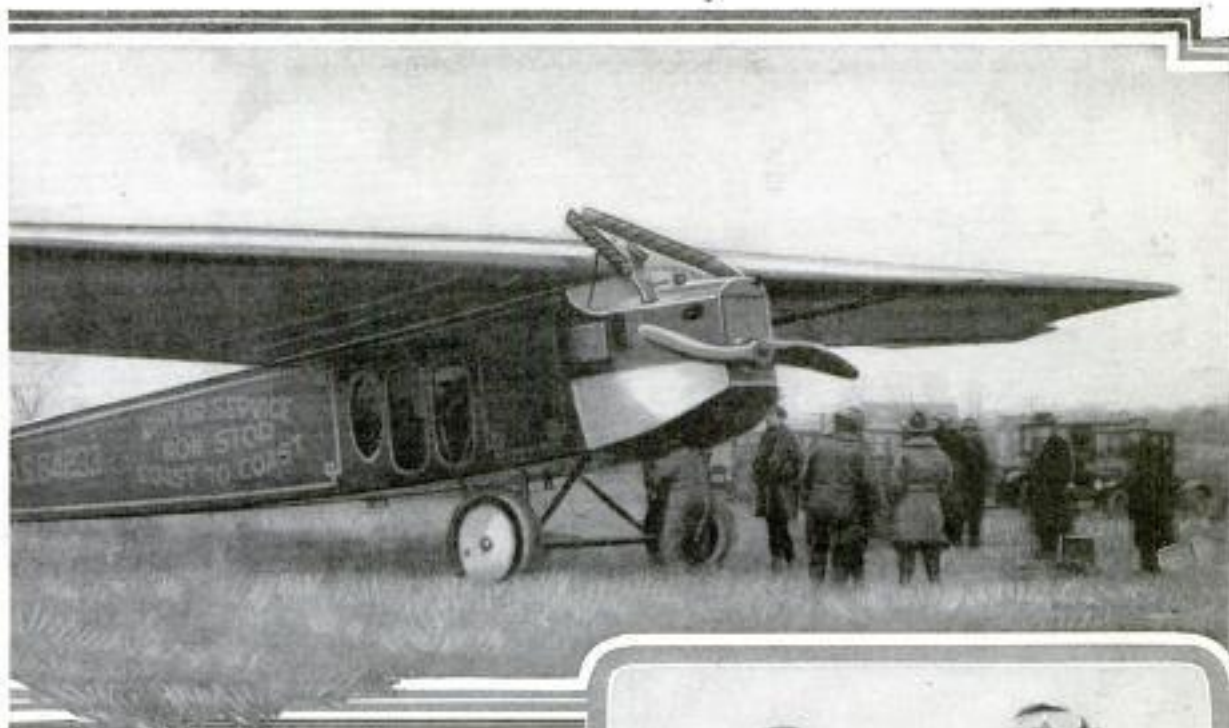

In the Picture Above is Shown a View of the Fokker Monoplane "T-2," Used in Establishing the Endurance Record of 36 Hours 5 Minutes 20 Seconds, Recently Made at Dayton, Ohio, by Lieutenants Macready and Kelly. This Shatters Their Own and Other Previous Records, and at the Speed They Maintained in Cruising around the 30-Mile Course, They Traveled Far Enough to have Crossed the Atlantic. The Ship Flew at an Altitude of About 2,000 Feet and Made 75 Miles an Hour



At the Left is Shown Lieutenant John A. Macready, and at the Right Lieutenant Oakley Kelly, Who are Accredited with a New Airplane Endurance Record

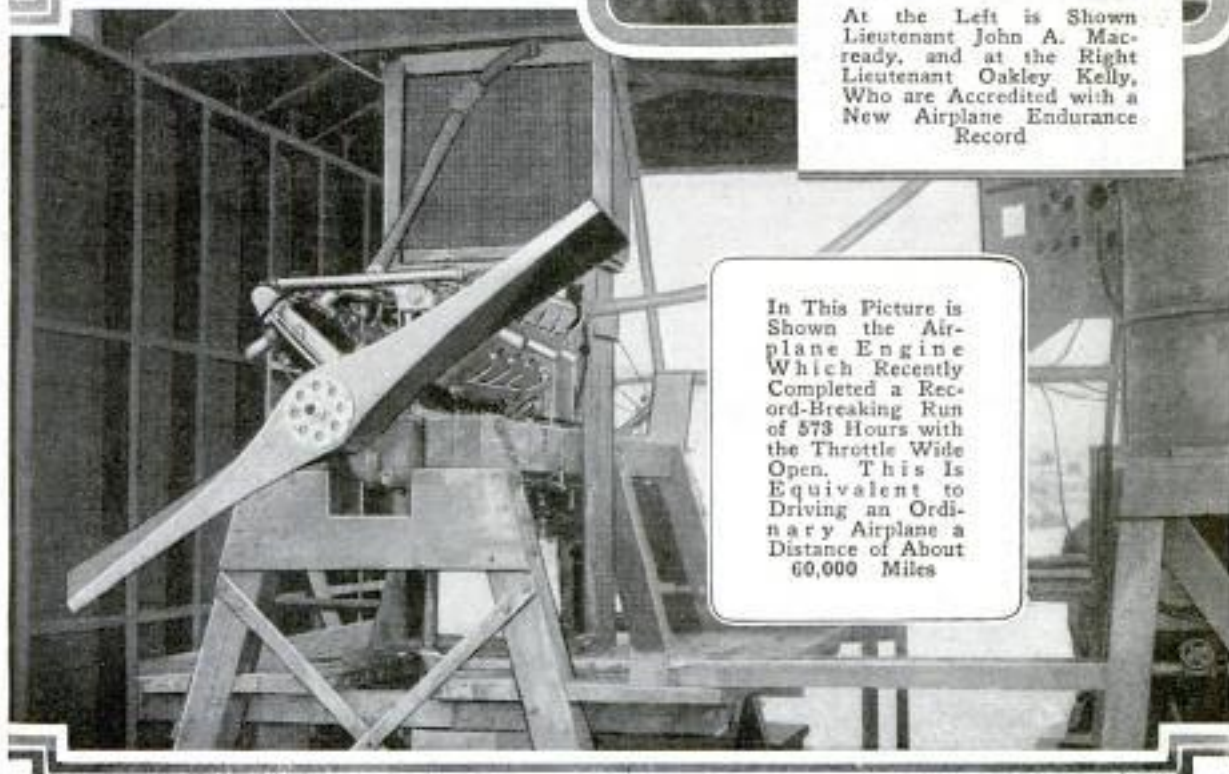

In This Picture is Shown the Airplane Engine Which Recently Completed a Record-Breaking Run of 573 Hours with the Throttle Wide Open. This is Equivalent to Driving an Ordinary Airplane a Distance of About 60,000 Miles

2002
CONVENIENT DRILLING TOOL
IS MOTOR-DRIVEN

A new utility drilling tool designed with especial reference to engraving work,

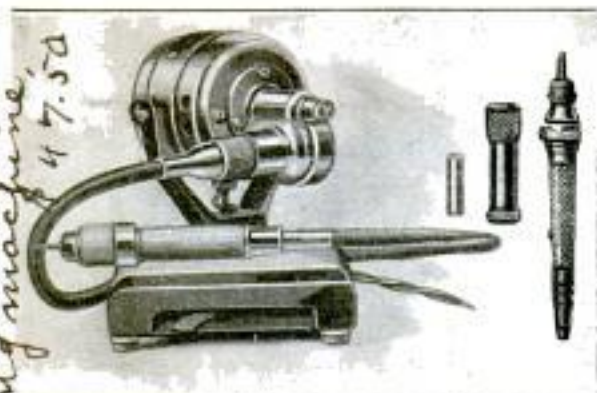

Motor-Driven Tool That Helps to Solve Hard Drilling Problems: It Is Easily Portable

is driven through a flexible shaft geared to a universal electric motor, which is pivoted to the base. The chuck, which takes a wide range of drill sizes up to 1/8 inch, has five speeds, from 500 to 2,000 revolutions per minute.

OX-DRAWN SLEDS THRESH
EGYPTIAN GRAIN

It is difficult for the American farmer, who uses agricultural machinery for practically all his operations, to realize how crude and rudimentary are the means used in other parts of the world. In Egypt, for example, a floor of beaten earth is used for threshing grain. The heads and straw are laid down lengthwise of the floor, and a crude ox-drawn timber sled is driven over the stalks. Iron

disks, mounted in the heavy frame of the sled, press out the grains, at the same time crunching the straw, which is later used for fodder. Broomlike wooden forks are then used to separate the grain from the chaff by tossing the mass up into the air, the prevailing northwest wind in Egypt being an essential factor in this operation. In spite of the crudity of the method, it is claimed that good results are attained.

2002

WATER-SERVICE BOX HAS
SAFETY FEATURES

A new water-service box, intended to meet the requirements of railroad work, is designed with a view to convenience and safety-

first measures. The box, which is built to be set flush with the ground or pavement, contains a lever-operated valve that must be either open or completely closed, and which is provided with a standard air-hose coupling. The device is non-freezing, is arranged for connection to surface drain, and has a self-closing cover.



Price \$35.00. S.S. White
hand price extra, 56.50
for party machine, 47.50
1978
Cmt. Day alden 1041 S Westlake
Los Angeles Calif



Egyptian Threshers, Using Oxen to Draw the Heavy Timber Sleds over the Grain on the Earth Floor: Wooden Forks are Used for Separating the Grain from the Chaff

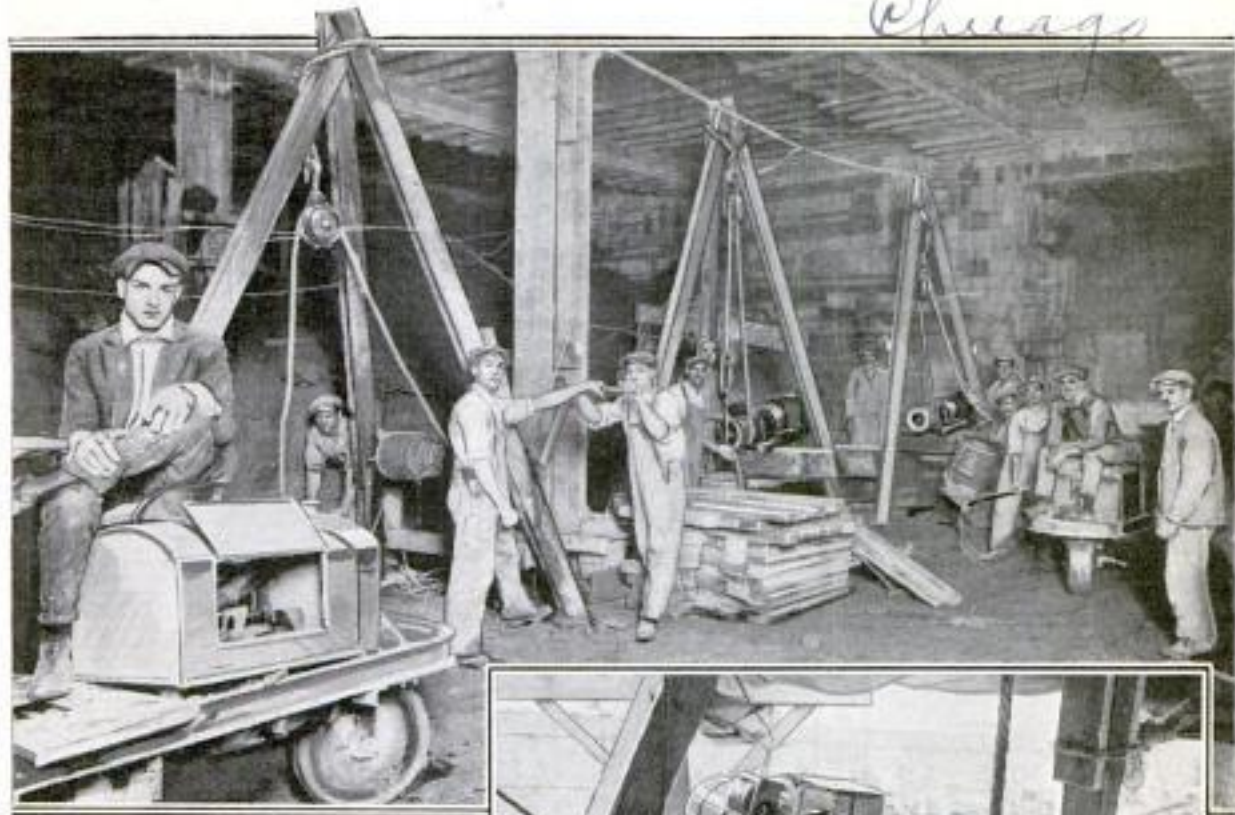

Above: A Construction View of a Large Building Operation, Showing How the Individual Caisson Hoists are Rigged Up over Each Pier or Well; They are Housed Over to Afford Shelter from Wind and Cold in Winter, and from the Heat and Rain in Summer. Deep in the Bottom of the Wells the Muckers Fill the Buckets. Right: Close-Up of the Operating Mechanism for a Single Caisson. It is Electrically Driven

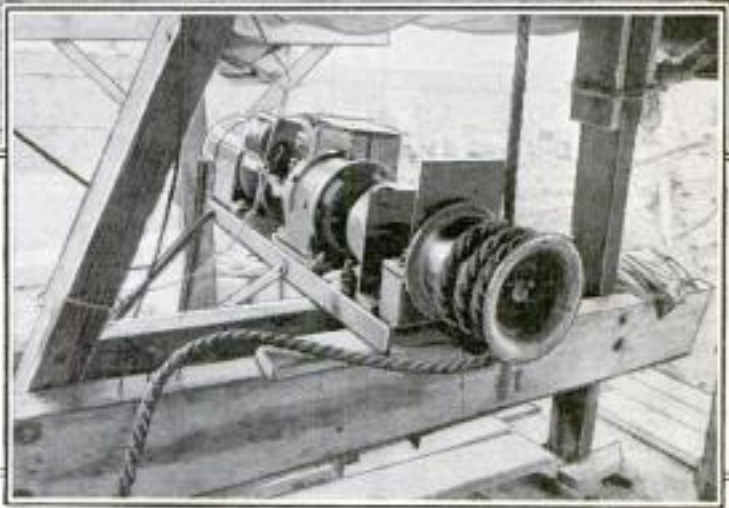

2051

CAISSON HOIST FACILITATES FOUNDATION WORK

An individual caisson hoist for each well or pier in a foundation was used with considerable success recently. This procedure has several advantages over the endless-cable system, in which 10 or more piers are worked at the same time by a single drum and engine, driving an endless cable encircling them all. In such a method the entire operation may come to a standstill if the cable fails or a sheave becomes worn. Furthermore, the set-up must remain in place until the last well is finished. On the other hand, the individual hoist can be set up anywhere, even under a building already built, without regard to the location of other hoists, and it can be shifted as soon as it has completed its particular well. It is electrically operated, and is protected against reverse motion by a positive safety device.

RED FINGER LIGHT TO AID NIGHT AUTO SIGNALING

2068

A small red light worn on the finger like a ring, has been made to aid night signaling by motorists. As the driver extends his arm and hand to signal a turn, or whatever it may be, the lamp is automatically lighted by the outstretching of the fingers. The cord connection can be plugged into the dashboard or under the driver's seat.



803 Hubbard Bldg
San Francisco

Copyrighted material
2801
Cesar H. Fisher

Merryweather + Sons Ltd
2104 Long Acre W.C. 2 London
Greenwich Road S.E. 10 + 63,
TURNTABLE FIRE LADDER EXTENDS FROM TRUCK
England

An effective fire-fighting unit is seen in a new extension ladder of English manufacture which is considered remarkable for its great "reach." The ladder, which is built to reach heights of 60 to 90 feet and upward, if necessary, is mounted on a turntable carried over the rear axle of a motor truck. It can be used either for life-saving or as a water tower. The truck motor operates the ladder mechanism by means of two levers under control of the driver, indicators showing the amount of the extension and the safe angle at which the ladder can be worked. Raising and extending the ladder can be done at one time. The four sliding sections of the ladder are raised by wire ropes, safety devices preventing overwinding and the ladders from dropping in case a rope should break. Revolving the ladder around the turntable may be

done by hand or with the motor. Adjustable hinged struts at the rear of the chassis provide direct support from the ground, instead of through the wheels and springs, when the ladder is in operation. In the traveling position the ladder sections are folded lengthwise above the truck, running over the platform from the rear forward and a few feet beyond the radiator.

2149
**RADIO NEWS
SENT TO CHINA**

A commercial telegraph company has succeeded in receiving daily messages from Hillsboro, Ore., at a radio-receiving station set up recently near Shanghai, China. Reception is over a loop antenna, transmission being through a standard arc used later in the day for working a Portland-San Francisco radio circuit. The wave length is 8,609 meters.

*Federal
Telegraph Co*



Motor Turntable Fire Ladder When Fully Extended to a Height of 90 Feet: With the Truck Stationary, the Ladder can be Turned Around at Right Angles to the Chassis. Indicators Give the Extension and Working Angle Found Safe

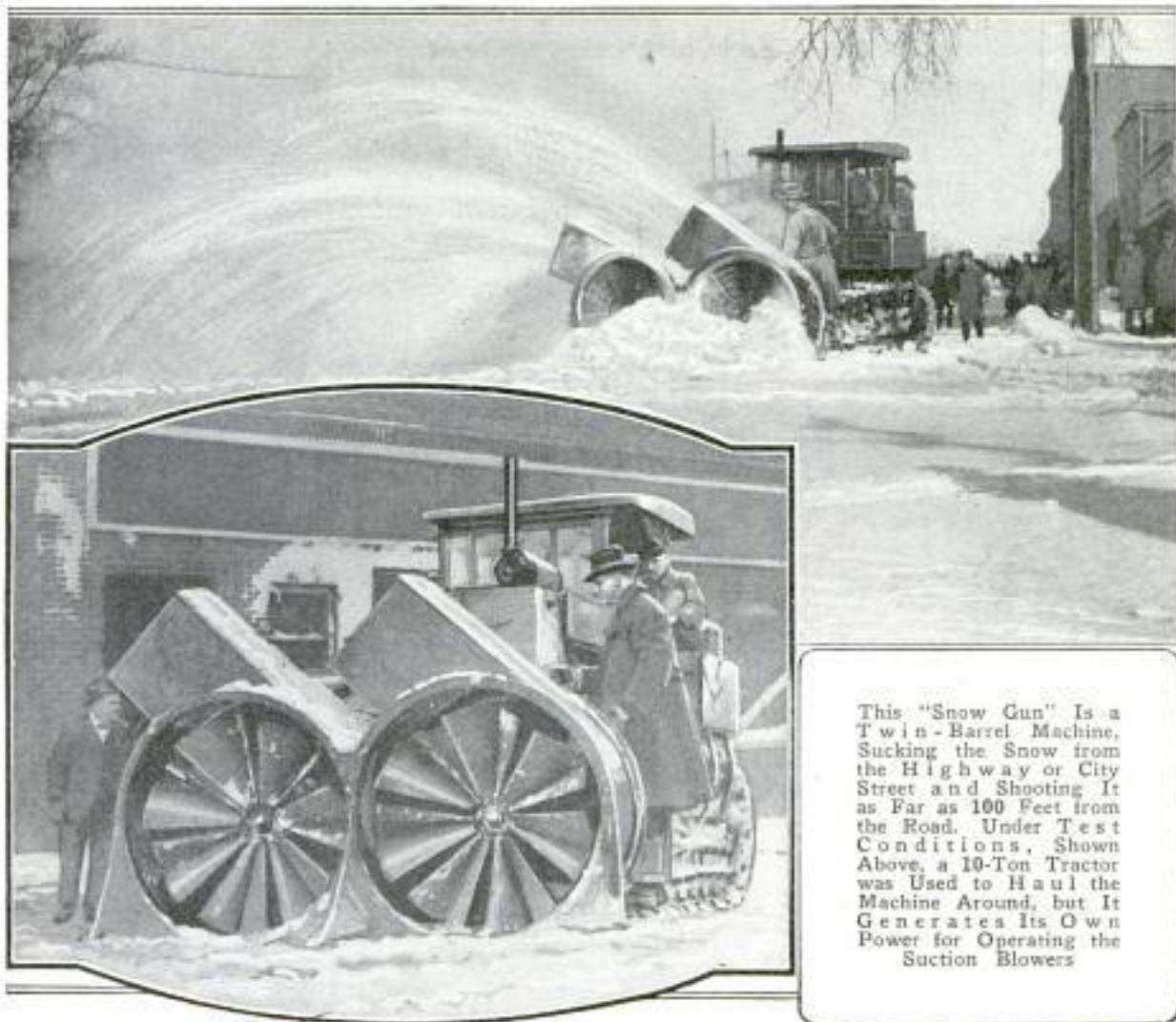

This "Snow Gun" is a Twin-Barrel Machine, Sucking the Snow from the Highway or City Street and Shooting It as Far as 100 Feet from the Road. Under Test Conditions, Shown Above, a 10-Ton Tractor was Used to Haul the Machine Around, but It Generates Its Own Power for Operating the Suction Blowers

1985
TWIN ROTARY BLOWERS SHOOT SNOW FROM HIGHWAY

A newly developed machine for clearing highways and city streets of snow was put through severe tests recently, with satisfactory results. It is a twin rotary machine, two blowers with very large nozzles being used to suck up the snow and shoot it off the roadway. An 80-horsepower gas engine is used to furnish the necessary power, but the outfit is not self-propelling, and must be hauled about by a tractor or other means. Its principal use is to "break road" quickly immediately after a heavy snowfall, and under these conditions it cuts an 8-foot swath very effectively.

2004

SUN'S RAYS AND FLASK BURN FINISH ON OFFICE DESK

How simple it is for a fire to be started was recently shown in an office at Corning, N. Y. The rays of the sun, coming through the window, fell on a decanter

that was being used as a vase on the desk. It happened that the rays were concentrated on a spot about the size of a small coin, such as would have been the case had a sun-glass been used. As a result, the finish at that point on the desk was burned through.

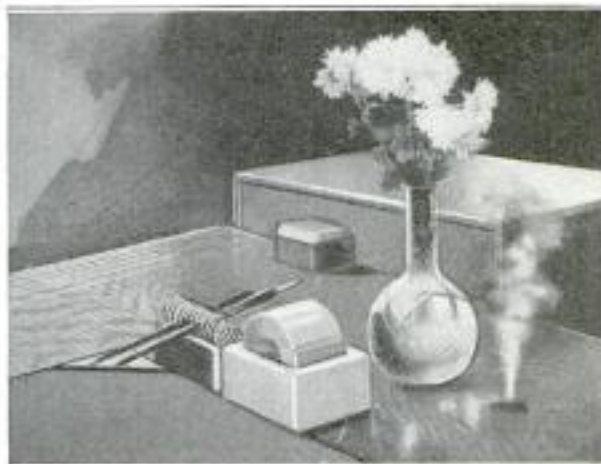

The Sun's Rays, Concentrated by the Decanter, Burned a Hole through the Finish of This Desk. Luckily, No Papers were Lying About

Ant. George F. Paul, 906 Ellsworth
 Beld, Chicago

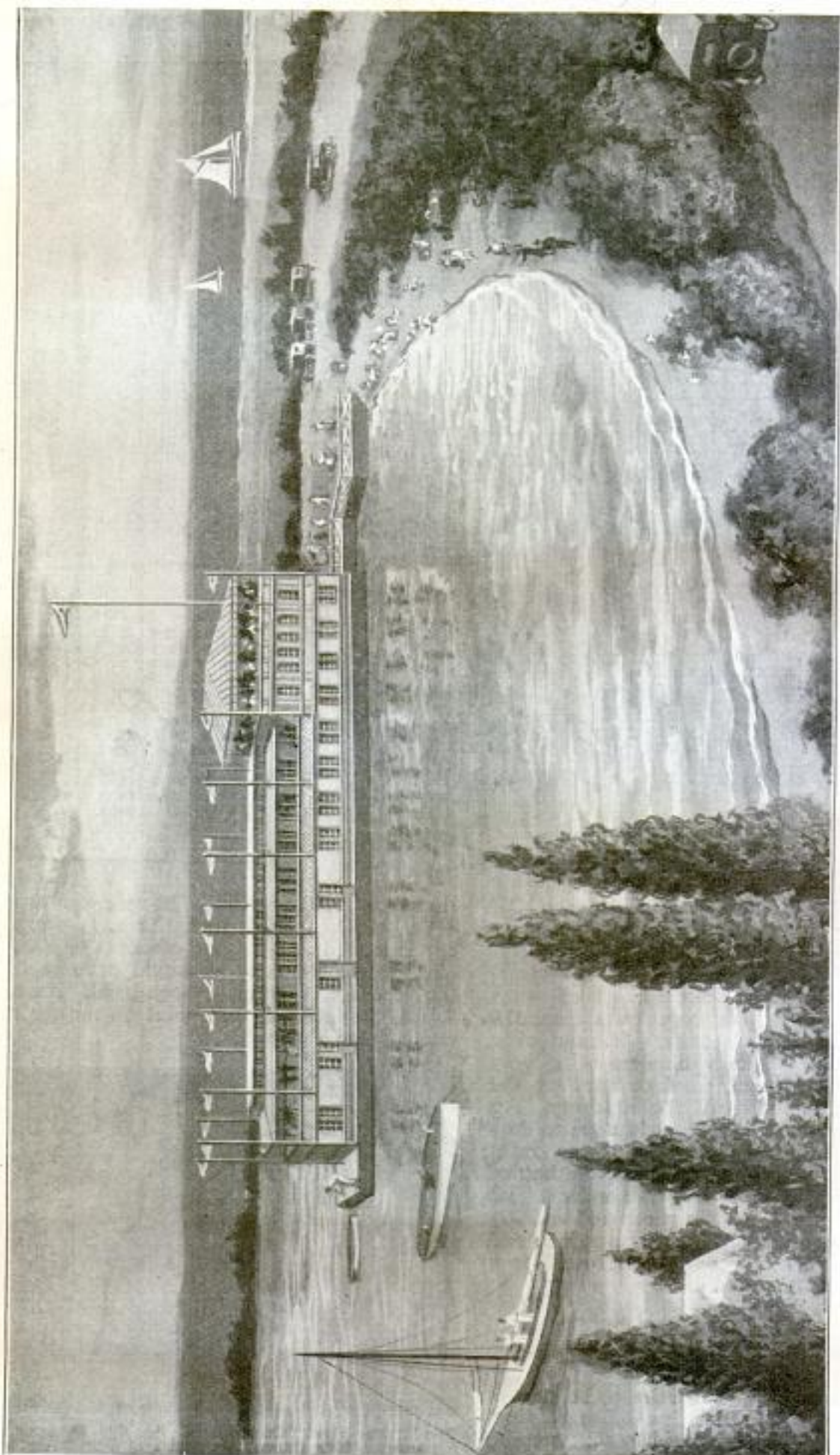

INTERESTING STEEL-BOTTOMED DOUBLE-DECKED YACHT-CLUB FLOAT LAUNCHED IN CHICAGO

A YACHT-CLUB float, 50 feet wide and 150 feet long, with ample sail and clothes lockers, cafeteria service, a lounge, large verandas, and dinghey space, is being put in service at Chicago by the Chicago Yacht Club. On the upper deck are the cafeteria and kitchen, a storeroom, a ladies' locker room, a rest room, lounge, and promenade deck. Folding doors between the last two open for dancing.

Designed by Cox + Stevens, 2069
New York City
Artist - C. McKnight - Smith
220 Broadway
New York City



LATEST ADDITION TO THE FLEET OF THE NEW YORK YACHT CLUB

THE grace and swift, birdlike motion of the sailing vessel are admirably brought out in the painting of the "Husar IV," here reproduced. The vessel is a pleasure yacht built for a New York sportsman and recently launched at Copenhagen, Denmark. For cruising purposes, it relies, besides its ample canvas, on a 600-horsepower crude-oil engine. It is 200 feet long and will be manned by a crew of 25, exclusive of officers.

Unable to locate
maker.

W. C. Roskar,
Port Clinton,
Ohio.

MAIL-BOX SENTINEL DEFEATS LETTER THIEVES

1987

The activities of mail-box thieves, who can easily take letters from the ordinary

ness. Crude oil, while also effective, is disfiguring to both trees and property, and, of course, the acid spray may not be used in contact with iron parts. If sprayed in the spring, before the leaves come out, no injury whatever results to the tree itself.

NEW VARIETY OF PEACH

2076 DEVELOPED

The efforts of horticulturists to supply the need for a yellow peach ripening a little later than the so-called "Elberta" peach has resulted in the development of a new variety which seems to fill the desired requirements. This peach, called "Wilma," is as large and of the same color as the "Elberta," but is rounder, held to be of better quality, and ripens a week later than the latter. The trees are vigorous, productive, and hardy, and have therefore been recommended to New York State fruit growers, as well as orchard owners elsewhere, as suitable for localities where the winters are severe.

STICKER LABELS FOR AMATEUR 1945 RADIO PANELS

The number of radio enthusiasts who are constructing their own sets has been growing so rapidly as to prompt one enterprising manufacturer to bring out something new for adding distinction to the completed product. This is a set of sticker labels, having a gold-dust surface, and bearing suitable identifying legends, as "aerial" or "loading coil," which can be quickly applied to their proper place on the panel. When applied, these labels have no perceptible thickness to the



At the Left a Man is Seen in Vain Attempt to Pick Mail from Letter Box Equipped with Wire-Hook Appliance Recently Placed on the Market

At the Right, View Showing Wire-Hook Antitheft Appliance as It Appears on the Inside of a Letter Box: Note Letter Gripped by Lower Series of Wires

COPYRIGHT, CLARKE & HIDE

box, are rendered fruitless by the attachment of a simple hook appliance recently placed on the market. This consists of two overlapping series of wires, having their upper ends coiled to impart a spring action to each series. When placed against the letter opening on the interior of the box, the upper series, like a one-way gate, permits the letter to be inserted and to fall into the box. The lower series of wires, however, has hooked ends, and guards against any attempt to withdraw the letter through the slot.

SPRAYED COTTONWOODS SHED 2086 NO COTTON

The United States Bureau of Plant Industry has developed a method of preventing the growth of the blossoms of the cottonwood tree, thereby freeing that popular shade tree from one of the greatest objections to its use, the falling of the cotton. Spraying with a 2-per-cent solution of sulphuric acid is the method resorted to, and when done in the spring, is effective in stifling the growth of the annoying tufts of cotton which otherwise would strew the streets and yards. A spray of kerosene, gasoline, or common-salt solution also gives desirable results, the last having the advantage of cheap-

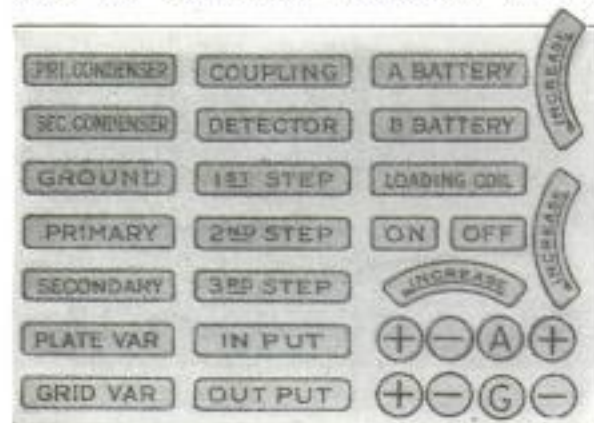

These Labeled Stickers are Intended for Amateur Makers of Radio Sets

touch, and add greatly to the finished appearance, and increase the convenience of the homemade panel.

American Scale Manufacturing Co.
229 W. Illinois, Chicago

Wastika Photos 35 S. Dearborn Chicago

Science 4/13/23

2060 Cent Verne Simkins, 2577
Rhode Island Ave. N.E.
POPULAR MECHANICS
Washington, D.C.

853

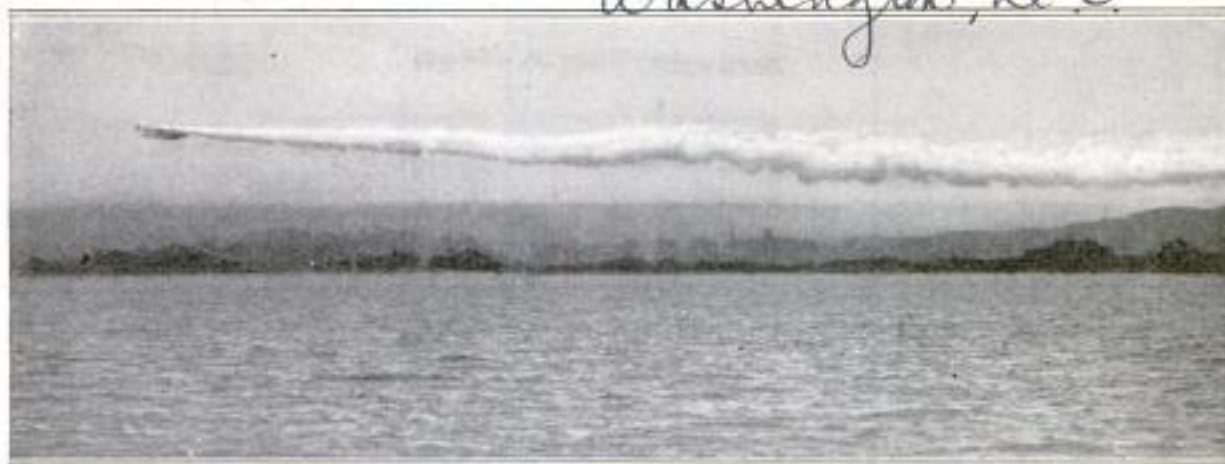

Seaplane Laying a Smoke Screen at a Height of 100 Feet above the Surface of the Water: It Is the Ability of the Seaplane to Regulate the Height of the Smoke Screen That Makes It Effective

²⁰⁶⁰
**SEAPLANE LAYS EFFICIENT
SMOKE SCREEN**

The use of dense smoke clouds by naval vessels for the purpose of screening battleships from the enemy, has been practiced for a long time. Fast destroyers are usually employed to lay the cloud of heavy smoke, which is produced by regulating fuel and draft in the main boilers. Recent tests, however, have proved the efficacy of seaplanes in this respect. In fact, the seaplane has at least two advantages over the destroyer: It can lay a screen much more rapidly; it can regulate the height of the screen above water, and may make it completely envelop an object by flying over and around the latter. When a seaplane is used for laying the screen, the smoke results from the introduction into the exhaust pipe of chemicals that increase the volume as well as the density of the exhaust gases.

²⁰⁹²
**MUSSEL CULTURE WILL HELP
PEARL-BUTTON INDUSTRY**

An important step toward insuring an adequate supply of raw material for the pearl-button industry is being made by the United States Bureau of Fisheries, which, for the first time in history, is cultivating fresh-water mussels during the entire first year of their growth. The activity of mussel culturists heretofore has been confined to getting the young bivalves well started in life, during the brief period when they attach themselves to the gills and fins of fish. Now, however, as a check upon the effectiveness of their work, the fish will be kept in large wooden troughs until the mussels drop off, after which the latter will be retained in the wooden tanks for a year, the better to observe and facilitate their growth. The mussels will then be planted in their natural environment to complete their life cycle.

Science 4/13/23

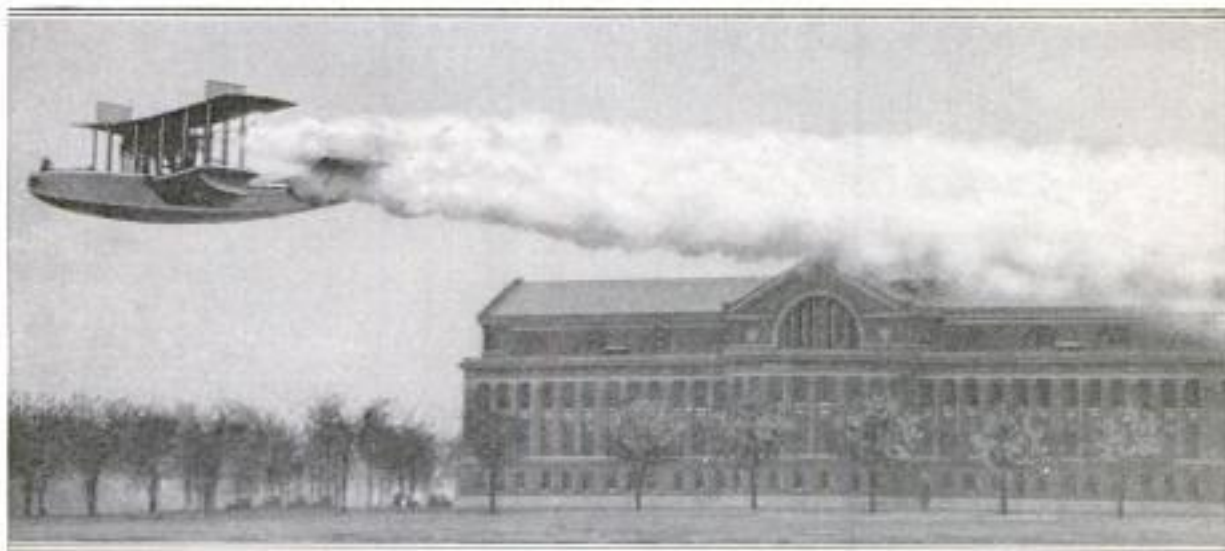

Seaplane Enveloping the Army War College Building with a Smoke Screen Laid at a Height of 50 Feet above the Ground: The Seaplane Has the Advantage of Speed over the Destroyer Previously Used for This Work

1995 **NEW CIRCULAR BUNGALOW SAVES SPACE AND STEPS**

Dissatisfied with the usual type of bungalow, a British architect has designed a circular bungalow which is cheap to construct and easy to maintain. The structure of the inner room, the largest one, forms the backbone of the whole framework, and from the corners of this, six partitions radiate, giving space for four rooms, a kitchen, a hall, a servant's bedroom, a bathroom, and a larder, in addition to the inner room. The outside wall forms a polygon of 12 sides, a dome fitted over the center room providing light and air. A form of laminated wood—three or more layers of wood cemented together under great pressure and stitched with thin cord—is used in constructing the bungalow, all sections of which are ready-cut at the factory and so designed as to enable three men to assemble them into a house in a week. The accessibility of every room should save many steps daily.

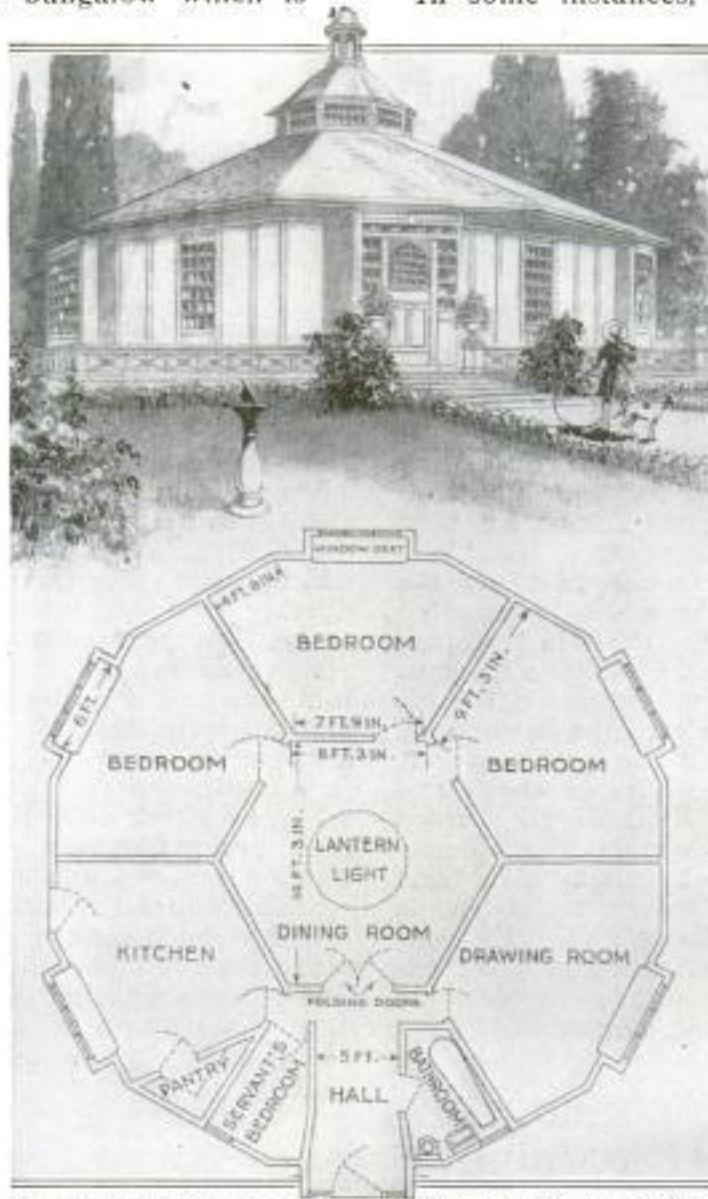

Outside View, and Floor Plan, of Bungalow Designed with a View to Economical Construction and Maintenance, and to Convenience

valuable land. In several cases, as at Levan, Nephi, Parowan, Beaver, and Cedar City, the townsites are so close to the cañon mouths that some of the property involved is particularly valuable.

In some instances, the gravel covers several acres, and grows deeper and larger with each spring freshet, forming fan-shaped deltas. New channels have been excavated annually in these gravel deposits, only to be filled again in the first few days of the snow-freshets; barriers have been constructed tending to confine the stream, and other devices and schemes have been tried, with only temporary success.

Probably the best arrangement was installed at Parowan some years ago, in the form of a riprap of large, loose logs, framed across the channel in the midst of the gravel delta. This tended to lift the stream and check the speed so that the suspended gravel was deposited in the place selected by the builders. In fact, by an ingenious arrangement of the logs, which allowed a shifting of the current when the deposit was built up to a certain height, the builders obtained deposits of sand and gravel of rather uniform sizes, which were used later in highway and building-construction work.

Also, by a system of wings it was possible to produce the deposits in suitable depths for ready loading by the dump-

Utah Agricultural College

2074 **CHANGING A RIVER'S MENACE INTO A UTILITY**

The spring flood waters in many of the mountain streams of Utah carry large amounts of gravel to the cañon mouths, where the arrested speed of the current allows the gravel to be deposited over

Horace W. Shelley, Dept. of Geology, Salt Lake City, Utah

Mr. J. C. Allen, 229 Fowler Ave
Lafayette, Ind.

POPULAR MECHANICS

855

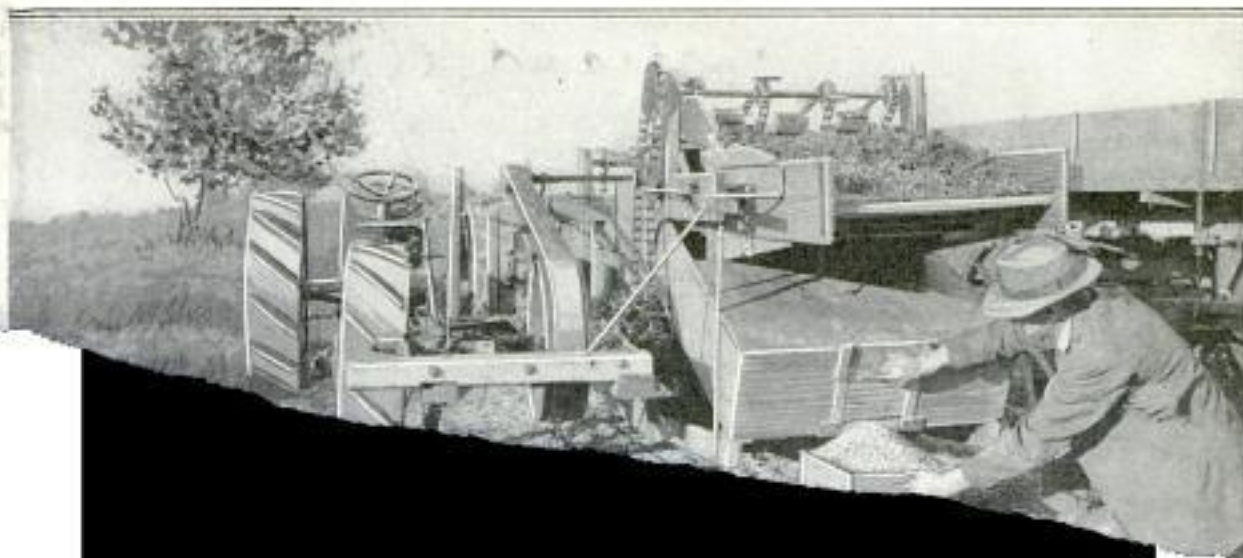

2061

*Hawley Pulp + Paper ->
Oregon City, Ore.*

MILLS RUN WHILE POWER DAM IS REPAIRED

BY HORACE E. THOMAS, *911 Cluncklay Ave
Portland, Ore*

WHEN the swollen waters of the Willamette River late last winter tore a great jagged hole in the dam that impounds it to supply power for the manufacturing plants at Oregon City, a serious engineering problem arose. This was to restore the dam and to keep the wheels of industry running in the meantime. The problem was solved by an engineering feat of exceptional difficulty.

The dam controls a large body of water that is diverted from the Willamette above the Oregon City falls, which, though not of great beauty,

gap and to string a 2½-inch cable between them. Hanger rods were attached to the cable and from the rods was suspended a large beam constructed of four timbers, each 8 by 16 inches, securely bolted together. As soon as this was in place, it was strengthened by a framework of large timbers heavily braced.

The upper surface of the dam has a slope of 45°, and the next time a slide into place, one by one, the timbers that were to

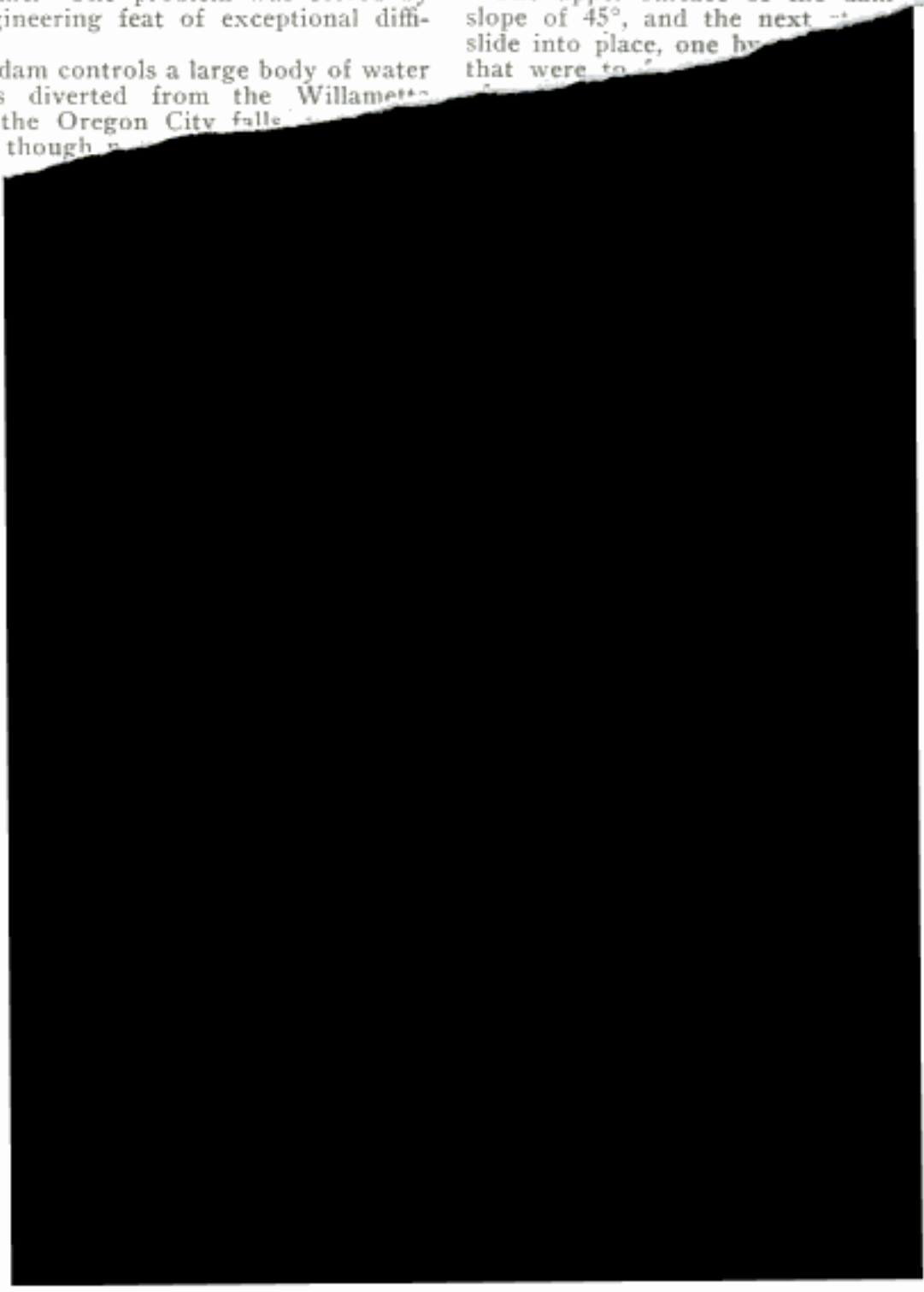

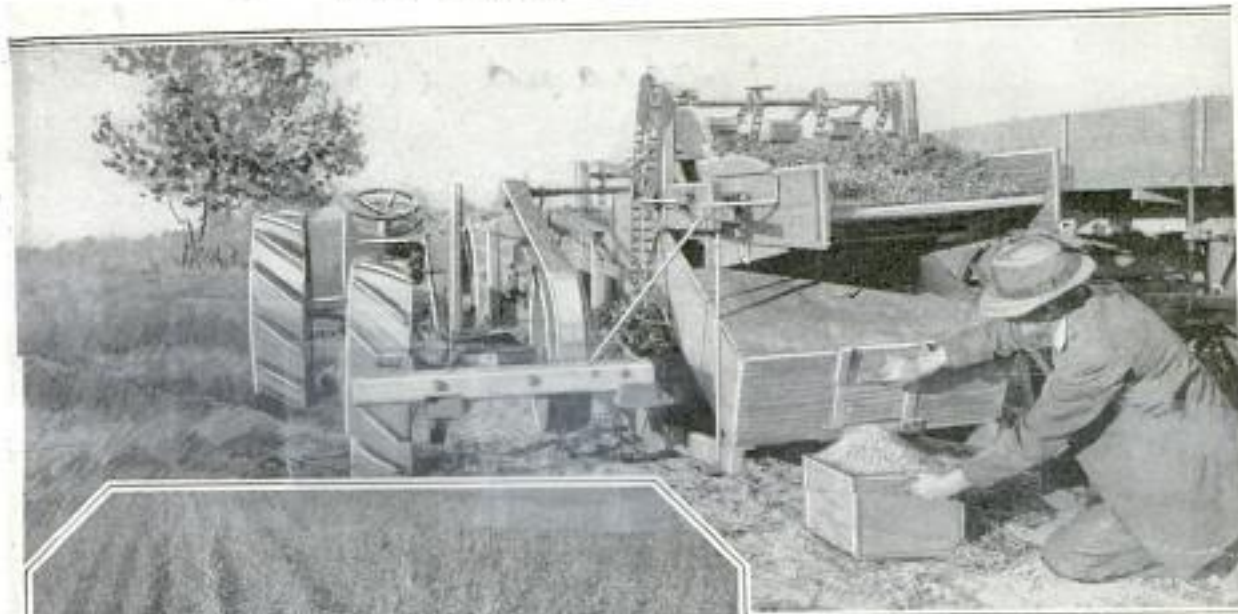

Above: Rear View of Combined Soy-Bean Harvester and Thresher, Showing Removal of Beans after Trip across Field. Left: Machine Operating in Field; Note That Machine is Offset from Tractor Which Travels over Harvested Ground



charged at the rear of the machine. The beans drop through the screens into boxes that are large enough to hold the accumulation from one complete trip across a 1,600-foot stretch. The machine is tractor-drawn, and it is stated that it will harvest approximately an acre of beans in one hour.

2014
GASOLINE BLOWTORCH HAS FOOL-PROOF FEATURES

Unusual features to promote safety have been embodied in a new blowtorch now on the market. It uses gasoline or kerosene as fuel. One of its favorable points is a safety valve that blows off at 40 pounds' pressure, which is about twice the normal.



Another advantage is that there is only one opening in the tank, above the fuel line, which eliminates troublesome soldered connections.

pit method, after the floods had subsided. A gravel-arresting dam at Kanosh, on Corn Creek, will have an initial capacity of about 50,000 cubic feet of gravel, but can be made to carry twice that amount by adding a few feet to the height of the barrier.

1825

BEAN HARVESTER THRESHES IN SAME OPERATION

A new machine for threshing beans as they are harvested has been built by a soy-bean grower who found separate harvesting and threshing too expensive. At the front of the machine are two slots, each for a row of beans, with guides that deflect the bean plants into the path of the slots, where the beans are threshed out by vertical beaters that strike both sides of the plant. The beans that fall from the pods are elevated by drag chains to the top of the machine, where shaker screens separate them from dirt and other foreign materials, these being dis-

Wm. Walter Hurtenbach, The Turner Brass Works, Westfield, Ind., Sycamore, Ill.

Mrs. Homer Johnston, Sheridan, Ind.

2061

Hawley Pulp & Paper Co.,
Oregon City, Ore.

MILLS RUN WHILE POWER DAM IS REPAIRED

BY HORACE E. THOMAS, 911 Cluncklay An
Portland, Ore

WHEN the swollen waters of the Willamette River late last winter tore a great jagged hole in the dam that impounds it to supply power for the manufacturing plants at Oregon City, a serious engineering problem arose. This was to restore the dam and to keep the wheels of industry running in the meantime. The problem was solved by an engineering feat of exceptional difficulty.

The dam controls a large body of water that is diverted from the Willamette above the Oregon City falls, a cataract which, though not high, is famed for its beauty, and is familiar to travelers in the West. The flood resulted from heavy rains and warm temperatures that melted the mountain snow at the source of the Willamette and its tributaries. The swift water, growing to almost unprecedented volume, practically leveled the falls, inundated the surrounding country, and exerted a tremendous pressure which the timber dam, 800 feet long and 17 feet high, could not withstand.

At the height of the flood came a crash of tearing timbers that could be heard above the roar of the water. A section of dam, 100 feet long, was swept away and the pent-up water found a new outlet through which it rushed.

As soon as the waters had receded sufficiently to permit operations, engineers surveyed the situation. The usual method would have been to construct a cofferdam and then make the repairs in comparative safety. This method was rejected, however, because it would have meant closing down many factories, entailing great loss to the paper and woolen mills affected. However, since the river was certain to remain at a stage of comparatively high water for several months, and since, even with the gap in the dam, there was sufficient power to keep the mills running, it was determined to restore the dam without the protection of a cofferdam.

Several methods were suggested. It was first decided to build a great slab of reinforced timbers and beams and to slide it into place, as a section of the dam, 20 feet at a time. This was abandoned as impractical, uncertain, and costly, and it was determined that it would be more feasible, although hardly less hazardous or difficult, to bridge the opening one timber at a time.

The first step was to build towers of piling, 20 feet high, at each side of the

gap and to string a 2 1/2-inch cable between them. Hanger rods were attached to the cable and from the rods was suspended a large beam constructed of four timbers, each 8 by 16 inches, securely bolted together. As soon as this was in place, it was strengthened by a framework of large timbers heavily braced.

The upper surface of the dam was a slope of 45°, and the next step was to slide into place, one by one, the timbers that were to form the component units of the dam. Each of these timbers was 14 inches square and 26 feet long. It was no simple job to place these timbers, but once in position, they were held securely by the pressure of the water and the reinforcing that connected them with the part of the dam already in place. The great beam on which they rested could not have borne the terrific weight if it were not for anchor cables attached to the beam at right angles and fastened on shore. Several of these cables were attached as soon as the beam was laid, and others added, every 70 inches, as the deck of the dam was built. Turnbuckles were provided, so that the cables might be tightened as required to keep the structure in alinement.

The difficulty of the work was increased by the fact that the lower ends of the timbers rested on solid rock. It would have been much easier to get them into position if the ends could have been buried in mud or sand. Once they were in place, the usual method of holding them with sacked sand was followed.

Hazardous as the work was, it proceeded without mishap. With the season of low water approaching, contractors rushed the dam to completion, so that by the time the river fell, the dam would be ready and the mills kept running.

ELECTRIC TREATMENT RAISES VISCOSITY OF OILS

That the viscosity of mineral oils can be raised by a combined treatment with electric discharges and with hydrogen, is the contention resulting from a series of systematic experiments recently completed. The treatment increases the viscosity of the oil and makes it more resistant to high temperatures, thereby rendering it suitable for use in place of more expensive lubricants, such as castor oil, in machines like air compressors, Diesel engines, and internal-combustion motors, it is claimed.

La Nature 3/24/23 material



Above: Looking alongside the Dam, from One End of the Temporary Framework, Erected to Assist in Stopping the Gap in the Dam. The Rushing Waters Made the Repair Operation a Hazardous One. Below is Shown the Opposite Face of the Dam, at the Crest. Heavy Cables Anchored the Framework to the Shore



Myr. Alex. Taylor & Co.,
22 E. 42nd St.

Welding + Franklin
Machine Co
314 Dean St
Brooklyn, N.Y.

new York City
**GLOVE PROTECTS THROWING
HAND OF CATCHERS**

A baseball glove to protect the throwing hand of catchers is being introduced



Above: A Close-Up of the New Glove. Right: As It would Appear When Worn by a Catcher in Batting Practice

by a sporting-goods company. The base of the glove is similar to a first baseman's mitten, with the exception that the fingers are joined together at the tips and heavily padded. The glove is designed for use in batting practice—particularly to protect the fingers from foul tips and wild pitches. In a game, it would, of course, have to be discarded, since it would interfere with throwing the ball.

**POCKET MICROSCOPE
FOR FIELD WORK**

A handy, compact microscope has been patented recently and placed on the market, designed especially for the use of those who frequently wish to make ex-



Price, \$30.00.

Left: A View of the Microscope Made to be Carried on Field Work. Above: Notice the Small Size of the Instrument

aminations while away from the laboratory, and for students. The instrument has a range of magnification from 25 to 225 times, is equipped with a hairline focusing device, removable stage, slide clamps, and reflecting mirror. The magnification is obtained without interchanging lenses by simply withdrawing or telescoping its tubes, which are conveniently marked for this purpose, to the desired degree. A dust-proof protective cap is provided, and the instrument is small enough to be carried in the pocket.

**PORTABLE PEELING MACHINE
FOR SMALL RESTAURANTS**

A peeling machine which is small, light, and can be put out of the way when not in use, has been made for smaller restaurants. The device, consisting of a circu-

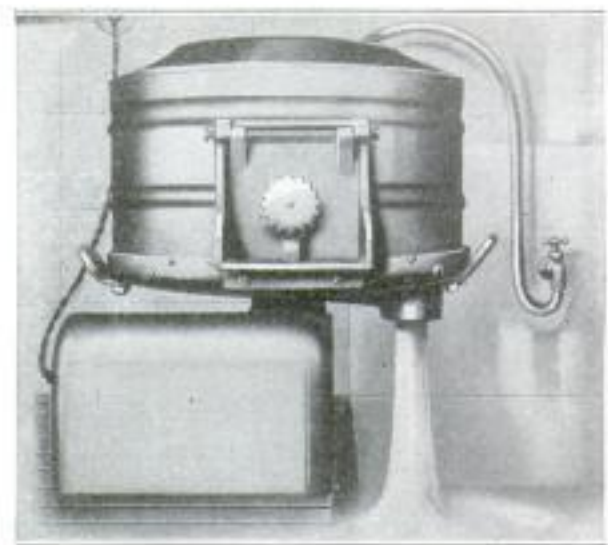

Portable Peeling Machine in Operation: It is Conveniently Rested on the Sliding Board of a Kitchen Sink

lar metal drum with an intake chute, a discharge door, a hose connection, a water-discharge opening, and an electric motor, is placed on the sliding board of the kitchen sink. Peeling is accomplished by an arrangement of revolving, perforated cylinders, while a continuous stream of water washes out the fine peel and dirt. It is claimed the device will peel 15 pounds of potatoes, turnips, or other similar vegetable in less than two minutes.

Rubber bands are placed about the Sunday home-subscription issues of an Indiana city newspaper. It is claimed that the innovation prevents the various sections of the papers from being blown about, and lost, while on the porch or doorstep.

*Dr. Elmer Berry Associate
Director International M.C.
College Springfield, Mass.
2025
W. Hensoldt + Sons
2 Stone Street, New York City*

1998 *Thos. P. Mc Mahon, c/o D. Vabsley,*
Esq. Bank of Australia, Martin
 POPULAR MECHANICS 859
Place Sydney Australia



COCONUT FESTIVAL STAGED IN SOLOMON ISLANDS

NATIVES of the Solomon Islands, who, because of their cannibalism, head-hunting, and other cruel habits, have long had an unenviable reputation among civilized nations, are gradually becoming less savage. Under strong British, German, and Dutch influence, they are largely confining themselves to more humane practices and ceremonies. One of the more popular of these is the festival of the coconut. Thousands of the nuts are strung along poles, and the tribesmen circle about them in a weird, frenzied dance to the music of tom-toms. Afterward, the coconuts are eaten at a great feast. The interesting photograph given here, showing a group of the warriors decked out in their holiday regalia, was snapped just before the festival began. Behind the tribesmen can be seen a section of the coconut poles around which they dance.

1934

**OLD NEW HAMPSHIRE MANSION
 TO BE MOVED TO NEW YORK**

An undertaking of no little difficulty faces the Metropolitan Museum of New York in the transporting of a New Hampshire mansion to Gotham. Searching for a suitable home for its colonial treasures, the museum finally purchased the Wentworth Gardner house, at Portsmouth, N. H., built in 1760. Containing as it does some of the finest examples of colonial art, particularly carved woodwork, the museum authorities believe it can be placed as a wing to the present museum building. The old furniture has already been sent to New York, and

soon the mansion will be moved, probably by dismantling it and shipping it in pieces. It will be incorporated as part of the museum, and its treasures will be on view to metropolitan visitors.



The Wentworth Gardner House, Now at Portsmouth, New Hampshire, Where It was Built in 1760; It is About to be Moved to New York City.

Emb. Walter S. Jordan, Weymouth, Mass.

Mr. L. S. Thomas
46. Lunter Road
Chelsea, England.

860

POPULAR MECHANICS

900

CHILD'S PUSH CART CARRIED LIKE BRIEF CASE

A new pushcart used for wheeling children along the street, that folds up and can be carried like a brief case, is being



Left: Wheeling a Child in the New Folding Pushcart. Above: Pushcart Completely Folded for Carrying Like a Brief Case, and Half Folded, Showing How Wheels Disappear from View When Cart is Completely Closed

placed on the market in England. It is designed for people traveling with children, and can be taken into busses or railway coaches like ordinary hand luggage. It is made mostly of aluminum, and as it weighs only 14 pounds, may be easily carried.

NOVEL FARMING EXPERIMENT FOR WAR VETERANS

Sixty world-war veterans are trying an interesting experiment in California's famous Imperial Valley. This group of men, injured during the war and now being assisted by the U. S. government, have taken peaceful possession of the land near Brawley, formerly known as McDevitt's Project. McDevitt was the leader of a group of idealists who established a colony, hoping for a perfect or Utopian community life.

When the colony failed, the Veterans' Bureau, aided by the businessmen of Brawley, decided to take over the land for its charges.

Under the plan worked out between

the bankers of Brawley and the Veterans' Bureau, each ex-warrior picks out his farm and contracts to pay for it in from 14 to 28 years. The cost naturally varies according to the character of the land and the improvements made. During

the first three years the veteran is required to pay only 3 per cent interest on the cost. After the third year he must pay one-fiftieth of the cost every six months. On these 50 installments he pays 5 per cent the first two years and 7 per cent for the remainder of the period.

As the buyers, in most instances, are starting the experiment with very little capital, the owners of the land are furnishing vines and fruit trees and making necessary improvements, the cost to be paid by the veteran when the vines and orchards begin to bear.

Another new idea adopted, was that a budget of expenses be made out by months for three years ahead and closely followed by the

purchaser. The benefits derived from the budget plan, however, have been quite remarkable, and it now has the hearty support of all the veterans.

In addition to this economic training, the settlers are also receiving the very best scientific training and advice. Naturally a large colony of this kind attracts attention. Experts connected with both government and private institutions and organizations are visiting the veterans and giving them the benefit of their experience in poultry and hog raising, dairying, the raising of fruits and vegetables, farm management, irrigation, machinery, in fact in every branch of farming.

When the floor of a concrete reservoir started to crack before it was put into service, the idea was conceived of accelerating the cracking so that its worst effects might be known and remedied. Ice and salt were spread over the floor for a depth of 6 inches, then drained away, the cracks opened with chisels, and then filled with a mastic composition.

John W. Ream,
Bureau of Navigation,
Washington, D.C.



A String of the 3,000 Camels to be Used in Carrying Railway Ties and Other Supplies for the New Railroad to be Built in Australia from Oodnadatta, in the South, to Port Darwin, in the North

²⁰⁶³
**DOUBLE GAS-MANTLE BURNERS
GIVE IMPROVED LIGHT**

Greater lighting efficiency is claimed for a new type of incandescent-mantle

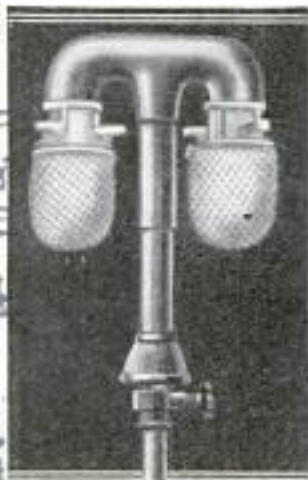

light, recently invented, which has twin burners. The gas inlet passes between the burners, permitting the gas to become heated by radiation from the glowing mantles. This system is credited with a considerable increase in light, with only a relatively small increase in gas consumption. The

argument is that the heated gas, reaching the mantles at or near the ignition point, can have no cooling effect on the mantles.

¹⁶⁸⁹
**NEW AUSTRALIAN RAILWAY
TAPS RICH LANDS**

The Australian commonwealth government announces that the new transcontinental railway, from Oodnadatta, in the south, to Port Darwin, in the north, will be built through the richest mineral and finest pastoral sections of the center of the continent. This will be the first step of a plan to cover every section, including the vast deserts, with railways which will not only facilitate commerce but also form a defensive barrier for the Australian coastline. It is estimated that, as

in the case of the east-to-west transcontinental railway, which was opened for traffic a few years ago, over 3,000 camels will be employed in the preliminary construction work.

²⁰⁴⁹ — Radio
**PORTABLE RECEIVING SET
IS EASILY INSTALLED**

A portable, extremely light radio-receiving set which can be put into operation by simply allowing some flexible insulated wire to lie on the floor and attaching another wire to a telephone or radiator. is being offered the



The Portable Radio-Receiving Set in Use; Above, a Similar Set for Use with a Permanent Aerial

public. The crystal, of the fixed type, is within a holder resembling a telephone pedestal, while the earpiece is set at the top. The usual means of tuning in are provided. The radius is from one to about 35 miles. Extra earphones may be attached by a special extension arrangement.

My address is 804 E. Hammond St. N. S.

*Street address unknown
Reliance Radiophone Co. Chicago*

W. Roy Harris, American Australasia Bureau, 500 516, S. P. O., Chicago.

BRITISH ROADBUILDING EXPEDITION



Settling of a Fixed Frontier Policy has Always Been One of the Most Delicate of the Problems Facing the British Government of India. Recently a Roadbuilding Expedition Began Operations from Thal to the Tochi River in the Rasmak Plateau. Rasmak Is the Objective of Getting into the Heart of Waziristan, Which has Always Been a Veritable "No Man's Land" between the British Northwest Frontier of India and Afghanistan. Consequently a Comprehensive System of Defense, by Soldierly, of the Road Workers has Been Necessary to Protect Them against the Constant Sniping of the Savage People, the Mahsud Tribes, Who Inhabit This Wild Stretch of Territory and Resent the Encroachment of Civilization. Above: The 58th Rifles Advancing as a Reserve Unit over a Section of the Completed Military Road to Rasmak. Left: Sappers and Miners Working on the Road. Camel Trains Supplying Water and Crushed Stone

*International Newsreel Corporation
New York City*

PENETRATES INDIA'S LAST FRONTIER

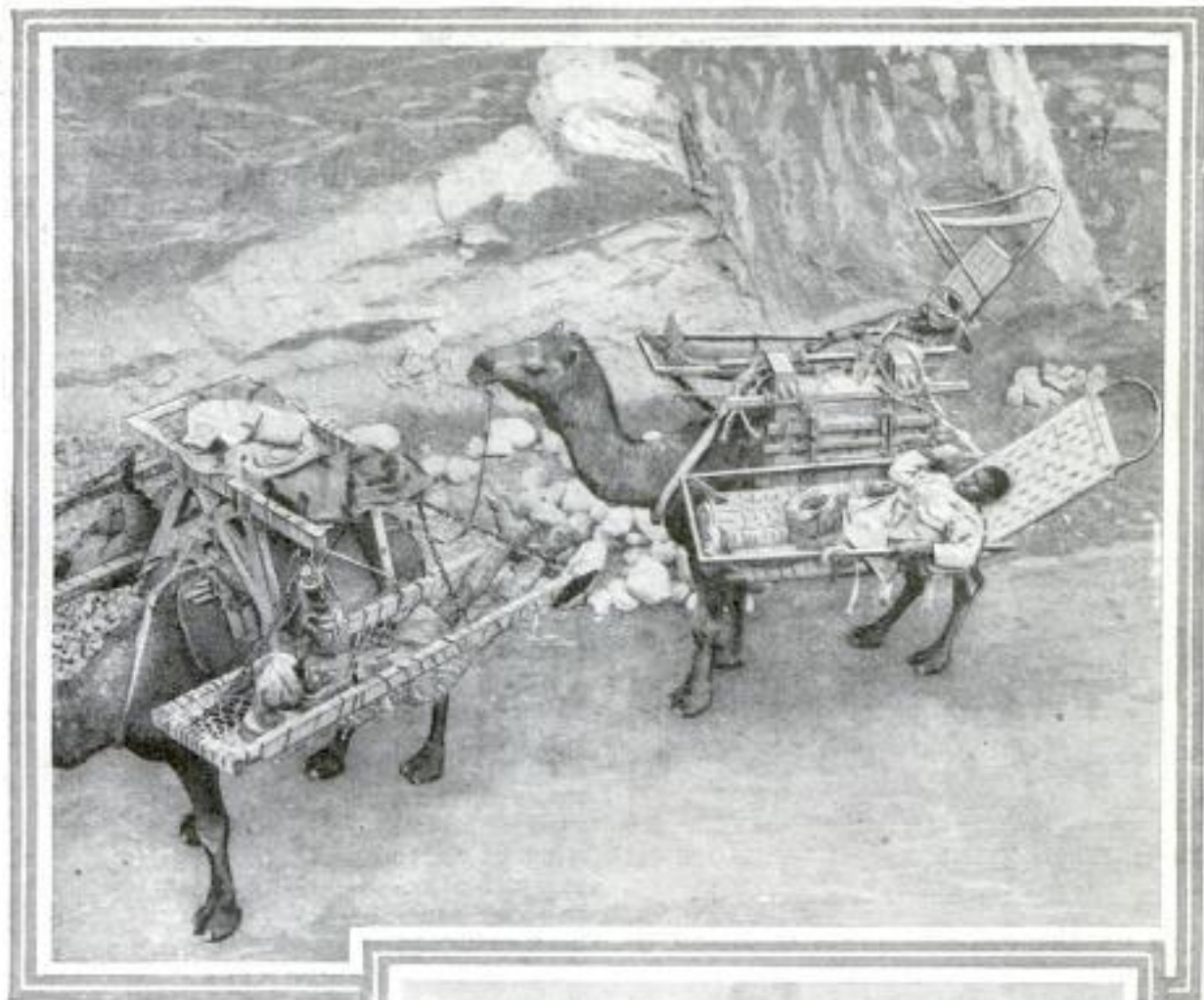

Above: In Spite of the Vigilance of the Military Corps, the Mahsud Outlaw Bands Continually Took Toll of the Workers. As a Means of Transporting Troops and Laborers Wounded in These Frequent Encounters, Captain C. M. Stoker, M. C., in Charge of the Work, Devised a Special Type of Stretcher for Attachment to the Camel Pack. The "Doli," as the Device is Named, is Here Seen. It is Made in Two Types, and a Pair is Swung from a Support on the Camel's Back. Right: A Large Steam Roller Brought from Delhi, Many Miles to the South, being Employed to Make a Road around a Bad Corner. The Presence of This Machine of Modern Life, Together with the Work it is Aiding in Performing, Symbolizes to the Wild Tribesmen the Advance of a Civilization they in No-wise Court. They Believe that When the White Man has Once Penetrated their Mountain Fastnesses, their Liberty will have gone.



W. James Whaley
2597 Crown Point Ave
Osaka, Neb.

**KITCHEN GAS-RANGE BURNERS
LIGHT AUTOMATICALLY**

1897

In the usual "self-lighting" gas burners on kitchen ranges it is necessary to

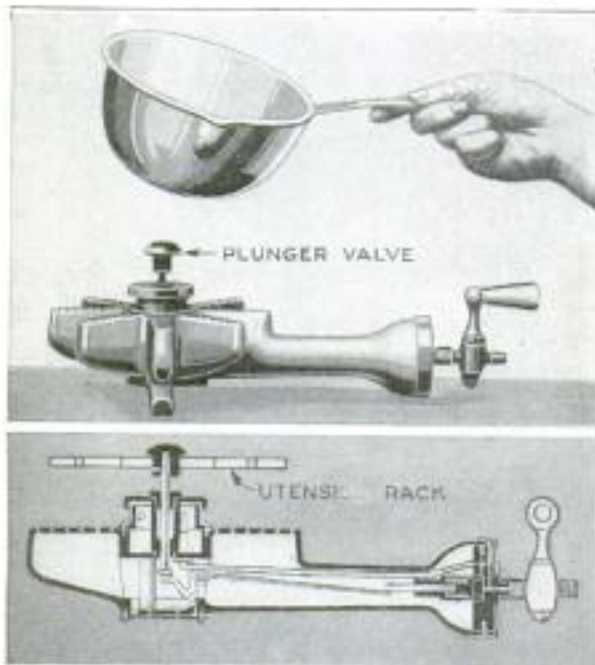

Above: Plunger Valve in Elevated Position, and Gas Supply Off. Below: Sectional View, Showing Interior of Burner

turn on the gas and press a button to cause the pilot flame to operate. A new burner, recently invented, does away with this feature, by lighting automatically when a vessel is placed on a rack above the burner. The weight of the vessel

operates a plunger which opens the main valve and admits gas to the burner, where it is ignited by a small pilot light. Removal of the vessel from the burner automatically cuts off the gas supply. The burner is made to fit any stove, and can be substituted for the ordinary burners.

The Sarrant Mfg Co, Duratoga

**TAR-POURING KETTLE HAS
ADJUSTABLE NOZZLES**

2017

An improved type of pouring kettle just placed on the market has the decided advantage of using adjustable nozzles for pouring tar, thereby minimizing drippings and leaks from the spout. Three sections, each screwing into the other, make up the spout, and any of these may be removed, according to the flow desired. The outlet valve is controlled from the handle, making it easy to fill any joint in the roadway with minimum drip, and the valve itself is so close to the nozzle that it aids in this effect.



Aeronautics - Spruign



JAPAN QUIETLY MAKING ADVANCES IN AVIATION

PHOTO BY GILLIAMS SERVICE

THE picture shows Akita, one of the Japanese flying aces, and the plane, of native manufacture, in which he has made some noteworthy flights. Japan is regarded as the most advanced in air craft of any of the nations of the Orient, although Siam and China are also showing progress. Not only is aviation being developed by the Japanese for military purposes, but also for commercial work and for sport.

*The Luthans Service
New York City*

1818 William Thompson,
Banco Lisboa + Acreez
Lisbon Portugal



Photo: 20 Photos
NOVEL PORTRAITS MADE BY MULTIPLE EXPOSURE

SOME interesting portraits have resulted from a method of multiple exposure which differs from the ordinary process in that there is an overlapping of the various views with no division line between them. It is likely the pictures were made against a dull dark background and in a room where the only illumination was from one or two lamps placed at the sides of the camera in such a way that light would be reflected only from the sitter. Then, by making a time exposure near one edge of the film, the other portions would be unaffected and different portions could be successively exposed by turning the camera slightly before each exposure.

No further information available



1512

MACHINE CUTS ICE CAKES TO STANDARD WEIGHT

To cut blocks of artificial ice into cakes of standard size and weight at the factory, an inventor has developed a machine for scoring the large blocks as they come from the refrigerating machines. After the 300-pound blocks come out of the machines they are run

through the scoring machine. Rapidly moving saws cut the blocks to size in two directions. Then a tap from the point of the iceman's tongs will divide the blocks, thus saving much time and unnecessary waste. A block so divided, will, of course, also greatly facilitate delivery.

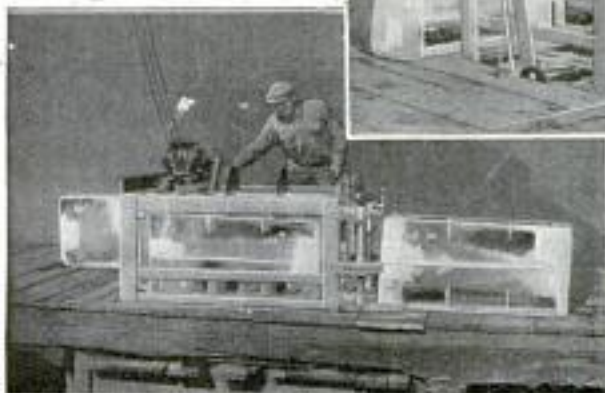
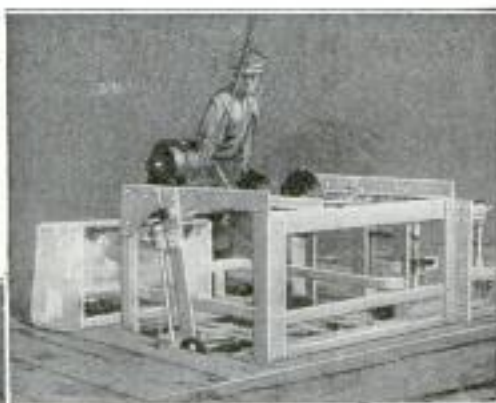

Above: Ice-Scoring Machine as It Appears Ready for Work. Below: Left, Machine in Operation, the Saws Cutting Marks to Indicate Weights; Right, Blocks Chopped after Leaving Machine, Showing Clean-Cut Surfaces

The Grayzor Ice Scoring Machine Co. Denton Texas

*of Mr. Hatten
copies names 1/2*

Naylor & Co. Ltd.
215 Victoria Arcade

Acme Sales Corp.
189 N. Clark
Chicago

866

POPULAR MECHANICS

Auckland, Masterton, N.Z. (Agents)

NEW MILKING-MACHINE VALVE PREVENTS INFECTION

A new type of vacuum valve has been devised which automatically and instantly closes whenever the operation of



New Milking-Machine Valve, Which Closes Automatically When the Cups become Detached, Preventing Dirt from being Sucked into the Milk Supply

the hose line to which it is attached is interrupted. The valve is especially adapted for use with milking machines. When the cup is accidentally detached from the cow's udder and falls to the floor, as frequently happens, instantaneous closing of the valve prevents dirt and other impurities from being sucked through the hose into the milk supply, thereby contaminating an entire tank of the fluid. The valve opens automatically as soon as the cup has again been attached to the udder.

light four-wheeled frame, having two inclined wheelbarrow handles for propelling by hand. A hopper with inclined bottom guides the young onion set into a funnel spout, dropping it directly into the bed of a short furrow which has been previously loosened up by a small specially shaped shoe just in advance of the spout outlet. The planter also has several adjustments for sets of differing size.

AUTO-WASHING DEVICE KEEPS SOAP SOLUTION UNIFORM

Garage workers realize the importance of using a proper soap solution for washing cars, knowing that an excess of soap, aside from being wasteful, will damage the car. A recent invention does away with this difficulty by providing mechanical means for properly dissolving the soap. It consists of a mixing tank, having inlet and outlet valves, and a perforated soap-holding receptacle which can

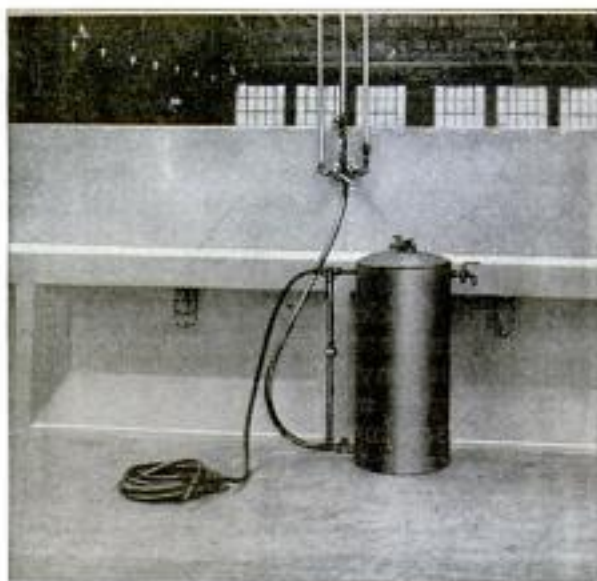

Either Hot or Cold Water, or Live Steam may be Used with This Soap-Mixing Device Designed for Use in Cleaning Automobiles

be agitated and revolved from the outside of the tank after water has been admitted. The piping is so arranged that live steam may be by-passed around the soap receptacle and through the outlets in case soap has accumulated in the valves or clogged the perforations.

Considering the title of chauffeur objectionable, a New York organization of hired drivers of private automobiles which recently opened a \$400,000 clubhouse, has named the club the Society of Professional Automobile Engineers.

Copyrighted material

ONION-"SET" PLANTER SAVES TEDIOUS LABOR

The drudgery of planting onion "sets" by hand is greatly lightened, if not entirely eliminated, by the use of a mechanical planter recently placed on the market. This device is conveniently mounted on a



Price \$65.00

This is the Mechanical Onion-"Set" Planter, Which is Capable of Planting from 15 to 25 Bushels of Sets per Day, in Rows 12 Inches Apart

Schutter & Hartly Ltd
Onion Planter Co. n. ally
London



View of a Room in the Department of Agriculture's New Moving-Picture Laboratory, Showing the Arrangement of the Lights and Camera: Note the Open Construction of the Room, Providing an Abundance of Light from Both the Skylights and the Windows

1915
**FEDERAL FILM LABORATORY
COMPLETELY EQUIPPED**

Covering 10,000 square feet of floor space, a motion-picture laboratory recently built and equipped by the Department of Agriculture for production of educational matter is said to be the only government film-producing and distributing agency of its kind. The fireproof brick structure, 90 feet long and 60 feet wide, has the second, or top, story roofed with skylights and fitted as a studio, while the first floor has various rooms for operations incident to the manufacture and distribution of the pictures.

In all there are about 15 rooms or compartments reserved for this purpose. These include offices for the title writers, storage vaults, and compartments for developing, drying, and assembling films. Apparatus for slow-motion analyses and a unit whereby microscopic objects may be visualized for portrayal on the screen, complete the camera equipment.

From a motion-picture entitled, "Exit Ascaris"—descriptive of a method for eradicating roundworms from swine—to a production labeled, "Sentinels of the Sunset"—showing the splendor of the scenery in the vicinity of Mount Lowe and Mount Wilson, in California—the films now on hand depict almost every phase of life in the countryside.

1940
**SIMPLE METAL PUNCH HAS
SELF-CONTAINED DIES**

A new portable metal punch of simple construction uses no separate dies and has few wearing parts. The instrument, which weighs about 5 pounds, is provided with punches for making five sizes of holes, from $\frac{1}{8}$ to $\frac{3}{8}$ inch, in sheet metal up to $\frac{1}{8}$ inch in thickness, and will work to within 3 inches from the edge. In operation, the magazine die is revolved until the desired size of hole lines up with the punch, when it is secured in place by

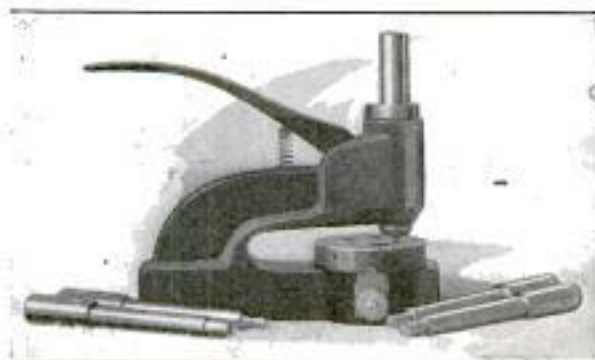

Showing Punch in Position: Note Circular Disk of Dies, Just below Punch Point, Which Is a Feature of the Device

a thumbscrew. A blow with a hammer on the top of the punch completes the operation. The device is so constructed as to make changing the dies easy.

Los Angeles, Calif.
W. A. Loewen, 9976
U. S. Dept. of Agriculture

Comd. John W. Dean, Navy Dept, Bureau of Navigation, Fred E. Wingard, One Hand Clock Co., Pa. Warren

868

POPULAR MECHANICS

OXYGEN-BREATHING APPARATUS WORKS AUTOMATICALLY

1156

A new oxygen-breathing apparatus that works automatically, even under water for a short time, is now being used by the Navy Department. The apparatus, which is self-sustaining for approximately 30 minutes under severe working conditions, consists of a steel cylinder, or flask, having a capacity of 13 1/4 cubic feet of oxygen under pressure of 2,250 pounds to the square inch. It is provided with control valves and a



reducing valve for bringing the pressure down to about normal, a cooler in which the oxygen and inhalation air mix, a regenerator for absorbing carbon dioxide, and suitable breathing tubes.

reducing valve for bringing the pressure down to about normal, a cooler in which the oxygen and inhalation air mix, a regenerator for absorbing carbon dioxide, and suitable breathing tubes.

STEEL-REINFORCED PLYWOOD APPEARS IN ENGLAND

2046

Ordinary three-ply wood, with one or both sides covered by a sheet of steel coated with lead or zinc, has made its appearance in England. The metal sheets are attached by a chemical process. The innovation, claims the manufacturer, protects the wood, makes it fireproof, and in addition improves the structural properties. Among the many ways it is expected it may be utilized are for shelves and partitions in houses; in vehicles, for

The Engineer 9/16/23

Mr. - Veresta Ltd, 1 Great Tower St, London, Eng

OIL-WELL FIRE SHOOTS 200 FEET INTO THE AIR

A fire of terrific fury raged recently when an oil well in the Okotoks oil fields of eastern Alberta caught fire, and roared continuously for 38 hours. The well was of recent origin, and for two months prior to the fire had generated the enormous gas pressure of 820 pounds per square inch. The friction of small gravel stones, rushing through the casing

body work of various descriptions, and on farms for silos, and tanks. The material can be readily cut with a circular or small handsaw, and wire nails can be driven through it without drilling. In tests, it is claimed, the material was found to be at least 80 times as stiff as mild steel.

CLOCK WITH ONE HAND AIDS IN AVOIDING ERRORS

1174

Designed to make the reading of time an even more simple matter, a clock with one hand has made its appearance. Between each of the usual hour markings, eleven equal divisions have been made bearing numbers from 5 to 55 inclusive, in multiples of 5, indicating the minutes. As the hand moves around the face, the point thus indicates the exact time. The makers



of the instrument point to frequent errors in telling time made because of confusing the two hands of an ordinary clock. The new instrument is made up in forms suitable for use on automobiles, and in watches and desk clocks.

The most powerful radio equipment afloat will be aboard the "Leviathan" when the giant ship reenters transatlantic service under the colors of the U. S. Lines some time in June. The equipment, which will be six times as powerful as that carried by the average steamship, will provide for uninterrupted communication with points 3,000 miles distant.

under this pressure, is believed to have generated the spark which ignited the gas. During the height of the fire, the peak of the flames roared more than 100 feet above the 87-foot derrick, and was visible for miles in the surrounding country. An estimated damage of \$30,000 resulted from the fire, in addition to the enormous quantity of gas consumed.

1932



The Illinois-Alberta Oil Well, in Alberta, Canada, So Named in Deference to the Home State of Most of Its Stockholders: This View Shows the Spectacular Appearance of the Fire at the Height of the Flames, Which Rose Fully 200 Feet into the Air. The Gigantic Jet of Burning Oil Roared Continuously for 38 Hours Before the Internal Pressure of the Well had Dissipated Itself

Mrs. E. M. Deber, Parkland
Alberta, Canada.

Davis & Thompson Co.,
251 Reed St.,

POPULAR MECHANICS

870
1746

Milwaukee, Wis.
NEW MULTI-SPINDLE MACHINE AIDS PRODUCTION

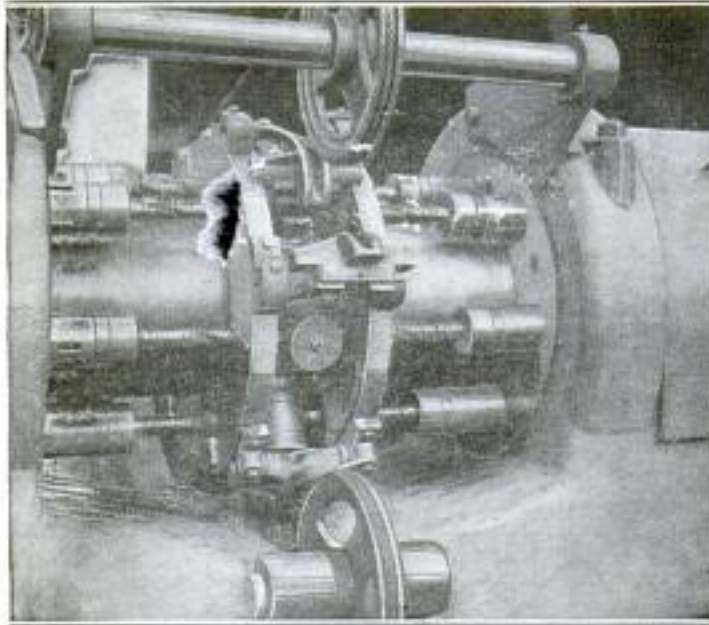

Partial View of Multiple-Spindle Production Machine, Set Up for Drilling Wristpin Holes in Automobile-Engine Pistons, Which can be Seen between the Two Large Flanges in the Center

A new multiple-spindle drilling, reaming, and threading machine of the drum type has been designed especially to meet the requirements of quantity production of parts like pistons, and bearing caps for automobile engines. The machine operates continuously, and all the attendant has to do is to put in and remove the work, which is carried between two large flanges and held in place by a shoe upon which a cable bears. It is not an indexing machine, as the spindles travel with the work and are moved through bushings in the flanges by a stationary cam. The machine is actually working through two-thirds of the revolution, and it is believed that, with a special attachment for loading, small parts could be speeded up to a production of 1,000 to 2,000 an hour.

1730 PORTABLE MACHINE MELTS ASPHALT PAVEMENT

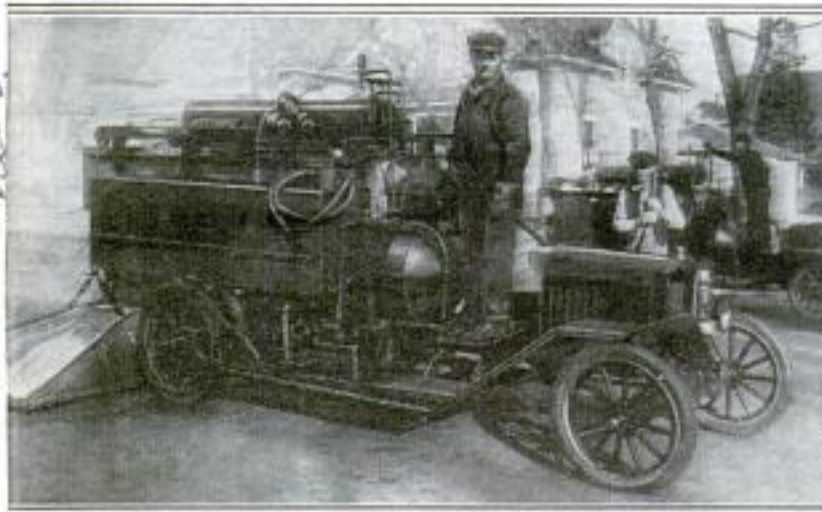

Above: Pavement-Melting Machine Mounted on Light Motor Truck, Which is Operated by an Auxiliary Steam Motor

the light motor truck on which the equipment is mounted, covers a 4 by 6-foot area of pavement, to which it conducts the heat generated by an oil-fired brick-lined furnace extending along the top. An auxiliary steam motor is used to move the machine back or ahead a few feet, while the old asphalt is raked off.



Pavement-Repair Machine Which Carries an Oil-Fired Brick-Lined Furnace, Extending along the Top to the Overhanging Hood at the Rear

114
Cnd. Sec. W. Bucklin
Serrinial. Lincoln
Neb.

A MILLION TREES FOR CALIFORNIA'S HIGHWAYS

1875

BY H. H. DUNN ²⁷²²
Prince St, Berkeley Calif

THE motorist driving anywhere over the 6,000 miles of paved highways in California soon will find himself protected by the shade of lofty trees in summer, yet warmed by the western sun in winter, for the state, through its highway commission, is planting, as rapidly as possible, a deciduous shade tree every 25 feet along both sides of every paved highway. This means that 1,267,200 such trees are to be planted to shade only the paved roads now completed within the state, while the annual increase in road building and paving in California will nearly double this number by the time the ten-year program of tree planting is completed. So far, over 200 miles have been planted, and there are more than 200 miles already shaded by older trees, set out by farmers and other residents. In the cities and some of the smaller towns, the municipal governments have assisted in this tree planting along the main highways, and it is estimated that approximately 300 miles more have been added to the highway planting in this manner, thus giving a total of some 700 miles lined with trees now giving complete or partial shade.

The means for this systematic planting was brought about by the establishment of the State Forest Nursery, near Sacramento, as a result of the coöperation of the California Highway Commission, which purchased the land, and the California State Board of Forestry, which propagates and distributes the trees. Thirty acres of land were purchased in

1921, and seeds planted, and buildings and lath houses erected, which now contain several hundred thousand trees, and by midsummer, this year, will hold nearly 2,000,000 seedlings. The principal trees raised, after some experimentation by the forestry board, are California black walnut, European sycamore, Lombardy poplar, American elm, and black locust, all of which shed their leaves in the winter, thus permitting the full heat of the sun on the highways in winter, yet providing dense and fast-growing shade in the summer.

Preference among these five trees is gradually crystallizing around the walnut, which is allowed to grow about ten years, and then is cut off and grafted with English walnut, resulting, in four years more, in a tree which has all the

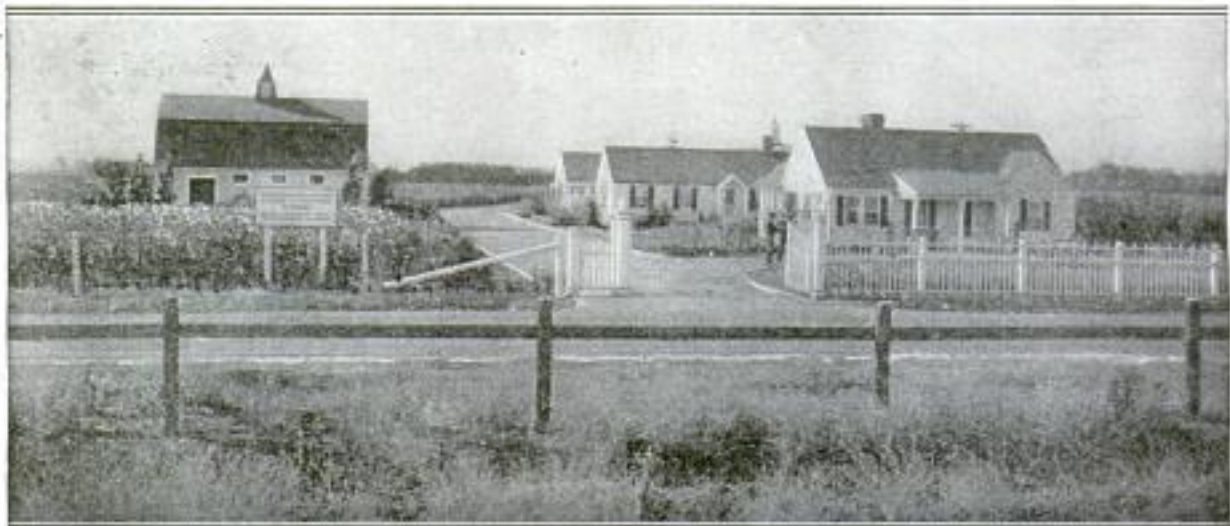

A Typical Bit of Paved Highway in the "Golden State": Within a Few Years It will be Lined with Sturdy Shade Trees, Now being Set Out by the State. Above: Main Pacific Coast Highways Soon to Boast a Continuous Border of Trees

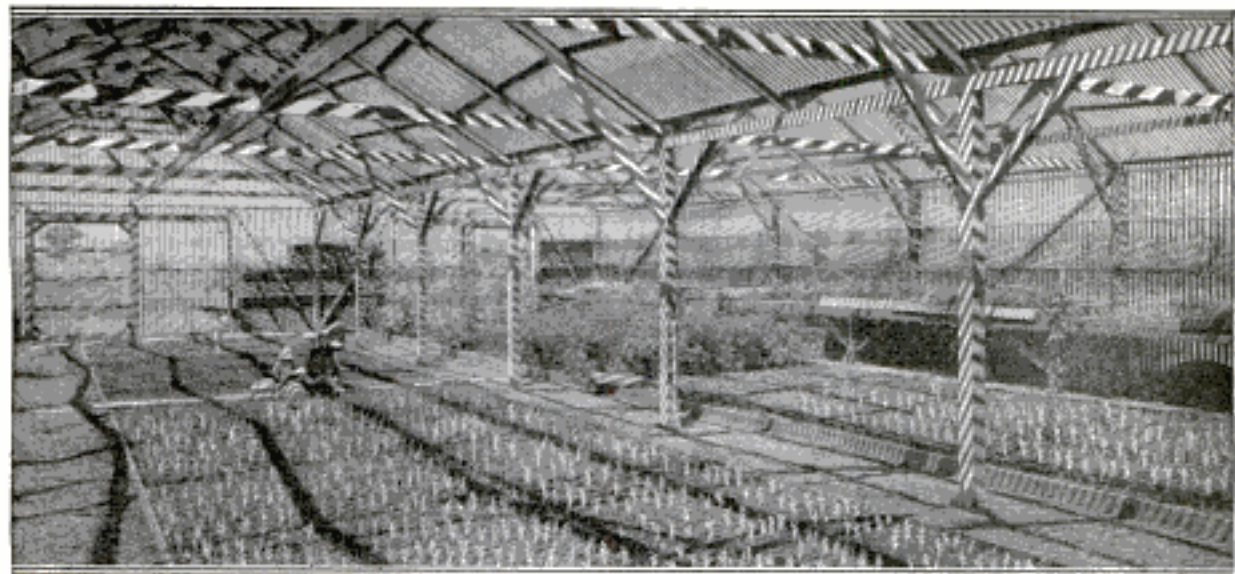

Interior View of a Part of the State Nursery Where Thousands upon Thousands of Tree Seedlings are being Propagated: Later It is Planned to Provide Farmers with Seedlings So That They may Plant Windbreaks and Decorative Groves

shade-giving properties of the wild walnut and discards its leaves in winter. Besides raising trees for the highways, the nursery also provides ornamental trees and shrubbery for the state parks, and the grounds of state-owned buildings and institutions.

The plan of planting the highways is coöperative, and involves three separate agencies—the California State Highway Commission, the California State Board of Forestry, and the agency, organization, or individual which applies for and puts out the trees. As soon as an application for trees is received from a county, city, automotive, or civic association, or other organization, it is referred to the Highway Tree Planting Committee, which consists of three members, namely, the state highway engineer, the state forester, and the gardener of the Capitol Park, at Sacramento. This committee makes a plan for the section of highway to be planted, giving the species of tree most suitable for use there, and indicating the best method of planting. Then a planting permit is issued by the State Highway Commission, and stakes marking the location of the trees are set by experts from that commission. The trees are furnished ready for immediate transplanting by the state nursery, and the applicant bears the cost of transportation,

planting, and supporting of the trees by stakes. After the trees are planted they are cared for and maintained by the State Highway Commission, which replaces any that may die. The state forester supervises this work.

The response to this plan has been widespread. In 1922 the state nursery was unable to supply the demand for trees, and indications are that this year, though the number of trees ready for planting is far greater than last year, there will not be enough to supply the demand. Chambers of commerce, boards of supervisors, city councils, women's clubs, and other organizations have asked for trees, and the states of Washington and Oregon are following California's lead in this praiseworthy undertaking.



What the Result will Be After the Years have Brought the New Planting to Mature Growth: A View along an Old Highway Now Properly Paved

Clayton Brick & Tile Co.
 Dubuque, Iowa.
 1777
 1779
 Cmt. Henry & Wood,
 Summitville

EGG-SHAPED CULVERT IS SELF-CLEANING

It has long been known that egg-shaped sewers are self-cleaning, if laid with the narrow end at the bottom, but a manufacturer has now applied that principle to culverts. The small bottom concentrates even a small flow, giving greater depth, and this has the effect of increasing the velocity and reducing the likelihood of deposit. This type will retard the deposit of silt or mud very efficiently even where the slope is not great.

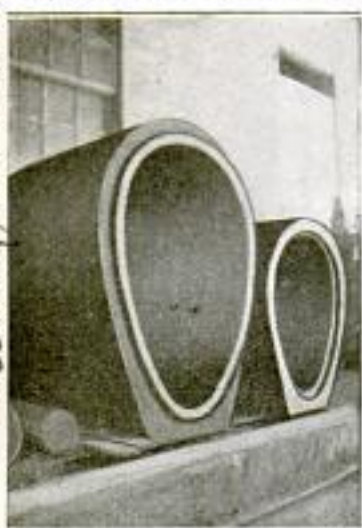

HYDROELECTRIC PLANT RUNS WITHOUT ATTENDANTS

No attendants are required at a new water-power plant built on the White River, in Indiana, operating two turbine-driven generator sets, each of 340 horsepower. A dam, 345 feet long and 10 feet high, makes available an adequate flow for the turbines. A feature is the auto-

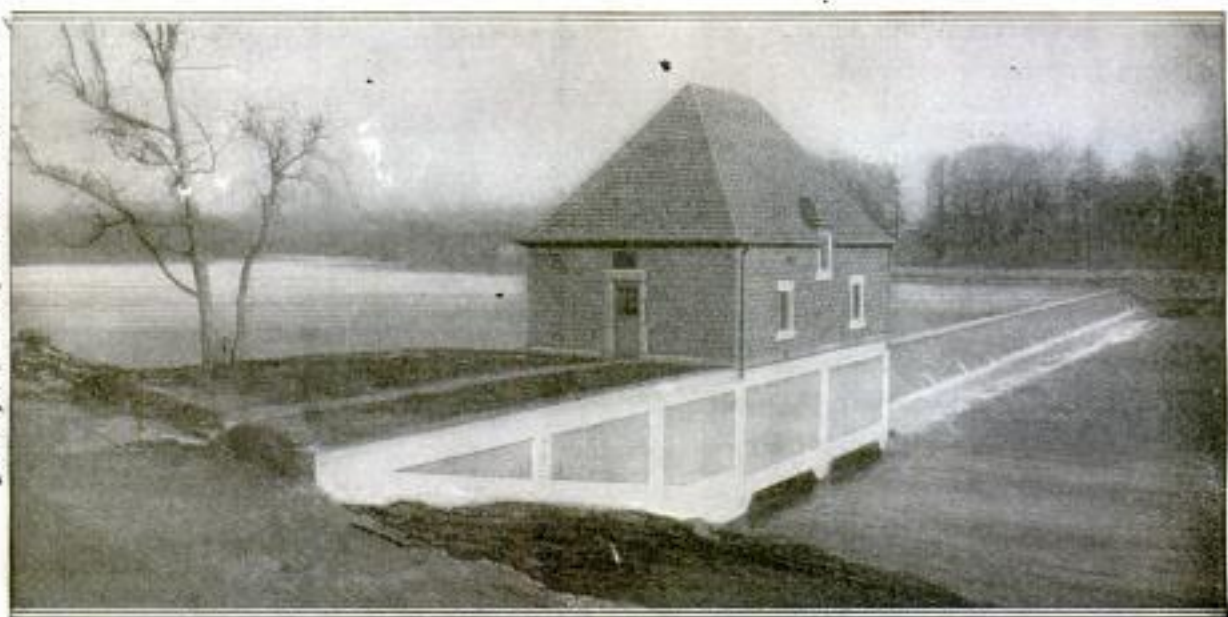

A Self-Operated Power Plant Requiring No Care except Periodic Inspection and Lubrication: All the Apparatus Controls Are Automatic, Furnishing Power According to the Water Level, and Insuring Safety by Shutting Down the Plant Before Any Permanent Damage can Result to the Equipment

matic control of the generators, which are actuated by float switches. Low water will automatically cut out one of the units, and high water will as promptly start it again. In addition, all the bearings of the machines are equipped with heat controls to prevent serious injury. An overheated bearing will automatically shut down the plant before permanent damage results. Adjoining the power house is a so-called fish ladder, which permits fish going upstream to pass the dam through an ascending series of pools.

NEW EXPANSION TURNBUCKLE HAS POSITIVE LOCK

An adjustable expansion turnbuckle is one of the clever and useful devices recently patented. The turnbuckle remains positively locked, when shut by means of an expansion lever which also serves as a wrench for making adjustments. The device has the same length of right and left-hand threads, all of the advantages of the usual turnbuckle, and will fit in the place of the usual type. The buckle is made in two parts riveted to an eccentric, of which the expansion lever is an integral part.

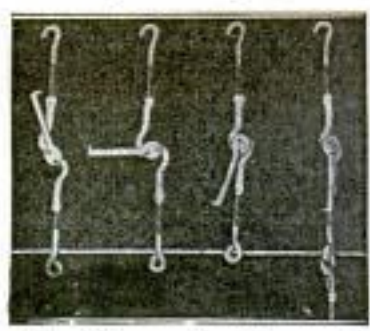

1952 *Burdette S. Wright Chief of Airways Section, office, Chief Air Service Washington D.C.*

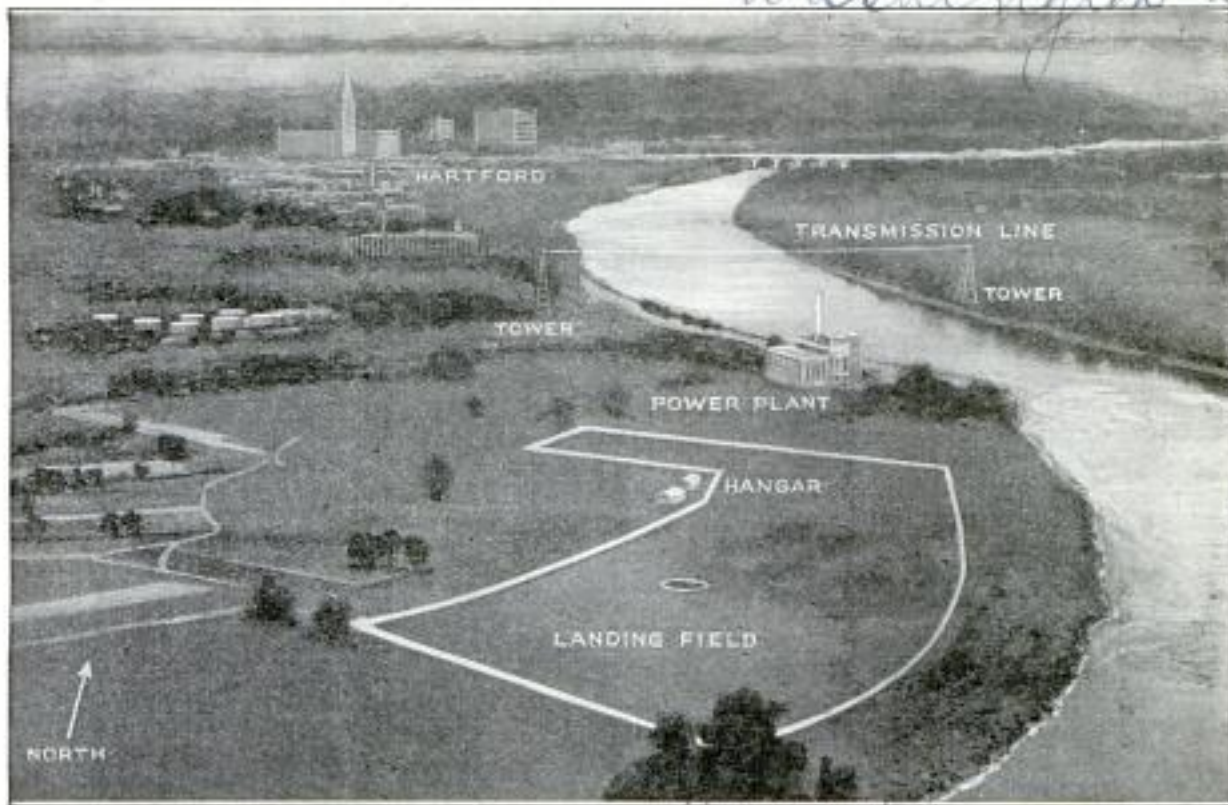

ACQUAINTING THE AIRMAN WITH THE LANDING FIELD

THE municipal landing field at Hartford, Conn., is here shown as pictured by an Army Air Service camera-man and interpreted by the airways section of the service, in the form in which it will be issued to airmen flying to Hartford. The field is located on a bend of the river just south of the city, which boasts other landmarks that are plainly visible to airmen. For safety's sake, attention is specifically directed to the power line and towers, which form dangerous obstacles for the flier near the field unless he is aware of their location. The field is identified by a circular marker, 100 feet in diameter, composed of a 4-foot band of crushed stone made more conspicuous by whitewash.

1988
WORLD'S-TIME CLOCK FOR RADIO PURPOSES

At the immense new central transmitting station in Berlin, it was imperative that the sending operators should know the exact time in any other part of the world at a given moment. Some form of clock was found necessary, that would indicate day and night, and simultaneously indicate the time at all other important radio stations throughout the world. A map of the world was therefore placed on a circular glass dial, on the outer edge of which two 12-hour scales were graduated at 5-minute intervals. This dial, being darkened around half the edge, to indicate where it is night, is moved around by clockwork. Arrows extend from the stations on the map to the edge,

indicating the approximate times at any given moment. The entire device, moving across the shaded area, eliminates need for calculation by the operator.

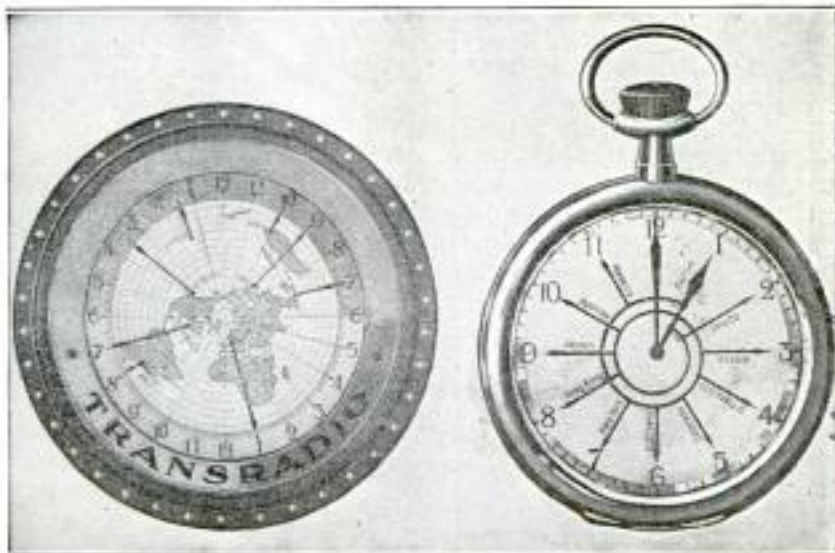

With This Form of Clock before Him, the Radio Operator in a Large Transmitting Station Knows at Once Just What Time It Is at Any Other Important Radio Station in the World

*H. G. Llesches
 Apr 12.*

*See also Chap. 14 for details
 Telegrapher, Berlin, S. W.*

Autocar Co., Ardmore, Pa.

Engineering, Revision, Air Service, McCook Field, Dayton, O.

876

POPULAR MECHANICS.

CAB TOP ON TRUCK LOWERED TO CLEAR LOW BRIDGES

AIR SERVICE PREPARES MAP FOR AIRMEN'S USE

771

1935

In use in Great Britain, but of American design, a motor truck is so con-

A new map which places before the airman practically all the desired information regarding the character of country he is flying over, has just been developed by the Airways Section of the Army Air Service. Rivers, railroads, highways, and towns are marked in different colors with a suitable indication of their class and relative importance. Various degrees of ground elevation are designated by various shadings of color. Small purple dots denote landing facilities, on which sketches are found along the border of the map, while purple crosses designate landing facilities on

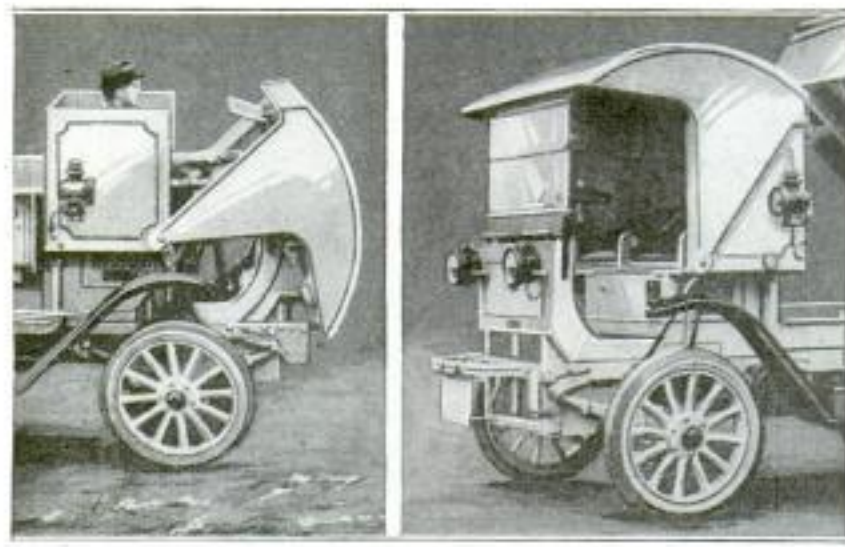

The Photograph to the Left Shows the Cab Top Swung Down over the Radiator of a Truck. To the Right, the Top Is Again in Place

structed that the cab top can be swung forward to the front of the radiator to enable the truck to pass safely under low bridges. Two triangular side supports, connected with the cab top, flank the sides of the cab, to which, at about the level of the driver's seat, they are pivoted. Between the dash of the cab and the front of the top is a hinged windshield that folds up when the top is swung forward, till it comes to rest in a position no higher than the driver's head.

which no sketches are available. The name of a town underscored means that there is a large building near the railroad, on which is the name of the town.

MICROMETER TAPE MEASURES DIAMETERS

A new tape has been produced for accurately measuring the diameter of machine parts, like the pistons of gasoline engines. It consists of a flexible steel band that is wrapped around the object to be measured, and gives a reading direct to the nearest one-sixteenth of an inch, and to the nearest one-thousandth of an inch by means of a vernier scale.

MINIATURE COPPER KETTLES 1904 MADE FROM COINS

An example of skill and patience, and the ease with which copper is worked,



Clever Manipulation and Painstaking Care Were Necessary to Produce This Set of Kettles, Each Made from a Copper Cent

is afforded in a group of miniature kettles, each of which was hammered from a copper penny. The smallest is 3/4 inch in over-all height, with a diameter at the base of 1/4 inch.

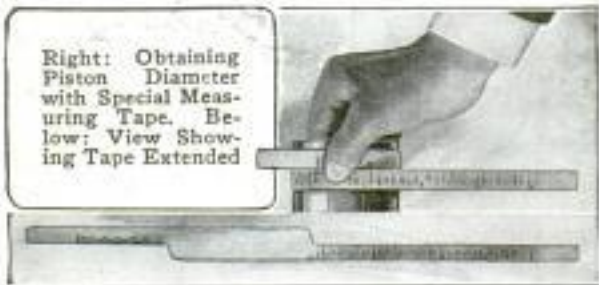

Right: Obtaining Piston Diameter with Special Measuring Tape. Below: View Showing Tape Extended

A government wireless system, with stations probably at Grays Harbor, Wash., and at Anchorage, Alaska, is planned to supplement the service to that territory now given by the army and navy.

The Schaap Co. 344 Cumberland St. Brooklyn, N.Y.

Copper & Brass Research Co. 25 Broadway New York.

1458

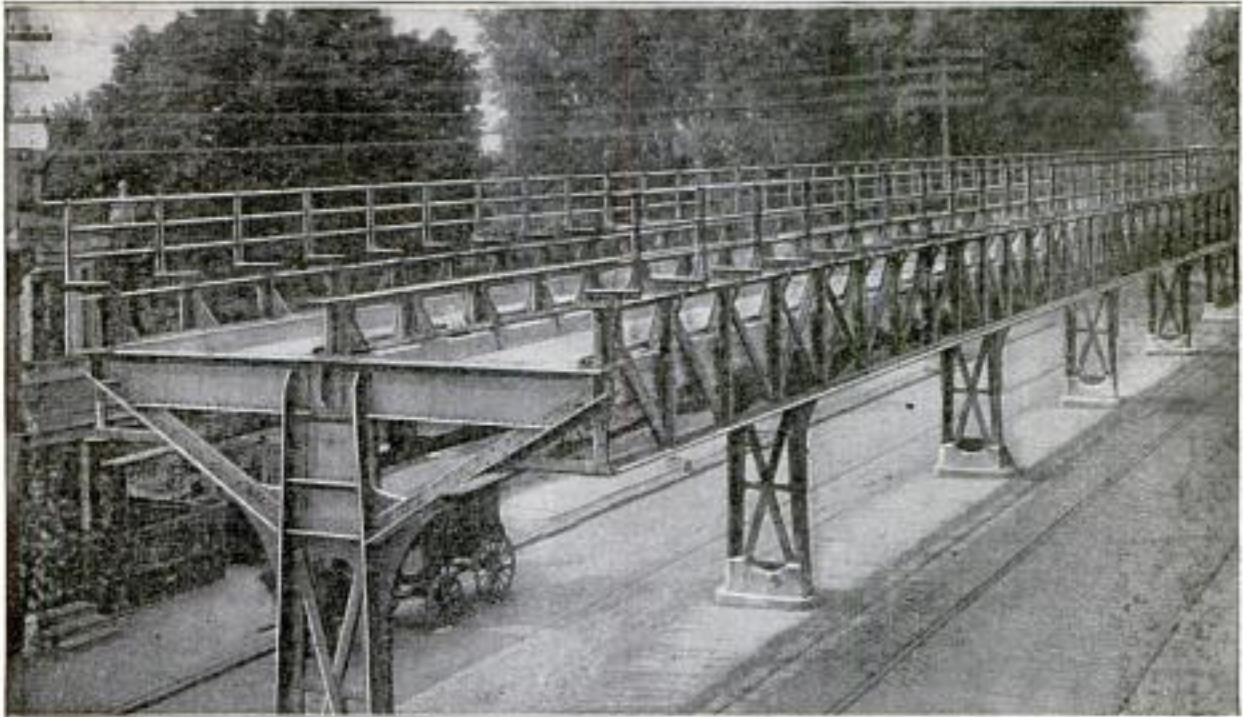

Section of the New Frankford Elevated Line in Philadelphia, in the Building of Which Every Effort was Made to Provide against Noise When the Line should Be in Operation: The Flooring Is Concrete. Supporting Posts are Resting on Concrete Foundations

PHILADELPHIANS BUILD "SILENT" ELEVATED LINE

BY WM. A. MCGARRY,

Philadelphia Pa.

THE "silent" elevated railway, or something approximating it, has been achieved in Philadelphia. That city has just completed and opened to the public a 6½-mile stretch of high-speed transit line that is held by engineers to be the quietest in the world. It is also of interest by reason of the advance it marks in the adoption and use of mechanical safeguards against accident.

The first contract for the work was let in 1915, and when completed, the aggregate cost of the line was \$15,000,000. Of this, \$3,000,000 alone was spent on cars.

Quiet operation has been achieved quite simply from the point of view of the engineer. The methods used represent a forward step in comfort and health. Pedestrians may converse without effort while a seven-car train passes overhead at full speed. There is a noise, but it is more like the distant boom of a big gun than the familiar high-pitched clatter of a passing train.

In the Frankford line, two major developments were made on the structure itself in addition to the improvements in the cars. The first was to fill the interstices of the H-beam uprights, on which the road is carried, with concrete. Various experiments have shown that such beams act as sound transmitters, carrying to the pedestrians vibrations that otherwise might have been dissipated in

the air above. The second change was in the support for the rock ballast in the roadbed. Instead of using the familiar bolted latticework of steel, the engineers put in concrete arches. The result was



General View of the Interior of One of the Stations on the New Philadelphia Elevated Railway: Entrance to Platform Is from Upper Level

Copyrighted material

*Pemberton Injector Co.
360 Holden Ave.
Detroit, Mich.*

a structure almost as solid and vibration-proof as masonry.

For about a mile near the terminus, the line runs through a part of Frankford Avenue, which is so narrow that a center-column structure had to be used. Even here the engineers managed to attain an unusual solidity. A special type of column was designed, supported below the street surface by plate girders that in turn rest on concrete piers 12 feet apart. The result has been a considerable deadening of noise even when the old-type cars are used.

The new cars are similar in some respects to those in use on the later lines in New York, but they have some addi-

tional safeguards. Fully automatic couplers were installed, the use of which not only eliminates the necessity of brakemen standing between the cars when trains are being made up in the yards, but also equalizes the speed of each car so that the train acts as a unit. It makes for less noise and more comfort. Another step in that direction is dual control of the air brakes, one of the old type, and the other electrical, the latter being instantaneous. In the old equipment, when the motorman applied the brakes, the first car in the train was the first to slow down. The second car bumped into the first, and so on throughout the length of the train.

**PORTABLE INSTRUMENT GAUGES
TANK CAPACITIES**

A portable instrument has been invented and marketed recently which quickly and conveniently determines the



capacities of large tanks of irregular shape, without special measurements and calculations. The device is mounted on a tripod, and is equipped with a stop watch, and inlet and outlet valves. In use, the instrument is placed over the manhole

of the tank to be calibrated, and a suitable nozzle, whose rate of flow is known in advance, is fitted to it, whereupon water is turned on. When the tank is full, the elapsed time is carefully noted with the stop watch, and the total quantity of water passed is determined from a set of tables.

**FREEZING BEFORE FORCING
IMPROVES RHUBARB**

Recent experiments have shown that rhubarb of exceptional tenderness can be grown from roots that are allowed to freeze before forcing their growth in a warm, moist atmosphere. The explanation is that the plants do better after

undergoing a rest, and that freezing provides the necessary dormant period during which nourishment is stored. The plants can be packed in moist sand and grown in a warm cellar. While the quality of the stalk is the same for plants grown either in the dark or the light, those grown in the dark have a very small leaf.

**RADIO HEADSET HAS WIDE
RESISTANCE RANGE**

The so-called "cracking" or rattling of the diaphragm common to most radio telephones is eliminated in a new type of headset, which

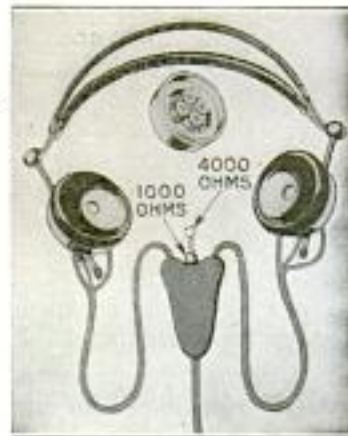

uses a four-pole, instead of the usual two-pole construction. This affords a resistance range of 1,000 to 4,000 ohms, making it suitable for the high resistance found in a vacuum-tube set as

well as for the low resistance of a crystal set. The poles of this improved headset are slotted their full length, in quarters, improving the tonal reproduction.

Oil-burning ocean vessels without large funnels are said to be regarded skeptically by Russians, Poles, and their neighbors, when about to emigrate to the United States. More often than not, in spite of explanations, they insist on using boats with smokestacks.

*W. J. Fraser & Co Ltd, England
Lagenham, Essex.
W. S. Blair, Supr. Dominion Experimental Farms,
Parkland, Alberta, Canada*

*12 centrolle. n.s.
steph of agriculture,*

2033

W. S. Blair, Supr. Dominion Experimental Farms, Parkland, Alberta, Canada

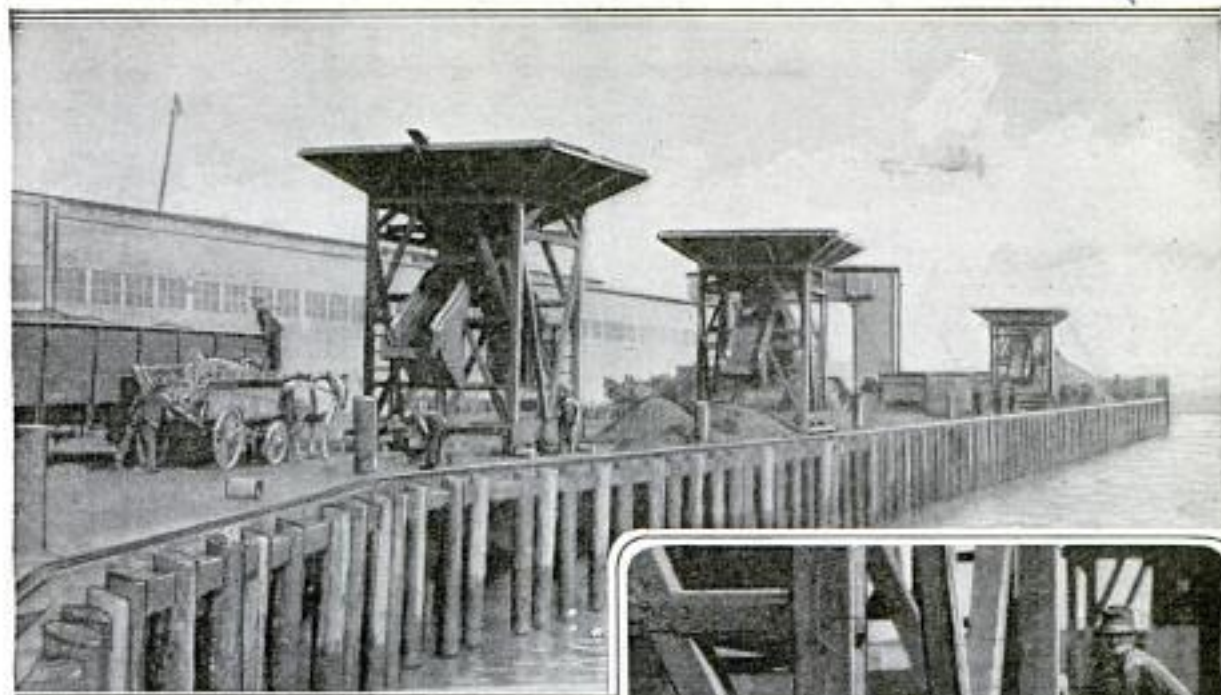

A View of One of the San Francisco Coal Docks, Showing the Unloading Towers Lined Up for Duty: Being Mounted on Rollers, They can be Shifted About Easily

1910
**ROLLER-MOUNTED TOWERS
UNLOAD COAL SHIPS**

Unusually heavy shipments of coal and coke coming into San Francisco by steamer made necessary a change in the design of the coal-handling towers in order to speed up the unloading of the ships. These towers were so heavy and cumbersome as to be moved only with great difficulty. It was decided to mount each of them on six heavy steel rollers to make them more easily portable. The rollers used were 8 inches in diameter and 3½ feet long, grooved deeply around their circumferences to receive the bearing of the tower supports. Iron bark, one of the heavy and tough woods, was used as bearing material. A steel plate, well lubricated, lying between the two parts of the bearing, permits it to be swiveled like a chair caster.

1956
**RADIO AND PHONOGRAPH SETS
IN TABLE LAMP**

Ingenious adaptations of radio outfits continue to appear on the market, one enterprising inventor having fitted up a table lamp to include both a radio set and phonograph in its base. No aerial is required, as the lamp is made of copper; neither are batteries necessary. One of the special features of the outfit is the use of a magnetized diaphragm, built like



Close-Up of the Steel-Roller Bearings, of Which Six are Located under Each Coal Tower: Details of the Swivel Arrangement may Also be Seen

a camera shutter, which can be opened or closed in order to vary the volume of sound. A door on the lamp base conceals the interior, thus effectively hiding the inner mechanism.



Right: Combined Lamp, Radio Set, and Phonograph, Said to Be the First of Its Kind Invented. Left: Magnetized Diaphragm for Varying the Sound

J. W. Hoehstetter, Dayton, Ohio.

1686

Hilroy Harris American
Australasian Bureau
PEARL FISHING OFF WESTERN AUSTRALIA
Box 516 Ed. P. O. Chicago

Group of Pearling Lug-
gers Anchored outside
Broome, on the North-
west Coast of Australia;
In the Town One Finds
Asia and the East Indies
Fully Represented; for of
the 2,500 Total Popula-
tion, 1,500 Are Colored
Allens, and Mostly Em-
ployed in Pearl
Diving



These Pearl Are of Various Grades. Other Qualities Being Equal, the Nearly Spherical or Symmetrical Pearls Are the More Valuable. Some of the Ornaments Carved from the "Baroques," or Irregularly Shaped Pearls, are Also Shown

One of the Divers About to Descend: Upon His Reaching Bottom, a Basket will be Lowered to Him for Use in Hauling Up the Shells. The Diver's Pay Is in Proportion to the Number He Collects. Some 120 Feet Is Usually as Deep as He Dares to Go. At Any Depth He can Stay under Water But a Short While

PICTURESQUE AND THRIVING INDUSTRY



Certain of the Shells, When Opened, may be Found to Contain a "Blister," as Shown to the Right. This may Cover a Valuable Pearl or, More Often, a Misshapen One. Above: A Close-Up of a Blister

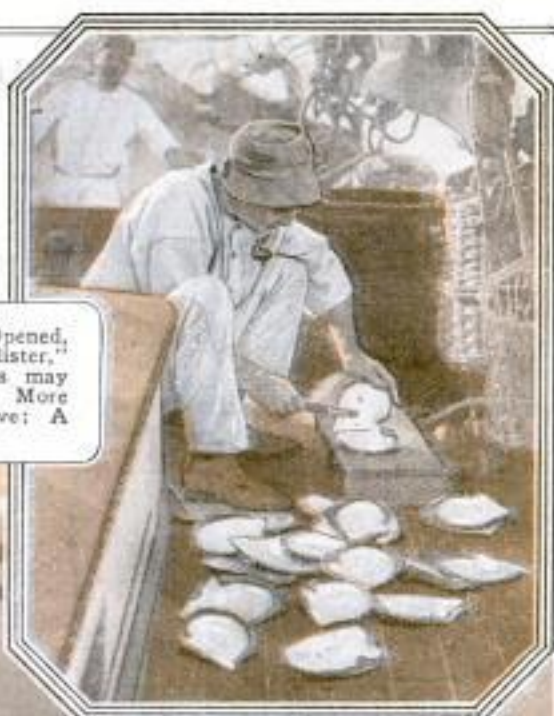

Whether or Not Pearls are Found, the Shells are Brought Ashore. The Pearlless Shells are Later Exported to Cities throughout the World to be Made into Pearl Buttons of Various Descriptions

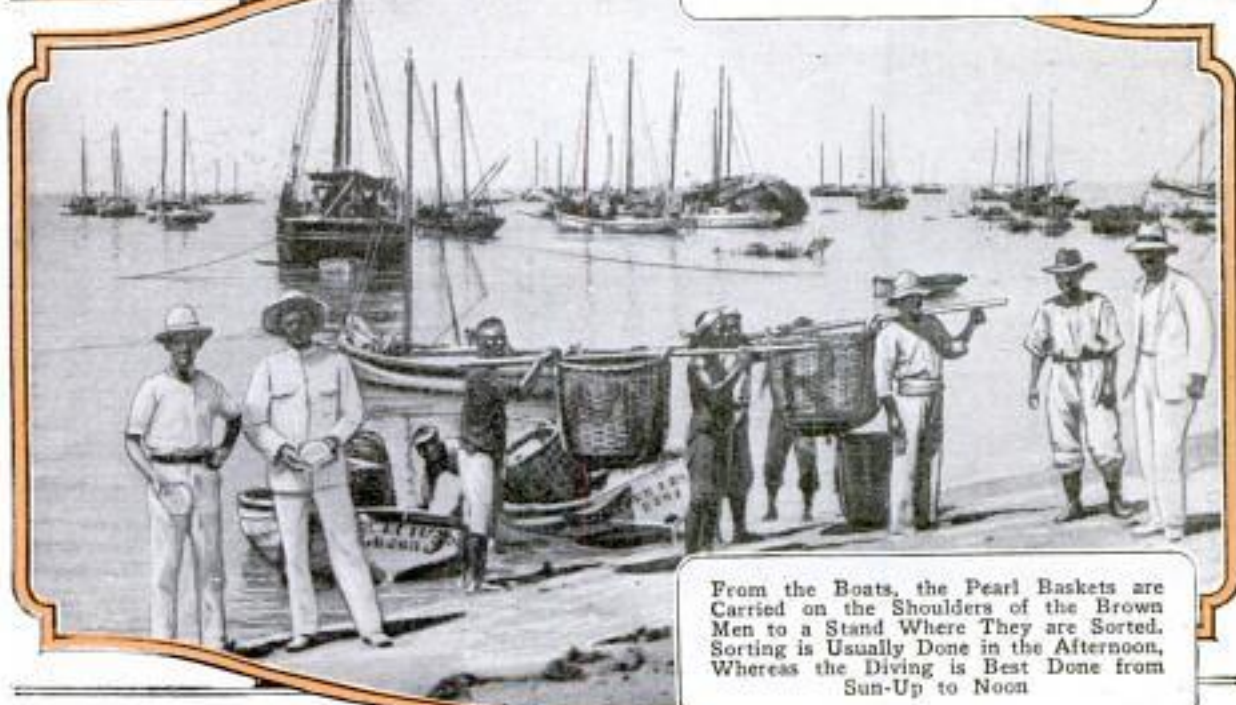

From the Boats, the Pearl Baskets are Carried on the Shoulders of the Brown Men to a Stand Where They are Sorted. Sorting is Usually Done in the Afternoon, Whereas the Diving is Best Done from Sun-Up to Noon

Frank A. Agner

Bemis Bag Co.

1214

WATER-SUPPLY INTAKE LINE FLOATED INTO POSITION

Floating into position 1,500 feet of 14-inch pipe in a continuous length composed of 30-foot sections, was an interesting piece of construction successfully accomplished in connection with a recently completed intake for the water-supply system at Peoria, Ill. The Illinois River at this point flows through a channel that is 22 feet deep 20 feet from the shore, but owing to the water received from the Chicago Drainage Canal, the stream overflows a flat, formerly a corn-field, to a depth of 3½ to 4 feet, and forms a shore line 1,500 feet from the edge of the channel.

The first step in the installation of the pipe line, which extends from a concrete pump pit on shore to a point just beyond the edge of the main channel, was the construction of two barges, 12 feet long, 4 feet wide, and 2 feet deep. The barges were then connected by 4 by 6-inch timbers which held them 30 inches apart. On each barge was erected an A-frame. Across the top

of the A-frames was fastened a beam, to the center of which was attached an eyebolt for the suspension of a chain hoist. Then, near the shore and in line with the concrete pump pit, were placed two bucks similar to the ordinary saw-buck. The first length of pipe, the outer end of which had been closed with a blind flange and chained to the cross

beams between the barges, was allowed to rest on the bucks, while a second length was brought from shore and bolted to its open end. When this was completed the second length was pushed ahead onto the bucks and across the barges out into the stream. The process was repeated until the barges were 1,500 feet from shore and the pipe line lay floating on the water with one end chained to the barges and the other resting on the bucks. Under these conditions it was possible to anchor the barges over the desired intake location, and, after removing the blind flange, attach a suction

length consisting of a swivel elbow and strainer. The shore end was then taken from the bucks and bolted to the pump

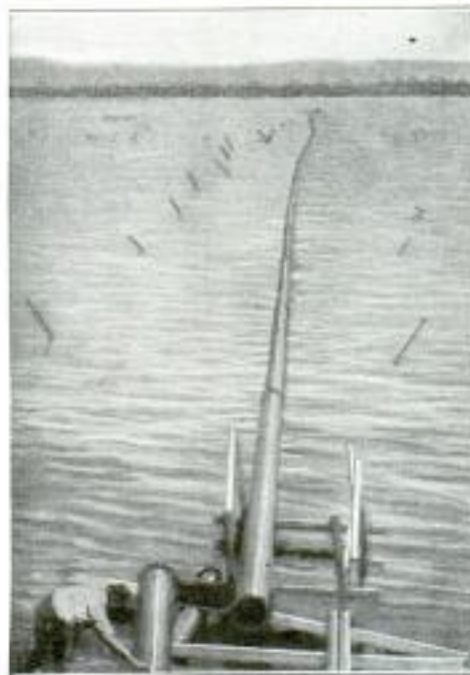

Rolling Last Length into Position for Attachment to the 1,500-Foot Pipe Line Which is Shown Floating on the Water

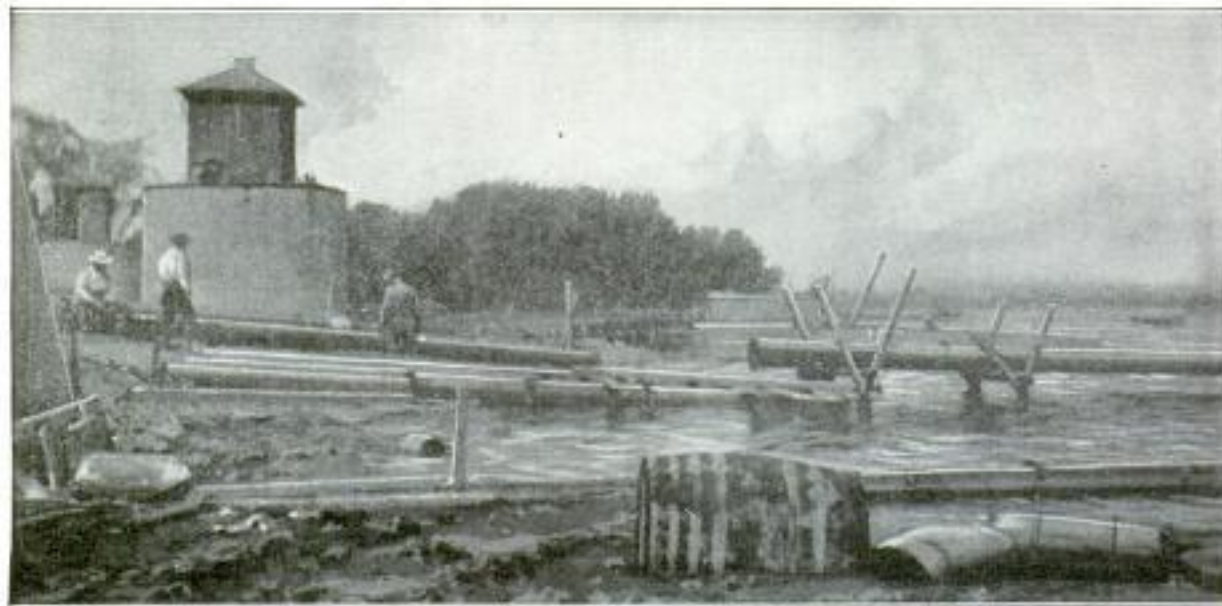

Workmen Bringing from the Shore, at the Left, a 30-Foot Section of 14-Inch Pipe to Connect to the End of the Intake Line Resting on the Bucks at the Right: The Line Floats with Its Outer End Chained to Barges

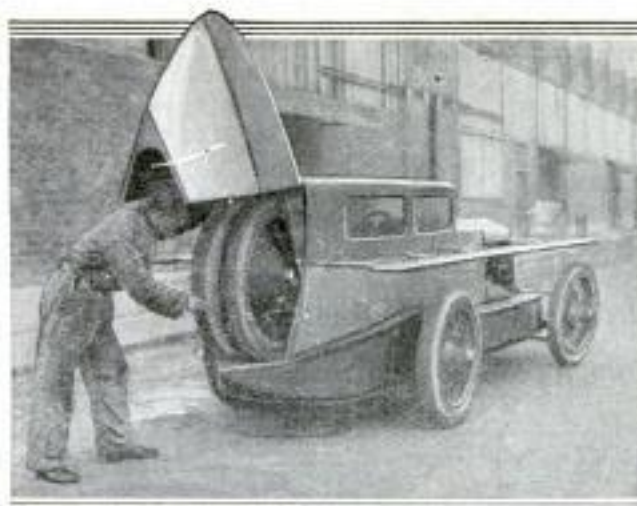

Entrance is Gained by Lifting a Side Panel

Above: The Rear Portion of the Car Swings Upward, Disclosing a Compartment for Two Spare Tires. Right: A Side View of the Automobile Which is Believed to Embody the Latest Development in Scientific Streamlining. The Car was Designed in Collaboration by French and English Engineers

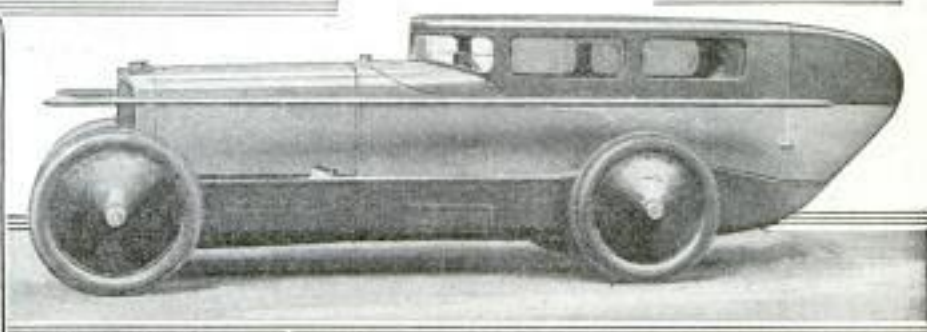

PHOTOS BY MEURISSE, PARIS

suction, with the joint cracked sufficiently to provide for a vent. By lowering on the chain hoist attached to the A-frames of the barges, the whole line gradually sank until it rested on the bottom. Anchors, composed of two 1-cubic-foot blocks of concrete joined by a chain, were placed at 100-foot intervals along the line, and thus the pipe finally imbedded itself firmly in the muddy bottom of the river.

2044

NEW TYPE OF FRICTION CLUTCH ENDS JERK

Improvements in the wood-shoe friction clutch are claimed for a new type recently brought out in Germany. The clutch features a specially designed, highly elastic S-spring inserted into the clamping mechanism. This, by reason of its great resilience, is said to overcome any jerk when the clutch is engaged, thus avoiding breakage of the clutch itself as well as the machine controlled by it. Moreover, the new clutch is greatly reduced in size and weight, and the clamping pressure, in the dead-point position, is only slightly in excess of what it is when the clutch is completely thrown in. The special spring also enables the clutch to be thrown in readily under any load.

STREAMLINING CUTS DOWN 1980 HEAD RESISTANCE

Concentrating their attention on scientific streamlining, Franco-British engineers have designed a most unusually shaped automobile which, they believe, will prove very speedy, since head-resistance to the wind has been cut down considerably. The body is built of duraluminum, a new light alloy, and aluminum on a system like that used in making airplane fuselages. The under part of the car is incased in sheet aluminum, only the brake drums and axles projecting. Entrance is gained to the car—powered by a six-cylinder motor developing 200 horsepower—by a side panel, and by a part of the roof and a section of the fender being hinged and, so, easily raised. The entire car weighs only about 3,000 pounds.

Experiments in growing rubber trees are expected to be the first concern of the Department of Agriculture on its test farm at San Diego, Calif., land for which has been chosen and a lease asked from the city by the government. The new station will propagate many foreign plants used in various industries, and conduct experiments for the purpose of discovering rubber substitutes.

mp. Wagon - machinbar, A. 22
Lorality Saermany

Manchester Guardian Commercial 3/29/23



CURTAIN OF WATER FIRE IN

BY CHAS.

AN effective method of extinguishing fires that occur in oil that is stored in large open-top tanks, recently demonstrated that a fire of considerable proportions could be quickly put out by a curtain of water properly applied. The features of the method lie in water distributors and their arrangement for covering the surface of the burning oil with an unbroken sheet of water that prevents air from reaching the source of the fire. The action of the spray nozzles is assisted by mist formed from the impact of the fine water jets against the sides of the tank and by some of the water being converted into steam due to the heat from the burning oil.

The water distributor, which is made of heat-resistant metal, consists of a nozzle with an orifice restricted by means of an inverted conical-shaped disk with a threaded stem that is screwed into a cross rib through the central opening in the nozzle body. Several small holes through the stem and outer face of the conical tip provide for additional jets of water. This type of nozzle produces a high-velocity spray that forms a sheet

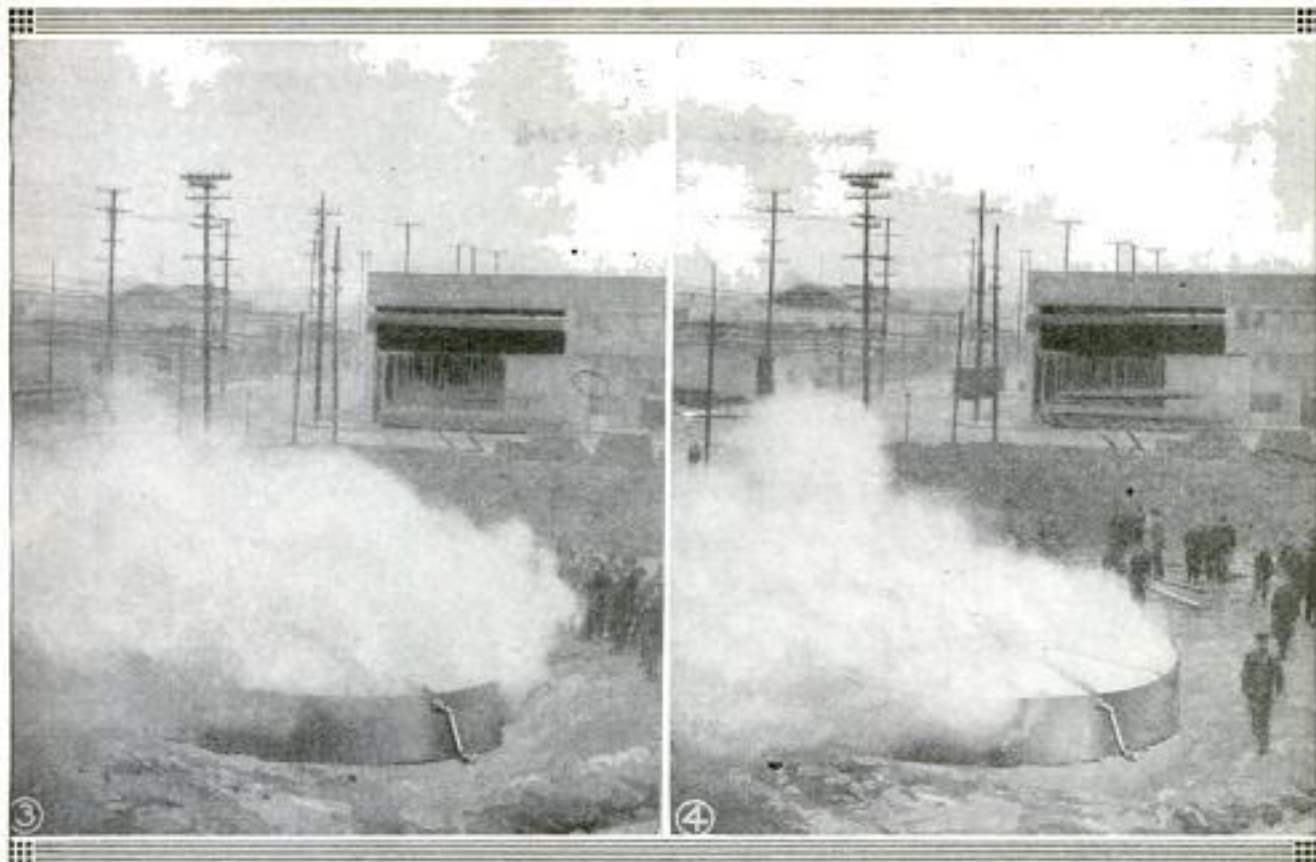

QUICKLY PUTS OUT OIL TANK

W. GEIGER

of water radiating out from it in a horizontal direction.

In one of the tests, the flames from 850 gallons of oil which had been burning for five minutes, were extinguished in less than five seconds with 25 gallons of water. The accompanying illustrations, in the order they are numbered, show an oil-tank fire which had been burning for four minutes; the fire just after the water had been turned on and the curtain of water had extended over the surface of the oil; the action of the water curtain in checking the fire, two seconds after the sheet of water had spread over the fire, which, it will be noted, is practically out; the effect three seconds later; the appearance 10 seconds later, and the water issuing from the nozzles shortly after the pressure was shut off.

☛ Stating that the development of aerial and submarine sound generators offers a large field for scientific effort, a member of the National Research Council's committee on acoustics has proposed an experimental ship to be equipped for research in this phase of marine physics.

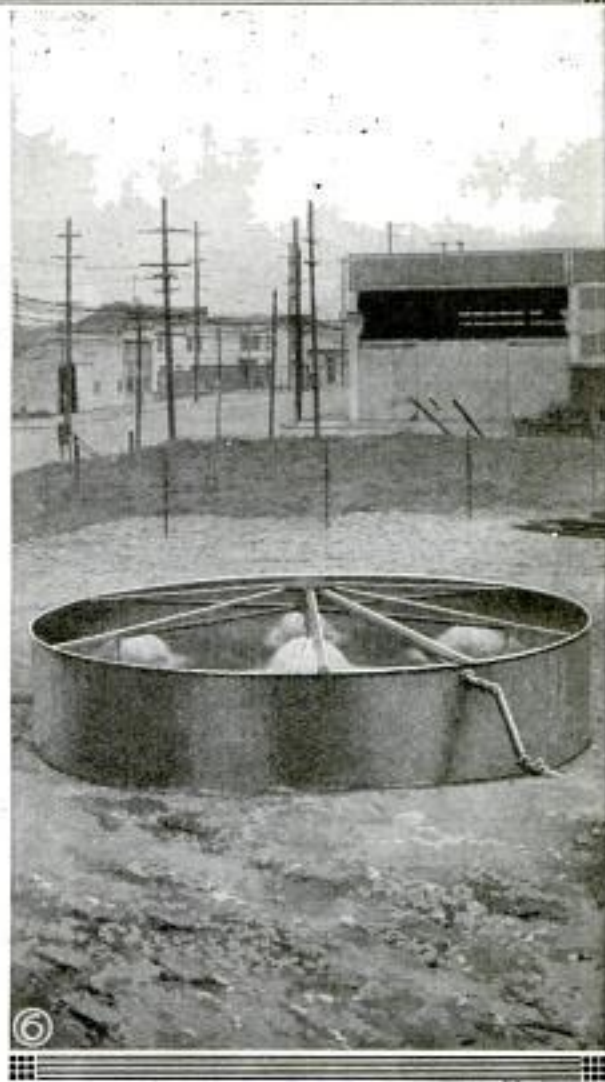



A Construction View on the Banff-Windermere Highway, Indicating the Mountainous Nature of the Country: In the Left Foreground a Portable Bucket Loader can be Seen Elevating Material from the Roadway and Depositing It into a Wagon for Removal

LAST LINK IN 6,500-MILE HIGHWAY COMPLETED

mo. By E. M. WEBBER *Parkland*
Alta. Canada

WITH the official opening of the Banff-Windermere Highway in the Canadian Rockies, scheduled for the near future, the last link in a 6,500-mile chain of scenic roadway will have been welded into place, making an unbroken circuit from California to Canada and return. Thousands of Americans will, no doubt, be attracted by this tour, as it passes through Grand Cañon Park, Yellowstone National Park, Glacier Park, and the Shuswap Indian Reserve in western Canada, and traverses part of a most picturesque country. From Macleod, in southeastern Alberta, a "rectangular" route can be covered, in-

cluding the beautiful 93-mile link from Banff to Windermere, just completed. One side of the rectangle runs north from Macleod, crossing many streams, through Parkland and Midnapore to Calgary. Here the road makes a great winding turn in a generally westerly direction toward the wonderful country surrounding Banff. After leaving this latter town the road soon begins to run south, ascending steadily past Sinclair Pass, which divides the Brisco and Stanford ranges. Vermilion Pass, the highest point on the trip, is just ahead with an altitude of 5,376 feet. The fourth, or southerly side of

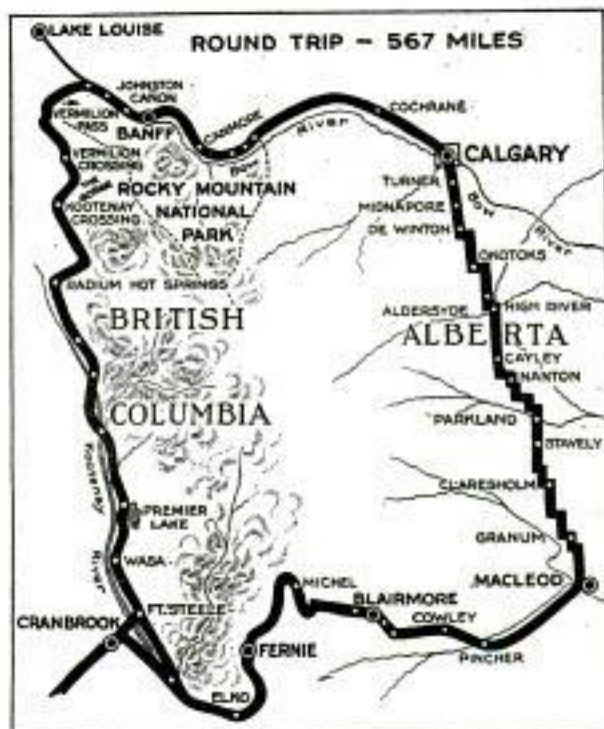

A Scenic Route for the Motorist Who Enjoys the Beauty of Mountainous Country: Banff Is in the Northwestern Corner of the "Rectangle"

883



On the Road between Banff and
Lake Windermere, near Radium Hot
Springs: Towering Cliffs Flank the
Highway That was Literally Blasted
Out between Them

the rectangle begins after Fort Steele is passed, near Elko. Here the highway swings sharply to the north, as if it had lost its sense of direction, but, recovering at Michel, it turns east, making a sharp "corner" again at Pincher, and reëntering Macleod, the starting point, from the

southwest. Every part of this 567-mile circuit passes through regions of great natural beauty, and the motorist cannot but feel well rewarded after making the round trip. The route is conceded to be one of the finest in Canada by those familiar with its scenic highways.

1934 *Brown*
OIL HEATER USES SEPARATE COMBUSTION CHAMBER

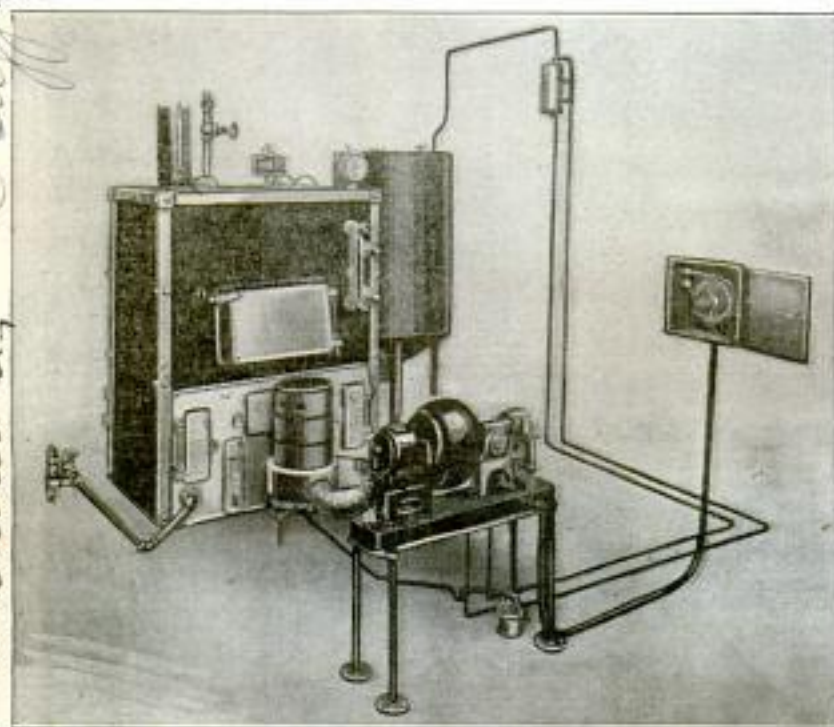

The Separate Combustion Chamber is the Small Cylindrical Tank Directly in Front of the Heater. A Rheostat on the Wall, Connected to the Temperature Regulator, Governs the Speed of the Motor Running the Air Blower

The necessity of lining with firebrick or clay the fire box of oil-burning boilers and furnaces is eliminated in a new type of burner which uses a separate combustion chamber. An additional advantage of this burner is that combustion is localized and intensified in the separate chamber, having the effect of muffling the roaring noise of burning oil. A motor-driven air blower maintains the proper air-to-oil ratio, and a centrifugal type of oil governor, mounted on the blower shaft, controls the oil feed. If the current should fail, the motor would, of course, stop, causing the weights of the governor to drop, closing the oil valve.

1858 **NEW DEVICE LOWERS VOLTAGE FOR ARC WELDING**

A new device designed for using arc-welding apparatus in connection with 500-

volt direct current, such as is available on many electric railways and in some industrial plants, consists of a resistor-reactor that operates in connection with a potentiometer. The potentiometer voltage, minus the arc voltage, determines the dropping-out voltage which may be set at some such value as 30 or 40 by means of special resistance and adjusted to a fraction of a volt. It is said to maintain a reliable 1/4-inch arc without objectionable flashing and the resulting crater.

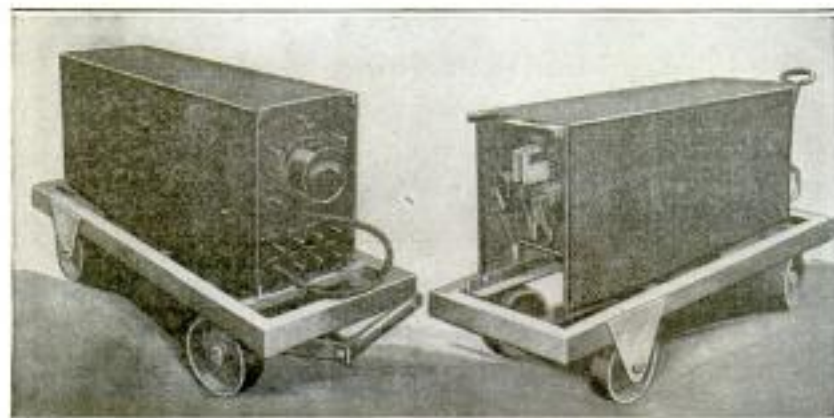

Two Views Showing Opposite Ends of the New Resistor-Reactor That Operates in Connection with a Potentiometer to Reduce Direct-Current Voltage to a Value Suitable for Arc Welding

Electric Arc Cutting + Welding Co. Newark, N. J.
 152
 Copyrighted material

1644 Chas. Cary Rumsey
 Studio Garden Wheatley Hills

L. d.
 N. Y.

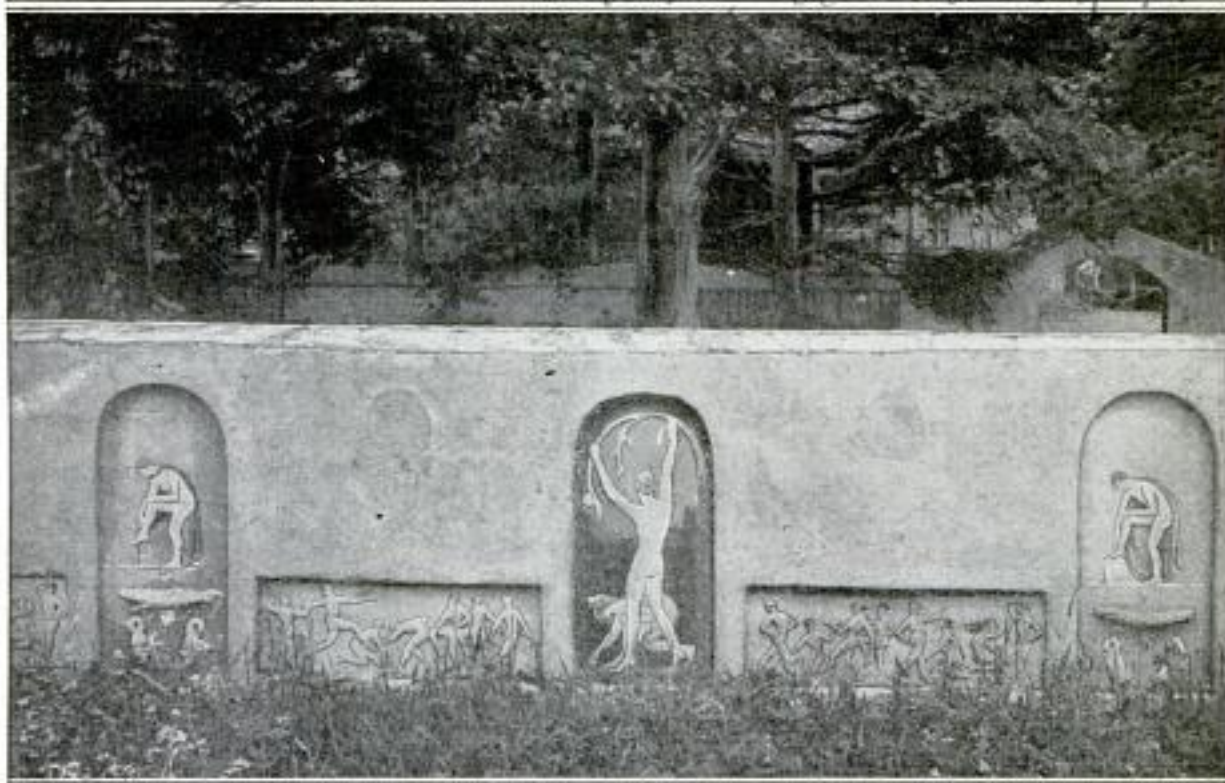

These Panels Easily Convey the Impression of Vigorous Outdoor Beauty. They are Molded in Appropriately Colored Cements, and Adorn the Studio Garden Wall of Charles Cary Rumsey, a New York Sculptor, at His Estate in the Wheatley Hills of Long Island. Note How Well They Harmonize with Their Setting

COLORED FIGURES ADD LIFE TO CONCRETE WALLS

1644

BY ARTHUR JONES

DECORATIVE panels for concrete walls on suburban estates may be developed to such a point as to form a most attractive feature. This conclusion was reached by a New York sculptor, Charles Cary Rumsey, after making extended experiments on his own estate in the Wheatley Hills of Long Island. What would otherwise be bare and unattractive gray walls are transformed by the magic of colors and lifelike figures into ornamental features that add greatly to the beauty of the lawn or garden. For the walls of his estate, the artist selected for panels and borders the figures of grace-

ful Grecian dancers, vigorous animals and flying birds. The first problem he had to solve was how to put the colored concrete into molds. He determined that

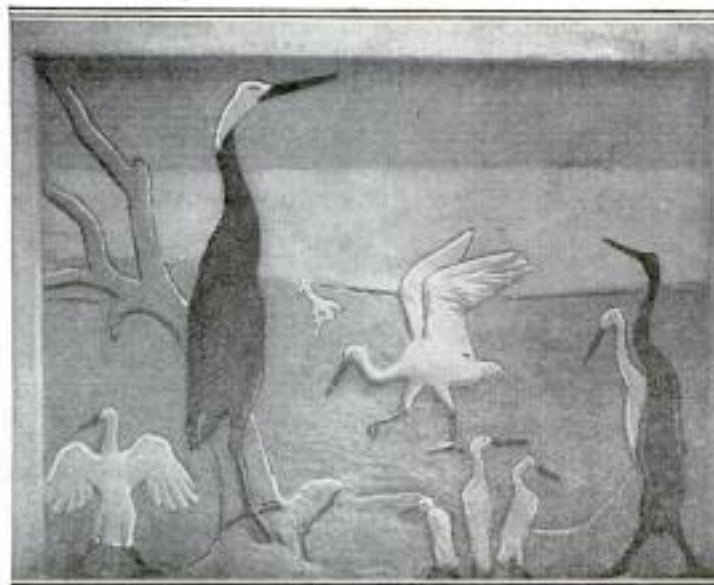

This Panel Is in Relief, and Illustrates How Effectively Colored Cements may be Used for Tinting Molded Figures. The Sculptor has Used Birds to Produce an Outdoor Effect

the relief must be simple and broad and not too sharp. One of its special charms must come from a softening and blurring of the outline through the peculiar rough nature of the concrete.

In making the panels, the sculptor has used many colors, that is, each panel is in a different color scheme. One panel, for instance, is in black and white, another in light and dark blues, a third in contrasted greens, and so on. Wild horses,

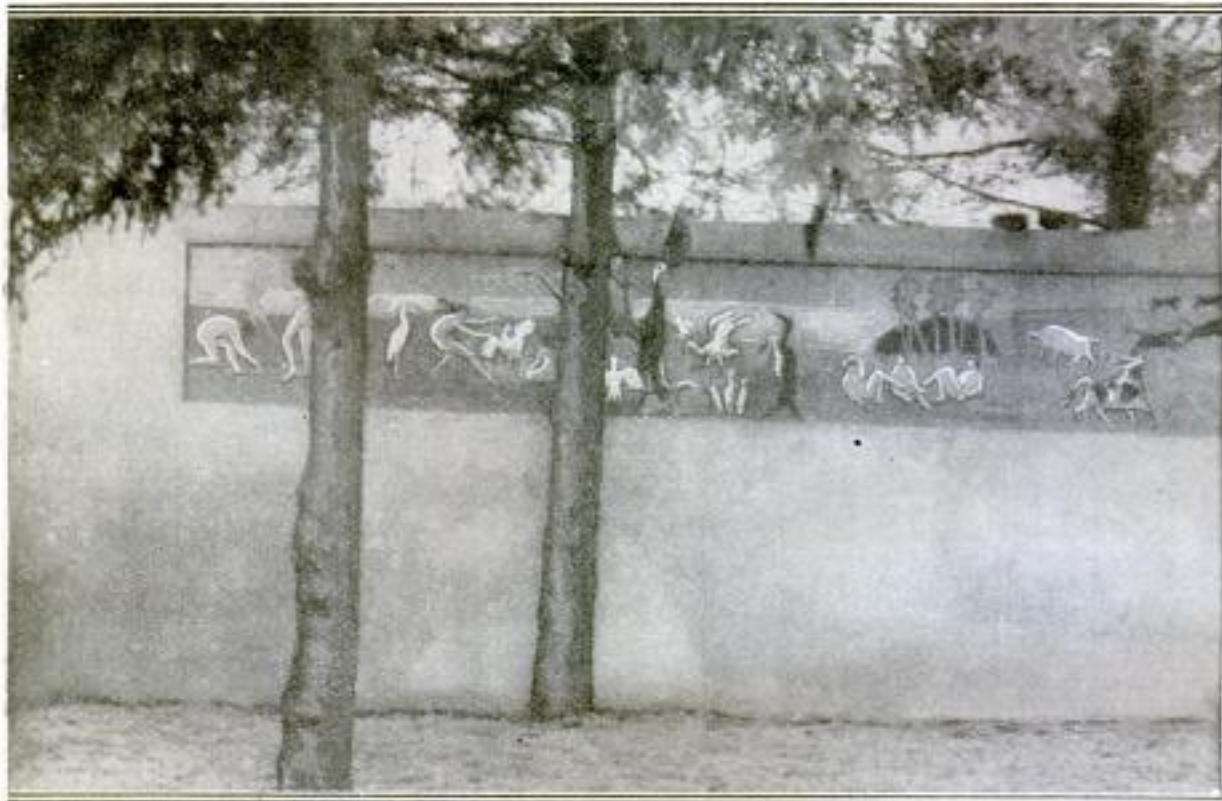

Flying Birds, Leaping Beasts, and Dancing Nymphs Are the Effective Mediums Which the Sculptor has Used to Add Color and Life to the Gray Walls. The Vigorous Action Portrayed in the Panel Is in Keeping with Its Surroundings, Also Supplementing Its Beauty

bulls, giraffes, pelicans—all in motion—are vividly portrayed in appropriate colors. Just how well these colors will stand exposure remains to be seen, though one panel that was built four years ago, has, so far, shown no deterioration through weathering.

ONE-SHEET WRITING PAD MADE TO LAST "INDEFINITELY"

A small writing pad which can be used "indefinitely" without renewal has been patented recently. The device is made of a sheet of cardboard covered on its upper side with a blue-wax composition. Over the wax is a sheet of strong tissue paper, and on top of this a sheet of a transparent substance resembling celluloid. This upper sheet, when written on with a blunt instrument, causes the tissue paper to stick to the wax, making visible the writ-

EMERY-WHEEL ATTACHMENT FOR FACING VALVES

The need of special and expensive grinding machinery for the facing of valves is eliminated by the use of a simple emery-wheel attachment which is about to be placed on the market. Valve and stem are supported in a small bracket easily attached to the grinding-

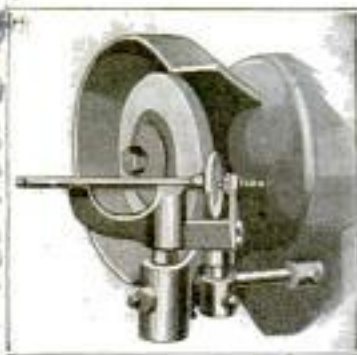

wheel frame, and vertical, horizontal, and rotating adjustments are provided to bring the valve face into proper contact with the emery wheel. A sheet-steel safety guard envelops the wheel and keeps the grindings within bounds.



The "Everlasting" Writing Pad: Lifting of the Central Tissue-Paper Sheet Causes the Writing on the Celluloid Top Sheet to Disappear

ing. To "erase," the tissue paper is lifted off the wax, neither retaining any impression.

*Mystic Novelty Co.
Cedar Rapids, Iowa*

*Spec. W. Sutton, Box 70,
Menasha, Wis.
1787*

1077

1787

Copyrighted material

1816 Eng.-Prof. Frank L. Snow,
Dept. of Industrial Journalism,

POPULAR MECHANICS

891

Oregon Agricultural College HENS REGISTER EGGS WITH NEW DEVICE *Corvallis, Oregon.*

Hens may now "write" their own egg-laying records by means of a device recently invented. It consists of a trap nest enclosed in a sheet-iron box, 36 inches long, 14 inches wide, and 20 inches high. The recording attachment is a rubber stamp bearing the hen's name or number, which is fastened to its back by wire loops. When the hen enters the nest, the stamp rubs against an ink pad. As the hen advances a few inches farther, the stamp makes an impression on a strip of paper running upon two rolls. Immediately beyond is the door of the nest proper, and as this is

forward the space of one impression. The egg rolls down into a small trough ex-

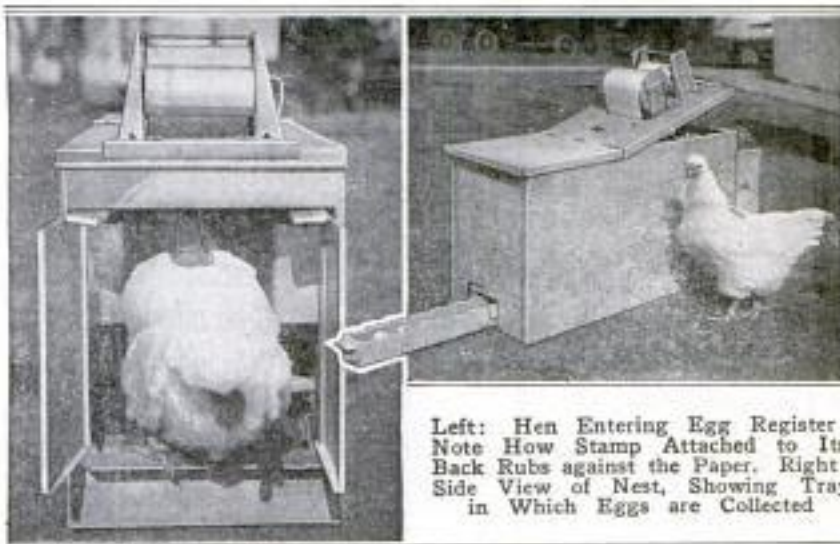

Left: Hen Entering Egg Register; Note How Stamp Attached to Its Back Rubs against the Paper. Right: Side View of Nest, Showing Tray in Which Eggs are Collected

opened, the paper is automatically moved

tending from the base. The arrangement permits accurate check by the owner.

11101

MINING ALABAMA COAL WITH STREAM OF WATER

For the first time in Alabama, hydraulic mining of coal has been resorted to at Alco, for loosening and breaking down the banks of a surface deposit, eliminating considerable hand labor. In this case, stripping operations with machinery would have been too

expensive, consequently a small steam-power station was erected near an



Above: The Force of a Stream of Water under High Pressure is being Used to Break Down the Bank of This Coal Deposit, Making It Easy to Handle. Below: A Section of Cast-Iron Pipe, Conveying the Water

adjoining creek for pumping water to the coal site. Cast-iron pipe is used to bring up the water, and a stream of great force is shot against the bank, loosening the coal so that it can be handled easily. This system has been used with great success for mining operations elsewhere.

Contrib. Will W. Nelson, 2509 15th Ave.
Birmingham, Ala.

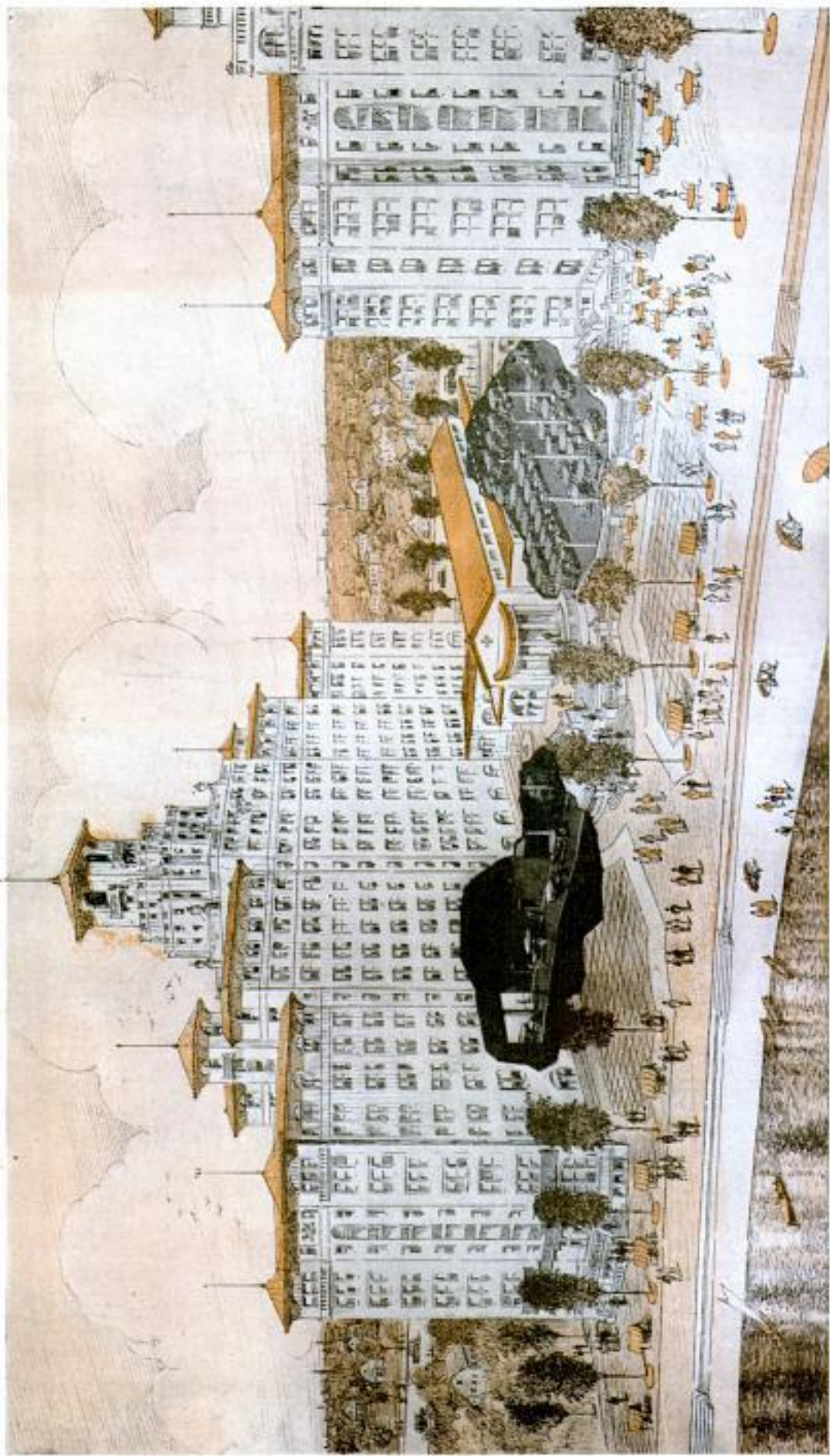

A Sectional Interior View of the Tunnellike Passageway, Which will be Built under the New Addition to the Edgewater Beach Hotel in Chicago: It Leads into an Underground Parking Space and Storage Area, Lying Directly under the Plaza That Connects the Two Main Sections of the Structure, and is Solely for the Guests' Convenience. This Storage Area will be Two-Thirds of an Acre in Extent

Architects - Marshall & Fos.
617 21 N. Michigan Ave.

UNDERGROUND PARKING SPACE FOR HOTEL GUESTS

BY H. S. GRASSMAN

Chicago

AN unusual innovation in hotel construction characterizes the plans for a new addition to the Edgewater Beach Hotel, in Chicago, ground for which has already been broken. The site, one of the choicest in the city, extends through from Sheridan Road, a popular driveway, to Lake Michigan, affording a wide vista over the lake's waters. In keeping with the nature of its patronage, largely of a resident character, the hotel management has devised an unusual scheme for adding to the structural convenience of the entire layout. Between the existing structure and the new addition, hidden underground, a large parking space and storage area for the guests' automobiles will be laid out, covering about two-thirds of an acre. Entrance to this subterranean garage will be through a street-level portal on one side of the new structure, and a tunnelliike driveway, 70 feet long, will pass under the building, running level a bit, then inclining downward and into the underground

area. From the surface no trace will be evident of this unusual feature of hotel construction. To the eye, there will be visible only the wide beautiful plaza which will span the space between the old and new buildings, and the low connecting structure which unites them. The latter is shaped like a cross, one arm being a passageway floored with art marble, and the other arm containing a lounge room and a conservatory. The conservatory fronts on the lake, the entrance from that side being a terraced plaza. Between it and the lake a marble dance floor will be laid out, for outdoor dancing in the summer. In conformity with the appointments and fittings of the present structure, one of the most attractive hotels in the city, the entire program calls for an establishment of luxurious comfort, unusual conveniences, and striking beauty. The entire plat area is almost five acres in extent, and permitted the designers a wide latitude in its architectural possibilities.

1996

DRYING UP OF OWENS LAKE REVEALS NEW WEALTH

Owens Lake, one of the great inland salt seas of California, located in Inyo County in that state, is rapidly shrinking in depth and area, and is doomed eventually to disappear. Maps printed perhaps within another decade will indicate the former location of this picturesque desert sea by a dotted line, and in the bed of the lake will be located numerous salt, soda, and potash plants, forwarding trainloads of these valuable materials into the avenues of commerce.

The disappearance of Owens Lake is the inevitable result of one of man's great engineering enterprises—the utilization for irrigation purposes of the fresh water supplies which originally served the lake. Although lying at an elevation of 3,569 feet, this body of water has no outlet. Following some prehistoric upheaval of the earth's crust, the Owens River, which is made up of innumerable streams trickling down from the mountains, was forced to discharge its waters into the immense basin formed in the Mojave Desert, and the resultant sea is now known as Owens Lake. Although fed with fresh water, the lake, having no outlet, heretofore lost its waters only by evaporation. Its level has been maintained by the balance between the rate

of evaporation and the amount of fresh water flowing into the lake. Naturally the water is very salty.

But that balance is now destroyed. Aside from the taking up of the little feeder streams by the irrigation of farm lands in the semiarid Owens Valley, by the building of the Los Angeles aqueduct the Owens River was taken away bodily through 286 miles of steel pipe and open ditches into the city. Such inroads upon the supplies of fresh water draining into the lake make the rate of evaporation far in excess of the quantity supplied. The level of the lake has fallen about 20 feet. With the receding of the lake, its waters have become increasingly saline. A number of salt, soda, and potash plants have already sprung up around the shores on locations that formerly were part of the lake bottom. These plants are now doing a profitable business. When the lake will have disappeared entirely, it is estimated that some 500,000,000 tons of salt, soda, and potash will be available.

Following a decision to expend \$20,000,000 during the next 10 years, on improvements to the Suez Canal, the channel will be deepened at once from 31 feet to 32 feet, and as soon as possible to 35 feet. The banks are to be 200 feet instead of 150 feet apart.

Emb. Hogg & Ford
416 Union

League City
Los Angeles Calif

Cml. Walter S. Jordan
Weymouth, Mass

POPULAR MECHANICS

894
1427



NEW TOTEM POST
ADDED TO
HARVARD MUSEUM

The Harvard College Indian Museum has come into possession of a totem house post from the Kwakiutl Indian tribe in the Northwest of Canada. This house ornament, together with the two house posts previously acquired, forms one of the most valuable additions to the collection. It stands about 17 feet high, with the upper part carved to resemble an eagle poised for flight, and weighs approximately two tons. A legend tells that an ancient tribal leader was erecting a house when a "thunder bird" alighted near by. From the bird's neck appeared a man who helped the tribesman erect the totem posts used in building the lodge.

Latest Totem-Post Addition to Harvard's Museum: These Posts were Carved from Cedar by Means of an Instrument Resembling an Adz. The Figures have to Do with Legends and Stories of Now Vanished Tribes

1839

AUTOMATIC GRINDER FOR LAWNMOWER BLADES

An interesting grinding machine has been devised recently, which has almost equal precision in grinding lawnmower and ledger blades, paper cutters, planer knives, and similar tools.

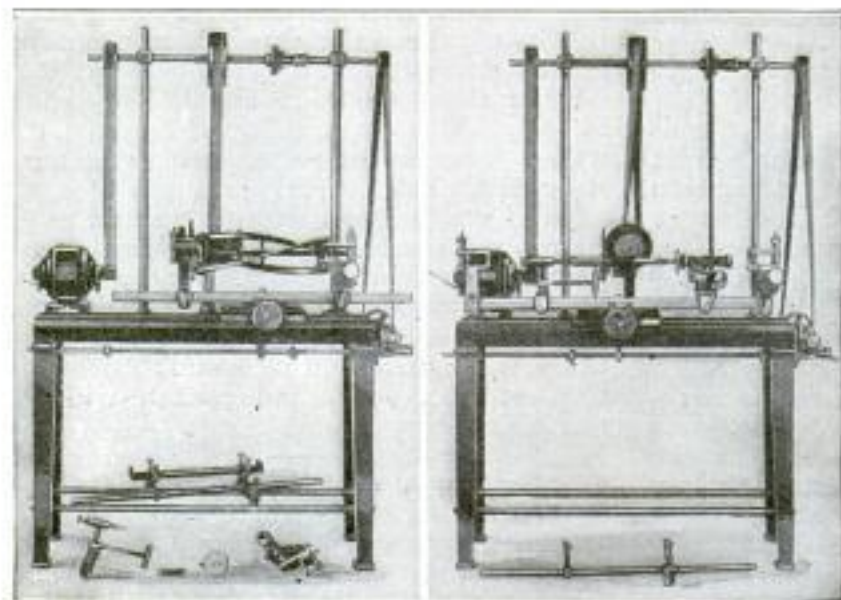

An Automatic Grinder for Tool and Lawnmower Blades: To the Left the Machine Appears Complete for Grinding Mower Blades; to the Right a Reamer is Shown in Position for Grinding.

The grinding action on this machine is entirely automatic; even when a lawnmower reel is set up, with its curved blades, no further attention is required until all the blades have been ground twice. At this stage a bell rings to notify the operator, who may deepen the cut and repeat the process by a slight turn of the feed screw. Arms are provided for gripping various-shaped blades by means of three contact points at each end, with a leveling adjustment to insure accuracy. The machine will also grind other tools.

Arion Palmer, Aliso, Cal. Copyrighted material

1861
mjr.
Lustar Heyde, ls M. & H.
Dresden, N.
Kleiststrasse 10,
Germany

PRECISE MAP SURVEYS BY AERIAL PHOTOGRAPHY

BY CLEVELAND GAINES

BATTLE-FRONT conditions during the World War greatly stimulated the development of aerial photography, and focused the attention of map experts upon the possibilities that lay hidden in that infant science. One of the principal advantages of the aerial survey is, of course, the rapidity with which it can be made; but hitherto all known methods have involved errors, which had to be computed and compensated for later. The construction of an accurate map from such data therefore involved considerable time and effort.

Doctor Hegershoff, professor of geodesy at the Forest Academy of Tharandt in Saxony, Germany, is responsible for an ingenious precision apparatus which is said to overcome these difficulties. The new instrument, which is really a huge stereoscope of special design, permits any two aerial photographs of the same region, partly overlapping, to be used automatically and without further calculation, for the

mapping of the area in question. Two important auxiliary instruments are used in connection with the device, and are

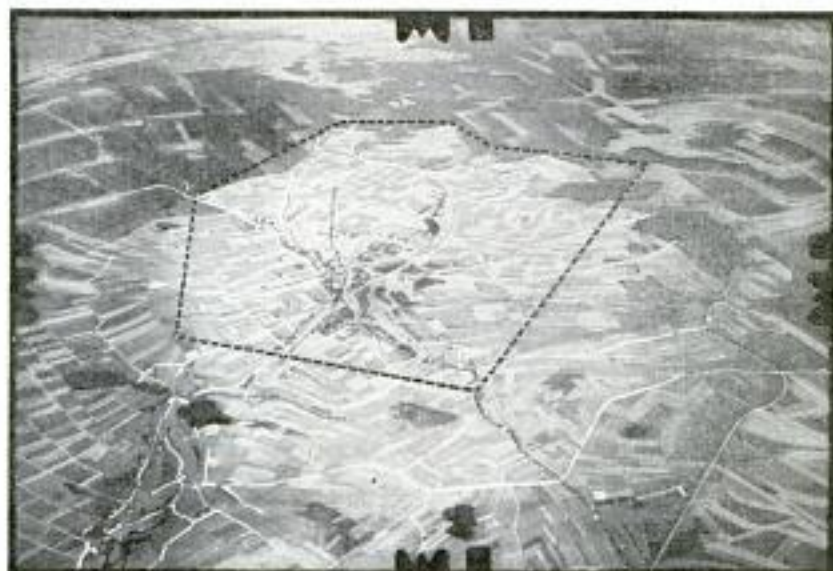

Aerial Photograph of the Town of Elterlein in Saxony and Its Environs: The Dotted Line Marks the Section Chosen for Enlargement in the Laboratory

responsible for its special claims to merit. The first of these is a computing theodolite, which mechanically records the point of reference as well as the various inclinations of the plate from the horizontal when an inclined photograph is taken. The second accessory, equally im-

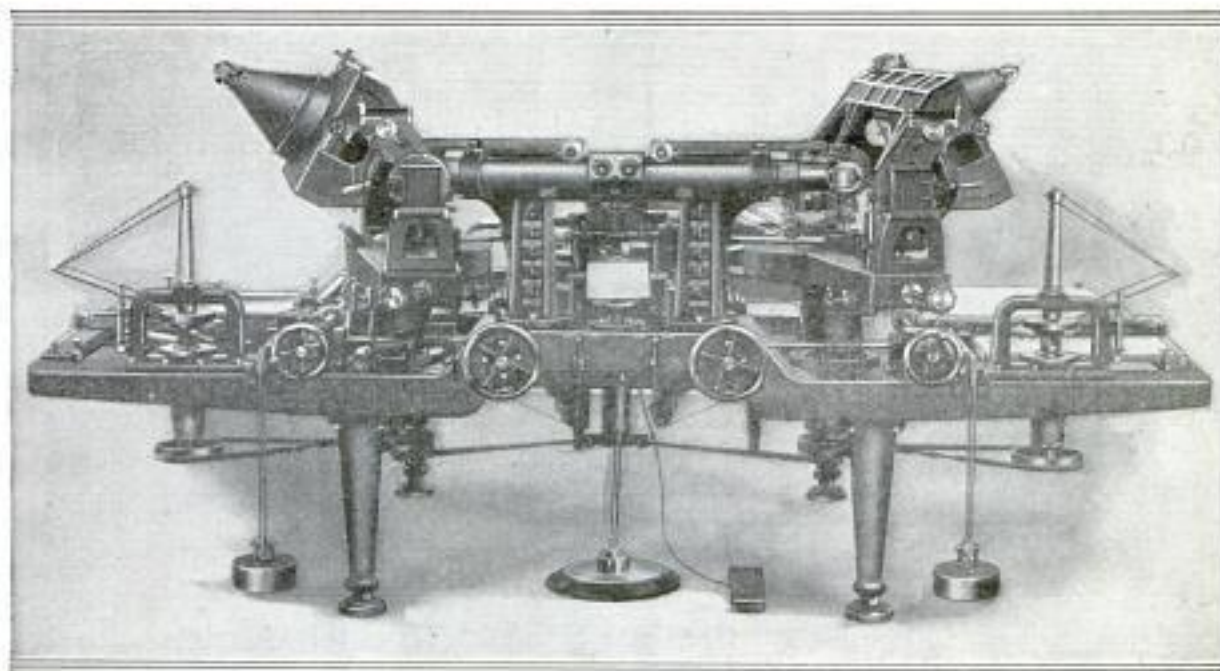

General View of Ingenious Apparatus Designed to Make Aerial Photography a More Accurate Science: The Machine Is 10 Feet Long, 8 Feet Wide, and 4½ Feet High. Roughly, It Allows Two Overlapping Photographs to be Used Automatically for Mapping

portant, is a drawing mechanism which enables the operator to trace on a sheet of paper, automatically and with accuracy, any topographic features passed over by a movable gauge mark, which is viewed through the eyepiece. Suitable control wheels enable the operator to regulate the gauge mark as he pleases, and a special

scale allows the altitude of any traced point to be read immediately. Actual experience has shown that the average error of points ascertained in this manner at a height of 1 mile does not exceed 4 feet, either in a horizontal or vertical direction; and such a degree of accuracy is sufficient for topographic purposes.

1885
ENGLISH RAILLESS CAR HAS SIX WHEELS

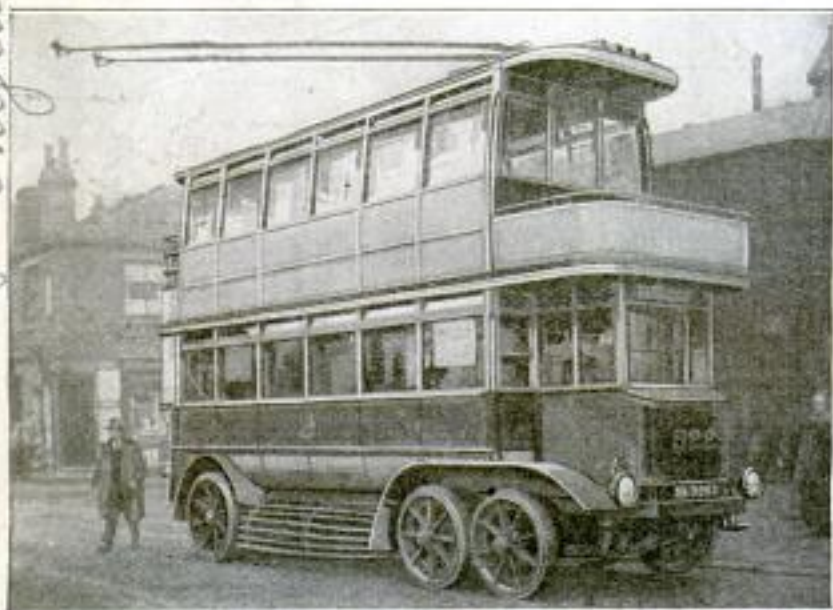

Six-Wheel Construction Is the Feature of This New "Trackless Trolley" in Use in England: Better Distribution of Weight is Claimed for It, and a Saving in Tires and Upkeep has Resulted

For the purpose of obtaining a more equal distribution of the weight, the company operating the railless trolley cars in Bradford, Eng., has redesigned its rolling stock so that each car is now equipped with six wheels. The two rear wheels support half the load, while the four front ones, all of which respond to the steering mechanism, bear the remainder. The load of the motor and front of the transmission is thus spread over eight tires. The front wheels are connected with a central steering column.

829
METAL CABINET FOR SHAKING OUT DUST MOFS

A portable metal cabinet in which the dirt accumulated on a dust mop may be shaken out, is now being sold. The cabinet stands about 2 feet high and 1 foot square. On one side is a hanging door, in the middle of which is a slit, closed by two rubber projections. After the mop has been placed in the cabinet, these projections cling to the pole and prevent the dust from escaping back into the room. The cabinet also has—for those who use a vacuum cleaner—another door on top, through which the dust bag may be emptied. At the bottom is a removable drawer for disposing of the contents. The "receiver" here described is carried by a handle at the top; another slightly larger model, intended for hotels, is equipped with small rubber wheels. Both

are constructed of a light, strong metal and are easily portable.

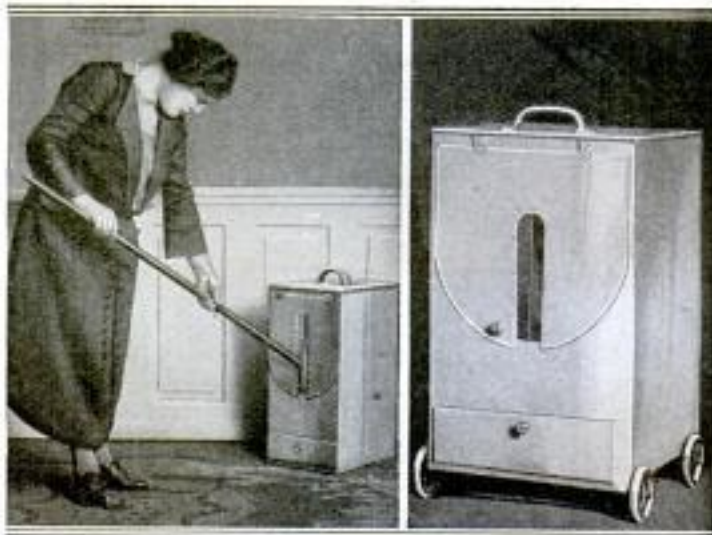

Left: Method of Inserting Mop into the New Receptacle. Right: Cabinet, Mounted on Wheels, for Use in Hotels.

Salt Lake City, Utah



Section of the Oregon Trail, 40 Miles West of Independence Rock, Utah, Showing Ruts Cut in the Sandstone by the Traffic of the Pioneers

1928
WHEEL-RUTTED ROCKS RECALL DAYS OF OVERLAND TRAIL

In certain sections of the West, deep ruts channeled in the rocky roadway bear mute evidence of the streams of immigrants who, 60 and 75 years ago, slowly toiled their way across the plains and through the mountain passes to the golden land beyond. With a distinctness slightly marred by the weathering of time, these grooves show the action of hundreds of iron-shod hoofs and of the wheels of heavily laden prairie schooners. One of the most marked is about 40 miles west of Independence Rock in Utah, not far from the crossing of the Pacific trails and the continental divide.

The burner with its ignition device is located above a central opening in the upper drum, and air from a motor-driven blower is introduced at the same point. The jet of fuel being ignited, the blower forces it toward the bottom of the boiler where, after contact with a steam-superheating coil, the burned gases are directed upward among the tubes by a deflector around the outside.

854
NEW BOILER DESIGNED FOR LIQUID FUEL

A new water-tube boiler, designed with regard to the characteristics of liquid fuel, which sometimes gives poor results because it is applied to boilers designed for solid fuel, has appeared recently in England. It consists of a number of vertical, bent tubes nested together somewhat in the shape of a lantern globe, with the ends welded into two annular drums.

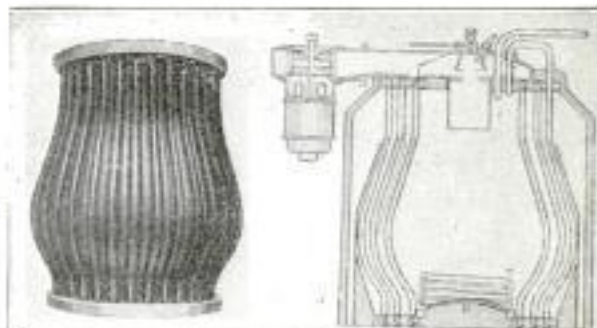

Above: Outside View of Nest of Tubes in New Oil-Fired Boiler. Upper Right: Cross Section, Showing Arrangement of Blower, Burner, Tubes, and Superheater. Right: View of Bottom Tube Sheet

J. H. Sutherland & Co. Copyrighted material
Wellington Road, Exton, Birkenhead, England

506 Produce Exchange Bldg.
200 Toledo Ohio

**OIL-WELL MAGNET RECOVERS
LOST EQUIPMENT**

A new feature of construction has been incorporated in a recently developed magnetic fishing tool, commonly used in oil-well operations to recover lost drills and other equipment. Unlike other devices, the new tool supplies its own electrical current for the magnets, doing away with troublesome wires. Six batteries are used, mounted one above the other over the magnet, and inclosed in a heavy protective casing. An automatic circuit-closing switch operates the magnet only when the tool touches the object being searched for. To prevent mud or other foreign matter

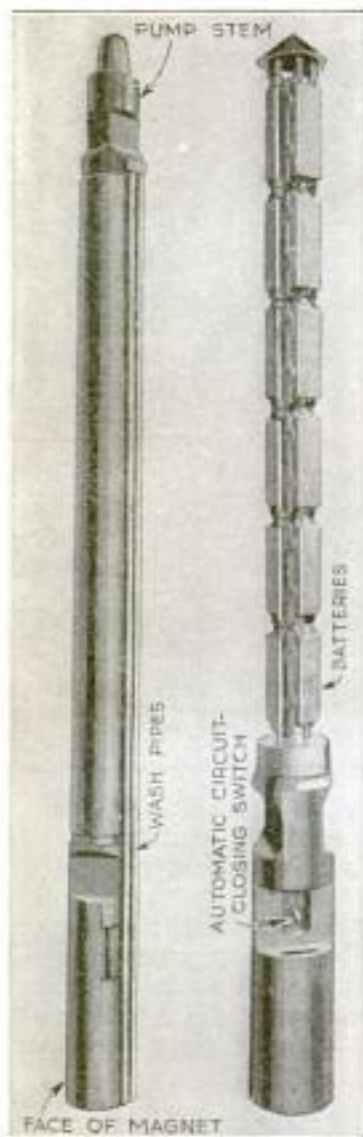

in the bottom of the well from interfering with the working of the magnet, a small pump within the device forces water around the face of the magnet and the object being fished for, thoroughly cleaning both, so that an effective magnetic contact is obtained. The lifting capacity of the instrument is stated to be about 4,000 pounds.

in the bottom of the well from interfering with the working of the magnet, a small pump within the device forces water around the face of the magnet and the object being fished for, thoroughly cleaning both, so that an effective magnetic contact is obtained. The lifting capacity of the instrument is stated to be about 4,000 pounds.

**SLEEPING-CAR LEAKAGE MAKES
PERFECT VENTILATION**

Years of experimental work, and the making of 5,000 tests, all bearing upon the problem of properly ventilating sleeping cars, have finally brought reward in the development of almost startling, yet

scientifically correct conclusions. It has now been determined that large openings are not necessary to secure an adequate fresh-air supply, the unavoidable leakage inward, caused by the car's motion, being sufficient to furnish all the air necessary. To stimulate the inward leakage, however, it has been found that exhaust ventilators, in the top of the car, are necessary to suck the dead air out, thereby improving the circulation. This simple means, scientifically determined to be adequate under actual service conditions, has the further advantage that the small incoming eddies take on irregular motions, that cause slight air movements which, however slight, are essential to proper circulation.

**AUTO GASOLINE GAUGE HOLDS
RESERVE SUPPLY**

A combination gasoline gauge, lock, and signal of simple design which reserves one gallon in the tank after a warning has been signaled the driver, has been placed on the market. When in the "on" position, gasoline flows freely through the gauge to the carburetor. In the "lock" position the supply is cut off. When the supply is low, the gauge cuts off the gasoline from the carburetor until the driver has turned the gauge key to the "reserve" position. In this way the device acts as a signal that the gasoline supply needs replenishing and yet prevents absolute draining of the fuel tank.

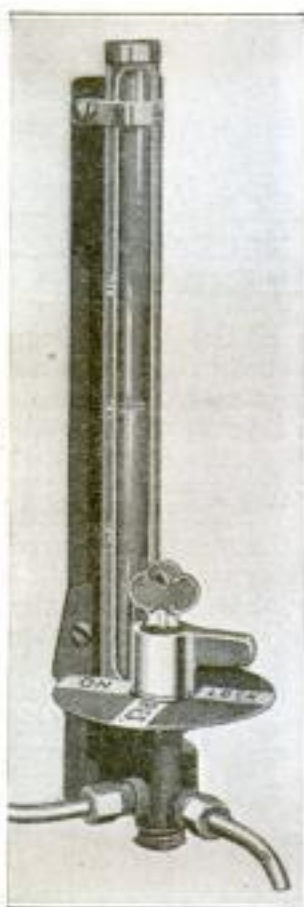

Scientists in Great Britain are developing a special thermometer to be used by fishermen in search of hake, a fish said to regulate its movements according to the temperature of the water. The thermometer is trailed behind the fishing boat.

Auto equip mfg. Co., Inc. Rochester N.Y.

211 Pullman News

SUPERCAMERA GAUGES SPEED OF EXPLOSIONS

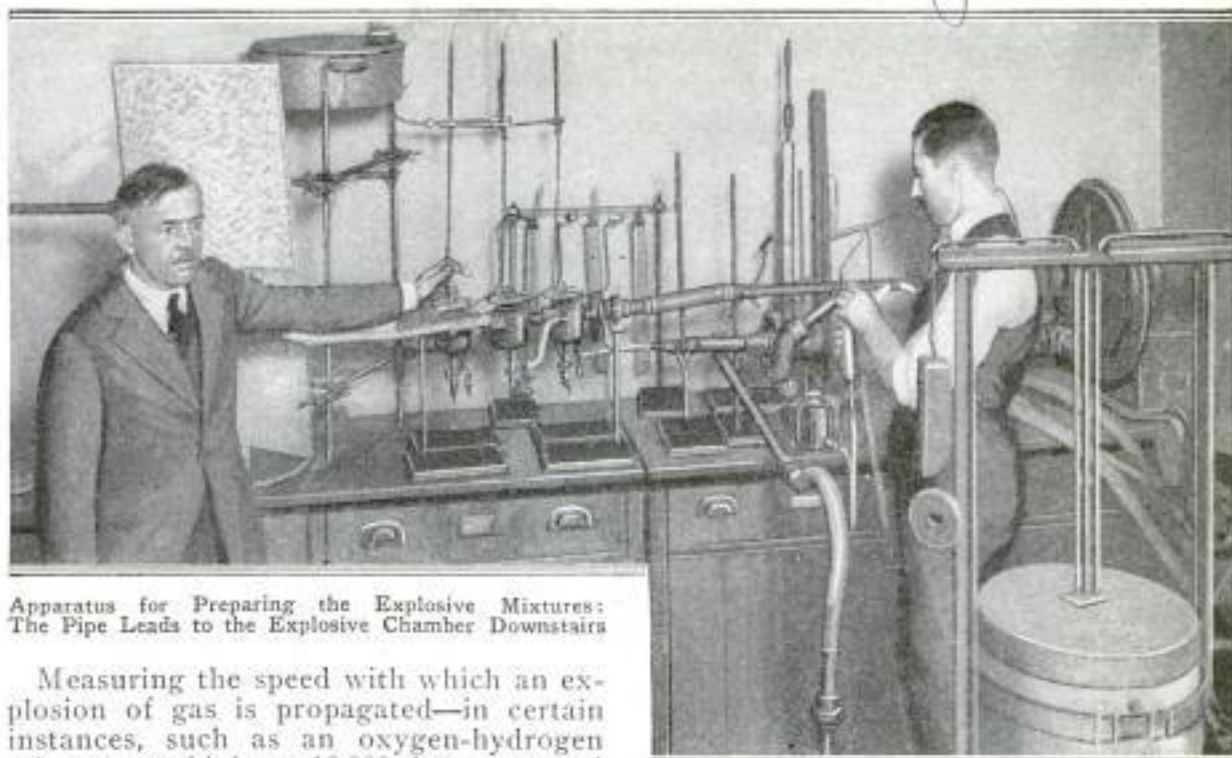

Apparatus for Preparing the Explosive Mixtures: The Pipe Leads to the Explosive Chamber Downstairs

Measuring the speed with which an explosion of gas is propagated—in certain instances, such as an oxygen-hydrogen mixture, as high as 10,000 feet a second—has been made possible through a new apparatus developed at the Underwriters' Laboratories in Chicago.

This device, a supercamera, consists of an explosion chamber, 4 inches in diameter and 10 feet long, in one side of which, near the ends, are slits covered with a quartzite lens. In front of these slits are attached small periscopes which deflect the light of an explosion against a photographic film on the outside face of a revolving drum. After preparation of the explosive mixture, it is piped to the explosive chamber. A spark plug explodes the charge at one end of the chamber. The flash is thus photographed on the film at the beginning of the explosion and again when it has traveled to the other end of the chamber. With the peripheral speed of the drum known, and the distance between the two images on the film ascertained, it is possible to determine how long it took the flash to travel the 10-foot length of the

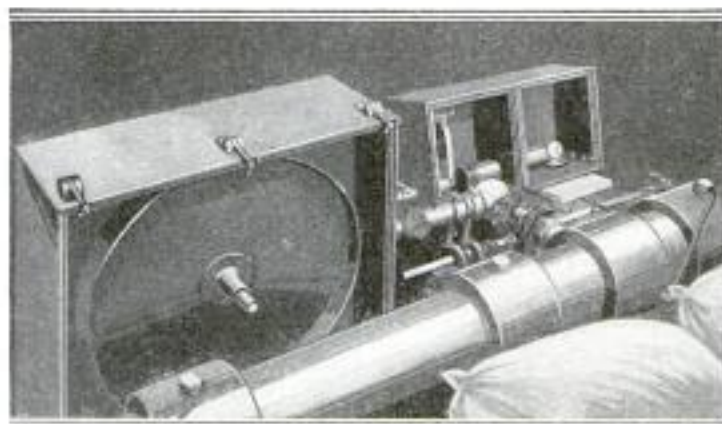

The Film Drum and the Explosion Cylinder: In the Small Box Is an Instrument for Gauging the Speed of the Drum

chamber, and from that figure compute the speed per second of the explosions. It will, of course, be necessary to so gauge the speed of the drum carrying the film, that it will not complete a full revolution while the explosion spreads from one end to the other of the test chamber. The device was made in an attempt to better safeguard life by learning more of explosive gases.

chamber, and from that figure compute the speed per second of the explosions

It will, of course, be necessary to so gauge the speed of the drum carrying the film, that it will not complete a full revolution while the explosion spreads from one end to the other of the test chamber. The device was made in an attempt to better

safeguard life by learning more of explosive gases.

STEAM-FLOW RECORDER FOR SMALL PLANTS

The importance of economy in small steam plants has prompted one enterprising manufacturer to develop a steam-flow recorder which indicates and records exactly how much steam is flowing from the boiler at any given time. This instrument can be easily attached to a range of boilers, and the cost of installation is quite moderate.

London, England
Hollborn, W.C.1.
210 8
Mrs. George
200 High

Journal
Copyrighted material
1/1/23

**FLOATING ICE IN THE MOVIES
MAY BE ONLY PARAFFIN**

All is not ice that glistens. Paraffin, for example, when spread over water, and

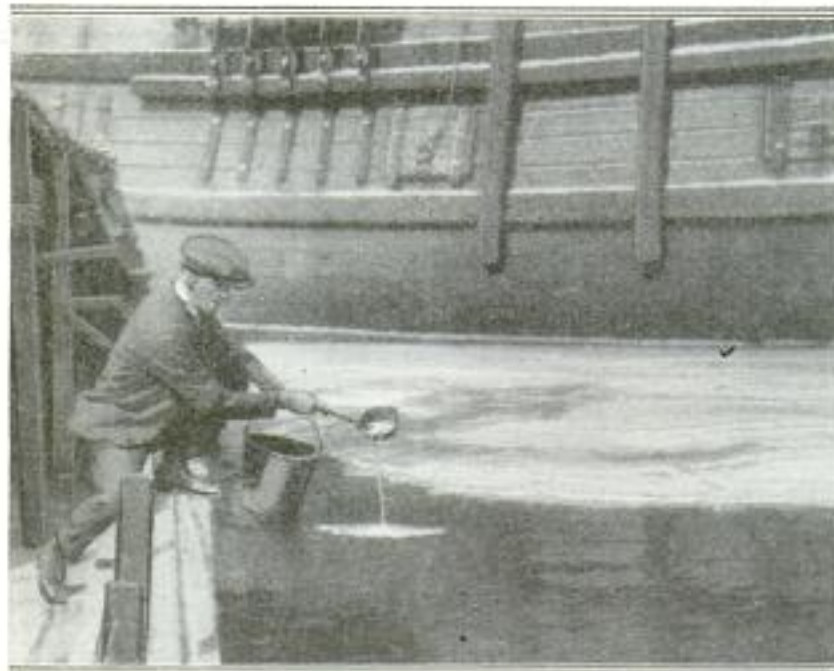

Copyright, Keystone View Co.
Motion-Picture Company's Employee, Spreading Hot Melted Paraffin on a Stretch of Water Which, When Photographed, will Appear Strewn with Ice

photographed with a movie camera looks as much like ice as that substance itself. Hence its popularity with motion-picture companies when taking scenes that call for floating ice.

**SLEEPING FLOWERS GIVE CLEW
TO NEW ANESTHETIC**

Florists' complaints that carnations curled up their petals and "went to sleep" when placed in some greenhouses, led to the discovery of a new anesthetic. Investigating the drowsiness of the flowers, it was discovered that it was caused by leaky fixtures permitting illuminating gas, which contains 4 per cent of ethylene, to escape. The ethylene caused the open flowers to close.

It was only recently, however, that Dr. A. B. Luckhardt and J. B. Carter tested the effects of this gas as an anesthetic at the University of Chicago, finding that it renders human beings and animals unconscious pleasantly and causes no bad after effects of any kind so far as can be determined. Recovery is said to be rapid even after long administration.

**LICENSE-PLATE CARRIER
FITS VARIOUS SIZES**

There is on the market a simple carrier that is adjustable to fit automobile-license plates of different sizes, and which requires no rivets, bolts, or screws for fastening the plate in place. It consists of two pieces of thin metal bent to receive the long edges of the plate, connected with two pairs of links and a coil spring that prevent the plate from slipping out.



Above: Arrangement of Adjustable License-Plate Holder. Below: Holder with License Plate in Place

**MACHINE TIES WIRE-STRAP
ENDS QUICKLY**

An easily handled wire-strapping machine has just been placed on the market which simplifies the labor of tying the ends of wire straps quickly and efficiently.

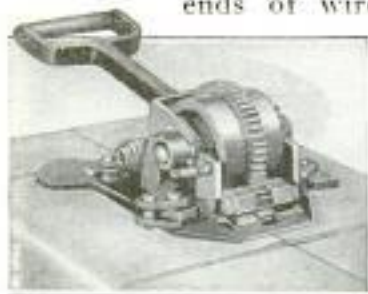

After enveloping the case to be strapped, one end of the wire is fed into the device, the other end, leading to the wire drum, being also gripped in the machine before cutting. Reversal of a lever automatically tightens the wire, twisting the ends and cutting them after they have become wrapped about each other. All moving parts of the machine then return automatically to their original positions.

no information available

The Tied Machines Co.
5832 S. Green, Chicago

1645

IOWA GRANDSTAND OF STEEL ASSURES PERMANENCE

The authorities at the University of Iowa had permanence as one of their objectives in building the grandstand for their athletic field, and with this in mind determined on a steel structure. The seats are built

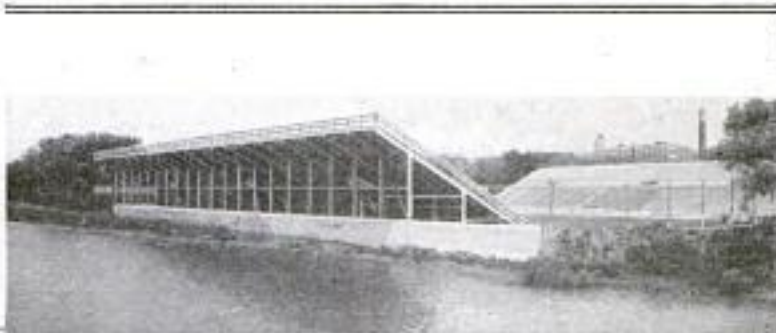

of two adjacent plates form the riser. The plates are riveted together at about the center of the latter, with the upper section overlapping the lower, so that the structure is prac-

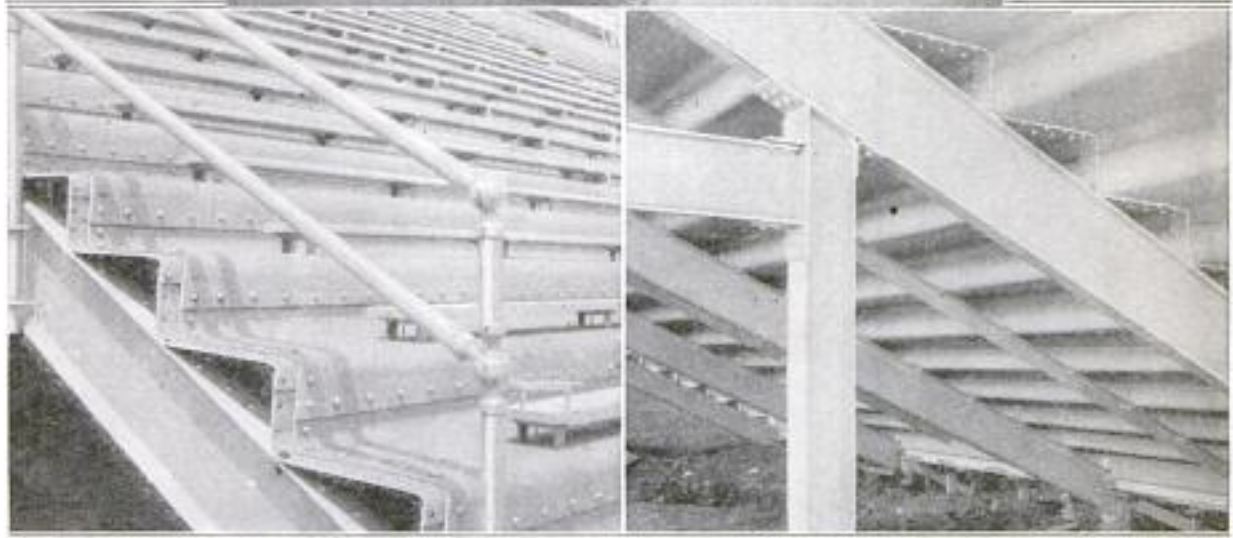

In the Upper Photograph is Given a General View of the University of Iowa's New Grandstand Which is Built of Steel, and Which, Accordingly, should Endure for Many Years. The Picture to the Left Shows How the Plates were Overlapped and the Seats Attached. Right: The Steel Supports under the Stand

of long plates bent along their edges so as to form a large Z-shaped cross section. The central part of the "Z" forms the tread of the seat plate and is about

tically waterproof. The plank seats are bolted to brackets attached to the seat plates by stud bolts. The sections now in place will accommodate 9,500 spectators.

1929

STUDENTS' HANDSAW HAS TWELVE SETS OF TEETH

Unusual means for bringing home to manual-training students and carpenter apprentices the proper index of a saw's qualities has been adopted by a large manufacturer of saws and other carpenters' tools. Shop instructors are loaned a demonstration handsaw of standard finish, but made with six varieties of teeth,

each variety illustrating, with two sets, correct and incorrect tooth filing, setting, and beveling, as well as defects in the blade caused by poor "smithing." Rip teeth and crosscut teeth are shown on this saw.

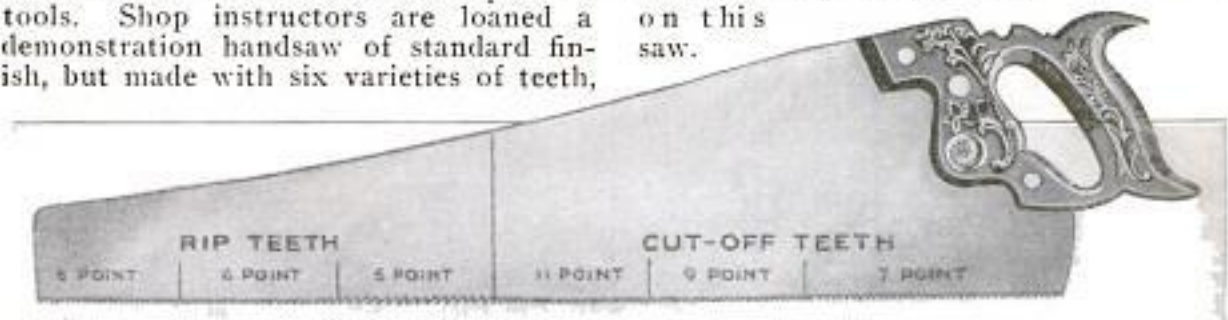

This Demonstration Handsaw Illustrates the Right and the Wrong Way of Filing, Setting, and Beveling Saw Teeth. It is Used in the Instruction of Manual-Training Students and Carpenter Apprentices

C. C. Utter & Co. 402 S. Illinois
Copyrighted material
Chicago, Ill.

PARISIAN STREET LAMPS HAVE BUILT-IN MAIL BOXES

1960



COPYRIGHT, UNDERWOOD & UNDERWOOD

The municipal authorities in Paris have taken official notice of the fact that visitors there find it difficult to post a letter, on account of the obscure location of the mail boxes. These were frequently located in doorways and tobacco shops, where their presence was unsuspected by the stranger. A new type now adopted, of which 3,000 have been

placed in service, is built into the base of a street lamp, so that even a visitor knows where to mail his letters.

"PLANT TREES" AS CIVIC-EMBLEM PLAN IN NEBRASKA CITY

A seal picturing a magnificent maple with the inscription above it, "Nebraska City, Nebraska, the Town That Gave the World a Great Idea," and at the bottom, "Plant Trees," is to be carried on the business stationery of the commercial and professional men of that city, if the plans of those sponsoring the idea are realized.



The motto, "Plant Trees," originated with the late J. Sterling Morton, of Nebraska City, who was also responsible for the movement resulting in the legalization of Arbor Day in that state. Following this lead, nearly every state in the

Union has set aside an Arbor Day, at which time school children and others plant trees. Ned C. Abbott, who suggested that the seal be adopted, writes that a short item in this magazine describing the slogan and seal adopted by the merchants of Walla Walla, Wash., "The Valley They Liked So Well They Named It Twice," inspired him to create the device.

2107

ITALY'S TELEPHONE SYSTEMS AGAIN IN PRIVATE HANDS

The telephone systems of Italy, lately owned by and under the supervision of the Italian government, will be turned over to private industry for operation, it is announced. The state will retain ownership for the time being, however, granting only the right to operate, with a percentage tax of the profits as requisite clauses of the agreements. The concessions, with a minimum of 25 years, may possibly terminate in complete private ownership.

Electrical World 4/14/20
SPRING LUBRICATING TOOL

1802 IS HATCHET-SHAPED



For injecting lubricant between the leaves of automobile springs, a new and simple tool has been devised. In shape it is similar to an ordinary hatchet, with an opening running through the handle and head, down to the edge. An outside screw thread runs around the end of the handle. The car is jacked up, the edge of the tool driven between the leaves, a tube of lubricant screwed on the thread, and the grease or graphite forced through the opening from the tube, into the space between the leaves of the spring.



Called upon to pay fees for the privilege of broadcasting dance music, and other copyrighted popular pieces, privately owned radio-broadcasting stations in Chicago have decided to omit music of that description from their programs.

Key stone Brass Works Erie, Pa.

Emb. N. C. Abbott School for the Blind Nebraska City, Neb.

1806 *Tompson & Co. 1000 Broadway Cleveland, Ohio.*

FOREST DISEASE FOUGHT BY AIR, LAND, AND WATER

BY FRANCIS DICKIE,

Heriot Bay, B.C., Canada

THE most important scientific battle in many years in the field of plant diseases has been waged within the last year on the Pacific coast of the United States and Canada, a battle in which the stake is standing white-pine timber valued at \$300,000,000, menaced by the destructive blister rust.

The pest, which formerly was found only in the eastern portion of North America, was discovered in the fall of 1921 on some black-currant leaves from Vancouver, and a search revealed the disease as present over a considerable area. Immediately the two governments took concerted action to check and stamp out the blight. Timber experts, forest rangers, and many civilians were enlisted in the service of scouring a wooded area of 4,000 square miles, and a well-equipped air force, which already was established at Jericho Beach, Vancouver, with three modern seaplanes, was called upon to lend assistance in car-

rying on the fight. In spite of a season of unusually severe forest fires, the work was effectively carried on until snowfall, and in five months a task was performed that would ordinarily have taken several years.

The disease is a fungous growth commonly known as white-pine blister rust, or black-currant rust, and in the past has been largely confined to currant and gooseberry bushes, where it has not been sufficiently virulent to attract much attention, although it has undoubtedly in many instances been responsible for the difference between a profitable and an unprofitable crop. On pine trees the disease spreads from year to year in the infected tissues, finally girdling and killing the affected part. Large trees as a rule resist the pest longer than small or young trees, but in cases where the infection is quite extensive or the growth very active, both succumb as easily. Seedlings in particular are liable to fall a quick prey to the disease, which is quite serious in view of the widespread attempts at reforestation.

While there is some difference of opinion as to the damage done to mature trees, according to some reports trees 2 feet in diameter are killed by this blight. The disease which is a native of Europe, and evidently originated in the Baltic provinces of Russia, has been known in the latter locality since 1865. It gradually spread to Switzerland, France, and Great Britain, and finally invaded the North American continent.



BY COURTESY OF A. T. DAVIDSON, CHIEF, DOMINION PINE BLISTER SURVEY

White Pine Girdled with the Rust Blight, and Dying

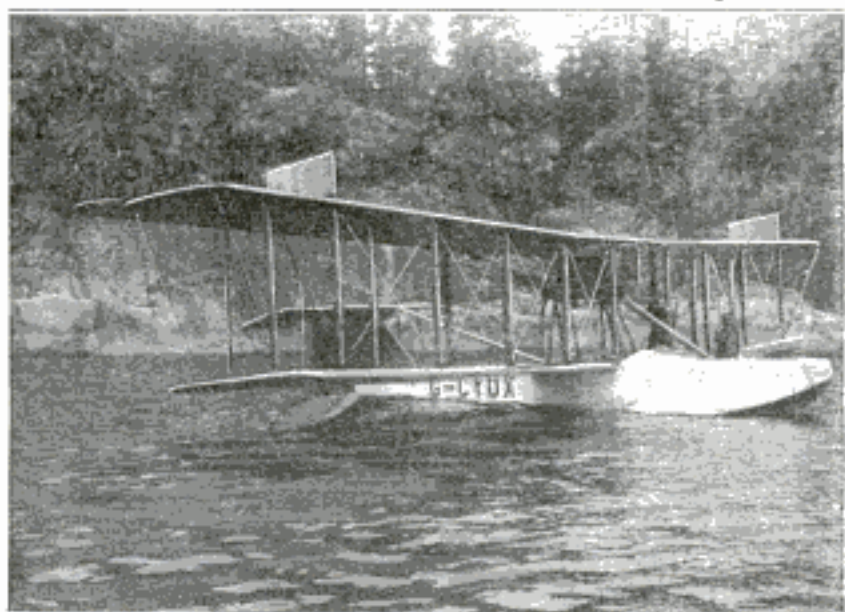

Seaplane Used in the Campaign against Blister Rust That Infests the Forests of the Pacific Coast Regions of the United States and Canada

1960

News-Photo
article in Engineering
Chief Engineer 5/24/23

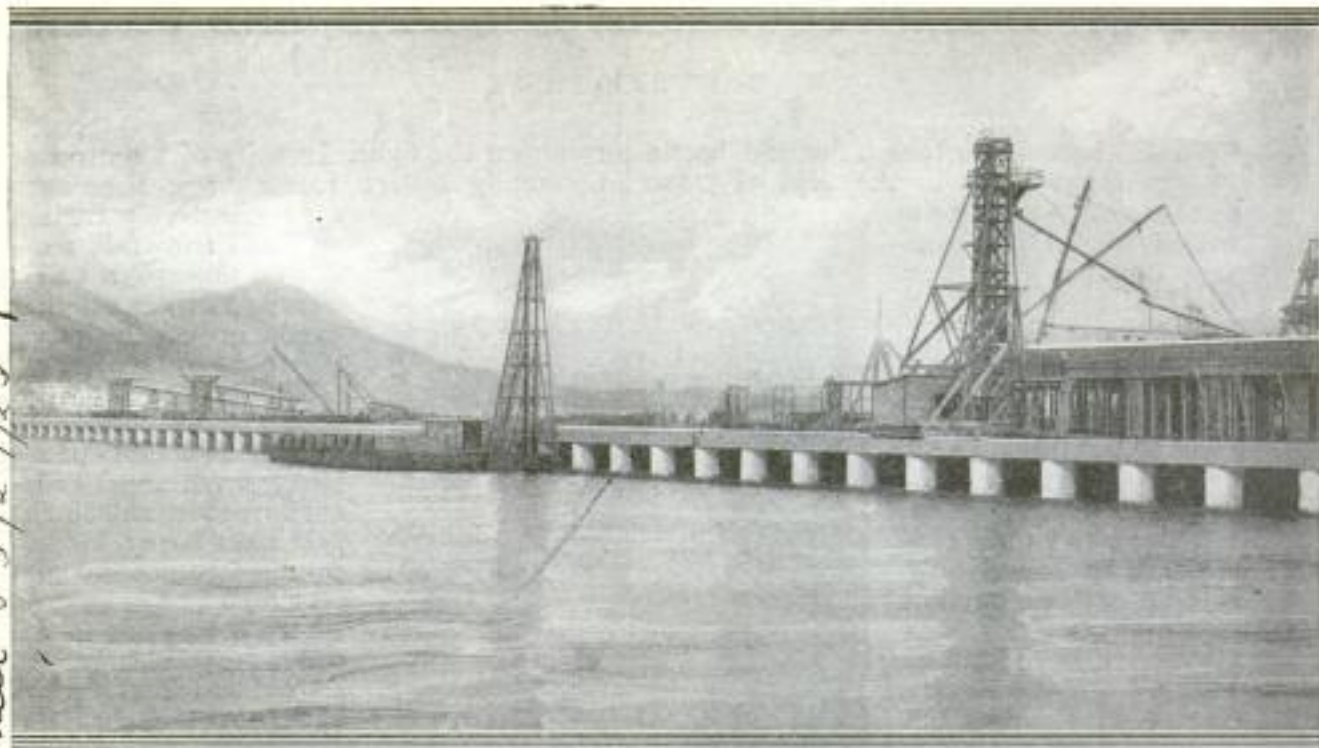

Panorama Showing Length of New Pier at Vancouver: Beginning at the Left can be Seen the Derricks for The Precast Sections are Loaded on Scows and Conveyed along the Pier as Needed. After having

LARGE PIER AT VANCOUVER NEARING COMPLETION

BY HENRY C. COPELAND, 1401 *Leguina*
Bldg. Vancouver B.C. Canada

Full details in
By William Smail,
Northern Construction Co.
Vancouver, Canada

THE Ballantyne Pier, now under construction at Vancouver, B. C., will

largest pier of its type on the Pacific coast, and one of the two or three largest of the kind on the continent.

Dredging for the foundation began in August, 1920, and construction work in May, 1921. The estimated cost will be 5,000,000 dollars.

The pier will be 1,200 feet in length by 341 feet in width, and will be used for general freight purposes. Rail service will be given by two tracks on each apron at the sides and three in the center. Warehousing facilities are provided in five two-story reinforced-concrete sheds, of which four are 500 feet by 110 feet, and the fifth 400 feet by 110 feet, in ground area.

Electric cranes will be used for loading and unloading the ships, and electric conveyors will handle the freight in the

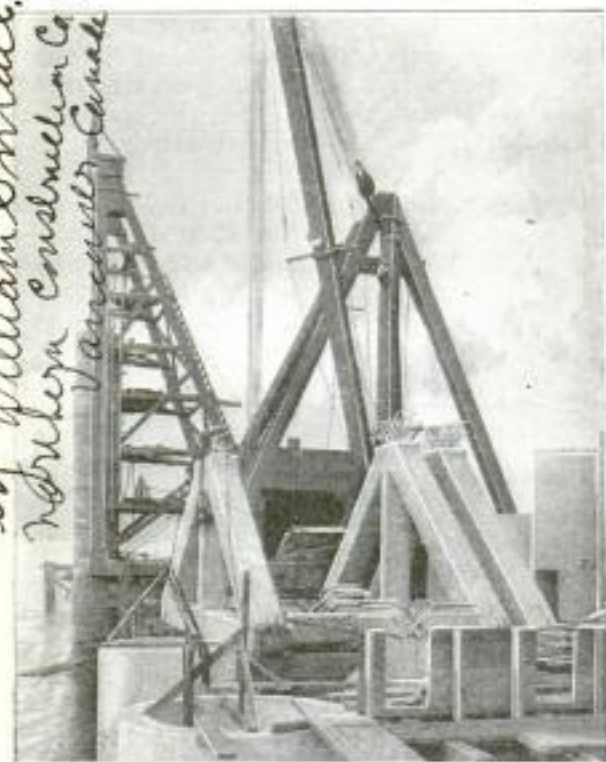

Derrick at Left Forcing Down Cylinder: In Fore-ground, Tops of Two Cylinders in Place, and Trusses

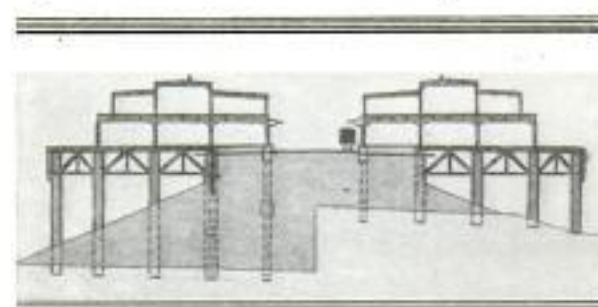
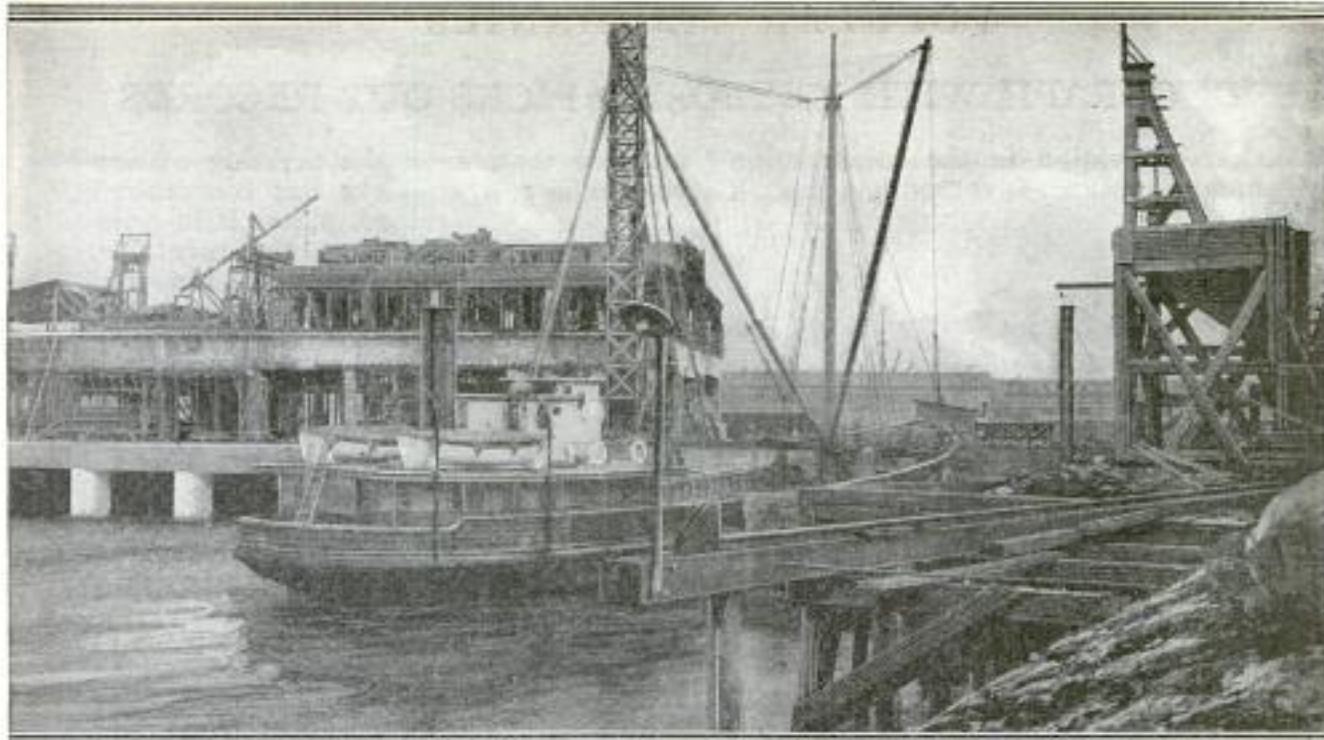

Diagram Showing Cross Section of Warehouse and the Arrangement of Cylinders Used as Supports

be completed and placed in service about August 1, this year. It is said to be the



Placing Cylinders, the Warehouses under Construction, and the Decks Where the Concrete Cylinders are Cast. been Set in Place by the Derricks, They are Sunk to Bedrock by Loads of Six-Ton Cast-Iron Rings.

warehouses. Grain galleries are also provided.

The method of constructing the pier is unusual. The structure rests upon 413 hollow concrete cylinders in sections. These are precast, and are 7 feet in outside diameter with 9-inch walls. Notches are cast in the ends of the sections, so that they will "key" together and can be cemented into one solid column as they are sunk into place.

The sections are guided into place and lowered from tall derricks. The dirt is brought out of the cylinders by means of a dredging bucket dropped down the inside. Large cast-iron rings, six tons in weight, are used as a load to force the cylinders down. At times as much as 450 tons of these weights are used on a single column.

In some cases, it has been necessary to sink the cylinders through 85 feet of material to reach bedrock. When the foundation rock is reached, a diver is sent down the inside of the cylinder to clean up the bottom preparatory to cementing the column to the rock. The entire core of the column is then filled with concrete, and the finished result is a pillar of solid stone, 7 feet in diameter, reaching and cemented to the bedrock.

On top of the columns precast trusses of reinforced concrete are placed, and about them is built the form for the concrete deck.

In carrying on this work, the cylinder sections and trusses were all cast at North Vancouver, across Burrard Inlet,

where there was plenty of room for assembling material and storing the cast parts for curing, whereupon they were conveyed to the site of the pier on scows as needed.

Considered from the standpoints of permanency and cost of maintenance, this type of wharf structure is far superior to the creosoted-piling structure.

1863 FOUR-IN-ONE TOOL MAKES, HANDY COMBINATION

Four commonly needed tools—jack, vise, breast drill, and screwdriver—in one are offered on the market in the form of a single combination tool. The ratchet driver which works the jack also serves to actuate the drill or screwdriver when it is fixed in a socket placed in the end of the shaft.

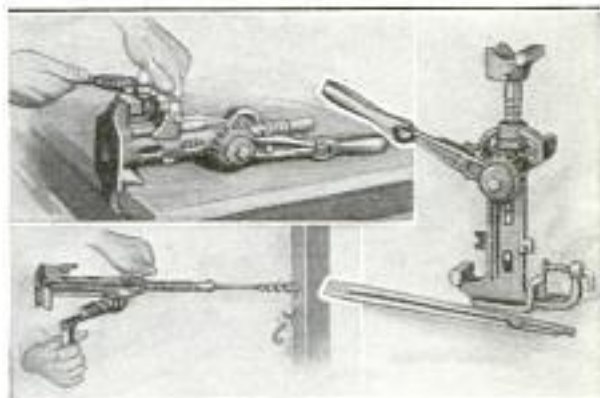

Left: The Combination Tool When Used as a Breast Drill. Above: As a Vise. Right: As a Jack

*The Utility Tool Corp.
Transportation Bldg.
1015 1/2 1st St. N.W. Wash. D.C.*

1709

PHONOGRAPH WITH KEYBOARD PICKS OUT RECORDS

As an innovation in the construction of phonographs, an inventor has built a machine that, upon the pressing of any certain two keys, picks out the desired record, places it in position on the turntable, swings in the tonearm, and lowers the needle into position, thereupon starting the playing mechanism. When the record is played through, the mechanism automatically gets into action again, swinging the playing arm back, stopping the turntable, picking up the record, and returning it to its place in the magazine, which holds 50 records. The pressed-down buttons lock themselves and the remainder of the keys in position, thus preventing tampering with and injury to the mechanism while the record is being played. Fifteen keys control the machine. These may be built on a portable board so as to be carried about the house, an electric cable connecting it with the phonograph.



Above: Two Views, Showing Mechanism of Phonograph That Picks Out Its Own Records. Lower Left: Portable Keyboard Mounted on Pedestal. Lower Right: Listening to the Music

RECORD FOR HAULING SPRUCE CLAIMED IN MAINE



The Enormous Load of More than 12 Cords Piled and Hauled by a Crew Working at Venture Brook, Washington County, Maine

Rivalry among the crews in the Maine woods, as to which could haul the biggest load of "pulp," as the peeled spruce for paper making is called, resulted recently in a crew at Venture Brook, Washington County, piling and hauling a sled with a total load of over 12 cords. This is considered quite unusual for haulage of this kind. The sled was 32 feet long, or the length of four cords, and the supporting stakes were 12 feet high. In spite of the heavy load, only the regular two-horse team was needed to pull it.

1721
Cmd. A. W. Keene,
Lubec Maine

4/9/32

2120

OLYMPIC GAMES' 1932 SESSION AWARDED TO LOS ANGELES

The Olympic Games will be held at Los Angeles in 1932. This announcement was made at the international Olympic committee's recent meeting in Rome to discuss plans for the games in Paris next year. It was decided that Amsterdam, Holland, would be selected for the meet in 1928, because disturbed economic conditions might prevent European competitors from financing a trip to the United States at that time, but that America should have the next available date. The award terminates a vigorous campaign by athletic authorities throughout the country, and by Los Angeles, which in building a new large stadium expressed the hope that the award would be made to that city. This will be the second time the games will be held in America, the first being in 1904, at St. Louis.

1984

SIGNAL INSTRUMENT CHARTS WATER-LEVEL RECORD

A constant check on the water level in steam boilers is the object of a new recording device recently placed on the market. The instrument makes a written record of the height of the water in the boiler



throughout the 24 hours, and in addition rings a bell whenever the level is either too high or too low. A mechanically operated pen draws a red-ink line on a circular, clock-driven

chart, and this record indicates graphically all the important facts which need to be known regarding the care the boiler is receiving. The red line also shows the exact time when the boiler was "cut in" and "cut out," when it was banked for the night, when it was "blown off," and when in operation. Foam in the boiler actuates the bell signal in the same way as would low water, and the ringing will continue until this undesirable condition is corrected. The water gauge is illuminated sufficiently to make its markings visible 50 feet away.

Hackman Water Recorder Co. 217 Metropolitan Block Mulvane U.S.

CONCRETE OFFICE BUILDING COMPLETED IN DALLAS

One of the world's tallest concrete office buildings, a 21-story structure known as



How the 21-Story Concrete Office Building in Dallas, Texas, Appears from a Neighboring Structure

the Medical Arts Building, has been completed in Dallas, Tex. Except for the three lower stories, it is in the shape of a cross, thus admitting outside light to all the offices. These are being occupied only by physicians and surgeons. The building might be called a monolith, having been poured in one continuous process. The cost was 1,250,000 dollars.

DESIGN HOSPITAL AIRPLANE FOR SURGICAL WORK

A hospital airplane, the first of its particular type in this country, will soon be built at McCook Field, Dayton, Ohio, it was recently announced. It will embody a special design, distinguishing it from ambulance planes now in use, and provides a compartment in which a surgeon can administer to two patients lying on comfortable cots while the plane is in flight. The capacity will be a pilot, a surgeon, and two patients, or, if some less essential parts of the equipment are left out, four persons in addition to the pilot can be carried.

Emb. C. A. F. Farming 4341 Armond Ave. Dallas Texas

2114 Power News Dayton Ohio

Copyrighted material

Portland Oregon
HUNDREDS OF SNAKES KILLED BY ROAD CREW



A Few of the Hundreds of Rattlesnakes Killed by a Road-Construction Crew Working between Yakima and Ellensburg, Washington: Many of the Reptiles Were More than Four Feet in Length

A road - construction crew working in central Washington has been killing hundreds of rattlesnakes daily. The road on which the snakes have been found in such numbers is being built from Yakima to Ellensburg by the United States Bureau of Public Roads. Recently a single blast killed 123 of the reptiles, 41 of which were more than 4 feet in length, some with as many as 15 rattles. The crew gathered a few dozen of the snakes, after a blast, and strung them from a rope "for exhibition purposes."

1849

GIANT "CASH REGISTER" AIDS UNIVERSITY CAMPAIGN

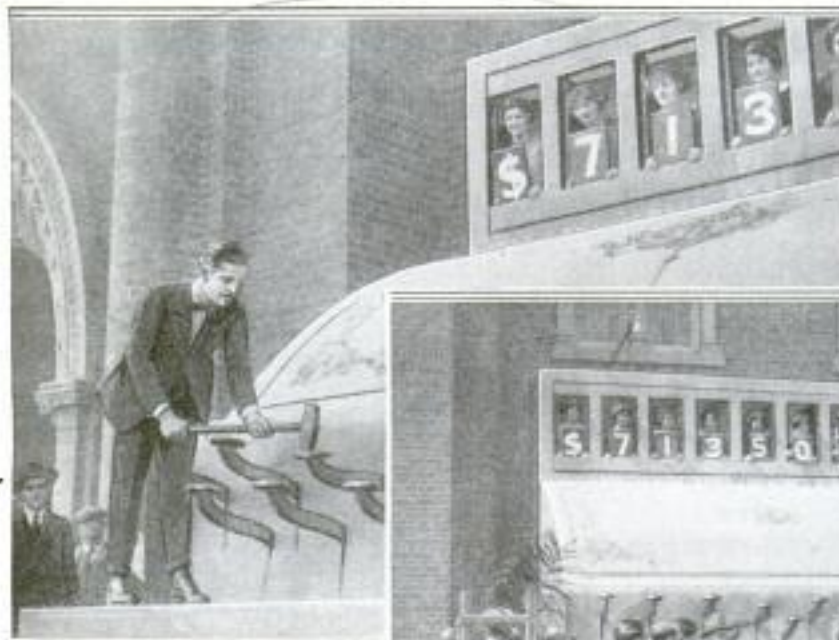

"Ringing Up" the Giant Imitation Cash Register at the University of Southern California

place of student-workers who met to report their progress. As the amounts were called, a campaign leader "rang them up" by striking the proper keys with a sledge hammer. Girl students, standing be-

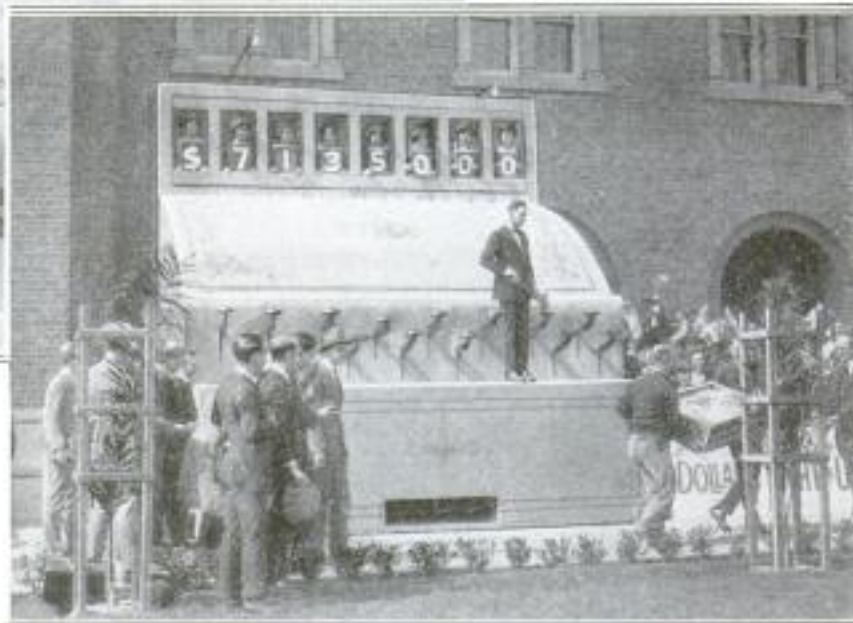

As Contributions to the School Fund were Reported, the Leader "Registered" the Amounts by Striking the Proper Keys

A giant "cash register" constructed of wood was recently used as a publicity stunt by students of the University of Southern California in conducting a drive for school funds. Placed at a conspicuous point on the campus, the register was the rallying

hind the appliance, slipped into place placards bearing the appropriate figures.

Los Angeles, Calif.

Alameda County Calif.



A Glance at This View of the Altamont Pass Viaduct, on the Stockton Highway, California, Brings Home at Once the Dangerous Nature of the Crossing before the Completion of the Structure

2013
**CONCRETE VIADUCT MAKES
ALTAMONT PASS SAFE**

The completion of the Altamont Pass viaduct on the Stockton Highway in California eliminates one of the most dangerous crossings as well as one of the worst stretches of road in the state. The structure is of concrete, built on what is known as a reverse curve, that is, like the letter "S," with its curves drawn out and flattened. It is 35 feet high, with the outer edges of its curved roadway elevated on the bends to assure safe travel. Foundations for the piers had to be carried down to bedrock, which was found 35 feet below the surface. The importance of this link may be gauged from the fact that more than 3,000 vehicles have occasion to use the crossing each day.

2022
**BLUEPRINT DRIER FEATURES
COPPER CYLINDER**

Embodying a number of features of merit, a new machine for drying blueprints has been placed on the market. In operation, the wet prints are drawn around a heated cylinder by means of an endless canvas belt and delivered dry and free from wrinkles in a receiving tray within easy reach of the operator. One feature is the use of a copper cylinder, which heats quickly and to which the prints will not stick. A thermostatic control for use when gas is the heating agent

and a set of switches for electrical heating, are provided. Special emphasis is placed on an ingenious arrangement whereby the canvas belt may be easily centered; an asbestos apron which may be run through the machine to protect the canvas belt from rotting when not

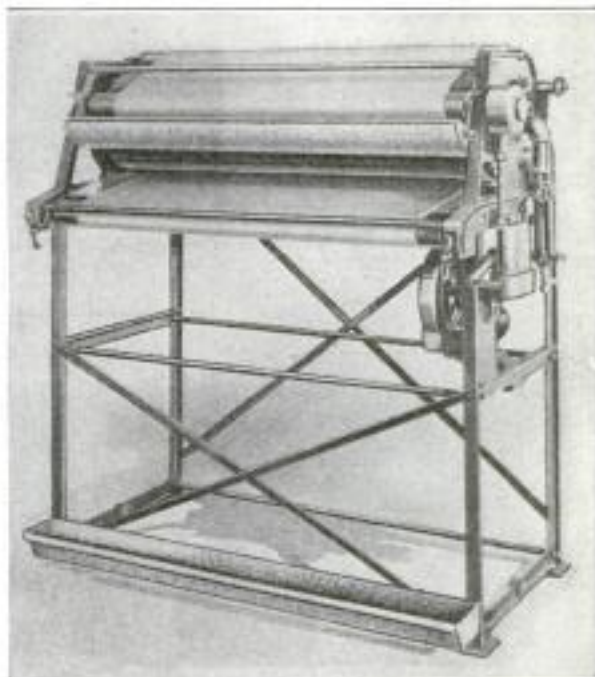

Blueprint-Drying Machine in Operation: The Copper Cylinder is Contained within Upper Part of Machine

in use, and cut gears and ball bearings in the driving mechanism. Eight to nine feet of prints may be run through the machine per minute.

The C. F. Peas Co., 813 N. Franklin Chicago

2042 The Hercules Mfg. Co
711 Cherry St.

910

POPULAR MECHANICS

Chattanooga Tenn

EGG-CANDLING MACHINE USES ACETYLENE GAS



An improvement over the electric type of egg candler is claimed for a new machine which employs acetylene gas as a source of illumination. By this means the machine makes a blood streak in the egg show red, instead of merely dark, as in the electric candler, thereby furnishing a more reliable means of grading the eggs. A small gas generator furnishes the light, and is connected to the candler by means of flexible hose. The device is hooded, and its interior painted a dull black, to minimize reflection.

An Acetylene Egg-Candling Machine, Claimed to Furnish a More Satisfactory Means of Grading Eggs than the Electrical Candler

2041

WELL-KNOWN SKIPPER GIVEN "LEVIATHAN" COMMAND

CAPTAIN HERBERT HARTLEY, recently given command by the United States Lines of the largest American ocean liner, the "Leviathan," and the second largest ship in the world, attained his post by reason of typical Yankee pluck and merit. He is, as well, the oldest in point of continuous service and the only American-born captain in the service of the American Line. He was born at Oswego Falls, N. Y., in 1875, and, after his years of training joined the "St. Louis," at that time (1896) one of the fastest and largest of transatlantic liners. For 21 years he was shifted from ship to



CAPTAIN HERBERT HARTLEY
Commander of the "Leviathan," America's Largest Ocean Liner

ship, always advancing, until, in 1917, he returned to the "St. Louis" as its captain. As skipper of the "St. Louis" he ran the German blockade in March, 1917, the vessel being the first armed merchantman to reach an English port. Later in the war he was made a lieutenant commander in the Naval Reserve, in recognition of his skill and daring. When, after the war, the "St. Louis" was burned, Captain Hartley was placed in command of the "Mongolia," which position he retained until he took a vacation recently, his appointment to the "Leviathan" following his brief rest.

The marine Journal 3/24/23
Pacific Atlantic photos of me
see page

1947

NOVEL SUBSCRIPTION APPEALS IN HAWAII



Money Pledges Hung Up in Front of a Store in Hilo, Hawaii, to Serve as an Appeal for More Subscriptions for the Benefit of Sufferers from a Tidal Wave

Among the victims of a tidal wave, which recently did much damage to Hilo on the island of Hawaii, were many Japanese and Chinese. When their countrymen set about raising funds for their relief, headquarters were established in one of the stores of the town, and money pledges collected. These, written on long strips of paper, were then hung about the front of the store to serve as an appeal for additional funds.

Club Hogg + Ford 416
Drum League Bldg
Los Angeles, Calif.

Copyrighted material

2016 Karboat Mfg Co
 364 W. Madison
 17 W. Illinois Chicago

KNOCKDOWN ROWBOAT SIMPLE AND COMPACT

As the Result of an Ardent Fisherman's Desire for a Quickly Assembled Knockdown Boat of Light Weight Yet Stanch Seaworthiness, a New All-Wood Boat has Made Its Appearance. The Picture to the Right Shows the Compact Case in Which the Boat may be Packed and Secured to the Running Board of an Automobile. Two Canvas Bags Provided with Strap Handles are Fitted to the Case. Although a 12-Footer, the Boat can be Contained in a 12 by 18-Inch Space



Left: With No Other Tools than the Hands, the 21 Separate Boards are Quickly Meshed Together. No Bolts, Screws, Complicated Fasteners, or Small Loose Parts, to Become Lost or Misplaced, are Used. After the Floor is Put Together, the Sides are Assembled and Attached

Right: Showing the Framework of the Boat Assembled, the Canvas Cover Yet to be Attached. A Padlock in the Bow Prevents Disassembling of the Boat. The Floor is So Constructed That a Weight on the Bottom Binds More Tightly the Metal Fastenings

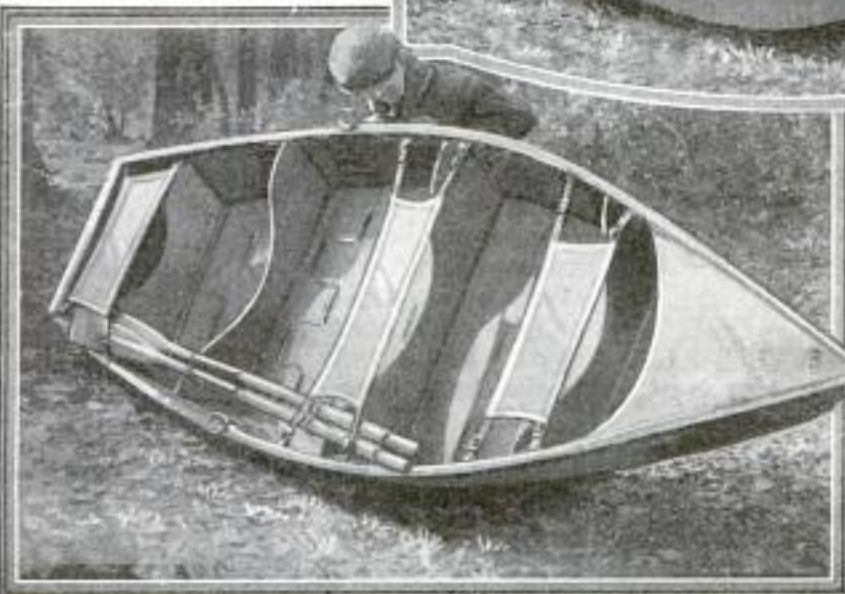

Left: The Boat Completely Assembled, the Heavy, Strong Army-Duck Canvas Being the Last Addition. The Buckling of the Seats Stretches the Enveloping Material over the Boat Tightly. All Wood Used Is Three-Ply Waterproof Airplane Board, Metal Fasteners being Riveted with Large Brass Rivets. Weighing 100 Pounds, the Boat will Accommodate Three Grown Persons. The Inventor Claims It can be Assembled in from Six to Eight Minutes, will Not Shrink from Heat, nor Leak, and will Last for Years

Boat - \$75.00
 With accessories - \$100.00

Photograms
New York City
POPULAR

J. S. Swan
Auburn
MECHANICS Neb

BUTTER VANITY CASES NOW USED IN GERMAN CITIES



Vanity cases are reported to be used for carrying butter by women restaurant patrons in Berlin and other German cities. The men use metal boxes, made in imitation of a small book, for the same purpose. Few of the restaurants can afford to serve butter as freely as in pre-war days, and in those providing it the price is exorbitant.

1925

SPECIAL SLEEVE FEATURES NEW ROLLER BEARING

A new roller bearing which, in common with others of the type, has for its main object the reduction of friction losses suffered in bearings where sliding friction occurs, offers a feature in an accurately ground high-carbon steel sleeve that is clamped to the shaft. Steel collars welded to the sleeve are so drilled and tapped as to render it impossible to put the sleeve on the shaft incorrectly, thus insuring a true bearing surface for the rollers.



thus insuring a true bearing surface for the rollers.

GULF STREAM PREVENTS MAIL FROM REACHING LIGHTSHIP

Though the ocean was calm, and apparently entirely "as usual," the mail boat calling at the Diamond Shoal lightship, near Cape Hatteras, N. C., recently found the Gulf Stream near the lightship running so strong that it was impossible

to row through it. Ordinarily, the stream is some distance from the ship. Before leaving, the captain took the temperature of the stream and found it to be 72° F., while about 100 yards away, outside the stream, it was 16° lower.

COLLAPSIBLE COOKSTOVE FOR CAMP USE

A collapsible cookstove and heater for camp use has been devised, which rightfully lays claim to the merit of great simplicity of construction. It consists of two sections of pipe, mounted vertically, one above and the other below the stove proper, at opposite ends of it. Wood or other fuel can be used in the lower pipe or chamber, the heat passing upward, through the

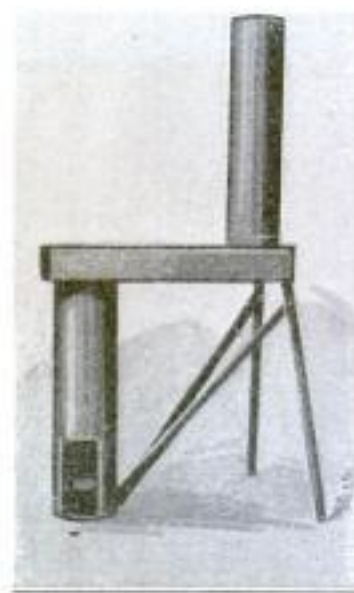

stand, and out through the upper pipe, a damper regulating the draft.

stand, and out through the upper pipe, a damper regulating the draft.

PORTABLE WELDING OUTFIT GENERATES OWN GAS

A new portable oxyacetylene appliance has appeared in the form of a gas generator intended to do away with the use of high-pressure cylinders. It operates automatically without clock or motors. is simple to use, and has the equivalent carbide capacity of a 150-cubic-foot cylinder of gas. It weighs about 200 pounds.



Read Foundry & Machine Co.
Lancaster, Pa.
Manchester

The Marine Journal
2/24/23

The Alexander Miltburn
Co. 1416 W. Baltimore
Baltimore, Md

2028

International Newsreel Corp
226 Williams St
New York City



OVER THE TOP—AND DOWN

THE English Grand National Steeplechase, one of the most colorful events in the world of sport, is never without its thrills—and mishaps. Few falls, however, have approached the spectacular more closely than that taken by "Trentino" at the Bechers Brook jump. Both horse and rider hit the turf almost perpendicularly.

A. J. Pidgeon, Inventor,
 Bethford Mines,
 N. H.

914

POPULAR MECHANICS

WINTER WHEEL DESIGNED FOR MOTOR VEHICLES



Motor-Driven Sleigh Equipped with Specially Designed Wheels, Which Increases Its Traction with the Load upon It: Each Wheel is Separately Driven through Gears at the Rear

Successful results are reported to have been obtained with a new type of wheel that can be used on a motor-driven sleigh or attached to an ordinary automobile by removing the rear wheels and mudguards. The wheel, which is in the form of a helix with its axis parallel to the ground, worms its way through snow and over ice with a traction that increases with the load in the vehicle. Each wheel is driven by special gears inclosed in a case at the rear.

DISSECTING SCOPE IS COMPACT AND EFFICIENT

A simple and efficient dissecting device designed for use in examining small objects found in plant and insect systems, offers a compact instrument that can be folded up and carried in the student's pocket. It consists of a tube-shaped holder which is held in the left hand with the forefinger in position while the thumb rests on the tiltable focusing block. The right hand is thus free for using the dissecting needle. When not in use the part to which the lens

and tweezer are attached, and the tools, can be slid into the hollow tube.

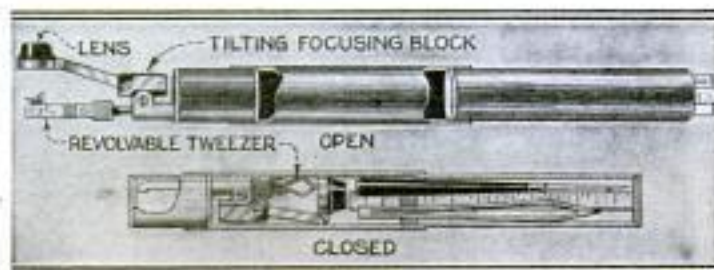

Above: Pocket Dissecting Scope with Tweezer and Lens Extended Ready for Use. Below: Sectional View, Showing Scope and Tools Folded into the Hollow Handle

WAGON FILLS AND DUMPS ITSELF IN SHORT TIME



A New Type of Dumping Wagon Designed for Scooping Up and Moving Earth and Similar Materials on the Farm: The Hand-wheel Controls the Depth of the Scoop

For transporting earth or other materials, a self-loading and dumping wagon has been invented. A wide blade in front lifts the earth, and a conveyor carries it upward into the box. Distributing is done by an apron, as in a manure spreader. The moving parts are actuated by traction of the rear wheels, and a wheel regulates the action of the blade. The wagon fills itself in about 50 feet, dumping as desired.

A. W. Robert Shedenhelm, Ladora, Iowa

Mrs. Elmer S. Campbell, Lafayette, Ind.
 Mrs. Purdie Shoverly, 26

185

7

7

1766

Copyrighted material

1926

Brown & Sharpe Mfg Co

Providence R.I.

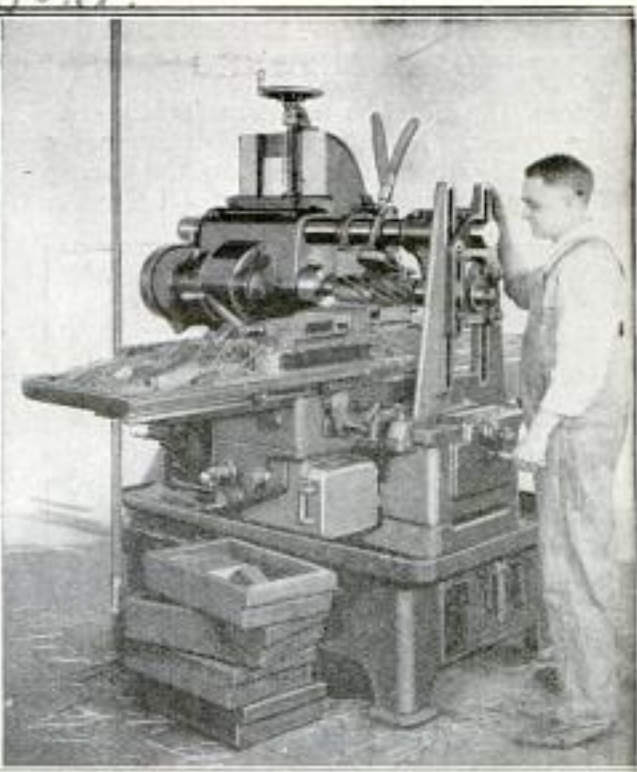
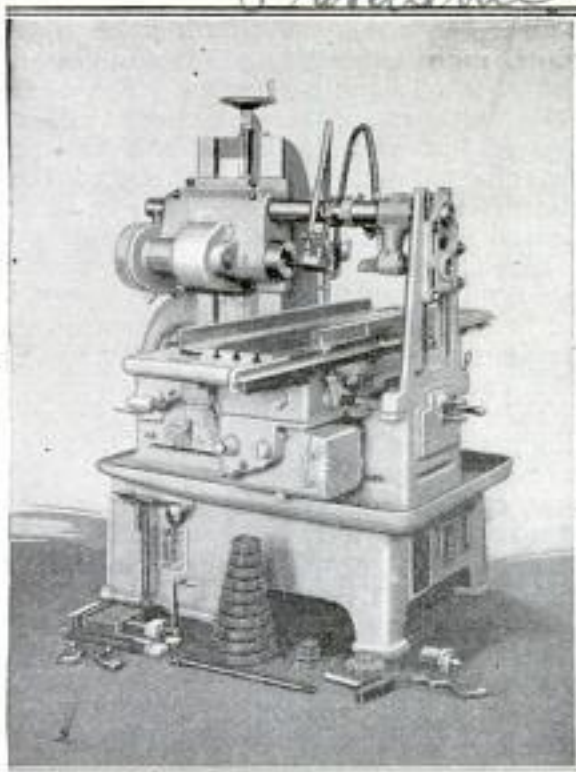

Left: New Automatic Manufacturing-Type Milling Machine, Which Provides for High Production of Duplicate Parts Where the Loading Time Is About Equal to the Cutting Time. Right: Machine in Operation; Note the Chips, Indicating the Heavy Cut That is being Made

1926
AUTOMATIC MILLING MACHINE FOR PRODUCTION WORK

The salient feature of a new milling machine, designed for the production of duplicate parts in large quantities, is the automatic control of the speed and travel of the spindle and table. This is accomplished by means of dogs located at the front and rear of the table. Other dogs provide for automatically working the starting, stopping, and reversing of the spindle. The automatic stopping of the spindle with the table on the return stroke provides against marring the work. By reversing the spindle, two sets of cutters with teeth facing in opposite directions permit a cut to be made in either direction. The table is long enough to permit setting up of work on one end while the cutter is operating. It is arranged for constant-speed drive either from a line shaft or from a motor in the base.

884
DEVICE HANDLES VEGETABLES MECHANICALLY

An interesting handling and weighing receptacle for vegetables has been placed on the market for the convenience of retail grocers. It is designed to simplify the labor of sacking onions, potatoes, and the like. Ordinarily, the merchant fills the sack at the barrel, then carries it to the

scales for weighing. The new device has a capacity of several bushels, and can be set up on the counter. A sack, resting on the scale platform, is placed under the spout, and it is only necessary to work a small lever back and forth, meanwhile keeping an eye on the scales, until the correct weight registers.

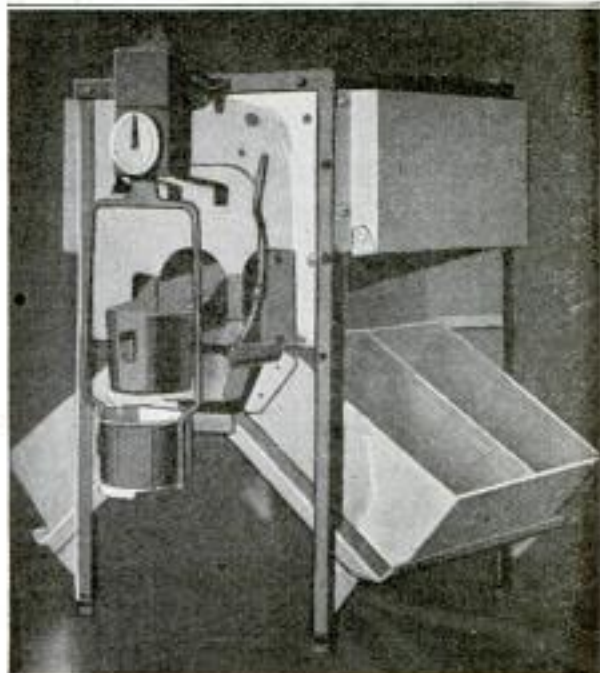

A Convenient Vegetable-Handling Receptacle, Which can be Attached to the Grocer's Counter: The Scale is Adjustable Vertically, for Handling Short or Tall Sacks

*clw. Albert Freeman, 2300 1/2
Hill St. Indianapolis Ind*

Dr. Herbert M. Shilstone (Carbros)
New Orleans, La.

**RICE-FIELD WASTE BENEFITS
SUGAR REFINING**

From the fibrous rice materials—the hulls, straw, and fibers—which formerly cost money to dispose of, now is being made a product that not only brings a



Discoverer of Method of Utilizing Rice Waste in His Laboratory: The Quantity of Waste on the Paper Is Sufficient to Treat 100 Pounds of Sugar

return to the planters and the mills, but finds a ready use as an economical substitute for boneblack in refining sugar. The fact was discovered by accident when a chemist, who was experimenting with the paper-making qualities of rice waste, left some of it in his drying oven for several days. He found that though the waste had become thoroughly carbon-

ized, it had not shrunk or lost its shape, which indicated it to be a porous material of clarifying properties. He mixed some with molasses and there was no change, but when he boiled it with caustic soda to remove the silica, and then mixed it with molasses, the mixture cleared up at once.

When treated commercially, the fibrous rice waste is put into a retort from which air is excluded, and there exposed to a temperature of 2,000° F. for half an hour. The carbonized material is then transferred to digesters and, with a strong alkali solution, is subjected to a temperature of 235° for two hours. A nearly pure carbon results, which is as porous as a sponge, and so hard that it requires several hours' grinding in a ball mill to reduce it to a powder. Even the dust particles retain a definite shape and their porous nature, which makes the material such an active clarifying and decolorizing agent. As a decolorizer it is mixed with a sugar solution in the proportion of one-half pound to 100 pounds of sugar, heated in a suitable tank, and filtered. The material still possesses considerable coagulating properties and gum-absorbing power, and is used for clarifying impure cane juice.

The use of boneblack in connection with sugar refining involves an expensive outlay for the production of the boneblack and for treating the sugar. It is said that with the new material a refined sugar of exceptional purity can be had at somewhat less cost than with boneblack. Another advantage that is to be regarded as of some importance, is

*Mr. Thomas E. Labney
of the New Orleans Co.*

*Mr. Carbros Co. & Co. St. Louis
New Orleans Co.*

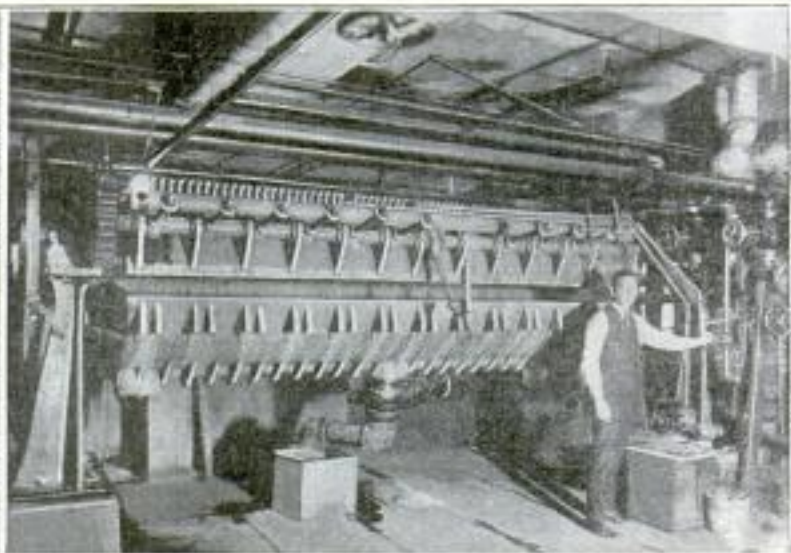

Twenty Tanks Similar to Those Shown at the Left are Required in the Boneblack Process of Refining Sugar, for Doing the Work That can be Done by Three Filters Like the One Shown at the Right, When Using Carbonized Rice Waste



Upper Left: Showing the Unusually Severe Test to Which a Sheet of Fiber Flooring was Subjected to Determine Its Fire-Resisting Qualities. The Intense Heat of an Oxyacetylene Flame was Applied for Several Minutes. Upper Right: After the Test; Only a Few Scorch Marks Resulted, Not Even Burning through the Sheet. Lower Right: How the Sheets are Laid Down. The Joints between Them are Later Filled with a Special Compound

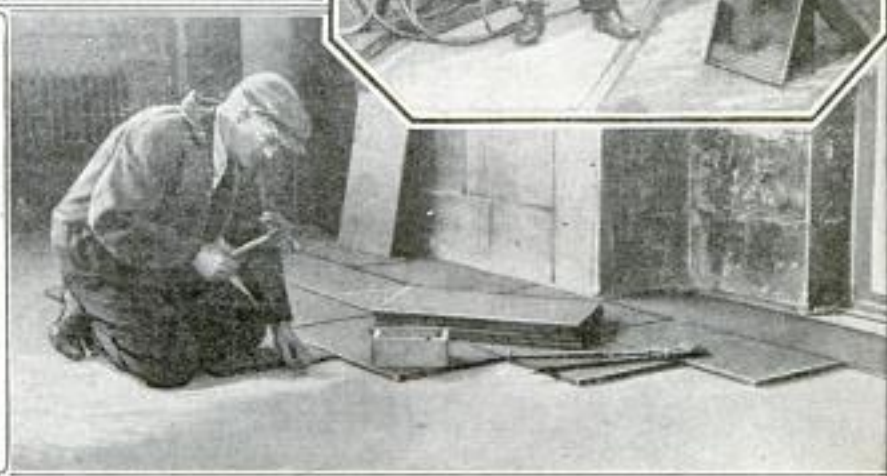

that the reasonable cost for equipment will put the use of this material within the reach of small refineries.

This carbonized rice waste has possibilities as a decolorizing agent for coconut and other oils, as well as for glue, gelatin, glycerin, and many chemical solutions.

1911

NEW FIBER FLOORING HAS FIREPROOF QUALITIES

Claims of unusually fire-resistant qualities are made for a new type of fibrous flooring material recently developed and placed on the market. The material is made up in sheets measuring 16 by 28 inches, and in two thicknesses, $\frac{5}{8}$ and $\frac{7}{8}$ inch. It is also asserted that it is a non-conductor of heat, and will neither expand nor contract appreciably under temperature changes—both very desirable qualities. Its additional bids for merit as a floor covering, are that it is noiseless to the tread, oil and waterproof, and not slippery to walk upon. When laid, the joints between the sheets are filled with a special compound, making a floor covering of practically uniform texture. The sheets are laminated, all the long, narrow

individual sections being held together by four parallel pins running through the sheet. Speed and ease characterize the labor of laying this floor.

AUTO STEERING-WHEEL LOCK 181/2 EASILY INSTALLED

One of the newer auto steering-wheel locks is made so that it can be easily installed by the owner himself. It consists of a section which is first clamped,

then pinned to the steering post, and the lock proper. The latter is of the plunger type with two plungers, one on each side of one of the spokes of the steering wheel, and when in position prevents turning of the wheel.



Lampman & Co. Chicago, Ill.

Flux Indicator Co.
60, 8 E. Pike St.

Enl. Maggie B.
Putney, Eagle Lake,
Texas.

918

POPULAR MECHANICS

909 Seattle, Wash

DEVICE REGISTERS QUANTITY OF OIL AND GAS IN TANK

PLAN MONUMENT AT CAPITAL FOR SOUTHERN "MAMMY"

The number of gallons of gasoline in the supply tank or the quarts and pints of oil in the crankcase of an auto engine, can be ascertained by the driver

A monument at Washington, D. C., to commemorate the virtues of the old southern "mammy" has been proposed by the Jefferson Davis chapter of the Daughters of the Confederacy. A government gift of land for that purpose is said to be under consideration by Federal authorities. While exact plans as to the form the monument will take have not been adopted, it has been suggested that it should be a seated figure of a middle-aged colored woman, the "real mammy type," with a "pickaninny" on one side holding her hand, and a white child on the other; this to symbolize the mothering she has given to the two races. Visitors to the South say that the cheerful, utterly unselfish mammy of the old days, whose character has become largely traditional, will soon disappear, and it is believed that she deserves a fitting memorial.

no price given

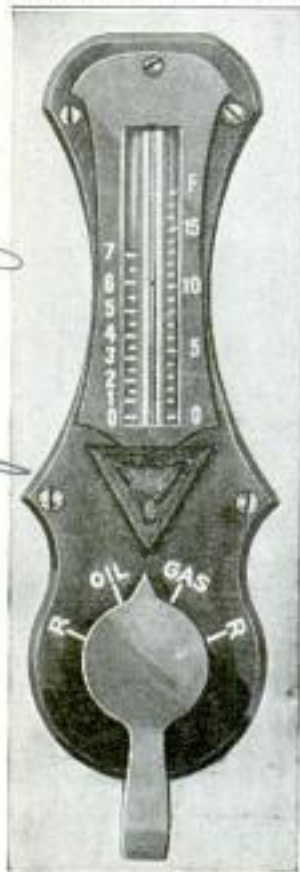

without leaving his seat, by means of a device recently put on the market. The indicator is placed on the instrument board, and from it are read either the gallons of gas or the amount of oil. In making a reading, one stroke on the pump handle located beneath the indicator, forces all the liquid out of the standpipe, which is then put in communication with the hydrostatic pressure of the tank by turning the lever to the register position. The gauge then shows the respective amounts on hand.

NEW LAMP LOCK ATTACHES TO BRASS SOCKETS

A new locking device that attaches to standard brass sockets and is intended to prevent theft of electric-light bulbs, is being placed on the market. It is simple in construction, being made of cold-rolled steel. When attached, it is nearly impossible to remove the lamp from the socket, and it is dangerous to attempt to do so without the use of the key. It is protected by an insulator that guards against shock.



lumber + 8 with Jackson, Mich

VERY DURABLE SCREWDRIVER WITH INSULATING HANDLE

Made from high-grade steel, a new screwdriver is tempered so as to give it such durable qualities that it is claimed to be indestructible. It has a handle, made of an insulating composition, which is secured by a patent locking device that prevents it from twisting on the shank. The insulation is tested to stand 15,000 volts. The blade is of selected steel, carefully forged and heat-treated, and extends through the handle. It is intended specially for the use of electricians and automobile mechanics.



762
Harold Tool Co. 212 E. Park Ave.,
Columbus, Ohio

Yellow, brown, chocolate, blue, and other bituminous paints, mixed and ready for use, and applicable without preparation of the surfaces to be painted, have recently been put on the market. The inventor claims that, no matter what the material to be painted, it need not be given the familiar red-lead priming.

Compressed Air Magazine
Easton, Pa.

1941 *Emr. G. Franklin Mendorf*
1108 Ashew Ave.
Kansas City
Mo

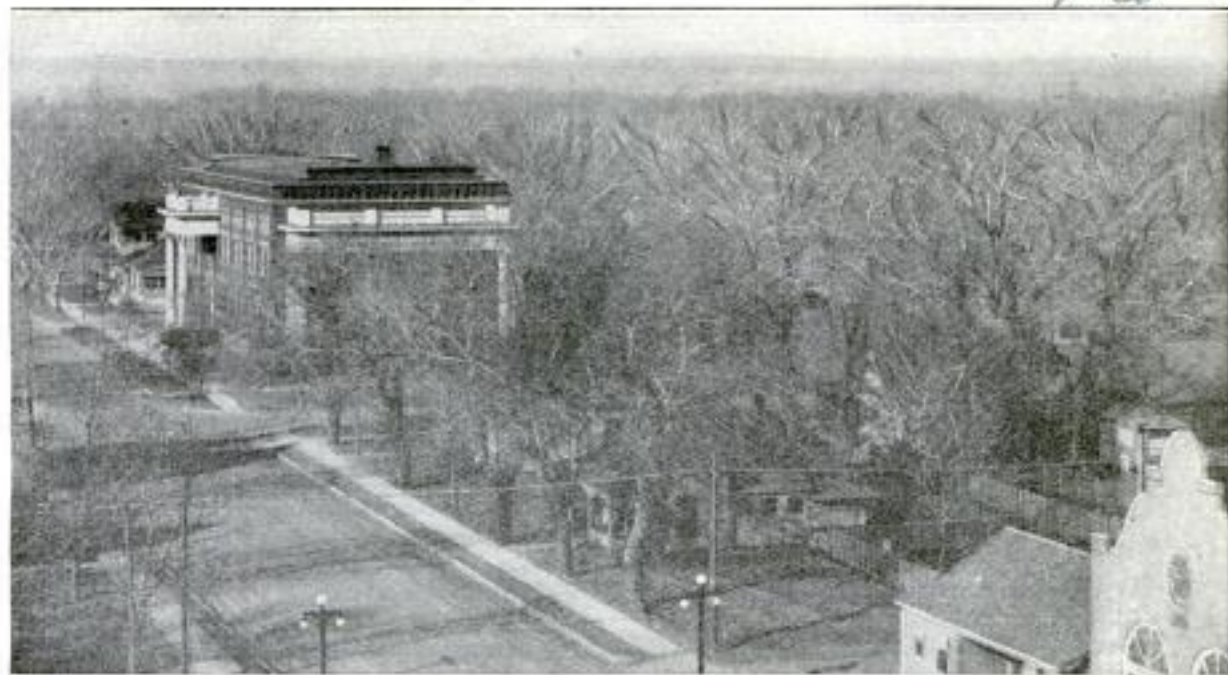

This Photograph Shows the Density of the "Forest," Roswell, New Mexico, Planted. Once on a Barren Plain, the Town Began Setting Out Cottonwoods Nearly a Half Century Ago. Today the Trees Literally Hide 325 Homes, Three Churches, and a School

1941
FOREST SURROUNDS HOMES OF CITY ON PLAIN

Shade trees in a city surrounded by the open-plains country of the Southwest have an appeal much stronger than in communities where any tree problem has been one of elimination rather than of production. On that portion of the plains which is now known as Roswell, N. M., cottonwood and elm trees have been planted with fervor since the 80's, and as an example of what can be accomplished, this city now has in its midst a veritable forest of shade trees. So dense is the growth that even without the foliage the branches of these city trees are thick enough to hide 325 homes, three churches, and a school. Property owners are required to care for all trees on and near their property. A special permit is required before any can be cut or removed.

1955
TELEPHONE LINEMAN USES HANGING CHAIR

A comfortable seat while making wire repairs is provided by the handy device developed by a western lineman for his own use. The chair is mounted on a collapsible platform, which is carried about on a small truck. On short trips this lineman wheels his little truck about by hand, but on longer ones it can be attached to an automobile. Ropes and pulleys are used for elevating the plat-

form and chair and keeping the whole on a level. The lineman finds that hav-



Showing How an Ingenious Lineman Lightened His Daily Grind by Using His Inventive Powers: Incidentally, He Is Able to Accomplish More and Do Better Work

ing a secure and comfortable seat improves the character and increases the amount of work done.

Emr. E. F. Cothye, Omaha, Neb. Copyrighted material

1889

CIVIC FEATURES THAT PROMOTE THE COMFORT

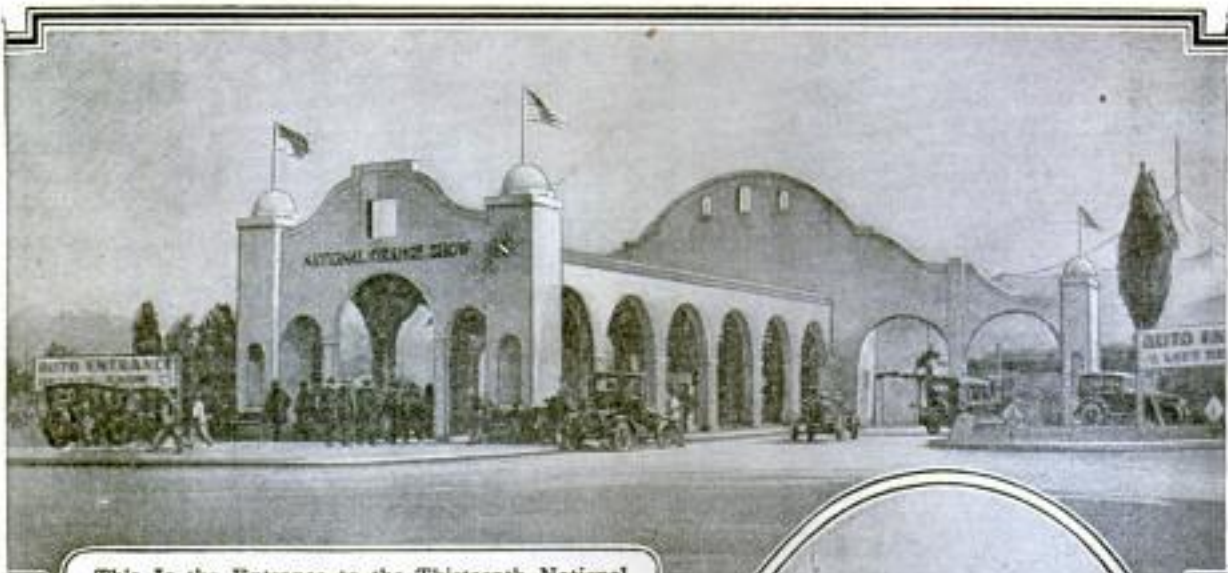

This is the Entrance to the Thirteenth National Orange Show, Held at San Bernardino, California. This Annual Event is of Considerable Importance to Southern Californians, and Always Draws Huge Crowds. Naturally, Most of the Space is Devoted to Exhibits and Feature Displays of Fruits



Right: Queen Anne Granted the Land upon Which This Church was Later Built at Wells, Vermont. It is 150 Years Old. The Large "Windows" over the Door are But Cleverly Painted Imitations — This Because of the Prohibitive Cost of Glass in Those Days. Left: A Sundial, Erected on the Bank of the Fox River, Illinois, Marks the Site Where Lincoln was Mustered Out of Army Service after the Black Hawk War



Two Years were Spent by an Artist in Edwardsville, Illinois, in Painting This Bird's-Eye View of His Home Town. His Painting Measures 5 Feet High by More than 20 Feet Long

1889

AND ENJOYMENT OF VISITORS AND RESIDENTS



The Tourist Overtaken by the Dark will Find Ample Hospitality If He Spends the Night at Pendleton, Indiana. A Comfortable Camp is Provided, Equipped with Running Water, Electric Lights, and Gas for Cooking, All Free. It is Supported Entirely by the Townspeople



Above: Bellevue, Iowa, on the West Bank of the Mississippi, Has a River-Front Park, Extending the Entire Length of the Town. This Boat Landing is One of the Numerous Beauty Spots of Bellevue. Left: A Simple, Sturdy Memorial, Erected by the Local Post of the American Legion on the Park Lawn. Below: Bellevue's Park Driveway, Skirting the River



The Everette Mfg Co
132 W. Madison St
Chicago, Ill.

Flash Sales Corp
4809 N. Ashland
Chicago

POPULAR MECHANICS Chicago

922
2024

CHECK PROTECTOR WEIGHS ONLY HALF POUND

The latest check-protecting device that has made its appearance claims the merit of extreme simplicity, and weighs only



This Check Protector, Nickel-Finished, is Gripped in the Hand Like an Office Punch, and Carries a Self-Inking Printing Dial in Its Interior

½ pound. It is handled like a small office punch, being gripped in the hand and the check inserted under two guides. A hard-rubber knob, grooved to facilitate turning accurately, carries all the necessary figures and characters on its circular edge. As each figure is set, the handles are squeezed and brought together; this action makes a red-ink impression of the figure which also bruises the paper and prevents erasure. On releasing the handles the check is automatically advanced a space ready to be given the next impression.

1981 TONS OF DUST TRAVEL IN THE SKY

Two thousand tons of dust was deposited per square mile in the vicinity of Laramie, Wyo., recently, according to the calculations of Prof. S. H. Knight, of the University of Wyoming. This dust was partly transported from other western states. Such deposits are comparatively large in all western states, though usually more than 90 per cent of the dust is of local origin. Only the very finely powdered dust travels very far, though

Encl. J. Cecil Atter, No. 3
Boston Bldg. Salt Lake City, Uta.

some has been carried from Utah, Nevada, and Arizona to Wisconsin and Ohio, as microscopic examinations have revealed.

The most favorable condition for precipitating the dust is, paradoxically, a snowstorm, though the late summer showers in the arid states are much more heavily freighted with dust, at times even mud. The rain and snow serve to filter the air, leaving it very clean. At times in the western states, clothing, windows, walls, and all other objects exposed at the beginning of a storm coming after a prolonged drought, will become badly smeared.

There are accounts of other heavy dust deposits, upward of 800 tons per acre being reported in one instance in the Dakotas. But where the dust deposited has been lifted from the Rocky Mountain region and carried to Wisconsin the amount seldom exceeds 15 tons per acre.

1992 WRENCH COMBINATION TOOL HAS STRONG GRIP

There has recently been introduced a combination tool which is essentially a wrench with a movable jaw that carries teeth engaging segmental gear teeth on the end of one of the plierlike handles. Three interchangeable jaws convert the tool into a wrench, suitable for many



The Three Interchangeable Jaws of This Tool Convert It into a Wrench for Several Purposes

purposes. The arrangement of the movable jaw provides for adjustments.

2048 METAL AND GLASS WELDED BY SIMPLE METHOD

Electrical fittings have recently been made in which copper and porcelain or glass were welded by a new method which is declared to be as cheap as it is effective. The copper rod, or rivet, is threaded through the porcelain or glass and a pressure of one-half ton applied for a quarter of a second, during which interval heat is instantaneously applied to effect a fusion.

Copyrighted material
Salt Lake City, Uta.

Price unknown.
Attention drawn

V.P. New York
C. Murray, Edison Co.
Shob. C. Murray, Edison Co.

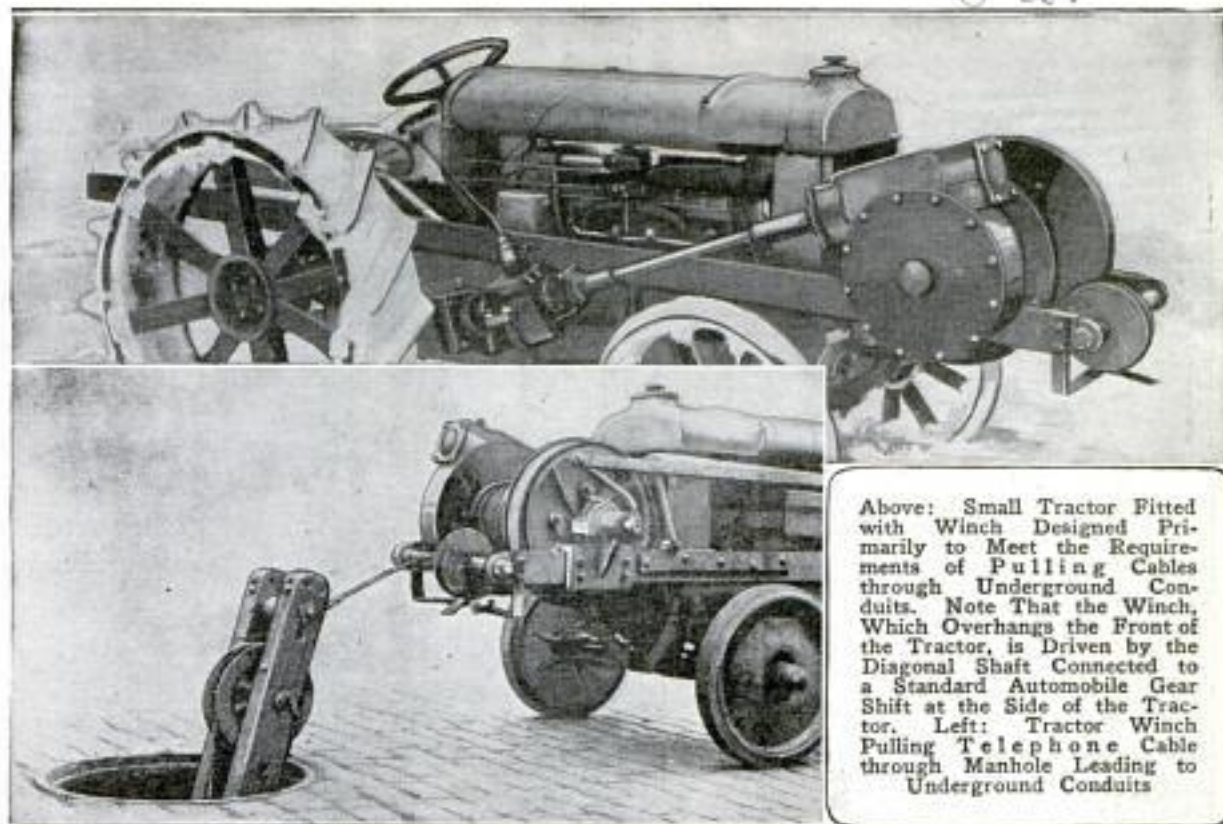

Above: Small Tractor Fitted with Winch Designed Primarily to Meet the Requirements of Pulling Cables through Underground Conduits. Note That the Winch, Which Overhangs the Front of the Tractor, is Driven by the Diagonal Shaft Connected to a Standard Automobile Gear Shift at the Side of the Tractor. Left: Tractor Winch Pulling Telephone Cable through Manhole Leading to Underground Conduits

1778
WINCH DESIGNED TO ATTACH TO FRONT OF TRACTOR

A new winch that attaches to the front of a tractor has been designed to pull cables through underground conduits satisfactorily. Though intended for use in telephone work, it is adaptable for many other purposes. The objection to some tractor winches that they have only one speed, has been overcome by introducing an ordinary automobile transmission between the power shaft of the tractor and the cable drum. Power is transmitted from the tractor through a set of gears to the transmission and through a cone clutch to the winch drum, thus providing three speeds forward and one reverse.

the device can be used in the course of hardening a small piece of steel, such as a tap, when heated over a Bunsen burner. The device requires no calibration.

1769
DEVICE SHOWS CRITICAL POINT IN HEATING STEEL

A new device for determining the critical point in the heating of steel, by indicating when the steel ceases to be magnetic, is a light self-contained instrument that can be held in one hand and is free from leads or electrical connections. The indicator receives its magnetism from a permanent magnet which is protected from injury by its location within the instrument itself. Inasmuch as the test is applied to the steel instead of the flame,

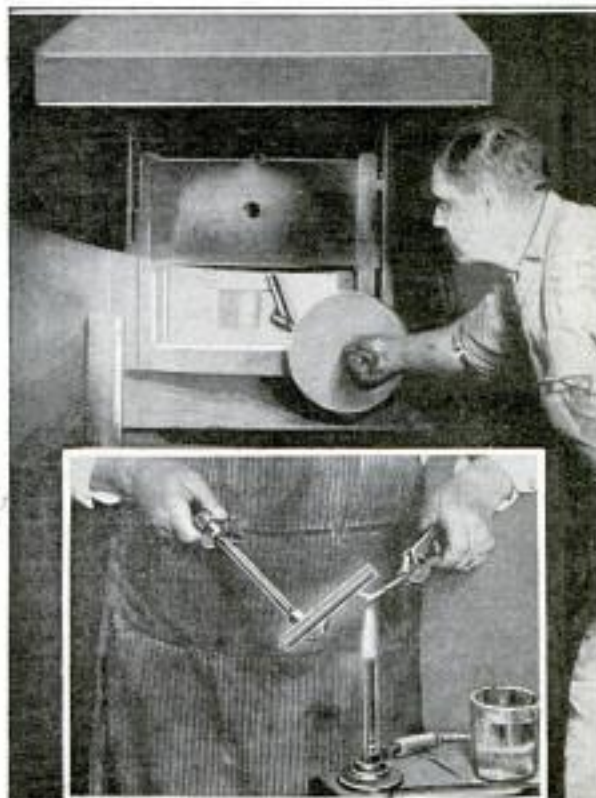

Above: Using Indicator to Determine Critical Point of Steel in Heating Furnace. Below: Applying Test to Steel Heated over Bunsen Flame

Herman H. Sticht & Co. 15 Park Row, New York City

1942

Portland Construction Co Portland, Maine



Considerable Rivalry among Various Cities and Villages has Sprung Up Concerning the Question of Which Has the Widest-Paved Thoroughfare. Here are Shown Two Views of the Work of Paving Main Street, Keene, New Hampshire, with Concrete. Keene Claims the Widest-Paved Street in New England. In the Upper Photograph are Seen the Details of the Construction, and the Great Width of the Thoroughfare Permits Inspection of the Various Steps in the Work. Below are Shown the Piles of Gravel and Rolls of Wire Netting Used as a Foundation for the Layers of Concrete



2036

TURN WORN-OUT MONEY BACK INTO PAPER

Worn-out United States currency representing millions of dollars, cut up and pulped, has been shipped to the Forest Products Laboratory at Madison, Wis., to be used experimentally in the manufacture of paper. Prior attempts at the laboratory resulted in paper of a poor quality, but it is expected that with a new cleaning process a more satisfactory product will be obtained. As much as two to three tons of paper money are discarded and destroyed on occasion at the treasury in Washington, D. C. If the experiment proves successful, the government will continue the pulp shipments.

1927

WATER-PROPELLED NOZZLE CLEANS SEWERS

A two-part water-propelled nozzle, made of bronze, has been developed lately for removing obstructions in sewer or drain pipes. The two parts are connected by a ball-bearing swivel mounted between them, the head, or forward end, being pointed and containing a series of diagonal vanes to produce a rotary motion when in action. When connected to a hose and the water is turned on, the latter escapes through perforations in the rear of the head, causing the nozzle to impel itself forward and drag the hose after it. The point of the head is also perforated, so that part of the stream serves to loosen up the obstructive material.



1942

WIDEST GRANITE CONCRETE ROAD IN THE WORLD

What is claimed to be the widest concrete-paved street in the world is laid at Keene, N. H., and measures 140 feet from curb to curb. On account of the lack of suitable trap rock or gravel in the state, and great prevalence of granite and marble, crushed granite was used in the concrete. After excavating to subgrade, the latter was rolled, and a 7-inch slab, reinforced with steel mesh, was applied to the roadway. The unusual width

AUTO-STEERING ATTACHMENT IMPROVES CONTROL

A new device has been developed for eliminating the wobbling of front wheels, particularly in cars whose steering posts are not fitted with a worm gear. The attachment is made of cast bronze, in two halves, which clamp around the post, the upper half being loose and the lower one tight. An adjustable spring that provides tension between the two halves, comes into play when the steering wheel is turned.



6035

NEW ISLAND REPORTED FOUND NEAR FRENCH INDO-CHINA

A new island, believed to be of volcanic origin, is reported to have been sighted between the Philippine Islands and French Indo-China. It is said to be about 50 feet above sea level and a half mile in circumference. Farther east, in the Pacific Ocean, a governmental scientific party is exploring Bird Island, one of the bits of isolated lands in the Hawaiian archipelago. This expedition also intends surveying most of the islets between Kauai and Midway Islands of the Hawaiian group.

Chicago Tribune 4/4/23

The Self-Propelling Nozzle Co. New York St. Water 99

**SIMPLE BUCKET ELEVATOR
STORES FARM GRAIN**

1856 A simplified type of bucket elevator intended greatly to facilitate the work of the farmer when storing corn or grain, has been placed on the market. Rolled-edge buckets with welded

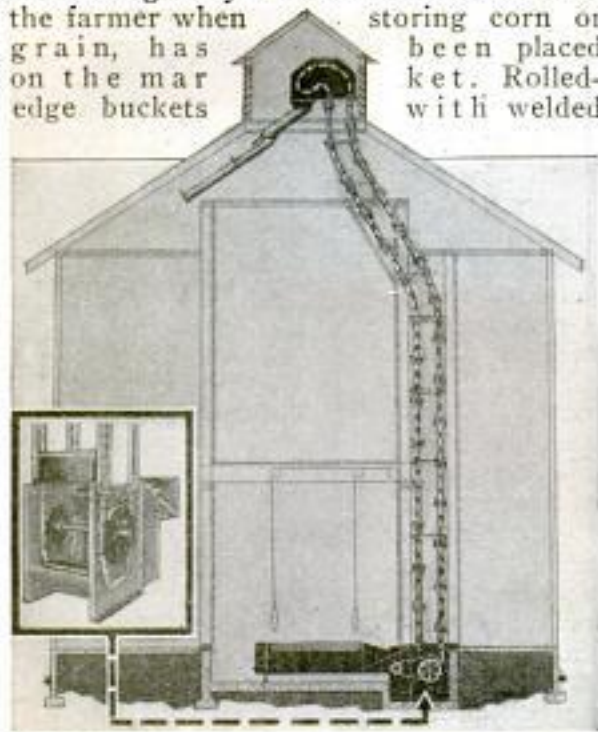

Sectional View of the Bucket Elevator Set Up in a Corn Crib: It Is of All-Steel Construction, and Has Only One Shaft and Two Bearings

joint are provided in the new elevator. These are mounted between an endless steel strap, whose links pivot on roller bearings, a feature which lessens the power requirements of the drive. Its capacity is 100 bushels of grain elevated in from three to five minutes, on a gasoline consumption of 1 gallon in 10 hours.

**PILOT IGNITION DESIGNED
FOR STEAM CARS**

1843 A new pilot-light assembly now on the market, for use as an ignition device for the fuel burner used on steam automobiles and trucks, features a rapid va-

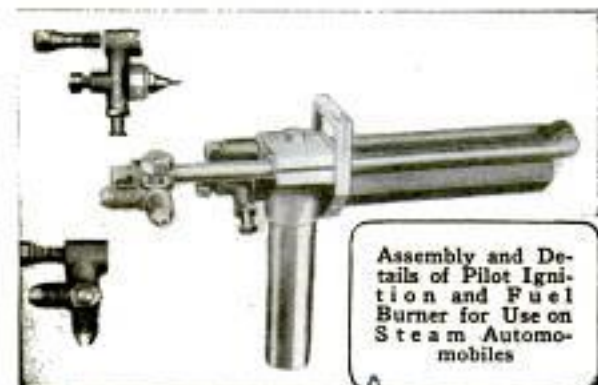

Assembly and Details of Pilot Ignition and Fuel Burner for Use on Steam Automobiles

porizer that, it is claimed, does not collect carbon, and an arrangement of the air intake that prevents the pilot from being blown out.

**HELICOPTER RISES 20 FEET
WITH NEW MOTOR**

2034 A new record was recently made at McCook Field by the De Bothezat helicopter, when a height of 20 feet was attained in several tests, none of which lasted over two minutes. The improvement over previous performances is attributed to a new 200-horsepower rotary motor with which it is anticipated a height of 100 feet can be reached.

Chicago Tribune 4/9/23

**MAGNET TURNS STIRRING RIG
INSIDE CLOSED DISH**

1800 A clever arrangement has been devised for stirring solutions that the chemist often finds necessary to keep from contact with the air, and which, for various reasons, cannot be put in containers that are susceptible to shaking. The agitator, which somewhat resembles the mixer of an ice-cream freezer, is mounted on a spindle which is pivoted at the bottom and the cover of

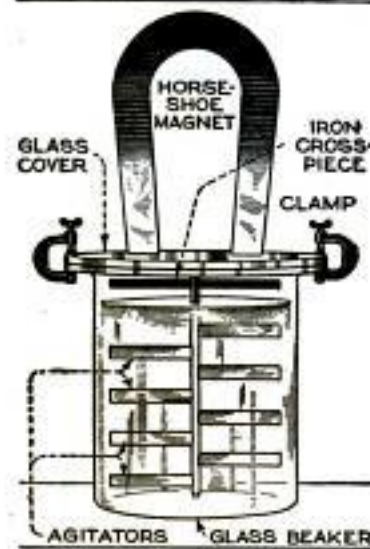

the vessel, and carries at the top an iron crosspiece. On the outside, and just above the cover, is mounted a strong magnet which is provided with a suitable driving means. When the magnet turns, the iron crosspiece at the top of the agitator spindle follows, thus creating the stirring action.

Surrounding Chicago's sewage-disposal plants with parks and golf courses is being considered by city officials. The plan has been recommended to offset the "sentimental" damage done to adjacent property under present conditions because of public dislike of such localities.

U. W. University of Chicago

Cruban Machine & Steel Corp. New York City

1746 Cont. George Es McVickie
North (Be ind. helr. ^{Washboro}

GOPHER HAS MECHANICAL FARM RIVAL

An interesting attachment for use with a farm tractor has been placed on the market, which greatly helps the farmer to till his soil. Instead of breaking it with a plowshare into lumps which later have to be broken with a harrow, this machine digs up the

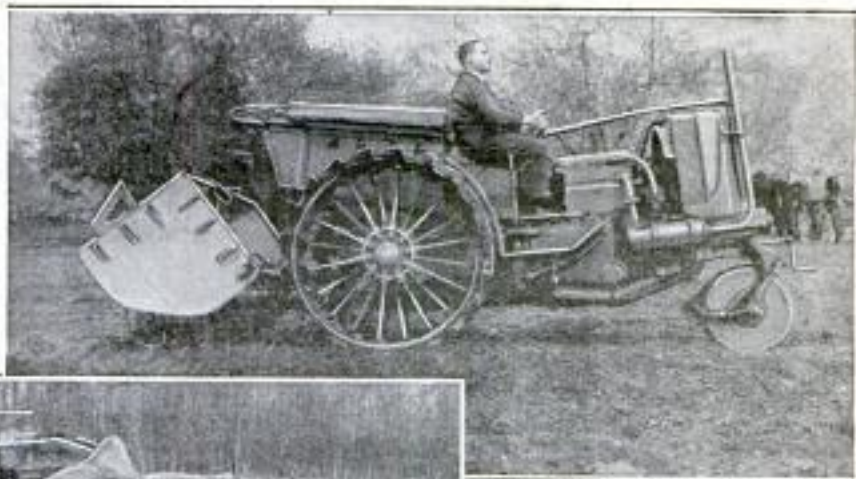

The New Mechanical Soil Gopher in Action, Operated by a 35-Horsepower Engine. It Propels Itself Along as It Tills the Soil

Details of the Construction of the Mechanical Badger, Showing the Hooks Which Act Like the Paws of the Little Animal, Digging Up the Soil and Throwing It Back into a Well-Pulverized Seed Bed

soil almost as a gopher does with its paws, and throws it back into a well-pulverized seed bed. The tractor, which is of 35 horsepower, may, of course, be used without the tiller for general purposes, as the latter is easily detachable.

1961

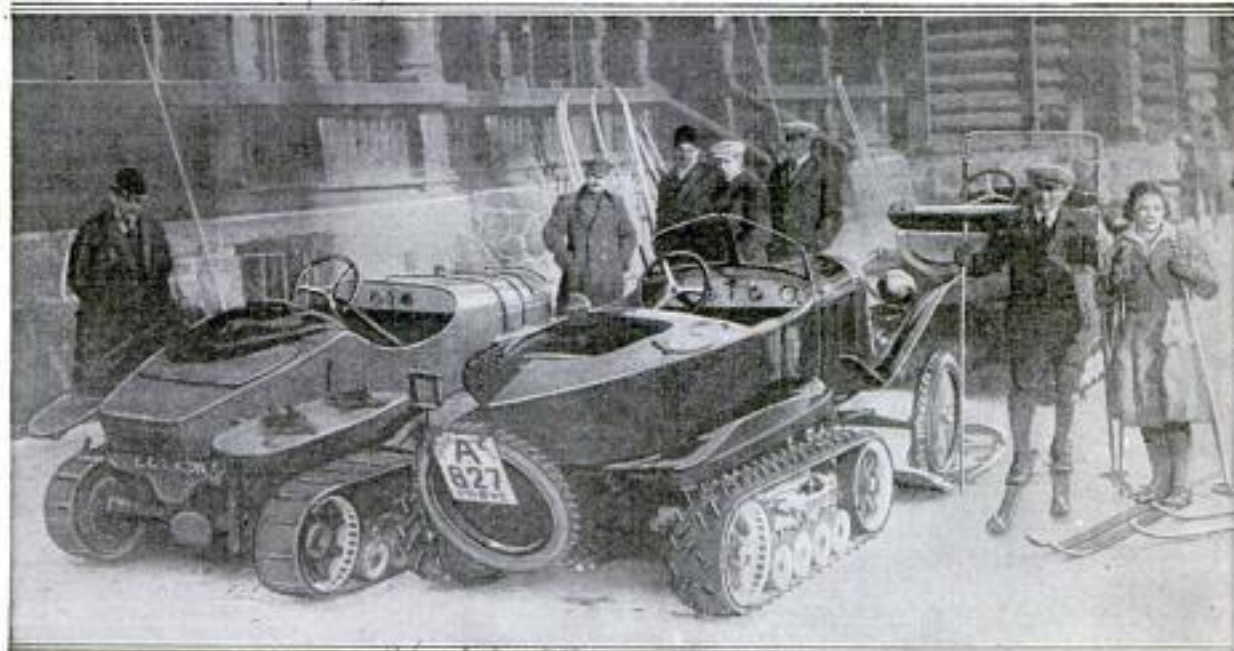

COPYRIGHT, UNDERWOOD & UNDERWOOD

AUTOS WITH ENDLESS TREAD SUCCESSFUL IN NORWAY

TWO automobiles equipped with endless-tread traction, not long ago successfully underwent severe tests near Christiania, Norway, where they were made to climb steep hills, cross ditches, and traverse underbrush and deep snowdrifts. The endless tread, which is quite similar to the traction rig of the tanks used during the war, enables the machines to travel at a good rate of speed under adverse conditions. The machines have finished bodies like an automobile, and the chassis is of the same type as that used on the trucks that crossed the Sahara Desert recently, as recorded in the March issue of this magazine.

Citroen - Christiania, Norway.

American Representative - Development Corporation, 21 E. 40 St. Washboro

Copyrighted material

1820

Overside Water Works

4/3/23

TANK WATER HEATER USES NO COILED TUBES

The copper coil of tubing found in most tank water heaters is dispensed with in a new type of heater which uses a



The Construction of This Heater Embodies a Departure from the Usual Coiled-Tubing System. The Burner is Designed to Prevent Flash-Backs

number of straight vertical tubes. The advantage claimed is that circulation of the heated water is very rapid, on account of the small travel necessary. The heater is tested to a pressure of 600 pounds per square inch, many times the pressure it would be subjected to in ordinary use. What is asserted to be a nonflash-back burner is incorporated with the heater, doing away with the annoyance which frequently occurs when the gas pressure fluctuates.

DUTCH RADIO STATION SPANS 12,000-MILE GAP

A new radio station recently installed at Kootwijk, Holland, makes it possible for the Dutch government to communicate directly with its East Indian colonies, without dependence upon foreign cables, as has hitherto been the case. A station at Bandoeng-Malabar, Java, has been equipped to both send and receive messages from Holland. The Kootwijk station is a sending station only, messages being received at Sambeek, 20 miles away. This receiving station is equipped with the most modern apparatus, including registering writing machines and machines that print the signs in relief on wax rolls, so that they can be reproduced vocally in much the same way as a phonograph record. These instruments are specially useful for automatically registering dispatches, as these are sent out with great speed.

MAMMOTH AUTO TRAILER HAS 1892 FREIGHT-CAR CAPACITY

The rapid increase in transportation by truck has been followed closely by an increase in truck capacities to meet this growth, and finally by the rapid development of trailer trucks. Perhaps the largest of these yet to appear is now being used in the transportation of automobile bodies, and is fully 40 feet long, exclusive of a 10-ton truck which hauls it around. It is of substantial pressed-steel construction, 8 feet wide by 12 in height, and is roomy enough to accommodate 24 bodies at one time. It is carried on only two axles, one of which is the rear axle of the truck proper, but the tread is very wide to distribute the load better.

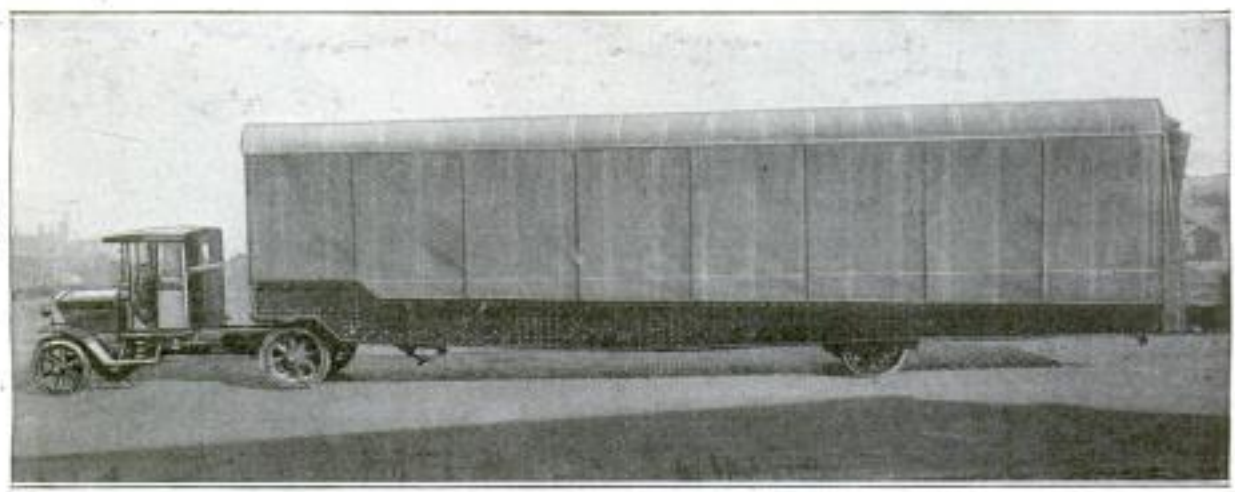

This Giant Rival to the Railroad Freight Car Bids Fair to Snatch Considerable Traffic Away from It. It Is 40 Feet Long by 12 High and 8 Wide, and Holds 24 Automobile Bodies. Rounding a Corner with This Outfit Is Something Like Swinging a Hook and Ladder Truck around a Curve

Detroit Trailer Co. Detroit Mich.
954 E Milwaukee Ave

1311 Owner of farm: Jack Allman
 Griffith Park, Los Angeles, Calif.

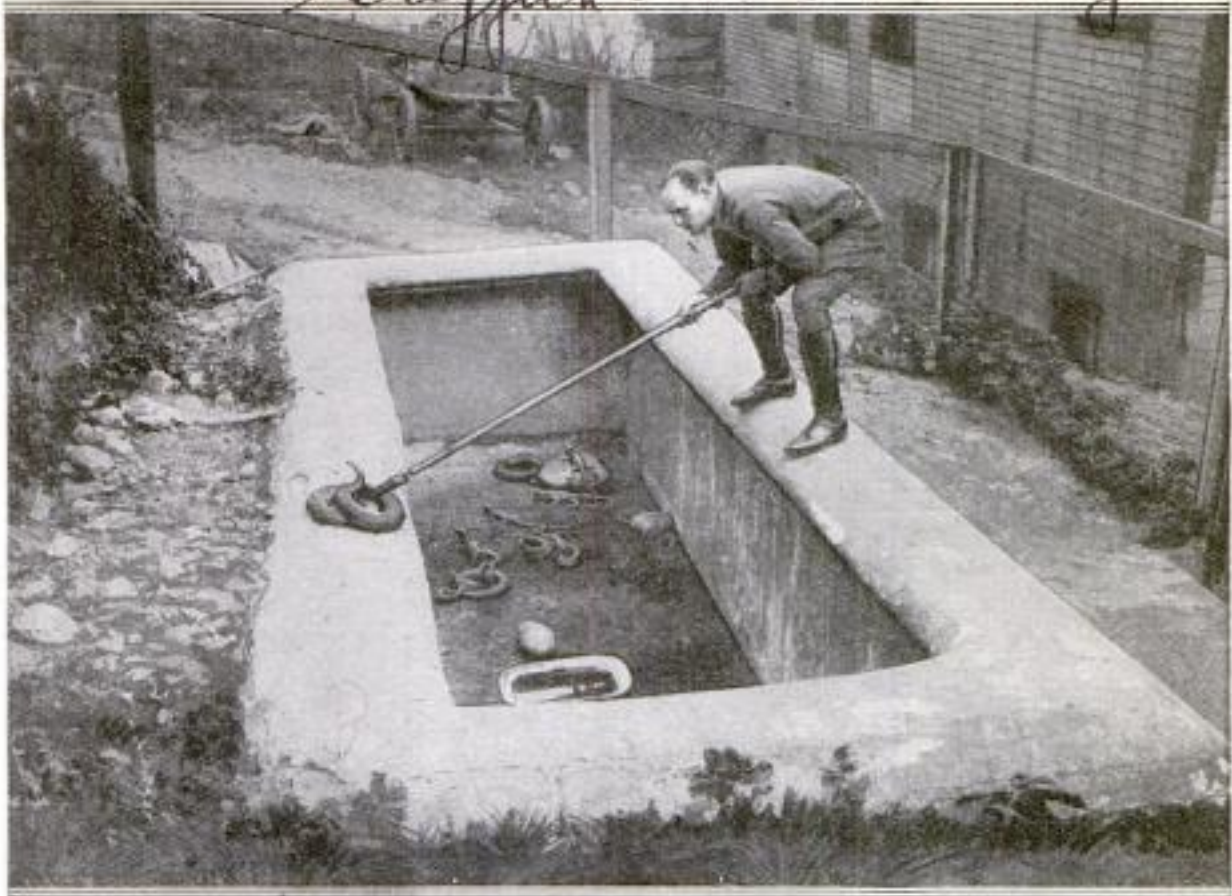

The Owner and the Small Snake Pit at the Rear of His Parking Lot opposite Los Angeles Courthouse: A Two-Acre Pit is being Built near Los Angeles for the Commercial Breeding of Snakes and Other Reptiles

COMMERCIAL SNAKE BREEDING IN CALIFORNIA

BY ARCHE M. DUNNING

923 Arapahoe St.
 Los Angeles, Calif.

A HUGE concrete-walled pit where snakes and other reptiles will be kept and permitted to breed under surroundings similar to their natural environment will shortly be established near Griffith Park, Los Angeles, Calif. This novel idea is being carried out by a citizen of Los Angeles, well known throughout the Southwest as an expert on rattlesnakes and reptile life. The pit will cover two acres, excavated below the level of the surrounding terrain and inclosed by a high and wide concrete wall, with a promenade atop. At intervals, similar walls will cross the entire tract, thus giving visitors ready access to any section.

Almost every reptile indigenous to the country, with the exception of alligators and crocodiles, will be found here. Near the center of the tract is to be located

a swampy pool for water moccasins of all obtainable varieties, spreading adders, and creatures of the lizard family that thrive in such surroundings.



Rattler's Fangs, of Which There Are 14 to a Set: Two Are Striking Fangs, Two Are Floating Fangs, and 10 Are Reserve Fangs

Rattlesnakes will, however, be the main attraction, and arrangements for the delivery this spring of 5,000 from a Texas dealer have already been made. Rattlers produce from 25 to 45 young in each litter, and the young attain maturity in one year. Consequently, there will be no lack of "stock" once the pit is in active operation.

Snakes will be supplied to the moving-picture studios and for educational films. Snake oil and venom will be marketed in

quantities. The oil is said to be of value in the treatment of rheumatism and is in demand among mechanics who do finer grades of machine work. There is a

steadily increasing call for the venom from physicians, chemists, and others, who use it for medicinal purposes. The supply is inexhaustible, for each snake may be deprived of its venom every eight or nine days without injury. Rattlesnake skins are sought by manufacturers of novelties, and there will be no difficulty in disposing of all that can be produced, it is believed.

Close by the pit an additional half acre is to be similarly fitted up as a breeding place for rats and mice to be used as food for the inmates of the pit. The weekly bill of fare, at first, it is estimated, will be from 10,000 to 15,000 rats and mice. Vice versa, snake carcasses will be fed to the rodents. Papier-mâché dens with hinged tops that may be lifted will be a feature of the pit. This will afford an excellent opportunity to make a close study of the reptiles under various condi-

studying, capturing, and exhibiting reptiles, mostly snakes, for the better part of 35 years, is the authority for some interesting statements.

"The rattlesnake is a gentleman among reptiles," he says, "because he never strikes unless molested, and even then gives his victim timely and ample warning. The 'hoopsnake' of folklore is a myth, and the 'jointed' snake credited with disintegrating itself into living sections at will, exists only in imagination. Most snakes are rendered dangerous only because of their own timidity, and occasionally one dies soon after

capture, literally frightened to death." Rattlesnake flesh is a succulent and delicious edible, resembling frogs' legs in flavor and appearance. The number of rattles is not a certain indication of a snake's age. Sometimes two rattles grow a year. Only one snake native to the

United States is susceptible to music. That is the "silver racer," found in California and in many of the middle-western states. This snake is particularly charmed by the twang of the jew's-harp, and will approach within a few inches of the player if the harmony is sustained for a moderate length of time.

The snake fancier's experiences with snakes started on his father's Iowa farm at the early age of seven. On his way to school one day he climbed an apple tree in pursuit of a woodpecker that had dodged out of sight into a knot hole. He plunged his hand into the hole and pulled out a blacksnake

tions and in the various seasons of the year. The originator, who has been

that had half swallowed the bird. Too frightened to let go, he dropped to the



Extracting Venom from a Snake Whose Upper Jaw is Held over the Rim of the Goblet: Note Pool of Venom at Bottom of Glass

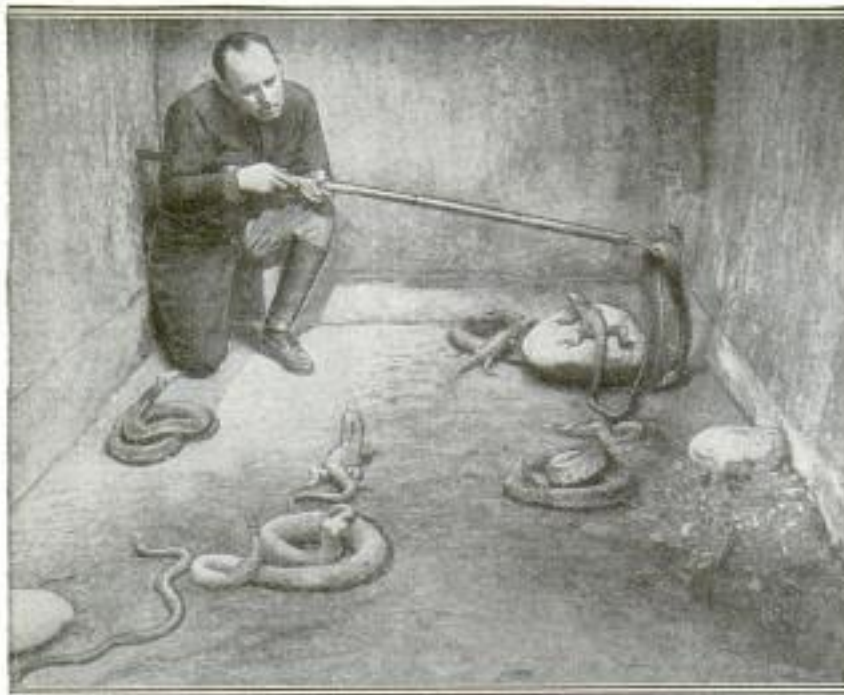

The Originator of the Snake-Farm Idea at Los Angeles, Playing with Some of His Pets in His Private Snake Pit



Left to Right: The Snake Trainer and Two Moving-Picture Men Watching Rattlers Used in Film Version of "The Virginian"

ground with his gorged prize, and taking it home placed it in a box behind the barn.

The thrill of the capture remained with him, so he hunted for more snakes and added them to his collection until he had perhaps a dozen. The neighborhood boys, at one cent each, were permitted to peep. After a while, a carnival company with one "Bosco, the Snake Eater," came to a neighboring town. Bosco heard of the collection, rented a horse and buggy (it was before the days of automobiles), came out to make an inspection, and bought the lot for \$10. That settled it as far as the amateur collector was concerned. Snakes from that time on were his absorbing passion. Their habits became the subject of his constant study, and their habitats his constant quest.

His travels have led him into the wildest sections of Old Mexico and over sterile Texas plains. He has captured the deadly water moccasin deep in the moss-hung Florida Everglades and in the sodden swamps of Arkansas. He has endured for weeks the terrific heat of Death Valley in order to get first-hand information regarding the reptile life of this sandy waste. When he first came to Los Angeles, moving pictures were just getting a start there. It was before the day of the esthetic "silver screen" and elaborately staged productions. Movies to be successful had to have an element of novelty and danger. Hence the advent of "Hugo."



Los Angeles Expert Snake Trainer in the Garb of a Zuni Indian Chieftain, Doing an Indian Snake Dance with Two of His Pets

Hugo was a South American python, 22 feet 8 inches long, weighing about 160 pounds. He was, notwithstanding his size, the one snake that the collector ever succeeded in thoroughly subduing, and it took the trainer six months after his purchase to accomplish it. For hours at a time the man worked with the big reptile in a room 12 by 14 feet, with a padded pillow to ward off the blows of the savage jaws. Finally, however, the snake Hugo became so tractable that he would drape himself over a beam and coil the lower part of his body into a swing for his master.

"The Coil of the Python," a prehistoric cinema thriller, was Hugo's most notable starring vehicle. During the big scene of the production, the trainer allowed the python completely to coil upon him at the imminent risk of being crushed into a pulp. As a matter of fact, it took all his skill and 20 minutes of hair-raising effort to extricate himself at the conclusion of the scene.

He accomplished it by tickling Hugo in the tummy!

The trainer's moving-picture experiences all had their part in fitting him for the management of his pit, which he plans to make his future life work.

Capt. Mc Bude
Chemical Warfare Service

Ross Lear
& Tool Co. 550
550 Heath St.
Lafayette, Ind.

932
Municipal Bldg
Washington, D.C.
NEW TEAR-GAS GUN MAKES
EFFECTIVE WEAPON

POPULAR MECHANICS
rail mounted on two movable legs, so as
to accommodate short or long bends.
The operation consists in passing a heavy
yoke under the rail and over the jack,
which is then pumped up, bending both
rail ends and plates slightly above level.

1731
A new tear-gas gun is being marketed
for the use of police officers and other
representatives of the law, to whom it is
released only after recording
the serial number of
the weapon. It is designed
to be used in quelling riots;
in making raids, when the
inmates of a room can be
subdued by discharging the
gas through a keyhole or
similar opening, and in
other work where physical
injury is to be avoided.



The gun consists of two cylinders, each
2 1/2 inches in diameter and 7 inches long.
One cylinder is charged with air at 1,800
pounds' pressure, and the other contains
a tear-stimulating liquid which is vaporized
through a nozzle by operating the
air-cylinder control valve.

1749
**AUTO CAM GEAR INCREASES
STEERING LEVERAGE**

A type of steering gear for automobiles
just placed on the market makes use of
a cam-and-lever arrangement which
greatly increases the leverage
at the driving wheel and
also hastens the turning
action. The cam, or
actuating member, is
similar in appearance
to a single-thread
screw of varying
pitch. In mid-position
the pitch of this
cam is very slight,
and the motion slow,
so that in straight-ahead
driving considerable
road shock is taken
up before reaching
the wheel. As the
pitch increases,
however, the motion
increases rapidly
toward either
extreme of the
cam; the result
being that only a
slight turn of the
steering wheel is
necessary in
rounding a corner.
The cam is
mounted in ball
bearings. Because
of its rapid
action, great
facility is given
in parking a car
close to the curb
in congested
districts.



1103
**BENDING DEVICE RENDERS
OLD RAILS USABLE**

Salem Division, Eastern
Mass. St. Ry. Co. Salem,
Mass.
A rail bender, developed for use on an
eastern street railway, was designed
for the purpose of taking out the
vertical bends from the ends of rails,
caused by car wheels passing over
the rail joints. The bender, which
is operated by a 35-ton jack, is
made of several pieces of old

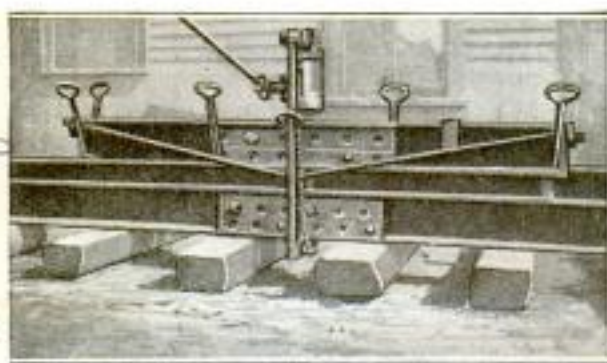

Left: Side View of Rail Bender in the Process of Straightening the Bent Ends at a Rail Joint. Right: End View of Bender, Showing the Yoke That Holds the 35-Ton Jack to the Rails, and the Brace Which Keeps It from Tipping

1847 Cont. W. A. Cather,
751 Kearny Ave. N.E.
Arlington, Va.

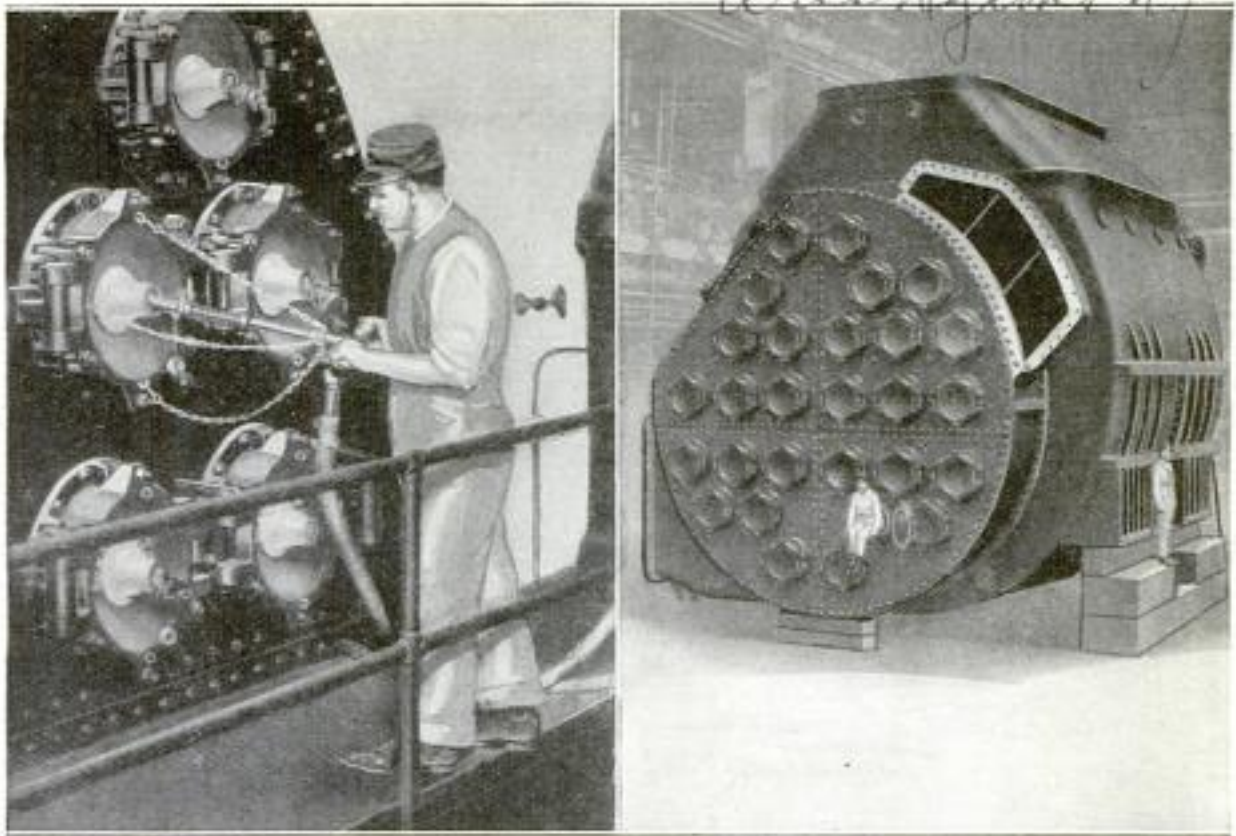

Left: Operator Using New Device Which Cleans Mud from Condenser Tubes, While Condenser is Operating, with a Jet of High-Pressure Water. Right: Large Surface Condenser Which Contains over 50 Miles of $\frac{3}{4}$ -Inch Copper Tubing

HIGH-PRESSURE STREAMS TO CLEAN CONDENSERS

One of the great nuisances in many power plants is the mud and slime that collect in the tubes of steam condensers. This foreign matter is brought into the condenser with the circulating water which is pumped through the tubes to cool and condense the steam on the outside of the tubes. After a few weeks' operation the tubes have a very noticeable coating of mud; hence the necessity of a tube cleaner. The mischief caused by the mud is quite apparent when it is remembered that dirt is a poor conductor of heat and acts as an insulating material inside the tubes, preventing the normal action of the condenser.

There are a number of more or less mechanical means of doing this cleaning, but most

of them require that the condenser should be shut down.

In a new device the condenser is fitted with special plates on the shell opposite one end of the tube nest. Each plate has a socket and check-valve arrangement through which a nozzle may be inserted and high-pressure water turned on, so that the nozzle shoots a stream of water into each tube. The force of the water jet dislodges any collected dirt, and after a few moments' application, the tube has been literally scoured clean. The socket is so constructed that the nozzle may be turned about until it has played over every tube within the range of that particular plate. Other plates give access to the other tubes.

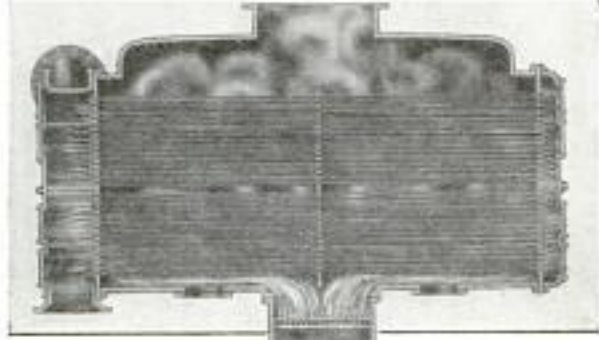
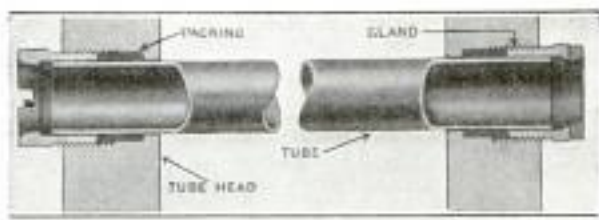

Above: Sectional Condenser Tube. Below: View of a Condenser Longitudinal Section Illustrating Action of Steam around Tubes, and Accumulation of Condensed Steam in Hot Well

188.

SOME NOVEL AND LITTLE-KNOWN ACCESSORIES



This Spool Serves as a Pincushion, and Has a Little Felt-Cushion Center. Shown at the Upper Right

One Hundred Hours of Light on a Teaspoonful of Kerosene Is the Claim for This Lamp. The Barrel Portion is Filled with Cotton

A Knife-Edge Sheet of Water is Used in this Dish-washing Appliance for Cleaning All Kinds of Tableware and Dishes. Its Action upon Grease is Similar to That of a Razor, and the Cabinet Eliminates All Splashing

The Advantage of This Ironing Board is That It Lies Flat against the Wall When Not in Use. A Hinge Permits the Board to be Swung Out Horizontally

The Spout on This Coffeepot cannot be Broken Off, for the Reason That It Has None. Even the Handle does Not Project



Something New in Oil Stoves: The Burned Fuel is Vaporized and Consumed Completely, without Smoke or Soot. The Shelf is Sufficiently High to Permit the Use of a Wash Boiler



This Device is for the Kitchen Wall, and Has One Connector Plug and Three Electric Outlets, to Keep Several Dishes Cooking at Once



Combination Chair and Bed, for Both Day and Night Use: The Back is Adjustable, and can be Tilted to Suit the Convenience of the User. It is Very Comfortable, and can be Used Where There is No Room for a Full-Sized Bed

INTENDED FOR THE HOME AND ITS MEMBERS

SPE
12
IRON
OIL
DIS
ELEC
KEROSE
SPOC
COMBI
FLO
TOL
CHU
RUB
TAF
SE
CE CR
OPE



In the Center of This Cluster of Hinged Metal Petals Is an Electric Socket, Ingeniously Concealed When Not in Use

A Light That Is Easy on the Eyes Results When This Shield is Slipped over the Bulb. It Comes in Sizes to Fit All Bulbs

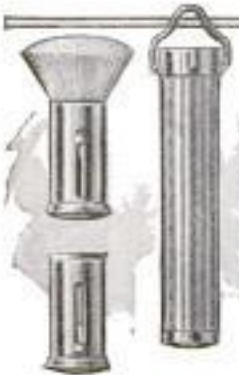

An Attractive Toilet Accessory, Which Contains a Silk-Fiber Puff and a Generous Supply of Powder

The Tilting Top on This Table Allows It to be Taken through a Doorway without Removal from the Legs. When House Cleaning, the Top is Quickly Tilted, and Moved Out of the Way. It Has Twin Pedestal Legs, Mounted on Casters, So That It can be Rolled About Easily



Ice-Cream Making Is Easy with This New Stand for the Machine. It Weighs Only 3½ Pounds



Butter can be Made Quickly in This White-Portland Porcelain Churner. Turning the Crank Results in a Rocking Motion, and the Transparent Celluloid Top Makes It Easy to See When the Butter Comes

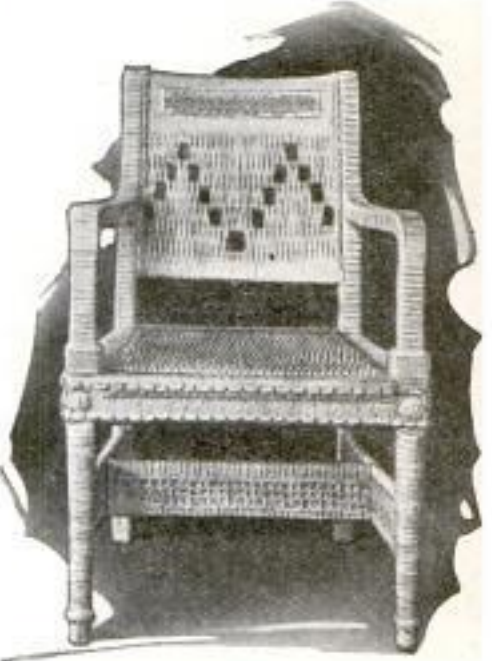

Decorative Articles of Furniture, of Which This Chair Is an Example, Are the Product of an Eastern Manufacturer. They are Woven by Hand from Sisal, Hemp, or Cotton Rope, by a Patented Process

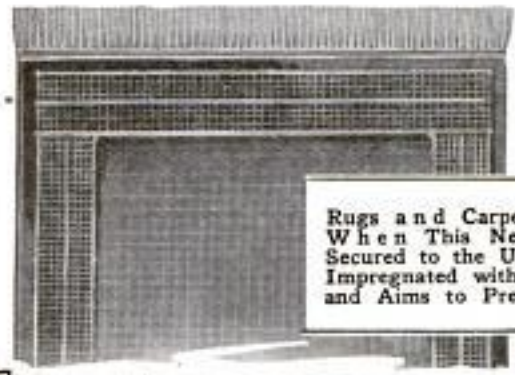

Rugs and Carpets cannot Slip When This Netlike Fabric is Secured to the Underside. It is Impregnated with Live Rubber, and Aims to Prevent Accidents

Wm. W. Huggent & Co.
146 W. Superior St.

936

5062

POPULAR MECHANICS

Chicago
OIL-FILTER ALARM WARNS OF CLOGGING

A clogged oil filter is worse than useless, and heretofore the only method of insuring certainty of uninterrupted operation has been frequent inspection. The result is that the

filter frequently becomes flooded and overflows, or the flow of oil to the lubricated parts is less than the requirements. In a new device, an automatic alarm is incorporated which gives ample warning when the straining bags begin to clog up. The supporting rings of the bags are made with an overflow spout which conducts the unfiltered oil to a tilting, two-compartment tank, attached to a transverse pivot shaft and free to rock from side to side. As one of the compartments becomes filled, the tank overbalances to that side, and discharges its contents, causing a striker to ring a gong. At the same time the other tank compartment is brought under the oil stream. This action continues as long as the oil overflows from the clogged filter bags.

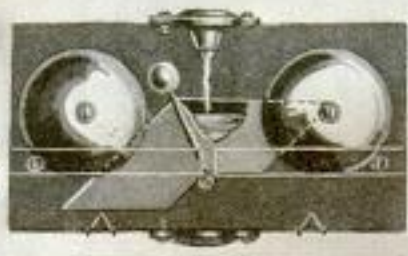
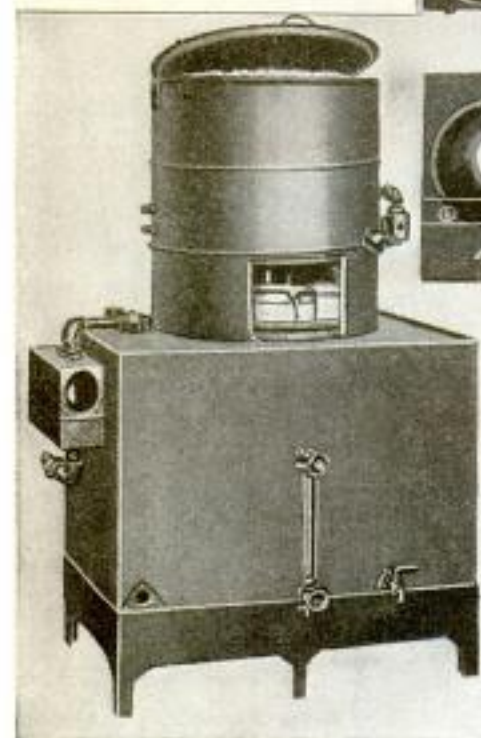

Left: The Small Rectangular Box, Connected with Pipes to the Left Side of the Oil-Filter Reservoir, Contains the Alarm Device Which Rings a Bell When the Filter Bags become Clogged and Overflow, Thus Warning the Engineer or the Attendant, That the Filter Bags Need Renewal or Cleaning. Above: Top and Side Views of Alarm Bells and Tilting Two-Compartment Tank

1950

BRANCH OF YALE COLLEGE SUCCESSFUL IN CHINA

"The College of Yale in China," a branch of the American college of that name, now has an enrollment of more than 500 men. This school was founded in Changsha-Fu, the capital of the province of Hunan, in 1906, with 13 students. Since then, the Yale alumni have been most active in supporting the institution, financially and otherwise, and it has progressed steadily. It is said that its school of medicine is one of the largest and finest in China. All instruction is given in English.

1680

EMERGENCY DEVICE REPAIRS BROKEN AUTO AXLES

A simple device for making emergency repairs in the case of a broken car axle is now on the market. The device which can be carried in the tool kit and can be installed with a wrench, will enable the autoist to travel under his own power

to some shop where permanent repairs can be made. It consists of a hardened steel bushing which is slid over the broken axle, to which it is held by a special locking pin and a setscrew. The bushing carries at its outer end a stub axle on which the wheel is mounted.

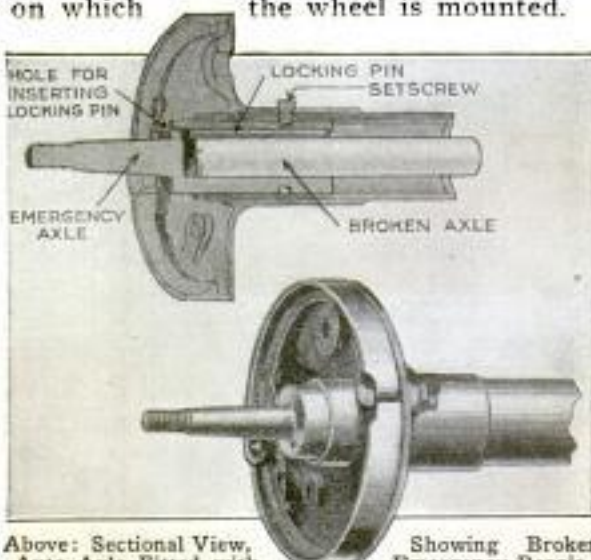

Above: Sectional View, Auto Axle Fitted with Device. Below: Side View of Repaired Axle

Showing Broken Emergency-Repair

Chicago, Ill. 1/29/23, Pg. 16.

Hoeffler & Robecharnd Co. 274 W. Superior St. Milwaukee Wis.

1970

Honeywell Heating Specialties Co., Wabasha

chud

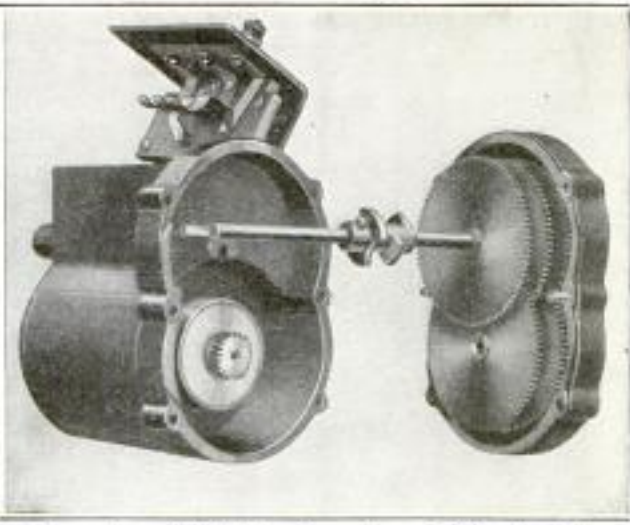
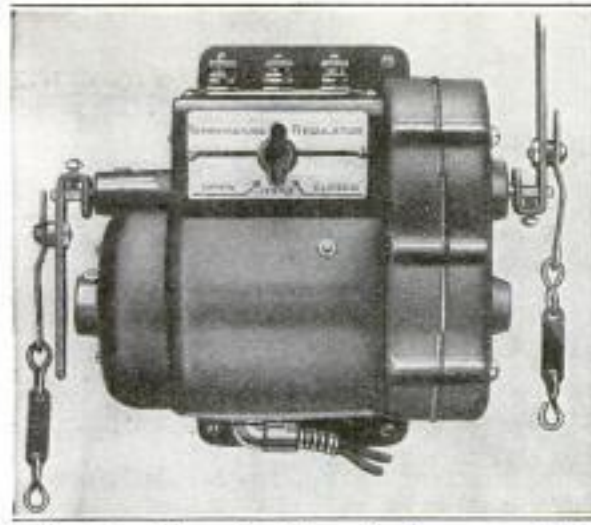

Left: New Motor for Use with Temperature-Control Apparatus, Which has Transformer Built into It and Is Ready for Connection to Supply and Thermostat Circuits. Right: Gear-Case Cover Removed, Showing the "Figure-Eight" Reduction Gearing

NEW MOTOR FOR TEMPERATURE-CONTROL APPARATUS

A new motor adaptable to temperature-control apparatus, either in connection with thermostats for residence heating or for industrial purposes, is built integral with the transformer, and is provided with leads ready to connect to the supply circuit. It is inclosed in a dust-tight casing and provided with a pressure-oiling system that requires but little attention. It transmits energy through a train of "figure-eight" gears, to a crank with a lifting power equal to 100 pounds at 1 inch from the crank center.

NONCORRODIBLE COPPER CAST UNDER HOT WATER

Copper castings are rendered noncorrodible by casting the metal at high temperature under hot water, according to a method that probably originated in Japan, where it is widely practiced. Articles known to have been produced in this way, are unaffected after 35 years, due to the protective coat of cuprous oxide formed from the decomposition of the film of steam which separates the hot metal from the water during the casting operation.

PARKING LIGHT FOR AUTOS WORKS BY CLOCK

An interesting attachment for preventing collisions has been invented recently, and will be a boon to automobile owners who park their cars in front of their homes for the night. The device con-

sists of a clock mechanism which is electrically connected to the parking lamp, and which can be set to turn on the light at any predetermined hour, as, for instance, when it is just getting dark. If the car is to be parked at the curb all night, the clock may be set to break the circuit to the light at any desired hour

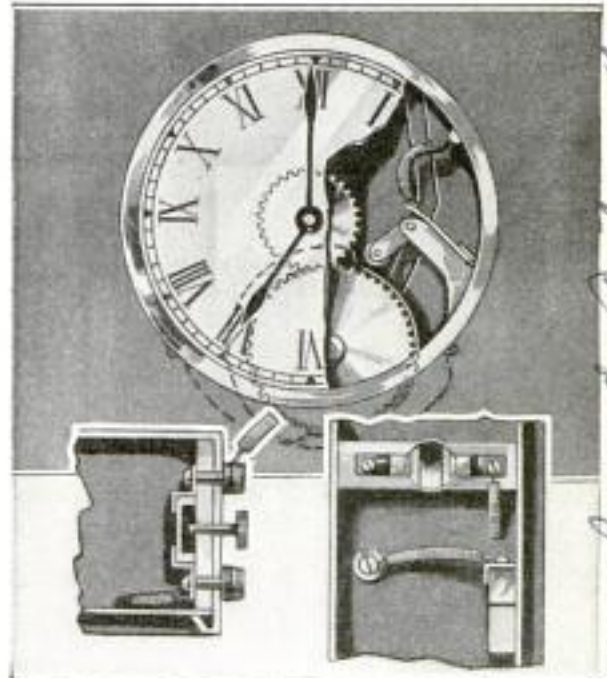

A Sectional View of the Clock-Driven Mechanism for Automatically Switching On or Off the Parking Light

in the morning, whenever dawn is breaking. A master switch permits breaking the circuit at any other time, regardless of the clock.

Our Bureau of Information is for your benefit. Use it as often as you please.

Manchester Guardian Special 1/18/27

Maryland Automatic Lighting Controller Cambridge Md.

Dr. William E. Winterling

Northern Equipment + Supply Co.
1301 Central Ave. Worcester, Mass
R. C. Isorran
Isorran, Box 732
POPULAR MECHANICS

938

NEW DEVICE CUTS AND CORES GRAPEFRUIT

An interesting machine now ready for the market cores grapefruit and cuts it

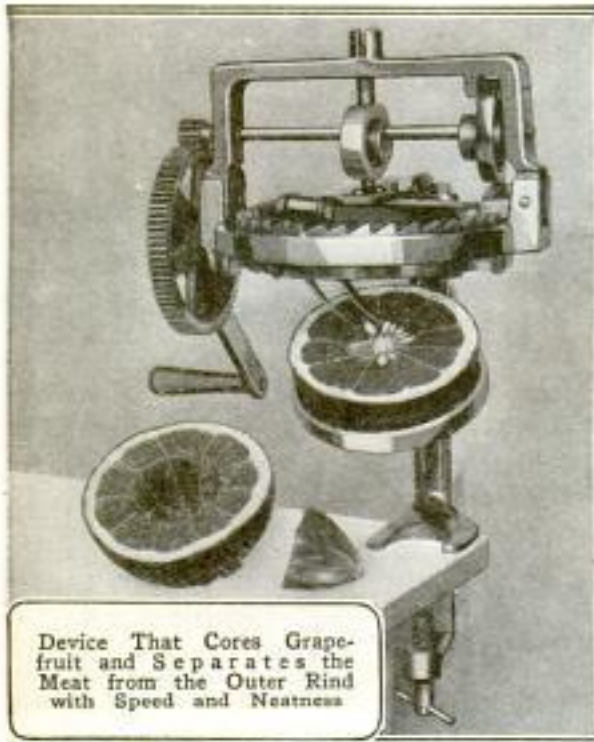

Device That Cores Grapefruit and Separates the Meat from the Outer Rind with Speed and Neatness

from the outer rind. In the main, the machine consists of a pair of curved blades supported from a carrier hinged to an inner toothed ring, that gives the blades a combined up-and-down and rotary movement. The ring is in turn carried on an outer fixed ring, which also supports the driving mechanism. Below this is placed the half grapefruit in a cup-shaped holder, that is forced upward by a handle against a ring that fits the cut edge of the fruit. The machine is said to do neat, clean work about five times as fast as it can be done by hand.

HUNDREDS ANSWER INVITATION SENT VIA RADIO BY MAYOR

In dedicating a new broadcasting station in San Francisco recently, Mayor Rolph spoke into the transmitter as follows: "I want to find how far my voice is carrying—how big my audience is. Send in telegrams to me and send them collect. Come on, Mayor Hylan of New York, and you, Mayor Curley of Boston!" Responses came from every state in the Union, Honolulu, Canada, and from a ship 1,000 miles at sea. It was estimated that \$3,000 worth of replies arrived within a very short time. Some of the more interesting ones were dis-

played in the window of a local telegraph company which handled the deluge of incoming messages.

ADJUSTABLE WINDOW SASHES FOR ANY WEATHER

A multiple-sash window, whose several sashes slide horizontally in the window frame, has been developed recently and will permit adjustment to suit any external weather conditions. Two or more sets of sashes may be mounted in the frame, of which one set may be provided with glass, and the others with wire screening, or Venetian blinds. In the winter all may be fitted with glass, insuring an absolutely weather-tight window for keeping the cold out. Horizontally grooved frames, invisible in the window wall, receive the flanged rollers with which each sash is provided; and the wall is recessed, of course, to receive those sashes which are not in use. The sides of the frame proper are also pro-

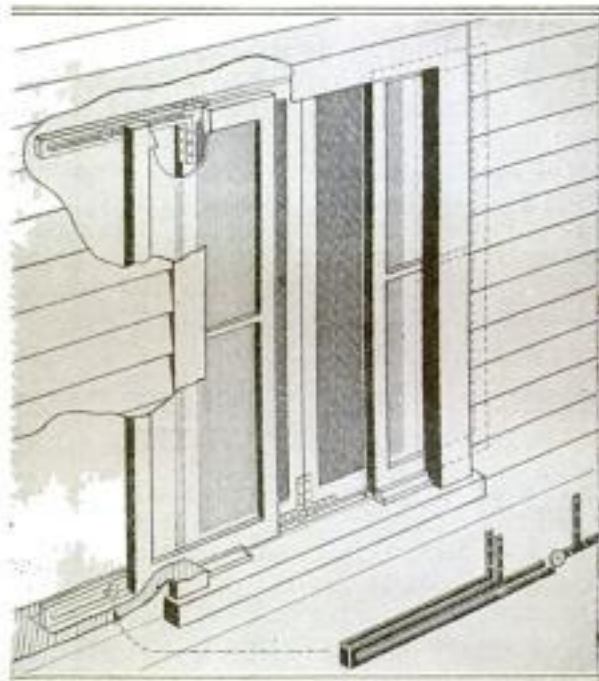

Multiple-Sash Window, Composed of Two or More Sets of Parallel Sliding Sashes Which can be Rolled Horizontally into the Wall

vided with a stop catch to limit the movement of each sash.

A moderate-priced automobile is now being introduced that has an air-cooled motor with copper cooling fins electrically welded to the iron cylinder casting. The advantage lies in the superior heat conductivity of copper, which is about nine times that of cast iron.

Cherryval Motor Co. Solder, Detroit Mich.
General Motors

1830

Cont.

Chas. W. Sauer, Union League Club, Port...

Saylor, San Francisco Calif.

Copyrighted material

1848

Oscar A. Israelson,
New York

d. m.
hills,
Maine



Simple Rig Devised by an Enterprising Farmer for Getting Heavy Stones Out of His Fields: One Pair of Horses, Pulling on a Rope around the Large Wooden Wheel, will Raise a Six to Eight-Ton Rock Out of the Ground

1840
HOMEMADE DEVICE HANDLES HEAVY STONES

A resourceful farmer of the Northwest has rigged up for himself an odd-looking device which he uses to lift heavy stones out of the ground and to haul them out of the field. The device, which is mounted on a frame built up on four wagon wheels, consists of a 5-foot-diameter wheel attached to a piece of 6-inch well curbing, around which is wound the chain that grapples the rock. One pair of horses pulling on a 2-inch rope encircling the wheel, will lift out of the ground a 6 to 8-ton rock requiring four horses to haul. The load is held in the raised position by a lever-operated piece of timber that slides across the frame and locks with one of the crossarms of the wheel.

1968
SOUND-WAVE "FILTER" MAY ELIMINATE NOISES

An unusually ingenious device has been invented by Prof. G. W. Stewart, of the University of Iowa, for suppressing, or eliminating entirely, undesirable sounds. Unlike previous attempts along these lines, Professor Stewart's principle is not to put obstructions in the path of the unwanted sound waves, but instead to cause successive sound waves to interfere with each other's transmission. Cylindrical tubes are used for this purpose, open at both ends and free from obstructions, but having, at regular intervals,

branching tubes and chambers. At each branching point waves are reflected backward through the tube. The inventor calls his device an "acoustic wave filter," and believes that it may find application in telephones, phonographs, and other musical instruments, so that these machines will make audible only those sounds desired.

1833
RATCHET SCREWDRIVER HAS PISTOL GRIP

An improved type of screwdriver has recently appeared on the market for handling large or stubborn screws with much greater ease than is possible with the ordinary straight-handled tool. A pistol grip is provided with this tool, which is of the ratchet type, enabling the operator to exert a powerful leverage even when the hands are wet or oily. In addition,

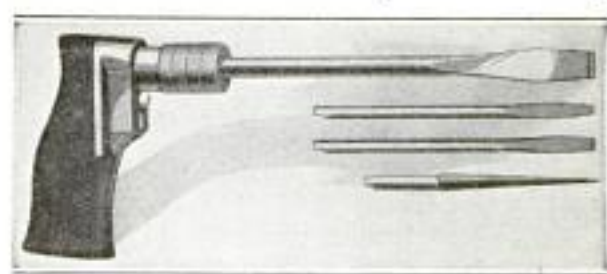

The Nonslipping Handle of This Pistol-Grip Screwdriver Prevents a Mechanic's Hands from Blistering. It Takes Several Blades

it has the advantage of being able to take a series of interchangeable blades.

Device Supplement
2/2/63

The Grinnell Tool Co
Norwood, Ohio

MACHINE CUTS RUBBER BANDS FROM OLD INNER TUBES

HYDRAULIC-DREDGING METHOD APPLIED TO PEAT DIGGING

1768

1969

Inner tubes that have passed their usefulness as part of a pneumatic tire, are

Excellent results were attained recently in the extraction of peat from the extensive bogs and moors of Finland by the use of water jets for tearing up the raw peat. By this method the resulting plastic mass is free from stumps, the presence of which makes hand digging so uneconomical. Two water jets, of from 225 to 300 pounds' pressure, are fed by a 330-gallon per minute pump, and cut up the outer layer of peat like knives. The resulting pulp is then further diluted, so that it can be pumped like water, in the meanwhile being thoroughly mixed by the blades of the pump at the rate of 4,000 cuts per minute. The stumps, which are laid bare and thoroughly cleaned by the action of the water, are cut to pieces with large shears attached to the pump cart, and then disposed of. In the drying yard, the thin peat pulp is allowed to settle in layers about 10 inches thick, the excess water evaporating.

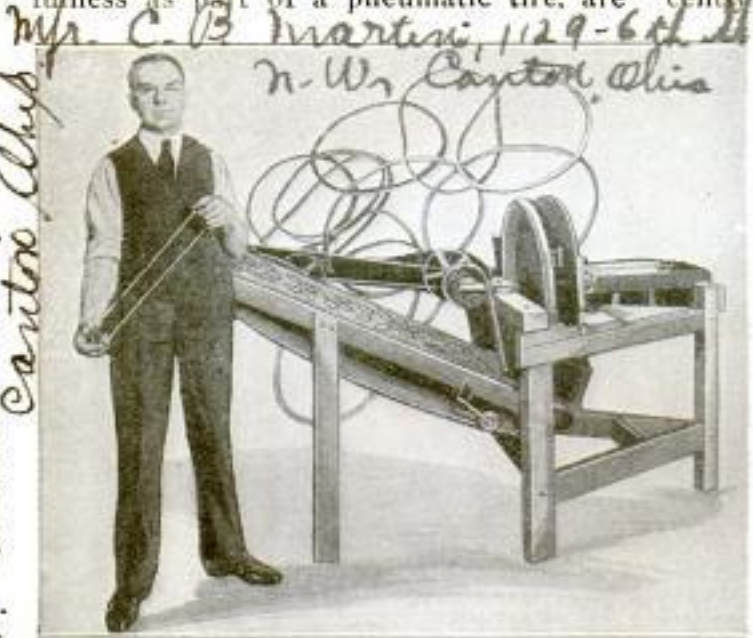

New Machine Which, by Means of a Special Saw, Converts Old Inner Tubes from Pneumatic Tires into Elastic Rubber Bands at the Rate of 20,000 an Hour

now being converted into elastic rubber bands by a man who has designed a machine for this purpose. In this machine the tube is automatically fed to a special saw that cuts off the bands at the rate of 20,000 an hour, and drops them on a conveyor. It is expected that the moderate price at which they can be offered will find the bands a ready market, as a substitute for wrapping twine, in many retail stores and in factories that put up merchandise in small packages.

TIRE DEFLATER LEAVES HANDS FREE FOR OTHER WORK

A simple device for deflating automobile tubes has been placed on the market recently which can be readily secured to the valve to keep it open when necessary. Only slight pressure is necessary to clamp the device to the valve stem, a small pin keeping the valve spring down and permitting air to escape from the tube. The hands are thus left free to do other work.



ELECTRIC ALARM PROTECTS BANKS FROM HOLDUP

Burglar-alarm equipment, for banks and similar institutions, is being provided in the form of an electric siren that can be sounded from any one of a number of different points. A central relay switch, to which the lighting circuit is connected, operates the siren whenever contact is made at a starting station. At each starting station is located a foot-operated push button, and at some convenient point a push button which stops the siren. The siren is operated by a universal electric motor, and the relay switch is independent of current for contact material

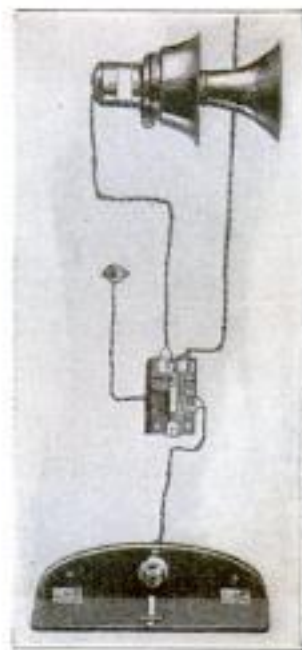

Industrial Products Co.,
1325 W. Tupper St.,
Canton, Ohio

Antique Mfg. Co. d. me.
556
Rochester, N.Y.

Enter State Machine Products Co., Rochester, N.Y.

1754, Cont. Mrs. Ruth Darling
 Schultis, 1009 E. Porter St.

Albion, Mich.

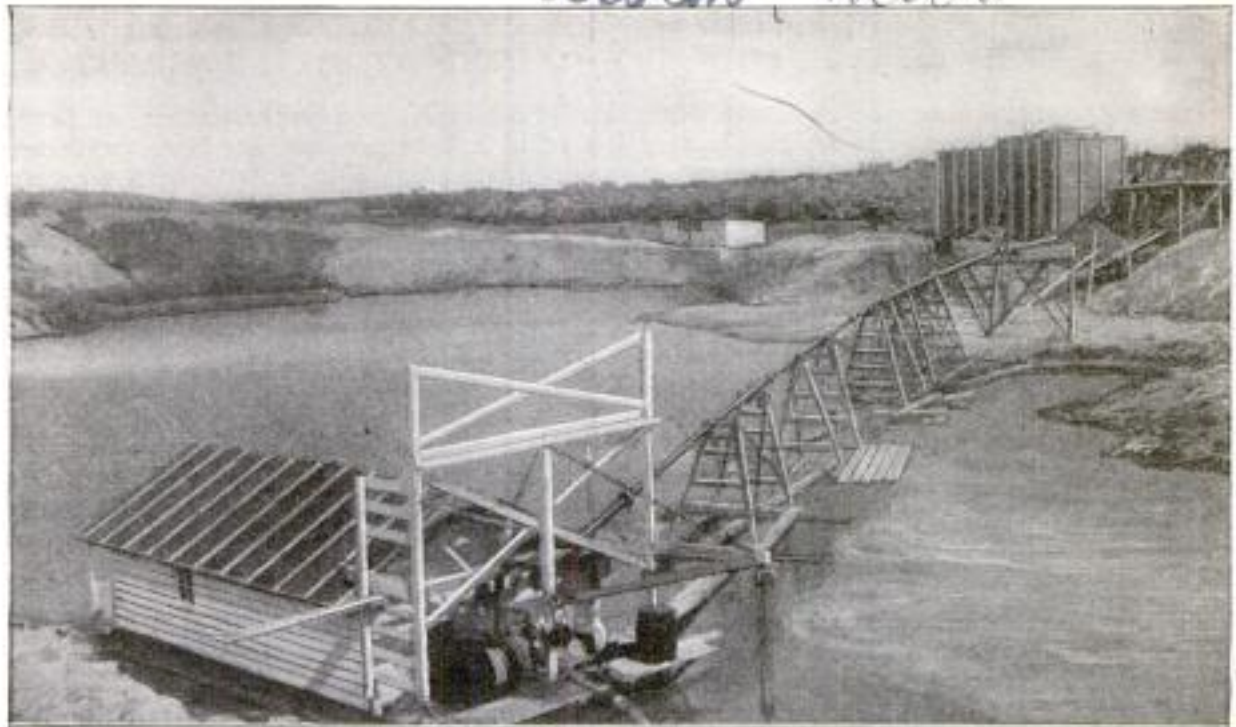

This View Shows the Suction Dredge in the Foreground, and the Flume, Supported on a Trestle, Which Carries the Pumped Gravel to the Storage Bins in the Background. Here the Gravel is Screened, Sorted, and Stored for Shipment. To the Left of the Bins, a Bathhouse Is Visible

SUCTION DREDGE GETS GRAVEL FROM BATHING POND

For years the residents of Cowles, Neb., had been compelled to get all their building gravel from outlying districts, because of its scarcity locally. What little there was, was of poor quality, mixed with dirt and clay, and unfit for use. Quite by chance, an observing farmer discovered that there was a fine deposit of clean gravel in the bed of a near-by pond, which had been very popular for bathing purposes. At first this was uncovered in small quantities, but finally a suction dredge was installed to meet the rapidly growing demand. A dynamo on the bank of the pit furnishes power for the pump equipment, and is fitted with a flexible connection to permit the dredge out in the pond to shift its position readily. A flexible flume, with its mouth buried in the gravel at the bottom of the pond, is carried on a trestle, and conveys the pumped material to the bank.

"SAFETY-FIRST" GUARD RAIL ENVELOPS CAR

The ever-growing extension of automobile traffic, with its accompanying increase in automobile injuries and fatalities, has stimulated the invention of numerous appliances, designed to minimize the effects of collisions. One of the latest

of these to appear on the market is an all-steel rail inclosure, about 1 or 1½ inches in diameter, which completely envelops the car, following the fenders and running board. It is claimed for this attachment that, when resiliently braced against

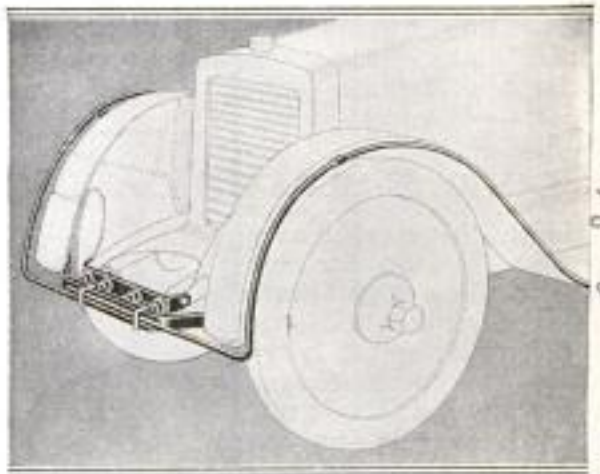

A Spring-Steel Guard-Rail Inclosure Which is Attached to the Car Frame and is Designed to Absorb the Shock of a Collision

the sides of the car, it provides sufficient recoil against shock to prevent buckling of the chassis frame.

Real estate is being sold "over the counter" at a Chicago department store as part of its regular "merchandise." The practice is said to have long been customary in London department stores.

Chas. A. Carr, 8030 S. 92nd, South Chicago

*Universal Supply Co
 6111 W. North Ave.
 Chicago*

Lt. R. M. Eichelsoeyer. The Sanitary Sold Seal Dairy Los Angeles, Calif.

942

POPULAR MECHANICS

**ARMY .45-CALIBER PISTOL
MAY BE CHANGED**

1918

Interesting recommendations have gone forward recently from the U. S. Cavalry Board to the chief of cavalry governing modifications to be made in the regulation .45-caliber automatic pistol. One

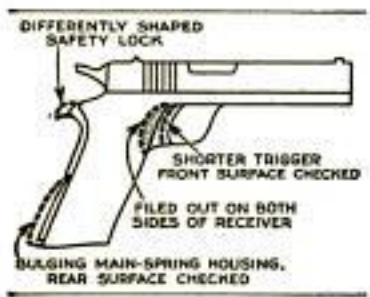

important change recommended is that the main-spring housing be bulged and checked, thus eliminating the tendency of the pistol to point

low when held in the natural grasp. A shorter trigger is also recommended, because it reduces the distance from the back of the grip to the front of the trigger and therefore allows a man with a small hand to grasp the pistol more comfortably. It is also desired to change slightly the shape of the safety lock, so that it will not pinch the skin. Ten sample pistols, incorporating these changes, were tried out in pistol practice with uniformly satisfactory results. The changes can be made with but slight additional expense, and it is believed that they will make the automatic pistol an even more satisfactory weapon than it is at present. Definite action approving these modifications is expected shortly.

**REDEEMABLE METAL TOKENS
USED BY MILK COMPANY**

1899

The handling of paper tickets, at times a troublesome problem for both customer and dealer, has been solved by a western milk-distributing company by the use of aluminum tokens which are redeemable at their face value in milk. The paper tickets had several serious disadvantages, among which may be mentioned the annoyance of extracting them from empty bottles, the heavy cost of printing, and the expense involved in employing a staff solely for counting, checking, and destroying those turned in. Now the driver buys \$100 worth of the metal checks, sells them to those desiring milk, and later uses the same ones over again.

**SIMPLE CARD INDEX INTENDED
AS CALENDAR MEMO FILE**

1917

A simple desk-calendar memo file has been made with a card-index arrangement. A card designating the month is placed first in a small built-up tray, open in front, while through a hole in the card's center can be seen another card with the day of the month printed upon it. Behind these daily key cards are kept the plain memo cards.



Weis Info. Co. Montreal, Quebec

DOUBLE-BLADED GARDEN HOE WITH SHARP EDGES

With the ordinary garden hoe, on account of the shape and bluntness of its single blade, considerable effort is required to force it into the ground, and it is not adapted for digging out weeds easily, or cutting off the stems of tuberous plants, such as potatoes. All these things can be readily done with a two-bladed hoe, recently patented, which has the blades extending outward from their connection to the handle and terminating in two sharp points.

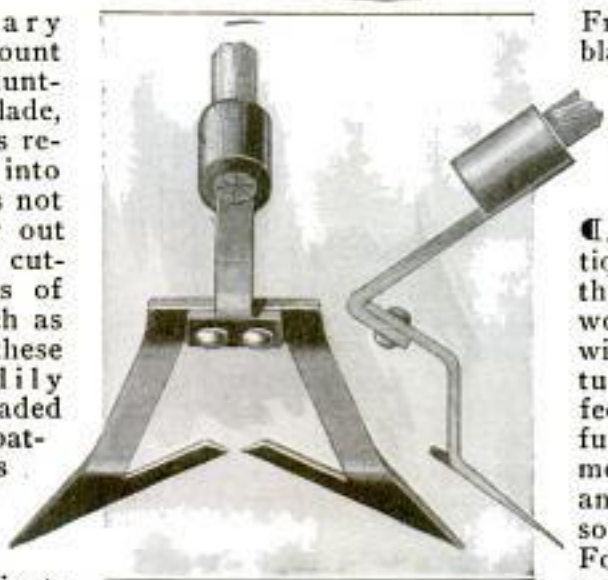

Front and Side Views of a Very Effective Hoe for Cutting Tubers

From these points the blades slope toward each other until they nearly meet, and are shaped like knife blades with sharp edges.

ⓂA French dealer in antiques is said to be in the habit of acquiring wood-boring worms with a taste for furniture. Some of these he feeds on his own new furniture to give it a more venerable appearance, while the rest are sold to other dealers. Formerly worm holes were simulated in cruder ways.

E. H. Warner. Foreign Patent Exchange, 1823 St. La Salle St. Chicago 9066

no information in maker
1964

CHILDREN'S PICTURE-STORY DEPARTMENT

Holograms



A New Vehicle for the Kiddies Which is Propelled with a Motion Similar to Rowing, and is Steered with the Feet: It is Also Seen as an Exerciser for Some of the Mothers

Into the Jaws of Death: This London Zoo Keeper must Be on Pretty Friendly Terms with His Charge to Place Himself So Smilingly within the Maw of a Hippopotamus



Major Clarence Weighs Only 17 1/2 Pounds, is 18 Inches High, is

COPYRIGHT, UNDERWOOD & UNDERWOOD

Smallest Adult in the World—and He is Attempting to Pull a Truck Load of Giants Whose Combined Weight Is About 1,000 Pounds. The Shortest Is 7 Feet 4 Inches Tall

Howerton, Who Pounds and Stands Believed to Be the

1/2 Madison Square Garden New York City

NEW TRENCH FORCE PUMP HAS CONVENIENT FEATURES

456

A new type of trench force pump has a number of features that will appeal to contractors and others having to drain

muddy and gritty water from sewers, ditches, and excavations. It will deliver water 10 to 80 feet above the pump, or through a hose or pipe from 100 to 1,000 feet long, and is fitted with an outside packed plunger as well as interchangeable poppet valves for suction and discharge. The unit consists of the pump and gasoline engine, or electric motor, mounted on a truck, and its usefulness is further increased by a winch head capable of a 500-pound pull.

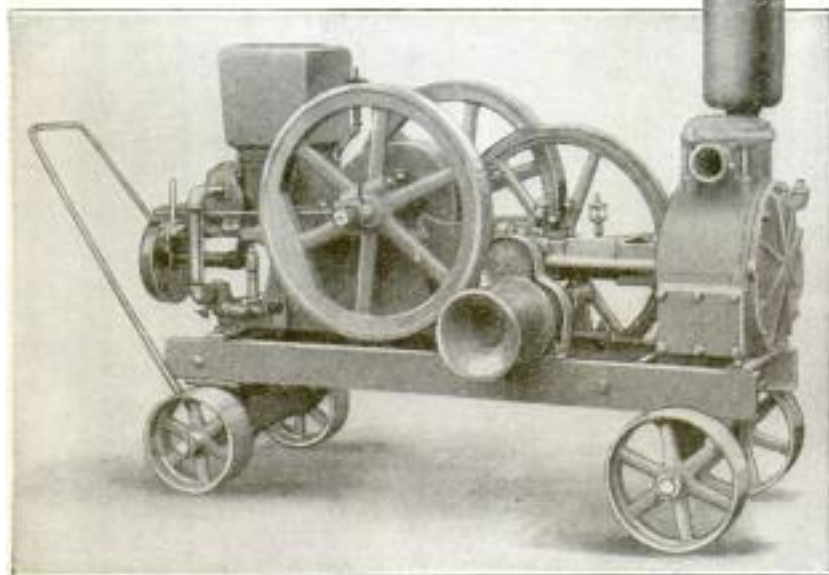

Portable Unit, Consisting of Gasoline Engine and Force Pump for Handling Dirty Water: The Pump Has an Outside Packed Plunger, and Interchangeable Poppet Valves for Suction and Discharge

☐ Night air service between London and Paris, with planes leaving each city at 6:30 p.m., is now being undertaken as an experiment. Ground lights every 30 miles and colored signals from the airplanes are planned.

COMB ON BARBER'S SHEARS INTENDED FOR HOME USE

Another device intended to make hair trimming at home easier has recently

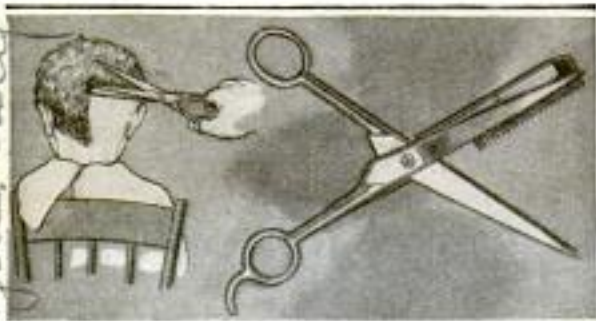

Hair-Cutting Device for Home Use Which Consists of a Pair of Barber's Shears with a Comb Holder Attached to the Underside

been patented. It is an ordinary pair of barber's shears with a holder of metal, attached to the underside. A comb is slipped into this holder, and the operator proceeds with the work much in the manner of a person using a pair of clippers. The comb is readily removed for the purpose of cleaning.

☐ Our Bureau of Information will answer all questions regarding articles appearing in this magazine.

NEW TIRE-RIM REMOVER UNUSUALLY POWERFUL

A newly invented device for contracting rims to remove them from a tire requires much less power in using than other similar tools. Two strong jaws, opened and closed with bolts and wing nuts, grasp the rim on each side of the joint. The alignment of the ends is broken with a specially designed lever. Then, by working a ratchet, a screw

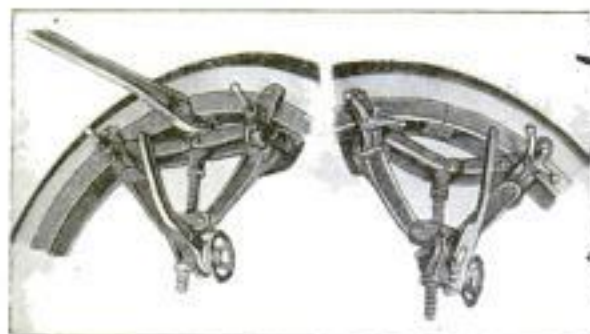

Device for Removing Split Rims, Shown at the Right When First Applied, and at the Left with the Rim Ends Out of Line

shaft is rotated, which operation pulls the jaws together, contracting the rim till it lifts off the tire. It is said a tire can be removed and replaced in about two minutes.

Langley, 520 S. Broadway - 926
 Los Angeles, Calif.
 % Domestic Engine & Pump Co.

service 1147 Co., Elkhart, Ind.



Information as to where to obtain any specified materials or parts for making objects described in the following pages may be had, on request, from our Bureau of Information.—Editor.

All Shop Notes published in 1922, in book form—Fifty Cents—from our Book Department.

Concrete Runways Aid Car Repairs

BY GEORGE A. LUERS

THE runways shown in the illustration will prove of great convenience in any garage or repair shop, public or private; they are far easier to make than pits, and can be built in a few hours.

A simple wooden form is made as shown in the lower right-hand corner; only one form is necessary, although two

edges of the hole. If there is a cement floor in the garage, it will be sufficient to chip it out to the dimensions of the inside of the form and about $1\frac{1}{2}$ or 2 in. deep, and to wet the rough clipped surface thoroughly, to allow the new concrete to bond with the old.

The main form being set in place, the

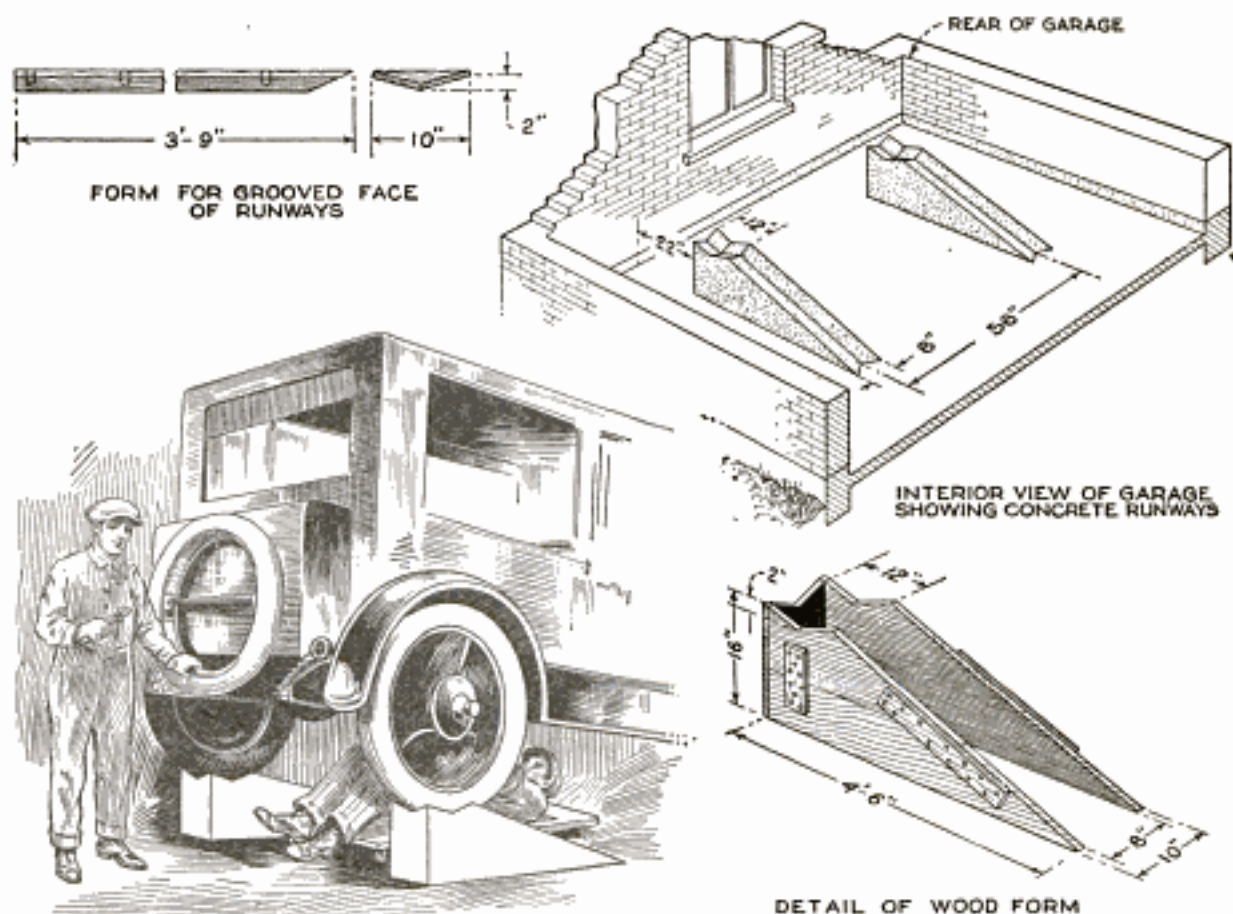

Easily Made Concrete Runways That Take the Place of a Pit in the Public Garage or Repair Shop, and Are Also Suitable for the Private Garage: The Dimensions Given Are Suitable for All Standard Cars. The Runways may be Placed Anywhere Convenient, Although Preferably Opposite a Window, to Provide Plenty of Natural Light

will speed the work. When the location of the runways has been decided upon, excavations are made, about 2 ft. deep and a little shorter in length and width than the form, to allow it to rest on the

V-shaped form for the grooved runway is set on top of it, and clamped in place by using C-clamps on the battens on the side of the main form; a mixture composed of 1 part portland cement to 2

parts sand is poured in, and thoroughly tamped with a long iron rod, poking all corners well, to insure that there will be no pockets or unfilled places.

The depression in the top of the runway that holds the car wheel is formed with a trowel or similar tool, while the concrete is still soft, and the form is allowed to remain for at least 24 hours, when it may be removed and used for the other runway. The runways should be kept thoroughly wet for about 10

days, when they may be put in service. The car is simply driven up the runways slowly, under its own power, the depressions in the tops preventing it from being driven over the back.

The dimensions shown will be suitable for most cars, and the runways should be 56 in. center to center. They should be set near a window, to provide sufficient natural light, and far enough from the wall so that the work on the car can be performed with comfort.

New Method of Lowering Quarry Floor

The lowering of a quarry floor is usually a most laborious operation. The original quarry is generally cut to about the

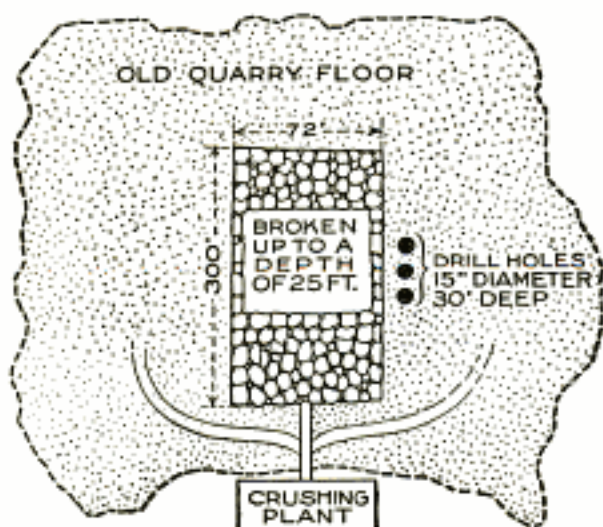

A Time and Labor-Saving Method of Lowering a Quarry Floor to a Depth of 25 Feet below the Original Floor, by Blasting a Large Area

ground-water level, and, in making a new cut below this level, the common method is to blast out a small hole, remove the stone with a clamshell, or by some other method that is just as tedious, and then pump the water out. After that a shovel is let down into the hole, and the hole is enlarged to a proper working face.

A new method, recently employed in an Ohio quarry, is to drill a large area with blast-hole drills, as in opening a new quarry. The entire area is shot at once with heavy charges, to break up the rock as much as possible. In this case an area, 300 by 72 ft. in size, was drilled and broken to a depth of about 25 ft. Holes, 15 in. in diameter, were then drilled close to the edge of the broken-up area, to a depth of about 30 ft. These holes, of course, were driven through broken and shattered rock, and were lined

with old screen plates. Suction intakes were let down into the drill holes, and the entire area was pumped out. A steam shovel was then set to work at the edge of the blasted area, and worked right down to the new level.

Internal Limit Gauge

While internal limit gauges, for determining the minimum and maximum allowable sizes of holes, are usually marked to distinguish the "go" and the "not-go" ends, the figures or letters are quite small, and they must be read each time so that the proper end may be used.

To eliminate this trouble, we knurled all our gauges on the "not-go" end, so that the inspector would know, by feel, which end he was using.—J. H. Moore, Toronto, Can.

Slide for Tool-Chest Drawers

There are several types of slides used for tool-chest drawers, but the one illustrated is novel and will be appreciated

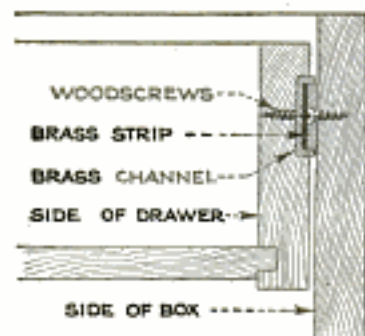

by woodworkers. The slide is metal, and is used on a tool box having an open front, similar to a machinist's tool chest. A brass channel is screwed to each side

of the drawers, and brass strips, an easy fit in the channels, are fastened to the sides of the box, as indicated. The metal slides have a long life, do not warp nor permit the drawers to rub against each other, and support the drawers firmly when the latter are drawn almost all the way out.

Fence-Post Attachment Made of Pipe

When it is desired to run a slanting wire fence on the top of the poultry fence, wooden slats, nailed to the fence posts, are generally used to support the wire; these, however, are not as a rule satisfactory, as they are neither as strong as they should be, nor do they last as long as desired.

A better and more substantial type of support can be made from 2-ft. lengths of pipe, flattened on one end for a distance of 8 in. and bent to a 45° angle as shown. The upper portion is slotted with a heavy hacksaw blade, for the reception of the barbed wire, and the flattened portion is nailed to the outside of the fence post with long spikes. Paint, applied both internally and externally by dipping, will keep the pipe from rusting.

After the wire has been pushed into the slot, and has been pulled up tightly, a blow with a light hammer on the edge of the slot will clinch the wire. This arrangement is the simplest and most effective

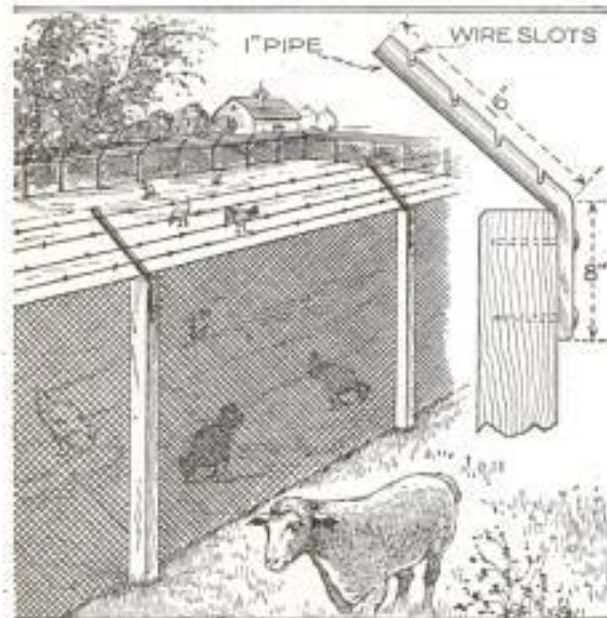

A Slanting Fence Top That Keeps the Poultry in the Yard: The Supports for the Barbed Wire are Made of Pipe

way of fastening the wire to the pipe.—J. V. Romig, Allentown, Pa.

Truck Attachment for Handling Armatures

It is usually a difficult and time-consuming task to move heavy armatures, as they must be handled with great care in order to avoid damaging the winding, commutator, or the shaft. A couple of iron arms, attached to an ordinary two-

wheel hand truck, have been found to facilitate this work greatly. The arms are



Attachment for Hand Truck That Facilitates the Handling of Armatures: With It One Man can Handle an Armature That Ordinarily would Require Two Men

bent as shown, faced with sheet lead, and bolted to the truck in place of the regular bracket. Armatures up to 15 and 20 in. in diameter, or other machine parts mounted on shafts, can readily be handled by one man on a truck of this type, providing, of course, the length does not exceed the distance between the arms.—Chas. J. Le Compte, St. Louis, Mo.

Rack for Drying Blueprints

Drying blueprints on a rack, as shown in the drawing, is a considerable improvement on the usual method of drying them over a line. A triangular frame of wood is built, as shown, the wooden cross-pieces having a number of small spikes driven through them so as to project about $\frac{1}{2}$ in. in front. The crosspieces are set far enough away from each other to allow a good circulation of air around the wet prints, when they are hung on the points to dry. A pan underneath catches the water dripping from the prints.



Height Gauge Made from Planer Gauge

The addition of a blade to the common planer gauge provides the mechanic with a very satisfactory height gauge. The

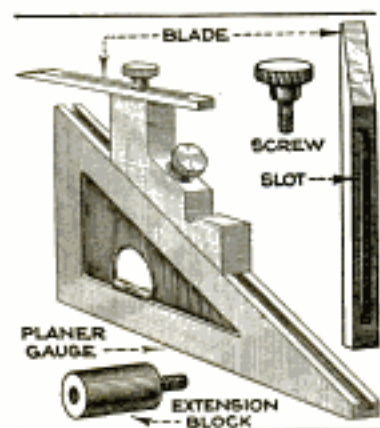

blade is made of tool steel, ground to a knife edge, as shown, slotted, hardened, and tempered, and the bottom surface ground true. The knurled screw that fastens it to the gauge has a thread of the same size

as the regular extension blocks for the gauge. The gauge is set, in the usual manner, with an outside micrometer, and the blade then clamped in place. With the use of the extension blocks, the gauge has quite a wide range of adjustment.—G. W. Nusbaum, Takoma Park, D. C.

Extractor for Locomotive Brasses

Many railroads are compelled to maintain small repair shops at outlying points to take care of engines running on branches, or shifting at junction points, and, as these shops are not usually fully equipped, many ingenious labor-saving devices are devised in the shops themselves.

One place, not equipped with a drop pit, was experiencing considerable trouble

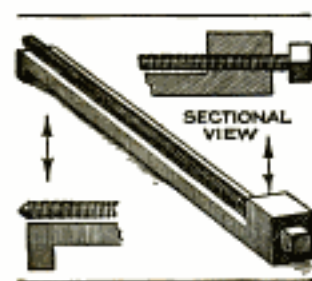

in removing journal bearings from engine-truck and trailer-truck boxes, as these were slid into the box from the center of the engine, and it was extremely difficult to obtain any hold

on the bearing when in place in the box, even after the "sponging cellar" was removed. The extractor illustrated was found to lessen the trouble considerably. After removing the sponging cellar, the engine is jacked up, and a chisel inserted between the crown of the brass and the box. An opening is thus made into which the extractor is thrust, far enough for the lip on the end to catch the inner side of the brass. Then, by using a

wrench on the square head of the long screw, the bearing can easily be withdrawn from the box. With a bearing that has run hot enough to melt the babbit, and where the latter has run down over the axle and cooled, this has proved to be about the only method of replacing the bearings without dropping the wheels, a practice that is not always applicable in small repair shops.—C. A. Sprout, Lancaster, Pa.

Trick Lock for Workbench Drawer

A trick lock for the workbench drawer is shown in the drawing. An ordinary butt hinge, with one leaf fastened to the underside of the drawer, as indicated, so that the

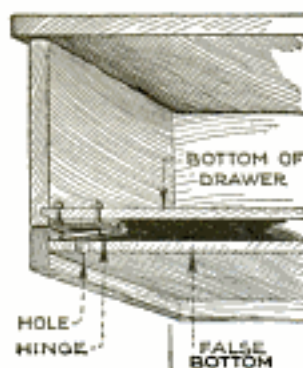

loose leaf will drop down of itself, is all that is necessary. A false bottom is nailed under the drawer to conceal the hinge. A small hole is drilled in this bottom, directly under the

hinge, so that the movable leaf can be pushed up with a pencil, or with the finger, to permit it to be passed over the lower edge of the drawer opening in the bench. When the drawer is closed, the leaf drops down, and prevents the drawer from being opened by anyone not acquainted with the secret.

Flushing Sewer by Water Pressure

When a sewer becomes clogged with lint, as is often the case in laundries, it is quite a problem to clean it out thoroughly and quickly.

It has been found that water under pressure is about as good a means of flushing the sewer as any. The water main is connected to the sewer above the trap, as shown. The connection is, of course, made as tight as possible, so that it will be waterproof and stand considerable pressure without blowing out. A good method of connecting is to use a coupling that will fit inside the sewer pipe, at one end, and reduced at the other to

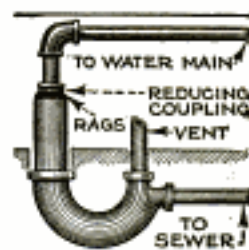

2 in., and to stuff the space between coupling and pipe with rags. Then, by wedging and bracing the coupling in place with a few heavy pieces of lumber, the connection is made secure. A 2-in. pipe is then connected from the coupling to the water main.

Water, under pressure of about 60 lb., is then turned on, and the obstruction will be forced away. By employing this means, the expense and time of digging up the sewer are eliminated.

Radius-Finding Tool

The tool shown in the illustration will be found very useful to machinists, patternmakers, and others.

With it the diameters of broken gear wheels, pulleys, and other parts, of which only a portion of the rim remains, can be found, or the radius of any arc determined. It consists of two arms, cut from sheet metal to the shape shown, and

slotted along their centers, to fit a small clamping screw with a flat head. Two points are filed on the end of each arm, as indicated in the drawing, on a line square with the centers of the arms. When in use, the four points are brought into contact with the curve or arc, and the nut tightened. The flat head of the screw has a fine mark in the center, and measurements may be made with a pair of dividers from this mark to one of the points. A wide range of radii is covered with this tool.

Cementing Gasoline-Line Couplings

While working on gasoline equipment, such as stove burners, one will often find a union or coupling that leaks, no matter how much white lead or other compound is applied. It has been found that if the ends to be connected are given a liberal application of ordinary liquid glue, tightened, and allowed to dry, the joint will be permanently leak-proof.

Novel Spanner Wrench

The illustration shows a spanner wrench that can be used on a large variety of work. It is made of bar stock, bent to the shape indicated, with the ends overlapping for the length of one side. A number of grooves are filed between these ends, as shown, to allow the insertion of small pins. A bolt or screw passing through the center of both ends enables the pins to be clamped in position. By having the grooves cut uneven distances apart, almost any desired spacing can be obtained. If necessary, a handle can be passed through the wrench to obtain greater leverage.

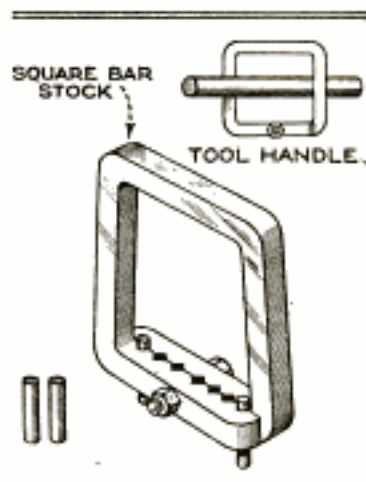

Pulling Pump Cylinders

The tool illustrated was improvised to pull up a pump cylinder that had fallen to the bottom of a well, and was found very satisfactory. It consists of an iron bar, to one end of which two iron dogs are loosely pivoted, as shown, on a rivet extending through both dogs and the bar. Small pins are driven into holes drilled in the bar, below the dogs, to keep them from falling below a horizontal position. Both dogs are pointed at the end, as indicated, and, when horizontal, measure a little more across than the inside diameter of the cylinder. The bar is threaded at the upper end, a length of $\frac{3}{4}$ -in. pipe screwed onto it, and the device lowered into the well, additional lengths of pipe being screwed on, until the bar strikes the bottom of the cylinder. Upon pulling up on the pipe, the dogs dig into the wall of the cylinder and allow it to be lifted with ease.—Ed. Henderson, Lake Mills, Ia.

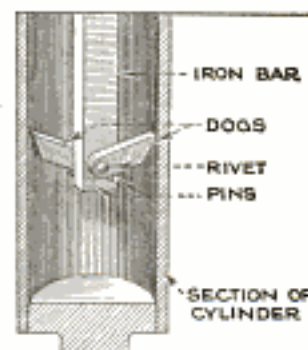

Shield for Post Holes

When setting up large posts or poles, a considerable quantity of dirt is usually pushed into the hole by the end of the

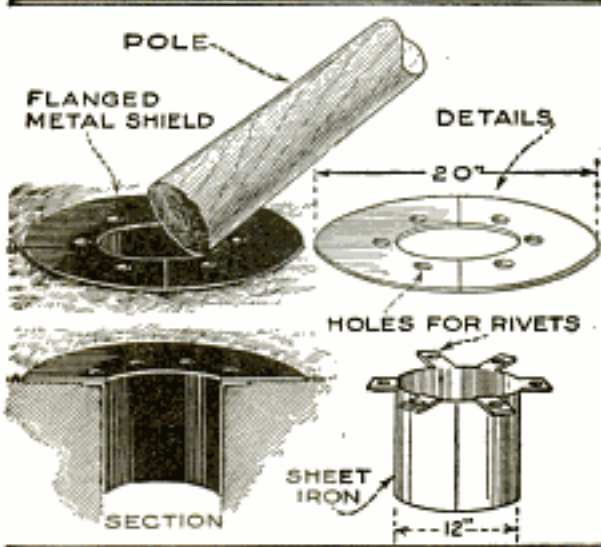

A Metal Shield That Prevents Dirt from being Pushed into the Hole When Setting Up Large Posts or Poles

pole, and this very often must be removed in order to sink the pole to the proper depth. To eliminate this difficulty a sheet-iron shield for the hole has been found very useful.

The shield consists of two semicircular lengths of sheet iron, to which a split flange is riveted, as shown at the right. The exact dimensions of these parts, of course, depend on the diameter of the poles, although the dimensions given in the drawing will serve in most cases. The guard is inserted in the hole as indicated, and can easily be removed after the pole has been set in place.

Tool Holds Auto-Cylinder Blocks for Preheating

An Indianapolis welder uses the simple but ingenious tool shown for handling automobile-cylinder blocks in a preheating furnace. It is usually necessary, when preheating the blocks, to turn them over often, and this tool reduces the labor required to the minimum.

The apparatus consists of a short piece of 3-in. pipe, welded to a long piece of 2½-in. pipe, which is drilled for a cross handle. A tee, which is a sliding fit on the 2½-in. pipe, is fitted with a smaller pipe, and this, in turn, with an elbow and horizontal pipe which has a hoist hook on it, to allow the assembly to be suspended from a crane.

The 3-in. pipe is fitted with a casting, as shown, which is fastened solidly to the pipe by setscrews, and which carries two arms, made of 1-in. square steel, bent at right angles, and held in a slot in the casting by means of a setscrew and plate, as shown in the sectional detail. These arms straddle the cylinder block, and support it, when the 3-in. pipe is thrust into the cylinder, and permit the cylinder to be manipulated in any manner that may be desired.

The crane used has a track running over the furnace, and the hoist can be swiveled so as to bring the block to any desired position.

The furnace used is of firebrick, built on an iron table, and is provided with doors, about 6 in. deep, swinging on a vertical rod which is welded to a clamp and fastened to the table. There are six doors, so that a six-cylinder block can be handled if necessary.

If a four-cylinder block is in the furnace, and it is necessary to turn it, the procedure is as follows: Four of the doors are opened, the remainder being kept shut, to conserve heat as much as possible; the 3-in. pipe is then thrust into a cylinder, with the arms straddling the block. The block is hoisted enough to enable it to be withdrawn, the setscrew on the tee is loosened, the block turned by means of the handle, the screw tight-

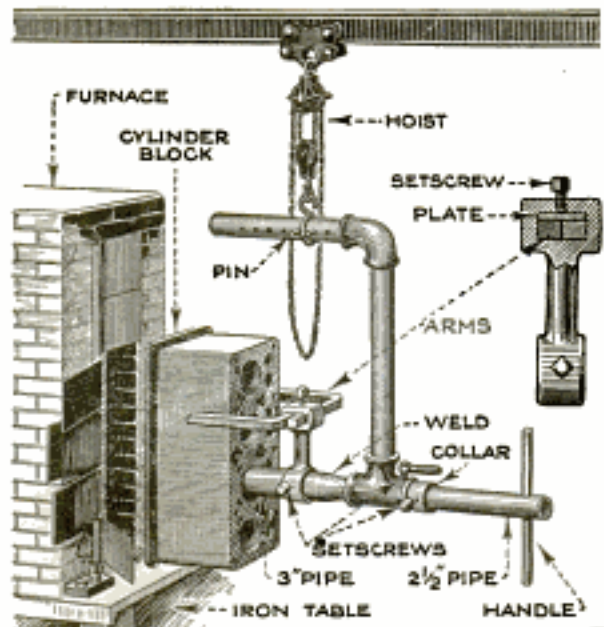

Simple Rigging Used for Handling Automobile-Cylinder Blocks When Placing Them in a Preheating Furnace, or Removing Them for Welding

ened, and the block replaced. There is no heavy lifting, no loss of time, and no waste of heat.—L. C. Land, Greenfield, Indiana.

Building a Small Horizontal Steam Engine

BY HAROLD E. BENSON

THE small engine described in this article was built by the writer in his spare time—about an hour a day for four months—and drives the machinery in a small shop. At 40-lb. gauge pressure, the engine runs at 150 r.p.m., under full load, and delivers a little over 4 brake horsepower. A cast steam chest, with larger and more direct steam ports, to reduce condensation losses; less clearance in the cylinder ends, and larger bearing surfaces in several places, would bring the efficiency of the engine up to a much higher point than this. In the writer's case, however, the engine is delivering ample power for the purpose to which it is applied, and consequently these changes were not made, but, if the engine is to be used for continuous rather than intermittent service, it would be foolish to waste power costing more than the changes needed to conserve it.

It might be remarked, at this point, that no method of construction described here is to be taken as the best; many better methods of making each part will doubtless occur to the reader. Some improvements that were thought of too late to be incorporated in the engine will be mentioned in the proper place.

The cylinder, shown in Fig. 1, is made from a piece of steel pipe, selected with special regard to the condition of the inner surface. This may be bored to size, and lapped, or ground. A standard inside diameter will make the fitting of a standard auto-engine piston ring easy. The ends are threaded on the lathe, standard pipe-thread size, while supported on two conical hardwood blocks, held on a threaded mandrel, and drawn firmly into the cylinder ends with nuts and washers. The standard mandrels for this purpose, if available, are more convenient. The rectangular plate A, that supports the rear end of the cylinder, is also bored and threaded on the lathe, using a four-jaw independent chuck to hold it. This plate, the rear cylinder head, and a copper gasket are clamped together, and the similar holes in each all drilled at one time.

The front cylinder head is a pipe cap, the exterior of which is turned to present a more pleasing appearance, and drilled and threaded to receive the stuffing box, Fig. 2. The distance between the edge of the front-end steam port and the inner side of the cap, when screwed home, should be much less than that shown, not over $\frac{1}{4}$ in., for efficiency, and the same at the rear end. When the cap has been permanently screwed on the cylinder, one side is flattened, as shown, on the shaper or grinder, and the steam ports laid out and drilled. It would be a decided advantage to make these ports as much larger than given as is possible, as the efficiency with $\frac{1}{2}$ -in. ports is far below what it might be.

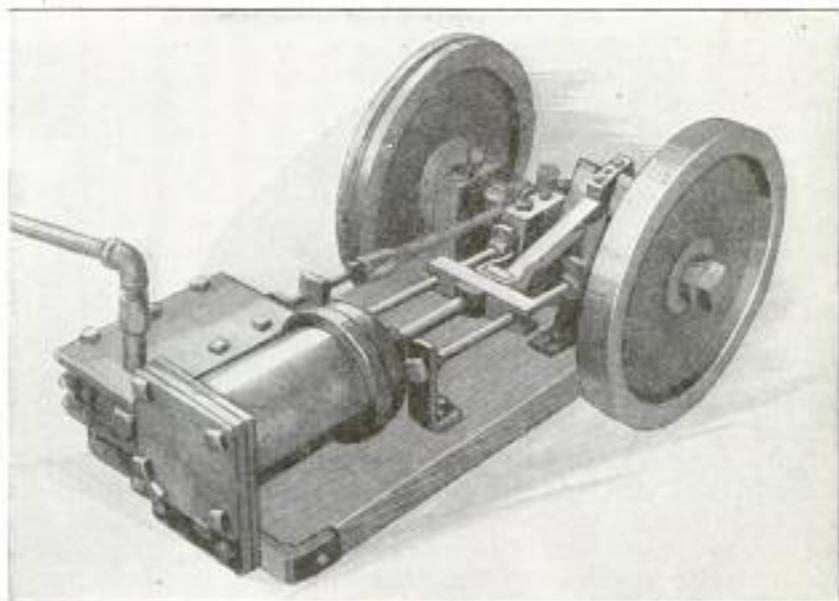

View of the Engine Complete, Ready to be Mounted on the Bed and to be Connected to the Steam Line: The Total Cost of Building Was \$15.40: This may be Considerably Reduced by Following Closely the Directions Given

To make the stuffing box, a length of 2-in. cast-iron rod is drilled to fit the piston rod, then turned out at the front, recessed to a width of $\frac{3}{8}$ in. for the packing, and threaded to fit the gland nut. The piece is then reversed in the lathe, and the outside threaded to fit the cylinder. After cutting off, the wrench flats are ground on the shoulder. The gland nut is made of brass-bar stock, threaded to fit the stuffing box, and the hexagon ground on it. When the parts are assembled, with the packing in place, the piston and rod should work smoothly, but stiffly, in stuffing box and cylinder, and be almost immovable when the ports are closed.

The piston is made of cast iron, and undercut to reduce the weight, as in Fig.

3. The groove is turned to suit a standard $\frac{3}{16}$ by 3-in. piston ring. The piston rod, which is of steel, must be fitted to the piston with great care, to insure their being exactly square with each other. If the face of the piston is square with the edge, the inner nut on the rod faced off square in the lathe, while on the rod, and the piston and locknuts then put on and tightened, no difficulty should be experienced.

The steam chest, shown in Figs. 4 to 7, is the hardest part of the engine to make. In this case, it is built up, using a square bar for the port block, an angle piece for the bottom and side, two endpieces, and a cover.

The port block, Fig. 5, is made of soft steel, the ports being drilled in as indicated by the dotted lines, from the ends and front, so as to provide a continuous passage for the steam. The exhaust port is drilled in from the front and bottom faces. The endpieces of the steam chest are held in place by short $\frac{1}{2}$ -in. capscrews, tapped into, and closing, the holes in the ends of the port block, and by long $\frac{5}{16}$ -in. bolts connecting the outer edges. The stuffing box on the front endpiece, Fig. 7, is made by brazing a blank nut to it, and making a snug-fitting gland for it, as shown in Fig. 8. The gland is drilled a neat fit for the valve rod, and for the $\frac{1}{4}$ -in. bolts that draw it into the stuffing box against the packing.

All parts of the steam chest are ground flat and smooth before assembling, and, when chest and cylinder are completed, are brazed together, all joints, the exhaust pipe, and the supports being brazed at the same time. When brazing, the steam ports should be plugged from inside the cylinder, to prevent any spelter from flowing into and closing them. The steam-chest cover is not brazed on, but is held by $\frac{1}{4}$ by $\frac{3}{4}$ -in. screws, entering the port block, and by long bolts at the outer edge, passing through a heavy strip of iron below the chest. Packing is used on the steam-chest cover joint.

The slide valve, Fig. 9, is cut from a block of soft steel, or cast iron, the opening in the face being cut as deeply as possible, drilling the center hole first, and plugging it to obtain centers for the drilling of the outer holes. If the steam ports are enlarged, the dimensions of the valve must be changed; the new dimensions can be found by making a full-size layout of the ports and valve, or by making cardboard models of steam chest, valve, and ports, and adjusting these until the correct dimensions are obtained.

There is room for considerable experiment on the valve; any textbook on steam engines will provide suggestions for adding lap to the valve, to cut off the steam before the end of the stroke, and since it is comparatively easy to make this part, it is well to fit the valve to the engine after the latter is complete.

The crosshead and guides, shown in Figs. 12 and 13, are simple in construction. If a shaper or planer is available, a better construction may be made by following any of the designs seen on large engines. Oil cups on each bearing will furnish sufficient lubrication.

The connecting rod, Fig. 14, is made of 1-in. square stock, turned to a diameter of $\frac{1}{2}$ in. in the center. The "big end" is drilled larger than the crankpin, and then sawed as indicated, so that the upper piece may be removed. Bolt holes are drilled through both pieces. When the engine is assembled, shims are placed between the halves of the big end, and babbitt poured through the oil-cup hole, around the crankpin, using putty dams on each side of the bearing. Small holes are drilled in the walls of the crankpin-bearing seat, before babbitting, to anchor the babbitt in place. The other end of the rod is fitted with a yoke and wristpin, as indicated, the diameter of the pin being made as large as possible, and run in babbitt bearings. Large-engine practice may be followed here, if desired; in fact, it will pay to study the details of large units, and to follow them as closely as possible everywhere, remembering that this description does not pretend to show the best practice, but only how the job may be done with material at hand.

The eccentric is turned from round stock, 2 in. in diameter, cutting the sheave first, then changing centers to turn the boss. The latter should be left long enough to enable it to be held in a chuck for drilling, after which it may be cut to length; the boss may be fitted so as to bear against the outboard crankshaft bearing, to prevent side motion of the crankshaft, instead of using collars.

The eccentric rod and strap are made of a length of $\frac{1}{8}$ by $\frac{1}{2}$ -in. flat iron, as shown in Fig. 15. The valve-rod end should be fitted with a wristpin and yoke as on the connecting rod, instead of the construction indicated, which is only shown to give the dimensions. The strap that fits the groove in the eccentric is lapped to a smooth bearing surface by clamping it round a mandrel covered with fine emery and oil, and grinding until the strap fits the eccentric sheave perfectly.

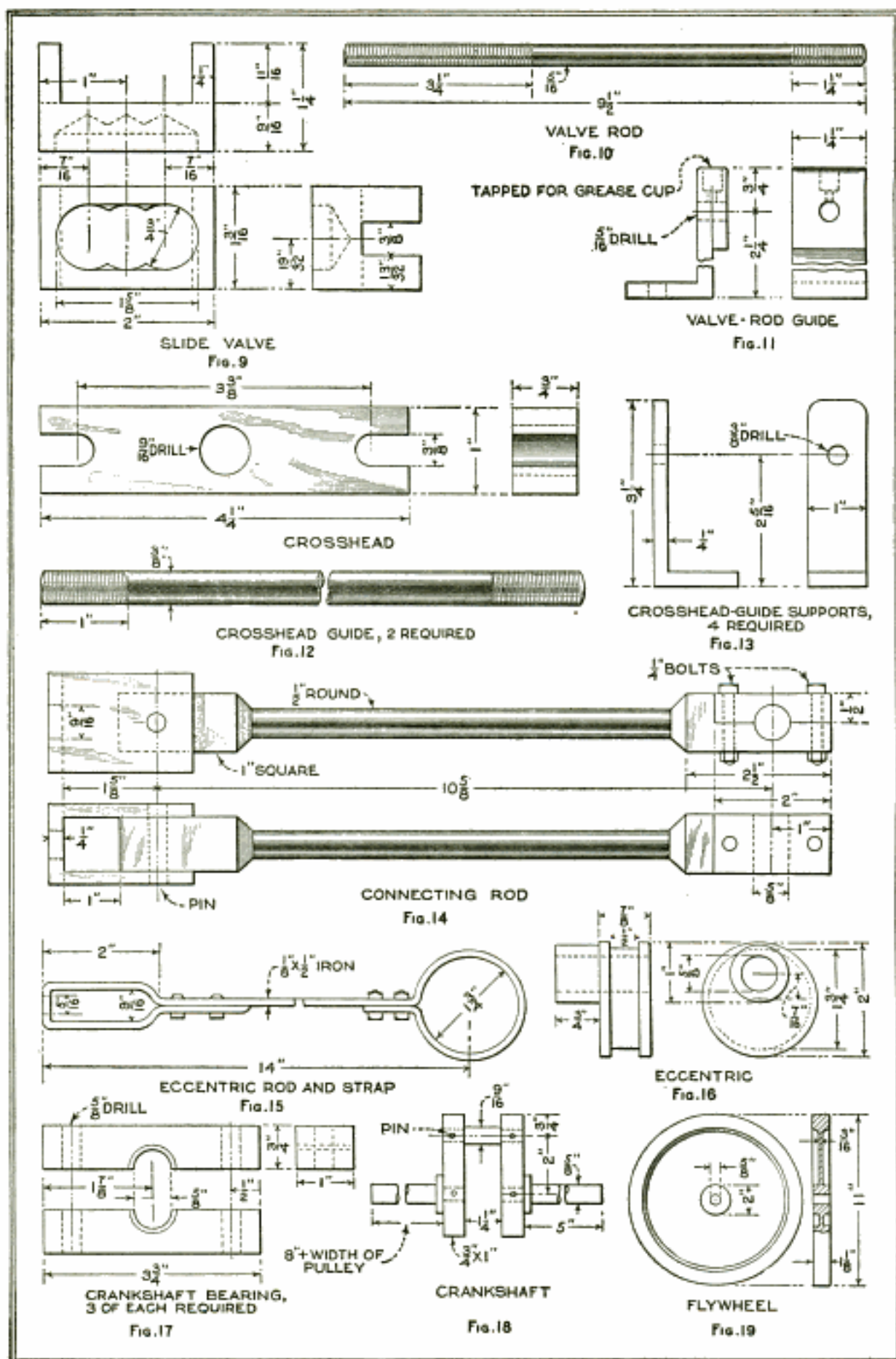

Figures 9 to 11, Details of the Slide Valve, Valve Rod, and Guide, Showing How Opening is Drilled in Valve; Figures 12 and 13, Crosshead, Crosshead Guides, and Crosshead-Guide Supports; Figure 14, Detail of Connecting Rod; Figures 15 and 16, Eccentric Rod and Strap, and Eccentric Sheave; Figures 17 and 18, Crankshaft Bearings and Crankshaft; Figure 19, Side View and Part Section of Flywheel.

The crankshaft may be made in two ways. It may be built up as shown in Fig. 18, the ends of the shaft and the crankpin being threaded, or shouldered and pressed into the webs, and pinned. This method requires great care and accuracy, to keep the shaft ends and pin square. The shaft may also be turned from a solid bar of steel, turning the crankpin first, then moving the centers and turning the main shaft. This method makes a fine crankshaft. After turning the crankpin, the space between the webs must be blocked firmly with a piece of metal or hardwood, to prevent the webs from being sprung in when turning the main shaft.

To set the valve, the crank is put on the forward dead center, and the eccentric set 90° ahead of it, then locked. The eccentric may be led or advanced a few degrees after the engine has been running, if necessary.

The flywheels are cast slightly larger than the size shown, then turned down on the lathe until of the proper weight. This will depend upon the speed of the engine, the load, and other factors; the flywheels on the writer's engine weigh 10 lb. each, and it will be noticed that as much of the weight as possible is concentrated in the rim, the web being made as thin as practicable. The wheels are keyed to the shaft, the keyseats being cut by holding the shaft stationary in the lathe, while running the cutting tool horizontally by means of the carriage feed, and feeding the tool with the cross feed.

The construction of the three crankshaft bearings, Fig. 17, is obvious; they are drilled out, while clamped together, to allow babbitting, the metal being poured through the oil-cup holes, which are easily redrilled and tapped afterward.

The engine base, shown in the assembly views, is made of oak, 2 by 8 $\frac{3}{4}$ by 25 in. in dimensions. A heavy iron base bracket, or reinforcing bar, Fig. 20, is fastened to the rear of the base with lag-screws. The holes in the front of the bracket are tapped to take the cylinder and steam-chest support screws, or they may be drilled plain and pockets cut di-

rectly behind them, in the base, to receive nuts for the screws. After the cylinder assembly has been bolted down, the crosshead guides may be bolted in place, so that the crosshead will come to within an equal distance of each support at the ends of the stroke.

When constructing an engine in this manner, it is best to build the cylinder and steam chest first, and make the subsequent parts conform to the dimensions of these parts. This is essential, in any event, in the case of the crosshead-guide supports and valve-rod guide; these should not be drilled until the crosshead is attached to the piston rod and the valve rod to the valve, and the correct height for the holes determined. The

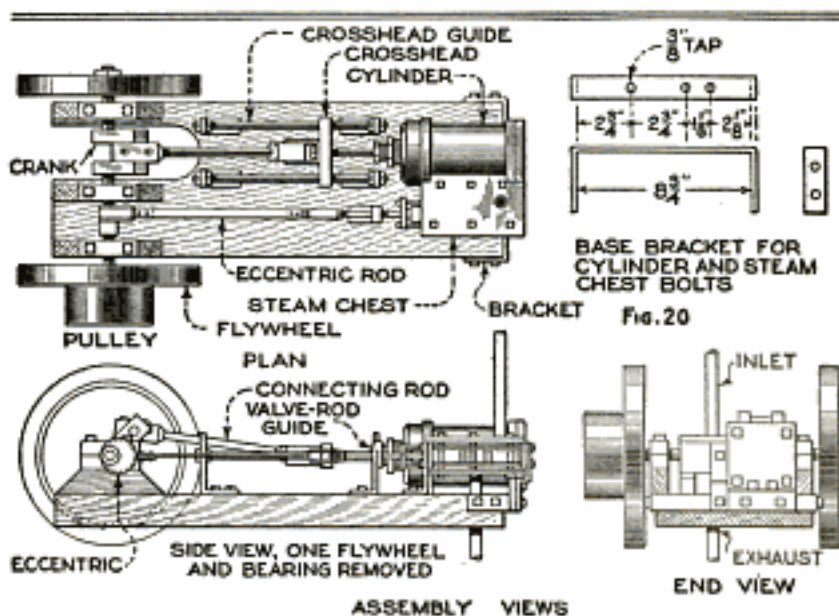

Plan, and Side and End Elevations of Horizontal Steam Engine Assembled: Figure 20 Shows the Bracket Used to Fasten the Rear-End Cylinder and Steam-Chest Supports to the Base

same thing applies to the other supporting brackets. The center of the crankshaft must, of course, be the same as that of the piston rod. The base is cut out to clear the crank and connecting-rod end, and the bearing-bolt heads countersunk in the underside of the base. The base may be attached to a concrete or brickwork bed, if desired, by means of bolts set in place in the bed.

For lubrication of the piston, a standard cylinder lubricator, costing about \$5, should be purchased, as it is not advisable to attempt to make this fitting.

The cost of this engine was \$15.40 complete, most of the material being new; part of the material was wasted in experimenting, and the cost of the engine could be cut in half, were the work to be done over again.

Guard for the Planer

The illustration shows a very good knife guard for the wood planer. It is made of $\frac{3}{4}$ -in. pine, cut to the shape

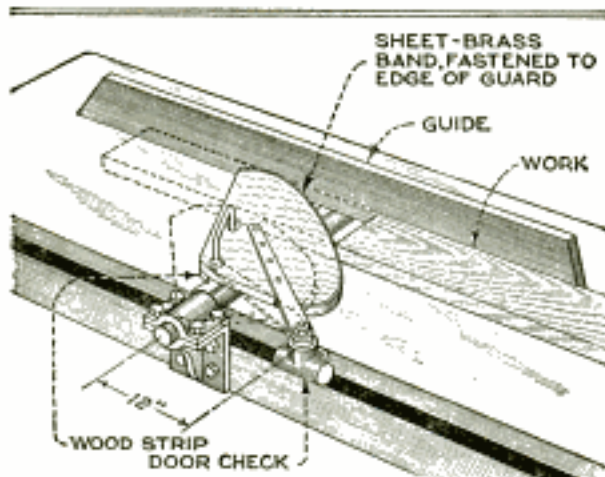

An Automatic Safety Guard for the Planer, Mounted on a Door Check: The Knives are Covered at All Times

shown, and is attached to a flat-iron lever fastened to the spindle of a common door check, which, in turn, is screwed to the edge of the planer table. The door check holds the guard tightly against the work guide, or against the edge of the work. The revolving knives are covered at all times. The edge of the guard is faced with a band of sheet brass to prevent wear. A drawer pull may be attached to the upper side of the guard to facilitate handling it on wide work.

Protecting Edges of Concrete Steps

To prevent the edges of concrete steps from being broken by the impact of heavy barrels, boxes, etc., it has been

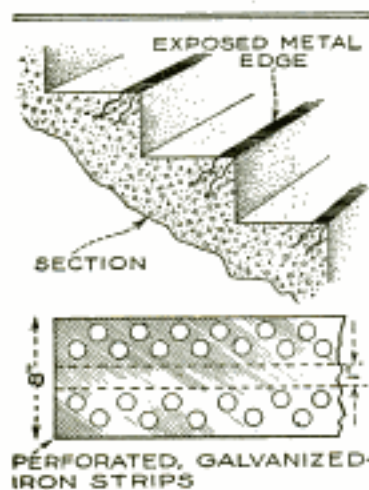

The part of the strip imbedded is first perforated with 1-in. holes along both

found very practical to reinforce them in the manner illustrated. Strips of galvanized iron, or other metal, as long as the steps, or at least as long as the part subjected to most wear, are bent and imbedded in the concrete, as indicated.

sides, leaving a space, about 1 in. wide, that is exposed on the edge of the tread.

The concrete steps to the basement of a warehouse that were reinforced in this way have withstood the jars of heavy boxes for two years, and the edges do not yet show any evidence of the hard usage to which they have been subjected.

Setting Milling Cutters to Depth

The drawing shows a neat little device to aid the milling-machine operator in feeding cutters to accurate depths. It is hard to tell just when the cutter actually touches the face of the work, although, if this can be determined accurately, the rest is merely a matter of feeding the cutter to the depth indicated by the graduations on the handle.

The tool is made of thin spring steel, bent as shown, and with the ends doubled over.

A short piece of $\frac{3}{16}$ -in. wire is passed through holes drilled in the body, and bent over at both sides.

To use the tool, a piece of heavy paper, about

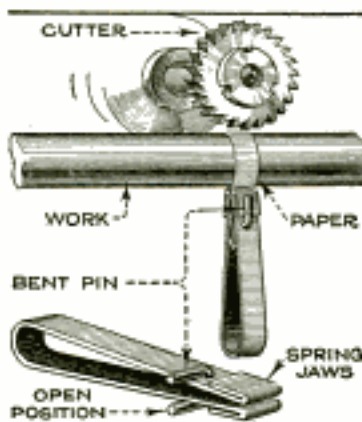

$\frac{1}{2}$ in. wide, is wrapped tightly once around the work, and the ends are caught in the jaws of the tool, which are closed on the paper by swinging the bent pin to the position shown. The table of the machine is then brought up, and at the same time run back and forth, until the revolving cutter cuts through the paper. The tool, of course, drops as soon as this occurs, warning the operator that the cutter is in contact with the work.

Scriber Set in Fountain Pen

The mechanic frequently finds it necessary to carry a scriber around, so that it is available whenever needed, but to carry it in one's pocket is rather dangerous. To overcome this difficulty, a scriber point can be set securely in the barrel of a fountain pen in the same position that the pen point and feeder otherwise occupy. The cap is screwed on the barrel as usual.

Flux for Brazing

The usual method of applying borax to metal before brazing is to apply it to the metal dry, after the metal has been thoroughly scraped or cleaned. It has been found, in a large coppersmith's shop, that a better way is to coat the metal with a solution of boracic acid. The advantage of this is that the solution penetrates every crevice, and covers the surface completely, thereby protecting it from oxidation and also from impurities while brazing. The boracic-acid solution is made by adding quantities of the acid to hot water, allowing it to remain for several hours, with an occasional shaking, and then bottling the liquid for future use.

Wall Troughs for Poultry Feed

Cleanliness and economy are effected in the chicken pen by the use of wall troughs for feed, such as shown in the illustration. They keep the feed clean, and prevent the hens from getting into the feed and scratching it out.

The upper detail shows a grain, dry-mash, or grit trough. It is made of wood, to the dimensions given, and is hung on the wall so that the bottom is about 2 in. above the ground. The lower detail shows a vegetable trough, made in a somewhat similar manner, with the exception that the front of the trough is made of coarse wire netting. Beets, po-

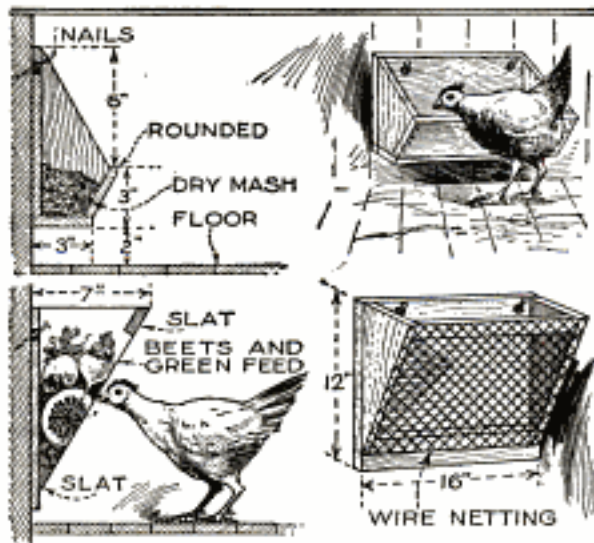

Wall Troughs for Poultry Feed: The Upper Detail Shows a Grain Trough and the Lower Detail a Vegetable Trough

tatoes, and green feed are deposited in the trough, and the hens pick them away, through the mesh, until the very last scrap disappears.

Holding Containers on Bench

The drawing illustrates an excellent method of holding small bottles and containers in place on the workbench,

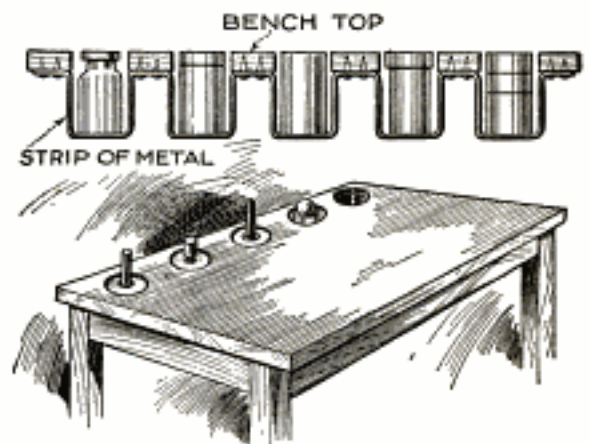

Neat and Convenient Method of Holding Containers on a Bench to Prevent Them from being Overturned Accidentally, or Damaged

to prevent them from being upset, pushed off, or broken accidentally.

A number of holes are bored through the bench top, near the rear edge, so that the bottles will be well out of the way. A strip of metal, bent as indicated, and fastened to the underside of the bench top, holds the containers in place. The holes are bored of various sizes, corresponding to the diameters of the bottles, and the metal strip is bent so that the top of each container is flush with the surface of the bench top.

An Improved Trammel

Frequently the machinist or carpenter needs to describe a circle or arc beyond the range of the ordinary dividers. This is easily done by clamping the dividers and a scriber to a stout wooden strip, in the manner illustrated. The pointed ends of both scriber and

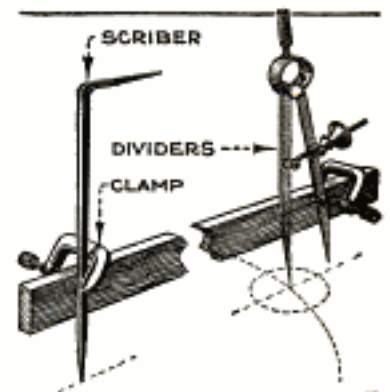

dividers are spaced a distance apart approximately equal to the radius of the arc to be described, and exact adjustment can then be made by means of the screw on the dividers. This trammel serves just as well as the regular instrument.

Removing Willows from Open Drain

It is usually a difficult matter to remove willows from the banks of a small stream of water, except in the dry sea-

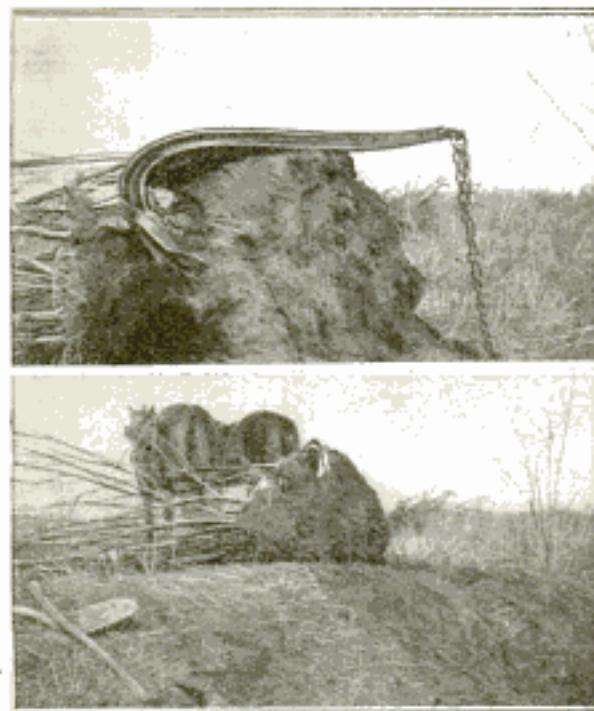

An Effective Method of Removing Willows from an Open Drain with the Beam of a Breaking Plow Hooked behind the Roots

son, and, at that time, other farm duties, such as cultivating and harvesting, are pressing and require all of the time. Hence the work of removing the willows is often neglected until the channel is almost choked.

By employing the method shown in the photographs, I was able to remove the willows easily and completely during the wet season. I obtained the beam of an old breaking plow, and after heating it, gave it a quarter twist a few inches from the back end, so that the share was turned at right angles to the beam. This blade I sharpened, and then replaced the clumsy plow clevis on the end with a smaller one.

With a few feet of log chain attached to the beam, and a team of good horses to pull the plow, the sharpened end was hooked behind the roots, and the team started. The result was that the blade drew still deeper under the roots and removed not only the roots and bushes, but, at the same time, a considerable portion of the earth that had accumulated in the ditch.

I have found this method quite the speediest I ever tried.—Elmer Hufferd, Rushville, Ind.

Tamping Explosives

Metal tools of any kind should never, under any circumstances, be used for tamping explosives in bore holes, or to press the charge into place, even in soft ground, as there is always the danger of striking a pebble, which might produce a spark sufficient to ignite the charge.

For loading and tamping, only a wooden tamping stick should be used. For shallow work, an old broom handle is ideal; for deep holes, when a long stick is needed, a straight sapling can be used to advantage.

For tamping horizontal holes, where a heavy tamping stick, such as one made of oak or hickory, would be difficult to manipulate, a stick made of a light wood, such as pine or bamboo, is very desirable. Bamboo fishing poles, which are light, straight, and strong, make ideal tamping sticks under these conditions. It is positively dangerous for a powerful man to ram a charge of high explosives into a bore hole with a heavy tamping stick, even if it is made of wood.

In deep holes, a very long, cumbersome tamping stick would be necessary, so a tamping block is used in holes that are vertical, or nearly so. This consists of a round piece of wood, from 3 to 6 ft. long, and a little smaller in diameter than the hole, so that it will slide easily in it. A small rope is attached to the center of one end, by boring a hole diagonally from the center out through the side, countersinking the hole on the side, then threading the rope through the hole from the end, knotting it, and pulling it back, so that the knot is drawn into the countersink and does not interfere with the sliding of the block in the hole.

The block should be made of hardwood, to resist wear, no metal parts should be used, and it should not be too heavy. It is operated by raising it a foot or two and allowing it to drop on the "stemming," as the tamping material is called. The block, of course, is withdrawn when fresh stemming is dropped into the hole. The tool recently described by one of our contributors, which was made from a long bolt, has been condemned by the leading explosives experts and insurance companies, for the reasons stated above, and our readers are warned against its use.

☐ Are you in doubt as to the best type of radio instrument to construct or purchase? Write to our Bureau of Information.

Sleeping Porches for Hospital

The illustration shows how an old western hospital was converted into a modern open-air sanitarium by reconstructing the windows so as to permit the beds to be pushed out onto small porches.

The window openings, which were of the ordinary size, were cut down to the level of the floor. A small porch, supported by iron brackets, was built on the outside of each window. A light metal railing was built around the porch and fastened to the wall, and the porch was screened in to keep out flies and other insects. Two doors were substituted for the part of the wall that was cut out below the window, as may be seen in the lower photograph.

With this arrangement the bed can be drawn into the room during stormy weather, and the doors and window closed. No drafts are encountered when the doors and windows of the rooms are kept closed. Shades can very readily be attached to the porch screens to keep off the rays of the sun, if desired; however, no shades are used on the building shown in the photograph, although it is located in a country where the sun shines with little interruption for long periods.—Edward H. Flaharty, Denver, Colorado.

Reseating Globe Valves

After the seat of a globe valve had been ground several times, it became necessary to renew it. Instead of employing the usual method of tapping out and using a threaded seat, I made a plain tapered seat and forced it in place. The job was accomplished quickly because no tapping was necessary. Hard metal was used for both seat and valve.—Robert D. W. Berry, Philadelphia, Pa.

Handling Cable Ends

Anyone who has used a wire cable for hoisting purposes, or elevator work, knows the difficulty of passing the end through a hole or eye only slightly larger than the cable itself; the end will twist and turn or flare out regardless of how well it has been wired, and perhaps the tie wire must be driven back to permit the cable to pass through.

To overcome this difficulty, wire the cable as usual on the end, and also 6 in. from the end. Heat the end of the cable with an acetylene torch, or dip it first in molten lead for a few minutes, to draw the temper, and then in soldering flux, and solder. When cool, file off the surplus solder, and with a pair of heavy pliers twist the cable tightly. It will be found that it will remain twisted and can be bent any way desired. By heating the cable the hemp core is burned out, making the cable smaller. When using this method, always cut the cable long

enough to allow the end to be cut off after the cable clamps are in place.

Making Tight Hose Connections

To make a tight rubber-hose connection to an air or acetylene tank, or to connect two pieces of rubber hose on a short nipple, heat the tapered end of a punch and insert this into the end of the hose for a few moments, just long enough to melt the surface of the rubber slightly. Then slip the hose over the nipple as quickly as possible. It will be found that the hose will slip over the nipple very easily, providing, of course, that the nipple is not too large. After the rubber has cooled, it will be on so tight that it cannot be removed except by cutting. No wires or clamps are necessary on a connection made in this way.—W. E. Rausch, Milan, Mich.



Above: Exterior of an Old Hospital That was Converted into a Modern Open-Air Sanitarium. Below: Interior of One of the Improvised Sleeping Porches

A "Sun Porch" for the Beehive

The newest "wrinkle" in beehive construction is the "sun porch." It is made of wood, with a glass front, and fits

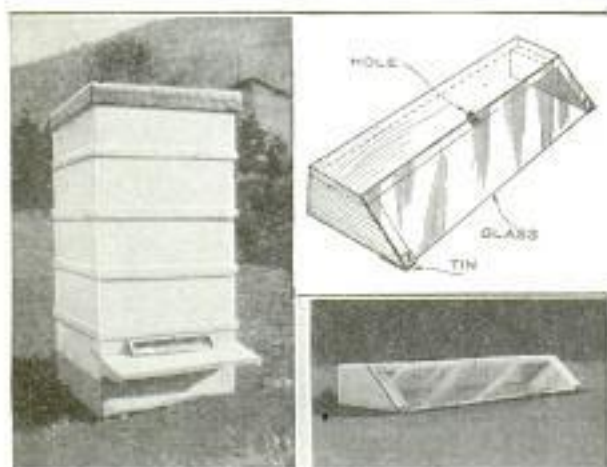

A Detachable Glass "Sun Porch" for the Beehive That Prevents Much of the Usual Bee Mortality during Winter and Early Spring

snugly into the opening of the hive case, as indicated in the photograph. It is claimed that the attachment adds to the warmth of the hive, and prevents much of the bee mortality that is usual during winter and early spring.

The porch provides a protected and well-lighted air space, about 5 in. wide, between the inner and outer entrances, into which snow and rain cannot penetrate, and enables the bees to bring out the dead ones all through the winter, so that the floorboards are kept sweet and clean. The framework of the sun porch is made just large enough to fit in the outer entrance of the hive case, and to butt against the block of the inner entrance. The glass front, which is cut to fit the framework, projects about 2 in. over the alighting board. A small piece of tin is nailed on the bottom of each of the sloping ends of the frame, and is bent up in front to form a holder for the glass. When the glass is in position, the bottom edge is about $\frac{1}{2}$ in. above the alighting board, so that the bees have a clear entrance all along. A $\frac{1}{2}$ by $\frac{3}{4}$ -in. slot is cut in the center of the framework, at the top of the glass, to allow any bees that may run up the glass to fly out.

The sun porch makes it possible for the bees to be left with little or no attention throughout the winter, as there is little danger of suffocation through the blocking of entrances by snow or ice. In the early spring, the space inside the glass is heated by the sun, and the bees revel in this and become warm before fly-

ing out. The porch also acts as a protection against robbing. It is easily removed or placed in position.—R. Franklin Mundorff, Kansas City, Mo.

Window Display for Coal Dealer

A retail coal dealer has arranged a display that is considerably more attractive than the usual assortment of lumps placed on exhibition in the office window. Wooden boxes, about 3 in. wide and as deep, were made in the form of letters spelling the word "coal." These boxes were painted white for the sake of contrast, filled with small lumps of coal, and placed in the window.

Oil Distributor for Milling Machines

The illustration shows an oil distributor that will supply a large surface, and that is especially valuable on form-milling cutters, to wash chips away. It is made of a piece of fine wire, twisted into a de-

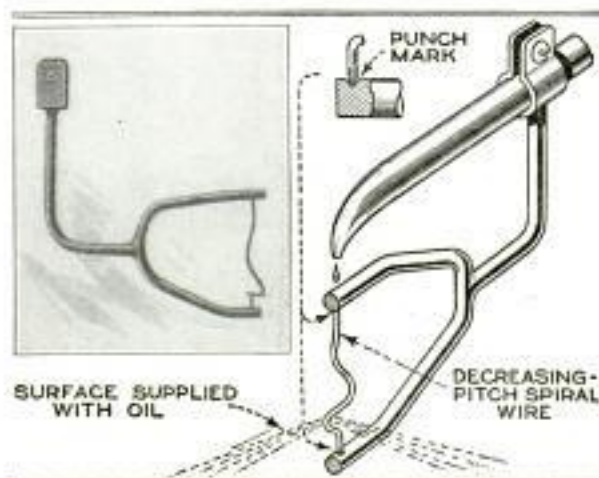

Novel Oil Distributor for Milling Machines: The Oil Running down the Spiral Causes It to Revolve, and the Final Twist Throws the Oil Off

creasing-pitch spiral, and mounted on a forked support, as shown. The weight of the oil running down the spiral causes the latter to revolve, at a speed dependent upon the amount of oil supplied. When the oil reaches the sharp twist where the pitch of the spiral is smallest, centrifugal force causes the oil to fly off. The area covered by the spray of oil depends upon the distance of the spiral above the work, the size and shape of the spiral, and the amount of oil supplied. The ends of the spiral are pointed to reduce friction and are set in punch marks made in the ends of the forked support.

Green-Gold Plating Solution

A green-gold plating solution for jewelers' use can be made by using regular yellow-gold solution, and adding to it, while plating, ordinary silverplating solution, watching the article closely until the desired color is obtained. Use a green-gold anode, and attach to the same wire a lead anode, the same size as the gold one. After plating, the high lights are brought out by rubbing with a wet finger, dipped in bicarbonate of soda.

Homemade Gas Torch

Sometime ago I saw a homemade gas torch used for heating a collar on a large shaft. The torch was made of pipe and fittings, and was so arranged that either a yellow or a hot blue flame could be obtained by the use of a sliding-valve arrangement to regulate the air supply.

The nozzle is made from a piece of $1\frac{1}{2}$ -in. pipe, 18 in. long, slotted as shown, threaded at one end, and provided with a cap. A hole, drilled in the exact center of the cap, is threaded to receive the jet.

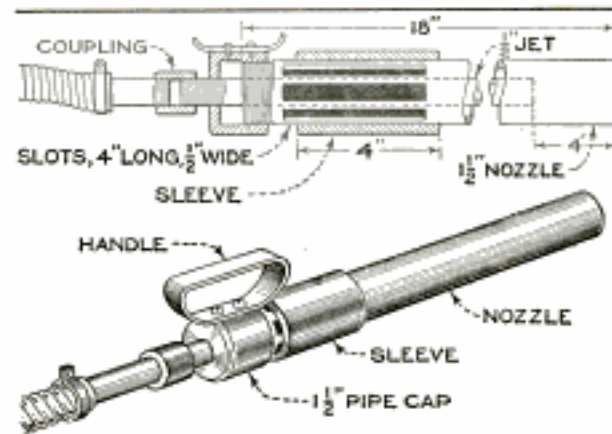

A Simple but Efficient Homemade Gas Torch with Which Either a Yellow or a Hot Blue Flame can be Obtained

This consists of a piece of $\frac{1}{2}$ -in. pipe, 15 in. long, having one end threaded for about 3 in., and screwed into the cap, as shown, so that the end of the jet comes about 4 in. from the end of the nozzle. A sleeve, made from a 4-in. length of pipe, is slipped over the nozzle to cover the slots; the sleeve should be a good sliding fit on the nozzle. The handle can be made from a length of strap iron, riveted or screwed to the cap as shown. The amount of gas fed to the torch is controlled by a valve in the line, and the air supply by means of the sleeve over the air slots.—L. B. Robbins, Harwich, Mass.

Improving the "Steamboat"

The drawing shows an improvement on the "steamboat" used for tracing designs and drawings. The improvement con-

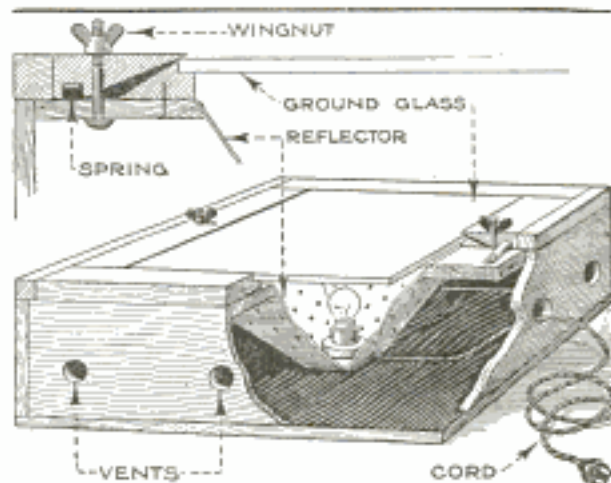

A "Steamboat" can be Greatly Improved by Providing It with Two Wooden Clamps on Opposite Sides to Hold the Work on the Glass Securely

sists in fitting two wooden clamps on opposite sides of the box to hold the work securely on the glass, and to prevent it from being moved accidentally while tracing.

The clamps are maple strips, held in place with bolts provided with wingnuts, as indicated. A flat steel spring is fitted under each clamp, to raise it when the wingnut is loosened in order to make it easy to insert the work.

Removing Tight Bolts or Screws

A convenient and effective method of removing tight bolts or screws is to place an ordinary detachable socket from a wrench set over the nut, so that two wrenches can be applied at the same time, as shown; the larger wrench on the side end of the socket keeps the socket from splitting open under the force applied to it with the smaller wrench. In almost every case this method will be found to loosen the bolt, without springing a good wrench, which is often done on jobs of this kind.

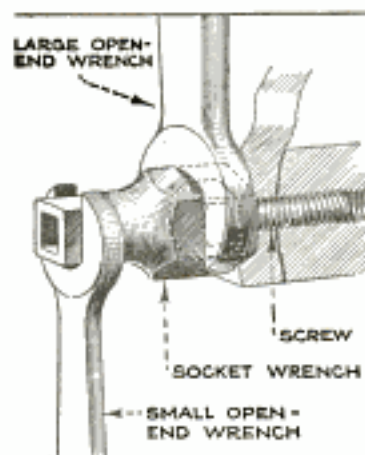

Serviceable Homemade Hoist

The portable hoist shown in the illustration has been found of great utility by a contractor whose work involves the

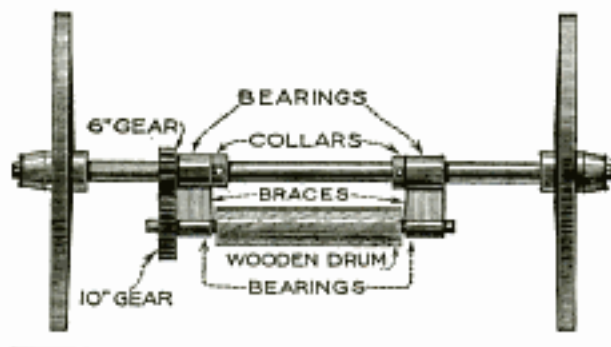
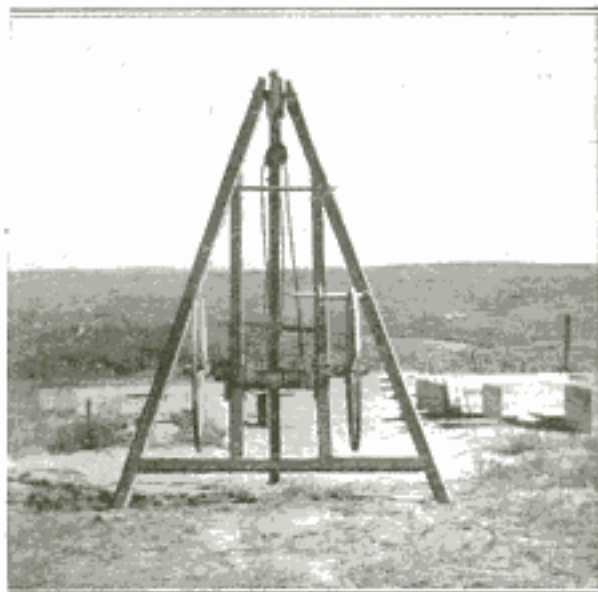

Above: The Homemade Hoist Set Up Ready for Use. Below: Details of the Hoist Mechanism

placing of concrete burial vaults weighing about 1,800 pounds.

The legs of the hoist are 12-ft. lengths of 4 by 4-in. stock, two of the legs being braced in the form of a triangle by a crosspiece and uprights of the same stock. The other leg swings, on a 1-in. bolt, between the first two, at the apex of the triangle. This leg is swung out when the hoist is to be used, and folded in against the other two when the hoist is to be hauled away.

A 6-in. wooden drum is fastened to an axle that runs in bearings bolted to the vertical 4 by 4-in. pieces, and a 10-in. gear is keyed on one end of the axle. This gear meshes with a 6-in. gear, keyed on a shaft that runs in bearings mounted on the other side of the uprights, and two buggy wheels are fastened to the outer ends of the shaft. By loosening the collars shown in the detail, the shaft can

be slid endwise, to put the gears out of mesh, when moving the hoist.

A heavy piece of wood, 2½ ft. long and fastened to one of the legs by a bolt, so as to permit its being pressed against the rim of the wheel, is used as a brake when lowering the load, and a long iron bar, sliding in a flat-iron bracket bolted to one of the legs, can be used to hold the load at any desired height, by thrusting it between the wheel spokes.

A heavy block and tackle is slung from the center leg by a clevis, the end of the cable being attached to the drum. Two long bolts, fastened through the triangular-frame legs, about 3 ft. from the bottom, provide handholds for moving the frame about, and spikes are driven into the lower ends of each leg to prevent slipping.

A large hook, fastened to the upper end of the center leg, allows the hoist to be attached to the rear end of a truck or car.—J. C. Coyle, Colorado Springs, Colo.

Guide and Die for Punching

When punching holes in sheet metal, it is sometimes difficult to locate the die exactly under the punch, especially when

the holes to be punched are at some distance from the edge. To facilitate punching such holes, I made the tool shown in the illustration. It consists of the two opposite

outer leaves of an elliptic rear spring. These I heated, straightened out, and cut to a convenient length, and then fitted the sockets so that, when hinged together, there was no sideplay. I drilled holes of various sizes through both pieces, after hinging, and then retempered the pieces. The tool thus made is placed over the sheet, so that a hole of the proper size is over the place where the hole is to be punched. It is then an easy matter to punch the sheet; the bottom piece serves the purpose of a die and is always in the exact position to receive the punch as it is driven through.

—G. G. McVicker, North Bend, Neb.

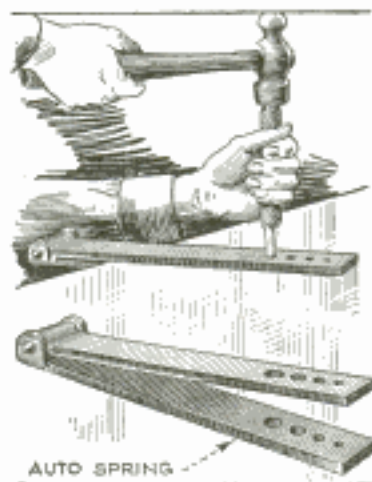



An Improved Lawn Canopy

BY C. W. MORGAN

THE lawn canopy shown in the illustration is rather unusual in design, and is very easy to construct. It may be used to shade the outdoor dining table or lawn furniture, and a hammock may be swung between its supports. The construction eliminates the faults of the common types, such as the sagging of the canvas and slacking of the ropes that are caused by changes in the weather.

The end supports are made of 2 by 4-in. stuff, the two sides of the triangular frame being 8 ft. 6 in. long, and braced, near the bottom, by a piece of 1 by 3-in. stock, 7 ft. 6 in. long. Bolts are used to fasten the frame together, and a space for the ridgepole is left between the upper ends of the sidepieces.

The ridgepole is a 12-ft. length of 2 by 4-in. stock, notched at each end, to fit over the upper edges of the top cross-pieces on the end frames, drilled, at the ends, for the bolts that fasten the end braces to it, and bolted to the sidepieces of the frame.

The end brace is 8 ft. 6 in. long, also of 2 by 4-in. lumber; it is bolted to the ridgepole at the top, and to a stake, driven into the ground, at the bottom. This, in the writer's opinion, is the best way to fasten the braces, although, of course, they can be fastened to the frames by struts, thus eliminating the stakes.

The canvas, which is 11 ft. long by about 11 ft. wide, is kept taut by a frame made of 1 by 3-in. stock and 2-in. poles or pipes. The frame is 11 ft. by 9 ft. 6 in. in dimensions, and the poles are fitted in hems, 4 in. wide, sewed in the canvas as shown in the detail. If pipes are used,

the ends must be plugged for the screws or pins that fasten the 1 by 3-in. cross-pieces to them.

Brass grommets are fastened in the canvas, at the points indicated, and tie ropes pass through them. The center grommets may be slipped over pegs in the ridgepole, or ropes passed through them and round the pole. The end tie ropes are fastened around the sidepieces

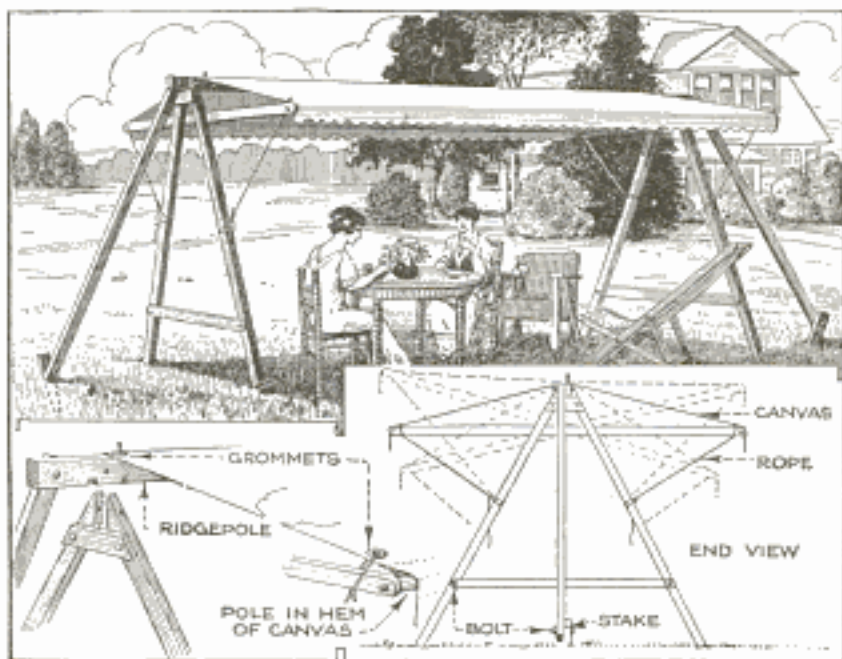

An Improved Type of Lawn Canopy, of Substantial Construction: The Canvas is Always Kept Taut, and, as the Top can be Tilted to Either Side, It Provides Plenty of Shade at Any Part of the Day

of the canvas frame, and then led down to the legs of the main frame and tied within easy reach of the hand.

With this design, the canopy is always taut, and may be tilted to either side, as indicated by the dotted lines, thus making it serviceable for use any part of the day. If bolts are used to fasten the frame together, the whole canopy can be dismantled and folded up into a comparatively small space. The ridgepole and braces fold up together, and the end frames may be collapsed also, by removing only two bolts.

Two Kinks for the Fisherman

The drawing shows a fish lure that seldom fails in its purpose, providing, of course, that there are fish in the vicinity.

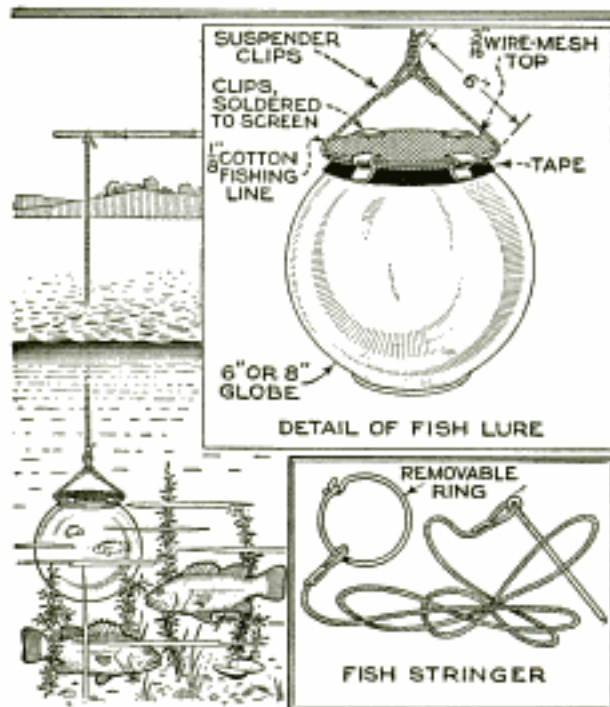

Above: A Transparent Glass Bowl, Containing Minnows, That Forms an Excellent Fish Lure. Below: The Fish Stringer Provided with Detachable Ring

The lure consists of a transparent glass bowl, preferably a goldfish bowl, about 6 or 8 in. in diameter, containing some minnows. It is suspended in the water a foot or two away from the point where the user is fishing.

To make the lure, cut a circular piece of galvanized, or copper, screen wire, about $\frac{3}{16}$ -in. mesh, to fit over the opening of the bowl. Solder four brass clips, shaped to fit under the edges of the bowl, to the screen, as shown. These keep the screen firmly in place while the bowl is immersed. Wind two layers of friction tape around the neck of the bowl, coat well with a good varnish, and allow it to dry. Then take a line of $\frac{1}{8}$ -in. cotton, of sufficient length to go around the neck, and allow two suspension leads about 6 in. long; form loops on the ends of the leads, and fasten the loops with common suspender clips. Then fasten the cord around the neck, apply another coat of varnish over the cord, allow it to dry, and the lure is ready for use. Fill the bowl with water, and place in it some live minnows, put on the cover, and lower into the water. I have found from experience that it is best to use from six to twelve minnows.

I have employed this lure for catching herring and perch, with a minnow on my hook about 3 ft. away from the lure. When the water is clear, the fish can plainly be seen to dart at the minnows in the bowl, but, upon coming in contact with the glass, they seem to realize that something is wrong, and immediately turn and snap at the minnow on the hook.

When removing fish from a stringer, it is usually necessary to force them back over the stringing needle, and this is not a very easy or pleasant task. To overcome this difficulty, I use a detachable ring on the lower end of the stringer, as shown in the illustration. The ring is made of No. 8 galvanized wire and has the ends hooked to engage with each other, as indicated. By squeezing the ring, it is loosened and can be removed from the stringer. With one jerk of the stringer, the entire catch will slip off.

The stringing needle is made of the same size of wire as the ring. The stringer is made of braided cotton line of the desired length, the ends being looped and fastened with suspender clips.—Frank L. Howe, Milwaukee, Wis.

Simple Filter and Water Cooler

The drawing shows a simple filter and water cooler that can be made from a tile pipe, filled with gravel, charcoal, and

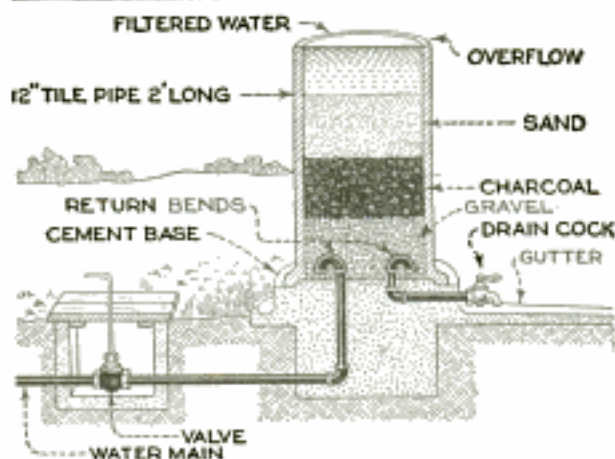

An Efficient Water Filter and Cooler Made from a Two-Foot Length of Tile Pipe, Filled with Gravel, Charcoal, and Sand

sand; the water enters the filter from below, flows over the top of the pipe, and is caught and led off by a gutter in the cement base.

The tile pipe is 12 in. in diameter and about 2 ft. long, and is set in a cement base, formed as shown. The water main enters from below, through the cement base, the end of the main projecting into

the tile pipe being fitted with a return bend, to prevent the gravel from choking the pipe. The water is regulated so as to rise slowly through the filter and overflow down the wall of the pipe, the partial evaporation of the water keeping the wall cool, and consequently the water inside. A drain cock should be provided, as indicated, so that the filter can be drained when it is to be cleaned, and new gravel, etc., substituted for the old.

Retainer for Gasoline-Tank Cap

The loss of gasoline-tank caps is a frequent occurrence, which, however, can easily be prevented by means of the simple attachment illustrated. One

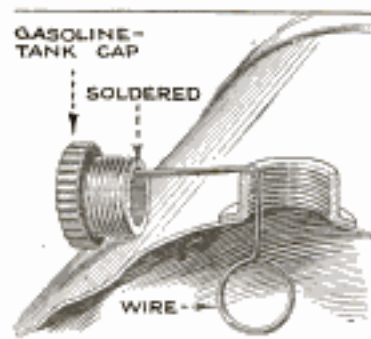

end of a length of wire is soldered to the cap; the other end is bent into a loop, and a right-angle bend is made in the center

of the wire. The loop at the end of the wire must be a little larger than the opening in the gasoline tank, and is sprung a trifle in order to force it through the opening.

Neat Method of Piling Stones on Cleared Land

A neat way for a farmer living in a rocky region to pile the stones gathered from his fields is to dispose of them in woven-wire containers located in the corners of the fields.

The containers are made from 12-ft. lengths of woven-wire fencing, rolled into the form of cylinders, the two meeting edges of each being stapled to a corner post. In filling the containers, the heavy stones are, of course, thrown in first. As the pile grows higher, it is built as evenly as possible to prevent it from sagging to one side. It may be necessary to drive a long stake on the side of the container opposite the corner post, and staple the mesh to the stake also. It is desirable that the mesh of the fencing be smaller at the top of the cylinder, so that the smaller stones will not fall through.

The piles of stone so arranged have a neat and roughly ornamental appearance, and add materially to the strength of the

fence, by bracing the corner posts. When the containers have been filled, a cement

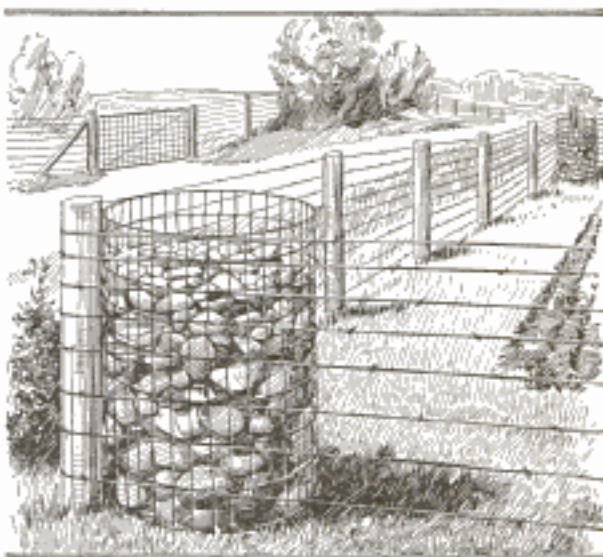

Neat Method of Piling Stones Picked Up from Cleared Land: The Stone Piles Also Add to the Strength of the Fence

composed of 1 part portland cement to 1 of sand can be poured over the pile, and tamped into all the crevices, making a solid, almost everlasting corner post, which will take the place of the wooden one when the latter is no longer serviceable. A solid foundation can be provided by digging under the pile, one side at a time, allowing some of the stones to drop into the excavation, and filling in with cement, or the hole can be dug before the stones are piled in the corner, the larger stones placed in the hole, and the cement poured in before building higher.—Ward L. Schrantz, Carthage, Missouri.

Preventing Poultry from Roosting on Nests

Finding that chickens had a preference for roosting upon the nests, rather than upon the roosts provided for them, the writer hit upon the simple idea illustrated to prevent this, and found that it worked effectively from the start.

All that is necessary is to saw notches in the edges of the nest boxes, as indicated. The notches are cut about 2 in. deep, and need not be of uniform size, although this makes a neater job.—Edward L. Clark, Scranton, Pa.

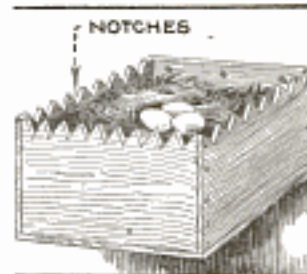

Novel Sliding Doors for the Buffet

The novelty of the sliding-door arrangement for a buffet or cabinet, shown in the drawing, lies in the fact that both

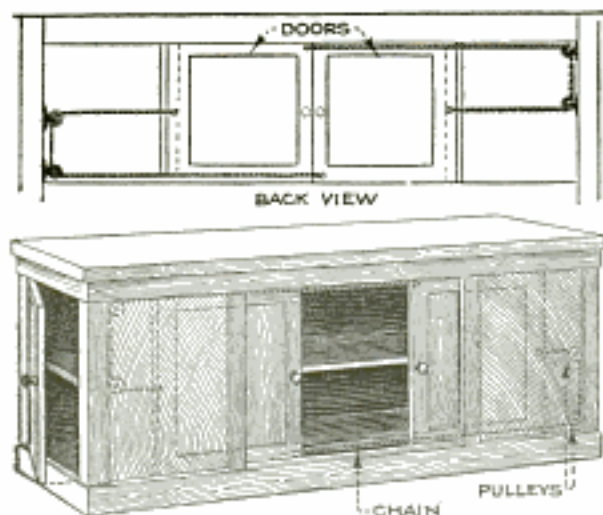

A Novel Arrangement of Buffet or Cabinet Doors: Both Doors Slide Open at the Same Time, and All the Interior Space can be Utilized

doors open at the same time, although only one of them need actually be pushed.

Four small grooved pulleys and two lengths of light chain are used; sash cord or rope may also be used, but chain is preferable, as it will not stretch. The method of arranging the pulleys and chains is clearly shown in the upper detail. An additional feature of merit is the provision of end doors and shelves, so that all the space in the cabinet can be utilized.—C. F. Wilhelm, Kitchener, Canada.

Transplanted Onions Grow to Double Size

Last year I planted a large patch of onions in my garden, and as soon as they were large enough for table use, I pulled about half of them out to allow room for the others to develop into bulbs. After the tops were trimmed and the fiber roots cut back, to prepare them for market, I found more garden space available and decided to replant them.

The soil of the two onion beds was practically the same, and there was no difference in the method of cultivating, but nevertheless the replanted onions developed bulbs that were double the size of the others.

This was quite a mystery to me, until an elderly market gardener explained that I had accidentally discovered one of the secrets of successful onion culture. According to him, the removal and trim-

ming of the onions when they were little larger than a lead pencil, caused the fiber roots to branch forth with thousands of minute roots, and limited the development to the bulb, which consequently grew to abnormal size.—G. E. Hendrickson, Argyle, Wis.

Improving Percolator Faucet

The illustration shows how a faucet for use on coffee percolators, etc., can be improved to prevent the drip that occurs a few seconds after the faucet is shut off.

Two $\frac{3}{32}$ -in. holes are drilled in the plug, and a $\frac{1}{8}$ -in. slot is filed in the body of the faucet, as indicated. The holes, in connection with the slot, provide an air vent that opens the instant the faucet is shut off, and prevents the retention of any liquid in the nose of the faucet.—G. B. Olson, Bridgeport, Connecticut.

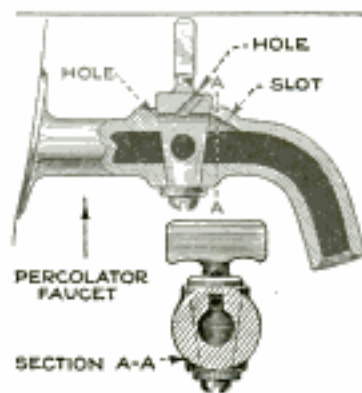

Spool Holder for the Sewing Room

A piece of $\frac{3}{4}$ -in. wood, cut to the shape shown, hinged to the window casing so that it can be swung out, and provided

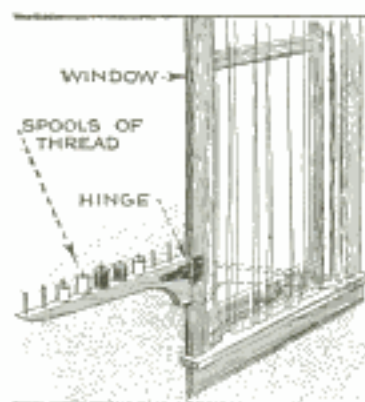

on the upper edge with a number of pins or dowels, makes an excellent spool holder for the sewing room. The holder can be made as long as desired, and smoothed down, stained,

and varnished to match the window casing. Holes, slightly smaller than the pins to be used, are drilled in the top of the holder, to an even depth, and about $1\frac{1}{4}$ in. apart. Large nails, about $4\frac{1}{2}$ in. long, clipped to even lengths, and with the upper ends rounded, make good pins.—E. W. Hall, Catskill, N. Y.

Bag Used as Dust Container

A cobbler who had installed an electric finishing machine found himself confronted with the problem of disposing of the dust. It was impossible to discharge the dust outside of the building, on account of the adjoining buildings. The difficulty was overcome by simply taking a grain bag and fastening it over the exhaust pipe, in the same way as the dust container is fastened to a vacuum cleaner. All the dust was retained in the bag, which was easily emptied.

Spraying Attachment for Garden Hose

The chief objection to the use of an ordinary garden-hose nozzle for spraying shrubbery or plants is that the flow of water must be reduced to a fine spray before any considerable area can be covered. To eliminate this objection, an attachment was made for the hose nozzle as shown in the drawing. A disk was cut from a tin can, and radial slits cut in it as indicated; after bending the sections, to form a "fan," the disk was mounted on a piece of heavy wire, bent and attached to the hose nozzle. Two



An Attachment for the Garden-Hose Nozzle That Enables the Spray to Cover a Wide Area and Prevents Injury to Plants and Flowers

corks were drilled and fitted on the wire, one on each side of the disk, to hold it in a vertical position. With this attachment, it is possible to use the full stream of water without damaging the plants.

Recess in Fence for Car

The illustration shows an arrangement used by a resident of Washington, D. C.,

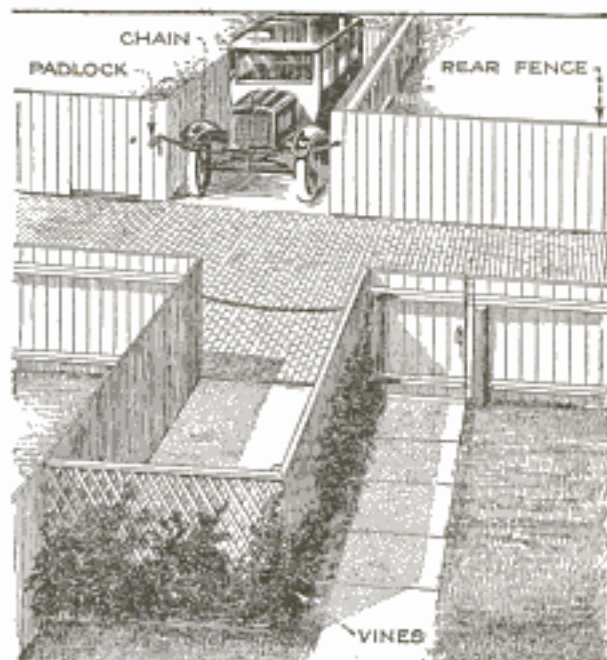

A Recess, Built in the Backyard Fence, and Equipped with a Chain and Lock, has been Found Convenient for Storing a Car Temporarily

for the temporary storage of an automobile until a garage could be built. A 7-ft. section of the backyard fence is removed and a recess, 14 ft. long, built in; it may be built of the same material as the fence, which is, perhaps, most advisable because the section of the fence cut out can then be used; or it may be built of lattice-work, as shown in the foreground, and vines planted around it, which would be the more decorative method. A strong chain is fastened securely around a corner post on one side of the entrance, and equipped with a heavy padlock, that can be snapped on an eyebolt fastened to the opposite corner post. If the recess is used during winter, it should be provided with a light roof to keep off the snow.—G. A. Luers, Washington, D. C.

Improvised Sash Weights

While repairing an old country building, sash weights improvised from old bottles filled with sand, were found to be entirely satisfactory. Although these weights were used only on one sash, they can be used equally well on both, but a lath, or other strip of wood, should be fastened vertically between the two adjacent bottles to prevent them from hitting each other and breaking.—P. F. Noyes, Wulfert, Fla.

Trousers Made to Fit in High Boots

A camper who found it rather uncomfortable to have the bulgy bottoms of his trousers "stuffed" into his high boots,



Alterations That Enable the Camper to Wrap the Trousers Snugly around the Leg, Eliminating the Discomforts Experienced While Wearing High Boots

soon remedied the trouble by cutting off the bottom hem of the trousers, a practice called "staggering" by woodsmen, then ripping open the inner seam of each leg nearly up to the knee, and resewing the seams down to the calf, and fitting the cloth loosely to the leg. Small snaps were used to hold the part of the trousers below the calf snugly around the leg. For additional security, a small tape was sewed on at the bottom, so that it could be tied around the leg just above the ankle. The alteration thus effected eliminated all the difficulty previously experienced when pulling the high boots and socks on or off, and was much more comfortable than the previous method.—Leroy W. Hutchins, Bronxville, N. Y.

Shock-Absorbing Radius Rods

The radius rods on a light car often cause considerable trouble, owing to the rapid wearing of the ball-and-socket joint

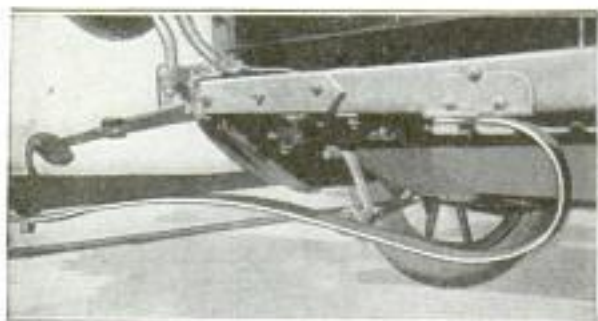

Flat-Spring Radius Rods Substituted for the Usual Rods on a Light Car: They are Bolted to the Frame Instead of the Crankcase

under the crankcase. To prevent this trouble, a California man substituted for

the regular rods, spring radius rods of the design shown in the photograph. They are made of flat spring steel, $\frac{3}{8}$ in. thick and $1\frac{1}{2}$ in. wide. One end of each is bent to a semicircle of about $3\frac{1}{2}$ -in. radius, and bolted to the frame, as indicated, and the other end to the underside of the front axle at the point where the ordinary radius rod is fastened. The curve in the spring allows vertical motion of the axle and also a slight "cushion" to the thrust of the rear wheels, thus materially lessening the shocks on the body and engine.—E. B. Winter, Alhambra, Calif.

Towing a Canoe

When towing a canoe behind a motorboat, great difficulty is usually experienced in keeping the light craft from yawing from side to side and upsetting, unless some expert is in the canoe to keep it in the track of the leader. However, this is a "ticklish" position for one to be in, as it means constant vigilance and considerable muscular effort to avoid a bath.



The difficulty can easily be eliminated by attaching the tow rope to the bow of the canoe in the manner shown in the illustration; the canoe can then be towed unoccupied, and will be found right side up and dry at the end of the trip. Tie the tow rope in a bowline, or any other secure knot, around the bow of the canoe as tightly as possible, pulling the knot under the middle of the canoe so that the rope will tend to pull the bow upward. Force one of the paddles under the forward seat or thwart, then over the loop of rope, and force it under the little triangular piece set in the bow of the canoe. This keeps the towline from slipping off the front of the canoe, and any speed can be made, with the assurance that the canoe will follow without any trouble.—R. Melrose, St. John, N. B.

☞ To remove dust and lint from dark-colored clothing, rub lightly with a piece of damp chamois skin.

Fly Trap for Dairy Barns

Milking fly-tormented cows in "fly time" has always been one of the farmer's special trials. One farmer, however, by an ingenious application of the wire-cone fly trap to his special needs, has been able to keep his cow stable almost free of flies. Not only has this made milking easy, but the milk flow has been noticeably greater.

A barrel of separated milk, which is used for feed, stands just outside the barn door on this farm. This barrel is, of course, a great attraction for the flies, and they swarm around it in large numbers. This milk is used as a bait, the fly trap illustrated being placed over the container. The trap consists of a wooden framework, about 2 ft. square, which is covered with wire-screen cloth on all but the bottom side. In the open side four screen-wire cones are fastened to suitable strips; the small open ends of the cones extend inside the trap to within a few inches of the top, and the spaces between the large ends and the trap sides are filled in with pieces of wood, to prevent the flies from escaping.

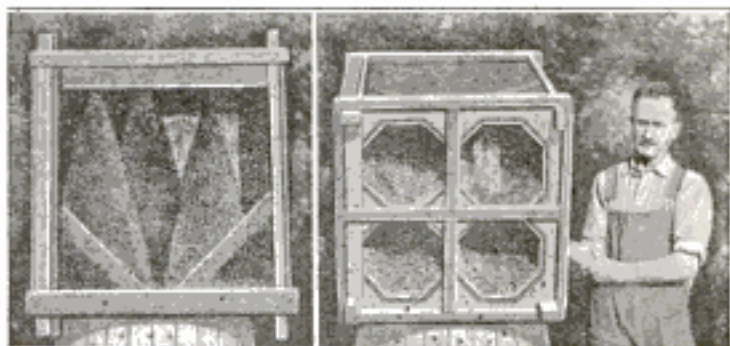

Side and Bottom Views of Effective Fly Trap, Showing How Cones are Placed and How the Bottom is Arranged

up through them, and out at the top inside the trap, from which there is no escape. The top cover of the trap is hinged so that the dead insects can be removed as required. Boiling water can be used to kill the flies before the trap is opened. With such a trap unbelievably large numbers of flies are caught; as much as 5 lb. of dead flies have been removed at one time from it.—Florence L. Clark, McGregor, Ia.

Self-Acting Door Latch

A door latch for barns and granaries should be certain in action, so that the door cannot open accidentally after being shut. A spring door latch frequently gets out of order, and is therefore not very satisfactory, but a simple wooden self-acting latch of the kind shown in the

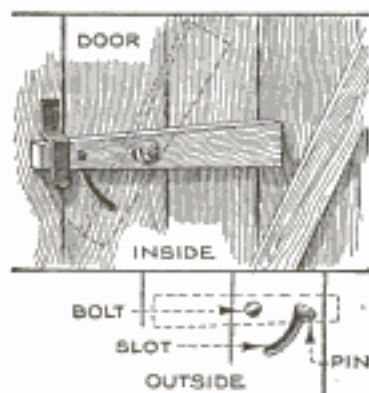

illustration has been found entirely suitable for the purpose. The latch consists of a single piece of wood, tapering from 4 in. to about 2 in. in width, so that one end will be much heavier than the other. It is bolted to the door loosely and slightly off center, so that the heavy end always tends to swing down. A curved slot is cut in the door, and a wooden pin, fastened in the latch, passes through the slot

so that the door can be opened from the outside. When the door is closed and the latch is released, it swings to the closed position, owing to the greater weight of the wide end.—H. F. Grinstead, Columbus, Mo.

Edging Lawns with a Blowtorch

Where the surface of a walk is on the same level as the lawn, it is a common practice to trim the overhanging grass by means of a spade or other sharp implement, leaving a small V-shaped trench. This may be practicable on some lawns, but if there is much of a slope to the walk, the rains often wash away the soil thus exposed, and make refilling necessary at intervals.

Under such conditions it is better to refrain from further trimming, and allow the grass to grow. As soon as the roots have gained a firm foothold, to prevent erosion of the soil, further growth can be checked for the remainder of the growing season by running the flame of a gasoline blowtorch along a narrow strip. It takes only a few minutes to scorch several rods of grass along the margin of the walk.



CONDUCTING AN EMPLOYMENT AND INFORMATION BUREAU

By E.W. HITCHCOCK



Awarded Second Prize—\$50.00—in Contest on Occupations for Shut-Ins

A WOMAN in a small country town in the East, who is confined to her bed by paralysis, conducts a very successful employment and information bureau. The methods applied by this woman should bring to others, similarly situated, not only the same measure of success, but also freedom from the mental depression that not infrequently accompanies bodily infirmity.

Beginning with two or three girls, for whom she undertook to find employment, her business has grown until her clientele covers the whole town and a large part of the surrounding country. She compiled a list of prospective employers in many different lines of business, and a corresponding list of prospective employes, and solicited patronage by means of personally written cards, and outlines of the qualifications of the applicants on her waiting list. She maintains a list of boarding houses and homes, to which she can send her clients, with the assurance that they will be suitably placed, and conveniently located, and where they can obtain rooms or board at reasonable rates.

Her ready sympathy, capability, and thorough understanding of the needs of employers and capability of employes, made both her firm friends, and, through these qualities, her business has increased until the financial return is sufficient to keep her in comfort.

The information bureau grew out of the employment business. By means of a large collection of books, magazines, trade journals, catalogs, and government bulletins, she has a wide variety of information at hand, and, with the assistance of the nurse who attends her, provides a service that is immensely appreciated by those in the community.

The conditions in most small towns are very similar, and, while some revision and adaptation of her methods and ideas may be found necessary to suit the particular needs of other communities, the

general principles will apply anywhere, and the equipment used in this case will serve equally well in other cases.

The hanging table shown at the top of the illustration was the first piece of equipment made. The table itself is made of light lumber, and is 18 by 30 in. in dimensions. Two large screweyes are driven into one of the 18-in. edges, and these slide on a wooden arm, shaped as shown, and hinged to the head of the bed at a convenient height. A piece of spring wire, bent and fitted to the end of the arm, as shown in the detail, keeps the table from sliding off the arm accidentally, while permitting it to be removed whenever necessary. At the bottom of the table, a 6 by 6-in. block is hinged; this supports the table level on the bed, when in use, and is folded back flat against the table when the latter is dropped. A portable typewriter, while not part of the original equipment, could be fastened to the table as shown in the lower right-hand view, and would prove of great value as the business grew, as not only would it save a lot of time, but would give a much more businesslike appearance to the outgoing letters and cards. For shut-ins who have lost the use of one arm, a stout cord could be attached to the lower end of the table and to the bed within easy reach of the patient's mouth. By gripping the cord in the teeth, the table could be raised to the bed, with a little assistance from the remaining hand; this applies also to the telephone.

Another piece of equipment that is indispensable, is the hanging filing cabinet. This is a light, but strong box, 18 in. wide, 24 in. long, and 6 in. deep. It is divided into as many compartments as necessary, one large enough to contain letterheads and envelopes; another for fountain pen, blotter, erasers, pencils, writing and scratch pads, etc.; the remainder of the space may be divided to suit the cards on which are listed the names and ad-

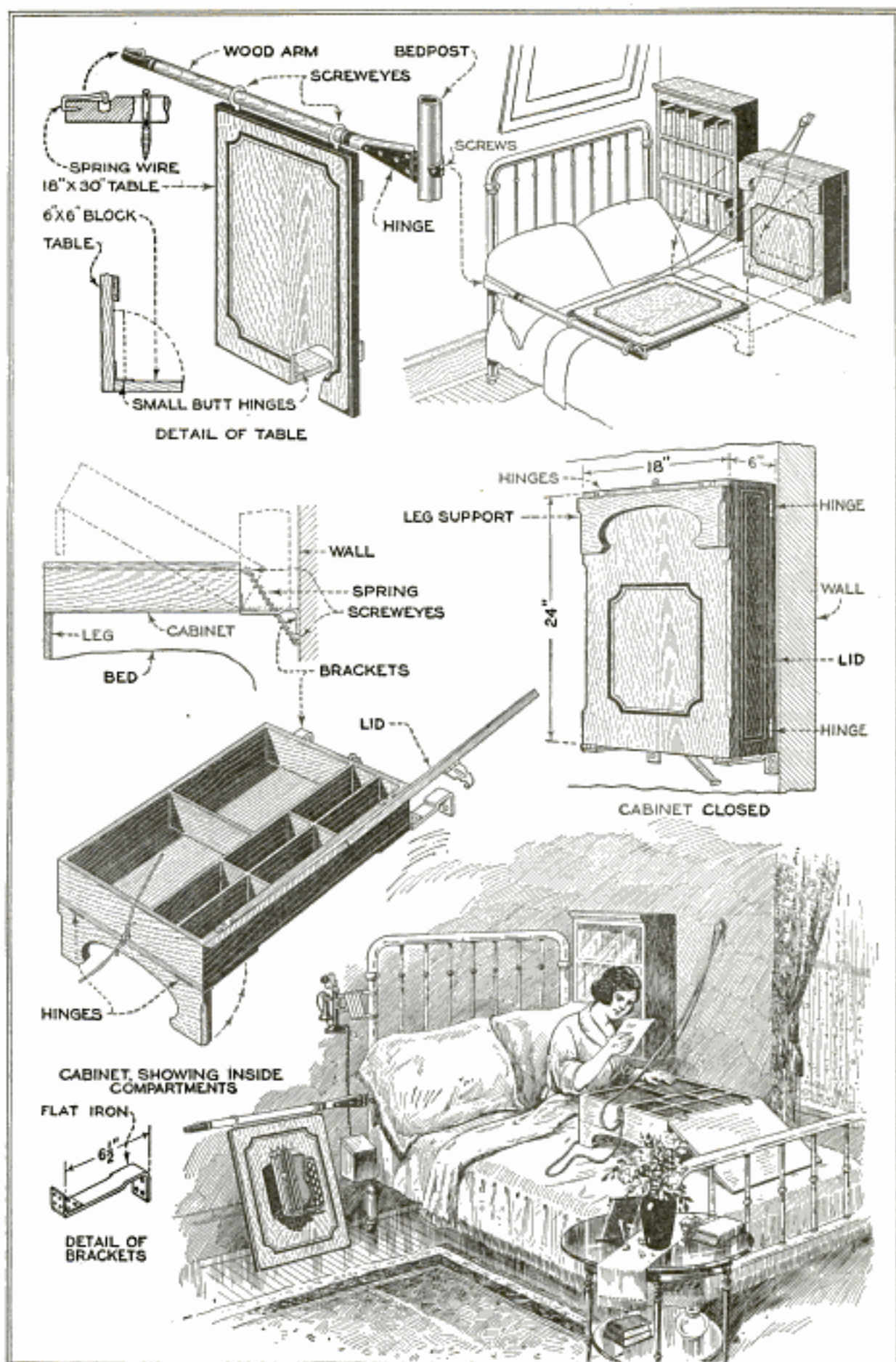

Simple and Easily Constructed Equipment for the Information and Employment Bureau Managed by the Shut-In: The Hanging Table, Hinged to the Head of the Bed, Provides a Splendid Writing or Typewriter Desk. The Hanging Cabinet Contains All Supplies for Correspondence, Together with the Index Cards Necessary for a Successful Business

dresses of employers and employes, and references to data for the information bureau.

The cabinet is hinged to the wall by means of two brackets, made of $\frac{3}{8}$ by about $1\frac{1}{4}$ -in. flat iron, $6\frac{1}{2}$ in. long; these are shaped as shown, and have strong butt hinges riveted or screwed to the outer ends, the hinges being also screwed to one of the 18-in. sides of the cabinet. A short, strong spring, which may be a screen-door spring, cut down, is attached to the cabinet and wall, as shown in the drawing; this spring aids in lifting the cabinet from the bed, and also assists in lowering, by checking the cabinet as it is dropped onto the bed. A leg is hinged to the lower edge of the other 18-in. side, to support the cabinet when lowered.

A pulley is fastened to the wall, above the cabinet, and a rope run through this, to a screw-eye driven into the cabinet as shown. This makes it possible to raise or lower the cabinet easily; another, but shorter rope, attached to the same screw-eye, is used to pull the upper part of the cabinet forward when it is desired to lower it, the patient keeping the other rope in the hand, and using it to lower the cabinet gently, when it has been pulled out of the perpendicular by the shorter rope. The hinged lid of the cabinet is provided with a lock, and may be used as a writing desk.

The telephone is attached to the head of the bed, on an extension bracket, within easy reach of the hand.

While this article is intended mainly to deal with the equipment necessary for a business of this kind, there are certain suggestions that may prove of help to those contemplating entering this field. Before starting on this work, the conditions in the town or territory in which the shut-in lives should be studied carefully. Lists of the households employing domestic help should be compiled; tactfully written letters to the persons employing such help will usually bring a response detailing such things as wages paid, hours of work, etc. This information should be card-indexed, and arrangements may be made whereby such employers will give notice of any prospective vacancy in their households. Advertisements must be inserted in the local newspapers, to get in touch with the help, and, once located, the agent should keep in touch, as closely as possible, with the applicant. These things are only suggestive, and domestic help is only used as an illustration; the method of attacking the problem will vary, but the same principle will apply.

If there are any factories in the neighborhood, these will usually have their own employment agents, but they should be approached, and an idea gained of the kind of help required, the hours, wages, etc.; it will probably be hard to break into this field, but if one or two good employes, carefully selected, can be supplied to a certain factory, respectful consideration of the service rendered may be confidently expected in the future.

Temporary help, homemaker's services, nursing service, and other work of the same nature, should all be investigated thoroughly, a list of reliable workers compiled, and homes solicited on their behalf. As the agent gains experience, more avenues of service will open up, until the business is finally a success.

On the information-bureau side, it will be necessary to build up a good library of books, magazines, trade journals, etc. A study of the questions-and-answers department in the women's pages of the metropolitan newspapers will indicate the general trend of the queries to be expected from women. These queries and answers should be carefully indexed and filed. For men, the problem is a little more difficult; if the community is a farming one, the bulletins of the Bureau of Agriculture and the farming papers will prove mines of information, and, while many farmers read these, only a few file the information for future reference. A good file once built up, an advertisement in the local papers offering information along these lines, should bring results, perhaps slowly at first, but growing in volume as the extent and reliability of the information are appreciated.

The ideas herein outlined are capable of almost indefinite expansion, and, intelligently applied, will lead to a life of cheer and service for any shut-in, with adequate financial reward.

Cleaning Rusty Crosscut Saws

An excellent method of cleaning and polishing an old rusty crosscut saw is as follows: Drill a vertical hole in the center of a small stump, and also saw a cut across it, passing through the hole; the depth of this cut should equal the width of the saw, minus the teeth. Invert the saw in the cut, allowing the teeth to project above the surface of the stump. Fill the hole around the saw with fine sand and moisten with a little water. By working the saw as if sawing, it will quickly be scoured as clean and bright as when new.—J. L. Jackson, Bass, Ark.

Auto-Trailer Rowboat Truck

During the dry days of summer, many rivers are reduced to shallows and pools, and to reach a good fishing or bathing location, without having to push or pull the boat over the shallows is impossible. Having this in mind, the rowboat truck illustrated was made from the front axle of an old automobile, to which two boards were bolted; the outer ends of the boards were bolted together, as shown. Crosspieces were nailed to the boards to serve as a cradle for the boat and prevent it from working out of position. The boat is placed on the truck so that most of the weight is



When Summer's Heat Dries Up the Streams So That Deep Water must be Sought Elsewhere, the Boat can be Loaded onto This Truck, Hitched behind an Auto, and Hauled to the Nearest Deep Water

supported by the axle instead of the planks. This truck is easily fastened to the rear of an automobile and hauled at fair speed over average roads to a place

where the water is deep enough for the engine.—A. E. Granville, Barbourville, Ky.

Lamp Shade for the Photographer

The photograph shows an improvised lamp shade for use in a photographer's dark room when developing prints. The shade is made from an amber-colored bottle, with a neck large enough to admit the end of a lamp socket. On some bottles the flange on the neck fits nicely in a common shade holder. The bottom of



the bottle is removed and the rough edges are ground down, to prevent injury. The bottle may be cut in several ways: A carborundum disk having a thin edge, if kept wet and rotated at a high speed, will cut heavy glass, but the bottle must be fed against the wheel very gently. A better way is to make a file mark—clean but not very deep—around the bottle and heat it with a long slender flame while slowly rotating the bottle. It is very important that the gas flame should not spread over the surface of the glass, for it is only the file mark that should be heated. A mere glancing touch is sufficient, and the glass will usually crack off in a very clean cut. Sometimes a fine platinum wire is wound around in the file mark and heated by an electric current. Less common is the trick of wrapping a strand of cord, soaked

in kerosene, around the mark and igniting it. The principle is the same in each case. The unequal heating of the glass causes it to break, and, of course, it breaks at the weakest point—the file mark.—Paul J. Garvey, Chicago, Ill.

in kerosene, around the mark and igniting it. The principle is the same in each case. The unequal heating of the glass causes it to break, and, of course, it breaks at the weakest point—the file mark.—Paul J. Garvey, Chicago, Ill.

Preventing Damage from Storage-Battery Acid

Storage batteries, used for radio purposes, are often set on the carpet or on the varnished and polished floor, and, while this may be unavoidable, it is not advisable to take chances of having the rug or the floor finish ruined by any acid that may accidentally be splashed out, or that, in case of old batteries, may seep through the bottom.

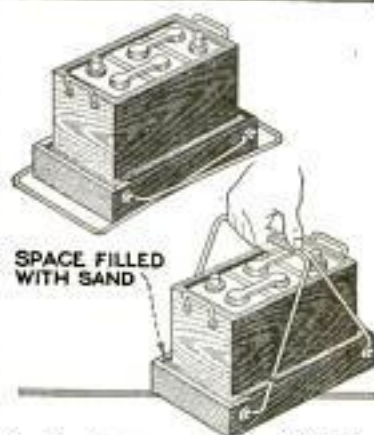

This danger is eliminated by the use of a shallow wooden box filled with sand, in which the battery is set, as shown in the drawing. A pair of handles, made of stout wire, are attached to the box to facilitate lifting and carrying the battery. Any acid that seeps through the battery case will be absorbed by the sand.

Simple Clothes-Drying Rack

The simple wooden clothes rack illustrated consists of two 1 by 3½-in. rails, held together at their ends by small

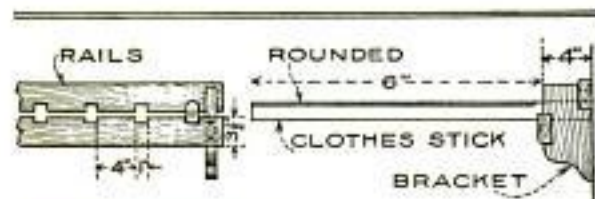

Clothes Rack for Drying Clothes Indoors That will be Found of Great Convenience to the Housewife: The Sticks may be Removed in a Moment

brackets. The rails are notched to receive the clothes sticks, and may be made any length desirable; they are fastened to any convenient wall or partition, about 5 ft. above the floor. The clothes sticks are made of 1 by 1¼-in. poplar, and are 6 ft. long, the part extending beyond the rails being rounded on top. When removing the clothes, all that is necessary is to draw the stick out of the bracket and allow the clothes to slide off into a basket.—M. E. Duggan, Kenosha, Wis.

Repairing a Fountain Pen

To repair a split fountain-pen barrel or cap, coat the section to be repaired with shellac, covering the barrel or cap all the way around. Then, before the shellac sets, wrap this section with silk thread as uniformly as possible, and with all the tension that the thread will stand, making no provision for the ends of the thread except to smooth them down well in the setting shellac. After the shellac is dry, which only takes a few minutes, the job is finished by covering the section with another light coat of shellac, using the fingers in both cases to apply it. The section thus repaired will be

the strongest part of the pen, and, if it should be the barrel, it will be absolutely leak-proof. If the shellac used is too heavy, it will not make a neat job, and if it is too light, it will set before it can be wrapped; it should have the consistency of flowing varnish.—E. H. Taylor, Howell, Tenn.

Adjustable Hanger for Baby's Swing

The adjustable hanger shown in the drawing is adapted for the common baby swing of canvas, and is well worth making for mother's convenience as well as baby's safety.

It is made of two lengths of 3/16-in. iron rod, bent to the shape indicated. One of the rods is fitted with a swivel, to which a coil spring is attached. The clamp consists of two washers: a guide washer that is doubled to slide over one rod, and a cam washer that is riveted loosely between the sides of the guide washer, as shown. The rod that has the coil spring attached to it is bent at the upper end and riveted loosely in a hole drilled in the cam washer, so that the weight of the swing, with its occupant, will force the washer tightly against the other rod.

The hanger must be made accurately, so that the guide will slide freely, and it may be made any desirable length, although one measuring 18 in., when closed,

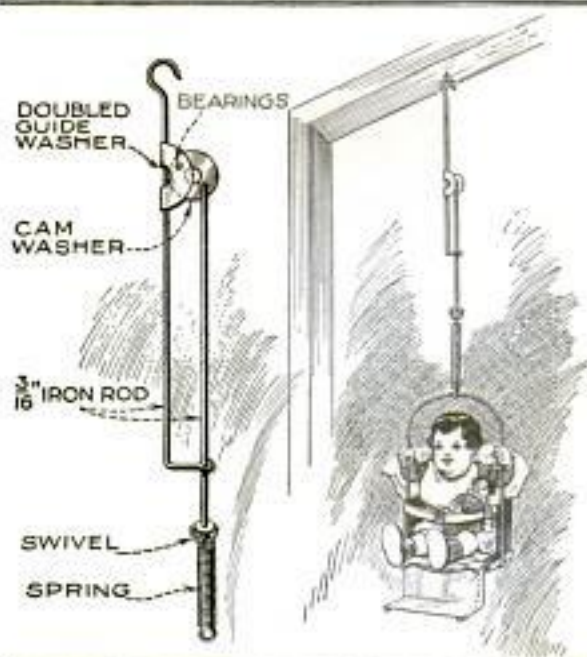

Adjustable Hanger for the Baby's Swing That Is Entirely Safe and Proves a Great Convenience for the Mother: It Locks Itself Tightly

has been found most convenient.—A. L. Long, Springfield, Ill.

A "Safety-First" Toy Gun

There is probably nothing that appeals to the average boy quite so much as a gun. However, a real gun is a dangerous thing to put into the hands of a small boy, and it is not by any means safe even for a larger one. Even the toy air gun is not safe, as the small bullets shot with it may easily destroy the eyesight. A very inexpensive and serviceable toy gun, and one that is quite safe, is shown in the drawing; it can readily be made from a length of 1-in. pine board and a few pieces of sheet metal.

The board is shaped to the form of the gunstock and barrel, and a slot cut through it, as shown. The foresight, trigger, and hammer are made of metal. Any kind of soft metal that can be cut easily with a hacksaw or cold chisel is used; brass, from $\frac{1}{16}$ to $\frac{1}{8}$ in. in thickness, is perhaps preferable. A groove to hold the foresight, is cut in the point of the barrel, and the hammer and trigger are pivoted on pins driven through the stock. A small coil spring, set in a hole drilled in the butt, forces the trigger forward, so that the gun can be cocked like any other gun. A rubber band is hooked over the foresight and stretched back over the cocked hammer, and the gun is then loaded. When the trigger is pulled,

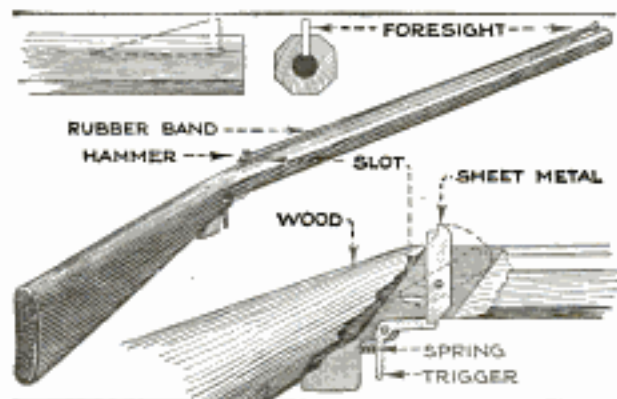

A "Safety-First" Toy Gun That Uses Rubber Bands as Ammunition: It Is Easy to Make, Shoots Quite Accurately, and Is Not Dangerous

the rubber band pulls the hammer forward, and slips off, and the sudden release of the tension propels the band forward with considerable force. The length of the barrel and the strength of the rubber band determine the distance that the band is thrown. The gun can be used for target practice, and will shoot quite accurately. Fly shooting with a gun of this type has been found to be an alluring pastime for the youngsters, and one that develops real skill.—H. H. Siegele, Emporia, Kan.

Weed-Pulling Fork for Hoe

Long-rooted weeds often grow so close to potato and tomato vines in the garden



Simple Fork Attachment for a Garden Hoe, That Enables Weeds to be Uprooted without the Danger of Cutting Near-By Plants

that they escape notice until they have attained considerable height. As such weeds are often in a position where they cannot easily be reached with an ordinary hoe without endangering the plants, the attachment illustrated for uprooting them was devised, and found to be a practical and back-saving tool.

A piece of $\frac{3}{8}$ -in. round iron rod is bent to the shape shown, to form a two-pronged fork. This fork is flattened and drilled at the points indicated. Corresponding holes are drilled in the blade of the hoe, and the fork riveted to the blade.

In use, the weed is gripped between the prongs of the fork, and the handle of the hoe pulled down, the edge of the hoe blade acting as a fulcrum. In this way the most stubborn weeds are uprooted. It takes only a short time to make the attachment.

Converting a Kerosene into a Gas Heater

A kerosene heater of the common type can readily be converted into a serviceable gas heater. Remove the oil receptacle and wick, and fasten a circular stove gas burner in position with wire. The gas burner can be purchased at small cost, and furnishes considerable heat.

Detector and Two-Step Amplifier for Dry-Cell Tubes

BY F. L. BRITTIN

THE introduction of the dry-cell tube has made possible the operation of tube detectors and amplifiers without the use of a storage battery, and enables those who, because of the trouble incident to the use of a storage battery, have been obliged to content themselves with a crystal detector, to build a set that will give every satisfaction.

The detector described in this article is designed as a separate unit, for those who do not wish to expend a great deal of money at the start; the two-step amplifier can be added at any time. The results obtained with these instruments are excellent; on a detector and two-step amplifier of this type, practically all of the large broadcasting stations in the country have been received in Chicago. The cost of the instrument is very reasonable, that of the detector being approximately \$25, including batteries, tube, and phones, and of the complete instrument approximately \$58. These figures may vary a little in different localities, but, as none but standard parts are used in the instruments, they will be found very close to actual cost.

The instrument is one of the simplest it is possible to make, as there are no coils to wind or tap, and no switches to mount. The inductance used is a 75-turn honeycomb coil, and tuning is accomplished by means of a 23-plate "vernier" condenser; the wave-length range is from 150 to 500 meters.

The panel used for the detector is $\frac{3}{16}$ by 6 by 9-in. bakelite, laid out and drilled as shown in Fig. 1. The panel is screwed to the base, which may be any piece of lumber $\frac{3}{8}$ by 6 by 9 in. in dimensions; it is best to attach the panel to the base by means of angle brackets—shelf brackets will serve excellently for this. It is a good idea to stain and varnish the base, to add to the appearance of the finished instrument.

The tube socket may be either of the types shown in Fig. 2; it is fastened to the base directly behind the $\frac{5}{16}$ -in. ports in the panel. The grid leak is also screwed to the base; this is of the standard 2-megohm type, but, if this is unobtainable, a piece of bristol board, $\frac{3}{4}$ by $2\frac{1}{2}$ in. in size, can be used instead. A pencil mark is drawn down the center of the bristol board, and brass wood screws are used to fasten it to the board, taking care to see that the screw heads make good contact with the pencil mark before wiring and screwing down tight.

The rheostat is mounted at the left of the panel, below the ports, as shown in Fig. 3, and the mounting for the honeycomb coil at the top of the panel, in the center.

The 23-plate vernier condenser is fastened to the right-hand side of the panel; this must be of the type specified, as the selectivity of the detector depends entirely upon this condenser.

The grid condenser is of standard type, of .00025-mf. capacity, preferably with mica insulation, and may be mounted anywhere found convenient.

The binding posts for aerial, ground, B-battery, phones, and dry cell are finally screwed in place. It is a good plan to put small brass or copper lugs behind these posts, and to solder the wires to the lugs.

The instrument is wired with No. 14 tinned-copper wire; the wiring can be covered with "spaghetti" tubing, if desired, or it can be left bare—busbar-fashion—as shown in the photo, Fig. 5. Every connection must be well soldered, using soldering paste, resin, or resin-cored solder; never acid, or acid-core solder.

The B-battery is a $22\frac{1}{2}$ -volt unit, and is connected to the two posts in the upper left-hand corner of the panel, Fig. 3. The phones are connected to the two posts directly below; these should be of a good make, and of not less than 2,000 ohms' resistance. The dry cell is connected to the two lower posts, the positive, which is always the center post of the cell, to the lowest post, and the negative to the one above.

The aerial used is of the ordinary type. If one wire is used, it should be 125 to 150 ft. long; if a two-wire aerial is used, it need not be more than 60 or 70 ft. long, constructed in the usual manner. In either case, the aerial should be 40 to 50 ft. above the ground for best results. The ground wire from the instrument is led to a water pipe, the pipe filed bright, and the wire fastened to it with a ground clamp. Instructions for installing aerials are given on page 814, in the May, 1923, issue of this magazine.

The panel for the two-step amplifier is $\frac{3}{16}$ by 6 by 12-in. bakelite, and the layout of the holes is shown in Fig. 7. The panel is laid out first, drilled, and the jacks and rheostats are mounted in place. It should be noted that two of the jacks, on the right-hand side, Fig. 8, are of the two-circuit type, and the one on the left, that for the second step of amplification,

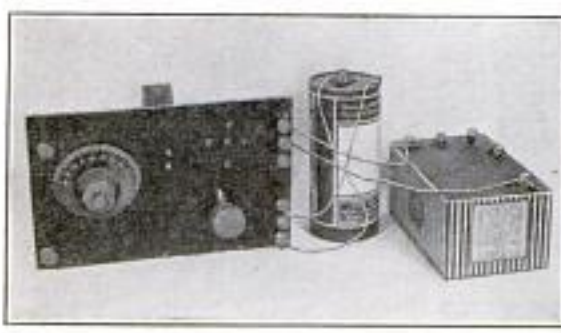
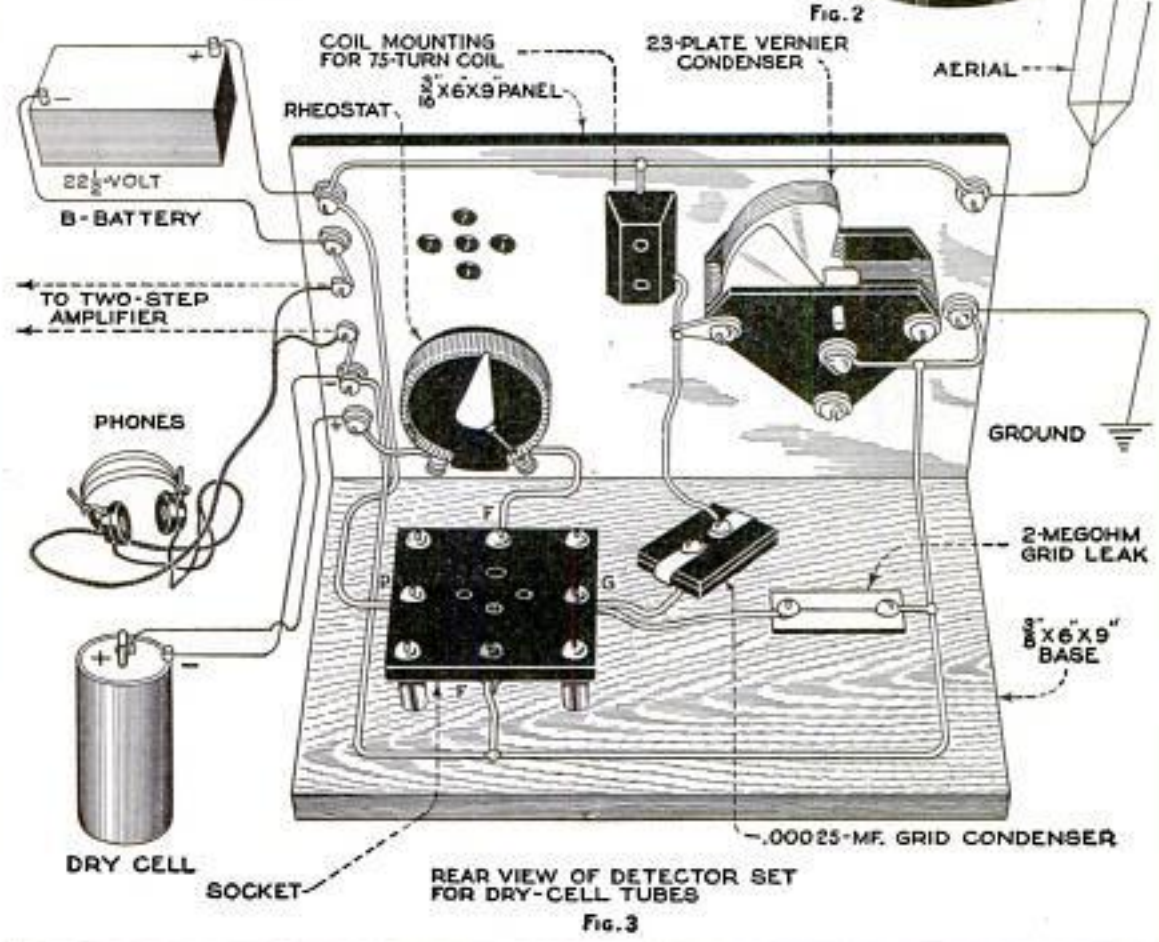
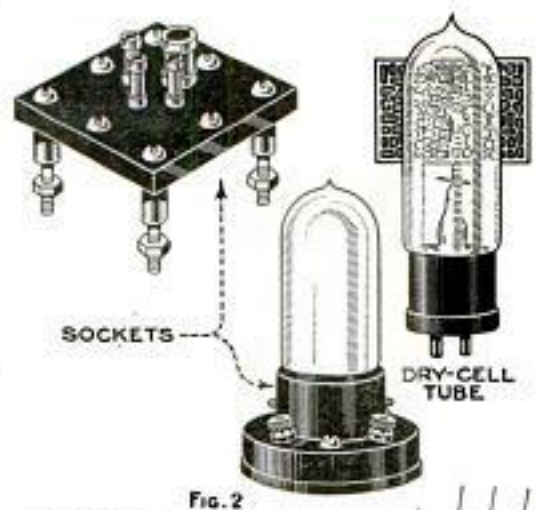
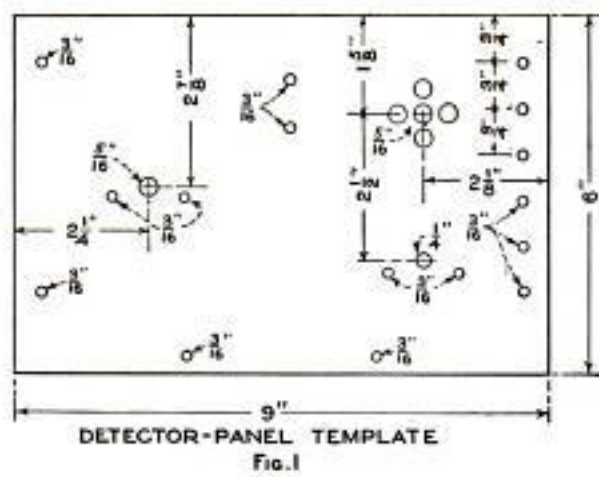

Figure 1, Template for Laying Out Detector Panel; Figure 2, Dry-Cell Tube and Sockets; Figure 3, Rear View of Detector Panel, Showing Location of Instruments, Battery and Phone Connections, and Method of Wiring; Figures 4 and 5, Front and Rear Photos of Completed Detector, with Batteries, Ready for Operation as Soon as the Phones are Attached

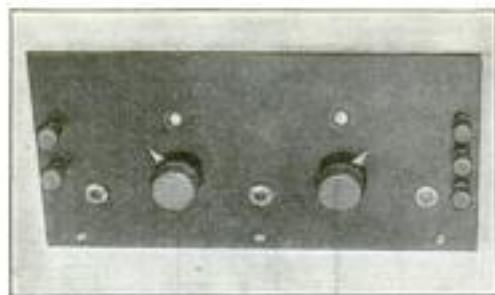
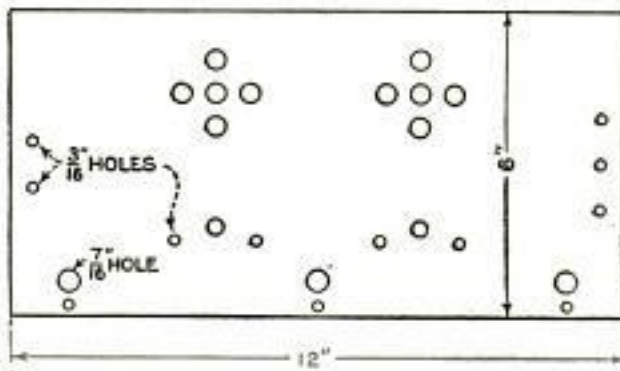

Fig. 6



AMPLIFIER-PANEL TEMPLATE

Fig. 7

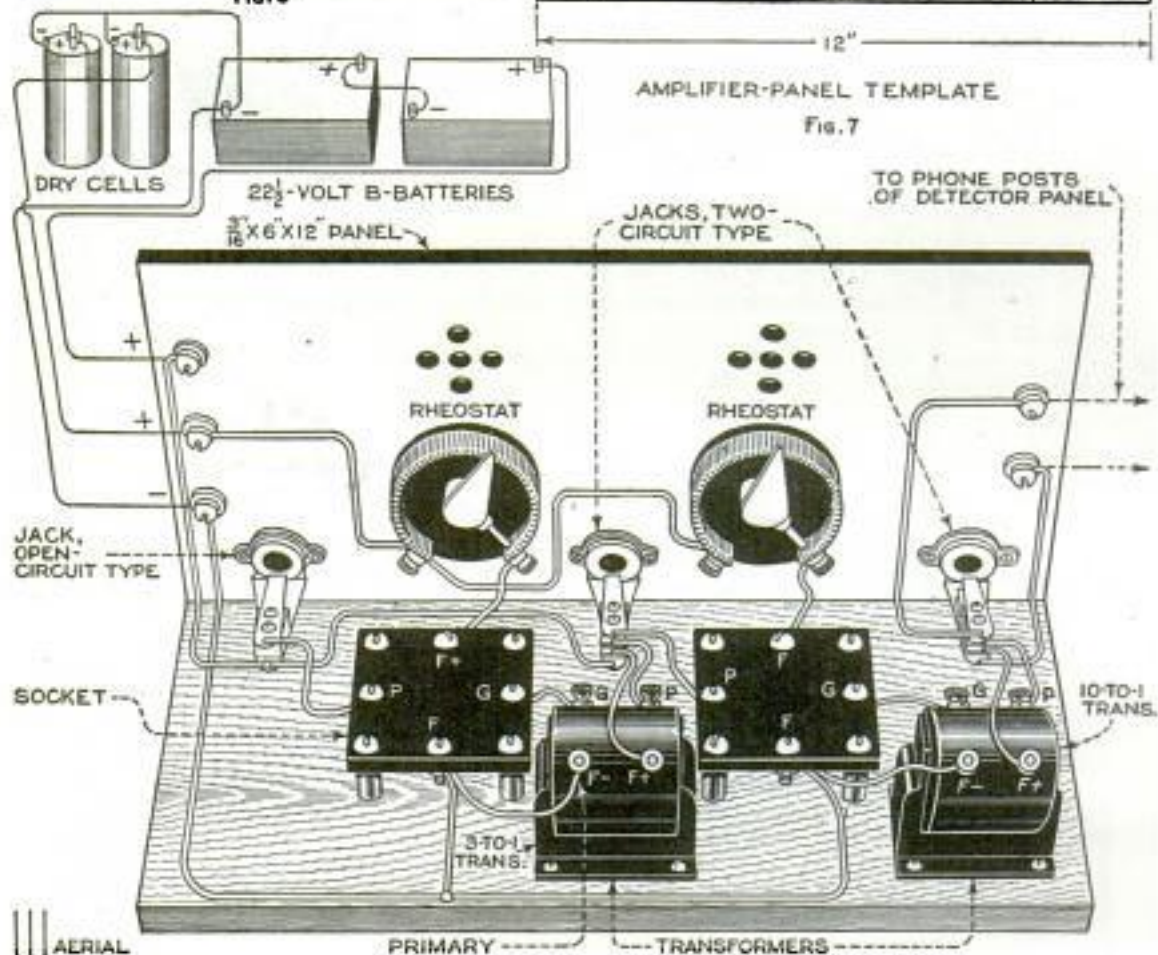

Fig. 8

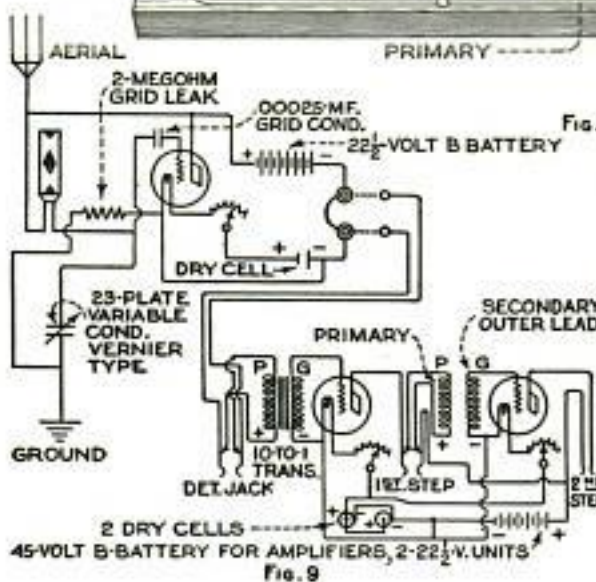

Fig. 9



Fig. 10

Figure 6, Front View of Completed Amplifier Unit; Figure 7, Template for Drilling Panel; Figure 8, Rear View of Amplifier Assembly; Note Especially the Method of Connecting the Batteries; Figure 9, Wiring Diagram for Detector and Two-Step Amplifier; Figure 10, Photo Showing the Back of Completed Amplifier

is of the single or open-circuit type. The transformers and tube sockets are mounted on the base, which is a $\frac{3}{8}$ by 6 by 12-in. board. The transformer for the first step is a 10-to-1 audio-frequency transformer, and the one for the second step is of the same type, but the winding ratio is 3 to 1. The transformers in the drawing are marked just as they will be found on the majority of transformers, so that no difficulty should be encountered in wiring; F stands for filament, G for grid, and P for plate. If any trouble should occur, due to different markings on the builder's transformers, a reference to the circuit diagram in Fig. 9 will make it clear.

The binding posts at the left of the panel, Fig. 8, are for the batteries. Two dry cells are used, one for each amplifying tube, and are connected in parallel, so that, while the voltage remains the same as that of a single cell, the amperage is increased. The dry-cell, or "peanut" tube, as it is popularly called, operates at 1.1 volts—the voltage of one dry cell. The positive lead from the cells is connected to the center post; the negative lead is connected to the negative terminal of the first of the 22½-volt B-batteries, shown above the panel.

The B-batteries are connected in series, the positive lead being connected to the

upper post on the panel, and the negative lead to the lowest post.

When the wiring has been done, the instrument is complete. If the builder desires, he can, of course, place each unit in a cabinet, or combine them in one cabinet, but this is not necessary.

To connect the detector to the amplifier set, all that is necessary is to disconnect the phones from the former, and to connect the phone posts on the detector straight across to the corresponding posts on the amplifier, as indicated by the dotted lines in Figs. 3 and 8, and in the wiring diagram, Fig. 9. The phone-lead terminals are then removed, and plugs substituted for them. The detector batteries remain exactly as they were.

To operate, put on the phones, turn the detector-tube rheostat until a hissing sound is heard in the receivers, then adjust the condenser until the signals "come in." If the amplifier is connected, the phones will be plugged into the first jack. Now plug in at the second jack, and turn the first amplifying-tube rheostat until the signal is loud, but clear; this is usually loud enough for comfort when listening to near-by stations. Distant stations will require the use of the second step, which is operated in exactly the same way as the first. A loud speaker can be used on the second step.

MATERIAL LIST

1 bakelite panel, $\frac{3}{8}$ by 6 by 9 in.....	\$1.08	1 .00025-mf. grid condenser	\$.35
1 bakelite panel, $\frac{3}{8}$ by 6 by 12 in.....	1.44	1 2-meg. grid leak75
1 baseboard, $\frac{3}{8}$ by 6 by 9 in.....		2 two-circuit jacks	\$.90 to \$1.00 each.
1 baseboard, $\frac{3}{8}$ by 6 by 12 in.....		1 open-circuit jack60 to .70 each.
3 dry-cell tube sockets.....	\$.75 to \$1.00 each.	1 10-to-1 audio-freq. transformer.....	\$4.50
3 dry-cell tubes	6.50 each.	1 3-to-1 audio-freq. transformer.....	4.50
3 rheostats75 each.	3 dry cells	\$.40 each.
1 23-plate vernier condenser with dial	\$4.00 to \$5.00	3 22½-volt B-batteries.....	\$1.75 to \$3.00 each.
1 75-turn honeycomb coil	1.50	1 pair 2,000-ohm phones	\$4.50 up.
1 honeycomb-coil mounting60	25 ft. No. 14 tinned-copper wire.....	.25
		4 3-ft. lengths spaghetti tubing.....	.17 each.

Renewing Old Rugs

Brussels or Axminster rugs, known as "pile" rugs, have a very hard finish on the underside when they are new, but after they have been used for some time they soften. This is true particularly of the smaller rugs, perhaps because they are subjected to more frequent and vigorous shakings, and they then become annoying because of their tendency to wrinkle, which causes them to wear out soon, the threads breaking along the folds.

Some years ago a dealer in rugs told me that it was a wise plan to have the backs of rugs renewed occasionally with

a glue preparation to lengthen their life. Having some small rugs that were worn, I decided to experiment with them. I found a package of some wall "sizing" in the house and proceeded to dissolve it according to directions, but made the solution thicker than usual so that it would not penetrate the rugs. I then placed the rugs face down on the floor, and spread the solution on the back with a broad, flat brush. When the rugs were dry, they lay as flat and firm as when new. It is sometimes necessary to stretch the rugs and tack them down on the floor until dry, as they must be kept flat.—Stella Henderson, Lake Mills, Ia.

Convenient Cupboard Stepladder

The stepladder for the kitchen cupboard shown in the drawing proves very handy for the housewife, as it fits in the

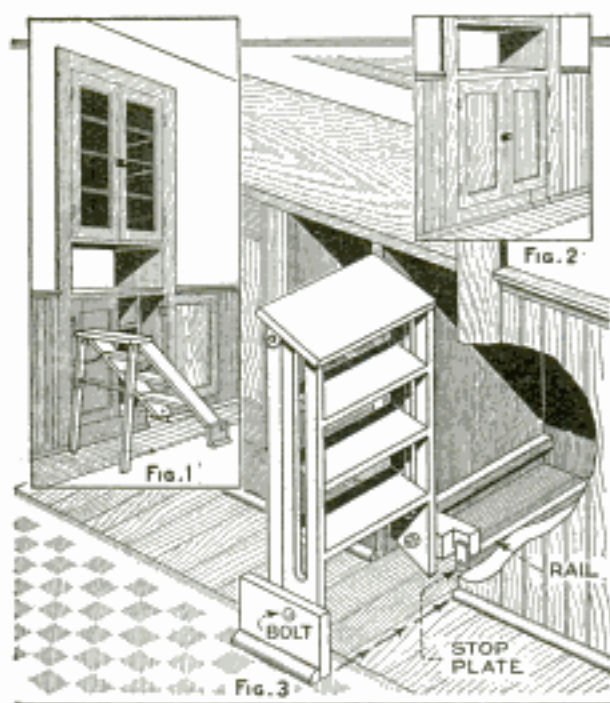

Figure 1, Ladder Ready for Use; Figure 2, Outside of Lower Section of Cupboard Containing Ladder; Figure 3, Ladder Folded to Slide into Recess

lower part of the cupboard when not in use, and can be drawn out and opened in a moment when needed.

A space, about 6 in. wide, is partitioned off in the lower cupboard, to hold the ladder when folded. A small stepladder that will fit in this space is made, or one can be purchased and fitted in. To the inside leg is bolted a wooden block, shaped as shown; this block slides on two strips of wood nailed to the sides of the compartment. The leg and block are bolted together loosely to permit the former to move freely. Part of the baseboard is then cut out and bolted loosely to the other leg. It is a good idea to reinforce this piece of baseboard, as it is otherwise likely to break. When the ladder is put in the cupboard, as shown in Fig. 2, the cut-out piece is in line with the rest of the baseboard, as in Fig. 2. When the ladder is pulled out and unfolded, as shown in Fig. 1, the steps are situated conveniently under the shelves above.

Shipping Berries by Mail

The usual plan for sending any variety of berries through the mail, by parcel post, is to put up the berries in small paper bags, and fit the bags into shallow,

square cartons. The arrangement works well, but considerable time is required for proper packing. The following method saves a great deal of time and is entirely satisfactory: Fill the berries into divided pasteboard egg cartons, which are made to hold a dozen eggs each. The berries ship well in this manner, if they are shaken down gently.

Heating Water with Oil Stove

A simple homemade water-heating attachment for an ordinary oil stove can be made up at little expense. The attachment consists of a water tank and a length of $\frac{1}{4}$ or $\frac{3}{8}$ -in. copper tubing, arranged as illustrated. Two coils are formed near the center of the tubing. The diameter of the lower coil should be a little greater than the diameter of the wick of the stove, and that of the upper coil a little smaller. The ends of the tubing are attached to a can of several gallons' capacity, or to a small water-tight barrel. The connections can be made with the parts of a discarded gas headlight of an automobile, or if these are not available, with similar plates made of flat iron, drilled as shown. One plate is soldered on each pipe near the end, and the other plate bolted to it on the inside of the tank, after the end of the

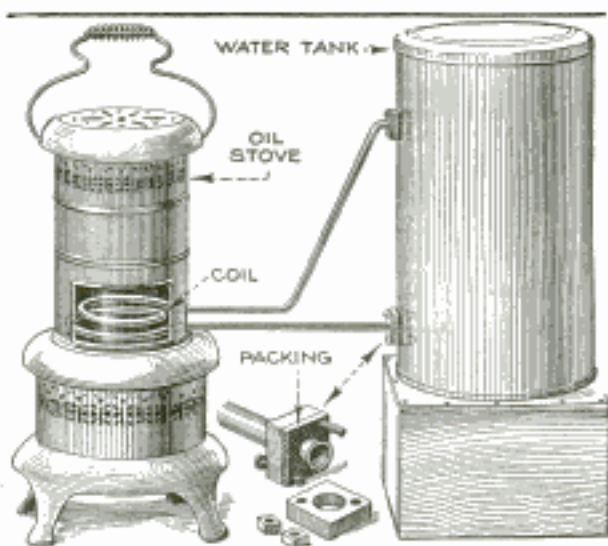

A Water-Heating Attachment for the Oil Stove, with Which Several Gallons of Water can be Heated to the Boiling Point in a Very Short Time

tubing is passed through the tank side. Packing is, of course, used to prevent leakage.

A slot, just large enough to admit the tubing, is cut in the side of the stove, upward from the lower edge, to allow the upper part to swing back freely, which is necessary when lighting it. The water

tank is placed on a wooden box or low stool to bring it to the correct level. The lower part of the tubing must be perfectly horizontal and enter the tank near the bottom. With this arrangement, water can be heated to the boiling point in a short time.

"Tumbling Barrel" Provides Sport for Bathers

A novel device that is popular at a Wisconsin bathing beach is shown in the illustration. An empty vinegar barrel, of about 50-gal. capacity, is filled with cement, to the level indicated, after nails have been driven through the sides to keep the cement in place when set. The bung-hole is tightly plugged, and a 1-in. pipe flange is screwed to the center of the upper end. Into this flange a 10-ft. "ladder," made of tees and long nipples, is screwed, which completes the device.

When placed in the water the "tumbling barrel," as it is called, floats with the upper end about 1 ft. above the surface of the water. The trick that affords so much amusement to the bathers is to mount the barrel and climb as far up the mast as possible before the barrel tips. The cement ballast of the barrel maintains the equilibrium of the "tumbler" as long as the bather stands upon its top, but any attempt to climb the mast results in some amazing gymnastics—and an eventual ducking.

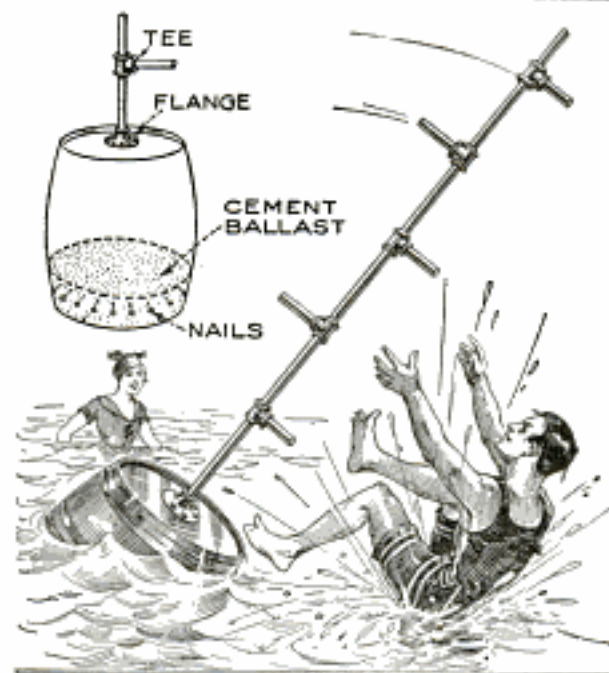

A Novel Device Called the "Tumbling Barrel" That Is Popular at a Wisconsin Bathing Beach: The Trick Is to Preserve the Balance While Climbing the Mast

Burning Out Stumps Effectively

When clearing land of stumps for farming purposes, it is desirable to have the soil free from all roots as well as the stumps. When the stumps are pulled,

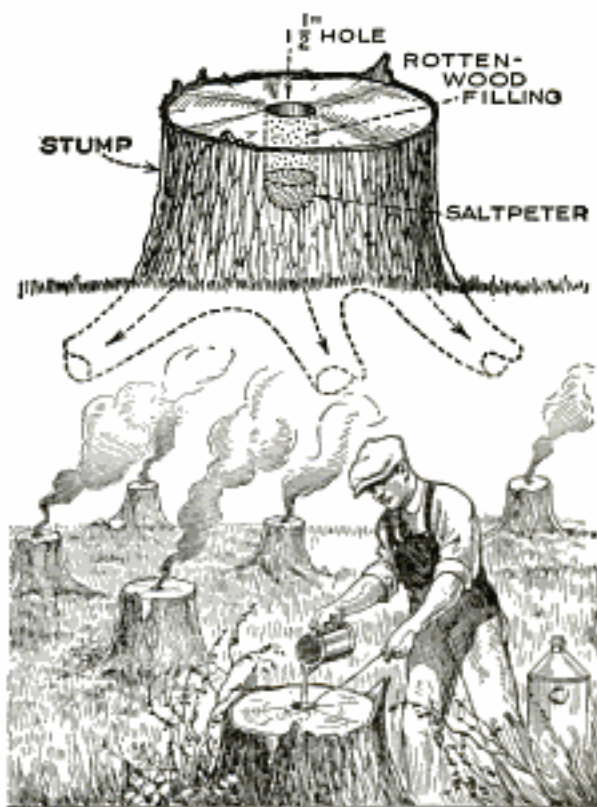

Effective Method of Burning Stumps: An Injection of Saltpeter Enables the Fire to Creep to the Ends of the Roots, Until They are All Consumed

the roots often break off. Some of these are overlooked and remain in the ground, and this, of course, is highly objectionable, as they will catch on the plowshare.

A good method of clearing land of stumps is to burn them out with the aid of saltpeter. Saltpeter, if so applied as to penetrate into the heart of a stump properly, will in a year's time reach down to the very ends of the roots. During the summer, when the stumps are thoroughly dry, drill a 1½-in. hole, about 3 or 4 in. deep, in the center of the stump, as indicated. Into this hole put 3 tablespoonfuls of saltpeter; then close the hole with decayed wood and dirt. During the following summer, dig out the dirt, fill the hole with kerosene, and set the stump on fire. It will burn slowly but surely, and will keep on burning under the ground until every piece of root is consumed. The action of the saltpeter makes a slow-burning match of the fibers of the roots, and carries the fire wherever it has penetrated.—J. V. Romig, Allentown, Pa.

A Homemade Statoscope

The statoscope is a simple form of aneroid barometer that is very sensitive to small changes of air pressure. It will readily detect the difference in barometric pressures of two levels 5 ft. apart, and will demonstrate that the air pressure is greater at the feet of a standing person than at his head.

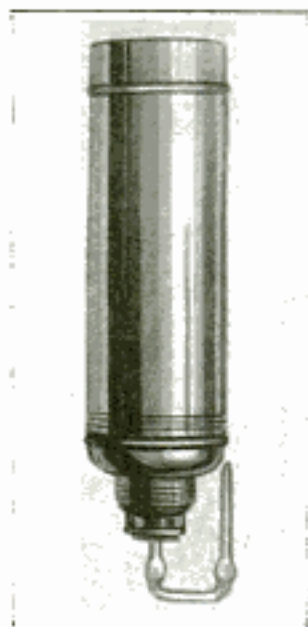

A homemade statoscope may be constructed as follows: Take a length of glass tubing having a small bore, open at both ends, and, by means of a gas flame, bend it to a U-shape, as shown in the photograph. Suck a few drops of water or oil into the tubing, just enough to fill a part of the length between the bends. Now insert one end of the tubing into the interior of an empty vacuum bottle of 1-qt. capacity, by forcing the tubing through a tight-fitting hole in the cork. Vaseline should be used on the tube to insure an air-tight connection. The bottle should be suspended, by cords, upside down and absolutely plumb, so that no motion of the water may occur due to the instrument being tipped.

The air in the bottle is separated from the outer air by the water "plug" in the tubing. Any change of volume of the air in the bottle will therefore be registered by a motion of the water plug. Only two factors will change the volume of the air in the bottle: change of temperature and change of pressure. By using a vacuum bottle as a container, temperature changes will not affect the statoscope appreciably, except over long intervals of time. There remains only the influence of a change in pressure of the atmosphere, transmitted to the air in the bottle by means of the water plug or piston.

For small changes of atmospheric pressure, the relative change of volume of the air in the statoscope is equal to the relative change of pressure in the external air. If the barometric pressure changes by 1 part in 40,000, the volume of the entrapped air will change 1 part in 40,000

also, and, as 1 qt. of air approximates 69 cu. in. in volume, the water plug in the tubing will move a little more than $\frac{1}{2}$ in., if the diameter of the bore in the tubing is $\frac{1}{16}$ in. This corresponds roughly to the change of pressure accompanying a change of elevation of 6 ft., for elevations less than 1,000 ft. above sea level.

If two enlargements, or bulbs, are blown in the tubing, as shown in the photograph, the water will not be driven entirely out of the tubing by great changes of pressure; air will simply bubble into or out of the flask for continuously increasing and decreasing pressures, respectively. As used in ballooning, if the bubble "breaks inward" the balloon is falling; if it "breaks outward" the balloon is rising. The rate at which the bubbles break is a measure of the rate at which the balloon ascends or descends. If the statoscope, with the enlargements in the tubing, is carried in an elevator, the number of feet change of level between successive breakings of a bubble serves to calibrate the device to read differences of level in actual feet. The device can be carried in an automobile winding its way up into the hills, and, from the counted number of times the bubble breaks, the rise in feet above the starting point may be ascertained. Of course, the number of feet elevation required to "break a bubble" varies with the actual elevation, so that the device should be calibrated in the region where it is to be used.

To take double precaution against temperature changes in the air within the statoscope, it is well to wrap the bottle in layers of felt. It is, of course, preferable to use a drop of oil in the glass tubing instead of water, as the oil does not evaporate.

Holding the Automobile Hood

The usual practice of raising one-half of an automobile hood and resting it on the edge of the dash is none too safe, as the vibration of a running engine, or any slight jar, will dislodge it.

To prevent this, cut a number of notches, about $\frac{1}{4}$ in. deep, along the edge of the dash, near the socket into which the hinge rod of the hood fits. These notches must be as close to the edge of the dash as possible, so that, when the hood is closed, the notches cannot be seen. When the hood is raised, its lower edge is set in one of the notches, to prevent it from slipping down.—L. B. Robbins, Harwich, Mass.

Aviation Commission

Aero Club of France

35 Rue Francois I,

PRIZE OFFERS AND ANNOUNCEMENTS

Paris

2083

ONE-MILLION-FRANCS ENDURANCE PRIZE FOR AERIAL ENGINE

An international prize of 1,000,000 francs (normally about \$200,000) is offered by the French Committee for Aeronautic Propaganda for the internal-combustion aerial motor showing the greatest endurance.

Application for the privilege to compete, however, must be made on or before Dec. 1, 1923. This should be accompanied by a sum of 40,000 francs, and a contribution of 10,000 francs for the test. Of the former sum one-half will be returned for motors passing the elimination tests. The latter sum will be returned only to competitors withdrawing their motors before March 1, 1924, on which date the tests are to begin.

For additional information address: Aviation Commission of the Aero Club of France, 35, Rue Francois I, Paris, France.

EXPOSITION OF VOCATIONAL SCHOOLS TO BE HELD IN CHICAGO

To arouse greater interest in vocational training and to give those who are contemplating taking up a trade or a vocation an opportunity to see "living" exhibits, demonstrating the various courses offered, an exposition of trade and vocational schools is to be held at the Coliseum in Chicago from May 30 to June 10. The schools planning to occupy booths represent a wide range of human activities. Among a partial list of 83 named, may be mentioned steam engineering, nursing, architecture, automotive electricity, masonry, office work, painting, bridge designing, dentistry, and engraving.

AMERICAN BALLOON RACE IS SET FOR JULY FOURTH, THIS YEAR

July 4 has been decided upon as the date of the national elimination balloon race starting at Indianapolis, Ind. At least 14 balloons will start, according to the National Aeronautic Association. Prizes will be awarded for the distance navigated, \$1,000 going to the winner, \$800 to second, \$600 to third, and \$300, \$200, and \$100 to fourth, fifth, and sixth finishing position, respectively. Three of the entries, it is said, will have craft of unusual design; and the army and navy air services will both compete. The contest is being promoted by the Aero Club of Indianapolis, and the Chamber of Commerce of that city.

AMERICAN-LEGION POST ESTABLISHES MEMORIAL SCHOLARSHIP

A memorial scholarship in honor of the dead of the 86th Division, has been established at the University of Chicago by Blackhawk Post, No. 107, of the American Legion. It will be awarded this year to the high-school student writing the best essay on the theme, "Why I Am Proud to Be an American." The essay must be typewritten, and must reach room 705, 21 North LaSalle St., Chicago, Ill., on or before May 20, 1923. Five hundred words is the maximum length considered.

FINANCIAL AND INDUSTRIAL RESEARCH BASIS FOR ANNUAL CASH PRIZES

For the greatest original contribution on any subject relating to business development and the modern trust company, a prize of \$2,500 is to be awarded in 1925, and a similar prize every three years thereafter, by the Chicago Trust Company. No restrictions are made as to the eligibility of the contestants.

Two other awards, of \$300 and \$200 respectively, to be presented annually for briefer studies, not exceeding 20,000 words, are also announced. This contest, however, is limited to bank employees, and to undergraduate students of economics, business, finance, or law.

The closing date each year will be August 31.

Committee of Award

When answering prize offers please mention Popular Mechanics Magazine

Chicago

PURCHASING POWER OF CONSUMERS SUBJECT OF ESSAY CONTEST

Prizes of \$1,500, \$800, and \$500 are announced by the J. Walter Thompson Company, of 242 Madison Ave., New York City, for the best essays on "A Statistical Index of the Purchasing Power of Consumers in the United States." It is hoped that the contestants will furnish material which will help in developing a more accurate measurement of the purchasing power of communities in this country.

The competition is open to all, the manuscripts may be of any length, and the closing date is Sept. 30, this year.

CIVILIAN ENGINEERING STUDENTS MAY CRUISE ON NAVAL VESSELS

The Navy Department, it is reported, has decided to offer to a limited number of leading universities and colleges, an opportunity to send two engineering students each to a cruising ship for a short time in the summer.

Commanding officers of the vessels will assign them to the ship's personnel, and then see that they are acquainted with the construction and operation of the machinery on board. It is expected that each student will have two weeks at sea.

DESIGN FOR SARAH BERNHARDT TABLET WANTED BY ORPHEUM CIRCUIT

For the best design of a memorial tablet to be placed on the tomb of Sarah Bernhardt, officials of the Orpheum Vaudeville Circuit, announce a prize of \$250. Four other prizes, totaling \$250, will also be given.

The sketches may be in ink or crayon, the idea rather than the execution being more important. Address J. J. Nash, manager of the Palace Music Hall, Chicago, Ill.

CONTESTS PREVIOUSLY ANNOUNCED

Medals, Diplomas, and Money Awards: Announced August issue, 1921; awards offered by the Franklin Institute. The Franklin medal is for workers in technology; the Elliott-Cresson is for original research work and invention; the Howard N. Potts is for important development of previous discoveries and inventions. Each award consists of a gold medal with a diploma. There are also a silver medal, and a Certificate of Merit awarded for meritorious discoveries, and cash premiums for certain work in optics.

One Million Francs for Best Motor: Announced January issue, 1922; closes June 1, 1923; address, Aero Club of France, Paris.

Best Treatise Regarding Immortality: Prize \$1,000; announced January issue, 1923; closes Dec. 1, 1923; address, Contest Editor, 2 West 47th Street, New York City.

Awards to Further Science of Electricity: Medals and prizes, amounting in all to about \$20,000; announced February issue, 1923. For particulars address General Electric Company, Schenectady, N. Y.

For Best Work by American Chemist: An annual award of \$25,000; announced February issue, 1923; address the Allied Chemical and Dye Corporation, New York City.

Names for Great Lakes Steamers: Two prizes of \$50 each; announced February issue, 1923; suggested names must reach the company before the opening of navigation season in 1924; address the Detroit and Cleveland Navigation Company, Detroit, Mich.

For Best Studies in the Economic Field: Four prizes from \$1,000 to \$200; announced March issue, 1923; closes June 1, 1923; address, Prof. J. Laughlin, University of Chicago.

Motorboat Race, Miami Beach, Fla., to Havana, Cuba: Prizes \$10,000; announced March issue, 1923. Write Miami Chamber of Commerce.

Essay on Economic Subject: Prize \$1,500; announced March issue, 1923; address the Simonds Economic Prize Contest, 470 Main St., Fitchburg, Massachusetts.

*Ambu Engineering Institute
263 Prairie Ave. Chicago
Lightner Pub. Corp.
1416 Michigan Chicago
71 E. Michigan Ave. Chicago*

1618

2080

2084

2075

2021

Pulitzer Prizes, Columbia University: For best work in various literary and journalistic lines; announced April issue, 1923; nominations of candidates must be made before Feb. 1, 1924.

Scholarships for War Nurses and Ex-Service Men: Numerous scholarships provided at colleges and universities throughout the country under the will of the late La Verne Noyes; announced April issue, 1923; apply direct to colleges.

Most Practicable Device for Recording Mine-Shaft Signals: Prize of £250, or about \$1,100; announced May issue, 1923; closes Sept. 30, 1923; address Rand Mutual Assurance Co., Ltd., P. O. Box 413, Johannesburg, Transvaal, South Africa.

Name and Slogan for Hats to be Worn by Middle-Aged Women: Four prizes; announced May issue, 1923; closes June 1, 1923; address Dept. 64, Gage Brothers & Co., 18 S. Michigan Ave., Chicago.

Boys' and Girls' Short-Story Contest: Two first awards of \$100, and other prizes; announced May issue, 1923; address The Haversack and The Torch-bearer, 810 Broadway, Nashville, Tenn.

Greatest Benefit to Community Rendered by Women's Club: Prize, \$1,000; announced May issue, 1923; closes Sept. 15, 1923; address Club Editor, Pictorial Review, 222 West 39th St., New York City.

Historical Essay on Eastern Hemisphere: Prize \$200; announced May issue, 1923; closes July 1, 1923; address the Secretary of the American Historical Association, 1140 Woodward Building, Washington, D. C.

Students' Essays on Municipal Government: Prizes \$250 and \$100 for postgraduates; \$100 for undergraduates; announced May issue, 1923; address National Municipal League, 261 Broadway, New York City.

SCIENCE NOTES FOR DAILY USE

FOOD RESEARCH BUREAU EXPLAINS VIRTUES OF STALE BREAD

2085
Most housewives know that the warming of stale bread when not too dry results in a freshening up of the loaf. The Food Research Bureau, in a report pointing out the wholesomeness of the stale loaf, explains that, in baking, much of the moisture in the bread is held by the starch which has been gelatinized. As the loaf comes out of the oven, this starch jelly, distributed throughout the bread, contains all the moisture it can hold.

As the bread cools, the starch gives up some of the moisture, which is absorbed by the other constituents of the loaf, changing the crust from a brittle substance to one more pliable and soft, while the gluten of the crumb is given a toughness and firmness which as fresh bread it did not have. This accounts both for the staleness and for the good results of again heating it.

Wholesale bakers lose millions of dollars yearly through agreeing to take back stale loaves. This raises the price to consumers. Bread a day old is as nutritious as when freshly baked, the bureau asserts.

SNEEZE GAS FOR USE IN ILLUMINATING GAS TO PREVENT SUICIDES

2082
Introduction of a new sneeze-gas compound into illuminating gas, in order to prevent suicide by asphyxiation and deaths from accidental escape of gas in burners and stoves, was suggested recently by Gen. Amos A. Fries, of the chemical-warfare service. One part of it in 10,000,000 of illuminating gas would be sufficient for the purpose, General Fries declared.

No matter how determined the suicide might be, he could not refrain from sneezing so long that he could carry out his suicidal intent. The gas would also serve as a warning of escaping gas from stoves and burners. When the illuminating gas is burning, the sneeze-producing element is consumed without any effect on the room's occupants.

TWO CHILDREN KILLED BY TOY BALLOONS

2058
Two children have died recently as the result, one of a toy balloon being sucked down into the throat, and the other when a balloon burst in its mouth. The first case aroused the attention of the medical fraternity by reason of the fact that the balloon, lodged in the throat, became partially inflated by every breath drawn by the unfortunate child, resulting in its speedy suffocation. The second death occurred when the mother of the child, giving it a slight slap on the cheek, caused the toy to explode. The exact cause of death was not made plain, but

physicians believed the rush of air from the burst balloon, passing into the child's throat, suffocated it.

Emergency treatment in such cases depends entirely upon the location of the object in the throat, it is explained. An immediate operation is the only hope in most cases, unless the object is so placed that it can be reached by a hooked instrument and withdrawn carefully from the throat so as not to injure the victim. Neither suggestion carries with it assurance of saving life.

JOURNAL OF AMERICAN MEDICAL ASSOCIATION UNIVERSITY PROFESSOR FINDS THREE MOST USED WORDS

2091
The words "the," "and," and "to" are most frequently used of any in the English language in speaking and writing, Dr. Ernest Horn, of the University of Iowa, finds. From a study of many compositions and types of written material, Doctor Horn makes the deductions that 300 words make up 75 per cent of all used in common speech and writing; 1,000 words form 90 per cent; 2,000, more than 95 per cent; 3,000, 98 per cent; 4,000, 99 per cent, and 6,000 make up 99½ per cent.

Ten words form more than a fourth of all these used, Doctor Horn asserts. These are, in addition to the three already noted, "you," "of," "be," "in," "we," "have," and "it." He has also selected a group of 100 words which, he believes, form 58 per cent of all that are used.

FAT MEN STAND HIGH TEMPERATURES BETTER THAN THIN ONES

2094
That fat men endure high temperatures and humidity better than thin ones has been proved to the satisfaction of a group of scientists who recently undertook a study of the effects of these two natural agents on the human body. In the course of their investigations they also blasted the popular theory that drinking iced water following exposure to high temperature caused serious and sometimes fatal cramps.

The experiments covered a rather extended period of time and were conducted by the American Society of Heating and Ventilating Engineers, the U. S. Bureau of Mines, and the Carnegie Institute of Technology. The scientific object was to determine what would be the right temperature and degree of humidity in a room most comfortable to a human being.

One of the important results of the study was the discovery that the human body can withstand great variations in temperature without seriously bad effects. Also, it was learned that the faster beating of the heart of a person in a heated room is responsible for discomfort more than the heat itself. Again, it was learned that sweat is the chief factor causing sore eyes when one becomes heated.

IN accordance with the editorial policy of this magazine never to accept compensation in any form for what appears in our reading pages, and also to avoid all appearance of doing so, we are obliged to omit the name of the maker or the seller of any article described. This information, however, is kept on file and will be furnished free, by addressing Bureau of Information, Popular Mechanics Magazine, Chicago. [Editor.]



A telephone personality

In your face to face contacts with people, your appearance, your bearing and many other things help you to make the right impression. But in your telephone contacts there is only one thing by which you can be judged—your speech.

An effective telephone personality is to-day a business and social asset. Everybody appreciates the person who speaks distinctly and pleasantly, neither too fast nor too slow, with a clear enunciation of each word, with lips facing the mouthpiece and speaking into it. In business, this is the telephone personality which induces favorable action on the part of the listener. To the salesman it may mean the difference between an order and

no order; between an interview granted and an interview refused.

Curiously enough, people who are careful to make themselves effectively heard and understood face to face, often disregard the need for effectiveness in their telephone speech. Perhaps they shout, perhaps they mumble, perhaps they hold the mouthpiece far from their lips. And frequently they never realize that their carelessness has defeated the purpose of their talk.

The Bell System maintains for telephone users the best facilities that science, modern equipment, skilled operation and careful management can bring to telephone speech. But these facilities can be fully effective only when they are properly used.

" BELL SYSTEM "

AMERICAN TELEPHONE AND TELEGRAPH COMPANY
AND ASSOCIATED COMPANIES

One Policy, One System, Universal Service, and all directed toward Better Service



\$1.00
A SUIT



Full Cut
ATHLETIC UNION SUITS

HANES GUARANTEE

We guarantee Hanes Underwear absolutely — every thread, stitch and button. We guarantee to return your money or give you a new garment if any seam breaks.

5 Big HANES Features

- 1 Hanes large, roomy armholes** taped instead of turned under. Can't curl or rip—but a friction-free surface that really wears.
- 2 Hanes webbing belt** guaranteed 2-thread elastic webbing instead of single thread, gives more elasticity and greater strength. Specially sewed to prevent tears and rips.
- 3 Hanes closed crotch** is cut and stitched in a special way that really keeps it closed. That means added hot-weather comfort.
- 4 Hanes crotch lap buttons** sewed on the seam. Won't come off. 4 thicknesses of material instead of customary 2. No patch used.
- 5 Hanes wide, full-length knees** cut so as to give greatest freedom without binding or creeping up the leg.

**“HANES” is a hit
in athletic unions!**

TALK about summer underwear—climb into “Hanes” at \$1.00 and get the biggest athletic union suit value you ever had handed out! Every garment is backed by the nationally known “Hanes” guarantee.

From the quality of the long-wearing nainsook, right down to the last stitch, you've got comfort and workmanship and service that never before have

been sold for one lone dollar bill!

Put “Hanes” in comparison for generous full size; for reinforced strain-points; for extra-strength-elastic webbing; for buttons sewed to stay on; for buttonholes that last the life of the garment! Compare “Hanes,” we tell you, and know what you buy for \$1.00!

“Hanes” is also made for little fellows from 2 to 16 years, in sizes 20 to 34.

*If your dealer can't fit you with
“Hanes” Underwear, write us immediately.*

P. H. HANES KNITTING CO., Winston-Salem, N. C.
New York Office, 366 Broadway

Next Winter You'll Want to Wear Hanes Winter Underwear

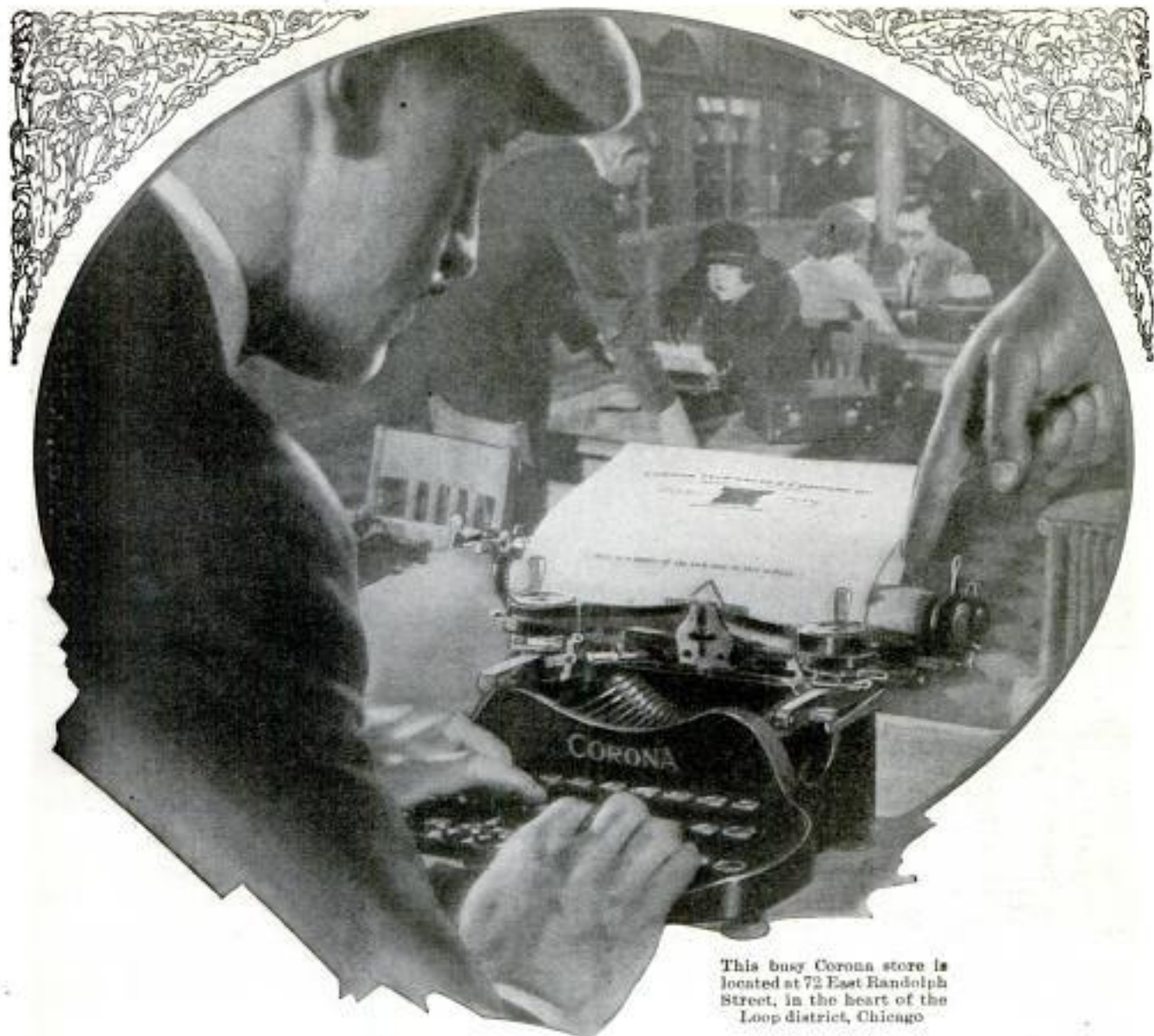

This busy Corona store is located at 72 East Randolph Street, in the heart of the Loop district, Chicago

See the New Corona today!

IT is the newest development in typewriters—a complete office typewriter in *portable* form—with every modern improvement, yet so inexpensive that every home can own one. Note these three points of superiority!

Speed: The Standard Portable Keyboard, with right and left shift keys, cannot be surpassed for simplicity and swiftness of operation.

Convenience: Automatic Ribbon Reverse, Two Color Ribbon, Extra Wide Carriage (10 inch), complete visibility of writing—everything you

would expect in a big, heavy machine. Foreign language or technical keyboards at no extra cost.

Strength: Corona is built to stand rough usage—Coronas have been dropped from every kind of conveyance, including an airplane, yet there is no record of a Corona frame ever having been broken! Corona is the only portable whose sturdiness has been tested by 16 years of use. More Coronas are in use than all other makes of portables combined.

Look for "Corona" in your phone book, or write us for our new, illustrated folder. Price \$50 with case. In Canada \$69.

CORONA TYPEWRITER COMPANY, Inc.
108 Main St. Groton, N. Y.

This Big Building Material Book is NOW Ready

Heating Plants
Plumbing Material
Paint
Roofing
Hardware
Radiation
Wallboard
Tanks, etc.
Pipe-Fittings
Wire-Fencing
Structural Steel
Agricultural Tools

Bathroom Outfits
Furniture and Rugs
Lighting Fixtures
Cabinet Work
Harris Homes
Steel Roofing
Plasterboard
Millwork
Lumber
Windows
Garages
Doors



Plumbing



\$23.50

One-Piece Sink

PJ-2—White porcelain enameled roll rim kitchen sink with right or left drain board. Complete with faucets and nickel plated trap. 44 in. long.....\$23.50
48 in. long.....27.00
52 in. long.....29.00

2 Part Laundry Tub \$18.75



PJ-4—Complete with 1/2 inch enamel and brass. Its 2 part laundry tub complete with 1/2 inch improve d swinging mixing faucet and latest style strong angle steel base; nickel plated brass trap. Each.....\$18.75



Complete Bathroom Outfit

PJ-4—Consists of bathtub 54 in. long and 30 in. wide. White porcelain enameled on the inside and over 3 in. roll rim. Deep sprue lavatory size 18x24 inches. Low pattern white china clean outfit with mahogany wood. Complete with all nickel plated fittings above floor \$60.....\$67.50

Mail This Coupon for
FREE BOOKS!
Dept. PK-7

Mark an "X" in squares to indicate books wanted. They are free and sent postpaid without obligation to you.

Building material and supplies
 Plan Book Harris Homes Beautiful
 Presto-Up Garage Book
 Presto-Up Cottage Book

Name.....
Address.....



Harris Homes Beautiful

Harris Home No. 1006, above, with 5 rooms and bath, size 30 ft. x 29 ft. 6 ins. is but one of more than a hundred beautiful, practical designs built many times with big economy in best residential districts.

FREE! Every prospective home builder should have this new plan book of Harris Homes Beautiful. More than a hundred designs—bungalows, cottages, residences. Explains the money saving advantages of our guaranteed Ready-Cut and Not Ready-Cut home building systems; the splendid quality of Harris Home building material; our liberal plan offers which save you from 50 to 100 dollars right at the start.



Numerous attractive designs; both single and double models, in every desired size, priced upwards from \$129.00.



Hot Water, Steam, Warm Air
Complete steam, and hot water heating systems—pipe and pipeless furnaces planned for you by experts and guaranteed to heat your home comfortably, economically and efficiently. Our big stocks insure quick shipment of everything needed to the last fitting. Capable engineers are waiting to help you. Send a rough sketch of your building showing size and location of rooms, number and size of windows and doors, height of ceilings and full information will be sent to you promptly.



Builders' Hardware
Locksets, butts and a complete line of builders' hardware of every description. All new modern designs featuring best construction, latest style and newest finishes. The complete line is illustrated, described and priced wonderfully low in our big building material book. Mail coupon for your copy today.



Lighting Fixtures
A complete line of lighting fixtures carefully chosen in sets for all rooms. Everything needed to wire your home. See them in our new book.



Guaranteed Paint \$1.85 Per Gallon
PJ-8—Best house paint in white, black and 26 non-fading colors. Per gallon.....\$1.85
PJ-9—Barn and garage guaranteed paint. Per gal.....\$1.35



Dept. PK-7
35th & Iron Sts.,
Harris Brothers Co., CHICAGO



21 Jewel Santa Fe Special Sent on Approval

Without one penny of advance payment let us place in your hands to see, to examine, to inspect, to admire, to approve a real masterpiece in watch creation.

Our determination to this year double our sales of the world famous Santa Fe Special and Bunn Special Watches prompts this matchless offer.

While other watch dealers are raising their prices, asking you for larger monthly payments, and making payment terms harder for you to meet, we are offering you our new model Santa Fe Special, no advance in price, no money down, easier terms and smaller monthly payments. WE realize the war is over and in order to double our business we MUST give you pre-war inducements, better prices, easier terms, and smaller payments.

Page Twelve of Our Watch Book is of Special Interest to You!

Ask for our Watch Book free—then select the watch you would like to see, either the famous Santa Fe Special or the 6-position Bunn Special, and let us explain our easy payment plan and send the watch, express prepaid, for you to examine. No money down.

SANTA FE WATCH CO.

66 Thomas Bldg. Topeka, Kans.

REMEMBER—No money down—easy payments buys a master timepiece—a 21 Jewel guaranteed for a lifetime at about half the price you pay for a similar watch of other makes. No money down. A wonderful offer.



*No
Money
Down*
TAKE ADVANTAGE OF
OUR GREAT WATCH OFFER.

SANTA FE WATCH CO.

66 Thomas Bldg., Topeka, Kans.

Please send prepaid and without obligation your Watch Book free, explaining your "No Money Down" Offer on this Santa Fe Special Watch.

Name.....

Address.....

*Mail
Coupon
Today*



Since 1882 when L. S. Starrett first introduced a line of tempered steel rules, machinists and mechanics have always looked to Starrett for the latest and best improvements in rules and mechanical tools. You will find some thirty of the newest Starrett Tools fully described in the new Revised Supplement and Catalog No. 22 AP. Write for it—we will mail you a copy promptly at our expense.

Here's the Rule *you've been waiting for*

The Stainless Steel Rule perfected by the L. S. Starrett Company represents a real achievement in fine tool making.

STAINLESS—it is made from the highest grade of non-rusting and non-staining steel.

HARDENED AND TEMPERED—the rule is light and vastly superior in point of wear to any soft steel rule.

GRADUATED—with the same fine accuracy that has distinguished all Starrett Steel Rules for more than forty years.

In short—the rule you've been waiting for. Ask for it at any good hardware store. **STARRETT STAINLESS STEEL RULE No. 1000.**

In two sizes—6 inch and 12 inch.
Each graduated 8ths and 16ths on one side—32nds and 64ths on the other.

THE L. S. STARRETT CO.

The World's Greatest Toolmakers
Manufacturers of Hacksaws Unexcelled
ATHOL, MASS.



Use Starrett Tools

STARRETT STAINLESS
STEEL RULE
No. 1000



STAINLESS
Hardened
and
Tempered

5167

ONLY
\$ **3**
DOWN
and you
keep this
typewriter



DIRECT
to you
from our
Factory

Big Saving
In Price

Yes, we will ship you this Genuine Underwood

Rebuilt in our own factory just like new for
ONLY \$3 down—NOT ONE CENT MORE

Until you have tried the machine 10 full days at our expense



Our Factory

EVERY MACHINE is fully guaranteed. New parts wherever needed. New enamel, new nickel, new lettering, new platen, new key rings—a complete, perfect typewriter. Impossible to tell it from a brand new Underwood either in appearance, durability or quality of finished work.

An up-to-date machine with two-color ribbon, back spacer, stencil device, automatic ribbon reverse, tabulator, etc. In addition we furnish **FREE** waterproof cover and special Touch Typewriter Instruction Book. You can learn to operate this Underwood in one day.

Big Book FREE

Our big handsomely illustrated catalog will be sent **free** on request. It tells you all about the advantages of owning a **STANDARD SIZE UNDERWOOD**; how and why this machine will last for years, saving many dollars not only in the purchase price but in its operation.

Send in the coupon and let us send you this beautifully illustrated book **FREE** without any obligation whatever.

Shipman-Ward Mfg. Co.
"Typewriter Emporium"
A-212 Shipman Bldg.
Montrose and Ravenswood Aves., Chicago

Write Right Now

and learn how it is possible for us to ship you this Underwood Typewriter upon our **free trial** plan and our direct-to-you **money saving methods**. Get the full details now—just sign the coupon and mail today. Get all the facts—then decide.

No Obligation

—to buy. You don't have to order. Just sign the coupon, send it to us and we will mail you our **big catalog** absolutely free.

Send the
Coupon
Today

10 Days' Free Trial

You have ten full days in which to try the typewriter before deciding whether you want to keep it. Give it every test—see for yourself—make the Underwood prove its worth to you. Don't take our word for it—put the Underwood before you and see if you don't think it is the greatest typewriter bargain ever offered.

You will be amazed at the liberality of our offer, the beauty and all around excellence of our typewriters.

This is the genuine Underwood Typewriter. We offer you the same three models of the Underwood Typewriter being made and sold by the manufacturers today. **Standard 4-row single shift keyboard. Absolutely visible writing—the full line of typewriting is visible at all times.** All the improvements and attachments that any high grade typewriter ought to have.

Big Saving to You

Our plan of selling to you **direct** makes possible enormous savings, which are all for your benefit. **Send in the coupon and we will send you prepaid** our big catalog, including "A Trip Through Our Factory." This shows how the Shipman-Ward Rebuilt Underwood is the best that can be produced at our **Special Price**.

You don't have to do a thing to get our big **Free** catalog and complete details of our amazing

typewriter offer except to sign and send in the coupon. There is no obligation.

FREE TRIAL COUPON

SHIPMAN-WARD MFG. CO.
A-212 Shipman Bldg., Chicago

Please send me **FREE**, all charges fully prepaid, your **BIG NEW** catalog of **UNDERWOOD TYPEWRITERS** and complete details of your **FREE TRIAL** Offer.

It is understood that I am under no obligation whatever and that this is to be sent without one cent of cost to me.

Name.....
Street.....
City..... State.....

Send for this booklet on—NEW TOOLS

by

BROWN & SHARPE



The New Tools described in this booklet are designed with typical Brown & Sharpe skill to meet certain present-day requirements of every mechanic and shop owner.

Such up-to-date tools as a single micrometer measuring from 2" to 6", a complete line of Micrometers covering a range from 0 to 24", and a 6" rule of Stainless Steel are a few of the New Tools this booklet describes.

These New Tools are direct helps toward better workmanship—they will benefit every man or shop which uses them.

Learn about these helpful tools—write for this booklet today.

With the booklet we shall be glad to send our No. 28 Small Tool Catalog if requested.

BROWN & SHARPE MFG. CO.
PROVIDENCE, R. I., U. S. A.

BROWN & SHARPE TOOLS

THIS WONDERFUL INVENTION



converts any ordinary cook stove into a gas stove. OXO-GAS is made from kerosene and air. Cheaper, cleaner and more efficient than coal. Responsible distributors wanted.

GLORIA LIGHT CO.
114 N. May St. Chicago, Ill.

Beautiful HOUSES \$900 and BUNGALOWS

CAN BE BUILT FOR AND UP
This and many others in my new book, *Building Plans for Modern Homes*, will save you hundreds of dollars. One of the most complete and comprehensive books of plans ever published by any architect. New edition just off the press. Nearly 600 floor plans and photographs of bungalows, Colonial houses, etc., costing from \$200 up; gives sizes and cost to build.

Sent postpaid for \$2.00



FREDERICK H. GOWING
ARCHITECT

101 Tremont St., BOSTON, MASS.



Strops ANY Safety Razor Blade Perfectly 100 SHAVES PER BLADE

Thousands now in use. Uses any strop. Special strop 50c extra. Sent postpaid for \$1.00. Money back guarantee. C. O. D. if you prefer.

Tompson Stropper Sales Company
Dept. 1275 Kansas City, Mo.

HAWAIIAN IM. DIAMONDS



No. 3020
Special price \$2.98

The Greatest Discovery the World Has Ever Known. Just to advertise these famous im. diamonds we will send you one of these 14K gold f. rings, postage paid. When it arrives pay postman \$2.98 C. O. D. charges to cover cost, etc. Only 10,000 rings given away. Money refunded if you can tell it from a genuine diamond.

KRAUTH & REED
Dept. C Masonic Temple Chicago



No. 3011
Special price \$2.98

**\$5⁰⁰**

2000 Ohms

\$5⁵⁰

3000 Ohms

You are taking no chances when you use Murdock Headphones with your Radio Receiving Set. Experts have used them for over 17 years.

And Murdock prices are so reasonable that every Radio enthusiast can afford them.

Get a pair from your dealer. Also ask him to show you the new Murdock \$5 Loud-speaker. If he doesn't have them send direct.

WM. J. MURDOCK COMPANY

General Offices and Factory

349 Washington Ave., Chelsea, Mass.

Sales Offices:

New York Chicago San Francisco
Los Angeles Seattle**MURDOCK
RADIO**

STANDARD APPARATUS SINCE 1904

**"Comin' in great!"**

Tune up a SIGNAL Radio Set, and that's what you'll say. SIGNAL'S been making wireless apparatus over thirty years — that's why.

Send for Catalog.

SIGNAL ELECTRIC MFG. CO. 1910 Broadway
Menominee, Mich.**RADIO BLUEPRINTS**

Blue Print Design of Radio Receiver guaranteed range 1,000, 3,000 miles, using dry cell....	10c
Blue Print Two Stage Amplifier for above outfit.....	10c
Blue Print of Radio Frequency Amplifier for above.....	10c
Guaranteed 1,000 Ohm Phone Receiver Postpaid.....	\$2.00
Guaranteed Bakelite Couplers, Green Silk Prepaid.....	\$3.00

Send 10c for our complete Catalog. Agents Wanted. Liberal Commissions
We sell Guaranteed Apparatus.

BADGER RADIO CO., 497 E. Water St., Milwaukee, Wis.

FREE Radio Catalog

Our big stock of standard makes of radio sets, parts and supplies enables us to make prompt shipment from stock. Play safe — buy standard equipment from a reliable house. No cut price material.

Send \$5.00 for Murdock Complete Loud Speaker, 70c for "A" Battery Switch, 80c for pair Rubber Ear Muffs.

JULIUS ANDRAE & SONS CO.

In business since 1860

116 Michigan St. Milwaukee, Wis

Wave TrapTRADE MARK
PATENT APPLIED FOR**The Missing
Link
in RADIO****Stops Interference!**

THE "WAVE TRAP" will eliminate interfering broadcasting stations and enable you to listen to your favorite station. It will work on any set, greatly increase its selectivity and clearness, and eliminate code and spark stations.

It is mounted on a Formica panel in a handsome mahogany finished cabinet 6 x 5 x 6. It is a high grade instrument throughout and a valuable addition to the operation and appearance of any set. It comes to you complete and there are no extras to buy. It is installed in a minute by changing only one outside connection.

Use the "WAVE TRAP" for real results.

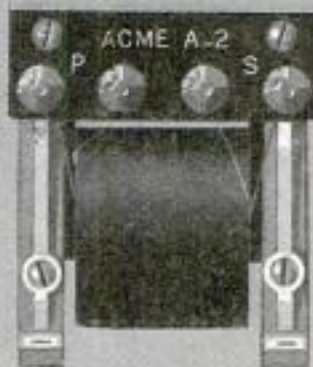
Ferbend Electric Co.
15 E. SOUTH WATER ST.
CHICAGO**ACME**
for amplification**Radio Apparatus
of distinction****ACME APPARATUS CO.**PIONEER TRANSFORMER AND
RADIO ENGINEERS AND MANUFACTURERS
CAMBRIDGE, MASS., U. S. A.



The only vise removable from base for continuous work

The "Yankee" Vise means more speed—greater accuracy. You don't have to remove work from vise until entire job is completed.

When you carry work from bench to drill press, to milling machine, and so on, simply lift vise, work and all, off base.

A "Yankee" vise always

assures perfect alignment; bottom, sides and ends are machined true.

Quickly released from base by turning set screw. Locks in any desired position by cam-throw lever at side. Hardened steel block, with V-shaped grooves, holds round or irregular work.

Some other "YANKEE" Tools

Spiral Screw-drivers
Quick-Return Spiral
Screw-drivers
Ratchet Screw-drivers
Ratchet Hand Drills
Ratchet Bench Drills
Ratchet Chain Drills
Automatic Push Drills
Ratchet Tap Wrenches

Dealers
everywhere sell
"YANKEE" Tools

"YANKEE" Vises with swivel base

No. 1994—Body, 10½ in. long; 4 in. wide. Jaws open to 4 in.
No. 1993—Body, 7¼ x 2¾ (wide) x 3 in. Jaws open to 3½ in.
No. 1992—Body, 4¾ x 2 (wide) x 2 1/16 in. Jaws open to 1 15/16 in.
No. 1991—Body, 3¾ x 1¾ (wide) x 1¾ in. Jaws open to 1¾ in.
Nos. 994, 993, 992, 991. As above, without swivel base.

Helpful Tool Book Mailed Free

Illustrates and describes all the ingenious "Yankee" Tools for saving time and labor in drilling and tapping in metal, boring in wood, and driving or drawing screws.

Send Postal Today.



NORTH BROS. MFG. CO., Philadelphia, U. S. A.

"YANKEE" TOOLS

Make Better mechanics



Design No. 2588

Plans \$18.00

California Bungalow Books

"Home Kraft" and "Draughtman" each contain Bungalows and Two Stories. "Plan Kraft" Two Stories. "Kozy Homes" Bungalows. \$1.00 each—all four for \$3.00. De Luxe Plans \$1.00.

DE LUXE BUILDING CO.

516 Union League Bldg.

Los Angeles, Calif.

\$600 to \$5,000 PROFIT FROM WASTE STORE SPACE



Business men! Send for amazing story of Butter-Kist Peppers and Peanut Machines profits. Pays big in drug, department, candy, other stores, theatres, etc. Write

HOLCOMB & HOKE MFG. CO.
946 Van Buren St. Indianapolis, Ind.

Automatic Rapid Electric FIRELESS COOKER

Gives every facility of electric range plus every advantage of fireless cooker at less cost than a good oil stove.

NEW INVENTION
REVOLUTIONIZES COOKING
Saves 50% to 75% fuel cost

Bakes, roasts, boils, stews, fries, toasts. Needs no watching. Shut electricity off automatically. Attaches to any electric socket. No special wiring. Write for FREE Home Science Cook Book, 30-day FREE trial offer and direct factory prices.

WM. CAMPBELL CO., Dept. 64, Detroit, Mich., Georgetown, Ont.



Different from all others—the NEW BENJAMIN

AIR RIFLE

Made on a different principle from all other Air-Rifles. The Benjamin is really a strong air-pump used to compress the air in the air chamber to any degree of power desired. From one to six strokes of the pump give all the force necessary. Each additional stroke gives increased power. The Benjamin works on the same principle as all air-drills and air-hammers—with this difference:

You control the shooting force as you desire. Look at this block of hardwood. It shows how Benjamin power is regulated as you wish.

You can't have accidents with a Benjamin. It's safe, always, because you control the power. The Benjamin never loses shooting force, and has no springs to get out of order or shake your aim. Write us for an interesting folder about this wonderful air-gun.

If your dealer does not handle same, send direct to factory.

**(PRICE \$5)
POSTPAID**

BENJAMIN AIR-RIFLE & MFG.
CO., 615 N. Broadway, St. Louis, Mo.

Ask your dealer for demonstration.

Pacific Coast
Representatives
THAYER &
BOWER
Los Angeles
Calif., and
San Francisco
Calif.



21 Jewel Burlington



Adjusted to the Second 21 Ruby and Sapphire Jewels
Adjusted to Temperature 25 Year Gold Strata Case
Adjusted to Isochronism Your Choice of Dials
Adjusted to Positions (Including Montgomery H. R. Dial)
New Ideas in Thin Cases

Only \$1.00 Down

Only One Dollar Down will buy this masterpiece of watch manufacture. The balance you are allowed to pay in small, easy, monthly payments. The Burlington—a 21-Jewel Watch—is sold to you at a price much lower than that of other high-grade watches. Besides, you have the selection of the finest thin model designs and latest styles in watch cases. Don't delay! Write for the FREE Watch Book and our SPECIAL OFFER today.

Write While This Special Offer Lasts

Get the Burlington Watch Book by sending this coupon. Find out about this great special offer which is being made for only a limited time. You will know a great deal more about watch buying when you read this book. You will be able to "steer clear" of the over-priced watches which are no better. Remember, the Burlington is sent to you for only One Dollar down, balance in small monthly payments. Send the coupon for watch book and our special offer TODAY! Do not delay one minute!

Burlington Watch Company

Dept. A-135 19th St. & Marshall Blvd., Chicago
Canadian Address: 62 Albert St., Winnipeg, Manitoba

Please send me (without obligations and prepaid) your free book on watches with full explanation of your \$1.00 down offer on the Burlington Watch.

Name _____

Address _____

Clear-Tone FOR

PIMPLES

Your skin can be quickly cleared of Pimples, Blackheads, Acne Eruptions on the face or body, Enlarged Pores, Oily or Shiny Skin. \$1,000.00 Cold

Cash says I can clear your skin of the above blemishes. WRITE TODAY for my FREE Booklet—"A Clear-Tone Skin"—telling how I cured myself after being afflicted for fifteen years.

E.S. GIVENS, 129 Chemical Bldg., Kansas City, Mo.

Great NEW

Invention for Seekers of Health—Power—Beauty

Revitalize yourself! Bring back energy. Be wholly alive. Elico Health Generator aids you to leave the lethargy and hopelessness of bad health behind forever. Yours for 10 days free trial.

FREE
Trial



Write
for Free
Book

Write for free book that tells all about this great instrument that gives you Electricity, Vibration, and Quone, the four greatest curative agents. Find out how you can have the Elico for 10 days free trial. Write today.

Lindstrom & Company
442 N. Wells Street, Dept. A135 Chicago



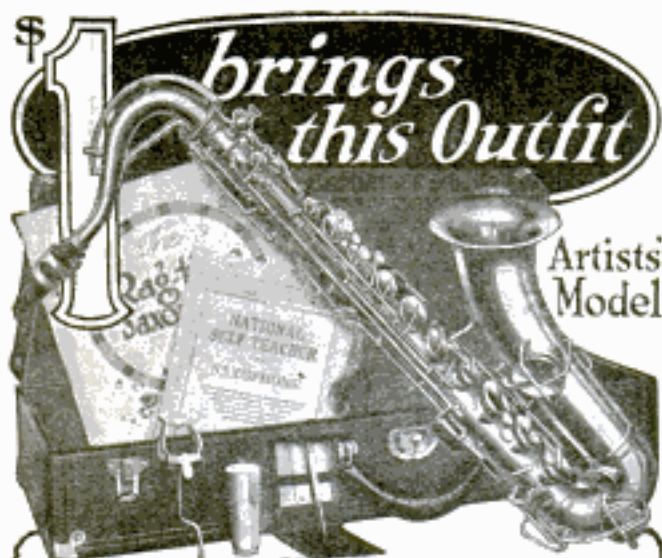

Standard "C Melody" SAXOPHONE

Learn to play Saxophone! The easiest instrument to learn, it is also the most popular! Pick out tunes in an hour, as quickly as with one finger on the piano. And there's no faster way to **make extra money** than playing Saxophone at dance or church or theatre. Makes you a social favorite, always welcome everywhere!

10 MONTHS TO PAY! The Standard "C Melody" Saxophone is the supreme grade, made in Elkhart. Choice of famous artists and teachers. The 1923 model with "beveled sockets" makes all other Saxophones "out of date." Sent to you for 6 days' trial, to prove to you its ease of blowing, simplified fingering and golden tone can't be equalled at any price. Complete 12 piece outfit direct to you from factory at only \$1 down and \$8.00 a month. Small first payment. Sensational cut in price during this sale. No interest, no tax, not one cent extra!—Saxophone, \$10 case, self-instruction system, book of music, reed, strap, pearl keys, etc., everything you need. Quality that enables you to buy **once** for a life-time.

CATALOG FREE! Tells you how you can secure the greatest of Saxophones on easy terms at less than cash price! Write today for this free book and complete information of our sensational offer! Standard Music Co., Dept. 1022, P. O. Box 503, Chicago

BOYS!!

LEARN HOW TO PLAY ANY TUNE IN ONE AFTERNOON

FREE Complete instructions for making real music with a Hohner Harmonica (Mouth Organ) sent free to any American boy.

First learn the scale—"do, re, mi, fa" etc. Then try "Home Sweet Home." Diagrams and full explanations show you how you can do this easily with a **HOHNER HARMONICA**.

After you've done this you can play any tune you can whistle—with chords and full accompaniment. Harmonica is most popular music on the radio. Biggest hit of the year in New York Orchestra. Be the first boy in your neighborhood to play a harmonica well. Anticipate your folks and friends. Be sure to ask at the music goods store, general store, stationery or drug store in your town for a Hohner Harmonica—50¢ and up. Write us this minute and say "Send me Hohner Harmonica Instructions" and give your name and address. Write now, to:—

M. HOHNER, Dept. 20, 116E, 16th St., New York City



Get a Hohner at Your Local Store

Wesley Barr, Warner Bros, star in a Hohner fan.

Send now for free instructions



Those who wear them say:
ERICKSON LEGS are Wonderful
because they do not chafe, overheat or draw end of stump.



If you have had a recent amputation send for new booklet on TEST LEGS for beginners.
E. H. ERICKSON CO.
38-A Washington Av. N.
MINNEAPOLIS • MINN.



Copyrighted material

Kingery

Start A Profitable Business for Yourself

—and make **MONEY** right away

KINGERY POP CORN POPPERS AND PEANUT ROASTERS often prove a gold mine for the ambitious person. The investment is small—practically no attention is required to machine while in operation—little expense for stock or power—and profits are BIG: 3 1/2¢ on every 5¢ sale or 8 1/2¢ on every 10¢ purchase.

KINGERY MACHINES are complete in every way. They turn out the buttered popcorn and hot roasted peanuts with little effort on your part.

VERY LITTLE SPACE IS REQUIRED—for KINGERY POP CORN POPPERS AND PEANUT ROASTERS can fit in practically any space.

Everybody—young or old—rich or poor—every person is a possible customer.

James Kipwisa, P. O. Box 56, Waynesburg, Pa., writes: "Since I got your machine, in 15 days I have made \$227.56."

INVESTIGATE TODAY

WRITE FOR FREE ILLUSTRATED CATALOG showing a model for every purpose at a price for every purse.

Dept. PM

KINGERY MFG. CO.
CINCINNATI, OHIO

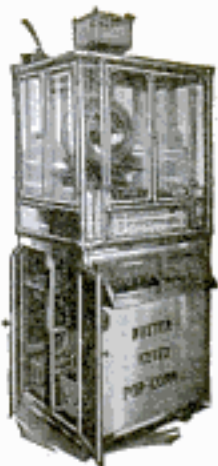

Wrestling Book FREE



Learn to be an expert wrestler. Know scientific wrestling, self-defense, and jiu-jitsu. Develop a splendid physique, and have perfect health. Join this popular school and learn by mail. The famous world's champions—the marvelous

Frank Gotch and Farmer Burns

offer you a wonderful opportunity. Wrestling is easily and splendidly learned at home by mail. Men and boys write now for this splendid free book. Learn all the science and trick. Be able to handle big men with ease. Accept this wonderful offer NOW. Send for free book today, stating your age.

Farmer Burns School of Wrestling, A977 Range Blvd., Omaha, Neb.

\$1.00 MYSTERIOUS CHARM



Latest fad—keeps everybody guessing—IF YOU ARE A MASON—you should carry a Mysterious Charm. Spin it—Instantly revealing the SQUARE AND COMPASS.

Gold plated. Sent postpaid, \$1.00 FREE. Masonic Catalogue listing publications, jewelry, paraphernalia.

REDDING & COMPANY
290-6th Ave., Dept. 25, N. Y. C.

AGENTS 500% PROFIT

\$60 - \$200 per week. Free samples **GOLD SIGN LETTERS** for store and office windows. Anyone can put them on. Big demand everywhere. Liberal offer to general agents.

METALLIC LETTER CO., 433B N. Clark, Chicago

\$2 Brings This Genuine DIAMOND RING

Set in Platinum

Seven brilliant steel blue genuine diamond are massed in a setting of solid platinum so that only close inspection will distinguish it from a solitaire valued at \$350.00. Shank of ring is 18 K. white gold, in latest design. Price only \$57.50—pay balance \$5.55 a month for ten months.

10 Days' Free Trial

Simply send \$2—if not satisfactory at the end of ten days, your deposit will be refunded to you. Can be supplied in gentleman's mounting without extra charge.



No Red Tape
No Delay

18 K

Free "Royalton" Pearls

We are giving an 18-inch strand of genuine "Royalton" Pearls fitted with a solid gold clasp **ABSOLUTELY FREE** just to get you started as a customer.

Free Book of Gems

Most complete jewelry catalog ever issued of Diamonds, Watches and Jewelry—latest designs at lowest prices.

10 Months to Pay on Everything from our Two Million Dollar Stock
Address Dept. 778

ROYAL DIAMOND & WATCH CO.
35 Maiden Lane - New York

Whittemore's

Shoe Polishes

ARE SUPERIOR

How to Select Safe Bonds

Every investor wishing to learn about bonds of absolute safety yet paying an attractive yield (ranging as high as 7%) should write at once for this book, which will be sent for the asking. It has been prepared by George M. Forman & Company.

YOUR COPY NOW READY

In every banking circle the name of George M. Forman & Company has always been associated with sound investments and an attractive yield. Just a postcard or a letter will bring your copy of our interesting book, "How to Select Safe Bonds."

GEORGE M. FORMAN & COMPANY, Dept. 446
105 W. Monroe Street, Chicago, Ill.
"28 Years Without Loss to a Customer"

AGENTS: 90c an Hour

Introduce "Sodereze." A new wonder. A pure solder in paste form. Works like magic. Stops all leaks. For mending water buckets, cooking utensils, milk pails, water tanks, tin roofs, everything including granite ware, agate ware, tin, iron, copper, zinc, etc.

QUICK SALES, NICE PROFIT

Everybody buys. Housewives, mechanics, electricians, jewelers, plumbers, tourists, automobilists, etc. No leak too bad to repair. Just apply a little "Sodereze," light a match and that's

all. Put up in handy metal tubes. Carry quantity right with you. Write for money-making proposition.

AMERICAN PRODUCTS CO., 7577 American Bldg., Cincinnati, Ohio

HOME LOVERS' BARGAIN BOOK FREE

Showing Over 10,000 Furniture Bargains
All selections loaned free for a month. Take a year to pay if satisfied, paying little by little almost as you please.
SPIEGEL, MAY, STERN CO., 1188 W. 35th St., Chicago

a hundred hurts—occur unexpectedly. For bruised or broken skin nothing is so convenient as antiseptic, germicide and liniment in one container. Makes each more efficient. A few drops suffice. \$1.25 at most druggists or postpaid. Liberal trial bottle, 50c, postpaid.

W. F. YOUNG, Inc.
147 Temple Street
Springfield,
Mass.

Absorbine J
THE ANTISEPTIC LINIMENT

"Been on a vacation Bill?"

"No, Jim—I've stopped smoking. Gained six pounds in a week. You know how I used to smoke—a package of cigarettes and a cigar or two a day—it sure had some hold on me. But I'm cured—took a scientific home tobacco treatment—fixed me up in two weeks.

"Wasn't hard on me at all—noticed improvement the first day—I feel like a new man. It didn't interfere with my work—didn't leave any druggish after-effects—the money I saved in the last two weeks has paid for the treatment alone.

"Why don't you take it? It has cured men like you and me for over forty years—it is a doctor's individual prescription that sure fixes you up. Just send the coupon for full information NOW. No obligation. All correspondence is strictly confidential."

THE KEELEY INSTITUTE
Dwight - - - Illinois

The Keeley Institute, Dwight, Ill.
Please send me, without any obligation on my part, your free booklet which will tell me how to rid myself of the tobacco habit.

NAME.....
TOWN.....
STREET..... STATE..... PM-6

DIAMONDS-WATCHES ON CREDIT

Loftis Perfection Diamond Ring
Blue white, perfect cut Diamond. The Ring is 14-K Solid Gold.
\$50
Others at \$75, \$100, \$125 up.

Sylvia Diamond Ring
Blue white, perfect cut Diamond. Ring is 14-K Solid White Gold.
\$125

Loftis Solitaire Diamond Cluster Ring
Blue white, perfect cut Diamonds, set in platinum. Ring is 14-K Solid Gold.
\$100
Others at \$95, \$125, \$150 up.

GENUINE DIAMOND RINGS FOR GIFTS

We import Diamonds direct from European markets and sell direct to you by mail. Our immense buying power is a great saving to you. Customers testify to Loftis values. Our long years of service to the public is our Guarantee of satisfaction and the safeguard of your interests.

Send for Catalog

There are over 2,000 illustrations. Select as many articles as you wish and have all charged in one account. Sent prepaid for your Free Examination. Catalog explains everything. **LIBERTY BONDS ACCEPTED.**



No. 16—Wrist Watch, 14-K Solid White Gold, 17 Jewels, \$39; 14-K, 15 Jewels, \$32.

CREDIT TERMS on all articles: One-fifth down, balance divided into equal payments within eight months. Send for Catalog.

17-JEWEL ELGIN
No. 15—Green Gold, engraved, guaranteed 25 years, 12 Size, gildial. Assorted patterns, \$35



LOFTIS THE OLD RELIABLE ORIGINAL CREDIT JEWELERS
DEPT. A-294
108 N. State Street, Chicago, Ill.
Stores in Leading Cities
EST'D 1858 BROS. & CO. 1858

Make the Parts You Need on a MONARCH Jr. Lathe

Metal or wood parts needed in your experiments, on your invention, or on your automobile can be made with a MONARCH Jr. Lathe. This 9" Engine Lathe is fully equipped—semi-quick change gear and automatic safety devices. Does any small work with 1/1000" accuracy.



\$245 9 in. Lathe—2 1/2 ft. Bed—with Bench Legs

Also built up to 5-foot bed lengths and up to 11-inch swing—at slightly higher price. SEND for Free Catalog of MONARCH Lathes which are built up to 30" swing.

THE MONARCH MACHINE TOOL CO.
400 Oak Street SIDNEY, OHIO

"LITEWATE JUNIOR" DRUM OUTFIT

for Home Orchestra
School Orchestra

Dance or
Theatre
Orchestra
only

\$48.60

\$8.60 Down
\$5.00 Monthly



Outfit contains one Lyon & Healy Professional Bass Drum; one Lyon & Healy Professional Snare Drum; Ludwig Pedal; Snare Drum Stand; Pedal Cymbal and Holder; Chinese Crash Cymbal and Holder; Tone Block; Pair of fine Sticks.

BIGGEST value in a complete outfit ever offered! It takes only practice to make you a Drummer—START NOW! You can practice with Player Piano or Phonograph and progress rapidly; soon give HOME DANCES; and in a couple of months be ready to step into the school or regular orchestra—and earn money evenings if you care to. Send for details or remit first payment and we will ship outfit on trial! For sale by your Music Merchant.
LYON & HEALY, 73-72 Jackson Blvd., Chicago

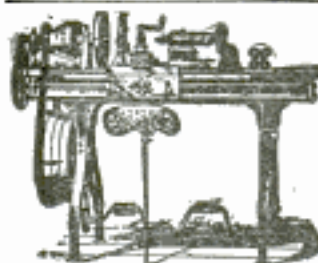

LATHES

9 to 18-inch Swing

List price \$165 and up according to size. When ready to buy send for Lathe Catalog and prices.

W. F. & John Barnes Co.
100 Ruby Street, ROCKFORD, ILL.



It is the well known quality of CRESCENT machines that justifies you in selecting one of them each time you have need for wood working machinery. The CRESCENT line is better than ever and will always give you satisfaction in every particular. Ask today for catalog of band saws, saw tables, jointers, shapers, planers, boring, planers and matchers, swing saws, disk grinder, cut off table, hollow chisel mortiser, variety wood worker, Universal wood worker.

THE CRESCENT MACHINE CO., 93 Columbia Street, Leontia, Ohio

RAISE BELGIAN HARES

New Zealand Reds—Flemish Giants—American Blues.
BIG PROFITS, WE PAY \$1.50 TO \$3 EACH.
Also Cavies, Mink, Skunk, Fox, Muskrat, Etc.
Easily raised anywhere. **FREE!**
page Catalog and Contract
Illustrated book "COMMON SENSE RABBIT RAISING," quarterly journal, and copy of America's leading small stock magazine, all for 10 cents. Address
Purdine Enterprises Co. 1005 N. E. 81st., KANSAS CITY, MO.

SQUAB BOOK FREE

Squabs are selling at the highest prices ever known. Breed them and make money. Write at once for free book, prices, etc.
Plymouth Rock Squab Co. 634 Howard St., Melrose Highlands, Mass.



South Bend Lathes SCREW CUTTING ENGINE LATHES

Standard Change Gear

9" x 3' Lathe.....	\$ 211.00
11" x 4' Lathe.....	248.00
13" x 5' Lathe.....	304.00
15" x 6' Lathe.....	376.00
16" x 8' Lathe.....	452.00
18" x 10' Lathe.....	656.00
21" x 12' Lathe.....	933.00
24" x 14' Lathe.....	1254.00

Quick Change Gear

9" x 3' Lathe.....	\$ 241.00
11" x 4' Lathe.....	288.00
13" x 5' Lathe.....	354.00
15" x 6' Lathe.....	431.00
16" x 8' Lathe.....	512.00
18" x 10' Lathe.....	721.00
21" x 12' Lathe.....	1016.00
24" x 14' Lathe.....	1353.00

Catalog No. 79 sent free to any address

SOUTH BEND LATHE WORKS
625 E. Madison Street SOUTH BEND, IND.

How to Run a Lathe New 80-page book, Revised Edition No. 24, for 10 cents postpaid, silver or stamps.

Fix it with BERNARD PLIERS



There are
Dozens
of Places

on your car, motorcycle or bicycle where Bernards can nose in and grip and cut better than any other tool. Compound leverage, parallel jaws, and outside cutting blades make Bernards the all around tool for men who appreciate the real thing. At good Hardware Stores.

Booklet "P" Free on Request.

**BERNARD
PLIERS**

Wm. SCHOLLHORN CO.
NEW HAVEN, CONN.



ALVAN CLARK TELESCOPES

Famous throughout the world as the highest grade Astronomical and Terrestrial Instruments. Now bringing to you at a reasonable price, these wonderful instruments—a source of pleasure and education—for the home—the school—the college. Send for circular and prices.

ALVAN CLARK & SONS CO.
Makers of the great "YERKES" and "LICK" Telescopes
55 Henry Street Cambridge, Mass.



BURN YOUR NAME ON TOOLS

WITH
ARKOGRAF

Protect your tools from theft. Write any name, engrave any design on metal with electricity like writing on paper with pen or pencil. Complete outfit \$3.50, prepaid anywhere. Interesting descriptive circular free. Write today. Agents Wanted. Arkograf Pen Company
1027 Yeon Building Portland, Oregon



Measure Hard-to-Get-at Places

instantly, accurately. Just slide rule out. No folding; strong; brass-trimmed. Any length 2 to 8 ft. 2c per lineal foot. If not at dealer's, sent post-paid.

Dealers and agents: Request attractive proposition.

'Interlox'
MASTER SLIDE RULE

MASTER
RULE MFG. CO.,
Inc., 841-43 East
136th St., NEW YORK CITY

TOOL CHESTS

for Machinists & Toolmakers
Every tool arranged in order. No up-to-date mechanic should be without one. A Gerstner Case costs no more than some tools, and will last a lifetime. Catalog free.

Gerstner & Sons.

717 Columbia Street DAYTON, OHIO



ATKINS METAL CUTTING SAWS



Use
Atkins
"Non-Breakable"
Hack Saw
Blades

"Best Hack Saw Blade I Ever Used"

That's what you'll say if you'll put an Atkins "Non-Breakable" Blade in your hack saw frame. You can cut faster and easier, and avoid losses due to blade breakage.

These blades are made of specially selected steel and tempered by an exclusive gas and oil process which gives them a harder, keener cutting edge and a tougher, more flexible back.

Tell us what metal you cut, enclose ten cents, and we'll send you a sample blade.

When you need any saw for cutting wood or metal—there's an Atkins product that will save time, money and labor. Write for free booklets on the saws you require.

Get This Book Sent You FREE

A 32-page book that's full of practical suggestions on metal cutting, and general shop information. Every man who buys or uses saws will find it helpful. Just write your name and address on the margin of this page and mail it to us—NOW.



E. C. ATKINS & CO., Inc.
Dept. P Indianapolis, Ind.

Makers of "Silver Steel"
Saws and Tools



E. C. ATKINS & CO.
INDIANAPOLIS, IND.

Please Mention Popular Mechanics

Copyrighted material

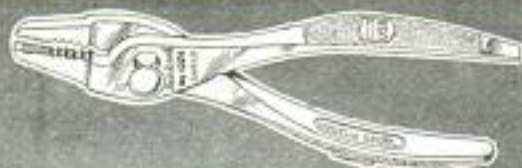

"Red Devil" Pliers made in 100 styles—one for every need. Known and used the world over. Style 1024—6½ inch shown above, \$1.00.

Red Devil Auger Bit

*The Harder the Wood
The Faster It Cuts*

THE "Red Devil" cuts twice as fast as ordinary auger bits.

You don't have to push the "Red Devil" Bit to make it go through a piece of oak as quickly as an ordinary bit will cut into soft pine.

The special construction of the worm makes the bit take hold quickly and strongly. It pulls itself into the wood in tractor fashion.

The "Red Devil" Auger Bit saves time because it cuts fast—won't clog—bores straight and true with or against the grain of any wood.

"Red Devil" Auger Bit No. 2400—made in 20 sizes, from 3/16 to 24/16ths. On sale at all good hardware dealers. If not in stock, send dealer's name and 75c for a sample bit, size 10/16ths.

The "Red Devil" mechanic's tool booklet will help you select the tools best suited for your particular purpose—send for it—it's free.

SMITH & HEMENWAY CO., Inc.
Manufacturers of "Red Devil" Tools
260 Broadway, New York, N. Y.

"Red Devil" Glass Cutters—the glazier's standard tools of the world. "It's all in the wheel." Made in 40 styles. No. 024 shown below, 20c.



Please Mention Popular Mechanics

Solder it with a

LENK
AUTOMATIC
BLOW
TORCH

No
Pumping
No
Priming

The One That Blows Itself

The handiest tool ever devised for soldering connections on Radio sets, repairing wiring in your house or on your car. Produces a 1400° needle-point flame instantly. Fine for close, careful work. Used by electricians and mechanics everywhere.

60" coil self-fluxing (acid or rosin core) solder..... 25c
Lenk Super (mouth blow) torch..... 75c
Lenk Jumbo (mouth blow) torch..... \$1.00
Marvel Soldering Kit—one Lenk Automatic Blow Torch and two coils self-fluxing solder—one acid and one rosin core, in neat leatherette case..... \$2.00

If your dealer doesn't sell them, order direct.

LENK MFG. CO. 30 Portland Street, BOSTON, MASS.

\$1.50

AT ALL
5 and 10 Cent
STORES

QUICK TO STICK
SOLD TO
HOLD



**IRON
GLUE**

10¢
15¢
SIZES

MCCORMICK & CO., Baltimore



Moore Push-Pins
Glass Heads—Steel Points

Moore Push-less Hangers
To hang up things

Ask your dealer to show them

Sold
Everywhere 10¢ per packet

Moore Push-Pin Co.

Wayne Junction Philadelphia

"Lighting Fixtures"

READY TO HANG

(Direct from Manufacturers)

Completely wired, including glassware.

New designs. Send for catalogue No 24.

Send for DEALERS' proposition.

ERIE FIXTURE SUPPLY CO.

STA. A. ERIE, PA.



Pepsodent
REG. U.S. PAT. OFF.

The New-Day Dentifrice

SELF-FILLING INK PENCIL

"INDEPENDENT"

Mets all requirements. Self-filling, non-leakable, safety cap. Attached clip. Smooth writing gold style point.

Guaranteed Improved Fountain Pen. Eliminates fatigue. Promotes efficiency. Writes uniform. A business necessity.

\$2.00

Your Name in Gold—25 Cents Extra

AGENTS WANTED

J. C. ULLRICH & CO., 161 Washington St., New York

Copyrighted material

OSTER



**BULL-DOG
DIE-STOCKS**

Send for folder describing the pipe threading tools with the 5 Big Features—Oster Bull-Dog Die-Stocks.

THE OSTER MANUFACTURING COMPANY
2100 E. 61st Place Cleveland, O.



GEARS ALL KINDS SMALL

The most accurate made and prices reasonable. We carry a complete line of gears in stock for immediate shipment. Can also quote on special gears of all kinds. Send us your inquiries. WRITE FOR CATALOGUE.

CHICAGO STOCK GEAR WORKS
105-109 S. Jefferson St., CHICAGO

REMINGTON

PORTABLE TYPEWRITER
Dealers and Branches Everywhere



\$1 Brings This Genuine DIAMOND

Blue white, perfect cut, genuine diamond; 18 kt. white gold, hand engraved and pierced mounting. Rare beauty. Only

\$32.50

Easy for you to own this beautiful ring or give it as a present. Simply send \$1. *Examine ring on arrival.* If you don't agree it is an amazing bargain, your deposit will be returned. If you keep it, pay postman only \$1 and send \$1 a week until \$32.50 is paid. *Guarantee Diamond Bond* with each ring.

FREE catalog, Diamonds, Watches, Jewelry, \$10 to \$1,000. All on long credit. Wonderful values.

Est. 1890 Address Dept. 626

BAER BROS. Co.
6 MAIDEN LANE - NEW YORK



Fun,— with Education

There's nothing like having a "hobby" when it leads to worthwhile results. The use of Tools gives you that mental rest so necessary after hours of hard study. The Training, of doing any job you tackle well, is admirable discipline. The use of Good Tools is bound to make a good craftsman.

STANLEY Tool Assortments

The same tools that carpenters have used for years are now sold in Cabinets, Chests and Boxes.

No. 904 Cabinet is shown below.

Ask any hardware merchant to show you this cabinet, or write for Folder "9-F" illustrating many Stanley Tool Assortments.



The Stanley Rule & Level Plant

THE STANLEY WORKS
NEW BRITAIN, CONN.

New York Chicago
San Francisco
Los Angeles Seattle

STANLEY TOOLS

Please Mention Popular Mechanics



Retail price
—including
tax, \$15.

Stevens "Visible Loading."
An accurate .22 Cal. Re-
peater. You know when it
is loaded, and you know
when it is empty.

Summertime coming

*fishing — swimming —
tramping — shooting*

A Stevens .22 rifle will do a lot to make your vacation a success. For a Stevens rifle does a man's work.

That's the only kind of rifle you can have any fun with—one that shoots straight and can stand a little rough handling.

And a Stevens stands at the top when it comes to accuracy and endurance. When a Stevens barrel is bored or drilled, the final cutting removes less than one-half of a thousandth of an inch. Slow work—but it gives *lasting accuracy*.

And the same painstaking care is given to every detail—to getting a handsome finish; to striking just the right balance. Once you get the feel of a Stevens, you'll hate to lay it down.

The finish put on Stevens rifles and shotguns is exceptionally fine. From butt-plate to muzzle nothing has been left undone to make every Stevens firearm thoroughly good looking and durable.

Finally—the prices. Little short of amazing are the Stevens prices. You can't do better.

Ask at your dealer's or write for the interesting catalog describing the Stevens complete line of rifles and shotguns.

J. STEVENS ARMS COMPANY
Dept. 566 Chicopee Falls, Mass.

Owned and operated by the Savage Arms Corporation.

Stevens

Summer Home in Maine

A gentleman's estate of 175 acres on the Maine coast, with frontage on a lake 9 miles long; master's house; large bungalow; caretaker's house; large garage; barns; private electric light and inexhaustible water works, and every modern improvement. Forty acres very large trees. Golf and yacht clubs only a few minutes away; good markets in the town.

The scenery of mountains, lake and ocean is pronounced one of the best five in New England. House and bungalow both completely furnished; steam heat.

Place will be sold at a great bargain as owner can no longer use it.

Address OWNER

206 East Ontario Street CHICAGO, ILL.

\$3 Cash Buys Typewriter



Balance Only \$5 Monthly

Save 35 to 60% on all standard makes—Underwood, Royal, Remington, etc. Every machine thoroughly rebuilt and GUARANTEED. Try five days at our expense before you buy.

WRITE at once for Free Descriptive Circular and Special Low Prices.

5
DAYS
FREE
TRIAL

WYNN TYPEWRITER EXCHANGE 11 Reliance Bldg. Kansas City, Mo.



MONEY
IN
MUSHROOMS

NOW TIME TO START

BIG DEMAND. HIGH PRICES BEING PAID. An uncrowded occupation. Exceptional opportunities for live men and women. Raised at home. Only small space needed. Small expenditures will start you in a practical money-making enterprise. Big profits. Booklet telling all free. Write Nat'l Spawm Co., Dept. 12, Waban, Mass.

SEND NO MONEY 2 GENUINE DIAMONDS $\frac{4}{100}$ Each

Solid Gold
\$25

14 kt. White Gold Top.
Gold Emblem Inlaid
in Genuine

Hope Ruby

Can be had in all initials (Old English); also in all lodge emblems, including American Legion. Send size of finger and ring will be sent for inspection.

Buffalo Jewelry Mfg. Co., "The Mail-Order House"
Dept. P-5, Brisbane Bldg., Buffalo, N. Y.



D J G M S W Any Letter

This Reg. Trade Mark guarantees you genuine diamonds.

STOP Paying the Penalty OF HIGH PRICED LAND

Whether you are a tenant farmer, longing to own a farm home of your own, or a farm owner handicapped by a need of more land or capital, you are fighting with the odds all against you. The high-priced lands around you will forever hold you down—for those fine producing acres are not going to be given up cheaply. The conditions that have held you back are changed. The Canadian Pacific Railway now offers you a farm home on a long term plan of easy payments that is remarkable. But you must act now!

Your Big Opportunity

Act now. You can still secure good farm lands in the rich open prairies or fertile park lands of the Lloydminster and Battleford districts of Central Alberta and Saskatchewan, or in Manitoba for an average of about \$18 an acre—the lowest prices at which good farm lands on the North American continent will ever be offered. This land is ideal for mixed farming as well as grain growing.

TWENTY YEARS TO PAY

All you have to pay down is ten per cent of the purchase price, balance in nineteen annual installments with interest at six per cent. But, if you purchase under settlement conditions, which require occupation and reasonable improvements, there is no further payment of principal until the end of the fourth year, and besides this the interest for the first two years will be only two per cent per annum, balance of interest at six per cent and the principal divided into sixteen equal annual payments. Taxes are moderate and there are no taxes on your livestock, buildings, improvements, implements, or personal effects. Good markets, modern schools, roads, churches, amusements, make farm life here desirable and attractive.

—No taxes on Improvements

Own Your
OWN FARM
in WESTERN
CANADA—
This offer
makes it
EASY

Be a Home-maker Special Home- seekers' Rates

Reduced railway fares for homeseekers make inspection easy. You can also secure free, illustrated pamphlets full of facts and government figures about land values, acreage yields, climate, Western Canada's farm achievements of the past and its possibilities of future development, and setting out in detail plans of selling farms to settlers on easy payment terms.

You Can't Buy Until You Have Investigated

You must be satisfied and have every question answered before taking up your farm home. There is time now for thorough, careful investigation, but do not delay in deciding to investigate. Send the coupon today for full information.

M. E. Thornton, Supt. of Colonization
CANADIAN PACIFIC RAILWAY
966 First St., E., Calgary, Alberta, Canada

M. E. Thornton, Supt. of Colonization
CANADIAN PACIFIC RAILWAY
966 First Street E. Calgary, Alberta

I am interested in learning more about:

- Prairie Provinces of Canada
 Irrigation farming in Sunny Alberta
 Business and Industrial Opportunities in Western Canada
 Lloydminster and Battleford Districts

My Name.....

Address.....

Town..... State.....

A NEW WAY TO GET YOUR CLOTHES ABSOLUTELY FREE

and Make Big Money during your spare time—something different, better, bigger, more liberal than any offer ever made. Lower prices—better clothes—bigger cash profits—express or postage paid on everything.

DOUBLE PAY

Free Clothes and Cash Profits Besides. You can easily earn \$50.00 cash, extra, every week during your spare time, taking orders for our made-to-measure clothes. We don't ask you to use your cash profits for your own clothes. That's not our way of doing business. Ours is a new and better plan.

Fifty-six styles, real cloth samples—FREE colored fashion plates; inside wholesale prices—everything FREE. Just drop us a line today and we will send complete outfit FREE.

SPENCER MEAD CO., Dept. T-245, Chicago



Are You the Man?

Here is your opportunity to establish a business or increase your profits. We need men in every locality to maintain a selling and installing agency for the Sager Metal Weatherstrip.

Not necessary to be a mechanic, but must be a good salesman. Sager Metal Weatherstrips reduce the coal bill $\frac{1}{2}$; therefore the demand is universal. It is easy to hire mechanics for installation.

We furnish prospects as well as advertising literature. It is an unusual opportunity—Are you the man?

ACT NOW—Write Today

Sager Metal Weatherstrip Company
160 W. Austin Ave., Chicago



Do Your PRINTING

Cards, circulars, labels, tags, book, menus, paper, Press, \$12. Larger \$35. Job Press \$150 up. Save money. Print for others. BIG PROFITS. All easy, rules sent. Write factory TODAY for press catalog, TYPE, cards, paper. THE PRESS CO. D-37, MERIDEN, CONN.

The
Prophy-lactic

is the

ONE Tooth Brush in universal
use today—everywhere



The Lightest,
Speediest and
Most Durable
Outboard
Motor in the
World.

Almost as Easy to Carry as a Pair of Oars

Makes a speedy power boat or pleasure launch of any boat or canoe. A boy or girl can handle it. The whole family enjoy it. 2 H.P. Twin Cylinder.

Weighs Only 35 Lbs.

15 to 50 pounds less than usual, yet guaranteed more durable. Has real carburetor, real magneto—no batteries to carry—spark and throttle control like auto, instant reverse, self tilting and ten other valuable features. Write for Free Catalog folder today.

JOHNSON MOTOR COMPANY

904 Sample Street

South Bend, Ind.

EASTERN OFFICE—120 Broadway, New York City

Johnson

"WATER-BUG"

THE LIGHTEST, LIVELIEST BOAT MOTOR ON THE WATER.

Use Insyde Tyres



Positively prevent punctures and blow-outs. Give double tire mileage, any tire—old or new. Use over and over again. Old worn-out casings will give three to five thousand miles more service. Car owners save \$50 a year. Over one hundred thousand satisfied customers. Low priced. Special representatives wanted.

AMERICAN ACCESSORIES CO., B-1276, Cincinnati, Ohio

Drive 100 Tacks and Save \$25.00

Ford Top Re-covering \$6.20, \$6.95 and \$9.50. Chevrolet, Dodge or Maxwell, \$18.95. All other 5 passenger cars \$16.50 with plate glass lights. Side curtains that open with doors \$11.50 up. Seat covers \$3.15 up. Quality the best and guaranteed to fit. Printed instructions given how to apply. Send for samples. Prices above include delivery at your door. Eastern orders shipped from Ohio. **AUTO EQUIPMENT CO., 1055 So. Broadway, LOS ANGELES, CALIF.**

\$520 up
Delivered

Dad! I can run her—



YOUR boy will be proud when he meets "Dad" for the first time with the new **WATERFORD**. Mother and the children will enjoy their summer this year if you provide them with this sturdy, reliable motor boat that they can run in absolute safety—over rocks, snags or in shallow water. Your week-end at the cottage will be a delight—you can reach the spot where they're biting without tiresome oar work.

Write today for the story of this wonderful boat "1500 Miles in Canadian Wilds."

DISAPPEARING PROPELLER BOAT CORPORATION
331 Robinson St. North Tonawanda, N. Y.

WATERFORD

The Disappearing Propeller Boat

CAILLE

PRONOUNCED "GAIL"

LIBERTY MOTOR

THE only rowboat motor that will drive your boat through weeds almost impassable—the only motor that will drive your boat well up on shore when landing—the only motor that rises over rocks and sunken logs while maintaining full power ahead—the only motor that can be attached to boat on shore when starting out. Provides plenty of power, is easily carried and has motorcycle control. No motor, regardless of price, can give you greater service. And a Caille Liberty Motor costs you but \$75.00 complete. Why pay more? Send for catalog and name of nearest dealer.

THE CAILLE PERFECTION MOTOR CO.
6218 2nd Boulevard Detroit, Michigan



\$75.00
Complete
Ready to Run

AUTOMATIC TIMER

for Ford Cars—positively prevents all timer trouble—**Automatically** gives proper spark for all speeds—Does away with spark lever. Back-kick practically impossible—No more broken arms or ruined starting systems—saves gasoline, gives more power—easier starting—steadier pulling. Sold on money back guarantee—Every Ford owner will buy at \$3.50. Agents wanted. Big profits. **AUTO SUN PRODUCTS CO., Dept. 47, Cincinnati, O.**



MOTORCYCLES

RELIABLE STANDARD MAKES that you can **DEPEND ON.**

Enjoy the glorious experience of going wherever you like—whenever you like. The price is within your means—35% to 50% less than others. These machines are slightly used, thoroughly overhauled or rebuilt. Send for catalogue.

MYEROW BROS.,
258 Columbus Ave., Boston, Mass.

MOTORCYCLE BARGAINS

Save 25% to 65%

on Slightly used and Rebuilt Motorcycles, Side Cars, Johnson Motor Wheels, Evans Power Cycles, Bicycles. Send for Free Bargain Bulletin and Money Saving Message, listing hundreds of Bargains in used, rebuilt and new machines, supplies, accessories, etc.

AMERICAN MOTOR CYCLE CO.,
Dept. 623 2047 W. Chicago Avenue, CHICAGO

Only \$45.00 For This Job Complete

Save exorbitant freight rates and one-half origin loss by buying Ford Speedster Bodies knocked-down. Simple, complete instructions furnished, all parts cut to exact fit. Anyone can assemble this job. Complete with hood, radiator shell, instrument board, upholstery, metal parts, wood parts, bolts, screws, etc. Flat radiator shell furnished made up. Designed low with lack of wind resistance. Price set up \$90, further particulars on request.

The Central Auto Supply Co. Eng. Des. 126, Louisville, Ky.



"Old Town Canoes"



Blue Sky and Silvery Water

WONDER days, when the sky is blue and the stream is calm, and you and she are idly drifting over the placid water.

The faintest dip of the blade keeps you moving. For an "Old Town" is the easiest canoe to paddle. The lightest canoe made—the steadiest, strongest and lowest priced, too! \$54 up from dealer or factory. Every one is patterned after a real Indian model.

The free 1923 catalog shows all models in full colors. Write for one to-day.

OLD TOWN CANOE CO.

1366 Middle St., Old Town, Maine, U. S. A.

MAKE OVER \$800.00 MONTHLY



Owning and operating an Anderson Vulcanizer which vulcanizes tires 3" to and including 5". You can vulcanize the smaller tires in all three molds. We guarantee no other vulcanizer will properly cure as many tires daily as the Anderson. It will do \$160 worth of work daily and will keep 8 men busy. You can run it ten hours daily, six days a week, for less than you can any other make, half a day. An Anderson School is near you.

ANDERSON STEAM VULCANIZER CO.
Popp-Williams Bldg. Indianapolis, Ind.



Catch Fish, minks, muskrats and other fur-bearing animals, in large numbers, with our new, Folding, Galvanized Steel Wire Trap. It catches them like a fly-trap catches flies. Made in all sizes. Strong and durable. Write for Descriptive Price List, and our Free Booklet on best bait known for attracting all kinds of fish.
J. F. GREGORY, Dept. 24, Lebanon, Mo.

In Strange Country

You don't need to know the ground if you pack one of the nine styles of Taylor Compasses—reliable guides that take you anywhere.

At your dealer's—ask him for prices.



TAYLOR COMPASSES



Taylor Instrument Companies
ROCHESTER, N. Y.

There's a Taylor Compass for Every Purpose



3 H.P. Fast Light Twin
"As light as right"

Lightest per H. P. —with double the bearing surfaces

ALTHOUGH the ELTO is a light weight motor—the lightest outboard motor per horse-power—it is built around big bearings—bearings twice as big as those of all other motors in the light weight class. And the life of any motor is in the bearings!

A Full Extra H. P.

The ELTO has an Extra Horse-power—3 full H. P. It is the only 3 H. P. light weight motor. It is by far the fastest motor. And while it is light, it is only as "light as right" with not an ounce of useless weight. Ole Evinrude, while bringing the weight of his perfected light twin down to easy portability, would not do so at the slightest sacrifice to safety, needed power or durability.

Instant Starting

Because there could be no relief from hard, stubborn and uncertain starting, without change of ignition. Ole Evinrude made the change. The ELTO starts on the first quarter turn under all conditions. No ropes or starting devices needed.

Safe Rudder Steering

—no possibility of dangerous pivot turning. No shaking steering handle. Tiller line steering from any part of the boat. Hands free except at turns.

Enlightning Information

Write us for ELTO Catalog—a book packed with interesting facts and illustrations which will show you how to judge outboard motor values.

Dealers and Demonstrating Agents—a fine proposition awaits you in open territory. Write today!

ELTO
Outboard Motor Co.
Dept. AA Manufacturers Home Bldg.
Milwaukee, Wis.



**FREE**

*A Vitalic
Bike Cap to
boys who
will write
for it.*

"Why Don't You Use VITALICS?"

"Mine are Six Years Old"

Boys tell us how their Vitalics resist punctures, and wear and wear for years. Stand the hard use that only boys know how to give tires. Their letters are the best evidence we have of Vitalic quality.

Such records of service and long lasting qualities are the kind of proofs that count most with buyers of tires.

And when such makers as Excelsior, Iver Johnson and others specify only Vitalics as standard equipment for their finest bicycles, is it any wonder that boys for years have preferred them.

For real endurance no tires equal Vitalics. "Tougher than Elephant Hide" is a slogan that thousands of boys have proven for themselves.

Whether it is on the new bicycle, or for the old—insist on Vitalics.

Continental Rubber Works
1944 Liberty Street Erie, Pa.

VITALIC Bicycle Tires



"TOUGHER THAN ELEPHANT HIDE"

DELTA

ELECTRIC BICYCLE LAMPS



Home from Work After Dark

With a Delta Electric Bicycle Lamp on your bike—you are protected from approaching automobiles, either front or rear, you can also see the road one hundred feet ahead. Ride in safety while others walk. Model 80 complies with all laws. Fits any bicycle instantly—under axle nut front left side.

Ask your dealer or sent prepaid for \$2.25 complete (less battery).

DELTA ELECTRIC COMPANY
100 Delta Block Marion, Indiana

Standard makers of Electric Lanterns,
Radio Headsets, Bicycle Lamps, and all
kinds of Dry Batteries.

New York San Francisco Winnipeg



MARION
ELECTRIC PRODUCTS
KNOWN BY THEIR PRODUCTS

MARVEL-O

Will keep the enameled finish of your automobile bright as new. Contains no oily ingredient, bees wax, acids or harsh abrasive. Is unequalled. Send name of your accessory dealer and \$1 for full size 16-oz. can.

MARVEL-O MFG. CO., San Diego, Calif.



You Can Save \$35.00



\$4.45 and up

Parcel Post Paid

Recover your old auto top frame yourself. Custom tailor made to fit all makes and models of cars. Any person that can drive a car can put it on. Roof and quarters sewed together, with rear curtain, fasteners, welts and tacks complete. Give name, year and model number of your car and we will send you catalog with samples.

LIBERTY TOP & TIRE CO., Dept. E-7, Cincinnati, O.

Las-Stik

—the ORIGINAL Patch with a 5-in-1-6-in—

The White Tube Patch That never fails

This white tube patch adheres instantly because made of pure para rubber, that stretches with the tube and can't creep or tear out even if tube is over-inflated. You can patch a pinhole or a seventeen inch blowout and the joint will become stronger than the tube itself.

Complete outfits 50c and \$1.00

LAS-STIK PATCH MFG. CO., Hamilton, Ohio



Try It In Your Own Home

You may now have any musical instrument for a week's trial in your home at our risk. No obligation to buy. Return the instrument at our expense at the end of a week if you decide not to keep it. The trial will not cost you a penny.

Convenient Monthly Payments

A few cents a day will pay. Special combination offers on complete musical outfits—velvet lined case, all accessories, self-instructor, etc.—everything you need at practically the cost of the instrument alone.

Send Coupon for New Catalog

Every known instrument illustrated, many in full colors. Also prices, easy terms and free trial blank. Catalog absolutely free. Write today.

The Rudolph Wurlitzer Co., Dept. A177
 117 East 4th St., Cincinnati — 229 S. Wabash Ave., Chicago
 120 W. 42nd St., New York — 250 Stockton St., San Francisco

Send me your new catalog illustrated in color with full details of Wurlitzer free trial and easy payment offer.

Name _____
 Address _____

(State instrument you are specially interested in)

WURLITZER
 200 YEARS OF MUSICAL INSTRUMENT MAKING
 Cincinnati Chicago New York San Francisco
 Copyright 1930, Rudolph Wurlitzer Co.



Steady Work

in a fast growing business with Vanderpool Latest Improved Vulcanizer. Made in America.

Ask for Catalog
Vanderpool Co. Springfield, O.

F. H. DIBB, Agent for British Isles
 26 Fairfield Rd. Winchester, England



\$25 A DAY Selling Shirts

Large shirt manufacturer wants agents to sell complete line of shirts, pajamas, and night shirts direct to wearer. Advertised brand—exclusive patterns—easy to sell. No experience or capital required. Entirely new proposition. Write for free samples.

Madison Shirt Co., 503 Broadway, N. Y. C.

HANDS BADLY SOILED?

You can wash them clean quickly with



GIT HAND PASTE

GIT MFG CO
 WILMINGTON, MASS

10¢ at F.W. Woolworth Co., McCrory and other stores

\$\$ for Photoplay Ideas

Don't send your manuscripts to studios until first protected by copyright. Plots accepted in any form; revised, criticised, copyrighted, marketed. We are right on the ground in daily touch with the studios. Not a school—no courses or books to sell. Advice free.

UNIVERSAL SCENARIO CORPORATION
 938 Western Mutual Life Bldg., Los Angeles, California
 Publishers SCENARIO BULLETIN-DIGEST Send for free sample copy



\$4.00 Adding Machine

The Gilson Adder will do your figuring easily, quickly and with absolute accuracy. Capacity 100,000,000 or \$1,000,000.00. It adds, subtracts, multiplies and divides and automatically carries from one column to the next. Made with aluminum case and steel operating parts, size 3 1/4" x 6" x 1 1/4". Written Two-Year Guarantee. Catalogue Free. Price, postpaid, \$4.00.

Your money back if you are not satisfied.

Gilson Slide Rule Co., Niles, Mich.

UNION FUSE BLOCK

\$1.50 Saves Your FORD

This small investment in a "Union" Fuse Block protects your Ford. In case of a grounded wire—often causing fire—a fuse blows instantly, preventing your wiring, and your Ford from burning up. Also puts an end to flickering lamps—binding posts bolted rigidly into fibre prevent that. Permits use of regular single-filament lamps for bright and dim lights.



SENT POST-PAID FOR \$1.50 if not at your dealer's. Money back if not satisfied. Write for Booklet.

CHICAGO FUSE MFG. CO.
 1503 West 15th Street, CHICAGO, ILL.
 Eastern Branch: New York

BIG PROFITS in 8 HOUR

Battery Charging



\$30 Monthly Pays for Your Outfit

8 Hour Constant Potential Battery Charging - Pays Big!

New HB Constant Potential System charges all sizes of auto batteries perfectly in 6 to 8 hours, while old systems take 2 or 3 days. You can clear \$150 to \$300 every month. No experience needed. HB Outfit comes complete, ready to connect to service lines and operate. Universal demand for quick, dependable battery charging means big business and steady profits for you.

\$30 Monthly Pays for Your HB Outfit

Small cash payment brings your HB 8 Hour Charging Outfit. Easy terms of only \$30 monthly let your profits pay balance, with nice surplus besides. Long free trial on money-back guarantee lets you try outfit at our risk. Don't delay and let some competitor get ahead of you with 8 Hour Battery Charging. Take the lead yourself. Order your HB Outfit NOW on free trial. Write today for full information and our easy-payment plan.

HOBART BROS. CO. Box M 6 Troy, Ohio
Your Satisfaction Guaranteed or Money Back

Small Cash Investment - Increased Profits Carry Balance

Roofing Book FREE



World's Best Roofing at Factory Price

Don't buy Roofing of any kind until you get our big Free Roofing Book, describing full line of Edwards Famous "Tightote" Galvanized Roofings, Sidings and Ceilings, and our lowest factory prices. Then see for yourself how much we save you by selling direct and saving you all in-between dealers' profits.

EDWARDS "REO" Metal Shingles

Absolutely rust proof. By our patented "Tightote" process, edges as well as sides of metal sheets are heavily coated with zinc—not a space the size of a pin point exposed to weather. Fire and lightning proof. Outlasts three ordinary roofs. Forever wind and weather proof. Need no repairs—and all roofing expense. Patent INTERLOCKING DEVICE makes water tight seams—all nail heads covered—no chance for rust or leaks.

EDWARDS Galvanizing Test

Edwards "Tightote" Galvanized Roofing can be bent, twisted or struck by lightning, and the galvanizing will not crack or flake. Bend it or hammer it—you can't loosen or scale the galvanizing. No other galvanized roofing can withstand this test.

Low Priced Garages



Wide variety of styles, all sizes of Portable Fireproof Metal Garages. Lowest prices ever made. Postal brings Big Garage Catalog free.

Write Today for free samples and proof that we can save you a lot of money on any kind of roofing siding or ceiling you may need. Ask for Roofing Book No. 150.

THE EDWARDS MFG. CO.,
600-650 Pike St., Cincinnati, O.



SEND NO MONEY

If You Can Tell it from a GENUINE DIAMOND Send it back

To prove our blue-white MEXICAN DIAMOND cannot be told from a GENUINE DIAMOND and has same DAZZLING RAINBOW FIRE, we will send a selected 1 carat gem in ladies Solitaire Ring. (Cat. price \$5.25) for Half Price to introduce, \$2.63, or in Gentle Heavy Tooth Helcher Ring (Cat. Price \$4.50) for \$2.25. Our finest 12k Gold Filled mountings. GUARANTEED 20 YEARS. SEND NO MONEY. Just mail postcard or this ad, State Size. We will mail at once. When ring arrives deposit \$2.63 for Ladies ring or \$3.25 for Gentle with postman. If not pleased return in 3 days for money back less handling charges. Write for Free catalog. Agents Wanted. **MEXICAN DIAMOND IMPORTING CO., Dept. ET-Las Cruces, N. Mex.** (Exclusive controllers Mexican Diamonds)

65% Have This Gland Trouble - At Middle Age



Do you suffer with sciatica, pains in back, legs or feet, frequent nightly risings, bladder or kindred trouble; have you lost the old pep and aggressiveness; do you have blues or mental depression?

Scientists and medical authorities agree that 65% of all men past a certain middle age (thousands younger) have a disorder of the prostate gland, often responsible for these annoying conditions.

Simple Home Treatment

But a new treatment has been discovered by a member of the American Association for the Advancement of Science. Already over 10,000 men have used this method with astonishing success. It has saved many of them from the surgeon's knife. Yet the method is so simple that it can be used by anyone—no drugs, lessons, electric rays. Nothing to pay unless you get immediate relief. If you have prostatic trouble, or any of the symptoms mentioned,

Free Book send immediately for a Free Book, "Why Many Men Are Old at 40," which tells all about this method—and the truth about glands. No obligation. Just give name and address. Write immediately to **The Electro-Thermal Company, 2122 Main Street, Steubenville, Ohio.**

"BOW LEGS and KNOCK-KNEES" UNSIGHTLY



SEND FOR BOOKLET SHOWING PHOTOS OF MEN WITH AND WITHOUT THE PERFECT LEG FORMS

PERFECT SALES CO.
140 N. Mayfield Ave., Dept. S, Chicago, Ill.

Indoor Sanitary Toilet



Shipped on approval. Write for our remarkable rock-bottom factory offer on COMFORT Indoor Toilet. No sewers, cesspools needed. No plumbing. Set up anywhere. Absolutely odorless. Sanitary. Chemicals consume matter and kill germs. Health authorities endorse. High grade white enamel. Send for literature.

AGENTS Get our terms. Exclusive territory. Wonderful opportunity for you to coin money.
ROBINSON HOUSEHOLD MFG. CO.
Room 809 Cherry and Huron Sts., Toledo, Ohio

PATENTS TRADE-MARKS AND COPYRIGHTS

SPECIAL OFFER — Free Opinion as to Patentable Nature

Before disclosing an invention, the inventor should write for our blank form "Record of Invention." This should be signed and witnessed and if returned to us together with model or sketch and description of the invention, we will give our opinion as to its patentable nature.

Our Three Books Mailed FREE to Inventors

OUR ILLUSTRATED GUIDE BOOK

HOW TO OBTAIN A PATENT

Contains full instructions regarding Patents, Trade-Marks, Foreign Patents, Our Methods, Terms, and 100 Mechanical Movements illustrated and described; Articles on Patent Practice and Procedure, and Law Points for inventors.

OUR TRADE-MARK BOOK

Shows the value and necessity of trade-mark protection and gives information regarding Trade-Marks and unfair competition in trade.

OUR FOREIGN PATENT BOOK

We have direct agencies in all foreign countries and secure foreign patents in the shortest possible time and at the lowest cost.

LIST OF PATENT BUYERS SENT FREE

IDEAS WANTED: Send for LIST OF PATENT BUYERS containing unsolicited letters from Manufacturers and others WISHING TO BUY meritorious patents. There is a great demand for NEEDED INVENTIONS. We endeavor to assist OUR clients in the commercial development of their inventions.

SPECIALIZATION—OUR STAFF

The field of invention is so vast that it is impossible for any one man to become an expert in all classes of invention. For this reason we employ a number of patent lawyers and mechanical experts selected for their special knowledge and ability in certain lines of invention.

THE VALUE OF YOUR PATENT

depends on the skill and care with which your case is prepared and prosecuted in the United States Patent office. That every case receives our best efforts, and that our work is done skillfully and thoroughly, is evidenced by the many unsolicited letters of commendation that we receive constantly from our clients. We will furnish upon request lists of clients from any state in the Union for whom we have secured patents.

Our New York, Philadelphia, Pittsburgh, Chicago and San Francisco Offices

We have established for the benefit of our clients Branch Offices in New York City, Philadelphia, Pa., Pittsburgh, Pa., Chicago, Ill., and San Francisco, Cal. These branch offices located in these large commercial cities together with our Main Office located near the U. S. Patent Office, in Washington, enable us to more promptly handle the business of our clients, particularly as the branch offices are in constant touch with the Main Office.

Highest References — Prompt Attention — Reasonable Terms

--- FREE COUPON ---

VICTOR J. EVANS & CO., Patent Attorneys

NEW YORK OFFICES
1007 Woolworth Building

CHICAGO OFFICES
1114 Tacoma Building

PHILADELPHIA OFFICES
714-715 Liberty Bldg.

PITTSBURGH OFFICES
514 Empire Building

SAN FRANCISCO OFFICES
Hobart Building

MAIN OFFICES: 765 9TH STREET, N.W., WASHINGTON, D. C.

Gentlemen: Please send me FREE OF CHARGE your books as described above.

Name Address

PATENTS

*Seventy-six
Years of Practice*

THE firm of Munn & Company filed its first application for a patent in 1846, and for seventy-six years has endeavored to keep pace with the inventive genius of the United States.

An experience of many years is at your disposal. If you have an invention which you wish to patent, send your sketches or model together with a description of your device, explaining its operation, and you will receive prompt, courteous attention.

*Write for our Handbook on
PATENTS*

A full and complete booklet on Patents, Designs, Trade-Marks, Foreign Patents, Copyrights, Labels and Patent Office Practice with an explanation about our methods, terms, etc.

All communications strictly confidential.

Keep in touch with the inventions of the world by reading

SCIENTIFIC AMERICAN

The MONTHLY MAGAZINE with a special appeal to every man of inventive genius. Recent rulings of the Patent Office, descriptions of the latest patented inventions, legislation and court decisions affecting patents, are noted in this authoritative publication.

MUNN & COMPANY

Patent Attorneys

672 Woolworth Building, New York City

Scientific American Building, Room 2
625 F Street, Washington, D. C.

Suite 801, Tower Building, Chicago, Ill.
601 Hobart Building, San Francisco, Cal.

Please Mention Popular Mechanics

U.S. PATENTS



**SEND FOR
THIS FORM**

DON'T LOSE YOUR RIGHTS TO PATENT PROTECTION

Before disclosing your invention to anyone send for blank form "EVIDENCE OF CONCEPTION" to be signed and witnessed. A sample form together with printed instructions will show you just how to work up your evidence and establish the same before filing application for patent. As registered patent attorneys we represent hundreds of inventors all over the United States and Canada in the advancement of inventions. Our schedule of fees will be found reasonable. The form "Evidence of Conception," sample, instructions relating to obtaining of patents and schedule of fees sent upon request. Ask for them—a post card will do.

PATENTS AND TRADE MARKS

LANCASTER & ALLWINE

480 Ouray Bldg. Washington, D. C.
Originators of forms "Evidence of Conception."

Have You An Invention?

If so the WORLD PROGRESS will show you how to **PROTECT AND PROFIT FROM YOUR IDEAS**

This magazine is devoted entirely to the interests of Inventors. Sample copy free. One year's subscription \$1.00. Also send for free book.

"WHAT TO INVENT"

containing SUGGESTIONS TO INVENTORS from prominent inventors and scientists of Inventions Needed. We invite manufacturers and promoters to address us regarding any inventions or patents they may want.

WORLD PROGRESS PUB. CO., Inc.
Room 203 Victor Bldg. WASHINGTON, D. C.

PATENTS Secured

Prompt service. Avoid dangerous delays. Send for our "Record of Invention" form and Free Book telling How to Obtain a Patent. Send sketch or model for examination. Preliminary advice without charge. Highest references. Write TODAY. Jacobi & Jacobi, 410 Ouray Bldg., Washington, D. C.

PATENTS As one of the oldest patent firms in America we give inventors at lowest consistent charge, a service noted for results, evidenced by many well known Patents of extraordinary value. Book, Patent-Sense, free. Lacey & Lacey, 646 F St., Wash., D.C. Estab. 1869.

PATENTS **C. L. PARKER**
Formerly Member Examining
Corps, U. S. Patent Office
PATENT LAWYER
MCGILL BLDG.
WASHINGTON, D. C.

Patents, Trade Marks, Copyrights, Patent Litigation
Handbook for Inventors, "Protecting, Exploiting
and Selling Inventions," sent free upon request.

Copyrighted material

CLARENCE A. O'BRIEN

PATENT ATTORNEY

REGISTERED IN UNITED STATES PATENT OFFICE

MEMBER OF THE BAR OF

SUPREME COURT OF UNITED STATES COURT OF APPEALS DISTRICT OF COLUMBIA

SUPREME COURT DISTRICT OF COLUMBIA UNITED STATES COURT OF CLAIMS

PRACTICE CONFINED TO PATENTS AND TRADE MARKS

EXPERIENCE

SERVICE

Protect Your Ideas

Any new article, machine, design or improvement thereof, or any new combination of parts or improvements in any known article which increases its efficiency or usefulness, may be patented if it involves invention.

If You Have Any New Ideas

which you feel are useful, practical and novel, take prompt action toward protecting your rights. If you have invented any new machine, or new combination of parts or improvements, or new process or design, send drawing, model or description of it for information as to procedure to secure protection.

Write today for Blank Form

"Evidence of Conception"

to be returned to me with drawing, description or model of your idea. Promptly upon receipt by me of your idea I will write you fully as to procedure and costs.

No Charge for the Above Information

All communications are held in strict confidence. My personal, careful and thorough attention is given to each case. I offer you efficient, reliable and prompt service —based upon practical experience. *Highest references.*

Write today for free book, "How to Obtain a Patent." This book will give you valuable information, and it may save you much time and effort. Send for it NOW.

My practice is devoted exclusively to United States and foreign patents and trade-marks. Very probably I can help you. Write today.

CLARENCE A. O'BRIEN

Registered Patent Attorney

1700 Southern Building Washington, D. C.

CLARENCE A. O'BRIEN, 1700 Southern Bldg.,
Patent Attorney, Washington, D. C.

Please send me your free book, "How to Obtain a Patent," and blank form "Evidence of Conception" without any obligation on my part.

Name.....

Address.....

(WRITE CLEARLY)



SCIENCE

INVENTION

INDUSTRY

ECONOMY

EFFICIENCY

INITIATIVE

INVENTORS

PROFIT FROM YOUR OWN IDEAS. We show you how. Thousands of men, and women, too, have ideas that would bring in fortunes if properly developed and protected.

HAVE YOU AN IDEA FOR THE IMPROVEMENT OF ANY THING? HAVE YOU AN IDEA OF SOMETHING ENTIRELY NEW? The smallest improvements, or new ideas, sometimes bring the biggest fortunes.

Can you think of a simple, practical idea that will fill one of the many requests we have on file for new inventions? Thousands of things are needed, NOW.

WE SHOW YOU HOW TO PROTECT YOUR IDEA; HOW TO GET THE MOST OUT OF IT.

SEND FOR THIS FREE BOOK

Tells you all you want to know about inventions, patents and trade marks. Valuable information. Patents advertised, for our clients, free, in "INVENTION and MANUFACTURING," a magazine for inventors, for the man with an idea. (One year's subscription 50c.)

A postal will do; but **DO IT NOW; IT MAY MEAN THE STEPPING STONE TO FUTURE SUCCESS.**

AMERICAN INDUSTRIES, Inc.
517 KRESGE BUILDING, WASHINGTON, D. C.



PATENTS

Booklet Free

Highest References

Promptness Assured

Best Results

Send drawing or model for preliminary examination

ALL BUSINESS GIVEN PROMPT AND PROPER ATTENTION

WATSON E. COLEMAN, Patent Lawyer, 624 F St., Washington, D. C.

PATENTS If You Have an Invention and Desire to Learn How to Secure a Patent

Send for our Guide Book, **HOW TO GET A PATENT**, sent Free on request. Tells our terms, methods, etc. Send model or sketch and description of your invention and we will give our opinion as to its patentable nature.

RANDOLPH & CO.
600 F St., N.W., Washington, D. C.

NAME.....

STREET.....

CITY.....STATE.....

WANTED IDEAS



Inquiries from Manufacturers and Others Who Are Looking for Good Ideas

PROTECTED BY PATENTS

are constantly being received. Manufacturers are always interested in any new device for which there is a market, which fills a long felt need, which makes production possible at a lower cost, or which will do the work BETTER. There is undoubtedly a great demand today for really worth while inventions.

Your First Step

If you have an idea, send immediately for my blank form "TO RECORD YOUR INVENTION." You should serve your own best interests by filling out and signing this form before you disclose your invention TO ANY ONE. This document will help you determine and establish evidence of invention before filing an application in the U. S. Patent Office. A copy, with full instructions, will be gladly sent free on request.

NEW BOOK "SUCCESSFUL PATENTS" SENT FREE

Every man who has an invention, or ever hopes to have one, should send for a copy of my book "SUCCESSFUL PATENTS." It tells what everyone should know about patents, trademarks, copyrights, etc. It describes my methods, fees and terms, gives information relative to assignment or sale of rights, and instructions in detail. Mail coupon today for a free copy of this book or a post card request will do.

To the Man with an Idea

I offer a comprehensive, experienced, efficient service for his prompt, legal protection, and will endeavor to aid him in the commercial development of his proposition—my service is distinguished by over 12 years' successful practice, and by thousands of satisfied clients and by reasonable fees.

Send sketch, or model, and description, for advice as to cost, opinion as to its patentable nature, etc. Preliminary advice gladly furnished without charge.

-----COUPON-----

RICHARD B. OWEN, Patent Lawyer

Main Office, 9-303 Owen Bldg., Washington, D. C.

Branch Office, 2276-E Woolworth Bldg., New York City.

Please send me, without charge, or other obligation, a copy of your book, "SUCCESSFUL PATENTS," your form "TO RECORD YOUR INVENTION," and information concerning patents, etc.

Name.....Address {

How to Invent

Edison Says "Invention is a Science and should be taught as a Profession"

One Idea May Win You a Fortune

THOUSANDS of inventions are needed today. Just one little idea can bring you fortune and fame. The world is waiting for new inventions in engineering, chemistry, household articles, radio, and other fields—and will pay big money for even the simplest idea.

Little things like the tin bottle cap, the crimped hairpin, the rubber on the end of a pencil brought their inventors hundreds of thousands of dollars.

Couldn't you make some equally simple invention? Haven't you ideas that could be turned into money? Inventing isn't a matter of blind luck—it isn't a question of guesswork. Invention is based on certain principles, just as any other profession. It follows a definite course of procedure step by step from the origination of the first idea to its final development on a commercial scale.



Learn at Home in Spare Time

Hitherto, every inventor had to work out these principles of invention for himself. For every successful inventor knows and uses these principles. He knows WHAT TO INVENT and HOW TO INVENT. But now you can learn in a few months what it took great inventors years of discouragement and terrific struggle to acquire. Fifteen famous inventors have now revealed, for the first time, the secrets of invention. They explain how to originate ideas, how to develop and perfect your ideas, how to patent your inventions, and how to sell them to your best advantage. In short, they make it amazingly easy for you to become an inventor, simply by learning the whole wonderful science of invention, step by step, from beginning to end. It requires just fascinating moments of your spare time at home.

First Course of its Kind

This is the first course in practical invention that has ever been devised. Now you can take Edison's advice and actually learn HOW TO INVENT—how to make invention a profession! In simple, easy-to-understand language, you are told how successful inventors work; you learn how to use the secrets of invention that convert a simple little idea into money.

FREE New Book on Inventive Science

A wonderful new book has just come from the press that tells all about the Science of Invention; that shows how great inventors work, how little ideas have made fortunes; how you too can easily learn the secrets of successful invention. This fascinating book will be sent free to all those who are genuinely interested. Send for this book today, as only a limited number are available for free distribution. Write your name and address on the coupon below, or send a post card NOW! There is no cost or obligation.

BUREAU OF INVENTIVE SCIENCE
Dept. 36 Wisner Building, Rochester, N. Y.

Bureau of Inventive Science,
Dept. 36 Wisner Building,
Rochester, N. Y.

Please send me your free book, "The Science of Invention."

Name.....

Address.....

City..... State.....



Get This Wonderful Ring. If You Can Tell It From a Genuine Diamond Send It Back

These amazing, beautiful CORODITE diamonds positively match genuine diamonds in every way—same blinding flash and dazzling play of living rainbow fire. They, alone, stand the diamond tests, including terrific acid test of direct comparison. Lifetime experts need all their experience to see any difference. Prove this yourself.

Wear a Corodite Diamond 7 DAYS FREE

Make this test. You risk nothing. Wear a genuine Corodite and a diamond side by side on the same finger for 7 days. If you or your friends can tell the difference, send it back; you won't be out a single penny. That's fair enough. If you keep the ring, price printed here is all you pay. No installments. Remember, Corodites alone have the appearance of genuine stones.

No. 1—Ladies' Solitaire 14K Gold S. Ring \$2.84

No. 4—Ladies' Hand-Carved Basket Setting, Plat. Finish \$3.96

No. 5—Ladies' Solitaire Bridal Blossom Engraved \$3.54

No. 6—Gents' Massive Hand-Carved Green Gold Gypsy \$4.39

No. 7—Gents' Heavy Belcher 14K Gold S. Ring \$3.68

Corodites genuine. Beautiful mountings of every modern design. Choice of gold or latest white-platinum finish. Unqualified, 3-year guarantee. Handsome or leather case free with each ring.

SEND NO MONEY

Keep your money right at home. Just send name, address and number of ring wanted and size as shown by slip of paper, fitting end to end around finger joint. Your ring will come by return mail. When ring arrives deposit amount shown above with postman. If you decide not to keep ring after 7 days' wear, send it back and your money will be immediately returned. Send today.

E. RICHWINE CO.

19 West Jackson Blvd., Dept. 402, Chicago, Illinois

Sole Importers Genuine Corodite Diamonds

PATENTS

Trade-Marks, Copyrights and Patent Litigation

Write for advice and instructions how to proceed, costs, etc. Hand Book with illustrations of 100 Mechanical Movements sent free on request.

ALBERT E. DIETERICH

Patent Lawyer and Solicitor

Successor to Fred G. Dieterich & Co. 621 Ouray Bldg., Washington, D. C.



PATENTS

Send us sketch or model for patentability opinion and exact cost of patent. Our book "How to Obtain a Patent." Sent Free on request. It tells how to apply for Patents, Trade Marks, Foreign Patents, Copyrights, etc.; gives information on Patent Procedure; tells what every inventor should know. Thousands of inventors, who are our clients, are our references.

Chandlee & Chandlee, 25 Years' Experience,
435 7th St. Washington, D. C.

PATENTS

TRADE-MARKS COPYRIGHTS

Send for our free book of patent information.

Beale & Park 802 F Street, Washington, D. C.
16 S. Broad St., Philadelphia, Pa.

PATENTS and TRADEMARKS

We offer a strictly professional service to inventors and manufacturers in the protection of their patent and trademark rights. Validity and infringement investigations conducted. Correspondence solicited. Moderate fees. Preliminary advice without charge. No literature.

MILO B. STEVENS & COMPANY

Suite 300 Barrister Bldg., Washington, D. C.

Suite 337A Monastreck Block, Chicago

ESTABLISHED 1894

Build a Sterling Home and Save Money

Buy direct from the mill—save middlemen's profit. All material comes in one complete shipment—cut to fit—ready to erect, all on ground when you start building. No waste. No guesswork. Send for beautiful book de luxe of

Sterling Built Homes

and see for yourself the attractive Colonials, beautiful bungalows, cottages—homes to fit every purse. Don't delay. Building costs are going up.

Send 20c Today for 1923 Book

International Mill & Timber Co.

1906 S. Wenona Ave.,
Bay City, Mich.



Built low, with its correctly fitted 28-in. seat rides wonderfully easy.

MAKE your FORD into this SPORTCAR

Red-i-Kut Life-Size Patterns
Instructions and Tail Delivered

\$640

The "Ace" of Fords

"Have finished my 'Pal.' It's some jazz boat. I go where a goat can't go on, or where others fail to go on. I can run thru mud on high where others can't go on low. Here is a picture I am so proud. I am called the 'Ace' of Fords, for I skip by them all kind of Elk a rabbit."—Cal Fortness, Columbia, Ky.

You can build it. Over 11,000 in use. Order Today



Send 5c coin for new manual of other distinctive sport body patterns from \$5.00 up—'RKO' Steel, 'Jiffy' Underling Irons, 'Jiffy' Tops and 'Gauss' Windshields.

Keen, Clear, Up-to-the-minute Order now while we can make good delivery and be ready for the happy summer days in your "Pal."
KUEMPEL CO.,
37 Keweenaw Bldg.,
Guthrie, Iowa

MOVIES

WE'LL SWAP YOU

your name and address for our catalogue on the greatest real home MOVIE-MACHINES in the world, with dazzling models as low as \$5.00 postpaid. And say, folks! We've also got the slickest films at ridiculously low prices—and what's more—we now have a film exchange plan that's the best ever. Of course we don't have to tell you that our films are the best. Let's not miss this opportunity—Write to-day—NOW.

PARAMOUNT MFG. COMPANY, Box 1371
Dept. M BOSTON, MASS., U. S. A.



BLANK CARTRIDGE PISTOL

Protection against Burglars, Thieves, & Dogs



PRICES
50c.
\$1.00

POST-PAID

Well made and effective, modelled on latest type of Revolver; appearance alone is enough to scare a burglar. When loaded it may be as effective as a real revolver without danger to life. It takes standard .22 Cal. Blank Cartridges obtainable everywhere. Price 50c., Superior quality \$1.00 postpaid. Blank Cartridges, by express, 50c per 100.

Johnson Smith & Co., 1218 Washington Ave., Dept. 947, Racine, Wis.



TYPEWRITER SENSATION!

Free Trial—Use as You Pay

After trial send us only \$4.00 a month until the low total price of \$48.80 is paid, and the machine is yours. This is absolutely the most generous typewriter offer we ever made. Do not rent a machine when you can pay \$4.00 a month and own one. Think of it—Buying a \$100.00 Machine for \$48.80. Cash price \$45.00, just a little less than half its original price.

REMINGTON MONARCH

Perfect machines. Correspondence size. Keyboard of Standard Universal arrangement, 42 Keys, writing 84 characters. The entire line of writing completely visible at all times, has the tabulator, the two color ribbon, with automatic reverse the back spacer, variable spacer, self-starter, in fact, every late '30s feature and modern operating convenience. Comes to you with everything complete; tools, cover, operating book and instructions—nothing extra to buy. You cannot imagine the perfection of this beautiful reconstructed typewriter until you have seen it. We have sold thousands of these perfect late style machines at this bargain price and every one of these thousands of satisfied customers had this beautiful, strictly up-to-date machine on five days' free trial before deciding to buy it.

We will send it to you F. O. B. Chicago for five days' free trial. It will sell itself, but if you are not satisfied that this is the greatest typewriter you ever saw, you can return it at our expense. You won't want to return it after you try it, for we are sure you cannot equal this wonderful value anywhere.

Send No Money! \$8.80 Put in Your Order Now

When the typewriter arrives deposit with the express agent \$8.80 and take the machine for five days' trial. If you are convinced that it is the best typewriter you ever saw keep it and send us \$4.00 a month until our bargain price of \$48.80 is paid. If you don't want it, return it to the express agent, receive your \$8.80 and return the machine. We will pay the return express charges. This machine is guaranteed just as if you paid \$100.00 for it. It is standard. Over half a million people own and use these typewriters and think them the best ever manufactured.

The supply at this price is limited, the price will probably be raised when next advertisement appears, so don't delay. Fill in the coupon today—the typewriter will be shipped promptly.

There is no red tape. We employ no solicitors—no collectors—no chattel mortgages. It is simply understood that we retain title to the machine until full \$48.80 is paid. You cannot lose. You will perhaps never have a greater typewriter opportunity. Do not send us one cent. Get the coupon in the mails to day—sure.

Young Typewriter Co., Department 66, Chicago
654 W. Randolph St.

Young Typewriter Co., Department 66, Chicago
654 W. Randolph St.

Ship me the Remington Monarch Typewriter, F. O. B. Chicago as described in this advertisement. I will pay you \$4.00 monthly as rent until the \$48.80 balance of the SPECIAL \$48.80 sale price is paid. The title to remain in you until fully paid for. It is understood that I have five days in which to examine and try the typewriter. If I choose not to keep it I will carefully repack it and return it to the express agent. It is understood that you give the standard guarantee.

Name
Street Address
City State
Business or Occupation

Please Mention Popular Mechanics

Diamonds Here at 60% of Market Price

Never in three quarters of a century have we offered such amazing bargains. Hundred of money-saving opportunities in latest Diamond Bargain List, equalling those shown here.

Here's why we can offer such remarkable values: This 75 year old firm—rated at over \$1,000,000.00 capital—the largest and oldest diamond banking institution of its kind in the world has made loans on Diamonds, Watches, and other jewels in excess of \$25,000,000.00.

Why Pay Full Prices Costs Nothing to See

Thousands of unpaid loans. Must sell now. Diamonds, Jewels, Watches and other Gems of unusual qualities—at an entirely different price basis—viz: loan values not market values. At our risk we send you any bargain you wish for absolutely free examination. No red tape. No obligation. Don't buy unless satisfied you can not match the bargain at 50 per cent more. Diamonds of desirable quality at \$125 per carat. Yes, some even lower priced—also, finest gems obtainable at higher per carat—but proportionately low bargain prices. Our bargains have guaranteed loan values also, unlimited exchange privilege at full prices.

Latest List Diamond Loans

Send at once for latest list. Thousands of unpaid loans and other special advantage bargains described in full detail with exact weight, color, quality, etc. Get details of Free Examination offer. No obligation. List is free.

Mail Coupon Now

Jos. DeRoy & Sons,
1999 DeRoy Bldg., Pittsburgh, Pa.

Without obligation, send me free, your latest Bargain List of Diamonds, Watches and other jewelry.

Name.....

Address.....

City.....State.....

\$100—\$500—\$1000

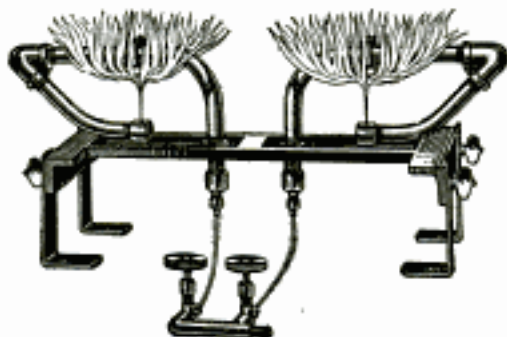

Unlimited money making possibilities offered through the agency for the sale of GAS FIRE Oil Burners. The highest class heat producing appliances of the kind in the world. Made of heavy brass; not acetylene, rusty gas pipe camouflaged with iron castings. Self de-carbonizing generators.

Write for full particulars at once.

HEAT APPLIANCE CORPORATION
111 North May Street CHICAGO, ILLS.

Engine Prices HIT BOTTOM

Read this new schedule of prices; and then act! And, Remember—you are getting these Bargain Prices on the FAMOUS

OTTAWA

—the most dependable engine on the market. Easier to start; Pulls more than its rated H-P.

BOOK FREE

Write today for your copy of Big Free Engine Book and complete list of New Low Prices.

Ottawa Mfg. Co.,
534-J King St.,
OTTAWA, KANSAS
DEPT. 534-J MAGIE BLDG.
PITTSBURGH, PA.

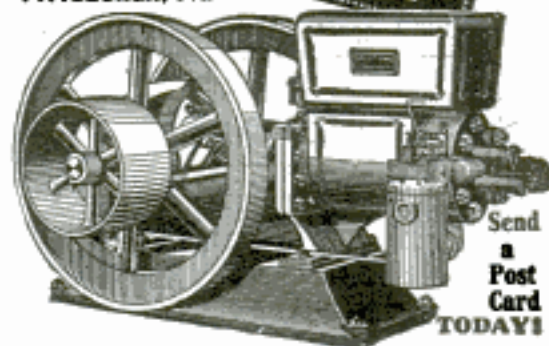

Send
a
Post
Card
TODAY!

1 1/2 H-P. \$37.00
2 H-P. \$42.50
3 1/2 H-P. \$69.50
5 H-P. \$97.50
7 H-P. \$127.50

Above Prices Each. Ottawa. For Shipment from Pittsburgh add Carload Fr't.

FREE ELECTRIC FIXTURE CATALOG!



1000 Different Pictures Illustrated

Write today for your copy. Save 50% direct from Mfgs. No Middleman's Profit.

OUR SPECIAL 8-room Electric Set ready to hang, \$24.50—Many other bargains.

UNITED LIGHTING FIXTURE CO.
280 Bowers, Dept. CC, New York City



Ra-Tone The Electric Tonic

Use the newest, most effective treatment that modern science offers to drive out aches, pains, soreness and weakness. Remove the cause, whether in blood, bone, nerve or tissue. Pleasant and absolutely harmless, but wonderful in beneficial and curative results. Thousands of users restored to health.

Sales Agents Wanted— to demonstrate and sell this wonderful home appliance. Pleasant, profitable. Write for attractive proposition.

Ra-Tone Electric Co.
610 W. Park Place
Detroit Michigan

Treat Yourself For
Anaemia
Nervousness
Insomnia
Rheumatism
Neuritis
Pimples
Falling Hair
Weak Eyes
Neuralgia
Headaches
Lumbago
Big Book FREE



The Perfected VIOLET RAY

Imperial Sanitary Floor

Base and Floor one solid piece

Put on like Plaster
Wears like Iron
-waterproof
-fireproof
resilient
noiseless
dust-
less

A composition material easily applied in plastic form over practically any kind of floor. Laid about 1/4 inch thick. Imperial floor does not crack, peel or come loose from foundation. A continuous, fine grained, smooth, non-slipping surface. No crevices to gather grease, dirt, dust, disease germs or moisture.

Ideal Floor for Kitchen, Pantry, Bath Room, Laundry, Porch, Garage, Restaurant, Theatre, Hotel, Factory, Office Building, Railroad Station, Hospital—wherever a beautiful, substantial floor is desired. Several practical colors. Full information and sample FREE of your first and second choice of colors.

Imperial Floor Co., 132-134 Halstead St., Rochester, N. Y.

A Success for 15 Years

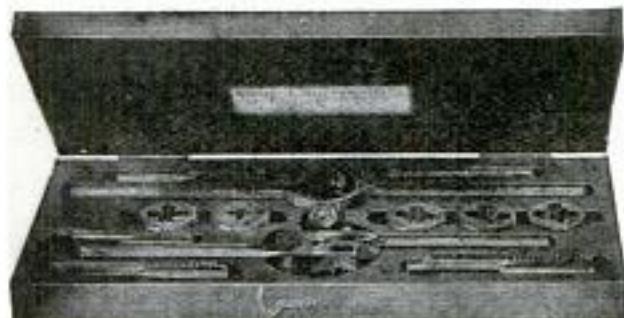

5 SIZE AUTOMOBILE TAP AND DIE SET, ONLY \$3.00

DIRECT FROM THE FACTORY TO YOU!

Our No. 12 Automobile Set furnished in our highly finished chestnut box contains 5 each taps and dies (1-4, 5-16, 3-8, 7-16 and 1-2"), in the S. A. E. thread. 1 die stock, and one tap and reamer wrench.

Our No. 11 Set is the same as No. 12 except that the thread is U. S. S. instead of S. A. E. You are purchasing a splendid set at a very low figure.

Send us your order of one and be one of our many satisfied customers. Let us also send you one of our circulars illustrating our full line of Handy Tools. WORCESTER STEEL PRODUCTS CO., Dept. T, 25 Union Street, Worcester, Mass., U. S. A.



\$8 TO \$16 A DAY

Take orders for New Serenola. Wonderful invention. Does more than machines costing five times its price. Demand enormous. Easily carried with you anywhere. Built in just like a suitcase. Fully guaranteed. Low priced.

OUR NEW PLAN

enables you to get your money daily. Territory given. Write for terms. Perry-Ludlow Co., S-1448, Dayton, O.

5 Magic Keys

Work like magic in emergencies or prove whether your door or padlocks are burglar-proof. **OPEN AND TEST THOUSANDS OF DIFFERENT LOCKS.** Recommended by users in ten different nations. Most wonderful and only keys of their kind. Send \$1.00 today. Novel key chain FREE with set. MASTER KEY CO., 25 Manhattan Block, Milwaukee, Wis.



Starting a Company?

Save expenses and taxes by organizing on the popular, COMMON LAW plan under a pure DECLARATION OF TRUST. No experience required to fill in DEMAREE STANDARD FORMS, issue shares and begin doing business at once. Genuine DEMAREE FORMS are nationally known, approved by attorneys, and utilized by successful concerns throughout the United States. Send for large, free pamphlet (D-53) containing valuable information that you may need. C. S. DEMAREE, legal blank publisher, 708 Walnut, Kansas City, Missouri.

\$1.00 DELIVERS to Your Home

Complete Outfit

Violet Ray

ONLY \$1.00 brings this complete, scientific Violet Rays outfit to you. Treat yourself and family at home, save delay, costly doctors and medicines. Thousands use Violet Rays at home to relieve pain and sickness. The identical outfits doctors have bought from us for years and with which they successfully treat many ailments, including those listed below.

QUICK RESULTS—No Medicine

Violet Rays work quickly, it's scientific, goes after the cause. That's why results are quick, permanent. Dr. Duncan, Kewanee, Ill., writes, "Violet Rays is the finest thing I ever used... to relieve pain, treatments are so pleasant all my patients like it." Use it yourself at home, you save Doctor's bills.

BEAUTY AID

Brings natural, magnetic beauty of health, no dieting, exercise or drugs. FREE book tells in detail how high priced beauty specialists use it to improve scalp and skin.

EARN CASH

Men, women, without experience earn liberal profits in spare time showing Violet Rays to neighbors. Proves results first demonstration. Sells on sight. Get attractive offer and wholesale prices now.

SEND FOR FREE BOOK

Explains how Nikola Tesla discovered Violet Rays, how it works, why it heals. Tells what doctors and plain folks accomplish in conquering pain, disease and nervous trouble with Violet Rays.

Reveals Marvelous Scientific Discovery Shows charts of human body, explains where pains start, how to banish them. Offered FREE for a limited time only, to introduce Violet Rays. Send for FREE copy.

Check Your Ailment Below for Free Advice

Here is a partial list of ailments successfully treated with Violet Ray:

Catarrh	Eye Diseases	Lumbago	Skin Diseases
Chilblains	Falling Hair	Nervousness	Sore Throat
Colds	Hay Fever	Neuritis	Sprains
Constipation	Headache	Paralysis	Tonsillitis
Earaches	Goitre	Piles	Whooping Cough
Eczema	Insomnia	Rheumatism	Asthma

Mail Coupon—Send No Money

VI-REX ELECTRIC COMPANY
326 West Madison St., Dept. 26, Chicago

Please send me without cost or obligation your free book describing your VI-REX Violet Ray outfits, and details of your \$1.00 offer.

Name _____

Address _____

City _____ State _____

Please Mention Popular Mechanics

Copyrighted material

"I have averaged \$7000 Per Year for Three Years—Have Made Over \$90 PROFIT in One Day"

That is the statement of Frank DePries, one of our live-wire representatives. Keeton of Mississippi made \$252 on his first sale. Vickers of Alabama made \$118 in one week. Conant quit a \$6,000 job to come with us.



DePRIES

Ford Auto FREE!

We have a plan whereby our active workers can get a Ford without cost, in addition to their big cash earnings. Get the plan—quick!

AGENTS WANTED

We need more men like these, because the demand for our Super Fyr-Fyter is growing by leaps and bounds. Sells to garages, stores, factories, schools, homes, hotels, auto owners. Approved by the Underwriters. If you are willing to work and ambitious to make some real money, get our plan. You need no experience, as we train you without cost for the work. No great capital required. Good territory going fast. Better write us at once.

THE FYR-FYTER COMPANY

1730 Fyr-Fyter Bldg.,

Dayton, Ohio

This is
**Ingersoll
Time**

For Outdoor Use
Why Risk Your
Expensive Watch?



The New Yankee \$2.00
Yankee Watch \$1.00

DIAMONDS

FOR A FEW CENTS
A DAY

Don't send a penny. Ten days' Trial. When the ring comes, examine it — If you are not convinced it is the *Greatest Bargain in America*, send it back at our expense. Only if pleased, send \$1.50 weekly — at the rate of a few cents a day. This Bargain Cluster Ring with 7 Blue-White Perfect Cut Diamonds can be yours. No Red Tape. No Risk. **FREE**

\$1.50 a Week
SEND NO MONEY
Looks like
\$350 Solitaire
No. 61
only **\$59.50**
We Trust You

MONEY BACK GUARANTEED

MILLION DOLLAR BARGAIN BOOK FREE

Send for it today. It pictures thousands of Bargains. Address Dept. A1178

J.M. LYON & CO.

2-4 Maiden Lane N.Y.

Big Sale NOW

Prices Smashed on this better, faster cutting machine.

30 Days' Trial
OTTAWA

Saws logs, limbs; falls trees. 10-year Guarantee. Cash or Easy Terms.

FREE BOOK and SPECIAL OFFER. Write quick before sale ends!

\$91.50
F. O. B. Ottawa, Kans.

From Pittsburgh, Pa., \$97.25

1741-G Wood St. OTTAWA MFG. CO. Room 1741-G Magee Bldg. PITTSBURGH, PA.

\$25 A DAY Clear Profit

—every day you work. Make \$5,000 to \$10,000 a year in the Floor Surfacing Business with the American "Universal" method. Work for yourself. Experience, special training or large investment unnecessary.

New Field; Big Profits

Better floors are demanded everywhere. American "Universal" electric machine, doing work of six men, assures BIG PROFITS in this new unworked field. Every floor,—old or new,—in town or city, is your prospect. Work easy to get. Profit possibilities unlimited. Positive guarantee and 5-day trial offer protects you. Write today for complete details.

AMERICAN FLOOR SURFACING MACHINE CO.
823 S. St. Clair St., TOLEDO, OHIO



\$35 Brings Your Shop GUARANTEED FREE AIR SERVICE With HB Automatic Twin Compressor

Increased earnings and profits from new business gained by improved service easily pay balance on small monthly terms. Good free air service Day and Night pulls trade, brings new customers. Helps you sell tires, oil, gas and accessories. Extremely compact construction enables you to use the HB Compressor in limited space. QUIETEST OPERATING outfit on the market. Entirely automatic. Maintains 120-140 pounds or higher on air lines 24 hours per day. Four cubic feet capacity. Saves current, due to compact single unit construction. Fully equipped, ready to connect up and operate. Comes to you on easy terms. Satisfaction guaranteed under our money-back guarantee. Write for information.

HOBART BROS. CO., Box M-63, Troy, Ohio

Absolute Satisfaction Guaranteed or Money Back





Sharp turns are easy for the Auto-Wheel

Sharp turns are easy for the Auto-Wheel Coaster even with the heaviest load. The special hound brace which runs from the tongue through the steering pivot to the bed of the wagon gives you the supporting strength which you need for easy steering.

Auto-Wheel Coasters and Auto-Carts

This special hound brace is only one of the features which make Auto-Wheel Coasters sturdy, substantial, easy to control. Other features are: rubber-tired disc wheels, steel-tired disc or wood spoke wheels—all wheels interchangeable—hand brake, special hub cap and locking pin, sides mortised as well as nailed, self-contained roller bearings.

Write for catalog which shows all models of the Auto-Wheel Coaster and the Auto-Cart, the Auto-Wheel's junior companion for little brother and sister. Send the names and addresses of three local coaster wagon dealers, and we will give you a year's subscription FREE to the "Auto-Wheel Spokesman," a dandy magazine for boys.



Auto-Cart
Auto-Wheel Coaster Co., Inc.
North Tonawanda, N. Y.

Big Short Story Writing Contest on. Write for Particulars and WIN A PRIZE

FREE Wonderful Book

Tell how to learn taxidermy—how to mount birds, animals, game-birds, fishes, tax skins.

Learn by mail. A necessity for hunters and nature lovers. Best methods, quickly learned, very fascinating. Success guaranteed. Decorate your home and den with splendid art. Make big profits. Write today for this fine illustrated, free book and our amazing offer.

Northwestern School of Taxidermy, A177 Elwood Bldg., Omaha, Neb.



Ride For 30 Days AT OUR EXPENSE

Ride for 30 days at our expense—the dandiest wheel made—the bike they are all talking about—the latest model, electrically equipped.

BLACK BEAUTY

Shipped express prepaid—direct from factory at wholesale price. Guaranteed 5 years; 6 months' insurance against accident. 30 days' trial. Large selection of models and colors. Lamps, horns, tires, brake parts, rims.

SUPPLIES Everything for the bike at WHOLESALE PRICES. Get a big Black Beauty Catalog—it's FREE!

HAVERFORD CYCLE CO. OF PA.
Established 26 Years
DEPT. 376 PHILADELPHIA

Be a Black Beauty Agent



FREE CORD TIRES

Make Big Money

without risking one cent. I'll start you as I have started so many others in a business of your own. All or part time. The MELLINGER PLAN is revolutionizing the tire business. No capital or experience needed.

I'll Show You How to Make More Money Taking Orders for Mellinger Tires

I want exclusive Agents, all or part time, to handle Mellinger Cord Tires under the MELLINGER PLAN. No experience necessary. My plan literally guarantees your success without risk or investment. Thousands of car owners say Mellinger Tires are the finest and most serviceable.

Guaranteed by Bond 12,000 Miles

Mellinger Hand-made, Oversize, Cords are the finest, most serviceable made. Super-vitalized rubber makes riding easy. New bead construction. My exclusive tread, protected by U. S. Patent No. 68612, gives 10% greater wearing surface. I specifically guarantee by legal bond, Mellinger Cord Tires 12,000 miles. Most manufacturers do not guarantee mileage. The motorist uses their tires at his own risk.

Lowest Wholesale Prices in America! Get My Inside Money Saving Figures!



Free This picture shows the Master Salesman

I send this sample Kit absolutely Free. A substantially bound portfolio containing good size samples of fabric, cord, rubber, cross sections cut from tires and pure gum tubes. In 5 Minutes you can demonstrate tire secrets that the average dealer knows nothing about. This Kit was developed by a Mellinger Agent who sells over \$50,000 worth of tires annually. He says: "It's like taking a prospect through the factory. The Kit sells the prospect and I take the order." This Star Salesman's Kit is very expensive, but I will gladly send it to you Free if you are in dead earnest.

If You Own a Car!

Write me quick. If there is no Mellinger Agent in your locality, I will want one owner to show and recommend Mellinger Tires. I will ship these magnificent Cord Tires prepaid. For a little of your time and enthusiasm, I will make you a surprising offer that will give you a set of tires FREE. Be the first from your locality to get my Confidential offer. Mail the coupon, today—right now; tear it off now. It's your big opportunity. Get my big free book that has proven the golden key to thousands. DON'T MISS IT.

B. L. MELLINGER, President
MELLINGER TIRE & RUBBER CO.
1706 Grand Ave., Kansas City, Mo.

Mellinger Tire & Rubber Co.,
1706 Grand Ave., Kansas City, Mo.

Without obligation, send me details of the Mellinger Plan, Free Book and Wholesale Prices and how, without investing money, I can become your authorized agent.

Name.....
Address.....

Please Mention Popular Mechanics

No More Punctures!

NO need to buy new tires this year. You can get double the mileage out of the old ones by injecting a 25c tube of Neverleak Tire Fluid into each tire. It's the best insurance you can have against trouble from destructive cuts, punctures and porous conditions. It makes your tires absolutely leak-proof. Just think of the trouble, delays and expense it will save.

NEVERLEAK TIRE FLUID

Heals Punctures on the Run

Neverleak is the old reliable tire fluid that has been giving entire satisfaction for over a quarter of a century. It never fails to do its work and as it preserves the rubber and fabric, it doubles the life of the tires.

Don't allow your dealer to sell you something "just as good," but be sure you get the original. Look for the signature on the yellow, green and white tube.

Buffalo Specialty
Company
BUFFALO, N. Y.



Please Mention Popular Mechanics

FREE

3⁹⁷

1¹⁵

12⁷⁶

77^c

13²⁵

33^c

This Big Book

The latest edition of the greatest Automobile Supply book in America is just off the press. Send for your copy at once, before the supply is exhausted. Contains over 3,000 bargains in standard repair parts and accessories—special bodies, tires, tools, etc., all of guaranteed quality.

Buy at Wholesale Prices

Our policy, "The highest quality at the lowest price," is made possible because we buy for cash and sell for cash. The prices shown at the left are only a few of the many bargains shown in our big free book. Get your copy now and start saving money by buying your supplies from

Nemco Bargain Supply House
37 N. Peoria Street, Chicago, Illinois

SEND for the INTERNATIONAL CATALOG

FOR FORD—PRICES FROM \$27.85 UP.

Factory to Consumer direct—Pay only one profit.

Our net price list. Full line of auto bodies and accessories for Ford at Wholesale Prices. Save big money on bodies by buying direct from factory.

International Body Works, 914 W. Ohio Street, Dept. 7, Chicago, Ill.

MAKE A MOTOR CYCLE
OUT OF YOUR BICYCLE

with a STEFFEY MOTOR ATTACHMENT. RELIABLE — ECONOMICAL — EFFICIENT. Easy to attach. Fits any wheel. Send stamp for circulars.

STEFFEY MFG. CO., Dept. P, 5025 Brown St., Phila., Pa.

MOTOR REPAIR BOOK FREE



Why spend dollars for motor and household repairs when a few cents' worth of

SMOOTH-ON CEMENT No. 1 will do? Write for FREE book and learn how Smooth-On can save you many dollars. Sold by Hardware and General Stores in 6-oz. tins 30c (by mail, add 6c); also in 1-lb., 5-lb. and larger sizes.

SMOOTH-ON MFG. CO., Dept. 37-F, Jersey City, N. J., U. S. A.

SMOOTH-ON IRON CEMENT No. 1
For Motor and Household Repairs

**SMOOTH-ON
REPAIR
BOOK**

SEND NO MONEY**"A Business Man's Watch"**

SOLID Gold Emblem; GREEN Gold Shell Case

Elgin

Movement

—12 size

Thin
Model**\$25**25 Years'
Guarantee
Fancy
Silver
DialCan be had in ALL Emblems or En-
graved Case instead of Emblems

Send us your name and the Watch will be sent for inspection.

BUFFALO JEWELRY MFG. CO.**"The Mail-Order House"**

Dept. 5, Brisbane Bldg.

BUFFALO, N. Y.

**The Sport of
Motorcycling**—gives you a new thrill. As you whiz
through the country astride your responsive
steed of steel, you feel the world is yours.Take fishing—with an INDIAN Motorcycle
you can comfortably and cheaply reach your
favorite sport more quickly than by any other
means.Or try the new, far away fishing haunts,
where woods are deeper and sport better.
No road too narrow, or hill too steep for
INDIAN Motorcycle.With an INDIAN Motorcycle, you can make
your half holidays like *full* days of sport; each
week end a real vacation. For motorcycling
is so inexpensive, you can enjoy it to the full.
The initial cost—as well as upkeep—fits the
pocket of the average man.INDIAN Scout is the most popular, eco-
nomical medium weight motorcycle. Lower,
100 pounds lighter than the average, 75
miles to a gallon, \$250; electrically equipped,
\$285, F. O. B. Easy payments.INDIAN Big Chief 74, 9 h.p. 74 cubic
inch motor, is the very latest in motorcycle
engineering. Ideal for heavy duty side car
work, \$345 F. O. B. Easy payments.*Get a free road ride at your dealers.
Write us, Dept. P6, for nearest dealer's
name and free illustrated booklet.***HENDEE MANUFACTURING CO.**
SPRINGFIELD, MASS.**Indian
Motorcycle**

Please Mention Popular Mechanics

Copyrighted material

MOTORCYCLES
ONE YEAR TO PAY.

Know the joy of owning—for business or
pleasure—a Harley-Davidson, Excelsior,
Henderson, Indian, Cleveland, or any
other standard make; thoroughly rebuilt
in our own factory.

Write for Free Bargain Bulletin and Easy
Payment Plan.

HAVERFORD CYCLE CO., OF PENNA.
America's Largest Cycle House
Established 26 years
503 Market St., Phila., Pa., Dept. P. M.

Great Bargain **2 SPLENDID SHIRTS \$3.79**
2 SILK KNITTED TIES \$3.79

Shirts, neat colored stripes, highest quality
material and poplin. Soft Collar. Finished
beautifully. Sizes from 14 to 17. Ties of finest
SILK KNIT. Fast colors. Full length.

Send No Money Just name and size of shirts.
We pay postage. Satisfaction Guaranteed.
FREE A handy pair of snap on Coll Buttons
FREE, if you send cash with order.
Rush Orders Now. Send for Free Catalog of Bargains
PUBLIC TRADING CO., 404 Fourth Ave., Dept. 251, New York

TOBACCO
HABIT CURED OR NO PAY

Any form, cigars, cigarettes, pipe, chewing or snuff.
Guaranteed. Harmless. Complete treatment sent
on trial. Costs \$1.00 if it cures. Nothing if it fails.

SUPERBA CO., E-41, BALTIMORE, MD.

Send for
Free Catalog
of Money Saving
Bargains

Bargains in clothing, sports, toys,
fishing tackle and other sport-
ing items await those who send
for this big, beautifully illus-
trated free catalog. Enjoy un-
usually low prices. Write
now for your free copy.

Paramount Trading Company
Dept. 531
34 West 28th St., New York

Bargains
in
Sporting
Goods



GET RID OF THIS

with no effort at all!

Here is the easiest way in the world to rid yourself of that useless, joke-inviting, health-menacing paunch! Simply fasten on *Dr. Lawton's Automatic Waistline Reducer*—and the flabby flesh will vanish. Absolutely automatically! For men and women.

DR. LAWTON'S AUTOMATIC WAISTLINE REDUCER



Hour by hour, with every breath you take and every step you make, the *Waistline Reducer's Vacuum Applicator* massages away unwanted bulge. Made of soft, pliable, glove-like rubber. Fits snugly and comfortably to the figure. Weighs but few ounces. Flexible as a handkerchief.

SATISFACTION A SURETY

Dr. Lawton's Automatic Waistline Reducer is sold under a guarantee bond of absolute satisfaction.

Your money back if you do not like it when you get it. Write now—this minute—to Dr. Lawton for full description, convincing literature and low price. Mail the inquiry blank below now to

DR. THOMAS LAWTON

Dept. 508, 120 W. 70th Street, New York City

Dr. Thomas Lawton, Dept. 508, 120 W. 70th St., New York City
Dear Sir—Send me complete description of Dr. Lawton's Automatic Waistline Reducer, convincing literature and illustrations, and tell me how low it is priced. This obligates me in no way.

NAME.....
STREET.....
TOWN.....STATE.....



SHOP WORK with a

CARNES ARTIFICIAL ARM

FOR nearly ten years a Carnes Artificial Arm has kept Mr. Pahhe Yazze of Lawrence, Kan., on the payroll as a draftsman and machinist at a good salary. Thousands of other mechanics, artisans, office workers, farmers and laborers owe their independence to this improved arm.

Life-Like in Action and Appearance

The Carnes Arm cannot be detected from the natural except by close inspection. Its user can dress himself, use knife, fork, pen, pencil and keys; pick up large or small objects, carry grips—in fact, do virtually everything that was possible before. He can bend the elbow of the Carnes Arm, bend and turn the wrist and open and close the fingers at will, even if the amputation is at the shoulder.

192-Page Book FREE. A book of 192 pages, profusely illustrated with photographs showing what can be done with this remarkable invention, will be sent free to any person interested. Send for it now.

CARNES ARTIFICIAL LIMB CO.,

208 Carnes Bldg.,

Kansas City, Mo.

Straightens Shoulders—Increases Pep

THE NATURAL BODY BRACE—Corrects stooping shoulders, straightens the back, gives the lungs chance for normal expansion, induces proper breathing. Brings restful relief, comfort, energy and pep. For men and women.

Costs nothing to try it

Write for 30 days' free trial offer and free book.

NATURAL BODY BRACE CO.

HOWARD C. RASH, President

64 Rash Building, Salina, Kansas

DEAFNESS IS MISERY



I know because I was Deaf and had **Head Noises** for over 30 years. My invisible Antiseptic Ear Drums restored my hearing and stopped **Head Noises**, and will do it for you. They are **Tiny Megaphones**. Cannot be seen when worn. Effective when Deafness is caused by Catarrh or by Perforated, Partially or Wholly Destroyed Natural Drums. Easy to put in, easy to take out. Are "Unseen comforts." Inexpensive. Write for Booklet and my sworn statement of how I recovered my hearing.

A. O. LEONARD, Suite 226, 70 5th Avenue, New York City

NO MORE BALD HEADS



WHEN our VACUUM CAP is used a few minutes daily. We accept no pay until you have tried the Cap 60 days and are satisfied. The Vacuum Cap is an appliance that draws the blood to the Hair Roots and starts a new healthy crop of hair. It stops Dandruff, stops the hair from falling out.

Bought by Doctors and men who know that it is the only reasonable HAIR GROWER known to science. No Drugs Used. Write for application blank, testimonials, and booklet on "HAIR," sent sealed in plain envelope, FREE.

THE MODERN VACUUM CAP CO.

K 559 BARCLAY, DENVER, COLO.

BRAND NEW CORD TIRES

Thousands of our customers are getting 12,000 miles out of these tires, you too can get this mileage. These tires are firsts.

SIZES	CORDS	TUBES
30x3\$ 5.95\$.90
30x3 1/2 6.9595
32x3 1/2 8.85 1.05
31x4 9.95 1.10
32x4 10.45 1.15
33x4 11.10 1.20
34x4 11.90 1.25
32x4 1/2 16.50 1.45
33x4 1/2 16.75 1.50
34x4 1/2 17.05 1.55
33x5 19.95 1.75
35x5 20.10 1.80

30X3 1/2

\$6.95

Send No Money

Write us and tell us the size of your tires and how many you want. Shipped C.O.D. with section unwrapped for inspection. Money back if not satisfied.

CHARLES TIRE CORPORATION

Dept. 682

1440 Michigan Avenue, Chicago, Ill.

STOP USING A TRUSS

Do Away With Steel And Rubber Bands

FREE TRIAL



Inner surface is made adhesive to secure the PLAPAO-PAD firmly to the body, keeping the PLAPAO continually applied and the pad from slipping. No straps, buckles or springs attached. Soft as velvet—easy to apply.

It's the Non-Slip-Rigid Pad and What is Within It That Counts

FREE to 5,000 Truss Sufferers

To the extent of 5,000 sufferers who may apply I will send, ABSOLUTELY FREE, a sufficient quantity of the Plapao to positively convince them that this is the only logical, common-sense way of treating rupture. Plapao is a highly astringent medication placed within the Plapao-Pad and being absorbed through the skin, creates a wonderful feeling of relief and at the same time tends to strengthen the weakened muscles and thus permanently close the rupture opening. The process of recovery is natural, so you'll have no use for a truss—you can throw it away forever! Old and young have testified under oath that the Plapao-Pads cured their rupture—many of them long-standing, aggravated cases—without delay from work. Patent allowed in U. S. and foreign countries. Awarded Gold Medal at Rome and Grand Prix at Paris.

Send No Money—for a sufficient quantity of the Plapao is sent without charge to enable you to give it a thorough test; you pay nothing for this trial now or ever. Write for it and full information today. Address: Plapao Laboratories, Block 1427 St. Louis, Mo.

NO JOKE TO BE DEAF

—Every Deaf Person Knows That I make myself hear, after being deaf for 25 years, with these Artificial Ear Drums. I wear them day and night. They are perfectly comfortable. No one sees them. Write me and I will tell you a true story, how I got deaf and how I make you hear.



Address
GEO. P. WAY, Artificial Ear Drum Co. (Inc.)
80 McKerby Building, 2631 Woodward Avenue, Detroit, Michigan

Medicated Ear Drum
Pat. Nov. 3, 1906

Buchstein's Fibre Limb

is soothing to your stump—strong, cool, neat, light. Easy payments. Braces for all deformities.
D. BUCHSTEIN CO.
113 5th St. S., MINNEAPOLIS, MINN.



Send for Catalog Today

PIMPLES

Blackheads, Acne Eruptions, Oily and Shiny Skin quickly removed by using SMOOTH-SKIN. \$1,000 money-back guarantee mailed with every bottle.

FREE! Valuable booklet explaining cause and cure of Skin Eruptions sent on request. Read what SMOOTH-SKIN has done for others after years of suffering.

Special Offer To New Customers.

Puritan Chemical Co. Dept. 20, Kansas City, Mo.

Learn Drafting

Individual study at home may be successfully engaged in with the aid of our new enlarged book
A Practical Course in Mechanical Drawing
Cloth. 160 Pages. 157 Drawings. Price, 50c Postpaid.
Popular Mechanics Book Dept., 200 E. Ontario St., Chicago.



BUY
TO-DAY
10
MONTHS
TO PAY



Send No Money

Ladies' Diamond Solitaire Ring
Examination FREE

\$2⁰⁰
DOWN

This exquisite, blue-white perfectly cut Diamond, in ladies' 14K solid-gold setting will be sent FREE of charge, all

transportation charges prepaid, for your examination. If satisfied, pay only \$2.00—balance at \$4.30 a month for ten months. Buying direct assures you this Rock Bottom Price, on easy credit terms. Take advantage of this amazing offer TODAY! Only \$4.30 a month after you have examined the ring and find it all and more than you expected. If not satisfied, simply return—examination will have cost you nothing.

No Security! No Red Tape!
We Gladly Trust You

Free

Send postal for Greatest Diamond, Watch and Gift Book ever published.



Let us send you FREE this beautiful De Luxe Catalog No. 63L. Contains 98 pages in colors, showing the most wonderful assortment of exquisite designs in Diamonds, Watches and Jewelry. Ten months to pay on everything. Write today! Address Dept. 63L. Capital \$1,000,000

"THE HOUSE OF QUALITY"
L.W. SWEET INC.
1650-1660 BROADWAY, NEW YORK

Please Mention Popular Mechanics

THE HEIGHT OF EFFICIENCY



Crosley Model X
Price \$55

For Sale by Best Dealers Everywhere.

Write for Catalog showing complete Crosley line.

New York Office, C. B. Cooper, 1803 Tribune Bldg., 154 Nassau St.
Boston Office, B. H. Smith, 929 Blue Hill Ave., Dorchester.
Chicago Office, 1311 Steger Bldg., 28 E. Jackson Blvd., R. A. Stamm, Mgr.

CROSLEY MANUFACTURING COMPANY
615 Alfred St. Cincinnati, O.

Remarkable
Regenerative
Receivers



ACE
Model V \$20

Formerly Known as
Crosley Model VC

A GREAT SUMMER SELLER

Licensed under Armstrong U. S. Patent
No. 1,113,149. Free Catalog on Request.

THE PRECISION EQUIPMENT CO.
Powel Crosley Jr. President
615 Gilbert Ave. Cincinnati, O.



Makes
Your Radio
Set Work Better

Perfect reception can be had only when wire connections are soldered.

SOLDERALL and a match make perfect joints—guaranteed equal to wire or bar solder.

At leading Jobbers and Dealers or sent postpaid for 25c a tube

SOLDERALL CO., Dept. P, Newark, N. J.

SOLDERALL
A Metal in Paste Form



Automobile Prices

6 Volt, 21 Plate \$13.25
Ford, Chev., Mitchell, Hup.,
Grant, Elgin, Vello, Saxon.
6 Volt, 13 Plate \$15.25
Overland, Buick, Geo., Paige,
Hudson, Nash, Stude., Dues.
12 Volt, 7 Plate \$18.00
Maxwell, Dodge, Regal, Frank,
Briscoe and Crow-Elliott.
Give year and model of car

A Better Battery Cannot Be Built

The best of material—careful construction by skilled mechanics—makes a battery that will give a long life of hard service.

Sold direct from factory to you. A written two (2) year guarantee. You take no chance with a World Battery—it is the most satisfactory battery you can get and you save the dealer's profit.

RADIO PRICES

6 Volt, 60 Amps—\$10.00
6 Volt, 80 Amps—12.50
6 Volt, 100 Amps—14.50
6 Volt, 120 Amps—16.00

5% discount for cash with order, or will ship C. O. D. Subject to inspection.

All orders shipped same day as received.

World Battery Co., Dept. 6, 1217 Wabash Ave., Chicago

RADIO DEALERS

AMERICAN RADIO MFG. CO. Write for 64 Pg. Catalog. Complete LINE, it's FREE Dept. O. Kansas City, Mo.

Don't just ask for
a Head Set—Say:
DICTOGRAPH
Choice of experts
Sold by all
Responsible
Dealers &
Department
Stores

DICTOGRAPH PRODUCTS CORP.
220 W. 42nd St., New York

RADIO Complete set \$15

Send for circular describing the SENSITONE Long Distance Armstrong Regenerative Radio Receiving Set, which we sell, complete with batteries, tubes, head set and aerial—all ready to listen to concerts—on easy payments. Enjoy the pleasure of radio while paying for a Sensitone.

HAROLD R. WAKEM & CO., 863 W. Washington Blvd., CHICAGO



I Need Branch Managers

LIGHTNING—WONDERFUL NEW ELECTROLYTE charges discharged batteries instantly. Eliminates old sulphuric acid method entirely. Uses no sulphuric. World has waited half a century for this invention. One gallon, retails \$10.00. Free to agents. Lightning Battery Co., St. Paul, Minn.

THE TRINITY LOUD SPEAKER

THE BEST YOU CAN BUY

TYPE A1 with 21" Horn	\$25.00	Literature upon request
TYPE "B" for use with Phonograph	12.50	

TRINITY RADIO CORPORATION
168 Dartmouth St. BOSTON, MASS.

Hit it anywhere!

MAGNETITE RADIO CRYSTAL—the world's most sensitive and efficient Crystal Detector.
GIBBONS-DUSTIN RADIO MFG. CO.
518 West 9th St., Los Angeles, California



THIS Crystal Detector is unaffected by handling or moisture and will render efficient service indefinitely. Price 50c at all dealers—or mailed direct.

Radio Fans!**TUNE IN
WITH THE NEW
"UNITED"
PLATE
CONDENSER
VERNIER**

Will increase receiving range and help tune out interference of all kinds.

Attach to any plate condenser by drilling one hole. Biggest little thing in Radio.

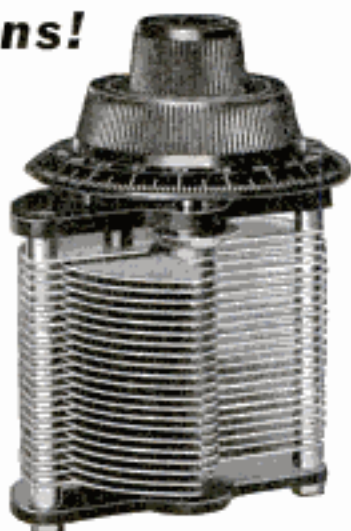

Sent pre-paid for **\$2.50**

**"United" Variable Condensers
with New Plate Condenser Vernier**

43 plate, **\$6.50** 23 plate, **\$6.00** 11 plate, **\$5.50**
5 plate, **\$2.50** 3 plate, **\$2.25**

Mailed on Receipt of Price

"United" Audio Frequency Transformer
Magnetically shielded, **\$4.50**

Ask your dealer first. If he can't supply you remit to us. Our money-back guarantee fully protects you.

United Manufacturing & Distributing Co.
536 Lake Shore Drive CHICAGO, ILL.

**Price: \$1.50 FROST
RADIO PROTECTOR
Has THREE Big Features**

1. The Frost Radio Protector is self-cleaning.
2. Positively no interference with radio reception.
3. Mounts indoors like your telephone protector.

Under new rules as revised May, 1922, every radio receiving station with outdoor aerial must use an approved protector. Frost "Sawtooth" self-cleaning protector is best for your set. Get one from your dealer today—protect your home and your set.

[The Frost Radio Protector is listed and approved by Underwriters' Laboratories, under revised regulations dated May, 1922.]



HERBERT H. FROST, Inc.
154 WEST LAKE STREET, CHICAGO, ILLINOIS.

Cartoonists!

The inspiration so necessary for success, as well as valuable hints regarding technique, methods of work and style will be yours if you equip yourself with portfolios of the work of the greatest cartoonists. Just such portfolios are the

**BOUND VOLUMES OF
CARTOONS MAGAZINE**

Here you find the best cartoons of Darling, Cesare, McCutcheon, Carter, Kirby and scores of other master cartoonists of this and other countries.

**PRICE \$2 PER VOLUME POSTPAID
WITHIN THE REACH OF ALL**

Think of it! These durable and attractively bound books (all new) each covering six months and containing 1200 cartoons, 900 pages (7 x 9 1/4 in.) 3 in. thick will be sold separately as long as the limited supply lasts at little more than cost of binding.

Make your selection from the following list and send in an order at once.

Vol. 11—January—June - 1917	} Part of World War Period
Vol. 12—July—December - 1917	
Vol. 13—January—June - 1918	}
Vol. 14—July—December - 1918	
Vol. 15—January—June - 1919	}
Vol. 16—July—December - 1919	
Vol. 17—January—June - 1920	}
Vol. 18—July—December - 1920	

Address:
POPULAR MECHANICS BOOK DEPT.
200 E. Ontario St. Chicago

**Everyone who is looking for
NEW PLAYS
FOR CHILDREN**

will be interested in this announcement.

The greatest plays being written for children today are those coming from the pen of T. C. O'Donnell. Whimsical, full of color and charm, imaginative, these plays make a universal appeal to the child because of their delightful humor and naturalness, and to the teacher because they lend themselves so readily to the very simplest stage. Every play has a well-worked out plot, plenty of action, surprise—yet can be "put on" in the living room as easily as on a thoroughly equipped stage.

The "JUST IMAGINE" Plays

is the newest series of O'Donnell plays. The first two numbers are just off the press. They are:

"THE SANDMAN'S BROTHER"
AND
"ANN'S HALF BIRTHDAY"

Through a special arrangement with the publishers we are able to make the first announcement of this series to teachers of expression, grade and high-school teachers, Sunday-school teachers, teachers of dramatics in neighborhood center work, mothers and others interested in clean, wholesome, easily produced plays for little folks from five to twelve years of age. (Even if you are not interested in producing children's plays you will find these plays fascinating for the story or bedtime hour.) Each play is artistically printed and bound—the price, only 50c each, postpaid. **Send \$1 today for the two.**

POPULAR MECHANICS BOOK DEPT.
200 East Ontario Street CHICAGO, ILLINOIS

This is the New DICTOGRAPH RADIO Loud Speaker

with The Adjustable
Air Gap That Tunes
Out All Harshness

Invite your friends tonight. Surprise them with a real concert or dance. The wonderful new Dictogrand will create the illusion that the artists are in the very room with you. Just go to your dealer's and hear this remarkable, clear-toned instrument. Take it home and plug in for the finest entertainment you've ever known. You don't need extra batteries.

Like all the other famous Dictograph Products, the Dictogrand is guaranteed for one year.

If your dealer hasn't the DICTOGRAND in stock, write to us direct.

DICTOGRAND

Mahogany Finish

\$28⁵⁰

DICTOGRAPH
PRODUCTS
CORPORATION
220 W. 42nd St., N.Y.C.



SEE YOUR DEALER FOR INFORMATION ABOUT
RADISCO Radio Products
THE RADIO DISTRIBUTING CO., Newark, N.J., U.S.A.

Valuable BATTERY BOOK FREE

INSIDE
FACTS
ABOUT
YOUR
BATTERY



Tells how to reduce your battery expense—how to get **QUICKER START** from your motor. Shows how to have **BRIGHTER LIGHTS** and **PERFECT IGNITION** by knowing more about your battery. Also tells how to charge your battery at home for a nickel with

Send for
Free Book today

THE HOMCHARGER

The world's most
popular rectifier.

The Automatic Electrical Devices Co.
129 W. Third St. Cincinnati, O.

Charges your
RADIO Battery too!



Charge Your Battery at Home for a Nickel!

DOUBLE HEAD
PHONES



BOYS! A REAL RADIO SET ABSOLUTELY FREE

RUSH your name and address and we will tell you **HOW** you can get this **RADIO SET Absolutely Free.**

RADIO SET comes to you complete, with single slide tuning coil, crystal detector and phone condenser. **AND DOUBLE HEAD PHONES.** No batteries required; no experience. *Write Today for Free Radio Plan*

HOME SUPPLY CO.,
131 Duane St., Dept. 829,
New York City

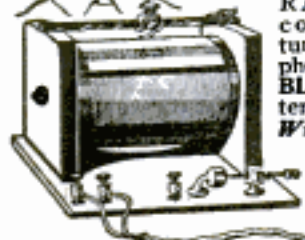

FREE —a book that tells how to get better results with radio tube sets. Address
WILLARD STORAGE BATTERY COMPANY
CLEVELAND, OHIO

BIG PROFITS in 8 HOUR
Battery Charging

30 Monthly Pays
for Your Outfit

OWN A MONEY MAKING BUSINESS

Make \$1500 to \$3000 Yearly Charging Batteries

Small cash payment brings your **8 Hour Charging Outfit.** **Easy terms of only \$30 monthly let your profits pay balance** with nice surplus besides. **Long free trial on money-back guarantee** lets you try outfit at our risk. Don't delay and let some competitor get ahead of you with 8 Hour Battery Charging. **Take the lead yourself.** Order your **8 Hour outfit NOW** on free trial. **Write today for full information and our easy-payment plan.**

HOBART BROS. CO., Box M-67, Troy, Ohio

Only **30 A Month**
Pays For
8-HOUR Battery Charging



**THE WORLD'S GREATEST
RADIO CRYSTAL**

THIS REMARKABLE CRYSTAL

is revolutionizing the possibilities of Crystal Sets. Unsolicited testimonials from all parts of the country report records of from 600 to 1200 miles with ordinary sets equipped with

M. P. M. (Million Point Mineral) CRYSTALS

Don't discard your Crystal Set until you have given M. P. M. a trial. Send 25c and name of your Radio Dealer for sample unmounted crystal—35c for mounted. Beware of Imitations.

M. P. M. SALES CO., Dept. P, 247 S. Central Ave., LOS ANGELES

Restful, Healthful Travel

Those who have traveled on D. & C. Navigation Company Steamers, for business or pleasure, have long come to associate every delight and comfort of outdoor travel with this line. Daily trips are made between Detroit and Buffalo; Detroit and Cleveland, on Eastern Time. Train connections at Buffalo for Eastern and at Detroit for Western Points.

Detroit & Buffalo

Lv. Detroit 5:30
p. m.
Lv. Buffalo 6:00
p. m.
Fare, \$6.00 one
way, \$11.50 round
trip.

Detroit & Cleveland

Lv. each city 11 p. m.
*Daylight trips dur-
ing July and Aug.
Lv. each city 8:30
a. m.
Fare, \$3.50 one way,
\$6.50 round trip.

* Operation subject to necessity for service.
Schedule subject to change without notice.
Berths \$1.50 up; staterooms,
\$4.20 up; parlor, \$7.50 up.
Rail tickets are accepted. Automobiles trans-
ported. Gas must be removed. Wireless
equipment.

For reservations and further infor-
mation address, R. G. Stoddard, Gen.
Pass. and Ticket Agt., Detroit, Mich.

Detroit & Cleveland Navigation Company

A. A. Schantz J. T. McMillan
Pres. & Gen. Mgr. Vice-Pres.



All Roads Lead to Joyland

A VACATION every week-end, a "sport-spin" every evening, brisk, bracing trips all summer in the cool, clean country air—if you have a Harley-Davidson!

Take any road—even where cars detour—and breeze swiftly and comfortably away from the din and dirt of the city. Easy on your pocket-book, too—the Harley-Davidson's average up-keep is only 2 cents a mile (gas, oil, tires and all.) No wonder they say motorcycling is "the greatest sport in the world!"

Pay-as-you-ride! Most dealers have an Easy Payment Plan. Ask yours about it. Lower prices and 10 improvements on 1923 Harley-Davidsons. Write us for free, illustrated literature.

Harley-Davidson Motor Company
Milwaukee, Wisconsin

Harley-Davidson The Motorcycle

Money-making sales opportunities in open territory. Write Desk A-2.

\$4.50 Guns for Brush Hunting



Famous
U. S. Cal.
45-70

rebored smooth, to shoot Bird shot,
total length 41 inches, weight 7 lbs. \$4.50

Bird shot cartridges for the above 3c each.

Rifle Barrels interchangeable for above - - - - \$ 2.00

U. S. Army Krag Rifle, like new - - - - - \$12.50

Send for Catalogue

W. STOKES KIRK 1627-P. M. N. 10th St.
PHILADELPHIA, PA.

FAULTLESS AUTO PRODUCTS



Speed and Power Equipment

Send for our new prices on Bodies and Accessories.

AMERICAN TOP & BODY CO.

Adams St., Delphi, Ind.

\$50 a Week EASY AGENTS Free Sample Offer



You can start a big paying business at once. Don't wait. Get big money. We tell you how—selling the famous E-Z Self-Heating Saddle Iron. No experience necessary. *Easy to sell.* Possibilities great. Every home a prospect. *Satisfaction guaranteed.* Absolutely safe. Thousands in use. Write today for proposition.

Enterprise Tool & Metal Works, Dept. 36, 2441-9 N. Western Ave., Chicago

For This Genuine
SELF-STARTING
REMINGTON
No. 10

\$38.65

Remington No. 10

30
DAYS
FREE
TRIAL

5
YEAR GUARANTEE
ALL LATE IMPROVEMENTS

ONLY
\$2.00
DOWN



BIGGEST VALUE EVER OFFERED!

Think of it! A Genuine, Self-Starting Remington No. 10 (the greatest advancement ever made in a typewriter)—a standard, thoroughly reliable machine—(guaranteed 5 years) with all the late improvements—one that will give you years of dependable service—and you save practically 70.00!

Guaranteed Equal to New

as regards character of work and speed. Compare it with a new machine, and if you are not convinced beyond all doubt—if you do not feel it is all we claim after a 30 day trial, you'll not be out one cent!

SEND TODAY A postal will do—for details of our \$2.00 down-direct-to-you selling plan. Learn why we can sell a genuine Remington No. 10 at such a tremendous saving to you! Or send \$38.65 NOW and if not convinced it is the biggest value ever offered, your money returned promptly without question. Our references: Any Mercantile Agency or Your bank. Address
LINCOLN TYPEWRITER CO. Dept. 298 BROADWAY
NEW YORK

AGENTS—Sell Towels

Make \$10 to \$15 a day selling **KNITTED** towels. This is something brand-new in the towel line. Patented and fully guaranteed. Each towel put up in sealed, transparent and germ-proof packet. Ready to open and use. Sells on sight because price is low and value is great. Big commissions paid agents. We want both men and women. Experience not necessary. Write for full information; or better still, send \$1 for complete sample outfit and get busy at once. Your dollar back if you are not satisfied with samples.

San-KNIT-ary Textile Mills, Dept. 36
1011 Diamond Street Philadelphia, Pa.

FREE TO AGENTS!



LU-MIN-IUS-CAP

\$100 to \$200 A WEEK!
Driver Agents! Put a Lu-Min-Ius-Cap on your car free and write orders day and night! \$35 electric-lighted outfit free to men without cars. \$100 to \$200 a week and more made by agents. You can do the same. Fordize \$7.50, others \$8.50
W. C. Perkins & Co., Dept. 105.

Thrift-proofs MOTOMETER!
A millionaire can't buy a more gorgeous ornament for his car, but price within reach of all. Parking lights, driving lights, trouble lights. ALL IN ONE. Nothing like it! Sells on sight! Write for information and how to get your own free, today!
3949 Sheridan Rd., Chicago

What About Radio in 1925?

Can You Keep Pace with Its Progress?

While RADIO is now a very big institution, it is true, nevertheless, that there will be many new developments, some new parts, and many new "hook-ups" before RADIO attains its final state of perfection. Can you keep track of all these changes—to-day, to-morrow, in 1924, and in 1925?

LEFAX RADIO HANDBOOK PERPETUALLY UP-TO-DATE!

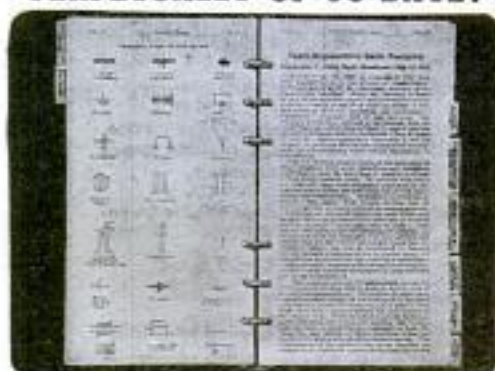

LEFAX RADIO HANDBOOK always keeps pace with new developments in Radio—the book is loose-leaf, and every month to every purchaser of the book is sent additional pages that keep the book up-to-date. No extra charge for this service for one year. Written by the two chiefs of the RADIO dept. U. S. Bureau of Standards. Fine imitation morocco leather cover.

Price \$3.50 postpaid, complete with year's service

POPULAR MECHANICS BOOK DEPT.

200 E. Ontario St., CHICAGO

Popular Mechanics Books

EACH one of the following books has been published by Popular Mechanics and is characterized by the same careful editing and authoritative presentation of the subject matter as is the magazine itself. All are unusually good values for the prices asked.

THE BOY MECHANIC—BOOK ONE 490 Pages—700 Articles—800 Illus.	\$2.00
THE BOY MECHANIC—BOOK TWO 480 Pages—1000 Articles—995 Illus.	2.00
THE BOY MECHANIC—BOOK THREE 480 Pages—800 Articles—802 Illus.	2.00
MISSION FURNITURE, HOW TO MAKE IT, PART 1 128 Pages—30 Designs, Illus.50
MISSION FURNITURE, HOW TO MAKE IT, PART 2 128 Pages—32 Designs, Illus.50
MISSION FURNITURE, HOW TO MAKE IT, PART 3 128 Pages—36 Designs, Illus.50
WOOD-WORKING FOR AMATEUR CRAFTSMEN 128 Pages—125 Illus.50
ARTS-CRAFTS LAMPS, HOW TO MAKE THEM 96 Pages—16 Designs, Illus.50
METAL WORK AND ETCHING 96 Pages—Illus.50
ELECTROPLATING 112 Pages—62 Illus.50
PRACTICAL COURSE IN MECHANICAL DRAWING 160 Pages—157 Drawings.50
HEAT 128 Pages—Illus.25
KINGDOM OF DUST 128 Pages—40 Illus.50
HOW TO MAKE DEVICES FOR OUTDOOR WINTER SPORTS. 64 Pages—Illus.25
SHOP NOTES FOR 1923 224 Pages—544 Articles—436 Illus.50
SHOP NOTES SERIES 10 Vols.	5.00
PATTERN MAKING 224 Pages—312 Illus.	1.00
POWER GAS AND THE GAS PRODUCER 192 Pages—Illus.	1.00

Above prices are postpaid.

POPULAR MECHANICS BOOK DEPT.

200 E. Ontario St., Chicago

4 CYCLE
5 H. P.

Weight
100 lbs.

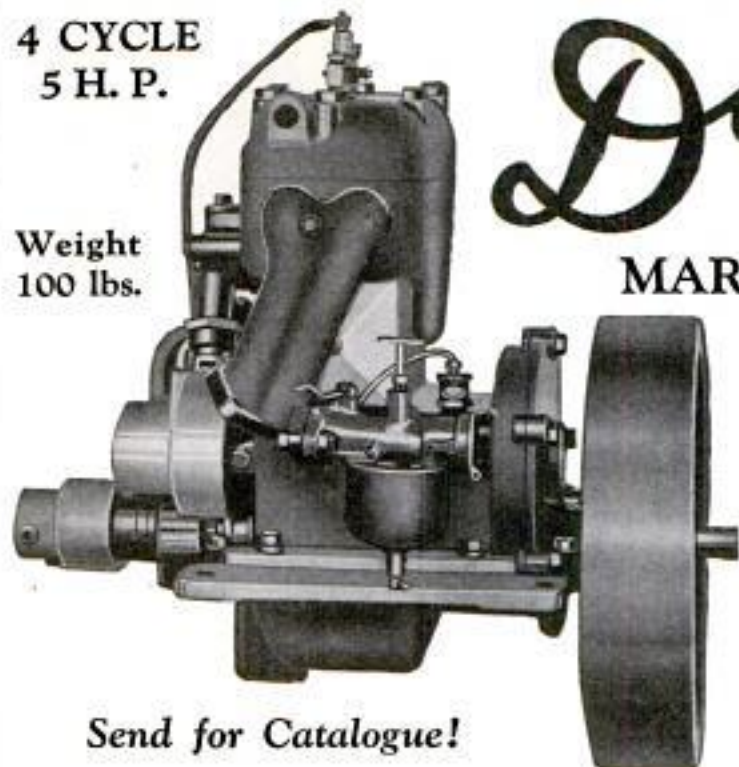

Send for Catalogue!

Dubrie

MARINE MOTORS

\$97⁵⁰
COMPLETE

Bosch Magneto!
Impulse Starter!
44 Ford Parts Used!
Investigate To-day!

DUBRIE MARINE MOTORS

7456 Jefferson Ave. E

DETROIT, MICH.

OUR BUREAU OF INFORMATION will answer all questions regarding articles appearing in this magazine. Address Bureau of Information, Popular Mechanics Magazine, Chicago.

**FORD OWNERS 50%
CUT YOUR GAS BILLS**

Get 35 miles on a gallon of gas. Do away with carbon by using **Koons Gas Saver**, the wonderful new invention. Pays for itself in two weeks. Install it yourself in five minutes. No mechanic needed. Send one dollar with order at once. Balance C. O. D. Price \$4.00—\$3.60 if paid cash in advance.

CHICAGO ENGINEERING CO.

Dept. A-12 120 E. 33rd Street CHICAGO, ILL.

SEND NO
MONEY

Save 50%

**20 YR 14KT GOLD-
FILLED CASE**

A rare opportunity to buy high grade watch 50% below cost. 12 size, thin model, 20 yr., 14kt gold-filled case. Beautiful of many finely chased border and back. Full jewel, well known ALBERT movement. Regulated and adjusted to keep excellent time.

Order today. Send no money. Pay only \$6.80 on arrival. Satisfaction guaranteed or money back. PRICE: 14kt gold-filled Waldemar chain and knife if you order now. Supreme Jewelry Mfg. Co. Dept. 728, 434 Broadway, New York



KNIFE AND
CHAIN FREE

**Easy to Play
Easy to Pay**



BUESCHER

**TRUE-TONE
SAXOPHONE**

Saxophone Book Free

Tells when to use Saxophone singly, in sextette or in regular band; how to play from cello parts in orchestra, and many other things you would like to know.

Easiest of all wind instruments to play and one of the most beautiful. You can learn the scale in an hour's practice and play popular music in a few weeks. You can take your place in a band within 90 days if you so desire. Unrivalled for home entertainment, church, lodge or school. In big demand for orchestra dance music. The portrait above is of Donald Clark, Soloist with the famous Paul Whiteman's Orchestra.

Free Trial You may order any Buescher instrument without paying in advance, and try it six days in your own home, without obligation. If perfectly satisfied, pay for it on easy payments. Mention the instrument interested in and a complete catalog will be mailed free.

BUESCHER BAND INSTRUMENT CO.

Makers of Everything in Band and Orchestra Instruments

2588 Buescher Block Elkhart, Indiana

Buescher Band Instrument Co.
2588 Buescher Block, Elkhart, Ind.

Gentlemen: I am interested in the instrument checked below:
Saxophone Cornet Trombone Trumpet
(Mention any other instrument interested in.)

Name

Street Address

Town State

DIAMONDS

\$197 per CARAT

Sparkling, blue white, perfectly cut, genuine diamonds are offered to you by direct DIAMOND IMPORTERS AT BIG DISCOUNT FROM their regular price. Former price \$325.00 per carat. **BUY FOR CASH** at wholesale prices and less. **40% SAVINGS ON DIAMONDS GUARANTEED OR YOUR MONEY RETURNED.** Written guarantee as to quality and exact weight sent with each diamond. **WE TELL YOU ALL THE FACTS** regarding the diamond you buy.

8% YEARLY INCREASE
Each diamond purchased from us has a yearly increase in exchange value of 8% guaranteed in writing.

30 DAYS' FREE TRIAL
Wear any article of your choice on trial for 30 days. If not satisfied send it back and we will return every cent you paid. Free examination at bank or savings office before paying deposit, if desired. Written guarantee that if any other jeweler in the U. S. can sell you equal merchandise for less money, you can get your money back. On this guarantee you cannot lose.

WRITE FOR CATALOG
Our big catalog of diamonds, watches and jewelry will save you 40% to 60% on your purchases. It shows rings and watches in natural colors. Diamonds in profusion at importer's prices. **CASH PRICES MEAN LOWEST PRICES.** Send for this catalog at once.

\$1,000,000.00 and 41 yrs experience back of our guarantees

B. GUTTER & SONS

Wholesale Jewelers & Diamond Importers
172 NASSAU ST., DIV. 952 NEW YORK

You 50¢ We'll Pay the Postage

Yes, upon the receipt of 50c we will ship prepaid this handy volume which tells how to make 16 beautiful designs of lamps. Simple reading lamps to elaborate chandeliers. This illustration shows one of the many beautiful designs contained in this volume. The instructions are so simple and so complete that anyone with the necessary tools and materials can make charming lamps for any room in the house.

Arts Crafts Lamps HOW TO MAKE THEM

Handsomely and durably bound in cloth, contains 96 pages (5x7 in.), 50 illustrations, diagrams and working drawings. Tells how to make Two Light Portable—Portable Reading—Four Light Chandelier—Reading Lamp—Dining Room Dome—Porch or Den Lantern—Four Light Chain Hung Chandelier—One Light Portable—Lantern—Drop Light—One Light Bracket—Plane Lamp—Wall Lamp—Electric Candle Sconce—Newel Post Lamp—Chain Hung One Light Bracket. You can save money making lamps for yourself—and make money making lamps for others.

Price Prepaid 50c Send for the book today. Send us only 50c. We will ship this book to you prepaid, no matter where you live. Take advantage of this bargain price now. Anyone can afford to have it. Put your evenings to profitable use. **Send 50c Today.**

POPULAR MECHANICS BOOK DEPT.
200 E. Ontario St., CHICAGO

Fords Run 34 Miles on Gallon of Gasoline

Wonderful new carburetor. Guaranteed to reduce gasoline bills from one-half to one-third and increase power of motors from 30 to 50%. Start easy in coldest weather.

SENT ON 30 DAYS' TRIAL
Fits any car. Attach yourself. Fords make as high as 34 miles to gallon. Other cars show proportionate saving. Send make of car and take advantage of our special 30-day trial offer. **AGENTS WANTED.**

AIR FRICTION CARBURETOR CO. Dept. 3380 DAYTON, OHIO

Tobacco

Special Bargain Introductory offer on Kentucky's Finest Good Old Melon Sweet Green River Smoking Tobacco. Two big 1-lb. cans, \$2.00 value for only \$1.00 postpaid. Satisfaction guaranteed or money back.

OWENSBORO TOBACCO CO., Dept. 130, Owensboro, Ky.

WANTED

RAILWAY MAIL CLERKS

\$1600 to \$2300 Year

MEN — BOYS, 18 OR OVER
SHOULD WRITE IMMEDIATELY

Steady Work. No Layoffs. Paid Vacations.
Travel — See the Country

Common education sufficient. Mail coupon today—**SURE**

CAMERAS

Over a Hundred Styles and Sizes

Send for new illustrated catalog showing latest reduced prices. It's Free.

10 days' trial given

SENECA CAMERA MFG. COMPANY
300 Central Avenue Rochester, N. Y.

WRITE TODAY for Our 168-PAGE **FREE BOOK on Deafness**

and learn how Perfect Hearing is now being restored in every condition of deafness or defective hearing. Our "Little Wireless Phones for the Ears" require no medicine, but effectively replace what is lacking or defective in the natural ear drums. They are simple devices, which the wearer easily fits into the ears, where they are invisible. Soft, safe and comfortable.

WILSON EAR DRUM CO., Incorporated
1079 Inter-Southern Bldg. LOUISVILLE, KY.

Fibre-Lite Limbs

Easy Payments—Do Nature's Work.

AGENTS WANTED who use Artificial Leg. **GOOD PAY.**
FREE Fibre Sample. DISCLOSE STUMP TO **WORMAN CO.** 252-P HENNEPIN AVE. MINNEAPOLIS, MINN.

RAILWAY

MAIL CLERKS

FRANKLIN INSTITUTE, Dept. S178, Rochester, N. Y.

Sir: Send me without charge, (1) Specimen Railway Mail Clerk Examination questions; (2) List of government jobs obtainable; (3) Send sample coaching lessons and tell me how I can get a position.

Name.....

Address.....

COUPON

WE WANT AGENTS

To introduce the Milburn Puncture Proof Inner Tube. Mr. P. H. Milburn, of the Milburn Puncture Proof Tube Company, Chicago, after many years of practical and theoretical experiments, has perfected an inner tube which in actual test suffered the loss of NO AIR after being punctured as many as 500 times. Many users have run over 20,000 miles without removing a tire from the wheel. Milburn Puncture Proof Inner Tubes are made of the best quality live red gum rubber—especially built and air inflated. Milburn Puncture Proof Tubes cost no more than other ordinary tubes.



CAR OWNERS WANTED

To sell and demonstrate this wonder tube. Interests everyone immediately. Automobile owners buy on sight. It makes no difference what car they drive or what tires they use. Our salesmen are coining money on our "DIRECT FROM FACTORY" scheme of selling. Absolutely no competition. We control all basic patents. No capital required to start. Previous selling experience not necessary.

Earn from \$5000 to \$10,000 a Year

Earn \$5000 to \$10,000 yearly or more. Get into business for yourself. Sell Milburn Puncture Proof Inner Tubes. Every car owner is a prospect. Your field is unlimited. Now is the season. Get in while it is good. Be independent.

TESTIMONIALS

Convincing Statements from a Few of Our Agents

J. D. Cooper—"I have made 30,000 miles with my Milburn Puncture Proof Tubes and have not as yet removed a rim or casing and my casings are still in excellent condition."

J. C. Jerves—"I sold 50 Milburn Tubes in the first three days."

Chas. Cayton—"I sold twelve tubes yesterday in ten minutes."

L. S. Knapp—"My first few hours out I sold eight tubes, no trouble at all to sell them. The most wonderful tube on the market today, I think. I am hoping you will give me the agency for a big territory."

D. Edlere—"I have driven seventy-five miles in one of the 30x3 tubes, and twenty were spike nails. It has gone above the test that you recommended to me it would do."

S. W. Dow—"Your tubes are fine; we have a 30x2 1/2 that has certainly stood the gaff; it has been punctured anywhere from forty to forty-five or fifty times this week, and is standing up in great shape."

Staples Brothers—"Your tube arrived and proved satisfactory in every respect. We think we know a good thing when we see it and would be pleased to represent THE MILBURN PUNCTURE-PROOF TUBE COMPANY."

FREE TUBE

SPECIAL FREE TUBE OFFER

Send coupon or write today for special free tube offer and further details.

References, Industrial State Bank of Chicago, National Bank of the Republic, Chicago, Baker State Bank of Chicago.

Don't hesitate. Fill out the coupon and send it in or write and send name and we will send you all details. This is your opportunity so don't delay. Address

P. H. MILBURN, Pres.

Milburn Puncture Proof Tube Co.

**335 West 47th Street
CHICAGO, ILLINOIS**

MILBURN PUNCTURE PROOF TUBE COMPANY
335 West 47th Street, Chicago, Illinois

Gentlemen: If the money making opportunity is as big as you claim, I am interested in getting the facts, so that I can get a share of the profits with Milburn Puncture Proof Tubes. Without this information send me information about commission and price offer to address.

Name.....
Address.....
City.....
State.....

SAVE MONEY
Get This Book

HANDY MAN BOOK

Install Your Own
PLUMBING & HEATING
NEW EASY WAY - SAVE HALF

25c
Reg. Price 50c

Brings you this big Plumbing and Heating Encyclopedia-Catalog. Write for your copy today without fail.

Guaranteed Heating Plants

Our Handy-Man Book shows how. Big 256-page well-bound encyclopedia of Plumbing and Heating Outfits, Systems, Supplies, Fixtures and Accessories—10,000 items—illustrated. Hundreds of floor plans, elevations, diagrams, trade secrets, money and trouble-saving hints, etc. "How to save coal in heating," "Easy repair methods." Every householder, contractor, farmer, mechanic, institution needs this book. Shows how to save wages, work and



Hot Water Boiler materials.

BIG HANDY MAN BOOK

Tells how we help you plan and install. From rough sketch or description we supply working plans and clear instructions. We loan the tools needed. Any handy man can install. This is the place to buy on money-back guaranty. Plumbing Outfits and Supplies; Water Systems; Hot-Air, Water or Steam Heating Plants; Radiators, Pipes, Boilers or Septic Disposal Tanks.

Send 25c for Yours Today

We have spared no effort or expense to complete this remarkable and instructive book. To keep from sending it broadcast to disinterested persons, we request a deposit of 25c, which will be refunded on your first order—or send for our FREE Bulletin. Write today and save half.



Pipeless Furnace

HARDIN-LAVIN CO.

50 Years
at 4547-57
Cottage Grove Ave.,
CHICAGO



Bathroom Outfit



BIASCOPE

SIX-POWER

A sturdy, compact pocket field glass. For the motorist, tourist, boyscout, bird study. Dimensions $3\frac{3}{8} \times 3\frac{1}{4} \times 1\frac{1}{4}$ ". Each in a leather case. \$5.00 Mailed Postpaid Anywhere.

WATRY & HEIDKAMP

ESTABLISHED 1883
Dept. P, 17 W. Randolph St., Chicago, Ill.

Our BUREAU OF INFORMATION will answer all questions regarding articles in this magazine. Address Popular Mechanics Magazine, Chicago.

EASY FOR YOU TO OWN A FINE INSTRUMENT!

YEARS ago the famous King Brass Instruments were sold only for cash to famous musicians. But now due to our easy payment plan anyone can own one of these wonderful instruments.

SAVE MIDDLEMAN'S PROFITS

Simply order direct from the factory. You save middleman's profit—and you get a fine, new, sound-laboratory tested, acoustically perfect King Instrument. With it goes our guarantee plus free factory-service.

IT'S EASY TO OWN A KING

Rebuilt instruments, refinished to look like new, we sell for cash at low prices. New instruments on the easy payment plan. Thus it's "easy to own a King". Send for our latest complete catalog and list of special bargains.

THE H. N. WHITE COMPANY
5249 Superior Avenue Cleveland, Ohio



PERSONAL STATIONERY

SEND \$1 ONLY Be distinctive—have your own stationery. Send cash or money order for 200 sheets, 100 envelopes, postpaid, printed in blue ink with name and address, not over 3 lines for 50 characters, on good white bond, sheets 6x7. Personal Printing Co., Box 5258, Boston, Mass.

FORD RUNS 57 MILES ON GALLON OF GASOLINE

A new automatic and self-regulating device has been invented by John A. Stransky, 15 Fourth St., Pukwana, South Dakota, with which automobiles have made from 40 to 57 miles on a gallon of gasoline. It removes all carbon and prevents spark plug trouble and overheating. It can be installed by anyone in five minutes. Mr. Stransky wants agents and is willing to send a sample at his own risk. Write him today.



Chewing Gum 1c per pack

Full size—5 stick packs—spearmint, peppermint and fruit flavors. \$5.00 for 500 packs. Suitable for Premium or Scheme purposes. Deposit required.

Prompt shipments.
HELMET GUM MAKERS, Cincinnati, Ohio

Our BUREAU OF INFORMATION will answer all questions regarding articles appearing in this magazine. Address Bureau of Information, Popular Mechanics Magazine, Chicago.

GREEN AUTOMATIC MACHINE



ADD TO YOUR INCOME

WITH LITTLE EFFORT
\$5 to \$10 A DAY MADE
EASY WITH

New Improved Green Automatic Machine

Sharpens, Honors and Strops all kinds of safety razor blades, in one operation, from four to six blades per minute. For both Quality and Quantity, this machine is in a class by itself. There is nothing like it on the market. Let us send you our descriptive literature explaining everything, including the "AMERICAN" Key Cutter—cuts square, angular or round slots.

AMERICAN SHARPENING MACHINE CO. (Inc.), Dept. 5, 134 W. Washington St., CHICAGO



Glands Used to Restore Hair Growth

Science of Gland Therapy Relieves Baldness—New Treatment Restores Health and Growth

Baldness in both men and women is now generally ascribed by scientists to defective functioning of endocrine glands. Hair growth is dependent upon the secretions of these glands—these secretions making possible the assimilation of those elements in the blood which are vital to a luxurious growth of hair.



Now it is possible for any bald person to have a full, luxuriant growth of hair through the discovery of E. R. Alexander, nationally known scientist. Dr. Alexander, through the concentration of glands, can supply the deficiency of gland secretion and produce a full growth of hair.

This discovery may be easily used in the privacy of your own home. Within a few weeks you will notice new, vigorous hair beginning to come in and with this growth you can gradually restore your hair to its former bright, healthy color.

So confident is Dr. Alexander that you can be relieved of the embarrassment of baldness and regain the normal hair growth by this method that he offers to send a regular \$4.00 treatment for only \$2.00 to anyone who will write for it. Use it according to directions, and if at the end of a month you do not find your hair returning with all its former vigor, the treatment does not cost a cent.

SEND NO MONEY—just your name and address to Alexander Laboratories, 812 Gateway Station, Kansas City, Mo., or 812 Terminal, Toronto, Canada, and this treatment will be mailed at once in plain wrapper. Try it according to directions and if at the end of a month you are not more than satisfied with results, your money will be refunded at once. A big Kansas City bank guarantees that Dr. Alexander is reliable and holds \$1,000 cash as a guarantee to return your money if you wish.

Don't suffer the embarrassment of baldness—give the treatment a trial on this liberal offer.

Please Mention Popular Mechanics



LOWEST PRICES GUARANTEED TYPEWRITERS

Send us only \$5.00 a month until the low total price of \$66.20 is paid, and the machine is yours.

FREE TRIAL This is absolutely the most generous typewriter offer ever made. Do not rent a machine when you can pay \$5.00 a month and own one. Think of it—Buying a \$110.00 Machine for \$66.20. Cash price, \$61.70, just a little more than half its original price.

EASY TERMS

The Famous **L.C. Smith** Silent Model No. 8

This is the famous L. C. Smith typewriter which has set the world's standard for quality and service for over twenty years. Perfect machines, Standard size, Keyboard of Standard Universal arrangement, 42 Keys, writing 84 characters—universally used in teaching, the touch system. The entire line of writing completely visible at all times, has the decimal tabulator, the two color ribbon, with automatic reverse, the back spacer, ball bearing type bars, ball bearing carriage action, ball bearing shift action, in fact every late style feature and modern operating convenience. Comes to you with everything complete; tools, cover, operating book and instructions—nothing extra to buy. You cannot imagine the perfection of this beautiful rebuilt typewriter until you have seen it. We have sold thousands of these perfect late style machines at this bargain price and every one of these thousands of satisfied customers had this beautiful, strictly up-to-date machine on five days' free trial before deciding to buy it. We will send it to you F. O. B. Chicago for five days' free trial. It will sell itself, but if you are not satisfied that this is the greatest typewriter you ever saw, you can return it at our expense. You won't want to return it after you try it, for you cannot equal this wonderful value anywhere.

SEND NO MONEY Order Now—Before They're Gone

When the typewriter arrives deposit with the express agent \$6.20 and take the machine for five days' trial. If you are convinced that it is the best typewriter you ever saw keep it and send us \$5.00 a month until our bargain price of \$66.20 is paid. If you don't want it, return it to the express agent, receive your \$6.20 and return the machine. We will pay the return express charges. This machine is guaranteed just as if you paid \$110.00 for it. It is standard. Over half a million people own and use these typewriters and think them the best ever manufactured. The supply at this price is limited, the price will probably be raised when next advertisement appears, so don't delay. Fill in the coupon today—the typewriter will be shipped promptly. There is no red tape. We employ no solicitors—no collectors—no chattel mortgage. It is simply understood that we retain title to the machine until full \$66.20 is paid. You cannot lose. It is the greatest typewriter opportunity you will ever have. Do not send us one cent. Get the coupon in the mails today—sure.

SMITH TYPEWRITER SALES CO., 300, 360 E. Grand Ave., Chicago, Ill.
SMITH TYPEWRITER SALES CO., 300, 360 E. Grand Ave., Chicago, Ill.
 Ship me the L. C. Smith Model No. 8, F. O. B. Chicago, as described in this advertisement. I will pay you \$5.00 monthly as rent until the \$66.20 balance of the Special \$66.20 sale price is paid. The title to remain in you until fully paid for. It is understood that I have five days in which to examine and try the typewriter. If I choose not to keep it I will carefully repack it and return it to the express agent. It is understood that you give the standard guarantee.

Name.....
 Street Address.....
 City..... State.....
 Occupation or Business.....

CAR OWNERS SAVE MONEY

Make Big Profits!



FOR ALL SIZES

Cut your own tire bills—and make good money selling **National Tirefiller** to others. A proven success for 12 years. Eliminates tubes, punctures and blowouts. Increases tire mileage 30 to 50% and still outwears several casings. Easily inserted; easy riding. Over 300,000 enthusiastic users. Big sales possibilities. Some good territory still open. Driver agents make good profits. Mail coupon today for proposition.

National Rubber Filler Co.,
232 College St., Midlothian, Texas.

Please send me your agent's proposition and full information on **National Tirefiller**.

Name _____

Address _____

MAIL
THIS
Now

MAKE \$8 TO \$32 A DAY

We have men making from \$8.00 to \$32.00 a day in the most agreeable of occupations. You can too. We want men who have good, clean records and who want to increase their present earning power. We have the way if you have the will to do it. You can establish a business of your own. Write today for our offer.

THE VITAL MFG. CO.

Dept. 26, Chicago and Clark Bldg., CHICAGO, ILL.



Sensational New Cord Tire Sale!

Our big volume business enables us to sell brand new Cord tires at lowest prices. Don't miss this Sale. Every Cord guaranteed first quality and new. Order your season's supply now and cut your tire cost in two. Thousands of steady customers getting full mileage and you, too, can get **10,000 Miles**

Size	Cords	Tubes	Size	Cords	Tubes
30x3 1/2	5.95	1.05	34x4	11.75	1.75
30x3 1/4	6.95	1.25	32x4 1/2	13.75	2.00
32x3 1/2	7.25	1.30	32x4 1/4	14.40	2.10
31x4	9.90	1.40	34x4 1/2	14.90	2.35
32x4	10.65	1.45	35x4 1/2	15.40	2.35
35x4	11.20	1.60	35x5	20.00	2.50

SEND NO MONEY

Just send your name and sizes of tires wanted. Don't wait! Price soon to go up. Take advantage of this sensational tire sale. Shipment C.O.D. Section unwrapped for inspection. Order now. Dept. 26
SUPREME TIRE CO., 3234 W. Jackson Blvd., Chicago

JOY—ADVENTURE—ROMANCE

LINGER NO LONGER

BY THE FIRESIDE



8-16 Overhead Valves
Selective Transmissions

Sport Fenders Underslung Sport Fenders for Standard Fords

You must seek them out in the City's White Lights; under the Country's Blue Sky; by the Rippling, Murmuring Waters. Get Busy! Buy a Ford and equip it with a Beautiful FORD-SPEED Sport Body and find the road to Happiness. We offer nine smart models to choose from \$29.00 up. Full line Racing Specialties to help you go faster. Free Catalog

This Month's Specials

	Price	Now		Price	Now
Disc, set of 8, flat	\$12.00	\$ 5.95	Underslung Fenders	\$12.50	\$ 9.95
Force Feed Pump Oiler		2.50	Worm Steering Gear	50.00	16.95
Power & Speed Camshaft	19.00	11.95	Crank Case Motor Arm Support	5.00	2.95
3:1 or 2 1/2:1 Gears	12.50	6.95			

SATISFACTION OR MONEY BACK guarantee. 30% with order, balance on delivery
G. M. FORD SPEED & POWER EQUIPMENT MFRS., 250 West 54th St., New York



Start in Business For Yourself

IF YOU ARE INTERESTED IN OWNING YOUR OWN BUSINESS ON A SMALL INVESTMENT—Income \$600.00 and up monthly—Write for our **SPECIAL SPRING EASY PAYMENT OFFER ON DUNCAN No. 10 or 3B COMPLETE TIRE REPAIR SHOP EQUIPMENT**, including high grade tube plate. Small initial payment brings complete money-making equipment to you.

We teach approved factory methods—experience not necessary—big field open for Progressive men to start in business for themselves and reap the harvest of the Big Spring and Summer Business.

SPECIAL INDUCEMENT ON ALL ORDERS RECEIVED WITHIN THE NEXT 30 DAYS. Write NOW for descriptive folders, prices, and Special Spring Offer.

F. M. DUNCAN COMPANY, 341-49 East Ohio Street, Department P, Chicago, U.S.A.

Agents Make \$12⁰⁰ a Day!



NEW Self-Heating IRON

New development makes ironing easy. Cuts ironing time in half. Saves steps. Costs one cent for 3 hours use. No attachments. Gives clean, quick heat easily regulated. Absolutely

safe. Uses kerosene or gasoline. Starts with match without smoke or smell. Sells fast. Mrs. Wagner, Ohio sold 24 in few hours spare time. Moyer of Pennsylvania made \$364 in one week. You can do as well. Work all or spare time. No experience needed. Simply take orders. We deliver and collect. Commissions paid same day you take orders. Send for catalog and **FREE OUTFIT OFFER**. Write today.

THE AKRON LAMP CO.

36 Iron St., Akron, O.

Custom-Made Tops Less Than Half Price

ASK US TO PROVE IT



You can attach them easily. Full instructions sent. Complete tops with beveled plate glass, tacks, fasteners and welts. Free delivery 1,000 miles. For all cars; special prices on Maxwells, Dodges and Chevrolts. Describe your car. Samples and money-saving Bulletins free.

S-C PRODUCTS CO., 758 Nicholas Bldg., Toledo, O.



EVINRUDE

Factory production on the new Sport Twin is oversold. To insure delivery, order from your dealer at once. Send for catalog.

OVERSOLD

W. L. DOUGLAS

NAME AND PORTRAIT is the best known shoe Trade Mark in the world. It stands for the highest standard of quality, style and workmanship at the lowest possible cost.

W. L. DOUGLAS shoes are actually demanded year after year by more people than any other shoe in the world

BECAUSE W. L. Douglas for forty-six years has been making surpassingly good shoes. The smart styles are the leaders everywhere. When you are looking for the best shoes for your money examine W. L. Douglas \$7.00 and \$8.00 shoes. They are exceptionally good value for the price. **WEAR W. L. DOUGLAS SHOES AND SAVE MONEY.**

\$5. \$6. \$7. \$8. & \$9. SHOES FOR MEN & WOMEN



NO MATTER WHERE YOU LIVE

shoe dealers can supply you with W. L. Douglas shoes. If not convenient to call at one of our 116 stores in the large cities, ask your shoe dealer for W. L. Douglas shoes. Protection against unreasonable profits is guaranteed by the name and price stamped on the sole of every pair before the shoes leave the factory. Refuse substitutes. The prices are the same everywhere.

IF NOT FOR SALE IN YOUR VICINITY WRITE FOR CATALOG.

TO MERCHANTS: If no dealer in your town handles W. L. Douglas shoes, write today for exclusive rights to handle this quick-selling, quick turn-over line.

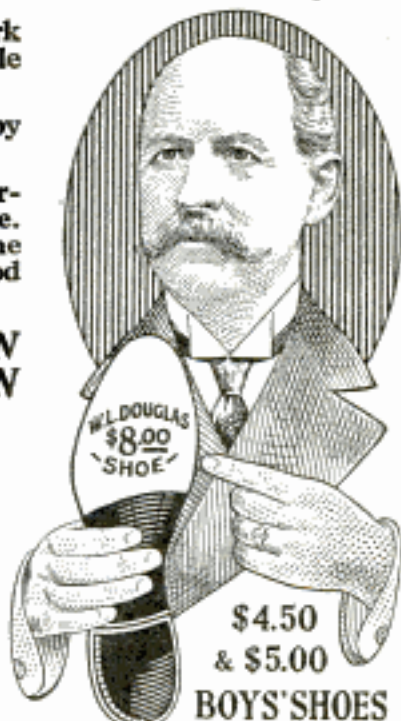

W. L. Douglas

President
W. L. Douglas Shoe Co.
128 Spark Street, Brockton, Mass.

RADIO & AUTO Storage BATTERIES CHARGED

FROM A LAMP SOCKET At Home For a Few Cents, With An P-F BATTERY CHARGER, a FULL WAVE AUTOMATIC MAGNETIC Rectifier for 100-125 Volt 60 Cycle A. C. Type A-B Charges 6 Volt "A" & Auto & Up to 120 Volts of "B" & LOUD SPEAKER Storage Batteries In Series Inductively At Home Overnight. Disconnecting Multiple Connections Unnecessary. No Grounds. Changing Circuits Replicate. **NO SKILL REQUIRED, AMMETER ELIMINATES GUESS WORK.** Indisputable Electrodes Rectify Current & Will Charge a Dead BATTERY. Leave Battery Connected, Screw Plug in Lamp Socket, Snap CHARGER Clips On Terminal, Turn Switch & Battery IS CHARGED In Minutes. **NOTHING LIKE IT MADE.** Is It Not Grand To Feel Your RADIO BATTERIES Are Ready For All RADIOPHONE MUSIC & NEWS & NEVER HAVE TO TELL Friends Your Batteries Are Dead? FULLY CHARGED BATTERIES By Starting Car QUICK. Require FEWER Expensive Replacements. Do Not Think Your BATTERY Is Dead & Worn Out Simply Because It Will Not START YOUR CAR. An P-F CHARGER Fills It With Life, SAVES More Than Its Cost & Lasts A LIFETIME. 7 TYPES BUILT BY A MASTER OF THE ART & POPULARLY PRICED.

Type 6 charges "A" 6 volt Battery, at 6 amperes \$15
Type 12 charges 12 volt Battery at 6 amperes \$15
Type B charges Radio "B" Bat's Up to 120 volts \$15
Type A-B is a Combination of Types 6 and B \$20
Type 166 charges 6 volt Battery at 12 amperes \$20
Type 1612 charges 12 volt Battery at 7 amperes \$20
Type 1626 is a Combination of Types 166 & 1612 \$28
Types B & A-B are Radio Specials. Types 166, 1612 & 1626 are For Cars & Radios. Charge in a SHIPPING WEIGHTS Complete With AMMETER & BATTERY CLIPS \$1 to 15 lbs. PURCHASE from DEALER; Mail Check, or WRITE us To Ship TYPE desired C.O.D. ORDER Now, or WRITE Immediately For FREE CHARGER BULLETINS 24 & 24A.

FRANCE MFG. CO., CLEVELAND, OHIO

PRACTICAL AMATEUR WIRELESS STATIONS

An experience book containing the best suggestions of 33 experimenters on building, installing, and operating experimental stations for radio communication. 136 pp. 6x9. Illustrated. 75 cents, postpaid. Popular Mechanics Book Dept., 209 E. Ontario St., Chicago



MARVEL ONLY TIRE

GUARANTEED 10,000 MILES IN WRITING!

LOOK AT THESE PRICES!
SIZE TIRE TUBE
30x3 1/2 \$ 9.85 \$1.35
32x3 1/2 12.50 1.50
31x4 13.75 2.00
32x4 15.50 2.10
33x4 18.75 2.20
34x4 16.50 2.30
32x4 18.75 2.50
33x4 19.75 2.60
34x4 20.75 2.70
35x4 21.50 2.80
36x4 22.50 2.90
33x5 23.75 3.00
35x5 24.50 3.10

AMERICAN TIRE CO. 1461 So. Michigan Blvd. Dept. 102 CHICAGO

FREE Book of Newest Styles just out. Women's, men's, children's clothing on credit and at bargain prices, less than cash prices everywhere. Very latest fashions; best materials. Open a charge account with us. Buy on credit and save money! Dress in newest styles. Send for Style Book absolutely FREE today! Elmer Richards Co., Dept. A177, W. 35th Street, Chicago.

What's Wrong With This Job?

**MEN 18 to 45
BECOME CITY MAIL CARRIERS**

City residence unnecessary.
\$1,400 FIRST YEAR
Raise Yearly to \$1800 Year

Steady work. Paid vacation. Common education sufficient. Pull or experience unnecessary.

Mail Coupon—Today Sure

COUPON

Franklin Institute
Dept. 5331
Rochester, N. Y.

Send me, without charge, (1) Your copyrighted Civil Service book, (2) Tell me how to get a position as Mail Carrier at \$1400 to \$1800 a year, (3) Send list of other U. S. Government Jobs obtainable.

Name.....

Address.....



Copyrighted material



The Benson Orchestra of Chicago, one of the famous broadcasting and phonograph recording orchestras, uses Conn instruments exclusively.

Why the Broadcasters Prefer CONNS

THE famous broadcasting orchestras and artists, just as the leaders in every other instrumental field, choose Conn instruments. The purity and brilliance of the distinctive Conn tone is particularly adapted for radiophone transmission. These artists know the superiority of Conn instruments, not only in tone, but in reliability of action, ease of blowing, and flexibility which enables them to play the most difficult music with comparative ease.

When you tune to your favorite station and there comes a melody which fairly lifts you up and makes you want to dance, it is practically certain to be Conn music, played by a Conn equipped orchestra.

You should know more about the exclusive processes and features which make Conn instruments the finest in the world. Send a post card for complete information and details of FREE TRIAL, EASY PAYMENT plan on any instrument for band and orchestra.

Highest Honors at World Expositions
Dealers and agents throughout the country
Factory branches in many large cities

C. G. CONN, Ltd.

631 Conn Bldg.

Elkhart, Indiana

CONN

WORLD'S
LARGEST MANUFACTURERS
OF HIGH GRADE BAND AND
ORCHESTRA INSTRUMENTS

CULTIVATE YOUR
MUSICAL BUMP

ALL-AMERICAN

AMPLIFYING
TRANSFORMERS
(Radio and Audio Frequency)

Give Wonderful Results

When Used In
"Neutrodyne" and
"Reflex" Circuits

For best results with the "Neutrodyne" & "Reflex" Circuits, use "All-American" radio frequency Amplifying Transformers. Type R-10 and Type R-13. Ratio 10 to 1 Audio Frequency Transformers.

Ask your dealer for FREE "All-American" Hand Book of Radio Hookups. If he cannot supply you, write us, sending two cent stamp for postage.



RADIO FREQUENCY
R-10 (150-550 meters)
\$4.50



AUDIO FREQUENCY
R-12 (Ratio 3 to 1) \$4.50
R-21 (Ratio 5 to 1) 4.75
R-13 (Ratio 10 to 1) 4.75

RAULAND MFG. CO.
200 No. Jefferson St., Chicago, Ill.

"The Torpedo"

The Model D — popular Torpedo type body equipped with a complete Flat style Radiator. The body is sturdy and guaranteed to stand up under any kind of strain (generally used for professional racing).



Gas tank in tail end, door on right side with inside lever lock.
CHAMPION RACING BODY CO., 7-9 East 28th St., CHICAGO, ILL.

BRAND NEW CORD TIRES

Thousands of our customers are getting 12,000 miles out of these tires, you too can get this mileage. These tires are first.

SIZES	CORDS	TUBES
30x3	\$ 5.35	\$.90
30x3 1/2	8.85	.95
32x3 1/2	8.85	1.05
34x3 1/2	9.95	1.10
36x3 1/2	10.45	1.15
38x3 1/2	11.10	1.20
40x3 1/2	11.80	1.25
42x3 1/2	12.50	1.45
44x3 1/2	13.75	1.50
46x3 1/2	17.05	1.55
48x3 1/2	19.95	1.75
50x3 1/2	20.10	1.80

30x3 1/2

\$6⁸⁵

Send No Money

Write us and tell us the size of your tires and how many you want. Shipped C. O. D. with section unwrapped for inspection. If not satisfied return tire unused and money will be cheerfully refunded.

Dept. 118 STARR & STARR Chicago, Ill.

SHOP MANUALS

for the AUTOMOBILE ELECTRIC SERVICE STATION



Automobile Ignition

Adjustment, timing, wiring, care, lubrication and repair of each type of the eighteen makes of both battery and magneto ignition equipment now in use. Includes eighty-three diagrams of internal and external connections and more than one hundred illustrations of construction and design.

Explanations of operation are given by description and explanation of equipment in actual service.

439 pages, 4 1/4" by 6 3/4", bound in flexible leatherette.

Price \$2.00 Postpaid

Automobile Battery Care and Repair

Practical repair methods from the time of opening the cells until the final reassembling. Explains methods of testing with hydrometer, voltmeter, ammeter, discharge set and cadmium stick; showing symptoms by which each kind of trouble can be recognized. Includes rules for charging new, used and repaired batteries; also instructions for the use of all types of charging equipment.

Among the tables are those showing effect of temperature, time and rate on capacity; required capacity for starting and lighting; discharge rates and voltage drop during tests; charging rates determined by battery size, heating, time available and line rate; gravity secured by various proportions of acid and water and gravity used in repair work.

335 pages, 4 1/4" by 6 3/4", 160 illustrations, bound in flexible leatherette.

Price \$2.00 Postpaid

Starting and Lighting Troubles, Remedies and Repairs

One hundred and five special diagrams show the internal wiring, also the connections between all the units of each type and make of electrical equipment from 1912 to the present time.

Opposite each diagram is a description including the normal amperage and voltage, the method of regulation, the type of cut-out and their adjustments.

Trouble location charts are based on the action of lamps and starter without the use of testing instruments.

Over two hundred pages of instructions for testing and locating faults in any part of the starting and lighting equipment. Includes sixty-four diagrams showing tests and repairs, also sixty illustrations of operating principles.

459 pages, 4 1/4" by 6 3/4", bound in flexible leatherette.

Price \$3.00 Postpaid

Automobile Starting and Lighting

Gives an elementary working knowledge of the construction and action of each part of all types of starting and lighting systems.

In addition to the subjects mentioned in the list of contents, this book gives a brief description of the systems that have been used, together with internal diagrams of dynamo, motors, cut-outs and current regulators.

It also includes definitions of two hundred and twenty-six words and terms used in automobile electrical work.

388 pages, 4 1/4" by 6 3/4", bound in flexible leatherette.

Price \$2.00 Postpaid

POPULAR MECHANICS BOOK DEPT.
200 E. Ontario St., CHICAGO

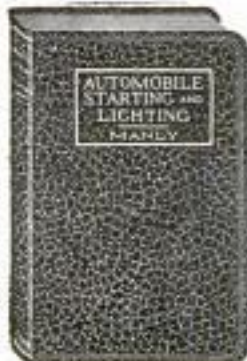

Tailoring Salesmen

The greatest—the most sensational—the steadiest money-making line in the field. SELL GREAT WESTERN CLOTHES—the equal of \$50.00 store values at \$33.65, suit or overcoat, one price, made to measure, all wool, money back guarantee.

We Pay You Salary and Commissions

We put you on our regular pay roll the minute you connect up with us and we send you a check every week. In addition you get your regular profit on every suit you sell, and you get this money in advance. McBurnie made \$392.50 last month, Landers seldom goes under \$100.00 a week. No line in the country offers the wonderful money making opportunity this does.

Read the following exclusive features and you'll understand why the GREAT WESTERN line has no equal as an order getter.

1. We pay salesmen weekly salary and Commissions in advance.
2. We prepay express or parcel post charges to customer.
3. No extra charges—everything free—nothing added to our one price.
4. All Wool fabrics, all wool linings, high grade workmanship.
5. Handsomest salesman's sample case and outfit ever gotten out.
6. Satisfaction guaranteed—money cheerfully refunded any time.

Tailoring salesmen—send the coupon today for complete information. Other live selling men write us. We'll train you and show you how to make big money selling one of America's oldest and best known brands of clothes. Send no money—complete sample equipment furnished FREE.

Mail the coupon NOW

Great Western Tailoring Co.
The Pioneer Line Est. 30 Years Chicago, Ill.

Great Western Tailoring Co.,
837-841 W. Jackson Blvd., Chicago, Ill.

Please send me full details of your salary and commission proposition for salesman and complete information on your line.

NAME.....

ADDRESS.....

TOWN.....STATE.....





Cut Your Own Hair

COWAN HAIR CUTTER

Most Useful Device on Earth



For Men or Women



\$2.00

Over 30,000 Business and Professional Men, Mothers and Nurses save Time, Money and Worry over Wasted Hours spent in barber shops.

The "Cowan" Combination HAIR CUTTER-SAFETY RAZOR makes them independent. CUT YOUR OWN HAIR in ten minutes. Adjustable for long, short, clipper-effect or pompadour. No practice needed. Any style finished like YOU want. No SPLIT hairs. Cuts wavy, silky, kinky hair. Reversible for ONE-ARM men, right or left-handed persons. SHAVES TOO - smoothest you ever had. Two-way SAFETY RAZOR - safe for LADIES - saw safety guards blade corners for working under arms, over bumps, hollow spots and behind ears. Barbers and Mothers find it convenient and safe for the child. Lifetime durability. Genuine SILVER PLATE, complete with two extra blades. Three months' service. Sent through DEALERS or direct by mail upon receipt of price plus 10¢ postage. 6 Extra Blades, 50¢. DEALERS WRITE. Sole Agents Wanted in U. S. and Provinces of Canada.

J. H. COWAN CO. Dept. 72, Admiral and McGee St. Kansas City, MO., U. S. A. Manufactured and sold in Canada by Cowan Hair Cutter Sales Co., of Canada, Ltd. Dept. 72, 141 Bannatyne Ave., Winnipeg, Man.



WEAR IT FOR 7 DAYS FREE

These beautiful RAJAH diamonds have all the living fire and dazzling beauty of the genuine blue white diamond and are the result of years of scientific and chemical research. They stand the test of direct comparison. YOU CAN BE THE JUDGE. Wear one of these rings on the same finger with a genuine diamond seven days. If you or your friends can tell the difference, send it back and we will refund your money. YOU TAKE NO CHANCES.

SPECIAL INTRODUCTORY OFFER for Short Time Only

No. 21—Ladies' high Tiffany mounting—white platinum	\$3.35
Snub ring, price \$6.70; now.....	
No. 98—Gentlemen's every mounting—white platinum	4.65
Snub ring, price \$9.30; now.....	

Mountings are beautifully designed from latest patterns and are exact reproductions of high-priced platinum rings. Unconditional 30-year guarantee. Handsome leather lined case with each ring.

SEND NO MONEY Just mail your name, address, number of paper filling and to end second finger index. You'll receive ring by return mail. When it arrives deposit amount shown above with postage. After wearing ring seven days, if you do not think it the biggest bargain ever offered, we want you to send it back, and your deposit together with postage will be immediately refunded. **SEND TODAY.**

A. ROTHCHILD CO., 608 So. 14th St., Omaha, Neb.

6-Room House \$710

22 ft. x 26 ft. Not Portable



You can buy all the material for a complete home direct from the manufacturer and save four profits on the lumber, millwork, hardware and labor. Price quoted includes all lumber cut to fit, windows, doors, woodwork, glass, paints, hardware, nails, lath, roofing, and complete drawings and instructions. Highest grade lumber for all interior woodwork, siding and outside finish. Many other designs. Send today for Free Muddle Catalog No. 2545.

The ALADDIN Co., BAY CITY MICHIGAN
Wilmington, North Carolina; Portland, Oregon; Toronto, Ontario

\$1000 a month in RADIO

Well-known radio manufacturer now has openings for state, district and county representatives. \$1000.00 a month easily earned by good men. Finest, popular priced radio. Write at once for details.

CHERINGTON MFG. CO. Dept. 16 WAUKEGAN, ILLINOIS



THE 1923 New OLIVER SPEEDSTER

Send for 1923 Oliver Catalog Showing New Standard three bank Keyboard.

THE OLIVER TYPEWRITER CO., Chicago



THIS PALATIAL Florida Home

can be purchased at a very reasonable price. It is the finest estate in a community of 30,000 situated amid 5 acres of orange, grape fruit, sweet bay, palmetto and a large variety of semi-tropical trees and foliage. A water front of 400 feet, with entrance from a Boulevard, affording every modern convenience. House recently completed and never occupied. Has every modern improvement, large sun parlors, sleeping porches and 8 bath rooms. Inexhaustible supply of soft water, steam heat, high, light basement under entire house. Surf bathing all winter within 5 minutes walk.

For full details, photographs and price address the owner,

H. H. WINDSOR,
200 E. Ontario St., CHICAGO, ILL.

10,000 Practical Recipes

HENLEY'S

Twentieth Century
Book of

Recipes, Formulas
and Processes

Edited by

GARDNER D. HISCOX, M. E.

Contains over 10,000 Selected Scientific, Chemical, Technological and Practical Recipes and Processes, including Hundreds of So-Called Trade Secrets for Every Business. This book of 800 pages is the most complete Book of Recipes ever published, giving thousands of recipes for the manufacture of valuable articles for every-day use. Hints, Helps, Practical Ideas and Secret Processes are revealed within its pages. It covers every branch of the useful arts and tells thousands of ways of making money and is just the book everyone should have at his command. A book to which you may turn with confidence that you will find what you are looking for. A mine of information up-to-date in every respect. Contains an immense number of formulas that everyone ought to have that are not found in any other work.

Price \$4.00
Cloth Binding

Popular Mechanics Book Dept.
200 E. Ontario St., Chicago

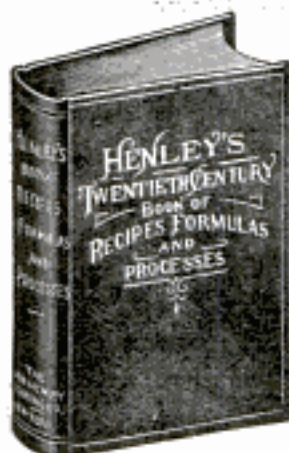

To the man who loves to smoke a pipe

THE ordinary pipe has certain disadvantages. At last, and for the first time in the history of pipe smoking, there is being offered to the pipe lover a pipe which is not only wonderfully sweet, cool and delightful to smoke but which absolutely overcomes all disadvantages.

The Sport-Briar

has created a sensation in Europe, the home of pipe smokers. While it has been on the American market only a few weeks we have received so many orders that we are nearly oversold. It is now available to you!

Some of the reasons a SPORT-BRIAR should have a place in the rack of every pipe smoker:

1. CAN BE THOROUGHLY CLEANED IN 20 SECONDS.
2. Smokes so well in rain or high wind as indoors.
3. Absolutely prevents the matter of ash or spark, protecting your face, clothes and furniture!
4. While holding as much tobacco as the ordinary pipe, it occupies no more room in the pocket than a cigar.
5. Will not burn the clothes.
6. Can be easily reloaded fully lighted!
7. Made of the finest, selected real French briar by the most skilled workmen in France. Mechanically it is a joy to use.
8. Smokes any kind of tobacco.
9. Its patented nicotine absorber (removable for cleaning) gives SPORT-BRIAR smokers the purest and coolest smoke in the world.

Money-Back Guarantee

There are always a certain number of "Doubting Thomases" in the world. To them we say—If, after you've tried a SPORT-BRIAR, you wish to return it, we will return your money as fast as Uncle Sam can take it to you. You need state no reasons why. We know, however, that you'll be delighted with your purchase. Everybody is.

Mail the coupon today.

AGENTS Can Easily Make
\$75 to \$100
Every Week

$\frac{3}{4}$ Actual Size

Write for SPECIAL AGENTS' PROPOSITION

The best agents in the country are making arrangements with us. Why? Because the SPORT-BRIAR not only causes them to clean up amazing profits every day but is such a fast seller and remarkable repeater that the work of selling is very easy. Pipe smokers take to the SPORT-BRIAR as a violin lover would take to a Stradivarius. Better get started before someone else is given your territory. Fill out the coupon now while you're thinking of it.



THE SPORT BRIAR PIPE CO.,
SINGER BLDG., NEW YORK

Gentlemen: Send me a Sport-Briar Pipe, for which I agree to pay \$5 to the postman who delivers it.

Name.....

Address.....

If you are likely to be out when the postman calls, you can save time by sending us the money with this coupon. Money back if not satisfied.

STANDARD ELECTRIC SERVICE FOR EVERY CAR

WELLS' AUTO ELECTRICIANS' HANDBOOK

Gives the exact performance, the construction, the method of testing, and explains all adjustments, settings and peculiarities of operation.

Blueprint internal wiring diagrams for each generator, motor, cut-out and regulator—drawn just as the machine is built.

Covers 1324 models of 270 different makes of cars from 1911 to date, showing more than 1000 changes of equipment. Loose-leaf with forty pages of Index.

PRICE \$12.50 PREPAID

WELLS' AUTOMOTIVE WIRING MANUAL

Real car wiring diagrams for shop work—showing the parts and wires the way they are placed on the cars themselves.

All in big, clear blueprint diagrams—from 1912 to date. Every diagram correct, the last word in usefulness.

The sixth consecutive year of issue—your guarantee of continued service in keeping up to date. Loose-leaf binder.

PRICE \$12.50 PREPAID

WELLS' AUTO ELECTRICIANS' CYCLOPEDIA

combining both of above in loose-leaf binder.

PRICE \$22.50 PREPAID

POPULAR MECHANICS BOOK DEPT.
200 E. Ontario St., CHICAGO



TOOTHPERL



25
CENTS
IN BOTTLE

TOOTHPERL will quickly and thoroughly remove tartar, film, black spots, brown stains, tooth marbling, yellowish spots, all particles and all other stains and discolorations from teeth.

You Can Now Have Beautiful Snow White Teeth

Send for information Book, Free or Illustrated price list. We guarantee **TOOTHPERL** to make your teeth snow white and give you more control of discoloration.



MARCH PRODUCTS CO., CHICAGO, ILL.

New Easy Way to Make Money Fast

**Make \$75.00 to \$150.00 A Week,
All Time or Spare Time**

**Just Place Card on Dealer's
Counter, Collect Once A Week**

TOOTHPERL amazes nation. Makes yellow, discolored, or tobacco-stained teeth as white as snow. Eliminates tartar. Just a clear liquid, absolutely harmless. Teeth shine and glisten like polished ivory. Everybody wants **TOOTHPERL**. Recommend it to their friends. Not an ordinary tooth paste or powder. It's a new, scientific discovery. Nothing else like it. Sells like hot-cakes.

All you have to do is place a card (containing 13 bottles) on the counter of drug, cigar and candy stores. Card brings in \$3.25. Dealer keeps \$1.25. Pays you \$2.00. You pay us \$1.00, making \$1.00 per card profit for yourself. Many stores sell first card in two hours. Chicago druggists call it fastest seller in history.

45,000 Bottles Toothperl Sold in 3 Months By Inexperienced Man

You don't need selling experience. You can make Big Money right from the start. All you have to do is place the cards and collect your profits. Territory going fast. Write today for complete details. Better still, mail \$1.00 for sample card. Don't delay.

MARCH PRODUCTS COMPANY
Dept. 18 5650 W. Lake St., CHICAGO, ILL.

Send \$1.00 for Sample Card

Place it on a druggist's counter. Watch it for a day or two. See how fast **TOOTHPERL** sells. Then grab your territory. If not satisfied, return card and we'll refund your dollar. Order several cards now if you want to get started quick.

Put this Parks in your shop

**Parks
"4-in-1"
Price
\$225**

Why spend time on hand work? Why not do every job on this husky, convenient, fast-working Parks machine? Make your shop up-to-date and a money-maker. The Parks "Four-in-One" is a circular rip and cross-cut saw, band saw, jointer and borer, all in one. Angle-steel frame, channel-steel top, fully equipped and guaranteed 10 years.



Send for circular and Parks catalog showing tables, saw-rigs, band saws and combination woodworkers for any shop requirements.

THE PARKS BALL BEARING MACHINE CO.
1500-1510 Knowlton St. Cincinnati, Ohio
Canadian Factory:
200 Notre Dame East, Montreal, Canada

PARKS

WOODWORKING MACHINES

"LYON BODIES" ONLY \$27.50
For Fords, Chevrolets and Dodges



SEND NOW

For Our 1923 "Book of Bargains"

Containing a full line of bodies and accessories at exceptionally low prices. Buy direct from the factory.

AUTO TIRE SALES CO., Dept. P8 Body Division
1346 S. Michigan Ave. CHICAGO



PILLIOD Tool Cases Excel

Machinists, Tool Makers and Carpenters find them most satisfactory in construction, appearance, service and price. Immediate shipment.

Booklet describing 20 styles on request.
THE PILLIOD LUMBER CO.
Dept. 1 Swanton, Ohio

CARPENTER'S The Original LIQUID COURT PLASTER



15¢

When your skin is injured DON'T use a clumsy quickly soiled cloth! Liquid Court Plaster quickly protects any small break with a flexible, clean, washable covering. Send 10¢ for a 1/2 tube, to cover handling and packing.
Carpenter Chemical Co.
80 Cadillac St., Detroit, Mich.

MAKE GAS IN ANY STOVE



**Cook in a
Cool Kitchen**

**The Instant-Gas Makes
Oil Burner**

summer cooking a pleasure. Gives you gas anywhere, everywhere, in any stove or range. Everybody knows gas means cleaner, cheaper cooking and a cooler kitchen.

Saves hours of time and loads of dirt. Start your stove with a turn of the wrist, turn high or low to suit and stop with another turn of the wrist.

Fits Any Coal or Wood Stove Different models for different stoves. Just set it in the fire-box. Put in or taken out in ten minutes. No damage to stove. Simple, safe, odorless, lasts a lifetime. Money-back guarantee.

30-Day Trial The Instant-gas Oil Burner makes its own gas from coal oil (kerosene) at one-sixth the cost of city gas. Much cheaper than coal or wood. Because it can be regulated the Instant-gas Oil Burner Cooks and Bakes Better than coal or wood in the same stove. No coal or wood to carry, no ashes, no chopping, shoveling or starting of fires. Greatest woman-saver in the world.

Write for 30-day trial offer and free book telling how Uncle Sam burns oil.

INTERNATIONAL HEATING CO.
Dept. 125
115 S. 14th St. St. Louis, Mo.

USER AGENTS

needed in every locality, to whom we can refer new customers. Send for our \$50 a week sales plan, giving exclusive territory free.

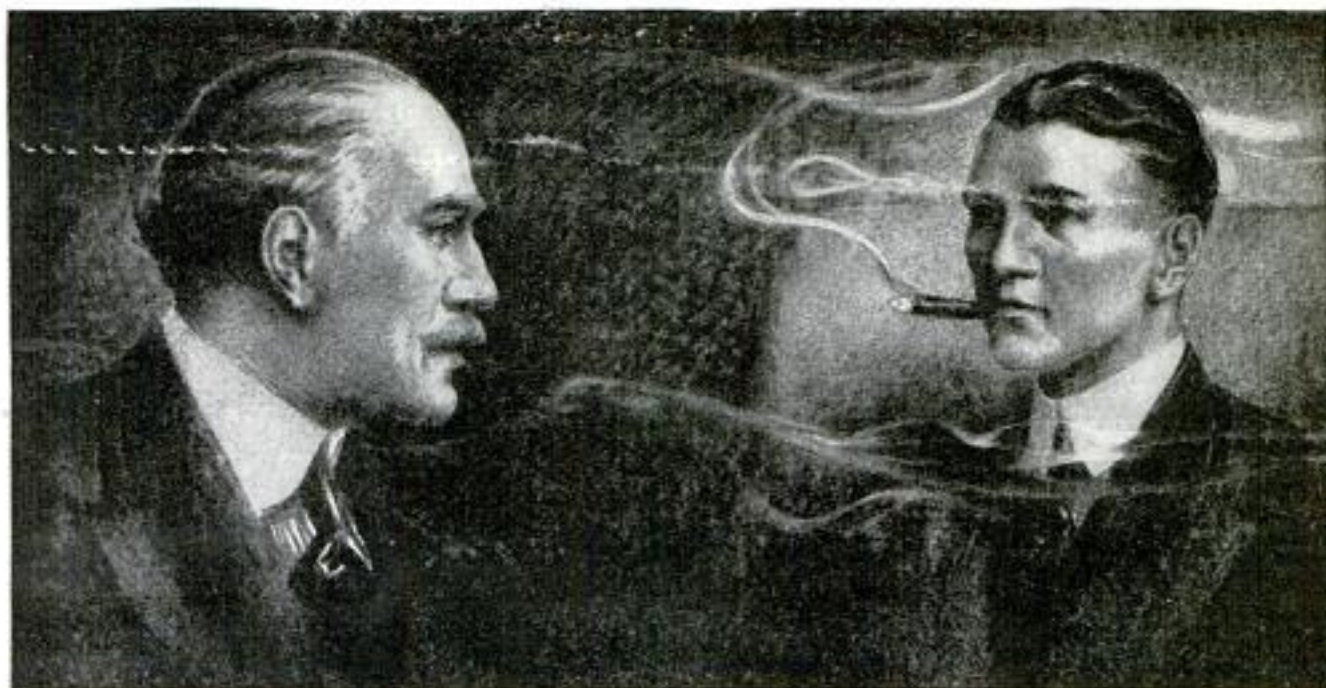

Tobacco Is Hurting You

Look at the facts square in the face, Mr. Tobacco User. You may think tobacco is not hurting you.

That is because you haven't as yet, perhaps, felt the effects of the nicotine poison in YOUR system. For you know that nicotine, as absorbed into the system through smoking and chewing tobacco, is a slow working poison. Slow, yes—but sure.

Tobacco is lowering your efficiency. It slows a man down. Makes it harder for you to concentrate your mind on your work. You haven't near the amount of "pep" and energy you would have if you stopped using it. There's many a man twice as old as you in years who's twice as young in energy, simply because he lets tobacco alone.

Some day you will realize to what an alarming extent tobacco has undermined your system.

When your hands begin to tremble—
and your appetite begins to fail—
and your heart seems to "skip a beat" now and then—
and slight exertion makes you short of breath—
then you have a right to suspect that
TOBACCO is getting the upper hand.

Any well-informed doctor will tell you that these are only a few of many symptoms of tobacco poisoning.

And YOU know that the use of tobacco in any form is an expensive, utterly useless habit. You know you ought to quit.

Tobacco Habit Banished Let Us Help You

It doesn't make a particle of difference whether you've been a user of tobacco for a single month or 50 years, or how much you use, or in what form you use it—whether you smoke cigars, cigarettes, pipe, chew plug or fine cut or use snuff—Tobacco Redeemer will positively remove all craving for tobacco in any form in a very few days. Not the slightest shock to the nervous system. Your tobacco craving will usually begin to decrease after the very first dose—there's no long waiting for results.

Tobacco Redeemer contains no habit-forming drugs of any kind and is marvelously quick, scientific and thoroughly reliable.

It is in no sense a substitute for tobacco. After finishing the treatment you have absolutely no desire to use tobacco again or to continue the use of the remedy. It helps to quiet the nerves and make you feel better in every way.

Results Guaranteed A single trial will convince you. Our legal-binding, money-back guarantee goes with each full treatment. We will refund every cent you pay for the treatment if after taking it according to the easy-to-follow directions, it should fail to banish the tobacco habit completely.

SEND Coupon for Free Proof Let us send you our free booklet on the deadly effects of tobacco, together with testimonial letters from men all over the country telling how they have been absolutely freed from the tobacco habit by this simple home treatment. You could not ask for stronger proof that Tobacco Redeemer will free you from the habit than the evidence we will gladly send on request. Just mail the coupon—or a postal will do.

NEWELL PHARMACAL CO.

Dept. 300

St. Louis, Mo.



Free Book Coupon

NEWELL PHARMACAL CO.

Dept. 300

St. Louis, Mo.

Please send, without obligating me in any way, your free booklet regarding the tobacco habit and proof that Tobacco Redeemer will positively free me from the tobacco habit or my money will be refunded.

Name

Street and No.

Town..... State.....

YOUR SUMMER HOME Wherever You Want to Make It!



WILLAMETTE AUTO TENTS

(Scientifically constructed)

2 windows, 2 shoe pockets, sod cloth all around. Made from U. S. government O. D. shelter duck. Packed in small canvas bag—no poles required.

Width	Depth	Height	Postpaid
7	7	7	\$22.00
9	7	7	\$24.00



APPELL'S South African Water Bag

Two gallon size—keeps water cool for 48 hours—Made from flax duck.

\$1.65 postpaid.

At your dealers or

Hirsch-Weis Mfg. Co.

205 BURNIDE STREET

PORTLAND, OREGON

13th Edition A NEW AND GREATER DYKE'S AUTOMOBILE ENCYCLOPEDIA

Entirely rewritten—rearranged and new illustrations from beginning to end. Mr. Dyke devoted almost two years of constant application to rewriting this book. We are confident that you will agree with us that it is the best book in the world today on the automobile, truck and tractor.

A PRACTICAL BOOK ON THE AUTOMOBILE FOR EVERYBODY

Over 1,200 Pages. Over 4,100 Illustrations
Over 14,000 Lines of Index

This book teaches the underlying fundamental principles of each and every part of an automobile—mechanical and electrical—in a simplified manner, and that is why the largest auto schools are using it as a textbook. Auto owners, students and repair men say that it contains the greatest array of automobile facts ever published in one volume.

This book will teach you to become an expert automobile repairman and also an electrical expert. You will understand fundamental principles, diagnosing troubles, testing, adjusting and repairing. If you were to purchase separate books on the subjects covered the lot would cost about \$21.00. The price of Dyke's book is

Cloth Binding, \$6. }
Flexible American } Postpaid
Morocco, \$7.50 }

Complete table of contents mailed free upon request

Popular Mechanics Book Dept.
200 E. Ontario St., Chicago

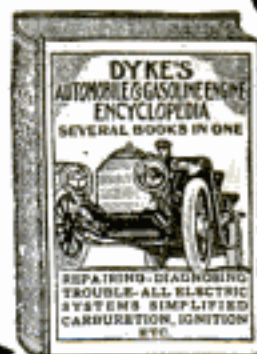

A New Book on Concrete For the Home, Farm and Factory

Describing 173 Ways of Using Concrete. Full directions for doing these things yourself with ordinary tools — 138 Illustrations.

Popular Mechanics' **CONCRETE** Handbook Number 1

Shows you how to make such things as

Concrete Fence Posts on the Farm
Cheap Concrete Mixer
Concrete Forge
Concrete Boat Landings and Docks
Garden Seats of Concrete
Molds for Making Concrete Blks.
Watering-Troughs in Concrete
Forms for Concrete Gate Posts
Rural Mail Box Post
Concrete Garden Furniture (5 articles)
Concrete Tile
Concrete Sidewalk Flagging
Horse Stalls of Concrete
Concrete Block Milk House
Sanitary Drinking Fountain of Concrete
Concrete Curbs and Gutters
Faultless Concrete Sidewalks

And practically any other requirement in concrete.

(THOROUGHLY INDEXED)

At the very outset it should be understood that while this book contains much that is of interest to the professional concrete worker, the clear directions and great variety of work covered make it especially suited to the needs of the amateur.

The farmer who wishes to make and set some concrete fence posts or make a watering trough for his stock; the shop man who wants a concrete forge, or the home lover who wishes to make some practical or ornamental article of concrete, will find that this handbook tells him just how to proceed, so that he may have confidence as to the outcome of his work. No wading through a lot of technical terms in order to pick out the bit of information needed; just step-by-step instruction "written so you can understand it."

Price 50c POST-PAID Send in your order at once and get ready to do that particular piece of work long deferred for want of the "know how."

POPULAR MECHANICS BOOK DEPARTMENT
200 East Ontario Street, CHICAGO

Fifty Cents

POPULAR MECHANICS' CONCRETE HANDBOOK No. 1



Describing 173 Ways of Using Concrete in the Home, Shop, and on the Farm. Full directions for doing these things yourself with ordinary tools. 138 Illustrations.

POPULAR MECHANICS PRESS
CHICAGO

Make Your Bike a Motorcycle

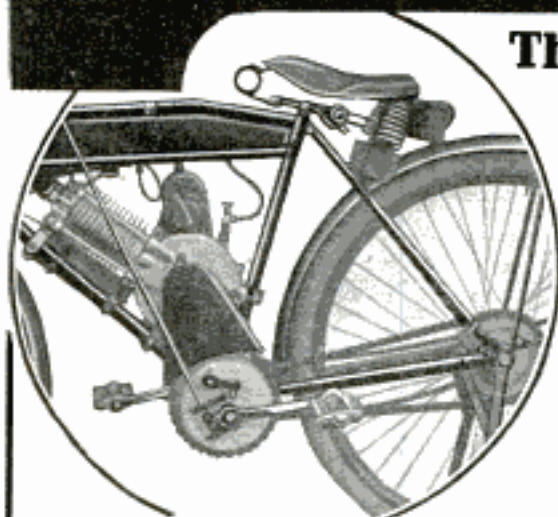

The Famous SHAW 2½ H. P. MOTOR ATTACHMENT

Why envy the fellow who rides an expensive heavy weight motorcycle? For a fraction of his investment you can easily convert your bike into a sturdy, lightweight, dependable motorbicycle. With a 2½ horsepower Shaw Motor on your bike you can travel with any of them—up the steepest hills, over sandy or muddy roads, and on long tours. You can enjoy the great out of doors and get the most out of life at the least cost.

The powerful Shaw Motor gives a speed of 4 to 40 miles an hour. 90 to 125 miles on a gallon of gasoline and 1200 to 1800 miles on a gallon of oil. Cheaper than walking. Sportier than foot pedaling.

Attach in 30 Minutes—No Special Tools FITS ANY MAKE BICYCLE

An ordinary wrench or screw driver are all you need to attach the Shaw Motor to your bike. No filing, fitting or boring. No changing or making over. 30 minutes after receiving your Shaw you can fill up with gas and oil and begin the greatest sport you've ever had. Simple directions are furnished. The Shaw clamps on bike frame making for easy control, better balance and greater power.

The Shaw Motor Attachment fits any standard bicycle frame. It transforms your bike both in appearance and performance. The perfect balance of the engine avoids vibration so common in most motors. Simple, dependable and safe at all times. The price is so low that you will hardly miss the money. In fact you'll soon pay for it in carfare and time saved.

The Complete Shaw Motorbicycle

If you have no bike and desire a complete Shaw Motorbicycle here it is. A lightweight, powerful, motorbicycle, complete in every detail. All latest 1923 improvements. 2½ horse power motor of highest efficiency. Special New Low Prices Now. Use coupon.



SHAW GARDEN TRACTOR

A better power farm tractor at a lower cost. Just the thing for truck gardeners, small farms, estates, etc. Equipped with famous Shaw motor. Get full particulars. Use coupon.



2½
H.P.
LOW
PRICE

Easy to Build this SHAW Cycle Car

A real automobile that you can easily build yourself. Carries 2 passengers anywhere. Power supplied by famous 2½ H. P. Shaw Motor. We supply everything. Check Coupon for free particulars. Complete Book of easy to follow plans only 25c. Please send stamps.



Take Advantage of New Low Prices

The 1923 Shaw Motor is the best model we have ever built. And we have made tremendous price reductions. You can now own a Shaw Motor Attachment at less cost than ever before. You can join the other thousands of happy, enthusiastic Shaw users. Do it now.

WRITE TODAY

The summer season is at hand. Write today for free complete descriptive literature and new low prices on Shaw Motor Attachment, Complete Shaw Motorbicycle, New Shaw Cycle Car or New Shaw Garden Tractor. Use Coupon. Check information desired.

SHAW MFG. CO.

Dept. 102, GALESBURG, KANS.

USE THE COUPON

Clip the coupon below. It is for your convenience. Check item on which you desire free information.

SHAW MFG. CO., Dept. 102, GALESBURG, KANS.

Please send me full particulars and new low prices on articles I have checked below, all without obligating me.

- | | |
|--|--------------|
| <input type="checkbox"/> Shaw Motor Attachment. | Name..... |
| <input type="checkbox"/> Complete Shaw Motorbicycle. | Address..... |
| <input type="checkbox"/> New Shaw Cycle Car. | R. F. D..... |
| <input type="checkbox"/> New Shaw Garden Tractor. | State..... |

\$48.00 **10 MONTHS TO PAY**

ONLY \$2.00 DOWN

PAY \$4.60 EACH MONTH

30 DAYS TRIAL

7 DIAMONDS SET IN SOLID PLATINUM

Pay only \$2.00 deposit to show your good faith; and select the ring you like best. We will deliver it without any delay or red tape. **DEALINGS CONFIDENTIAL. IF YOU RETURN IT WITHIN 30 DAYS WE WILL RETURN YOUR MONEY.** If you keep it, pay only \$4.60 per month for 10 months. Total price only \$48.00 for either ring.

FORMER CASH PRICE WAS \$75.00

The beautiful, blue-white, perfectly cut, sparkling genuine diamond is set in a popular 18-karat solid white gold ring and equals any \$75.00 ring. The cluster ring has seven perfectly cut, brilliant, blue-white genuine diamonds, set in solid platinum. The cluster is 1 1/2-carat size, and looks like a \$600.00 solitaire diamond. Order now; save 50%.

WRITE FOR BIG CATALOG No. 676

It brings a large jewelry store right into your home.

STERLING DIAMOND & WATCH CO.
63 PARK ROW, Dept. 676, NEW YORK (Est. 1879)

The Dragon

One of the many beautiful models we manufacture for Fords and Chevrolets. Mr. Dealer, pay only one profit, buy direct from us, the actual manufacturers of these bodies, and save money.



VICTOR AUTO BODY CO., 1422 Blue Island Ave., Chicago, Ill.

Our **BUREAU OF INFORMATION** will answer all questions regarding articles in this magazine. Address Popular Mechanics Magazine, Chicago.

Emboss YOUR OWN

Your name, monogram,
seal or trade mark
in raised letters ~ ~
Economical - Guaranteed

- Stationery
- Circulars
- Blueprints
- Photographs
- Imprints

Salesmen - write for exclusive offer. Everybody wants this handy device

Write for complete description of the Empress Embosser
THE FULNAME CO.
Southern Railway Bldg.
CINCINNATI, OHIO

You want to be well and keep well—send for the book "Health." It tells you how the healing powers of electricity can be safely used to help you.

Rheumatism, neuralgia, neuritis and sciatica and over one hundred other diseases of the nerves, blood and tissues have been successfully treated.

A letter or post card brings the book. Write today.

Renulife Electric Company

614 Newberry Building

DETROIT

MICHIGAN

DETROIT BELT LACING OUTFIT

ASSORTED BOX \$1.50

\$5

375

The fastest, strongest, smoothest, most economical, biggest looking way to lace belts is with Detroit wire hook staggered grip lacing. It is the nearest approach to an endless belt. Easy to apply. Saves time, belts and money. Tool for applying lacing \$3.50 or, together with assorted box of lacing an shown—complete outfit postpaid \$5.00. Laces belts for 1 1/2 in. Money back if not satisfied.

Detroit Belt Lacing Co., Detroit, Mich.

Six Machines in One

Combines bench saw, sander, drill, grinder, polisher and buffer for working in wood and soft metals

Boice Pony Bench Machine

—a precision machine especially adapted to rapid and accurate work. Handles 4" and 5" grinding wheels, 6" saws, 6" and 8" sand disc and 3/4" chuck. Saws 1 1/4" wood. Mountable on separate base with motor. Height 10". Weight 31 lbs. Top 10" x 12" easily removed. All metal construction. Easily driven by 1/4 or 1/2 H. P. motor. Especially suited for Private Shops, Laboratories, Shipping Depts., Printers, Cabinet and Pattern Makers, Furniture Repairmen, etc. Machine sold with a money-back guarantee.



Our line includes 4" bench jointers, 14" bench band saws, bench drills, 1/4 and 1/2 H. P. Ball-bearing motors, and larger motor driven bench saws.

Write for descriptive literature and prices on Boice Pony Bench Machines and Motors.

W. B. & J. E. BOICE, Dept. P.M. 6, Toledo, O.



Car Owners Wanted!

—to show and sell this greatest improvement in Inner Tubes since autos were invented. Air Gauge on every tube built in as part of the valve stem tells at a glance actual air pressure all the time. Just look through the unbreakable transparent valve cover and see pressure instantly. No more guessing. No more bothering with separate air gauge. No more soiling of hands and fussing with dirty valve covers and caps to find out if tires need more air. Car owners buy on sight, no matter what car they drive or what casings they use. Our "direct-from-factory" salesmen are cleaning up with this great new invention. Many make \$5 an hour—right from the first. Absolutely no competition. All basic patents owned and controlled by this company. No capital required to start. Previous selling experience not necessary. You can sell—

AIR-GAGE Extra Heavy Inner Tubes

—to almost every car owner because they cost no more than others of equal quality. Made of best quality live red rubber, built up on the multiple ply laminated process. Tough, live, durable. Every tube guaranteed in writing. Read how we help you make a success.

- We pay the largest commissions offered by any tire maker.
- We actually make and fully guarantee every Tube and Tire we sell.
- We give exclusive agency in territory you select and credit you with all orders received from same.
- We ship all orders to our men all charges prepaid.
- We advertise Air-Gage Tubes in Magazines reaching 20,000,000 readers.

Big Free Book Explains All

Send coupon or write today for big new illustrated book. Tells how to sell Air-Gage Tubes. How to become a successful Paul Salesman. How to start in a big paying business of your own without capital, how to be the one to nail down this tube and tire business in your territory, how to get the special Demonstrating Outfit. How to get your own Tires and Tubes at factory prices. If you want to get all the facts about this wonderful new invention and the "Paul Plan" of distributing through exclusive factory representatives, send the coupon today. We refer you to Dun's, Bradstreet's or any Bank in North Carolina.

THE PAUL RUBBER CO., Dept. 25, Salisbury, N.C.



THE PAUL RUBBER CO., Dept. 25, Salisbury, N.C.
 Without obligation on my part, send me your Free Book about Air-Gage Tubes and the "Paul Plan" of selling. Also your Exclusive Agency offer and discounts I would get on Air-Gage Tubes, and Coverlat and Long Distance Cord Tires.
 Name _____
 Address _____
 Reference _____

A BETTER Engine For Less Money

Only
Engine
Sold on
Lifetime
Guar-
antee

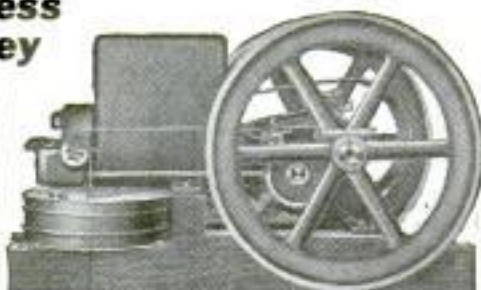

THE NEW WITTE

Throttling Governor

Easy to install—Easy to handle—Gives more power than rating—Increase or decrease speed at will—Run on cheap fuel, Gasoline, Kerosene, Distillate or Alcohol—Steady speed on variable load—Starts without cranking—So simple a boy can understand it.

Adaptable to any power job anywhere

Comes complete—Battery equipped. BOSCH Magneto at small cost extra. All other sizes and styles at proportionate low prices.

WRITE FOR CATALOG

WITTE ENGINE WORKS (Write Nearest Address)
1748 Oakland Avenue, KANSAS CITY, MO.
1748 Empire Building, PITTSBURGH, PA.
1748 Fremont Street, SAN FRANCISCO, CAL.

2 H.P.—Pulls 3
\$45.00
Fig. #48.50
Prisco 257 At K. C.

3 H.P.—Pulls 4
\$69.50
Fig. #73.50
Prisco 257 At K. C.

5 H.P.—Pulls 6½
\$99.00
Fig. #137
Prisco 257 At K. C.

Build Your Own PHONOGRAPH

IT'S EASY WITH OUR HELP

A few hours' interesting work saves over half and gives you a machine to suit your ideas. We furnish motors, tone arms, case material, blue prints and full instructions. Plays any record. Make fine profit building phonographs for your friends.

Write today for our **FREE** Blue print offer.

GET YOUR **RADIO SUPPLIES** FROM US
Choraleon Phonograph & Radio Co.
623 1st St., Elkhart, Ind.



SAVE
OVER
HALF

STEP ON HER!



Zingo! 20 miles per hour using our 1923 motor.

Prices reduced on all parts. Anybody can assemble this car. Send 25c for plans, including instructions and price list.

SYPER MANUFACTURING COMPANY
146 Syper Bldg. TOLEDO, OHIO

\$3,000.00 IN ONE YEAR



This Bunch of Tires Will Make Several Dollars Profit

Easily possible with Tire Surgery. Tire prices on upward trend. Car owners again flocking to repair stations. We have wonderful proposition for ambitious men. Oldham made \$2200 in 4 months. Evans average \$100 week. Several choice locations available. Write quick for details. May be opportunity you seek. Write and find out. We will place whole proposition before you within 72 hours. Address
Haywood Tire & Equipment Co.
1315 S. Oakley Ave. Chicago, Ill.

DEAF

Hear After Using Radio, Amazing Discovery

Hundreds of people heretofore DEAF ARE HEARING AFTER USING RADIO. This new principle has been embodied in a self-contained device, the Syncro-Vibrator, which is giving amazing results in restoring hearing. No radio needed. Full details on request. No obligation. Address Yorke Burgess, Consulting Electrical Engineer, 744 East 42nd St., Chicago, Ill.

AMATEUR MECHANICS

A book for those who like to make things. 132 separate articles tell how to build electrical and mechanical devices, read fusions, balling tackle, hammocks, etc. 128 pp. illustrated. 25 cents postpaid. Popular Mechanics Book Dept., 209 E. Ontario St., Chicago



CATALOG No. 22 IS READY

Small Steam and Gasoline Engines, ¼ H. P. up, Pumps, gears, model makers' supplies. Sent postpaid (2 dimes preferred) or 20c stamps.

Modern Engine & Supply Co.
334 Monadnock Bldg., Chicago



Our BUREAU OF INFORMATION will answer all questions regarding articles appearing in this magazine. Address Bureau of Information, Popular Mechanics Magazine, Chicago

Direct at Factory Prices

This \$2 KNIFE \$1.18 Postpaid
Hand Forged Razor Steel Blades
Handy shaped Blade makes this knife best for mechanics, sportsmen and farmers; light but strong; re-sharpened easily. Stag handle. German silver finish; blades file tested, hand forged from razor steel and warranted.

Sample \$1.18 3 for \$3.00 Postpaid.
Send for our 100-page List and "HOW TO USE A RAZOR" **FREE**

MAHER & GROSH CO., 106 A St., Toledo, Ohio

Hand
Forged
Razor Steel
Blades, No. 57



A GENUINE \$2 KNIFE
FOR
\$1.18 POSTPAID

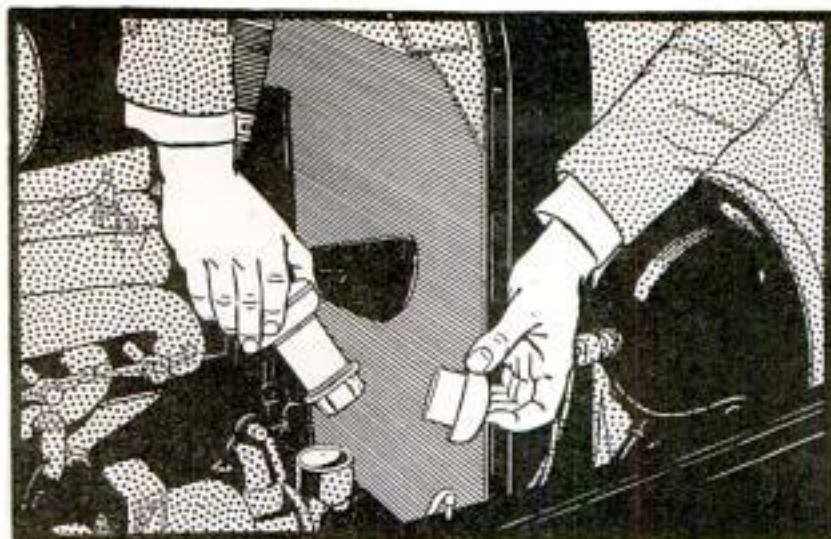

FREE Trial of Autovac

**The Amazing
Discovery That
Cuts Oil Bills
33 $\frac{1}{3}$ % to 50%!**

Now you can try this remarkable new invention on your Ford for 10 days at our expense. Send no money. Simply mail the coupon below.

Here is a new scientific discovery that every man who understands a Ford motor instantly appreciates. It is called AUTOVAC—and it is the invention of P.W. Craig—Motor Specialist.

What it accomplishes is scarcely believable until you have actually seen it work.

The first and most obvious thing that AUTOVAC does is to cut your oil consumption 33 $\frac{1}{3}$ to 50%. It pays for itself 5 to 6 times a year in oil savings alone. But AUTOVAC does far more than this.

Clean Lubrication

At the present time dust and grit-laden air is constantly being drawn into the crank-case of your motor. This grit acts like an emery, grinding out the bearings. AUTOVAC stops this grit from being drawn into the crank-case! Now for the first time you can feed your motor oil that is really CLEAN. And clean oil means an infinitely smoother-running motor—and longer engine life.

By stopping the oil from passing from the piston rings to the spark plugs AUTOVAC eliminates the cause of mis-firing.

It keeps the terminal wires and fan-belt dry by keeping the oil from contact with them. Thus saving expensive replacement.

How AUTOVAC Works

AUTOVAC takes the place of the oil-filler plug in the crank-case of your car. It creates a partial vacuum which sucks the oil in—absolutely preventing oil leakage in the joints and bearings.

AUTOVAC isn't an untried experiment. It does the work every time. Over 65,000 Ford owners who have subjected it to every sort of test, enthusiastically endorse what it has accomplished.

Ford-Owner Agents Wanted

You can make from \$10 to \$40 a day putting this amazing new invention on Fords in your town. We have a new selling plan that makes selling easy. Write now for Special Offer.

Our Amazing Free Trial Offer

We have yet to find a single instance where AUTOVAC has not made good! So we make this remarkable offer.

Simply fill out and mail to us the coupon below. Send no money—pay the postman nothing. We will send you an AUTOVAC at our expense. Any child can attach it. You simply remove the oil filler plug—insert AUTOVAC instead. It starts saving oil immediately. Your engine instead of being oily and sloppy is kept clean. Your motor gets clean oil.

AUTOVAC comes to you at our expense. If it doesn't do everything that we say it will—and more—simply mail it back and you are under no obligation. If after 10 days you are astonished at the results that it has produced, then mail us only \$3.50—payment in full. You take no risk. So mail the coupon now.

We Guarantee

1. That Autovac will cut your oil consumption 33 $\frac{1}{3}$ to 50%.
2. Will keep your terminal wires and fan belt dry.
3. By proper lubrication prevent fouling of spark plugs.
4. Prolong the life of your motor by keeping grit and dirt out.
5. Give you clean dirt-free lubrication.
6. That it will pay for itself five or six times a year in oil savings.

Price \$3.50

**AUTOVAC COMPANY, 614 Wallace Building
Salisbury, North Carolina**



MAIL THIS COUPON

Autovac Co., 614 Wallace Bldg.
Salisbury, North Carolina

I accept your Free Trial offer. Send me Autovac. I will put it on my Ford for 10 days. If it does everything you say, I will send you \$3.50. Otherwise I will return it—without obligation.

Name.....

Street.....

City.....

State..... Car License No.....

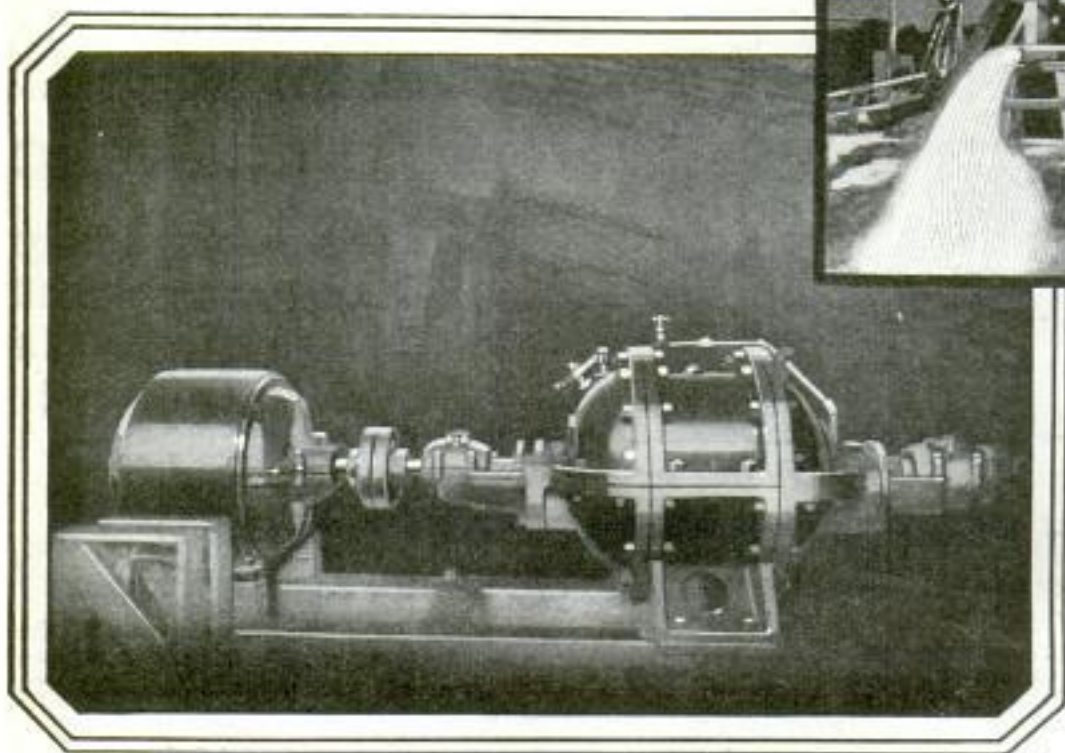

Who started this pump?



Whatever *your* industry may be, the scientists and engineers of General Electric Company are at work in it, discovering new ways by which electricity can lighten human labor and protect human life. The experience and counsel of these men is at your command, without obligation or cost.

Nobody. A tiny stream of water trickled into the mine. Faster it came, touching the float switch of the G-E Automatic Starter. Instantly the great pump went into action.

In subways, coal mines, railway tunnels, the pumps are always ready, and the lives of millions of people are kept safe by this General Electric invention—a sentinel who never sleeps.

GENERAL ELECTRIC



The cutter
may be *removed and replaced*
without changing adjustment

THE Sargent Auto-Set Bench Plane will mean a great saving of time and trouble at your work-bench. For whenever you have to remove the cutter, you can replace it at the same adjustment you were using and go on with your work.

The cutter of chromium alloy steel keeps its edge an unusually long time. And always makes shavings—even when cutting across the grain or through tough, knotty wood. The cutter is so

rigid it will never chatter.

For the smaller jobs—the finishing touches or the work in close quarters—use the Sargent Steel Pocket Plane and the Steel Block Plane. They are light, handy, dependable and faithful to your best craftsmanship. See these planes at hardware dealers everywhere.

Write for the Sargent Book of Planes. It is full of detailed information on these fine tools and many other styles of superior planes.

SARGENT & COMPANY

Hardware Manufacturers

49 Water Street, New Haven, Conn.

SARGENT
Tools & Hardware

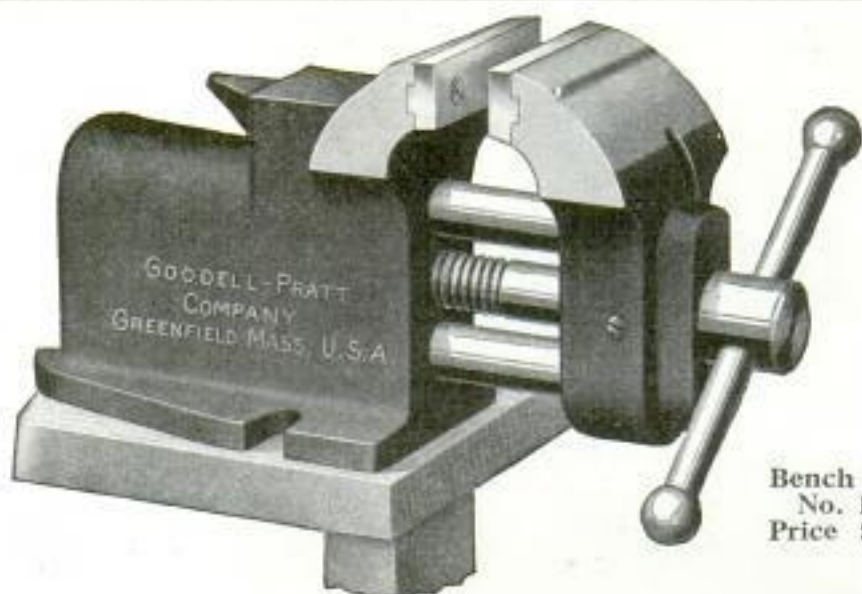

Bench Vice
No. 168
Price \$7.40

Want two more hands?

THEN put this Goodell-Pratt Vice on your work bench. It's the equivalent of having two more hands, for it will hold any piece of work tight and rigid.

The only bench vise made with two-guide-rod construction. These steel guide-rods are pressed into the movable steel jaws and run in long reamed holes back under the small anvil. Jaws open $2\frac{1}{2}$ inches. Weight, 10 pounds.

Iron parts are finished in red and black enamel; steel parts are polished.

Other tools for amateur mechanics

No matter what kind of work you want to do, no matter what the job, you'll find somewhere in the Goodell-Pratt line of 1500 Good Tools, the very tool made for that specific kind of work.

The design, workmanship, and finish of all Goodell-Pratt tools make them splendid investments for men who love good tools.

Write for catalog No. 15. It illustrates and describes the Goodell-Pratt line. You ought to have a copy.

GOODELL-PRATT COMPANY, Greenfield, Mass., U.S.A.

Toolsmiths

GOODELL- PRATT

1500 GOOD TOOLS



Mr. Punch says:

"A work bench without a good vise is almost as lacking in equipment as a saw without a handle."



“Topkis costs One Dollar —but I’d pay twice that”

TOPKIS certainly gives me my money’s worth—and then some! Dollar Topkis more than repays its cost every minute I’m wearing it.

“On top of perfect fit Dollar Topkis gives me better fabric and longer wear than lots of underwear that cost me double.

“It’s good to know that when I buy Topkis Size 38 I get full 38 measurement. I can’t try on underwear in the shop, like a hat or shoes.”

Men everywhere say Dollar Topkis is the biggest underwear value. Easy, roomy

fit. Extra long, extra wide legs. Big armholes. Full cut chest and waist.

Best nainsook and other high-grade fabrics—pre-shrunk. Full size guaranteed.

No mistake, the Topkis Men’s Athletic Union Suit is a big dollar’s worth. No good dealer will ask more—but they know it’s worth more and will say so.

Men’s Shirts and Drawers, 75c a garment; Boys’ Union Suits, Girls’ Bloomer Union Suits, and Children’s Waist Union Suits, 75c.

In Canada, Men’s Suits, \$1.50.

Free booklet tells what you ought to know about underwear. Write for it.

TOPKIS BROTHERS COMPANY, Wilmington, Delaware
General Sales Offices: 350 Broadway, New York City

Ask your dealer for TOPKIS.

Look for the TOPKIS label.



THESE MEN WON—WHY NOT YOU?

The following IDEAS for Pressed Metal Articles, heretofore made of other materials, have already been purchased from readers of Popular Mechanics.

The Engineering Advisory Board of Pressed Metal T. E. C. reports on Ideas thus far approved, accepted and paid for, as follows:

INDEX NO.	Article described as per instructions in the Pressed Metal Booklet. (Have you one?)	SUBMITTED BY: (To whom checks have duly been mailed.)
130	Piston Vise.....	MR. GEORGE H. BARROTT Box 313, Shelburne Falls, Mass.
115	Side Frames for Sewing Machines.....	MR. CHAS. E. BOWN 414 Oxford Ave., Dayton, Ohio
139	Baby Carriage Wheel Toy.....	MR. VERNON W. J. COPPIN 174 Drayton Ave., Toronto, Can.
163	Spring Clip.....	MR. ERNEST GRAY 173 East 3rd North, Logan, Utah
167	Parts for Hot Air Furnaces.....	MR. FRANKLIN HORNE Box 505, Manitou, Colo.
165	Parts for Police, Fire and Tel. Station Call Boxes.....	
011	Auto Hood Spreader.....	DR. A. C. MULLER Strathmore, Calif.
208	Pulley Guard.....	MR. C. R. MULLIN 314 2nd St., Watertown, S. Dak.
219	Toilet Seat and Shoe Lace Fastener.....	MR. A. J. McCORMACK 294 Elmdorf Ave., Rochester, N. Y.
301	Auto Battery Casing.....	MR. R. J. NELSON Hopkins, Minn.
241	Ladder Rung Replacement.....	MR. C. H. RICE, c.o. Engineering Dept. Olds Motor Works, Lansing, Mich.
305	Slot for Cleaning.....	MR. PAUL F. STINER 520 2nd Ave. East, Twin Falls, Idaho
258	Signs for Houses and Roads.....	MR. SCOTT M. SAWYER Glenwood, Minn.
269	Clips for Wire Lines.....	MR. H. M. TAYLOR 17 Caithness Ave., Toronto, Can.
308	Auto Emergency Brake.....	MR. W. C. WILSON 924 W. Maple St., Johnson City, Tenn.
431	Storage Battery Plates.....	MR. C. R. MULLIN 314 2nd St., Watertown, S. Dak.
377	Photo Support.....	MR. PERCY L. MANN Box 104, Grant, Mich.

No longer need your mechanical cleverness remain "hidden under a bushel." It seems that almost everybody is suddenly (and most intelligently) interested in PRESSED METAL. Why can not *you* suggest some *new way* to utilize its practically unlimited usefulness and economy? The ideas we buy become a public benefit. Just remember that Pressed Metal is *anything* that can be produced by *stamping* from sheets of steel, brass, aluminum, copper or any other useful metal.

The FREE Pressed Metal Booklet Tells HOW TO CAPITALIZE YOUR MECHANICAL TALENT or inventive genius—or maybe just your "good old common-sense." It tells all the conditions and the amounts to be paid for the successful ideas, and also how to protect yourself against misappropriation of your creative thoughts by others. **WRITE TODAY.** (A post card will do, but please make it easily legible so it can be properly filed and acknowledged.) "Every day lost is lost." Address

DEPT. **A** **PRESSED METAL** TRADE COUNCIL
EXTENSION
27 QUINCY STREET, CHICAGO

AGENTS WANTED!

No More "Greasing Day" in Gasoline Alley

No more ruined clothes and spoiled dispositions. No more putting off that lubricating job for the service station or repair man to do. Here's a lubricating system that you will actually use because you can do over your car in a few minutes' time, readily lubricate it and keep your hands and clothes clean.

2000 lbs. "Hydraulic Pressure"

The SAAL Oil Shooter utilizes a simple and easily understood principle in building up 2000 pounds of hydraulic pressure merely by pushing the plunger. A few pounds of pressure on the handle of the oil shooter becomes a ton of pressure at the nozzle. No coupling is used in the SAAL. Simply hold the nozzle against the ball-checked spring of the SAAL fitting.

Will You Sell Your Time for \$100 to \$200 a Week?

Driver-agents wanted to sell the only high-pressure heavy-oil lubricating system for autos ever put on the market. Free trial offer sells them all. No experience or capital needed. Any man who follows our instruction can make \$5,000 to \$10,000 a year.

Heavy Oil at 2000 lbs. Pressure

With no more pressure than you would use on a hand tire-pump, SAAL Oil Shooter actually generates 2000 pounds of pressure which crashes through dirt and rust and forces the velvety flow of transmission oil into the bearing.



2000 lbs. Pressure

100% Lubrication!

Ford Size \$5.00

Complete with fittings and holster. Also used for Chevrolet, Overland, Gray and Star.

For all other cars:

\$8.00

Complete with 42 fittings and holster

Heavy Oil—or Grease?

When you ask for a "can of grease" you usually get 25% lubrication and 75% "binder", which is neither more nor less than soap. In a dry, thirsty bearing grease can only get in where it won't do any good. Grease is dead. Lubricating engineers say heavy oil is the 100% lubricant. It is **live!** It doesn't stay put, it flows all over the bearing. The SAAL Heavy Oil System is the first successful method which employs heavy oil for lubricating steering shackles, fan, springs, transmission, differential.

SAAL HEAVY OIL System

42 Fittings—fit every car!

The largest car requires only 37 fittings. We supply you with 42 fittings standardized and interchangeable. Unscrew the grease cups or oil cups from your car with pliers, and screw in SAAL fittings. No mechanic or expense necessary. The SAAL Heavy Oil System fits all cars, and this is one reason the price is lower than you must pay for other lubricating systems.

Driver-Agents! Get yours FREE!

Equip your own car without a penny of cost, and you will find it easy to take orders everywhere with our free trial and money-back offer. Don't wait, be the first to write from your territory. Mail coupon or telegraph!

Coupon brings your big opportunity!

H. G. SAAL CO.

Dept. 301
1801 Montrose
Ave.,
CHICAGO

Mail it
Today!

Carry It Under the Hood

We supply free steel holster which can be fastened to the dash under the hood, so it's convenient when you stop for gas or before you start out in the morning to shoot heavy oil into every bearing. Takes only a few minutes. Throw away your oil can and get a SAAL!

Dealers, Garage, Repair Men!

Mail coupon for our irresistible offer and sensational profit-making proposition. SAAL Oil Shooter will be the biggest selling auto-accessory in 1923. Get your share of the profit!

H. G. SAAL CO., Dept. 301
1801 Montrose Av., Chicago

Please send me complete information about SAAL Heavy Oil System. I am marking X for proposition in which I am interested.

- Agents proposition paying \$100 to \$200 a week.
 Free trial offer to motorists.
 Special profit-making offer to dealers, garage and repair men.

Name.....

Address.....

CAPITAL \$2,500,000
Established 22 years

5 SAAL FACTORIES

FROST-JAC-BOX



Complete as shown \$3.00

A handy accessory for your receiving set

BY means of a Frost-Radio Jac-Box you can quadruple the jack capacity of your radio set. Neat—handy—beautifully made. Permits use of three pairs Frost Fones and loud speaker at one time or four fones without loud speaker. See it at your dealer's. Order one for your set.



HERBERT H. FROST, Inc.
154 WEST LAKE STREET, CHICAGO, ILLINOIS.

COMMERCIAL ENGRAVING and PRINTING

Contains hundreds of ideas and suggestions of service to the advertising man, printer, salesman, student, photographer, artist, engraver, electrotypist, bookbinder, paper jobber, etc., and will be invaluable as a permanent work of reference.
850 Pages. Over 1500 Illus. Cloth. Price \$15.00, postpaid.
Popular Mechanics Book Dept., 200 E. Ontario St., Chicago.

Our BUREAU OF INFORMATION will answer all questions regarding articles appearing in this magazine.

Address Bureau of Information, Popular Mechanics Magazine, Chicago

Range, Power, Portability With a Single Tube!



FREE!

Erla Bulletin No. 13, giving diagrams and notes for building the Erla Duo-Reflex circuit, is obtainable gratis from leading dealers. Also complete blue prints are available at 25c per set. Ask your dealer or write.

Vacation time holds new and untold pleasure, when you tune in with Duo-Reflex, the most powerful single-tube circuit ever built.

Through a loud speaker, it brings in all but the most distant stations; and with headphones it ranges from coast to coast. Its light weight, less than fifty pounds, with dry cells, makes it ideal for camping trips or week-end tours.

Responsible for the efficiency of this circuit, and the secret of its amazing power, is the Erla radio frequency reflex transformer. Be sure to get the genuine! Electrical Research Laboratories Dept. J. 2515 Michigan Ave., Chicago.

ERLA

Moore's Universal Assistant and Complete Mechanic

Contains 1016 Pages, 500 Engravings, and Over 1,000,000 Industrial Facts, Calculations, Receipts, Processes, and Trade Secrets for Every Business!



For Sterling Value, Elegance, and Low Cost, This Work Has No Compeer in the English Language

The Work contains 200,000 items for Gas, Steam, Civil and Mining Engineers, Machinists, Iron Founders, Plumbers, Metallurgists, Assayers, Miners, Builders, Metal and Wood Workers, Manufacturers, etc. Full details (with 500 Engravings) for constructing, operating, and repairing Mill and Steam Machinery of every kind, setting of Valves, Link and Valve Motion, Eccentrics, Indicator Diagrams, Injectors, Steam Boilers, Gauges, Machinists' Tools, Mechanical Movements, Tunnelling, Mining and Rock Drilling Machinery, Wheel Gearing, Gas Meters, Diagrams for Sheet Metal Workers, Views of Noted Buildings, Bridges, Plans of Mills, etc.

FULL INSTRUCTIONS TO ENGINEERS, FIREMEN, BOILER MAKERS, ENGINE AND CAR BUILDERS, ETC. Proportion of Engines, Repairing Locomotive Break-Downs on the Road, Boiler and Steam Pipe Covering, Cements—69 kinds, Bright Polish—4 kinds, Scale Preventives—10 kinds to Clean Waste, Details for Cotton, Woolen, and Fulling Mill Machinery; ditto, for Flour, Oatmeal, Saw, Shingle, Planing, Paper and Wind Mills, Grain Elevators, Sugar, Oil, Marble and Rolling Mills, Blast Furnaces, Gas Works, Water Works, Mill Dams, Water Wheels, Hydraulics, Cotton Presses, Speed of Wheels, Pulleys, Drums, Circular Saws, Woodworking Machinery, Horse Power of Streams, Belts, Strength of Metals, Timber, Building Materials, etc. Seasoning of Timber—12 ways, Growth of Forest Trees, Logging, Cost of Supplies, Stream Driving, Lumber Measurement and Surveyors' Tables, full and complete, Views of Lumbering Scenes, Saw Mills, Saw Filing, etc., etc.

PRICE ONLY \$2.00 POSTPAID
Popular Mechanics Book Dept.
200 E. Ontario St., Chicago

DON'T BURN COAL!

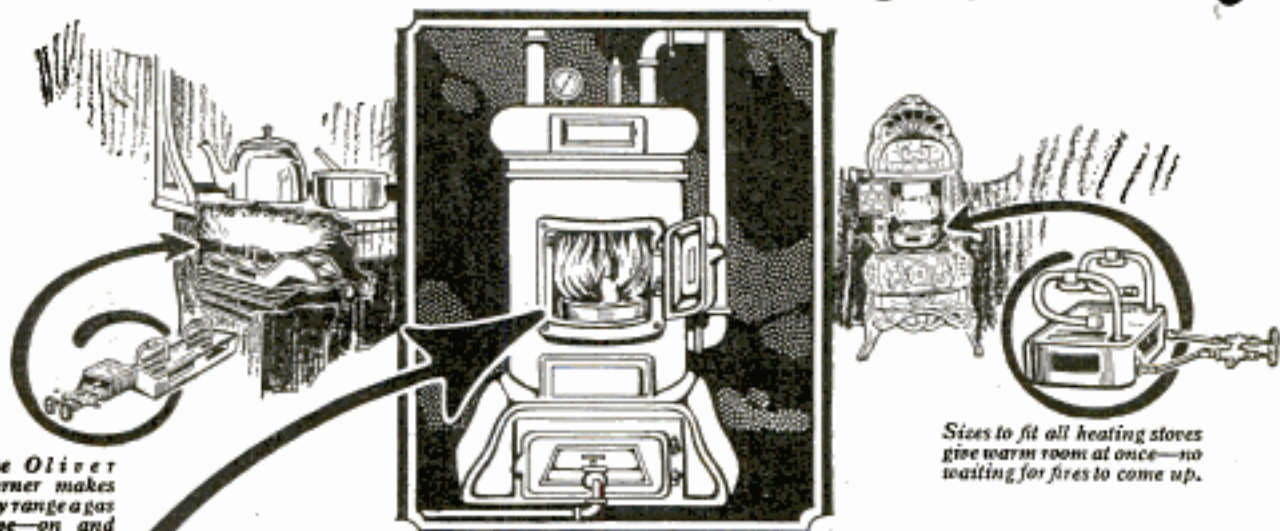

The Oliver Burner makes any range a gas stove—on and off at turn of valve.

Fits all hot water, hot air or steam furnaces.

Sizes to fit all heating stoves give warm room at once—no waiting for fires to come up.

New Kind of Fuel Replaces Coal -In Ranges, Heaters and Furnaces

EVERY householder in America has been waiting for this startling new invention. For by its use you are freed forever from the dirt and muss of coal and ashes, from the uncertainty of fuel shortages and from exorbitant prices.

No more worry about coal strikes, no bills for hauling ashes or janitor service. Simply put this amazing new invention in your Furnace, Range or Heating Stove. Install it yourself in a few minutes and the dirt, soot, smoke, and drudgery of coal is ended forever.

Satisfaction Guaranteed!

Already this amazing invention has been severely tested under laboratory conditions in thousands of homes. Its performance is so perfect that Mr. Oliver guarantees it absolutely.

Find out now how you can burn this new cheap fuel in your furnace or stove. The coupon below will bring you this information—and will entitle you to a special Low Introductory Price if you send it at once. There is no cost or obligation. Mail it now.

Cheaper, Cleaner, Hotter!

A St. Louis inventor, Mr. B. M. Oliver, has perfected a simple mechanical device which combines 95% air with 5% kerosene, thus producing a new kind of fuel technically known as oil gas which burns with an intense, clean flame in any type of hot air, hot water or steam heating plant—giving three times the heat of coal!

No Expensive Equipment!

Best of all, the equipment is so simple and inexpensive that every family can now afford to install an Oil-Gas Burner. The Oliver regulates the temperature of your home automatically. Simply set the thermostat and your Furnace runs itself. No more rebuild, no more shaking of ashes and continuous tending of fires. No more frozen pipes, because this heat stays at any temperature, without attention. No need for you to pay exorbitant prices for coal.

OLIVER OIL-GAS BURNER CO.

2014-F Oliver Bldg. ST. LOUIS, MO.

Oldest and Largest Manufacturer of Oil-Gas Burners in the World.

Canadian offices, 2014-F Webster Bldg., Toronto, Ont.

Agents, Salesmen and Regional Distributors are needed

Demand is enormous. Thousands of spare time workers, agents, and salesmen are needed. \$75 a week easy! Many getting \$1,000 a month. Free Fords to producers.

Men with crews who can swing whole territory can earn \$10,000 to \$50,000 a year.

Write or wire at once for details or appointment. Write to me personally, B. M. Oliver, address shown below.

OLIVER

OIL GAS BURNER CO.

OLIVER OIL-GAS BURNER CO.,
2014-F Oliver Bldg., St. Louis, Mo.

Send me your book, "New Kind of Heat," and full details of Burner and prices. I am interested in the burner for a

Coal Range Heating Stove (Steam) (Hot Air) (Hot Water) Furnace

Name.....

Address.....

City.....State.....



This Beautiful Book on Wood Finishing **FREE**

GIVES complete instructions for finishing all wood—hard or soft, old or new. Explains just what materials to use and how to apply them. Tells how inexpensive soft woods may be finished so they are as beautiful and artistic as hard wood. This book is the work of experts—illustrated in color. Gives covering capacities, includes color charts, etc.

JOHNSON'S ENAMEL

Johnson's Perfectone Undercoat and Enamel is the ideal finish for wood, plaster and metal. It will not chip, check, crack, peel or change its color. Gives a beautiful,

germ-proof porcelain-like finish which is impervious to hot soapy water, iodine, ammonia, etc.

Fill out and mail coupon for a free copy of "The Proper Treatment for Floors, Woodwork and Furniture."

S. C. JOHNSON & SON, Dept. PA6, Racine, Wis.
Please send me, free and postpaid, your Instruction
Book on Wood Finishing. The best dealer in paints

here is.....

My Name.....

My Address.....

City and State.....

S. C. JOHNSON & SON

"The Wood Finishing Authorities"

Dept. PA6, RACINE, WIS.

Canadian Factory—Brantford

RIDE A RANGER

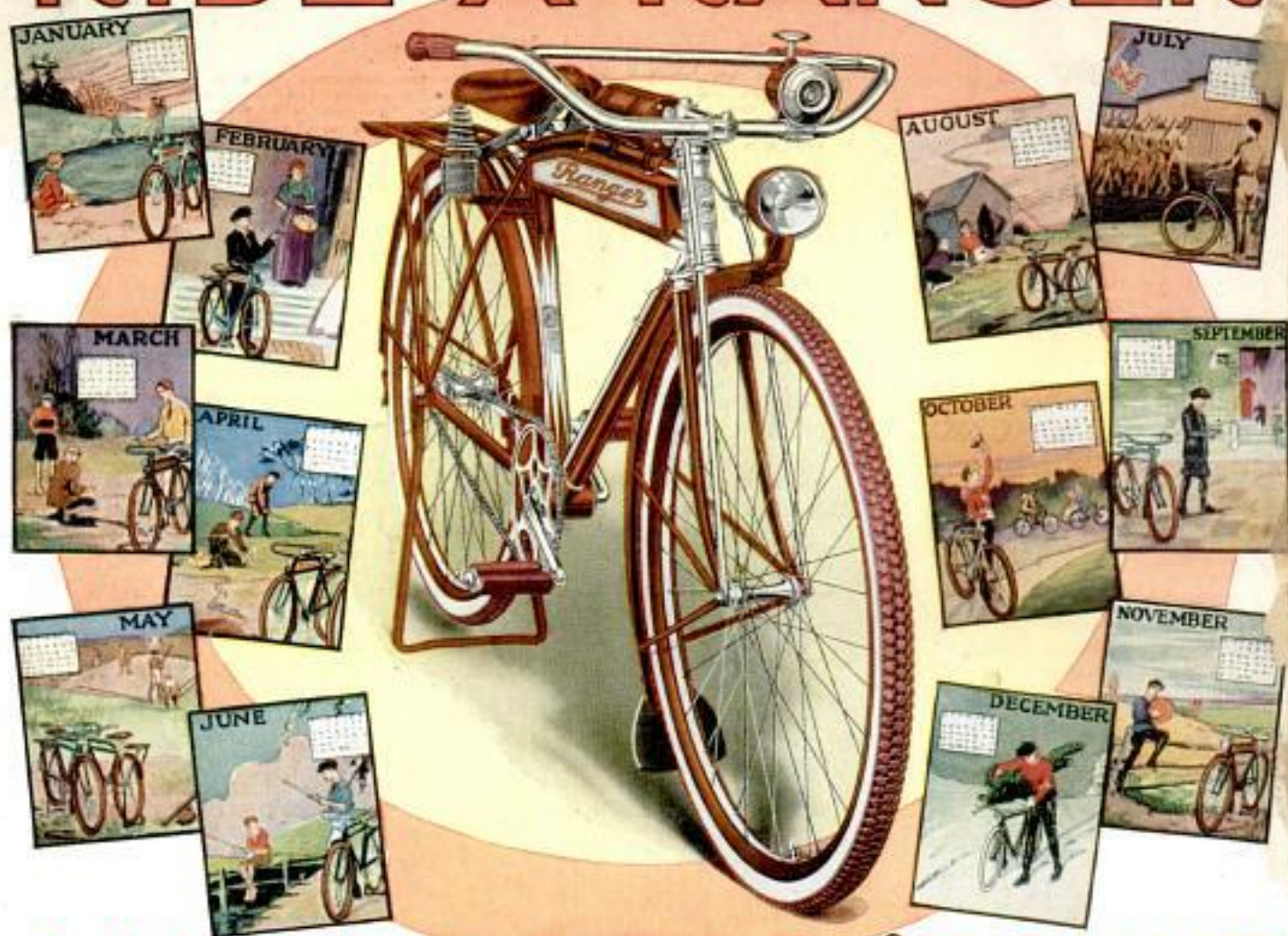

ALL THE YEAR 'ROUND

30 Days' Free Trial

ment and exclusive features. If at the end of thirty days you want to return it for any reason, send it back and you will not be out one cent.

Factory-to-Rider When you buy a Ranger you are dealing direct with the makers at Factory Prices. Your "Ranger" is waiting for you. The parks, country lanes and swimming holes are calling you out of doors to health and freedom. When we get your order your bicycle will leave on a fast express train (*all charges prepaid*) packed in a waterproof paper bag and enclosed in a strong wooden crate. Safe delivery in perfect condition guaranteed.

Pay \$5 a Month

If not convenient to pay cash for your "Ranger" bicycle, we will ship it to you at once and arrange with you to accept monthly payments which enables you to take advantage of our rock-bottom factory-to-rider cash price with only a slight amount added to cover the cost of extra bookkeeping on credit accounts. Parents frequently advance the initial small payment and energetic boys and girls save and earn the later monthly payments.

See for yourself the values found in Ranger bicycles with their complete equipment of accessories and extras. Send to-day for catalog and select the model you prefer. Ride it thirty days, test its speed, sturdy qualities, de luxe equipment and exclusive features. If at the end of thirty days you want to return it for any reason, send it back and you will not be out one cent.

There are 44 styles, colors and sizes in the famous line of **RANGER Bicycles** a model to suit every taste and any pocket book.

5-Year Guaranty

Every Mead "Ranger" is warranted for five years. This means we make good trouble arising from any defect in workmanship or material at no cost to you. Our guaranty is a written contract—we are directly responsible for the satisfaction and general performance of your bicycle because we made it.

Tires and Equipment

Our big free catalog illustrates and describes parts, equipment and sundries that our more than a million riders may need. All are carefully selected from the leading parts makers of the world, to Save You Money at our Factory Prices.



Get this FREE Catalog



We have a copy all ready for you and it will be sent as soon as we receive the coupon in the lower corner of this page. If you prefer send a postcard—only write your name and address plainly. Turning the pages of the "Ranger" catalog is like walking down the aisles of the largest and greatest of bicycle stores seeing bargains, new ideas and conveniences that you never saw or heard of before.

Send No Money Ask for the big catalog and full particulars of our Factory Prices, marvelous offers and Easy Payment terms. Read especially about our extra \$5.00 FREE Premium set which goes with every "Ranger" bicycle.

MEAD CYCLE COMPANY
Dept. T-108, Chicago, U. S. A.

Send me the new Ranger Catalogue, factory-to-rider wholesale prices, 30-day Free Trial Offer and Easy Payment Terms.

Name.....
R. F. D. or
Street No.

Town..... State.....

FACTORY DISTRIBUTORS IN 264 CITIES

The nearest city (with a population of 25,000 or more) which I can conveniently visit to select a Mead Ranger is.....
If you have a Special Factory Distributor there, send me letter of introduction to him so I can inspect the Rangers and take delivery from there at Factory prices or on Easy Payment Plan if I prefer.

MEAD CYCLE COMPANY

DEPT. T-108 CHICAGO, U. S. A.

POPULAR MECHANICS MAGAZINE

WRITTEN SO YOU CAN UNDERSTAND IT

REG'D. TRADE MARK, GREAT BRITAIN, No. 410426

REG. U. S. PAT. OFF.



SEE PAGE 511

It takes *only* 8 weeks to get a big job



O. H. Justus owns a big agency and repair shop at Parkersburg, W. Va. He says "that my schools give motor secrets that will put any man 'on easy street.'"

In the Auto and Tractor Business

Read what these men are doing—here is your big chance to get "on easy street." Come to these great shops on the biggest **FREE** offer ever made.

Big Firms Need Trained Men

The Auto and Tractor Business is on the boom. Thousands of trained men will be needed during the next few months. I get calls every day from Garages, Battery Stations, Auto Repair, Welding Shops and other successful concerns for Rahe men. When the big fellows need high grade men they know where to come for them. They want Rahe trained men.

My Training Unusual

Scientific tool training—that's the secret. You do things here according to the latest engineering standards. Thousands of dollars have been spent in modern tools and equipment. That's why my men are at home in the biggest shops in the country. If you want to succeed the way Beimer and Justus and the rest have—qualify by the same method in only eight weeks or stay as long as you like.



Emanuel Rushfeldt, Alberta, says: "Earning \$10 a day and only 20 years old."

I'll Pay Your Railroad Fare and Board You

In order to fill the openings that now exist, I am making an offer no one has ever made before—**Free Railroad Fare, Free Board for eight weeks.**

SAVE
\$50 to \$75

You Save Big Money by acting now. Pack your grip—get on a train—Come to school right now before it is too late—**OR WRITE TODAY.**



W. W. Peace gets \$250 a month and expenses operating a tractor in the oil fields.

Send for **FREE** Book

My big illustrated training book tells how others are succeeding. It tells many things you ought to know about Autos and Tractors. Write for it and my **short time** offer NOW. It soon expires.

Rahe *Auto & Tractor* Schools

CHICAGO
4445 Grand Blvd.

Dept. 902. CINCINNATI
Ninth and Walnut



Louis Beimer at 24 was made foreman over men many years older. That's not luck—it's Rahe training.



Rahe Auto & Tractor Schools,
Dept. 902, (address school nearest you)
4445 Grand Blvd., or Ninth & Walnut,
Chicago, Ill. or Cincinnati, Ohio.

Without any obligation, send me your big free book, "The Evolution of Transportation." Also information regarding special temporary offer.

Name.....
Street.....
City.....State.....