

May

25 Cents

POPULAR MECHANICS MAGAZINE

WRITTEN SO YOU CAN UNDERSTAND IT

REG'D TRADE MARK, GREAT BRITAIN, No. 410426

REG. U. S. PAT. OFF

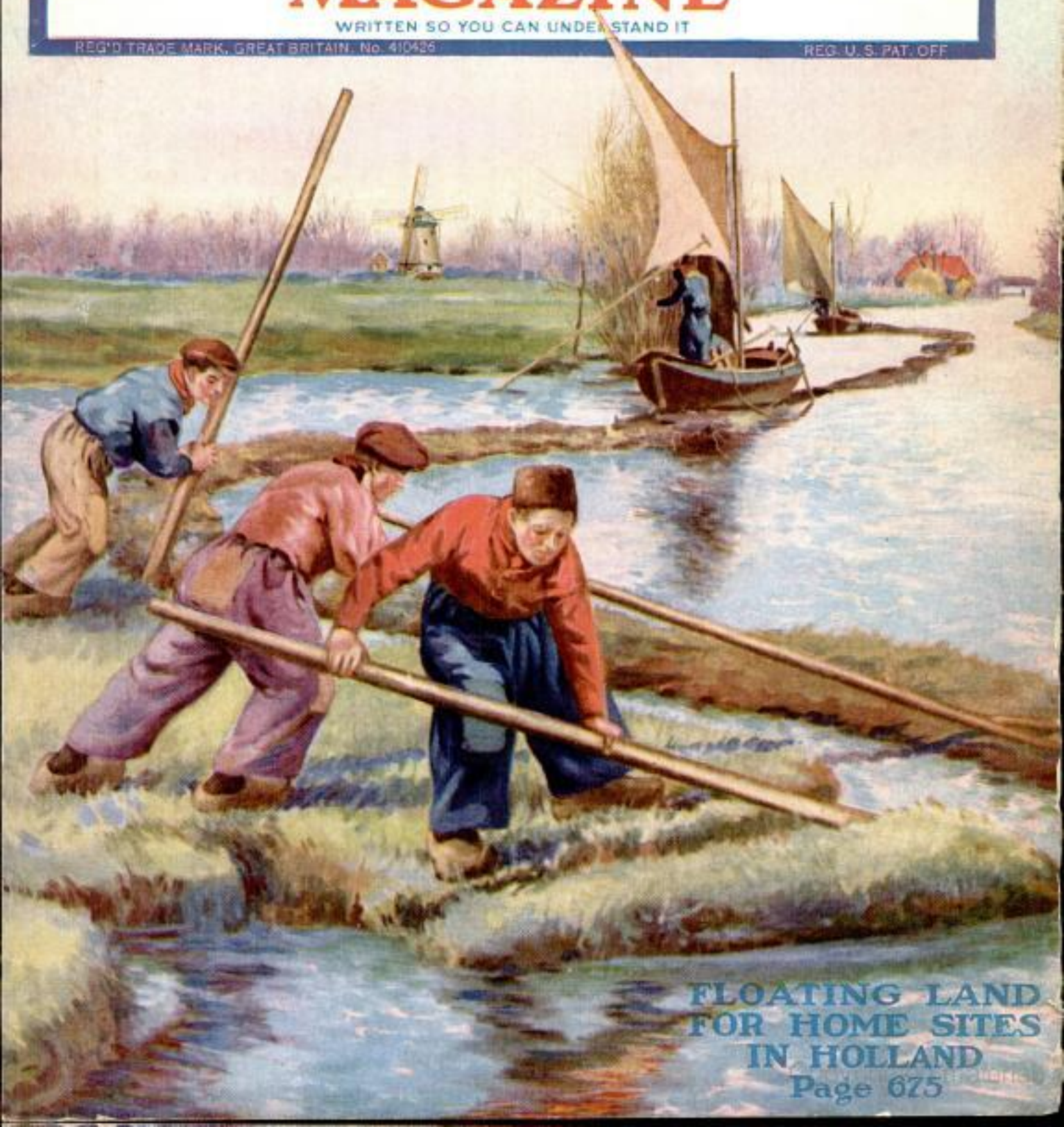

FLOATING LAND
FOR HOME SITES
IN HOLLAND
Page 675

THE SPORT TWIN

40 Pounds of Quiet Power

LIGHT, compact, sturdy, a "twin," and a genuine Evinrude! Look it over. Notice its clean, closely-knit design—its obvious ruggedness. And it performs even better than it looks.

The Sport Twin combines every feature you have wanted in a lightweight, two-cylinder, detachable motor. Instant starting — silent, vibrationless power—and typical Evinrude reliability.

Automatic Reverse and wide sweep of tiller give perfect control of boat and assure safety. Evinrude Tilt-up prevents damage by bottom or snags, makes beaching easy. Evinrude built-in-flywheel magneto, no batteries. Float-feed carburetor.

Ask your sporting goods or hardware dealer about the Sport Twin. Write for new catalog describing the complete Evinrude line of detachable and built-in motors.

Evinrude Motor Company
169 Evinrude Block, Milwaukee, Wis.

DISTRIBUTORS:

69 Cortlandt St.,
New York, N. Y.
780 Commonwealth Ave.,
Boston, Mass.
211 Morrison St.,
Portland, Ore.
119 Broadway,
Oakland, Calif.

*The Complete
Evinrude Line*
Sport Twin
Big Twin
Standard Single
Built-in
Evinrudes
One and two
cylinder
models

EVINRUDE



Blame Yourself

If This Message Doesn't Bring You A Big Salary Increase

LET'S be specific. What do you want in life? You want more money than you're getting. You want your own home, a car, membership in a good club, you want to wear good clothes, educate your children and put away enough money to make you independent. If you are like other men, you want to be your own boss in a position that grows every day in interesting fascination. You want to travel, see the world, and meet the wide-awake people who are doing things.

All right. I'll tell you a quick, easy way to accomplish all this. If you don't take it you are the only loser. You are the only one who will have to face the accusing finger of the man you might have been. If you do take it, you'll thank me the rest of your life for putting this information in your hands. For now it is possible for you to quickly enjoy bigger earnings, and have all the joys in life that your bigger self demands. If this was a guess I couldn't print it. I know it to be a certainty. It is proved by the cases of thousands of other men who have done exactly the same thing. Listen.

What It Brought These Men

Charles Beery, a farm hand of Winterset, Iowa, was offered this chance. He took it and jumped from \$18 a week to a position paying him \$1,000 the very first month. J. P. Overstreet, Denison, Texas, was on the Capital Police Force at less than \$1,000 a year. He wasn't content with a bare living and he jumped to an income of \$1,800 in six weeks. F. Wynn, of Portland, Oregon, an ex-serviceman, wanted the joy of a real success. He earned \$544 in one week. George W. Kearns, working on a ranch for \$60 a month, took the quick road I offer you and in two weeks he earned \$524. Warren Hartle of Chicago was a railway mail

clerk for ten years—in as deep a rut at as low an income as any man could stand. But he wanted success, he longed for the good things of life that he saw other men having. He took my advice and earned over \$7,000 the first year.

The Secret Is Yours

But, of course, you want to know how it's done. I'll tell you. Although none of these men had ever sold a thing in their lives—though many believed that a salesman must be "born"—a salesman—we took them, without experience or training of any kind, and in a short period of time made Master Salesmen of them. Then our Employment Department helped them to select the right position and they were off with a boom to the success they had dreamed of.

The National Salesmen's Training Association can do exactly this for you. If this big organization of Master Salesmen and Sales Managers had raised the salaries of only a few men, then you might call it luck. But we've been doing it for fifteen years, day in and day out. Today we're so accustomed to the amazing increases in salary our members receive that we take them as a matter of course.

There is only one thing I ask of you in return for this offer. Don't let the idea of a big salary, the thought of traveling all around the country and meeting worth-while people, make you think that the job is beyond you. Keep an open, unprejudiced mind on this subject—at least until you have seen the

remarkable book that I want to send you without charge.

Read This Free Book

This book, "Modern Salesmanship," explains why thousands have quickly succeeded in the selling field—how it is easy to make big money once you are in possession of the Secrets of Selling—how you can quickly get these fundamental secrets, apply them and achieve a quick and permanent success. This is the book I will send you, absolutely free of obligation and expense. Read it through and then decide for yourself.

But remember this one thing: This is your opportunity. If you don't realize a big salary increase from this message, you have no one to blame but yourself. Send me the coupon before you turn this page and I'll send "Modern Salesmanship" immediately.

National Salesmen's Training Association
Dept. 12-E, Chicago, Illinois

National Salesmen's Training Association,
Dept. 12-E, Chicago, Illinois.

I am willing to investigate the opportunity you offer without cost to myself. Please mail me Free Proof that I can become a Master Salesman and qualify for a good sales position. Also send your illustrated book, "Modern Salesmanship," and particulars of membership in your Association and its Free Employment Service. This is all free of cost or obligation.

Name.....

Address.....

City..... State.....

Age..... Occupation.....

This One



NXEA-D78-F2FH

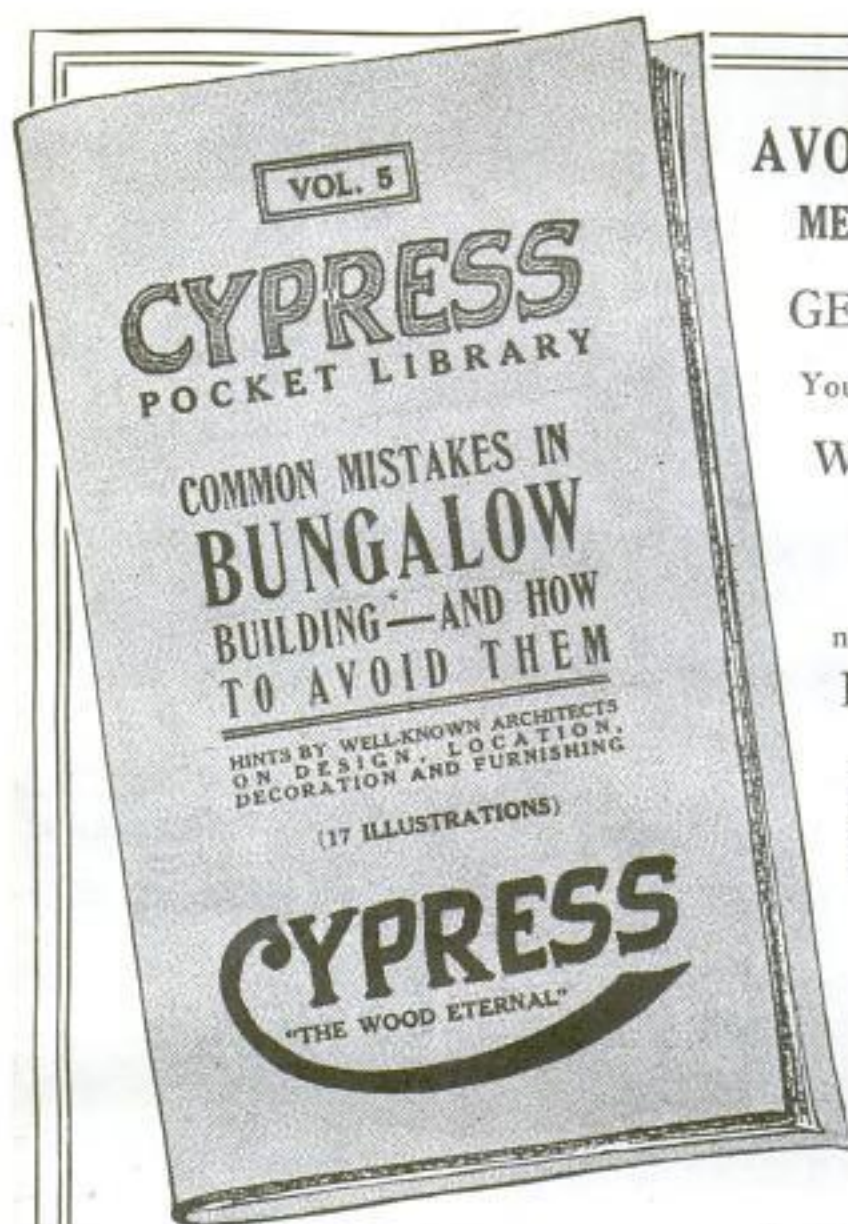

AVOIDING MISTAKES

MEANS SAVING MONEY

GET VOL. 5—QUICK

Your name on a post-card will do.

When Everybody is
Urging You to
"Build Now,"

now is the time of times to
BUILD RIGHT.

The less you have to spend in building, the more important it is that you secure the longest possible life for your investment. The *more* you spend the more important it is that your money shall represent a definite and permanent investment,

and not have to be spent over again in exasperating repairs. Cypress is "the one best buy" in the entire wood market for those who care what they get for their lumber money. Because it lasts and lasts and lasts and lasts and LASTS. We manufacture Cypress lumber—and are proud of that fact. But—we don't want you to use Cypress except where Cypress, "The Wood Eternal," is *best for you*.

PROBABLY THE BEST THING FOR YOU TO DO
is to write us for a copy of Volume 5 of the internationally famous Cypress Pocket Library.
AND PROBABLY YOU WOULD BETTER "DO IT NOW."

Let our ALL-ROUND HELPS DEPARTMENT help YOU MORE. Our entire resources are at your service with Reliable Counsel.

Southern Cypress Manufacturers' Association
1219 POYDRAS BUILDING, NEW ORLEANS, LA., or 1219 GRAHAM BUILDING, JACKSONVILLE, FLA.

INSIST ON TRADE-MARKED CYPRESS AT YOUR LOCAL LUMBER DEALER'S. IF HE HASN'T IT, LET US KNOW.

Stepped Claw Hammer makes Under Concrete Blocks - 684 nail Pulling Easy - 734

Popular Mechanics Magazine

200 E. Ontario Street, Chicago, U. S. A.

H. H. WINDSOR, Editor

London: Hachette & Co.,
16-17 King William Street, Charing Cross, W. C. 2

Paris: Hachette & Co.,
111 Rue Reaumur

Melbourne, Australia
The Australasian News Co.

ISSUED MONTHLY

SUBSCRIPTION:

SINGLE COPY, 25 CENTS

In United States and its possessions, also Canada, Cuba, and Mexico, per year, postpaid \$3.00

To all other countries in the Postal Union 3.50

All subscriptions are discontinued at expiration. Please examine the date printed on your wrapper.

Entered as Second Class Matter Sept. 15, 1903, at the Post Office at Chicago, Illinois, under Act of March 3rd, 1879.

Entered as Second Class Matter at the Post Office Department, Canada.

Published monthly by POPULAR MECHANICS CO. Copyright, 1923, by H. H. WINDSOR. Copyright in Australia.

Vol. 39

Contents for May, 1923

No. 5

Airplane Height Indicator for Night Flying.....	703	Circus Lighting Plant Has Large Capacity.....	715
Airplane—Night Service between New York and Chi- cago.....	680	Civic Features.....	706
Airplane Speed and Height Records Made in France	680	Clock, Desk, Sounds Alarm to Jog Owner's Memory	708
Airplane Survey of Salt Creek Tea-Pot Dome Oil Fields, by Bob E. Nowland.....	690	Cloth Knitting Machine, English.....	721
Airplane Taxi, Wingless, Makes Trips over Snow..	689	Coal Mine Views, Recent German, Held by France in Ruhr District.....	718
Airplane Tows Skiers at 60 Miles an Hour.....	705	Concrete Piers, Action of Salt Water Tested on.....	774
Arbor, Turning and Grinding, Fits All Pistons.....	712	Concrete Pipe Cast by New Centrifugal Process....	738
Automobile Chassis, Tandem, Used for Railway Coaches.....	770	Concrete Reinforcing Bars Indicate Own Size.....	695
Automobile Demonstration Shows Flexibility of Car's Drive.....	775	Concrete Road Form Has New Features.....	681
Automobile Engine Heats Quickly with New Device	747	Convention to be Held in Deep Salt Mine.....	769
Automobile Headlight Dimmer Operated by Push Button.....	686	Cooking Device, European, Does Double Duty.....	747
Automobile Oil Signal Flashes Warning Automati- cally.....	747	Cotton Spraying Machine Uses Liquid or Powdered Poison.....	760
Automobile—One Man Racing Car Ready for Speed- way.....	686	Cripple in Wheeled Chair Tills Garden.....	736
Automobile Radiator Funnel Requires No Holding..	740	Cultivator Blades Save Hand Weeding.....	681
Automobile Roadster Has Golf Lockers and Other Features.....	733	Cupola Tapper and Stonner Is Simple and Safe....	746
Automobile Speedometer Signal Flashes Danger Light	665	Diamonds, Drill, and Diamond Drilling, by Charles Nichols Webb.....	713
Automobile Top Cleaned by Duster in Garage.....	685	Dog Derby, American, by O. J. Grimes.....	678
Automobile Windshield for Rear Seats Easily Attached	731	Dog—Watchdog "Travels Best" in Aerial Cable Cage	710
Automobile "Yacht" Seen on California Roads.....	710	Drilling and Inserting Machine for Wood.....	758
Automobiles Visiting Park Registered by Automatic Device.....	773	Drummer's Case Has Space for Accessories.....	682
Awnings, Window, Adjusted from Inside House....	773	Dry Cleaning Plant Explosions Averted by Chain... 772	
Baby, Electric, Proves Attractive Sign.....	682	Drydock, New York, to Equal Boston's in Size.....	745
Background, Painted, for Displaying Removable Ob- jects.....	682	Egg Grading Scale Tells Weight per Dozen.....	684
Balloon, New Type Spherical, Has Propeller Control	721	Electric Fan Uses Aluminum Airplane Propeller... 717	
Barrels, Concrete Water, Adopted by Railroads.....	776	Electrode Alloy, New, Cuts Copper Refining Cost... 711	
Baseball Cover, New, Cuts Manufacturing Cost....	780	Electrotype Plates, New Method Easily Corrects... 730	
Ball, Rubber, Has Many Corners.....	694	Elevated Cars, Chicago's, to Have Plush Cross Seats 681	
Beetle, Centuries Old, Same as Modern Species....	694	Elevator, Portable Farm, for Hay or Feed.....	681
Bells Cast from Steel Instead of Bronze.....	725	Engine, Portable Oil, Runs Pump or Bucksaw.... 744	
Bells, Notre Dame, to be Electric Toned.....	673	Explosive, New, Made from Sawdust.....	752
Bender, Simple, Forms Iron into Many Shapes...	673	Factory Buildings, New, Form Upward Steps.....	742
Bicyclists, Denver, Required to Have License Plates	756	Fence, Australian Rabbit, Covered by Sand.....	753
Blasting Fuse, New Device for Lighting.....	687	Ferris, Automobile, Drives Blindly before Gale into Port.....	734
Blimp, Giant, being Built to Circle World.....	720	Fishing, Dugong, in Australia.....	687
Boats—Racing Shells, New, Western University Builds.....	732	Flag Holders, Locomotive, Are Also Containers... 726	
Boll Weevil, Vacuum Machine Destroys.....	702	Floor Lamp, Attractive, Made from Rope.....	746
Bonfire Signals to Tell of Amundsen's Start.....	740	Flux, New, Permits Zinc Welding.....	737
Bridge, Arkansas River, to Be War Memorial.....	659	Forestation to Help City Reduce Indebtedness.... 688	
Bridge Concrete Distributed in Unusual Way.....	673	Furnace, Electric, Pilot Lights Aid Control of.... 780	
Bridge Damage Causes Sacrifice of Tree.....	706	Furnace Regulator and Fan Effect Economies.... 667	
Building Blocks Subjected to Novel Fire Test....	741	Gas Cut-Off Valve, Street, for New York Buildings 704	
Cable, Aerial, Carries Melons over Creek.....	700	Gas Radiator Made Fumeless with Gas Mask.....	775
Caisson, Floating, Serves as Fire Stop, by R. Frank- lin Mundorff.....	685	Gas Well, Large, Photographer Risks Hearing to Snap.....	762
Canal, Welland, by Geo. F. Paul.....	684	Gears, Hot Rolled, Produced by New Process.... 718	
Canaries, Newly Arrived, Must Pass Inspection...	728	Geysers Harnessed to Furnish Power, by H. H. Dunn 705	
Carburetors, Testing Apparatus to Improve, by J. C. Allen.....	765	Gliding Record, New, Made by French Pilot.....	711
Cement Particles, New Apparatus Determines Size of Centering and Drilling Machine, Automatic.....	734	Goats, Herd of, Used to Prevent Fire.....	751
Checking Tool, Alignment, of High Precision.....	727	Goggles Also Contain Small "Trouble Light".....	713
Children's Picture Pages.....	709	Grandstand, Single Deck, Is World's Largest, by Henry S. White.....	723
Church, New, to Receive Services via Radio, by F. N. Hollingsworth.....	697	Granite, Five Miles of, Is Back Wall of House.... 739	
Church Skeleton, Steel, Is Unusual Sight.....	751	Hammer, Device Converts into Pine Wrench.....	740
	707	Heater, Special Electric, for Ticket Booths.....	702
	707	Hedge Trimmed to Form House Owner's Name... 760	
	731	Helicopter, Spanish, Rises 81 Feet.....	685
	696	Hill, Historic Battery Park, at Asheville, is Removed 677	
	733	Hoist, Portable Electric, Has Many Uses.....	702
	778	Honey Claimed to Be Excellent Antifreeze Remedy 747	
	663	Horse Races, Adjudging by Photography.....	754
	737	Hose Clamp, Emergency, Plugs Leaks.....	717
		Hospital, French, Interesting Amolitheater in.....	702

[Continued on Page 4]

Copyrighted material

[Contents—Continued]

House, Large Wooden, "Sails" Long Island on Barge.....	667	Ships, Tank, Using Panama Canal Are One-Eighth of Traffic.....	745
House on Tree Stump Built by Civil War Veteran.....	764	Shoplifters, Police "Dead Line" Bars.....	763
Household Devices.....	770	Silk, Qualities of, New Treatment Improves.....	682
Hydroelectric Power Plant North of Arctic Circle.....	759	Silo Blocks, Standard, Simplify Construction.....	777
Ice Cream Cones with Nuts, Candy, or Sirup.....	770	Skating on Lincoln Memorial Reflecting Pool.....	686
Ice Scoring Machine Saves Waste and Time.....	742	Skating Taught in Indoor Schools in Norway.....	769
Ice Skating is Featured in Warm Weather.....	738	Sled can Run over Ice, Snow, or Water.....	676
Ice Storage Practice, Usual, Reversed.....	773	Snakes—Pythons in Dallas Zoo to Have Padded Cages.....	736
Inner Tube, New Type, Needs No Valve.....	704	Stadium, Los Angeles, to Seat 75,000, by Frank B. Howe.....	757
Inner Tubes, Emergency Repair Device for.....	776	Stepladder, All Steel, Has Many Advantages.....	772
Insulation Tester, Portable, Is Very Light.....	701	Storage Battery, New, for Radio Tubes.....	774
Islands, Mud, Laid Bare by Gale in Baltimore Harbor.....	746	Stronghold, Old Stone, Made into House.....	744
Jail, Australian, for "Wildmen".....	743	Stucco Work, New Steel Fabric Simplifies.....	687
Labels, Kitchen, for Empty Cans Given by Firm.....	730	Switch, Electric, Regulates Temperature.....	736
Ladder, Collapsible, Makes Fruit Picking Easy.....	732	Tennis Courts, City of, for Australian Players.....	715
Land, Floating, for Home Sites in Holland.....	674	Tile, Big, in Deep Ditch to Reclaim Iowa Land.....	716
Leveling Instrument of Simplified Design.....	733	Tire Slicer Fits Worm Tires for Reuse.....	777
Lifeboat, Speedy, University of Wisconsin Buys.....	685	Tomb of Tutankamen, How Tourists Reach.....	683
Locomotives, Passenger, Are World's Largest.....	693	Tractor Lifts Itself by "Boot Straps".....	704
Magazine Holding Rack Fits on Narrow Ledge.....	773	Tractor "Locomotive" Helps Advertise Car Company.....	693
Manhole Cover, Self-Locking, Prevents Accident.....	747	Tractor Proves Efficient Fire Fighter.....	683
Molds for Making Decorative Sealing Wax Forms.....	734	Typewriter Device, Mechanical, Aids Touch Writing.....	732
Monkey Wrench, New, Works from Handle.....	752	Typewriter, Pocket Size, Is Smallest in World.....	740
Monorail Car, Hand Operated, Excels Wheelbarrow.....	720	Universal Joint Eliminates Pins and Screws.....	732
Motion Picture Projector Arc Feed, Continuous Automatic.....	695	Violoncello, New Form of, Has Five Strings.....	726
Motion Pictures—"Souls for Sale".....	672	Weeder Is Adjustable to Width of Row.....	720
Motorcycle Engine, All Aluminum, Light and Powerful.....	720	Weights That Grow Puzzle Bureau of Standards.....	760
Motorcycle Is "Made Up" to Photograph Well.....	703	Wood Waste Briquettes as Good as Anthracite.....	656
Oars, Broken, Cornell Finds It Difficult to Replace.....	702	X-Ray Movies Await Higher Perfection.....	760
Ocean Traffic Lanes Planned for Pacific Shins.....	775	Zoos, Caging Animals in, by Hjalmer Lindquist.....	660
Oil Field, Alaskan, Reserved for Navy's Fuel.....	702		
Oil Tank, Giant Concrete, Has Thin Walls.....	763		
Oilcan Has Large Strainer and Control Valve.....	778		
Packing Plant, Built by Hand, by D. C. Retzlaff.....	761		
Pageant, Unique, to Promote Fishing and Hunting Interests.....	748		
Park, New Niagara Falls, to Benefit Residents.....	708		
Petroleum Consumption, U. S., Breaks Previous Records.....	704		
Platform, High Leg, Aids Loading of Ships.....	768		
Plastering, Furring Clin for Wire Mesh Helps.....	684		
Pocahontas' Grave, American Seeks to Locate.....	695		
Pontoons, Steel, for Federal Dredging.....	669		
Popcorn Stand on Chassis of Small Auto.....	724		
Prize Offers.....	813		
Radio Antenna Hat, Working, Worn at Fashion Show.....	704		
Radio Detector, New, Has Improved Qualities.....	693		
Radio, Photographs Wirelessly by.....	678		
Radio Programs, Chicago Sunday Club Broadcasts.....	772		
Radiophones, Teaching Deaf Children with.....	672		
Railroad, Alaskan, Must Battle Big Drifts.....	745		
Railroad Car, Self-Propelled, Runs on Waste Fuel.....	753		
Railroad Coaches, Swiss, Electric Boiler Car Heats.....	727		
Railroad Crossing Safety Signal, New Type.....	730		
Railroad, English Coast, Sail Rigged Hand Cars Ride.....	701		
Railroad Jack, Ten Ton, Has Push and Pull Features.....	737		
Railroad Penstock, Mammoth, Easily Accommodates World's Largest Locomotive.....	688		
Railroad Signal Inspector Has Simple Trouble Finder.....	720		
Railroad Station Remodeled at Osaka, Japan.....	686		
Red Cross Relief, Government Plans to Aid.....	662		
Reindeer Herd, Michigan Now Has Its Own.....	668		
Rice Harvesting, Indian, Is New Industry, by Lawrence Wm. Pedrose.....	728		
River, Chicago, Great Street may Cap, by Arthur Arrow, Jr.....	657		
River, Cooperation with, Averts Floods, by Ivan E. Hook.....	680		
River Course Changed in Indiana by Engineers.....	759		
Rivet and Bolt Extractor Exerts Heavy Pressure.....	780		
Rivet Hammer, Electric, Works without Shock.....	750		
Road Recording Instrument, Auto, Shows Condition.....	764		
Roller Skates, Four Wheeled, Have Rubber Tires.....	750		
Rubber Product Filled with Gas.....	696		
Rust Proofing Process, New, for Iron and Steel.....	763		
Sand Heater, Portable, Mixes Asphalt for Pavement Repairs.....	676		
Sand Sprinkler Makes Icy Sidewalks Safe.....	684		
"Sanders" Once Used for Blotting Ink.....	750		
Seed Packet Case, Wooden, Displays Attractively.....	752		
Serving Machine, Automatic, Saves Time and Labor.....	756		
Sewer Pipe, Large Concrete, for City.....	751		
Ship Bottoms, Fouling of, Influenced by Color.....	769		
Ship "Bulges," War Time, Now Stabilize Peace Ships.....	742		
Ship "Leviathan" Reconditioned as Most Palatial Liner.....	670		
Ship Steering Gear, Compressed Air Operates.....	708		
Ship "Tuscania" Has Circulating Library.....	725		

SHOP NOTES

Automobile Contact Points, Setting.....	792
Automobile Engine As Power Unit.....	798
Axle Bushings, Reaming.....	797
Bearing Cap Faces, Filing.....	800
Brake Bands, Fixture for Relining.....	783
Brush Attachment for Drawing Borders.....	793
Cable, Steel, Dog for Adjusting.....	791
Clamp, Simple Woodworker's.....	795
Climbing Irons, Emergency.....	794
Clutches, Greasy, Cleaning.....	782
Corners, Square Building, Laying Out.....	790
Cotter Pins, Tool for Spreading and Extracting.....	792
Countersink, Removing Chatter Marks from.....	790
Cylinders, Simple Attachment for Testing.....	785
Disks, Measuring in Micrometer.....	794
Door, Double Swing, Method of Hanging.....	799
Drawings, Reference, Holder for.....	783
Engine Oil Cup Heated with Exhaust.....	789
Etching Tool for Steel.....	795
Farmyard Lights, Electric, How to Make.....	781
Files, Finger Protector for.....	783
Files, Two, Used as Gripping Tool.....	783
Fuses, Color Code for.....	794
Fuses, Testing with Flashlight.....	791
Gilding Small Articles.....	793
Glaziers' Pliers, Handy.....	785
Heater, Electric, Used as Lamp.....	791
Holes, Elongating in Plates.....	792
Holes, Horizontal, Drilling Straight.....	799
Ladle, Protecting When Melting Babbitt.....	795
Lathe Chip Shield, Simple.....	797
Lathe Improvised from Hand Grinder.....	789
Oils and Greases, Burning, Extinguishing.....	798
Planing Stop and Vise, Simple.....	793
Polisher for Tempering.....	792
Pump Cylinder, Recovering from Well.....	800
Railroad Wheel Tire Setting Gauge.....	800
Rivet Backing Tool.....	791
Roofing, Corrugated, Tool for Cutting.....	799
Screws, Stripped Wood, Removing.....	797
Slotter, Four Inch Bench, How to Make.....	786
Solder, Felt Pad for Wiping.....	797
Springs, Hair, Testing for Magnetism.....	785
Stencils, Clean Cut Metal, How to Make.....	796
Truck Wheels, Heavy, Method of Handling.....	790
Valve Grinding Tool, Novel.....	784
Wire Cutting Fixture on Lathe.....	784

AMATEUR MECHANICS

Automobile Coil Box Device Foils Thieves.....	818
Automobile Fan Belts, Replacing.....	803
Automobile Floor Boards, Keeping in Place.....	811
Automobile Valve Springs, Removing and Replacing.....	813
Basket, Berrying, Made of Birch Bark.....	817
Cellars, Disinfecting.....	812
Cement, Fireproof, How to Make.....	817
Drawers Made from Varnish Cans.....	803

DRAKE'S PRACTICAL MECHANICAL BOOKS

THEY WILL RAISE YOUR PAY—

ORDER ON 5-DAY TRIAL

The books listed below will perfect you in your chosen trade — pave the way to the big positions. Written in non-technical language—easy to read and understand. *Every book covers its subject completely. An entire course of instruction condensed into one volume.* Your choice sent postpaid — you benefit 5 days — money refunded in full if not entirely satisfactory. Order direct from this page.



Automobile Books

- Automobile Ignition, by ManlyLeatherette \$2.00
 Automobile Starting and Lighting, by Manly.....Leatherette \$2.00
 Brookes' Automobile Handbook.....Leatherette \$2.00
 Ford Motor Car, Truck and Tractor, by Manly.....Cloth \$1.50
 Starting and Lighting Troubles, Remedies and Repairs, by ManlyLeatherette \$3.00
 Automobile Battery, Care and Repair, by Manly.....Leatherette \$2.00
 Automobile Catechism and Repair Manual.....Leatherette \$1.50
 Tires and Vulcanizing, by TuffordCloth \$2.00
 Gas and Oil Engine Handbook.....Cloth \$1.50
 Automobile Upkeep and Care, by Manly.....Cloth \$1.50
 Motorcycle Handbook, by ManlyCloth \$1.50

Shop Practice Books

- Sheet Metal Workers' Manual.....Leatherette \$2.00
 Oxy-Acetylene Welding and CuttingCloth \$1.25
 Slide Rule and Logarithmic TablesLeatherette \$2.00
 Handbook for Millwrights.....Cloth \$2.00
 Modern Blacksmithing.....Cloth \$1.25
 Machine Shop Practice.....Cloth \$2.00

- Mechanical Drawing and Machine DesignCloth \$2.00
 Pattern Making.....Cloth \$1.50

Carpentry Books

- Cloth Binding
 Modern Carpentry, 2 vols.....\$3.00
 The Steel Square, 2 vols.....\$3.00
 Wooden Boat and Shipbuilding.....\$1.50
 Modern Estimator\$1.50
 Timber Framing\$2.00
 Builder's Architectural Drawing.....\$2.00
 Concrete\$1.50
 Practical Bungalows\$1.00
 Low Cost Homes.....\$1.00
 Roof Framing, by Van Gasbeek.....\$1.50
 Stair Building and Hand Railing\$1.50

Electrical Books

- Practical Applied Electricity.....\$2.00
 Alternating Current\$1.50
 Electric Motor Control Systems.....\$1.50
 Wiring Diagrams and Descriptions\$1.50
 Electrical Tables and Data.....\$1.50
 Armature and Magnet Winding.....\$1.50
 Modern Electrical Construction.....\$1.50
 Modern Electric Illumination.....\$1.50
 Electricians' Operating and Testing\$1.50
 Motion Picture Operation.....\$1.50
 Drake's Electrical Dictionary.....\$1.50
 Electric Motors, D. & A.....\$1.50
 Electrical Measurements and Meter Testing\$1.50
 Drake's Telephone Handbook.....\$1.50
 Easy Experiments.....Cloth \$1.25
 Wireless Telegraph and Telephone Handbook.....Cloth \$1.25
 Telegraphy Self-Taught...Cloth \$1.25

Steam Engineering

- Swingle's Handbook for Steam Engineers and Electricians.....Leatherette \$4.00
 Examination Questions and Answers for Marine and Stationary Engineers.....Leatherette \$2.00
 Steam Boilers.....Leatherette \$2.00
 Swingle's Catechism of Steam, Gas and Electrical EngineeringLeatherette \$1.50

Painting Books

- Scene Painting and Bulletin ArtCloth \$4.00
 A Show at Sho' Cards.....Cloth \$4.00
 Sign PaintingCloth \$4.00
 Strong's Book of Designs.....Leatherette \$4.00
 Strong's Art of Show Card WritingCloth \$4.00
 Signal's Alphabets.....Cloth \$1.50
 Modern Painter's Cyclopaedia.....Cloth \$2.00
 Automobile Painting.....Cloth \$1.50
 Estimates, Costs and Profits, Painting and Decorating.....Cloth \$1.50
 New Hardwood Finishing.....Cloth \$1.50
 The Amateur Artist.....Cloth \$1.50
 New StencilsCloth \$1.25
 Chalk Talk and Crayon PresentationCloth \$1.25

Farm Books

- Farm Mechanics.....Cloth \$1.25
 Farm Buildings.....Cloth \$1.25
 Farm Engines.....Cloth \$1.25
 Traction Farming.....Cloth \$1.50

Business and Reference Books

- Better Business Letters.....Cloth \$1.00
 Better Business English.....Cloth \$1.00
 Better Advertising.....Cloth \$1.00
 Finger Prints Simplified.....Cloth \$2.00
 Practical Bricklaying.....Cloth \$1.25
 Practical Instruction for DetectivesCloth \$1.00
 Practical PlumbingCloth \$1.50
 Hot Water Heating.....Cloth \$1.50
 Elementary Chemistry.....Cloth \$1.50
 Courses in Civil Service.....Cloth \$1.50
 Cyclopaedia of Recipes.....Cloth \$1.50
 American Star Speaker...Cloth \$1.50

Modern Languages

- By Prof. P. S. Allen, U. of Chicago
 French without a Teacher.....Cloth \$1.25
 Spanish without a Teacher.....Cloth \$1.25
 German without a Teacher.....Cloth \$1.25
 Everyday French.....\$1.25
 Everyday Spanish.....\$1.25

ORDER DIRECT FROM THIS PAGE—ON OUR MONEY-BACK PLAN

The books listed above are only a few of the many in our catalogue, which you will receive promptly after filling out and mailing us the attached coupon. For quick action order direct from this page—cross name of each book wanted and send in with price quoted. We prepay postage and send the books on our money-back plan.

FREDERICK J. DRAKE & CO.

PUBLISHERS

1008 Michigan Ave., Chicago

Drake Books Are For Sale at All Book Stores

FREDERICK J. DRAKE & CO.
 1008 Michigan Avenue
 Chicago, Ill.

GENTLEMEN:—Please send me free, postage paid, your illustrated catalogue which lists and describes over 100 Practical Mechanical Books for Home Study.

My name is

and my address

Mail Coupon For Free Catalogue
 Your Guide to Home Study

"SOME SUMMER SELLER"



Says Slade of N.J.
Have made \$13,500
in 3 months. Some
summer seller.

Every Woman Wants It Low Price—Big Profit

Representatives, salesmen, spare time workers are literally cleaning up fortunes with an amazing new invention—the Oliver Oil-Gas Burner that makes any range just like a city gas stove. No more sweltering summer kitchens, coal, soot or ashes.

Amazing Invention Ends Summer Coal Fires

Right in her own range, the housewife can cook and bake quicker and better than ever before. She turns a valve—just as with city gas—and her own oven regulates to any temperature. Then, the instant she is through the heat is turned off, the kitchen is cool and clean the rest of the day. Saves 65% of all household work. No lifting or carrying dirty coal, wood, ashes—no wicks, no experimenting. Absolutely safe. Last a lifetime.



TURN A
VALVE

\$100 a Week—Spare Time—Easy

You can see how Slade, N. J. made \$13,500 in 3 months. Why Russell makes \$660 a month, J. Carnegie makes \$1,000 a month, how hundreds of others make \$100 a week and more just in spare time. Here is an opportunity to make a Summer's work yield more than you ever made in a whole year. You don't need to be a super-salesman. The Oliver—sells itself. You

OLIVER GIVES take the money. Write at once for full details about our Free Sample Case and **FORDS AWAY** Big Exclusive Territory Offer. Oliver gives Foods away—no contests. Write quick for Big Summer Profits.

OLIVER OIL-GAS BURNER & MACHINE CO.
2014-Q Oliver Bldg., St. Louis, Mo.
Canadian office, 2014-Q Webster Bldg., Toronto

Learn Watchwork, Jewelrywork and Engraving.

A fine trade commanding a good salary, and your services are always in demand. Address **MOROLOGICAL**, Dept. P, Bradley Institute, PEORIA, ILL., for our latest catalog.

[Contents—Continued from Page 4]

Electrical Coils, Winding Tightly.....	804
Flowers, Artificial, How to Make.....	808
Garage Doors, Fixture for Holding Open.....	804
Garden, Method of Irrigating.....	810
Gaskets, Emergency, for Auto.....	811
Gaskets, Replacing, Hints on.....	803
Gate, Dog, Built in Fence.....	802
Gate, Double, for Farmyard.....	811
Hedge, Neat and Simple, How to Make.....	811
Hedges, Garden, from Sod.....	805
Lawn Frontage, Grading.....	810
Photography—Camera Finder, Obtaining Clear Image in.....	805
Photography—Film Developing Rack, Homemade.....	813
Radio Apparatus, Installing on the Farm.....	814
Radio "Vernier" Rheostat, Easily Made.....	818
Refrigerator for the Camp.....	804
Silver, Tarnished, Cleaning.....	818
Steps, Track Aids in Pulling Buggy Over.....	803
Table and Parasol for Lawn.....	817
Tea Wagon, Homemade.....	801
Tire Blow Out Shoe, Simple.....	805
Tire Pump Attachment Inflates Quickly.....	817
Tube Deflater, Simple.....	803
Typist, Home, Hints for.....	802
Vise, Homemade.....	812
Window Shutters, Colonial, Fasteners for.....	812
Windows, Lubricating.....	805

Learn Illustrating

At Home—In Your Spare Time

from the school that has trained many commercial illustrators now earning \$50 to \$200 or more weekly. Plenty of opportunities open for trained artists. Work can be done at home. The Landon Picture Chart Method makes original drawing easy to learn. Write for full information and sample chart.

THE LANDON SCHOOL
138 National Bldg., Cleveland, Ohio



Can you afford to

STAMMER?

OR STUTTER?

It ruins many chances for promotion. Send postage for large free book "The Correction of Stammering and Stuttering." Methods successful for over a quarter-century. **THE LEWIS INSTITUTE**, 33 Lewis Bldg., 77 Adelaide St., Detroit, Mich., U.S.A.

Whatever Your Question;—be it the pronunciation of Bolsheviki, the spelling of a puzzling word, the location of Murman Coast—the meaning of blighty, ace, tank, ukulele, etc., this Supreme Authority—

WEBSTER'S NEW INTERNATIONAL DICTIONARY

contains an accurate, final answer 400,000 Words, 2700 Pages, 6000 Illustrations.
*Regular and India-Paper Editions. G. & C. MERRIAM CO., Springfield, Mass.
Write for specimen pages, prices, etc. and FREE Pocket Maps per Popular Mechanics



"THERE'S MONEY IN IT"

AT HOME

LEARN TELEGRAPHY

AT HOME

MORSE AND WIRELESS

TEACH YOURSELF

in half usual time, at trifling cost, with the wonderful Automatic Transmitter, **THE OMNIGRAPH**. Sends unlimited Morse or Continental messages, at any speed, just as an expert operator would. Adopted by U. S. Government, and leading Universities, Colleges and Telegraph Schools. 3 Styles. Catalog free. **OMNIGRAPH MFG. CO., 16-22 Hudson St., NEW YORK**

If you own a Radio Phone Set—and don't know the code—you are missing most of the fun.



WANTED! Get \$1600 to \$2300 a Year

U.S. RAILWAY MAIL CLERKS

BOYS — MEN 18 OR OVER SHOULD MAIL COUPON IMMEDIATELY

Franklin Institute, Dept. R180, Rochester, N. Y.

Sirs: Send me, without charge, (1) sample Railway Mail Clerk Examination questions; (2) list of Government jobs obtainable; (3) tell me how I can get a position.

Steady Work No Layoffs Paid Vacations
COMMON EDUCATION SUFFICIENT
TRAVEL—SEE YOUR COUNTRY

Name.....
Address.....

ENTIRE SET ONLY \$12

FLEXIBLE
BINDINGPOCKET
SIZE\$1
PER
MONTH

\$10,000. Master Set AUDEL'S ENGINEERS and MECHANICS GUIDES —

THE BOOKS YOU HAVE
BEEN WAITING FOR

4750 Pages—8754 Illustrations

Just completed—Audel's New Master Set for Engineers and Mechanics!

Every Engineer, Mechanic and Electrical worker will welcome this set as a sure source of advancement and higher pay because of the complete up-to-date information that is thoroughly and easily explained on every branch of Engineering and Electrical practice.

Why a \$10,000 Library? Because it would cost the reader more than \$10,000 together with years of labor and experience to collect, plan, arrange and prepare for his own study and ready reference, the vast fund of knowledge printed in this Master Set.

The entire set costs you only twelve dollars—knowledge and instruction that has cost thousands of dollars and years of time—yours for \$12.00—\$1.00 a month.

Study This Brief Table of Contents

Theory, Practice and Operation of ALL Steam Engines, Valve Motions—VALVE SETTING; complete information on ALL engines and parts—CORLISS ENGINE and the Theory, Construction and Operation of all Steam Engines, including UNIFLOW and POPPET VALVE ENGINES, and LOCOMOBILES—Locomotive-Marine Engines; Turbines; Rotary Engines—the Indicator—Lubrication—PRACTICAL MANAGEMENT, How to use Indicator—GAR, GAROLINE, OIL, RESIL, and FULL DIESEL ENGINES—Accumulators and Air—HOW TO SELECT AN ENGINE, working instructions, drawings on STEAM ENGINE DESIGN, including rules and formulas, Theory and Construction of ALL Steam Boilers; Heat-Combustion; Fuel and Flue Gas Analysis—CO₂ recorder—Characteristics of Boilers—Materials

—Construction of all types of Boilers. (THE LATEST PRACTICE.)—Boiler Construction—Mechanical Stokers—Oil Burners—Setting—Chimneys—Mechanical Drafts—HOW TO SELECT A BOILER—Complete instructions and drawings on BOILER DESIGN based on A. S. M. E. BOILER CODE—OPERATION, including installation, FIRING; care and repair of Steam Boilers—Pipes, Fittings and Pipe Flanges—Insulation and Ventilation—Refrigeration—Cooling Towers—Condensers—Distilling Apparatus—Elevators—Cranes and Hoisting Machinery—Ropes and Cables—Splicing—electric wiring in ALL branches; compendium of practical electrical engineering as an aid for engineers and electricians in obtaining a license—27 chapters—ready reference index, covering entire field of Modern Electricity.

*Helping Hand
Books that answer
Your Questions*

FREE
EXAM-
INATION



Send No Money—Send Only This Coupon

THEO. AUDEL & CO.,
72 Fifth Ave., New York City

Please submit me for free examination, AUDEL'S \$10,000 MASTER SET FOR ENGINEERS AND MECHANICS, 8 books at once prepaid, the 8 numbers, total cost \$12.00. If satisfactory, I agree to send you \$1 within seven days and to further mail you \$1 each month until paid.

Name.....

Occupation.....

Employed by.....

Home Address.....

Reference.....

PM May 23

Drawing Table Free!



Yes, this is exactly what I am doing. I am giving this drafting table free to you when you enroll as my student. I do this because I want you to have the right kind of Draftsman's Working Outfit — because I want to help ambitious men and boys get ahead. This is the kind you will use when you have completed my course and have become a regular draftsman.

Complete Drawing Outfit FREE

Besides the drafting table I also furnish free the \$25.00 set of regular working instruments shown here. You get both table and instruments free if you enroll at once. I will do everything possible to help you get ahead.

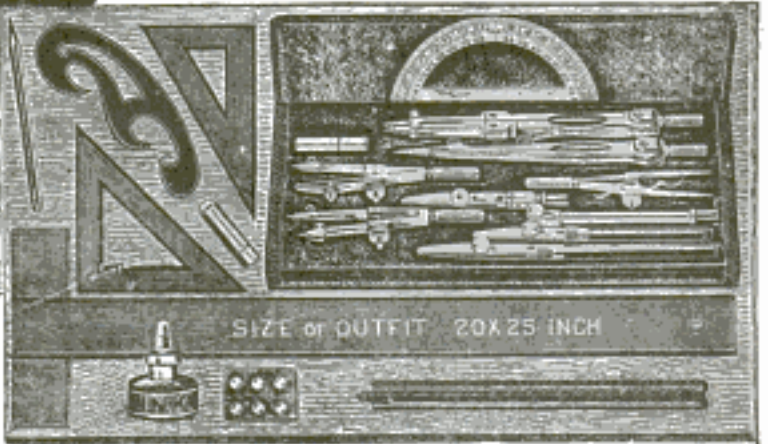

Also FREE \$90 Drafting Course

To my students enrolling now I give an opportunity of getting a \$90 drafting course absolutely without cost to them. This means you need not pay me for my personal instructions or for the complete working outfit.

Salaries up to \$250 and \$300 a Month

Positions paying up to \$250 and \$300 a month which ought to be filled by skilled draftsmen are vacant everywhere. There are in every part of the country ambitious men, who with practical training and personal assistance will be qualified to fill the positions. I can now take and train a limited number of students, guarantee to train them by mail UNTIL placed in a permanent position at a salary up to \$250 and \$300 a month.



Here is the Rule you get FREE

To each young man stating his age when sending a sketch as shown in box at right, I am going to mail FREE AND PREPAID the Draftsman's Ivory Pocket Rule shown here.

Chief Draftsman, Engineers' Equipment Co.
1951 Lawrence Ave., Div. 13-55, Chicago, Ill.

Without any obligation to me please mail your book "Successful Draftsmanship" and full particulars of your liberal "Personal Direction" offer to a few students. Also full information as to how I can get a \$90 Drafting Course Free.

Name

Address

Age

Extra!!

Copy this Sketch and Get Ivory Pocket Rule

To each young man of 16 years or older sending a sketch I will mail free prepaid the Draftsman's Ivory Pocket Rule shown here. With it I will send you a 6 x 9 book on "Successful Draftsmanship."

There are no conditions requiring you to buy anything. You are under no obligations in sending in your sketch.



Mail Coupon

Mail coupon at once for full information how you can get the table and working instruments Free, also how you can get the \$90 drafting course Free. Even if you don't send in a copy of the sketch send for this information.

Chief Draftsman, Engineers' Equipment Co.
1951 Lawrence Ave., Div. 13-55 Chicago, Ill.

See How Easily You Can Learn to Dance This New Way

If you can do the step illustrated in the chart in lower corner, there is no reason why you cannot easily and quickly master all of the latest steps through Arthur Murray's method of teaching dancing right in your own home.

NO matter how skeptical you may be about being able to learn to dance by mail, this new course will quickly prove to you that you can easily learn without a teacher on the ground to direct your steps—and without music or partner—right at home.

Even if you don't know one dance step from another, these new diagrams and simple instructions will enable you to learn any of the newest dances in an amazingly short time. You don't need to leave your own room—it isn't necessary to go into a dancing class—or to pay large fees for private instruction. All you need to do is to follow the instructions as shown on the diagrams, practice the steps a few times to fix them in your memory and there is no reason why you should not be able to dance on any floor, to either band or phonograph music, and to lead, follow and balance correctly, no matter how expert your partner may be.

Arthur
Murray
Dancing
Instructor
to the
Vanderbilts.



FIRST PART Forward Waltz Step

1. Begin with left foot and step directly forward, weight on left foot.
2. Step diagonally forward to right, placing weight on right foot (see illustration).
3. Draw left foot up to right foot, weight on left. That's all. Simply follow the numbers in the footprints. Master this part before going further.



Learn Any Dance in a Few Hours

Whether you want to learn the Fox Trot, One Step, College Rock, Conversation Walk, Waltz, or any of the newer steps, you won't have the slightest difficulty in doing so through this new method. Then, the very next time dancing starts you can surprise your friends by choosing a partner and stepping right out with perfect confidence that every step you make and every movement is absolutely correct. Arthur Murray guarantees to teach you, or your lessons won't cost you one cent.

More than 90,000 people have learned to become perfect dancers by mail. In fact, about five thousand people a month are becoming wonderful dancers through Arthur Murray's amazing new method.

Good dancers are always the most popular people in their set—they never lack partners and are invited to every social event because dancing is the most pop-



Courtesy Metro Pictures Corp.

Scene from the famous screen version of "The Four Horsemen," showing Rodolph Valentino in one of the wonderful Tango steps.

FREE Three Tango Lessons

Arthur Murray has diagrammed the principal steps in the famous Tango as danced by Rodolph Valentino in such a simplified way that you can quickly and easily master this fascinating dance, after you have the Murray foundation to your dancing. Send for these Tango lessons today and you will soon be able to amaze all your friends with your ability to perfectly dance it.

ular form of recreation, and good dancers are always in demand. But beside this, good dancers always have perfect mental and physical control, ease of manner, poise, are never embarrassed, shy or timid. Very often they meet influential people in this social way who are very helpful to them in business.

FREE The Fascinating Tango

Simply fill in and mail the coupon and Arthur Murray will immediately mail to you the complete 16-lesson dancing course. He will also send you FREE the complete diagrams of three lessons in the tango that was danced in "The Four Horsemen," all just as we have explained it in this advertisement.

When your postman hands the special sixteen-lesson course to you, simply deposit only \$1.00 with him, plus a few cents postage, in full payment. Keep the course for five days. Practice all of the steps, learn everything these sixteen lessons can teach you and prove to your full satisfaction that you have found the quickest, easiest and most delightful way to learn to dance. Then, within five days, if you desire, you may return the course and your dollar will be promptly returned to you. But if you decide to keep the course—as you surely will—it becomes your personal property without further payments of any kind.

Every month thousands of men and women are quickly learning to become fine dancers through Arthur Murray's methods of home instruction. There is no reason why you should not learn just as easily and quickly. This offer is made for a very limited time and may soon be withdrawn, so you must act quickly if you are to accept it. **Arthur Murray, Studio 710, 290 Broadway, New York.**

Arthur Murray, Studio 710, 290 Broadway, New York.

To prove that I can learn to dance at home in one evening, you may send the sixteen-lesson course and the Three Fascinating FREE Tango lessons in plain cover, and when my postman hands it to me I will deposit with him only \$1.00, plus the few cents postage, in full payment. If, within five days, I decide to do so, I may return the course and you will refund my money without question.

Name.....
Address.....
City..... State.....

Would You Like to Teach Dancing?.....
If apt to be out when postman calls you may send one dollar with coupon.

Residents in Australia and New Zealand write to Arthur Murray's N. Y. School of Dancing, Dept. 3, Daking House, Sydney, N. S. W.

FREE



\$125 Drafting Course!

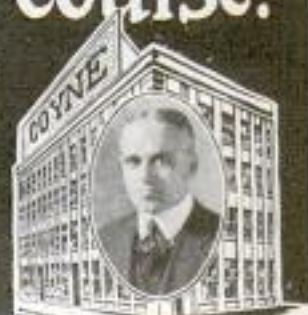

Draftsmen Wanted!

\$300 a Month! "We want Cooke-trained Draftsmen"—"Send us Coyne graduates at \$50 to \$100 a week"—such a tremendous demand from all over the U. S. for Draftsmen—we make this unbelievable FREE offer to start 5000 men on the road to big pay QUICK! Not a contest — YOU may have the Coyne "Job-Method" course absolutely FREE—coupon brings complete information. But don't wait, don't lose this life-time opportunity!

President Cooke of the Coyne School of Drafting, "the greatest institution of its kind in the world," offers you FOR A LIMITED TIME the new "Job-Method" course in Drafting ABSOLUTELY FREE! Complete Outfit and Instruments included without one penny of cost. Here is your big opportunity—mail coupon TODAY!

Mechanics, Builders!

Learn not only how to read blue prints—learn how to make them; how to draw plans, design machinery, etc. Thousands of men in mechanical lines have increased their income, advanced to better positions AS FOREMEN, SUPERINTENDENTS, ENGINEERS and MANAGERS by learning Drafting. Nothing you can learn so quickly pays such big money!

What is the "Job-Method"?

President Cooke's copyrighted system of home-study puts you to work on actual Drafting Jobs, same as you would get in a big Drafting Office. You learn to draw machine parts in the very first lesson. Most complete Drafting course ever put on the market, yet by the "Job-Method" you cover all the ground in a few weeks' time! You can get into this easy, pleasant, profitable line of work no matter how little schooling you have.



Professional Drafting Instruments and Outfit FREE!

Learn Drafting by the famous "Job-Method"—learn ALL that a Draftsman needs to hold down big pay Jobs—learn more in HALF the time! This costly outfit Free to every "Job-Method" student.

Course in RADIO FREE!

This complete course teaches you to design, build and operate crystal and tube sets. Armstrong Regenerative, Rehnartz, Pierce-John and other circuits explained SO YOU CAN UNDERSTAND IT. Big opportunities for extra money-making in RADIO. This \$45 course FREE to "Job-Method" students this month only!

B. W. COOKE, President
COYNE SCHOOL OF DRAFTING
Dept. 202, 552-598 S. Throop St., Chicago

Without obligating me in the slightest way, please send me BY RETURN MAIL your 2 Free books and special offer of your \$125 Drafting Course FREE, including Drafting Outfit and Radio Course without one penny of cost.

..... Name

..... Address

.....

2 BOOKS FREE!

"Loan me a part of your spare time" says President Cooke—"and I'll make you a big-pay Draftsman in double quick time!" Only from Coyne can you get the "Job-Method" course. Coupon brings 2 Books FREE and the new "Free Course" offer. Make TODAY the RED-LETTER day in your life—mail the coupon TODAY!

B. W. COOKE, President

COYNE
SCHOOL OF DRAFTING

Dept. 202, 552-598 S. Throop St., Chicago

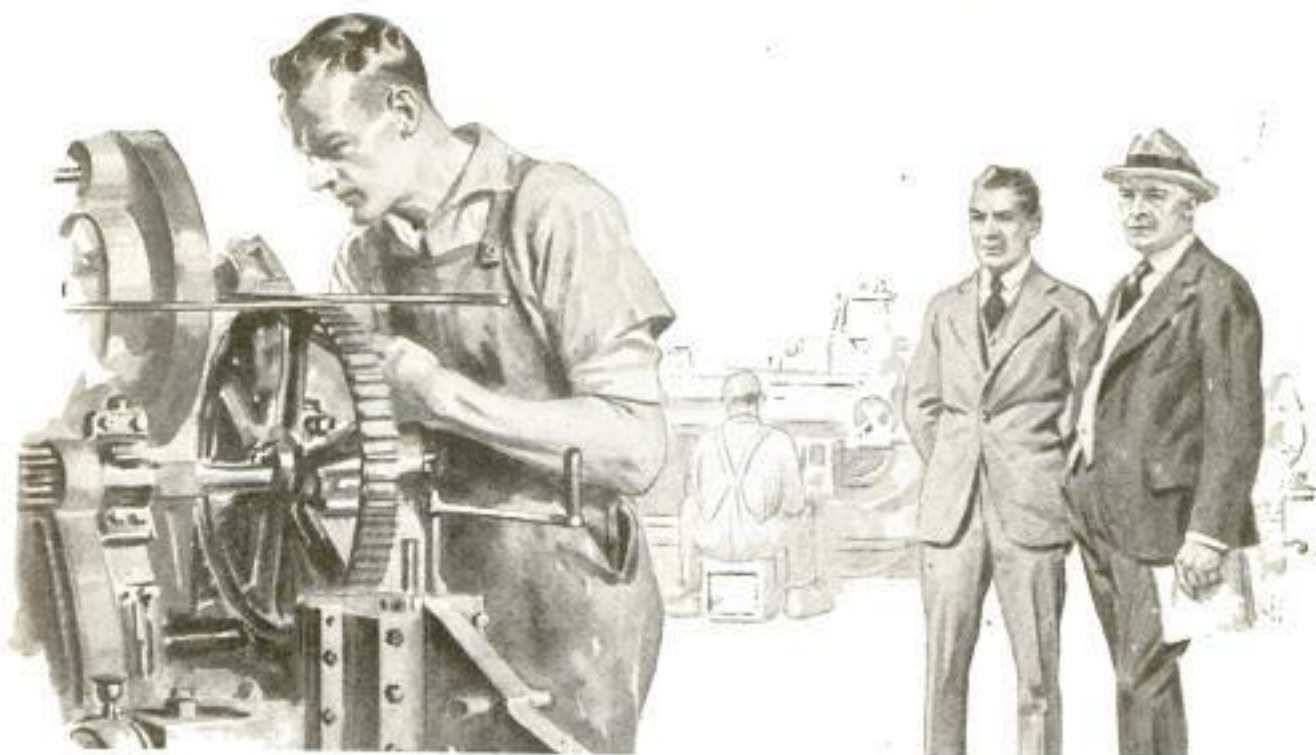

“He’s Already Patented Four Inventions”

FUNNY thing too . . . When he first came here he was just an ordinary worker. For a time, when things were slack, I even thought that we might have to let him go.

“Then, gradually, I noticed an improvement in his work. He seemed to really understand what he was doing.

“One day he came into my office and said he had worked out a new arm for the automatic feeder. I was a little skeptical at first, but when he started explaining to me, I could see that he had really discovered something. And when I started questioning him, I was amazed. He certainly did know what he was talking about.

“So we sat down and talked for over an hour. Finally, I asked him where he had learned so much about his work. He smiled and took a little book from his pocket.

“‘There’s no secret about it,’ he said. ‘The answer’s right here. Four months ago I saw one of those advertisements of the International Correspondence Schools. I had been seeing them for years, but this time something inside of me said, *Send*

in that coupon. It was the best move I ever made—I knew it the minute I started my first lesson. Before, I had been working in a sort of mental fog—just an automatic part of the machine in front of me. But the I. C. S. taught me to really understand what I was doing.’

“Well, that was just a start. Three times since he has come to me with improvements on our machines—improvements that are being adopted in other plants and on which he receives a royalty. He is certainly a splendid example of the practical value and thoroughness of I. C. S. training.”

Every mail brings letters from students of the I. C. S. telling of advancements and larger salaries won through spare-time study. There’s still a chance for you, if you will only make the start.

Just fill out and mail the coupon printed below and, without cost or obligation, get the full story of what the I. C. S. can do for you. To-day—not To-morrow—is the day to take that first definite step toward Success.

These inventors and many others once studied with the I. C. S.

JESSE G. VINCENT

Vice-President of Packard Motor Car Co., inventor of the Packard Twin-Six and co-inventor of the Liberty Motor.

JOHN C. WAHL

First vice-president of The Wahl Co., inventor of the Wahl Adding Machine, the Eversharp Pencil and the Wahl Fountain Pen.

W. J. LILLY

Inventor of the Lilly Mine Hoist Controller.

H. E. DOERR

Chief Mechanical Engineer, Scullin Steel Co., St. Louis.

----- TEAR OUT HERE -----

INTERNATIONAL CORRESPONDENCE SCHOOLS, BOX 5517-D, SCRANTON, PA.

Without cost or obligation on my part, please tell me how I can qualify for the position or in the subject before which I have marked an X in the list below:—

- | | | | |
|--|--|---|---|
| <input type="checkbox"/> Automobile Work | <input type="checkbox"/> Civil Engineer | <input type="checkbox"/> Business Management | <input type="checkbox"/> Salesmanship |
| <input type="checkbox"/> Gas Engine Operating | <input type="checkbox"/> Surveying and Mapping | <input type="checkbox"/> Industrial Management | <input type="checkbox"/> Advertising |
| <input type="checkbox"/> Airplane Engines | <input type="checkbox"/> Mine Foreman or Engineer | <input type="checkbox"/> Personnel Organization | <input type="checkbox"/> Stenography and Typing |
| <input type="checkbox"/> Radio | <input type="checkbox"/> Marine Engineer | <input type="checkbox"/> Traffic Management | <input type="checkbox"/> Teacher |
| <input type="checkbox"/> Electrical Engineering | <input type="checkbox"/> Architect | <input type="checkbox"/> Business Law | <input type="checkbox"/> Civil Service |
| <input type="checkbox"/> Electric Lighting and Hwys. | <input type="checkbox"/> Blue Print Reading | <input type="checkbox"/> Banking and Banking Law | <input type="checkbox"/> Railway Mail Clerk |
| <input type="checkbox"/> Mechanical Engineer | <input type="checkbox"/> Contractor and Builder | <input type="checkbox"/> Accountancy (including C.P.A.) | <input type="checkbox"/> Common School Subjects |
| <input type="checkbox"/> Mechanical Draftsman | <input type="checkbox"/> Architectural Draftsman | <input type="checkbox"/> Bookkeeping | <input type="checkbox"/> High School Subjects |
| <input type="checkbox"/> Machine Shop Practice | <input type="checkbox"/> Structural Engineer | <input type="checkbox"/> Business English | <input type="checkbox"/> Illustrating |
| <input type="checkbox"/> Railroad Positions | <input type="checkbox"/> Chemistry <input type="checkbox"/> Pharmacy | <input type="checkbox"/> Business Spanish | <input type="checkbox"/> French |

Name..... Street Address.....

City..... State..... Occupation.....

Persons residing in Canada should send this coupon to the International Correspondence Schools Canadian, Limited, Montreal, Canada.



WANTED-
for murder!

**\$1,000
Reward!**

In a dirty, forelorn shack by the river's edge they found the mutilated body of Genevieve Martin. Her pretty face was swollen and distorted. Marks on the slender throat showed that she been brutally choked to death. Who had committed this ghastly crime?

Crimes like this are being solved every day by Finger Print Experts. We read in the papers of their exploits, hear of the mysteries they solve, the rewards they win. Finger Print Experts are the heroes of the hour.

**Not Experienced Detectives —
Just Ordinary Men**

Within the past few years, scores of men—men with no police experience, men with just ordinary grade school educations—have become finger print experts. You can become a finger print expert, too. Can you imagine a more fascinating line of work than this? More trained men are needed. Here's your real opportunity.

**Learn Identification
Secrets**

More and more the detection of crime resolves itself into a problem of identification. You can learn the methods of the famous identification experts. You can learn the science of Finger Print Identification—right at home in your spare time.



T. G. Cooke,
President

FREE For a limited time, we are making a special offer of a Professional Finger Print Outfit absolutely free and FREE course in Secret Service Intelligence. Mastery of these kindred professions will open up a brilliant career for you.

This coupon will bring you FREE book and details of this great offer. Don't wait until the offer has expired. Fill in the coupon now. Mail it today.

University of Applied Science
1920 Sunnyside Ave., Dept. 13-55, Chicago

University of Applied Science
1920 Sunnyside Avenue, Dept. 13-55, Chicago, Ill.

Gentlemen:—Without any obligation whatever, send me your new, fully illustrated, FREE book on Finger Prints and your offer of a FREE course in Secret Service Intelligence and the Free Professional Finger Print Outfit.

Name.....

Address.....

City & State.....

Age.....

Please Mention Popular Mechanics

Stop Forgetting



Make Your Mind a File—Not a Pile

Let me show you how to make your mind as forget-proof as a card index file. When you wish to recall a name, place or date, must you grope in vain in a pile of miscellaneous knowledge? Summoned to give facts and figures does your mind become a blank? Be master of your mind's infinite resources—instead of a victim of its disordered details.

KNOWLEDGE IS POWER

and Memory Is the Basis of All Knowledge

I HAVE HELPED THOUSANDS

The Dickson Method of Memory and Mental Training, perfected by 20 years experience, is recognized as the most thorough, efficient of its kind. Highly endorsed—easy to master. Give me 10 minutes a day and I will train your memory so you can classify ideas, names, faces, etc., and recall them instantly. Develop self-control, concentration; overcome bashfulness.

**Perfect Your Memory and
Command What Salary You Will**

Send name and address and I will send you free, my interesting booklet, "How to Remember," and unique, copyrighted Memory Test; also tell you how to secure free of charge my \$3.00 book, "How to Speak in Public."

Prof. Henry Dickson, Principal
DICKSON MEMORY SCHOOL
Dept. 705
Evanston, Ill.



The Key to Success



Violin, Hawaiian Guitar, Ukulele, Guitar, Mandolin, Cornet, Banjo-Ukulele, Tenor Banjo or Banjo. Wonderful new system of teaching note music by mail. To first pupils in each locality, we give a \$20 superb Violin, Mandolin, Ukulele, Guitar, Hawaiian Guitar, Cornet, Tenor Banjo or Banjo absolutely free. Very small charge for lessons only. We guarantee success or no charge. Complete outfit free. Write now. No obligation. SLINGERLAND SCHOOL OF MUSIC, Inc. Dept. 214, CHICAGO, ILL.

Rider Agents Wanted

Select from the 44 Styles, colors and sizes of Ranger Bicycles. Ride and exhibit sample Ranger and make money. Delivered free, express prepaid, on Approval. Factory-to-Rider prices save \$10 to \$25. 12 Months to Pay on any Ranger if desired. Boys and girls easily save the small monthly payments. Parents often advance first payment. Best quality, at factory prices, express prepaid. Tires, Large wheels and equipment, low prices. Send No Money, do business direct with makers.



Mead Cycle Company
Depts. 5108 Chicago

Write today for free Ranger Catalog, factory prices and marvelous easy payment terms

LEARN WATCHMAKING AND ENGRAVING

Earn while learning. Most practical watch school. Individual instructions. Graduates in great demand. Book free. Chicago School of Watchmaking, Dept. 20, 4840 Lincoln Ave., Chicago



**SAVE
MAKE MONEY**

You positively can install and repair any electrical job in the home or business place, without previous experience. Installations and repairs become like play when you own our new book ELECTRICAL KINKS, explaining everything about bells, lighting, garage wiring, vacuum cleaners, washing machines, etc. Most complete book on everything electrical in the home. You can do work for others, thus making your spare time profitable. SEND TODAY, \$1 cash, or C. O. D. plus postage. Money back if not satisfied. Circular free.

Home Book Co., 383AG Arcade Bldg., Cleveland, Ohio

Man—the Miracle Worker

He has wrested from the universe its most wonderful secrets—he reads the story of the distant star, translates the history of life from the record of the rocks—he watches the delicate organs working in the body and the processes of the brain—he has conquered the air, the sea, the bowels of the earth—he has defeated death by defeating disease—

and Now This Whole Thrilling Story Is Told for You with Nearly a Thousand Magnificent Illustrations

In all the world's fiction—romance—history—there is nothing so fascinating as this absorbing story of how man has conquered the universe, solved its mysteries, put its forces to work. From the dawning mind of the caveman to the wizardries of the twentieth-century scientist, his achievements have been almost unbelievable. And at last, this amazing romance is yours in one flowing, simple, accurate story.

The Outline of Science

Edited by J. Arthur Thomson

Professor in the University of Aberdeen, Scotland

What a stupendous task to tell the whole marvelous story in terms so simple that anyone can understand—to tell it accurately and fully in a work priced low enough to be within the reach of all—to illustrate it with authentic photographs and drawings! Yet Professor Thomson and his associates have done this—giving you the cream of the world's scientific genius in a plain story, simply told—a story that scores of thousands are eagerly reading—that must have a place in every cultured home.

DR. FRANK CRANE SAYS: "The Outline of Science ought to be in the place of honor and of daily use in every civilized family. It contains the fundamentals of what every growing mind should know. If you can possibly get the money, buy this book and read it, not cursorily as you would other books, but diligently, faithfully and daily. Here are the foundations of our civilization. Here is the stuff of which all respectable thinking is composed."

Four splendid volumes—beautifully bound, stamped in gold. Nearly 1,000 magnificent illustrations. Each volume 7½ in. wide, 10½ in. deep, 1¾ in. thick. Rich paper and new, large, readable type.

**Examine It
FREE**

Own It on Easy Terms

The publishers will deliver to your home, before you pay a dollar, the four superb octavo volumes of this work for five days' examination. If you keep them, make a first payment of \$1.00 and nine monthly payments of \$2.00—\$19.00 in all—or one cash payment of \$18.00—as you prefer. Send the attached coupon with no money and see for yourself the entertainment and instruction that is here for every man, woman and child.

G. P. PUTNAM'S SONS
Dept. 212, 2 West 45th St., N. Y.



**This Coupon Brings the
Whole Set on Approval**

G. P. PUTNAM'S SONS, Dept. 212,
2 West 45th Street, New York.

Send me, on approval, The Outline of Science in four large volumes, handsomely bound, with nearly a thousand illustrations. I may, if I wish, return the volumes within five days and owe you nothing. If I keep them I will send you either \$18.00 in full payment, or a first payment of \$1.00 and \$2.00 each month thereafter for nine months.

Name.....

Street and Number.....

City and State.....

Occupation.....



WILLIAM BEEBE, famous scientist: "Written by the most able man in his field, who conceived it at the most propitious time, and has executed it in the most admirable manner."

N. P. DAWSON, in the New York Globe: "More interesting to read than any romance."

H. L. PANGBORN, in the New York Herald: "An epoch-making performance of incalculable value."



Take -Autos

Learn the Auto and Tractor Business. Learn a trade. Eight weeks course leads to employment. Free Railway fare to Kansas City. Wonderful offer to you from world famous Million-Dollar trade School. Free Radio Course.

Hundreds of Good Jobs paying \$50.00 a Week and More are open to Sweeney Trained Men. You need no PREVIOUS Experience. I train you in 8 weeks with tools, not books.

The AUTOMOBILE BUSINESS is America's greatest industry. It employs twice the capital of all the National banks in the United States. In 1922 people paid ONE BILLION FOUR HUNDRED AND NINETY MILLION DOLLARS for cars, over SIX HUNDRED MILLIONS FOR TIRES, and over SEVEN HUNDRED MILLION DOLLARS for parts and accessories. Yet this great business is just beginning. In ten years there will be over 23 million pleasure cars alone. That is about one for every family. Trained mechanics are in demand. Hundreds of thousands of men are needed not only as mechanics but as salesmen, garage owners, tire repairers, dealers, demonstrators, chauffeurs, etc. How can you learn and get into this great business?

SWEENEY System of Practical Instruction

is the ONLY WAY to learn if you want to save time and money and be properly trained. You get this at the WORLD'S greatest trade school, the MILLION DOLLAR SWEENEY SCHOOL and you get it nowhere else.

FREE RAILWAY FARE. If you will come now I will help by paying your railway fare from any point in the U. S. to the Sweeney School. I will also give a FREE RADIO COURSE to all who answer this ad. I want you to come now in order to have things your own way this spring. The first step is to send for my Free Catalog. Get all the facts.

FREE Simply send name today for my big 72-page catalog. Shows hundreds of pictures of men at work in the school. Tells all about wages, profits, opportunities in auto and tractor business. Explains step by step how you learn. Interesting letters from graduates telling how they made good. Shows how men come from all over the world to this big school. Makes you want to join the crowd. Tells everything you want to know about it, including all new radio details. No cost, no obligation. Clip the coupon, or a postcard will do. Get the catalogue now—that's the first step. Don't put it off one minute. No colored students accepted.

E. J. SWEENEY,
President.

LEARN

Swe

**AUTOMOTIVE &
1182 SWEENEY BLDG.**



For Auto Catalog Mail This Coupon

EMORY J. SWEENEY, President
Dept. 1182, Sweeney Bldg.
Kansas City, Mo.

Send me free, without any obligation on my part, your 72-page catalog. Tell me of the opportunities in the Auto business.

Name.....

P. O.

State

Your Pick or Electricity

I made my first announcement of this course in practical electricity by RADIO BROADCAST on the occasion of the 15th anniversary of the school, when we broke the World's Record by a 12-hour continuous program. Telegrams, letters, telephone calls came in from everywhere asking for details.

What you young men want isn't to be Engineers, or Designers, or Theorists, or Scientists. What you want is the actual ability to go out and install, operate and repair all kinds of Electrical Machinery. How to handle, as a competent workman, Electrical Power Plants, Electric Signs, Farm and City Lighting Plants, Storage Batteries, Radio Sets, Wiring, Electric Driven Machinery, of all kinds, such as Elevators, Street Railway Motors, etc. When you get through this Course, you will know how to handle Electrical Machinery, because I don't fill your head with hazy ideas; but I train your hands with the real work you will be called upon to do.

\$150,000 Special Equipment

The Million Dollar Sweeney School has \$150,000 worth of Special Electrical Equipment and teachers specially trained, men who take a personal interest in you—and teach you by the Sweeney System of practical Experience. Some of this wonderful equipment simply can't be duplicated; for example, a \$50,000 radio broadcasting station (Call WHB, famous the world over), and a factory where we build radio sets; a factory where we build storage batteries; a 100-kilowatt complete electric power plant; the largest mechanical electrical sign in America, etc.

SWEENEY System of Practical Instruction

Quit thinking about electricity as something "deep" and hard to learn. All I ask is that you like mechanics and realize the opportunities for a man in the electrical business. This is an Electrical age. Train yourself for the countless opportunities that every new day brings. The world is calling for electrically trained men—you don't need to be an engineer or designer or scientist, but you must know how to fix, repair, build, install, operate all kinds of electrical machinery. This is what gets you a real job the minute you are qualified.

FREE Railway fare to Kansas City
Free radio course—no extras

FREE Send for this big
Special Offer To-
day. If you like
electricity, if you

want to get profitable employment, if you want to get into the liveliest and fastest growing industry in the whole world, if you want to make a real success of life, send for my big circular and special Opening Offer. You bet I am going to make the men who start the first class, graduates to be proud of. Come in, you live ones, for here's your chance! I don't care how much education you have. You don't need any previous experience. I teach with tools. So get my offer and learn the particulars of this amazing course. Write me today—just send name—sign coupon, or post card will do.

E. J. SWEENEY, President

A TRADE
Sweeney
ELECTRICAL SCHOOL
KANSAS CITY, MO.

Real Jobs for Electrical Workers

Conduit Man.....	\$160
Electric Light Service....	160
Trouble Shooter.....	160
Installing Radio.....	200
Power Plant Foreman....	200
Block Signal Man.....	240
Auto Electric Work.....	250
Elevator Electrician.....	210
Plant Building Installation	400
Electrical Construction...	300
Power Plant Installation..	400
Ry. Electrician.....	300



For Electrical Course Mail This Coupon

EMORY J. SWEENEY, President
1182, Sweeney Bldg.
Kansas City, Mo.

Send me big circular and full details of your Special
Opening Offer.

Name.....

Address.....

STEP UP!

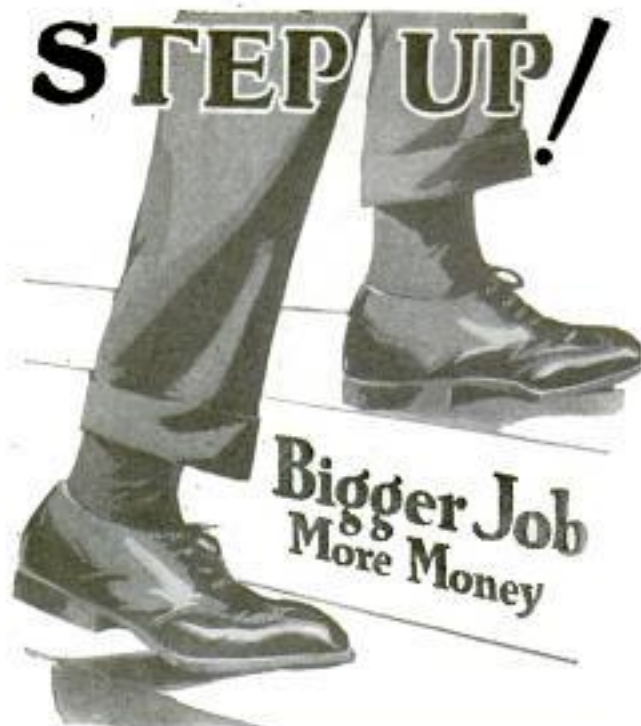

**Bigger Job
More Money**

"I have made another step up and am now advertising manager of the *Grand Junction (Colorado) News*," writes an enthusiastic United Y. M. C. A. Schools' student.

Two years ago he began devoting evening hours to the study of a United Y. M. C. A. Schools' correspondence course. He was not depending on pull or luck to get ahead. He believed that when he was qualified for a bigger job, the opportunity would come to "step up."

This Colorado student's letter is a fair specimen of hundreds that come to us.

It's not difficult to "step up" if you have ambition and the kind of training employers want. Will you let us tell you how you can move upward steadily by simply making use of your spare hours?

Some of our 300 Correspondence Courses

Technical Courses		
Agricultural Courses	Farm Management	Rural Engineering
Architecture	Foremanship	8 up Courses
Automobile Courses	Highway Engineering	— Blacksmith—Machines
Building Construction	Mechanical Engineering	— Foundry—Patterns
Civil Engineering Courses	Plumbing	Steam Engineering
Concrete Engineering	Poultry Husbandry	Structural Drafting
Drafting Courses	Radio Engineering	Surveying
Electrical Courses	Radio Telegraphy	
Commercial and Other Courses		
Accountancy	Business English	Insurance Courses
Advertising	Business Finance	Mathematical Courses
Applied Psychology	Business Law	Physical Directors' Training
Banking	English Courses	Public Speaking
Better Letters	Foreign Languages	Salesmanship
Bookkeeping	Grammar School Courses	Shorthand and Typewriting
Business Arithmetic	High School Courses	Show Card Writing
Business Administration	Illustrating	Traffic Management

Mark and mail this coupon and get our friendly counsel free.

Without obligating me, please advise regarding the course in.....

Name.....

Full Address.....

Dept. 2-My

Please write plainly

United Y.M.C.A. Schools
Correspondence Instruction *The most Service for the least Money*
347 Madison Ave. New York City, N.Y.

Please Mention Popular Mechanics

Drawing

for Advertising
Pays Big Money to Men and Women

Nearly Everything Sold is ADVERTISED
Nearly Everything Advertised is ILLUSTRATED
Big Field and Big Money for You

A Beautifully Illustrated Book of Valuable Information FREE if you are over 15 years old.

Class Room or Home Study Instruction
Address Dept. 6

**NATIONAL ACADEMY
of COMMERCIAL ART**
230 East Ohio St. CHICAGO III.

STAMMER

If you stammer attend no stammering school till you get my large FREE book entitled "STAMMERING. Its Origin and the Advanced Natural Method of Cure," bound in cloth and stamped in pure gold. Ask for special tuition rate and a FREE copy of "The Natural Speech Magazine." Largest, best equipped and most successful school in the world for the cure of stammering; stuttering, etc. No sing-song or time bent. Write today. The North-Western School, 2317 Grand Ave., Milwaukee, Wis.

LEARN WATCH REPAIRING

You can learn by our modern and original system of instruction every part of the **Watch Repairing Trade** at home as good or better than at a shop. You can earn money while learning and secure a well paying position or start in business after completing our course of instruction. Good watch repairers are always in demand and earn from \$30 to \$70 per week. For particulars apply to the **Wisconsin School of Watch Repairing** 156 Mason St., MILWAUKEE, WIS.

WHY NOT spend Spring, Summer and Fall gathering butterflies, insects? I buy hundreds of kinds for collections. Some worth \$1 to \$7 each. Simple outdoor work with my instructions, pictures, price-list. Send 10c (not stamps) for my illustrated prospectus before sending butterflies.

Mr. Sinclair, Dealer in Insects, Dept. 6, Ocean Park, Calif.

Learn Photography at HOME

Make \$75.00 a Week on the Side

Establish yourself as a Photographic Expert quickly—during your spare time—under a leading photographer. I'll show you how to start your own business—or command a large salary. Send for my unusual offer—It's coolly temporary. Act at once. A postal will do. H. S. VANT.

INTERNATIONAL STUDIOS, Inc.
Dept. 1195, 3601 Michigan Ave., Chicago, U. S. A.

How to Read Blueprints and Plans.

How to Use the Steel Square Successfully.

What You Should Know About Carpentry and Building.

How to Build a Frame or a Brick Structure.

What You Should Know About Sheet Metal Work.

How to Be a Successful Building Superintendent.

What You Should Know About Heating and Ventilating.

A Thousand Things You Ought to Know

How to Write and Read Building Specifications.

EVERY day in your work you get up against new problems—sometimes it is only some old "sticker" coming in a new way. Just the same, though, it takes a lot of time to figure them out. **Don't do it.** Here's everything worked out for you. Every problem, big or little, that you will meet in a day's work. Hundreds of new ideas and better ways of doing things. Hundreds of ways the other fellows are making money. Hundreds of ways **you** can make more out of the same work you are doing now.

What You Should Know About Water Supply and Drainage.

CARPENTRY AND CONTRACTING

How to Estimate the Cost of a Building.

Five great big volumes flexibly bound in genuine American Morocco with 2,138 pages and more than 1,000 blueprints, plans, pictures and diagrams. It is the newest, most complete, most practical work of its kind ever published. Twenty-five well-known experts prepared these great books, gathering the material from hundreds of different sources. Every man in the shop and on the job should have them. Written in such plain language that anyone can understand them.

What You Should Know About Plastering and Painting.

7 Days' FREE Examination

Send the coupon for these great Carpentry and Contracting books **TODAY**. You can't afford to be without them and you don't take any risk at all. The coupon brings the whole set by express collect for a week's free examination. Use the books a week and notify us to get them back if they don't please you. If you like them, send us only \$2.80 and \$3.00 each month thereafter until \$19.80 is paid. If you prefer to pay cash with order, send only \$17.80. The return privilege holds good just the same. Send the coupon **NOW**. Remember—sending for the books does not obligate you to buy.

AMERICAN TECHNICAL SOCIETY, Dept. G-195, Chicago

How to Know Material and Select the Best.

How to Build of Concrete and Steel.

How to Care for Tools.



**American Technical Society,
Dept. G-195, Chicago**

Please send me the five-volume Cyclopedia of Carpentry and Contracting, shipping charges collect. I will send you \$2.80 in seven days and \$3.00 each month thereafter until \$19.80 has been paid, or return the books at your expense.

To insure prompt delivery, fill out all lines.

Name

Street and No.

City and State

Reference

21 Jewel Burlington

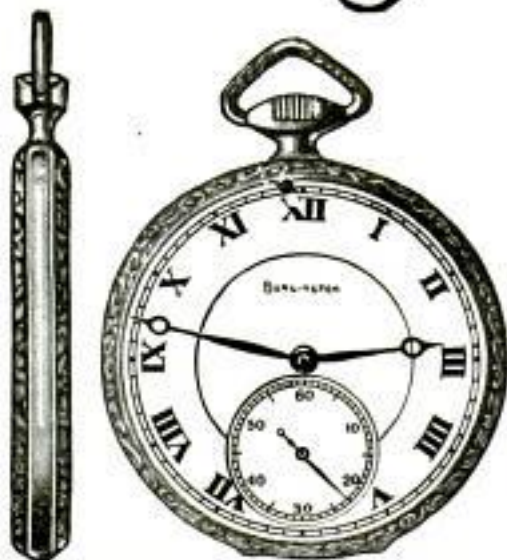

Adjusted to the Second
Adjusted to Temperature
Adjusted to Isochronism
Adjusted to Positions

21 Ruby and Sapphire Jewels
25 Year Gold Strata Case
Your Choice of Dials
(Including Monipony R. R. Dial
New Ideas in Thin Cases)

Only \$1⁰⁰ Down

Only One Dollar Down will buy this masterpiece of watch manufacture. The balance you are allowed to pay in small, easy, monthly payments. The Burlington—a 21-Jewel Watch—is sold to you at a price much lower than that of other high-grade watches. Besides, you have the selection of the finest thin model designs and latest styles in watch cases. Don't delay! Write for the FREE Watch Book and our SPECIAL OFFER today.

Write *While This Special Offer Lasts*

Get the Burlington Watch Book by sending this coupon. Find out about this great special offer which is being made for only a limited time. You will know a great deal more about watch buying when you read this book. You will be able to "steer clear" of the over-priced watches which are no better. Remember, the Burlington is sent to you for only One Dollar down, balance in small monthly payments. Send the coupon for watch book and our special offer TODAY! Do not delay one minute!

Burlington Watch Company

Dept. 93-55 19th St. & Marshall Blvd., Chicago
Canadian Address: 62 Albert St., Winnipeg, Manitoba

Please send me (without obligations and prepaid) your free book on watches with full explanation of your \$1.00 down offer on the Burlington Watch.

Name _____

Address _____

Please Mention Popular Mechanics

WE TEACH COMMERCIAL ART

Meyer Both Company, the largest Commercial Art Organization in the World, offers you an unusual opportunity for practical training. If you like to draw develop your talent. Study this practical course—taught by this nationally known organization with twenty-two years success—who each year produces and sells to advertisers over 15,000 commercial drawings. Our teachers give you the double advantage of being instructors of proven ability, as well as artists in this widely known organization. Meyer Both instruction is the difference between successful fact and experimental theory Commercial Art is a highly paid, intensely interesting profession, equally open to men and women. Home study instruction.

Get Facts Before You Enroll in any School.

Ask the Advertising Manager of the leading newspapers in your city, anywhere in the United States, Canada, England or Australia about the Meyer Both Company—let them tell you about us. Write for our Illustrated book—telling about the success of our students—for one-half the cost of mailing—four cents in stamps.

MEYER BOTH COMPANY

Department of Art Instruction

Michigan Ave. at 29th St., Dept. 16 CHICAGO, ILL.

NOTE—To art and Engraving Firms: Secure practical artists among our graduates. Write us.

ELECTRICAL ENGINEERING

men with training are in demand. For more than a quarter of a century this school has been training men of ambition and limited time, for the electrical industries. Condensed course in Electrical Engineering enables graduates to secure good positions

and promotions. Theoretical and practical Electricity, Mathematics, Steam and Gas Engines, Mechanical Drawing. Students construct dynamo, install wiring and test electrical machinery. Course with diploma, complete



Thoroughly equipped fireproof dormitories, dining hall, laboratories, shops. Over 3000 men trained.

Write for catalog. 31st year begins Sept. 26, 1923.

BLISS ELECTRICAL SCHOOL

104 TAKOMA AVENUE, WASHINGTON, D. C.

MUSIC LESSONS FREE

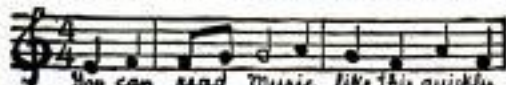

You can read Music like this quickly

IN YOUR
OWN
HOME

Piano, Organ, Violin, Mandolin, Guitar, Banjo, etc. Beginners or advanced players. One lesson weekly. Illustrations make everything plain. Only expense about 2c per day to cover cost of postage and music used. Write for FREE booklet which explains everything in full.

AMERICAN SCHOOL OF MUSIC, 51 Lakeside Building, CHICAGO

HOW TO BECOME A PROFESSIONAL PHOTOGRAPHER

EARNING \$35 TO \$125 A WEEK



Three to six months' course. Motion Picture, Commercial, Portraiture. Practical instruction. Modern equipment. Ask for Catalog No. 49.

N. Y. INSTITUTE OF PHOTOGRAPHY
NEW YORK CHICAGO BROOKLYN
141 W. 36th St. 630 So. Wabash Ave. 505 State St.

WRITE JOKES

Publishers pay from \$1 to \$5 apiece for jokes, epigrams and humorous stories. Tremendous demand for original material. Professional humorists earn good salaries. Our course in Humor Writing teaches you how to originate ideas for jokes, epigrams, stories. Learn in your spare time—earn in your spare time. Markets furnished.

Write for Information

AMERICAN INSTITUTE OF HUMOR
Office J, 414 Park Bldg., Cleveland, Ohio



Be An **ELECTRICAL** **TECHNICIAN**

GET YOUR ELECTRICAL TECHNICIAN'S CERTIFICATE THROUGH ME AND YOU WILL BE GUARANTEED THE AID OF MY ORGANIZATION TO SECURE YOU A POSITION PAYING YOU THE HIGHEST SALARY YOU EVER RECEIVED TO START

Command \$250 to \$600 Monthly

My course is designed to fit you for a position as Electrical Technician, Supervisor, Foreman or Manager of Equipment. These positions cover the electro-technical field and pay a rate of compensation running into thousands of dollars a year. Take my Home Study course and prepare yourself in spare time by this most simple, direct and inexpensive method to become an expert in *MOTOR MAINTENANCE, ARMATURE WINDING, BATTERY, SUB-STATION AND POWER HOUSE WORK, AUTOMOTIVE, AIRCRAFT, TRACTOR AND ILLUMINATING ENGINEERING, GENERATOR, SWITCHBOARD AND HOUSE WIRING, TRANSMISSION, INSTALLATION AND LINE CONSTRUCTION*, and I will not only guarantee your

success in this study, but I will undertake to train you until you are actually earning \$3,000 a year. More than that, when you graduate and are qualified to receive your Electrical Technician

S. V. Smith,
Chief
Engineer
Home Study
Dept.

Certificate from me, if you are not more than pleased with your training, or if you are not fully convinced your earning power has been GREATLY INCREASED, or if you are not completely satisfied you can hold down a high-class job at the highest rate of compensation paid men of your experience—either you may come in with me and finish your training here in my plant—at no cost to you—or

I WILL GIVE YOU MY COURSE—FREE

There are no "ifs" nor "buts" about this offer. If you have a common school education and will agree to study a little evenings for a few months, I guarantee to train you to be a first-class man, or the course need not cost you one penny. Therefore, write at once or mail the coupon for full details of my truly remarkable proposition. **DO THIS NOW**—to avoid possible disappointment.

Wonderful FREE OUTFIT Offer

With this electrical course you will get free and prepaid an up-to-date outfit of electrical apparatus, instruments and appliances for doing experimental and practical work at home, and, in addition, if you reply to this ad promptly, I shall give you, as my student, a complete EXPERT'S training in

RADIO FREE. This is a wonderful opportunity for you, for with this splendid, up-to-the-minute FREE Course in Radio, (covering construction, operation and installation) and my help, it is possible for you to make \$50.00 a week and up right at home while learning. I shall supply what you need to aid you to do this without one penny expense to you and you can start RIGHT IN. Get details of this great offer at once. Send Coupon or Write—NOW.

S. V. SMITH, Chief Engineer
Home Study Dept., S. & H. Electrical Works
Desk EE1, 308 S. Green St., Chicago

Desk EE1,
S. V. Smith,
Chief Engineer
Home Study Dept.,
S. & H. Electrical
Works,
308 So. Green Street
Chicago

Dear Sir: I am interested in your guaranteed Home Study Course of Training in the best-paid divisions of Electricity; also how you aid me free to make money while learning. Send particulars at once free of charge.

Name.....

Address.....

MAIL THIS FOR BIG FREE OFFER



What Are You Thinking About?

Day-dreaming led many a man to make plans that brought him big success. Don't be ashamed when your thoughts are wandering away, when you dream that you are a leader of men—a doer of big things in the business world—a builder of lasting structures. Your day-dreams are an indication of your ambition and of your desire to accomplish things. The man who never dreams has no imagination, he will not get very far. But you can make your dreams real—You can materialize your ambition.

Just dreaming alone won't do. Hitch your dreams up to facts and you will go far. You will get the facts through special training along the line in which you want to succeed. And the place to get just that training is the American School. This is proven by the quarter of a century of successful experience we have in helping many thousands of men and women gain an enviable place in the business and social life.

Another reason why the American School is the place to get your training—it is not a business corporation but a chartered Educational Institution, incorporated not for profit.

Space here is too limited to tell you of all the advantages you will gain by getting your training from the American School, but the coupon will bring you full information and a descriptive book, without cost or obligation to you. Fill out and mail the coupon NOW, while you are thinking about it. No agents will bother you.

American School

Dept. G-574, Drexel Ave. and 58th St., Chicago

American School

Dept. G-574, Drexel Ave. and 58th St., Chicago

Send me full information on the subject checked and how you will help me win success.

- | | |
|-----------------------------|---------------------------|
|Architect |Lawyer |
|Building Contractor |Machine Shop Practice |
|Automobile Engineer |Photoplay Writer |
|Automobile Repairman |Mechanical Engineer |
|Civil Engineer |Shop Superintendent |
|Structural Engineer |Employment Manager |
|Business Manager |Steam Engineer |
|Cert. Public Accountant |Foremanship |
|Accountant and Auditor |Sanitary Engineer |
|Bookkeeper |Surveyor (& Mapping) |
|Draftsman and Designer |Telephone Engineer |
|Electrical Engineer |Telegraph Engineer |
|Electric Light & Power |High School Graduate |
|General Education |Fire Insurance Expert |
|Vocational Guidance |Wireless Radio |
|Business Law |Production Manager |
|Advertising Manager |Undecided |

Name.....

Address.....

Please Mention Popular Mechanics

Magic nights under the red moon



Come to the big woods of the great Northwest! Here's glorious adventure for you! Stand under the great open sky—gaze at the wondrous red moon—hear the cry of the wolf-pack—sit by the glow of the camp-fire.

James Oliver Curwood 6 Complete Novels —at a Special Price

"The Hunted Woman," "Baree, Son of Kazan," "God's Country and the Woman," "The Grizzly King," "The Courage of Marge O'Doone," "Nomads of the North."

Every one of these six great books is packed full of adventure in the great Northwest. Curwood takes you on thrilling trips through the wilderness—by canoe, by snow shoe, by dog sled.

SEND NO MONEY Just write postcard or letter saying: "Send me the six volumes, cloth bound set of Curwood for 7 days' FREE examination." You can return the books or send only \$1.50 in 7 days and \$2.00 a month for 3 months. If you prefer ½ leather send \$1.50 in 7 days and \$2.00 a month for 4 months. If cash is sent with order deduct 50 cents.

NELSON DOUBLEDAY, Inc.
DEPT. C-585, GARDEN CITY, N. Y.



Big Money In Photography!

Photographers and Photo-Engravers are well paid. More men and women are needed to fill attractive positions all over the country. The demand is far greater than the supply. The largest and best college of its kind in the world will teach you these fascinating professions in a few months. Established over 30 years. Hundreds of satisfied graduates now earning big pay. Good positions secured. Tuition and living expenses low. Write for interesting book—now!

ILLINOIS COLLEGE OF PHOTOGRAPHY
Box 553 Effingham, Ill.



Wonderful, new device, guides your hand; corrects your writing in few days. Big improvement in three hours. No failures. Complete outline FREE. Write C. J. Ozment, D-34, St. Louis, Mo.

STAMMERERS

You can be cured by our course of natural individual lessons. Write today for free booklet, "How To Stop Stammering."

SAMUEL A. ROBBINS, Director,
Boston Stammerers' Institute, Founded, 1887
246 Huntington Ave. Boston 17, Mass.

LEARN WATCHMAKING

and become independent. Good-paying positions secured. Easy to learn. Send for FREE CATALOG.
ST. LOUIS WATCHMAKING SCHOOL, Dept. 5, ST. LOUIS, MO.

LAW High-Grade Instruction

By Correspondence
Prepares You for the Bar—Est. 1892
University Methods.
Standard Text-Books. Approved by Bench and Bar. Graduates practicing in every state. Send today for Free Catalog and Rules for Admission to the Bar.
Chicago School of Law
520 Reaper Block Chicago, Ill.



GREER Trained Auto Experts Make Big Money

Earn \$50 to \$125 a Week



Erwin Greer, President, has trained thousands for higher jobs—he can help you. GREER graduates, trained under his personal supervision, are making big money in all parts of the country.

GET ahead fast through GREER training. Big Pay—Fascinating Work—Unlimited Opportunities! Previous experience unnecessary. In eight weeks you can qualify as an Expert Mechanic, Garage Foreman, Demonstrator, Battery and Ignition Expert, Auto Salesman, etc. GREER-trained men are preferred for the Better Paying Jobs.

We Pay Your Railroad Fare to Chicago Direct to Greer College

This is **your** opportunity. Make a start **now** for the famous GREER COLLEGE—no matter what part of the United States you're in, get on the road to a Better Job while this offer of FREE RAILROAD FARE is open. Come to Chicago, America's wonder city, at our expense.

Automobile Business Is Booming

There is a demand for GREER-trained men. Increasing growth of Automotive Industry creates new jobs, new opportunities every day. Take the GREER course, then earn high pay as an Auto Expert.

Greer Course

The GREER Super-Course of Automobile instruction covers the following subjects—all included in the complete course long experience has proved necessary:

- | | |
|---|---|
| Truck, Tractor and Automobile Repairing and Overhauling, | Machine Shop Practice, Acetylene Welding and Cutting, |
| Automobile Driving, Roadside Repairs, Primary Ignition, Vulcanizing and Tire Repairing, | Storage Batteries, Salesmanship, |
| Electric Lighting and Starting Systems, | Garage and Repair Shop Management |
| | How to Get an Automobile, Truck or Tractor Agency. |

FREE BOOK

Free—our new 64-page book, "How to Succeed in the Automobile and Tractor Business." Just write your name and address on the coupon below and mail **at once**.



Here's the big, 7-floor GREER building, with its thoroughly up-to-date equipment. You learn by actually doing the jobs, after you master the theory.

GREER COLLEGE

of Automotive Engineering

2055 S. Wabash Ave., Chicago, Ill.

Don't wait—
Write at once—NOW!

ERWIN GREER, President
GREER COLLEGE OF AUTOMOTIVE ENGINEERING
2055 S. Wabash Ave., Chicago, Ill.

I am interested in making more money and want you to send me your book, "How to Succeed in the Automobile and Tractor Business," without obligation.

Name

Address

Present Occupation

Why haven't
you
clipped this
coupon

----- TEAR OUT HERE -----

INTERNATIONAL CORRESPONDENCE SCHOOLS
Box 5518-D, Scranton, Penna.

Without cost or obligation, please tell me how I can qualify for the position or in the subject before which I have marked an X:

BUSINESS TRAINING DEPARTMENT

- | | |
|---|---|
| <input type="checkbox"/> Business Management | <input type="checkbox"/> Salesmanship |
| <input type="checkbox"/> Industrial Management | <input type="checkbox"/> Advertising |
| <input type="checkbox"/> Personnel Organization | <input type="checkbox"/> Better Letters |
| <input type="checkbox"/> Traffic Management | <input type="checkbox"/> Foreign Trade |
| <input type="checkbox"/> Business Law | <input type="checkbox"/> Stenography and Typing |
| <input type="checkbox"/> Banking and Banking Law | <input type="checkbox"/> Business English |
| <input type="checkbox"/> Accountancy (including C.P.A.) | <input type="checkbox"/> Civil Service |
| <input type="checkbox"/> Nicholson Cost Accounting | <input type="checkbox"/> Railway Mail Clerk |
| <input type="checkbox"/> Bookkeeping | <input type="checkbox"/> Common School Subjects |
| <input type="checkbox"/> Private Secretary | <input type="checkbox"/> High School Subjects |
| <input type="checkbox"/> Business Spanish | <input type="checkbox"/> Illustrating |
| <input type="checkbox"/> French | <input type="checkbox"/> Cartooning |

TECHNICAL AND INDUSTRIAL DEPARTMENT

- | | |
|---|--|
| <input type="checkbox"/> Electrical Engineering | <input type="checkbox"/> Architect |
| <input type="checkbox"/> Electric Lighting | <input type="checkbox"/> Blue Print Reading |
| <input type="checkbox"/> Mechanical Engineer | <input type="checkbox"/> Contractor and Builder |
| <input type="checkbox"/> Mechanical Draftsman | <input type="checkbox"/> Architectural Draftsman |
| <input type="checkbox"/> Machine Shop Practice | <input type="checkbox"/> Concrete Builder |
| <input type="checkbox"/> Railroad Positions | <input type="checkbox"/> Structural Engineer |
| <input type="checkbox"/> Gas Engine Operating | <input type="checkbox"/> Plumbing and Heating |
| <input type="checkbox"/> Civil Engineer | <input type="checkbox"/> Chemistry |
| <input type="checkbox"/> Surveying and Mapping | <input type="checkbox"/> Automobile Work |
| <input type="checkbox"/> Metallurgy | <input type="checkbox"/> Navigation |
| <input type="checkbox"/> Mining | <input type="checkbox"/> Agriculture and Poultry |
| <input type="checkbox"/> Steam Engineering | <input type="checkbox"/> Mathematics |
| <input type="checkbox"/> Radio | <input type="checkbox"/> Airplane Engines |

Name.....
Street.....
Address.....

City..... State.....

Occupation.....

Persons residing in Canada should send this coupon to The International Correspondence Schools Canadian, Limited, Montreal, Canada.

Please Mention Popular Mechanics

BE AN ARTIST

We can teach you **DRAWING** in your own home during your spare time.

Our 18 years of successful teaching prove our ability. 30 Courses in Commercial and Illustrative Drawing. Teachers Normal and Applied Art. Endorsed by high art authorities. Students trained by members of our Faculty are filling high-salaried positions. Artist's Outfit FREE to Enrolled Students. Write today for Art Year Book.

OUR HANDSOME ART YEAR BOOK IS FREE TO YOU!

SCHOOL OF APPLIED ART
ADDED ART BLDG. NO. 2 BATTLE CREEK MICH.

MAKE MEN THINK YOUR WAY Apply this Simple test with startling results to release you from Poverty, Failure, Fear. Simply send name with permanent address today. Learn this secret method without cost or charge. If valuable, pay what you think right within 5 days, otherwise simply return to us. No obligations. Positive instructions by return mail.

THE CARNAGEY INSTITUTE
416 Hayes Bldg. Kansas City, Mo.

SPEECH DEFECTS

A private residential institute for the correction of Stammering, Stuttering, Lipping, Loss of Voice, Monotonous Pitch, Attention Deafness and for those retarded in school because of cognate defects. Conducted by

DR. FREDERICK MARTIN
(himself once a confirmed stammerer)

Lecturer, Post Graduate Medical College and Hospital, New York City—Formerly Director of Speech Improvement, Board of Education, New York City.

Normal courses for Teachers of Speech Improvement.
MARTIN INSTITUTE FOR SPEECH CORRECTION
419 DeWitt Park, Ithaca, N. Y.

Mount Birds

We teach you by mail to stuff and mount all kinds of Birds, Animals, Game Heads. Also to tan skins and make rugs. Be your own taxidermist. Decorate your home with your beautiful trophies or increase your income selling specimens and mounting for others. Easily, quickly learned in spare time by men and women. Highest endorsements by thousands of students. Write today for our great free book "How to Mount Birds and Animals" Free—write today, N. W. School of Taxidermy, 9775 Elwood Bldg., Omaha, Neb.

LAW IN YOUR SPARE TIME

Learn law with only institution giving same course by correspondence as was given for years at resident classes of this college. **DEGREE OF LL. B. CONFERRED.** One year business law course prepares you for success in business. Law trained business men in demand. Three year university course covers preparation for bar examination. Money back guarantee if not satisfied. Low fee, easy terms, includes complete 1921 thirteen volume library, text material and all expenses. Write for **FREE BOOK.**

Hamilton College of Law
431 South Dearborn St., Dept. 65 Chicago

LEARN SHOW CARD WRITING BY MAIL OR LOCAL DISPLAY ART CLASSES

Study under the direction of Arnold Binger, the leading expert in the line. Positions await competent students. Write for our beautiful illustrated booklet and terms.

BINGER SCHOOL OF SHOW CARD & DISPLAY ART
2116 Flatiron Building, Broadway & 23rd Street, NEW YORK CITY

LEARN ENGINEERING

Courses, 3 months to 2 years practical-technical training under experts. Not a Trade School, but a practical technical college teaching electricity, steam, gas, auto-electric, armature winding, drafting, radio. Extensive laboratory and shop equipment. Degrees awarded. Day and night sessions. Enroll any time.

FINLAY ENGINEERING COLLEGE 1001 Indiana Avenue KANSAS CITY, MO.

“O.K.”
say
5000
READERS

GUIDES SENT FREE FOR YOUR O. K.



\$1 PER MONTH

“Worth ten times their price.” “I wouldn’t send them back for a handful of diamonds.” “I congratulate you on their excellence.” “Helped me to two raises in four months.” “Better than a school of instruction.” “Studied them when I was laid up and got further ahead than if I’d been on the job.”

These are the words of gratitude that come to us by every mail from Electrical workers. There is no short cut to genius. But there are sign posts all along the road to success. **Hawkins Electrical Guides** find these sign posts for you. It is so easy to pay for the **Guides** that you will scarcely miss the monthly payments.

HAWKINS ELECTRICAL GUIDES

Do you want to know the facts about the following electrical subjects? They are all covered in Hawkins Electrical Guides.

Electrical signs and symbols—static and current electricity—primary cells—conductors and insulators—resistance and conductivity—magnetism—induction coils—dynamic principles—pieces of dynamo—armatures—windings—commutator brushes. Motor principles—armature reaction—motor starting—calculations—breaks—horse power—selection and installation of dynamos and motors—galvanometers—standard cells—current measurement—resistance measurements—voltmeters—wattmeters—watt-hour meters—operation of dynamos—operation of motors. Distribution systems—wires and wire calculations—inside, outside and underground wiring—sign flashers—lightning protection—rectifiers—storage battery systems. Alternating current principles—the power factor—alternator principles—alternating construction—windings. A. C. Motors—synchronous and induction motor principles—A. C. commutator motors—induction motors—transformers;

losses, construction, connections, tests—converters—rectifiers. Alternating current systems—switching devices—circuit breakers—relays—lightning protector apparatus—regulating devices—synchronous condensers—indicating devices—meters—power factor indicators—wave form measurement—switch boards. Alternating current, wiring power stations—turbines, management, selection, location, erection, testing, running, care and repair—telephones, telegraph—simultaneous telegraphy and telephony—wireless—electric bells—electric lighting photometry. Electric railways—electric locomotives—car lighting—trolley car operation—miscellaneous applications—motion pictures—gas engine ignition—automobile self-starters and lighting systems, electric vehicles. Elevators—cranes—pumps—air compressors—electric heating, electric welding—soldering and brazing—industrial electrolysis—electro-plating—electro-therapeutic—X-rays.

Also a complete 126-page ready reference index of the complete library. This index has been planned to render easily accessible all the vast information contained in the 10 Electrical guides. There are over 13,500 cross references. You find what you want **instantly**.

4700 PICTURES
3500 PAGES

Flexible Covers
Pocket Size

FREE

Examination Coupon

Send No Money--Send Only This Coupon

THEO. AUDEL & CO.,
72 Fifth Ave., New York City

Please submit me for free examination, **HAWKINS ELECTRICAL GUIDE**, (Price \$1 a number) Ship at once prepaid, the 10 numbers. If satisfactory, I agree to send you \$1 within seven days and to further mail you \$1 each month until paid.

Name

Occupation

Employed by

Home Address

Reference

PM May 23





Every fighter knows the value of training

Training means as much in work as in sport.

Without training, you are helpless in competition with the trained man.

Build up your brain just as you do your muscle. Let the United Y. M. C. A. Instructor, who will take an interest in all your problems, be your trainer. He can put you "in good condition" so you can do a higher grade of work, shoulder more responsibility, earn more money, have more comforts and privileges.

Write us about your ambition. Learn what the United Y. M. C. A. Schools' correspondence-teaching service is doing for thousands of men everywhere in their spare evening hours.

Life is a real contest, calling for head work and staying power. Some of our 300 Correspondence Courses

Technical Courses		
Agricultural Courses	Auto Management	Rural Engineering
Architecture	Freemanship	Shop Courses
Automobile Courses	Highway Engineering	—Blacksmith—Machine
Building Construction	Mechanical Engineering	—Foundry—Pattern
Civil Engineering Courses	Plumbing	Steam Engineering
Concrete Engineering	Poultry Husbandry	Structural Drafting
Drafting Courses	Radio Engineering	Surveying
Electrical Courses	Radio Telegraphy	
Commercial and Other Courses		
Accountancy	Business English	Insurance Courses
Advertising	Business Finance	Mathematical Courses
Applied Psychology	Business Law	Physical Directors' Training
Banking	English Courses	Public Speaking
Better Letters	Foreign Languages	Salesmanship
Bookkeeping	Grammar School Courses	Shorthand and Typewriting
Business Arithmetic	High School Courses	Show Card Writing
Business Administration	Illustrating	Traffic Management

Begin your training for the Big Fight. Send this coupon for our friendly counsel.

Without obligating me, please advise regarding the course in.....

Name.....

Full Address.....

Dept. 74-My

Please write plainly

United Y.M.C.A. Schools
Correspondence Instruction *The most Service for the least Money*
347 Madison Ave. New York City, N.Y.

Please Mention Popular Mechanics

Music Lessons

UNDER MASTER TEACHERS

At Home

A Complete Conservatory Course By Mail

Wonderful home study music lessons under great American and European teachers. Endorsed by Paderewski. Master teachers guide and coach you. Lessons a marvel of simplicity and completeness.

Any Instrument Write telling us course you are interested in—Piano, Harmony, Voice, Public School Music, Violin, Cornet, Mandolin, Guitar, Banjo or Reed Organ—and we will send our FREE CATALOG with details of course you want. Send NOW.
UNIVERSITY EXTENSION CONSERVATORY, 775 Siegel-Myers Bldg., CHICAGO, ILL.

IT'S EASY TO PLAY THE TENOR-BANJO

THIS \$15.00 TENOR BANJO FREE

No Previous Musical Knowledge Necessary. Play Music Your First Lesson. Wonderful Method Only 6 sessions and you master them quickly. After a short period of easy practice you will be playing all the popular hits, just as you have heard experts play them on the stage, in Dance Orchestras—everywhere! It is the most popular instrument of the age and you can quickly learn to play it. Prof. Barker will teach you to chord and harmonize exactly as he does in an amazingly short time! And remember we furnish your tenor banjo free. Write for details of our course and free offer. Address

First Hawaiian Conservatory of Music, Inc. Desk 60, 233 Broadway, (Woolworth Bldg.) N. Y.



BE A NEWSPAPER ARTIST!



Win fortune and fame. MANUEL ROSENBERG COURSE IN NEWSPAPER ART tells you how. 71 Lessons and 150 illustrations. Drawing made easy. Complete instruction in layouts, lettering, illustration, cartooning and sketching. Ten years' experience as staff artist of important American dailies. Price only \$5. Order TODAY. Your money refunded if you do not agree that this is the greatest art course value ever offered. MANUEL ROSENBERG, Butler Bldg., Cincinnati, O.

"STAMMERING"

Its Cause and Cure

You can be quickly cured if you stammer. Send 10 cents, coin or stamps, for 288 page cloth bound book on Stammering and Stuttering. It tells how I cured myself after Stammering and Stuttering for 20 years. BENJAMIN N. BOGUE
749 Bogue Building, 1147 N. Ill. St. Indianapolis

AGENTS—GET THIS AUTO



Take orders for finest All-Wool Tailored-to-Measure Suits. Guaranteed \$50.00 values for \$29.75. Fastest selling one-price line. Agents making \$75 a week and up. We supply finest selling outfit, pay highest commissions and furnish auto to men who qualify.

Write Quick For Startling Offer

PARK TAILORING CO., Dept. 618, CHICAGO



FREE BOOK LEARN PIANO

This Interesting Free Book shows how you can become a skilled player of piano or organ at quarter usual cost. It shows why one lesson with an expert is worth a dozen other lessons. Dr. Quinn's famous Written Method includes all of the many important modern improvements in teaching music. Brings right to your home the great advantages of conservatory study. For the beginner or experienced player. Endorsed by great artists. Successful graduates everywhere. Scientific yet easy to understand. Fully illustrated. All music free. Diploma granted. Write today for free book. Quinn Conservatory, Studio PMCS, 598 Columbia Road, Boston 25, Mass.



If He Had Passed It Up

He Would Still be a Laborer at \$2 a Day. No Money, Nothing Ahead but Hard Work, Longer Hours—and Regrets. But He Didn't Pass It Up

He decided to learn Mechanical Drawing. He buckled down to work with the Columbia School of Drafting. When he had a quiet half hour to spend he spent it—as a wise man spends money—to get full returns.

MADE \$275 EXTRA IN 3 DAYS. He recently received \$275 for one drawing that only took him three days to draw.

NOW HOW ABOUT YOU? Are you working up hill or down? Count the money in your pay envelope next pay day. You'll find the answer there.

MAKE \$35 TO \$100.00 A WEEK. We will train you to be an expert Draftsman in your spare time at home by mail. There's lots of room for you if you act now.

PROMOTION IS QUICK. WE'LL QUALIFY YOU for a high-salaried position in the drafting field and keep you in touch with openings for Draftsmen in the big machine shops, industrial plants and United States Government departments. Men who start as

Draftsmen are often advanced to Chief Draftsmen, Chief Engineers, Production Managers and so on.

GET THE RIGHT TRAINING. Mr. Claffin, the founder and director, stands personally in back of the Columbia School of Drafting. You spend no time in long-winded theories—useless and expensive to you. You start on actual drawing work the day you receive your first lesson.

YOU NEED NO PREVIOUS TRAINING. The course is easy to understand and easy to follow. Many students are qualified even before they complete the course.

SUCCESS CALLS MEN OF ACTION ONLY. If you are a man of action clip the coupon now and show that you are a man of action. Keep right on top of this opportunity to make real money. Don't go looking for a pair of scissors. Tear the coupon off and mail it right now. We have a special offer for those who reply promptly. Get started now.

What We Give You

PRACTICAL PROBLEMS. You are carefully coached in practical Drafting work.

WE HELP YOU GET A JOB. We help you get a position as a practical Draftsman as soon as you are qualified.

PERSONAL INSTRUCTION AND SUPERVISION THROUGHOUT THE COURSE. You receive the personal instruction and help of Roy C. Claffin, president of the Columbia School of Drafting and a practical Draftsman of many years' experience.

DRAFTSMAN'S EQUIPMENT. We furnish you with a full set of Drawing Equipment and Drafting Instruments as shown in the picture below when you enroll. You keep both sets on completing the course.

CONSULTATION PRIVILEGES. You are free to write us at any time for advice and suggestions regarding your success.

DIPLOMA. The diploma we give you on completing the course attests to your proficiency as a Draftsman. It is an "entering wedge" to success.

FREE SUBSCRIPTION TO DRAFTSMAN'S PUBLICATION "THE COMPASS." You are given free a subscription to our helpful, inspiring publication, "The Compass."

U. S. Civil Service Commission Needs

DRAFTSMEN The following are a few of the many positions open in Government Departments from time to time. The salaries are starting salaries, subject to increase. Practically all of them carry a bonus of \$240 a year additional.

Architectural Designer..... \$4,000
Chief Draftsman (Aeronautical) Naval Aircraft Factory, per day..... 15.04
Aeronautical Draftsman—Field Service of Navy Department, \$5.20 per day to \$12 per day.

FREE BOOK Send in this coupon today. Immediately on receipt of it we will send you our book, "Drafting—Your Success," which tells you all about our new method of teaching Mechanical Drawing and gives full details of our special offer to those who reply promptly.

THE COLUMBIA SCHOOL OF DRAFTING

Roy C. Claffin, President

Dept. 1976, 14th and T Sts., N. W., Washington, D. C.

Free Book Coupon

COLUMBIA SCHOOL OF DRAFTING,
 Dept. 1976, 14th and T Sts., N. W., Washington, D. C.

Enter my name for a free subscription to "The Compass" and also send me without charge your illustrated book on Drafting, telling me how I can secure your complete Home Study Course and your help in securing a position as Draftsman.

Name.....

Address.....

City..... State.....

Drafting
 Outfit
 Free



FREE We give you free with our course this professional Drafting outfit. It is yours to keep when you complete the course.



BE A RAILWAY TRAFFIC INSPECTOR

Most Interesting Position With Unlimited Opportunities

By **GLEN O. TREGO**



"Having completed the course in Railway Traffic Inspection about nine months ago and having received a position within a few days thereafter (it was furnished me as guaranteed by the Institute) I now feel it my duty to express my gratitude for the help which was extended to me after I began work.

"And that was far more than I expected.

"I find Railway Traffic Inspection to be the most interesting position with unlimited opportunities that any man could wish for. I find that being a Railway Traffic Inspector does not only enable a man to receive higher positions in railways, but it also verses one so he is more capable of conducting any kind of business which may be chosen for the future.

"I must admit that the price paid for the course of Railway Traffic Inspection is the best investment I ever made."

POSITION GUARANTEED

Earn Up to \$250 Per Month Expenses Paid

GUARANTEE

Our guarantee states that tuition will be refunded to you, if upon graduation, position is not obtained paying at least \$110 per mo. and expenses.

You are practically your own boss as Railway Traffic Inspector. You can travel or remain near home; steady, pleasant, outdoor work; something new every day. Many opportunities for advancement through contact with leading railway officials.

EASY TO QUALIFY

Any average man can prepare in three months' spare-time study at home for this fascinating profession. Start at \$110 per month or more, expenses paid. Our guarantee assures you of a position; you take absolutely no risk.

Send for Particulars Today (Get our free Booklet No. D-63, giving full details and easy terms. Don't wait - send coupon now.)

Standard Business Training Institute Buffalo, N. Y.



Standard Business Training Institute Buffalo, N. Y.

Send me, entirely free, Booklet No. D-63, giving full particulars about course in Railway Traffic Inspection.

Name.....
 Street.....
 City.....

Please Mention Popular Mechanics

Learn to Write



I Teach by Mail

I can make a good penman of you at your home during spare time, no matter where you live or how poorly you now write. My simplified system has shown thousands the way to good penmanship during the past twenty-five years - I CAN and WILL do the same for YOU.

My beautifully illustrated 32-page Book

"How to Become a Good Penman" FREE!!

It contains many beautiful specimens of penmanship showing what others have accomplished by the Tamblin System, with testimonials and general information about our course. (Four name envelopes written on a card of your address stamp for postage.) Ladies taught as successfully as men. Write Today. Address

F. W. TAMBLIN
 418 Ridge Bldg. Kansas City, Mo., U. S. A.

HOW TO PAINT Signs and Sho-Cards

MEN! Learn the Sign and Sho' Card business. Become independent. Easy to learn. Pays big money. Our remarkable book gives complete instructions.

STOREKEEPERS! This book will quickly teach you how to make your own signs.

CONTENTS: Alphabets, Colors, HOW TO MIX PAINTS, Show Cards, Window Signs, Banners, Board and Wall Signs, Ready-Made Letters, Gilding, Commercial Art and Tricks of the Trade. Contains 100 alphabets and designs. Bound in desirable imitation leather, gold edges. \$2.00 postpaid or C. O. D.

OGILVIE INSTITUTE
 57 Ross St. Dept. 5 New York



LEARN WATCH REPAIRING

Be a watchmaker—you can learn this profitable trade by correspondence in a few weeks in your own home by the DeSelms Chart System. After you complete the course you will know a watch from A to Z. You will know just what the matter is and how to repair it. When you graduate you will be a practical watchmaker and repairer and competent to fill any position. Possibilities are unlimited.

Ask for our Free Book. It explains our system and terms.

THE DeSELMS WATCH SCHOOL
 23 Perry Street ATTICA, INDIANA



RAISE POULTRY FOR PROFIT

We teach you how. Easily learned at home. Our guaranteed methods make success certain—indorsed by leading Agricultural Colleges. Send TODAY for FREE BOOK—"How To Raise Poultry For Profit."

National Poultry Institute
 Dept. 312 Washington, D. C.



WANTED! RAILWAY MAIL CLERKS

Write Today for List of Government Positions Open—Men and Women Wanted Over 16 Years of Age—Salary \$1600 to \$2600

-----COUPON-----

UNITED GOVERNMENT TR. ASS'N.
 314 K Plaza Building, DETROIT, MICH.

Please send me free booklet and list of Government positions open.

Name.....
 Street.....
 City..... State.....



A Big Raise in Salary!

Is Very Easy to Get, If You Go About It in the Right Way

You have often heard of others who have doubled and trebled their salaries in a year's time. You wondered how they did it. Was it a pull? Don't you think it. When a man is hired he gets paid for exactly what he does, there is no sentiment in business. It's preparing for the future and knowing what to do at the right time that doubles and trebles salaries.

Remember When You Were a Kid

and tried to ride a bike for the very first time? You thought that you would never learn and then—all of a sudden you knew how, and said in surprise: "Why it's a cinch if you know how." It's that way with most things, and getting a job with big money is no exception to the rule, if you know how.

We Will Show You How

Without loss to you of a single working hour we can show you a sure way to success and big pay. A large number of men in each of the positions listed are enjoying their salaries because of our help—we want to help you.

Make check on the coupon against the job you want and we will help you to get it. Write or print your name on the coupon and send it in today.

American School

Dept. G-574-a Drexel Ave. and 58th St., Chicago

American School, Dept. G-574-a Drexel Ave., and 58th St., Chicago

Send me full information on the subject checked and how you will help me win success.

- | | | |
|------------------------------|-------------------------------|----------------------------|
|Architect |Electrical Engineer |Steam Engineer |
|Building Contractor |Electric Light and Power |Foremanship |
|Automobile Engineer |General Education |Sanitary Engineer |
|Automobile Repairman |Vocational Guidance |Surveyor (& Mapping) |
|Civil Engineer |Business Law |Telephone Engineer |
|Structural Engineer |Lawyer |Telegraph Engineer |
|Business Manager |Machine Shop Practice |High School Graduate |
|Cert. Public Accountant |Photoplay Writer |Fire Insurance Expert |
|Accountant and Auditor |Mechanical Engineer |Wireless Radio |
|Bookkeeper |Shop Superintendent |Undecided |
|Draftsman and Designer |Employment Manager | |

Name..... Address.....

Get Into The AUTOMOBILE BUSINESS

Greater opportunities are opening every day in this wonderful field. This year will add another two million cars to the more than twelve million now in use. Nearly sixty-five million tires to repair, more than twelve million batteries and electrical systems to keep in running order. Keep these facts in mind and you can quickly realize WHY the Automobile Business is THE Business to get into.

No matter where you go you will find a need for additional garages, battery repair shops, tire shops, welding shops, etc. to handle all this work.

Can you think of a better business for wide-awake, ambitious fellows who are specially trained for this work? Have a business of your own, and do the service work on these cars.

Make \$2000 to \$10,000 Yearly

—and those are conservative figures. Some of our graduates do even better. Thousands of them are making good money today. Good jobs await our graduates in the big auto factories, or in garages and service stations. They continually ask for M. S. A. S. Trained Men. Then there are thousands of opportunities to go in business for yourself. The man who is trained at the M. S. A. S. doesn't have to worry. He KNOWS that his FACTORY ENDORSED TRAINING will get him the right place in the Automobile Business. Prepare yourself now to have a business of your own.

Courses Complete, Practical—Endorsed by Auto Manufacturers

Our Courses thoroughly cover every branch of the Automobile Business. Students are given actual work on various kinds of machines. They are made thoroughly familiar with every part and its operation. Factory executives and service men assisted in arranging our courses. That's why they can't be beat.

Read WHAT the BIG Auto Manufacturers Say About the M. S. A. S. These letters from factory executives speak for themselves. They prove that M. S. A. S. Training is the recognized standard—the only FACTORY ENDORSED SCHOOL in the world!

PACKARD—"Do not believe you would make any mistake in attending this school if you wish to become thoroughly experienced in the Automobile business. Have no hesitation in recommending it in every particular."

Learn in The Heart of the

MAXWELL—"We heartily recommend the Michigan State Automobile School."



Detroit, the Auto Center, is the logical place to learn the Automobile Business. When anyone thinks of automobiles, they think of Detroit, and when you think of learning the Automobile Business, it is only natural to think of the M. S. A. S. located right here in the very Heart of the Auto Industry. 79% of the Automobiles are made in the Detroit district. This fact is a big advantage to M. S. A. S. students. They visit the big factories and get the benefit of close contact and co-operation of factory executives.

BUICK—"We believe the Michigan State Automobile School located at Detroit would best meet your requirements as its courses in technical training are most thorough and complete in every detail."

HUDSON—"The Michigan State Auto School is the finest institution of its kind in the country. In fact we endorse its method of instruction because it ranks highest in the standard of schools. Its equipment and personnel is second to none. This school is thought very highly of by the automobile men of Detroit. You will make no mistake by entering for a course."

STUDEBAKER—"The Michigan State Automobile School at Detroit conducts a very good school, in fact we do not know of a better automobile school than the Michigan State."

THE AUTOMOBILE JOURNAL—"The Michigan State Automobile School today is conceded by those who know, to be the greatest institution of its kind in America. It is endorsed by the leading men in the industry. A first-class automobile mechanic is in demand today and can always earn a salary consistent with his knowledge and ability. We do not hesitate to recommend the M. S. A. S."

**Be a WINNER! Get Started!
Fill out and mail the Coupon
NOW—TODAY!**

Michigan State

Dept. 305, 3729 Woodward Ave.,
Detroit, Mich.

Have a Business OF YOUR OWN

Hundreds of M. S. A. S. graduates are in business for themselves all over the world. You can have a shop of your own too. With 12 million cars to repair there are wonderful opportunities for garages, tire repair shops, battery repair shops, electrical service stations and welding shops. And it means success to train in Detroit the Automobile Center at the M. S. A. S. Read what our graduates say, below.

What Our Graduates Say

Our files are full of letters from men who have finished our Courses and who are now in the automobile business for themselves making big money. Read these—they are typical of the thousands of letters we get:

"I have been in business now for myself about three years; we sure have a good business. There are several garages here in a little city of about 2,500 and we get all we can do all the time. We also employ two men, besides overtime, so you see, we are getting our share."—W. F. Dehnert, Neillsville, Wisc.

"An very busy these days—lots of repair work. Have five men working for me. I am just past twenty-one and I was seventeen when I took the automobile course at your school."—J. H. Nelson, Worcester, N. Y.

"I am now foreman of the shop where I work, and am making good with a Capital G. I have doubled my salary and am also turning out far better work than I did before taking your course."—Mervin S. Gill, Kimberly, Idaho.

"Have been in the garage here for two years and my wages have increased three hundred per cent."—Robert L. Beck, Picture Rocks, Pa.

"Since going to your school, I am making three or four times the money I was before going there, and I feel greatly obligated to you and the faculty. I have a good job with the Tanswell Motor Co., Tanswell, Va., and am making good."—J. O. Orger.

"I have been running a garage since Feb. 1920, and am doing fine. We have the sub-agency for the Ford car and Ford's tractor and thodge. Exclusive agency for the Buffalo tractor and truck and have been doing fine with all."—H. J. Nachtrieb, Peabrocks, N. Y.

"I have in charge for the Government and State of N. C. 400 trucks and 200 tractors. I am making \$250 a month and all of my expenses."—W. L. Herrelson, Beardsville, N. C.



You Can Be As Successful As These Fellows

"Before taking your course was working in silk mills at \$18.00 per week. Am now making \$100.00 a week. Cleaned up \$2,500.00 in six months repairing cars, selling accessories, etc. Five had money spent at M. S. A. S. was best investment I ever made."—J. S. Stetzel, Pa.

"It is four years last month since I finished the two courses at your school. Have not had a single job I could not master. Have saved \$100 every month since I got home. I give M. S. A. S. credit for my success."—J. I. Mayas, Kansas.

"Have been rushed since leaving the M. S. A. S. last November. Can surely give the M. S. A. S. credit for raising my pay from a pencil pointer at \$12.50 a week to \$42.00 which I am now getting."—F. W. Johnson, Ohio.

"Since I left your school have found it takes M. S. A. S. training to get ahead in the world. Have worked with men who had fifteen years experience, but my M. S. A. S. training put me up with them, and sometimes ahead of them. If I had it to do over again would be to M. S. A. S. two years earlier."—J. B. Navarre, West Va.

"Before entering your school was earning \$12.00 per week. I knew absolutely nothing about automobiles—didn't know the difference between carburetor and wheel base. Since I left your school have worked up through several positions, in 1 year paying \$100 per month. Then decided to go into the business myself. Present earnings are \$100 per month."—H. S. Bradley, Ohio.

Our Money-Back Guarantee

We guarantee that a graduate of our Automobile and Tractor Course will be qualified to fill a position as assembler, demonstrator, tester, repair man, auto electrician, chauffeur, tractor operator or farm lighting expert, or we will refund his tuition fee.

Train for Success—Let Us Help You—Start Now!

The letters above prove all we have said about the opportunities in the Automobile Business. It's up to YOU! If you want to get ahead, all you need do is GET BUSY! Our training will positively help you. One of the great advantages in coming to the M. S. A. S. is that you get a long thorough course, learning everything in detail. Men are beginning to realize they cannot learn the Automobile Business in six or eight weeks while studying three or four other trades at the same time. Each one must be given enough time to learn it properly. That's why QUALITY TRAINING is the ideal at the M. S. A. S.

Show Your Grit—Grab This Opportunity

Don't say you never had a chance. A Big One faces you right now! Get Busy! Don't wait for some one to push you along. Send for our free illustrated catalog! You see what other fellows have done—then show the world what you can do.

Automobile School

The Only Factory Endorsed School

Courses Also in
Battery Repairing
Welding and Brazing
Tire Repairing—Machine Work

Send This Coupon Today!

Michigan State Automobile School
305 Auto Bldg., Detroit, Mich.

Gentlemen: Send me your FREE Catalog telling all about the opportunities in the Auto Business.
Write or Print Name Plainly

Name.....

Street or R. F. D.....

City.....State.....



An Easy Way to Learn PHARMACY AT HOME

Graduate pharmacists are always in demand. The work is interesting and pleasant and salaries are good. Many young men open drug stores of their own and become independent.

There's an easy way to learn pharmacy right in your own home in spare time, without losing a day or a dollar from your present work.

The International Correspondence Schools course in Pharmacy supplies the knowledge which it will be necessary for you to have in order that you may pass your State Board Examination.

Just mark and mail the coupon printed below to the International Correspondence Schools, Box 5519-D, Scranton, Pa., and full particulars about the Pharmacy Course or any other work of your choice will come speeding to you by return mail.

INTERNATIONAL CORRESPONDENCE SCHOOLS Box 5519-D, Scranton, Penna.

Without cost or obligation, please send me full information about the subject before which I have marked an X in the list below:

TECHNICAL AND INDUSTRIAL DEPARTMENT

- | | |
|--|---|
| <input type="checkbox"/> PHARMACY | <input type="checkbox"/> Civil Engineer |
| <input type="checkbox"/> Chemistry | <input type="checkbox"/> Surveying and Mapping |
| <input type="checkbox"/> Automobile Work | <input type="checkbox"/> Mine Foreman or Engineer |
| <input type="checkbox"/> Navigation | <input type="checkbox"/> Steam Engineer |
| <input type="checkbox"/> Agriculture and Poultry | <input type="checkbox"/> Gas Engine Operating |
| <input type="checkbox"/> Mathematics | <input type="checkbox"/> Wireless <input type="checkbox"/> Airplane Engines |
| <input type="checkbox"/> Electrical Engineering | <input type="checkbox"/> Architect |
| <input type="checkbox"/> Electrician | <input type="checkbox"/> Contractor and Builder |
| <input type="checkbox"/> Mechanical Engineer | <input type="checkbox"/> Architectural Draftsman |
| <input type="checkbox"/> Mechanical Draftsman | <input type="checkbox"/> Concrete Builder |
| <input type="checkbox"/> Machine Shop Practices | <input type="checkbox"/> Structural Engineer |
| <input type="checkbox"/> Railroad Positions | <input type="checkbox"/> Plumbing and Heating |

BUSINESS TRAINING DEPARTMENT

- | | |
|---|---|
| <input type="checkbox"/> Business Management | <input type="checkbox"/> Salesmanship |
| <input type="checkbox"/> Industrial Management | <input type="checkbox"/> Advertising |
| <input type="checkbox"/> Personnel Organization | <input type="checkbox"/> Better Letters |
| <input type="checkbox"/> Traffic Management | <input type="checkbox"/> Foreign Trade |
| <input type="checkbox"/> Business Law | <input type="checkbox"/> Stenography and Typing |
| <input type="checkbox"/> Banking and Banking Law | <input type="checkbox"/> Business English |
| <input type="checkbox"/> Accountancy (including C.P.A.) | <input type="checkbox"/> Civil Service |
| <input type="checkbox"/> Nicholson Cost Accounting | <input type="checkbox"/> Railway Mail Clerk |
| <input type="checkbox"/> Bookkeeping | <input type="checkbox"/> Common School Subjects |
| <input type="checkbox"/> Private Secretary | <input type="checkbox"/> High School Subjects |
| <input type="checkbox"/> Business Spanish <input type="checkbox"/> French | <input type="checkbox"/> Illustrating <input type="checkbox"/> Cartooning |

Name.....
Street.....
Address.....
City..... State.....

Occupation.....
Persons residing in Canada should send this coupon to the International Correspondence Schools Canadian, Limited, Montreal, Canada

Please Mention Popular Mechanics

Be A Practical Electrician

YOU can qualify in three months for a real job by the Sweeney System of Practical Experience. You don't need to be an engineer or scientist to install, operate and repair all kinds of electrical machinery. We teach with tools. You learn by actually working on our \$150,000 special equipment in this world famous Million Dollar Trade School where we have turned out 55,000 trained mechanics.



E. J. SWEENEY,
President

FREE Simply send name today. Get our Special Offer and interesting Electrical Catalog. Free radio course. Free Railway fare to Kansas City. Big opportunities in Electrical industry for young men. Colored students not accepted.

WRITE US AT ONCE

LEARN A TRADE—
Sweeney
AUTOMOTIVE & ELECTRICAL SCHOOL
3 SWEENEY BLDG. KANSAS CITY, MO.

STAMMER NO MORE
Kill the fear of stammering. Re-education the key. The widely famed Hatfield Method fully outlined in an accurate, dependable, worthwhile book—"HOW TO STOP STAMMERING." It has helped thousands. Free copy today.

THE HATFIELD INSTITUTE, 109 N. Dearborn, Chicago, Ill.

Cheapest Way to Go

to work or school and recreation is on a Ranger bicycle. You can have your choice of 44 Styles, colors and sizes. **30 DAYS' FREE TRIAL.** Express prepaid. **Factory-to-Rider Prices** save you \$10 to \$25.

12 Months to Pay if desired. Saved time and carfare easily meets the small payments. Parents often advance first payment.

Tires best quality, at factory prices, express prepaid. 12 Lamps, wheels and equipment, low prices. Send No Money, do business direct with us.

Mead Cycle Company

Dept 5108 Chicago

Write today for free Ranger Catalog, full cost prices and marvellous easy payment terms



Clear-Tone
FOR
PIMPLES
Your skin can be quickly cleared of Pimples, Blackheads, Acne Eruptions on the face or body, Enlarged Pores, Oily or Shiny Skin. **\$1,000.00 Cold Cash says I can clear your skin of the above blemishes.**

FREE WRITE TODAY for my FREE Booklet—"A Clear-Tone Skin"—telling how I cured myself after being afflicted for fifteen years.

E.S.GIVENS, 123 Chemical Bldg., Kansas City, Mo.

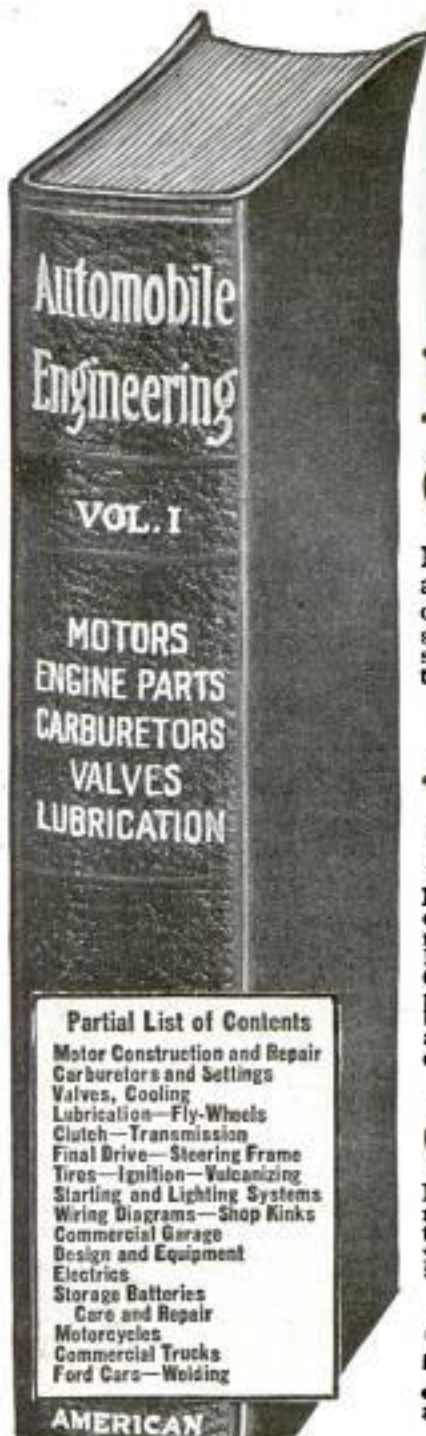

Partial List of Contents

Motor Construction and Repair
 Carburetors and Settings
 Valves, Cooling
 Lubrication—Fly-Wheels
 Clutch—Transmission
 Final Drive—Steering Frame
 Tires—Ignition—Vulcanizing
 Starting and Lighting Systems
 Wiring Diagrams—Shop Kinks
 Commercial Garage
 Design and Equipment
 Electric
 Storage Batteries
 Care and Repair
 Motorcycles
 Commercial Trucks
 Ford Cars—Welding

AMERICAN

NAME	POSITION	SALARY
John	AUTOMOBILE ENGINEER	\$125 A WEEK
	REPAIR MAN	\$50 A WEEK
	CHAUFFEUR	\$40 A WEEK

Put Your Name On this Pay-Roll

Men like you are wanted for big-pay positions in the fascinating field of automobile engineering. We have made it easy for you to fit yourself for one of these positions. You don't have to go to school. You don't have to serve an apprenticeship. Fifteen automobile engineers and specialists have compiled a spare time reading course that will equip you to be an automobile expert without taking any time from your present work.

AUTO BOOKS 6 Volumes Shipped FREE

Now ready for you—at a big reduction in price—an up-to-the-minute six-volume library on Automobile Engineering, covering construction, care and repair of pleasure cars, motor trucks, tractors and motorcycles. Brimming over with advanced information on Lighting Systems, Garage Design and Equipment, Welding and other repair methods. Contains everything that a mechanic or an engineer or a motorcyclist or the owner or prospective owner of a motor car ought to know. Written in simple language that anybody can understand. Tastefully bound in flexible covers and gold stamped. 2700 pages and 2400 illustrations, tables and wiring diagrams. A library that cost thousands of dollars to compile but that comes to you free for 7 days' examination.

Only 10 Cents a Day

Not a cent to pay in advance. First you see the books in your own home or shop. Just mail coupon and pay express charges when books arrive. You can read them and study them for seven whole days before you decide whether you want to keep them or not. If you like the books send \$2.80 in seven days and \$3.00 a month until the special price of \$21.80 has been paid. (Regular price \$45.00.)

Send No Money Now

Don't take our word for it. See the books without cost. There is so much profit in this offer for you, that we urge you not to waste a moment in sending for the books. Put the coupon in the mails today. SEND NO MONEY—only the coupon.

American Technical Society

Dept. A-195

Chicago, Illinois

American Technical Society, Dept. A-195, Chicago

Please send me a set of Automobile Engineering books in 6 volumes by express collect, for a week's free use. At the end of a week I will either send the books back at your expense or send you \$2.80 as first payment and \$3.00 each month thereafter until a total of \$21.80 is paid.

To insure prompt delivery, fill out all lines.

Name

Address

City

State

Reference

Mail The
Coupon For
These Books

Your Success Is Certain In the Big-Pay Field of Today—ELECTRICITY

So rapid and tremendous has been the growth of the Electrical Industry that today this great field is badly in need of men—even the so-called Electricians, the "screw-driver" kind, are making big money, and are never out of work. But it's the trained man—"Electrical Expert"—who is cashing the big-pay check and bossing the big jobs. There's a place waiting for you in this big-pay field. You too can qualify in a few months as an "Electrical Expert."

"Electrical Experts" Earn \$12 to \$30 a Day

Be a Big-Pay Man

The "short-cut" to "Big-Pay" is training. The big field of today for the trained man is Electricity. Trained "Electrical Experts" can earn \$12.00 to \$30.00 a day.

Why Work for Less?

Why work for \$25.00 or \$30.00 or \$40 a week? With a few months training under me, through my easily-learned, quickly-grasped, right-up-to-the-minute, spare-time, Home-Study Course in Practical Electricity you can fit yourself for one of these bigger jobs—one of these jobs that pay \$12.00 to \$30.00 a day.



I Train You at Home

As Chief Engineer of the Chicago Engineering Works, I know just the kind of training you need to succeed as an "Electrical Expert." My course in Electricity is so simple, thorough and up-to-date that you can easily understand and apply every line of it—no big words, no useless theory, no higher mathematics—just plain, every-day, straight-from-the-shoulder, man-to-man English—the kind you and I use every day.

Satisfaction Guaranteed

My course is backed by an iron-clad guarantee that insures your success and satisfaction. I positively will refund every cent paid me in tuition if you are not fully satisfied. No other school will do this for you. Back of me in my guarantee stands the Chicago Engineering Works, a Million Dollar Institution.

Ten Things I Guarantee to Do for You



Positive Money Back Guarantee Bond



Personal Attention and Instruction



Handsome Diploma Upon Graduation



Thorough and Complete Course of Training



Early Special Instruction in Practical Money-Making Work



This is part of the FREE Complete Electrical Working Outfit

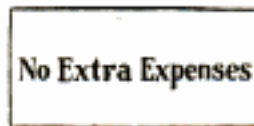

No Extra Expenses

Enrollment Fee Covers All Charges—No "Extras"



Free and Unlimited Expert Employment Service



Unlimited Consultation Service With Our Experts—FREE



FREE Subscription to Monthly Engineering Magazine

Get In Line for a Big-Pay Job — START NOW!

Mail This Coupon Today

L. L. COOKE, Chief Engineer,
Chicago Engineering Works, Dept. 15
2154 Lawrence Ave., Chicago, Ill.

Dear Sir:—Send at once Sample Lessons, your Big Book and full particulars of your Free Outfit and Home Study Course—all fully prepaid, without obligation on my part.

Name.....

Address.....

(122)

Now is the time to start. By enrolling now, you can save \$45.50 on the already low price of my course in Electricity. But you must act at once. Write immediately for my Big FREE Book, "How to Become an Electrical Expert." Write today—it's the first step towards bigger pay. Yours for success.

L. L. COOKE, CHIEF ENGINEER
CHICAGO ENGINEERING WORKS

Dept. 15 2154 Lawrence Ave. Chicago, Ill.

THE "COOKE" TRAINED MAN IS THE "BIG-PAY MAN"

CLASSIFIED ADVERTISEMENTS

WORLD'S BEST WANT AD MEDIUM

Advertisements in this section, 25 cents per word, each insertion, minimum 10 words, payable in advance. To be inserted under proper classification in June issue, copy should be in our office April 25th.

AUTOMOBILE SUPPLIES

AUTOMOBILE parts for all makes and models of cars. We save you 10 to 90% and ship same day your order is received. We have gears, shafts, springs, pistons, pins and rings, cylinder head gaskets, bushings, clutch leathers, radiators, coils, magnets, Timken, Hyatt, New Departure and connecting rod bearings, crank cases, crank shafts, connecting rods, Atwater Kent, Connecticut, DeLoe and Remy ignition systems and parts. When you want auto parts, write us, giving make, model and year of car and what parts are wanted. We will quote prices before making shipment, if you desire. We guarantee to please you or money refunded. Auto Tire & Parts Co., 501 Broadway, Cape Girardeau, Mo.

AUTO Parts at cut prices! All kinds, new and used, for all cars. Engines, Clutches, Transmissions, Axles, Radiators, Magnets, Generators, Batteries, Shafts, Gears, Bearings, Springs, etc., etc. Send for our booklet, "A Peep Into the House of a Million Parts." Mention parts wanted and Make, Year and Model of Car. Warsawsky & Co., World's Largest Car Wrecker and Replacement Parts House, 1917-33 So. State St., Chicago.

AUTOMOBILE Parts. All cars and trucks, motor parts, clutch parts, universal joints, axle shafts, gears, ball, roller, and thrust bearings, timing chains and gears. State make, model and parts wanted. Special prices. All new parts. In stock. Merrin Motor Parts Co., 1728 Michigan Ave., Chicago, Ill.

PACKARD Single Six Owners. Save \$5 to \$15. Watco Spring Covers, the perfect Lubricators, direct from the makers. Especially fitted to Single Six Springs. Alentite filler. Guaranteed to fit, wear and satisfy, or money refunded. Price \$10, postpaid. Why pay more? Waverley Cover Co., 60 Crosby Rd., Waverley (79), Mass.

PISTON Ring Tool Removes and replaces set of rings on piston, entering same in cylinder in one minute. Sample, three dollars. Money refunded if dissatisfied. Particulars free. Canadian Sales Co., 286 Edinburgh St., Petersburg, Ont., Canada.

AUTOMOBILE Parts—Used parts for most any car at half factory list prices. Allen, Briggs, Buick, Cadillac, Chalmers, Chevrolet, Dodge, Deet, Grand, Hudson, Hummel, Oakland, Overland, Oldsmobile, Reo, Studebaker and many others. Send list of parts wanted. Maxwell Bros., 4106 Olive St., St. Louis, Mo.

AUTOMOBILE parts, guaranteed new for all cars. Save money; get our wholesale prices on gears, shafts and bearings. State make of car, model and parts wanted. Parts shipped immediately from stock. We refund your money, including transportation charges, if not satisfied. Mechanics Gear Co., 3765 No. Halsted St., Chicago.

LIBERTY Air Compressors, for garages, tire-shops, filling stations, also paint spraying equipment. Air Compressor & Equipment Co., 1137 Carroll Avenue, Chicago, Ill. Distributors wanted.

25c IN coin brings you latest spark plug cleaner on the market. Cleaner, gauge and file, all in one. 1/2 and 3/4 A. C., Champion and others of like type. Dealers wanted. Frederick Wambach, Greenwich, Conn.

AUTO parts—Save 25-90%. New gears, axles, bearings, springs, radiators, magnets—4,000 models. Bankrupt supplies, retooling outfits. Brightman Auto Exchange, 321 Windsor Ave., Hartford, Conn. Largest in the East.

AUTOMOBILE owners, garagemen, mechanics, send today for free copy America's most popular motor magazine. Contains helpful articles on overhauling, repairing, ignition, carburetors, batteries, etc. Automobile Digest, 505 Butler Bldg., Cincinnati.

COMPRESSORS, twin cylinder automatic air electric driven. \$28 cash, balance easy terms. Buffers, battery chargers, same easy payments. Send postal to Hobbs'rs, Troy, Ohio.

STATE Distributors Wanted. Magneto Recharger, Alternating, Reliable, Utica, New York.

CRACKED auto curtain's light mended without removal; dry in ten minutes. Sample 25c. Satisfaction guaranteed. D. L. Lawson, Orby, Calif.

BARGAINS—Radiators—Sport bodies. All makes and models; ask for price of your requirements. Chevrolet 400, \$17.95. Dodge and Maxwell Radiators, \$19.95. Ford, \$10.90. Wabash Radiator Co., 1117 Wabash Ave., A, Chicago.

MANUFACTURE Auto Polish. Gives wonderful results. Costs 40 cents make, sells \$1 gal. Formula prepaid \$1. Waide, 657 Pennsylvania, Washington, D. C.

TIRE Dealers! Goods bought right are half sold. Buy guaranteed tires from factory. All perfect firsts. Prices sell them. Quality holds customers. Your profit is there. Write on letterhead, A. H. Culberley, Pres., 612-614 Washington Ave., Belleville, N. J.

WRECKING and Towing jobs pays big profits when equipped with Syracuse Wrecking Cranes, sold on easy monthly payments. Syracuse Mfg. Co., 100 S. State, Syracuse, N. Y.

LET us show you how to save thirty percent of your Gasoline. Send your name and address, we'll do the rest. Southwest Research Laboratories, Oklahoma City, U. S. A.

CONSTANT potential 8-hour battery charging pays big profits. Eliminates competition. Comes on easy monthly payments, paid by profits. Send postal to Hobbs'rs, Troy, Ohio.

PROTECT your rights—Write for "Record of Invention" and booklet about Patents. Prompt personal service. Advice without charge. J. Reaney Kelly, 612-G Columbia Building, Washington, D. C.

FRONTO Series Gap Mica Spark Plugs. Guaranteed-life of motor. Positively sheds through oil. 100% Government Air Mail Service test. Real dealers and distributors write. Fronto Mfg. Co., Omaha, Neb.

WINDSHIELD Cleaner, one rub keeps glass clear 24 hours from rain, snow, sleet, fog. Agents wanted. Auto Owners Supply Company, Davenport, Iowa.

USED parts for Dodge Brothers Cars. 50% from list. Satisfaction Guaranteed. Harris Motor Car Company, Cape Girardeau, Mo.

AUTOMOBILES

PATENTS—Write for our free Illustrated Guide Book and Evidence of Conception Blank. Send model or sketch and description of your invention and we will give our opinion of its patentable nature. Highest references. Prompt service. Reasonable terms. Victor J. Evans & Co., 185 Ninth, Washington, D. C.

AUTOMOBILE owners, garagemen, mechanics, send today for free copy America's most popular motor magazine. Contains helpful articles on overhauling, repairing, ignition, carburetors, batteries, etc. Automobile Digest, 505 Butler Bldg., Cincinnati.

AUTO Mechanics, Garagemen and Re-pairmen: Do you know that perfect Main and Connecting-Rod Bearings are easily and quickly obtained by using Mechanics-Friend? Old-timers have used it successfully on close work for the past forty years. It saves you time and money on every job. Price \$1.50, three for \$3.50. Colwell Machine Works, Norfolk, Neb.

BEST Seller Auto Accessory. Exclusive. Patented. Necessary. Emmons Mfg. Company, Alliance, Ohio.

MOTORISTS, build your own Garage; easy building plans 35c. W. Olsen, 6731 Dorchester Ave., Chicago, Ill.

PATENTS procured. Send sketch or model today for examination, prompt report and advice. No charge for preliminary advice. Write for free Booklet and blank form on which to disclose your idea. Highest references. Promptness assured. Clarence A. O'Brien, Registered Patent Lawyer, 502 Southern Building, Washington, D. C.

DYKE'S Automobile Encyclopedia, 13th edition, new, greater than ever, entirely re-written and rearranged. Contains greatest array of auto facts ever published in one vol. Separate books containing same information cost \$21. Over 1200 pages and 4100 illus. Cloth \$6. Flex. Amer. Morocco \$7.50 postpaid. Popular Mechanics Book Dept., 200 E. Ontario St., Chicago.

REPAIRING Ford Cars, Trucks and Tractors in the most proper and efficient way is explained in a new 229-page book by the former director of the Ford Motor Co. Service School. This information is otherwise unavailable outside of the Ford plant. Written more especially for the mechanic and repairman. Price \$2 postpaid. Popular Mechanics Book Dept., 200 E. Ontario St., Chicago.

FOR FORD OWNERS

FORD Owners: Install a Pike's Peak Carburetor Control on your Ford in five minutes. Makes starting easier and going cheaper. Price 25c, stamps or coin. Guaranteed for the life of your car. If not entirely satisfied after 30 days' trial, your money will be cheerfully refunded. A. C. Dean (Distributor), 321 Klittridge Bldg., Denver, Colo.

FORD Car Repair Book Sent Free. This complete and well illustrated valuable book explains in a simple way how to overcome Ford car troubles; Repairing, Economical Winter Driving, Cold Weather Car Startling, Equipment for Fall and Winter, Curbs, Piston Ring Troubles, Carburetor Adjustments and Repairs, Connecting Rods, Timers, Transmission Troubles, and practically every phase of Ford car driving, repairing and equipment. Send 25c coin for three months' trial subscription and get the valuable repair book free. Ford Owner and Dealer Magazine, 529 Montgomery Bldg., Milwaukee, Wis.

FORD magnets recharged in five minutes without removing any parts from car. Secret exposed. Any one can do it with materials that you already have. Nothing extra to buy. Uses either storage battery or city lighting current. It will do all that an expensive recharger does and then some—burns out grounds and finds shorts in the field coil. Complete simple instructions and wiring diagram \$1 prepaid. The Auto Electrician, Box 261, Middletown, N. Y.

FARM with your Ford. The Adapto Tractor makes your Ford a powerful tractor that will plow and do any three horses' work. Includes Belt Power Attachment that buzzes wood, fills silo, etc. Guaranteed not to injure your Ford or money back. Dealers wanted. Tractor Co., Geneva, Ohio.

FORDS run 31 miles on gallon gasoline. Other cars show proportionate saving. Wonderful new carburetor. Starts easy in coldest weather. Fits any car. Attach yourself. Money back guaranteed. Sent on 30 days' trial. Agents wanted. Air Friction Carburetor Co., Dept. 3221, Dayton, Ohio.

SIMPLEX (Ford) Starter \$28. Guaranteed. American-Simplex Co., Anderson, Indiana.

SPEEDSTER Parts. Don't fail to see "Red-I-Kut" ad, Page 120.

EQUIP your Ford with the **Krafve Mixer Manifold**. Greatest improvement ever produced. Increases speed, power, pep and flexibility. Saves up to 40% on gas and oil. Buy now. Price \$5.00. Agents wanted. Krafve Automotive Corp., Oakham, Mass.

FORD Owners save money—time—trouble. Read about **Sum Automatic Timer** on page 140.

ALL About Ford Wiring. A book, 42 diagrams, layouts, sketches, page size 6x9. Part list, lengths, voltages, troubles, cautions. All models. Wire all accessories yourself. 25¢ a copy. "All About" Pub. Co., Franklin, N. H.

FORD used parts 50 to 70% off list. Guaranteed good condition. Economy Car Parts Co., Bowling Green, Ky.

FORD water circulator prevents freezing and overheating. Easily attached. Satisfaction guaranteed. Pay postman only three seventy. Tractor Co., Geneva, Ohio.

MOTORCYCLES, BICYCLES AND SUPPLIES

WONDERFUL bargains in reconditioned motorcycles. Priced as low as \$35. Sidecars from \$25 up. Everyone expertly rebuilt and guaranteed in absolutely first-class condition. Don't delay. Send 2¢ for new big catalog showing 1923 bargains. Western Supplies Co., 539 Hayutin Bldg., Denver, Colo.

SAVE money—Order parts for all motorcycles from us. Largest stock new or used parts in America. Send 10¢ today for big **Cycle** or **Henderson** parts catalogue. Nebraska Motorcycle and Bicycle Co., 1512 Howard, Omaha, Nebr.

GOOD used motorcycles. Prices lowest. Free lists. Seiber & Hofheins, Buffalo, N. Y.

MOTORCYCLE Prices Slashed—Forced to sacrifice big stock used motorcycles, all makes, all models. \$35.00 up. Guaranteed. Shipped on approval. New easy payment plan. Send stamp for big free list. **Floyd Clymer**, Denver, Colo.

SEND for free list of second hand Motorcycles and salvage parts at 75% off catalog list. **Tulsa Motor & Cycle Co.**, 262 So. Lansing, Tulsa, Okla.

LARGEST stock of new and used motorcycle parts and accessories in the world at your disposal via **Uncle Sam's** mail. Write for quotations. **Motorcycle Parts Mfg. Co.**, 2036-38 Wabash Ave., Chicago, Ill.

SEND for our **Bargain Bulletin** and **Money-Saving Message**. It will save you money on Motorcycles, Side Cars, Motor Wheels, Repair Parts and Accessories. Some used parts at less than half. **O'Connell and Henderson Motorcycles** our specialty. See our ad on page 143. **American Motor Cycle Co.**, 2013-5-7 W. Chicago Ave., Chicago.

1921 **HARLEY-DAVIDSONS**, \$135; 1920, \$115; 1919, \$100. Indian Scouts, \$125. Guaranteed. Money refunded if not satisfied. Circular free. **Wisconsin Cycle Sales Co.**, 726 National Ave., Milwaukee, Wis.

USED parts for all motorcycles, cheap. State wants. **Schuck Cycle Co.**, 1922 Westlake, Seattle, Wash.

'19 **INDIAN 3 Speed** \$75.00. '20 Indian 3 Speed \$95.00. '21 Indian 3 Speed \$125.00. **Howard A. French Company**, Baltimore, Md., Washington, D. C.

SEND for big list of slightly used motorcycles on the easy payment plan. **Howard Cycle Co.**, Trenton, N. J.

DON'T buy a Bicycle Motor Attachment until you get our new catalogue and prices. Also runs washers, pumps and shop machinery. **Shaw Mfg. Co.**, Dept. 27, Galveston, Kans.

MOTORCYCLE cylinders reground, fitted with new pistons and rings, \$6.00. Guaranteed. **Muncie Piston Co.**, Muncie, Ind.

AVIATION

"FLYING Instructions." Six hours for \$164. Students soloed and given certificate. Curtiss planes. Army pilot instructors. Course takes one to four weeks. Motors and rigging included. Several students trained this Spring, and ready for more. Come and join us. **Aviation Engineering Co.**, Lawrence, Kansas.

MOTORCYCLE motors, propellers and equipment for Aerosols, snow and ice, low prices. **Shaw Mfg. Co.**, Galveston, Kans.

THE American School of Aviation announces a new correspondence course in **Mechanics of Aviation**. A thorough training in Practical Aeronautics. **American School of Aviation**, Dept. 1863, 3601 Michigan Ave., Chicago, Ill.

A **REAL** proposition for real ambitious young men who want to learn to fly. Work with pay, while you are learning. One extra hour flying, a bonus for all enrollments prior to May 1st, on our six hour flying course, at \$100.00. **Heath Airplane Co.**, Chicago, Ill.

AVIATORS, 90 horse new Curtiss propellers, \$2.00. Everything for building gliders aeroplanes, motor. **Air Transport Co.**, Long Island City, N. Y.

PROPELLERS, 5 ft. diameters, \$12, 4 ft. for Potts, sleds or road speedsters, \$15; others in proportion. Pictures free. Address **Crawford Motor Aeroplane**, Long Beach, California.

AVIATORS' leather coats, used, \$10 to \$15; OX5 toothpick propellers, new, copper tipped, \$10; others \$0.50. Airplanes \$200 up. Motors, 25 to 200 h. p., \$75 to \$200, some new. **Smith Machinery Company**, 403 Gorman Bldg., Houston, Texas.

INVENTORS desiring patents should write for our Free Illustrated Guide Book and Evidence of Conception Blank. Send model or sketch for our opinion of its patentable nature. Highest references. Prompt service. Reasonable terms. **Victor J. Evans & Co.**, 187 Ninth, Washington, D. C.

RESISTAL grades, \$2.98. Send for Sale Sheet listing airplane material at reduced prices. Glider circular, also literature on our latest Ford or Motorcycle Motored Airplane, 4¢ each. **Heath Airplane Co.**, Chicago, Ill.

LARGEST, best catalogue Model Aeroplanes, Parts and Supplies; 5¢ Postpaid. **Ideal Aeroplane Co.**, 72½ Green St., New York.

LEARN Aviation: Complete course \$200; position for competent graduates; ships \$750 up. Excellent opportunity. **Ardie Miller**, Benton, Ill.

WELDING

WELDING Encyclopedia—A complete instruction book on all welding processes: oxy-acetylene, electric arc, electric resistance and thermit. Welding of all weldable metals fully discussed. 326 pp. 375 Ills. The accumulated experience of the welding brains of America is yours for \$5. Money back if not satisfied. **Popular Mechanics Book Dept.**, 209 E. Ontario St., Chicago.

BOOKS AND PERIODICALS

"**ELECTRICAL** Kinks." Most complete book on everything electrical in the home. See advertisement on page 12.

NEW Astronomy proves our Earth a concave hollow globe and stationary. Sun and Moon inside of our Earth and moving as described in **Bible Astronomy—God's Divine Word**. Scientifically demonstrated with modern telescopes, and absolutely proven with mechanical equipment. Astronomers having ridiculed **Bible Astronomy** with contemptuous derision, are now helpless, and must accept a proven fact. **Viz. —We live inside the Earth, —not outside on the Earth.** Scientific illustrated work. Price only \$7.00. Sold on a money-back basis guaranteed by the **American Scientific Sales Co.** You must be convinced or money refunded. Order today—pay when postman delivers greatest scientific book. Your money returned if not convinced. **American Scientific Sales Co.**, 2220-A Park Ave., W. H., Cincinnati, Ohio.

FREE Spanish Lessons; news of Latin America, \$1.00 year, 10¢ copy. **Sister Republics Magazine**, Clayton Block, Denver, Colo.

1,600,000 INDUSTRIAL Facts. Calculations, Receipts, Processes, and Trade Secrets for every business are contained in the 1016 page Book "Moore's Universal Assistant and Complete Mechanic." 500 Engravings. Cloth. Price \$2 postpaid. **Popular Mechanics Book Dept.**, 209 E. Ontario St., Chicago.

YOU should have our New Illustrated List of Practical Books, Free, Spon & Chamberlain, 129 P. M. Liberty Street, New York, N. Y.

ADVANCED Machine Work, Seventh Edition, by **Robert H. Smith**, Massachusetts Institute of Technology; 707 pages, 880 engravings, postpaid \$3.25. A practical book for apprentices, machinists, tool-makers, auto and farm mechanics, students, teachers and engineers. Instruction is given in measuring with light waves to the millionth of an inch. Address, **Industrial Education Book Co.**, Box 153, Back Bay, Boston.

INDUSTRIAL Alcohol, **Wright's** book everybody wants. Full directions for making with drawings of necessary apparatus. \$2.50 postpaid. **Spon & Chamberlain**, 129 P. M. Liberty Street, New York, N. Y.

LIGHTS, Colors, Tones and Nature's Finer Forces—**Marsvelous**. Scientific Measurements, 250 Pages, Just Out. Includes—Vibrations; Odors; Cold-lights; Radioactivity. Illustrated. \$2.00. Satisfaction Guaranteed. Department—**Mechanics**—**Stevens Publishers**, 212 Powell, San Francisco, California.

BOOKS, All Kinds. Lists. **Higson's**, 2311 Post Street, San Francisco, Calif.

PLANS for Poultry Houses. All styles. 150 Illustrations; secret of getting winter eggs, and copy of "The Full Egg Basket." Send 25 cents. **Inland Poultry Journal**, Dept. 74, Indianapolis, Ind.

LEFAX—"Facts on Leaves." You make your own handbook, loose-leaf. From our complete list of Lefax data sheets you select only those you actually need, then fill in your own notes or diagrams on extra blank sheets which come in 100 different styles. These in loose leaf binder make up book covering your individual needs. Send for complete information and price list to **Popular Mechanics Book Dept.**, 209 E. Ontario St., Chicago.

BOYS' toy-maker book, 64 pages, illustrated, 10¢. **Amateur Electrician**, 61 pages, illustrated, 10¢. **Radio Sets**, how to build, illustrated, 25¢. **Western Puzzle Works**, St. Paul, Minn.

BIG money in writing photoplays, stories, poems, songs. Send today for free copy America's leading writer's magazine, full of helpful advice on writing and selling. **Writer's Digest**, 708 Butler Building, Cincinnati.

HYPNOTISM (Autosuggestion) **Astonish**, Controls. Wants gratified. Twelve easy methods, \$1.10. "Mindreading" (any distance), ten wonderful lessons, \$1.10. **Popular Institute**, M-1014 Belmont, Chicago.

ELECTRICIANS' Examination books of questions and answers with diagrams, symbols, tables, notes, and formulas, for preparation for license, \$1.25. **Aaron Shapiro**, 296 Broadway, New York.

EXTRAORDINARY Bargain!! Copies of 25 different mail order publications, only 5¢! Address **Hansen Company**, Brookings, S. Dak.

VALUABLE mail order instruction book, 25¢. **Clifton K. Mathews**, Hempstead, N. Y.

HOW to Write Picture Plays, and five profitable books for writers of stories, news, plays or poems, \$1 the six, postpaid. Moneyback guarantee. **P. McQueen Co.**, Box 723, Cincinnati, Ohio.

CHAS. K. HARRIS, author of "After the Ball," tells you how to write and sell words and music in his book "How to Write a Popular Song." Send \$1 and receive this money-making book by return mail, postpaid. **Chas. K. Harris**, Broadway and 47th St., New York, N. Y.

NEW Book—**Where To Buy Ten Thousand Things** At Wholesale. Worth \$10 per copy to anyone, says Professor **Abbitt**. Price 60¢, prepaid. **G. O. Shaver**, Publisher, Pa. 29, Oil City, Louisiana.

"**THE** Master Key." Wonderful for Success. 410 pages, \$2.50. **Phiggo**, 1614 Belmont, Chicago.

LOOK! Artistic name cards, samples free. **Prince**, 130 W. 104th, New York.

PICTURES AND POSTCARDS

GENUINE post card photographs of American Indians, Dozen, \$1. Hand painted 16"x20" enlargement, in colors, Indians in war paint and costumes, \$10. 24"x36" oil, \$100. Dozen 3½"x5" copies your favorite portrait in large folders, \$3.50 (guaranteed). **Pettit Brothers**, Fairview, Oklahoma.

JOIN Live Postcard Club: Membership Lists, including Catalog, 10c. Harvey Torspe, Decatur, Ind.

CARD Buyers—12 unusual cards, 25 cents; 30, 50 cents. No duplications. Scenic, Move and Educational. Real quality goods. Money back. H. Mease, 1017 West 13th St., Des Moines, Ia.

EXCHANGE Postcard, letters, curls with foreigners. Membership \$1 (bill). Delacoefer, 282-M d'Entragues, Tours, France.

GAMES AND ENTERTAINMENTS

VENTRILQUIISM taught almost anyone at home. Small cost. Send 2c stamp to-day for particulars and proof. George W. Smith, Room M-733, 125 N. Jefferson Ave., Peoria, Illinois.

FOR indoor carnivals, bazaars, etc., we supply you with all necessary paraphernalia and merchandise—dolls, candy, aluminumware, silverware, blankets, lamps, bead and mesh bags, Wheels to loan. Premium Supply Co., 171-77 N. Wells, Chicago.

NEW Plays For Children—The greatest plays being written for children to-day are those coming from the pen of T. C. O'Donnell. By special arrangement with the publisher we are able to make the first announcement of The "Just Imagine" Plays, the newest series of O'Donnell plays. The first two are "The Samlman's Brother" and "Ann's Half Birthday." Everyone interested in clean, wholesome, easily produced plays for little folks from five to twelve years of age will find these ideal. Artistically printed and bound, 50c each postpaid. Send \$1 to-day for the two. Popular Mechanics Book Dept., 200 E. Ontario St., Chicago.

200 KINDS Iron, wood and wire puzzles. Leader and Illustrated list 10c. Western Puzzle Works, St. Paul, Minn.

PLAYS, musical comedies and revues, minstrel music, blackface skits, vaudeville acts, monologs, dialogues, recitations, entertainments, musical readings, stage hand-looks, make-up goods. Big catalog free. T. S. Denison & Co., 623 So. Wabash, Dept. 11, Chicago.

MASTER Mind Calendar Fant. Wonderful. With 100 tricks 25c. Murphy, Box 1321-P, Asheville, N. C.

SMALLEST Deck of Cards on Earth, 52 cards in deck. Over million decks sold. Sample deck, 15c. Ten for dollar. Specialty catalogue free. P. & F. Sales Co., Madison, Wis.

MAGIC TRICKS, BOOKS AND JOKERS' NOVELTIES

PAPER Magic—A new book by Houdini in which are described not only a large number of tricks with paper but also the amusing and puzzling articles which may be made of folded paper and tearing of paper. Paper puzzles are also included. 206 pages, illus. Price \$2.50 postpaid. Popular Mechanics Co., 200 E. Ontario St., Chicago.

47 TRICKS, 250 jokes, riddles, 73 toasts, 8 Fortune Telling secrets, 52 money-making secrets, 22 funny readings and big catalog, 10c. "Andeo," 4447-TE North Wabash, Chicago.

FREE—Our puzzle, trick, game, joke, Novelty Catalog. Wright & Son, 601-G Ind. Ave., Peoria, Ill.

MAGIC, Ventriloquial, Punch Figures, Pocket Tricks, Books, Magazines, Escapes, Secrets, Illusions, Flowers, Roll Paper. Catalogs 10c. Address, Gilmaglio, Mezan Park, Ill.

TRICKS, Puzzles, jokes, magical apparatus, plays, stage supplies, mind-reading, sensational escapes, 160-page illustrated professional catalog, 10c. Oaks Magical Co., Dept. 548, Oshkosh, Wis.

"IMPROMPTU" Magic, With Patter"—New book teaches how to mystify with cards, coins, etc., and what to say. No skill required. Postpaid, 75c. T. S. Denison & Company, Dept. 123, 623 So. Wabash, Chicago.

FUN! Jokers' Pocket Novelties, Small Bombs, Sneeze Powder, Puzzles, Trick Matches, Shooting Novelties, Living Photos. Send 2c for Illustrated Catalogue. Grandfeld, 1288 Theriot Ave., Bronx, New York.

SNEEZE powder. Itch powder. Smell bombs. Greatest fun-makers on earth. Each, per box, 10c. C. Fenner, 2401 Jefferson, Louisville, Ky.

AMAZE and Mystify your friends! New 48-page Magic Book tells how—explains 23 Mystifying Effects. Sent with Catalogue of 20 Tricks and Novelties, only 6c. Write today. Lyle Douglas, Station A, Dallas, Texas.

MAGIC Disappearing Writing Pad. You simply write anything at all on the top sheet of the pad; then lift; Presto! the writing vanishes. Mystify your friends. Great fun. Price 25 cents, postpaid. Popular Mechanics Book Dept., 200 E. Ontario St., Chicago.

250 MAGIC Tricks Dime. Actor Joke Book Dime. Large Magical Catalog Dime. Union Co., Barnes City, Iowa.

STAMP COLLECTING

SNAPS—200 different stamps, 10c; 60 different United States Stamps, 15c. With each order we give free our price list of sets, packets, albums, etc., and our pamphlet which tells "how to make a collection properly." Queen City Stamp Company, Room 38, 604 Race, Cincinnati, Ohio.

LIKE Triangular Stamps? To introduce our Sudden Service Approvals we'll send triangular Flange, set China ships, large \$1.00 United States revenue, also packet 50 foreign, millimetre scale, perforation gauge, ruler and bargain lists for only 9c! Fenell Stamp Company, Dept. P, Fullerton Bldg., St. Louis, Mo.

"WORTH-WHILE" Stamps on approval. Special sheets and books at 50% discount. Net Books, priced according to rarity and condition. First-class references absolutely necessary. C. Osborn, 486 Park Ave., Weehawken, N. J.

FREE—1,600 varieties, mounted—particulars 2c. W. M. Hudgens, Norman, Okla.

158 GENUINE Foreign Stamps Mexico War Issues, Venezuela, Salvador and India Service, Guatemala, China, etc., only 10c. Finest approval sheets 50 to 60%. Agents Wanted. Big 72-pg. Lists Free. We Buy Stamps. Estab. 29 yrs. Hussman Stamp Co., Dept. 51, St. Louis, Mo.

100 DIFF. Europe, 10c; 50 Diff. French colonies, 25c; 1,000 hinges, 10c. Price List Free, 50% Approvals with each order. We Buy Stamps. Byner Stamp Co., Dept. P, St. Louis, Mo.

STAMPS: 50 Diff. World, 7c; 100 Diff., 10c; 50 Diff. Portuguese Col., 25c; 1,000 Peelable Hinges, 10c. List Free. 50% Approvals with every order. I Buy Stamps, L. B. Doran, Dept. P, St. Louis, Mo.

OLD Coins. Large Spring selling catalogue of coins for sale, free. Catalogue quoting prices paid for coins, 10c. William Hessler, 101 A Tremont St., Boston, Mass.

BEST one-cent approvals in America, P. Hand, 1117 So. 60th St., Philadelphia, Pa.

100 FOREIGN Stamps 10c. Five stamps set on approval, J. A. Flaton, Fertile, Minnesota.

24 YARKEYIES Cuban stamps, 10 cents. List of 6,000 low-priced stamps free. Address Chambers Stamp Co., 111P, Nassau St., New York City, N. Y.

UNIVERSAL Packet, 100 varieties, all over the world, 10 cents. Covert Stamp, 29 State, Rochester, N. Y.

FREE! Sectional Loose Leaf Postage Stamp Album at the rate of 8 pages each month given with subscription to our monthly Journal. Send two-cent stamp for prospectus. United Stamp Co., 140 S. Dearborn St., Chicago, Ill.

LET me show you how you can increase your collection to at least 10,000 at a cost of only a few cents per stamp. Address Tubbs, 4021 First, San Diego, Calif.

STAMPS, 50 Varieties, Africa, Brazil, Peru, Cuba, Mexico, etc., 10c. 50 different U. S., 25c; 1,000 mixed, 40c; 1,000 hinges, 10c. List free, C. Stegman, 5948 Coto Brilliante, St. Louis, Mo.

200 DIFFERENT Stamps 10c; 500, 40c; 1,000, \$1.40; to approval applicants only. W. Standler, 437 Beach Ave., Bronx, N. Y.

\$3.28 CATALOGUE for 10c to introduce our new Better Service Approvals at 50% discount and bargain price list—etc honest for honest customers. Address, Dept. 102, Pioneer Stamp Co., 734 Prospect, Kansas City, Mo.

STAMPS, 20 unused, all different, free. Postage 2c. Mention paper. Quaker Stamp Co., Toledo, O.

FREE—New Europe, 20 diff. to applicants for my 1c, 2c and 3c approvals. Send reference and get extra premiums. Chas. Schmidt, 3257 Benner St., Wissaminburg, Philadelphia, Pa.

PACKET of 21 stamps, no two countries alike. Packet hinges. Set of \$1 and \$2 U. S. Rev., all for 5c. Mention paper. Miami Stamp Co., Toledo, Ohio.

FIRST class stamps on approval, 60% off. Norman Skultz, Colorado Springs, Colo.

20 UNUSED stamps free. All different. Postage, 2c. Fisk Stamps, Toledo, Ohio.

105 CHINA, etc., stamp dictionary, list. 2c. Album (500 illustrations), 3c. Bullard, Sta. A, Boston.

FRENCH Colonies Free—Beautiful Picture set, including Native Clubs, Towers, Victorials, 2c Postage. Empire Stamp Company, Toronto, Canada.

FOREIGN Stamp Collection Sent Free. Cornish Company, Schenectady, N. Y.

BIG Variety Packet Foreign Stamps free for 2c postage. Gray Stamp Co., Station E., Toronto, Canada.

FREE set of stamps to all approval applicants. Address Fryrear, 1411 4th, Cedar Rapids, Iowa.

125 DIFFERENT stamps 10c. Mogenssen, 414 North 10th, Omaha, Neb.

FREE—14 varieties Utenida, Postage 2c. Heatherdale, 4019 Lyndale So., Minneapolis, Minn.

ZAMBESIA, Zambar, Abyssinia, Herzegovina, Alenstein stamps, menagerie collection, hinges, 10c. Liberty, 3974 Arsenal, St. Louis, Mo.

LOOK! Poland, 25-50-100 mths, catalogued 45c, only 8c with approvals. William Remetsch, Bridgerort, Conn.

10c SETS, 50 United States, 30 Austria, 20 Belgium, 20 Denmark, 25 France, 25 French Colonies, 25 Germany, 20 Netherlands. All different, 6 sets 50c. Seidenberg, Merton, Wis.

100 DIFFERENT foreign, many rare unused. 7c. Stanton, Niantic, Conn.

500 MIXED U. S. 10c; 1,000 hinges 10c; Album 15c; 100 different War 15c; 1,000 diff. Foreign \$1.50. Weatherby, Medina, Ohio.

FREE German Air Plane Set, Perforation Gauge and Packet, to all sending 2c and Reference for our Approvals. Clifford Manning, 314 University Place, Grosse Pointe, Mich.

MARTHA Washington 4c Brown unused, also 50 different French Colonials for 20c. Jacob Fischer, 1529 North Lawler, Chicago.

200 DIFFERENT Stamps, 25c; 200, 15c. Michael, 5602 Prairie, Chicago.

MENAGERIE Stamps Free Approval Applicants; postage 2c. Sound Stamp Co., Owen Sound, Can.

FREE 50 Unused for Stamp to Serious Approval Applicants. Sellem Stamp Company, 2116 Niccollet, Minneapolis, Minn.

\$3.00 CATALOG 12c. \$5.00 catalog 30c. All different stamps. "Klesse's Net Approvals" with order. William Klesse, Jr., 222-34 East 80th St., New York City.

FREE! World's smallest stamp. Approvals, Postage 2c. Cannon, 1415 Carey, Davenport, Iowa.

200 DIFFERENT stamps from all over the world postpaid for 12c. These are the biggest value for the money we have ever offered. Fenway net approval sheets with each order. Fenway Stamp Co., Box 81, Fenway Station, Boston 171, Mass.

HONEST prices paid for stamps. International, 2117 Regent Place, Brooklyn, N. Y.

FREE Premium. Beautiful Views of California. Fifty genuine foreign stamps, one dime and stamped envelope. Pacific Stamp Co., Sausalito, California.

NYASSA set Free for a request of my % 1 and 2c approvals, also the higher priced desirable stamps at 50% disc't. Send reference and get extra premiums. Chas. T. Egner, 4455 Frankford Ave., Phila., Pa.

FREE. One Dollar's Worth of Stamps with Approvals. Address Gramp, 911 Michigan, Buffalo, N. Y.

FREE—1,000 different stamps. Hall, 12 West 101st, New York.

103 DIFFERENT, including German Airplane, Fiume, Esthonia, 10c. James Musick, 4440 Natural Bridge, St. Louis, Mo.

APPROVALS, Better Grade. William Stone, 172 Sherman Ave., New York City.

500 ALL different stamps \$1.00. Address Mrs. Murphy, 25 Nelson, Newark, N. J.

STAMPS sent on approval at 70% discount. Reference required. Emory Renoll, Hanover, Pa.

STAMPS Free—War Stamps, Surcharged, Unused, Pictorials, British, French Colonials, 2c postage. Midland Stamp Co., Toronto, Canada.

1,000 DIFFERENT, \$2.00: 500, 75c; 325, 50c; 225, 25c. Fred Onken, 630 79th Street, Brooklyn.

FREE! 25 British Colonials to approval applicants sending 2c. Nickles, 122 Florida, Washington, D. C.

FREE, 3 Abyssinian Stamps to approval applicants, 50% commission and free premiums. Enclose 2c. 100r. 642 Eugene Street, Indianapolis, Ind.

FREE—50 varieties or set to approval applicants sending 2c. 500 different 60c. Richard P. Lamprocht, Valparaiso, Ind.

FREE—Thirty unused stamps to applicants for may not priced approvals. Extra premium to first ten applicants. G. C. Moore, Clearfield, Pa.

RARE COINS

MAIL This Slip with your name and address and 19 cents and you'll get a large U. S. Copper Cent nearly as big as half dollar, and large 50-page illustrated coin catalog. You'll find it fascinating and profitable. Send Now. B. Max Mehl, Numismatist, Mehl Bldg., Dept. P, Fort Worth, Texas. Largest Rare Coin Establishment in the United States.

\$2 TO \$500 each paid for hundreds of Old Coins. Keep all Odd or Old money. It may be very valuable. Send 10c for New Illustrated Coin Value Book, 4x8. Get 10c tested. We pay cash. Address Clarke Coin Co., Ave. 2, Le Roy, N. Y.

50,000 COINS, medals, papermoney, antique firearms, curios, relics. Catalogue free. Collection Exchange, 1538 Willington, Philadelphia.

EXTRA—2c Silver and \$5 Ohio Bill, 1838, 25c; 3c Nickel and 2c piece 15c; California Gold, 1/4, 27c; 1/2, 53c. Price Lists and Wild Cat Bill, 5c. Al E. Bonnell, Richmond, Indiana.

TEN Colorful Neoprene War Notes—25c. Germain Benneau, Bayside, N. Y.

CALIFORNIA gold, 8 1/2 size, 27c. 8 1/2 size, 52c. 3c piece and catalogue, 10c. Address Norman Shultz, Colorado Springs, Colo.

OLD coins wanted. Do you know that coin collectors pay up to \$100.00 for certain U. S. Cents, and high premiums for all rare coins? We buy all kinds. Send 4c for large Coin Circular. May mean much profit to you. Numismatic Bank, Dept. H, Ft. Worth, Texas.

100,000 RUSSIAN Rubles, 25c. Craig Dare, 440 55th, Brooklyn, N. Y.

BANKNOTES of different European countries in every denomination up to 1,000,000. Write for collector's list. George Grigolett, 20 E. Jackson, Chicago.

BY return mail, four rare coins (one silver), no trash, for fifty cents, also membership endless chain of free coins. Honest dealings. Southampton Coin Exchange, 5427 Nottingham, St. Louis.

FOR BOYS

BOYS, sell single-shot rifles with 750 shots ammunition; sample postpaid 35c. Kell Novelty Works, 241 East 5th St., Erie, Pa.

MAKE Dandy Calif. Toy; instructions dime (easy). John Hudson, El Centro, California.

MOUTH-ORGAN Instructor, 25c. Play in one hour. Toy-maker book, 10c; Boy Electrician, 10c; 250 Magic Tricks, 10c; Parody Song Book, 10c; Ventriloquism, 10c; Boxing Guide, 25c. G. Elsen, Bowling Green, Ohio.

CAMERAS AND PHOTO SUPPLIES

MODERN Photography in all its branches now taught by mail. New Successful Method. Students earning \$300.00 while learning. Big Opportunity. Write for particulars and unusual offer open for short time. Dept. 3435 International Studios, Inc., 3601 Michigan Ave., Chicago.

JUST Published—Our new complete 128-page catalog and bargain book of new and used cameras and supplies. Our prices are guaranteed finest quality obtainable. We have thousands of satisfied customers. Write at once for this bargain bulletin, just hot from the press. Address Central Camera Co., 124 S. Wabash Ave., Dept. E-69, Chicago, Ill.

SPECIAL Trial Offer: Any size Kodak film developed for 5c; prints 3c each. Overnight service. Get a Free Auto. Ask for details. Roanoke Photo Finishing Co., 209 Bell Ave., Roanoke, Va.

BUSCH slightly used German army field-glasses, 8 power \$12.50, wonderful value, sent prepaid, \$72 Goetz 6-30 binoculars, new \$37.50, many others, we take shot-guns in trade for cameras, lenses, binoculars and telescopes, write your wants. National Camera Exchange, 29 So. 5th Minneapolis, Minn.

SAVE Money on Radio Apparatus. Lowered Prices. Ray, 325 5th Avenue, New York, N. Y.

FREE with kodak finishing: one pair radio legal phones, Dime brings samples and information. Address A. Anderson Studio, 408 Wabasha St., St. Paul, Minnesota.

THE new "Rito" finish makes bright, permanent pictures from your Kodak films; three samples from your negatives free. The Photo-Finishing Co., Atlantic, Ia.

KODAK Films—Special trial offer: your next kodak film developed, 5c—prints, 2c each. Moser & Son, 1917 St. James Ave., Cincinnati.

PHOTOGRAPHIC Nature Prints, hand-tinted; catalogue free. E. V. Butler, Houghton, Mich.

HAVE You a Camera? Write for Free sample of our big magazine, showing how to make better pictures and earn money. American Photography, 790 Camera House, Boston, 17, Mass.

KODAK Finishing of superior quality, prompt service, and complete satisfaction. Write for list. Liberty Photo Company, O-we-go, N. Y.

SAMPLE enlargement, dime and negative (returned). Sample 6-exposure roll finished glossy, 25c silver. Brown Studio, Lake Elmo, Minn.

FREE Developing—Glossy Prints, four cents each. Excellent Work. Macfarlane's, 4166 Hamilton, Cincinnati, Ohio.

MOTION PICTURES

\$35.00 PROFIT nightly. Small capital starts you. No experience needed. Our machines are used and endorsed by government institutions. Catalog free. Atlas Moving Picture Company, 482 Morton Bldg., Chicago.

PORTABLE Moving-Picture Machines Films, Akrasales, 130 West 46th Street, New York.

AMERICA'S Greatest Fortunes have been made in the Moving Picture Business. Small investment needed. We furnish complete theatre equipment. Easy payments. Openings everywhere. Catalog free. Monarch Theatre Supply Co., Dept. F, 724 So. Wabash Ave., Chicago, Ill.

JUST in time to get in on the big money to be made! Bass will start you in the Motion Picture Making Business, enormous profits making Industrial Films, News Weeklies, etc. Catalogue and full information Free! The Cinema Handbook, 575 pages, for \$3.00 postpaid. Bass Camera Company, 105 No. Dearborn St., Chicago, Ill.

REMARKABLE value; Light Weight Professional Motion Picture Projector, Mazda Illuminated, with 1,000 feet of film, \$37.50. Send for photograph. DeFrame Importing Company, 109 No. Dearborn St., Chicago, Illinois.

FILMS—Standard size for Toy and Professional machines. Special Bargain—500 ft. lengths \$3.00. We sell everything for "The Movies." Monarch Theatre Supply Co., Dept. P, 724 So. Wabash Avenue, Chicago.

FREE to Writers—A wonderful little book of money-making hints, suggestions, ideas; the A B C of successful story and play writing. Absolutely Free. Just address Authors Press, Dept. 12, Astoria, New York.

\$\$\$ FOR Ideas. Photoplay plots accepted any form; revised, criticized, copyrighted, marketed. Advice free. Universal Scenario Corporation, 917 Western Mutual Life Bldg., Los Angeles.

MOVIE Films for Toy Projection, 101 feet, \$1.00 postpaid; 800 feet, \$3. Films suited for homes, churches and schools. Home Projector, \$25. Cameras, \$40. Ray, 528 5th Avenue, New York, N. Y.

MAKE money writing photoplays; detail free to beginners. No correspondence course. Producers League, 230 Wainwright St., Louis.

FILMS: Comedies—Cartoons—Dramas—Westerns—Serials and Educational Subjects. Get our Big Hit and bargain prices before you buy. Monarch Theatre Supply Co., 228 Union Avenue, Memphis, Tenn.

SCENERY TO RENT

SETTINGS for Opera, Plays, Minstrels. Plus Dress. Address Amelia Grain, Philadelphia.

EDUCATIONAL AND INSTRUCTION

BE a Laboratory Expert. Earn \$300.00 to \$500.00 a month. Study Microbiology, Bacteriology, Laboratory Technology, Sanitation, Interesting Extension and Residential Courses. Diplomas and Degrees granted. 71-piece Urinalysis Outfit Free to students. Write for Free 48-page Prospectus. International Physicists and Surgeons College of Microbiology, Room 955, 550 Garfield Ave., Chicago, Ill.

CARTOONISTS—Improve your style by following the work of the greatest cartoonists found in the bound volumes of Cartoons magazine. Eight volumes, each covering six months, Jan.-June, 1917, to July-Dec., 1920, inclusive. 1,200 cartoons, 900 pages to a volume, 7 by 9 1/2 in., 3 in. thick. New books; durable and attractive binding. Sold separately at \$2 per vol. postpaid. Supply very limited. Send at once. Popular Mechanics Book Dept., 200 E. Ontario St., Chicago.

INVENTORS—Write for our illustrated guide book and Evidence of Conception Blank. Send model or sketch and description for free opinion of its patentable nature. Highest references. Prompt attention. Reasonable terms. Victor J. Evans & Co., 147 Ninth, Washington, D. C.

ARE you mechanically inclined? Learn watch and clock repairing as a trade or for spare time. Big Money. Drexler's Simplified System makes it easy. Write for particulars. B. P. Co., Security Bldg., Milwaukee, Wis.

YOU can have a business profession of your own and earn big income in service fees. A new system of foot correction; readily learned by anyone at home in a few weeks. Easy terms for training; openings everywhere with all the trade you can attend to. No capital required or pools to buy, no agency or soliciting. Address Stephenson Laboratory, 1 Back Bay, Boston, Mass.

SHOW-CARD writing a pleasant, profitable profession easily and quickly learnt by our new, simple graphic block system. Artistic ability not necessary. We teach you how. Distance no object. Full particulars and booklet free. Wilson Methods, Limited, Dept. M, 64 East Richmond, Toronto, Canada.

MATHEMATICS taught by mail. Arithmetic, Algebra, Geometry, Mensuration, Trigonometry, Logarithms, and Mechanics courses. Address, Harding School, 74 Brighton, Highland Park, Mich.

WORLD-ROMIC System. Masterkey to All Languages. Primers, 23 languages, \$1.94 each language: Arabic, Bohemian, Bulgarian, Cantonese, Chinese, Danish, Dutch, English, Scotch English, French, German, Hungarian, Italian, Japanese, Latin, Panjabi, Polish, Portuguese, Rumanian, Russian, Sechuana, Spanish, Swedish. Pronunciation Tables, 94 languages, 30c each language. Languages Publishing Company, 8 West 40th Street, New York.

ROPP'S Calculator and Short-Cut Arithmetic shows the answer as quickly as a watch shows the time to all problems likely to occur in office, store, shop, bank, farm or factory. Price, pocket size, paper 35 cents, cloth 50 cents, leatherette \$1. Desk size, cloth \$1.50 postpaid. Popular Mechanics Book Dept., 206 E. Ontario St., Chicago.

STUDY Bacteriology, Hygiene, Public Health, Laboratory Technologists make good income. Interesting course, can be mastered at home or in school in a few months. Other courses in Arts and Sciences, Chiropractic, P. G. Pharmacy, etc., 15th year. Diplomas conferred. Send for Announcement, American College of Bacteriology, 2923 S. Michigan Blvd., Chicago, Ill.

DOUBLE Entry Bookkeeping mastered in 40 hours with 8 keys guaranteed; diploma. Our graduates lead in bookkeeping, auditing, accountancy, balance sheets, and financial statements. International Bookkeeping Institute, Dept. 8, Springfield, Mo.

BIG Money in writing photoplays, stories, poems, songs. Send today for Free copy America's leading writer's magazine, full of helpful advice on writing and selling. Writer's Digest, 603 Butler Building, Cincinnati.

WRITE articles, stories, news, in spare time for newspapers and magazines. Big pay. Copyright book free. Press Syndicate, 552, St. Louis, Mo.

FIND Your True Life Work. Ask for free Vocational Self-Analysis Chart PM-1. Vocational Service Bureau, 20 E. Jackson, Chicago.

USED books and educational matter bought, sold, exchanged. List 1,000 items free. Students' Exchange, 47-A West Forty-second Street, New York, N. Y.

LEARN electro-engraving. Highly paying work easily done at home. Battery or regular current. Limited Laboratory, 3515 Butler St., Pittsburgh, Pa.

ARTIFICIAL Marble, sanitary flooring instructions, ornamental casting, concrete plaster, papier-mache decorations, garden furniture, statuary, Rubber-moulds, Electro-metallurgy, particulars and 200 illustrations free. Chris Mahler, Box 122, Huntington, N. Y.

USED educational books sold, rented, bought and exchanged. Bargain list free. Lee Mountain, Pisgah, Ala.

WHY pay \$40.00 to learn sign and show card painting trade when my price is only \$2.00? Clinton K. Matthews, Hempstead, N. Y.

USED books and educational matter bought, sold, exchanged. Bulletin free. Instruction Correspondence Exchange, 1660 Broadway, N. Y.

"WHAT to Invent for Profit" free. Patent News, N. Washington, D. C.

TELEGRAPHY

WANTED—Young men and women to learn Morse and Wireless Telegraphy. Railroads and Wireless Companies in great need of operators. We teach you quickly, and secure positions at big salaries. Great opportunities for advancement. All expenses low; can earn part. Write today for free catalog. School established 1874. Inigo's Telegraph Institute, "H" Street, Valparaiso, Ind.

TELEGRAPHY—Morse and Wireless—taught at home in half usual time and at trifling cost. Omnigraph Automatic Transmitter will send, on Souther or buzzer, unlimited messages, any speed, just as expert operator would. Adopted by U. S. Govt. and used by leading Universities, Colleges, Technical and Telegraph Schools throughout U. S. Catalog free. Omnigraph Mfg. Co., 18 Hudson St., New York.

EITHER sex, \$1,500 to \$3,000 yearly. (Read Announcement, April Popular Mechanics, same heading.) American Telegraphic Studio, Box 793, Worcester, Mass.

RADIO OUTFITS AND SUPPLIES

ARMSTRONG Representative Tuner Licensed. Using coil similar to Rheimartz. Complete \$10.00 and postage. Knocked down parts \$5.00. Catalog free. Ashross, Treco, Davenport, Iowa.

LOUD Speaker for Any Crystal Set. Hear music over entire house, with Steinmetz Amplifier, \$8.50; easily constructed by amateurs. Eliminates storage battery. Instructions complete. 25c. Catalogue Free. Representatives named Steinmetz Wireless Mfg. Co., Eastend, Pittsburgh, Pa.

RUSONITE multipoint crystal rectifier. The standard crystal. A synthetic crystal detector sensitive over its entire surface. Extraordinary clearness and volume. Price mounted, 50c. Rusonite 14 Karat gold superconductive cathodizer, Price, 25c. Guaranteed. Rusonite Products Corporation, 15 Park Row, New York.

"RANG," that new discovery. The Desert Cactus Cat Whisker, improves your set 100%. Mail 25 cents for set of two and details of the new 300 mile Mars Radio Crystal Receiving Set. Address, Million Article Radio Service, Box 822, Needles, Calif.

RADIO Generators—500 Volt, 100 Watt, \$21.50 — High Speed Motors — Federal Phones, \$5.50 — Battery Chargers, \$12.50. Motor Specialties Co., Crafton, Penna.

RADIO Call Book—The Who's Who of Radio, 50c each. Illuminat Company, 5128 Rice, Chicago.

GENUINE Brooklyn Condenser. Range 729 degrees. No plates. Mounts entirely on front of panel. Sub-ether tuning assured. Price: \$3.50 postpaid. Guaranteed. Get our prices on "A" batteries, Safe money. Noble Batteries, Monmouth Rock, Chicago, Ill.

GUARANTEED 1,000-Mile High Grade Receiving Sets complete with all accessories and Storage Battery, ready to operate, \$60.00. Write us before purchasing outfit of any kind. Quality Radio Company, 833 West 15th, Chicago.

TRADE SCHOOLS

LEARN Photoengraving. Short intensive course. Positions secured. Terms reasonable. Catalogue address: Eaton School of Photoengraving, Ellingham, Ill.

BUSINESS OPPORTUNITIES

SEE what I can do for You and what you can do for yourself manufacturing these Biggest Selling Specialties from Miller's Guaranteed Manufacturer's Formulas and detailed Simple Instructions. No Machinery Required—Investment Small. Start in Home, Office, Store or Factory, making 20-Minute White Beauty Clay, Mexican Yucca Soap, Merte's Toilet Specialties, Vanil, Fifteen Pure Food Specialties, Concentrated Summer Drinks, Washing Marvel Powder, Amazon Tire Repair, Rubber Toy Balloons, White Floating Laundry soap, and many other largest sellers in all lines. Stamp brings all lists and valuable descriptive literature. Don't compare these high grade successes with anybody's "Bargain Collection" of cheap Recipes, 26 years supplying the Best. Highest references. Miller, Chemist, Tampa, Florida.

MAKE and sell Mexican Hot Tamales. Recipe \$1. Pettit Bros., Patritew, Oklahoma.

MAIL Order Business is your opportunity. Brenner's Famous Handbooks teach how to start small, grow big. Sell merchandise, service, ideas; enormous profits. Spare time to begin. Get complete set, 11 books, \$3.00, and be posted. Brenner, 335 Walnut, Philadelphia. Descriptive Catalog and big batch interesting mail order information, 25c. None free.

YOUR chemical problem solved by an expert chemist. Consultation five dollars. Write me. W. Swelman Richards, Consulting Chemist, Box 2402, Boston, Mass.

FREE Advice, on How to Become Successful in Real Estate and Insurance. Particulars. Macdonald Cooperative Realty, San Diego, Calif.

GET into the specialty manufacturing business. Amazing profits. We will send you free book explaining our system. Write immediately. A wonderful opportunity awaits you. National Scientific Laboratories, 211 North Monroe, Richmond, Va.

CARPENTERS, Wood Mechanics—Handsome profits manufacturing my Patented Combination Instand. New and unique. Easily made. Youth with small shop can make these. Instand has Perpetual Calendar, Thermometer, Pencil Sharpener, Pyramid Pin Box, six compartments for stamps, pens, elastic, paper fasteners. County Shop Rights for sale. Reasonable prices, easy payments. You can have neat, protected business. Pattern and all material supplied where desired. Particulars and Illustration Free. W. H. Colby, 115 Spruce Street, Detroit, Mich.

BIG Money in Spare Time for one man in each locality making embossed show cards and price tickets for stores and others. Easy, quick work. No training needed. New embossing machine does it all. 400% profit. Signs sell on sight. T. W. Cushing of Chicago sold \$76 first rail. S. D. Downes averaged \$15 a day for 6 months. Many sell \$5 to \$20 daily. No speculation. Before you invest a penny we send you free sample cards to show merchants and convince yourself they sell at sight. Write today. Praemath Corporation of America, Dept. 390, Geneva, N. Y.

START a Lucrative Business of Your Own. We teach you how to establish and operate a successful collection business and refer items to you. Capital unnecessary. Practically no competition. Walter Sanford, Nashville, reports \$62,021.94 gross commissions last year. Joseph Cullen, Washington, sends same statement showing gross earnings \$8,039.07 for one month. Orville Greenholzer, Darton, says: "I averaged nearly \$100 net commissions monthly last year. Such earnings bought my home and farm." Start now in spare time. You can succeed like 4700 others. Write today for New Plan. American Collection Service, 802 Shelby Block, Detroit, Mich.

SANITARY Marble Flooring and Tile instructions as how to mix and lay, used to cover old wood or cement floors. Laid like cement 1/2" thick will not crack or chip, easy to keep clean, cheaper than linoleum, noiseless, resilient, waterproof, fireproof, dustless and nonslippery. Polishes like glass, wears like iron, can be laid for 15c a square foot and charged for, from 30c to \$1.50 a square foot, a fine floor for bathrooms, kitchens and any place where a substantial covering is desired; instructions complete, ready to work by, price \$5.00. Address C. H. Yeager, 2138 Olney St., Indianapolis, Ind.

BIG Money, making polished Granite, Marble, Agate and Turquoise Face Brick, Blocks and tile from common Cement. Write for information, Spencer Instruction Department, Elshure, Calif.

SILVERING Mirrors! My exclusive French Tartaric method opens enormously profitable business. Booklet free. H. Barston, 514 23d Street, Oakland, Calif.

RAISE guinea pigs. Pay better than poultry or rabbits; easy to raise; little space required. We guarantee market. Particulars and booklet how to raise free. Cavies Distributing Co., 3102 Grand Ave., Kansas City, Mo.

AGENTS—Send for sworn proof of \$5 to \$15 Daily—introducing New Style Guaranteed Hosiery—37 styles, 17 colors—No capital or experience required. Just write orders—We deliver and collect. Your pay daily, also monthly bonus. Free auto offer besides. Complete outfit furnished. All colors—grades including silks. Mac-O-Cheo Mills Co., Desk 2585, Cincinnati, Ohio.

MEN—Look into our proposition of Wallpaper Cleaning. Take big cleaning contracts. Unlimited field. C. Swanson & Sons, Mankato, Minn.

FREE Formula Catalog. S. & H. Laboratories, Boylston Building, Chicago.

ORANGEADE, in powder—just add cold water—most delicious drink you ever tasted. Fine for home, parties, picnics, dances, etc. Start in this business—big money easily made. Send dime for ten glass package, postpaid, 7 knobs, Cherry, Grape, Lemon, Strawberry, etc., for 70c glasses only 50c, postpaid. Morrissey Company, 4417-25 Madison St., Chicago.

"SCHEMER Magazine" Alliance. Ohio, prints big profit schemes; one subscriber making \$25,000 from three; another \$10,000 from one. Try your luck. Yearly only \$1.00; three months, 25c.

CUTS made easily, chalk plate method, 25c. Mac Clarke, Ottawa, Kansas.

PATENTS procured. Send sketch or model today for examination, prompt report and advice. No charge for preliminary advice. Write for free booklet and blank form on which to disclose your idea. Highest references. Promptness assured. Clarence A. O'Brien, Registered Patent Lawyer, 561 Southern Building, Washington, D. C.

PATENTS Procured; Trade Marks Registered—A comprehensive, experienced, prompt service for the protection and development of your ideas. Preliminary advice gladly furnished without charge. Booklet of information and form for disclosing idea free on request. Richard B. Owen, 30 Owen Bldg., Washington, D. C., or 227-B Woodworth Bldg., New York.

HAVE a business of your own; the most fascinating, best paying business—profession in the World, a foot correctionist; easy terms for training you at home in a few weeks, a new protected system that has enabled men and women to rise in one step to greater earnings than they ever thought possible; no capital required or goods to buy, no agency or soliciting. Address, Stephenson Laboratories, 1 Back Bay, Boston, Mass.

WE Start You in Business, furnishing everything; men and women. \$30.00 to \$100.00 weekly operating our "New System Specialty Candy Factories" anywhere. Opportunity lifetime; booklet free. W. Hilmyer Bagdale, Drawer 4, East Orange, N. J.

MODEKN Photography in all its branches now taught by mail. New successful Method. Students earning \$300.00 while learning. Big Opportunity. Write for particulars and unusual offer open for short time. Dept. 2865, International Studios, Inc., 3601 Michigan Ave., Chicago.

\$2,000 BUYS valuable silver-lead property; one-half, \$1,000. S. Gabel, Kaslo, B. C.

START a cleaning, dyeing, pressing shop. Big profits. Experience unnecessary. Plans 25c. International, Dept. 19, Excelsior Springs, Mo.

LEARN Destroying Superfluous hair permanently. Men—Women prospects; profitable local business averaging \$4 hourly; \$29 needed. Particulars 25c. B. Zitka, Fairview, Mass.

GET on the right road toward independent prosperity with a business of your own. Men, women operate "Sure-Profit-Store" anywhere. Success with us. Details free. Doubly Co., 8-15, Ann Arbor, Mich.

DOLLARS yearly in your backyard. No mushrooms done. Particulars free. Metz, 813 East 89th, New York, N. Y.

START in Business. Samples and stock 15c. Cochran, Grayville, Ohio.

CHEMICAL Expert will furnish Formulas and Trade Secrets. All lines. Lists Free. W. L. Cummings, Ph. D., 228 Gordon Ave., Syracuse, N. Y.

OPERATE a Typewriter Exchange. Wonderful opportunities. My complete set instructions tells how. Write for full particulars. Sahin K. Elder, "The Typewriter Man," Brownsville, Texas.

FREE Book. Start Little Mail Order Business. Home employment evenings. Pier, 218-A, 74 Cortland St., New York.

MONEY-MAKING Books, Plans, Formulas. Big catalogue free. Ideal Book Shop, 5501-BE North Robey, Chicago.

500 FORMULAS. Resilvering Mirrors—Renewing Dry Batteries—10 Luminous Paints. 25c. Ideal Book Shop, 5501-BE North Robey, Chicago.

EXCEPTIONAL Opportunity for Sales Manager capable of handling state distribution. Marvelous new Adding Machine. Retails \$15. Work equals \$350 machine. Tremendous possibilities. Unlimited profits. Write quick for details. Lightning Calculator Co., Dept. B., Grand Rapids, Mich.

RESPONSIBLE Corporation wants general sales manager to open branch office, manage salesmen. \$500 to \$5,000 necessary; expenses allowed to Baltimore if you qualify. Address Manager, 693 N. Eutaw St., Baltimore, Md.

OPEN Hat Cleaning Parlor. "Cash in," on Big Straw Hat Business. Particulars Free. Byron 27, Sta. 1, New York, N. Y.

I MADE \$30 a week home. French breadmaking. 15 years' experience; free booklet tells. Ashbrook, 67, Marengo, O.

PROTECT your rights—Write for "Record of Invention" and booklet about Patents. Prompt personal service. Advice without charge. J. Beany Kelly, 612-G Columbian Building, Washington, D. C.

LEARN at Home—Make automobile specialties. New Tops—Repaint, Retrim and clean cars. Endorsed by Trade Experts. Start your own shop. We tell you how. Autorenture, Sheboygan, Wis.

"WHAT to Invent for Profit" free. Patent News-C., Washington, D. C.

\$36.00 PROFIT on \$1.50 outfit; gold initials for automobiles, etc. Address: National, Station D, Brooklyn, New York.

MANUFACTURE Auto and Furniture Polish. Costs 40 cents make, sells 100% profit. Great repeater. Formula prepaid \$1. Waple, 635 Pennsylvania, Washington, D. C.

MAKE thirty articles to sell by mail. Information, red stamp. Braceland 1457 So. Ninth, Philadelphia, Pa.

COST \$3.00. Your profit \$103.75, applying gold initials to autos. Particulars and samples free. World Monogram, Dept. B, Newark, N. J.

MANAGE'S wanted with \$3,000 or more to operate branch chain store, or agency, every city. Big sales certain. Income \$35-\$95 weekly. Belleville Tire Co., Belleville, N. J.

EARN \$10 daily silvering mirrors, plating and refinishing metalware, autos, chandeliers, bedsteads, bezelizers. Outfits furnished. E. Dele Laboratories, 1183 Broadway, New York.

CHEMICAL Expert Furnishes Manufacturing Formulas with Complete Working Directions. Processes Perfected. All Lines. Unexcelled Service. Charges Reasonable. Correspondence Invited. Dr. Arthur Vanheeden, 508 South Oakley Boulevard, Chicago.

\$88.00 WILL establish you in Cash Business. Wonderful Opportunities everywhere for making Fortunes. Details Free. Monarch Theatre Supply Co., Dept. 46, 726 So. Wabash Av., Chicago.

GOOD money easily earned at home spare time silvering mirrors; no capital. Free instructive book tells how. Patterson & Co., Brooksville, Ky.

START Automobile Polishing, Plating, etc. Profitable plans free. Korick, 427 Carroll St., Akron, Ohio.

\$3,000 TO \$6,000 Yearly. Want It? Others are making it. Send check or money order today for our invaluable books "How to Sell Real Estate." \$3.00—and "How to Conduct Real Estate and Insurance Business." \$1.50. Absolute satisfaction guaranteed. Free catalogs. Realty Sales Co., Dept. 52, Cleveland, Ohio.

MARBLE mixing instructions, covering wood or cement flooring $\frac{1}{2}$ inch thick, fire-proof, waterproof, low cost, sanitary, all colors. Particulars, 200 illustrations free. Chris Mahler, Box 122, Huntington, N. Y.

LEARN the collection business. Good income, quick results. Interesting booklet, "Skillful Collecting," free. National Collectors Assn., Long St., Newark, O.

MAKE Money silvering mirrors, all kinds plating, knives, spoons, auto headlights. Outfits furnished. Free booklet. International Laboratories, Dept. 26, 311 Fifth Ave., New York, N. Y.

START business Electric Lawn Mower Sharpening Machine. Capacity \$3.00 per hour. Write Springer, Kuala, 415 South Lawndale, Kansas City, Mo.

INCH Display Advertisement 141 Magazines This \$15. Year \$50. Page \$100. Wood's Popular Services, Atlantic City, N. J.

START a Mail Order Business. We manufacture and supply you with Wild Animal Sets all boxed ready for mailing. Send for sample One Dollar Postpaid. Russell-Graff Co., 292-P Alden Ave., New Haven, Conn.

"HOW to Sell Patents" free. Patent News-H., Washington, D. C.

BE a Laboratory Expert. Earn \$300.00 to \$500.00 a month. Study Microbiology, Bacteriology, Laboratory Technology, Sanitation. Interesting Extension and Residential Courses. Diplomas and Degrees granted. 71-piece Urinalysis outfit free to students. Write for Free 48-page Prospectus. International Physicians and Surgeons College of Microbiology, Room 97L, 550 Garfield Ave., Chicago, Ill.

MANUFACTURE Letters for signs. No Experience necessary. Big Money. Particulars free. J. F. MacPherson, No. Main St. Ext., Butler, Pa.

53 GREAT Money-Making Plans Free. Universal Bureau-M. Boston, Mass.

AUTOMATIC Fly Ejecting Window Screens. Your opportunity. Your own business at a cost of a hammer, saw and \$3.00 for all the particulars. Address F. Rohrer, Box 178, Palo Alto, Calif.

FORMULAS, Trade Secrets—Different, dependable. Catalog free. B. Thaxly Co., Washington, D. C.

INCORPORATE any enterprise under common law; any capital, transact business any state, no corporation taxes; no personal liability; raise capital; keep control. Booklet free. Herbert Co., Band-McNally Building, Chicago.

START a pressing, cleaning and dyeing shop, excellent field, splendid profits. We tell you how. Write for booklet. Ben-Vande System, Dept. C, Charlotte, N. C.

LEARN Mail Merchandising. Work home evenings. Make big income. Instructions, details; write Kraft, Box 896-PM, San Francisco, Calif.

MAKE Money at Home—Making toys. We show you how. Send \$1 for complete working drawings and instructions. Dekalb Designing Co., Dept. 6, Decatur, Ga.

MANUFACTURE Extracts, and other necessities, 200% profit; we tell you how. Write White Manufacturing Drug Co., 1426 Lahillaw Ave., Cincinnati, O.

ATTENTION!! You can have a business of your own. Establish and operate New System Real Estate Business, brokerage and insurance agency in your community. Office at home. Earn \$5,000 year. Representatives wanted everywhere. Send stamp free booklet. Hayes Realty Association, Cincinnati, Ohio.

CHEMISTRY

CHEMICAL and bacteriological examinations guaranteed accurate. Formulas, processes. Write me about your chemical problems. List free. J. F. Mazur, M. B., 937 W. 20 St., Lorain, Ohio.

1,000,000 FORMULAS, 1016 pages, \$2.500 Formulas Free if you order quick. Ideal Book Shop, 5501-ME North Robey, Chicago.

FORMULAS AND TRADE SECRETS

AUTO and Furniture Polish. Costs 40 cents make, sells \$4. gal. Formula, instructions prepaid \$1. Waple, 639 Pennsylvania, Washington, D. C.

5,000 RECIPES, \$1.25. Best formulas and processes for every business, trade or occupation are in "Yeoman's Guide." Many never before published. Worth \$1.25 each. 330 pages. Paper cover \$1.25. Cloth \$2.00, postpaid. Book catalog free. Wells and Edwards, X552 George, Chicago.

FORMULAS—Guaranteed. Catalog free. Bestovall Laboratories, 4049-FE, North Whipple, Chicago.

FORMULAS of the better sort. Write for our free catalog. National Scientific Laboratories, 211 North Monroe, Richmond, Va.

FREE—Formula Catalog. S. & H. Laboratories, Boylston Building, Chicago.

FOR Sale—Hand cleaner formula. Send 10c. Box 825, Campello, Mass.

10,000 SELECTED scientific, chemical, technological and practical recipes and processes including hundreds of so called trade secrets for every business alphabetically arranged in one large volume of 800 pages. Price \$4 postpaid. Popular Mechanics Book Dept., 200 E. Ontario St., Chicago.

3,000 FORMULAS, Money-makers, 400 pages, \$1. Bestovall Laboratories, 4049-BE, North Whipple, Chicago.

3,000 FORMULAS, 400 pages, \$1.60. Hillside Laboratories, 7021-AC South Winchester, Chicago.

FREE—Formula Catalog. Big Selling Specialties. Fast Money-makers. Allen's Enterprises, 1227 Milwaukee Av., Chicago.

500 VALUABLE Formulas, 25c; Formula Literature, 2c. Harvey Temple, Decatur, Ind.

"BEAUTY Clay," Widely advertised Beautifier. Women wild over it. 500% profit. Guaranteed Formula. \$1. Bestocal Laboratories, 4047-CE North Whipple, Chicago.

DON'T Waste Money on "Junk." Stamp brings Valuable Literature of High-Grade, Reliable Formulas of Best Sellers in all lines. Buy from chemist and get real service. Miller, Chemist, 807 De Leon Street, Tampa, Florida.

SIXTEEN Beauty Formulas for 35c. Formula for Beauty Clay \$1.00. Make your own beauty preparations. Adam Janowski, London Court, Bristol, Conn.

800 FORMULAS 25c; Luminous Paint—Reversing Mirrors—Renewing Dry Batteries—Mechanics Soap—Gas Tonic—Carbon Remover—Puncture Plugger, 20c each. Entire collection 50c. Catalog Free. Ideal Book Shop, 5501PE North Robey, Chicago.

AGENTS WANTED

TAILORING agents wanted—to sell all wool suits tailored to order \$29.50, all wool tropical worsteds two-piece suits—\$18.50, Palm Beaches—\$17.50. We believe this is the best and biggest value line in America for the man who believes in pleasing his customers and getting repeat business. To such men we will gladly send full information about our selling plan. Address Salesman, J. B. Simpson, Dept. 551, 831 W. Adams St., Chicago.

AGENTS—Send for sample "Fretnot"—the washday wonder. Be convinced you can do a whirlwind business. You can clear at least \$20 to \$100 weekly, according to space or whole time. You don't have to talk; if she doesn't buy at sight, leave sample; she will be looking for you long before you are able to make the rounds again. Samples furnished free. Premiums for your customers. Exclusive territory guaranteed to agents who can produce. Credits given. Don't call. P. M. Motter & Sons, 20 E. Jackson Blvd., Chicago.

LARGE Shirt Manufacturer wants Agents to sell complete line of shirts direct to wearer. Exclusive patterns. Big values. Free samples. Address Madison Mills, 563 Broadway, New York.

300% PROFIT—Whirlwind Seller, Kleen-Rite, New Washing Discovery. Washes clothes without rubbing. Women throw away washboards. Write Quick for Free Package and Special Offer. Restever Products Co., 1911-K4, Irving Park, Chicago.

REGAL Keyless Spare Tire Lock—newest, greatest auto invention. Quick, easy seller. Tremendous money maker for agents. Buffalo tires. Cannot be picked—forced—sawed—filed or nicked. Opens only by secret combination. Simple for owner—he just moves combination till letters on discs spell secret word and presto! it opens. Safer than a safe. Every motorist buys. Low price. Unlimited guarantee. Nothing like it. Novel features and safety attract customers. Sell motorists and dealers—make \$2.66 per sale. Write quick. Regal Keyless Lock Co., 1369 N. Wells St., Dept. 10, Chicago.

AGENTS—Earn \$25 to \$100 weekly introducing Ho-Ro-Co. toilet goods, extracts, and household necessities. Men or women wanted for full or spare time. Ho-Ro-Co. Tonic and Medicated Skin and Scalp Soap are great profit makers. Repeat orders easy and sure. Over 100 other fast sellers. Free sample case offer; free samples and advertising matter. Write today. Ho-Ro-Co. Mfg. Co., 188 Locust St., St. Louis, Mo.

AGENTS—Best seller: Jem Rubber Repair for tires and tubes; supercedes vulcanization at saving of over 800 per cent; put it on cold, vulcanizes itself in two minutes, and is guaranteed to last the life of the tire or tube. Sells to every auto owner and accessory dealer. For particulars how to make big money and free sample, address Amazon Rubber Co., Amazon Bldg., Philadelphia, Pa., Dept. 505.

AUTO owner the agent wanted each locality to use and take orders for handsome Mellinger fabric and steel tires; guarantee Ford 8,000 and 12,000 miles (no seconds); shipped prepaid on approval; get your tires free; no capital or experience required; make \$100 to \$300 weekly. Write for wholesale prices and sample kit. Address, Mellinger Tire Co., Dept. 100, Kansas City, Mo.

FORTUNE Maker—Thread-Cutting Thread, 1-1/2 wire only. Sample, 15c. Automobile Mfg. Co., 5753 Monticello, Chicago.

WHY work for others? Make and sell your own goods. We show you how. Enormous profits. Write quick for free book explaining everything. National Scientific Laboratories, 211 North Monroe, Richmond, Va.

AGENTS Wanted—\$1.00 to \$10.00 daily taking orders for "Super" and "Junior" Fyr-Fyter Extinguishers on our new Sales Plan. Commissions paid cash daily. Everyone who owns anything that will catch fire is a live prospect. Homes, farms, auto-owners, schools, churches, factories, all need them. Sell on sight. Sales limited only by calls you can make a day. Write today for exclusive territory and free booklet, "Building a Permanent Income as a Fyr-Fyter Representative." Fyr-Fyter Co., 103 Fyr-Fyter Bldg., Dayton, Ohio.

MEN—Women—Fastest selling line. Food Products, Coconut Oil Shampoo, Toilet Preparations, Household Specialties. Sales in every home. Ransell Co. World Building, N. Y.

AGENTS—Send for sworn proof of \$5 to \$15 Daily—Introducing New Style Guaranteed Hosiery—37 styles, 17 colors—no capital or experience required. Just write orders—We deliver and collect. Your pay daily, also monthly bonus. Free auto offer besides. Complete outfit furnished. All colors—grades including silks. Mac-O-Chase Mills Co., Desk 2565, Cincinnati, Ohio.

WANT Distributing Agents everywhere for Hanslick, the new original powdered handsoap. Removes grease, grime, ink, paint, and most anything from the hands without injury to the skin. Every mechanic and auto-owner, everybody who gets his hands dirty will be a customer. A great opportunity for a hustler to get in business for himself. Full information free. Send 10 cents, coin or stamps, for liberal sample can. Solar Products Company, 122 West Lake Street, Chicago.

FREE Sample, "Rain Shield Wiper." Retail \$1.00—Costs 25c (100% Profit). Just invented. Sold on Clear and Rainy Days. Automobiles buy quickly. No Cloth—No Paste—No Attachment. (1) Rub keeps Windshield Clear (48) Hours. Riley made \$108.00, three days. Experience unnecessary. Wonderful Side-Line. NuLife (O) Corporation, Hartford, Conn.

AGENTS—If you are making less than \$300 a month our proposition on Sentinel Burglar Alarms for windows and doors will interest you. Many agents earn \$20 daily. Brand new inventions. No wires, batteries or nails. Instantly attached to any door or window. Handsomely nickel plated. Sell on sight. No competition. Provides cheap burglar insurance. Big money makers. Write today for extremely liberal terms to agents. Sentinel Alarm Co., 110 S. Dearborn St., Chicago, Ill.

WANTED—Tailoring Sales Agent—Make big money from very start—\$60.00 to \$75.00 weekly. Largest made-to-measure tailoring house, furnishing an equipment of five hundred woolsens, wants you to take orders. Satisfaction guaranteed. Biggest merchants in many towns have started with our line. If you want to establish yourself permanently in business and make big money write for full particulars, giving your experience as salesman or tailor's sales agent. H. F. Foster, Sales Manager, Lock Box 153, Chicago.

ROBERT Wrench is a sensation in wrenches. It surprises everybody. Grasps pipes, nuts and bolts any size without adjusting. Over 30,000 sold. You make almost 100 per cent profit. If you call on stores, shops, garages, factories or homes, write us today for full particulars about "The Wrench With The Bull Dog Grip." Robert Wrench Co., 71 Murray St., New York.

AT Last—World's Greatest Adding Machine. Almost human. Retail \$15; work equals \$300 machine, \$50 monthly easily made, demonstrating to stores, offices, garages, factories. Simple, easy; adds, subtracts, multiplies, divides automatically. Speedy, accurate, durable, handsome. Five year guarantee. Tremendous demand; amazing profits. Liberal trial offer. Protected territory. Write quick. Lightning Calculator Corp., Dept. F, Grand Rapids, Mich.

HERE it is—Fifty fast sellers. Everybody needs and buys. Fifty dollars weekly easily made. B. & G. Rubber Company, Dept. 258, Pittsburgh, Pa.

AGENTS and Canvasers: Hundreds of firms looking for you. Write for particulars. Agents Employment Bureau, 314 Shawmut Building, San Francisco, Calif.

\$15.00 DAILY Easy selling Unbreakable Amberoid Combs; kind can hit with hammer, saw wood with the teeth, etc. Top-notch sellers with agents. Many street-men selling over \$100.00 worth Saturday afternoon and evening. You can do as well. Terms and money-making proof free. Oliver Gandy, Crisfield, Md.

\$75.00 WEEKLY with new specialty. Sells on sight to auto owners and trade. One man in Columbus, Ohio, sold 55 gross in 60 days, 100 to 200% profit on small investment. Write today for wonder-selling plan and information. C. L. Winegar, Dept. 13, West Foot Ann, N. Y.

AGENTS—Make \$5.00 an hour; our beautiful silk knitted neckwear sells on sight; latest New York styles direct from mill to you; popular price; instant sale; steady all year round proposition; big repeater; your own territory open. Write today. Knit-Art Silk Neckwear Co., 298 Broadway, New York.

AGENTS—Finest line of silk hose you ever saw. Latest styles and colors. New style guaranteed hosiery for men, women, children. Must give satisfaction or new hose free. Write for samples. Parker Mfg. Co., Sample 278, Dayton, Ohio.

AGENTS—Snappiest household line on earth. Red hot sellers, steady repeaters—100% profit. 500 light weight, fast selling, popular priced necessities. Agent's outfit free. Get busy quick—Write today; postal will do. American Products Co., 8434 American Bldg., Cincinnati, Ohio.

INSYDE Tyres inner armor for automobile tires. Prevent punctures and blow-outs. Double tire mileage any tire. Tremendous demand. Big profits. Sample and details free. American Accessories Co., R-178, Cincinnati, Ohio.

AGENTS: \$50 a month selling guaranteed hosiery in spare time. Mrs. Schurman averages \$15 a week working 2 hours a day. Write for sample outfit. Thomas Mfg. Co., Class 362, Dayton, Ohio.

AGENTS wanted in every state to handle our line of high grade specialties—toilet preparations, food flavors in tubes, kitchen needs. An old well known line. Fast seller, big repeater. Liberal commissions. C. H. Stuart & Company, 5167 B'way, Newark, New York.

SALES Agents. Men or women, \$210 a month. Steady employment. Take orders for Jennings New Guaranteed Hosiery for men, women, children. Written guarantee with each pair to wear and give satisfaction or new hose free. All styles. Finest silk hose. Low priced. Write for complete line of samples. Big roomer for spare time. Jennings Mfg. Co., Dept. 368, Dayton, O.

GREATEST Sensation! Eleven piece toilet article set selling like blazes at \$1.75, with \$1.00 dressmakers' shears free to each customer. Spring rush on. Foster Road Co., 38 Winslow Bldg., Station C, Chicago.

PHOTO Medallion Salesmen: Earn \$100 to \$200 every week selling P. & G. Photo Medallions. No investment—Free equipment. Guaranteed 4-day Service. Send for Sales Plan and Free 1923 Catalogue with 102 beautiful designs, including clock and religious medallions. Puddin' & Goldstein, 259 Bowery, New York, Dept. "A."

AGENTS wanted to sell shirts direct from our factory to wearer. Write for our proposition. Fifty-two years' experience in shirt making. Paul H. Krauss Co., Indianapolis, Ind.

\$3,000 OR more in four months taking orders for sell on sight new home necessities. Saves purchaser hundreds dollars Doctors and Druggist bills yearly. Puzzle contest, \$11,500 cash prizes, free, \$15 sample kit free to live agents. No experience necessary. Full or part time. Research System, 2329 W. Chicago Ave., Chicago.

AGENTS—New discovery makes all Jelly "Jell." Big profits, constant repeater. Sample free. Address, Jig-Jel Company, 865 Grand, St. Joseph, Mo.

WONDERFUL discovery. Charges batteries in ten minutes. Gallon free to agents. Address, Radolite Co., St. Paul, Minn.

WE want a few more men to take orders for our one-price Line of Tailoring, offering All-Wool Made-to-Measure Suits, guaranteed \$50.00 values, at only \$29.75. Summer goods at \$17.50. Every order you take pays you a good profit, in advance. Experience not necessary. Hustlers can clean up big. Write today. Park Tailoring Company, Dept. 615, Chicago, Ill.

AGENTS—\$1.25 an hour spare time near home. Light pleasant work, showing samples and distributing tea, coffee, extracts, soups, food products, things people eat. 19 full-sized packages and complete free outfit to first person in your locality answering. Write quick, Dept. A-37, Harley Company, Dayton, Ohio.

WORLD'S latest cooking utensil, endorsed by Good Housekeeping Institute; sells on sight, \$100 profit. Details free. Write Squire Brocket, 1150 Broadway, New York.

AGENTS—At last! Special machinery enables us to sell our patented curtain rods at the old price of Three Cents each. Big Spring Sellers. Write Home Curtain Rod Co., Providence, R. I.

PICTURE man made \$50,000 pushing bells. Free instruction book teaches my spiel from "Good morning, Lady" to "Thank you, Madam." Prints, Postcards, Frames, \$2.00 Samples Free. Picture Man Friedman, Dept. 8, 673 Madison, Chicago.

MAKE \$1.00 Profit With Only \$1.50 Selling Gold Leaf Monograms for Automobiles, Trunks, Bags, Window and Wagon Letters. Applied Instantly. Experience Unnecessary. Quiff brings \$32.50—Costs \$1.50. You Make \$31.00 Profit. Free Samples (36 Designs). Nullife Auto (A) Aid, Hartford, Conn.

AGENTS make \$10.00 a day or more selling Coffield Tire Protectors. Prevents punctures and blow-outs. Doubles mileage. Easily applied, no cement or tools required. Absolute three-year guarantee. Nothing like them. No capital required. Big commissions paid weekly. No delivering. Get our proposition. Write Coffield Tire Protector Co., 275 Court St., Dayton, Ohio.

\$75-\$150 WEEKLY assured if you hustle. Sell attractive gold signs to stores, offices. Unlimited demand. Experience unnecessary. Free samples. Acme Letter Co., 363 W. Superior, Chicago.

WHY work for others? Make and sell your own goods. We show you how. Enormous profits. Write quick for free book explaining everything. National Scientific Laboratories, 211 North Monroe, Richmond, Va.

HANDKERCHIEFS, "Quality" line. Agents get best factory prices. Write for the plan of this dependable business. Turner Sales Company, 18 East 17th St., New York.

AGENTS—Household necessities galore. food products, toilet preparations, extracts, remedies, soaps; two big lines; catalogues free. Western Products, 604 N. Oakley, Dept. AE, Chicago.

AGENTS wanted—To start a business of their own. Brains and energy the only capital required. Full particulars and working plan by mail for 50 cents. Address P. D. Burda, Mfr., 2000 Olive St., Kansas City, Mo.

SEWING Machine Trouble Charts open all doors. Invaluable psychological aid to all salesmen dealing with women. Wins friendships. Quadruples sales. Mail \$1.25. M. M. Stewart, Box 213, Las Cruces, New Mexico.

AGENTS—\$100.00 weekly, selling tailored caps. Can use limited number of agents. Commissions paid daily. Wonderful free sample outfit offer. We deliver and collect. Send application today. Kramer-Phillips Co., 453 Monon Bldg., Chicago.

AGENTS, control territory. Edjel Flavors, household necessities, perfumes, creams, toilet waters, famous "Edjel's Herb Tablets." Jet Pharmaceutical Co., Allentown, Pa.

\$10 DAILY and more to real workers. New discovery sells like hot cakes to homes, merchants, everybody. Over 100% profit. Popular price. Big repeater. Exclusive territory. Write for Money-Coining sales plan. Denmac Co., Dept. E, 347 Madison Ave., New York.

EARN big money fast applying gold initials to autos. Every owner buys—\$1.25 profit on \$1.50 sale—particulars and samples free. Write quick. Lithogram Co., Dept. 17, East Orange, N. J.

EASY sales, quick returns, 500% profit, selling Coconut Oil Shampoo, Soaps, Extracts, Perfumes, Combination Sets, etc. P. Verdina Co., 200 East 23rd St., New York.

ONLY One Policy Daily Means \$130 per Month Profit. Same on renewals. Policy pays \$5,000 death; \$25 weekly benefit for injury or sickness. Men and women both acceptable. Premium \$10 yearly. Full or spare time. Easy seller. Write quick for territory. Underwriters, Dept. R.L., 194 Market St., Newark, N. J.

AGENTS Sell Harper's Ten Use Household Cleaning Set. Washes and dries windows, cleans walls, sweeps, scrubs, mops, and does five other things. Sells for only \$2.85. Over 100% profit. Free information. Harper Brush Works, 111-A St., Fairfield, Iowa.

BOYS—Agents make \$8.00 daily selling Vexcel oil toilet soap. Free sample. Address: Henry Moritz, 1969 West 17th, Cleveland, Ohio.

LIVE man to distribute for great "Foot Oilment," hand or nail. Odor sells it. Splendid opportunity. Write now. The Elder Co., 294 Parkdale, Buffalo, N. Y.

PATENTS—Write for our free illustrated guide book and Evidence of Copyright Blank. Send sketch or model for our opinion of its patentable nature free. Highest references. Prompt attention. Reasonable terms. Victor J. Evans & Co., 163 Ninth, Washington, D. C.

27,000 RECORDS guaranteed with one Everplay Phonograph Needle; new—different; cannot injure records; \$10.00 daily easy. Free sample to workers. Everplay, McClure Bldg., Desk 56, Chicago.

BUILD a permanent business of your own with the high-grade, quick-selling "Nibeo" Specialties. Exclusive territory. \$10.00 to \$20.00 profits a day easy for earnest salespeople. Send for interesting folder. A. A. Silver-Chamberlin Co., Clayton, N. J.

HOUSEHOLD and office necessity, endorsed by "Good Housekeeping." An article of daily use. Large profits. Everett & Barron Co., Providence, R. I.

100% PROFIT—Exclusive Territory. Earn latest model Ford and \$75.00 to \$100.00 weekly selling Merrimotor Products. Merrimotor Parts Company, 1726 S. Michigan Ave., Chicago, Ill.

REX India Fibre Broom: One of the biggest sellers on market. Outlasts five ordinary brooms—price no higher. 100% profit. Rex Fibre Products Company, 145-C New Jersey Ave., Brooklyn, New York.

MEN and Women Wanted. Big Money sure and quick selling Dr. Blair's famous toilet and household preparations. Permanent business. Exclusive territory. Complete line. Remarkable Selling Outfit. Investigate. Write today. A. B. Blair Laboratories, Lynchburg, Va.

BIG Money and Fast Sales. Every owner buys Gold Initials for his auto. You charge \$1.50; make \$1.25. Ten orders a day easy. Write for particulars and free samples. American Monogram Co., Dept. 40, East Orange, N. J.

OUR Ex-Cel Luminous Crucifix "shines brilliantly in the dark." Sells on first demonstration. Big profits. W. G. Hannan Co., Dept. B, 57 E. 18th St., Chicago.

LIVE Agents make \$10 Day selling Eureka Strainer and Splash Preventer for every water faucet. Takes on sight. Widely advertised and known. Get details today. A. B. Seed Filter Company, 73 Franklin, New York.

SPECIALTY Salesmen making \$10.00 daily selling Ball Valve Non-Splash Water Filters on sight. Best canvassers' article ever put on market. Write for details. C. A. Shinn, Manufacturer, 73 Franklin, New York.

"\$10 A DAY and More." our new book, shows clearly how you may gain sure success and large profits selling Guaranteed Hosiery and Underwear, factory to family. It is Free. Write today. C. & D. Company, 41-E Grand Rapids, Mich.

AGENTS—Ezy Repair Links sell to every autoist on sight. You can coin money with a pocketful every day. Take my word. Get details quick. You'll win. E. N. Elzey, Ezy Link Company, Parkersburg, W. Va.

FREE—Formula Catalog. S. & H. Laboratories, Boylston Building, Chicago.

BIG Profits With Exclusive Territory—\$50 to \$100 weekly easy. More has been made repeatedly in one day's work. Wonderful intention delights householders. Automatic hot and cold water bath outfit without plumbing; only \$7.50. Eager buyers everywhere. Send no money. Terms. Write today. Allen Manufacturing Co., 698 Allen Bldg., Toledo, Ohio.

AGENTS—\$3 per hour and more!! Sell Iron Board Covers, Rubber Aprons, Shopping Bags, Embroidered Aprons, Sateen Corset Dresses. Free Sample offer! American Braiding Company, Dept. P, 320 W. Monroe, Chicago.

AGENTS—C. T. A. prices reduced again. Suits \$18.00 made to order, any size or style. Orders easy to get. Big profits. Sample outfit free. Write Chicago Tailors Ass'n, World's largest tailors, Dept. 207, Station C, Chicago.

\$75-\$150 WEEKLY assured if you hustle. Sell attractive gold signs to stores, offices. Unlimited demand. Experience unnecessary. Free samples. Acme Letter Co., 363 W. Superior, Chicago.

AGENTS—\$10.00 daily on side. Factory. Office employees—milk, grocery, laundry, butter deliveries, collectors, sell soaps, flavoring, toilet goods. Experience unnecessary. Bick Co., 118P Olive, St. Louis, Mo.

WE start You Without a Dollar. Soaps, Extracts, Perfumes, Toilet Goods. Experience unnecessary. Carnation Co., Dept. 201, St. Louis.

MEN'S Shirts. Easy to sell. Big demand everywhere. Make \$15.00 daily. Under-sell stores. Complete line. Exclusive patterns. Free samples. Chicago Shirt Co., 9 So. Clinton, Factory 205, Chicago.

WANTED—Representatives to sell Automobile necessity. Kills headlight and sun glare. Write for sample. Dept. P, The Clark Products Co., Springfield, Ohio.

AGENTS make a dollar an hour. Sell Mendels, a patent patch for instantly mending leaks in all utensils. Sample package free. Collette Mfg. Co., Dept. 404-B, Amsterdam, N. Y.

AGENTS—Clean up \$100 Weekly With "Nifty Nine." Weekly average, 100 sales—dollar profit each. 30-40 sales daily frequently made; demonstrating outfit clinches order. 30 other coin-coaxers, all daily necessities. Postal brings our unique plan. Davis Products Co., Dept. 506, Chicago.

"FIFTY "Ideal" Sidelines for Mail Dealers and Agents, 500% profit. K. Home, 1957 Warren, Chicago.

AGENTS—Sell Patented Cigar Lighters and Cigar-Case Moisteners. Big Profits. Start making money at once. Write for circulars, cuts and sales plan. Drake Mfg. Co., Dept. M, Milwaukee, Wis.

ANY man handy with paint brush or light tools can start new mechanical business on nearly nothing; needed everywhere; nearly all profit; experience not required. John Broadland, 1457 So. Ninth, Philadelphia, Pa.

SALES position open to live aggressive agents; local territory; high commission. Advancement if successful. Pome, Box 929, New Orleans, La.

CABBAGE Cutter, 5 knives, slices 20 vegetables, finer than aluminum; never dulls. 20,000 users. Cincinnati alone; endorsed by Good Housekeeping Institute. Sample 48c. Meyer Cutter Co., Orland Ave., Cincinnati, Ohio.

AGENTS to sell high-grade men's neckwear direct from manufacturer to consumer. Big profits, quick sales, free samples. S. Jachel, 2831 Third Ave., New York.

FACTORY representatives to sell 3 auto accessories; big demand; exclusive rights open; men who have been used to making \$10 to \$30 day wanted; 30,000 sold in Chicago alone 1922. Write general experience and qualifications. Allen Specialty Co., 2751 W. Lake St., Chicago.

PORTRAITS, photo pillow tops, frames, sheet pictures, medallions, merchant's signs, water-proof and tea aprons, guaranteed hose, toilet requisites, luminous crucifixes; catalog, 50 specialties free, 30 days' credit. Jas. C. Bailey Co., Desk M-5, Chicago.

FOUR \$7.50 sales to merchants net you \$20.00 daily; largest manufacturer of its kind in the World, Sayers Systems, 2815 Sheffield, Chicago.

AGENTS—Men and Women to sell direct to Consumer, well-known line of Guaranteed Hosiery for Ladies, Men and Children, All Grades. We pay Big commission and teach you how to sell. Immediate delivery. Write today. Lynx Knitting Mills, 72-P Leonard St., New York.

PORTRAIT Agents—If you are looking for a better grade of work, we can satisfy you. Our enlargements have that finished appearance together with perfect likeness, which makes it a pleasure to deliver, and best of all our prices are not high. Export work a specialty. W. G. Hannan Co., Dept. A-5, 57 E. 18th St., Chicago.

AGENTS—Big profits. Genuine Gold Leaf Window Letters anyone can put up. Scripts and 57 varieties. Chicago Agency Co., 842 Altgeld St., Chicago.

PORTRAIT Agents and Others. Get Big Profits. Sell Perry Photo Medallions. You charge \$2.98; make 400% profit, \$10 daily easy. Big exclusive line. 4-day service. Perry Photo Novelty Corporation, Section 16, 360 Bowery, New York.

PORTRAIT Agents: Our goods will make you big profits. Delivery guaranteed. Refunds credited. Prompt shipments. Send for latest catalog and prices. Adam J. Krull & Co., 662 Blue Island Ave., Chicago, Ill.

MAKE \$25 to \$50 Week representing Clows' Famous Philadelphia Hosiery, direct from mill—for men, women, children. Every pair guaranteed. Prices that win. Free book "How to Start" tells the story. George Clows Company, Desk 31, Philadelphia, Pa.

AGENTS, salesmen, dealers! Guaranteed indestructible French pearls, unusually beautiful color, 24 inches long, in handsome velvet box, satin lined. These are most unusual and can be furnished promptly, insured parcel post, at \$66.00 per dozen. You can sell a dozen strands in one day at double this price. Earn some real money—start now! Don't let "the other fellow get it all." Sample strand, \$3.50. J. Bennett, 1040 Lawrence Ave., Chicago.

AGENTS and Salesmen calling on garages and repair shops can make 300% selling a small staple article used in every shop. This is not a once-over proposition. Colwell Machine Works, Norfolk, Neb.

FREE Book, Start Little Mail Order business, Home employment certificate. Pier, 217-A, 74 Cortlandt St., New York.

OFFERS from firms throughout country. Send 2c stamp. Capital Service Agency, 427 P Street, N. W., Washington, D. C.

AGENTS—Steady Income. Large manufacturer of Handkerchiefs and Dress Goods, etc., wishes representative in each locality. Factory to consumer. Big profits, honest goods. Whole or spare time. Credit given. Send for particulars. Address: Freeport Mfg. Co., 59 Main St., Brooklyn, N. Y.

AGENTS can easily make 900%. 15c packages Sweetest Sachet for \$5.00. Complete instructions 25c. Address J. B. Fogal Co., Ashbury Park, N. J.

AGENTS—Genuine Gold Letters anyone can put on Store Windows. Guaranteed to not tarnish. Large profits. Enormous demand. Free samples. Write today. Genuine Gold Letter Co., 429-A North Clark, Chicago.

THREE Brite Lites Cleaning-kom—Rust-1-Chlo—Removes Rust, Furn-A-Tone, Tones Woodwork, Glass Brite—Clean Glass Right, Literature Free, Sample Set postpaid, 50c. The Rusticide Co., Cleveland, Ohio.

SIGN Agents: Bigger profits, putting up our patented flexible genuine gold leaf letters. Something entirely new. Look exactly like hand gilded work on glass. Sell on sight. Write for folder A and free samples. Realart Sign Letter Co., Lock Box 855, Chicago.

WHY work for others? Make and sell your own goods. We show you how. Enormous profits. Write quick for free book explaining everything. National Scientific Laboratories, 211 North Monroe, Richmond, Va.

EASY To Make \$10.00 Daily. Samples Free. New inventions. Sponge Dusting Cloths, Velvet Metal Polishing Cloths, Brushes, Dusters, Mittens. Sell Homes, Automobiles, Stores. No Competition. NuLife Home (E) Aid, Hartford, Conn.

WORLD'S fastest agent's seller. 300% Profit. Needed in every home and store. Established Permanent business. Premier Mfg. Co., 813 E. Grand Blvd., Detroit, Mich.

EASY applied Transfer Lettering. Big Money proposition. Samples Free. Address Auto Monogram Supply, 14 Green St., Newark, N. J.

100% PROFIT each 50c Sale. Nearest competitor \$1.50. Indispensable to drivers. Sell to owners and chauffeurs. Valuable and profitable territory for workers. Quick action. Perkins, 359 Broadway, New York.

NEW invention: reduces gas bills 50%; big money for agents; write quick. Allied Products Co., Box MP, Waterloo, Iowa.

AGENTS wanted to sell our Keyless Padlock. Write today. Exclusive territory on easy terms. Sorel Lock Limited, Sorel, Que., Canada.

MANUFACTURER of rubber goods specialties for women makes it possible for Agents to sell every home. \$10 to \$15 daily. Free Catalog. American Rubber Products Co., Dept. 508, Pittsburgh, Pa.

AGENTS and Side Line Men—Newly patented article. Big money, quick sales, no competition. Act quick. Hartogh & Beaudin Co., Duluth, Minn.

WANTED—District Purchasing agents, experience unnecessary. National Instrument Co., 4704 North Hamilton, Chicago.

AGENTS—Ever-Grip repairs Auto tubes instantly. Quick, easy demonstration means sure sales. Goes like hot cakes at price that eliminates competition. Big profit. Rush season just opening. Address W. B. Williams, Dept. 1812, Montclair, N. J.

YOU can be your own boss with our Key-Check outfit. Good for \$5 a day stamping names on pocket key checks, fobs, etc. Sample check with your name and address. 20 cents. Pease Die Works, Dept. M, Winchester, N. H.

SELL Wall Emblems. Every Lodge Member wants one. Big money—all or spare time. Free sample and cash bonus plan. Kier Emblem Co., Dept. PM-3, 538 So. Clark, Chicago.

AGENTS: Big Money Monogramming by Transfer Method. Catalog Showing Over 50 Styles and Particulars Free. Motorists' Accessories Co., Mansfield, Ohio.

VANILLA—(non alcoholic) make $\frac{1}{2}$ pint 20c. sell for \$1; 12 other flavors. Labels, Flavor, etc., furnished. Sample Free. Lawrence Chemical Co., Marietta, Ohio.

AGENTS! A sale in every home for our beautiful dress goods, silks and general yard goods. Quick sales! Big profits! Large book of nearly 1000 handsome fabric samples furnished to agents. Write today. National Importing & Mfg. Co., Dept. 6X, 573 Broadway, New York, N. Y.

YOU Can Make Good Durable Paint and Varnish 500 per gallon. Write Dept. 2, Emanuel Bros. Mfg. Co., Indianapolis Ind.

POLMET Polishing Cloth cleans all metals; retails 25c; sample free. Gale & Co., Inc., 15 Edinboro St., Boston.

AGENTS Wanted—To sell Instant-Servec salt and pepper shakers. Write us today for amazing offer. Free folder. The Oster-Barr Co., Rockford, Ill.

MAN in each town to plate auto parts, reflectors, bathroom fixtures, refinish beds, mirrors, chandeliers; by new method. No capital or experience required. Simple plan of manufacturing at home starts you in big money-making business. Outfit furnished. Free particulars and proofs. Gun Metal Co., Ave. H., Decatur, Ill.

500% PROFIT selling Genuine Gold Leaf sign letters. Guaranteed never to fade. Easily applied. Experience unnecessary. Wonderful future. Free Samples. Guarantee Sign Service, 363 W. Superior, Chicago.

AGENTS—Stamping names on Pocket Key Protectors; sample Check with your name and address, 25c. Stamping Outfits, Emblem Checks, Check Fobs, Name Plates. Hart Mfg. Co., Desk 2, 303 Degraw St., Brooklyn, N. Y.

AGENTS—Slo-Melt Ice Blanket cuts ice bills one-half. Large profits. Season now. Write Hendrickson, 1126B West Third Street, Duluth, Minn.

AGENTS, men and boys, who understand Baseball can earn money in their spare time. Bartel Prokesch, Inc., 359 Canal, New York.

MILLION Dollar Business, nationally known, wants one man to take charge each county. 75 Different household necessities. "Sure-Shot" selling plan with Free Gift makes sales easy. Wizard Products Co., 140 W. 37th St., Chicago.

OUR Agents make \$12 to \$20 every day and are getting it with new invention that sells to everybody. Low Price. Pocket sample. Write Edward Suren Company, 25 N. Dearborn St., Chicago.

AGENTS: Big profits, Best and cheapest window letters made. Easily applied. Dime brings five samples. Particulars free. Stalbrite Co., 1115 Second Ave., New York.

LARGE manufacturer wants agents to sell guaranteed made to measure raincoats. Galardines and Reversible top and raincoat combined. Make \$75 to \$100 weekly. Profit in advance. We deliver and collect. Outfit free. Standard Raincoat Co., 163 West 21st Street, New York, N. Y.

300% PROFIT. Sell best washing tablet made. Big repeater. No experience required. Send \$1.00 to cover postage, wrapping, for large beginner's outfit. Details free. Products Company, Glen Ellyn, Ill.

AGENTS, Secure exclusive agency for your city. High-class, permanent proposition, worth \$10,000 yearly. No investment, everything furnished. Address Box 1422, New Haven, Conn.

MORE Money For You; Agent's Magazine Three Months, 25c, including "Supply Guide." Mail Order Propositions, Harvey Teeple, Decatur, Ind.

AGENTS—\$15 a day—Easy, quick sales —Free Auto—Big weekly Bonus—\$1.50 premium Free to every customer. Simply show our Beautiful 7-piece, Solid Aluminum Handle Cutlery Set. Appeals instantly. We deliver and collect. Pay daily. New Era Mfg. Co., 803 Madison St., Dept. 21-M, Chicago.

MAKE Big money selling delicious puddings, polishing cloth, stain remover, 100 other topnotch sellers. Equipment free. Write, Newton Co., 11 Main, Newark, N. Y.

SELL Necessities. Everybody needs and buys the "Business Guide." Bryant cleared \$500.00 in July. Send for sample. It's free. Nichols Co., Box 4-B, Naperville, Ill.

EASY, pleasant work for Moctanles, Shop Men, Clerks, during spare hours; will add many dollars to their salaries. Also want persons who can give full time. Big wages assured. Novelty Cutlery Co., 67 Bar St., Canton, O.

AGENTS—N-R-G Laundry Tablets, the old reliable moneymaker for live agents. Millions sold—used in many homes—sales waiting for you. Clothes washed spotlessly clean in 10 minutes without rubbing. Free samples. N-R-G Company, 732-A N. Franklin, Chicago.

AGENTS: Big Returns, fast office sellers; particulars and samples free. One Dip Pen Co., 2 Daily Record, Baltimore, Md.

A BUSINESS of your own; Make Sparkling glass name plates, Numbers, Checkerboards, Medallions, Signs. Big Illustrated book Free. E. Palmer, 507 Worcester, Ohio.

AGENTS make \$10 daily—Big line guaranteed extracts, food products, perfumes, toilet goods, household necessities. No capital or experience needed. Free sample case and instructions. Write for amazing offer. Perkins Products Co., Desk 6, Hastings, Neb.

IF you need good live agents—fellows who can get the business—ask me how others are doing it. I'll gladly render the necessary assistance. J. Roy McClellan, Mgr. Classified Advertising, Popular Mechanics Magazine, Chicago.

AGENTS—Mason sold 18 Comet Sprayers and Autowashers one Saturday. Profits \$2.50 each. Particulars free. Established 30 years. Rusler Co., Johnstown, Ohio, Dept. D.

EARN \$10 daily silvering mirrors, plating and refinishing metalware, autos, chandeliers, bedsteads, headlights. Outfit furnished. E. Decker Laboratories, 1133 Broadway, New York, N. Y.

\$100 WEEKLY. Agents, Crew Managers. Absolutely new article selling big to housewives. No capital required. Commissions paid in advance. No collections. No delivery. Exclusive territory. Write quick. Pioneer Corp., 4301 Yale Ave., Chicago, Ill.

\$15.00 DAILY selling Radio Gas Lighter. Sells on sight. No matches or friction required. Sample, 10c. Rapid Mfg. Co., 10 E. 14 St., New York, N. Y.—Dept. P.

NEW Office Article. Works like Magic. Rempe Mfg. Co., 2827 Myrtle St., Oakland, Calif.

AGENTS—Sell Neverfail Iron Rust and Stain Remover. Huge profits. Big line. Sample. Write today. Sanford Beal Co., Inc., Newark, N. Y., Dept. 6.

AGENTS make 500% profit handling Auto Monograms, New Pictures, Window Letters, Transfer Flags; Novelty Signs. Catalog Free. Write Hinton Co., Star City, Ind.

AGENTS and Canvassers, write for particulars about the Japanese Fountain Pen. \$1.25. It makes carbon copies, has beautiful finish, wonderful quality. Wholesaler, New Richmond, Wis.

AGENTS—Clever Invention! Inkspoon makes every pen a fountain pen. Fast office seller; big profit, demand increasing everywhere. Exclusive territory offered. Sample free. H. Marui Company, Tribune Bldg., New York, N. Y.

\$50-\$150 A WEEK. Free Samples Gold Window Letters Easily Applied. Liberal Offer to general agents. Enormous demand. Metallic Letter Co., 428 N. Clark St., Chicago.

DON'T Risk One Penny for Anyone's Formulas for Information to "Make and Sell your own Goods" till I've sent you my Valuable Literature and Many Formula Lights of Guaranteed Reliable Formulas for Manufacturing Biggest Selling Specialties in all lines. Highest References. Twenty-six years supplying the Best. Miller Chemist, 805 De Leon, Tampa, Florida.

CALIFORNIA Rosebuds selling like hot cakes. Agents coinng money; new stuff. Big profits. Catalog free. Mission, 2421-PM, Smith, Detroit.

WHY work for others? Make and sell your own goods. We show you how. Enormous profits. Write quick for free book explaining everything. National Scientific Laboratories, 211 North Monroe, Richmond, Va.

SELFOLITE—Agents. Street men—Selfolite lights any fire while user sleeps, or any time. Performs surprising stunts. Newly patented. Sample 25c, postpaid; money back. Particulars. Kaytwo Mfg. Co., C195 Station A, Boston, Mass.

MOST Wonderful Seller. 96c profit every dollar. No stock to carry. License unnecessary. Sample free. Mission, 2421-PM, Smith, Detroit.

GET Our Free Sample Case—Toilet articles, perfumes and specialties. Wonderfully profitable. La Derma Co., Dept. A, St. Louis, Mo.

SELL our "guaranteed" granite and marble memorials. Hundreds of prospects in your territory. Big commissions, easy sales. Write for proposition. Etowah Monument Company, 214 Confederate Avenue, Atlanta, Georgia.

EVERYBODY buys printing; anybody can sell ours. Social stationery, business, professional cards specialty. Liberal commissions. Forman Printery, Dept. 75X, Plantsville, Conn.

PROTECT your rights—Write for "Record of Invention" and booklet about Patents. Prompt personal service. Advice without charge. J. Reaney Kelly, 612-G Columbian Building, Washington, D. C.

PATENTS procured. Send sketch or model today for examination, prompt report and advice. No charge for preliminary advice. Write for free Booklet and blank form on which to disclose your idea. Highest references. Promptness assured. Clarence A. O'Brien, Registered Patent Lawyer, 562 Southern Building, Washington, D. C.

AGENTS—To sell Herith Auto Specialties. One hundred per cent profit. Agent should have Car and some selling ability. O. B. Herith Mfg. Co., Hartford, Conn.

GET posted—Good prices paid for butterflies, insects. See Sinclair display advertisement, page 16.

SELLS Like Lightning; Big Money; New Ironing Wax Pad and Asbestos Rest; Clamps Board; Perfumes Cloths; Outfit, 10c. Yankee Mfgs., 380 Atlantic Ave., Brooklyn, N. Y.

AGENTS—Good salary and commission selling "Ratskill," new rat and mouse exterminator; ready for use; no bait required; non-poisonous; rodents die outside premises; no odor. Empire Specialties Co., 1549 N. Wells, Dept. 301, Chicago, Ill.

SLIDEMUP—Expanding Kuff Buttons. Great Shirt Savers, wonderful convenience, sample pair sent C. O. D., \$1.00. Fifty other High Grade Jewelry specialties. Big profits for Jewelers, Master Jewelers, Sheboygan, Wis.

BIG Proposition; Agents Wanted; Article sells at every house. Particulars free. Write, Utility Manufacturing Company, Norwich, Conn.

AGENTS—\$20 daily distributing bamboo self-filling fountain pen; just out; sample free. Address, Sports Co., LeSueur-Center, Minn.

FISH Bait Guaranteed, 25c. Agents and Dealers, eight packages, \$1.00. Green, 312 Northwestern Ave., Springfield, Ohio.

AGENTS—Pay yourself and others real Money. Buy and sell German Marks, Crowns, Rubles and all kinds of currencies. Write for free dealers' quotations. George Grigolett, 20 E. Jackson, Chicago.

"HOW to Sell Patents" free. Patent News-O, Washington, D. C.

GOLD Leaf Sign Letters; make and sell; profits exceed 1,000%; immense demand; particulars free. Johnston Co., Quincy, Ill.

AGENTS—make 50 to 100% profit, selling our complete line of rugs. Tremendous demand. Thousands of dollars being made by agents. Territory protection guaranteed. Eastern Mills, Everett, Mass.

EASTEST Seller Out—Lucky Charms, \$6.00 Gross, Sample 10c. Also Pencil Sharpeners, Hutter Specialties, Milton, N. Y.

FORMULAS, Trade Secrets—Different, dependable, Catalog free. S. Thaxby Co., Washington, D. C.

AGENTS, control territory. Edjol Flavors, household necessities, perfumes, creams, toilet waters, famous "Edrol's Herb Tablets." Jet Pharmaceutical Co., Allentown, Pa.

ENORMOUS Profits, absolutely new patented household necessity. Everybody wants it. Rapid easy seller, exclusive territory. No competition. National Manufacturing Company, Room 2512, 3713 Euclid Ave., Cleveland, Ohio.

FORD Owners Ride With Us and sell Monarch Cantilever Shock Absorbers. Spring business opening up. Write immediately for exclusive territory money-making proposition. Sold on money-back guarantee. Monarch Mfg. Co., 625 W. Jackson St., Chicago.

PORTRAIT Agents. Our bromide prints are so good that we can guarantee them. United Print Co., Station D, Chicago, Ill.

AGENTS. Few territories still open for agents to handle select line of moccasin-shoe footwear. \$29.00 a day easily made. This is a patented line, no competition. Your section may still be open, write or wire at once. Dura-Tex Co., Dept. I, Brockton, Mass.

OUR sparkling plate glass house numbers, Desk and Window Signs, sell like hot cakes. Enormous profits. Write for particulars. F. Coleman, 223 Bagley Ave., Detroit, Mich.

HECK-O-BRIGHT Polishing Cloth Sell Fast at 25c. Sample Free. Heckman Bros., 3125 Northwestern Ave., Indianapolis, Ind.

AGENTS—W. F. Omels, a former brush salesman, made over \$5,000.00 during 1922 selling our \$1.50 kitchen specialty. He is now a district manager. We are offering you the same proposition—an opportunity as big as you want to make it. You can do what Omels did. Write today to M. H. Tyler Mfg. Co., Manager's Desk, Muncie, Ind.

CLARKE made \$18 an hour selling vest-pocket windshield cleaner needed by every autolite, motorman, engineer; one rub keeps glass clear 24 hours; 60,000 sold; amazing proposition free. Security Mfg. Co., Dept. 662, Toledo, Ohio.

RAINCOAT Agents. Get Our Prices. Sell made-to-measure raincoats. We deliver and collect. Outfit free. World Raincoat Co., 659 Morris Park Ave., New York.

SENSATIONAL new vest pocket cigar lighter. Retail \$1.00 Triple plated, fastens to watch chain. Agent's sample and particulars, 61c. C. Thomas, 5234 Harrison, Chicago.

AGENTS: \$5 per hour taking orders for our Union Made raincoats. Outfit and out, \$2.98. We deliver and collect. Particulars free. Eagle Raincoat Co., 510 Lee Bldg., Chicago.

FORDS use kerosene and start instantly with new Super Carburetor. Seward's profit, one day, \$74.00, write quick. 1396 Super, 1301 Fondulac, Milwaukee, Wis.

SELL "AMENZ" Shirts. Wonderful opportunity for big profits. Made-to-measure and Stock Shirts; finest materials. Write for details. Menin Shirt Co., 3863-A Third Ave., New York, N. Y.

AGENTS—Crew men, novelty men. Gloo-Pen, a 50c mullage fountain pen; everybody buys on demonstration. Write for big profit plan. Gloo-Pen Co., 75 (PF) Front St., New York.

HIGH-GRADE SALESMEN WANTED

TAILORING agents wanted to sell all wool suits tailored to order, \$29.50, all wool tropical worsteds two-piece suits—\$19.50, palm beaches, \$17.50. We believe this is the last and biggest value line in America for the man who believes in pleasing his customers and getting repeat business. To such men we will gladly send full information about our selling plan. Address Sales-Manager, J. B. Simpson, Dept. 551, 831 W. Adams St., Chicago.

AGENTS—Send for sworn proof of \$5 to \$15 daily—Introducing New Style Guaranteed Hosiery—57 styles, 17 colors—No capital or experience required. Just write orders—We deliver and collect. Your pay daily, also monthly bonus. Free auto offer besides. Complete outfit furnished. All colors—grades including silks. Mac-O-Chee Mills Co., Desk 3045, Cincinnati, Ohio.

WANTED—Financially responsible men of high calibre who can assume and direct the entire state or county sales for a new exceptional device of great utility. Our proposition enables you to sell Jobbers, Dealers or direct to autoists, factories, garages, farmers, mechanics, etc. Sawyer, state representative, makes \$1,683.23 profit first month. Men who are accepted will be granted exclusive territory and are given active sales co-operation. Write to Sales Manager, Park Metalware Co., Inc., Dept. 6, Orchard Park, N. Y.

SALESMEN—Earn the highest possible pay. "Dig in" and learn how. Choose between routine work at low wages and a responsible position at handsome earnings. Win success thru practical training by practical salesmen. We help you to money-making positions. Write, American School of Salesmanship, 408 Circle Bldg., Indianapolis, Ind.

BEST Seller: Jem Rubber Repair for tires and tubes; super-rubber vulcanization at saving of over 800%; put it on cold, vulcanizes itself in two minutes, guaranteed to last life of tire or tube; sells to every auto owner and accessory dealer. Get particulars how to make big money and free sample. Amazon Rubber Co., Philadelphia, Pa., Dept. 518.

SALESMEN—Become Independent. Own your business; experience unnecessary; selling our \$7,500 Accidental Death, \$50 Accident, \$25 Sick Weekly Benefits; \$12.50 yearly; other amounts proportionate. Guaranteed steady income from renewals. \$250,000 deposited Insurance Department. Registration Dept. A, Newark, N. J.

TAILORING Salesman, all towns, for by far best fitting, richest-looking, soft as silk, all wool, made to order men's suits (smartest) at wholesale price \$27.50. We deliver, collect, furnish advertising, \$80 to \$100 weekly. Tailoring experience unnecessary. Swatch Outfit shipped for free examination. Wholesale Direct Tailors, Dept. 100, Buffalo, N. Y.

TAILORING Salesman, Make \$75 a week selling our strictly all-wool made-to-measure suits at \$29.75. Summer goods at \$17.50. You collect profits in advance and keep them. We supply finest selling outfit in America. Many exclusive money-making features. Tailoring, raincoat and side-line men, part or full time, get in touch with us immediately. Park Tailoring Co., Dept. 616, Chicago, Ill.

\$5.00 PROFIT selling \$7.50 necessity. Sample free. Merchants Ass'n, Minneapolis, Minn.

SALESMEN: If you want \$6000.00 this year write me now. Strong line for retail stores; nationally advertised; liberal weekly advance to producers. Geo. B. Williams, Mgr., 1920 Euclid, Cleveland, Ohio, Dept. 200.

NEW Specialty. All retailers, \$40 a week and expenses guaranteed against liberal commissions. Good steady income from retailers. Address Dept. 4, Box 602, Cedar Rapids, Iowa.

MAKE big money. Surely. Easily. Honestly. Most amazing offer to try out now. We trust you. Belleville Tire Co., Belleville, N. J.

SUBSTANTIAL corporation manufacturing several articles under valuable patents can place several more general sales managers, open branch offices, manage salesmen, \$500 to \$2,000 necessary to finance agency; expenses allowed to Chicago if you qualify. Mr. Inman, 9 South Clinton St., Chicago, Ill.

SIDE-LINE Salesmen: Big profits assured. National organization selling staple specialties to trade or consumer. Send for catalogue and winning sales plan. Ostra Corporation, 114-L East 25th Street, New York, N. Y.

COMMISSION salesman to sell auto specialty calling on jobbers and large dealers. Good opportunity for live wire—others please don't write. Cataract Auto Washer Co., Topeka, Kan.

WANTED: Aggressive salesmen in all sections of the United States and Canada to sell our White Way Shoe Cleaning Gloves, Wire Suede Brushes and Stocking Savers. Every woman and girl is a potential user. Liberal Commission. Give age, experience and territory wanted.

SALESMEN—Side-line pays five to ten dollars a day taking orders for Specialty printed gummed advertising and Match Box Stickers. Write for proposition, samples, etc., today. Hendley's Printery, Rock Island, Ill.

SIGN Letter Agents and Painters: 500% Profit Gold and Silver Sign Letters for Stores and Office Windows. Anyone can put on. Big demand. Free samples. Metallic Letter Co., 431D N. Clark St., Chicago.

CALIFORNIA Rosebuds selling like hot cakes. Agents coinng money. Absolutely new. Big profits. Catalog free. Mission, 2421-8P, Smith, Detroit.

HIGH-GRADE salesmen, Agents and dealers! Why not make some real money handling my imported indestructible French wares—wonderful, rich color, 24-inch strands with 14-K plain gold clasp, in handsome velvet, satin-lined gift case? Can furnish promptly, postpaid, insured, at \$5.50 per strand, or \$46.00 per dozen. You can sell a dozen per day at \$10.00 each. Don't let another fellow in your territory take advantage of this ad when you can do it yourself. Order today! Certified check or P. O. money order only. J. Bennett, 1069 Lawrence Ave., Chicago, Ill.

WERE You Ever Offered a Grocery Store? Our Proposition is Better. You can handle Sugar, Flour, Canned Goods, Dried Fruit, Coffee and entire line of Groceries, as well as Paints, Roofing, and Automobile Oils, with no rent to pay; no money invested; take large orders from samples. Goods are guaranteed and proven quality. Selling experience not necessary. Steady, profitable work for "workers." Address Hitecock-Hill Co., Dept. 204, Chicago, Ill. Reference: Any Bank or Express Co.

GREATEST opportunity for cigar, electrical, drug, grocery and specialty salesmen selling jobbers and retailers nationally advertised Humidifier. Necessary accessory for cigar cases. Something entirely new. Rapid seller. Act quick for protected territory. Herbert Hoyer, Consumers Bldg., Chicago.

EASY to sell Groceries, Paints, Automobile Oils, Roofing, Stock Food to consumers from samples, no capital or experience necessary; steady, profitable work. Commissions advanced. Satisfaction guaranteed. 50 years in business. Write for full particulars, Loverin & Browne Co., Wholesale Grocers, 1775 S. State Street, Chicago, Ill.

EVERETT salesmen earn largest commissions paid by any Woodware Manufacturer. Sell High-Grade Household Woodware to Hardware and Furniture dealers. Big demand. Salesmen wanted in both United States and Canada. You can build up a big business with dealers in your territory. Some of our salesmen average a \$1,000 a month. Write today. Everett Mfg. Co., Dept. Eight, Sault Ste. Marie, Canada.

SALESMEN Can make \$5.00 a day selling our Calendars, Pencils, Signs, Advertising Novelties, Yardsticks, Whistles, etc. Liberal terms. Sells entire year. Fine side line. Local and traveling agencies. Model Calendar Co., Dept. 226, South Bend, Ind.

SELL "Rug Down" snap fasteners, keeps rugs in place, prevents slipping. Dealers quickly interested. Vest pocket sample. Other quick-selling specialties. State experience, references. Empire Notion Co., 72 Madison Avenue, New York, N. Y.

TAILORING Salesmen—Fastest selling line, suits, made to measure—\$29.50—one price, all wool. Profits in advance. Biggest old reliable house, W. D. Smith Co., established 1895, Dept. 11, Chicago.

SPECIALTY Salesmen, if you are convinced that it is "Good Business" to have a fire extinguisher in the home or car when a fire starts, you can sell others. Arrange with us for exclusive territory at a very good income. McMullen Fire Extinguisher Co., 6504 Dubois St., Detroit, Mich.

\$4.00 PROFIT on every \$5.00 sale. "Free Sample"—New Specialty. (Money Getter.) Every Storekeeper, Doctor buys quickly. Commors made \$20.00 First Hour. Dacey made \$35.00 First Day. Experience unnecessary. All territories Now Open. Salesmanager (I), Drawer 596, Hartford, Conn.

SPECIALTY salesmen—look on with us—in our latest expansion move. Just now getting settled in our new location—largest and finest publicity motion picture studio in the world. Just received a bunch of subscriptions from one man on which we paid \$3,800 commissions. This business, largely renewals, was sold during ten days of intensive work. Just send a note for details which point the way to bigger money. Alexander Film Company, 3389 South Broadway, Denver, Colorado.

TRAVELING Salesmen calling on retail stores wanted by large manufacturer to sell wonderful line of business-boosting articles. Year round, fast selling, main or side line. If not earning \$150 weekly, address Elbaser Works, 222 Charles St., Broomville, N. Y.

SALESMEN—Bonded Aspirin Easels. Twenty sales a day will make you \$1,430.00 a month. Send \$1.25 for \$9 case, Prepaid. Tellin Laboratories, LaCrosse, Wis.

\$125 TO \$300 a week. Salesmen with slight knowledge of motors who can reach car owners, can earn \$300 weekly without making a single sale. If they can also make sales, profits may reach \$25,000 yearly. Phillips, 228 W. 29th St., New York.

SOMETHING original! Beadle sold nine merchants—town nine stores. Exclusive features sells "Zim's Peerless" (Collection System). Sells \$7.50. Creditors' Association, E-312, McKnight Bldg., Minneapolis, Minn.

SALESMAN fond of automobiles, who likes to solve their difficulties and make them run smooth, can make a connection worth \$5,000 to \$10,000 in an automotive accessory line. Prefer man without salesmanship experience to good salesman who doesn't like machinery problems. Permanent and will be as big as the man himself. Address Bridgers Corporation, Florence, S. C.

SPECIALTY Salesmen or State Distributors for Auto replacement part. Sells to all leading dealers. Big repeats. Act quick. Good proposition. Keystone Sales Co., Pacific Bldg., San Francisco, Calif.

SALESMEN, sanitary twisted-in-wire brushes—ivory and tortoise shell handles—highest commission, exclusive territory, inexperienced trained. Maxwell Brushes, Inc., 496-498 E. 134th St., New York City, N. Y.

SALESMEN, Sell State Pocket maps, showing auto roads, to advertisers and dealers. Easy to sell. Get our splendid offer. Standard Map Company, 127 West Ohio Street, Chicago.

SALESMEN—New auto tube, seals its own punctures, fully guaranteed. Car owners buy on sight, when demonstration is shown. Harrison Mfg. Co., Hammond, Ind.

HELP WANTED

AGENTS—Send for sworn proof of \$5 to \$15 Daily—introducing New Style Guaranteed Hosiery—57 styles, 17 colors—No capital or experience required. Just write orders—We deliver and collect. Your pay daily, also monthly bonus. Free auto offer besides. Complete outfit furnished. All colors—grades including silks. Mac-O-Chee Mills Co., Desk 2665, Cincinnati, Ohio.

\$1600-\$2300 YEAR, Railway Mail Clerks, Specimen examination questions free. Franklin Institute, Dept. R-21, Rochester, New York.

U. S. GOVERNMENT Positions, \$1400 to \$2300 year. Men 18 up. Become Railway Mail Clerks—City Mail Carriers—Post Office Clerks—Rural Carriers. Steady work. No layoffs. Life positions. Paid vacation. Influence unnecessary. Common education sufficient. Specimen examination questions and list positions obtainable—free. Write immediately. Franklin Institute, Dept. R-3, Rochester, N. Y.

SELL Tailoring—the quickest selling, most profitable line in the selling field. Our one-price line shows 80 all-wool fabrics to sell at \$29.75 for a tailored-to-measure suit. Special showing of Summer-Weight fabrics at \$17.50. Every order pays you good profit, cash in hand. Tailoring experience not necessary. We furnish you handsome selling outfit and most effective selling helps. Write at once. Dept. 617, Park Tailoring Company, 844 W. Adams Street, Chicago.

YOU Are Wanted, Men—women. Government jobs. \$1140-\$2300 year. List positions free. Write immediately. Franklin Institute, Dept. R-21, Rochester, N. Y.

\$1600-\$2300 YEAR, Become Railway Mail Clerks, Specimen examination questions free. Write immediately. Franklin Institute, Dept. R-21, Rochester, N. Y.

GET Government Jobs, Become Railway Mail Clerks—City Carriers—\$1400-\$2300 year. Steady. Common education sufficient. Free particulars. Write immediately. Franklin Institute, Dept. R-21, Rochester, New York.

SILVERING Mirrors, French plate, Easily learned; immense profits. Plans free. Address, Wear Mirror Works, Excelsior Springs, Mo.

\$75 WEEK, Boys—men, Become Automobile experts. Learn while earning. Write Franklin Institute, Dept. R-401, Rochester, New York.

SIGN Letter Agents and Painters: 500% Profit, Gold and Silver Sign Letters for Stores and Offices, Windows. Anyone can put on. Big demand. Free Samples. Metallic Letter Co., 431-D N. Clark St., Chicago.

FIREMEN, Brakemen, Baggage-men, Sleeping car, train porters (colored). \$140-\$200. Experience unnecessary. 810 Railway Bureau, E. St. Louis, Ill.

WE pay big money for painting pillow tops. Simple, easy, quick. Experience unnecessary. Nibleart Company, 2241 Ft. Wayne, Ind.

GET Government, Railway Mail, Postoffice, Clerical positions. Paying \$1,400-\$2,300. Men, Women. Experience unnecessary. Full particulars free. Write G. W. Robbins, Civil Service Expert, 411 Pope Bldg., Washington, D. C.

BE a Finger Print Expert, Demand Increasing. Write for special free offer, American Finger Print System, 1966 Broadway, New York.

SALESMEN—Reliable brand hair nets, big commission, orders, reorders. Betty Ross Hair Net Corp., 32 Union Square, New York.

LARGE corporation wants a Service Man in every town to paste up its signs on store-keepers' windows. Excellent opportunity for reliable party. Steady work. No experience necessary. We also have attractive proposition for agents and salesmen. Guarantee Sign Service, 361 W. Superior, Chicago.

LANDSCAPE Architects earn big money; needed everywhere! Fascinating work. Particulars free. Address Landscape Gardener, 425 Union League Building, Los Angeles, California.

CIVIL Service Courses, \$1.50; Chalk Talk, \$1.25; Fingerprints, \$2.00; Cuno Method, 50c. Other subjects. Mention course interested in. Address Book Exchange, Lowville, N. Y.

SALESMEN, we pay larger commissions than any other Brush House in the country to men selling our line of Sanitary twisted-in-wire brushes. Sanitary Wire Grip Brush Co., 15-17 Mercer St., New York.

GOVERNMENT Railway Mail Clerks start \$133 month; expenses paid. Specimen questions free. Columbus Institute, Dept. E-2, Columbus, Ohio.

INVENTORS desiring to secure patents should write for our book "How to Get Your Patent," tells our terms and methods. Send sketch for our opinion of its patentable nature. Randolph & Co., Patent Attorneys, 629 F. Washington, D. C.

EARN \$10 daily silvering mirrors, plating and refinishing metalware, autos, chandeliers, bedsteads, headlights. Outfits furnished. E. Decie Laboratories, 1133 Broadway, New York.

FREE Plans, Stop Daily Grind, Silver mirrors, headlights, tableware, etc. Clarence Sprinkle, Dept. 28, Marion, Ind.

EARN \$110 to \$250 monthly, expenses paid, as Railway Traffic Inspector. Position guaranteed after 3 months' spare time study or money refunded. Excellent opportunities. Write for Free Booklet CM-46, Standard Business Training Inst., Buffalo, N. Y.

MAKE money writing Photo-plays; details free to beginners. No correspondence course. Producers' League, 230 Wainwright, St. Louis.

WE'LL pay you \$17.50 to \$30.00 weekly to distribute our circulars. If you mean business send \$2.50 for 1,000 circulars and get busy. Money back guarantee. Pettit Brothers, Fairview, Oklahoma.

WRITE articles, stories, news, in spare time for newspapers and magazines. Big pay. Copyright book free. Press Syndicate, 553, St. Louis, Mo.

OUR genuine gold window sign letters are an excellent money-making proposition for handy men. Slann Sign System, Balthuse Ave. E., Detroit, Mich.

LEARN Railway surveying. Easy, new method; two months' study, you can start as assistant, \$120 month, expenses paid; later \$500. Sample lesson free. Biostad Institute, Duluth, Minn.

WANTED—District Purchasing agents, experience unnecessary. National Instrument Co., 4704 North Hamilton, Chicago.

WANTED correspondents at present employed or in business for themselves. Men in touch with the industries of their locality. This is profitable work that will not interfere with your present employment and it does not involve selling. Give full particulars regarding yourself. The Fuerst-Friedman Company, Cleveland, Ohio.

BE a Finger Print Expert—Opportunities opening everywhere. Write National System, 186 East 79th, New York.

\$75 TO \$125 weekly organizing for fastest growing fraternal society. Don't answer unless capable of financing yourself several weeks. Opportunity to control territory with deputies. \$12,000 yearly. Address Order of Stags, St. Louis, Mo.

ALL men, women, boys, girls, 17 to 60, willing to accept Government Positions, \$117-\$190, traveling or stationary. Write Mr. Oment, 101 St. Louis, immediately.

WANTED: Railway Mail Clerks—\$1,600 to \$2,300. Exams everywhere. Write today for full information. Patterson, Civil Service Expert, Box 4025, Rochester, N. Y.

STORIES, poems, plays, etc., are wanted for publication. Good ideas bring big money. Submit manuscripts or write Literary Bureau, 522, Hannibal, Mo.

HOTELS Need Trained Men. Nationwide demand for high-salaried men; past experience unnecessary. We train you by mail and put you in touch with big opportunities. Big pay, fine living, interesting work, quick advancement; permanent. Write for Free Book, "Your Big Opportunity," Lewis Hotel Training Schools, Room 351, Washington, D. C.

GET posted—Good prices paid for bulletins, inserts. See Standard display advertisement, page 16.

SECURE a better position with an expertly written application letter. To competent people; service guaranteed or no fee. Letter and service, \$3. Beard, 63 Grafton Ave., Cortland, N. Y.

SOUTH AMERICA. Names of prospective Employers, \$1.00. Foreign Service, 904 Carey, South Bend, Ind.

GOVERNMENT has openings for Railway Mail Clerks, Post Office and other help; good pay \$1,100 to \$2,300. Examinations everywhere. Write for our free 36 page book, "A Good Job With the Government for You," A. E. Waterman, B-41 Kesner Bldg., Chicago.

RAILWAY Mail Clerks. Postoffice and other help wanted by Government, \$1,100 to \$2,300. Examinations everywhere soon. Write today for full information. Chicago Civil Service College, A-41 Kesner Building, Chicago.

FOR ADVERTISERS

INCH display. 100 magazines, \$4.00, three issues \$8.00. Pennell Company, Covington, Ky.

INCH display advertisement 100 magazines, three \$8. Book Agency, 5400 Alaska, St. Louis.

COMMERCIAL Engraving and Printing—the most practical and complete book on engraving, printing and allied subjects ever published. Over 800 pages and 1,500 illustrations presenting over 3,500 distinct ideas on 35 separate subjects. Cloth, Price \$15.00—prepaid. We highly recommend this book. Popular Mechanics Book Dept., 200 E. Ontario St., Chicago.

ADVERTISE in 24 Big Sunday Newspapers, 25 weeks \$15.00. Catalog listing 1,000 leading Dailies, Weeklies, Magazines, 4c stamps. Union Advertising, Baltimore Bldg., Chicago.

ADVERTISERS! I write clever money-making ads that bring big business. Also circulars, folders, booklets, etc. Very reasonable. "Adservice," 491 Wash. Ave., Muskegon, Mich.

IF its advertising write Jacinius Advertising Service, Irvington, New Jersey.

INTERNATIONALIZE Your Business!!! Sell—Trade!—Buy! Everything!—Everywhere!!! \$1.00 incl; 1c word. Circulation worldwide! Copy 10c. Eight Months (trial only), 25c. International Opportunity, 2470 First Ave., New York.

MAILING LISTS

200 FEBRUARY, 1923, names, \$4.00; 500, \$7.00. Pennell Company, Covington, Ky.

LITERARY SERVICE

MAKE money writing stories. Your manuscript criticized, revised, edited, typed, sold. 20 years' experience. Write for terms. F. C. Hill, Suite M, 150 Nassau St., New York.

TYPEWRITERS AND SUPPLIES

UNDERWOOD Typewriters at far less than manufacturers' price; rebuilt, all worn parts replaced, guaranteed good as new. Cash, installment payments. Write for Catalog 1515. Shipman-Ward Mfg. Co., estab. 1892, Montrose and Ravenswood Ave., Chicago, Ill.

TYPEWRITERS, all standard makes, \$10 up. Fully guaranteed. Free trial. Write for Illustrated Bargain List. Northwestern Typewriter Exchange, 329 West Gothic St., Chicago.

ALL makes refinished, rebuilt and guaranteed ten years; shipped thirty days' trial. Underwood, Remington, Monarch, Oliviers, others \$15.00 up. Get our catalogue and agents' proposition. Typewriter Exchange, 2316 University Ave., New York City, N. Y.

ADDING MACHINES

FREE Trial. Marvelous new Adding Machine. Adds, Subtracts, Multiplies, Divides, automatically. Work equals \$350.00 machine. Price only \$15.00. Speedy, durable, handsome. Five-year guarantee. Used by largest corporations. Write today for catalogue and free trial offer. Lightning Calculator Co., Dept. E, Grand Rapids, Mich.

DUPLICATORS AND DEVICES

"MODERN" Duplicators save Time, Labor and Money. Gets Business, Reproduces Typewritten or Printed Letters, Drawings, Lessons, Music, Menus, Bills, Notices, Specifications, Maps or anything in one or more colors. Prints Ten per minute. Special Sale On 30 Days' Free Trial, \$2.25 up. Booklet Free. J. E. Durkin-Reeves Co., Pittsburgh, Pa.

YOU can make 50 to 100 copies of a letter, notice, etc., at a cost of three cents on a Hoyer Quality Duplicator. Write for free trial offer. The Hoyer Duplicator Co., 162 N. Wells St., Chicago, Ill.

STENCIL Duplicator—Two Dollars. Print Typewriting—Handwriting. On Approval. Primos Specialty Co., M-3, Primos, Pa.

PRINTING, ENGRAVING AND MULTIGRAPHING

1,000 LETTERHEADS, Envelopes or Statements \$1.50, Samples free. Johnson & Sharp, Bayfield, Wis.

PRINTING, Multigraphing Mimeographing. Low Prices. Attractive Work. Quick Service. Address Adco, 444 Broadway, Albany, New York.

GUMMED Labels!!! Interesting Samples Free!!! Edward Harrison, "Printing Rubber Stamps," Baltimore.

"STAY-PUT" gummed labels. Bargain prices. Free catalogue. Erb Publishing Company, Vineland, N. J., Dept. A.

LETTERHEADS, statements, envelopes, etc., \$3.00 per 1,000 delivered. Special prices on Imitation Typewriter Letters. Send copy. Journal Printing Co., Tallapoosa, Ga.

1,000 HAMMERMILL bond letterheads or envelopes, \$1.50. Glick Printing Co., Ridgefarm, Ill.

500 GUMMED Labels. Name and Address, 30c. Eastern Label Co., Clintonville, Conn.

1,000 LETTERHEADS \$3.50; 1,000 Envelopes \$3.25. Riley-Zaur Co., 1517 48th Court, Cicero, Ill.

GOOD Multigraphing-Printing. Reasonable prices. Anco Letter Shop, 229 Emerson, Detroit.

QUALITY Printing at Reasonable Prices. Tell us your printing wants and we will quote prices which will save you money. Best work. We print anything from a letterhead to a catalog. Fantus Co., 525 S. Dearborn St., Chicago.

PRE-USED Printing Presses. Type and supplies. List for stamp. Popular Bargains, Richland, Pa.

QUALITY Printing—100 8x11 bond letterheads and 100 bond envelopes, \$2.00; 250 each, \$3.50; 500 each, \$5.25; 1,000 each, \$8.00 prepaid. Model Company, Manchester, Iowa.

2,000 LETTERHEADS or Envelopes \$6.25 prepaid. 3rd zone. Samples Free. Quality Printing, Marietta, Ohio.

MULTIGRAPHING—Fine work. Quick service. Reasonable rates. Letter Service, 209 Ohio, Watertown, N. Y.

PRINTING: Quality Guaranteed. Samples Free. Reliance Print Shop, Box 192, Elyria, Ohio.

5,000 6 1/2 ENVELOPES—\$12.50; cash with order. C. Kullman, 307 Bond, Cincinnati.

MUSIC rubber stamps. Rubber type catalogue 25c. W. Karstaedt, Dayton, Ohio.

GET our printing prices. Jacinius Advertising Service, Irvington, New Jersey.

BOND Letterheads, envelopes, multigraphing \$3.50 thousand; 500—\$2.00; 5,000—\$12.50. Samples. Printery, BR-437 North Avenue, Chicago.

500 TWO-COLOR letterheads \$2.65. Samples free. "Adservice," Station C, Milwaukee.

500 BOND letterheads \$1.85 postpaid. Grant, 1713—12th, Detroit, Mich.

EMBOSSED Stationery, Business, Personal. Samples, stamps, Daniels Company, Pittston, Pa.

WE print anything. Circulars, Stationery, Catalogs, Samples. Commercial Press, Batavia, Ohio.

1,000 LETTERHEADS or Envelopes, \$3.00. Sent Prepaid. Samples Free. Monitor Press, Morrisville, Pa.

325 BOND letterheads, envelopes, billheads, cards, \$1.25 each. Combination, \$1.00. Economic Press, Louis, N. J.

FOR MEN

EXTRA Pants to match any Coat. Send measure with sample. Fit-well Trousers Co., Dept. 38, Kansas City, Mo.

ARE You Old at Forty? See our advertisement on page 126 of this issue. The Electro Thermal Company, 2120 Main Street, Steubenville, Ohio.

FOR SMOKERS

HOMESPUN Tobacco. Chewing, 5 pounds, \$1.75; 10 pounds, \$3.00; 20 pounds, \$5.25. Smoking, 5 pounds, \$1.25; 10 pounds, \$2.00; 20 pounds, \$3.50. Send no money, pay when received. Co-Operative Tobacco Growers, Paducah, Kentucky.

ENJOY Life. Smoke "Old Field Tobacco." Sample 10c. Best Mailing Co., Paducah, Ky.

RAZORS AND BLADES

BLADES resharpened, one edge, 2c; double, 3c; Regular razor only 20c. All hand honed. Address Conn Honing Co., New Britain, Conn.

WANTED—Salesmen. Territory still open to handle "Lowgold" imported razors, shears, complete line imported cutlery. Good commissions. Lowgold Imports, Box 547, Syracuse, N. Y.

BLADES, resharpened, one edge 2c; double 3c. New York Edge Co., Glen Cove, N. Y.

BLADES Resharpened 2c. New Blades for "Gillette" 55c Dozen. Standard Safety Razor Corporation, Pittsburgh.

SLICKEST clipper shaver you ever saw. No grinding, no honing. Sharpener with full instructions \$1. The Klipper King—607 N. San Dimas Ave., San Dimas, Calif.

BOATS AND LAUNCHES

MAKE your rowboat sail, folding centerboard and case, \$10.00. F. A. Graham, Harbor Springs, Mich.

"HOW to make your boat leakproof." Send for booklet. L. W. Ferdinand & Co., 152 Kneeland St., Boston, Mass.

10' ROWBOAT—Easily made. Construction blueprint 30c. Weeslin-Geo, West Market, Detroit, Mich.

FOR THE HOME

GRANDFATHER Clock works, \$5.00. Build your own case; instructions free; make good profits selling your friends. Clock works with chains for old or new cases. Write for full particulars. Clock Co., Ruffner St., Philadelphia.

CANDY

CANDY—Very choicest, 1½ lbs. for \$1. postpaid. Superb hand-dipped chocolates; a pleasing variety of nuts, fruits, nougats, caramels, etc. So good your friends will ask where you got them. Aunt Mary's Chocolate Co., M-310 West Superior St., Chicago.

OPTICAL GOODS

THE Invisible World Revealed! Microscopes, magnifying 500 times, by mail 75c. George Mayerle, Expert Optical Service, 960 Market St., San Francisco, Calif.

DIAMONDS, WATCHES AND JEWELRY

WONDERFUL Scientific Discovery: "Rainbow Sapphire," changes color under every different light condition; sample stone \$3 carat, any size, guaranteed as advertised or refund, Pauer (Importer), 152 Duane St., Buffalo, N. Y.

IMPORTED, genuine indestructible French pearl necklaces, 24 inches long, exquisite color, plain gold (14-k) clasp, in handsome velvet, satin-lined case, \$5.50 or \$66.00 per dozen. With white gold clasp. Chip set, \$2.50 extra. Agents wanted. Retail at from \$10.00 to \$12.50 per strand. Extraordinary value, J. Bennett, 1640 Lawrence Ave., Chicago.

ANTIQUES AND WAR RELICS

INDIAN Baskets, Blankets, Wampum, Mats, Wholesale, Catalogue, Gilham, Kelseyville, Calif.

ANCIENT Indian Relics bought, sold, exchanged, Donald Boudeman, Kalamazoo, Mich.

INDIAN Baskets, Blankets, Wampum, Mats, Wholesale, Catalogue, Gilham, Kelseyville, Calif.

POB Collectors, sportsmen.—Relics collected from Europe's battlefields. Illustrated catalogue and sample War Photo 2c. Lieut. Welsh, 2117 Regent Pl., Brooklyn, N. Y.

PHONOGRAPHS AND RECORDS

BUILD your own phonographs. We can supply you with motors, tone arms and all accessories at wholesale prices. Write for catalogue A.X. Pleasing Sound Phonograph Co., 204 East 113th St., New York, N. Y.

PHONOGRAPHS repaired, all makes, also motors and tonearms to build own machine. Central Music Sales, 711 Wells St., Milwaukee, Wis.

BUILD a genuine Choraloon phonograph and save over half. Big profit building and selling. We furnish motors, tone-arms, full instructions and all necessary parts. Send for catalog and free blueprint offer. Choraloon Phonograph & Radio Co., 423 11th St., Elkhart, Ind.

BUILD your own Phonograph. We furnish everything at lowest prices. Write for Catalog. American Phonograph Co., 3515 North Crawford, Chicago.

BUILD a genuine Choraloon phonograph and save over half. Big profit building and selling. We furnish motors, tone-arms, full instructions and all necessary parts. Send for catalog and free blueprint offer. Choraloon Phonograph & Radio Co., 523 11th St., Elkhart, Ind.

MUSIC AND MUSICAL INSTRUMENTS

SONG Poem Writers. Have real proposition. Hübeler, D110, 4040 Dickens Ave., Chicago.

CORNETISTS — Trombonists — Saxophonists — Clarinetists. Send for "Free Pointers No. 2." Name instrument, Virtuoso School, Buffalo, New York.

VIOLINS—Deep, Mellow, Soulful—on credit. Easy terms for wonderful instrument. Get details today. Gustaf F. Hennig, 2121 Gaylord St., Denver, Colo.

NEW Mechanical Playing Concertinas, \$30. Central Supply House, 615 Seneca Ave., Brooklyn, N. Y.

WRITE Songs, Big money and reputation. Write for information, J. Gordon Pub. Co., 201 N. Hoyne Ave., Chicago.

"MUSIC Composed" to words. Hauer Bros. (formerly of Sousa's Band), Oshkosh, Wis.

I WANT song poems. Chas. Nathan, Garrick Theatre Building, Chicago.

PATENT ATTORNEYS

PATENTS—Before disclosing an invention the inventor should write for our blank form "Record of Invention." This should be signed, witnessed and returned to us together with model or sketch and description of the invention and we will give our opinion as to its patentable nature free. Our Three Books mailed free to inventors. Our Illustrated Guide Book, "How to Obtain a Patent," contains full instructions regarding patents. "List of Patent Buyers" sent free, contains unsolicited letters from manufacturers and others who are constantly writing us regarding the purchase or leasing of meritorious patents. We have recently received a number of requests, among which are the following: 45 requests for Miscellaneous Articles in all classes of invention, too numerous to mention. 14 requests for Household Novelties and Specialties. 11 requests for General Novelties and Mail Order Articles. 6 requests for Automobile Accessories and Specialties. 3 requests for Small Metal Articles and Metal Specialties. 2 requests for Radio Accessories and Equipment. 1 request for Amusement Apparatus. 1 request for Refrigerators. 1 request for Tractors and Similar Machines. 1 request for Farmers' Supplies. 1 request for Games. 1 request for Toys. We endeavor to assist our clients in the commercial development of their inventions. Owing to the growth of our business we have established for the benefit of our clients, Branch Offices in New York City at 1067 Woolworth Bldg., Philadelphia at 714 Liberty Bldg., Pittsburgh, Pa., at 514 Empire Bldg., Chicago, Ill., at 1114 Tacoma Bldg., and San Francisco, Calif., at 1010 Hobart Bldg. Victor J. Evans & Co. Main Offices, 146 Ninth, Washington, D. C.

PATENTS secured. Prompt service. Avoid dangerous delays. Send for our "Record of Invention" form and Free Book telling how to obtain a Patent. Send sketch or model for examination. Preliminary advice without charge. Highest Reference. Write Today, Jacob & Jacob, 408 Ouray Bldg., Washington, D. C.

INVENTORS—Read the treatise "How to Reduce Your Invention to a Property Right," free on request. Lester E. Barrett, Drawer 830, Washington, D. C.

INVENTORS: Send sketch or model of invention for opinion concerning patentable nature and exact cost of patent. Book "How to Obtain a Patent," sent free. Tells what every inventor should know. Established twenty-eight years. Highest references. Prompt service, reasonable charges. Address Chandler & Chandler, 438 Seventh, Washington, D. C.

PATENTS, Booklet free. Highest references. Best results. Promptness assured. Send model or drawing for preliminary examination. Watson E. Coleman, Patent Lawyer, 624 F Street, Washington, D. C.

"INVENTORS' Guide" free on request; gives valuable information and advice for all who have original ideas or improvements. Frank Ledermann, Registered Attorney and Engineer, 15-P Park Row, New York.

PATENTS promptly procured. Personal, careful and efficient service. Highest references. Moderate fees. Send sketch for model or actual search and advice. George P. Kimmel, Master of Patent Law, 54-H, Loan and Trust Bldg., Washington, D. C.

PATENTS and Trade-marks obtained. Prompt service. Write for our new book on patents. Established in 1889, D. Swift & Co., 369 7th St., Washington, D. C.

BEFORE or after filing application for patent on your invention it will pay you to read over my "Inventor's Adviser No. 3," free for asking, M. Labiner, Registered Patent Attorney, 3 Park Row, New York.

TO proceed properly and safely, send sketch and description for personal advice in your particular case and estimate of costs. H. F. Lowenstein, Registered Patent Attorney, McLachlen Building, Washington, D. C.

PATENTS. My fees in installments. Advice look free. Frank Fuller, Washington, D. C.

PATENTS procured; trade marks registered—A comprehensive, experienced, prompt service for the protection and development of your ideas. Preliminary advice gladly furnished without charge. Booklet of information and form for disclosing idea free on request. Richard B. Owen, 30 Owen Bldg., Washington, D. C., or 2476-R Woolworth Bldg., New York.

PATENTS Procured. Send sketch or model today for examination, prompt report and advice. No charge for preliminary advice. Write for free Booklet and blank form on which to disclose your idea. Highest references. Promptness assured. Clarence A. O'Brien, Registered Patent Lawyer, 561 Southern Building, Washington, D. C.

PROTECT your rights—Write for "Record of Invention" and booklet about Patents. Prompt personal service. Advice without charge. J. Reaney Kelly, 612-G, Columbian Building, Washington, D. C.

PATENTS, Trademarks, Copyrights procured; all countries; very reasonable; 20 years' experience; booklet free. H. Sanders, Registered Patent Attorney, 7 Rand McNally Building, Chicago.

BOOK on inventions, patents, trademarks, sent free, advice given; excellent references. Twenty-three years' experience. Robb, Robb & Hill, 1348 Hanna Bldg., Cleveland, Ohio, 811 McLachlen Bldg., Washington, D. C.

PATENT application filed on partial payment plan. Trade-marks, copyrights, etc. Milo B. Stevens & Co., 685 F St., Washington; 352 Monascock Bldg., Chicago. Estab. 1864.

INVENTORS—Send for form "Evidence of Conception" to be signed and witnessed. Form, fee schedule, information free. Lancaster and Alwine, 221 Ouray Bldg., Washington, D. C.

INVENTORS: Record invention legally before disclosing to others. Our Invention-Record and Data Sheet shows how. Sent free and valuable information given on patent procedure, costs, etc. Report on patentability includes copies of patents nearest your idea. O'Connell & O'Connell, Jenifer Building, Washington, D. C.

MILLIONS spent annually for ideas! Hundreds now wanted! Patent yours and profit! Write today for free books—tell how to protect yourself, how to invent, ideas wanted, how we help you sell, etc. 500 Patent Dept., American Industries, Inc., Washington, D. C.

PATENTS—Before Submitting Invention, write for information concerning procedure, cost, and ability of attorney. These promptly furnished. References to clients in your state. B. P. Fishburne, Registered Patent Lawyer, 331 McGill Bldg., Washington, D. C.

MONROE MILLER, Ouray Building, Washington, D. C., patent attorney, mechanical and electrical expert. Best quality of work and results. Moderate charges.

FOR INVENTORS

PATENTS. If you have an invention which you wish to patent you can write fully and freely to Munn & Co. for advice in regard to the best way of obtaining protection. Please send sketches or a model of your invention and a description of the device, explaining its operation. All communications are strictly confidential. Our vast practice, extending over a period of seventy-seven years, enables us in many cases to advise in regard to patentability without expense to the client. Our Handbook on Patents is sent free on request. This explains our methods, terms, etc., in regard to Patents, Trade Marks, Foreign Patents, etc. "Scientific American" contains Patent Office Notes, Decisions of interest to inventors and particulars of recently patented inventions. Munn & Co., Solicitors of Patents, 623 Woolworth Bldg., New York; Scientific American Bldg., Washington, D. C.; 801A Tower Bldg., Chicago, Ill.; Hobart Bldg., San Francisco, Calif.

GET your own patents. Application blanks, complete instructions \$1. Cutting Sons, Campbell, Cal.

INVENTORS—Send your ideas for manufacturing development in our modern sheet metal and angle iron fabricating plant. Liberal payment for accepted inventions. Kirk & Blum Manufacturing Co., 2851 Spring Grove Ave., Cincinnati, O.

PATENTS secured. Prompt service. Avoid dangerous delays. Send for our "Record of Invention" form and Free Book telling how to obtain a Patent. Send sketch or model for examination. Preliminary advice without charge. Highest Reference. Write Today, Jacob & Jacob, 408 Ouray Bldg., Washington, D. C.

PATENTS. Write for free illustrated guide book. Send model or sketch and description for free opinion of its patentable nature. Highest references. Prompt attention. Reasonable terms. Victor J. Evans & Co., 157 Ninth, Washington, D. C.

INVENTOR'S Educator, 990 Mechanical Movements, 50 Perpetual Motions. How to procure and sell patents. Mechanical Movements greatly assist inventors, suggest new ideas. Explains how to select an attorney and avoid Patent Sharks. Price \$1.50. Postage free. Fred G. Dietrich & Co., 621 Ouray Building, Washington, D. C.

HAVE You an invention? If so, write for our free book, "How to Get Your Patent," tells our terms and methods. Send model or sketch for our opinion of its patentable nature. Randolph & Co., Dept. 141, Washington, D. C.

I SELL Patents. Mr. W. E. Wells, Phoenix Bldg., Minneapolis, Minn., placed his Patent on Screen Door Catch in my charge to sell. I sold it to the Chum Manufacturing Co., 425 National Ave., Milwaukee, Wis. Have you a patent to sell? Charles A. Scott, 773-PM Garrison Avenue, Rochester, N. Y. Established in 1909.

PATENTS Sold—leased—promoted. Experienced handling; immediate action. Send copy of Patent and receive Free, my booklet, "The Business End of a Patent." Address Arthur S. Billings, 101 Dekum Bldg., Portland, Oregon.

"INVENTOR'S Guide" free on request; gives valuable information and advice for all inventors. Frank Lederbaum, Registered Attorney and Engineer, 15-F Park Row, New York.

INVENTORS and Manufacturers: Have your inventions, labor-saving devices, models and automatic machinery designed and constructed by mechanical experts. Color-controlled dispensing machines a specialty for any purpose. John Frick, Mechanical Engineer, 1165 Arch St., Philadelphia.

MODEL Making and experimental work. Modern Shop; expert workmen. Manufacturing. Lamson Electrical & Mfg. Co., 625 W. Jackson, Chicago.

PATENTS procured. Send sketch or model today for examination, prompt report and advice. No charge for preliminary advice. Write for free booklet and blank form on which to disclose your idea. Highest references. Promptness assured. Clarence A. O'Brien, Registered Patent Lawyer, 561 Southern Building, Washington, D. C.

PATENTS procured; trade marks registered. A comprehensive, experienced, prompt service for the protection and development of your ideas. Preliminary advice gladly furnished without charge. Booklet of information and form for disclosing idea free on request. Richard B. Owen, 70 Owen Bldg., Washington, D. C., or 2276-R Woodworth Bldg., New York.

PATENTS procured. Send sketch or model today for examination, prompt report and advice. No charge for preliminary advice. Write for free booklet and blank form on which to disclose your idea. Highest references. Promptness assured. Clarence A. O'Brien, Registered Patent Lawyer, 562 Southern Building, Washington, D. C.

PROTECT your rights—Write for "Records of Invention" and booklet about Patents. Prompt personal service. Advice without charge. J. Reaney Kelly, 612-G Columbian Building, Washington, D. C.

HAVE your invention designed correctly, yet simple to make. Drawings made, proper materials specified, quotations answered. Commercial Engineering Co., Box 289, Spokane, Wash.

INVENTORS! Write Patent Office for free copy of "Information Concerning Patents." Send me sketch for preliminary search and advice. Low fees. Ralph Birch, Patent Lawyer, Jenifer Bldg., Washington.

UNPATENTED ideas can be sold. I tell you how and help you make the sale. Particulars free. Write W. T. Greene, 166, The Atlantic, Washington, D. C.

INVENTORS, write for free copy of Modelcraft. R. G. Cline, St. Louis, Mo.

PATENT Application Blanks free to inventors. Patent News-D, Washington, D. C.

PATENTS FOR SALE

PATENT for Sale—Soap-suds Maker. Simple, handy, efficient. Saves soap, time, labor and money. Every housewife a live prospect. Get details. Spicker G. Kurtz, Millburg, Pa.

PATENT—Keyless auto-locking device. Electric contacts known only to owner, unlocks. Changed at will. Wonderful alarm feature. Cash or royalty. E. Carlson, Box 172, Brooklyn, New York.

TWO Spark Plug Patents—Copper pipe flanging tool, Auto Lock. Will sell cheap—Box 2528, Boston, Mass.

PATENT 507,149—design 61,826, for placing ornaments (jewels) on spectacle bridge. Solid or soldered. Get details. J. S. Greene, Connell, Tex.

MANUFACTURER to make and sell steel moulds for a patented concrete necessity. Can show you how to make two hundred thousand dollars clear in a year. Write John T. Elmore, 409 West Gwinnett St., Savannah, Ga.

OUTRIGHT or Royalty: Electric wash-boiler wash-machine. Pat. pending. Electric ice cream freezer attachment. Pat. pending. Wash-machine and freezer attachment operated with a sewing-machine motor. Motor is removable and can be used either on wash-machine, freezer attachment or on sewing machine, without alteration. Wm. Writz, Box 414, Cristobal, Canal Zone.

PATENT Pending; bids open on "Automatic Revolving Calendar Clock." Shows day, week, month, year, and time automatically. Calendar good for ten centuries. Paul Madlrich, Peter Carevich (partners), 311 Cedar St., Oakland, Calif.

SEWING Machine Specialty; a new and novel drive mechanism. No crank. No centers to stop on, or reverse; no thread breaking. Runs forward only, at any speed regardless how trouble is rooted. Use both hands on sewing instead of one on top fly-wheel. Patent pending. Drawings and Specifications will be sent. Oscar Lundberg, Skaneateles, Mich.

NEW Side Wings for all makes of Automobiles; possesses broad merit. Easily manufactured. Something worth investing in. Address Lennie Hansen, Kirkland, Wash.

HOLDER, paper; household or display use. No waste. Cost negligible, 5 or 10c article. Patent granted. First time offered. Patent agents need not apply. Star Pub. Co., Carlos, Ind.

CAKE Biscuit and Doughnut cutter. Will sell in ice stores, outright or Royalty. R. B. Charcoal, Cantrah, Ill.

FOR Sale or Royalty—Patent Transmission Band Hiding for Ford cars. Proved to outlive a car. Made cheaper than any other band on market. Eliminates chattering and grabbing. Patent pending. L. K. Fapp, Fall River, Wis.

FOR Sale—Patent applied for—hog ruing chute. Hog raisers need them. Free specifications. J. M. Baggsdale, Waverly, Kan.

YOU have a worth-while patent, haven't you? Why don't you tell our two million readers about it? Most of them are specially interested in patents and new inventions. Ask me to tell you how other inventors successfully sold their patents. J. Roy McCallan, Manager, Classified Advertising, Popular Mechanics Magazine, Chicago, Ill.

PATENT for Sale—Attractive article for Christmas, never seen before. H. Linder, 619 Wayne Ave., Chicago.

FOR Sale: Automatic Metal Weather Strip. Patent pending. Fred Caron, 317 Harner Avenue, Detroit, Mich.

THREE Advanced Aeroplane Patents for sale outright. Particularly adapted for Commercial Plane. Only prospective buyers need answer ad. Drawings and literature furnished on request. J. T. Hughes, 2924 6th Ave., Council Bluffs, Iowa.

WISH offer, before applying for patent on self-picking and grading potato digger. J. Lawton, Lawtons, N. Y.

NEATEST toy pistol invented. Sheet metal. Few parts. Will sell outright or Royalty. G. A. Wilbur, 1363 W. Mich Ave., Lansing, Mich.

FOR Sale, Pat. No. 14,134,488, 1922 process and adaptation of natural, everlasting flowers, bouquets, hat wreaths, produced from spawn or eggs of the Gulf Crinid, a substance resembling gelatine film, but more durable and water proof—responds to all delicate shades—corsage bouquets, lamp shades, hats, etc. Parties desiring a profitable industry address Mrs. Louise P. Welch, Gulf Port, Fla., Box 17.

OUTRIGHT or Royalty—Device for automatic control of automobile headlights. Something entirely new. Every automobile needs this. Patent pending. Address "Accessory," Box 171, Edgewood, R. I.

PATENTS For Sale: To sell, buy or obtain patents write Patent News—P, Washington, D. C.

PATENTED adjustable "Hose Clamp," outright or royalty; splendid device that will prove big money-maker. Lewis Cronk, 2314 Haste St., Berkeley, Calif.

FOR Sale—Spark Plug attachment. Patent allowed. 10c store article; a stamping job. M. Barrett, 2941 2nd St., Detroit, Mich.

PATENT for Sale! Universal Divider and Center Gauge. No measurement—no mechanical eye—no second's time—no movement and the center point is found with unquestionable accuracy. Every tool-maker, machinist and pattern maker a prospect. Unexcelled. Get full details. Rold. Livingston, 1425 Scott St., Williamsport, Pa.

CONSULTING ENGINEERS

SCIENTIFIC Designs and Working Models of valuable inventions prepared and guaranteed. Consulting Engineer, 2 East 23 Street, Room 711, New York City.

SURVEYING INSTRUMENTS

NEW and used surveying instruments direct from factory. Satisfaction guaranteed or money refunded. Wisliser, 619 Broadway, St. Louis.

MODELS AND MODEL SUPPLIES

MODEL Steam Engines, Boilers, Houts, Model Ship and Naval Fittings, Model Makers' supplies. Send 20c for new, enlarged illustrated catalogue and handbook. Bath Mfg. Co., Dept. D, 5214 Woodland Ave., Philadelphia, Pa.

INVENTORS—Write for our free illustrated guide book and Evidence of Conception Blank, Highest references. Prompt attention. Reasonable Terms. Victor J. Evans & Co., 165 Ninth, Washington, D. C.

PUNCH press and screw-machine work, tool and die making, model and special machine work wanted. Have doubled our manufacturing space and added machinery. Let our factory be your factory. Quality Hardware and Machine Co., Dept. A, 6150-56 N. Clark St., Chicago.

DIES, Tools and General Manufacturing, Models, and Manufacturing of new inventions our specialty. Logan Machine Co., 222 S. Clinton St., Chicago, Ill.

MODEL Making and experimental work; Modern Shop, expert workmen. Manufacturing. Lamson Electrical and Mfg. Co., 625 W. Jackson, Chicago.

WE make working models for inventors and do experimental work and carry a complete stock of brass gears and model supplies. Send for catalogue. The Pierce Model Works, Tinley Park, Ill.

PATENTS procured. Send sketch or model today for examination, prompt report and advice. No charge for preliminary advice. Write for free Booklet and blank form on which to disclose your idea. Highest references. Promptness assured. Clarence A. O'Brien, Registered Patent Lawyer, 562 Southern Building, Washington, D. C.

WE build models, design, develop, and manufacture articles in large or small quantities. Homsey Machine Products & Mfg. Co., 1385 E. 17th St., Cleveland, Ohio.

BEFORE ordering your model write for free copy of Modelcraft. R. G. Cline Engineering Co., St. Louis, Mo.

METALS, Brass, bronze, copper, aluminum, German silver, zinc, iron and steel in rods, tubes, wire and sheets. No order too small. Jones Cut Metal Co., 58 Maspeth Ave., Maspeth, Long Island, N. Y.

MODELS. We have fully equipped model shop and carry full line of model supplies. Modern Machine & Pattern Co., Terre Haute, Ind.

FOR MANUFACTURERS

WANTED—Metal Stamping and Model work taken on contract basis. We are ideally located and equipped to develop patents. Meyers Company, Box 263, Bedford, Ind.

WANTED—Manufacturer for New-Idea Metal Invention. E. Hedburg, Kinzmann, Ariz.

PATTERNS, wood and metal. Models, tools and dies. Brass, bronze, aluminum and iron castings. Screw machine work, production work of all kinds. Write Modern Machine & Pattern Co., Terre Haute, Ind.

MANUFACTURING

WANTED—Patented folding camp furniture and other wood specialties to manufacture on Royalty basis. Seaver Furniture & Specialty Mfg. Co., Eugene, Ore.

IF you want dies and metal stampings write us, Lyons Machine Works, Lyons, Ia.

WIRE Goods, all kinds, made to order. Cooley Mfg. Co., 524-530 N. Western Ave., Chicago.

SCREWS, nuts, screw machine products, all metals, Autosew Works, 355 West Broadway, New York City.

LONG established manufacturer of auto accessories which are daily sold by practically all wholesale and retail accessory houses will consider manufacturing and distributing new automobile products, capable of equally wide sale through same channels. Patented articles preferred. Address Auto Accessory Manufacturer, 1400 North American Bldg., Chicago, Ill.

MANUFACTURING concern with unlimited capital is looking for new ideas on coin savings banks. Will buy patents or manufacture on royalties. Reply, giving full details, drawings or patent copies. Harrey Machine Company, Los Angeles, Calif.

MANUFACTURE Salable Patented Specialty. Shop Rights for sale. Read advertisement, this issue, "Business Opportunities." W. H. Colby, 115 Sprout Street, Detroit, Mich.

MANUFACTURERS, let us make your jigs, fixtures and special tools and do your manufacturing in our plant. We can make almost anything in the electrical or mechanical line if made of metal. Correspondence solicited. F. Jos. Lamb Co., 1966 Franklin St., Detroit, Mich.

PATENTED Articles, Models, Brass Work, Machine Construction; Dies Made, Baum's Metal Specialties, Kansas City, Mo.

GEARS, tools and metal specialties. Send for price list, Weldon Machine Works, 2940 Fernon St., Chicago.

WE design and build special machinery. Send for free copy of Modelcraft. R. G. Clyde Engineering Co., St. Louis, Mo.

WE specialize on Dies, Stamping, Light Mfg. The Times Mfg., 410 Kimball St., Danville, Ill.

MACHINERY, TOOLS AND SUPPLIES

BARGAINS in used machines; send for list. The Challenge Machinery Co., Grand Haven, Mich.

POPULAR Mechanics Shop Notes for 1923, latest volume in the series, recently issued. Don't miss getting this one. It is one of the best we have ever published. Contains 544 valuable articles with 436 illustrations, 224 pages. Price 50 cents, postpaid. Popular Mechanics Book Dept., 200 E. Ontario St., Chicago.

CONCRETE Building Block Machines and Molds. Catalogue free. Concrete Machine Co., 303 South Third St., St. Louis, Mo.

LIGHT Power Transmission Machinery, Bearings, Hangers, Pullers, Reducing Gears. Send for Catalog. Winfield H. Smith, Buffalo, N. Y.

SEVEN-INCH Bench Lathes, two new models, \$12.00 up. Mechanical Lathe Co., 2111 So. Springfield Ave., Chicago.

ELECTRICAL

ELECTRICAL Experimenters—Here is the book you have been waiting for—"How to Make Things Electrical." 236 articles, 427 pages, 333 illustrations. Size 4 1/2 x 7, cloth binding. Price \$2.50 postpaid. Popular Mechanics Book Dept., 200 E. Ontario St., Chicago.

WHOLESALE Prices Motors and Electrical supplies, including sockets, taps, rosettes, switches, wire, conduit, cleats, loam, porcelain goods. Illustrated Catalog free. Hyre Electric Co., 633-RR S. Dearborn St., Chicago.

ELECTRICITY for 10c Per Hour. Monarch Auto Generator. Operates on any make automobile. Produces electricity for Moving Picture Machines, Theatres, Schools, Churches, Homes, Etc. Write for free particulars. Monarch Theatre Supply Co., Dept. AG, 724 South Wabash Ave., Chicago.

ENGINES, MOTORS AND DYNAMOS

MOTORCYCLE Engine \$8.50; small 4-cylinder engine \$16.00; charging dynamo, 1 K. W., \$8.50, 632 W. 62nd St., Chicago.

GOVERNORS on used auto engines make road power plants. Circulars. Address Candler-Smith Governor Co., Springfield, N. Y.

ALTERNATING Current Motor Bargains. Reliable Makes only, including new 1/2 H. P.—\$13.00; new 1/2 H. P. General Electric \$29.00. Westinghouse, Crocker-Wheeler, Wagner, Emerson, Century motors, special prices. All guaranteed for one year. Buy now before prices advance. Motors repaired and exchanged. Hyre Electric Co., 633-FX South Dearborn St., Chicago.

AUTOMOBILE owners, garagemen, mechanics, send today for free copy America's most popular motor magazine. Contains helpful articles on overhauling, repairing, ignition, carburetors, batteries, etc. Automobile Digest, 507 Butler Bldg., Cincinnati.

3 NEW, First-class, Repulsion Induction, 110-220 Motor Bargains. Good for pumps, farm, garage, shop or home use. 3/4 HP. \$39. 1 HP. \$40. Richard E. Jordan, Box 295, RR 16, Dayton, Ohio.

MOTORS G. E. 1/2 HP \$16.50—1/4 HP \$29.50—5 HP \$98.50. Generators 5 Volt 10 amp \$15.00—32 Volt 300 Watt \$29.50. Write for Catalog. Motor Specialties Co. Crafton, Pittsburgh, Penna.

FOR MECHANICS

SHOP Notes Volume 17 contains 702 practical articles such as Half-ton Traveling Crane, Boring Machine, Toggle Press, Gas-Fired Forge, Oil-Gas Generator, Movable Table for Drill Press, etc., 224 pp. 496 illus. 50 cents postpaid. Popular Mechanics Book Dept., 200 E. Ontario St., Chicago.

PATENTS—Write for our free illustrated guide book and Evidence of Conception Blank. Send model or sketch and description of the invention for our opinion of its patentable nature free. Highest references. Prompt attention. Reasonable terms. Victor J. Evans & Co., 184 Ninth, Washington, D. C.

FOR THE SHOP

LATHE Work for Beginners—opens up a new world for the amateur worker in wood and metal. A practical treatise on Lathe Work with complete instructions for properly using the various tools including complete directions for wood and metal turning, screw cutting, measuring tools, metal spinning and instructions for building home-made lathes with their attachments, etc. 240 pages, 167 illus. Cloth. Price \$2 postpaid. Popular Mechanics Book Dept., 200 E. Ontario St., Chicago.

SIX-INCH Bench Lathe, Small Bench Gilder, Small Bench Miller, are some of the valuable articles found in Shop Notes Vol. 18. Full details of construction are given. In addition hundreds of other important articles make up one of the best book values recently offered the shop man. Price 50c postpaid. Popular Mechanics Book Dept., 200 E. Ontario St., Chicago.

BLACKSMITHS

BLACKSMITHS. Listen: Any Handy man can make more money doing hard jobs easy. Forging and welding solid, with Toy's Modern Methods of Blacksmithing. Hardening and tempering to a standard with colored tempering charts. All for one dollar. Samples free. W. M. Toy, Sidney, O.

BE a tempering wizard. Secret method of tempering. Add life and strength to steel. All kinds of drills, springs, chisels, etc., toughened and tempered by this formula. Non-breakable, absolutely reliable. Never fails. You need it, \$1.00. The Cold Chisel King, 697 N. San Dimas Ave., San Dimas, Cal.

BLACKSMITHS, Plumbers, etc. Here's what you have needed for years. Simple, Powerful, Inexpensive Universal Bending Machine. Bends Eyes, U's, Angles, etc. Bends 1 1/2" standard Pipe cold. Also bends Automobile Spring Eyes. Send for circular. Little Giant Bender Co., Lewiston, Minn.

FOR SALE—MISCELLANEOUS

SPRINGS, assortment of 50 small springs \$1.00 postpaid. Springs made to order. Wright Bros. Spring & Wire Works, 5610 Huron St., Chicago, Ill.

FOR Sale, complete set of Watchmaker's Tools at a Bargain. R. Jaegermann, 5815 Easton Ave., St. Louis, Mo.

BUY—Exchange—Sell! Many of our readers have for sale or exchange the article you are looking for—and lots of them are looking for the very items you want to turn into cash. Get together! Let our two million readers know your wishes—they'll help you! Send your ad today to J. Roy McClellan, Manager Classified Advertising, Popular Mechanics Magazine, Chicago.

FOR Sale—Fine new \$20 mechanical drawing outfit, Bargain \$8.75. National Instrument Co., 4700 North Hamilton, Chicago.

ADDRESSOGRAPHS. Letter Folders, Multigraphs, Envelope Sealers, Duplicators, less than half price. Guaranteed. Pruitt Co., 112-B N. La Salle, Chicago.

GASOLINE Lamps and Lanterns, Catalog Free. Little Wonder Light Co., Terre Haute, Ind.

BIRDWHISTLE Mould, \$25. H. J. Payne, 866 Royal, Jackson, Tenn.

FLOUR mill and water power for sale in Northern Wisconsin. Inquire "S. M.," Popular Mechanics Magazine, Chicago.

WANTED—MISCELLANEOUS

EXCLUSIVE Selling Rights Wanted on Patented Novelties. Laurel Company, Branford, Conn.

WILL buy good patent. What have you? Gordon, 114 N. Seventh St., St. Louis.

CASH for old gold, silver, platinum points, diamonds, false teeth, Liberty Bonds, unused stamps, and precious articles. Goods returned immediately if not satisfactory. Bush Products, 144 Fifth Ave., New York, N. Y.

MAIL us your discarded Jewelry, Gold Crowns and Bridges, Watches, Diamonds, Silver Platinum, and Old False Teeth. Money promptly mailed. Goods returned if offer refused. United States Smelting Works (The Old Reliable), Dept. 71, Chicago.

REAL ESTATE AND FARM LANDS

WANT to hear from owner having farm for sale; give particulars and lowest price. John J. Black, 11th Street, Chippewa Falls, Wis.

PECAN-Orange Units. Easy terms. Big returns. Write Dept. B, Suburban Orchards Co., Biloxi, Miss.

FOR Sale—Three full sections in McKenzie County and two sections in Billings County, North Dakota. Each section contains land suitable for crops, balance for cattle. Each section has valuable deposits of lignite which some day will alone be worth many times the present value of the land. This part of the state is developing very rapidly, with good schools within easy access. As owner cannot use this land himself, will sell one or more sections at a price which almost anyone can afford to pay. Address W., care Popular Mechanics, 200 East Ontario St., Chicago.

SELL your property quickly for cash, no matter where located. Don't pay big commissions. Particulars free. Real Estate Salesmen Co., Desk B., Lincoln, Neb.

OKLAHOMA farms. Write for information. Board of Commerce, Shawnee, Okla.

WANT to hear from owner having for sale store, restaurant, garage, rooming house, barber shop, or any suitable business. Address John Evans, Franklinville, New York.

FARMS wanted by cash buyers, various states. Describe, state lowest price. R. A. McNown, 312 Wilkinson Bldg., Omaha, Neb.

\$10 TO \$50 down starts you on 20, 40 or 80 acres; near bustling city in Michigan; balance long time. Learn how we help you get a farm home. Write for free illustrated booklet giving full information. Swartz Land Company, P-1259, First Nat'l Bank Bldg., Chicago.

ATTENTION—"Get acquainted." Cash for your property. Farm, Hotel or Retail Store, no matter where located; confidential service. Hayes' Business Agency, Cincinnati, Ohio.

DOGS, BIRDS AND OTHER PETS

AIREDALE Terriers—All ages, Reasonable prices. Farmer's Kennels, Comanche, Texas.

A FREE copy descriptive booklet of world's largest dog kennels will be mailed on request. Listing for sale the famous Oorang Airedales specially trained as watch-dogs, farm dogs, stock drivers, automobile guards, companions and hunters on all kinds of game. Also choice breeding stock, puppy stock, kennel supplies, dog foods, dog medicines, etc. Satisfaction and safe delivery guaranteed. Oorang Kennels, Box No. 20, LaRue, Ohio.

AIREDALE Puppies for sale. From best registered stock. Farm bred. Harvey Myers, Fridley, Minn.

SILVERBLACK Foxes, \$300.00. Alreadies. Contract, dime. Arthur Schumacher, Lockland, O.

POULTRY

PEAFOWL, Pheasants, Bantams, Wild Geese, Ducks, Twenty Varieties Pigeons, John Bass, Bettendorf, Iowa.

BREED Squabs, Book free. E. Rice, Melrose Highlands, 77 Massachusetts.

PERSONAL

ASTROLOGY Reveals—2,000-word trial reading 25¢. Two personal questions considered free. State Birthdate, Prof. Andrey, Dept. P-M, Box 831, Washington, D. C.

PYROSINE for Pyorrhea. If your gums bleed, teeth loose or mouth sore, use Pyrosine. Money refunded if not satisfied. Send 75 cents for large bottle. Pyrosine Co., 828 State Street, Lima, Ohio.

STUDY Your Type—Do More—Be More—Have More. Self-Revealing Chart and Personal Development Guide for 10¢. Write Thurston-Heywood, Dept. 985, Chronicle Bldg., San Francisco, Calif.

TOBACCO or Snuff Habit, cured or no pay. \$1.00 if cured. Remedy sent on trial. Superior Co., TP, Baltimore, Md.

RELEASE your personality. Banish worry and self-distrust. For particulars, write Robert Knox, Box 728, San Francisco, Calif.

TOBACCO, liquor and morphine habits can be overcome with the aid of Hill's Chloride of Gold Preparations. Liquor remedy can be given secretly. Particulars free. Ohio Chemical Works, Dept. 9, Charleston, S. C.

UNUSUAL Horoscope—Six pages, consisting of extensive and constructive four-page Special Horoscope and Astro-Analysis, and two-page valuable guide showing daily and monthly advice covering entire year. Send 50¢ and birthdate, Prof. Bolles, Box 5, Fordham Station, New York, N. Y.

FREE—Stop using tobacco. We will give free information how to conquer habit easily and permanently. Result guaranteed. Anti-Tobacco League, Box K, Omaha, Neb.

TOBACCO Kills Manly Vigor, Quit easily. Cigarettes, chewing, smoking, snuff conquered or no charge. Small sum if satisfactory. Stops craving; harmless. Full treatment on trial. Perkins Co., 34-A, Hastings, Neb.

ARE you old at forty? See our advertisement on page 126 of this issue. The Electro-Thermal Company, 2120 Main St., Steubenville, Ohio.

ARE you bashful, self-conscious, easily embarrassed? These troubles overcome. Send dime for particulars. C. Veritas, 1400 Broadway, New York, N. Y.

MISCELLANEOUS

ART Metal Workers—You will find our book "Metal Work and Etching" a complete manual on making book ends, desk sets, pad corners, paper knives, letter openers, stationery racks, rocking blotters, desk calendars, arts and crafts jewelry, etc. 96 pp. illus. Price 50 cents postpaid. Popular Mechanics Book Dept., 200 E. Ontario St., Chicago.

INCORPORATION In Arizona Completed In One Day. Any capitalization, least cost, greatest advantages. Transact business anywhere. Laws, by-laws and forms free. Standard Incorporating Co., Dept. 2, Phoenix, Arizona.

ARTIFICIAL Eyes, \$3. Booklet free. Denver Optic, 559 Barclay, Denver, Colo.

STARTING a Company? Save expenses and taxes by organizing on the popular, Common Law plan under a pure Declaration of Trust. No experience required to fill in Demaree Standard Forms, issue shares and begin doing business at once. Genuine Demaree Forms are nationally known, approved by attorneys and utilized by successful concerns throughout the United States. Send for large, free pamphlet (C-51) containing valuable information that you may need. C. S. Demaree, legal blank publisher, 708 Walnut, Kansas City, Missouri.

CUTS anybody can make. Simple, cheap process. \$1. Specimens, particulars, 2¢ stamp. M. Day, Windfall, Ind.

BLUE-PRINTS, Castings, 1/4, 1/2-horse-power gasoline engines. Model steam engines, horizontal or vertical. Blue-prints of any one, 50 cents. Order from ad. Stamp for circular, Master Model Co., Box 212A, Elgin, Ill.

CONCRETE Handbook, New, for the Amateur. We have just published a book describing 178 ways of using concrete in the home, shop and on the farm with full directions for doing these things yourself with ordinary tools, 138 illustrations. It is "written so you can understand it." Price 50 cents, postpaid. Popular Mechanics Book Dept., 200 E. Ontario St., Chicago.

CANDY—Very choicest. 1 1/2 lbs. for \$1.00, postpaid. Superb hand-dipped chocolates: a pleasing variety of nuts, fruits, nougats, caramels, etc. So good your friends will ask where you got them. Aunt Mary's Chocolate Co., M-316, West Superior St., Chicago.

LOCKSMITHS: Send \$1.00 for valuable chart for cutting tumblers padlock keys. Globe System, 278 Washington St., Newark, N. J.

ARE you old at forty? See our advertisement on page 126 of this issue. The Electro-Thermal Company, 2120 Main St., Steubenville, Ohio.

MAKE big money opening Safes and setting combinations. Wayne Strong, Box 22, Eagle Rock, Cal.

5 MASTER Keys. Work like magic in emergencies or prove whether your home is burglar-proof. Test and open thousands of locks. Send \$1 today. Novel key chain free. Master Key Co., 3 S. Manhattan Block, Milwaukee, Wis.

LOCKSMITHING from A to Z—500 tricks of the locksmith trade. \$1.50—money back if dissatisfied. H. Routson, 3406 Anderson St., Oakland, Cal.

GET posted—Good prices paid for butterflies, insects. See Sinclair display advertisement, page 16.

"I Never Saw a Summer Seller Like the Oliver" WRITES SLADE OF NJ

\$4,500 PROFIT A MONTH



YE GODS! SOME SUMMER SELLER
Have more than kept up my quota. \$4,500 gross profits per month. Gave up a \$10,000 job to take up the Oliver. Some Summer Sellers. A. R. Slade, N. J.

\$215 in One Day
"I made \$215 today!"
W. F. Bentley, Pa.

Beats Bentley
"I've smashed Bentley's record. Made \$279.65 profit from 1 day's sales. Oliver sells itself. I take the money."
John A. Ames, New York.

Earns \$3,900 in 6 Months
"I have averaged \$660 profit a month for the last six months."
A. M. Russell, Conn.

Big Spare Time Money
"I made \$45 last night."
N. B. Chelen.—Wash.

NO longer will housewives be chained to a dirty, mussy, coal or wood fire, all Summer long in a sweltering kitchen. 150,000 women have already equipped their ranges with this amazing new invention—the **Oliver Oil-Gas Burner**—that turns off and on with a valve, just like city gas. No more hot kitchens all day long just to cook a few meals. No more ashes, dirt, soot, smoke—no more undependable oil stoves. No wonder our representatives are cleaning up fortunes.

Every Woman Wants One

No work at all to sell this amazing invention. One minute to connect and light it and the sale is made. Every woman wants this wonderful work-saver that does away forever with carrying dirty coal and wood and is cheaper—because it burns 95% air, only 5% coal oil.

Right in her own range oven, the housewife can bake better and quicker than ever before. She can regulate her oven for any temperature—for quick baking or slow baking. Then, a little turn of the valve, the heat is off and the kitchen is cool and clean the rest of the day. Preserving and canning are done with one-sixth the work of the old way. No dirty coal, wood, ashes—no wicks, no soot, no odor, no grimy hands.

The Secret of Quick, Big Profits

You can see why this timely invention means big money during the Sum-

mer months. Here is an opportunity of a lifetime. A. R. Slade actually made \$13,500 in three months. Many make \$100 to \$200 a week just in spare time. You, too, can clean up big profits—you don't need to be a high-powered salesman or even a clever talker. The Oliver sells itself.

Free Sample Case Offer
Oliver Gives Fords Away.

During the last two months we paid over \$138,647 to our representatives. Write at once and we will give you full facts of how you, too, can make this Summer's work yield you a fortune. If you will write now you will be entitled to our special Free Sample case and Exclusive Territory offer. We are giving Fords away to producers—no contests.

The coupon brings full details—don't delay—every day means money lost. Act now.

OLIVER Oil-Gas Burner & Machine Co.
2048-Q Oliver Bldg. St. Louis, Mo.
Canadian Offices: 2048-Q Webster Bldg., Toronto

Oliver Oil-Gas Burner & Machine Co.
2048-Q Oliver Bldg., St. Louis, Mo.

Without obligation on my part, please send me full details of how I can make \$5,000 or more a year representing you. Also, tell me about your Free Sample Case Offer and how I can get a FORD FREE.

Name

Address

City..... State

Ticket to Chicago

(The Electrical Center of the World)

FREE



WE pay your railroad fare to Chicago—the Electrical Center of the World—from any place in the United States. Grasp this opportunity to see the country at our expense. Don't stick in one spot—travel—get experience. Come to Coyne—learn electricity in 3 months. Fit yourself for a big paying job. The largest electrical school in the country specializing in electrical instruction only.

Learn Electricity in 3 Months

Get a complete training so you can make big money as Power Plant Operator, Superintendent, Telephone man, Construction worker, auto, truck or tractor electrician, battery man, radio expert, or you can go into business for yourself as electrical contractor, dealer, auto ignition or battery expert and make from \$3,000 to \$20,000 a year. Hundreds of our graduates today are making big money and you can do the same if you grasp this opportunity—act now.

Great Shops of Coyne

No books or useless theory. You are trained on \$100,000 worth of electrical equipment. Everything from door bells to power plants. You work on motors, generators, house-wiring, autos, batteries, radio, switch-boards, power plants—everything to make you an expert ready to step right into a position paying from \$45 to \$100 a week.

RADIO COURSE FREE. We include the following free with the regular course:

- [1] A complete course in auto, truck and tractor electricity and storage batteries. Greatest outlay of auto, electrical and battery equipment in the country.
- [2] Course in Radio—the marvel of the age. Constructing, installing and operating. You can build your own wireless telephone set.
- [3] A life scholarship in the Coyne school. You can stay as long as you wish and return for further training at any time in the future.

Earn While You Learn! We help students to secure jobs to earn a good part of their expenses while studying.

Send Coupon

Don't delay a minute—send that coupon right now for our big free catalog and full particulars of Free Railroad Fare offer. Remember this special offer is limited so act now!

B. W. Cooke, Pres., Coyne Electrical School
1300-1310 W. Harrison St., Dept. 13-55 Chicago, Ill.

Dear Sir: Please send me free your big catalog and full particulars of your special offer of Free Railroad Fare and two extra courses.

Name

Address



Somerset Maine



Fairview Minnesota



Student Winding a Stator

COYNE

Endorsed by Electrical Industry

1300-1310 W. Harrison St., Dept. 13-55 Chicago

Mechanical Engineering



Learn at Home!

EMLOYERS everywhere are looking for men with mechanical ability. Splendid salaries and rapid advancement are offered those with special training.

There is an easy, delightful way in which you can learn right at home in spare time. For 31 years the International Correspondence Schools have been giving men and women just the training they need for success in mechanical engineering and more than 300 other subjects. Hundreds of thousands have stepped into good positions through I. C. S. help, but never were opportunities so great as now.

Let the I. C. S. help you. Choose the work you like best in the coupon below, then mark and mail it today. This doesn't obligate you in the least and it will bring you information that will start you on a successful career. This is your chance. Don't let it slip by. The most important thing you have to do is to mark and mail this coupon now.

----- TEAR OUT HERE -----

INTERNATIONAL CORRESPONDENCE SCHOOLS
Box 5521-D, Scranton, Penna.

Without cost or obligation, please tell me how I can qualify for the position or in the subject before which I have marked an X:

BUSINESS TRAINING DEPARTMENT

- | | |
|---|---|
| <input type="checkbox"/> Business Management | <input type="checkbox"/> Salesmanship |
| <input type="checkbox"/> Industrial Management | <input type="checkbox"/> Advertising |
| <input type="checkbox"/> Personnel Organization | <input type="checkbox"/> Better Letters |
| <input type="checkbox"/> Traffic Management | <input type="checkbox"/> Foreign Trade |
| <input type="checkbox"/> Business Law | <input type="checkbox"/> Stenography and Typing |
| <input type="checkbox"/> Banking and Banking Law | <input type="checkbox"/> Business English |
| <input type="checkbox"/> Accountancy (including C.P.A.) | <input type="checkbox"/> Civil Service |
| <input type="checkbox"/> Nicholson Cost Accounting | <input type="checkbox"/> Railway Mail Clerk |
| <input type="checkbox"/> Bookkeeping | <input type="checkbox"/> Common School Subjects |
| <input type="checkbox"/> Private Secretary | <input type="checkbox"/> High School Subjects |
| <input type="checkbox"/> Business Spanish <input type="checkbox"/> French | <input type="checkbox"/> Illustrating <input type="checkbox"/> Cartooning |

TECHNICAL AND INDUSTRIAL DEPARTMENT

- | | |
|--|--|
| <input type="checkbox"/> Electrical Engineering | <input type="checkbox"/> Architect |
| <input type="checkbox"/> Electric Lighting | <input type="checkbox"/> Blue Print Reading |
| <input type="checkbox"/> Mechanical Engineer | <input type="checkbox"/> Contractor and Builder |
| <input type="checkbox"/> Mechanical Draftsman | <input type="checkbox"/> Architectural Draftsman |
| <input type="checkbox"/> Machine Shop Practice | <input type="checkbox"/> Concrete Builder |
| <input type="checkbox"/> Railroad Positions | <input type="checkbox"/> Structural Engineer |
| <input type="checkbox"/> Gas Engine Operating | <input type="checkbox"/> Plumbing and Heating |
| <input type="checkbox"/> Civil Engineer | <input type="checkbox"/> Chemistry <input type="checkbox"/> Pharmacy |
| <input type="checkbox"/> Surveying and Mapping | <input type="checkbox"/> Automobile Work |
| <input type="checkbox"/> Metallurgy <input type="checkbox"/> Mining | <input type="checkbox"/> Navigation |
| <input type="checkbox"/> Steam Engineering | <input type="checkbox"/> Agriculture and Poultry |
| <input type="checkbox"/> Radio <input type="checkbox"/> Airplane Engines | <input type="checkbox"/> Mathematics |

Name.....
Street..... 1-10-23
Address.....

City..... State.....

Occupation.....

Persons residing in Canada should send this coupon to the International Correspondence Schools Canadian, Limited, Montreal, Canada.

Please Mention Popular Mechanics

ELECTRICITY

Learn and Earn

Be An A1 Automotive Electrician

Make Real Money

Electricity is one thing the average auto mechanic is weak on.

Electricity is the CREAM of the automotive business.

Electricity in any way it is followed is a real money-maker for the man who has had this standard training.

We are especially equipped to teach this business right, as well as all other branches of the automotive business. The very best ideas, coupled with years of experience, have been combined in working out a continuous and well-rounded system of practical training, made as simple as it is humanly possible to make it.

Write for Big Free Catalogue Today

Iowa State Auto and Electrical School
739 Nebraska St. SIOUX CITY, IOWA

AVIATION FREE

Send us your name and address for full information regarding the Aviation and Airplane business. Find out about the many great opportunities now open and how we prepare you at home, during spare time, to qualify. Our new book "Opportunities in the Airplane Industry" is given free if you answer at once.

AMERICAN SCHOOL OF AVIATION

Dept. 1195 3601 Michigan Ave. CHICAGO

12 Months to Pay

You can easily earn or save money for the small payments. Parents often advance first payment to help buy a RANGER bicycle. Choice of 44 styles, colors and sizes. FACTORY-TO-RIDER prices. DELIVERED FREE express prepaid on approval for 30 DAYS' TRIAL, actual free riding test.

Tires best quality, at factory prices, express prepaid. Lamps, wheels, and equipment, low prices. Send No Money.

Mead Cycle Company
Dept. 5108 Chicago

Write today for free
Ranger Catalog. See
how prices and marvelous
easy payment terms



START A BUSINESS OF YOUR OWN

There is Money in Show Card lettering.
We will teach you how. Write To-day.

..... Illustrated booklet and terms free.....

DETROIT SHOW CARD SCHOOL
214 Dinan Building, Detroit, Michigan

Kindly send me Free Booklet and information.

Name.....

Street.....

City..... State.....

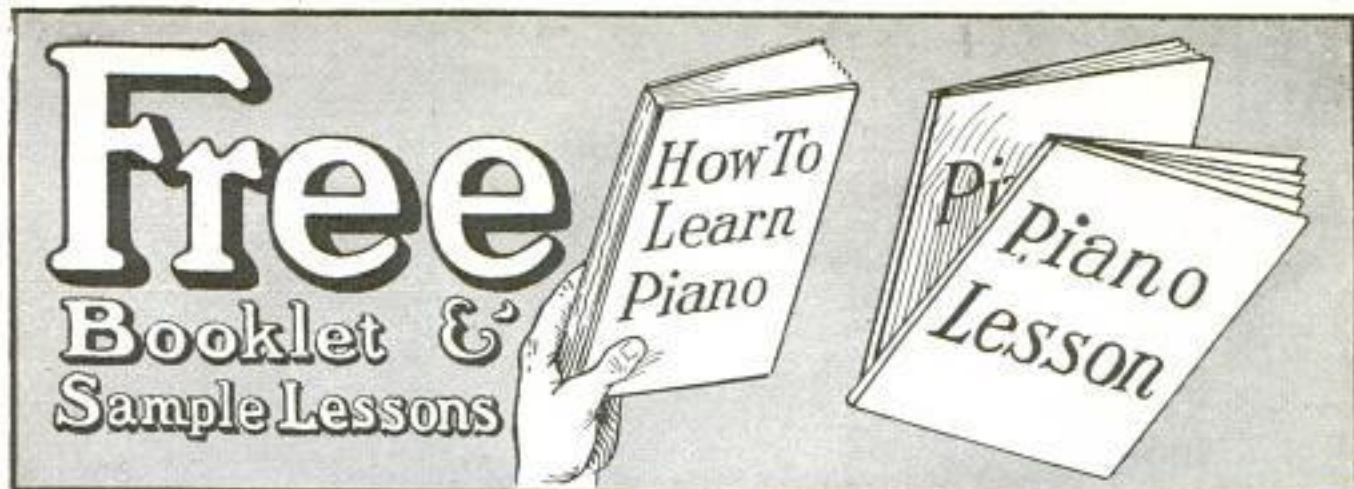

Stop Wondering How I Teach Piano; I'll Show You, FREE

YEAR after year you've seen my advertisement in all the leading publications, offering to teach you piano in *quarter* the usual time. Year after year my school has grown and grown until now I have far more students than were ever before taught by one man. In 1922 over a thousand students *graduated* from my Piano or Organ course and received their diplomas.

Yet when I first started giving piano and organ lessons by mail in 1891 my method was laughed at. Could my conservatory have grown as it has, obtained students in every state of the Union and in fact practically every civilized country of the world unless it produced very unusual and satisfying RESULTS for its students? See for yourself what it is that has brought my method so rapidly to the front. Write for free booklet and sample lessons.

Now, for the first time, you can obtain sample lessons without charge. In the past I have always been opposed to sending out free lessons, even to persons who were seriously interested in my course. But my friends have insisted that I give everybody a chance to see for themselves just how simple, interesting and DIFFERENT my lessons are and I have consented to try the experiment *for a short time*. Simply mail the coupon below or write a postcard, and the 64-page booklet and sample lessons will go to you at once absolutely free and without obligation.

Within four lessons you will play an interesting piece on the piano or organ, not only in the original key, but in all other keys as well. Most students practice months before they acquire this ability. It is made possible by my patented invention the Colorotone. Another invention obtainable only from me is my hand-operated moving picture device, Quinn-dex. By means of Quinn-dex you actually see my fingers in motion on the piano, and can learn just how to train your own fingers.

When I say that I can teach you piano in *quarter* the usual time, do not think that this is too good to be true. Modern inventions and improved methods have accomplished just as great wonders in other branches of education. You at least owe it to yourself to *investigate*. Send coupon or postcard at once, before the offer of free sample lessons is withdrawn.

Quinn
Conservatory,
Studio PM 65,
598 Columbia Road,
Boston 25, Mass.

Please send me, without cost or obligation your free booklet, "How to Learn Piano or Organ," free sample lessons, and full particulars of your method.

Name

Address

LEARN TO DRAW AND MAKE MONEY

Study in the **SCHOOL** that has the **LONG ESTABLISHED REPUTATION**

Here is a **SIMPLE WAY** **TRY IT**
To Draw a Comic Face

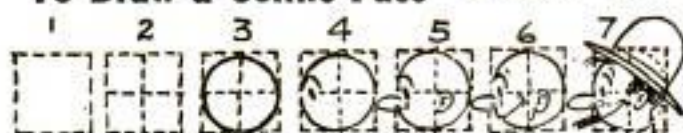

Take your pencil and draw lightly a square (any size). Then add to it with pencil as shown in the small squares above. Erase all pencil guide lines after the drawing is completed. You can draw any kind of comic face by simply changing the shape of the nose, forehead, chin, etc.

Send in your drawing and let us see what you can do. You may have more natural ability than you think. Some of the **cleverest cartoonists** are former students. They had **no experience** before enrolling, but worked at the lessons **during their spare time**, and found Cartoonist **EVANS' METHOD "easy to learn"** and are now **making good money**. It is not hard to learn to draw **originals** when you are shown in a **practical way**. The method above is only one of many **simple methods** explained in the course.

We don't offer any "grand prizes," or "free materials" to encourage enrollments. The school is endorsed by well known cartoonists because they know the students are handled **right**.

Write today for **Portfolio of EVANS Cartoons** and **full information** about the school, and learn how to draw pictures which you can sell. The Course Is Not Expensive.



THE W. L. EVANS SCHOOL OF CARTOONING
821 Leader Bldg. CLEVELAND, OHIO

LEARN BY DOING

Every phase of all branches of

ELECTRICITY

Taught by Actual Practice

In America's foremost and oldest institution for trade training

No Books Used
Individual Instruction
Start Any Day

A **SPECIAL** and **SEPARATE** Course in Ignition, Auto Lighting and **STARTER** Systems. Write for **FREE** 64-page catalog.

THE
NEW YORK ELECTRICAL SCHOOL
44 West 17th Street, NEW YORK CITY

An Uncrowded Field

Modern photography offers big opportunities for men and women. New easy method prepares quickly by mail. Only a step from amateur to professional work. Earn money on the side while learning.

FREE Professional Camera and equipment free. Write today for full information. Find out about the many opportunities now open in the different branches of photography and how you can qualify.

INTERNATIONAL STUDIOS, Inc.
Dept. 1165 3601 Michigan Ave. Chicago, U. S. A.

BE AN EXPERT Penman

I TEACH BY MAIL. You can become an expert penman right in your own home by my method. Small Cost. All that is required is some of your Spare Time. Write for my book, "HOW TO BECOME AN EXPERT PENMAN." It contains specimens and tells how others became expert writers by the **TEVIS METHOD**. Your name written on a card if you enclose stamp. **FREE BOOK.** Write today. **T. M. TEVIS, BOX 25K, CHILLICOTHE, MO.**

THIS WONDERFUL INVENTION



converts any ordinary cook stove into a gas stove. **OXO-GAS** is made from kerosene and air. Cheaper, cleaner and more efficient than coal. Responsible distributors wanted.

GLORIA LIGHT CO.
114 N. May St. Chicago, Ill.

5 Master Keys

Work like magic in emergencies or prove whether your door or padlocks are burglar-proof. **OPEN AND TEST THOUSANDS OF DIFFERENT LOCKS.** Recommended by users in ten different nations. Most wonderful and only keys of their kind. Send \$1 today. Novel key chain **FREE** with set.
MASTER KEY CO.
28 MANHATTAN BLOCK MILWAUKEE, WIS.



Which job can you fill?

All these jobs were advertised in a single issue of a Chicago newspaper under "Help Wanted." Which one can you fill? There are good jobs like these with big pay everywhere for men capable of holding them. Why don't you get one? If you haven't the knowledge necessary to make you capable of holding down the best kind of a job, *make up your mind right now to get it.* There is a set of Home Study Books listed below that will quickly fit you to hold any job you want—spare time only is needed.

These books were written by some of the greatest experts in each line. Nothing but plain everyday English is used—thousands of pictures, diagrams and tables help to make everything as simple as A B C. You can't go wrong with these books before you—they explain everything you need to know. Pick out the set you want and see our *free* trial offer below.

Cut Prices on Practical Books

Carpentry and Contracting, 5 vols., 2138 pp., 1000 pict. Was \$37.50. Now \$19.80
Civil Engineering, 9 vols., 3000 pages, 3000 pictures. Was \$67.50. Now \$34.80
Electrical Engineering, 8 vols., 4100 pages, 3300 pictures. Was \$60.00. Now \$29.80
Automobile Engineering, 6 vols., 2600 pp., 2000 pictures. Was \$45.00. Now \$21.80
Machine Shop Practice, 6 vols., 2300 pp., 2500 pictures. Was \$45.00. Now \$21.80
Steam and Gas Engineering, 7 vols., 3300 pp., 2500 pict. Was \$52.50. Now \$24.80

Law and Practice (with reading course) 13 vol., 6000 p., illus. Was \$97.50. Now \$49.80
Fire Prevention and Insurance, 4 vols., 1500 pp., 600 pict. Was \$30. Now \$14.80
Telephony and Telegraphy, 4 vols., 1728 pp., 2000 pict. Was \$30.00. Now \$14.80
Sanitation, Heating, Ventilating, 4 vols., 1454 pp., 1400 pict. Was \$30. Now \$14.80
Business Management, 8 vols., 2500 pp., Well illus. Was \$52.50. Now \$29.80
Drawing, 4 vols., 1578 pages, 1000 pictures, blueprints, etc. Was \$30.00. Now \$14.80

7 DAYS' FREE TRIAL

We'll gladly send you any set of these books you want for seven days' free examination. Don't send us a cent. Just pay the small shipping charges when the books arrive. Examine them carefully. Use them at your work for an entire week. If you feel that the books are not worth more than we ask for them, send them back at our expense. If you keep them, pay only the bargain price on the easy terms explained below.

75c a Week That's all you pay if you keep the books you select. Send \$2.80 within 7 days and the balance of the cut price at the rate of \$3.00 a month (75c a week). Did you ever hear of a more generous offer? Remember, you take no chances—you don't pay us anything if you don't keep the books. *Mail the coupon NOW—before you turn this page.*

AMERICAN TECHNICAL SOCIETY, Dept. X-195, Chicago

Wanted

Office Men

Auditors, Accountants, Office Managers, Credit Men, Cashiers, Bookkeepers and Cost Clerks—\$2,000 to \$7,500 a year.

Factory Men

Electrical and Mechanical Engineers, Factory Managers, Superintendents, Foremen, Designers and Draftsmen—\$2,000 to \$12,000 a year.

Construction Men

Civil and Structural Engineers, Transients, Construction Superintendents and Foremen, Estimators, Designers and Draftsmen—\$2,500 to \$10,000 a year.

Trades

Machinists and Toolmakers, Auto Repairers, Electricians, Stationary Engineers, Firemen, Plumbers, Carpenters, Pattern Makers and Telephone Men—\$2,000 to \$4,000 a year.

A Real Bargain

The price of these Pay Raising Books is cut in half

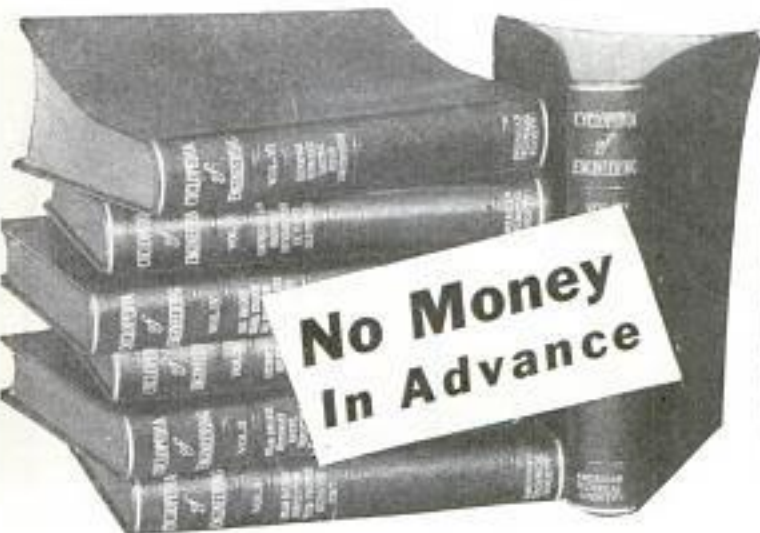

SPECIAL DISCOUNT COUPON

AMERICAN TECHNICAL SOCIETY
Dept. X-195, Chicago, U.S.A.

Please send me set of

for **7 DAYS'** examination, shipping charges collect. I will examine the books thoroughly, and, if satisfied, will send \$2.80 within 7 days and \$3 each month until I have paid the special price of \$..... If I decide not to keep the books I will return them at your expense at the end of one week. Title not to pass to me until the set is fully paid for.

To insure prompt delivery, fill out all lines.

Name.....

Address.....

City..... State.....

Reference.....

Only 8 weeks to get a big job in auto & tractor business



Louis Beimer at 24 was made foreman over men many years older. That's not luck—it's Rahe training.

Emanuel Rushfeldt, Alberta, says: "Earning \$10 a day and only 20 years old."

Big Firms Need Trained Men

The Auto and Tractor Business is on the boom. Thousands of trained men will be needed during the next few months. I get calls every day from Garages, Battery Stations, Auto Repair, Welding Shops and other successful concerns for Rahe men. When the big fellows need high grade men they know where to come for them. They want Rahe trained men who know the work from A to Z.

My Training Unusual

Scientific tool training—that's the secret. You do things here according to the latest engineering standards. Thousands of dollars have been spent in modern tools and equipment. That's why my men are at home in the biggest shops in the country. If you want to succeed the way Beimer and Rushfeldt and the rest have—qualify by the same method.

I'll Pay Your Railroad Fare and Board You

In order to fill the openings that now exist, I am making an offer no one has ever made before—Free railroad fare, Free board. But even that is not all. I'll tell you about the rest in my letter. Write me at once.

Rahe AUTO & TRACTOR Schools

CINCINNATI Dept. 903 **CHICAGO**
Ninth and Walnut 4445 Grand Blvd.

My big illustrated training book tells how others are succeeding. It tells many things you ought to know about Autos and Tractors. Write for it and my short time offer NOW. It soon expires.



ACT NOW

Without any obligation, send me your big free book, "The Evolution of Transportation." Also information regarding special temporary offer.

Name _____ Street _____ City _____ State _____

Please Mention Popular Mechanics

SHOP WORK with a

CARNES ARTIFICIAL ARM

FOR nearly ten years a Carnes Artificial Arm has kept Mr. Pahbe Yazze of Lawrence, Kan., on the payroll as a draftsman and machinist at a good salary. Thousands of other mechanics, artisans, office workers, farmers and laborers owe their independence to this improved arm.

Life-Like in Action and Appearance

The Carnes Arm cannot be detected from the natural except by close inspection. Its user can dress himself, use knife, fork, pen, pencil and keys; pick up large or small objects, carry grips—in fact, do virtually everything that was possible before. He can bend the elbow of the Carnes Arm, bend and turn the wrist and open and close the fingers at will, even if the amputation is at the shoulder.

192-Page Book FREE. A book of 192 pages, profusely illustrated with photographs showing what can be done with this remarkable invention, will be sent free to any person interested. Send for it now.

CARNES ARTIFICIAL LIMB CO.,
208 Carnes Bldg., Kansas City, Mo.

STOP USING A TRUSS

Do Away With Steel And Rubber Bands

FREE TRIAL

TRADE MARK

STUART'S ADHESIVE
PLAPAO-PAD

PAT'D APRIL 6 1909

Inner surface is made adhesive to secure the PLAPAO-PAD firmly to the body, keeping the PLAPAO-PAD continually applied and the pad from slipping. No straps, buckles or springs attached. Soft as velvet—easy to apply.

It's the Non-Slipping, yet Non-Rigid Pad and What is Within It That Counts

FREE to 5,000 Truss Sufferers

To the extent of 5,000 sufferers who may apply I will send, ABSOLUTELY FREE, a sufficient quantity of the Plapao to positively convince them that this is the only logical, commonsense way of treating ruptures. Plapao is a highly astringent medication placed within the Plapao-Pad and being absorbed through the skin, creates a wonderful feeling of relief and at the same time tends to strengthen the weakened muscles and thus permanently close the rupture opening. The process of recovery is natural, so you'll have no use for a truss—you can throw it away forever! Old and young have testified under oath that the Plapao-Pads cured their ruptures—many of them long-standing, aggravated cases—without delay from work. Patent allowed in U. S. and foreign countries. Awarded Gold Medal at Home and Grand Prix at Paris.

Send No Money—for a sufficient quantity of the Plapao is sent without charge to enable you to give it a thorough test; you pay nothing for this trial now or ever. Write for it and full information today. Address: Plapao Laboratories, Block 1427 St. Louis, Mo.



Play "JAZZ" on the Saxophone

Become a musician so quickly as to astound everyone. Learn by playing real music—instead of tiresome "exercises." You'll soon become the most popular person in your "set."

NEW EASY METHOD

is a revelation. Nothing else like it for thoroughness and rapidity. So simple that young and old find it easy to play with amazing skill. No "trick music"—but actual notes, learned quickly right in your own home.

Free Book offers this wonderful musical opportunity. Send for it today before copies are exhausted. You'll be astounded, thrilled, fascinated, at this easy, rapid way to become a veritable master of your favorite instrument. Name below the instrument you are particularly interested in.

LEARN TO PLAY ANY INSTRUMENT

Piano	Mandolin
Organ	Drums and
Viola	Traps
Saxophone	Harmony and
Clarinet	Composition
Flute	Sight Singing
Harp	Ukulele
Coronet	Piccolo
Cello	Trumpet
Guitar	Saxophone
Voices and Speech Culture	Automatic Flinger Control

U. S. SCHOOL OF MUSIC, 75 Brunswick Bldg., New York City
Send me your amazing free book, "Music Lessons in Your Own Home." This does not put me under any obligation. (Please Write Plainly.)

NAME

ADDRESS

INSTRUMENT



More Money For You in RADIO

The amazing expansion of Radio has opened up thousands of wonderful new positions on land and sea. Big salaries, fascinating, easy work, short hours, and a wonderful future are offered to ambitious men who get into Radio now.

Take advantage of these wonderful opportunities to step into a big paying position in this great new field. Radio offers you an opportunity to travel and see the world, with all expenses paid, and a fine salary besides. Or you can stay at home and work up to a position paying up to \$10,000 a year. One of our recent graduates secured a position one week after graduating, paying a salary of \$300 per month.

Easy to Learn Radio at Home

Hundreds of men are already earning handsome incomes in this wonder science. If you want to get into a profession where opportunities are unlimited make Radio your career—become a Certified Radio-trician.

Thousands of Certified Radio-tricians are wanted to design Radio sets; to make new Radio improvements; to manufacture Radio equipment and to install it; to maintain and operate great Broadcasting stations and home Radio sets; to repair and sell Radio apparatus; to go into business for themselves; to operate aboard ship and at land stations.

You can easily and quickly qualify in your spare time at home through the help of the National Radio Institute. Prominent Radio experts will help you. Four wonderful instruments are furnished free, making the work thoroughly practical. The same plan that has already helped hundreds of our graduates to real success and real money in Radio is open to you.

Special Opportunity Now Open

The urgent need for radio experts and the calls which come to us for our students prompt us to make a special offer open to new students for a limited time. Through this special offer your enrollment will be accepted at a special rate, and you will receive, without extra cost, our new course in Wireless Telephony.

BIG BOOK FREE

No other field today offers such great opportunities as Radio. Take your choice of the many wonderful openings everywhere. Prepare now to step into the most interesting and best paid profession today. Read about the opportunities open now—the different kinds of work—the salaries paid. Write today for the free 44-page book that tells how America's first and biggest Radio school can make you a Certified Radio-trician in your spare time. Mail the coupon or write a letter NOW. NATIONAL RADIO INSTITUTE, 1345 Pennsylvania Ave., N. W., Dept. 15-E, WASHINGTON, D. C. Men, boys 16 or over should mail coupon immediately

National Radio Institute, Dept. 15-E
1345 Pennsylvania Ave., N. W., Washington, D. C.

Send me your free book "How to Learn Radio at Home" with full particulars about the opportunities in Radio and how you will quickly train me in my spare time at home to become a certified Radio-trician. Also tell me how your free employment service will help me to a position and particulars of your special short time offer.

Name.....Age.....

Street.....

City.....State.....

Please Mention Popular Mechanics

NO MORE BALD HEADS



WHEN our VACUUM CAP is used a few minutes daily. We accept no pay until you have tried the Cap 60 days and are satisfied. The Vacuum Cap is an appliance that draws the blood to the Hair Roots and starts a new healthy crop of hair. It stops Dandruff, stops the hair from falling out.

Bought by Doctors and men who know that it is the only reasonable HAIR GROWER known to science. No Drugs Used. Write for application blank, testimonials, and booklet on "HAIR," sent sealed in plain envelope. FREE.

THE MODERN VACUUM CAP CO.

J 559 BARCLAY, DENVER, COLO.

BECOME A RAILWAY MAIL CLERK

Examinations soon. \$1600 to \$2300 a year.
No strikes or lockouts. Common education

sufficient. No "pull" necessary. Mail coupon for catalog.

Patterson Civil Service School
Dept. 85, Rochester, N. Y.

Sirs:—Send me without charge your Catalog, describing this and other fine U. S. Government positions.

Dept. 85
Patterson Civil
Service School
Rochester,
N. Y.

Name.....

Address.....

New Profession Attracts Many

Public Welfare Service Proves Popular Field

At last this country seems to be waking up to one of its gravest dangers and most serious losses. A nation-wide movement is now under way to supplement the work of conservation, sanitation and extermination started by the Departments of Agriculture and Forestry a few years ago.

The movement is under the direction of the Exterminating Engineers of America. This organization has recently made remarkable discoveries in this field, and now, in order to meet the tremendous demand for its successful, scientific methods, it is selecting a limited number of men from every section of the country, training them by mail in its newly discovered methods, and starting them in business for themselves as local representatives of the Exterminating Engineers of America.

Men from every walk in life are being attracted to this dignified, patriotic profession. A new untouched field, it offers an ambitious man a most unusual opportunity. In a few weeks, without capital or previous experience, working through the Exterminating Engineers of America, he can become established in a thriving, professional business of his own—a business where there are big rewards and no competition. Representatives of this organization, established in this profession, are earning from \$60 to over \$300 a week.

Recent government reports show a two billion dollar property and crop loss last year from damage done by insects and pests of all descriptions. Investigations indicate that practically every office, hotel, warehouse, ship, farm and private dwelling suffers seriously from some species of pest or vermin. Thousands of specialists are needed to handle this public welfare service. Local representatives are wanted in this vicinity. Full information about the Society's work, the opportunities this new field offers, and how men are quickly qualified to enter it, is given in an interesting booklet which will be mailed free to anyone who will write for it.

Address THE EXTERMINATING ENGINEERS OF AMERICA, Dept. 15, 43 W. 16th St., New York City

Please Mention Popular Mechanics



LEARN AUTO PAINTING IN DETROIT

Earn \$50 to \$300 Weekly

Auto business on the Boom. Hundreds of Auto Painters needed. Now is the time to get out of the rut. Now is the time to prepare for a better job. Over 400 men who have taken our training are making big money. You can do the same. Age or education makes no difference. Ambition and common sense is all that is necessary.

Start a Business of Your Own

Little capital necessary. Every Village, every Town and City offers big possibilities for the ambitious Automobile Painter. Custom Shops are fast following in the wake of the service station and garage. You can learn in from 8 to 10 weeks' time. We teach you in a practical, methodical way on real Automobiles, Bodies, etc. The Instructors are men who have made Automobile Painting and teaching their life's work.

Instructions are Individual. You can start any time. The cost is small. **TODAY—RIGHT NOW—write** for our special offer and catalogue. No colored students accepted.

DETROIT AUTO PAINTING SCHOOL
25 D. A. P. S. Bldg., 426 Superior St., DETROIT, MICHIGAN

FREE SAXOPHONE MUSIC LIST

Theatrical Supplies, Plays, Sketches, Jokes, Minstrel Shows, Material, Make-Ups, Songs, Wigs and Dream Books.

WILL ROSSITER, Dept. P. M., 30 West Lake St., Chicago

BE AN ARTIST

Cartoon, Cartoon, Commercial, Newspaper and Magazine Illustrating, Pencil, Crayon, Pastels and Pastels. Our simple method quickly develops your talent in spare time. By Mail or Local Classes. Write for terms and list of successful students. **ASSOCIATED ART STUDIOS 87-B Madison Building, NEW YORK**

TOBACCO HABIT CURED OR NO PAY

Any form, cigars, cigarettes, pipe, chewing or snuff. Guaranteed. Harmless. Complete treatment sent on trial. Costs \$1.00 if it cures. Nothing if it fails.

SUPERBA CO., E-41, BALTIMORE, MD.

WRITE TODAY for
Our 168-PAGE
FREE BOOK on **Deafness**

and learn how Perfect Hearing is now being restored in every condition of deafness or defective hearing. Our "Little Wireless Phones for the Ears" require no medicine, but effectively replace what is lacking or defective in the natural ear drums. They are simple devices, which the wearer easily fits into the ears, where they are invisible. Soft, safe and comfortable.

WILSON EAR DRUM CO., Incorporated
931 Inter-Southern Bldg. LOUISVILLE, KY.

PIMPLES Blackheads, Acne Eruptions, Oily and Shiny Skin quickly removed by using **SMOOTH-SKIN**. \$1,000 money-back guarantee mailed with every bottle.

FREE! Valuable booklet explaining cause and cure of Skin Eruptions sent on request. Read what **SMOOTH-SKIN** has done for others after years of suffering.

Special Offer To New Customers.
Puritan Chemical Co. Dept. 20, Kansas City, Mo.

You Can Easily Learn to Play Any Music on the HAWAIIAN GUITAR

Just As Hawaiians Do—Native Instructors Teach You QUICKLY!

Here's Proof of our Remarkable Course

Buchanan, Va.,
First Hawaiian Conservatory of Music, Inc.

It has been two months since I have finished your course on the Hawaiian Guitar and I can play anything I wish. The course was all that could be desired and I am perfectly pleased with my playing ability since finishing your course.

Respectfully yours,
Louise K. Hammond

Koester School,
314 So. Franklin St.,
Chicago, Ill.

First Hawaiian Conservatory of Music, Inc.

I shall certainly be very glad to recommend your course whenever the chance is mine to do so. Mr. W. H. Johnson has not phoned me yet, and if he does not phone in a day or so, will write him. Am sending a letter to Miss Helen Slavik today which I think may help to secure her enrollment, and I shall be glad at any time to write a personal letter to anyone whom you may suggest.

Your former student,
W. L. Walker

Special Courses under famous Teachers. Tenor-Banjo, Violin, Banjo-Ukelele and Ukelele. Fine Toned Instruments FREE!

In Half an Hour You Will Be Playing "ALOHA". Soon You Will Be Winning Praise Everywhere Playing "Stumbling", "Three O'Clock in the Morning", "Hot Lips" and ALL Popular Music as Well as the Beautiful Hawaiian Melodies

Here's the chance you've been waiting for—the opportunity to play popular music quickly on the most entrancing instrument of the age—the Hawaiian Guitar. No previous musical knowledge necessary.

ONLY FOUR MOTIONS TO LEARN

and these you acquire in a few minutes. No troublesome scales or runs, you begin to play harmonious chords immediately! We don't care if you never saw a note of music in your life, we guarantee to teach you to play just as the Hawaiians do!

We Furnish Everything—a Beautiful Hawaiian Guitar, Picks, etc., and 52 Pieces of Music FREE!

You have always wanted to play some instrument, so we have made it unusually easy for you by furnishing everything—a beautiful Hawaiian Guitar, complete Conservatory Course of instruction and 52 pieces of especially selected music.

No Other Course Teaches as Quickly and Easily

This is the only Conservatory Course where you get the personal instruction of Native Hawaiian Experts—Frank Ferrera, Walter Kolomoku, Lawrence Kalaluki and Carl Seville, famous the world over and the most noted makers of phonograph records, supervise your playing.

Mail Coupon for Details of FREE Offer

Don't wait another minute—clip, fill in and mail the coupon NOW and get full details of our remarkable offer to teach you how to play the Hawaiian Guitar just as the Hawaiians do.

Special Arrangements for Lessons if You Have Your Own Instrument

FREE

This \$15
Hawaiian
Guitar

You will be delighted with the fine tone of this splendid Hawaiian Guitar



First Hawaiian Conservatory of Music, Inc.,
Desk 43, 233 Broadway (Woolworth Bldg.), New York.

Send me at once details about your 52 easy lessons and FREE Hawaiian Guitar offer!

Name.....

Address.....

Town..... State.....

Print name and address clearly

California's Auto School

Wants 250 Men to Train for Auto Jobs Now Open

Only men who have the keenest desire to get into big-pay auto jobs are urged to answer this advertisement.

Now, auto opportunities are greatest in California. A million autos in the State—garages needed, repair shops needed, hundreds of auto jobs open.

This opportunity for only 250 mechanically inclined men. National Automotive is a quality school—our practical system of individual and specialized instruction makes it impossible to take thousands of students as some schools do. For this reason National Automotive is known as "Training Headquarters for Auto Experts." Since 1905 National Automotive has trained men to become auto experts. Now a new and greater National Automotive building and thousands of dollars worth of new and special equipment are ready for you. Also wonderful recreation advantages—ball grounds, gymnasium, world's largest stadium, amusements, etc., across the street in 130-acre Exposition Park, all free to you.

FREE Illustrated Auto Book

Sent only to men who are ready to come to Los Angeles to take this splendid course. A book of auto facts and information about National Automotive—tells why National training is more thorough and practical; how we make you a big-pay expert in a short time; how you can earn your room and board while learning. How National free employment service finds your job for you. Write today for this big free book.

National Automotive School

Dept. 25, 4006 S. Figueroa St.

Los Angeles, California



New and finer National Automotive Bldg., located across the street from 130-acre Exposition Park, Los Angeles, Cal.

The many unusual advantages offered by National Automotive training, together with the wonders of a trip to California, will more than repay your railroad fare.

World's Largest Stadium, Exposition Park, Los Angeles

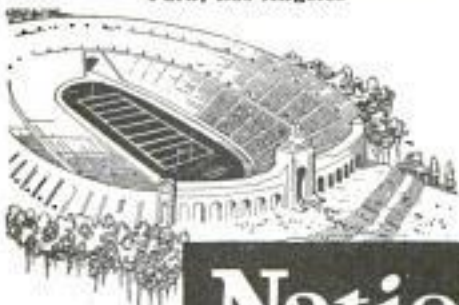

National Automotive





THE SECRET OF DRAWING

WE'LL tell you the secret of drawing, right here! It is *learning of correct principles, observation, practice, and perseverance.*

No marvelous "secret" of drawing exists that will make you a success overnight. In any line of endeavor where the *hand and the eye must be skilled*, practice is essential. But there is a vast difference between *haphazard "practice"* and the scientific practice given by the Federal Course, that develops your talent on a sure foundation by the *quickest possible method*, and makes the work truly a pleasure. Learn at home in spare time. No previous training or experience needed. The Federal Course clearly explains each step, and gives you *individual personal criticisms* on all lessons.

Get This Free Book

"YOUR FUTURE"

Send for this book to-day if you are 16 years old or more and in earnest about your future. It is beautifully illustrated, tells every detail you need to know about the Federal Course, and shows work of Federal students. Fill out and mail the coupon NOW, kindly stating your age.



COUPON

Federal School of Commercial Designing,
690 Federal Schools Bldg., Minneapolis, Minn.

Please send me "YOUR FUTURE," without charge or obligation.

Name.....

Age.....Occupation.....

Write your address plainly in margin.



High School Course in Two Years!

Lack of High School Training has kept thousands of men and women from attaining business and social position. Without this training you are absolutely barred from a successful business career, from leading professions, from well-paid civil service jobs, from teaching and college entrance. In fact, all preferred positions are closed to you without this vital training. You can't stand this heavy handicap nor do you have to. The American School can give you the valuable training you missed.

Put Your Idle Hours to Work You can complete our simplified High School Course within two years by spare-time study. Then you will be mentally equipped to handle a worthwhile position. This course, prepared by some of America's leading professors, will broaden your mind, give you a wider outlook and make you keen, alert and capable.

Remove Your Handicap

Whether you need High School Training or specialized instruction in your chosen line—NOW is the time to remove your handicap. You must know the short cuts and efficiency methods. You must know the HOW and WHY. Over 50,000 students owe their success to training received from the practical, money-making Courses in the coupon below. Let us tell you about this training—about the Course you are interested in. Check and mail the coupon.

American School

Dept. H-574, Drexel Ave. and 58th St., Chicago

American School

Dept. H-574, Drexel Ave. and 58th St., Chicago

Send me full information on the subject checked and how you will help me win success.

- | | |
|------------------------------|----------------------------|
|Architect |Lawyer |
|Building Contractor |Machine Shop Practice |
|Automobile Engineer |Photoplay Writer |
|Automobile Repairman |Mechanical Engineer |
|Civil Engineer |Shop Superintendent |
|Structural Engineer |Employment Manager |
|Business Manager |Steam Engineer |
|Cert. Public Accountant |Foremanship |
|Accountant and Auditor |Sanitary Engineer |
|Bookkeeper |Surveyor (& Mapping) |
|Draftsman and Designer |Telephone Engineer |
|Electrical Engineer |Telegraph Engineer |
|Electric Light & Power |High School Graduate |
|General Education |Fire Insurance Expert |
|Vocational Guidance |Wireless Radio |
|Business Law |Undecided |

Name.....

Address.....

marked copy

GREATEST OFFER EVER MADE BY GREATEST AUTOMOBILE SCHOOL

AMERICAN MOTOR SCHOOLS



Capital \$500,000
Building and Land \$350,000

MONEY IN YOUR POCKET

No offer equal to this ever made—
In America's Leading Motor School.
Write at once and we will pay your fare
to Washington, D. C., from East of Miss-
issippi River; give you FREE Kit of
Tools; Locker; Radio Outfit and Instruc-
tion; Y. M. C. A. Membership and Sight-
seeing Trips with Guide—ALL
FREE!

In Short Time You Become Independent

Learning at the AMERI-
CAN MOTOR SCHOOLS is
fascinating; each student gets
personal instruction from Mas-
ter Mechanics and anyone can
equip himself in a very few
weeks to command a high salaried posi-
tion; from then on it is up to the man—
the possibilities are limitless.

Opportunity Invites You

If you are plugging away at the same
old job and really want to get ahead, and
desire the luxuries in life which only suc-
cess can bring, fill out and send this
coupon. Don't delay—this is a turning
point in YOUR life—take advantage of
it NOW.

AMERICAN MOTOR SCHOOLS

Dept. 326

1612-1622 U St., N. W., Washington, D. C.

One convincing reason why the AMERI-
CAN MOTOR SCHOOLS maintain the lead
in giving easily-absorbed and quickly probed-
by INSTRUCTION, is because its EQUIP-
MENT is the final word of modern excellence.
Here, you are enabled to make SHORT CUTS
and not only become familiar with the best
manner in which to handle the problems con-
cerning present models of automobiles but,
in addition, those of future types.

You Have Natural Ability

Let our skillful, friendly, help-
ful instructors—under the guid-
ance of Vice-President Edward
H. Cooley, Director of Education
and Master Mechanic, give you
the THOROUGH TRAINING
which means that you will have
absolute confidence in your pow-
ers of performance and attain
FINANCIAL INDEPENDENCE
THROUGHOUT LIFE.

Our students make good because they are
thoroughly grounded and absorb the AD-
VANCED METHODS prevailing here. Write
at once.

FREE COUPON

To American Motor Schools,
Dept. 326, 1612-1622 U Street, N. W.,
Washington, D. C.

Send me full particulars as to PAYING MY FARE TO
WASHINGTON, Free Tools, Locker, Radio Outfit and In-
struction, Y. M. C. A. Membership and Sight Seeing Trips
—ALL FREE. Also send Free Catalog showing how I can
make big money in the Automobile field.

Name

Address

City

FROM
\$27.50
A
WEEK

TO
\$350.00
A
WEEK

FREE



KIT



Visit Washington, D.
C., at our expense, see the
Capitol, Washington
Monument, National
Museum, Library of Con-
gress, Arlington Wireless
Towers and Cemetery,
White House, Treasury,
Bureau of Bank Note En-
graving and Printing,
Lincoln Memorial and
other Wonderful Sights
dear to Americans.



"A Dollar A Minute"

"That's what I figure my spare-time study with the I. C. S. was worth to me. It was the best investment I ever made. I'm now making \$160 a week—or almost twice as much in an hour as I used to make in a whole day!"

EVERY mail brings letters from some of the two million students of the International Correspondence Schools telling of promotions or increases in salary as the rewards of spare-time study.

What are you doing with the hours after supper? Can you afford to let them slip by unimproved when you can easily make them mean so much? One hour a day spent with the I. C. S. will prepare you for the position you want in the work you like best. Yes, it will! Put it up to us to prove it. Mark and mail this coupon now!

TEAR OUT HERE

INTERNATIONAL CORRESPONDENCE SCHOOLS

Box 5520-D, Scranton, Penna.

Without cost or obligation, please tell me how I can qualify for the position or in the subject before which I have marked an X:

BUSINESS TRAINING DEPARTMENT

- | | |
|---|---|
| <input type="checkbox"/> Business Management | <input type="checkbox"/> Salesmanship |
| <input type="checkbox"/> Industrial Management | <input type="checkbox"/> Advertising |
| <input type="checkbox"/> Personnel Organization | <input type="checkbox"/> Better Letters |
| <input type="checkbox"/> Traffic Management | <input type="checkbox"/> Foreign Trade |
| <input type="checkbox"/> Business Law | <input type="checkbox"/> Stenography and Typing |
| <input type="checkbox"/> Banking and Banking Law | <input type="checkbox"/> Business English |
| <input type="checkbox"/> Accountancy (including C.P.A.) | <input type="checkbox"/> Civil Service |
| <input type="checkbox"/> Nicholson Cost Accounting | <input type="checkbox"/> Railway Mail Clerk |
| <input type="checkbox"/> Bookkeeping | <input type="checkbox"/> Common School Subjects |
| <input type="checkbox"/> Private Secretary | <input type="checkbox"/> High School Subjects |
| <input type="checkbox"/> Business Spanish <input type="checkbox"/> French | <input type="checkbox"/> Illustrating <input type="checkbox"/> Cartooning |

TECHNICAL AND INDUSTRIAL DEPARTMENT

- | | |
|--|--|
| <input type="checkbox"/> Electrical Engineering | <input type="checkbox"/> Architect |
| <input type="checkbox"/> Electric Lighting | <input type="checkbox"/> Blue Print Reading |
| <input type="checkbox"/> Mechanical Engineer | <input type="checkbox"/> Contractor and Builder |
| <input type="checkbox"/> Mechanical Draftsman | <input type="checkbox"/> Architectural Draftsman |
| <input type="checkbox"/> Machine Shop Practice | <input type="checkbox"/> Concrete Builder |
| <input type="checkbox"/> Railroad Positions | <input type="checkbox"/> Structural Engineer |
| <input type="checkbox"/> Gas Engine Operating | <input type="checkbox"/> Plumbing and Heating |
| <input type="checkbox"/> Civil Engineer | <input type="checkbox"/> Chemistry <input type="checkbox"/> Pharmacy |
| <input type="checkbox"/> Surveying and Mapping | <input type="checkbox"/> Automobile Work |
| <input type="checkbox"/> Metallurgy <input type="checkbox"/> Mining | <input type="checkbox"/> Navigation |
| <input type="checkbox"/> Steam Engineering | <input type="checkbox"/> Agriculture and Poultry |
| <input type="checkbox"/> Radio <input type="checkbox"/> Airplane Engines | <input type="checkbox"/> Mathematics |

Name.....

Street.....

Address..... 1-10-23

City..... State.....

Occupation.....

Persons residing in Canada should send this coupon to the International Correspondence Schools Canadian, Limited, Montreal, Canada.

Make \$10 a Night

Be a Drummer Professional drummers in demand everywhere and make big money. You can quickly and easily learn to play band, orchestra and dance music through my home study course. Write for particulars Today, NOW! Write for folder of special snare drum offer.

The Herman H. Rinne Correspondence School of Modern Drumming
3154 Park Ave. INDIANAPOLIS

BART CHALK-TALK

If you can draw a little, you can do the Bart Chalk-Talk. Send 4c in stamps for Chalk-Talk folder and complete catalog of art and Chalk-Talk Supplies.

Bart Supplies, East 81st., Minneapolis, Minn.

LEARN TO PITCH

Lessons by "MATTY" WALSH, WHITE, JOHNSON, RUCKER, WOOD—PITCH THE FADE-A-WAY, SPITTER, KNUCKLER, SMOKE BALL, etc. Clearly described and illustrated by 56 Pictures. Entire COURSE OF LESSONS sent p. p. for 25c

J. C. DORN, 721 S. Dearborn Street, Dept. 65, CHICAGO, ILL.

Be A Virile Red Blooded Man



Get the Joy Out of Life

Win back your health, strength, vigor and vitality—the ability to do what you want to do, enjoy what you wish to enjoy, live as you like to live. It's a joy you never can know while handicapped by miserable ailments or habits that take the tuck out of you and unfit you for work or play. You can't be welcomed in the home, in society, business, anywhere while you are burdened with bad breath, pimply skin, catarrh, constipation, indigestion, dyspepsia, crippled with asthma, weak heart, weak lungs, rupture—wretched with nervousness, fear and the numerous other results of violating Nature's Laws. (See consultation coupon.) It looks gloomy to you but cheer up—I can help you with

STRONGFORTISM

The Modern Science of Health Promotion will conquer your weaknesses, banish your ailments and make you over into a real red-blooded man. I guarantee it.

Mark the items on the consultation coupon (write other ailments on extra line) on which you want special confidential information and send with 10c (one dime) to help pay postage, etc., on my free book, "Promotion and Conservation of Health, Strength and Mental Energy." It's a builder of real men. Send for my free book Right Now, TODAY.

LIONEL STRONGFORT Physical and Health Specialist
Dept. 332, Newark, New Jersey

FREE CONSULTATION COUPON

Mr. LIONEL STRONGFORT, Dept. 332, Newark, N. J.—Please send me your book, "PROMOTION AND CONSERVATION OF HEALTH, STRENGTH AND MENTAL ENERGY," for postage on which I enclose a 10c piece (one dime). I have marked (X) before the subject in which I am interested.

- | | | |
|---|--|---|
| <input type="checkbox"/> Colds | <input type="checkbox"/> Catarrh | <input type="checkbox"/> Weak Eyes |
| <input type="checkbox"/> Asthma | <input type="checkbox"/> Blackheads | <input type="checkbox"/> Gastritis |
| <input type="checkbox"/> Hay Fever | <input type="checkbox"/> Insomnia | <input type="checkbox"/> Increased Height |
| <input type="checkbox"/> Obesity | <input type="checkbox"/> Short Wind | <input type="checkbox"/> Heart Weakness |
| <input type="checkbox"/> Headache | <input type="checkbox"/> Flat Feet | <input type="checkbox"/> Poor Circulation |
| <input type="checkbox"/> Fear | <input type="checkbox"/> Stomach Disorders | <input type="checkbox"/> Skin Disorders |
| <input type="checkbox"/> Thinness | <input type="checkbox"/> Constipation | <input type="checkbox"/> Neurasthenia |
| <input type="checkbox"/> Rupture | <input type="checkbox"/> Biliousness | <input type="checkbox"/> Dependancy |
| <input type="checkbox"/> Lumbago | <input type="checkbox"/> Torpid Liver | <input type="checkbox"/> Round Shoulders |
| <input type="checkbox"/> Neuritis | <input type="checkbox"/> Indigestion | <input type="checkbox"/> Lung Troubles |
| <input type="checkbox"/> Neuralgia | <input type="checkbox"/> Nervousness | <input type="checkbox"/> Weaknesses (Specify) |
| <input type="checkbox"/> Flat Chest | <input type="checkbox"/> Poor Memory | <input type="checkbox"/> Muscular Development |
| <input type="checkbox"/> Deformity (Describe) | <input type="checkbox"/> Rheumatism | <input type="checkbox"/> Great Strength |
| <input type="checkbox"/> Diabetes | <input type="checkbox"/> Pimples | |
| <input type="checkbox"/> Female Disorders | <input type="checkbox"/> Falling Hair | |

Mention other ailments here.....

Name.....

Age..... Occupation.....

Street.....

City..... State.....

ELECTRIC

Motor-Masters Wanted

Come to our shops here in Chicago and learn by ACTUAL PRACTICE how to be a *MASTER OF THE ELECTRIC MOTOR*. We will teach you rapidly how to repair, test, wind, install and control all kinds of electrical machinery, make you an electric wiring, transmission, and illuminating expert, give you a complete knowledge of circuits, electro-magnetic induction, power house and substation work, teach you how to make or repair all kinds of storage batteries and handle expertly all types of automotive-electrical equipment.

A Real, Practical and Technical Electrical Training in 15 Weeks

PLAN YOUR LIFE. STOP EXPERIMENTING WITH YOUR FUTURE. STOP DEPENDING ON BLIND ALLEY JOBS. GET INTO A PRACTICAL AND HIGHLY-PAID PROFESSION. Come to us and become a **MOTOR AND GENERATOR EXPERT** and qualify to make your \$250 a month up, or start a motor maintenance business, a battery station, or an electric repair shop of your own and

Earn \$3,000 to \$10,000 a Year

We will make you a practical and technical master of all kinds of electrical machinery, apparatus, installation and management in the shortest possible time. Such knowledge ensures your success. It means you become a *DIPLOMA* man, who, as an expert, will be in constant and general demand everywhere, and able to *COMMAND* promotion and big pay right from the start.

POSITIONS SECURED FOR YOU—FREE

This school will train you at least cost, and in the shortest, most practical manner to qualify for a real position at the highest rate of compensation paid and we **AGREE TO DO THIS UNTIL YOU ARE COMPETENT TO ACCEPT A \$250 TO \$350 A MONTH POSITION**. We are also very successful in securing positions for beginners who come here needing help in paying their training expenses; so very successful, in fact, that we will if desired, undertake to provide you with a position. There is absolutely no doubt about this if you accept our wonderful offer and start your training at once.

SEND COUPON OR WRITE—NOW!

Valuable and important information on getting started **RIGHT** in this great profession, will be sent to you free—Write today.

HARRY HART, Chief Engineer
Residence Dept., S. & H. Electrical Works
Desk E1, 308 South Green St., Chicago



**We Pay Students
R. R. FARE
from anywhere**

A complete Encyclopedia of Electrical Science, value \$80.00, FREE. \$65.00 set of fine tools FREE.

**Harry Hart,
E. T.,
Chief Engineer,
Res. Dept.,
S. & H.
Electrical
Works**

For 21 years with Commonwealth-Edison, America's greatest public service company, Mr. Hart will give you a training that has high voltage salary-earning power in any part of the United States.

MAIL-FOR VALUABLE INFORMATION-NOW

Desk E1,
Mr. Harry Hart,
Chief Engineer,
Residence Dept.,
S. & H. Electrical
Works
308 South Green Street
Chicago, Ill.

Dear Sir: Send me free and prepaid without obligation information that will enable me to get started right on electrical work of a high-grade type; also full particulars of your practical shop training system for beginners or advanced men in the electrical field.

Name

Address

LEARN CARTOONING the Right Way



Have your ability trained by the school that has developed many famous cartoonists.

If you like to draw—if you find pleasure in picking up a pencil and paper and trying to make sketches or cartoons, don't regard it merely as a hobby. Have your ability developed and earn a good income as a cartoonist.

Hundreds of nationally known cartoonists, such as Branner of the Chicago Tribune; Blosser, who draws "Freckles and His Friends"; Gene Byrnes, creator of "Reg'lar Fellers"; Thiele of the Sioux City Tribune; Fung, of the Seattle Times and others equally well known, took the Landon Course at home, in their spare time, and fitted themselves for their present positions at salaries ranging from \$50 to \$200 and more per week.

Have YOUR talent developed by the same method

What the above mentioned boys did you can do, with the same training. The Landon method of teaching makes cartooning easy to learn. By means of an extensive series of Big picture charts all the necessary details of ORIGINAL drawing are explained step by step, in a clear and simple manner.

FACTS that determine the superiority of the Landon School:

1. Landon School Students are securing the best cartooning positions which open up everywhere.
2. The picture chart method of instruction was originated and is used exclusively by the Landon School.
3. From the very beginning, the Landon Course teaches ORIGINAL drawing. No copy work.
4. Individual attention and criticism of student's work. Personal coaching whenever necessary.
5. Specialized instruction on how to originate cartoon ideas. This is an exclusive feature of the Landon Course.
6. Practical assistance in securing positions for students and help in marketing their work.
7. The price is within reach of everyone who is ambitious to succeed. Easy payments can be arranged.

Write today for full information about the Landon Course, and sample chart by means of which you can test your own ability. Find out what the possibilities are for YOU in this interesting profession. Please state your age.

The Landon School
838 National Bldg. Cleveland, Ohio

The Music Pals of the Nation



New friends, new pleasures, new and interesting experiences, invitations galore—dinners, dances, week-end parties, outings,—are some of the good things playing a Gibson brings into your life.

Gibson
Instruments

are easily learned in spare time without previous knowledge of music. A few weeks of pleasant, interesting study and you'll be able to play. And there's no other joy in life quite equal to hearing music you make on your own instruments.

\$5.00 Monthly buys a Gibson. The ultimate in construction, finish, tone quality and volume. Built like a violin. Adjustable bridge, non-warpable truss rod neck and thirty other exclusive Gibson features. **Guaranteed for life.** Non-Gibson instruments exchanged.

Make \$25 to \$200 weekly, selling, playing, teaching. Own a high class, exclusive business. We furnish stock, advertise, help sell, carry accounts. Gibsons easily sold on confidential credit plan.

Send for FREE catalog, FREE music and information about Mandolin, Mandola, Mando-cello, Mando-bass, Guitar, Harp-guitar, Mandolin-banjo, Tenor-banjo, Cello-banjo, Guitar-banjo. If interested in Agency, check here..... Teacher..... Clip, check and mail this ad today. Address all mail to Kalamazoo.

Gibson Mandolin-Guitar Co.

1585 Parsons St.
Kalamazoo, Mich.

Foreign Dept.
25 Broad St., N. Y. City

TRI-STATE COLLEGE OF ENGINEERING

Makes you a Civil, Mechanical, Electrical or Chemical Engineer in two years, 48 weeks each. No entrance examinations. High School Diploma not required. Compact courses made up of essentials only. Expenses low.

FOR CATALOG ADDRESS 100 M. Street, Angola, Indiana

LEARN TO GET DOLLARS OUT OF WATCHES.

WATCH-REPAIRING, ENGRAVING, JEWELRY REPAIRING.



WRITE NOW.

ENICAR TRADE SCHOOL
530 W MONUMENT SQUARE, RACINE, WIS.

Buchstein's Fibre Limb

is soothing to your stump—strong, cool, neat, light. Easy payments. Braces for all deformities.

Send for Catalog Today

D. BUCHSTEIN CO.
113 6th St. S., MINNEAPOLIS, MINN.

DEAFNESS IS MISERY

I know because I was Deaf and had **Head Noises** for over 30 years. My invisible Antiseptic Ear Drums restored my hearing and stopped Head Noises, and will do it for you. They are Tiny Megaphones. Cannot be seen when worn. Effective when Deafness is caused by Catarrh or by Perforated, Partially or Wholly Destroyed Natural Drums. Easy to put in, easy to take out. Are "Unseen comforts." Inexpensive. Write for Booklet and my sworn statement of how I recovered my hearing.

A. O. LEONARD, Suite 226, 70 5th Avenue, New York City

STOP TOBACCO

If you cannot stop it, do you know why? Do you know its effect on efficiency? This subject discussed in common-sense manner in booklet written by one who conducted anti-cigarette clinic for L. A. Police Dept. for over a year. Treated thousands—all forms. Booklet free as long as they last. Write Dr. T. H. Trinwith, Black Bldg., Los Angeles, Calif.

Useless as a Rabbit's Tail

The best thing a rabbit can do with his tail is to sit on it. And that's about as much use as some men make of their bodies. There are so many flat-chested, weak-kneed specimens walking the streets these days that a real live man is a curiosity. The average man of to-day has about as much ambition for exercise as a jelly-fish. If he runs 50 yards, he puffs like a steam engine, sits down and feels as though he were ready to die. And, take it from me, he isn't far from it.

Cut it out fellows. Don't be a cake-eater. If you ever knew the joys of a real healthy body, you would start this minute to get one. And that is just what you are going to do. The undertaker has his eye on you, but give him the laugh and say: "Not yet, old boy."

The Gateway to Health

It is open to you. Come on in and get busy. Yes, it means work, but Oh boy! what it brings to you. In just 30 days I am going to put one full inch on your biceps; yes, and two inches on your chest. But that is only the start. Now comes the real works.

I am going to broaden your shoulders, fill out your chest and give you a pair of arms that carry a wallop. Meanwhile I work on your inner muscles surrounding your vital organs. Every breath you take brings a deep inhale of oxygen into your lungs, purifying your blood, so that your whole body will fairly tingle with new life. You will feel real pep in your old backbone. This is no idle talk. My treatment has stood the test of years and is now endorsed by experts as absolutely the shortest and only sure route to Health and Strength. I don't promise results—I guarantee them. Come on now and make me prove it.

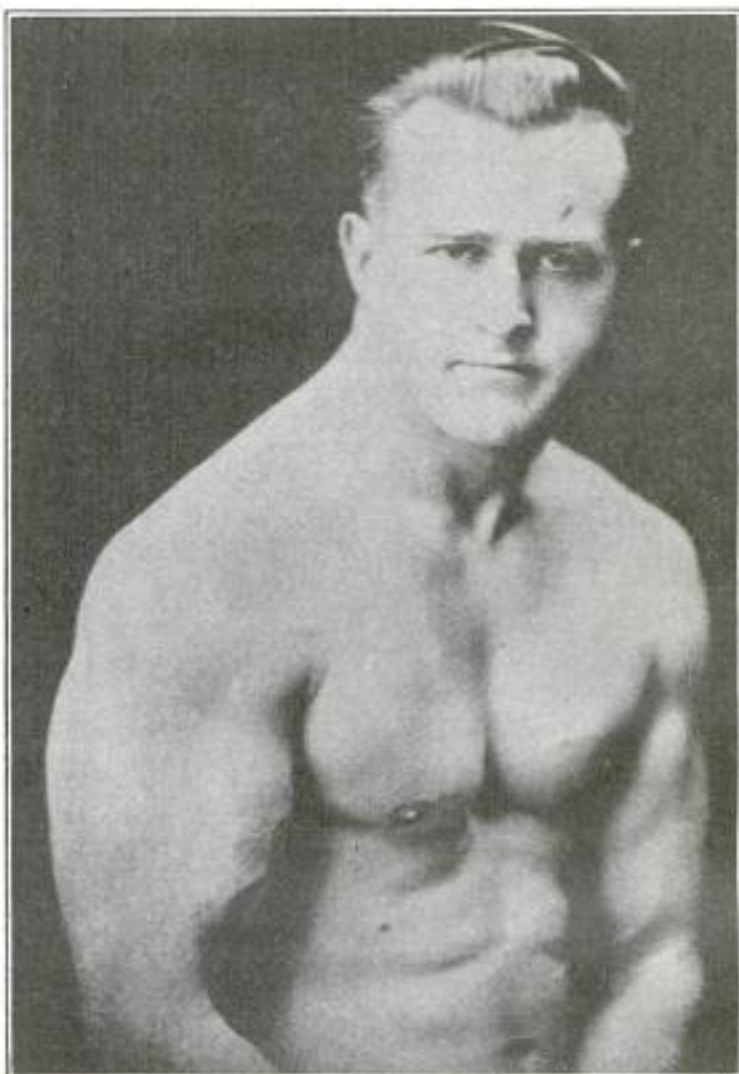

EARLE E. LIEDERMAN as he is to-day

Send for My New 64-Page Book, "MUSCULAR DEVELOPMENT"

It contains forty-three full-page photographs of myself and some of the many prize-winning pupils I have trained. Some of these came to me as pitiful weaklings, imploring me to help them. Look them over now and you will marvel at their present physiques. This book will prove an impetus and a real inspiration to you. It will thrill you through and through. All I ask is 10 cents to cover the cost of wrapping and mailing and it is yours to keep. This will not obligate you at all, but for the sake of your future health and happiness, do not put it off. Send today—right now, before you turn this page.

EARLE E. LIEDERMAN
Dept. 2005
309 Broadway NEW YORK CITY

EARLE E. LIEDERMAN

Dept. 2005, 309 Broadway, New York City

Dear Sir:—I enclose herewith 10 cents for which you are to send me, without any obligation on my part whatever, a copy of your latest book, "Muscular Development." (Please write or print plainly.)

NAME.....

STREET.....

CITY.....STATE.....



Get the Training that Doubles Incomes!

Rex Cary had a job with a contractor but wasn't satisfied. He saw that big pay went to experts and enrolled for a home study course with Chicago "Tech". He soon became a Chief Draftsman and his salary was doubled, then doubled again and he hasn't reached the limit yet. J. D. Woodside was a carpenter at \$6 a day. He took the Chicago "Tech" Builder's Course, and was made Foreman at \$8 a day—then Superintendent. Now has paying contracting business of his own. These men are cashing in on the spare time they used to get specialized knowledge, and you can do the same.

Chicago "Tech" Experts Will Train You by Mail

Big jobs are waiting for skilled Draftsmen, for Building Experts who can read plans, estimate costs and direct work and for men with other technical knowledge. Don't let your chance get by. Get the training that brings quick advancement and more money.

Now!

Put X in coupon to show which subject interests you and we will send valuable information. If inquiry is on **Drafting**, you also get a **Free Trial Lesson**. If on **Building**, 2 books and **Blue Print Plans**. Mail the coupon today.



Chicago Technical College, 530 Chicago Tech. Bldg. Chicago, Illinois

Without cost or obligation on me, please send instructive matter about opportunities in line I have marked with "X".

- | | |
|---|--|
| <input type="checkbox"/> Drafting (The Big Salary Course) no experience necessary. | <input type="checkbox"/> Aeronautic Engineering
All about aeroplanes. |
| <input type="checkbox"/> Building Trade Course for men in the building lines. | <input type="checkbox"/> Plumbing, Heating and Ventilating. |
| <input type="checkbox"/> Surveying and Map Drafting. | <input type="checkbox"/> Steam Engineering. |
| <input type="checkbox"/> Automobiles, Gas Engines, Starting, Lighting, etc. | <input type="checkbox"/> Plan Reading for Shop Men—Machinists, Assemblymen, etc. |

Name.....

Address.....

Post Office..... State.....

Please Mention Popular Mechanics

EASY FOR YOU TO OWN A FINE INSTRUMENT!

YEARS ago the famous King Brass Instruments were sold only for cash to famous musicians. But now due to our easy payment plan anyone can own one of these wonderful instruments.

SAVE MIDDLEMAN'S PROFITS

Simply order direct from the factory. You save middleman's profit—and you get a fine, new, sound-laboratory tested, acoustically perfect King Instrument. With it goes our guarantee plus free factory-service.

IT'S EASY TO OWN A KING

Rebuilt instruments, refinished to look like new, we sell for cash at low prices. New instruments on the easy payment plan. Thus it's "easy to own a King". Send for our latest complete catalog and list of special bargains.

THE H. N. WHITE COMPANY
5248 Superior Avenue Cleveland, Ohio



PUT YOUR VOICE ON A PHONO-RECORD

PERMANENT REMEMBRANCE

Great Fun, parties etc.—Just think, you can make YOUR OWN phono records. Talk-Sing-Play. Simple, anybody can do it. Use any phonograph. No special attachment needed. Mail your voice instead of a letter. COMPLETE OUTFIT, including 3000 face metal records, special recording needles, also reproducing microphone. Sent postpaid only \$2.00 (C. O. D. 10c ex.) (Complete instruction free.)

COMPLETE \$2.00
OUTFIT

C. C. ARCHIBALD CO., INC.
1540 Broadway New York

LEARN MECHANICAL DENTISTRY

EARN \$30 TO \$125 A WEEK. Taught by actual practice—day or night. Three months' course. Modern laboratories. No previous training required. Established 30 years. For 35-page catalog, write Dept. 2.

BODEE DENTAL INSTITUTE

NEW YORK 136 W. 32d St. PHILADELPHIA 1315 N. Broad St. BUFFALO 1225 Main St. BROOKLYN 15 Flatbush Ave.



FACTORY SALE \$2.95

100% Copper

Non-explosive, fire-proof, air-tight cans made of pure cold-rolled heavy gauge copper, for home and garage use. Only factory in U. S. selling at old prices in spite of higher copper cost! 5 top screw-top permits easy cleaning. Prices must go up soon—so order today!

Old, Low Prices!
2 gallons \$2.95 8 gallons \$7.45
4 gallons 4.85 10 gallons 8.50
6 gallons 6.35 15 gallons 9.95
3-8 inch tubing 29c foot
1-2 inch tubing 38c foot

Send No Money

Shipped in plain wooden box. Remit in any convenient form or order C. O. D. DON'T WAIT or you will have to PAY MORE!
DORMAC MANUFACTURING COMPANY
Dept. 232, cor. Racine & Roscoe Sts., Chicago



THE PRACTICAL Automobile, Wagon, House and Sign Painter

By W. F. White
Postpaid \$1.00

This book is written for the man who wishes to paint his automobile, or his home, or wagon. It will tell the inexperienced just how to do it, and it will tell him how to mix paints. It also contains many painters' recipes and trade secrets of great value. Bound in Cloth—157 pages—Size 5 x 7 1/2.

Postpaid \$1.00

SHREWSBURY PUBLISHING COMPANY
5525 West Lake Street Chicago, Illinois

Learn to **PAINT** Signs and Show Cards

Big field—unlimited possibilities—increasing demand for men with creative ideas. Our course develops ability and originality. Work intensely interesting.

EARN \$25 TO \$75 WEEKLY

You can do it if ambitious. Successful graduates everywhere. Our course thoroughly covers every phase of work. Our graduates command big salaries. Write for catalog, samples, guarantee and Free Outfit Offer.

Detroit School of Lettering, 630 D. S. L. Bldg., Detroit, Mich.



Learn Drafting

Individual study at home may be successfully engaged in with the aid of our new enlarged book

A Practical Course in Mechanical Drawing
Cloth. 160 Pages. 157 Drawings. Price, 50c Postpaid.
Popular Mechanics Book Dept., 200 E. Ontario St., Chicago.

Learn to Play Violin, Mandolin
Banjo, Mandolin

The NEW PHONOGRAPH WAY

To advertise the World's most famous method in teaching Violin, Mandolin and Banjo-Mandolin, Prof. Schneider will give away absolutely FREE to one pupil in each locality their choice of either one of the three instruments. Only a small charge for lessons—a few cents a week your only expense. Your success guaranteed. Pay nothing if you fail to learn.



YOUR CHOICE
FREE

SCHNEIDER'S SIMPLEX SYSTEM

Covers all three instruments in one course. Twelve complete lessons on records. Simple as A-B-C. You can play anyone of these instruments by note in a few days and Play for Money in 2 months. 300,000 have learned to play beautifully. Some are now leaders of bands, others play in orchestras, at weddings, parties, and church socials. Be popular—save months of time this New Positive Way.

GET FIRST RECORD FREE—5 DAYS' TRIAL

We will send you absolutely free the first record for 5 Days' Trial. Your request will enable us to protect you on free instrument in your locality. See for yourself how easy and simple it is to learn to play music. Just fill out the coupon and mail today.

SEND NO MONEY—JUST SEND COUPON

Prof. Schneider, 238 Vermont St., Blue Island, Ill. (B-5)
Please send me FREE and PREPAID for 5 Days' free trial your first lesson Record with complete information on course and how I can secure a musical instrument absolutely free. If I decide not to enroll I will return record after the five days' trial and will not be obligated in any way.

NAME.....
ADDRESS.....
CITY..... STATE.....

FREE Finger Print Outfit



Yes, I will give you this complete Finger Print outfit absolutely free. It is the regular expert's working outfit—the same kind that I use myself. I am making this offer to those who enroll right now. Start today and get this outfit absolutely free.

Be a Finger Print Expert

Learn at Home — 30 Minutes a Day

Only 30 minutes a day for a few months—that is all the time necessary. I am a Finger Print Expert and I know what is required. I will give you just the training that you need to be an expert yourself. You need not give up your present occupation while you are studying this fascinating work. But get started in this big paying profession. A position is waiting for you. I guarantee to place you in it as soon as you have completed this course.

More Men Needed Right Now!

The Professional Finger Print Expert is always in demand. I have so many positions waiting to be filled right now that I am guaranteeing to place every man as soon as he has finished my course. And I am backing this remarkable offer with \$1,000 bank guarantee, deposited with the Phillips State Bank of Chicago. Let me make you a Finger Print Expert and start you in a big paying permanent position.

WRITE today! I will send you full information about this fascinating big paying profession. Get started! The big opportunity you have been waiting for is here. Send the coupon and learn all about it.

U. S. SCHOOL OF FINGER PRINTS
Room 13-55, 7003 No. Clark St., Chicago, Ill.

U. S. School of Finger Prints,
7003 No. Clark St., Room 13-55, Chicago, Ill.

Dear Sir: Send me at once, without obligation, complete information about your Guaranteed-Position offer, Free Finger Print outfit offer, and tell me how I can become a Finger Print Expert.

Name.....

Address.....

Age.....

Please Mention Popular Mechanics



"We pay him \$100 a week"

AND he's worth every cent of it. Came here several years ago asking for a job. He got just that—a small job at a small salary.

"Then I forgot about him—hardly knew he was on the payroll until one day I got a letter from the International Correspondence Schools telling me that he had enrolled for a course of home study. It was remarkable the way he went ahead.

"We pay him \$100 a week now and he's going to be earning even a larger salary some day. I wish we had more men like him."

HOW do you stand when your employer checks up his men for promotion? Does he think of you? Is there really any reason why you should be selected? Ask yourself these questions fairly. You must face them if you expect advancement and more money.

One hour after supper each night spent with the I. C. S. in your own home will prepare you for the position you want in the work you like best.

Yes, it will! Put it up to us to prove it. Without cost or obligation, just mark and mail this coupon.

TEAR OUT HERE

INTERNATIONAL CORRESPONDENCE SCHOOLS Box 5522-D, Scranton, Penna.

Without cost or obligation, please tell me how I can qualify for the position or in the subject before which I have marked an X:

BUSINESS TRAINING DEPARTMENT

- | | |
|---|---|
| <input type="checkbox"/> Business Management | <input type="checkbox"/> Salesmanship |
| <input type="checkbox"/> Industrial Management | <input type="checkbox"/> Advertising |
| <input type="checkbox"/> Personnel Organization | <input type="checkbox"/> Better Letters |
| <input type="checkbox"/> Traffic Management | <input type="checkbox"/> Foreign Trade |
| <input type="checkbox"/> Business Law | <input type="checkbox"/> Stenography and Typing |
| <input type="checkbox"/> Banking and Banking Law | <input type="checkbox"/> Business English |
| <input type="checkbox"/> Accountancy (including C.P.A.) | <input type="checkbox"/> Civil Service |
| <input type="checkbox"/> Nicholson Cost Accounting | <input type="checkbox"/> Railway Mail Clerk |
| <input type="checkbox"/> Bookkeeping | <input type="checkbox"/> Common School Subjects |
| <input type="checkbox"/> Private Secretary | <input type="checkbox"/> High School Subjects |
| <input type="checkbox"/> Business Spanish <input type="checkbox"/> French | <input type="checkbox"/> Illustrating <input type="checkbox"/> Cartooning |

TECHNICAL AND INDUSTRIAL DEPARTMENT

- | | |
|--|--|
| <input type="checkbox"/> Electrical Engineering | <input type="checkbox"/> Architect |
| <input type="checkbox"/> Electric Lighting | <input type="checkbox"/> Blue Print Reading |
| <input type="checkbox"/> Mechanical Engineer | <input type="checkbox"/> Contractor and Builder |
| <input type="checkbox"/> Mechanical Draftsman | <input type="checkbox"/> Architectural Draftsman |
| <input type="checkbox"/> Machine Shop Practice | <input type="checkbox"/> Concrete Builder |
| <input type="checkbox"/> Railroad Positions | <input type="checkbox"/> Structural Engineer |
| <input type="checkbox"/> Gas Engine Operating | <input type="checkbox"/> Plumbing and Heating |
| <input type="checkbox"/> Civil Engineer | <input type="checkbox"/> Chemistry <input type="checkbox"/> Pharmacy |
| <input type="checkbox"/> Surveying and Mapping | <input type="checkbox"/> Automobile Work |
| <input type="checkbox"/> Metallurgy <input type="checkbox"/> Mining | <input type="checkbox"/> Navigation |
| <input type="checkbox"/> Steam Engineering | <input type="checkbox"/> Agriculture and Poultry |
| <input type="checkbox"/> Radio <input type="checkbox"/> Airplane Engines | <input type="checkbox"/> Mathematics |

Name.....
Street.....
Address.....

1-10-23

City..... State.....

Occupation.....

Persons residing in Canada should send this coupon to the International Correspondence Schools Canadian, Limited, Montreal, Canada.

Please Mention Popular Mechanics

BE A DIAMOND EXPERT!



Do you know that of two diamonds of equal size one may be worth a hundred times as much as the other? Who can distinguish them but an expert? My short, easy course will make you a diamond expert in a few months! Get it before you buy your next diamond—it will save you money!

FREE! GENUINE Diamonds
if you enroll at once

\$5,000 to \$15,000 a Year!

Be a diamond expert and go into business for yourself on only \$25 or \$50 capital! We will show you how! Be a diamond expert and become independent. The diamond business is a gentleman's business. Success in any other line of business means \$5,000 a year—success in the diamond business means up to \$15,000 a year! Millions of dollars are paid out every year for diamonds! Jewelry stores everywhere need diamond experts—always pay high for expert opinions. Diamond experts are rare!

Write for free booklet

My booklet "Faying Diamond Knowledge" telling you how to start in the diamond business will be sent to you absolutely free! Contains new and amazing and startling facts about diamonds. Write now!

CODINGTON SCHOOL OF DIAMONDS
1461 Cullom Ave. Dept. 105 CHICAGO, ILLINOIS

LEARN Wrestling Secrets at Home by Mail



Yes, learn the secrets of World's Champions—how to wrestle expertly—how to handle big men with ease—how to win. Be athletic, be strong, be healthy. Learn how to defend yourself.

Farmer Burns

the world's most scientific wrestler, who trained the undefeated Champion Frank Gotch— who also trained six other World's Champions, will now train you. Investigate today his wonderful methods—the secrets of Champions. Every man and boy in the world, no matter what age, needs this information on **SCIENTIFIC WRESTLING — PHYSICAL CULTURE — JIU-JITSU — SELF DEFENSE.**

Free Book Send your name and age and get my splendid 32 page illustrated wrestling and athletic book—absolutely free—no obligations of any kind. Write NOW.

FARMER BURNS, 1775 N. Exchange Bldg., Omaha, Neb.

Learn Expert Auto Painting



There is **Big Money** in auto painting and refinishing. Our Home Study Course in **Practical Auto Painting** will enable you to do the finest work and earn big wages. Wonderful opportunity for new money-making business of your own.

FREE circular tells all about this big new business. Be first. Write quick.

CHICAGO COLLEGE OF AUTO PAINTING
Dept. 5, 20 E. Jackson Blvd., CHICAGO, U.S.A.

BIG SURPRISE FOR LOVERS OF MUSIC



Our instruction books show you how to play at once without tedious lessons. We furnish them free with any instrument selected from our catalog. Write for it immediately. Thousands have told us of their worth.

BENSHRAGO STUDIOS, Dept. 011, 212 Fifth Ave., New York City

ELECTRICITY LEARN AT HOME

Send for catalog which tells how Burgess Home Training enables men and boys to get good jobs and keep them. **BURGESS ELECTRICAL SCHOOL, Dept. P5, 744 E. 42nd Street, CHICAGO**



"BECOME A LIGHTNING TRICK CARTOONIST"

MAKE MONEY QUICK TALKING. SEND \$1.00 FOR SALARY PROGRAM OF TRICK DRAWINGS WITH INSTRUCTIONS BY A PROFESSIONAL CARTOONIST. SATISFACTION GUARANTEED. CIRCULAR FREE. BALDA ART SERVICE, 01, 05H KOSH, WIS.

Become a CERTIFIED AUTOMOTIVE ELECTRICIAN



Specialize in Ignition, Starting, Lighting and Storage Batteries and become a highly paid expert or start your own business. Day, evening, and home service courses. Endorsed by Automotive Electrical Association of Wisconsin. Write for free 48 page catalog.

SCHOOL of AUTOMOTIVE ELECTRICITY, Inc.
Dept. PM. 5 415 Marshall St. Milwaukee, Wis.

**MEN!
YOU CAN
NOW**

STUDY AUTOS AT HOME

**Just What You
Have Been Waiting For
A Real Home Study Course
From a Reliable Institution**

You can now be a student of the Michigan State Automobile School without leaving your home. You can get the advantage of training approved by the auto industry, from the *only school that can give it to you*, even though you can't make a trip here. The twelve years of experience of this great school is now open to you without leaving your job, and with no extra expense.

Thousands of men all over the country have wanted to come to Detroit to learn the Auto Business at the "Old Reliable" M. S. A. S. Many have been unable to get the necessary money together to do so. We have had insistent and continued requests for some way to learn at home, by a good course from a reliable institution of high standing. In response to this demand the Michigan State Automobile School (the factory endorsed school) has prepared a complete Home Study Course in Automobile Mechanics and Auto Electricity. We have been nearly two years preparing this course. It is most complete—thorough in every detail, we have put all of our twelve years of training experience into it. You can now learn by the famous M. S. A. S. factory endorsed methods at home!

Study at Home, or in Detroit—(or Both)

The M. S. A. S. Home Study Course is written so you can learn the business entirely at home. But it includes the privilege of coming to Detroit to take our practical course also, with actual experience in our laboratories and shops. You can start at home and continue your training here later if you wish to. If you plan to come to Detroit later but can't come now, start now at home and have that much advantage. That will save part of room and board expense when you do come. It's a wonderful opportunity for you to make your start now toward success. Remember that this is the only Home Study Course put out by a factory endorsed school. It is also the only Home Study Course giving you the privilege of continuation in a real practical school.

Earn \$125 to \$500 Per Month

The *Automobile Business* is THE Business to get into. Over 12 million cars to overhaul and repair. Millions of batteries, electrical systems, and tires to repair and replace. Thousands of good garages are needed. Can you think of a better business for a man to get into? You can get started now—at home. You don't need to wait until you've saved up enough to come to Detroit for three months. Start now, study at home and come to Detroit later if you want to.

Very Easy Terms—Nothing to Wait for Now

No matter what your situation is you can take this course, on the astonishingly easy payment plan. You pay as you go and you take no chance. We give you a signed absolute guarantee to give your money back if you are not satisfied with the Course. You are to be the sole judge of whether you are satisfied or not.

OUR GUARANTEE

All of our time and effort for the past twelve years has been centered on just one thing—training men for the automobile business. We know exactly what training is required by the man who earns the big salary or succeeds in a shop of his own. We can't afford to put out a Home Study Course that isn't absolutely right, you can depend on that. But to make you doubly safe we will guarantee (in writing) to refund every penny of your tuition fee if on completing our course, you are not entirely satisfied with it.

GET STARTED NOW

Now—when you are working—is the time to prepare and train yourself for times when you may be out of a job. Have a good trade that you can work at anywhere any time. That's the automobile business. With 12 million cars to keep running a trained man can always get a good job or open a shop of his own.

Don't say you never had an opportunity. Here's a golden one placed right before you, and everything made easy for you to take it. Write for full particulars today. The coupon is the first step on your road to success. Mail it to us now.

MICHIGAN STATE AUTOMOBILE SCHOOL

Home Study Department

25 Auto Bldg., DETROIT—The Automobile Center

Endorsed by Automobile Manufacturers

HUDSON MOTOR CAR COMPANY
DETROIT, MICH., U. S. A.

This school is thought very highly of by the automobile men of Detroit. You will make no mistake by entering for a course.



BUICK MOTOR COMPANY

We believe the Michigan State Auto School located at Detroit, would best meet your requirements, as its course in technical training is most thorough and complete in every detail.

THE STUDEBAKER CORPORATION
OF AMERICA

We do not know a better automobile school that we could recommend to you than the Michigan State.

MAXWELL MOTOR SALES CORPORATION
AUTOMOBILES
DETROIT, MICH.

We heartily recommend the Michigan State Auto School of this city.

SEND THIS COUPON TODAY

Michigan State Automobile School
25 Auto Bldg., Detroit, Mich., U. S. A.

Please send me particulars of your Home Study Automobile Course.

Name.....
(Print or write plainly)

St. or R. F. D.....

City.....State.....

You can earn MORE MONEY



in the Automobile Business

Learn in the pioneer auto school—twenty years of success back of it—and a reputation for successful graduates. The demand for trained men exceeds the supply. Opportunities exist everywhere.

You learn by actual practice in our \$75,000 shops and use tools and machinery under instructors carefully chosen for their ability to teach. You learn the complete electrical and mechanical details of both gasoline and steam cars. Special

training on electrical systems. Final training in our Commercial Repair Department working on actual jobs. Our instructors show you how and check and inspect each step of the work.

GET TRAINED NOW FOR SUCCESS

The Cleveland Auto School is conducted by expert automobile engineers. Over 7,000 graduates have made good. Our graduates not only get good jobs, but are able to make good in them because

they KNOW. Our classes permit PERSONAL work under close supervision. You have every opportunity for DOING. It isn't all "listen and watch."

OUR STUDENTS MAKE MORE MONEY

We make no promises—no free offers—no baits or allurements other than the fact that we teach you thoroughly. You get the mastery of motor car, truck and tractor construction and mechanism that will place you squarely on your feet in competi-

tion with men of much longer experience. We send out only trained graduates, who make big money. Our record speaks for itself. Our fees are reasonable. Write today for catalog and full information, or come direct to the School and enroll.

THE CLEVELAND AUTO SCHOOL

1814 EAST 24TH STREET

The Pioneer Auto School

CLEVELAND, OHIO

PRACTICAL ELECTRICAL EDUCATION

Learn by the thorough approved scientific methods which our seventeen years of special training enable us to give you. A. C. and D. C. Armature Winding, Wiring and Testing, Practical Electricity, Drafting, Electrotechnics, Commercial Engineering, Electrical Engineering with B. S. Degree. "Earn While You Learn." Radio Broadcasting WIAO, Every Day. Next class begins May 14th. Write for 72 P. M. catalog. It's Free. Mention Age, Education and Course Interested in.

SCHOOL OF ENGINEERING OF MILWAUKEE
PM-5, Marshall Street, Milwaukee, Wis.



CAN YOU DRAW?

Earn Money Drawing Pictures

Opportunity to increase your earnings. Learn to do it once and make pay. "MONEY HUNCHES FOR THE ARTIST" — book instructs you, How and What to Draw and Where to Sell. List of Markets, etc. For the artist in the country as well as the city. Satisfaction guaranteed. Send \$1 TODAY for copy or send stamp for particulars.



NOVEL ART STUDIOS

7 East 42nd Street, NEW YORK CITY

BE A JAZZ MUSIC MASTER

PLAY PIANO BY EAR

Play popular song hits perfectly by ear. Hum the tune, play it BY EAR. No tedious, ding-dong daily practice — just twenty brief, entertaining lessons which you can master

At Home in Your Spare Time

Send for the FREE BOOK.

It tells how to start if you want musical ability at which friends will marvel.

NIAGARA SCHOOL OF MUSIC,
Dept. 541 Niagara Falls, N. Y.



Send for this Free Book

How to Box 40c

By Terry McGovern, James J. Corbett, J. Gardner Smith, M. D., Arthur P. Keeley and Gus. E. Keeley.

How to Box to Win, How to Build Muscle, How to Punch the Bag and How to Stand, Walk or Run.

This interesting book written by experts is known also as "The Book of Health and Strength." It will greatly assist everyone in keeping fit, in putting them in condition to master a strenuous undertaking either physical or mental.

22 illustrations. Size 4 1/2 x 7 1/2 in. Paper copy 135 pages
SHREWSBURY PUBLISHING CO.
5525 West Lake Street, Chicago, Ill.

DO YOU WANT THIS JOB?

MEN 18 to 45 BECOME CITY MAIL CARRIERS

City residence unnecessary.

\$1,400 FIRST YEAR

Yearly Raise to \$1800 Year

Steady work. Paid vacation. Common education sufficient. Pull unnecessary.

Mail Coupon—Today Sure

COUPON

Franklin
Institute
Dept. R329
Rochester, N. Y.

Send me, without charge, (1) Your copyrighted Civil Service Book. (2) Tell me how to get a position as City or Rural Mail Carrier at \$1400 to \$1800 a year. (3) Send list of other U. S. Government Jobs obtainable.

Name.....

Address.....



MEN-I Will Make You AUTOMOTIVE ELECTRICIANS



"I Teach You a New Easy Way

No longer is it necessary for you to spend years studying electricity—or to be a college graduate to get a big pay job. I have discovered and perfected an amazingly easy way by which any one can become an Automotive Electrician in a few weeks. Ambu graduates are holding down the best jobs in the country—stepping right out of the school into \$75 a week jobs. Yet I guarantee to teach you in 8 short weeks here in Chicago—or right in your own home in spare time. This is no idle talk. I can prove every word I say. I will give you the name and address of my graduates—they will tell you what they are making. And you don't have to worry about getting a job. My employment department will give you Free Service. Write me at once, or mail the coupon. You might as well have one of these jobs and be an Automotive Electrical Expert and get the big pay that is waiting for you."

—C. J. BUCKWALTER,
President

Wonderful New Field Pays \$75 to \$100 a Week After Few Weeks Training

If you want big money, here's your chance. Don't study for months and months learning some business that may not pay you as much as you want to earn. Here is a wonderful new field—Automotive Electricity—the highest paying branch of both the Electrical Field and the Automotive Industry, and there are not enough men by half to fill the thousands of jobs that are waiting—jobs that pay \$75 to \$150 a week. Just think of it! 78% of all automobile repairs are electrical. Yet, not one out of 50 garage men know enough about electricity to cash in on this field. No matter what you now know about automobiles, this is your big chance. For, by an amazingly new, easy method which I have discovered I will make you an automotive electrician in a few weeks of interesting study and equip you to take any of these big pay jobs you want.

Thousands of Men Wanted

Other branches of electricity are crowded. Men are out of work. Ordinary automobile mechanics cannot find jobs. But the demand for men who know Automotive Electricity is so tremendous that the men I train are snapped up the minute they finish my new, easy method of learning.

NO EXPERIENCE NEEDED

You don't have to be experienced. You don't have to know a thing about automobiles or electricity. You don't even have to have a high school education. No matter what you are doing now, no matter what your age, education or occupation, I will fit you in a few weeks to instantly locate any electrical trouble on any make or model of car and have your repairs made while the average man is fiddling around looking for the trouble.

BIG FREE BOOK

This big Free book about Automotive Electricity has started hundreds of men on the road to success and big pay in this amazing new field. Bletcher of Chicago earns \$100 a week. William Bass, of Louisiana, doubled his salary in two weeks. Ellerd makes \$1000 clear profit every month. Ludlow increased his income four times. Every one of these men started out by sending for this book. This is your opportunity. Send for this big book immediately. Don't delay your success a minute.

Jobs Waiting—Hurry

Learn at once all about this amazing new, easy way of becoming an Automotive Electrician. See for yourself what a tremendous future is ahead of you. See what my other graduates are doing. See how you can quickly get one of these big pay jobs with a real man's salary. A special limited time offer is now being made—so mail the coupon at once for the Free book and full details.

C. J. BUCKWALTER, President

Ambu Engineering Institute
Dept. 15, 2632 Prairie Ave. CHICAGO, ILLINOIS

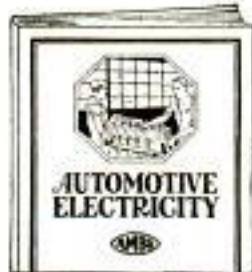

**Ambu
Engineering
Institute**
Dept. 15
2632 Prairie Avenue
Chicago

Please send me FREE Book and complete information on Automotive Electricity. Tell me of the rich rewards which await me in this uncrowded field. I am interested in your

- Home Study Course
 Residence Course

Name

Address

City State

PATENTS

*Seventy-six
Years of Practice*

THE firm of Munn & Company filed its first application for a patent in 1846, and for seventy-six years has endeavored to keep pace with the inventive genius of the United States.

An experience of many years is at your disposal. If you have an invention which you wish to patent, send your sketches or model together with a description of your device, explaining its operation, and you will receive prompt, courteous attention.

Write for our Handbook on
PATENTS

A full and complete booklet on Patents, Designs, Trade-Marks, Foreign Patents, Copyrights, Labels and Patent Office Practice with an explanation about our methods, terms, etc.

All communications strictly confidential.

Keep in touch with the inventions of the world by reading

SCIENTIFIC AMERICAN

The *MONTHLY MAGAZINE* with a special appeal to every man of inventive genius. Recent rulings of the Patent Office, descriptions of the latest patented inventions, legislation and court decisions affecting patents, are noted in this authoritative publication.

MUNN & COMPANY

Patent Attorneys

672 Woolworth Building, New York City

Scientific American Building, Room 2
625 F Street, Washington, D. C.

Suite 801, Tower Building, Chicago, Ill.

601 Hobart Building, San Francisco, Cal.

Please Mention Popular Mechanics

Have You an Invention?

If so the WORLD PROGRESS will show you how to

Protect and Profit from Your Ideas

This magazine is devoted entirely to the interests of Inventors. It opens the mysteries of Science and Invention to the student of every day problems. Sample copy free. Also send for free book, "WHAT TO INVENT" containing suggestions to inventors and scientists of inventions Needed. We invite manufacturers and promoters to address us regarding any inventions or patents they may want. We will publish such inquiries without charge. Address

WORLD PROGRESS PUB. CO., INC.
Room 203 Victor Bldg. Washington, D. C.
One year's subscription \$1.00

PATENTS

TRADE-MARKS COPYRIGHTS

Send for our free book of patent information.

Beale & Park 802 F Street, Washington, D. C.
16 S. Broad St., Philadelphia, Pa.



PATENTS

Send us sketch or model for patentability opinion and exact cost of patent. Our book "How to Obtain a Patent." Sent Free on request. It tells how to apply for Patents, Trade Marks, Foreign Patents, Copyrights, etc.; gives information on Patent Procedure; tells what every inventor should know. Thousands of Inventors, who are our clients, are our references.

Chandlee & Chandlee, 25 Years' Experience.
435 7th St. Washington, D. C.

PATENTS

Trade-Marks, Copyrights and Patent Litigation

Write for advice and instructions how to proceed, costs, etc. Hand Book with illustrations of 100 Mechanical Movements sent free on request.

ALBERT E. DIETERICH

Patent Lawyer and Solicitor

Successor to Fred G. Dieterich & Co. 621 Ouray Bldg., Washington, D. C.

INVENTORS

who derive largest profits know and heed certain simple but vital facts before applying for Patents. Our book Patent-Sense gives those facts; free. Write **Lacey & Lacey, 645 F St., Washington, D. C.** ESTABLISHED 1869.

Get into Business for Yourself \$50 TO \$200 A WEEK

Make both the Salesman's and manufacturer's profit. Start your business at home. No special equipment required. By our unusual plan you make 120 to 210% profit and develop a steady high-class repeat business. Our Service Department helps you free. Write today for details and exclusive territory. **D. C. DRAPER, Sales Mgr., Dept. 1-5, 6155 Wentworth Avenue, Chicago, Ill.**

FREE Book of Newest Styles just out. Women's, men's, children's clothing on credit and at bargain prices, less than cash prices everywhere. Very latest fashions; best materials. Open a charge account with us. Buy on credit and save money! Dress in newest styles. Send for Style Book absolutely FREE today! **Elmer Richards Co., Dept. A171, W. 35th Street, Chicago.**



Ingersoll Watches

Models \$1.50 to \$9.00

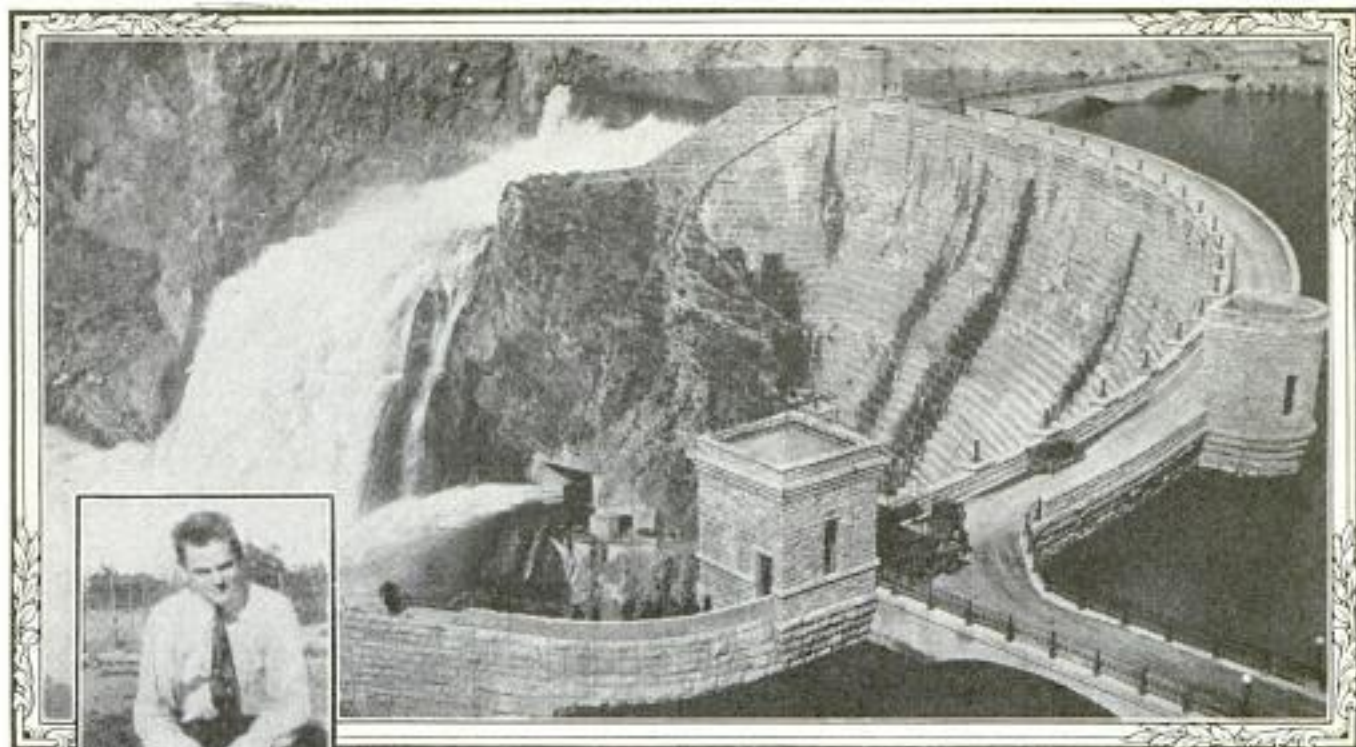

Will Your Picture Appear Here Next Year?

If Electricity Interests You Read This Story of Success

W. A. Granville, Power House Foreman of the great Roosevelt Dam in Arizona, is one of the many successful graduates of the American School's Course in Electricity. Read what he, himself, has to say about the work.

Dear Mr. Dunlap:

Your course is thorough and complete, understandable and easy to grasp. The interest you take in your students makes it more like a real study system. The price is reasonable and the terms will suit anyone.

I am Power House Foreman at Roosevelt Dam and you may refer to me at any time as I can speak only favorably of the School in every respect.

W. A. Granville,
% Lakeside Club,
Roosevelt, Arizona.

Mr. Granville is one of the far-sighted men who saw the big future in the electrical field. He chose the simplest, quickest and most economical means to equip himself for one of the many prosperous openings.

By studying evenings, while he worked for his livelihood in the daytime, he was able to prepare himself and when opportunity knocked it found him ready to step into a position of importance and real pay.

He Started Where You Are

If you want to get into this big profitable electrical field—want the kind of job that will satisfy—want the money that goes with a real job; **You Can Do What Granville Did.**

He knew big jobs require special preparation, knew the American School offered the best training in his line. He took that training and got the job he wanted.

What You Can Do in a Year

You can get into the kind of job you have hoped for—can complete the American School course in one year without giving up your present job. Hundreds of our students have done so. You can earn money on the side while you are learning. Let us show you how you can get practical training, with the useless, tiring matter

© A. S. 1923

eliminated—knowledge that you can immediately use, that will enable you to take a big job and handle it thoroughly from the start. Every student receives absolutely free a real Electrical Outfit containing a high-grade motor, Wheatstone bridge, electrical magnet, etc. It is not a plaything but a practical experimental outfit, that would cost you \$30.00 retail. The special instruction papers for this course were prepared by 20 big electrical experts.

We have prepared an interesting booklet—"Your Future in Electricity" which will give you valuable information about this Course, who the instructors are, what it costs and how it has helped others. Just cut off the coupon below, fill in your address and mail it today.

AMERICAN SCHOOL
Dept. EX1, Drexel Ave. &
58th St., Chicago



American School

The American School is not a money-making corporation, but like resident schools and colleges, is chartered strictly as an "Educational Institution, not for profit."

More than 200 famous engineers and educators prepared the special instruction papers for our students.

For over a quarter a century, Big Engineers, Educators and Business Men have recommended the American School. They know that our long experience as an educational institution guarantees better training at less cost than can be given by any school conducted for profit.

AMERICAN SCHOOL

Dept. EX1, Drexel Ave. & 58th St., Chicago

Send me the free Booklet, "Your Future in Electricity." This request puts me under no obligation.

Name

Address

City State

YOU CAN NOW LEARN HOW TO INVENT!

- How to develop your imagination
- How to develop your ideas
- How to get the facts you need for inventions
- How to keep legal records of ideas
- How to use scientific principles of mechanics
- How to avoid wasting time on impractical inventions
- How to apply for a patent
- How to organize a company
- How to protect your rights
- How to market a patent

and hundreds of other vitally important facts which EVERY successful inventor knows and uses. A remarkable new, and much needed course which can be studied in spare time, at home.

Make Your Ideas Pay You a Fortune

You can now learn how to train your mind along scientific inventive lines. No longer need you let your mind wander in unprofitable fields. You can learn how to think of worth-while ideas and make your ideas pay you money. The trouble with most people is that they do not know what to do with their ideas. Millions of dollars go to waste because of these undeveloped ideas. Now for the first time you can learn to harness your thoughts and make them work for you! One little invention, properly developed, may make you independent for life!

You Are Born an Inventor Develop your ability



Raymond F. Yates

Every man, woman, and child is born with creative imagination. Some develop this faculty to a greater degree than others, and those who develop it to the greatest extent are successful inventors. Invention is an orderly process of the mind, which combines two or more known facts to produce a new fact. Anyone who develops the right mental process can become an inventor. Every successful inventor has this type of mind, developed by constant experience over a period of perhaps many years. Heretofore those who succeeded in the field of invention had to discover all the principles themselves. But, now, just as any student of medicine, law, or engineering can take full advantage of all the recorded experience in those fields of study, so can YOU take the same kind of short-cut to the habits of thought, and the methods of work required of successful inventors.

"Invention Is a Science and Should Be Taught as a Profession,"

Says Edison!

Every inventor realizes the hopelessness of groping in the dark for the habits of thought and methods of work required for successful invention. Trying to

invent without knowing the fundamental requirements of invention is like trying to build a bridge without knowing engineering.

This is the first course in practical invention that has ever been devised. Now you can take Edison's advice and actually learn HOW TO INVENT—how to make invention a profession! In simple, easy-to-understand language, you are told how successful inventors work; you learn how to use the secrets of invention that convert a simple little idea into money.

Amazing Book On Inventive Science Free

Fortunes have been made by men who have thought of a "little" idea in a flash—the bottle top, the crimped hairpin, the thin lead automatic pencil, the snap fastener—earned fortunes, yet there are as many fortunes lost by inventors who did not know just what to do about their ideas.

BUREAU OF INVENTIVE SCIENCE

Dept. 35, Wisner Bldg.
Rochester, N. Y.

Please send me your free book "The Science of Invention."

Name.....

Address.....

City..... State.....

Bureau of Inventive Science, 35 Wisner Bldg., Rochester, N. Y.

Please Mention Popular Mechanics

U.S. PATENTS



SEND FOR THIS FORM

DON'T LOSE YOUR RIGHTS TO PATENT PROTECTION

Before disclosing your invention to anyone send for blank form "EVIDENCE OF CONCEPTION" to be signed and witnessed. A sample form together with printed instructions will show you just how to work up your evidence and establish the same before filing application for patent. As registered patent attorneys we represent hundreds of inventors all over the United States and Canada in the advancement of inventions. Our schedule of fees will be found reasonable. The form "Evidence of Conception," sample, instructions relating to obtaining of patents and schedule of fees sent upon request. Ask for them—a post card will do.



480 Ouray Bldg. Washington, D. C.
Originators of forms "Evidence of Conception."

PATENTS and TRADEMARKS

We offer a strictly professional service to inventors and manufacturers in the protection of their patent and trademark rights. Validity and infringement investigations conducted. Correspondence solicited. Moderate fees. Preliminary advice without charge. No literature.

MILO B. STEVENS & COMPANY
Suite 300 Barrister Bldg., Washington, D. C.
Suite 337A Monadnock Block, Chicago
ESTABLISHED 1864

PATENTS C. L. PARKER

Formerly Member Examining Corps, U. S. Patent Office

PATENT BLDG.

MCGILL BLDG.
WASHINGTON, D. C.

Patents, Trade Marks, Copyrights, Patent Litigation

Handbook for Inventors, "Protecting, Exploiting and Selling Inventions," sent free upon request.

PATENTS Secured

Prompt service. Avoid dangerous delays. Send for our "Record of Invention" form and Free Book telling How to Obtain a Patent. Send sketch or model for examination. Preliminary advice without charge. Highest references. Write TODAY. Jacob & Jacob, 410 Ouray Bldg., Washington, D. C.



GEARS ALL KINDS SMALL

The most accurate made and prices reasonable. We carry a complete line of gears in stock for immediate shipment. Can also quote on special gears of all kinds. Send us your inquiries. WRITE FOR CATALOGUE.

CHICAGO STOCK GEAR WORKS
105-109 S. Jefferson St., CHICAGO

WANTED IDEAS



Inquiries from Manufacturers and Others Who Are
Looking for Good Ideas

PROTECTED BY PATENTS

are constantly being received. Manufacturers are always interested in any new device for which there is a market, which fills a long felt need, which makes production possible at a lower cost, or which will do the work BETTER. There is undoubtedly a great demand today for really worth while inventions.

Your First Step

If you have an idea, send immediately for my blank form "TO RECORD YOUR INVENTION." You should serve your own best interests by filling out and signing this form before you disclose your invention TO ANY ONE. This document will help you determine and establish evidence of invention before filing an application in the U. S. Patent Office. A copy, with full instructions, will be gladly sent free on request.

NEW BOOK "SUCCESSFUL PATENTS" SENT FREE

Every man who has an invention, or ever hopes to have one, should send for a copy of my book "SUCCESSFUL PATENTS." It tells what everyone should know about patents, trademarks, copyrights, etc. It describes my methods, fees and terms, gives information relative to assignment or sale of rights, and instructions in detail. Mail coupon today for a free copy of this book or a post card request will do.

To the Man with an Idea

I offer a comprehensive, experienced, efficient service for his prompt, legal protection, and will endeavor to aid him in the commercial development of his proposition—my service is distinguished by over 12 years' successful practice, and by thousands of satisfied clients and by reasonable fees.

Send sketch, or model, and description, for advice as to cost, opinion as to its patentable nature, etc. Preliminary advice gladly furnished without charge.

COUPON

RICHARD B. OWEN, Patent Lawyer

Main Office, 9-303 Owen Bldg., Washington, D. C.

Branch Office, 2276-E Woolworth Bldg., New York City.

Please send me, without charge, or other obligation, a copy of your book, "SUCCESSFUL PATENTS," your form "TO RECORD YOUR INVENTION," and information concerning patents, etc.

Name.....Address {

INVENTORS

PROFIT FROM YOUR OWN IDEAS. We show you how. Thousands of men, and women, too, have ideas that would bring in fortunes if properly developed and protected.

HAVE YOU AN IDEA FOR THE IMPROVEMENT OF ANY THING? HAVE YOU AN IDEA OF SOMETHING ENTIRELY NEW? The smallest improvements, or new ideas, sometimes bring the biggest fortunes.

Can you think of a simple, practical idea that will fill one of the many requests we have on file for new inventions? Thousands of things are needed, NOW.

WE SHOW YOU HOW TO PROTECT YOUR IDEA; HOW TO GET THE MOST OUT OF IT.

SEND FOR THIS FREE BOOK

Tells you all you want to know about inventions, patents and trademarks. Valuable information. Patents advertised, for our clients, free, in "INVENTION and MANUFACTURING," a magazine for inventors, for the man with an idea. (One year's subscription 50c.)

A postal will do; but **DO IT NOW; IT MAY MEAN THE STEPPING STONE TO FUTURE SUCCESS.**

AMERICAN INDUSTRIES, Inc.
517 KRESGE BUILDING, WASHINGTON, D. C.



PATENTS

Booklet Free Highest References Promptness Assured Best Results

Send drawing or model for preliminary examination

ALL BUSINESS GIVEN PROMPT AND PROPER ATTENTION

WATSON E. COLEMAN, Patent Lawyer, 624 F St., Washington, D. C.

PATENTS If You Have an Invention and Desire to Learn How to Secure a Patent

Send for our Guide Book, **HOW TO GET A PATENT**, sent Free on request. Tells our terms, methods, etc. Send model or sketch and description of your invention and we will give our opinion as to its patentable nature.

RANDOLPH & CO.
600 F St., N.W., Washington, D. C.

NAME.....
STREET.....
CITY..... STATE.....

PATENTS TRADE-MARKS AND COPYRIGHTS

SPECIAL OFFER — Free Opinion as to Patentable Nature

Before disclosing an invention, the inventor should write for our blank form "Record of Invention." This should be signed and witnessed and if returned to us together with model or sketch and description of the invention, we will give our opinion as to its patentable nature.

Our Three Books Mailed FREE to Inventors

OUR ILLUSTRATED GUIDE BOOK

HOW TO OBTAIN A PATENT

Contains full instructions regarding Patents, Trade-Marks, Foreign Patents, Our Methods, Terms, and 100 Mechanical Movements illustrated and described; Articles on Patent Practice and Procedure, and Law Points for Inventors.

OUR TRADE-MARK BOOK

Shows the value and necessity of trade-mark protection and gives information regarding Trade-Marks and unfair competition in trade.

OUR FOREIGN PATENT BOOK

We have direct agencies in all foreign countries and secure foreign patents in the shortest possible time and at the lowest cost.

LIST OF PATENT BUYERS SENT FREE

IDEAS WANTED: Send for LIST OF PATENT BUYERS containing unsolicited letters from Manufacturers and others WISHING TO BUY meritorious patents. There is a great demand for NEEDED INVENTIONS. We endeavor to assist OUR clients in the commercial development of their inventions.

SPECIALIZATION—OUR STAFF

The field of invention is so vast that it is impossible for any one man to become an expert in all classes of invention. For this reason we employ a number of patent lawyers and mechanical experts selected for their special knowledge and ability in certain lines of invention.

THE VALUE OF YOUR PATENT

depends on the skill and care with which your case is prepared and prosecuted in the United States Patent office. That every case receives our best efforts, and that our work is done skillfully and thoroughly, is evidenced by the many unsolicited letters of commendation that we receive constantly from our clients. We will furnish upon request lists of clients from any state in the Union for whom we have secured patents.

Our New York, Philadelphia, Pittsburgh, Chicago and San Francisco Offices

We have established for the benefit of our clients Branch Offices in New York City, Philadelphia, Pa., Pittsburgh, Pa., Chicago, Ill., and San Francisco, Cal. These branch offices located in these large commercial cities together with our Main Office located near the U. S. Patent Office, in Washington, enable us to more promptly handle the business of our clients, particularly as the branch offices are in constant touch with the Main Office.

Highest References — Prompt Attention — Reasonable Terms

--- FREE COUPON ---

VICTOR J. EVANS & CO., Patent Attorneys

NEW YORK OFFICES
1007 Woolworth Building

CHICAGO OFFICES
1114 Tacoma Building

PHILADELPHIA OFFICES
714-715 Liberty Bldg.

PITTSBURGH OFFICES
514 Empire Building

SAN FRANCISCO OFFICES
Hobart Building

MAIN OFFICES: 765 9TH STREET, N.W., WASHINGTON, D. C.

Gentlemen: Please send me FREE OF CHARGE your books as described above.

Name Address



CLARENCE PATENT

MEMBER OF
SUPREME COURT OF UNITED STATES
SUPREME COURT DISTRICT OF COLUMBIA
REGISTERED IN UNITED STATES PATENT OFFICE

EXPERIENCE

PROTECT

Any new article, machine, design or improvement thereof, or any new combination of parts or improvements in any known article which increases its efficiency or usefulness, may be patented if it involves invention.

If You Have Any New Ideas

which you feel are useful, practical and novel, **take prompt action toward protecting your rights.** If you have invented any new machine, or new combination of parts or improvements, or new process or design,

Send Drawing, Model or Description of it for information as to procedure to secure protection.

**WRITE TODAY FOR BLANK FORM
"Evidence of Conception"**

to be returned to me with drawing, description or model of your idea. Promptly upon receipt by me of your idea I will write you fully as to procedure and costs.

SCIENCE

INVENTION

INDUSTRY

A. O'BRIEN

ATTORNEY

THE BAR OF

COURT OF APPEALS DISTRICT OF COLUMBIA

UNITED STATES COURT OF CLAIMS

PRACTICE CONFINED TO PATENTS AND TRADE MARKS

SERVICE

Your Ideas

No Charge For Information

All communications are held in strict confidence. My personal, careful and thorough attention is given to each case. I offer you efficient, reliable and prompt service—based upon practical experience. *Highest references.*

WRITE TODAY FOR FREE BOOK
"How to Obtain a Patent"

This book will give you valuable information, and it may save you much time and effort. *Send for it NOW.*

My practice is devoted exclusively to United States and foreign patents and trade-marks. Very probably I can help you. Write today.

CLARENCE A. O'BRIEN, Registered Patent Attorney
 17 Southern Building WASHINGTON, D. C.



CLARENCE A. O'BRIEN, Patent Attorney,
 17 Southern Bldg., Washington, D. C.

Please send me your free book, "How to Obtain a Patent," and blank form "Evidence of Conception" without any obligation on my part.

NAME _____

ADDRESS _____

(WRITE CLEARLY)

ECONOMY

EFFICIENCY

INITIATIVE



Copy this Sketch

Draftsman's Pocket Rule Free— To Everyone Sending Sketch

To every person of 16 years or older sending a sketch I am going to mail free and prepaid the Draftsman's Ivorine Pocket Rule shown here. This will come entirely with my compliments. With it I will send a 6x9 book on "Successful Draftsmanship". If you are interested in becoming a draftsman, if you think you have or may attain drafting ability, sit down and copy this drawing, mailing it to me today, writing your name, and your address and your age plainly on the sheet of paper containing the drawing. There are no conditions requiring you to buy anything. You are under no obligations in sending in your sketch. What I want to know is how much you are interested in drawing and your sketch will tell me that.

Positions Paying Up to \$250 and \$300 per Month

I am Chief Draftsman of the Engineers' Equipment Co. and I know that there are thousands of ambitious men who would like to better themselves, make more money and secure faster advancement. Positions paying up to \$250 and \$300 per month, which ought to be filled by skilled draftsmen, are vacant. I want to find the men who with practical training and personal assistance will be qualified to fill these positions. No man can hope to share in the great coming prosperity in manufacturing

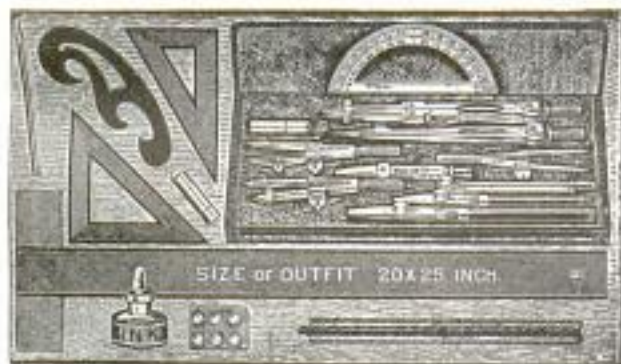

FREE this \$25 Draftsman's Working Outfit

These are regular working instruments—the kind I use myself. I give them free to you if you enroll at once. Don't delay. Send for full information today.

Chief Draftsman, Engineers' Equipment Co., 1951 Lawrence Av. Div. 93-55, Chicago

FREE

\$80 Drafting Course

There is such an urgent demand for practical, trained Draftsman that I am making this special offer in order to enable deserving, ambitious and bright men to get into this line of work. I will teach you to become a Draftsman and Designer, until you are drawing a salary up to \$250.00 a month. You need not pay me for my personal instruction or for the complete set of instruments.

Send above Sketch and Get This

Ivorine Pocket Rule FREE

and building unless he is properly trained and is able to do first class practical work.

I know that this is the time to get ready. That is why I am making the above offer. I can now take and train a limited number of students personally and I will give to those students a guarantee to give them by mail practical drawing room training until they are placed in a permanent position with a salary up to \$250 and \$300 per month. You should act promptly on this offer because it is my belief that even though you start now the great boom will be well on by the time you are ready to accept a position as a skilled draftsman. So write to me at once. Enclose sketch or not, as you choose, but find out about the opportunities ahead of you. Let me send you the book "Successful Draftsmanship" telling how you may take advantage of these opportunities by learning drafting at home.

Mail Your Drawing at Once

— and Get an Ivorine Pocket Rule Absolutely **Free!**

Ambitious men interested in drafting hurry! Don't wait! This is your opportunity to get into this great profession. Accept the offer which I am making now. Send in your sketch or request for free book and free Ivorine Pocket Rule.

THOROPHONE

TRADE MARK REG. U.S. PAT. OFFICE

For Tone ~ Volume ~ Appearance
High Power Model

The
Worlds
Greatest
Loud-
Speaker

THE air is full of the most wonderful music—great artists, huge orchestras, ensembles, famous bands. Are you receiving this marvelous entertainment with all the original beautiful shadings and with great or low volume to suit the occasion? The Thorophone with a good receiving set will do this for you.

The Thorophone combines perfect tone quality with great sensitiveness and powerful amplifying strength. Far distant stations—even foreign countries—have been brought in

loud and clear over a Thorophone. Its super-sensitiveness enables you to bring in stations you never heard before and to realize the full value of your receiving set.

It is manufactured and guaranteed by America's oldest manufacturer of loud-speaking telephones.

The WINKLER-REICHMANN CO., Chicago

Type - S-5
\$45.00

S-6 consists of the Thorophone "S" type unit mounted on its side in a low, flat, beautifully finished wooden container.

It is arranged to lay on a phonograph and to connect to the phonograph horn. It has a universal adapter, fitting all makes of phonographs.

The loud speaker is the same as in the S-5. This in combination with a good phonograph horn makes a most satisfactory outfit.



S-6
\$35.00



- A. Heavy spun 16 ga. aluminum bell, dull back enamel finish, will not chip. Low permeability. Non-vibrating.
- B. Solid cast iron throat, correct acoustically; dull black enamel finish.
- C. Powerful Viola-like, WOODEN tone arm. Amplifier, retracts, purifies the tone. Dark walnut grain, hand-rubbed finish.
- D. Wood cabinet, dark walnut, piano finish.
- E. Vibrating solenoid coil.
- F. Sound Box Reproducer with controlled mica diaphragm. Much of the exquisite tone quality of the Thorophone is in this construction, which represents the highest development of the sound-reproducing art.
- G. & H. Terminals for A Battery and input with new low safety feature.
- I. Switch controlling A Battery for electric magnet, making it unnecessary to disconnect wires to A Battery.
- J. Powerful thermal electro magnet, the "piano solenoid" of the Thorophone.
- K. Rubber feet protect furniture upon which base may be set.
- L. Induction coil permitting a thousand volts of B Battery. You cannot injure the Thorophone by over-voltage.

† The height is 28 inches

The mechanism of the Thorophone consists of a powerful electro-magnetic solenoid excited from your A battery. This solenoid operates a controlled mica diaphragm, thus combining great amplifying power and sensitiveness with perfect tone quality. The solenoid is built big and strong and requires no adjustment. The Thorophone is designed with a large factor of safety to withstand unusually strong radio currents.

The great amplifying power of the Thorophone has been proven over and over again on comparative tests. Tone reigns supreme in music. The Thorophone's rendition is perfect—the pure, clear tones grip you. You feel the living presence of the artist. The Thorophone is a great musical instrument, built for lovers of fine music.

Manufactured by
WINKLER-REICHMANN CO.
4801 S. Morgan St., Chicago, Illinois

Sales Department
THE ZINKE CO.
1323 S. Michigan Ave., Chicago, Illinois

MAIL THIS COUPON TODAY
I am interested in the Thorophone.
My name is.....
Street.....
City.....
State of.....

1836



Popular Mechanics Magazine

REGISTERED IN U. S. PATENT OFFICE

WRITTEN SO YOU CAN UNDERSTAND IT

Vol. 39

MAY, 1923

No. 5

1836 Great Street may Cap Chicago River

BY ARTHUR ARROW, JR.

THE Chicago River, little used by boats, but because of its bridges at vital points a serious hindrance to traffic in that city, may soon be closed to navigation and its area utilized by build-

ing over it a great street, available for motor vehicles of all kinds.

The proposed plan, now in the hands of the Chicago Plan Commission and the Board of Local Improvements, calls for

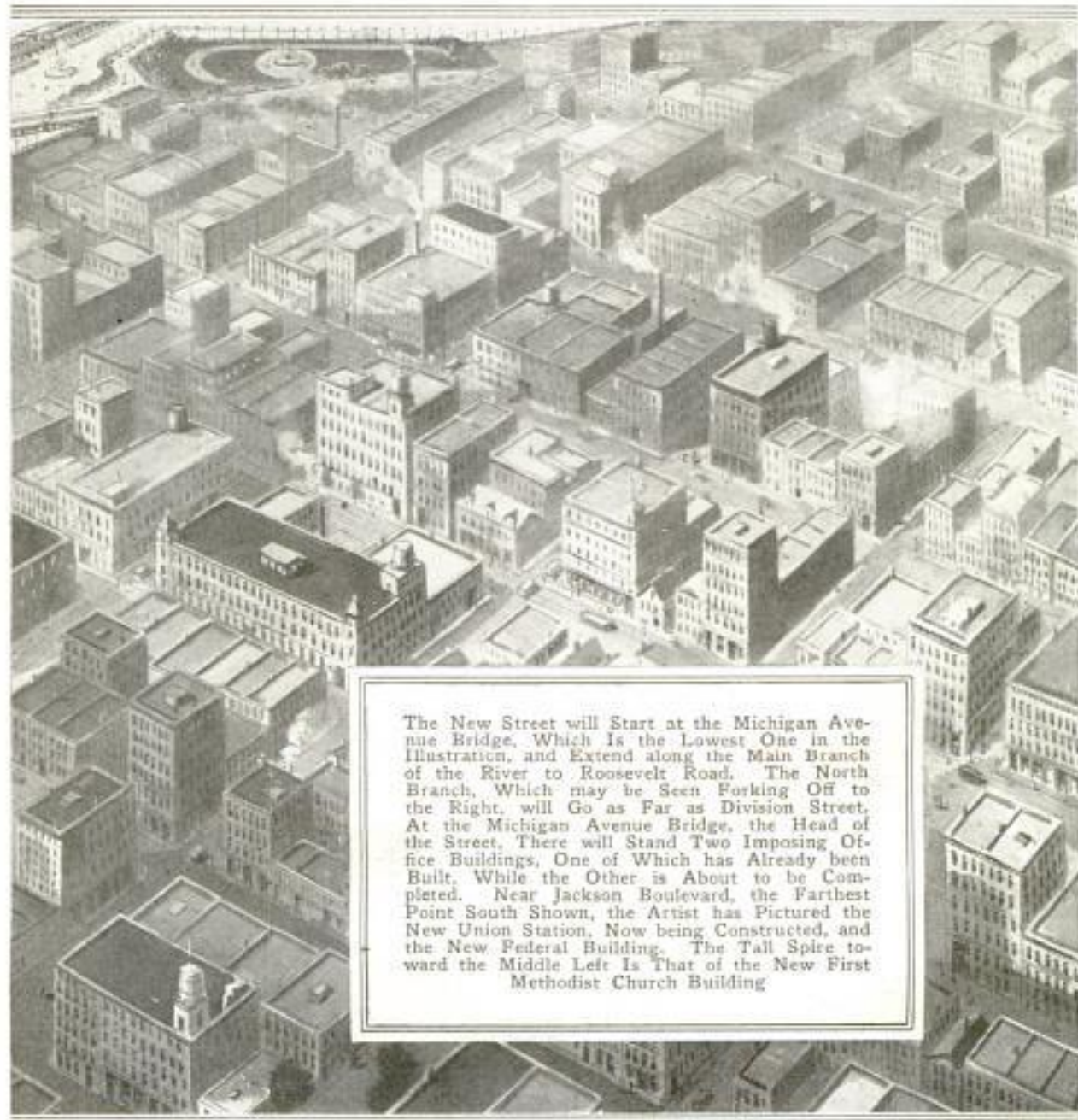

The New Street will Start at the Michigan Avenue Bridge, Which Is the Lowest One in the Illustration, and Extend along the Main Branch of the River to Roosevelt Road. The North Branch, Which may be Seen Forking Off to the Right, will Go as Far as Division Street. At the Michigan Avenue Bridge, the Head of the Street. There will Stand Two Imposing Office Buildings, One of Which has Already been Built, While the Other is About to be Completed. Near Jackson Boulevard, the Farthest Point South Shown, the Artist has Pictured the New Union Station, Now being Constructed, and the New Federal Building. The Tall Spire toward the Middle Left Is That of the New First Methodist Church Building

Architects, Holabird & Roche⁵⁷
Chicago

1836

a street 200 feet wide, built of concrete slabs on concrete piling about 4 feet above the water level, and extending from the Michigan Avenue bridge along the main river to Roosevelt Road, and up the north branch of the river to Division Street.

According to the plan, it is to pass under existing bridges, as well as any new ones to be constructed, all of which will have headroom sufficient for all vehicles. Sidewalks, 15 feet in width, will run the entire length of the new street, and there will be two driveways, 51 feet wide, each providing for traffic in one direction.

In the middle space, 68 feet wide, there is to be a municipal garage, extending from bridge to bridge, relieving the loop streets and alleys from such parking, and bringing to the city, by means of reasonable charges, a large revenue. Upon the roofs of the garages, it is proposed to have public parks, with gardens, benches, and fountains, thus beautifying the thoroughfare and affording an attractive breathing space for public use. The driveway itself will have no grade crossings, nor will pedestrians need to cross the street. All vehicles will turn into it or out of it with right-hand turns, joining the stream of traffic in the direction in which it is going.

With the bridges fixed as permanent extensions of the streets they are connecting, it will be possible to erect on their sides attractive shops, such as may be found in Florence, Brussels, and other European cities.

Along the east and west sections of the river, the 200-foot stretch will not occupy the entire area, but space ranging from 50 to 90 feet will be added to the present dock line, and filled in for building purposes. Arcade streets, in the middle of all the blocks, leading to thor-

needed for lighterage and boat service, Angus Hibbard, of Chicago, the originator of the plan, states that experience has shown the coming of the automobile to have made lighterage uneconomical. In ordinary cases, he says, freight must first be unloaded from a car to a truck, then hauled to a river dock and transferred to a lighter. The lighter must then proceed to another dock, the load removed to another truck, and hauled to its destination. It is more economical to load such freight from car to truck and proceed directly to the destination, and this is the general practice. Even in cases where the destination points are immediately on the river bank, the lighter is not generally used as a means of conveyance. No one has gone into the lighterage business.

Among the many minor points involved, it may be mentioned that motor trucks loading with freight at near-by railway sidings, or warehouses, will be able to reach the new street at the nearest entrance, take their way along it, and then enter the loop at the point nearest their destination. A great part of the motor trucking would thus be taken out of loop streets which must now be used. Or again, the space now used for railway tracks, and for loading and unloading cars, might be disposed of at considerable profit. The cap will not in any way interfere with the utility of the proposed canal to the Mississippi River, as, by means of the Sag branch of the canal, boats would go directly to South Chicago harbor, where almost unlimited dockage is available.

All in all, the plan, claims Mr. Hibbard, will open up traffic lanes of great advantage to the city, will make the down-town district a more beautiful place to work in, and, incidentally will, in a direct way, help pay for itself.



Cross Section at One of the Bridges: The Distance from the Water Level to the Street will Be 4 Feet, and from the Street to the Roof of the Bridge About 14 Feet. The Sidewalks will Be 15 Feet Wide, the Driveways 51 Feet, and the Garage Space between Them, 68 Feet. Each Section will Be Large Enough to Accommodate 250 Cars

oughfares paralleling the driveway, will be another interesting feature.

Answering objections that the river is

Meanwhile the river will flow on, carrying away the city sewage, at present its most useful function. This waste mat-

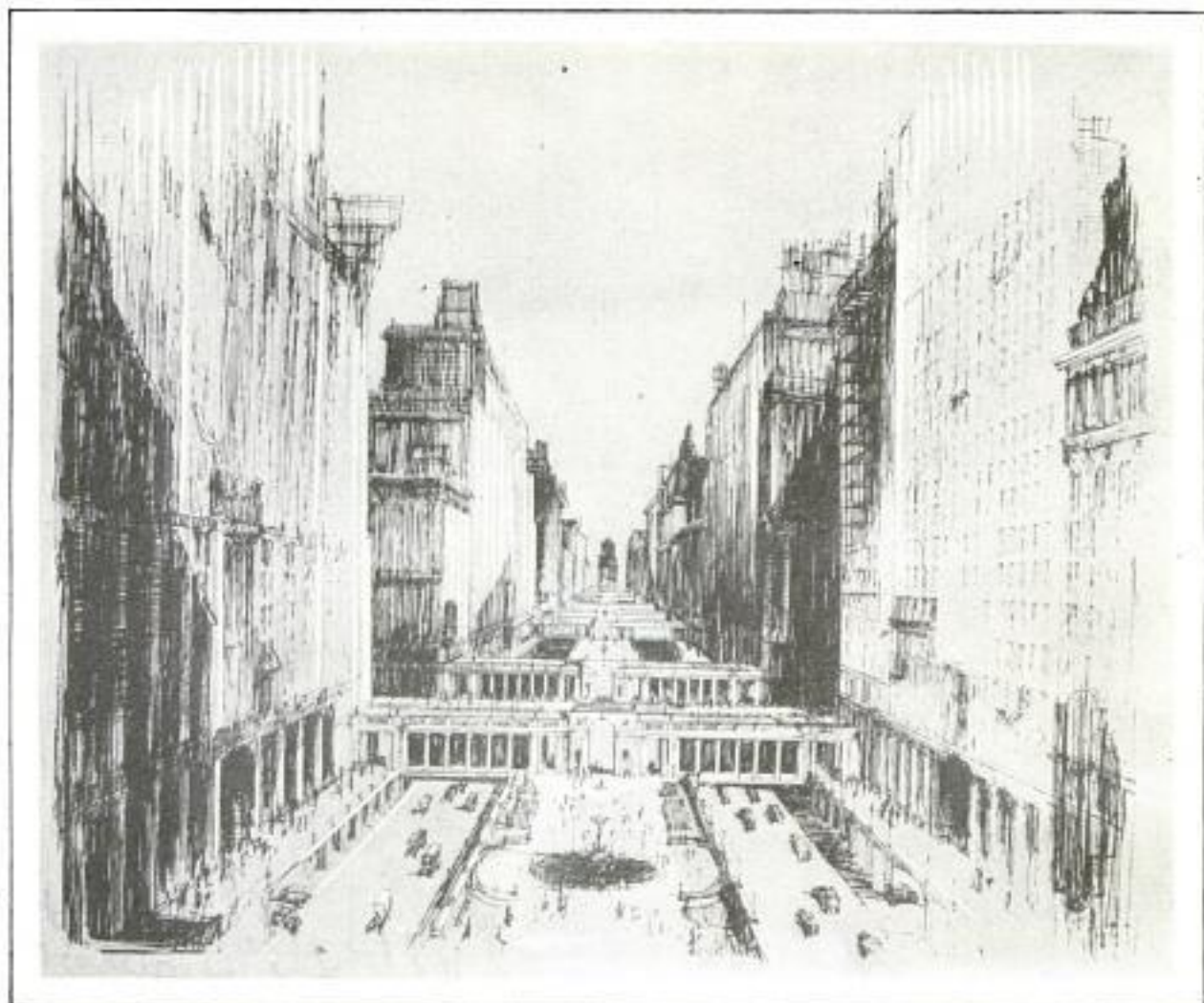

Vista of the Proposed Park and Driveway: On the Roof of the Municipal Garage There will Be Gardens, Fountains, and Benches, While Built about the Bridges will Be Stores and Shops

ter is carried to a drainage canal southwest of the loop, which in turn empties into the Illinois River.

It is estimated that the improvement, if adopted, will cost approximately \$2,500,000 per mile.

1815

LICENSE PLATES REQUIRED FOR DENVER CYCLISTS

Since the passage of an ordinance by the Denver city council requiring all bicycles to carry license plates, the police department has been busy attaching plates to the bicycles of owners who are eager to take advantage of this protection against thieving. The license costs but \$1 a year. All police officers are instructed to look out for bicycles without plates, and secondhand dealers must report the license numbers of wheels for sale.



Cyclists of Denver, Gathered at Police Station, to have License Tags Affixed to Their Wheels. The Measure was Ordered for Protection against Theft

Cmt. Jos. H. Langer, of The Post, Denver, Colo.

1916



The Model Gives an Excellent Idea of How the New Cook County Zoo will Look When Completed. In the Building to the Left There will Be Refreshment Counters, and in the Court, Tables from Which the Visitors will Have an Unobstructed View of the Numerous Animal "Cages"

CAGING ANIMALS IN MODERN ZOOS

BY HJALMER LINDQUIST, *713 Sunset Blvd, Los Angeles, Calif.*

HOWEVER well satisfied captive wild animals may be in a zoölogical cage, there are always sentimental persons who find cause to pity the beasts and censure those public officials they think responsible for this seemingly cruel confinement. The provocation for such criticism can be traced in most instances to the cage. The zoo cage is exhibited more than the animals in it. There is too much evidence of the prison, and not enough of the frolicsomeness of the animals.

The solution of the problem has been found in not only making the home of the animals more agreeable, but also in having the cage in appearance proclaim this quality to everyone who sees it. Thus, in the latest practice, all bars are done away with, and the animals are placed in a habitat such as they might well choose for themselves. Then pity for the beasts vanishes and real enjoyment is found in observing them.

Perhaps the latest, and certainly one of the finest examples of a barless "cage," is now being completed at St. Louis, Mo. Though not radically different from similar cages in Denver and in some foreign cities, it has incorporated in it many little refinements that place it in a class by it-

self. The barless cage, as is quite generally known, consists of a three-sided arrangement of rock with a wide moat in front. The sides, of course, are so built that it is impossible for the animal to climb over or jump from them, while the moat is equally impassable.

In making the rock background for the St. Louis cage, which, by the way, was made to exhibit bears, the forms were first copied in glue molds from natural limestone ledge rock along the Mississippi River. These were then made into plaster molds, fitted together, and supported to form the wall design facing the interior of the dens. Finally plain and colored mortar was sprayed upon the forms, and the surface brushed over with muriatic acid.

Behind the back wall of the den is a feeding room extending the full width. It is entered by the bears through openings left in the back wall, the keepers using a special passageway also built in concrete. If desired, the animals may be separated in this room by a series of gates which are ordinarily left open. Underneath are mating rooms, and rooms for the mother bear to rear her young.

One of the most ambitious undertak-

1916

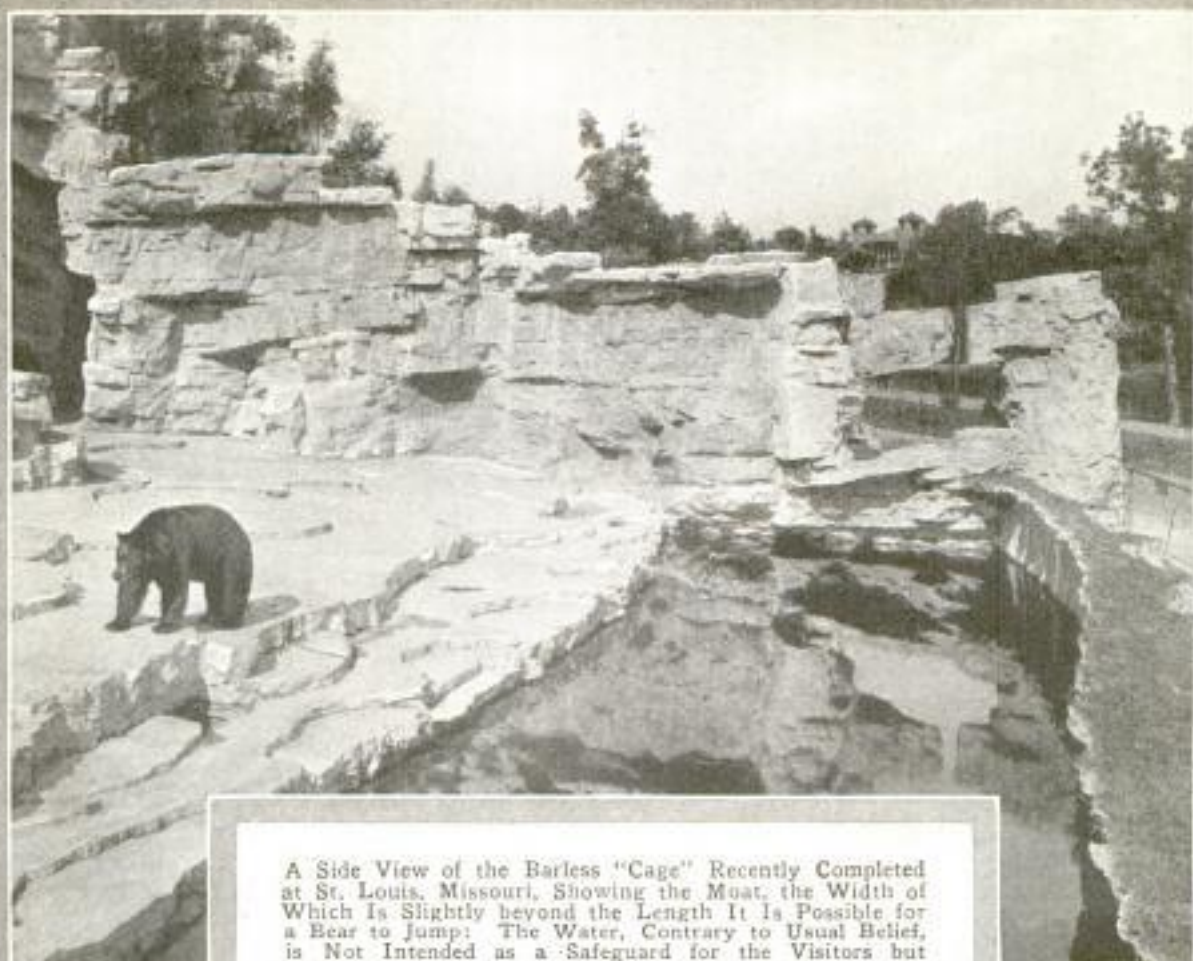

A Side View of the Barless "Cage" Recently Completed at St. Louis, Missouri, Showing the Moat, the Width of Which is Slightly beyond the Length It is Possible for a Bear to Jump: The Water, Contrary to Usual Belief, is Not Intended as a Safeguard for the Visitors but Rather as a Means of Recreation for the Bears. The Barrier, of Course, would Be Equally Effective without Any Water. Below is a General View of the Den, Showing How the Scene Appears to the Spectators. Openings in the Rock, Which may be Observed at the Right, Lead to Feeding Chambers, and Other Special Quarters for the Animals.



ings of this kind—a zoölogical park in which not only the bear den but all the other animal quarters, with few exceptions, are to be of the barless type—is being planned for Cook County, Illinois. The county owns a tract of forest land a short distance from Chicago, and it is there that the new zoo is to be built. If present plans are adopted, and it seems that this is likely, the county will have a zoölogical park distinctly different from any other in America.

From the entrance the visitor will see stretched before him a natural panorama of hill, rock, stream, and forest—all inhabited by wild beasts, and seemingly unconfined. Off toward his left will be zebra, and ostrich, and polar bear. Then

as he turns, he will see the lions, bears, tigers, antelope, monkeys, and other animals. Perched on a rocky mound, some 200 feet above the level of the surrounding land, and about in the center of the park (which will be about a mile long, and a half mile wide), will be the mountain goats. How utterly unlike anything America has today!

Not even the spectators will be seen, for while walks are to be arranged so that visitors may come within close distance of the animals, they will not be visible from the main entrance. It seems that a new era is about to be ushered in, in zoölogical work, and that America, not always among the first in this field, is now to take its place as the leader.

**HANGING DUSTER CLEANS
AUTO TOP IN GARAGE**

Hanging from the ceiling of the home garage, a new duster automatically cleans



Auto-Top Duster, Hanging from Ceiling of Garage, Automatically Cleans Top of the Car as It Enters and Leaves

off the top of the car every time it enters or is driven out. It is made of a soft woolly material, and hangs at such a distance from the ceiling that it brushes the top as the car passes under it. Proper attention to the top of an automobile is often neglected because, without a special device such as this, it is difficult to get at it.

**GOVERNMENT PLANES TO AID
RED-CROSS RELIEF**

Air craft of the army and navy and the Post Office Department will cooperate in the future with the American Red Cross to the extent of being available for the speedy transportation of disaster-relief personnel. Although completion of the

arrangements for this purpose have only recently been announced, the War Department has already notified the Red Cross officials that airplanes would be placed at their disposal to carry such aid to the scene of any disaster, upon telegraphic request from a duly authorized Red Cross agent.

**TRAP DRUMMER'S CASE HAS
SPACE FOR ACCESSORIES**

A newly designed musical-instrument case is made for the use of a trap drummer and contains space for his drum and its accessories, as well as for sheet music and a uniform. Made of a chemically treated fabric, it is said to be strong and durable. Fiber disks fit over the cymbals to hold them in place, and a tray holds the uniform. The cases are made in sizes for drums from 13 to 15 inches in diameter.



Trapdrum Case
Containing Drum, Cymbals, Sheet Music, and the Drummer's Uniform, Which Fits into a Tray over the Drum

Fibre Case + Novelty Co
586 536 W. 28 St
New York City

Mr. P. V. Es. Perez, 159 Santa St. San Francisco, Calif. \$6.50

1813
1819
Fibre Case + Novelty Co. 231 W. 28 St. New York

N.Y. Times 3/18/23 P.1

1706

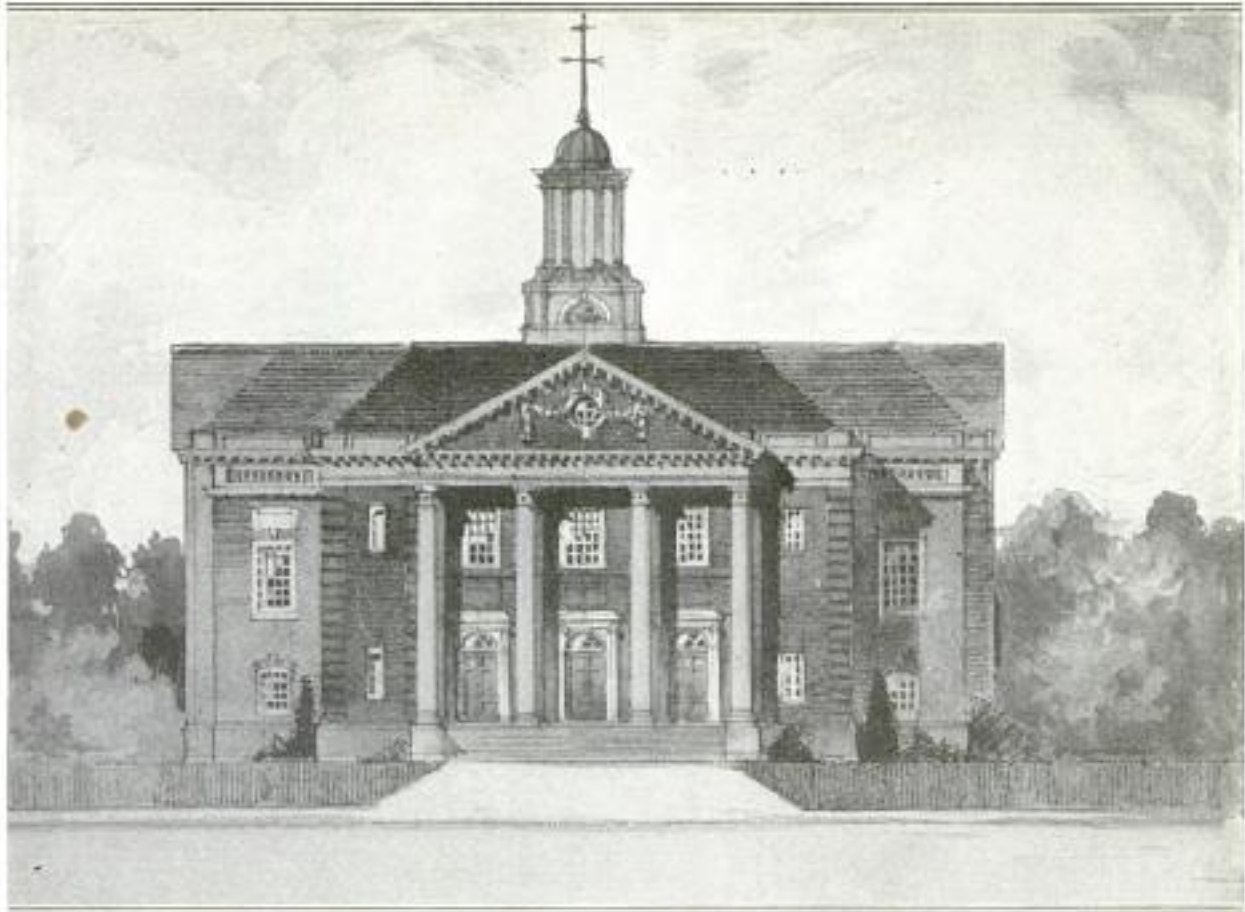

Front Elevation and Entrance to the Nonsectarian Church Which will Soon be Opened at Wellesley Hills, Massachusetts, as the Gift of a Local Resident: On the Church Platform will Be a Radiophone Receiving Set, and Distributed about the Auditorium will Be 100 Earphones

NEW CHURCH TO RECEIVE SERVICES VIA RADIO

BY F. N. HOLLINGSWORTH,

168 Marlborough St., Boston, Mass.
213 Trinity Bldg.

THE first wireless nonsectarian church in the country will soon be opened at Wellesley Hills, Mass., the gift of Roger W. Babson, a well-known statistician. In this church the usual radio Sunday services will be reversed. That is, instead of the service being broadcast from it, as in the case of St. Paul's Cathedral and other churches near Boston, services will be broadcast to it, either from other churches or by special arrangement.

On the church platform will be a

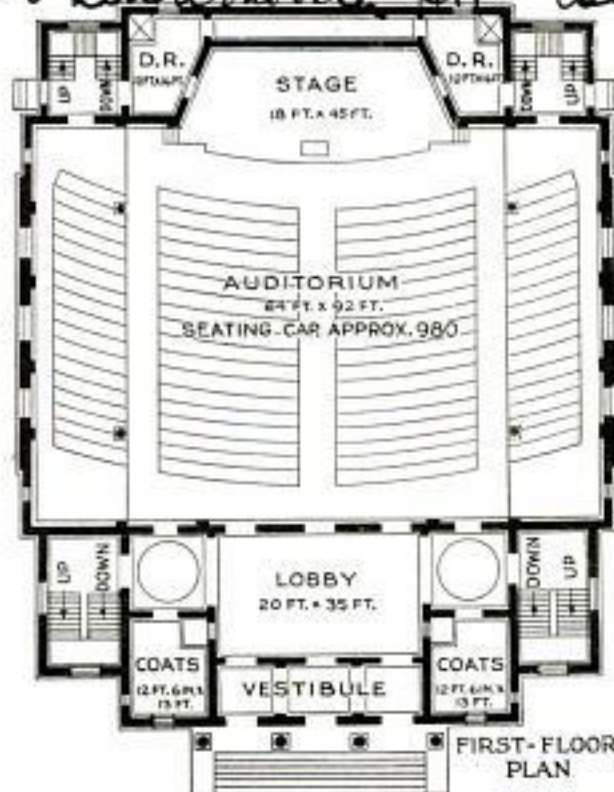

Plan of the Main Auditorium and Stage of the New Radio Church, to be Finished in June: The Seating Capacity will Be 980. There will Be No Pulpit

radiophone receiving set, and out of its loud speaker will come the prayer, music, sermon, and other transmissible features of the regular church service. As it is planned to conduct services for several different denominations, this will, of course, necessitate a workable schedule. For example, at 8:30 a. m. there may be a sermon for Catholics, sent very likely from Schenectady or New York; at 9:30 there will be a service for Baptists broadcast from President Harding's church

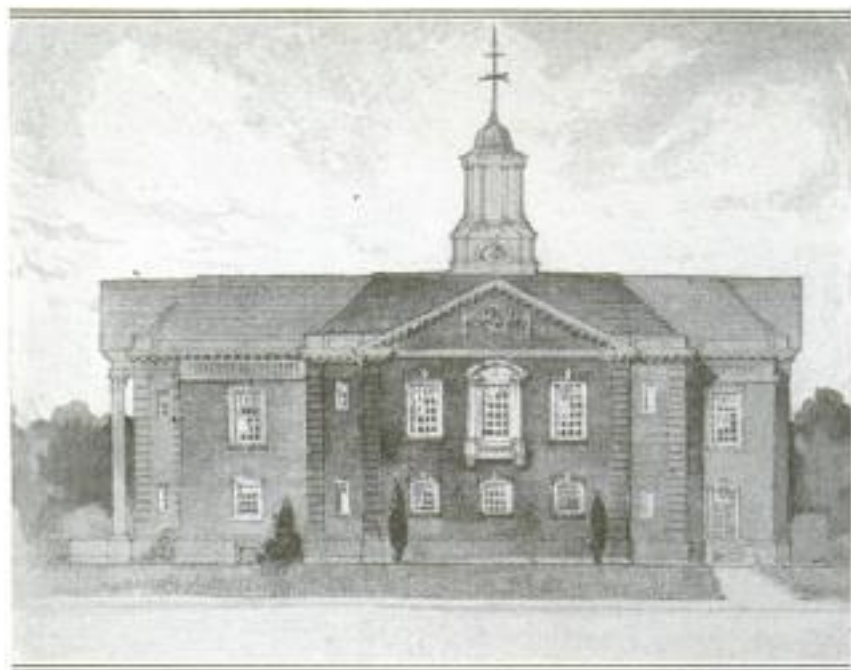

Side Elevation of the Church: On Sundays, Services via Radio will be Held First for Catholics, Then for Baptists, Congregationalists, and Christian Scientists, in the Order Named

at Washington; at 11:30 a service for Congregationalists; and at 12:30 a service for Christian Scientists. It is thought that this arrangement will help solve the difficulties of the rural church, and that it will be a new power for good.

Collections taken up at the several denominational gatherings will go to the denomination holding that service.

☛ A proclamation by the president has established the Pueblo ruin, near Aztec, N. M., presented to the government by the American Museum of Natural History, as a national monument.

1822 ARKANSAS RIVER BRIDGE TO BE WAR MEMORIAL

The completion of a five-span concrete-arch bridge over the Arkansas River at Little Rock, marks all but the final step which the Bear State is taking to honor the memory of its sons who fell during the war. Final tribute will be paid shortly, when the splendid structure, almost 3,000 feet long, will be dedicated as a war memorial, with fitting ceremony. The bridge will serve as one of the most modern traffic spans in the country,

and will carry a 60-foot roadway across the river between Little Rock and North Little Rock. In addition to vehicular traffic, provision is made for two lines of street-car tracks, and pedestrians will be amply accommodated with two 10-foot walks, one on each side. Long land approaches on each bank form part of the bridge proper, the river crossing being made by arches only, each having a span of $202\frac{3}{4}$ feet.



A Bird's-Eye View of the New Concrete-Arch Bridge Thrown across the Arkansas River at Little Rock: This Structure was Built to Commemorate the Soldiers, Sailors, and Marines Who Died during the War. Five Arches Span the River, with Long Approaches on Each Bank

Comd H. E. Juels, c/o Arkansas
Democrat Little Rock Ark.

Chicago Tribune

3/12/23

1962

POPULAR MECHANICS

Buffalo Harry Miller

Los Angeles, Calif. 665

BONFIRE SIGNALS TO TELL OF AMUNDSEN'S START

When Amundsen, the explorer, hops off on his flight across the North Pole, on or about June 20, a system of signal fires or smudges will carry the news of

FIRST ONE-MAN RACING CAR READY FOR SPEEDWAY

The first American one-man racing car has been completed, and it is predicted that the mechanic, who has always been the second member of the racing

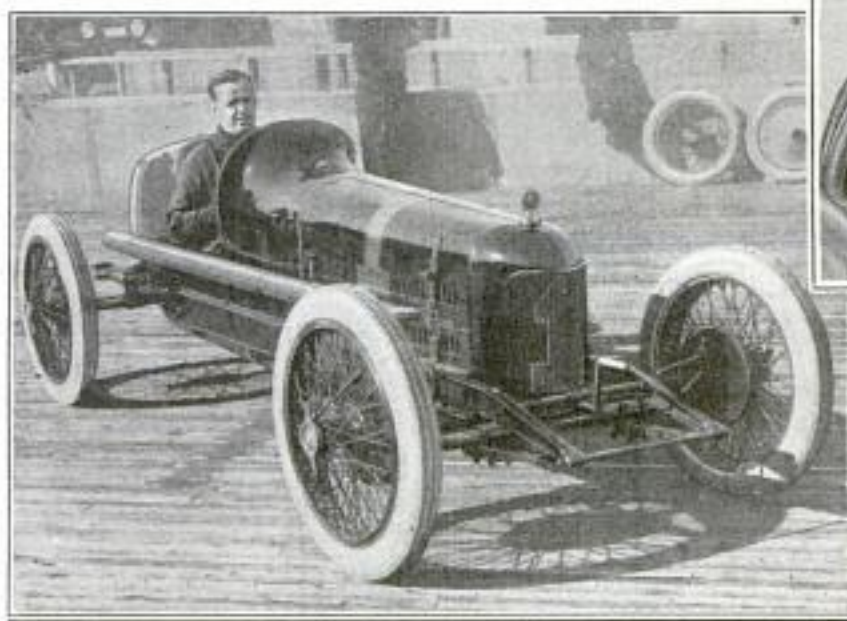
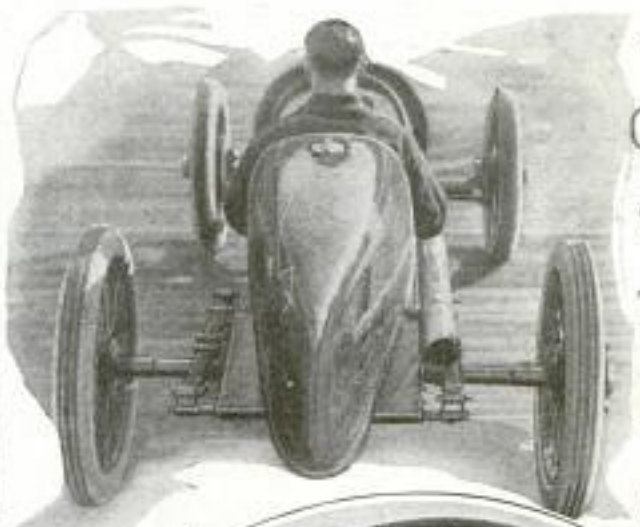
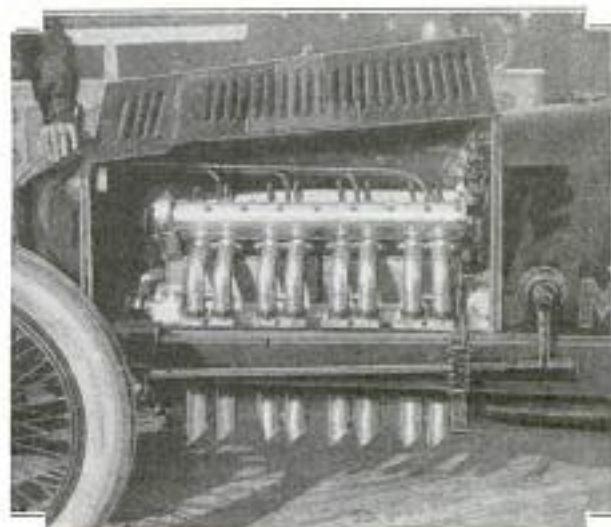

Upper Left: One-Man Racing Car with Hood Raised, Showing Eight-Cylinder Motor. Upper Right: Rear View, Showing the Narrow Streamline Body. Lower Left: Side View of Car Which Is About 400 Pounds Lighter than Other American Racers. Above: Steering Wheel and Instrument Board of New Car

Mr. H. A. Miller
Los Angeles, Calif.
265 2 Long Beach Ave.

his start from Wainwright to the nearest radio station, some 400 miles away. From the radio station the word will be sent to the scout planes at Spitzbergen, which are to be on the lookout to render any possible assistance on his arrival. It is expected that the bonfire signals arranged will convey the news in a few hours. Even if the weather or other agencies interfere with some of the signals, it is believed that the Eskimos in charge will be able to make connections by runners, and that thus the message will be completed on schedule without difficulty.

crew, will soon make his farewell bow to the public. This new car, which is about 400 pounds lighter than other American racers, has a piston displacement of only 122 cubic inches, is 4 inches shorter, and 4 inches narrower than usual. A polished steel mirror will give the driver a view of things at the side and in the rear. The body is constructed along airplane lines, and, although no attempt was made to force it, the car made 110 miles an hour in a recent trial. This is only another step in the tendency of recent years, to develop high-speed cars of low weight with small motors.

Robert B. Allen, Secy. West Coast
Lumbermen's Association, Henry Alder

WOOD-WASTE BRIQUETTES AS GOOD AS ANTHRACITE

616 Seattle
Wash.

BY LAWRENCE WM. PEDROSE, 1453 W
54th St., Seattle, Wash

CARBONIZATION and briquetting of sawdust and other waste wood material from lumber mills and wood-working plants is an important new industry developed in the Pacific Northwest through experiments financed by leading lumber manufacturers of the district. The product is a fuel high in fixed carbon, low in volatile constituents and ash, and equal to Pennsylvania anthracite, making it ideal for domestic, industrial, and metallurgical purposes.

How profitably to utilize wood waste has long been a problem confronting lumber manufacturers. From data gathered from Pacific-coast mills, it has been ascertained that a mill cutting 200,000 board feet of lumber daily has 200 cords of waste after its own fuel requirements have been taken care of. In the larger cities and industrial districts part of this waste is utilized as hogged (chip) fuel or as firewood, but the cost of distribution is so great that the average mill operator cannot afford to engage in the fuel business, and usually sells the waste to fuel dealers at a very low price to get it out of the way.

The lumber mills of the states of Washington and Oregon alone cut approximately 9,000,000,000 board feet of lumber annually, which means approximately 9,000,000 cords of wood waste, based upon a conservative estimate of one cord of wood waste to every thousand board feet of lumber. Hence it will be seen that utilization, in a practical way, of this waste is of great economic importance.

Experiments in the carbonization and briquetting of wood waste were made recently at Centralia, Wash. It was found that carbon briquettes could be successfully produced from waste wood at a cost of \$8 a ton, constituting a fuel equal to the best anthracite coal in every way. The process of manufacture is not intricate, and the plant is self-contained in that the material used for binder is obtained from the waste wood itself.

Hogged wood is run through a rotary drier, where a part of the moisture is removed, and conveyed to retorts. In the retorts the material is carbonized; it is then ground through a cage grinder, con-

ditioned by a formula on which patents are pending, put through a secondary grinding process, passed into a mixer and combined with the binder, again conditioned, and then pressed into briquettes ready for the secondary retort. In the secondary retort the lighter oils of the binder are recovered, leaving the active elements with a physical structure sufficient to withstand any condition that might arise while the briquettes are being consumed, and forming a sootless, smokeless fuel.

Investigation by a competent staff of engineers has shown that a 60-ton per day plant of finished briquettes, which would require approximately 150 cords of wood waste per day, can be operated profitably by a mill cutting 200,000 board feet of lumber a day and would absorb the surplus waste after the mill's own fuel requirements were taken care of. The cost of such a plant at the present time is about \$150,000. This plant will produce 20,000 tons of briquettes annually at a cost of \$8 a ton. It has also been found that from each



Fuel Briquettes. Like This, Made from Wood Waste, are Said to Equal Anthracite

ton of briquettes there can be obtained 15 gallons of tar oil, valued at \$3; 30,000 cubic feet of gas, valued at \$6, and seven gallons of acetone alcohol, valued at \$5.25, or a total valuation of \$14.25.

Because of their structural strength and the absence of any injurious impurities, the carbon briquettes are declared ideal for the smelting of ores. During the experiments, special tests were made to demonstrate these qualities. At an additional cost of 25 cents per ton, briquettes were produced having a compression strength of 650 pounds per square inch. Since a strength of 300 pounds per square inch is ample to resist the load in a 90-foot blast furnace, the importance of the new briquettes as a metallurgical fuel is readily seen.

Street cars equipped with roller bearings are soon to appear in St. Paul and Minneapolis, and it is expected this departure will make the operation of the cars almost as noiseless as eight-cylinder automobiles. In addition it is believed 12 to 15 per cent on power will be saved and service speeded up.

1750

Publishers Photo Service
426 Fifth Ave, New York.
POPULAR MECHANICS 667

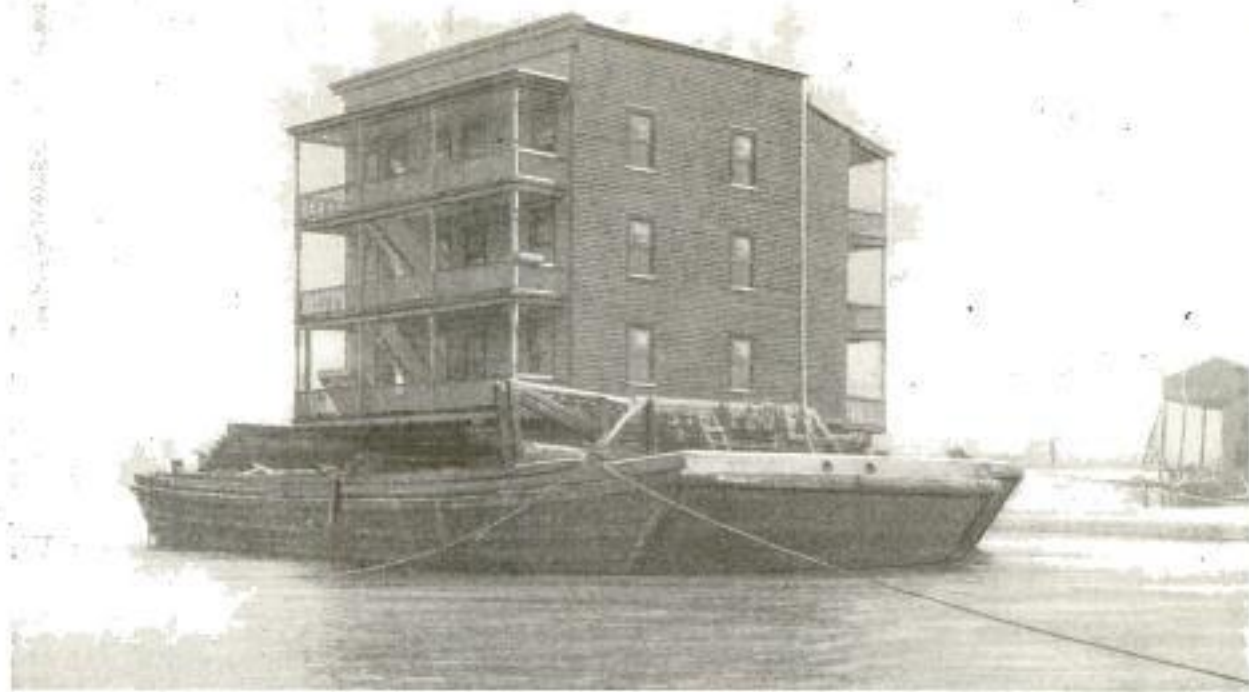

LARGE WOOD HOUSE "SAILS" LONG ISLAND ON BARGE

SPRING moving of a rather unusual nature was undertaken at Stamford, Conn., recently, when a large wooden three-story house was mounted on a barge, hauled out to Long Island Sound, and brought to a new location north of Shippan Point. Aside from certain obvious difficulties, the greatest trouble was encountered in transferring the house to the barge with the changing tide raising and lowering the water several feet—and in fighting a five-mile breeze on the sound.

1677

DUGONG FISHING IN AUSTRALIA

The Australian land fauna is noted for its many exclusive specimens, but even the surrounding sea offers some queer animals unknown in most other waters. Of these, the dugong, also known as the sea cow, but not to be confused with the animal of northern latitudes also so designated, is one. While it is found elsewhere around the Indian Ocean, it is caught mainly in the waters of Northern Australia, and the fishing, though done on a small scale only and by hired native fishermen, gives good returns to the few Australians who have taken up the industry. The dugong is a warm-blooded mammal, and its flesh is much appreciated for its fine flavor, in which there is no suspicion of fishiness. Salted and smoked, the meat serves as an equally palatable

bacon, and the "blubber" gives an excellent oil or lard with all the virtues of cod-

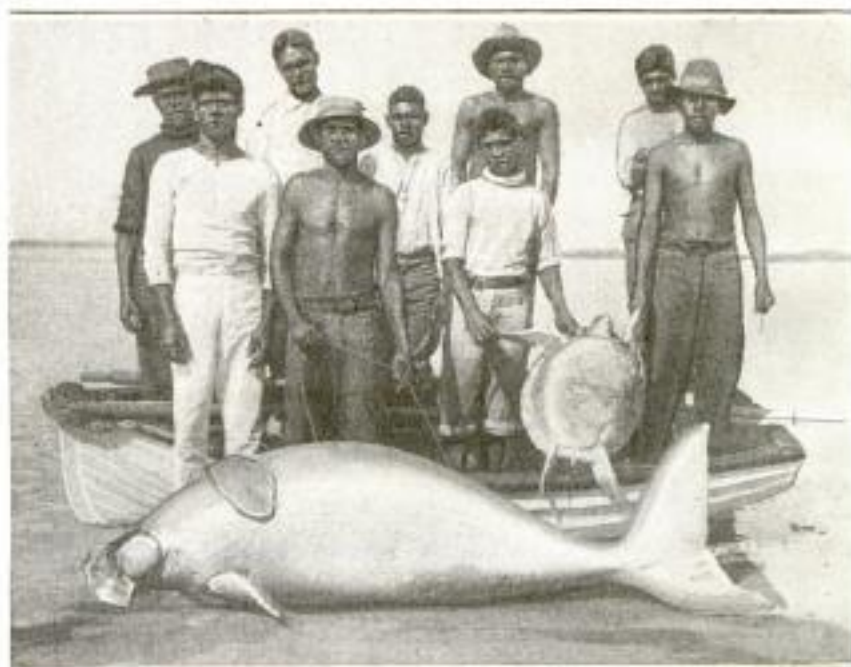

Australian Fishermen with Their Catch of a Large Dugong, a Warm-Blooded Mammal Inhabiting the Waters around Australia and Some Parts of the Indian Ocean: Dugong Fishing Is an Industry Still Little Developed

liver oil. In addition the hide makes a good leather.

Kilroy Harris, American Australasian
Bureau, Box 516, S. P. O., Chicago

Copyrighted material

Cont. George F. Paul,
400 Ellsworth Bldg
Chicago

668

POPULAR MECHANICS

MICHIGAN NOW HAS ITS OWN 731 REINDEER HERD

Will reindeer thrive in Michigan?

State game officials are making a very practical test in order that they may answer this question to their complete



Close-Up of a Specimen of Norway Reindeer, Imported from That Country by the State of Michigan: Both Male and Female Reindeer Have Antlers of Great Spread

satisfaction. On an immense tract of cut-over land, near the city of Grayling, in Roscommon County, is a herd of reindeer imported several months ago direct from Norway, as recorded at the time in this magazine. Extreme care was taken in shipping the animals. Each had a crate to itself, and as a result not a

single one of the entire shipment was lost in transit. What is more, the original herd of 60 has made a remarkable increase, and, at present, counts 81 head.

Upper Michigan has tens of thousands of acres of cut-over land that is lying practically idle. Many settlers have attempted to raise sheep here or tried to farm the land, but have failed. Stockmen have had to face the fact that, for several months, the ground is covered with snow. Their winter feed bills have been so high that scarcely any profit could be realized.

Then the State Board of Conservation came along and said, "Surely there must be some way to make these lands profitable throughout the whole year. There seems to be no good reason why the grasses and wild forage crops of our northern peninsula would not raise to healthy maturity any game animal."

It was this belief that led the state to buy the herd of 60 reindeer, 10 male and 50 female, from Norway, at a price of \$125 each. The reindeer have an average weight of about 250 pounds, which means about 180 pounds when the animal is dressed.

The herd is to be placed on a 62,000-acre tract of cut-over land bordering the south shore of Lake Superior.



A Herd of Reindeer, Recently Imported, Making Themselves at Home on a 62,000-Acre Tract in Northern Michigan: They Are under State Control, and the Experiment is being Watched with Interest on Account of the Solution It Affords in Putting to Use the Great Waste Lands of the Upper Peninsula

1963 Dr. W. Prof. H. Inc Campbell, Chicago
2357 Milwaukee Ave Chicago

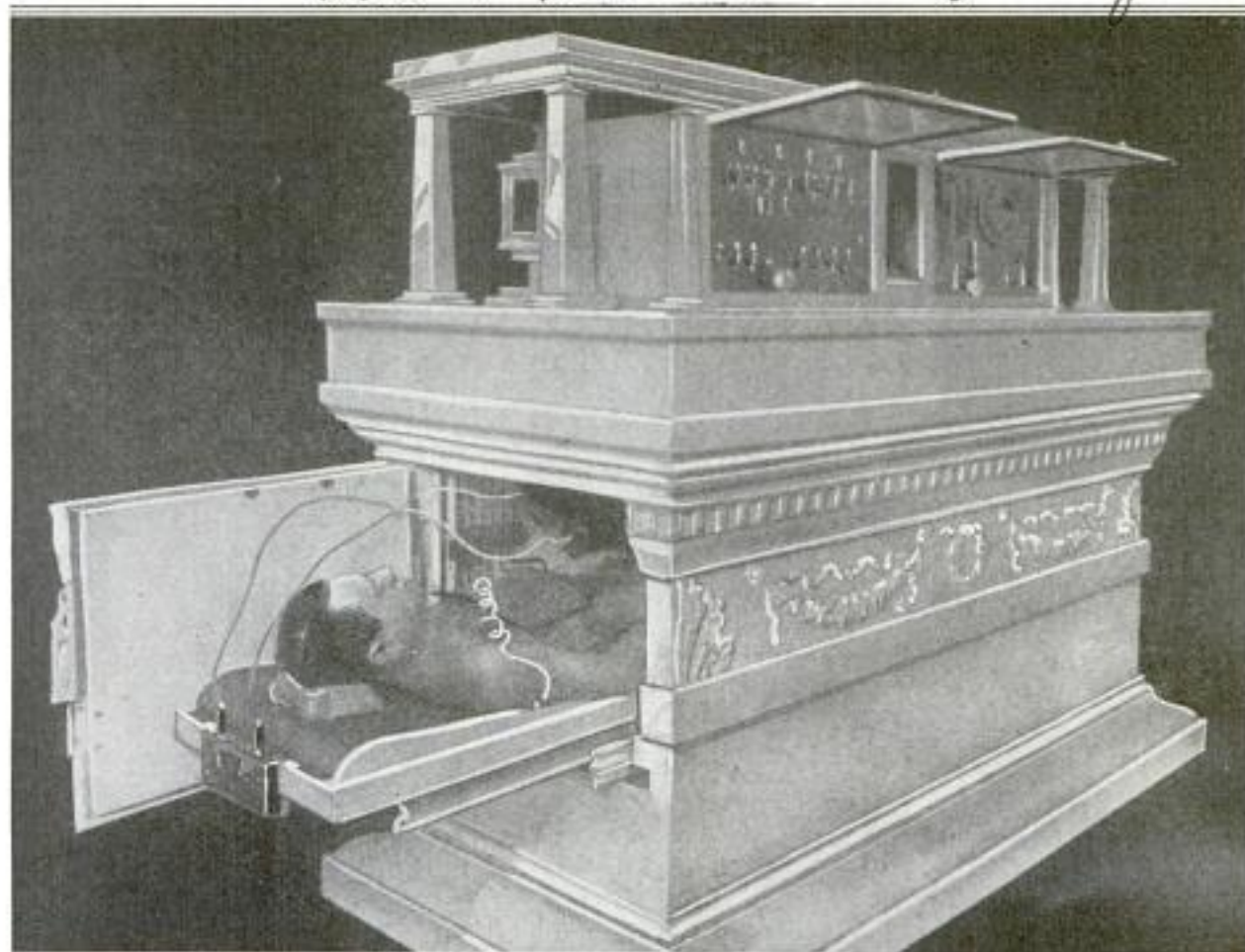

ELECTRIC MUMMIFICATION

BY R. C. FOLGER

THE long-sought art of preserving the human form after death in nearly lifelike aspect, has apparently been achieved in a scientific method developed by an expert embalmer who, as a pioneer in this field, has devoted years of thought and patient investigation to the work. The method not only promises to afford a means of perpetuating the illustrious dead more successfully than the Egyptian mummies, but offers possibilities for the disposition of the dead in sanitary ways that introduce none of the objections of ordinary burial methods nor of cremation. As in many other modern inventions, electricity plays the leading part in the apparatus wherein the body is sterilized and dehydrated beyond the point where the organisms that cause decomposition can exist. The method also offers an opportunity to test for suspended animation by the application of electricity under proper control and of reviving apparently dead persons under the stimulating action of the electric current.

The apparatus which has been assembled at small cost by the inventor himself, has the outward appearance of a sarcophagus and consists of a chamber which receives a rolling copper table upon which the body is placed. This table forms one terminal for the contact with the body and the other terminal consists of a number of contacts made on the upper surface of the body. When the circuit is closed an electric current passes through the body at many different points, setting up sterilizing action due to the heat produced by the resistance offered by the body, and an electrolytic action that reduces the moisture. It is possible that the sterilization is assisted by the breaking up of saline solutions into chlorine and caustic soda, both active sterilization agents. Electric-resistance units placed below the table in the chamber supply additional heat, and an exhaust fan changes the atmosphere in the chamber at regular intervals. The electrical-control devices provide for regulation of the temperature and current by means of red signal lights and an alarm bell as well as recording instruments. The success of the method is attested by experiments performed upon dogs and cats, and by a test upon the body of a man who was the victim of a bullet. The test upon the man's body was witnessed by persons of authority, and they were surprised to note the absence of any discoloration due to the method, and that the form showed so little apparent shrinkage, although there was a loss in weight of about one-fifth.

1701

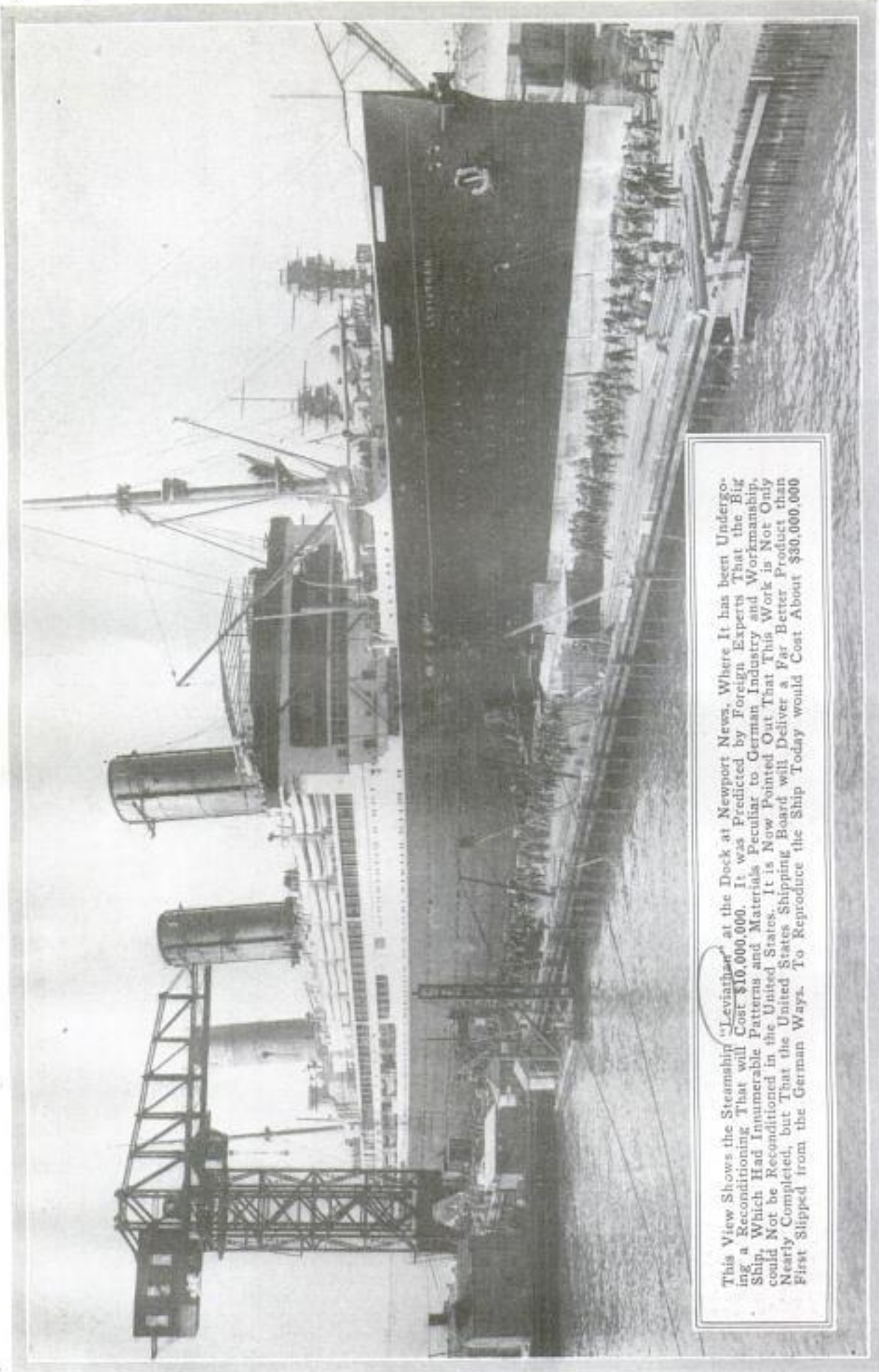

This View Shows the Steamship "Leviathan" at the Dock at Newport News, Where It has been Undergoing a Reconditioning That will Cost \$10,000,000. It was Predicted by Foreign Experts That the Big Ship, Which Had Innumerable Patterns and Materials Peculiar to German Industry and Workmanship, could Not be Reconditioned in the United States. It is Now Pointed Out That This Work is Not Only Nearly Completed, but That the United States Shipping Board will Deliver a Far Better Product than First Slipped from the German Ways. To Reproduce the Ship Today would Cost About \$30,000,000

PHOTO COPYRIGHT, UNDERWOOD & UNDERWOOD

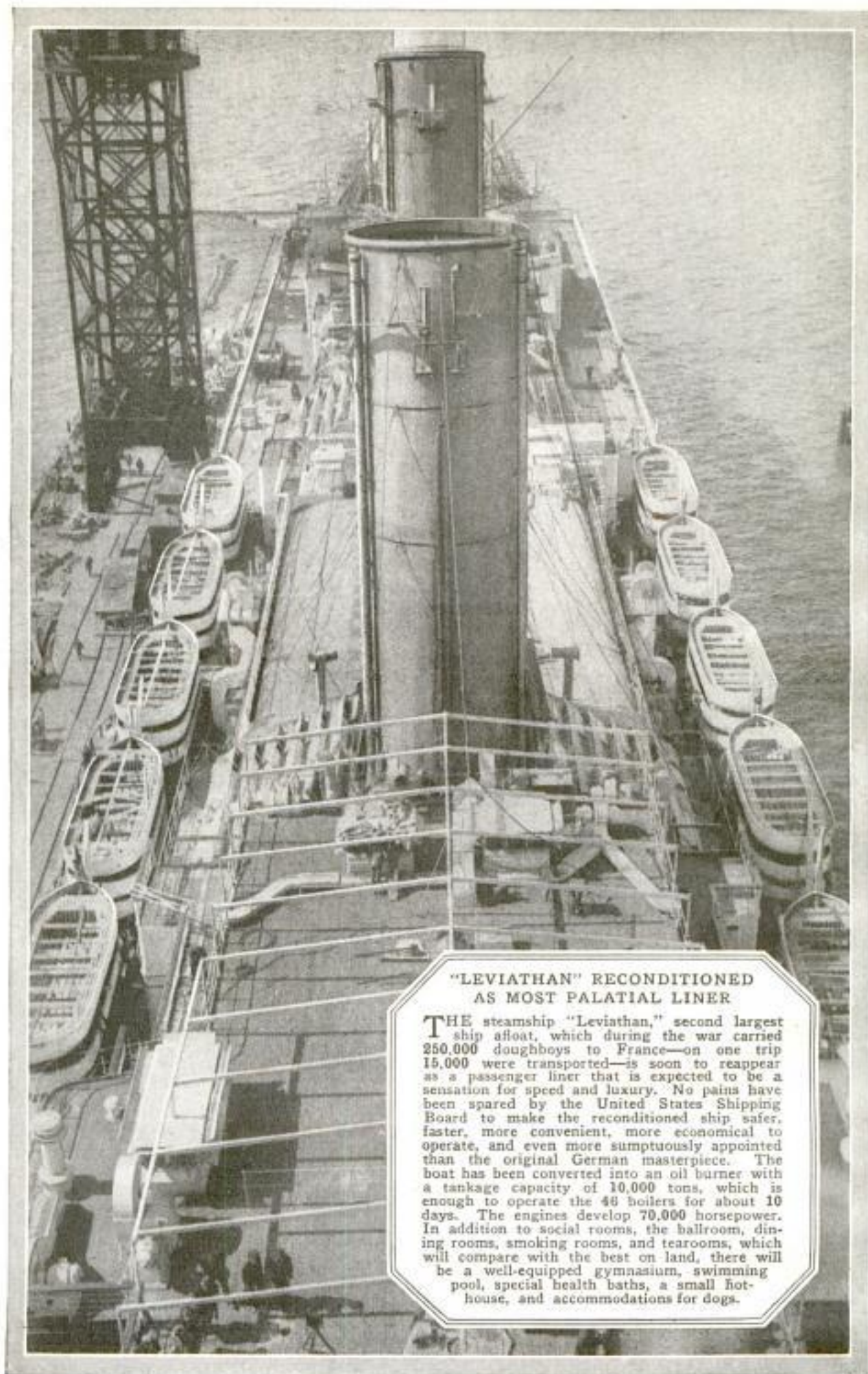

**"LEVIATHAN" RECONDITIONED
AS MOST PALATIAL LINER**

THE steamship "Leviathan," second largest ship afloat, which during the war carried 250,000 doughboys to France—on one trip 15,000 were transported—is soon to reappear as a passenger liner that is expected to be a sensation for speed and luxury. No pains have been spared by the United States Shipping Board to make the reconditioned ship safer, faster, more convenient, more economical to operate, and even more sumptuously appointed than the original German masterpiece. The boat has been converted into an oil burner with a tankage capacity of 10,000 tons, which is enough to operate the 46 boilers for about 10 days. The engines develop 70,000 horsepower. In addition to social rooms, the ballroom, dining rooms, smoking rooms, and tearooms, which will compare with the best on land, there will be a well-equipped gymnasium, swimming pool, special health baths, a small hot-house, and accommodations for dogs.

C. B. Cooper, Oral School for the Deaf,
Cincinnati, Ohio.

672

POPULAR MECHANICS

J. R. Schmidt, 1557 St. Charles Place,
Hyde Park
Cincinnati,
Ohio.

TEACHING THE
DEAF WITH
RADIOPHONES

Radiophones have been used during the last year as an aid in teaching deaf children in the Cincinnati public schools, by Miss Clara B. Cooper, formerly of the Deaf, Dumb, and Blind School at Berkeley, Calif. The radio experiments conducted at this school were fully discussed in our January issue. In several other places somewhat similar work has been done, and it is the consensus of the teachers that radio will prove of increasing value in making the deaf hear, although this point cannot as yet be definitely settled.



The Radiophone as Used in Teaching the Deaf to Hear: The Teacher Speaks Plainly and Slowly into the Transmitter, and the Pupil Listens through the Usual Head Receiver. The Method has Been Fairly Successful

1949



SPECIAL tent and mechanical devices erected for filming part of the forthcoming motion picture "Souls for Sale"—a story of how motion pictures are made. On the occasion of the recent visit there of a member of our staff, Maj. Rupert Hughes, the author who is directing the production of his own story, stopped work while the above picture was taken. Major Hughes stands in the center of the group holding a cigar; at his right, Mr. Roy of this magazine, and his wife, at left.

~~M. J. Corbett~~ W. Isoldwyn Studios.

Copyrighted material

Raydall G. Cynnam,
Supb. of Schools
Cincinnati,
Ohio.

1655 M. G. Corbett, Wm. E. Huffman,
C. F. Adams

Lighter than Air Section Engineering
Division, McCook Field,
Dayton, Ohio.



Left: New "Jumping Balloon" Developed by Employees of the Engineering Division at McCook Field, Dayton, Ohio, Ready to Begin an Ascent. Right: Balloon About to be Cut Loose for an Ascent. The Feature of This Balloon Is a Small Control Propeller

1655
NEW-TYPE SPHERICAL BALLOON HAS PROPELLER CONTROL

The novel feature of a new balloon, recently tried out, lies in a third means of control, which consists of a propeller that can be revolved by a rope belt within reach of the pilot. A pull on the right-hand side causes the balloon to ascend, while a left-hand pull causes descent. The weight of the entire equipment, including bag, rigging, basket, and propeller mechanism, all of which can be folded into a small enough bundle to be carried in a small car, is only 125 pounds. A three-hour flight has been made by a 186-pound man, without using the gas valve and at the expense of only one bag of ballast. Among the advantages are quick get-away without dropping too much ballast, and ascensions from grounds surrounded by buildings and other obstructions.

with black powder, and the spool holder, which also carries a knife for cutting off the burning end of the tube.

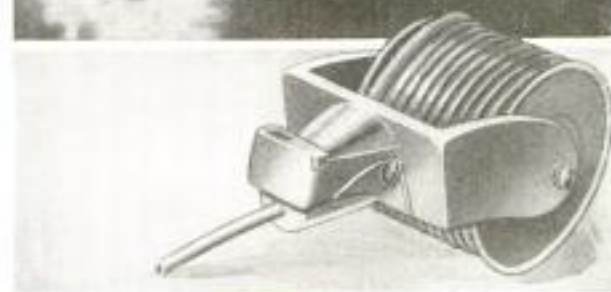

1831
NEW DEVICE FOR LIGHTING BLASTING FUSE

A convenience for blasting work is seen in a new device for lighting the ends of the fuse preparatory to firing a round of holes. The device consists of a spool holding about 25 feet of lead tube filled

Top: Applying New Lighting Device to the End of Blasting Fuse. Center: Cutting Off Burning End of Tube. Bottom: Close-Up of Device

Coast Mfg. & Supply Co. Livermore, Calif.

1462

Photograms, 129 E. 27th St
New York

FLOATING LAND FOR HOME SITES IN HOLLAND

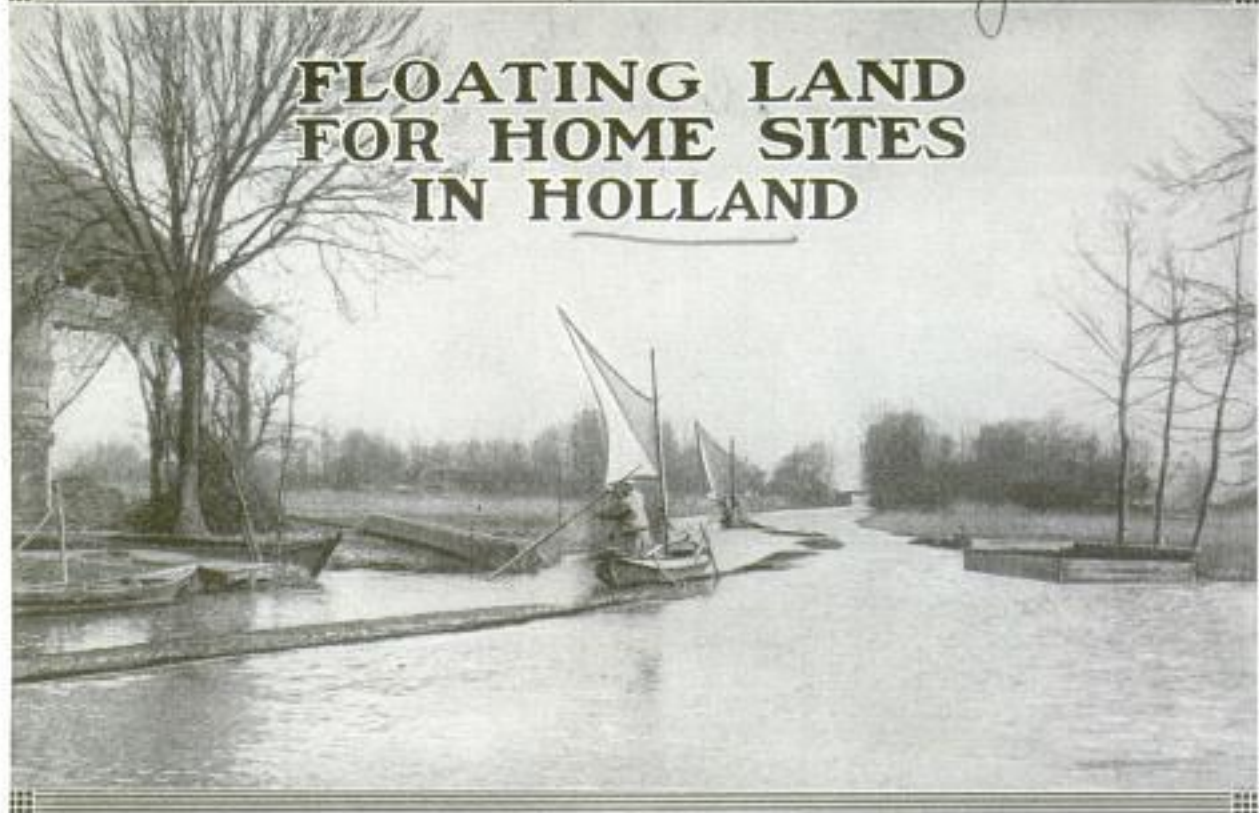

A View Just beyond the Limits of the Village of Giethoorn, in Holland, Where Sections of Water-Logged Land are Cut Away and Floated to Town: A Long Narrow Piece is being Guided along the Canal, and is Seen Just Arriving at the Village. Great Maneuvering Skill Is Necessary for This Work

OF all the countries of Europe, Holland affords, perhaps, the best example of how the topography of a country affects the habits of its people, and influences their lives. A considerable portion of the Low Country lies below the level of the sea, and it was to resist

its cruel invasions that the gigantic levees, or dikes, were built. Nevertheless, some of the flooded regions, periodically inundated by the sea, have been water-logged for centuries, and one of these is the province of Overijssel. Way up in northern Holland it lies, skirted by the



Four of the Professional Land Cutters Slicing Off a Section of Ground Preparatory to Floating It to Town: It is Then Carefully Guided through the Canals and Brought to Rest Wherever the Prospective Home Builder Desires to Build His House



A View of "Main Street" in the Floating Village of Giethoorn, in the Province of Overijssel, Holland: The Skillful Dutchmen have Towed and Pushed Their Floating Strip of Land Right into Town, and Are About to Guide It under the Bridge. One of Them is Giving It a Shove to Clear It from the Bank and Start It under the Bridge

mighty Zuider Zee, and perhaps its quaintest spot is the floating village of Giethoorn. Taking advantage of the condition of the soil, these hardy Dutchmen have learned how to cut away sections of turf, and then float them to the spot where they are wanted. Considerable skill, of course, is necessary to escape a ducking, because the footing is uncertain and slippery, and the marshland deceptive and treacherous. Poles, about

12 feet in length, are employed to shove off the floating home sites, which are cut away beyond the village limits and then guided to town. Some 8 or 10 men follow this work exclusively, and, naturally, are very adept in the handling of their poles and the "islands" in their charge. All of Giethoorn has been built up in this manner, until now it boasts a population upward of 2,000, living on the fertile strips which bank its canals.

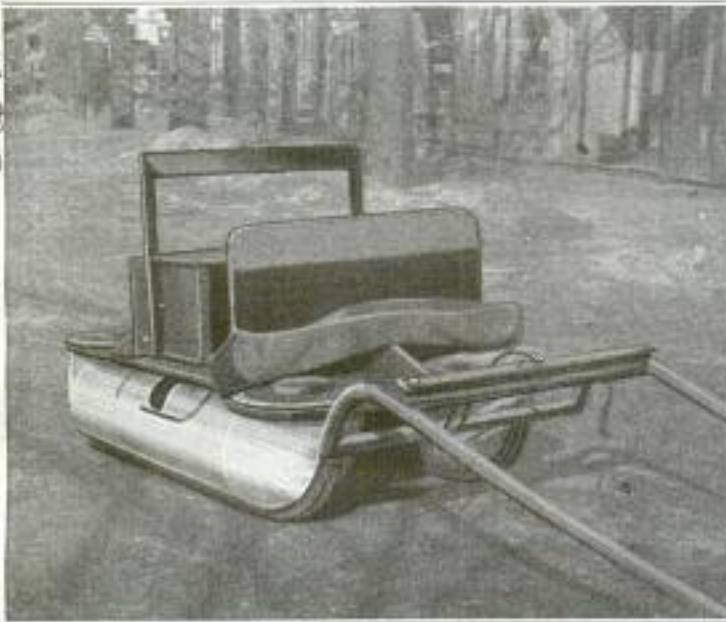

This Sled, Built with Cylindrical Runners, That will Hold Luggage, Glides over Ice, Snow, or Water

SLED CAN BE RUN OVER ICE, SNOW, OR WATER

1763

A horse-drawn sled which glides equally well over ice or loose snow, and which, because of its pontoonlike runners, can also cross shallow streams or other bodies of water, has been made by a Canadian. The runners, the only unusual feature of the sled, are air-tight metal cylinders, having along their underside a converging projection which enables the sled to glide over ice. The peculiar build of the cylinders makes it also possible for them to be effective in soft snow or water. There are doors in the cylinders, so that the interior can be used for carrying luggage if so desired.

1665 PORTABLE SAND HEATER FOR PAVEMENT REPAIRS

The difficulty of making a suitable sand and asphalt mix under heavy-traffic conditions has prompted a southern street-car company to devise a portable sand-heating unit, along the same lines as the asphalt units which have long proved effective. A motor-driven drum, taking power from the overhead trolley wire, is charged with sand, then revolved slowly over a furnace contained in the unit. A temperature of 400° F. is attained, which has the effect of driving off the moisture and thereby facilitating a mix with the previously heated asphalt. The materials are used in equal parts, and the mix is poured between the

granite blocks alongside the street-car tracks. When carefully prepared, as in this case, the mixture forms an excellent filler and binder for this purpose.



A Portable Repair Outfit for Pavement between, and Abutting, the Street-Car Tracks: The Sand and Asphalt are Heated to 400 and 370° Respectively before Mixing, the Higher Temperature of the Sand Keeping the Mix Sufficiently Hot to Flow Readily

Public

Utilities Co.
New Orleans, La.

Copyrighted material

Bulder Mathias Bean
Port Colborne, Ontario
Canada

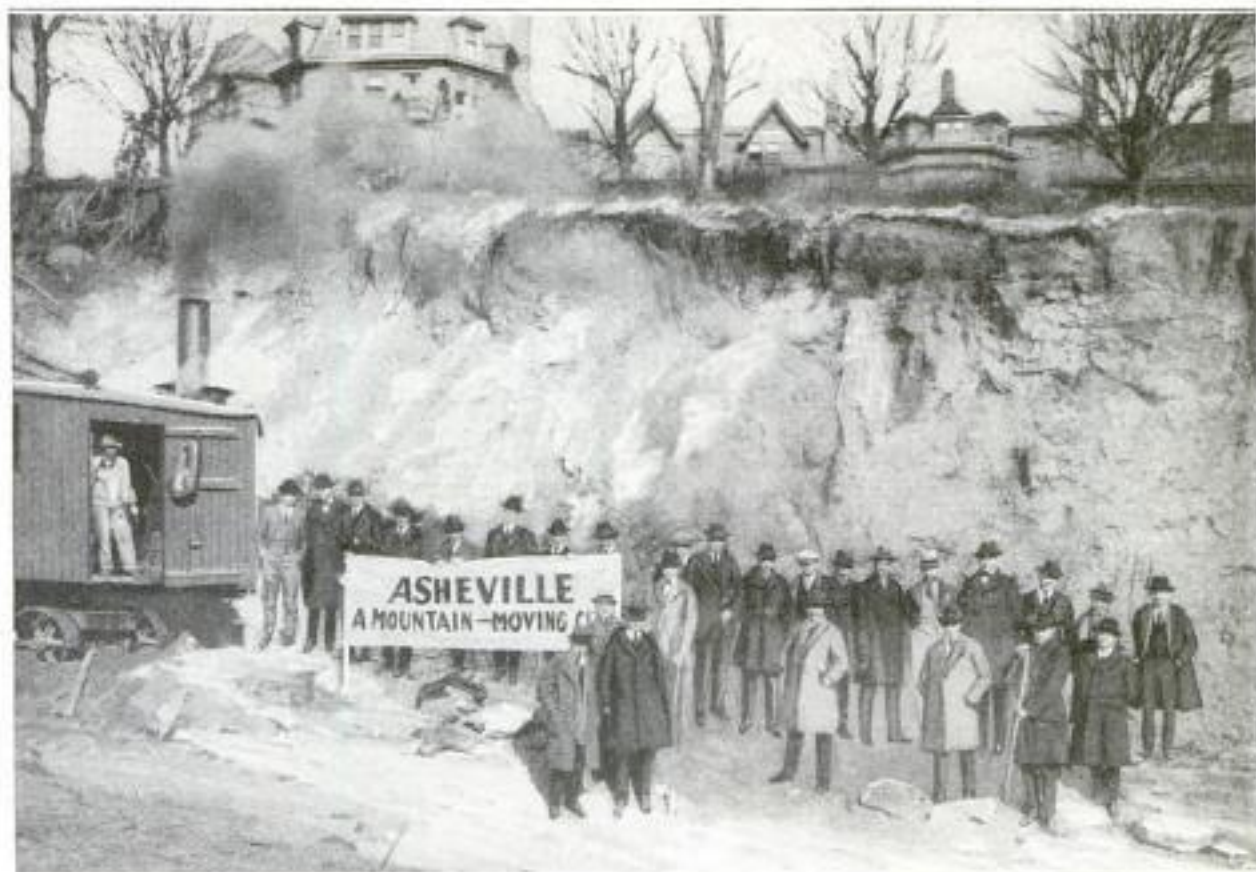

This Picture Shows the Old Height of Battery Park Hill, and the Progress Which has Already been Made by the Company Employed to Remove It. In the Background may be Noted the Upper Part of the Old Hotel, Which has Helped Make the City a Popular Winter Resort

1664
**HISTORIC BATTERY PARK HILL
 AT ASHEVILLE REMOVED**

Bodily removal of Battery Park hill, Asheville, N. C., which is well known to thousands who have visited there, is now under way. During its reign, the hotel on the hill entertained numerous celebrities who, attracted by the magnificent views, the climate, and old-fashioned hospitality, made Asheville one of the most famous winter resorts of the South. With the growth of the city, however, it has finally become necessary to demolish the old hotel, and to use the land surrounding for business purposes. In its stead will be erected a new ten-story structure, the roof garden of which will be just above the present summit of the hill.

**REGULATOR AND FAN EFFECT
 FURNACE ECONOMIES**

173
 An economy of 20 per cent is claimed for a combination of two devices to be applied to warm-air furnaces to increase the circulation of air. One of these is a fan installed in the base of the furnace to accelerate the draft; the other a regulating device placed at the top of the furnace shell. It is operated by electricity to start

or stop the fan and open or close dampers as required. Economy of fuel is effected, the manufacturers claim, by removing the necessity of using fuel to create draft.

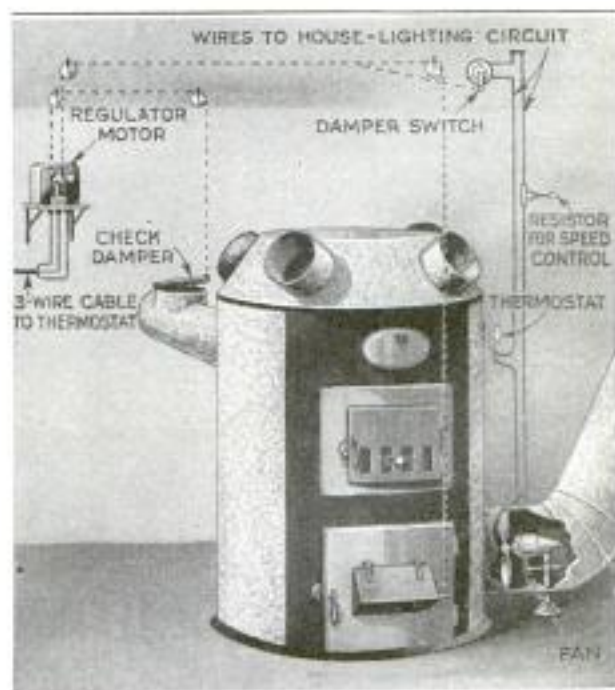

Furnace, Showing Installation of Devices to Promote Air Circulation and Fuel Economy: Upper Left, Motor Regulator and Check-Damper Control; Right, Fan in Air Inlet, and Thermostat.

Honeywell Heating Appliances Co.
 Wabash, Ind.

1817

THE AMERICAN DOG DERBY

BY O. J. GRIMES

1037 Third Ave Salt Lake City Utah

SO long have we associated dog teams and sledges with Alaska and the Hudson's Bay country that we have come to believe that this mode of travel is peculiar to the regions of the Far North. But it isn't. In that section, west of Yellowstone Park and between the Union Pacific winter railhead at Ashton, Ida., and the Great Northern, trappers, woodsmen, and ranchmen travel by dog sledge through the long winter and frequently haul burdens of a thousand pounds or more.

In celebration of the snowfall, so necessary to crops of farm and range in the region, and to afford winter recreation, the community of Ashton decided to make use of the unusual feature of the dog sledge. It organized the American Dog Derby Association, and at mid-winter of each year invites anyone with a dog team to participate in the American dog derby, a test of speed, gameness, and clever driving, rather than of endurance. It is a 25-mile course, which is sufficiently grueling when covered in less than 2 hours 10 minutes, as it was this year.

The huskies of the North are not looked upon with favor in this country

because the distances are not so great as in Alaska and greater speed is desired. Bird dogs, crossbred with German and Belgian police and even Russian wolf and staghounds, are most favored, although this year some shepherds also were given a trial. But the bird dogs were the winners. Of ten teams starting, five made the 25-mile journey almost in a bunch, less than 18 minutes separating the first and the fifth, and the two lead teams crossed the tape just 14 seconds apart.

Aside from forming the feature of a winter carnival that is attracting international interest, the dog derby is stimulating an unparalleled interest in dog breeding. The intelligence of the bird dog, as well as its gameness, is being crossed with the strength of the police dog, and the results being obtained are something watched closely by dog fanciers throughout the country.

Drivers of this country admit that huskies are better for the distances of the Far North, but insist the dogs they are breeding can run rings around huskies on a 25-mile course and are issuing challenges to their brethren of the North to come down next winter for a test.

1812

PHOTOGRAPHS WIRELESSED BY RADIO



The Photograph of President Harding Wirelessly from Washington to Philadelphia



Another Good Example of Wireless Photography in Profile



A Picture Sent Full Face: The Blemishes are Attributed to Static Interference

The first photographs ever transmitted by radio in the United States were made recently by the United States Naval Radio Station at Washington, and wirelessly to Philadelphia. The apparatus by which these pictures were sent is the invention of C. Francis Jenkins, who is also the inventor of the first motion-picture machine, and a description of it appeared in the December, 1922, issue of Popular Mechanics. Its salient feature is a prismatic

annular rim which is rotated at high speed, transferring light impulses into electrical impulses and then into radio impulses. An 1,150-meter wave length was used in the sending of these photographs. Although the transmitted pictures are not perfect, they are easily recognizable, and experts state that the faults are remediable and will be eliminated with improvements in radio reception. The sending was done from ordinary photos.

Washington, D. C.



Olcott Zarn, 15-Year-Old School-boy, Driving His Single-Harness Team to Third Place



Above: Miss Lydia Hutchinson, Known as One of the Best Woman Drivers, "Harnessing Up"

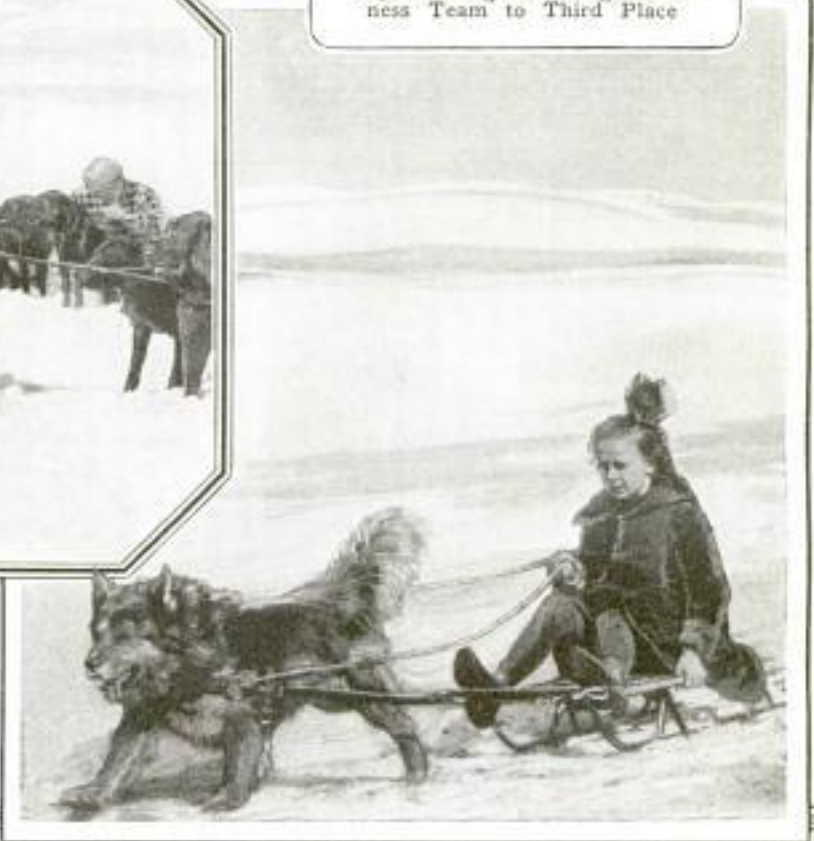

Right: One of the Contestants Leading the Procession in the Girls' Junior Derby

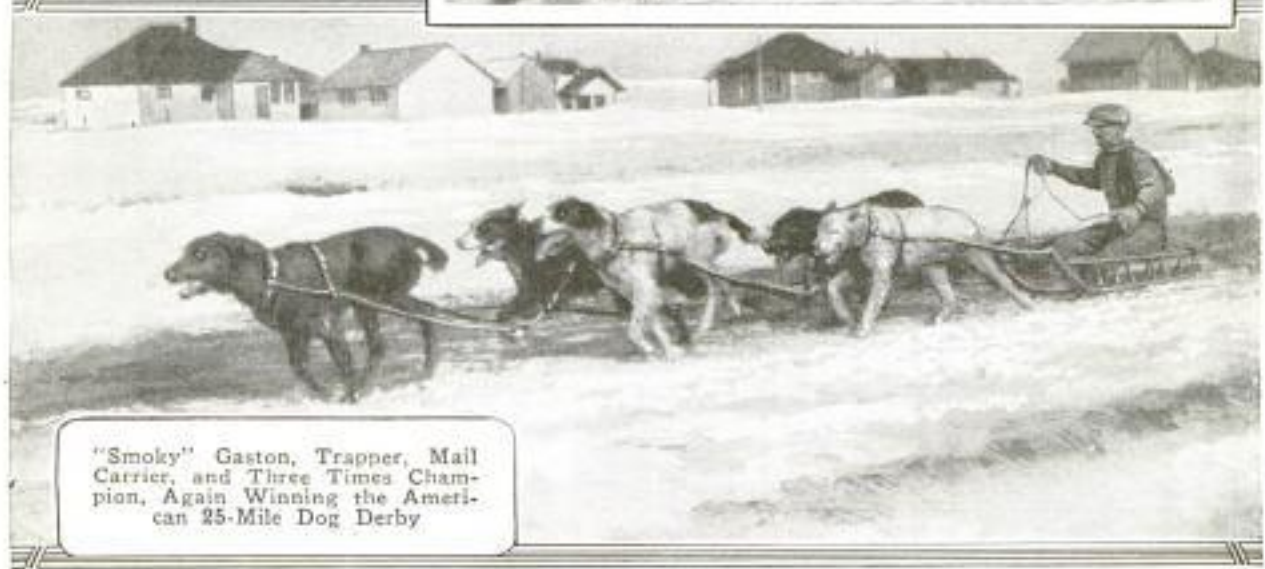

"Smoky" Gaston, Trapper, Mail Carrier, and Three Times Champion, Again Winning the American 25-Mile Dog Derby

1798

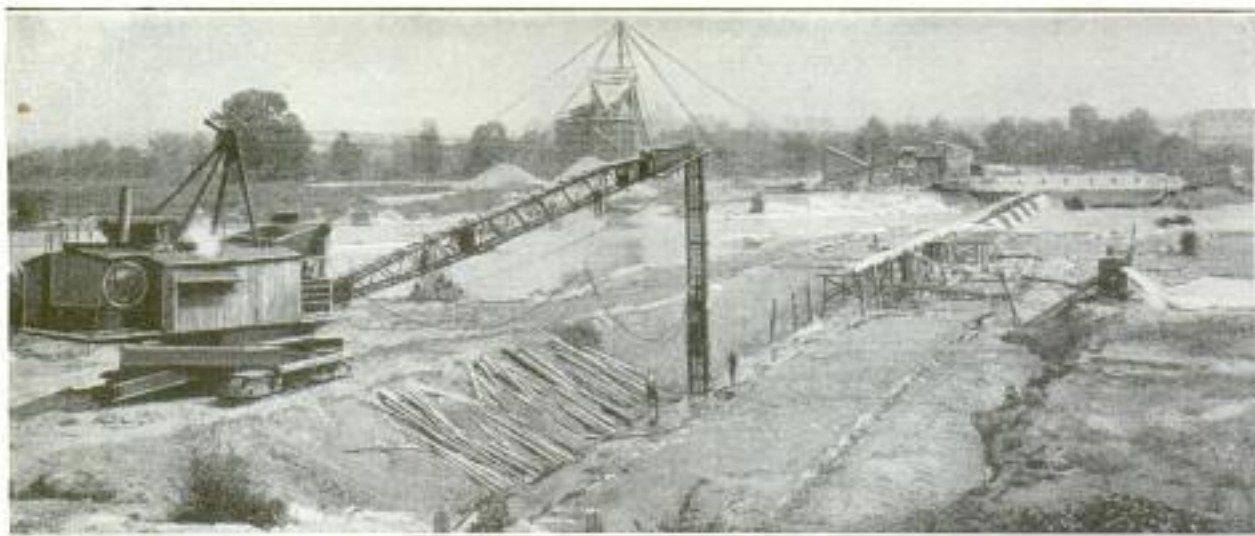

Dragline Excavator Operating a Pile Driver during Construction of a Dam across the Miami River at Hamilton, Ohio: In the Background Appears the Gravel Plant That was Built to Handle Gravel Accumulating in the Artificial Settling Basin Created by the Dam

COÖPERATION WITH RIVER AVERTS FLOODS

BY IVAN E. HOUK, *City Engineer of Dayton, Ohio.*

EVERYONE who has walked along our river channels knows that during flood periods the water moves the gravel along the bottom, depositing it in some places and scouring it out in others, often filling in sewer outlets, choking navigable waterways, and interfering with various commercial activities.

Inasmuch as this habit seems uncontrollable, except by the construction of large and expensive works, the Miami Valley flood-control authorities decided to keep the improved channel at Hamilton, Ohio, clean by coöperating with the river rather than by attempting to curb its natural tendencies. Consequently they built a concrete dam across the channel at the upper edge of the city, just high enough to form a pool and cause the gravel to settle; and then ar-

anged with a local gravel company to build a plant at this location and to take its supply from this artificial settling basin.

Both dam and gravel plant are now completed and operating as planned. If at some time in the future the floods should deposit gravel faster than the market demands, the excess can be excavated and stored along the bank. If, on the other hand, the floods do not bring the gravel fast enough, the bed of the river can be excavated below its natural level.

In constructing the dam, a dragline machine was used in excavating for the foundations, in driving piles, and in building cofferdams around the different sections of the dam. Five gaps, 24 feet long, were left in the first section, to

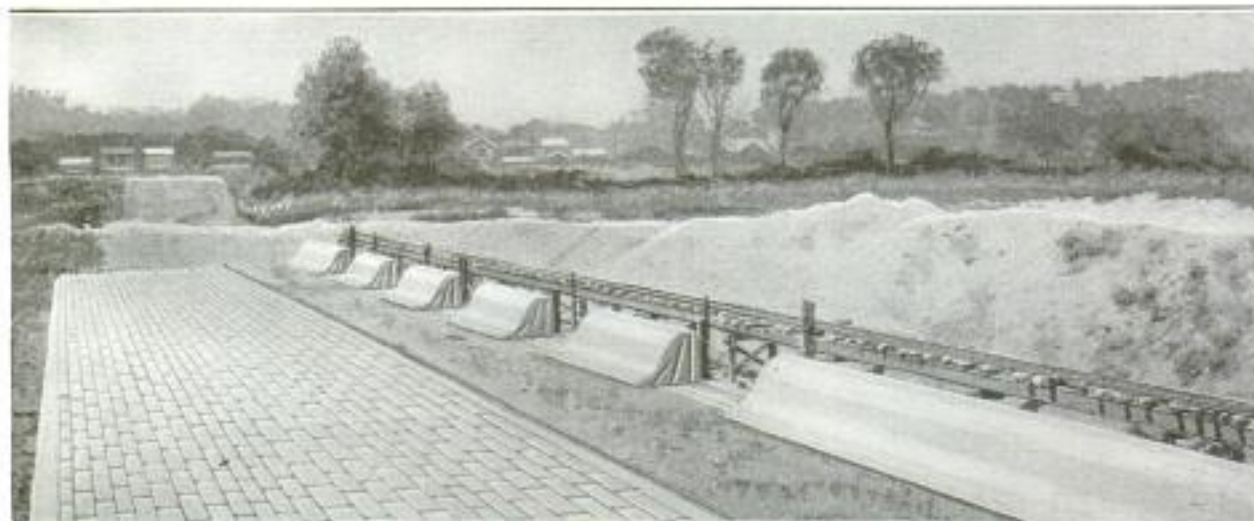

First Section of the Hamilton, Ohio, Dam during Construction: Note the Gaps Left in This Section to Carry the Flow of the River While the Remaining Portion was being Built; Also the Flexible Concrete Apron along the Downstream Apron

carry the river flow while the remaining portion was being built. These were filled in one by one. The dam is protected from undermining by steel sheet piling along the upstream apron, and by timber piling and a flexible concrete-block mattress along the downstream apron, the flexible mat being 40 feet wide.

CONCRETE ROAD FORM HAS

1864 NEW FEATURES

Several interesting changes are apparent in a new type of concrete road form which has recently appeared on the market.

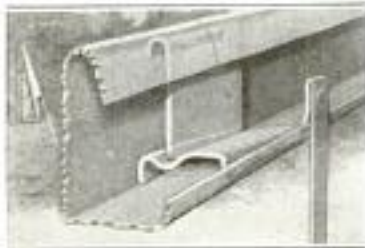

The new form is of steel, $\frac{3}{16}$ inch thick, and comes in 12-foot sections instead of the usual 10-foot lengths,

thereby reducing the number of joints necessary to be installed. The top edge of the form has been made rounded, making it impossible for small stones or concrete to lodge there and cause the finishing machine to ride high. Flat steel stakes, of 18-inch penetration, pin the form to the subgrade.

1795 —
BLADES ON CULTIVATOR
SAVE HAND WEEDING

A new form of a cutter blade for attachment to a hand cultivator is a new device for the home gardener. It consists of two pairs of sharp steel blades which go through the soil like a hoe, cutting weeds below the surface. They are provided with sets of shields or leaf lifters which permit cultivating close to the plants and do away with much hand weeding.

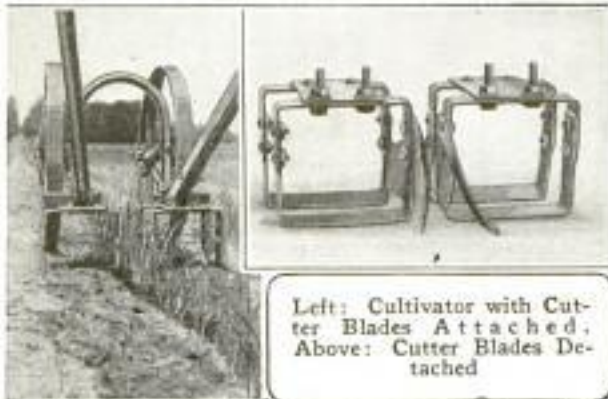

Left: Cultivator with Cutter Blades Attached. Above: Cutter Blades Detached

176 PORTABLE FARM ELEVATOR
FOR HAY OR FEED

A portable elevator has been found of great use at the Missouri Experimental Farm in raising bales of hay and



Portable Elevator for Raising Baled Hay and Mill Feed into Barn Loft

sacks of mill feed into the loft of the dairy barn. The incline has a steel base on which the load rests as it is raised by slats attached to a chain. The ends of the slats are carried on small wheels running in grooves. The elevator is adjustable for height and will lower loads by reversing. It is operated by electric or gasoline power.

1936
CHICAGO "L" CARS TO HAVE
PLUSH CROSS SEATS

Plush cross seats similar to those designed for railroad coaches, a mahogany interior finish, an arrangement of shaded side lights, and an automatically controlled electric-heating system are to be some of the unusual features of a new type of car ordered for Chicago's elevated lines. More than 100 of the cars have been bought, and it is expected they will be in the regular service in May. They cost \$22,000 each.

Chicago Journal 3/6/23

Ans. Vern J. Moore, Asa J. Asa. Copyrighted material

1809

682

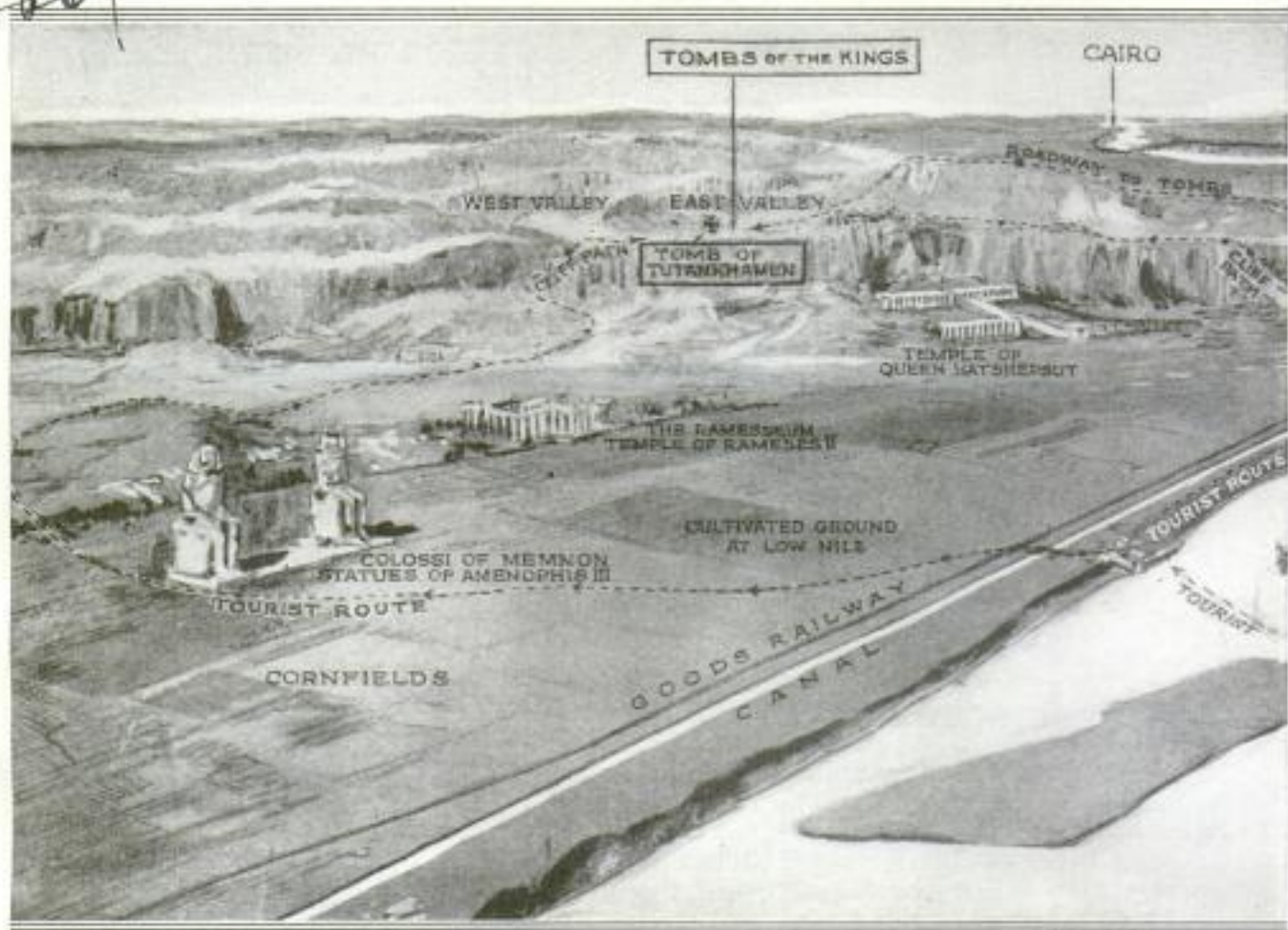

The Above Picture Shows the Lay of the Country around the Famous Valley of the Tombs of Kings into Which Tour to Accommodate the Visitors Who Come There Every Winter to Visit the Historic Tombs at Karnak and Across the Nile and on One of the Principal Roads to the Tombs of Kings, Are the Colossi of Memnon

COPYRIGHT IN THE UNITED STATES

Autocar
WINDSHIELD FOR REAR SEATS EASILY ATTACHED

A windshield which can be easily attached to the back of the front seat has been devised for increasing the comfort of automobile passengers occupying the rear seats. The new attachment has glass panes which are mounted in a



A Tonneau Shield with Adjustable Wings: The Attachment is Said to Be Rattle-Proof, and Easily Secured to the Back of the Front Seat

\$45.00

black-enameled steel frame, the center pane being stationary and secured with rigid attaching brackets. Two side panes, or wings, are mounted on vertical pins located on each end of the center pane, and these can be adjusted to any angle and locked in position. Curtains are also furnished for attachment to the lower edges of the frames.

1896
NEW TREATMENT IMPROVES QUALITIES OF SILK

Stronger and more elastic silk is obtained by a special treatment recently developed in France. After weighting, the silk is treated with tin phospho-silicates and organic compounds in a suitable solvent at temperatures up to the boiling point. Preference is given to compounds that are soluble in water, or evaporate at ordinary temperature, or do not give colored reactions, which include compounds containing nitrogen and sulphur. Useful organic compounds mentioned are chlorine, betaine, alkaloids, and others more easily reduced than fibroin.

French patent 480,206
Journal
tertile
 Com. E. F. Cone, 8 Ash St. Flushing, New York.

*Tonneau Shield Co, Inc.
 47 W. 63rd St. New York 1919*



BY THE SPHERE, LONDON

ists are Streaming to View the Tomb of King Tutankhamen. At the Right Is Luxor, Which Possesses Many Hotels Thebes. Just to the North of Luxor Lies Karnak, Famed for the Wonderful Ruins of the Temple of Ammon. non, Two Gigantic Statues That Once Marked the Entrance to a Temple Erected to Amenophis III

HOW TOURISTS REACH TOMB OF TUTANKHAMEN

The tourist desirous of visiting the new-found tomb of Tutankhamen travels from Cairo by boat or rail 350 miles up the Nile to Luxor, which lies at the river's edge on the east bank. To reach the spot, it is necessary to "go west," as described in the ancient "Book of the Dead," and a short trip across the Nile lands the tourist at a point where two routes lie open to him—one westward across the fertile flat, past the Colossi of Memnon, and up the cliffs to the south of the Valley of the Tombs of Kings; the other along the river to the outlying spur of the range of hills, where the tourist may choose between a path along the cliff or a longer roadway around the hills.

Word comes from England that an important weekly has begun the use of the new rubber-latex paper, in which up to five per cent of raw rubber is incorporated with the pulp.

TRACTOR PROVES EFFICIENT FIRE FIGHTER

Considerable ingenuity is evident in the novel adaptation of a track-laying tractor for fire-fighting purposes, at the Naval Proving Grounds at Aberdeen, Md. Frequent target practice increased the fire hazard, but a large area of soft ground prevented access of the heavy fire engines. A tank mounted atop of the tractor transformed it into a miniature fire-fighting unit, which could go anywhere and fight the small blazes.



Emb. Al. Bullock
R. F. W. Warroad
Copyrighted material
Minn.

Cml. C. L. Hendrickson, Arthur B. Coleman,
 110 4 Arthur Ave, Mrs. Leosnells,
 684 POPULAR MECHANICS Western Australia.
 Milwaukee, Wis.

SAND SPRINKLER MAKES ICY SIDEWALKS SAFE

1799

When the sidewalks in Milwaukee are slippery with ice, a sand-sprinkling machine is used to make them safe for

owned by City of Milwaukee



Machine Used to Sprinkle Sand on Icy Streets: A Chain Running on Sprocket Wheels Works an Agitator That Scatters the Sand from the Box

pedestrians. Mounted on two wheels is a triangular box filled with sand and with an opening at the apex of the triangle. A chain runs around a sprocket on the inside of one wheel and around a smaller sprocket just below the outlet. As the chain moves it engages a third sprocket which operates an agitator in the outlet and sprinkles the sand upon the ground.

EGG-GRADING SCALE TELLS WEIGHT PER DOZEN

To make the grading of eggs by weight more convenient, there has been invented an improved egg-grading scale, which gives the weight per dozen of any-size

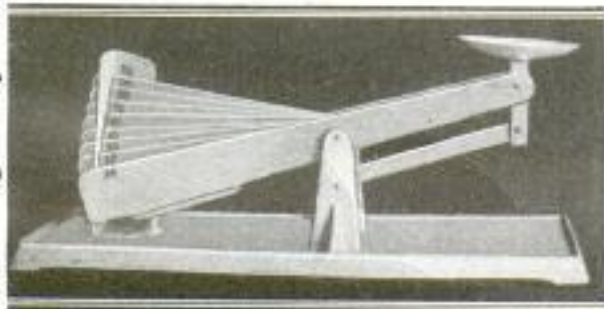

With This Grading Scale, the Lowest Number Visible on the Blades to the Left Indicates the Weight per Dozen of Any Egg Which is Placed in the Cup

egg. One side of the beam consists of several blades of uniform weight, marked to indicate the weight of a dozen eggs of the size of an egg placed in the pan at the opposite end of the beam. When there is no egg in the pan, the scale is in balance, but when an egg is placed in it, that side of the beam goes down, and the opposite side rises. As it does so, it picks up one blade after another until balance is again restored. The lowest visible number then indicates the weight of a dozen eggs of the size in the pan.

STEPPED CLAW HAMMER MAKES 1827 NAIL PULLING EASY

An ordinary carpenter's hammer has been modified in such a way as to dispose of the usual difficulty of having a nail stick when it is partially pulled out. This hammer has a series of three sets of claws, instead of the single set usually found. The claws are staggered in steps, thus making it possible to use whichever set of claws will give the best leverage on a particular nail.



FURRING CLIP FOR WIRE MESH 1648 HELPS PLASTERING

A new type of furring clip, made of galvanized plate, has been placed on the market, which is intended to be looped



The New Furring Clip Showing, from Left to Right, How It is Applied to the Wire Mesh and Nailed to the Wall

over the mesh with which it is used, and then be secured to the sheathing of the building. The clip has four leaves, each being so punched that the nail passes through all the four holes.

The Specialty Hardware Co. 12 29 2 St. Paul Minn.

Is. L. Spring Water Co. Savoy Theatre Bldg. San Diego Calif.

1693 Built by Spanish engineer
Juan la Cerva.

Pat. Luis Spencer. Spanish Army
flyer.

see also April 1925
541

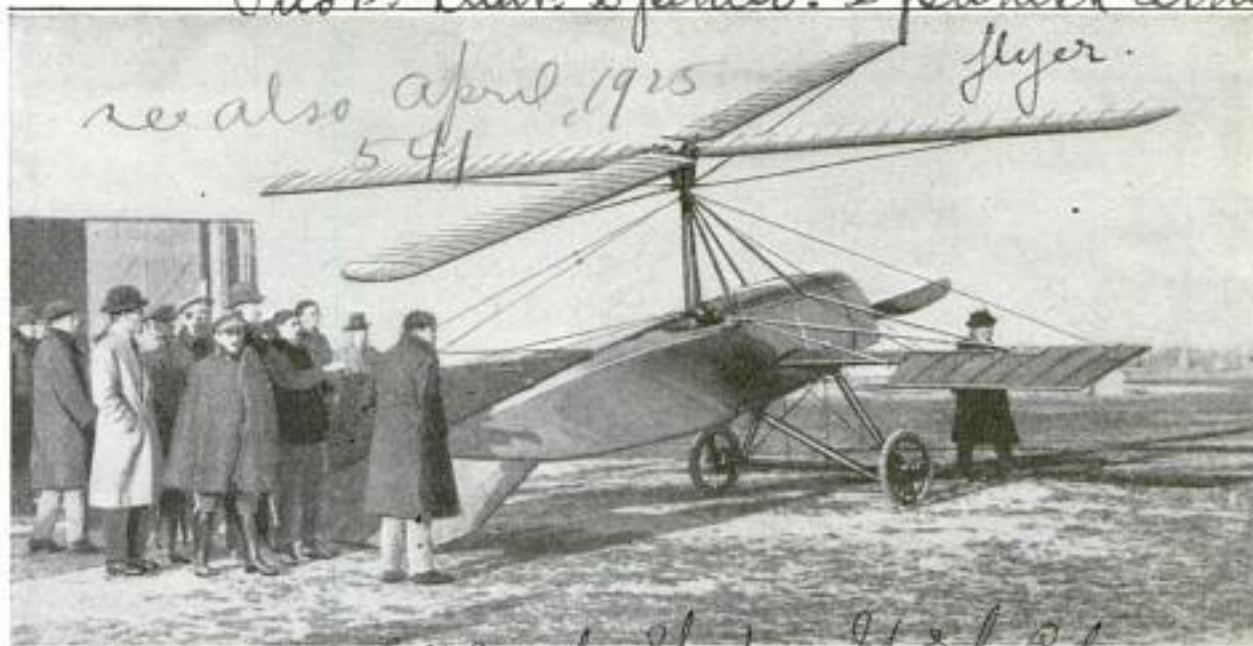

COPYRIGHT, KAGEL & HERBERT

Spanish Helicopter Which is Reported to have Recently Ascended to a Height of 81 Feet and to have Successfully Carried Out Several Horizontal Flights: The Machine is Supported by a Four-Bladed Propeller and is Motored by an 80-Horsepower Engine

1821

**UNIVERSITY OF WISCONSIN
BUYS SPEEDY LIFEBOAT**

The "Isabell," the new lifeboat recently purchased by the University of Wisconsin for over \$4,000, is said to be one of the fastest and finest boats used for this kind of work. In its trial run on Lake Mendota, it attained a speed of 28 miles an hour, and it is claimed that it is capable of doing even better. The craft is 30 feet long, with a 6.6-foot beam, and replaces launches which have hitherto served the double purpose of life-saving boats and coaching launches. Sixty-eight persons were rescued during the past year with one of the boats which the "Isabell" is replacing.

**SPANISH HELICOPTER
RISES 81 FEET**

A helicopter built by a Spanish engineer successfully rose to a height of 81 feet and maneuvered in the vicinity of the aerodrome, according to recent reports from Madrid. The machine, which is powered with an 80-horsepower engine, is designed very much along the lines of the ordinary airplane except for the smaller wings which are replaced by a large four-bladed propeller mounted on a vertical shaft. In addition to this performance, the present unofficial world's records for free helicopters stand as follows: duration of 2 minutes 37 seconds, and distance of 250 feet, both made in France.



The "Isabell," Purchased by the University of Wisconsin, to be Used as a Lifeboat on Lake Mendota: The Craft Is 30 Feet Long, Has a Beam of 6.6 Feet, and Is Capable of Doing 28 Miles an Hour or More. Its Steering Wheel and Other Controls Resemble Those of an Automobile

Cont. Allen P. Child, Box 4673,
Kansas City, Mo.

Copyrighted material

AUTO ENGINE HEATS QUICKLY WITH NEW DEVICE

The problem of heating an automobile engine to the proper operating tempera-

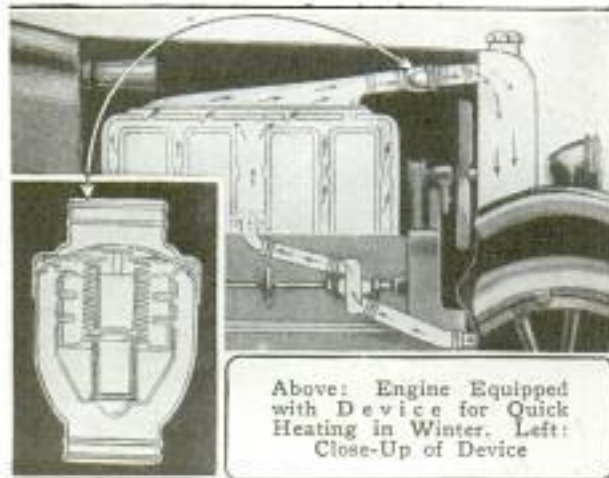

ture in cold weather has been greatly simplified by a device that is inserted in the water-circulation system, between the cylinder head and the radiator. It consists of a valve that automatically prevents water from going to the radiator, until it has reached a predetermined temperature. A seepage of one-tenth prevents the radiator from freezing.

REMODEL RAILWAY STATION AT OSAKA, JAPAN

Remodeling of the Osaka railway station, which is to be begun in the latter part of 1923 and completed in 1931, embraces plans for large passenger stations separate from each other. In order to provide space for the new terminals, some additional land, including the present

sites of several schools, has been acquired. The freight yards and station will be the largest and most up-to-date in Japan. A canal leading to the freight yard will be constructed for the purpose of transferring cargoes quickly to boats. The cost is estimated at \$15,000,000.

SKATING ON LINCOLN MEMORIAL REFLECTING POOL

Washington ice skaters enjoyed a treat in February when the water in the new reflecting pool in front of the Lincoln Memorial froze to a sufficient thickness to permit skating. Opportunities to skate in Washington are quite rare, and when they do occur all classes take to the ice.

In May the memorial, built of Colorado marble at a cost of \$2,939,729, was dedicated with elaborate ceremonies. In December, with less elaborate ceremonies, the water was turned into the reflecting pool. These ceremonies had kept up the interest in the memorial and the pool. From the day it was announced that a pool would be constructed, however, the lovers of skating had been anxious to learn whether they would be allowed to use it for this sport.

Finally it was announced that skating there would be permitted.

An interesting detail in connection with the construction of the pool, is the fact that it was found necessary to waterproof the bottom thoroughly. This was done by digging the basin, which is 2,000 feet long and 160 feet wide, sloping to a depth of 3½ feet in the center. The bottom was then covered with cinders, followed by alternate layers of asphalt and tar paper. Upon this substantial base was laid the final layer of slate.



Outdoor Enthusiasts of Washington, District of Columbia, Enjoying the Privilege of Skating on the Reflecting Pool of the Lincoln Memorial: After Waiting Most of the Winter, They were Rewarded When a Cold Snap in February Froze the Surface of the Pool to a Safe Thickness.

Com. John W. Kean, Bureau of Navigation,
 Navy Dept, Washington, D.C.

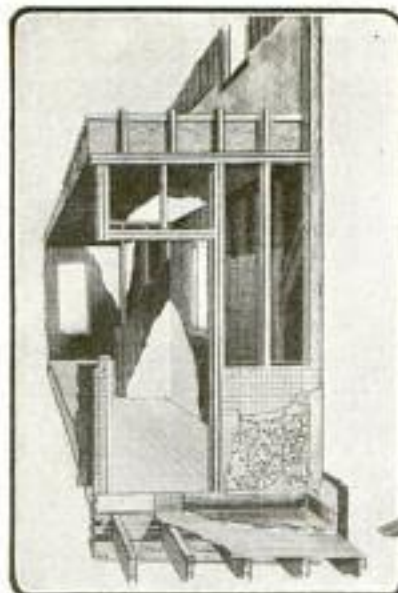

An Exterior View, Showing the Application of the Steel Fabric to Both Exterior and Interior Walls, as Well as to Porch Floors



**NEW STEEL FABRIC SIMPLIFIES
 1733 STUCCO WORK**

Of interest to architects and home builders is the recent development of a galvanized-steel mesh fabric which serves as a base for stucco or plaster work. The fabric is backed with a saturated rope-fiber waterproofing material, which, being porous, exerts a capillary attraction on the plastic material and thereby tends to hold it in place. The fabric itself functions primarily as a reinforcement to the applied stucco or plaster, and by eliminating keys, has an equal reinforcing value in all directions. Another advantage is that no furring strips are required, the fabric being crimped at uni-

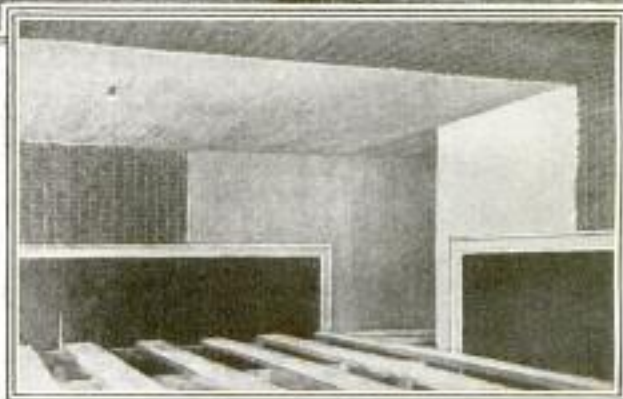

Above: Applied as Stucco Reinforcing on a Frame House. Below: Showing How the Steel Fabric is Used on Walls and Ceilings of a New House

form intervals and in reality "self-furring." These features insure an exceedingly workmanlike job, without seams or lines of weakness in any direction.

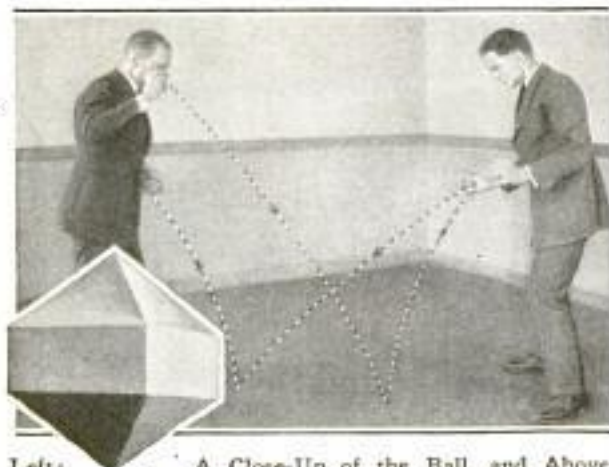

Left: A Close-Up of the Ball, and Above, One of the Simple, Though at Times Strenuous, Games Which may be Played with It

**1792
 MANY-CORNERED RUBBER BALL
 GIVES GREATER EXERCISE**

A solid rubber ball with 10 corners and 12 faces has been made to furnish additional excitement to games usually played with a round ball. Under the same conditions, an ordinary ball will always act in one certain way. The new ball is anything but dependable; no matter how carefully the players may endeavor to duplicate a special rebound, the likelihood is that every time it hits the floor, it bounces off in a slightly different direction. This, of course, makes the playing more interesting—and more exciting.

Poly-Cal Mfg. Co., 501 Main St.
 Bradley Beach, N.J.
 Copyrighted material

*Cmt. Robert Page Lincoln
4943 Bluffmont Ave.
Minneapolis, Minn*

*The William Cramp & Sons Ship & Engine Building Co
Philadelphia, Pa*

845

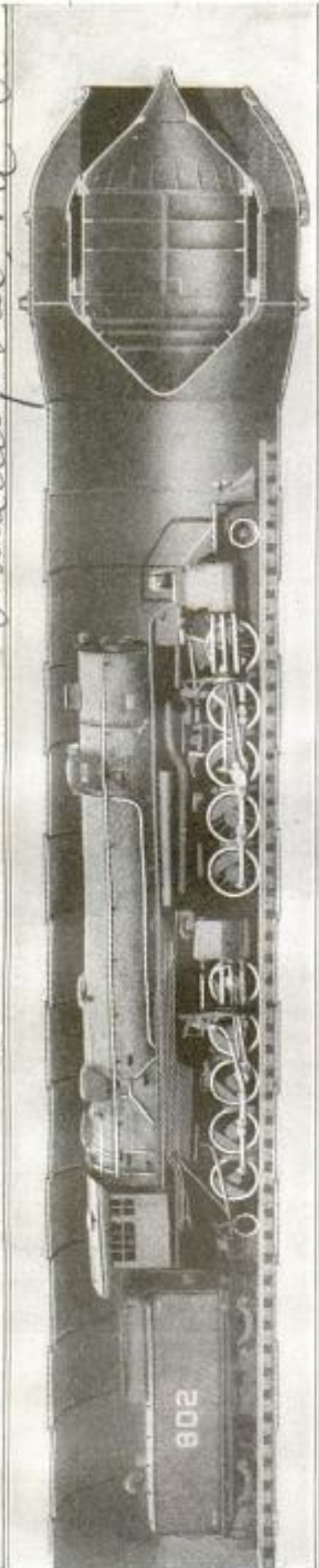

MAMMOTH PENSTOCK EASILY ACCOMMODATES WORLD'S LARGEST LOCOMOTIVE

THIS giant penstock, or tube, 21 feet in diameter and 600 feet long, is one of a series of three constructed for the Niagara Falls 200,000-horsepower hydroelectric development. They will be drilled through solid rock, and are designed to pass a flow of 2,800 cubic feet of water per second to three turbines, each rated at 70,000 horsepower, located in the power house below them. Some conception of their capacity may be gained from the fact that nearly 3,000,000,000 tons of water will rush through these penstocks in a single year. The above view shows how "The Virginian," which is one of the world's largest and most powerful locomotives, could easily be run through one of the penstocks. On the right is a view of a 500,000-pound "needle valve," which will be used to control the flow in each of the three penstocks. So ingeniously is this enormous valve constructed, that only five seconds are necessary to completely shut off the huge flow. The design of the valve is such that it utilizes instead of opposes, the enormous pressure of the rushing water, when it is necessary to check the flow. This is accomplished by admitting water to the inner side of the valve, so that its force will be balanced on both sides of the valve gate.

**FORESTATION TO HELP CITY
REDUCE INDEBTEDNESS**

1907

The town of Ilion, N. Y., hopes, by a community practice of reforestation, both to benefit its people in an immaterial way and to derive a substantial profit from it, and is already well along toward the realization of its aims. In 1910 the unproductive land that skirted its reservoir streams was planted with 5,000 pine-tree seedlings and about 3,000 spruce. In 1911, some 12,500 more were planted; in 1912, 5,000 spruce were purchased and set out, and in the following years 25,000 additional trees were planted, making a total of 50,500 trees. Some 90 per cent of these trees now live, a majority having attained a height of 14 feet, adding great beauty to a hitherto unsightly region. Within 30 or 35 years these trees will have reached commercial size, and as they are cut down, younger growths will take their place. In this manner considerable sums will be realized from the sale of the timber, and it is planned to apply these funds toward liquidating whatever municipal bonds may be outstanding at that time.

1938 — *Aeromarine*
**PLAN FAST AIRSHIP SERVICE
NEW YORK TO CHICAGO**

An overnight airship service is now being planned between New York and Chicago, as the beginning of a line of dirigibles that will operate on a scale heretofore not attempted even by Germany with the Zeppelins and Shütte-Lanz airships. After a survey of the past performances of air craft of this type, the advocates of the idea appear to be convinced that with the use of helium gas and with other protective measures, safe travel can be assured, and that it will be commercially possible to maintain service with a fleet of rigid dirigibles similar to the Shütte-Lanz type. Air terminals at which the liners would be moored to great masts and with provisions for heavier-than-air machines, would receive passengers from the smaller craft for transfer to the through-route airships. Accommodations for about 50 passengers would be provided and would include staterooms approximating, in size and appointments, those of a Pullman car; a dining room, an observation lounge, and a promenade deck, as well as quarters for the crew. The motors would be entirely removed from the passenger compartments so as to insure quietness and minimize vibration.

N.Y. Times 3/4/24

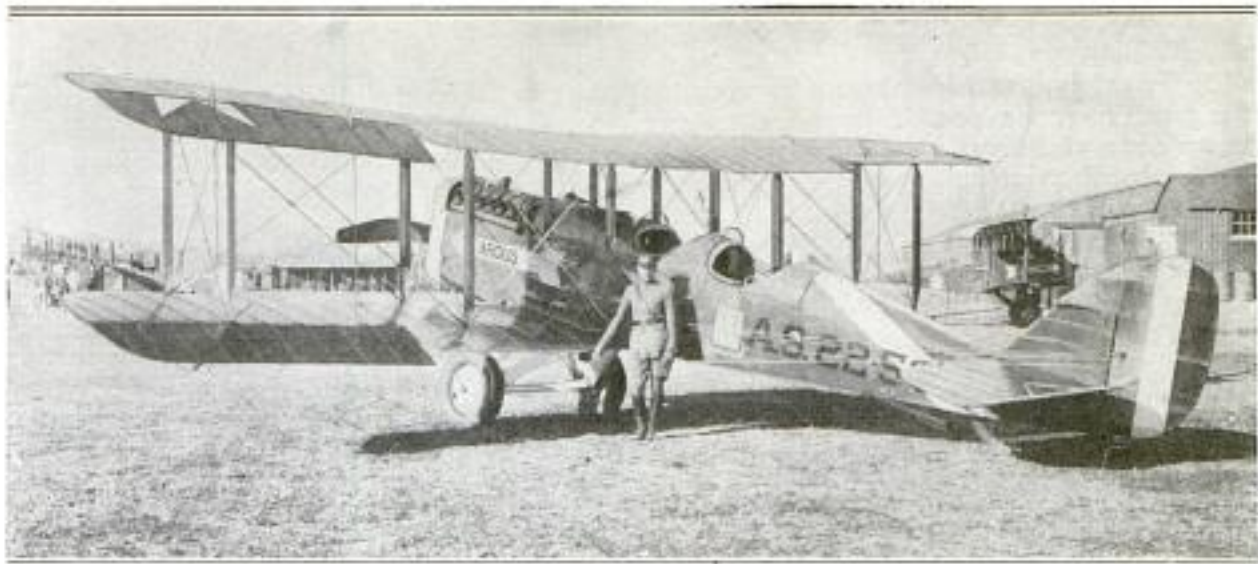

The DeHaviland Airplane Which Lieutenant Nowland Piloted in Making an Aerial Survey of the Salt Creek-Tea Pot Dome Oil Fields near Casper, Wyoming: A Film-Type Camera was Suspended Vertically in the Rear Cockpit of the Machine

THE LOG OF AN AERIAL SURVEY

BY BOB E. NOWLAND,

Lieutenant, Army Air Service

Fort Riley, Kans.

THE following account of a map-making flight was written for Popular Mechanics Magazine, at the instance of the Chief of Air Service of the War Department, by the pilot in charge of the expedition, and the illustrations are reproduced from official photographs by courtesy of that department. We are requested to mention, in this connection, that the Army Air Service is operating a school of aerial photography at Rantoul, and that full particulars may be obtained by writing the Commanding Officer, Photographic School Department, Chanute Field, Rantoul, Ill.—Editor.

AT seven o'clock on the morning of Aug. 7, 1922, the writer, as pilot, together with Master Sergeant Fred Carducci, photographer, left Fort Riley, Kansas, by airplane, for Casper, Wyo., some 600 miles away, to map, by order of the Army Air Service, the Salt Creek-Tea Pot Dome oil fields.

Our plane, an army DeHaviland with a 400-horsepower Liberty motor, was heavily loaded with camera, films, and miscellaneous equipment, but when once in the air, handled as easily as a training ship.

The flight to North Platte, Neb., our first stop, was made in 3 hours 25 minutes. With new

supplies, we were in the air again in 20 minutes, bound without further stop for Casper, 310 miles away. As the country in western Nebraska was quite

rough and unsettled, it seemed a good plan to keep in sight of the North Platte River, so that, in case of trouble, a landing could be made near civilization.

The motor was working perfectly and we seemed to be traveling with a favorable wind, as our speed over the ground figured out close to 120 miles per hour.

Just after crossing the Nebraska

line into Wyoming we passed over some very bad country, but the motor was run-



A Section of the Territory Mapped by Aerial Photography: A Close Inspection of the Picture will Disclose the Presence of 14 Oil-Drilling Rigs with Derricks

ning "sweetly," and in 3 hours 15 minutes we were over Casper. After circling the town several times, a landing was made at the local aviation company's field east

to be photographed. These maps gave very little information, as no contour or topographical maps of this country have been made. The area to be photographed was 35 miles north of Casper, and contained about 300 square miles of fairly rough country. The elevation above sea level at this point is approximately 5,000 feet, and as we planned on flying at 10,000 feet above the ground, to get pictures of a scale of 1:10,000, it will be seen that we were in for quite a bit of high-altitude work. Our camera was of the film type, taking a picture 7 inches wide by 9 inches long, and with 100 exposures to each film. This camera was suspended vertically in the rear cockpit of the airplane, in a mounting that allows it to be kept absolutely vertical at all times. To make an exposure, the photographer has only to press a trigger;



The Dark Patch Is the Shadow of a Cloud. To Avoid This Effect, the Mapping was Done before 10:00 o'Clock in the Morning

of town. The representative of the Bureau of Mines met us at the field, so we loaded all our equipment into his machine and drove to town. We spent the balance of the day in getting acquainted and in studying the existing maps of the area

ger; then, by turning a small handle about three revolutions, the film is wound into position, and the shutter cocked, for the next exposure. Exposures taken at 10,000 feet above the ground cover an area of $1\frac{1}{2}$ square miles to each picture.

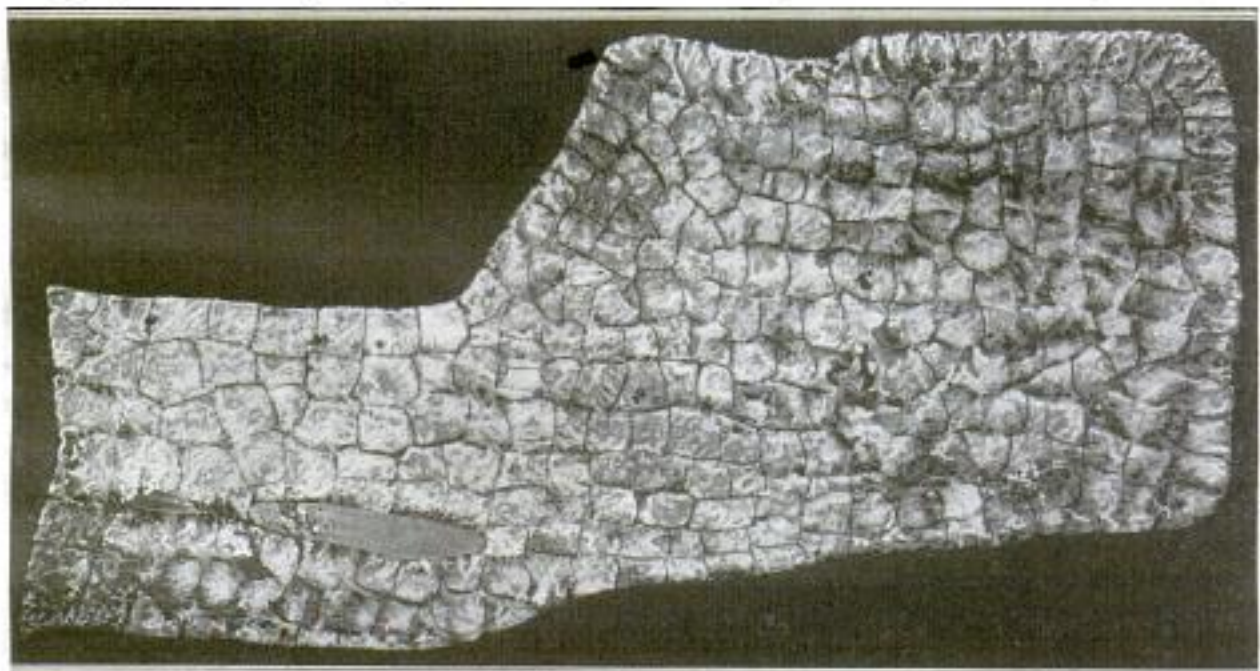

This Is a Reproduction from a Poor Print of the Finished Aerial Map Which was Completed in Four Months After the Project was Begun. Under the Old Method of Land Surveying, It would have Taken Much Longer and Cost More to Cover the Same Area



Above: Aerial Photograph of an Oil Field near Casper, Wyoming. The Arrows Point to Wells That Were Gushers, and It can be Noted from the Dark Spots Where the Oil has Flowed over the Ground. Below: Aerial View of Casper, Showing the North Platte River, the Railroad Tracks, and the Oil-Storage Tanks and Refineries

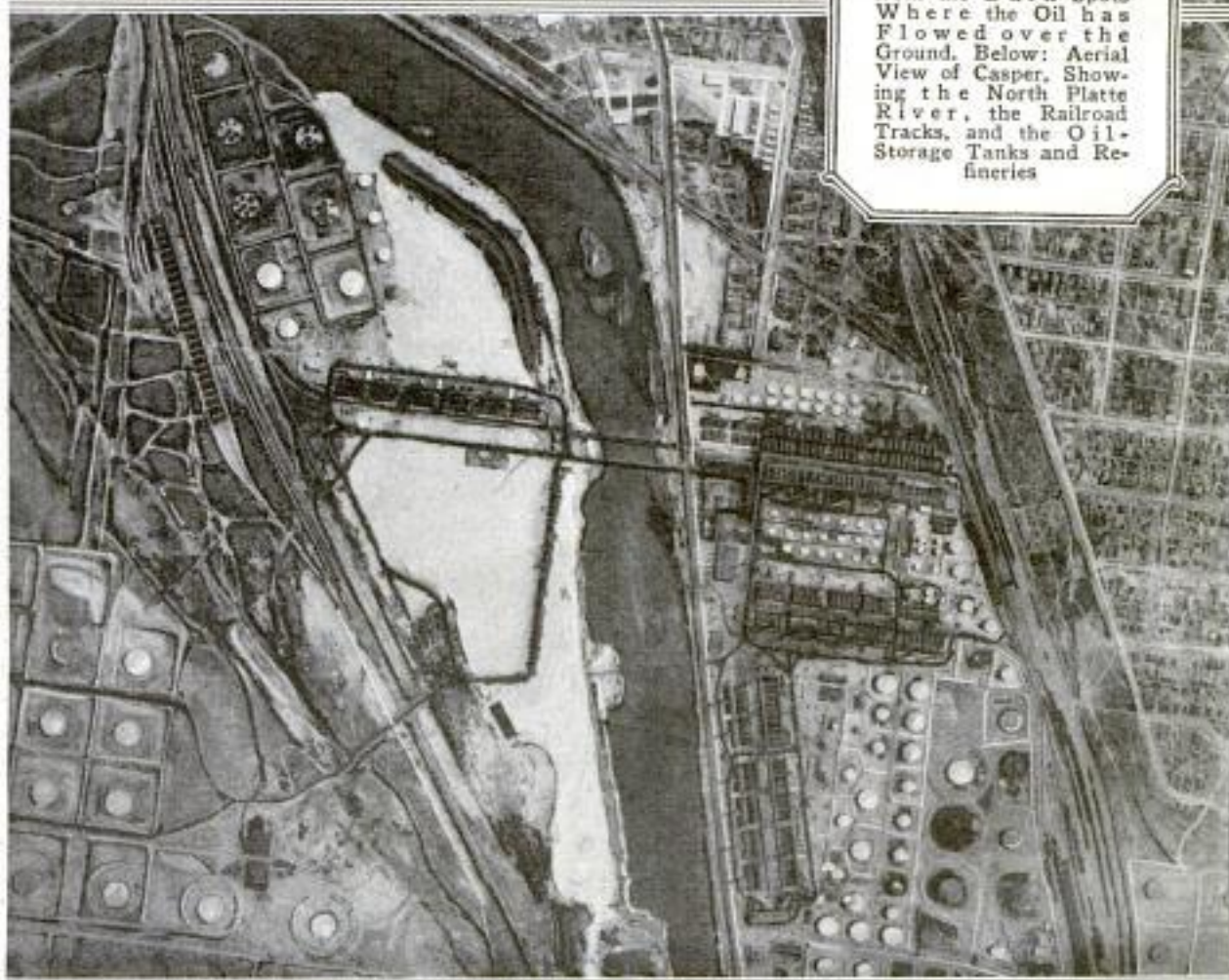



In This Aerial Photograph, 1 Indicates a Portion of the Road between Casper and the Oil Fields; 2 Points to Motor Trucks Loaded with Freight, and 3 Denotes Pipe Lines Carrying Oil from the Wells to Casper, the Nearest Railroad Point

It was decided, after an inspection of the maps of the area to be photographed, that some method of marking the boundaries of the area would be necessary, to prevent useless waste of time, film, and gasoline, so a trip to the oil fields was made by automobile, and markers were laid down at known positions around the area. These markers were made of cheesecloth, staked securely to the ground. They were in the form of a letter "L," the arms of the letter being 50 feet long and 6 feet wide. An entire day was taken up with this work, as some little difficulty was experienced in finding the corner locations.

A dark room was fitted up in a local blueprint establishment, and our tank-developing apparatus moved in. That afternoon we made a flight of $1\frac{1}{2}$ hours over the area to note the position of prominent landmarks, and to see how well our cheesecloth markers showed up from the air.

As everything was in readiness, the following morning we started mapping the area. The temperature on the ground was up around 90° , but by the time we had reached our altitude, which took an hour, it had dropped to below freezing. We sat there for 2 hours 20 minutes, our

teeth chattering, getting a picture every 25 seconds, as we rode up and down the 25-mile strips, until our film gave out. That afternoon and evening we developed and printed our film, and the next day laid down the prints on large pieces of beaverboard, to see how much of the area we had covered. We were trying to snap a picture often enough to get a 50-per-cent overlap, and found when the prints were down, one over the next, that we had succeeded pretty well.

The next day's flying went much as the first, only we profited by the chilly ride of the first day, and wore our heavy leather flying clothes, and were much more comfortable. It was found that, due to the white billowy clouds that formed over the area each day, our photographic efforts had to be over by 10:00 o'clock each morning, otherwise our pictures would be spoiled by the black shadows that these clouds cast on the ground.

The rest of the flying went much as the first two flights had gone: an hour to climb up, a couple of hours up and down the area, and the long glide of 40 miles back to our field. The old Liberty motor worked perfectly for the $16\frac{1}{2}$ hours spent over the area, and slowly,

1679

day by day, the prints began to cover up the spots of the area unphotographed, until, on August 23, the job was completed—a total of five flights with over 600 exposures taken.

We packed and shipped our developing apparatus, and got away for home at 7:30 the morning of the 24th. This time we decided to go back by Cheyenne and Denver, so headed out over the mountains to the southeast. Cheyenne rolled by beneath us in 1 hour 20 minutes, and at 10:10 we were on the ground in Denver, taking on gasoline and oil, having covered 240 miles. At 11:00 o'clock we got under way from Denver, and at 3:00 o'clock that afternoon put our wheels down on the airdrome at Fort Riley, Kan., having covered the last 440 miles in just 4 hours.

Now came the slow and painstaking part of aerial mosaic-map making—the laboratory and assembling work. Four

Connecticut Telephone & Electric Co
Meriden Conn.

**NEW RADIO DETECTOR HAS
1807 IMPROVED QUALITIES**

One of the most important recent developments in radio is the so-called non-interfering detector, which is said to give greater signal strength than the ordinary single-tube regenerative set. Essentially it is a vacuum tube, containing a filament, with an anode of sodium on its outer wall and with a U-shaped collector placed above the filament and facing the anode. A short length of resistance wire, in series with the filament, is cemented to the outside of the glass directly underneath the anode, and serves to maintain the anode at the proper operating temperature. It combines, in a sense, the features of a detector and an amplifier, and requires only a six-volt battery.

**153 STREET "LOCOMOTIVE" HELPS
ADVERTISE CAR COMPANY**

A gasoline tractor, fitted up to resemble a locomotive, and used to pull a truck upon which is mounted an automobile made by the same company, is at

Hellman Motor Co.
Long Island City, N.Y.

prints were made of each of the 600 views. These were looked over, and those of a certain uniform shade were selected. These prints were glued down to a heavy cardboard mounting, each overlapping the next until the job was completed. This map, when finished, was 13 feet long by 7 feet high, and is now in the office of the petroleum division of the Department of Interior in Washington.

From the beginning of this project until the finished article was delivered, about four months elapsed, and an area was covered which, with the old method of ground surveying, would have taken a crew of men several years to accomplish, and at many times the cost of an aerial map. The camera gives all the small detail.

This is one of the many peace-time uses of the aerial photographic section of the Army Air Service.

tracting attention in and about New York City. The tractor is a standard model, equipped with rubber-tired wheels, a cab and engine hood, and with headlights for night operation. As warning

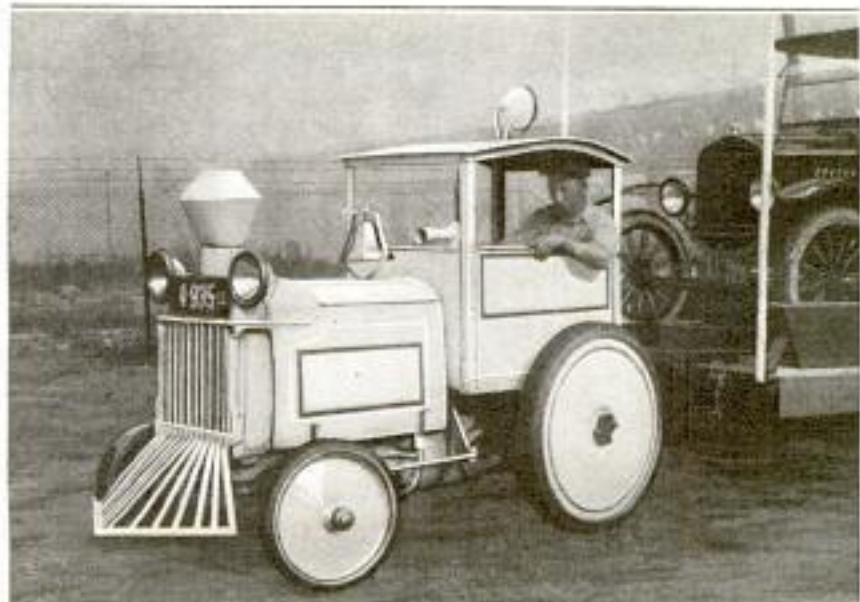

Advertising Tractor Equipped to Resemble a Locomotive, and Used to Pull a Truck upon Which is Mounted an Auto Made by the Same Company

signals, there are both a bell and a horn. The crank, in front, is covered by a cow-catcher, hinged so that it can be raised.

Extensive anti-aircraft maneuvers, in which numerous kites and balloons will be shot at from Fort Totten, will be held this summer to determine the requirements for adequate air protection of New York City.

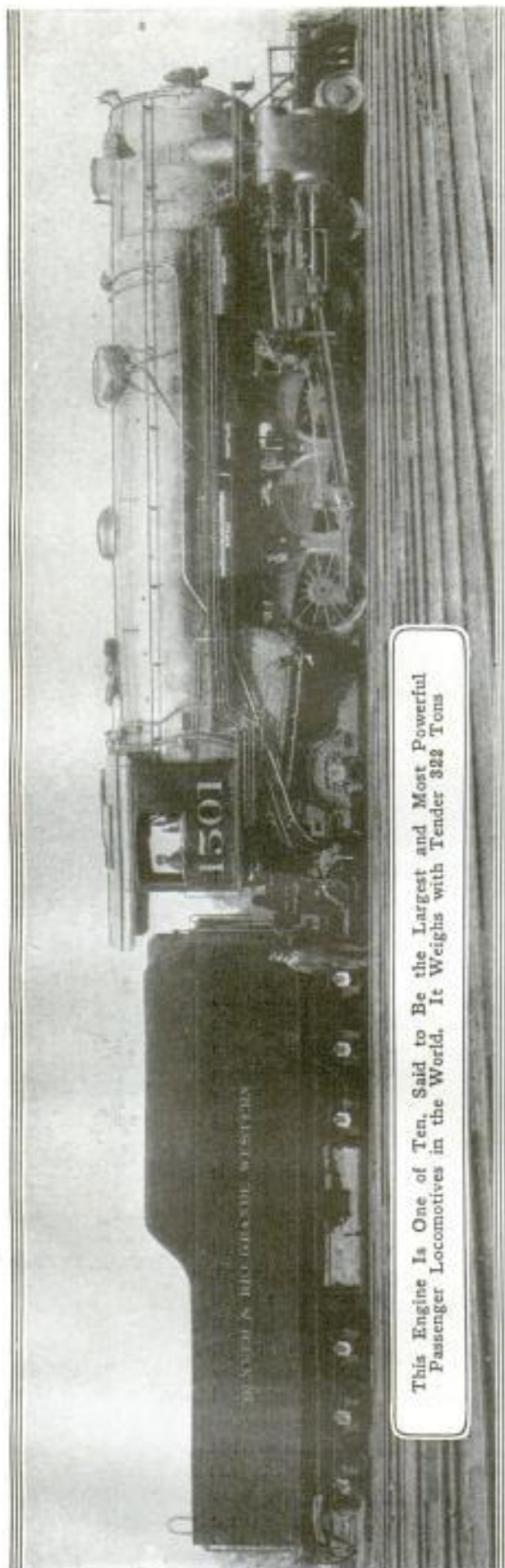

This Engine Is One of Ten, Said to Be the Largest and Most Powerful Passenger Locomotives in the World. It Weighs with Tender 328 Tons

WORLD'S LARGEST PASSENGER LOCOMOTIVES

The 10 largest passenger locomotives ever constructed, both in weight and tractive power, for use on mountain or plain for any railroad in the world, have been placed in operation on the mountain divisions of the Denver and Rio Grande Western Railroad.

The monster engines are 95 feet in length, 11 feet 2½ inches wide, 16 feet high, and weigh 644,600 pounds, with loaded tender. The wheelbase, including the tender, is 82 feet 2¾ inches, the drive-wheels are 63 inches in diameter, and the cylinders have a diameter of 26 inches and a 30-inch stroke. The weight on the drivers, of which there are eight pairs, is 257,500 pounds. The tender has a capacity of 14,000 gallons of water and 22 tons of coal. When the locomotive is working to maximum capacity, 8,000 gallons of water are evaporated each hour and 5½ tons of coal are burned. When first put into service, the latter part of 1922, the locomotives were used in freight service until broken in. They now haul 16-coach trains over the continental divide, running from Pueblo and Denver, Colo., to points in Utah. They each replace two of the former largest mountain-type engines used in the Rocky Mountains. A speed of 60 miles an hour can be developed with a train of 16 steel coaches, which aggregate 2,000,000 pounds in weight, so that the whole train weighs 2,644,600 pounds. The total length of such a train is 1,200 feet, or nearly a quarter of a mile.

ELECTRIC BABY PROVES

1850 ATTRACTIVE SIGN

At Piccadilly Circus, London, there has long been a free entertainment at night, and the pavement on the opposite side to the Monico is filled, two deep, with people gazing at the electric signs which proclaim glitteringly the excellency of something or other. But to the number has just been added the cleverest electric sign ever seen. It is a performing baby. There never was such a baby. At first it is glum and bad-tempered. Electric tears pour down its cheeks, electric furrows appear on its brow, its electric mouth opens. It is obviously yelling with rage. Then a bottle of somebody's milk appears, and the baby's face is wreathed in electric smiles, it winks an electric eye, and its one lock of electric hair stands on end with joy. It is drawing all London.

Cont. Herald Kietzshmar, Box 3306,
Johannesburg, South Africa

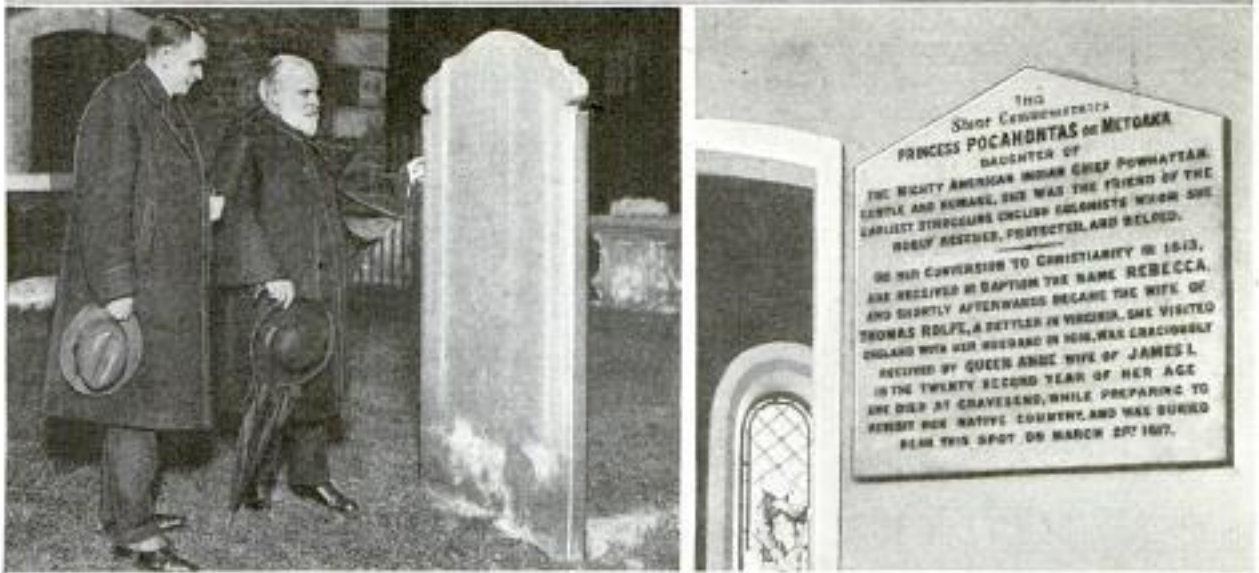

Left: Edward Page Gaston, on the left, and Canon Gedge, at the spot where Pocahontas' Grave is supposed to be. Right: Tablet in Memory of Pocahontas in New St. George's Church, Gravesend. This is one of several memorials in the church.

AMERICAN SEEKS TO LOCATE POCAHONTAS' GRAVE

Although it is generally known that Pocahontas, the Indian princess whose memory is linked with that of Capt. John Smith in the school histories, married an Englishman and died in England in 1617 as she was about to return to America, not much is known regarding her last resting place. According to old records, she was buried under the old church in Gravesend, which burned in 1727. Now an effort will be made by Edward Page Gaston, an American, to find her grave. He has permission from Canon Gedge, of St. George's church, to dig on the site of the old church, but before he can go on with the work he must have a permit from the British government. The new Gravesend church contains memorials to Pocahontas in the form of a pulpit made from Virginia wood and given in 1904 by the state of Indiana, a stained-glass window given by women of Virginia, and a tablet, reading in part, "Gentle and humane, she was the friend of the earliest struggling English colonists."

CONCRETE REINFORCING BARS INDICATE OWN SIZE

Deformed reinforcing bars for concrete work with the deformations indicating the size of the bars, in eighths of an inch, have been found of benefit in saving labor, and in insuring accuracy in sorting, storing, and placing. The figures used are symbolic, 3 denoting 3/8 inch, 5 standing for 5/8 inch, and so on.

CONTINUOUS AUTOMATIC ARC FEED FOR MOVIE PROJECTOR

¹⁷²² A motor attachment for use with any motion-picture projecting machine has been placed on the market which is designed to provide automatically a continuous carbon feed to the arc. The entire unit can be clamped to the projector, and, through reduction gears to the carbon feed, operates the latter at a ratio of 204,800 to 1. Power is furnished by a small 115-volt motor, whose speed is governed by a resistance coil

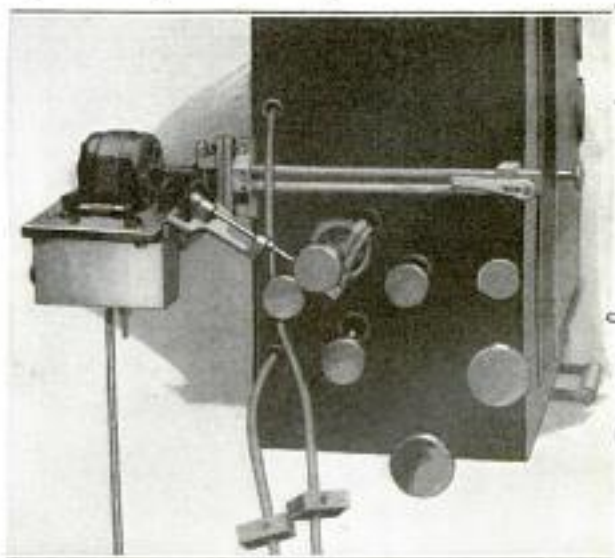

A Continuous Arc-Feed Attachment for Projecting Machines Which Relieves the Operator Entirely of Hand Feeding

mounted directly beneath it. With this arrangement, it is possible to speed up or slow down the motor as the space between the carbons demands.

U. O. Standeford, 3412 Brooklyn Ave. Kansas City Mo. Standeford mfg Co.

National Concrete Metal. Horms Corp., 342 Madison Ave. New York City

Pratt & Whitney Co. The Aeroplane
 111 Broadway, New York City
 2/21/23

696

POPULAR MECHANICS
 New York City
 MACHINE CENTERS AND DRILLS
 AUTOMATICALLY

985

Designed for use in quantity production, an automatic centering machine has two heads which center work at both ends in one operation, accurately.

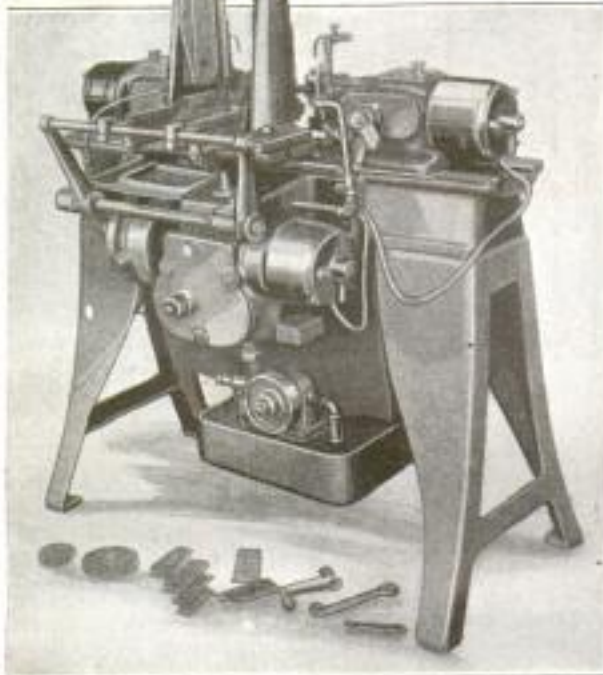

This Machine, Designed for Production Shops, Automatically Centers and Drills Work That is Taken to Other Machines for Various Finishing Operations

rately and rapidly. The machine has also an automatic drill-feed mechanism operated in conjunction with a magazine. Clamping of the work is done mechanically, so that after it is set up, it is only necessary to replenish the magazine, and take away the finished parts. The work is removed from the magazine by transfer slides, is placed in the vise, clamped, centered, and then released into the work box, without any attention from the operator. The feed to the drills is automatic, by means of the same cam that operates the transfer slides. This cam is driven by a small motor, and a set of change gears adjusts the drilling time.

982

UNUSUAL RUBBER PRODUCT FILLED WITH GAS

A new form of rubber impregnated with nitrogen gas, possesses such unusual properties that it promises to become an important product of the rubber industry. It is so buoyant as to support five times its weight in water, and a specimen, left for five months in sea water, indicated no increase in weight.

Christian Dulce Moulton
 3/14/23

MECHANICS

Owing to the presence of the multitude of nitrogen-filled cells, its resiliency is far greater than that of solid rubber. In evidence of this, a ball subjected to a pressure of 32,000 pounds, sufficiently reasserted itself in 24 hours, to hit the ceiling when bounced from the floor. It is either hard like brick or soft and resilient, depending upon the processing it receives.

AIRPLANE SPEED AND HEIGHT RECORDS MADE IN FRANCE

1878

Flying over a four-kilometer course at an average speed of 234 2/3 miles an hour, Sadi Lecoq, on February 15, near Marseilles, broke the standing record of 224 1/2 miles an hour made by General Mitchell of the U. S. Air Service on Oct. 18, 1922. Lecoq was flying a Nieuport - Delage "Sesquiplan," fitted with a 320-horsepower Hispano-Suiza engine. On February 11, Casale, flying a Spad-Herbemont biplane, motored with a radial air-cooled engine, reached a height of over 23,600 feet with a useful load of 550 pounds.

1784

NEW BASEBALL COVER CUTS MANUFACTURING COST

A one-piece baseball cover has been invented which requires only 114 stitches. The seam runs around the ball in such a manner that its two ends are parallel on one side of the ball with a diagonal joining them on the other side. Because of the design, it is thought that new curves in pitching may be possible. The principal object, however, is economy in manufacture. It is estimated that from

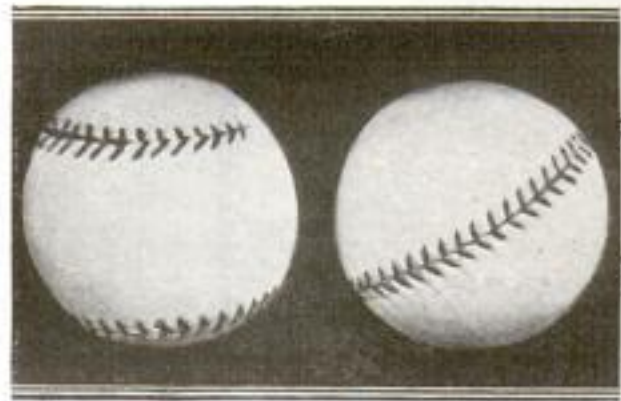

Front and Back Views of the Recently Invented Baseball Cover, Which Is in One Piece, and Requires Only 114 Stitches

an ordinary horse hide from three to six covers more can be made.

Mfr. P. Soldman & Co.

Romona St. San Antonio, Texas
 S. Miller, 224 W. San Antonio, Texas
 Mfr. P. Soldman & Co.

English product.

THE WELLAND CANAL

By George F. Paul, 900
Ellsworth Bldg,
Chicago



A View during Construction of Lock Number Six of the New Welland Ship Canal, as Seen from the Upper West Entrance Wall: Each of the Locks, of Which There Are Seven, Has a Usable Length of 800 Feet, a Usable Width of 80 Feet, and a Depth of 25 Feet

THE government of Canada is actively pushing the work on the new Welland Ship Canal, which is declared to be the largest earth-moving project now under way in the world. Centuries ago, Nature hewed the mighty Niagara gorge to join Lake Erie with the lowlands to the north. Today steam shovels are eating their way through this same ledge to link the two lakes and provide a series of safe steps by which loaded ships may quickly descend or climb back up.

The new Welland Canal may rightly be said to rival the Panama Canal. American builders overcame a difference of 85 feet between the levels of Gatun Lake and the ocean by building three locks at each end. The Welland Canal is only half as long as the Panama Canal, but—what is of more importance—Lake Erie is not a mere 85 feet higher than Lake Ontario, but 326½ feet higher. In other words, the builders of the Welland Canal have had to provide for a vertical lift nearly four times as great as the engineers of the Panama Canal.

This is the fourth canal project undertaken by the Canadians to span the Niagara peninsula. This canal cuts through

the valley of Ten Mile Creek, 10 miles west from Niagara River. It will have a total length of 25 miles, and will follow a practically straight line. It rises from Port Weller, on the Ontario side, to Thorold, where it crosses the present canal; here the level of both will be at an elevation of 382 feet above sea level. From there on to Allanburg, the new canal will straighten the present unsatisfactory alignment, crossing the old canal near the latter place, where both canals will be at an elevation of 568 feet, or the extreme low-water level of Lake Erie. The course of the present canal will then be followed to Port Colborne, the southern terminus on Lake Erie.

The big locks, of which there are seven, are all located within a few miles of Lake Ontario. Each lock provides a lift of 46½ feet, or nearly twice the lift of the Panama Canal locks. The builders are going down to bedrock for these locks, and are constructing them of concrete throughout. The canal will be excavated so as to have a bottom width of 200 feet with two-to-one slopes. For the present the excavation work will go

1694

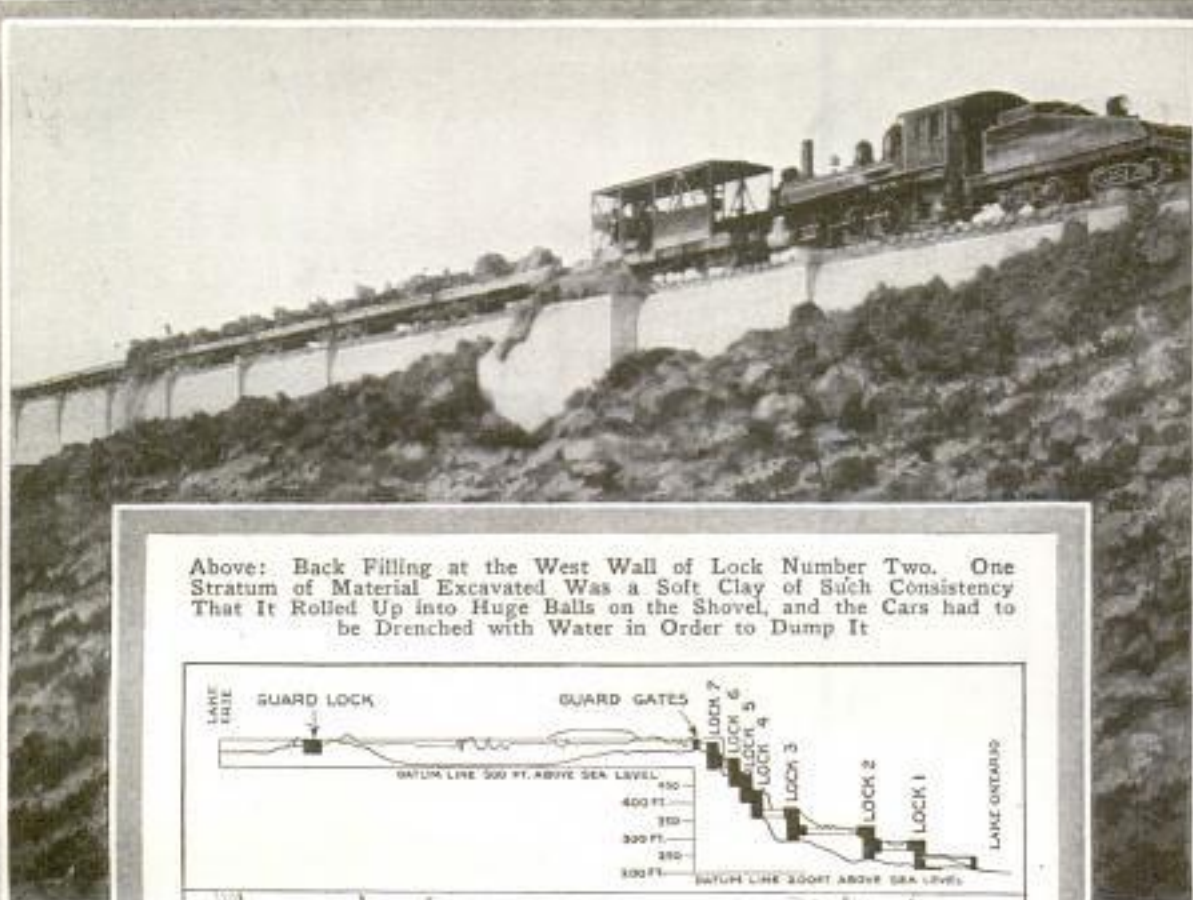

Above: Back Filling at the West Wall of Lock Number Two. One Stratum of Material Excavated Was a Soft Clay of Such Consistency That It Rolled Up into Huge Balls on the Shovel, and the Cars had to be Drenched with Water in Order to Dump It

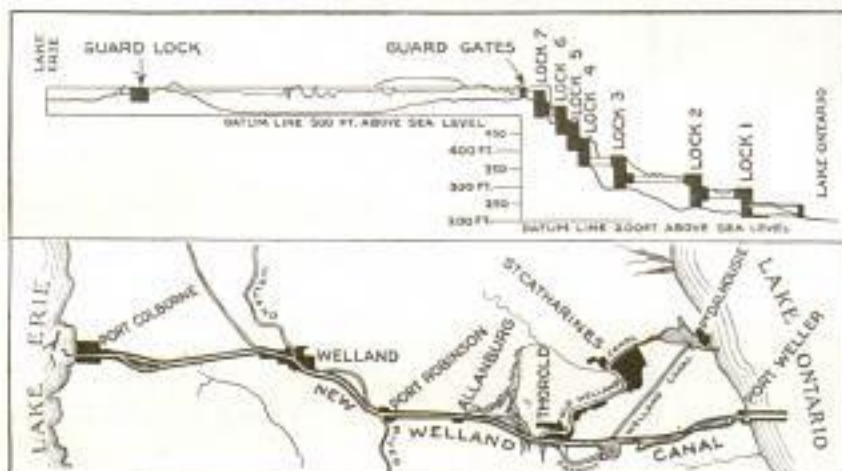

Above: At the Top of the Diagram is Given a Profile of the New Welland Canal, While below It Is a Map Showing the Course of the Canal When Completed. Below: View Showing Completed Section of Center Wall of Lock Number Six

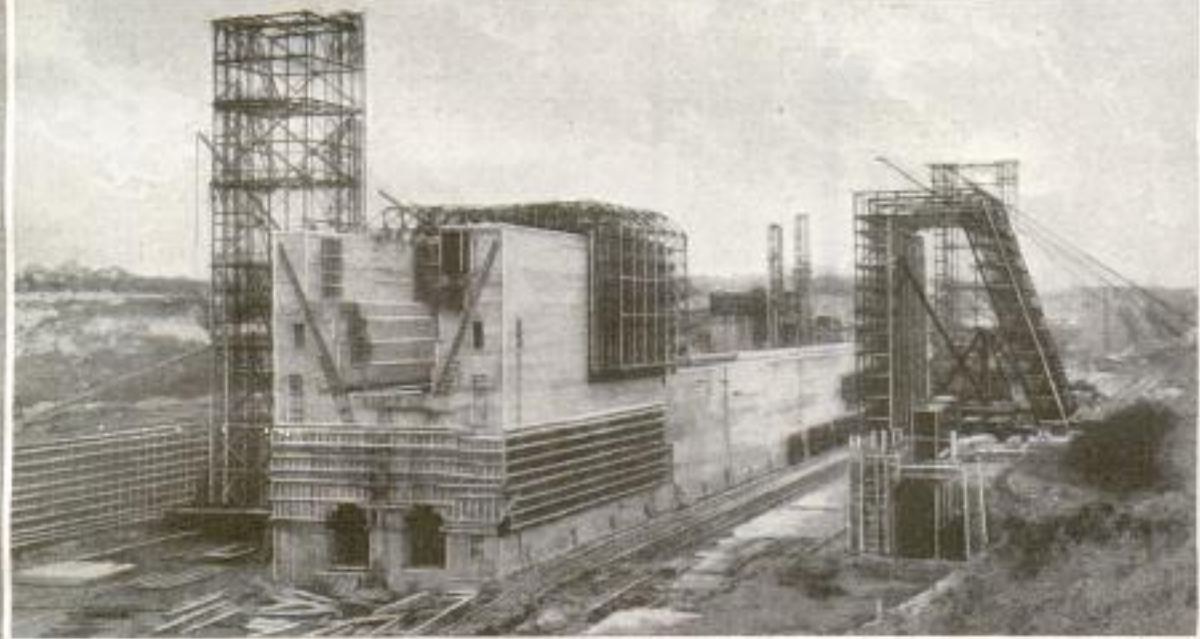

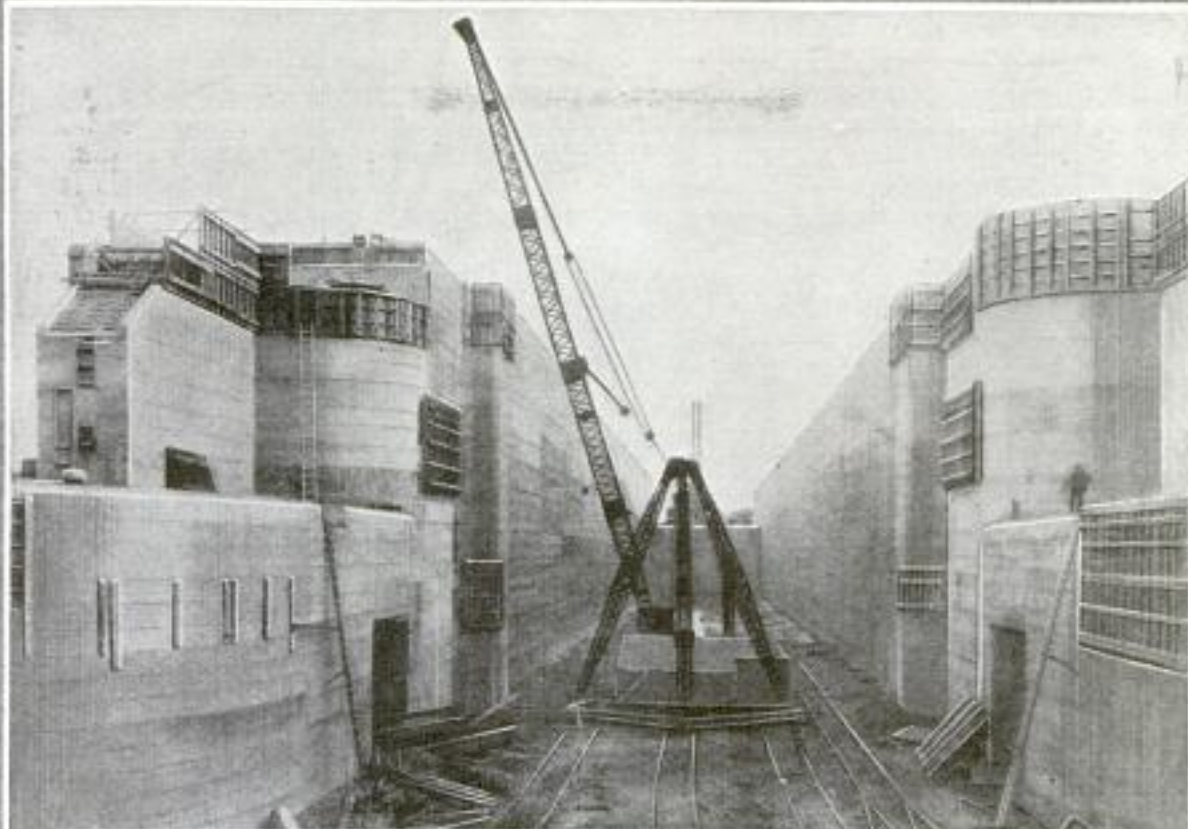

Above: A View during Construction of One of the Locks of the New Welland Ship Canal That the Canadian Government is Building between Lake Ontario and Lake Erie. The Foundations are Carried Down to Bedrock and the Present Excavation Provides for Boats of a Draft of 25 Feet, Which will Later be Deepened to 30 Feet. Below: One of the Large Steel Forms Used in Building the Concrete Work for the Locks

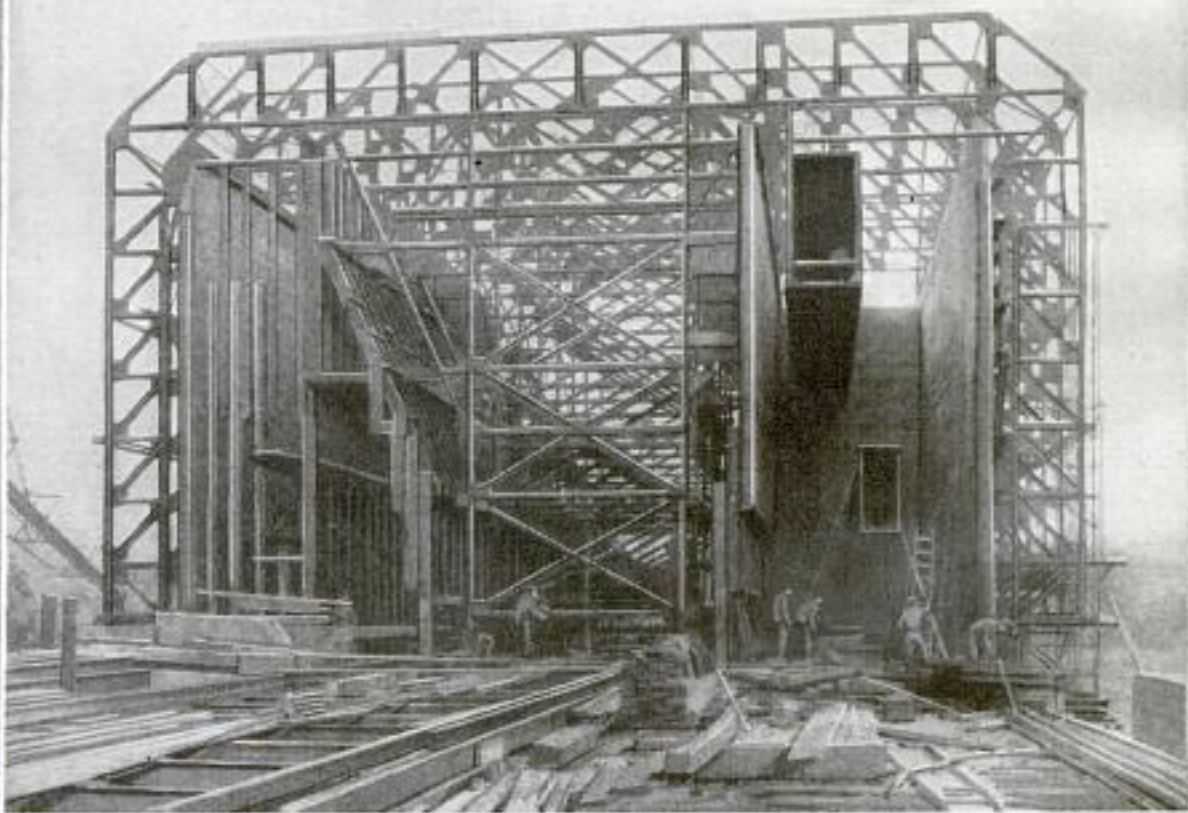

down to a depth of only 25 feet. However, the intention is to make enlargements at some future time, and therefore all the structures are to be built for a 30-foot depth.

The project was started before the World War. At that time, the estimated cost was placed at \$50,000,000. Now it is believed that the total cost will run close to the \$100,000,000 mark, but the Canadians are determined to go on with the work and push it through to successful and early completion.

When this new canal is in working shape, lake boats of a maximum draft of 25 feet can pass safely to Lake Ontario and proceed to Prescott, there to unload for reshipment in 14-foot draft vessels to Montreal. This new arrangement will give the grain producers of the Northwest direct transportation by water for a total distance of 2,339 miles to the Straits of Belle Isle. There is but little doubt that within a few years Canada and the United States will reach a joint agreement for the improvement of the St. Lawrence River, so that the Welland Canal will be the great connecting link between the Great Lakes ports and the seaports of the whole world. There is great optimism in Canada over this outlook, some of its leading engineers firmly believing that within five years work will be started on the St. Lawrence waterway.

One unusual feature should be noted in commenting on this canal, and that is that in the first sections the material ex-

cavated is like plastic clay. It stretches much like rubber, and can even be worked up into the form of rope. This peculiar consistency makes it difficult to handle it in bulk. The steam shovels load on the dump cars great balls of this material about 6 feet in diameter. At first the contractors used straw to keep the clay from sticking to the bottom of the cars. Then they hit upon a better plan—they turned the hose on the sides and bottom of the cars before loading, and also turned the hose on the slopes where the cars were being dumped. When the embankments were thus drenched they became slippery skids, down which the sticky balls of clay took a rapid slide.

Another noteworthy feature of the new canal is the guard lock to be installed at Humberstone, about three miles from Port Colborne. The water level of Lake Erie varies from 568 feet to 579 $\frac{3}{4}$ feet. In order to care for these variations, which are due largely to high winds and storms, the guard lock is to be provided.

The construction figures for this canal run up into the millions. For instance, 6,740,000 cubic yards of rock excavation will be needed, about one-half of which has been completed, and there are 40,200,000 cubic yards of earth excavation, according to careful calculations. The structures call for the placing of 2,850,000 cubic yards of concrete, and nearly 20,000,000 pounds of steel will be required for reinforcement.

BOLL WEEVILS DESTROYED BY VACUUM MACHINE

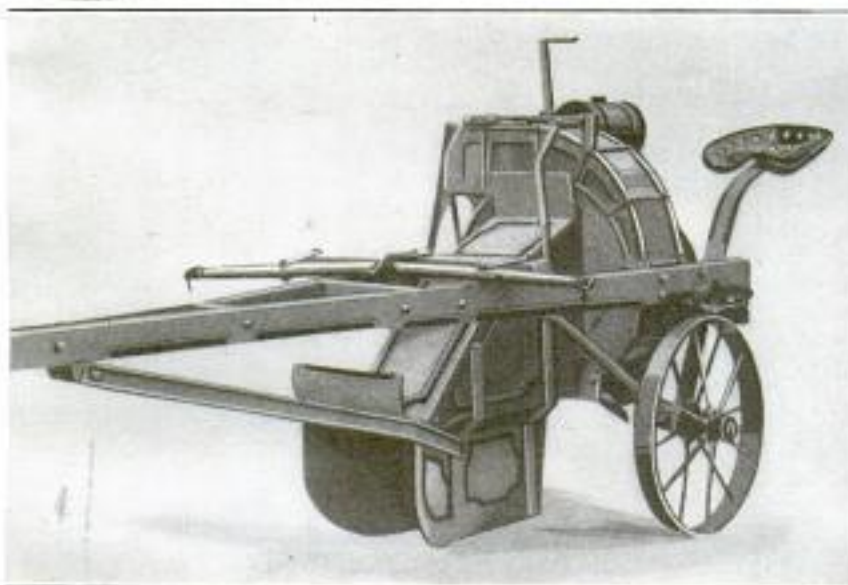

The Machine Which Uses the Vacuum Principle for Sucking Boll Weevils and Their Eggs from Cotton Plants: It Is Adjustable for Height, to Facilitate Operations on Rolling Ground

An interesting application of the vacuum-cleaner principle has been made by an Iowa manufacturer in a machine for destroying the boll weevil on cotton plants. It may be used also in killing potato bugs and other pests. The machine straddles the row, and the huge rotary fan in a circular housing sucks the insects into a canvas bag from the plants, which are brought into the suction area by sidewalls extending close to the ground. The machine may be raised and lowered for plants of different sizes.

maytag Co., Newton, Iowa.

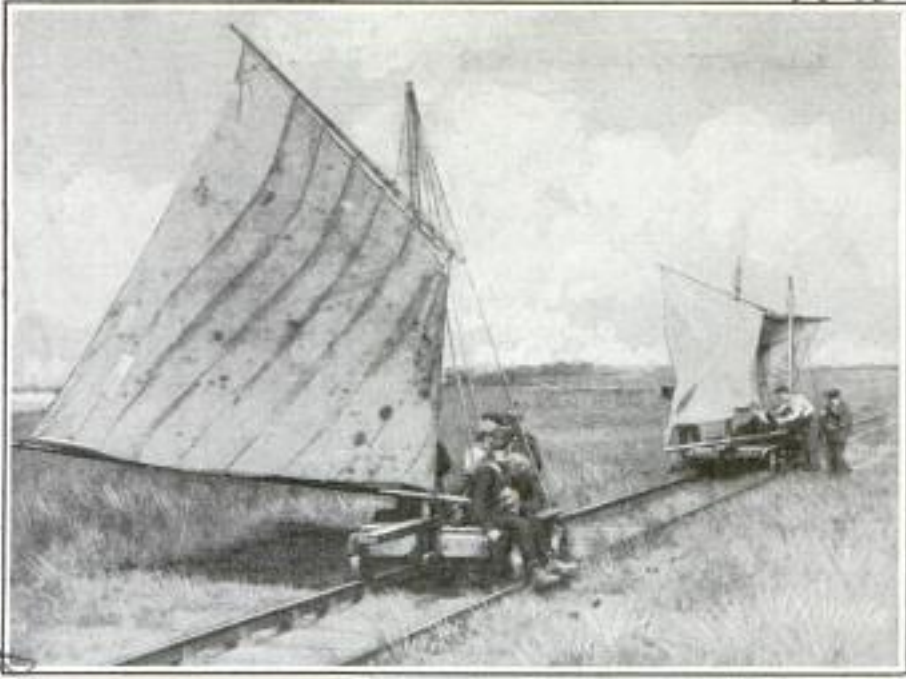

Sailing Cars on English Railroad Track. Above: Cars Sailing the Track with Wind on Their Beams. Right: Car before the Wind, Whose Force is Shown by the Tautness of the Sheet, or Rope Holding the Boom



1683

SAIL-RIGGED HAND CARS RIDE ENGLISH-COAST RAILROAD

Sailing a railroad track on small cars is the novel means of transportation used by battery officers and men, lighthouse and coast guards, and visitors, to travel from Spurn Head, the utmost point of a narrow spit of land on the east coast of England, to the town of Kilnsea, about four miles away. With a mast, or sometimes two, stepped on small hand cars and sails rigged up, the cars make good time.

1516

PORTABLE INSULATION TESTER IS VERY LIGHT

A small, light insulation tester has been developed recently whose portability affords a wide range of application in the industrial field and inspection service. The instrument consists of a direct-reading ohmmeter and a hand-driven direct-current generator, substantially mounted together in a cast-aluminum casing. The ohmmeter scale reads from 0 to 100 megohms, and is viewed through a protected glass window in the top of the case. "Line" and "earth" terminals

are provided which are protected from external injury by their convenient location below the ohmmeter housing. These are also provided with a "guard" circuit, so that errors due to surface leakage are



Left: The Tester with Handles Up, Ready to be Carried About. Right: Ready for a Test, the Hinged Door being Raised for Taking Readings

eliminated. The voltage rating of the instrument is 500, and its dimensions, with handles down, are only 5½ by 7¾ by 6¼ inches.

(An advertising card so painted on one side that, when properly folded, it becomes a toy model of their regular automobile bus, is being distributed by British manufacturers.

Everched + Vignettes, Ltd.
 Acton Lane Works, Chawick, London 4, England.

designed by Maurice Aleyne, 9, Southampton St., London W.C. 2, England.
 Made by South Wales Commercial Motors, Ltd., Cardiff, Wales.

(James L. Buddle, 1211 Arch St., Philadelphia, Pa.)

PORTABLE ELECTRIC HOIST HAS MANY USES

1717

A portable, self-contained electric hoist has just appeared which is intended for

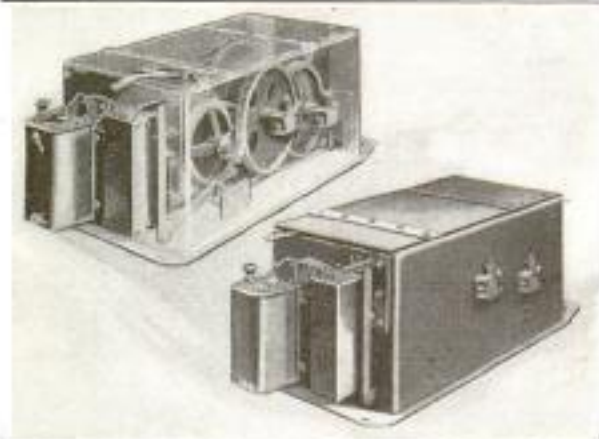

Above, Phantom View of the Portable Hoisting Unit, Shown Complete Below: Both Driving Gears and Pinions are Machine-Cut from Electric Steel

use on construction jobs or in industrial plants. It is also adapted for skidding crates and general warehouse handling, and even for shifting freight cars on sidings. A steel casing completely envelops and protects the hoist mechanism and motor, which has a rating of 5 horsepower at 1,200 revolutions. The lifting capacity of the unit is 1,500 pounds at a hoisting speed of 100 feet per minute, and its over-all dimensions are only 2 by 2 by 4½ feet.

RESERVE ALASKAN OIL FIELD FOR NAVY'S FUEL

1737

More than 35,000 square miles in the northwest of Alaska have been set aside as an oil reserve to insure fuel for the



Map Showing Location and Relative Size of the 20-Million-Acre Tract Set Aside in Alaska as an Oil Reserve for the Navy

navy, by a recent order of President Harding. The petroleum possibilities of the reservation, which is mostly flat, grassy tundra, devoid of other vegetation, are practically unknown, but they are sufficient to attract some 50 private interests to whom allotments, totaling about 125,000 acres, have been granted for development. For years seepages of oil along the seacoast have indicated the existence there of large oil fields.

SPECIAL ELECTRIC HEATER FOR TICKET BOOTHS

1740

A convenient type of electric heater has been placed on the market recently for use in ticket booths. It is 20 inches long, and can easily be attached to the sides of the booth with screws. Resistance units are mounted inside, and the proper amount of heat is insured by a three-heat snap switch. The heater is of all-steel fireproof construction, and may



In This New Type of Electric Heater, Which can be Used as a Footrest, Danger to Footwear is Eliminated by an Air Space That Protects the Resistance Units

also be used as a footrest with perfect safety. Current may be tapped from any 110 or 220-volt circuit.

FAMOUS BELLS OF NOTRE DAME TO BE ELECTRIC-TOLLED

176

The successors of Quasimodo, Victor Hugo's fictitious bellringer of Notre Dame, will give way soon to the inroads of 20th-century mechanical efficiency. An electric motor is to be installed for tolling the first bell, which will be in the nature of a try-out before the other bells are similarly equipped. The introduction of modern appliances in the ancient cathedral is the result of the high post-war wages demanded by the ringers. The position as head ringer, of which there are several, has, at least in one case, been held by successive generations of the same family.

Chicago Tribune 2/28/23

n. y. Times 2/26/23

material

AIRPLANE-HEIGHT INDICATOR FOR NIGHT FLYING

Night-flying problems are now engaging the attention of aeronautical men. To be successful, flying by night must be made as safe as flying by day, otherwise the gain in speed over other methods of transportation would be of no benefit.

One of the unsolved problems of night flying has been the determination of the plane's height above the ground, especially when landing. An answer to this problem has been worked out in an altitude indicator recently tested by the Bureau of Standards.

This indicator consists of three tubes, each with an incandescent lamp at one end. Two of the tubes are parallel and stationary, while the third can be moved within a prescribed angle. This tube is equipped with a scale of numerals which are projected on the ground or water, just as a picture is projected on the screen. One of the sta-

ber between the brackets. This number will be his altitude.

The device indicates any height between 50 and 500 feet. If the plane is over 500 feet above ground, a cross appears between the bracket-shaped figures,

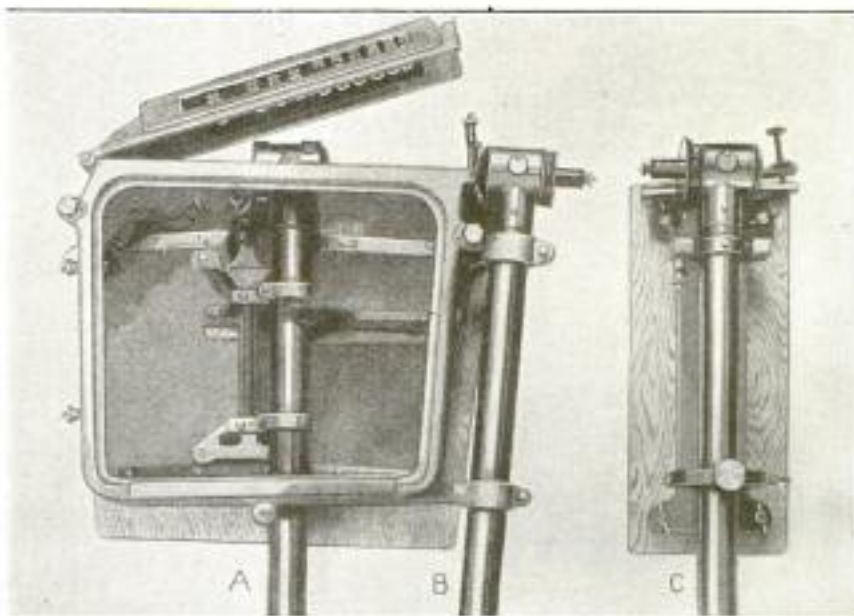

Apparatus for Night Indication of Airplane's Flying Height: Each of the Three Tubes Has a Small Incandescent Lamp at the Upper End, Which Throws an Illuminated Image upon the Ground. B and C Are Stationary, While A Is Movable and Projects a Number from the Scale Directly above It

and when it is less than 50 feet high, the number 50 moves toward the bar of light. The latter is simply a guide for determining the height when the machine is nearing the ground.

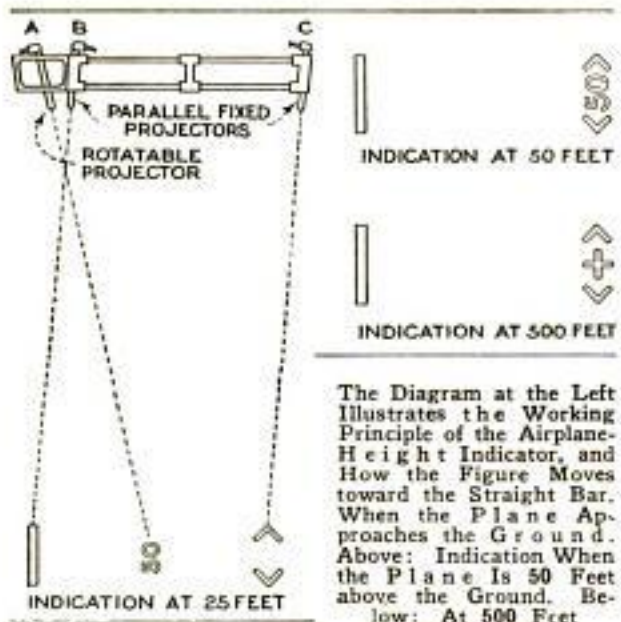

tionary tubes projects two figures in the shape of rectangular brackets, and the other a straight bar of light.

To determine his height, the pilot turns the movable tube until it projects a num-

MOTORCYCLE IS "MADE UP" TO PHOTOGRAPH WELL

A motorcycle with an extraordinary color design, an entire lack of nickel-plated parts, no reflecting surfaces, and miscellaneous trimmings of weird colors, has recently attracted attention on the streets of Los Angeles. The explanation of the odd design is simply that a motorcycle manufacturer is following a practice old in the motion-picture industry in having produced for advertising purposes a machine having a color scheme that will photograph as its stock models appear to the human eye. In motion-picture work, a white tablecloth, for example, makes a glaring white when projected on the screen. A light-yellow tablecloth, however, gives a natural white. So, wishing to have a machine that would photograph naturally without retouching, this and other color variations were taken into consideration, and the peculiar motorcycle mentioned was developed.

Harley Davidson Co., Milwaukee Wis

Cincinnati, Ohio.

**WORKING RADIO-ANTENNA HAT
WORN AT FASHION SHOW**

1741

One of the fantastic hats worn at a recent millinery show in Cincinnati had



two aerial towers running up a few inches on either side, with the usual arrangement of wires strung across the top, and connected to a radio-receiving set which the wearer carried. It is said that the set "tuned in" with local stations readily.

veloped the rear drivewheels, to which they were secured. One set of straps then passed around the front wheels, and was secured to the top of the scaffold frame, while the other set of straps, after passing around the drivewheels in a counterdirection, was carried up to the frame at the rear. Although the differential was not locked, the tractor retained its balance when free from the ground, and gently raised or lowered itself with 12 men on board.

**NO VALVE NEEDED IN NEW
TYPE OF INNER TUBE**

1711

The claim is made for a newly invented inner tube that it does away with the use of the valve in inflating, air being introduced to the tube with a small hollow needle. When the tube is fully inflated and the needle withdrawn, the tube automatically



COPYRIGHT, UNDERWOOD & UNDERWOOD

seals the puncture with a substance it contains. Before the tire is mounted, it is necessary to fill the opening in the rim for the valve with a rubber plug.

**TRACTOR LIFTS ITSELF
BY "BOOT STRAPS"**

1652

An odd demonstration of the drawbar pull of a farm tractor was staged recently, in which the delivered power of the engine was used to lift the tractor from the ground, literally by its own "boot straps." A special scaffold was erected for this purpose, and two sets of suspending straps, acting as belts, en-

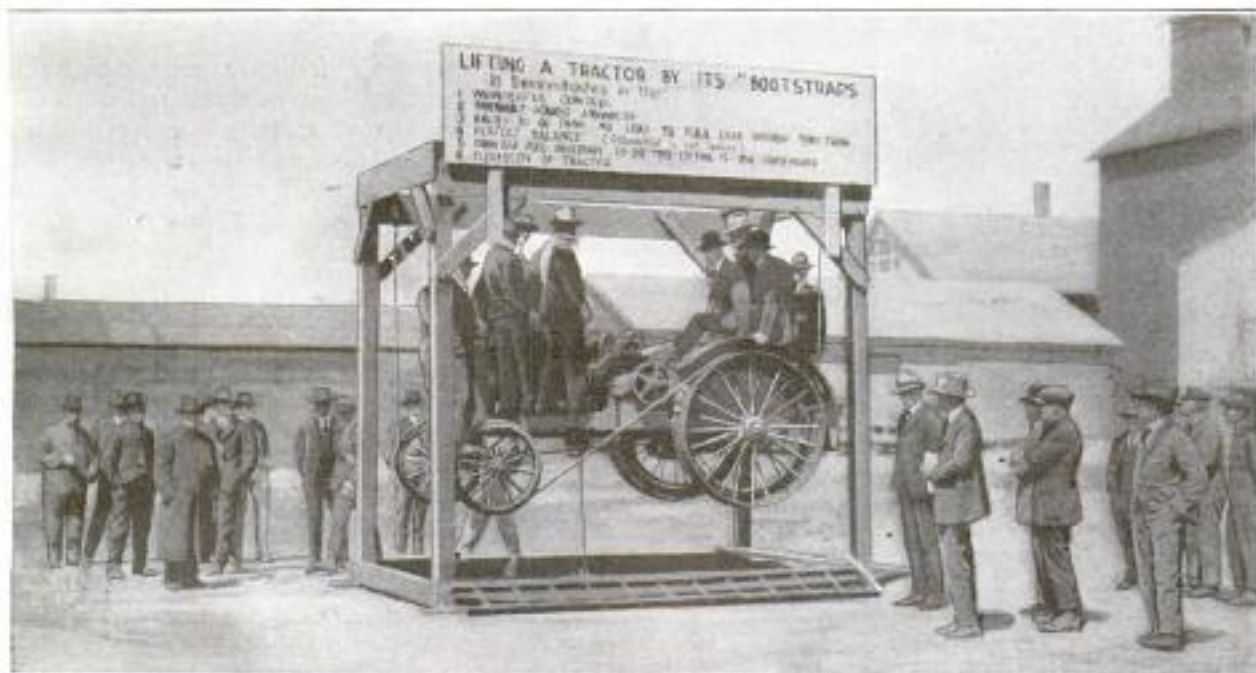

A Demonstration of Brake and Differential Qualities, as Well as Delivered Power, of a Farm Tractor: Even with Differential Unlocked, and with a Load of 12 Men in Addition to Its Own Weight, Power was Uniformly Received at the Driving Wheels, Resulting in Even Balance.

Harb. Parr Co, Charles City, Iowa.



Geysers at the Base of Mount Lassen, California, Which are to be Tamed and Trained to Furnish Steam for Engines; Other Geysers at the Foot of Mount Helena will be Similarly Exploited

GEYSERS HARNESSSED TO FURNISH POWER

BY H. H. DUNN,

*27 22, Prince St.
Berkeley Calif*

THE largest group of geysers in California, in Sonoma County, is being harnessed to the steam engine to provide power. At the middle of February, one geyser had been tapped and connected with a steam engine, where it yielded 150 horsepower, which was put to work immediately drilling the "well" with which another geyser is to be tapped, and likewise connected with another engine. The ultimate object of the project is to provide steam enough from the whole group of geysers to drive turbines in a power house, thereby supplying electric current, at a cost price below even that at which hydroelectric power can be produced, to a dozen large towns and cities in the northern and central parts of the state.

Only about one-half of the steam available from the first geyser has been taken, owing to errors in drilling the first well and to lack of experience in keeping the steam confined and hot between the geyser and the engine. Plans under which the work is now being done provide for the taking of approximately 90 per cent of the steam from each geyser tapped in the future. Esti-

mates based on the production of the first geyser are that approximately 1,500,000 horsepower can be obtained from this group.

Though volcanic heat has been harnessed in Italy, this is the first time that power has been taken from the subterranean fires of the New World, and the only question which arises is as to the period of time over which these geysers will continue to furnish steam at pressure and heat sufficient for the operation of engines or turbines. The geysers at this point have been pouring forth their torrents of superheated steam and boiling water for some 200 years, since white men first knew of them, and have been increasing, rather than diminishing, in volume. The same statement is true of other geysers at the foot of Mt. Helena, near Calistoga, and at the base of Mt. Lassen, the recently active volcanic cone, farther north, where other interests are preparing to put the steam to work.

The method of taking the steam from the geysers is comparatively simple. A well is driven at an angle, from a point some hundred or more feet from the mouth of the geyser, to strike the throat

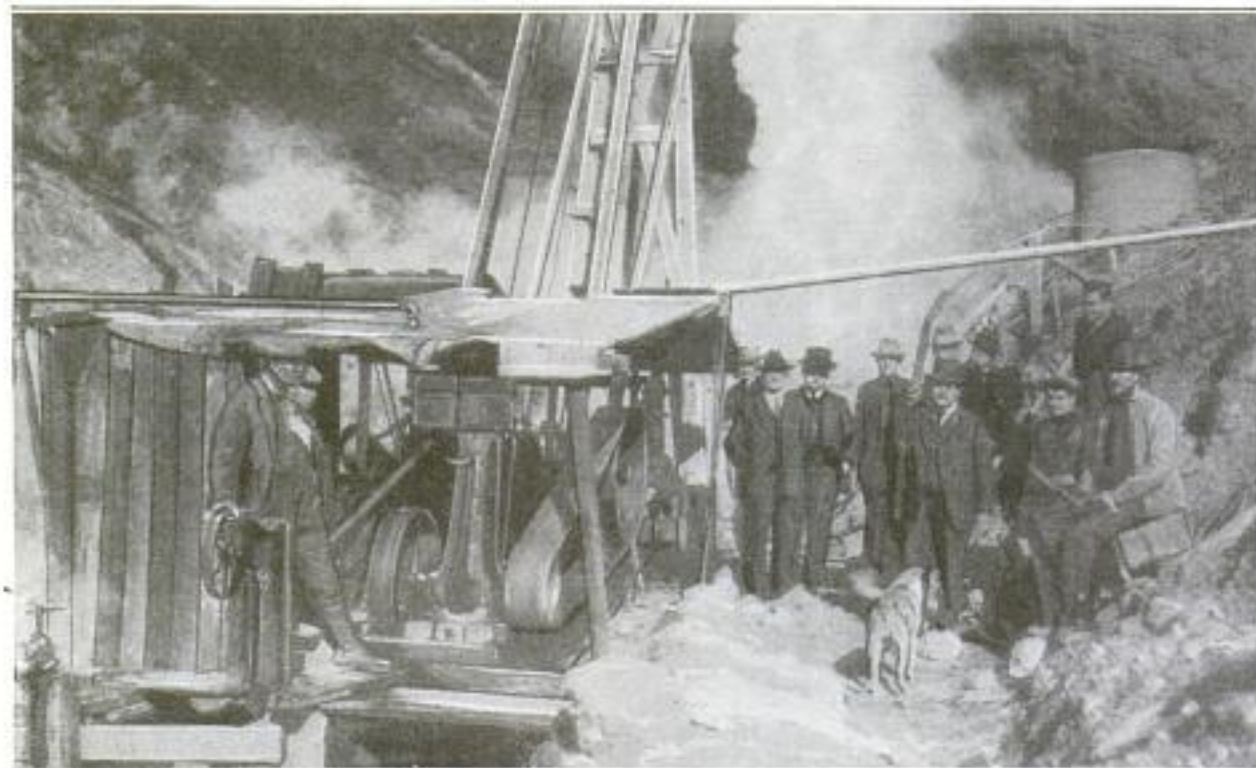

The First Engine to be Operated by Steam Direct from a Geyser in the United States: It is Installed at The Geysers, Sonoma County, California, and Takes Steam from One Geyser There, Developing 150 Horsepower

of the geyser at a depth of 200 to 400 feet, this depth depending on the solidity of the earth and rock formation surrounding the geyser.

Closely following the drill goes the 2-inch pipe, and when this tube breaks through the side of the throat of the geyser, the steam, under considerable pressure, follows it as an outlet, rather than the rougher and usually twisted natural vent. The upper end of the 2-inch pipe is then capped, an exhaust and a safety valve put on, and the steam conveyed in a smaller pipe to the engine. Greater power can be obtained, if necessary, by laying the pipe in a large tube, through which is allowed to flow the abundant hot water from the geyser, while still greater pressure can be maintained by superheating the steam at the engine. These things, however, have not been done, since the steam derived from the first geyser has been of sufficient pressure and hot enough to more than supply all power necessary for drilling operations on several other adjacent geysers.

At first it was thought that all the geysers were connected, that all were vents from the same subterranean lake of boiling water, and that by finding the proper location, and tapping this source of supply, the steam could be collected in one pipe and thus only one well would have

to be drilled. Experiments showed, however, that if all the geysers came from the same source, that source must be at such great depth that it could not be reached with any ordinary drill. It was then decided to take the steam from each geyser, allowing it to rise in its own vent to a point within 200 to 400 feet of the surface, as mentioned above, and there remove it. This has proved successful.

GIANT BLIMP NOW BUILDING 1804 TO CIRCLE WORLD

The large dirigible airship "ZR-1," now under construction for the U. S. Navy, will be sent on a trip around the world when completed next summer, and may later go to the north and south poles, according to plans recently announced. This ship, and the "ZR-3" that is being built in Germany for the navy, the first rigid dirigibles for this country, represent the most improved features in airship design, and it is expected they will be the forerunners of a large fleet of dirigibles. They will be filled with helium, the noninflammable gas that is available in large quantities only in the United States. For long-distance sustained flights and for carrying heavy loads, the rigid dirigible is regarded by many as the logical type of craft.

Ref. June 3/7/23

1824

Auto World

TESTING APPARATUS TO IMPROVE CARBURETORS

BY J. C. ALLEN, 229 *Howler Ave*
West Lafayette, Ind

IN an effort to increase the mileage obtained by automobiles on a gallon of gasoline, extensive experiments are being conducted at Purdue University, and the indications are that proper carburization will make an improvement of about 25 per cent. The apparatus is built with the idea of establishing the best methods of fuel preparation and of obtaining information concerning fuel-air ratios for efficient engine performance. Primarily, the test plant consists of an air chamber, an electrically driven vacuum blower, an air heater with motor-driven blower, a fuel-flow meter, a fuel-weighing apparatus, a manometer

board, and an air-flow control. The air chamber is designed to withstand high vacuums for altitude work and vaporization research, and provides mounting for side or top-outlet carburetors, connections for manometers, air inlet, and an inspection door. A gas heater is arranged for heating the air, before it enters the chamber, to temperatures as high as 500° F. The fuel is measured by a

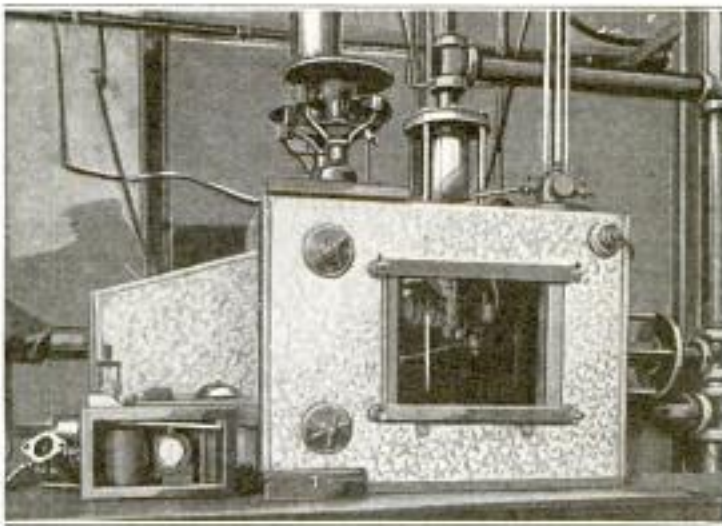

Close-Up of Carburetor-Testing Apparatus Which has been Worked Out to Give Results Quickly and under Conditions Actually Existing on an Engine

flow meter, or by direct weighing for more accurate results. Everything is arranged so that a complete test of the carburetor can be made quickly and under conditions existing on an engine driving an automobile.

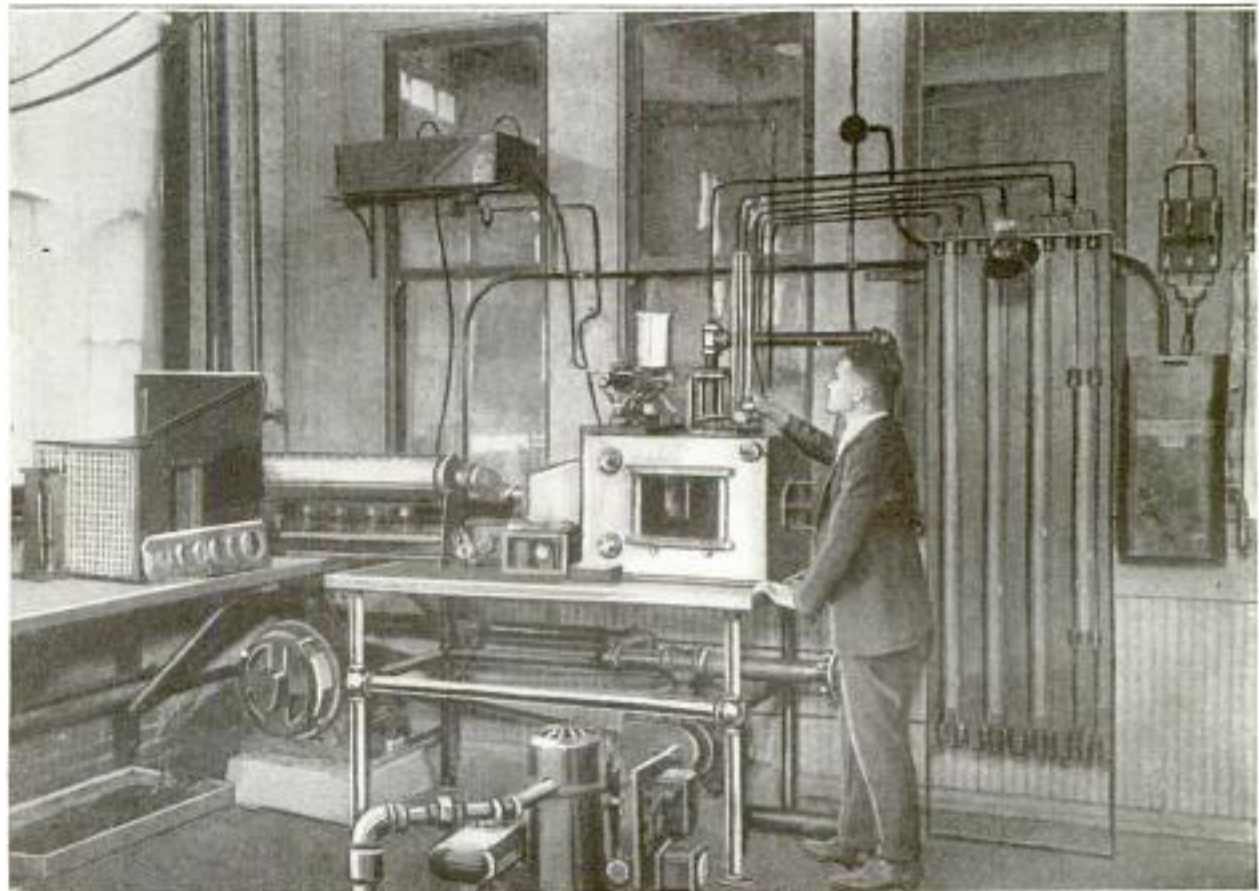

General View of Testing Apparatus Built with the Idea of Reducing the Gasoline Consumption of Automobiles, by Furnishing Carburetor Designers with Information as to the Fuel-Air Ratios of an Engine

Prof. C. S. Keggeries
Purdue University
West Lafayette, Ind.

Spalding Bldg. Portland

COMPRESSED AIR OPERATES

1646 SHIP'S STEERING GEAR

Air control for steering vessels has been used successfully on the Pacific

regulate the movements of the tiller. As air is released from a cylinder by a lever in the pilot house, the tiller moves in that direction. The cylinders also act as buffers to take up shocks to the rudder.

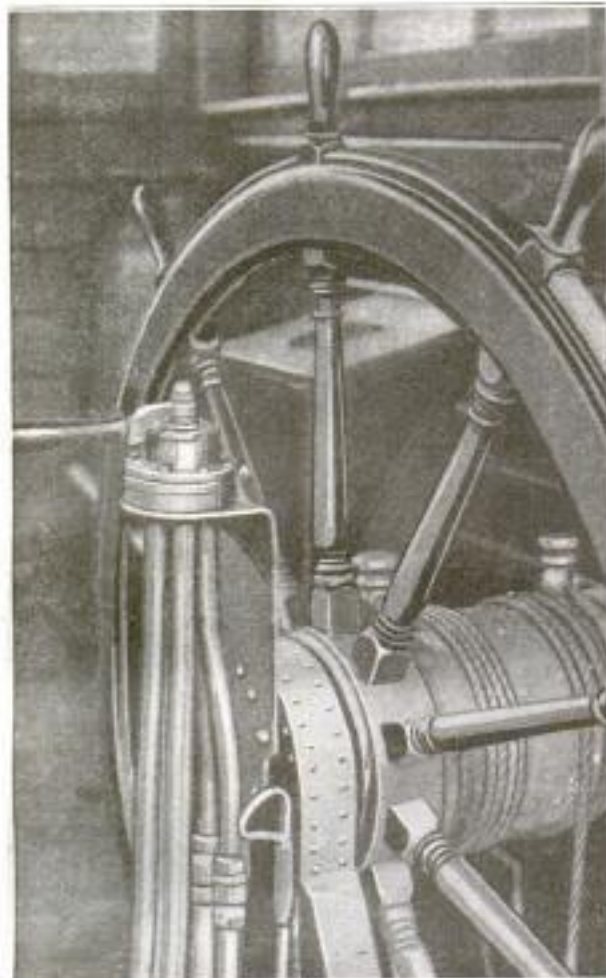

The Controller for Compressed-Air Device, Which Actuates the Steering Gear and Moves the Rudder, is Shown Here Immediately behind the Wheel

coast in an experimental way, instead of the standard wheel or tiller, and one boat on Puget Sound has been equipped with it. It has to recommend it, lightness, simplicity, and ease in keeping in repair. Two cylinders just behind the pilot house, filled with compressed air,



Connected with the Controller in the Wheelhouse, These Cylinders on Deck Actuate the Tiller of the Rudder

NIAGARA FALLS NEW PARK TO BENEFIT RESIDENTS

1875 The city of Niagara Falls, for many years one of the world's most famous tourist cities, is now to possess a 300-acre recreation park for the enjoyment of its own residents. Permission to expend the needed money has already been granted, and the probability is that the preliminary work will soon be under way. It is planned to have the park on the east side of the city, extending from the north boundary 2 1/2 miles to the Niagara River at the south. Playgrounds, picnic groves, a permanent band stand, an outdoor stage, a wading beach for children, a swimming pool, a lake, and boating lagoons, are among the details which will be incorporated.

1811 DESK CLOCK SOUNDS ALARM TO JOG OWNER'S MEMORY

For the busy man to whom time is valuable and keeping engagements promptly is important, a memory-jogging clock has been devised to set on his desk. Opposite the quarter hours on the dial, small cards are inserted in slots just outside the dial, and when the cards are in the slot, the clock's alarm rings at the quarter hour. Memoranda of the dates to be kept may be written on the cards. The clock is finished to be an ornament to the desk.



CA refuge is now being planned, on the Island of Andros, in the Bahama group, to save from extinction the last of the flame-colored flamingoes, which once were so numerous in Florida and the Bahamas. Only 1,000 or so remain where 20 years ago more than 12,000 are known to have flourished.

Chicago Reminder Clock Works, 923 N. La Salle, Chicago

169 7 Builders } H. A. Reed, C. E., Manchester
 Ship Canal Co., Manchester, Eng.
 41 Spring Garden St.

FLOATING CAISSON SERVES AS FIRE STOP

B. Morton & Sons,
 78 Quay St., Manchester, Eng.

BY R. FRANKLIN MUNDORFF, 1108 Askew Ave
 Kansas City, Mo

LARGE quantities of petroleum and oil have been imported into England via the Manchester Ship Canal during past years. Hitherto, however, the canal company has not permitted the importation of oil having a flash point below 73° F., owing to the want of a safe place to moor the vessels while discharging their cargoes. This difficulty has been overcome by the provision of a separate dock and discharging equipment in an isolated location, in which the vessels can be shut off from the canal by means of a floating reinforced-concrete caisson—a precautionary measure in case of fire and escape of the fluid.

The dock, which is 600 feet long and 100 feet wide, admits vessels of 30-foot draft, and the entrance is 80 feet wide. It is placed at a convenient angle to the canal to give easy access to the ships. In each of the entrance piers is provided a vertical U-groove, into which two projections at either end of the caisson fit. Thus an oil fire—if one should break out—could not spread by water beyond the limits of the dock itself.

The caisson, it may be explained, is a bargelike vessel, with its semicircular ends terminating in the substantial stem

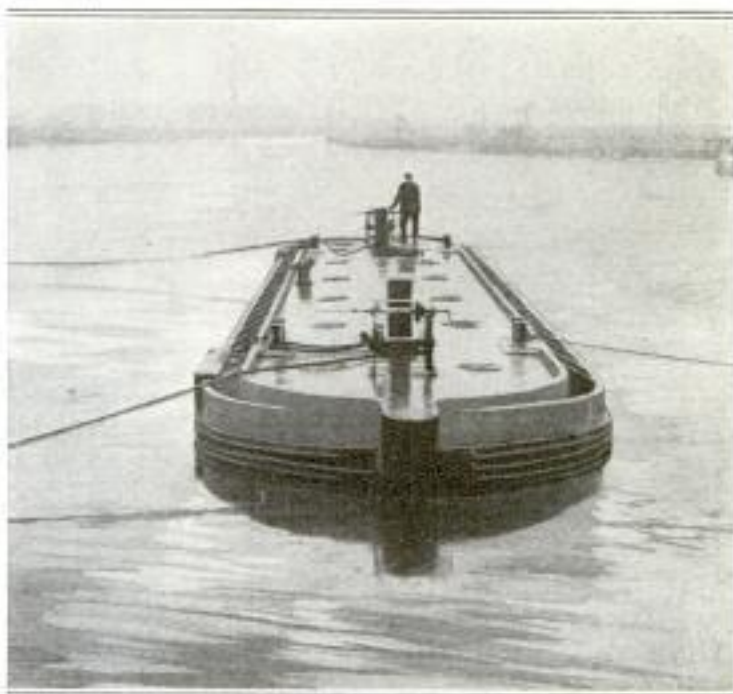

Head-On View of the Concrete Floating Caisson Which, When Swung into Place at the Entrance to the Dock, will Serve to Stop the Spread by Water of an Oil Fire

and stern posts mentioned. Its length over all is slightly more than 82 feet, and the beam 12 feet, while the depth from

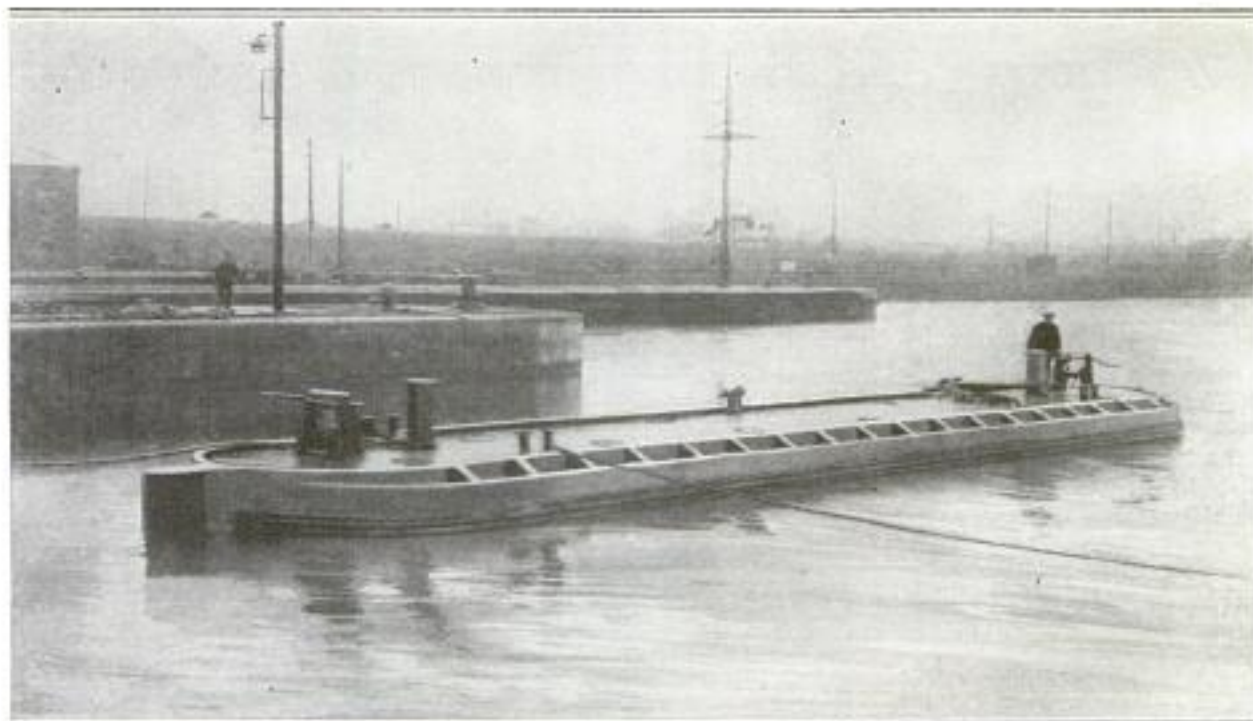

In This View, Note the Projection at the Stem. This, and a Similar One at the Stern, Fit into Two Vertical U-Grooves in the Entrance Piers. The Over-All Length of the Vessel Is Slightly More than 82 Feet, the Beam 12 Feet, and the Depth from Deck to Keel About 10 Feet

the crown of the deck to the keel is about 10 feet. A fore-and-aft central wall, together with six transverse bulkheads, divide the boat into 14 water-tight compartments. All these sections are provided with manholes with air-tight covers, a scuttle plug, and a sounding pipe.

For adjusting the water ballast, and for pumping out the ballast chambers, each compartment has a sluice valve con-

nected to a hand pump on deck. If desired, the sections may be dealt with singly or any number at a time. Two winches and four mooring bits complete the deck equipment.

Timber fenders bolted to a reinforced-concrete counter, carried by wings springing out from the upper parts of the sides, at the water level, form another interesting detail. The total weight of the vessel without ballast is 125 tons.

ROADSTER HAS GOLF LOCKER AND OTHER FEATURES

A small compartment, or buffet, for liquid refreshments, a locker for golf equipment, an ice chest, and a lunch kit are found in a newly designed sporting roadster. The buffet is within the right door, the golf locker runs crosswise behind the seat and has a door opening on the right side, and both ice chest and lunch kit are arranged in the end of the rear deck. There is also an emergency rear seat for two.

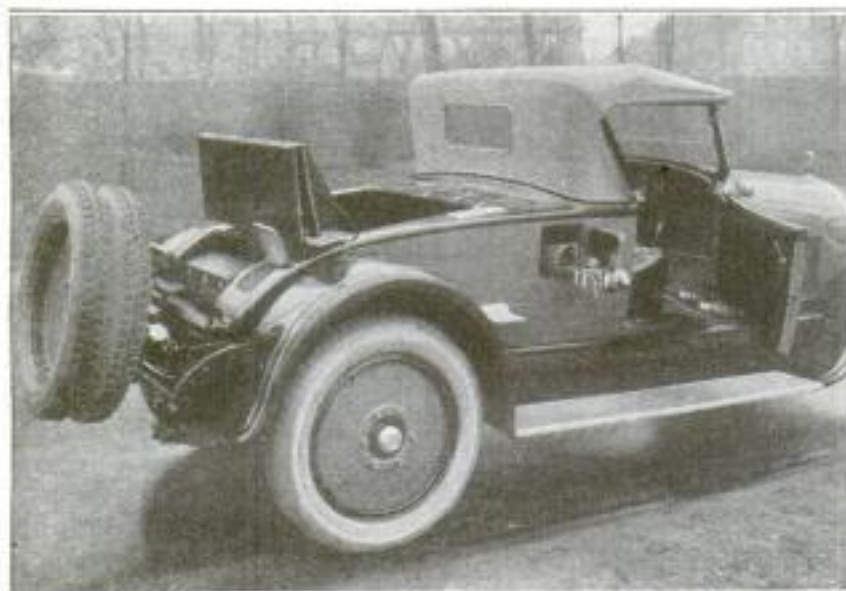

This New Roadster Has a Lunch Kit and an Ice Chest, an Emergency Rear Seat for Two, a Locker for Golf Equipment, and a Disappearing Compartment for Liquid Refreshments

WATCHDOG "TRAVELS BEAT" IN AERIAL-CABLE CAGE

Similarly to the way in which packages are carried in stores in traveling overhead baskets, a dog makes the circuit of his master's grounds in London at regular intervals in a traveling elevated cage. The dog appears to understand the responsibility of his place and is keenly on the lookout. From his position he becomes aware of an intruder's presence and speedily gives the alarm.

Two rhinoceroses, believed to be the only mated pair in captivity, have been presented for a new Chicago zoo.



English Watchdog, in Traveling Aerial Cage, Protecting Property: Note the Dog's Alert Attitude as He Watches for Intruders on His Master's Grounds

International Newsreel Corp.
226 William Street, New York

Chassis + body built by Stearns + Co. 521 E. 72nd St. New York. 1495

1682

1685

International Newsreel Corp
 226 William St
 POPULAR MECHANICS
 New York. 711



Above: A Scene at the French Glider Camp at Biskra, Algeria, in the Sand Hills at the Foot of the Atlas Mountains. It is Here That a New World's Record for Motorless Flight was Made. Right: Descamps Standing beside the Glider with Which He Recently Established a New Endurance Record



1685 *Aeroplanes*
**NEW GLIDING RECORD MADE
 BY FRENCH PILOT**

With a sustained flight of 8 hours 40 minutes, Warrant Officer Descamps, of the French army, established a new endurance record for motorless planes. The flight took place at the French glider camp near Biskra, Algeria, over rolling desert sands. In another recent flight there, Descamps covered a distance of over three miles measured in a straight line. Now that the motorless plane has demonstrated its ability to stay in the air, attention is turning toward developing the distance-flying feature.

Ordinary house closets are being lined with cedar by a southern concern. This comparatively new arrangement is much more convenient than the usual cedar chest, and is equally effective as a moth deterrent.

1872
**NEW ELECTRODE ALLOY CUTS
 COPPER-REFINING COST**

The introduction of a new alloy for making one of the electrodes used in the electrolytic refining of copper, resulted in such savings that a South American copper company reduced the cost of production in 1922 to two-thirds the cost for 1921, and to nearly one-third the 1915 figure. The anode is made from the new alloy, which consists essentially of copper and silicon. The savings result from a reduction in the losses of electric current and those due to contamination of the product from the ferrosilicon and lead electrodes previously used.

Science 3/2/23
 Copyrighted material

Chile
 Copper Co., Chuqui canata, Chile.
 120 Broadway, New York

The Lead Corp.
 712 S. Dearborn
 Chicago

POPULAR MECHANICS

712
 1790
 1920

"TROUBLE LIGHT" ARRANGED ON PAIR OF GOGGLES

A pair of goggles with an electric light so arranged between the glasses that it



The Light between the Glasses of These Goggles is Arranged to Focus in the Direction of Vision. At the Right is Illustrated One of the Uses for Which the Lamp is Particularly Adapted

focuses in the direction of vision, has been made to aid motorists and others, who occasionally need a light that will permit the free use of both hands. The current is supplied by a small battery carried in the vest pocket, or in some other convenient way. The outfit may also be useful to linemen, gas inspectors, and firemen.

SKIERS TOWED BEHIND PLANE AT 60 MILES AN HOUR

Traveling over the snow on skis behind an airplane is the latest in outdoor sports, to which some Long Island boys were treated the other day at a demonstration of a small airplane. In the open field, the pilot was able to keep his plane as close as 5 feet above the ground, and at times towed the skiers along at a speed of 60 miles an hour. To further demonstrate the unusual qualities of the craft, it was piloted almost vertically down the side of a 40-foot embankment, without turning over. The machine, as used during this demonstration, was equipped with skids for landing gear.

N.Y. Times 3/10/23

1720



ALL-YEAR WILD-FLOWER SUPPLY IN "ROCK GARDEN"

IN order to supply students of botany with wild flowers for study, Harvard College has built a "rock garden" under glass where flowers are grown, so that they may be available at any time of the year, instead of in spring and summer only. As nearly as possible, the flowers are grown under natural conditions, and many foreign species are also raised here. With the present garden as successful as it has proved itself, another and a larger rock garden is under construction to meet growing demands, which will provide for thousands of additional plants.

Com. Walter S. Jordan, Weymouth, Mass.

DRILL DIAMONDS AND DIAMOND DRILLING

BY CHARLES NICHOLLS WEBB, *Box 452,*

Virginia, Minn.

THE log of the prospector never fails to reward the seeker for romance. Even that of the present-day iron-ore explorer whose equipment is elaborate, and who resembles not in the least the pack-carrying pioneer, furnishes a thrill occasionally without the slightest intention.

For example, take this entry in the log of a Mesaba drill contractor:

"September 7—9. Advanced 33 feet and then lost another bit in the hole."

A brief matter-of-fact statement, meaning little to the average reader—not much more significant than "Encountered bad weather," in the seaman's chronicle—is it not? Yet, a loss no greater, under different conditions, would be recorded in glaring headlines, with much desirable publicity for a musical-comedy queen.

To the man making the entry it means that some \$4,000 worth of diamonds lie at the bottom of a hole, 2 inches in diameter and possibly 1,000 feet deep. It means that days, probably weeks, may be spent in fishing for that handful of precious Brazilian carbons. That is one phase of diamond-drill exploration on the Mesaba and Vermilion ranges of northern Minnesota.

tion of the deposit underfoot. Some day, a cutting edge will be found which can be substituted for diamonds, and the state of Bahia, Brazil, will then lose its most important industry. From all reports, Bahia needs the diamond industry to insure its future prosperity.

Black diamonds are sometimes harder than the brilliant or crystallized diamond. Technicians explain the difference in the varieties by saying that the Brazilian stone is "opaque and amorphous." Natives of the La Chapada and Lavras districts in Brazil mine the stones from alluvial deposits in much the same manner as gold is mined in the placer fields of California. They sell their finds to the agents of exporting firms in Bahia, who send them to the London, Paris, and New York markets. The stones are found in sizes ranging from small fragments up to 100 to 500 carats. One stone, found in 1895, weighed 3,078 carats, and was broken into pieces suitable for diamond-drill work by the purchaser, who paid \$32,000 for it. At the present time, it would be worth nearly \$400,000. Black diamonds are seldom black. They range in color from black to gray, the prevailing tone being a dark brown.

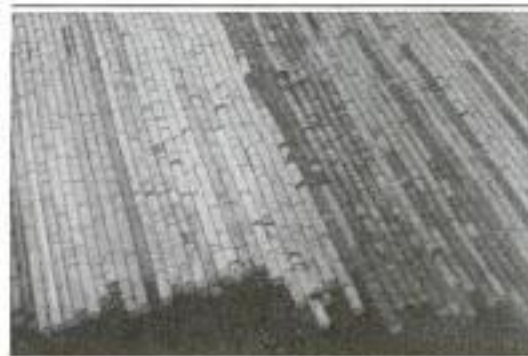

Rows of Cores Which have been Drilled with Diamond Bits: The Cores Vary in Length but Are All About $\frac{1}{2}$ Inch in Diameter



This Is a View of a Diamond-Drilling Outfit, with Its Supporting Derrick, Taken in the Lake Superior Iron Region of Minnesota

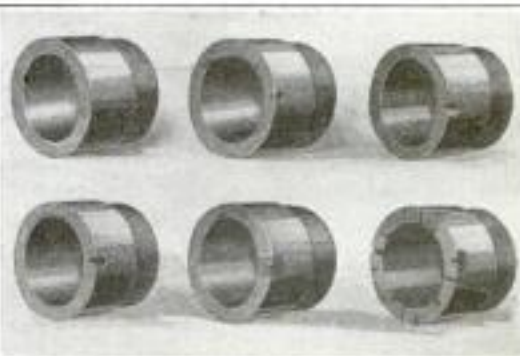

Showing the Successive Stages in Preparing a Bit for Setting with Diamonds, Beginning at the Upper Left of This View with a Blank Bit

There are other methods of testing and proving the extent of ore bodies. There are other methods of drilling besides the one necessitating the use of diamonds, but there is no other way of drilling through hard ore and rock and securing a core which shows, layer upon layer, the forma-

huts and do their mining with the most antiquated tools imaginable.

A short-handled hoe to stir the dia-

Sullivan Machinery Co., 122 S Michigan Ave. Class 2-1

mond-bearing gravel, a crowbar to pry up stones or break down banks, an iron hook on a pole to remove material from under stones or from otherwise inaccessible cracks, wooden basins of different sizes for final washing and concentrating the gravel, a sieve of some kind for sorting, a hammer and drill for the work of blasting—these include nearly every essential of a diamond miner's equipment. From this land of the crudest mining methods and through the hands of brokers and various agents, the diamonds travel to fields where different metals are mined by the most modern and scientific processes.

When the stones are purchased, they are split and usually cubical in shape, with sharp-pointed corners, and it is necessary to place them in the hands of an expert diamond setter who can mount them in a blank bit without breaking them, and who can so set them that the sharp edges will wear off evenly and so that the strain on all of the stones in the bit is uniform. The stones are set—sometimes in copper packing—in the cutting edge of the bit, which is a small cylindrical arrangement that removes a core of approximately $\frac{15}{16}$ inch in diameter from the ore or rock through which it bores.

Where one drill is on the job, the setter is usually the foreman. In any event, the foreman is responsible for the diamonds. In the morning, when work is begun, he turns over a bit already set, to the drill runner. The runner can tell from the character of the rock and the manner of the cutting, how long a bit should be run. In some formations, it can be used only through 6 inches or 1 foot, and, in

others, as much as 20 feet before it is necessary to pull it up and exchange it for another bit. When it is finally turned back to the foreman or setter, the stones are cut out and weighed in a delicate

balance to determine the loss for that run. Then they are reset to be used again. Wear of \$2 and \$3 a foot is reported sometimes.

Stones are often used until they are reduced to $\frac{1}{8}$ carat and even less.

Used stones are considered of more value than new ones, for the rough corners have been worn off and the hardness and the texture have been definitely proved, whereas new stones, despite the closest scrutiny and tests,

often go to pieces quickly. The trials and vicissitudes of diamond drilling are many. Sometimes a drill rod parts. This means a fishing job with special tools.

Diamonds very seldom fall out of their settings if reasonable care is used. If they should happen to break loose, a wax-filled impression cup will serve to recover them.

Oftener a bit will drop into the hole and the time required to fish it out may be a few hours or it may be several weeks or even months. It is all a part of the day's work to the diamond-drill prospector. He expects to lose diamonds and he loses them in plenty. He drills patiently for weeks at a time for their recovery and piles up costs in four figures for his company. And at the end of that time, he closes his logbook with the following entry, just as laconic but

no less significant than the one quoted before:

"December 24. Broke pinion tooth and delivered hole to company to finish, the lost bit having been recovered."

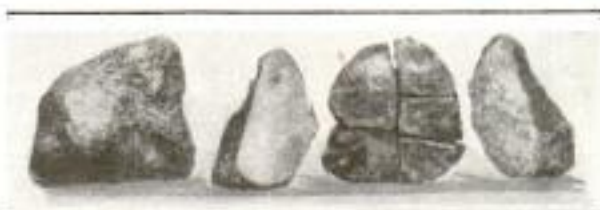

How an Unusually Large Black Diamond Was Split Until Ready for Use

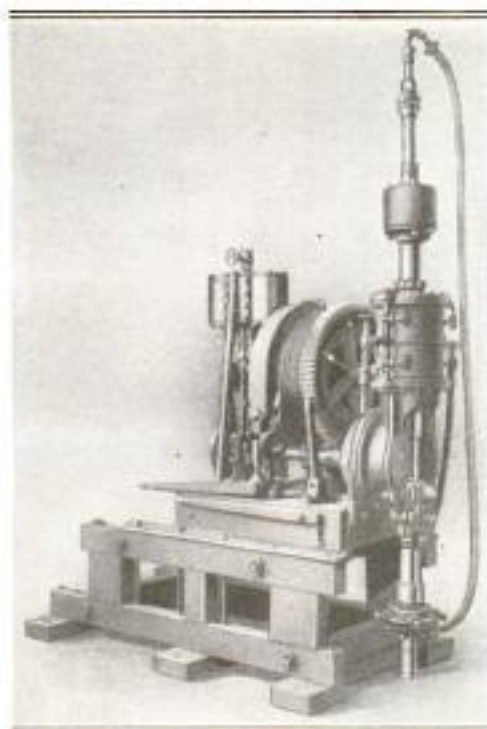

A Diamond Core Drill: Its Use Is the Only Known Method of Securing a Stratified Core of Tough Ore Which Reveals the Formation



Kadel & Herbert, 153 E. 42nd St. New York
 CITY OF TENNIS COURTS BUILT FOR AUSTRALIAN PLAYERS

AS many as 50 tennis games may be in progress at the same time on the courts of the White City Tennis Club, the largest in Australia, and one of the largest clubs of its kind in the world. The grounds now occupied by this organization were previously the site of Sydney's White City, an amusement resort—with numerous scenic railways, merry-go-rounds, and other attractions—corresponding to White City in Chicago, or Luna Park, at Coney Island. It is said the courts have proved popular with Australia's champions, many of whom practice there.

956

CIRCUS-LIGHTING PLANT HAS LARGE CAPACITY

An electric-lighting plant, similar to those used by the army and navy for emergency light and power during the late war, has been adapted for circuses, and is mounted on an ordinary horse-drawn circus wagon. The outfit consists of an automobile-type gasoline engine which drives a generator. A switch-board for controlling the lights is also erected on the wagon. Heavy cables lead from the switch-board to batteries of floodlights at the top of the "big tent" and side-shows, the generator having a capacity of approximately 1,000 medium-sized floodlights.



Electric-Lighting Plant Mounted on an Ordinary Horse-Drawn Circus Wagon, Which Supplies the Energy for Approximately 1,000 Medium-Sized Floodlights: It is Driven by a Gasoline Engine

Matthews

*Engineering Co.,
 Sandusky, Ohio.*

HOT-ROLLED GEARS PRODUCED BY NEW PROCESS

1716

The production of accurately formed gears has long been a difficult manufac-

and grinding machines. A new method has now been devised for shaping accurate tooth profiles, in which a hot plastic blank is rolled in forced contact with a forming master gear. Power is transmitted through two other gears, in order that the shaping gear may not transmit any driving power to the plastic blank and thereby cause tooth distortion. To build up the structure and profile absolutely symmetrically on both sides of the teeth, the master gear is oscillated by repeated reversals of the direction of rotation. This is accomplished automatically by electric-control apparatus connected to the motor. The effect of these reversals, while the blank is plastic, is to work and knead the metal into proper form and to give a polish to the tooth surface, practically forging the teeth. The spindle shaft is adjustable lengthwise, to accommodate different thicknesses of blanks.

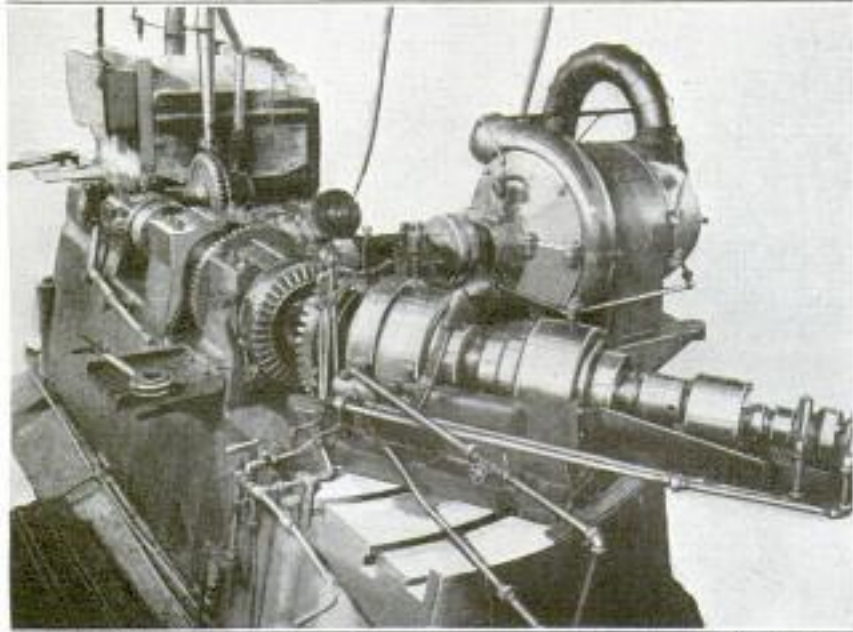

A Machine for Producing Accurately Formed Gears by Hot Rolling: Power is Transmitted through the Two Bevel Gears at the Ends of the Spindle Shafts. The Plastic Gear Blank and the Forming Gear are Rigidly Mounted between Them, in Forced Contact with Each Other, and the Former is Kneaded into Shape

turing problem on account of the inherent defects common to all gear-cutting

shaft is adjustable lengthwise, to accommodate different thicknesses of blanks.

1695

BIG TILE IN DEEP DITCH TO RECLAIM IOWA LAND

JOINT drainage operations which are expected to reclaim some of the richest lands in the state for farming

purposes, are in progress by the city of Clarion, Ia., and Wright County. The ditch has an average depth of 16 feet, and

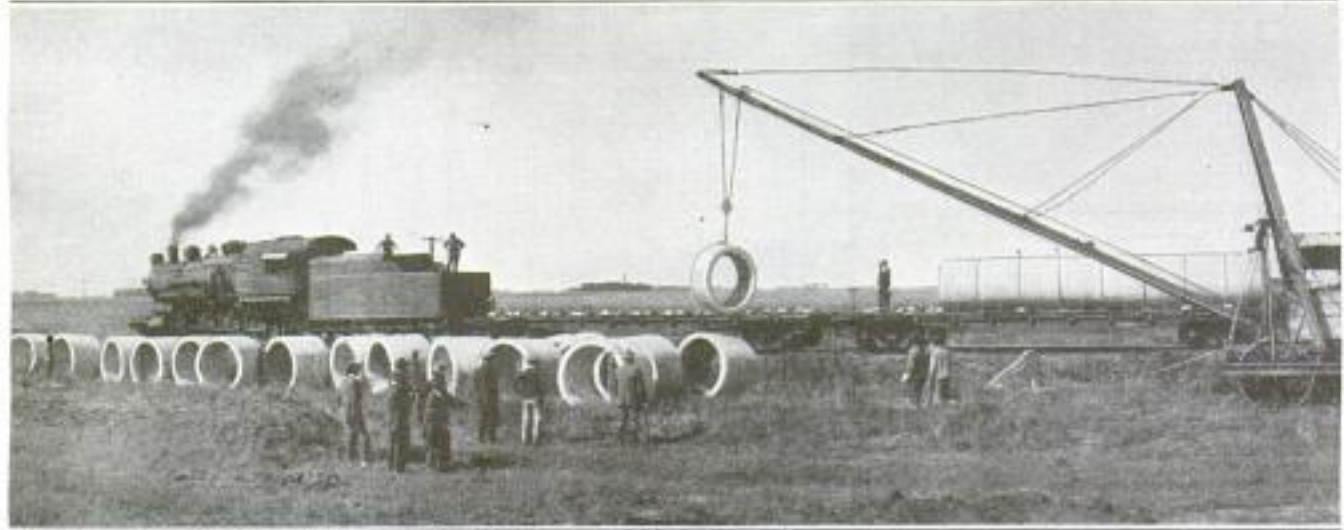

Unloading Mammoth Sections of Drain Tile for Iowa's Deepest Ditch: At the Left the Derrick is Lifting Sections Tile Lie on the Cars like Sections of a Tunnel, Large Enough for a Man to Walk Upright It is Subject to Overflow, and Large-Scale Operations

Cont. George F. Paul, 900 Ellsworth Bldg
 Chicago

Buffalo Forge Co
490 Broadway

J. E. Carter,
Cedar Rapids
Iowa 717

POPULAR MECHANICS

Buffalo, N. Y.

in places it is 23 feet deep. It is three miles long. What is said to be the largest drain tile ever used in Iowa—perhaps in the Middle West—will carry the water. These tiles are 56 inches in inside diameter, with 5-inch walls reinforced with mesh wire, and are made in 4-foot lengths. The tiles were unloaded from cars with the aid of an excavating machine having a 50-foot boom.

**ELECTRIC FAN USES ALUMINUM
1726 AIRPLANE PROPELLER**

Something entirely different from the ordinary wall type of ventilation fan has been placed on the market. The new fan is 16 inches in diameter, and is fitted with a miniature reproduction of an airplane propeller, cast of aluminum and highly polished. Although designed to run at a much higher speed than the multiblade fan, its operation is claimed to be more

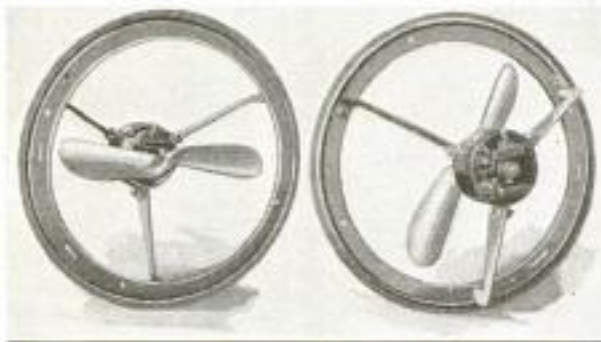

This Fan Uses a Single High-Speed Blade, Made of Highly Polished Aluminum, and Is Almost Noiseless

quiet, and to result in handling a larger volume of air. The fan weighs 15 pounds.

**EMERGENCY CLAMP PLUGS
HOSE LEAKS**

1783 The unexpected failure of a line of fire hose, or the air line on a train, always occasions great inconvenience, and some-

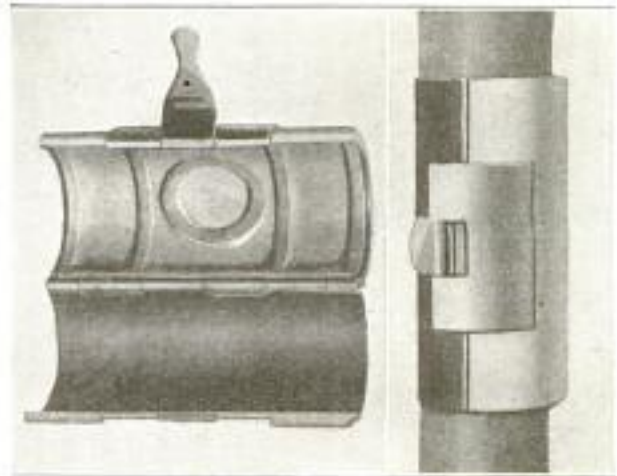

Left: Showing How One-Half of the Clamp is Lined with Sheet Rubber Having Raised Edges. Right: Locked in Position, around a Defective Portion of Hose

times such an accident even has a serious result. A new hose clamp has been devised for making a quick emergency repair of such breaks, which consists of two curved pieces of iron plate hinged to each other. One of these is lined with sheet rubber, the surface of which has raised sections for rendering the seal effective. After fitting the clamp around a defective portion of hose, it is locked in place by means of a double-spring fastening device, which holds it securely in place, until permanent repairs can be made. The device can be applied very quickly.



from a Train of Flat Cars, While Trainmen and Spectators Look On. At the Right of the Picture, the Lengths of or a Pony and Cart to be Driven Through. While the Soil in the Picture Looks Productive, Are the Only Means of Making Its Fertility Available

1734 First Ave.

RECENT VIEWS FROM GERMAN COAL MINES

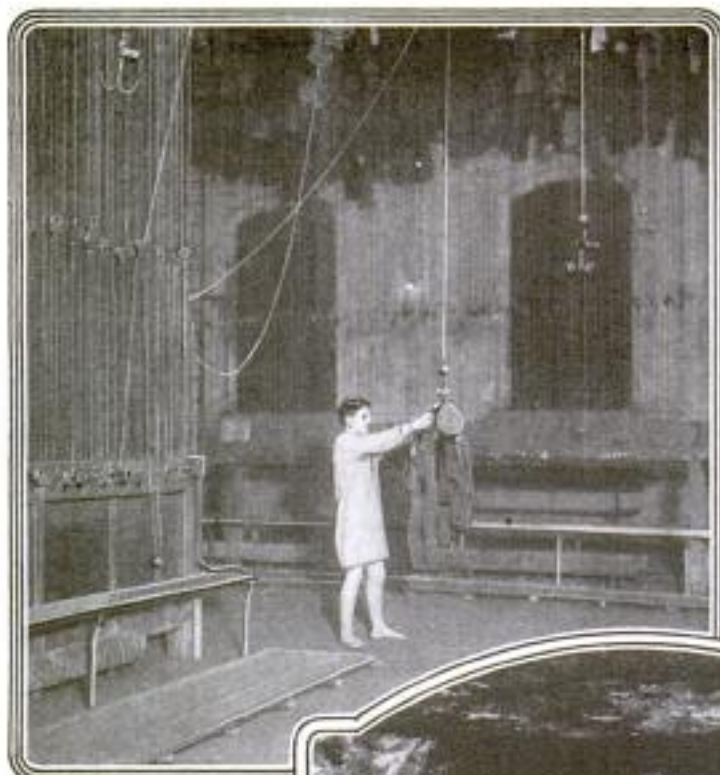

Change Room in a German Coal Mine Where the Miners Put on Their Working Clothes at the Beginning of Each Shift: Their Street Clothes are Hung on a Hook Attached to a Rope and Hoisted to the Ceiling to Prevent Theft



A Master Miner Establishing the Direction, by Means of a Surveyor's Compass, for a New Working in the Ruhr: In a Well-Organized Mine This Work is Done with Great Care, So as to Develop the Property Economically



A Subterranean Passageway between Two Ruhr Coal Mines: The Trench at the Left is for Drainage Purposes



Life-Saving Corps at the Gladbeck Mine in Germany, Which is Maintained to Render Assistance to Workers Who have been Exposed to Fire, Gas, or Other Mine Dangers

HELD BY FRANCE IN THE RUHR DISTRICT

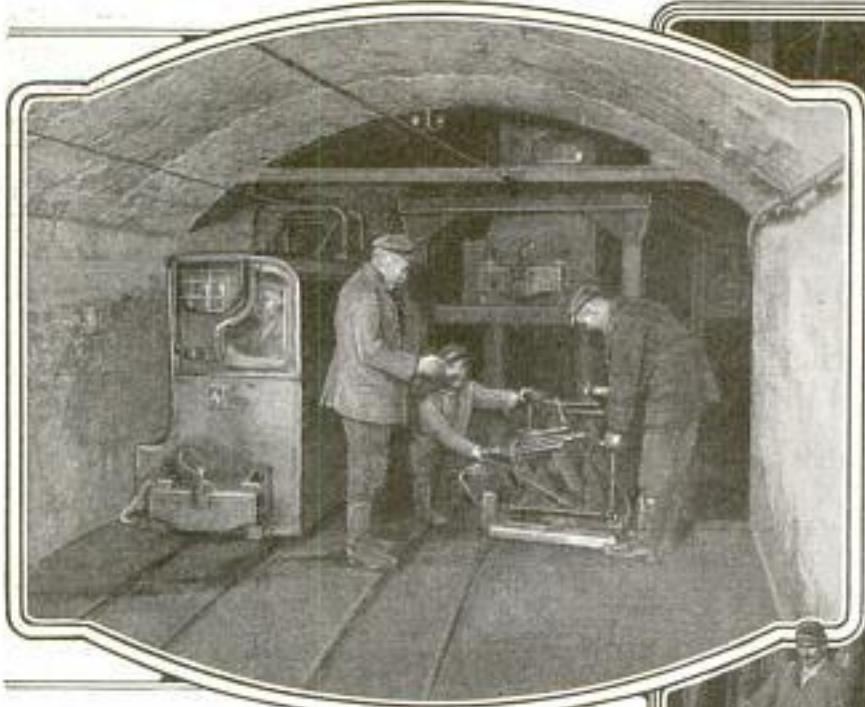

Above: A Workshop 400 Feet Underground Where Mechanics Repair Electric Locomotives Used for Hauling Trains of Small Cars in the German Coal Mines. Right: Miners at Work with Compressed-Air Machines Drilling Holes in the Coal



The Picture Below Shows Women Workers Removing Loaded Cars from a German Coal Mine in the Ruhr District, Which Supplies 70 per Cent of the Coal Output of Germany. Seizure of the Ruhr Coal Mines Was One of the First Acts of the French in Their Recent Occupation of Germany



Inv. Jesse E. Lebrick
Baltimore, Md.

Ace Motor Corp
Erie Ave. +
Sebring St
Philadelphia
Pa.

720

POPULAR MECHANICS

**RAILROAD SIGNAL INSPECTOR
HAS SIMPLE TROUBLE FINDER**

174

A signal foreman on the Baltimore division of the Pennsylvania Railroad



This Signal Inspector Saves Himself Much Extra Labor with His Iron Walking Sticks. With the Receiver at His Ear He "Listens In" for Trouble.

uses a simple and quick method of locating open or grounded wires, which is equally effective for both surface and underground wiring. Two iron walking sticks are used, each connected by wire to a headpiece telephone receiver mounted over the man's cap. Thus equipped, he goes searching for trouble, walking astraddle the signal conduits, and prodding his sticks frequently into the ground, listening intently. When the defective spot is reached, naturally the grounded wire makes the sticks "talk," thereby revealing the fault.

**FIND BEETLE CENTURIES OLD
SAME AS MODERN SPECIES**

187

Examining a 1,700-year-old tree from the giant forest of Tulare County, California, a scientist has found that two wood-boring beetles, sealed in a hole in the tree over a thousand years, are not appreciably different from beetles of the same species now infesting the forest. It is judged the tree was struck by lightning when about 421 years old, and that it was at that time the tree became infested. Later, the indications are, the

Science 3/2/23

tree healed the wound, thus completely sealing in the beetles. Though it is considered remarkable that there has been so little change in so variable a species, one must also recognize, says the scientist making the discovery, that the insect in question pertains to an archaic type, and that undoubtedly the characteristics of the species had been well fixed before the Christian era.

**ALL-ALUMINUM CYCLE ENGINE
LIGHT AND POWERFUL**

1743

The demand of motorcycle fans for a powerful yet lightweight motor has resulted in the development of a four-cylinder aluminum engine. Special attention has been paid to accurate balance, in order to produce ease of steering and more perfect control at high speeds or on bad roads. A three-speed transmission is housed in the rear portion of the motor base, power being transmitted through a large multiple-disk clutch built into the flywheel. The pistons are also made of aluminum and have a bore of 2 3/4 inches by 3 1/4-inch stroke. This machine is said to have unusually secure and comfortable riding qualities, owing to

more power than given

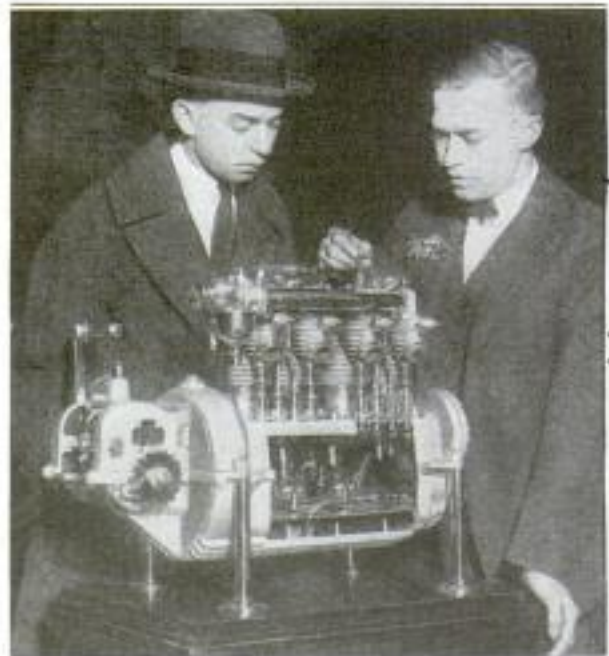

This Four-Cylinder Aluminum Motorcycle Engine Was One of the Chief Attractions at a Recent New York Exhibit Because of Its Light Weight

the use of a bucket-type seat and to handlebars of new design.

There are now 148 national forests, embracing 181,799 acres, according to the Department of the Interior.

Mr. George Blackburn & Sons, Nottingham, England.

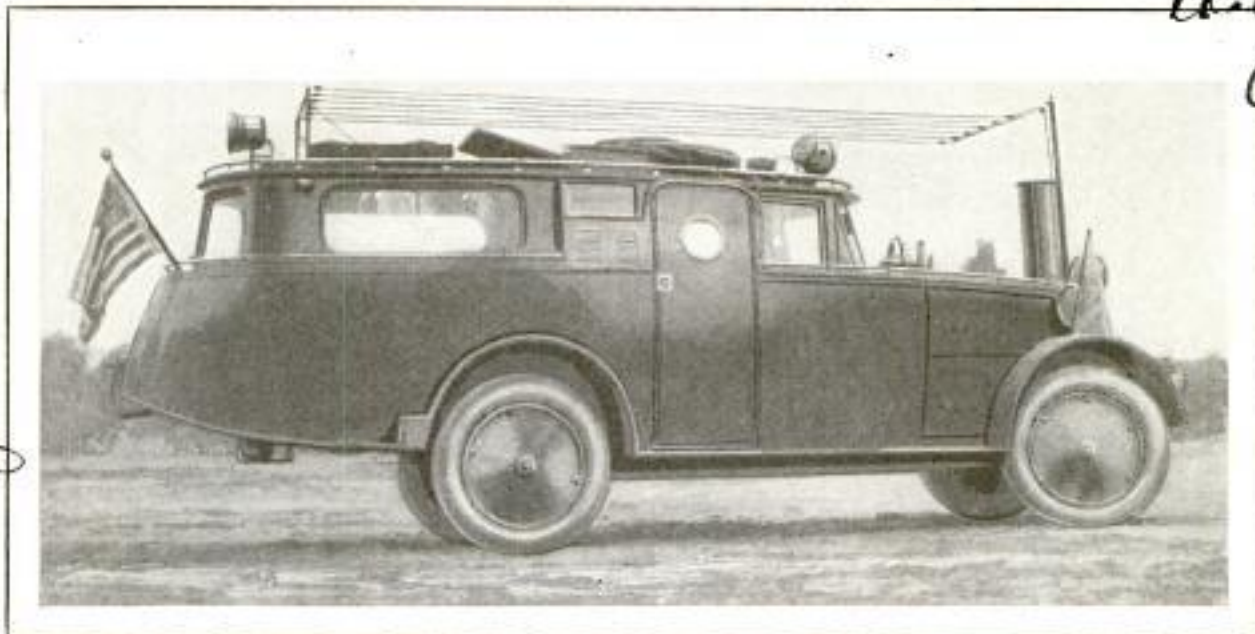

Side View of Steam Automobile Fitted with a Body Similar to a Cabin Cruiser: It Is 20 Feet Long, Weighs 4½ Tons, and Provides Accommodations for Six Persons. The Wireless Equipment Has a 1,000-Mile Range

1735
**CLOTH KNIT, NOT WOVEN,
 BY ENGLISH MACHINE**

Following the improvement of knitting processes for underwear to the point at which it has practically displaced cloth, comes an English method of knitting cloth for outer garments. For two years, coarser woolen mixtures like heather cloth have stood the test of wear. Now a knitting machine has been manufactured which is claimed to turn out the fine, smooth-finished fabrics, like meltons, at a cost which makes them competitors of woven goods. What is called the "80-feed circular latch-frame needle" will produce a fabric for general clothing purposes at the rate of one yard a minute. Knitting at this rate, one girl is able to tend two machines.

1624
**LAND-GOING "YACHT" SEEN
 ON CALIFORNIA ROADS**

A land-going "yacht" has made its appearance in southern California. The queer "craft," built on the chassis of a steam automobile, has the appearance and most of the equipment of a small modern yacht. Twenty feet long and with a "displacement" of four and one-half tons, it accommodates six persons. Within the cabin are a refrigerator, steam tables for cooking, and a wash basin with hot and cold water, while other nautical touches, visible from the outside, include a steam whistle, ship's bell, port and starboard lights, and several strong searchlights. A stack, at the front, carries the exhaust from the engine.



Front View of the Land-Going "Yacht," the Stack of Which Carries the Exhaust from the Engine: A Refrigerator and Steam Tables for Cooking are Included in Its Equipment

Manchester Guardian Weekly.

Archit. J. S. Davis, P.O. 406. Wrigley Bldg.
Chicago
1622 Contractors - Languish & Halsey, 1100 N.

Clark.
Chicago

Moving Contractor - L. P. Friestedt
7 S. Dearborn, Chicago

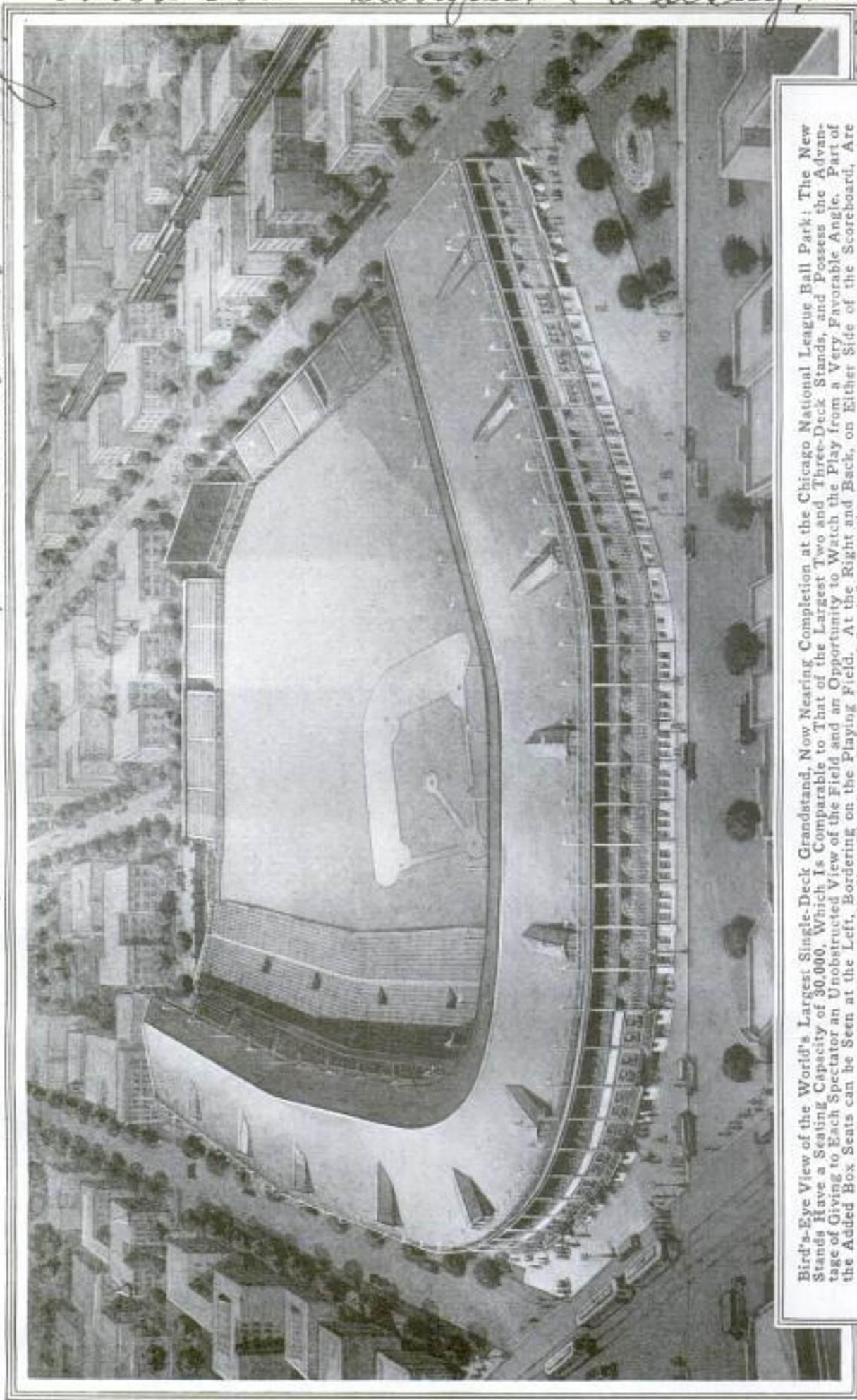

Bird's-Eye View of the World's Largest Single-Deck Grandstand, Now Nearing Completion at the Chicago National League Ball Park; The New Stands Have a Seating Capacity of 30,000, Which Is Comparable to That of the Largest Two and Three-Deck Stands, and Possess the Advantage of Giving to Each Spectator an Unobstructed View of the Field and an Opportunity to Watch the Play from a Very Favorable Angle. Part of the Added Box Seats can be Seen at the Left, Bordering on the Playing Field. At the Right and Back, on Either Side of the Scoreboard, Are the New Bleachers, Which Are of Steel Construction

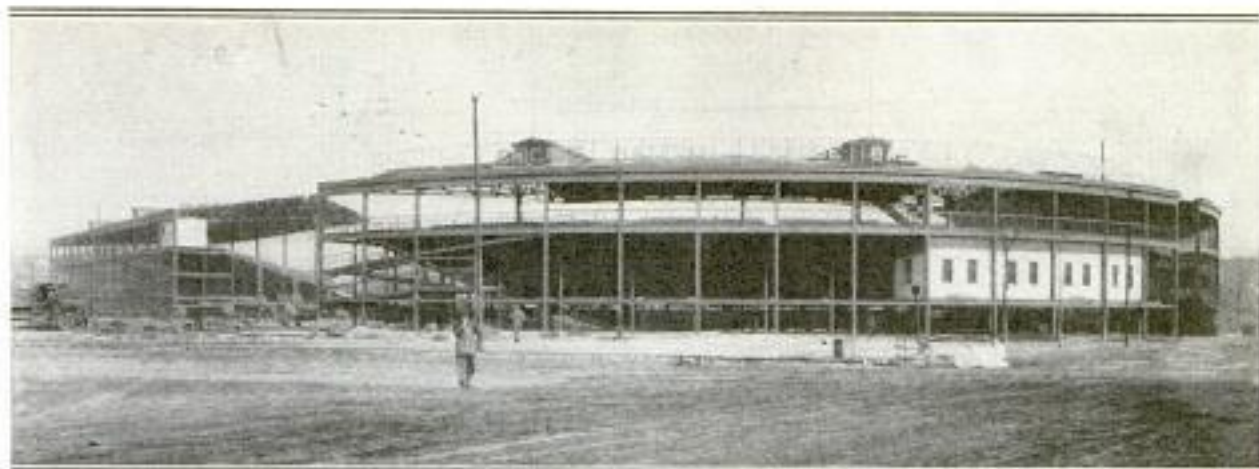

View from the Southwest Side of the Chicago National League Ball Park, Showing the Old Stands after being Moved to Their New Position: The Gap between the Stands at the Left has Since been Filled In with New Stands

WORLD'S LARGEST SINGLE-DECK GRANDSTAND

BY HENRY S. WHITE

AN altogether unprecedented engineering enterprise, that will involve an outlay of \$450,000, is now nearing completion at the Chicago National League Ball Park. The old grandstand, with a seating capacity of 15,000, is being transformed into a new stand with a seating capacity of 30,000. Moreover, the playing field has been considerably increased in area, so that one of the foul lines, which was formerly 50 feet short of the regulation, is now moved back the proper distance.

The original stand was entirely of structural steel. It was 120 feet wide and about 765 feet long, with a single sloping deck, and the usual kind of steel-trussed roof. In plan it was composed of a central curved section with a straight section at each end, tangent to the curve. In undertaking the enlargement, the rivets in all the splices of the steel structure along each of the two radial lines where the straight sections joined the curved one, were burned out, thus disjuncting the stand into three sections. The section at the east end of the stand was left in place, the curved one was moved back about 100 feet, and

the other straight section, at the north end, was moved back until it was in position to increase the length of the grandstand to nearly 1,000 feet. This left two gaps between the sections in their new positions, one about 115 feet long, and the other about 150 feet. These two gaps were built in with steel roof trusses and new seating decks to line up with the deck in the old sections.

Before this was done, the ground level of the playing field was lowered about 7 feet, allowing for the erection of new box seats that extend around the whole inside line of the new stand, making its total width 167 feet, nearly 50 feet more than the old stand. This will make it the largest single-deck stand in the world. There are a few two and three-deckers with a greater seating capacity, but they have disadvantages

not possessed by the single-decker, where there are no obstructions whatever, so that spectators in all parts of the stand with equal facility can see balls in the air, and watch the players in the field. There are also no stairs necessary. Instead there is a ramp, or walk, slightly inclined and easily accessible.

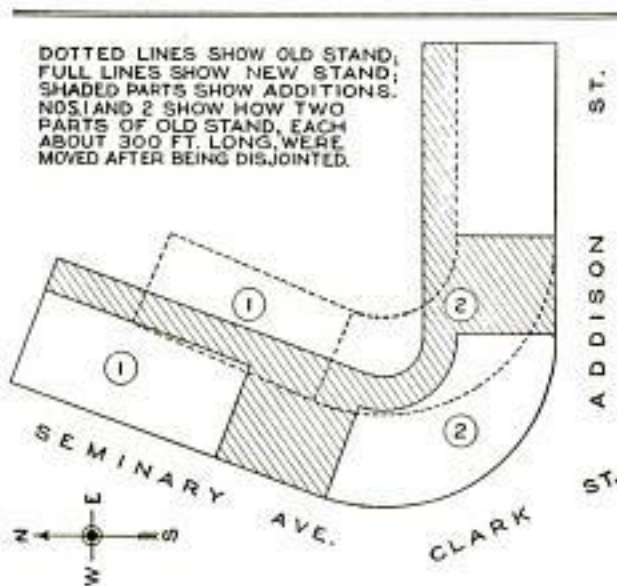

Diagram Showing the Relative Size, Shape, and Location of the Old and New Stands at the Chicago National League Ball Park

One of the most interesting features about this undertaking was the manner



Close-Up of the Northwest Section of Stands after Moving, but before the New Box Seats were Added: Back of the Stand, at the Right, a Part of a Ramp Appears

of moving the two sections of the old stand to their new locations as parts of the new stand. Naturally the more difficult section to move was the curved one. It had 144 columns for which concrete foundation piers had to be prepared in the new location before the moving. In each of these piers were either two or four vertical anchor bolts—altogether about 450—that had to be set so accurately that every one of them would exactly match up with the holes in the 144 column base plates.

To accomplish this, the section, before being moved, was jacked up and placed with the column bases upon very rigid

timber horizontal framing, which was so constructed that continuous cap timbers lined up with nine narrow-gauge railroad tracks previously laid from the old to the new location, where each track straddled each line of foundation piers in such a manner that each column came to rest exactly over its individual pier. Between the bottom of the cap timbers and across each of the rail tracks, were steel rollers to facilitate the moving of the whole structure.

The moving was done by means of two horse-driven capstans, one opposite each end of the structure, with a long continuous steel cable between them, which, in connection with a series of pulleys and blocks—a set for each rail track—hailed the curved section of the old stand back 91 feet in two hours. At each column were an average of about six jacks, making a total of 840. These were operated by 80 men directed by whistle signals from the superintendent. At its new location everything had been done with such remarkable precision that when the structure was slowly lowered, by simultaneously and equally turning all the jacks, the 450 holes in the column bases slid over their respective anchor bolts without a single exception—certainly a remarkable example of perfect accuracy.

830

POPCORN STAND ON CHASSIS OF SMALL AUTO



Two Views, Front and Rear, of Corn-Popping Outfit, Mounted on an Auto Chassis: The Vender Operates the Outfit in a Wisconsin Town

An enterprising popcorn vender, operating in a small Wisconsin town, has removed the body from his automobile and erected on the frame, at the rear, a modern corn-popping outfit. This unusual arrangement makes it possible for him to tour the city and near-by communities during the summer, when fairs, picnics, circuses, and the like, are in progress. In the winter he parks at a busy street intersection

Conr. Felix J. Koch, 3711 Clifton Ave.
Cincinnati, Ohio.



The Canvas Above Has behind It a Magnetized Framework, So That the Models, Also Painted, may be Attached on Their Appropriate Places, by Fastening a Tin Strip to Their Backs with Adhesive Tape. To the Left are Shown a Salesman's Traveling Case, Two of the Canvases, and Some of the Models

1612
**DISPLAY REMOVABLE OBJECTS
 ON PAINTED BACKGROUND**

Models of monuments and other objects are often displayed without the proper settings. To show reproductions of this kind to better advantage, there has been invented a system in which a natural setting for the article is painted upon a canvas, backed by a framework that is magnetized in certain appropriate places. The models are also paintings and may be attached at the magnetized areas of the background by fastening a tin strip to their backs with adhesive tape. There are no projections or defacing objects to mar the background. While this innovation may be of benefit in stores or other permanent quarters, it is thought it will be of even greater advantage to the traveling salesman who may carry with him one of the backgrounds and various styles of the articles he sells.

593

**OCEAN SHIP HAS CIRCULATING
 LIBRARY AND BOOKSHOP**

Space for a combined circulating library and bookshop has been arranged on the new steamship "Tuscania," which plies across the Atlantic. The library, said to be the only one of its kind, has a large collection of books and has

proved popular among the passengers. The bookshop run in connection with the library, carries a representative number of the latest works, and has also met with success.



Passenger Taking Out Book from the Circulating Library of the High-Seas Bookshop on the "Tuscania," a New Atlantic Liner

Kadel & Herbert
 153 E. 42nd St
 New York

Dr. Prof. Karapetoff,
Dept. of Electrical Engineering
 726
POPULAR MECHANICS
Cornell University, Ithaca, N.Y.

NEW FORM OF VIOLONCELLO HAS FIVE STRINGS

1628

A new form of the cello, having five strings instead of the usual four, has been developed.



The additional one is an E-string, made of No. 7 piano wire, which is kept under a tension of 60 pounds by a small worm gear, and extends the tone range of the instrument considerably. The cello has a leather strap attached to it, which

passes around the body of the player, while his left foot rests on a small stool with a toe strap.

ing on a single rail. Upon this frame a dumping body is mounted, and a long rod is attached to the frame for pushing the car along. This rod gives the operator sufficient leverage to control the car with ease. The body is easily tipped by tilting it on its frame when it is necessary to discharge a load.

LOCOMOTIVE FLAG HOLDERS ARE ALSO CONTAINERS

1574

A new holder for the signal flags carried by locomotives has been designed



to serve also as a container, to prevent unnecessary soiling or misplacing of the flags. The device resembles a double-barreled auto-tire pump, with an extension at the base which fits into the present flag socket on the locomotive. The flags, green

and white, are drawn from a slot made along the entire length of each cylinder, while springs inside prevent them from dropping out. After use, the flags are rolled back by turning the knob at the upper end of each flag-staff.

1617

HAND-OPERATED MONORAIL CAR EXCELS WHEELBARROW

To reduce the amount of energy required to push or haul a wheelbarrow or small-wheeled truck, a German engineer has designed a monorail hand car, which, he claims, lessens this energy by three-fourths. The new car consists of a frame in which two flanged wheels are mounted, one behind the other, for rid-



Ans. H. M. Williams
Little Rock, Ark.
2124 W. Eleventh St.



A Monorail Hand Car Which is Supplanting the Wheelbarrow in Germany: At the Left, It is Used on a Temporary Portable Single-Rail Track, and at the Right, on the Right of Way of a Railroad

Mfr. H. Buesching & Son
Braunschweig, Germany.

Copyrighted material



Saving Time and Distance Carrying Melons over a Creek on a Cable: Left, Starting with the Load; Middle, Crossing the Creek 100 Feet above the Water; Right, Unloading Melons on Farther Side of the Creek on Receiving Platform

1772

ELECTRIC BOILER CAR HEATS SWISS RAILWAY COACHES

A railway car carrying an electrically heated boiler for generating steam to heat passenger coaches, was recently put in service on the Swiss federal railways. This unusual equipment was introduced because, on through trains, there are a certain number of coaches from foreign lines arranged for steam heat, although, as on most electric lines, the Swiss coaches are provided with resistance heaters. The boiler, which is rated at about 1,000 horsepower and intended for about 120 pounds' steam pressure, is supplied with 15,000-volt alternating current, which passes from the overhead line through the trolley, and through choke coils and special switches, to two electrodes inside the boiler. A built-in pump circulates water against the electrodes.

wire cable and a small automobile. On the farther side of the creek, one end of a 238-foot cable was attached to a tree, 100 feet above the creek, while the other end of the cable terminated at a shanty in the melon field. Then great



The Car That Pulled the Melons over the Creek with a Long Rope, and Booth on a Public Road Where They were Delivered and Sold

boxes of melons were hung to a pulley running on the cable. A rope running through another pulley lashed to the tree had one end fastened to the box of melons and the other tied to a small roadster car on the far bank of the creek. It was an easy matter for the car to pull the box of melons, as it swung 100 feet above the stream, to an unloading platform at the foot of the tree. Much time was saved in a busy season by the simple plan of the cable and the car and the use of a little ingenuity.

AERIAL CABLE CARRIES MELONS OVER CREEK

In an Ohio melon-growing neighborhood quick time was made and a two-mile detour avoided in getting melons across White Oak Creek by the use of a

Brown, Boveri & Co., Baden, Sulzer Bros., Winterthur

1634

INDIAN-RICE HARVESTING NEW INDUSTRY

BY LAWRENCE WM. PEDROSE

1953 10.54 th 2
Seattle, Wash

AN industry of growing importance to the Northwest, in that it garners a food resource heretofore used only in a desultory manner, is the harvesting of Indian, or Canada, rice, a wild grain which grows in great abundance in the lake region of northern Minnesota and sister states, and in the northwest territories of Canada.

Wild rice has both food and medicinal value, possessing high caloric content and being easily digested. It is often

the rice shoots commence to grow from the lake bottom, and by the beginning of summer appear above the surface of the water. In August, the stems head out and quickly ripen, dropping the grain, which sinks into the muck of the lake bottom, protected from the cold of winter. Soon after the ripening period, the rice grass disintegrates and also sinks to the bottom to rot and form new soil for the growth of the next crop.



PHOTOS COPYRIGHT BY ABRAHAM CURTIS FOR THE NORTHERN PACIFIC RY.

Harvesting Indian Rice Is Something Machinery cannot Do. Left: Using, Alternately, the Right Hand and Left, the Harvester Bends the Rice Stems over the Boat's Gunwale and Knocks Off the Heads with a Sharp Blow of the Stick. Right: A Typical Chippewa Squaw with Her Basket of Grain

prescribed by physicians for dyspepsia and other intestinal disorders. Because of its delicate flavor, it is also prized as a companion dish for game, and is in demand for this purpose both in this country and abroad.

As far back as history records, wild rice was harvested by the Indians and the grain used for gruel. It is a product of lakes and swamps in the prairie regions and not adapted to any form of cultivation, but in the Northwest tens of thousands of acres of wild rice are to be found, and these constitute the principal feeding and breeding grounds of ducks, geese, and other migratory waterfowl during their summer stay in the North.

The largest wild-rice fields are found around the edges of prairie lakes in water 2 to 4 feet deep. In the spring

The delicate nature of wild rice has made it difficult to improve the Indian method of harvesting. The grain falls from the ripening heads before it becomes dry, otherwise it would float upon the water, and thus harvesting is a task requiring skill. The best method has been found to be the use of a canoe, or other light boat of shallow draft. The boat is poled through the rice patch. A squaw sits in the stern with a round stick, 1 inch in diameter and about 2 feet long, in either hand. With her right hand she sweeps a quantity of grass in over the gunwale of the boat and knocks off the heads of grain with a sharp blow from the stick in her left hand. Then with the left hand she sweeps in a quantity of grass, from the other side of the canoe, and knocks off the headed grain with her right hand.



This View Shows How the Indians Thresh the Grain by Prodding It with Clubs Which Bruise the Husks and Thereby Release the Grain from the Chaff. It is Claimed This Is the Only Task Which could be Improved by Mechanical Means

From 10 to 15 bushels of headed grain can be gathered in a day by each boat. The heads are heavy, weighing about 40 pounds to the bushel, and the gathered

product runs about 80 per cent grain and 20 per cent stems and chaff. The grain is about as thick as a knitting needle and varies from $\frac{1}{2}$ inch to $1\frac{1}{4}$



PHOTOS COPYRIGHT BY ASAHEL CURTIS FOR THE NORTHERN PACIFIC RY.

A Rice-Harvesting Camp of the Chippewa Indians: This Is a "One-Squaw" Tepee Made of Birch Bark, and Is Portable, as It can be Quickly Rolled Up and Easily Carried About by One Person. In the Background Are a Few Chippewas, Pioneer Experts in the Harvesting of the Wild Grain

inches in length. The heads are placed in a hand mill for separating the grain from the chaff, the Indians using small cone-shaped "mortars" of wood, into which the heads are dumped and pounded with large pestles. In a receptacle holding a bushel of grain, five or six persons usually operate the threshing clubs.

Lately, the harvesting of wild rice has been undertaken in a commercial way, and machinery is being developed to replace the crude Indian method of threshing, but no successful mechanical device has been found for harvesting the headed grain. In northern Minnesota several large wild-rice plantations have been leased and are being developed. The possibilities of the industry may be seen

from the fact that, at present, the retail price of wild rice averages about \$1 a pound, with the demand far exceeding the supply. A large part of this demand is from sportsmen's associations and owners of wild-waterfowl preserves, who sow the rice for game food.

Recent improvements in handling and shipping wild rice have increased its scope for propagation purposes. Formerly the only known method of keeping the grain fertile was by submerging it in cold water. Now a container has come into use which provides an insulation of damp moss that keeps the grain in excellent condition, and the product is shipped successfully in 1, 5, and 10-pound packages.

NEW TYPE OF SAFETY SIGNAL FOR RAILROAD CROSSINGS

A new type of railroad signal has been installed, and is now under test, at a level crossing on a street in Chicago, Ill. On an iron post, bearing the word "Railroad" very conspicuously, that display the 10-inch bright-red train is approach

under a sign "Railroad" are four lights which display the word "Stop" in letters when a train is approach



COPYRIGHT UNDERWOOD & UNDERWOOD
 Railroad Safety Signal for Level Crossings: Whenever a Train is Approaching, the Four Lights under the Sign "Railroad" Display the Word "Stop" in Bright-Red 10-Inch Letters

signal appears only at the approach of a train.

NEW METHOD EASILY CORRECTS ELECTROTYPE PLATES

Corrections and alterations on electrotype plates have always been tedious tasks because of their permanence, which from other considerations is a virtue. A new method devised by the Bureau of Standards makes this comparatively easy and rapid. An electrode inserted in the nozzle of a hose, through which a solution of copper sulphate is forced against the area on the plate where the correction is to be made, forms the negative terminal of an electric circuit of which the plate is the positive electrode. This rapidly removes the copper to the desired depth. The remainder of the plate is kept from being affected by a coating of ink or other nonconducting material. Current at 12 to 15 volts has been found most satisfactory. The depression, which is as deep as the engraved lines, is leveled from the other side with a hammer and anvil, and, after polishing, is ready for the new work.

CA "steam screen" declared to be the newest effect in motion photography is seen in a late production. The scene is a stage setting. The curtains are drawn apart, showing a wall of steam coming from the floor back of the footlights and cutting off the view of the stage. Slowly the screen of steam is dissipated, revealing the dancers behind.

Mr. G. B. Ramey, Asst. Dir. Pres. - Attd. Chicago
 Rock Island R.R., 179 W. Jackson St.

Com. S. O. Winters, 703
 Reldg., Washington, D. C.

NEW APPARATUS DETERMINES SIZES OF CEMENT PARTICLES

Nearly every large industry now has its research laboratory. As most people know, Portland cement has to undergo many exacting tests in order to prove beyond a doubt that the product conforms to the quality requirements of standard specifications.

Blowing cement up a short brass stack to measure the size of almost infinitesimal particles is one of these tests. Standard Portland cement must be so uniform that 78 per cent will pass a sieve with 40,000 openings to the square inch. But the industry wanted to know just how fine that 78 per cent was. To the average person the task of measuring so nearly impalpable dust particles would seem impossible. An apparatus known as the air analyzer, used at the Structural Materials Research Laboratory, Lewis Institute, Chicago, separates and gives accurate average measurements for particles of cement so fine that it would take 80,000,000 of them, placed in closely fitted rows, to cover a glass plate 1 inch square. In other words, if it were possible to weave a sieve with 9,000 wires each way in a square inch, some cement would pass through.

The air analyzer consists of four brass stacks, each 61 inches high, equipped with a small bowl that fits tightly at the bottom. An air inlet enters the stack a few inches above the bowl, and at the top of each stack a cloth dust collector is attached.

The measuring and separation are done by placing a sample of cement in the bowl and letting air through the inlet nozzle at a specific pressure for a given time. The separation size, which is the measuring unit, depends upon the velocity of the air through the stack. This in turn depends on the size of the air nozzle and the diameter of the stack up which it is blown. In each of the four units the stacks are of different diameters, and the openings in the inlet nozzles are of different sizes. These are so arranged as to give air velocities which separate particles ranging from .00181 inch for the swiftest air flow in the smallest stack, to .00035 inch for the lowest velocity in the largest stack.

Many days were spent in establishing these separation sizes by means of microscopic measurements when the laboratory staff first completed the analyzer. With it, they have proved beyond all doubt that the manufacture of cement requires finer

grinding than any other industrial process used on such a large scale. Fine

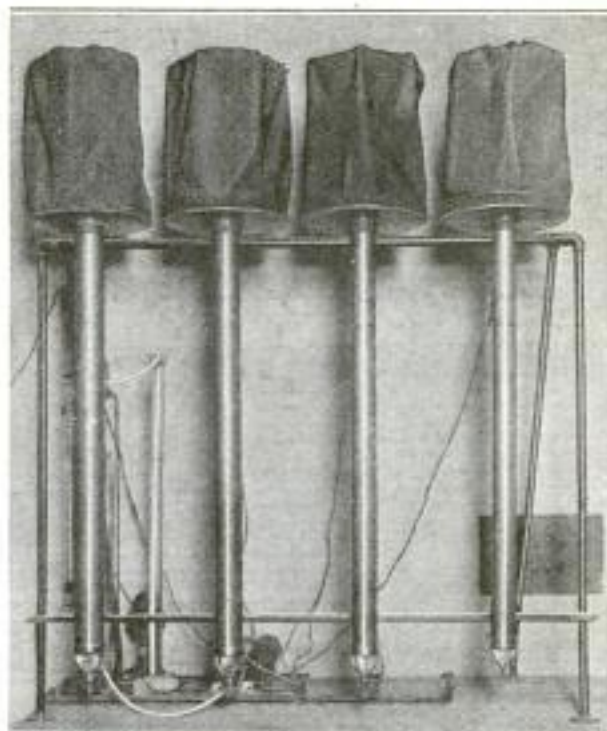

With This Apparatus for Analyzing the Fineness to Which Cement is Ground, Particles as Small as .00035 of an Inch can be Separated

grinding requires power, which accounts for much of the expense involved in the manufacture of Portland cement.

RADIATOR FUNNEL REQUIRES NO HOLDING

Automobile owners will greet with satisfaction the appearance of a new type of radiator funnel, which, after insertion in the inlet cap, will stand erect without holding. In this position it is sufficiently rigid to permit a pail of water to be rested on its edge, thus not only leaving both the filler's hands free to empty the pail, but also relieving him of most of the weight of the pail. The funnel also contains a brass strainer.



A New Funnel for Automobile Radiators: After Insertion, the Funnel Stands without Holding, and the Radiator may be Quickly and Easily Filled

Vincent Funnel Co.
18 N. Main St.
Ashley, Pa.

MECHANICAL DEVICE AIDS TOUCH TYPEWRITING

1568

A recently invented attachment for typewriter keyboards, is for the assistance



The Keyboard of This Typewriter is Fitted with an Attachment to Assist the Beginner in Learning the Touch System

of the beginner at touch typewriting. It consists of a frame with inclined bars, extending from the top to the lowest bank of keys, between the rows. The bars project a slight distance above the keys, thus serving as a guide to keep the fingers in the right positions.

COLLAPSIBLE ORCHARD LADDER MAKES FRUIT PICKING EASY

A collapsible orchard ladder, made in two sections, has been placed on the market recently, which greatly facilitates fruit-picking operations and the work of tree pruners. The upper section of the two-part ladder is disposed at an obtuse angle to the lower one, and terminates in a single rail. As this rail is sheathed,

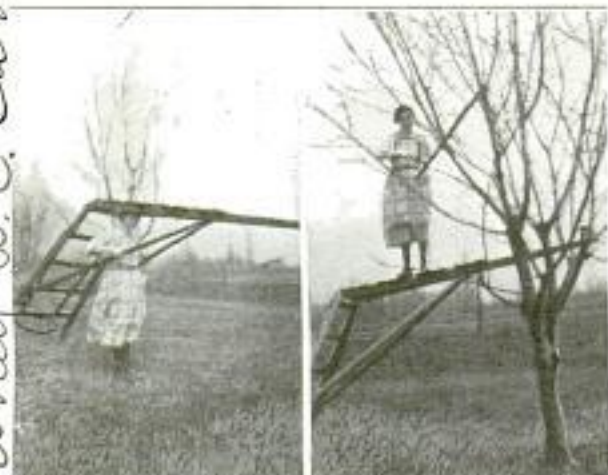

The New Orchard Ladder is Easily Carried, and Fruit Picking over a Wide Range is Possible without Frequent Descents to Shift It to a New Position

no damage to the bark is possible when it is adjusted between the limbs of a fruit tree, and the fruit picker can pick over a considerable range without having to descend and shift the ladder to a new position. This improved ladder can also be quickly adjusted for use as an ordinary ladder, if desired.

BELLS CAST FROM STEEL INSTEAD OF BRONZE

1703

Bells cast from steel are being made to replace those that were melted in Germany during the war, in order to obtain the copper, tin, zinc, and other metals which they contained. Open-hearth steel is specially treated to produce bells that closely resemble in tone and resonance those made of bell-metal alloy. The manufacture requires care in molding, the metal being poured into a mold set with the mouth of the bell uppermost. The casting is cooled slowly, accurately tuned, and given a rust-proof coating.

UNIVERSAL JOINT ELIMINATES PINS AND SCREWS

1502

A ball-bearing universal joint of extremely simple construction has been placed on the market recently, which dispenses with small pins as working connections. Each of the two working shafts of the joint has two forked projections at the contact end, which fit into, and are contained by, a two-part spherical housing which is recessed to receive these projecting lugs. The contact faces of the housing also serve as bearing surfaces for each shaft, receiving the thrust and thereby reducing the wear.

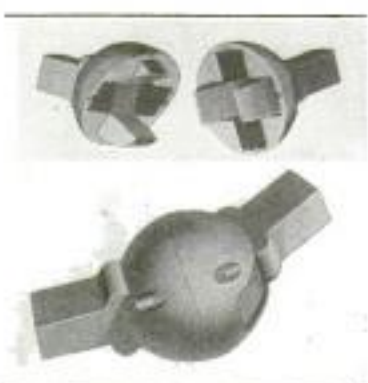

Experiments made with different types of miners' lamps show that the amount of coal miners are able to move is much greater with a better light. With lamps giving six times the usual illumination, the amount of coal taken out was increased 14 per cent with 21 per cent less dirt, although the improved lamps weigh five times as much as the ordinary type.

I. W. H. Allister Thompson,
Woodney B. C. Canada

Smeecher Products Co
Trenton, Mo.

Some interesting departures from the usual construction of engineers' levels have been embodied in a new instrument which has just appeared on the English market. Of special interest is the fact that the telescope is not rigidly mounted to the vertical center of the instrument, as is common practice, but is free to revolve a half-turn within the two collars in which it is mounted. This feature

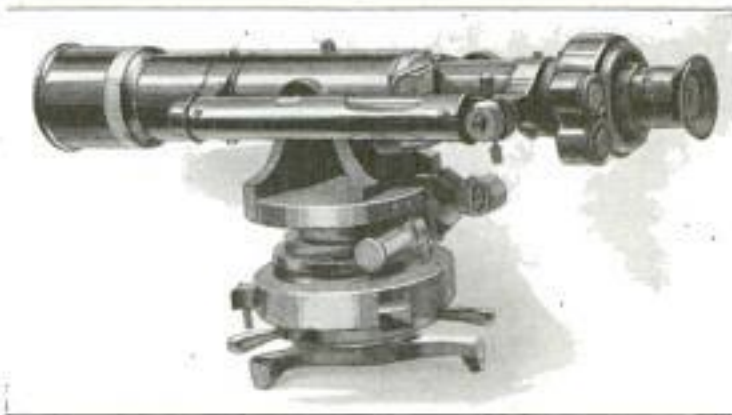

A New Surveyor's Level of Simplified Construction: Instead of Centering between Hair Lines on the Level Tube, One End of the Bubble is Brought Up to a Pointed Indicator. The Bubble is Visible from the Eyepiece

provides an instant means of checking the line of collimation, or the true axis of the telescope, without the more laborious method necessary with the rigid type. Equally advantageous is the placing of the spirit tube to one side of the telescope, instead of under it, and the use of a reflecting prism to facilitate reading the level. The surveyor is thus able to observe the bubble from the eyepiece.

1662. *1662. [unclear]*

ALINEMENT-CHECKING TOOL OF HIGH PRECISION

The accuracy of automobile parts is an important factor in the construction of a car, and is carefully controlled at the plant, but when repairs are made at a garage, careless checking methods are too often used. An improved instrument and tool has been brought out for service-station use, which is designed to test, straighten, and check any to .002 inch on the connecting rods of the engine as well as the connecting rods of a car, in three positions, inch. An attachment tool also permits check-alinement of the pistons, as their bore. The tool

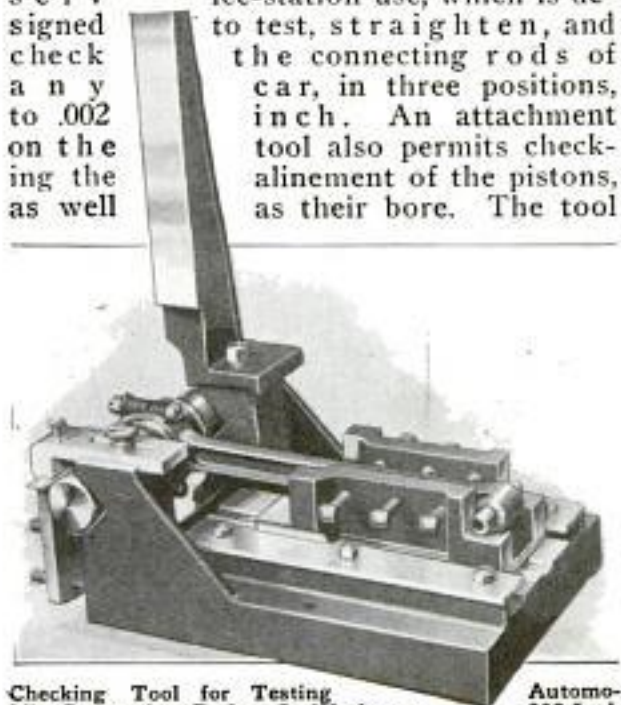

Checking Tool for Testing Automobile Connecting Rods: It Works to .002 Inch

is designed to permit convenient adjustment of its parts for making the tests.

1639. *1639. [unclear]*

OIL SIGNAL FLASHES WARNING AUTOMATICALLY

An automatic oil signal for automobiles has been placed on the market recently which flashes a warning to the



An Automatic Oil Signal for Automobiles: After Fitting to the Dash, a Connecting Wire is Run to the Lamp and Then to the Switch Ignition Terminal

driver whenever the oil in the crankcase is low or the lubrication is faulty. The signal consists of a cast aluminum base, fastened to the dash, and having a very thin brass diaphragm at the top. Electrical contact points are arranged beneath the cover in such a way that a circuit is established whenever the oil pressure becomes too low, lighting a small ruby lamp as the danger point is near. The device is dependent for operation on connection with the oil pump of the car, but not applicable to cars which are lubricated by the splash system.

Perfection Tool Works, 209 Liberty St. Jackson, Mich. *Elgin Cante Tool Co., d no. Elgin, Ill.*

MOLDS FOR DECORATIVE SEALING-WAX FORMS

1533 Molds of various forms, which enable the home decorator to make book ends, toys, and other articles from sealing wax,



Decorative Forms Made from Sealing Wax: Above, Book Ends of Wax; Below, Molds for Making Animal Forms

are a novelty on the market. The molds are inexpensive. A lead base gives stability. Should the worker become tired

1620

OWNER MAKES NOVEL FIRE TEST FOR NEW HOUSE

When an eastern architect received a commission recently to prepare plans for a new residence, he had no inkling that the owner would subject the building material used to the extraordinarily severe tests described below. The wall material selected — cinder-concrete blocks—was to be coated with stucco, and was expected to be fully fire-resistant. Accordingly, the owner proceeded to build a small test-house with blocks of this material, which he weighted down with 11 tons of pig



Test Block House, Loaded with 11 Tons of Pig Iron, in Which the Fire Raged for an Hour: The Blocks Withstood This as Well as More Severe Compression Tests Later

of any object he has made, the wax may be melted and made into some other article. The process offers possibilities for developing artistic talent and an eye for color.

CAR FERRY DRIVES BLINDLY BEFORE GALE INTO PORT

1798 By a wild freak of chance, when Ann Arbor car ferry "No. 4" was battling an 80-mile hurricane on Lake Michigan with the mercury near 20° below zero, the storm drove it through the narrow space between the breakwaters and into Little Betsey Bay at Frankfort, Mich., its home port. With 19 loaded cars loose on the lower deck and battering the sides, Captain Fredericksen had lost his bearings at night. His wireless operator sent out the "S. O. S." call, and near morning the reply came that the ferry must be close to shore. Half an hour later the crew felt a crash. They rushed on deck. "No. 4" was safe at home. In the blinding snow, by some miracle, it had driven through the 260-foot channel into Little Betsey Bay, and it lay to with ice 30 feet high round its masts. The Ann Arbor Railroad car ferries carry loaded freight cars winter and summer between Frankfort, Escanaba, Menominee, and Manistique, Mich.

Chicago Tribune 2/25/23

iron. This done, he had the house filled with cord wood, poured some kerosene on it, and then applied a match. The fire raged for a whole hour, the maximum temperature reached being 2,200° F., but the blocks remained undamaged. Not yet content, the owner then took one of the blocks down to the plant of which he is superintendent, and had it subjected to a pressure of 1,200 pounds to the square inch in a large hydraulic press.

1620 Archt. Henry Zwettcher,
Lancaster, Pa.

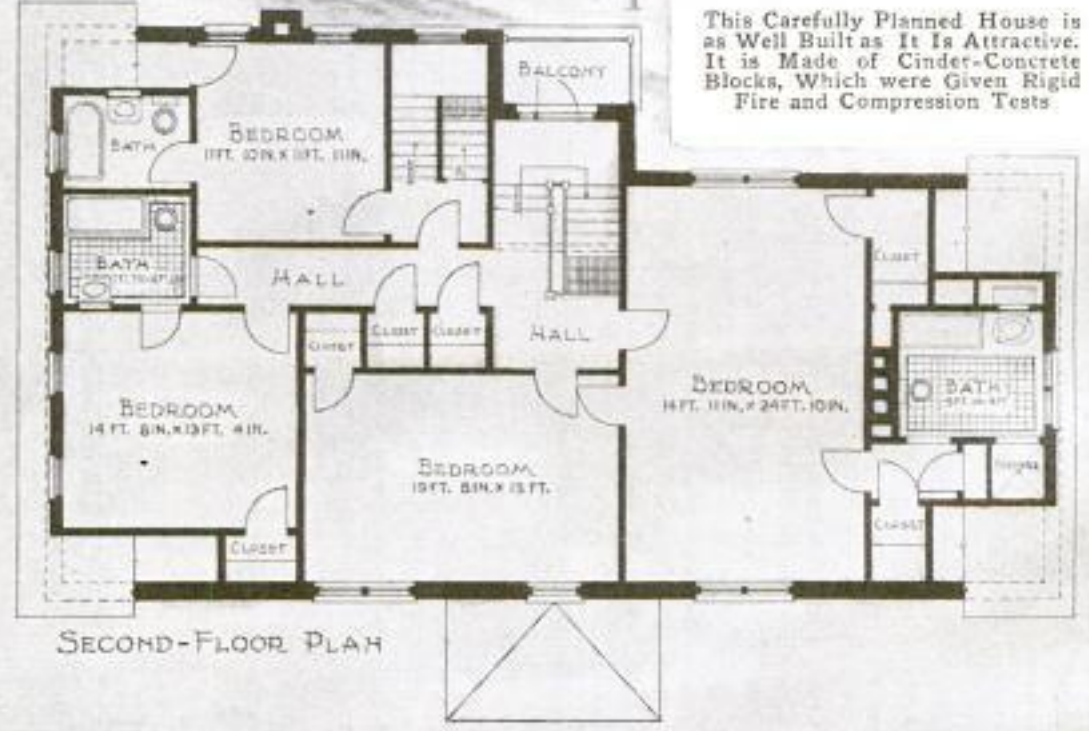
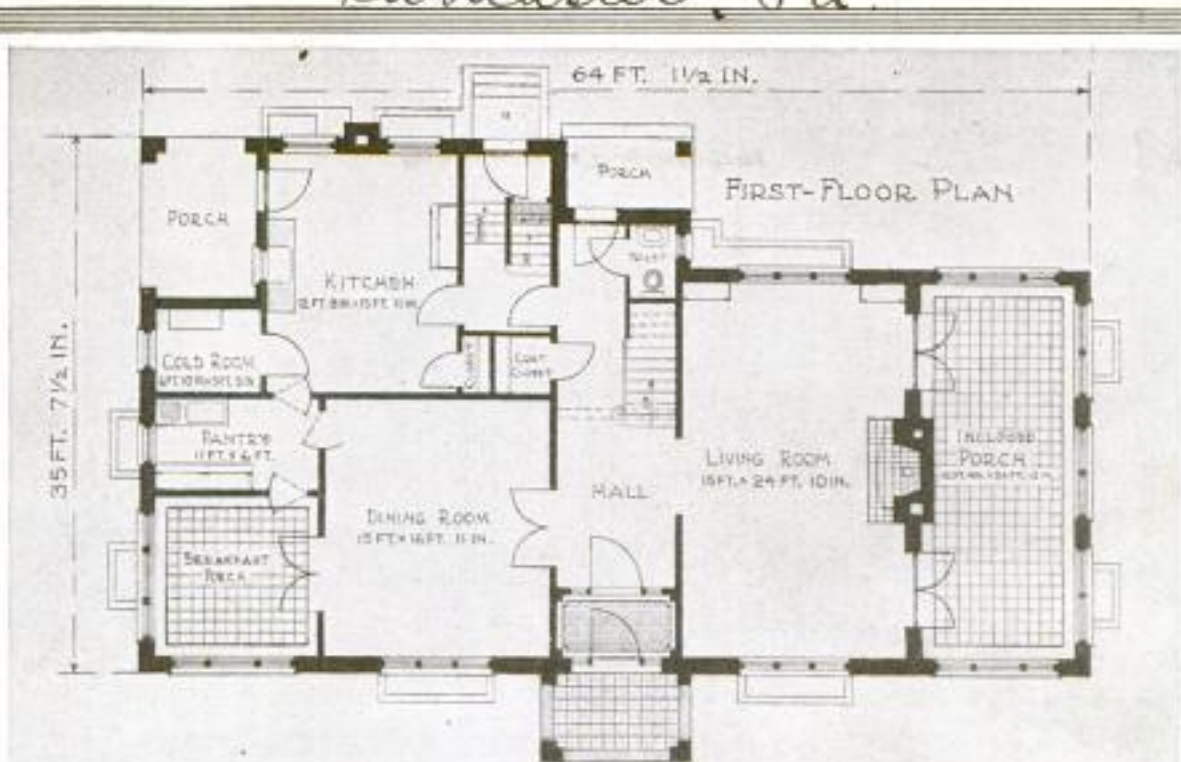

This Carefully Planned House is as Well Built as It is Attractive. It is Made of Cinder-Concrete Blocks, Which were Given Rigid Fire and Compression Tests.

Owner - Alfred Jones, Dupel. Construction with Cinder-
 blocks Lancaster, Pa.

ELECTRIC SWITCH REGULATES TEMPERATURE

1669

A new type of automatic relay switch has been placed on the market which is

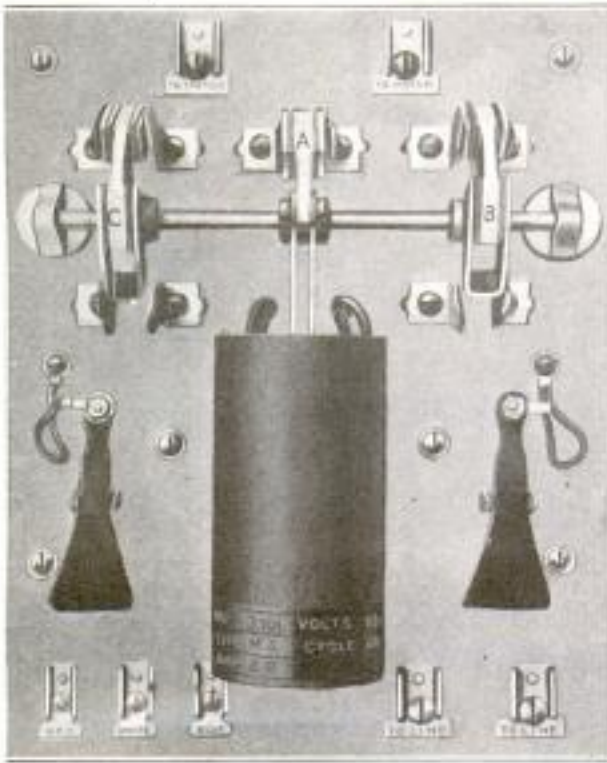

A Heat-Governed Electric Switch: A Is the Main-Line Switch to Apparatus to be Controlled; B Is the Selector Switch, and C Controls the Two Contactors on Either Side of the Containing Cylinder

designed to provide convenient means for temperature control on automatic oil burners, electric refrigerating apparatus, electric heating units, or similar equipment where it is necessary to operate a switch in accordance with temperature changes. The unit is in reality a double-control switch of low voltage, power for which is provided from a transformer built into the relay. The control for temperature changes selectively energizes two low-voltage magnets, which in turn energize 110-volt solenoids, closing or opening the main-line circuit to the motor or other apparatus to be controlled.

1757

PYTHONS IN DALLAS ZOO TO HAVE PADDED CAGES

Hereafter pythons kept in the zoological gardens at Dallas, Tex., will be quartered in padded cages. The death of two mammoth pythons, each over 22 feet long, was due, according to their keepers, to cankerous sores on their mouths and tongues, caused by striking the sides of the cages when devouring their food. They will be mounted and preserved in the Texas Museum of Natural History.

FIRM GIVES KITCHEN LABELS FOR USE ON EMPTY CANS

1797

In order that the consumers of its product may use emptied cans more conveniently as containers for beans, starch, corks, twine, and other kitchen miscellanea, a San Francisco coffee firm is distributing booklets containing 24 gummed labels which may be used to index the cans for the pantry shelves. The labels are red with white lettering, and are 2 1/4 by 3 3/8 inches in dimensions. This affords a neat and convenient way of keeping various kitchen commodities.

PARALYZED MAN IN WHEELED CHAIR TILLS GARDEN

1699

With his combined wheel chair and cultivator and his half-acre garden, William Hartig, of Excelsior, Minn., gives a demonstration of what can be done in overcoming physical handicaps. Hartig has had three strokes of paralysis, has lost the use of his left side, has the use of only two fingers and one thumb, and is unable to stand or walk. Yet, with a chair mounted on a pair of old buggy wheels, he works his garden. Pushing backward with his right foot in his wheeled chair, he cultivates with hoe and rake as far as he can reach, then pushes farther backward for a new start.



Above: Paralyzed Man Working in His Garden with Chair Cultivator. Below: Side View of Cultivator

A. Schullery + Co, 9nd + Holborn
 San Francisco, Calif.

emb. William Allen Ward Box 1614
 Dallas, Texas

Route 1, Box 48

STEEL SKELETON OF CHURCH IS UNUSUAL SIGHT

With its steel skeleton towering skyward and its walls hardly half finished, a church under construction in San Francisco stands as an evidence of a new idea in church architecture. Even to the finials on the steeple tops, the steel structure is complete. Contrasted with the usual method of building a church stone by stone from the foundation up, the skeleton of steel with its interlocking beams and columns and its slowly rising walls is sufficient to attract attention.

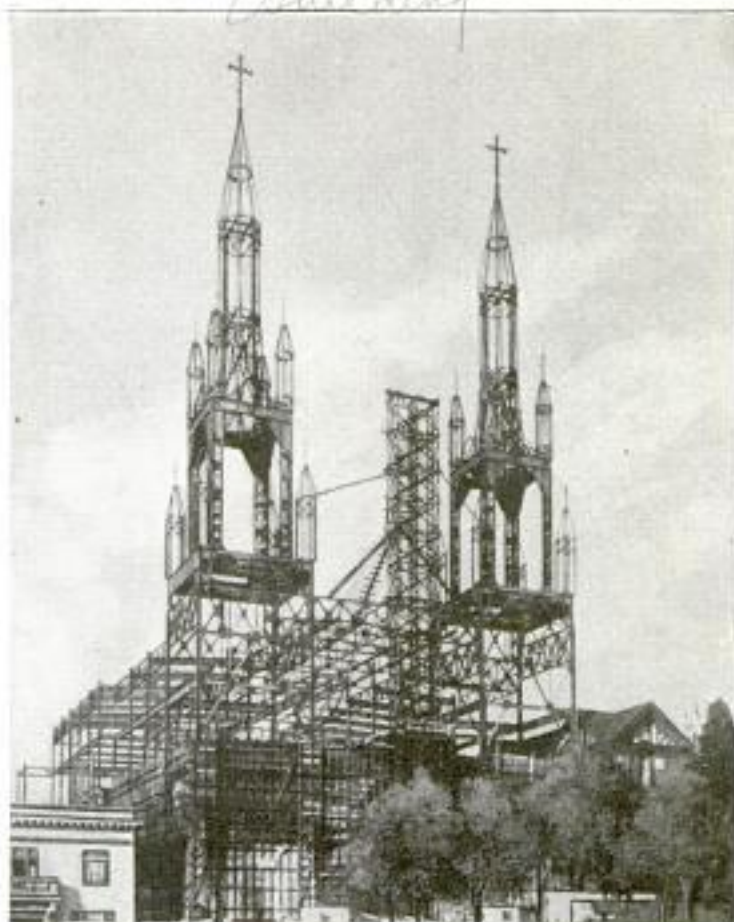

Frame of Church in Construction, Showing Steel Skeleton Far in Advance of Concrete Walls: The Beauty of the Completed Structure is Suggested Even in This Unfinished State

NEW FLUX PERMITS ZINC WELDING

A flux has recently been developed in Germany, that is said to enable the successful welding of zinc. The oxide that forms on the surface of molten zinc is dissolved by an alkaline flux which liberates hydrogen. Not only is continuous welding of zinc possible, but other metals, such as copper and brass, can be joined to zinc with the aid of this flux, which can be applied like solder or made into a solution to form a bath.

TEN-TON JACK HAS PUSH-AND-PULL FEATURES

An interesting push-and-pull jack has been developed recently, which is intended primarily for straightening center

sills on the draft-gear end of railroad cars—the sides of steel gondola cars frequently becoming distorted with heavy

usage—either by pushing apart or pulling them together where bent. The design of the new jack is extremely simple, consisting of a steel screw, ratchet with pawl, and two cast-steel nuts. The latter are provided with flat projections on one side for pushing, and hooks on the opposite side for pulling. Chains and additional hooks may also be attached for pulling in the sides of freight cars which have been bent outward. The jack is made in various capacities up to 10 tons.

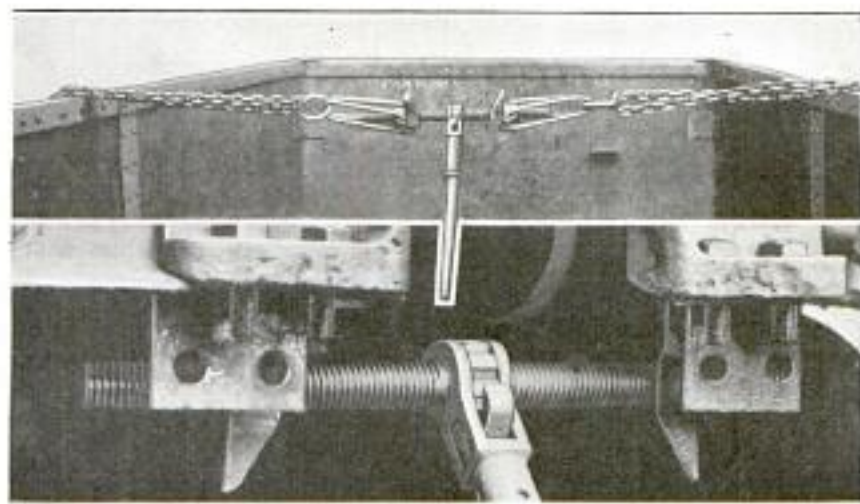

A 10-Ton-Capacity Push-and-Pull Jack, Combining Ruggedness and Simplicity of Construction, for Straightening Center Sills on the Draft-Gear End of Railroad Cars: Flat Lugs are Provided for Pushing, Hooks for Pulling, and Extra Hooks on the Sides for Pulling with Chains

The Huff Mfg. Co., Preble Ave. N.S.
 Pittsburgh, Pa.

Cont. H.C. McLeod

1717 St. Paul St

E. F. Con.

8 Ash St.

738

POPULAR MECHANICS

Baltimore, Md.

Flushing, N.Y.

FIVE MILES OF GRANITE IS
BACK WALL OF HOUSE

CONCRETE PIPE CAST BY NEW
CENTRIFUGAL PROCESS

1502

With the back wall of his house composed of five miles of granite and the

Concrete pipe, centrifugally cast, is now being made at several places in the



Built against the Side of a Mountain, This House in the Blue Ridge Range of North Carolina Has Five Miles of Granite for One of Its Walls

United States, according to a system which has some original features as compared with the methods developed in Germany and later used in modified form in other countries. The first step in the process is building up a wire cage, to the ends of which are tied the metal end joints of the pipe. This is placed in a horizontal cylindrical form which is then partly filled with concrete mortar. The form is revolved rapidly on its horizontal axis, which action throws the concrete against the inside of the form, making what is the wall of the pipe when the concrete sets. The finished units are said to present a smooth uniform surface, and when placed end to end are remarkably true to line and circumference. By means of a special joint the pipe can be made tight for comparatively high pressure, a 20-inch pipe line being in service under a pressure of 50 pounds to the square inch. This pipe has walls 2½ inches thick.

other three of substantial masonry, the owner of a certain home in the Blue Ridge Mountains of western North Carolina is comfortably free from worries about the stability of his dwelling. It is known popularly as "the house with a wall five miles thick." Its occupants call themselves the "cliff dwellers."

☞ Rabbits breed so fast in the Hawaiian island of Laysan and destroy the vegetation to such an extent that the government will exterminate them in order to protect the birds.

1527

ICE SKATING IS FEATURED IN WARM WEATHER

Outdoor ice skating was the novel attraction at a pageant held in Forest Park, St. Louis. In spite of the maximum St. Louis temperature, ice was produced artificially and a surface maintained that permitted skating. The skating rink was 26 by 48 feet in size. First, a foundation consisting of a false floor was built, on which cork board was laid to prevent

heat leakage. Over this came a sheet of waterproof canvas, and on the canvas were supports for the refrigerating coils. Frozen sand made a base for the water which was sprayed upon it, and frozen in 10 hours by the direct-expansion system. So successfully did the freezing process operate, that the skaters commented on the perfect surface of the ice.

1527 The Osrecht Co, St. Louis,
1201 Cass Ave Mo.



In Bright Sunshine and a Setting of Green, Skaters in Sport Costumes Formed an Interesting Feature of a St. Louis Pageant. Note the Contrast between the Skaters' Outdoor Costumes and the Court Dresses of the Other Performers. Refrigerating Machinery was Concealed in the Oval Platform, under the Ice.

DEVICE CONVERTS HAMMER INTO PIPE WRENCH

1296

A new and interesting device is a simple attachment that in a few seconds



makes a pipe wrench out of an ordinary claw hammer. It consists of two hardened steel jaws that swing on a ring which slips over the claw of the hammer. The action is such that the harder the pull on the hammer handle, the tighter the

jaws grip the pipe. It is an inexpensive and convenient device for home use.

1627 HEADLIGHT DIMMER OPERATED BY PUSH BUTTON

An automobile headlight-dimming device, recently placed on the market, is in the form of a push-button control fastened to the footboard of the car. Two wires connect to the headlight circuit and a slight pressure of the foot sends the

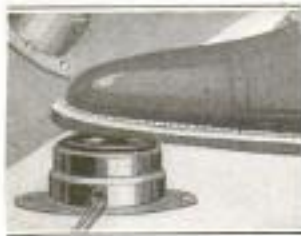

current through the self-contained resistance in the device, instantly dimming the lights. The lights become bright when the foot pressure is removed.

1636 SELF-LOCKING MANHOLE COVER PREVENTS COMMON ACCIDENT

The frequent accidents caused by the tilting of manhole covers in streets are

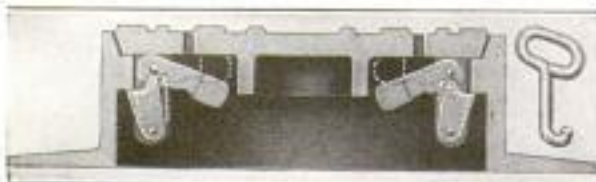

Manhole Cover Which Locks Automatically: At Right is One of the Keys Required to Unlock It

not likely to occur when a new automatic locking device is used. The cover locks automatically when placed in the frame. To unlock it, two keys are inserted through slots in the cover and given a quarter turn, when levers are engaged which release the latches. The mechanism will not unlock without the keys.

1610 SIMPLE BENDER FORMS IRON INTO MANY SHAPES

A handy device for bending bar iron in various sizes of rounds, flats, and squares, has recently been put on the market for the benefit of blacksmiths, repairmen, and farmers. It consists of two forked pieces of steel, each having a number of different-sized holes, hinged together. One end can be fastened to a post or bench, or held in a vise.



1613 POCKET-SIZE TYPEWRITER IS SMALLEST IN THE WORLD

The making of miniature models of comparatively large mechanical appliances seems to have a peculiar attraction for inventors, who often display considerable ingenuity in giving free rein to their hobby. An interesting example of this kind is the recent construction of a miniature typewriter, pocket-size, and claimed to be the smallest of its kind in the world. The machine takes a full-sized letterhead sheet, yet is so small that it can easily be held in the palm of one hand while typing with the other.



COPYRIGHT, KADEL & HERBERT

When you want anything and do not know where to get it, write Bureau of Information, Popular Mechanics, Chicago.

Limit Co, Inc. 1533 Mt. Royal Ave. Baltimore, Md.

conv. with work. Stallman, F. I. D. m.

The Chalners Pump & Mfg. Co. Lima, Ohio.

1637

Com. L. W. Pedrose
617 Pacific Block
Seattle Wash.

WESTERN UNIVERSITY BUILDS NEW RACING SHELLS

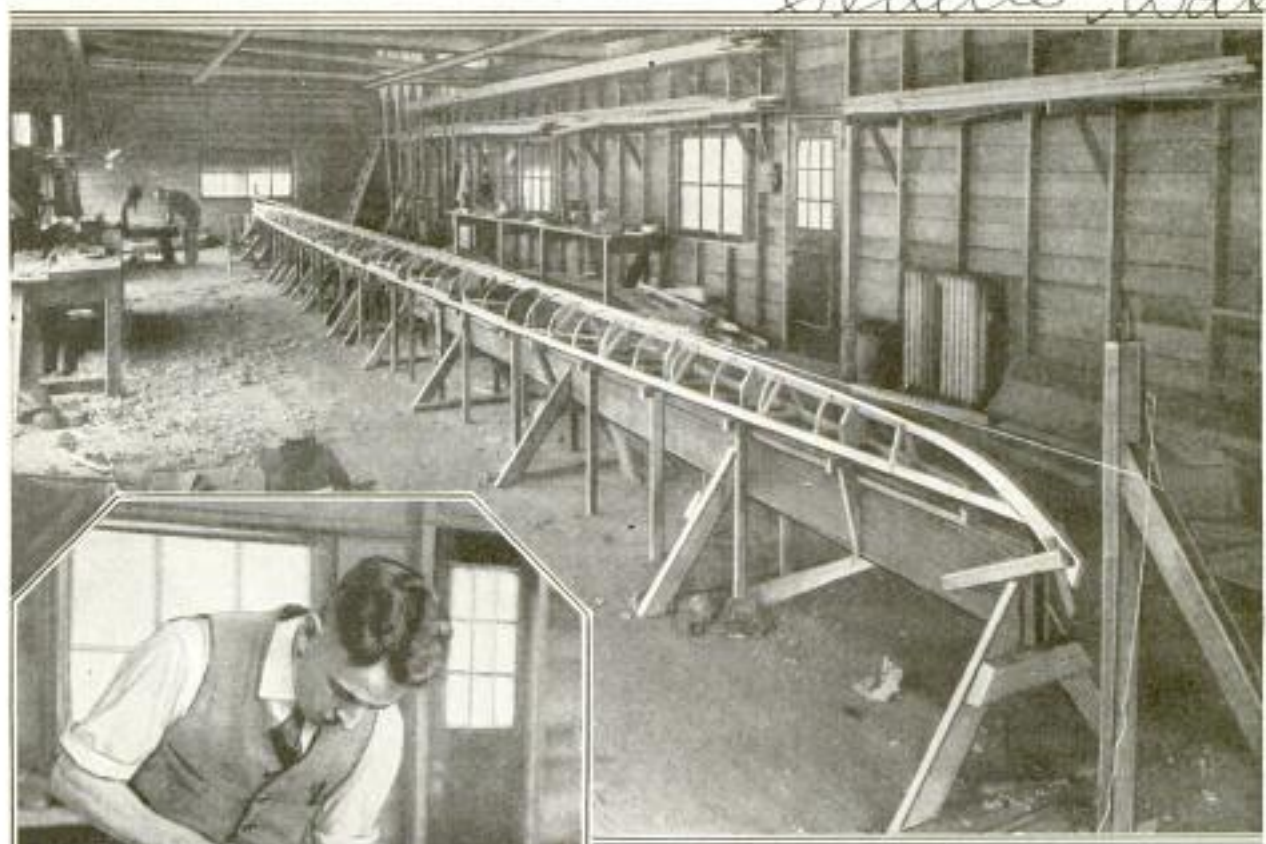

Above: One of the New Racing Shells of the University of Washington in the Course of Construction. The Framing is Made of Spruce and the Planking of Port Orford Cedar. In Order to Meet the Requirements of the Western Oarsmen, the Shell is Designed with a Decided Bow Lift. Left: Close-Up, Showing the Joining of the Keel and Ribs

Determined to achieve superiority in shell racing, the state University of Washington has recently conducted experiments in the design and construction of shells which are said to be revolutionary.

Until new designs were introduced by Washington last year, there had been very little changes in the construction of racing shells since the first craft with a sliding seat was developed. English shells are constructed of sycamore, brought from France, and pine from Norway, and are planked with Spanish cedar, whereas Americans have substituted ash for sycamore in the ribbing. However, the conventional English design, with low forward deck, has been copied both in this country and abroad for several decades.

The new Washington shells are constructed of spruce and Port Orford cedar, materials also adopted for Yale's shells this year. The peculiar stroke of western oarsmen has influenced the de-

sign, and the Washington shells are being constructed with a pronounced bow lift. Western oarsmen are trained to check their shoulder swing and take the weight out of the bow of the shell the instant the stroke is finished. This tends to eliminate the plunging of the forward deck under the water—"sousing." In contrast, the English style is a longer, heavier stroke which gives a full body swing and carries the entire weight of the crew forward in the boat. The new Washington shells are designed to be sensitive to the quick check of the oarsmen's stroke.

On the new shells no bolts are used, braces being fastened to the frame with screws and rivets. The planking, which is only $\frac{5}{16}$ inch thick, is fastened with copper rivets. Use of spruce also is an improvement over Norway pine in that it has a finer grain, is tougher, and is obtainable in greater lengths. The keels on the new shells are $\frac{5}{8}$ inch thick, in 40-foot and 21-foot sections. The completed shells will weigh about 250 pounds.

1621 ICE-SCORING MACHINE SAVES WASTE AND TIME

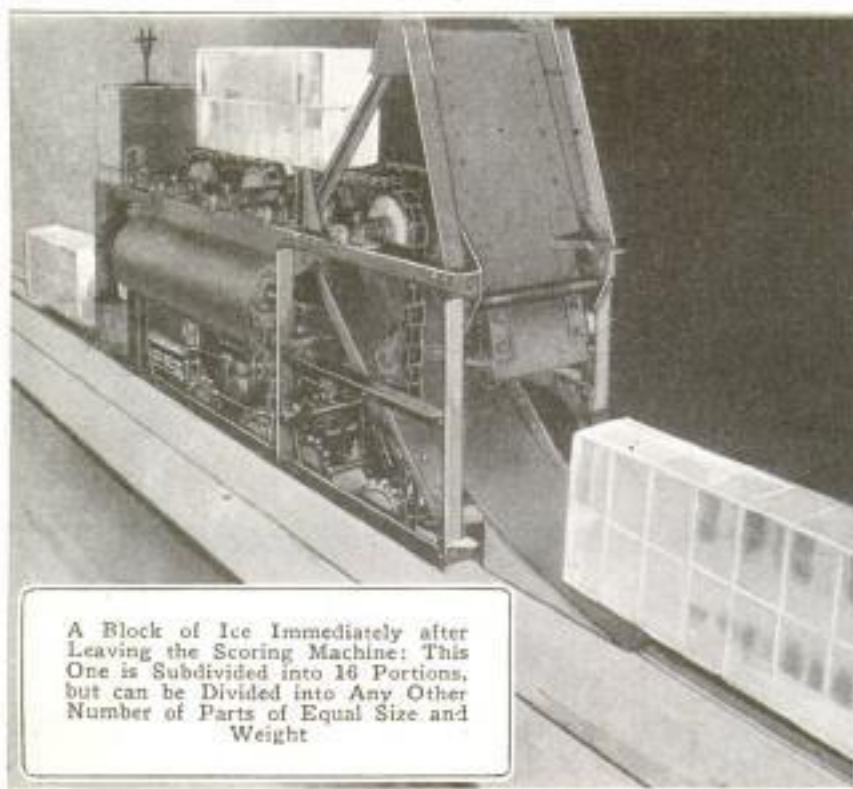

A Block of Ice Immediately after Leaving the Scoring Machine: This One is Subdivided into 16 Portions, but can be Divided into Any Other Number of Parts of Equal Size and Weight

An ice-scoring machine to facilitate the delivery of accurate weights of ice to consumers is now being placed on the market, and is said to be gaining considerable favor among ice cutters. The new machine is entirely automatic in operation, receiving the standard 300-pound cake of ice at one end and turning it out promptly at the other end, scored or divided into any desired number of pieces. It is then easy to disengage one of the smaller portions from the block without waste, and it is also obvious that the machine will save considerable time for the deliveryman.

1489 NEW FACTORY BUILDINGS FORM UPWARD STEPS

With only one direction to extend its buildings and that direction upward, a German watch factory is literally growing uphill step by step. The factory is at Schramberg, in the Black Forest. As the growth of the business required additions to the building, they have been constructed one by one, each a little higher up the steep hill, till the roof line takes on the form of a flight of steps.

1715 WAR-TIME "BULGES" NOW STABILIZE PEACE SHIPS

"Bulges" like those fitted to battleships during the war for protection against mines and torpedoes, are now being added to passenger liners by German ship-builders to give greater stability by balancing the superstructure. The first large vessel to be built on this plan is the "Albert Ballin," a 620-foot passenger and cargo ship launched recently at Hamburg.



PHOTO BY GILLIANG SERVICE
German Watch Factory Which Expands by Climbing a Mountainside in the Only Possible Direction: Its Growth is Marked by Additions Which Rise like Steps

The Engineer 2/9/23

32
Union Square
Copyrighted near 1/21

1687

Kilroy/Harris American
Anthraxasia Bureau
Box 516, 12 P. O. Chicago

Although More Like a Tropical Trading Station or Encampment, This Sunny and Pleasant-Looking Place Is Really a Jail. It is Situated at Broome, on the Northwest Coast of Western Australia, and Serves to Confine Offenders of the Aboriginal Population, or So-Called "Blackfellows"

AUSTRALIAN JAIL FOR "WILDMEN"

THE aborigines—native "blackfellows"—of Australia are born with a natural instinct to kill, and are consequently a great trouble to cattle breeders in isolated parts of north-western Australia. They spear cattle for no apparent reason whatever, except to gratify their lust for killing. Occasionally, when the station owners endeavor to punish them, a white man is killed, and immediately a hue and cry is raised for the murderers. It usually takes months for the mounted-police trooper, who is responsible for law and order over a stretch of country many hundreds of square miles in area, to track down the black-fellow and bring him to justice. Such murders, fortunately, are few. However, the jail is usually full of offenders who are serving terms for spearing cattle, and various minor infractions of the law. The town of Broome, where the jail is located, is the terminus of an important highway and is situated on Roebuck Bay in the northwestern part of Western Australia, not far from the Kimberley gold field. This is the first paying gold field found in that province, and was reported by government geologists in 1882. Then started the gold rush to this part of the continent, which soon led to rich discoveries in other districts.

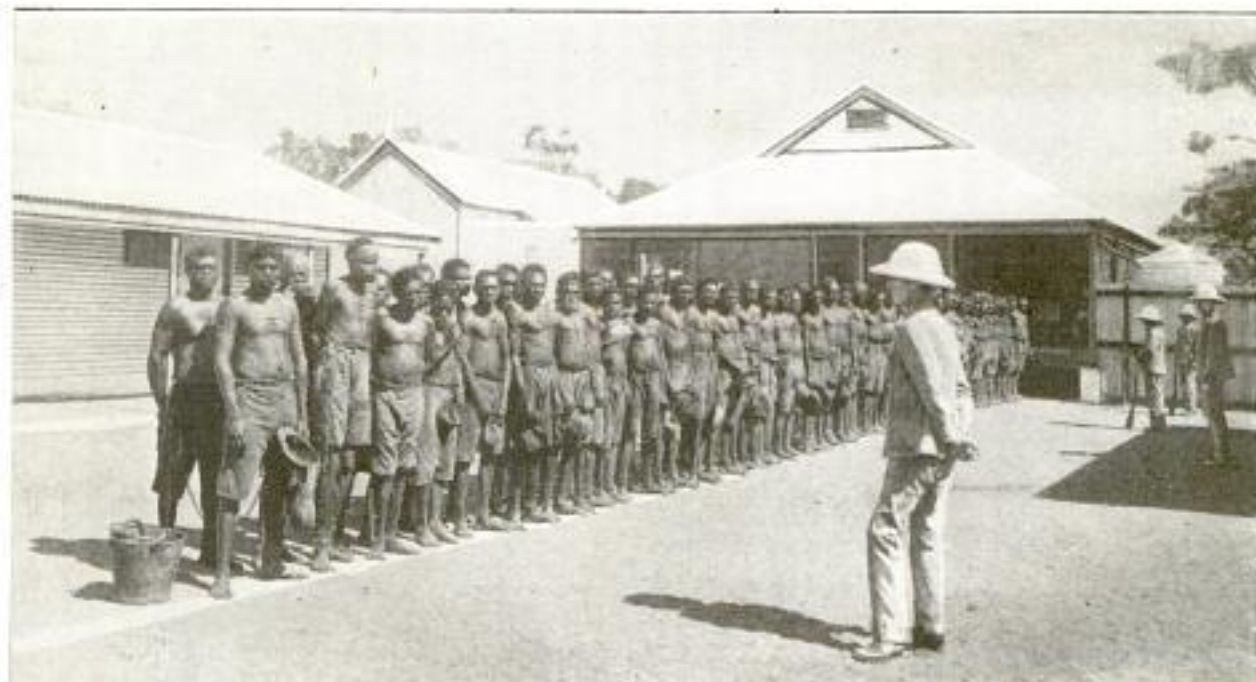

The Blackfellows Lined Up for Inspection in the Prison Yard: The Principal Crime of These "Wildmen" Is Cattle Killing. They Are Very Bloodthirsty and Spear the Cattle of the Ranchmen Apparently for No Reason Whatever, but Criminals of Minor Degrees are Also Kept Here



The Massive Stone Wall and Parapet of the Old Round Tower at Fort Snelling, Minnesota. Indicate Its Original Purpose of Indian Defense

OLD STONE STRONGHOLD MADE INTO A HOUSE

With its massive stone walls and parapet built for defense against the Indians, the Round Tower at Fort Snelling, Minn., on the Mississippi River, has stood for a hundred years in a perfect state of preservation. Now it has been remodeled into a home with modern conveniences for the post electrician of the fort and his family. It stands a few hundred feet from the river.

☛ The depth of natural-gas wells varies greatly, from less than 1,000 feet to over 6,000 feet, the deepest well now producing reaching 6,822 feet.

Bureau of Mines

167 PORTABLE OIL ENGINE RUNS PUMP OR BUCKSAW

An unusually compact and well-planned oil-engine unit, of English make, which is specially suited for farm needs or construction work, has been placed on the market recently. The engine is designed to run a bucksaw, with which it is conveniently mounted on either a fixed frame or a portable truck. A feature is a locking attachment, consisting of a chain and self-holding lever, for gripping a log or any unevenly shaped timber without slippage. The saw re-

quires practically no attention from the operator, as an automatic cut-off comes into play as soon as the piece of wood is severed. The unit, being entirely self-contained, can also be mounted for use as a portable pump, and when so used has a claimed output of 1,000 gallons of

water per hour against a 100-foot head. The engine is of 3 brake horsepower, and must be started with gasoline. The less volatile fuel is, of course, turned on when the cylinder is warmed up.

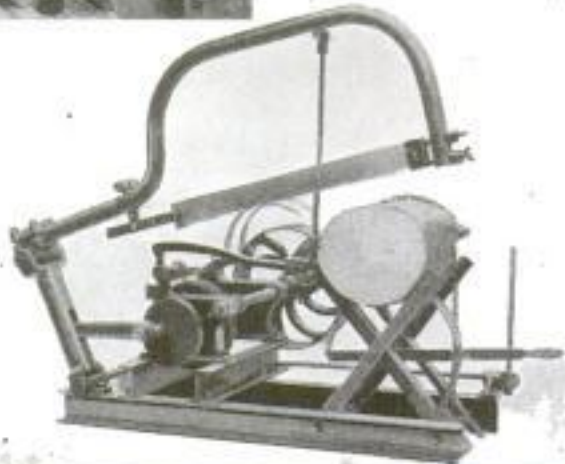
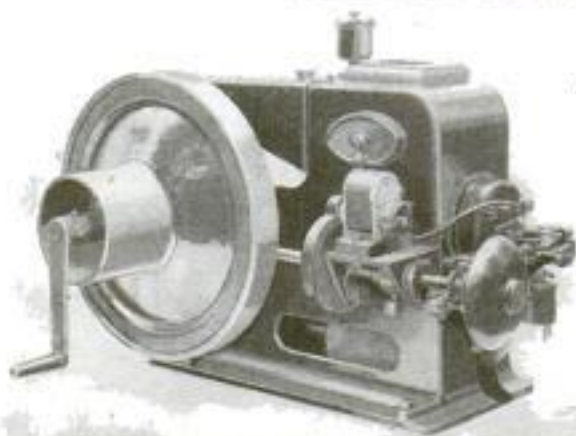

Above: The Bucksaw and Engine at Work Sawing a Log. Both Mounted on a Truck. Left: Engine Alone Dismounted. Right: Saw and Buck for Holding Timbers. Note the Locking Chain and Lever at the Right-Hand End.

W. S. Drummond Bros. Ltd. Salford, England Scotland

1674 Todd Shipyard Corp. 25

POPULAR MECHANICS

Brooklyn New York 15

NEW YORK DRYDOCK TO EQUAL SIZE OF ONE AT BOSTON

A drydock large enough to accommodate the largest vessels afloat will soon be built at New York. Plans calling for a dock of this description were recently approved by the directors of a well-known shipyard corporation. While the exact figures have not been given out, it is intimated that the drydock will be equal to, if not larger than, the navy dock near Boston, which is 1,200 feet long, 149 feet wide, and 45 feet deep.

ALASKAN RAILROADERS MUST BATTLE BIG DRIFTS

Railroading in Alaska in the winter season always proves to be a battle royal against the snow. The snow drifts badly in the cuts, then packs hard and freezes into walls that put up a strong and determined resistance before they are battered down by the snowplows. The White Pass and Yukon route is one of the lines that is hit the hardest by blizzards. It climbs a heavy grade, starting from sea level at Skagway and extending as far as White Horse, a distance of 110 miles.

In the dead of winter, operations are

sometimes brought to a standstill because of the heavy fall of snow. The snow of itself would not be so bad if it were not for the sudden drops in temperature fol-



Tunneling in the Snow to Dig Out a Buried Locomotive on the White Pass and Yukon Route: Note How Firm and Hard the Frozen Side Walls Look

lowing the snowfalls. It often happens that the mercury will register 15 to 25° below zero at Skagway, and up at White Horse it falls as low as 60° below. This means that when a train crew starts out on a run, the members never know when they will get back to the starting point. Railroading in this far-northern region calls for foresight and first-class snow-fighting equipment.

TANK SHIPS USING THE CANAL ARE ONE-EIGHTH OF TRAFFIC

Tank ships using the Panama Canal represented 12 per cent of the entire commercial traffic during 1922. These vessels carried about 1,500,000 long tons of cargo, or 10.4 per cent of all the cargo passing through the canal. The United States led in the number of ships and had 56.3 per cent of the total tonnage; Great Britain was second with 36.6 per cent, and Norway third with 4.3 per cent. However, only 55 per cent of the tonnage of tankers consisted of loaded ships, the remainder being ballasted.



Clearing the Right of Way after an Alaskan Snow-storm: This View Shows the Hard Pulling a Snowplow must Do When the Drifts Are as Heavy as This One

Mr. George Paul Bldg
900 Elsworth
Chicago

artificus
Copyrighted material
2 24/23

*maker. Ed Johnson
 Safety Theatre
 Detroit, Mich*

746

**ATTRACTIVE FLOOR LAMP
 MADE FROM ROPE**

1623

An attractive imitation floor lamp was made entirely from hemp rope recently by the stage manager of a Detroit



Imitation Floor Lamp Made from Ordinary Hemp Rope, the Natural Golden Color of Which Creates a Very Striking Effect

theater. The whole is in the natural golden color of the rope. The shade is covered by a fine net of the same material, to hold the strands in place, and the stand is elaborately ornamented, a basket for flowers around the lower part of the upright being the principal feature.

1649

**GALE LAYS BARE MUD ISLANDS
 IN BALTIMORE HARBOR**

Land unseen for a generation or more was exposed to view in the vicinity of historic Fort McHenry, Baltimore harbor, during a heavy storm last February. Under the influence of a two-day northwest gale, reaching a velocity of 42 miles an hour, a quantity of water, estimated by harbor engineers at several million gallons, was blown from the harbor toward the Chesapeake Bay with the result that the water level at the city pier was lowered by 4 feet 4 inches, by actual measurement. The bar at Fort McHenry, normally submerged, was uncovered to the extent of more than an acre, and Mud Islands, ordinarily under water,

showed above the surface along a frontage of nearly 2,000 feet. Vessels were unable to dock at the Clinton Street ferry because of the low water. Members of the harbor board, in boarding the official tug "Baltimore," found it impossible to step from pier to tug, as usual, and a ladder had to be used. Harbor work which is being done at the piers of the Pennsylvania Railroad, was visible for inspection, although the construction is considerably below the normal water level.

**CUPOLA TAPPER AND STOPPER
 SIMPLE AND SAFE**

In order to do away with the old hand method of tapping and stopping the flow of molten metal from cupolas, which requires experience and skill and is subject to accidents, a mechanical device has been developed. It consists of a piston-operated rod, with a cup at the end, into which is placed a composition ball that fits against the breast of the cupola when the flow is stopped. The piston movement is controlled by an arrangement of levers and rods that may be extended to some convenient point in the foundry. With this device, the flow can be easily gauged and effectively stopped. A counterweighted lever holds the ball in the desired position, and the whole device can be swung to one side for lining the spout or building up the breast.

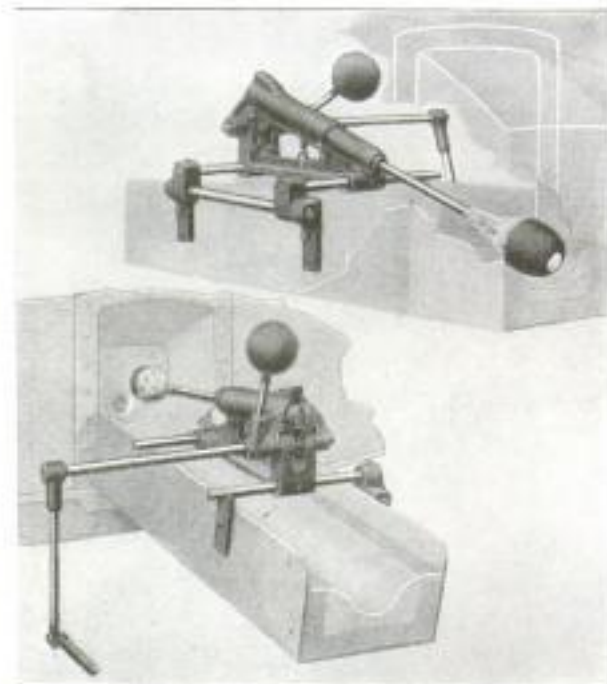

Above: Cupola Tapper and Stopper Device in the Position When the Flow is Stopped. Below: Position When the Flow is Tapped

*The Medart Co.,
 St. Louis, Mo.*

*One! N. C. Inc. Found. 1917
 St. Paul St. Baltimore, Md.*

1638 Cont. L. W. Pedrose,
617 Pacific Block,
POPULAR MECHANICS
Seattle Wash. 547

FLEXIBILITY OF CAR'S DRIVE SHOWN BY DEMONSTRATION

To show the flexibility of the drive of a new light motor car, a novel demonstration was made recently at Seattle, Wash. An ordinary hunting-case watch with the lid open was placed on the brick pavement of a level street and the motor car slowly driven forward. Barely moving, the car crept forward until the left front tire touched the lid of the watch. Then, even more slowly, the car advanced until the lid was forced down and snapped shut. Upon backing away from the timepiece, the driver picked it up and offered it for examination, and it proved to be undamaged.

During the demonstration the driver was aided with hand signals from a man crouching beside the watch. Five, four, three, two, and one-inch distances were signaled by the watcher with the fingers of his hand. When the tire had reached the timepiece, the signal was a shake of the hand. The driver

then lined up with his eye a rivet on the running board with the edge of a brick in the pavement, and by thus sighting was able to gauge the movement forward of the car. An interested group of spec-



Above: Finger Signals were Used to Guide the Forward Movement of the Car. The Flagman is Signaling an Advance of Four Inches toward the Watch. Left: Close-Up of the Watch on the Pavement, with Its Lid Partly Depressed under the Advancing Car Wheel

tators witnessed this test, which reflected much credit on the driver's skill.

EUROPEAN COOKING DEVICE DOES DOUBLE DUTY

With the object of saving every penny's worth of gas, a European invention

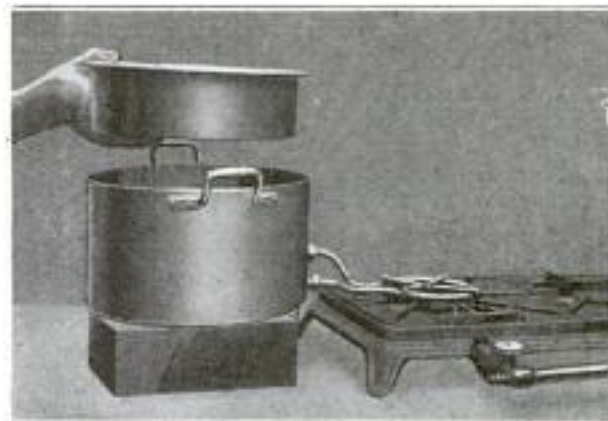

European Gas Saver Cooks with Double Boiler at Left, While Food is Cooking over the Burner

makes a gas burner do double duty. A coil over the burner heats and circulates water through a double boiler beside the gas plate, and while the food in its upper part is cooking, another dish of food may be cooking over the burner.

CLAIM HONEY IS EXCELLENT AS ANTIFREEZE REMEDY

Farmers of northeastern Wisconsin claim to have discovered that honey in the radiators of their automobiles is an excellent antifreezing agent. While certain chemists point out that the substance would gum and stick if the motor became overheated, the farmers in question seem to be well satisfied. It is said that 10 pounds of honey with an equal quantity of water will last through the winter, and that the solution is effective even at as low a temperature as 20° below zero.

Cont. S. A. Higgins, 56
D. 70th St. New York
Maker unknown.

Star - Leonard Motor Co. Agents
Seattle Wash.

UNIQUE PAGEANT IS STAGED BY SPORTSMEN

Seattle Wash.



FOR the purpose of calling attention to the hunting and fishing resources of the state of Washington, as well as for obtaining publicity for a membership drive, the men's Association of Seattle held what is believed to be the first pageant of ever offered. It consisted of a parade, nearly a mile long, of floats depicting various phases of hunting, fishing, and camp life, and in conjunction, a large outdoor life was held at a downtown auditorium. In the parade were men, of various ages from 3 to 70 years, and such novelties as a fish hold a ton of fish, a landing net that would hold a small whale, and an expert fly casters who cast numerous objects into the crowd. Above is shown one of the sets within the auditorium men, while below are two original the parade, an "honest-to-equally genuine trapper."



TO PROMOTE FISHING AND HUNTING INTERESTS

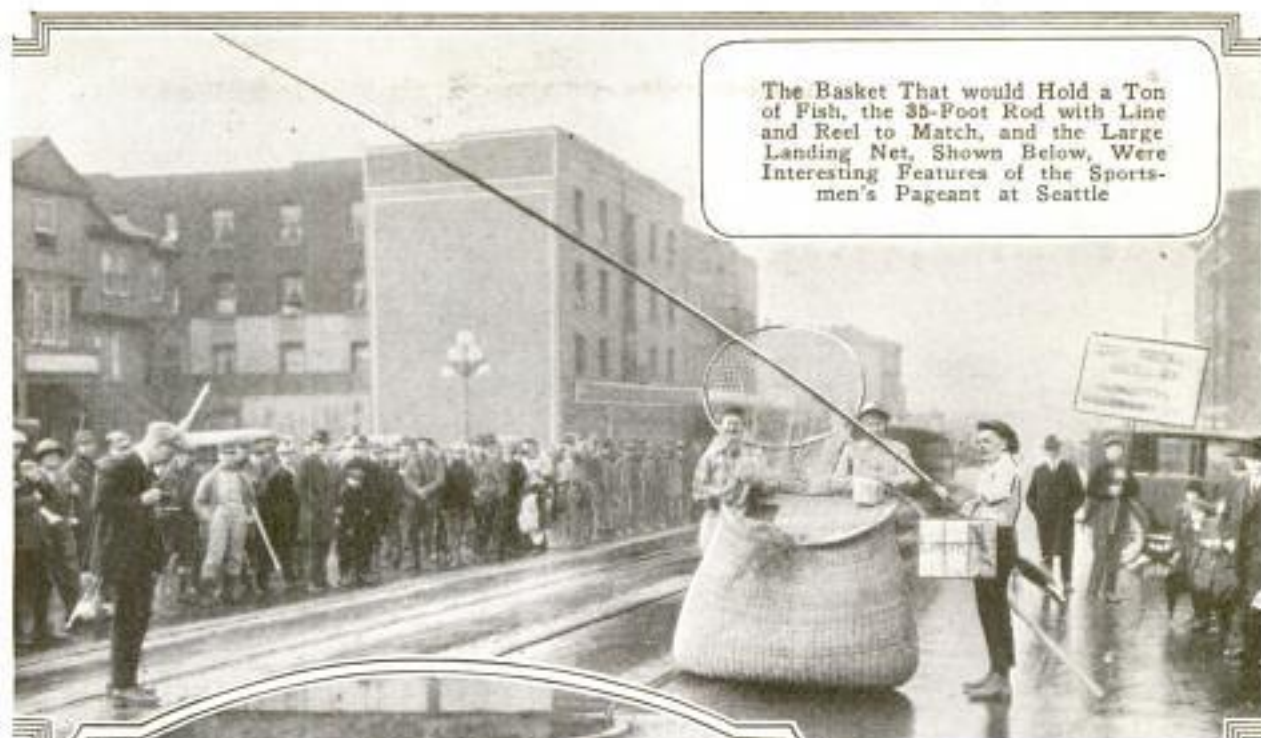

The Basket That would Hold a Ton of Fish, the 35-Foot Rod with Line and Reel to Match, and the Large Landing Net, Shown Below, Were Interesting Features of the Sportsmen's Pageant at Seattle

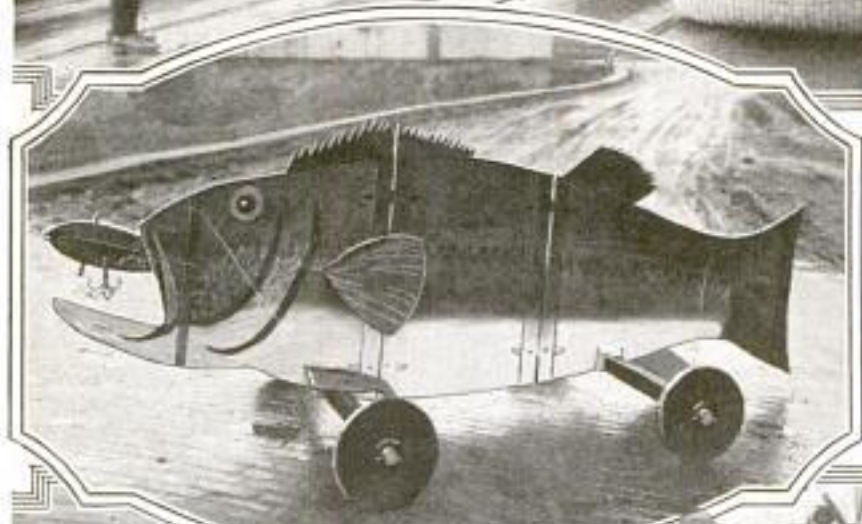

Another of the Unique Wheeled Devices That Appeared in the Parade is Shown at the Left. This Large Wooden Fish was Towed along the Street by a Fisherman, and Wriggled from Side to Side in Imitation of the Movements of a Bass Swimming through the Water



A Float Representing a Fishermen's Camp, Displayed in the Parade by a Neighboring City Which Boasts of Its Fishing Resources: Only Floats Referring to Outdoor Scenes and Activities were Permitted

WOODEN CASE DISPLAYS SEED PACKETS ATTRACTIVELY

A new wooden case for displaying seed packets has one side for displaying vege-



Front of Self-Selling Seed Case: At Left, Shelf for Cash Register; Bottom, Compartments for Grass Seed, Corn, Beans, and the Like

table seeds, while the other holds flower seeds. Three 34-quart bins, pivoting outwardly at either side of the base, a projecting bracket, for supporting a cash register and with compartments for holding bags, at one end of the case, and three carton shelves at the opposite end, are other new features. The case stands about 6 feet high, and is 5 feet in length. There are eight rows of compartments on each side, their size increasing from the top to the bottom row. In all, they contain about 8,000 packets.

"SANDERS" ONCE USED FOR BLOTTING INK

Before the invention of blotting paper, writers with a pen were accustomed to the use of sand to dry the ink on a sheet



Forms of "Sanders" to Contain Dry Sand for Blotting Ink: Left, Wooden Sander, 125 Years Old; Right, Sheet-Iron Sander

of parchment or paper, and some receptacle for fine, dry sand was always found on the writing table. In the picture, two of these "sanders" are shown. The one on the left is of wood, over 125 years old. The other is of sheet iron and of unknown age. Sanders and quill pens were used in the same period.

FOUR-WHEELED ROLLER SKATES HAVE RUBBER TIRES

Standard-size roller skates with rubber tires, recently invented, are said to permit a greater freedom in fancy skating, and at the same time do away with all noise. The tires are of solid rubber, and secured by a flange so that they cannot work off. As with other types, the length of the skate can be adjusted to the size of the foot.



ELECTRIC RIVET HAMMER WORKS WITHOUT SHOCK

Wear and tear on vibratory equipment, such as rivet hammers, is always very severe, due to the shock which is trans-

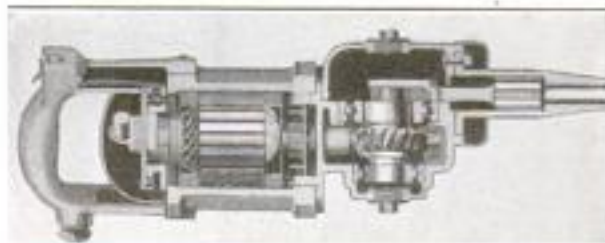

Sectional View of Riveting Hammer and Concrete Drill, Showing Interiors of Motor and Driving Mechanism, and Ball-Bearing Journals

mitted thousands of times a day as the hammer blow is struck. In a new portable rivet hammer and concrete drill now being marketed, the effects of these hammer blows have been eliminated by automatically disconnecting the hammering member from the drive mechanism at the moment the blow is struck. At that instant the hammer rebounds from the blow, affording it a slight longitudinal movement which frees it from the drive, and therefore does not communicate shock to it.

1570
 1672
 James S. Loomis, N.Y.
 L. L. Loomis, N.Y.

Chicago Roller Skate Co.
 4450 Ch. W. Lake

American Iron
 & Steel Co., 430 E. 53rd St.
 New York City.

9584

**HERD OF GOATS
USED TO
PREVENT FIRE**

As a means of fire prevention at the Naval Powder Factory at Indian Head, Md., a herd of Rocky Mountain goats are allowed to roam around the buildings, so that they may devour the dead leaves and other inflammable rubbish that otherwise would litter the ground. The goats effectively remove this dangerous material, as it is all that they have to subsist on.



Part of the Grounds of the Naval Powder Factory at Indian Head, Maryland, Showing the Herd of Rocky Mountain Goats That Eat All Inflammable Rubbish That might Be a Cause of Fire

1670

**NEWLY ARRIVED CANARIES
MUST PASS INSPECTION**

All shipments of birds or other animals into the United States must pass the inspection of experts to prevent the importation of diseased or harmful specimens, and it is a rule which is carefully observed. This is specially true of canaries, which are inspected one by one. They come in large packages, each containing 21 rows of cages with one bird in each cage. Immediately on their arrival the cages are placed in the sunlight and the birds examined one by one. The cages of birds passed are marked with chalk to show that they are approved for sale.



Inspector Examining Foreign-Bred Canaries to Prevent Bringing In Diseased Birds

Chas. E. A. Higgins, 56 W. 70th St., New York.

1559 **USE LARGE CONCRETE PIPE FOR CITY SEWERS**



Transporting a Section of Concrete Sewer Pipe, 108 Inches in Diameter: One of These Pieces of Pipe Weighs About Six Tons

Concrete pipe for sewer construction has in recent months been used in large sizes by several middle-western cities. At one place over 1,000 feet of pipe, 96 inches in diameter, has been used, and at another, considerable pipe, 108 inches in diameter, has been laid. The 108-inch pipe weighs 3,250 pounds per foot of length, and the 96-inch pipe over 2,700 pounds. Considerable skill, of course, is required in the handling and laying of these heavy pieces.

*Independent Concrete Pipe Co.
201 N. West
Indianapolis, Ind.*

NEW EXPLOSIVE MADE FROM SAWDUST

1615

A new explosive compound in which ordinary sawdust replaces the nitroglycerin used in most high explosives,

has recently been announced by the chemistry department of the University of Washington. The discovery consists in the proper cooking of a mixture of sawdust and ammonium nitrate, which have long been known to form an explosive.

It is estimated that the explosive can be made to sell at about one-third the cost of commercial dynamite, as neither the ammonium nitrate, which forms 80 per cent of the mixture, nor the sawdust making up the balance, is an expensive material. The new explosive apparently has the strength and qualities desired in a high explosive. It is claimed to be practically smokeless and that the fumes from it do not cause headache or other physical inconvenience to the user; that it can only be exploded by detonation, that it does not require thawing, and does not burn readily. An effort is being made to make a state industry of the manufacture of the new explosive, which would be distributed at cost for the benefit of farmers and others who use explosives extensively for clearing land and increasing the productivity of the soil. It has been recently demonstrated in public.



Above: Fir Stump, 14 Feet in Circumference, Used in Demonstrating the Effectiveness of the New Explosive Compound. Below: Result of the Explosion of 25 Pounds of the New Compound under the Stump

NEW MONKEY WRENCH WORKS FROM HANDLE

1658

Several interesting improvements have been incorporated in a new type of monkey wrench recently developed and placed on the market. The usual nut for adjusting the jaws has been eliminated, being supplanted by a ratchet which is easily operated from the handle. A trigger at the back of the tool provides quick release of the jaws by disengaging the ratchet. The face of the upper jaw is curved and corrugated, so that the tool can also be used as a pipe wrench when necessary.

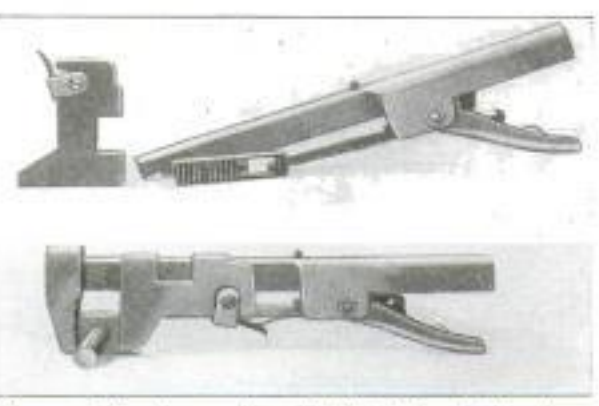

Above: The Lower Jaw of This Wrench has been Removed and Set Up on Its Face, for Use as a Jack. Below: The Assembled Wrench, Showing the Trigger Release and the Ratchet Handle

No. 1. Homerughausen, 2 1/2 E. Grand Ave., Alhambra, Cal.

15171 *Ensl. Herald Kietzechinol*
(Box 3306

Joanuesberg, South Africa



Self-Propelled Railway Car, Which Runs on Gas Generated from the Unburned Carbon in the Ashes Dumped from the Ordinary Type of Locomotive: It Carries Its Own Gas Producer, Internal-Combustion Engines, and Electric Generators That Supply Current for the Motors

SELF-PROPELLED RAILWAY CAR RUNS ON WASTE FUEL

An electric-motor-driven railway car that generates its own electricity has been satisfactorily operated by a South African railroad. The unburned carbon in the ashes dumped from the grates of the regular locomotives, is used as fuel in a producer which generates gas for internal-combustion engines. The engines are connected to electric generators which furnish current to run the two 35-horsepower motors. The control is about the same as in the ordinary street car, and one man can operate the car. The first car weighed about 30 tons, and as it was of an experimental nature, was constructed of such standard equipment as was easily obtainable. Because of the relative scarcity of fuel, the car was developed to meet the need of an economical unit for operation on branch lines.

AUSTRALIAN RABBIT FENCE COVERED BY SAND

Just as snowdrifts cover fences in northern latitudes, the shifting sands in Australia cover the fences erected by the government to keep out the hordes of rabbits which devour the crops. To such an extent does this condition prevail that the fence of wire netting between Queensland and New South Wales has been wholly covered and the drifts of

sand have crept part way up a second fence built on top of the first. Now it is proposed that the Australian Common-



Original Boundary Fence in Australia Covered by Sand Drift, Which is Creeping Up on the Second Fence

wealth float a loan of \$15,000,000 to build more rabbit fences.

Estimates of the available amount of coal in the world will need revision, according to reports from the Belgian Congo, where two coal deposits estimated at over one billion tons are reported to have been discovered. One is 16 feet thick.

*Eng. to. Divisional Superintendent
South African Railways, Beermatun
South Africa*

*Copyrighted material
Australia (Box 516, N.P.C.)*

1500 C. P. Isberg, Berlin,
Friedenau, Germany

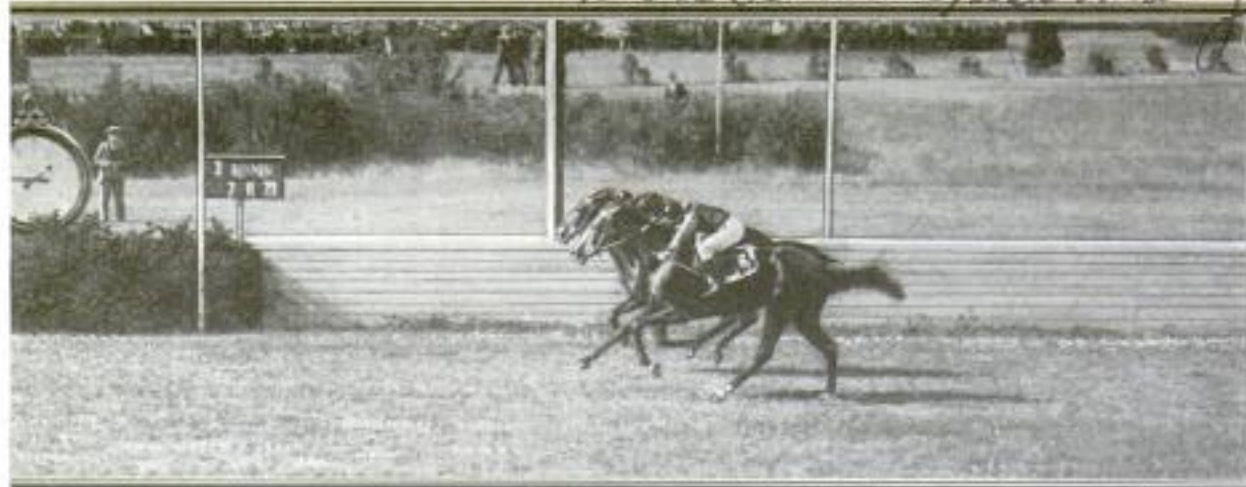

Two Horses Running Neck and Neck at the Finish of a Close Race: Without the Use of the Quintuple Camera, It Is Often a Matter of Compromise among the Judges in Declaring the Winner in a Finish Like This One

ADJUDGING HORSE RACES BY PHOTOGRAPHY

WHEN a group of race horses cross the finish line nose to nose it is difficult to determine the actual winner.



Judges Stand with Two of the Special Cameras Mounted One above the Other

To obviate this difficulty and to eliminate all disputes, a well-known German camera maker has developed a special camera for taking pictures of the finish of a horse race. A moving picture is not wholly satisfactory because it is not fast enough. Experience shows that it is desirable to take a series of five pictures while the horses are moving two yards,

and when it is remembered that horses can do nearly 20 yards a second, it means that these five pictures must be snapped in a tenth of a second. To attain this result, five objectives are arranged one above the other and are provided with very fine, large lenses, and extremely fast shutters, capable of a speed of $\frac{1}{12,000}$ second on a sunshiny day. The cameras are adapted to taking snapshots even when it is dusk. Special arrangements have been made so that a finished picture can be delivered 7 or 8 minutes after the race is finished. The camera is operated electrically, and the intention is to snap the camera so that the middle of the series of five pictures will show the horses crossing the finish line. Two cameras are used, so that if anything happens to one set of pictures, the other set is available.



Five-Story Camera, Designed to Take Five Pictures in Rapid Succession, So as to Record Accurately the Winner of a Horse Race

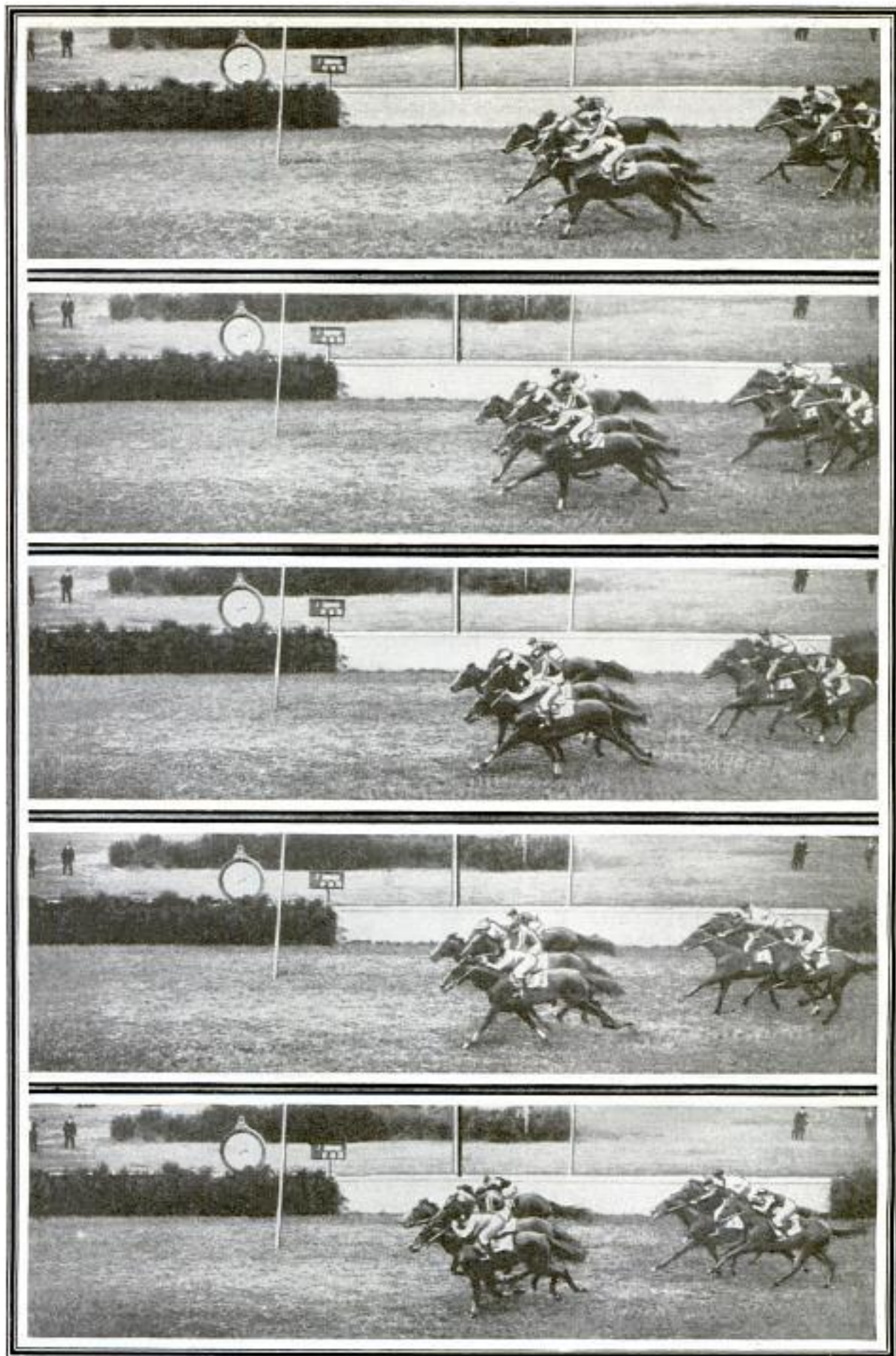

From the Top Down, These Pictures, Which were All Snapped within an Interval of One-Tenth of a Second by the Electrically Operated Quintuple Camera, Show Progressively a Number of Closely Bunched Horses as They Approach and Cross the Finish Line

*Western Reinforced Concrete
Pipe Co. 517th + Main Sts.
756 Los Angeles, Calif.*

POPULAR MECHANICS

**WATER BARRELS OF CONCRETE
ADOPTED BY RAILROADS**

1589

Through the western timberlands, over precipitous mountains, and across arid country, railroads have found some difficulty in maintaining their water barrels,

very bothersome, while up in the mountains the storms are severe, and at times the wooden barrels are destroyed or blown away.

An interesting type of concrete water barrel has been introduced lately on several of these railroads. The barrels are

cast in concrete in much the same manner as a concrete irrigation pipe, reinforced with a heavy basket of galvanized-metal fabric in the center of all the walls. Those in use on the Union Pacific system, and on the San Diego and Arizona branch of the Southern Pacific, have a diameter of 24 inches and a depth of 30 inches. The walls are 2½ inches thick, and the weight is 796 pounds. Each barrel holds 60 gallons. While this type is expected to be especially useful because it will decrease evaporation, it is



Concrete Water Barrels Which are being Introduced on the Union Pacific System, and on the San Diego and Arizona Branch of the Southern Pacific: Less Evaporation Is One of the Benefits Expected

a necessary means of protecting isolated bridges and bridge decking, as well as other structures, against fire. In hot climates the evaporation of the water is

also thought by some that the weight will be an advantage in that it will be too heavy for marauders along the right of way to carry off.

**AUTOMATIC SERVING
MACHINE SAVES TIME
AND LABOR**

A clever device, called a serving machine, has been patented for winding twine and other material on marline-wound cables. Actuated by a ¼-horsepower motor, this little machine can be started at the end of a long cable and will automatically travel to the other end, winding the protecting material on the cable as it goes. It is said to do the work faster and better than six expert riggers could, and as the first cost and maintenance are low, it is thought that it will increase the use of marline-wound cable. The machine was developed by a former navy-yard rigger.

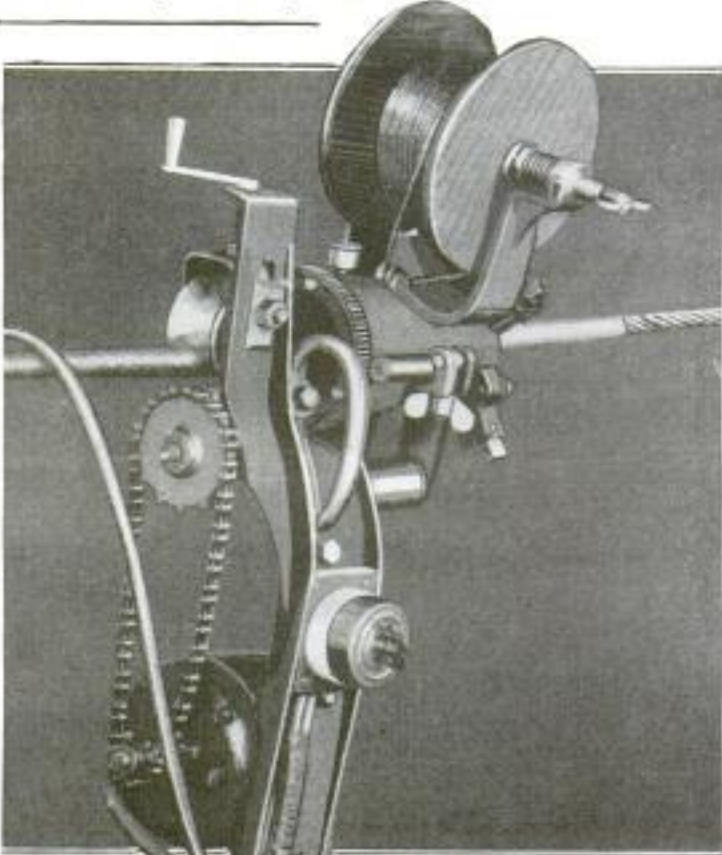

Motor-Driven Pounds, That is Twine around a

Serving Machine, Weighing But 40 Said to Do the Work of Winding Cable Faster and Better than Six Men

ⒸThe Hippodrome, New York's famous playhouse, considered one of the largest in the world, is to be torn down and a \$15,000,000 hotel built in its place.

*Claw, Verge, S. Columbia
angel sound may*

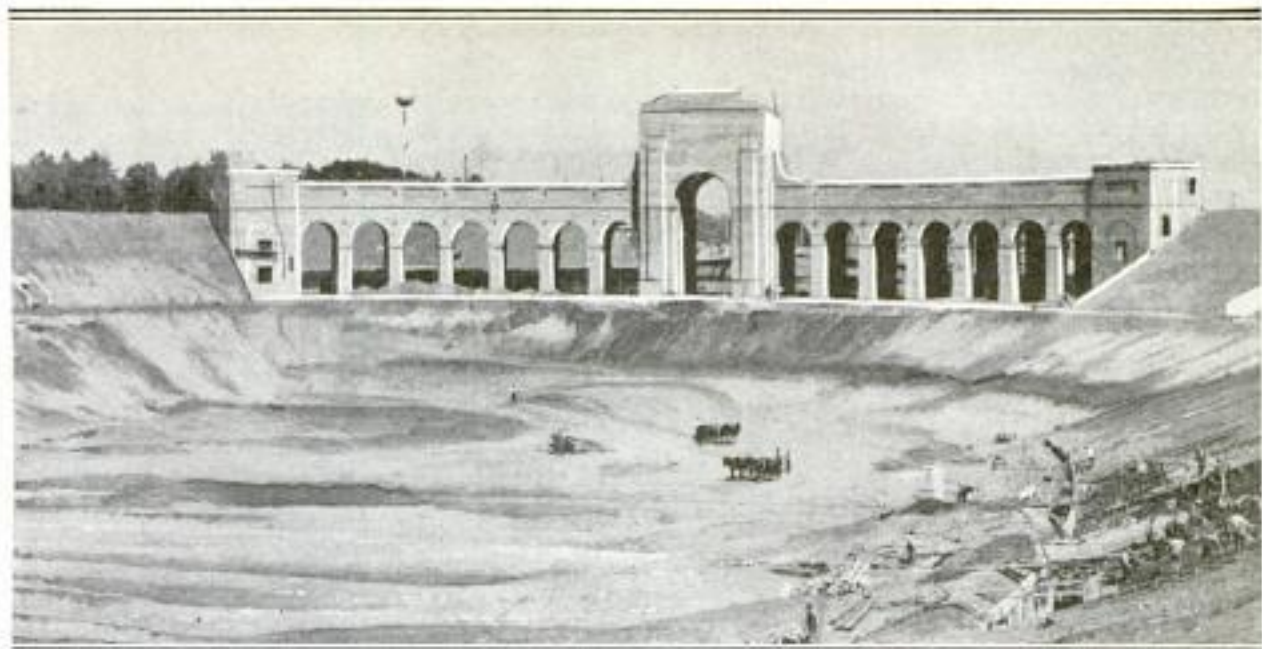

Main Entrance of Los Angeles Stadium, Which, It is Said, will Be the World's Largest Amphitheater: In the Foreground Appears the Excavation for the Bowl, and on the Right Forms for Concrete Construction. The Illustration Gives a Good Idea of the Size

GREAT LOS ANGELES STADIUM TO SEAT 75,000

By FRANK B. HOWE

*412 Masonry
House Los Angeles, Calif.*

FACED with the problem of erecting the largest colosseum in the world—a stadium of the bowl type—at Los Angeles on a plot of land absolutely flat and without any of the natural advantages which often help stadium builders, the contractors devised an efficient working plan.

A huge derrick, nearly 150 feet in height, featured the first stage of the work. It was mounted on rollers on a track encircling the site of the stadium. From the operating engine at the bottom of the derrick a cable was run to the top and thence out to the middle of the



Towering Derrick Used to Operate Bucket for Excavating, and Endless Cable on Which the Bucket Moves

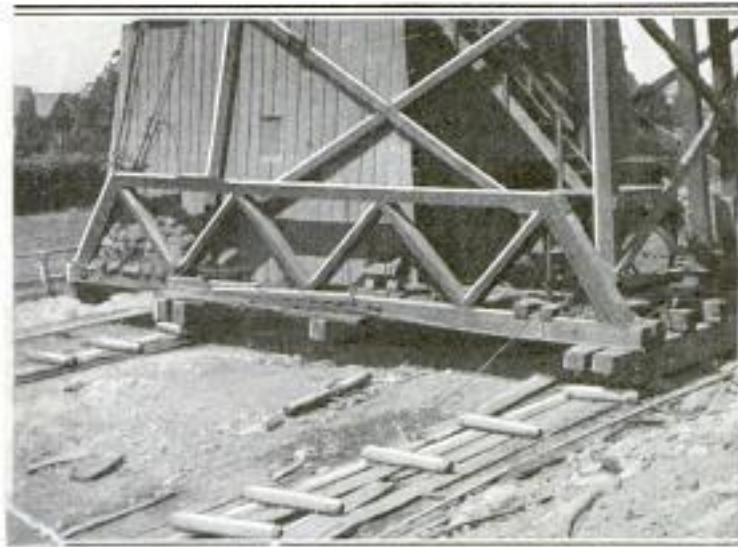

Base of the Derrick, and Roller Track on Which It Traveled in Excavating and Filling for the Bowl of the Stadium: As the Middle was Excavated and the Sides Filled, the Derrick was Moved

stadium. A scraper bucket of extra size was hung on this cable. Starting with the derrick and bucket, the earth was gradually worked from the middle to the outer edge of the arena, lowering the middle and raising the sides. On being placed in position, the scraper digs itself in as it is filled with earth, and when full, the cable drags it to the place where it is to be dumped. Then by reversing the cable, the bucket is returned. As the stadium site is lowered in the middle and raised on the sides, the derrick is moved along on the track and the same op-

eration repeated. When the hollowing-out process is finished, the interior of the bowl is smoothed.

and complete what is said to be the largest amphitheater ever erected.

The middle was excavated to a depth of 32 feet, and the sides rise to a height of 79 feet. The length of the stadium is 1,080 feet and its width 644 feet. It will seat 75,000 spectators who come into it through 103 entrances to fill the 65 rows of seats while they watch the players in the athletic field, 344 by 688 feet in size. Concrete to the amount of 27,000 cubic yards will be used in the construction of the stadium, and its cost, it is estimated, will be about 800,000 dollars.

The stadium will have its first use in the try-out games for the Pacific section in 1924 for the Olympic games in France the same year. And since the stadium



Bowl of Stadium during Construction: Note Rim, 79 Feet High, in Background, Compared with Derrick behind It; Also Forms for Concrete Construction in Left Foreground

With the bowl of earth replacing the level ground, it is a simple operation to line it with concrete, build in seats and a stage, provide the minor requirements,

is built, the people of Los Angeles hope to secure the international Olympic games of 1928 as an event worthy of the new arena.

1560 MACHINE DRILLS HOLES AND INSERTS PINS

What is known as a gudgeon-drilling and inserting machine has been developed for automatically doing work that

ordinarily requires a number of hand operations. The new machine is used principally in the manufacture of wooden rollers. In the middle of the machine is a revolving carrier into which the operator puts the blank pieces of wood. At each end of the machine is a drill spindle carrying a long drill, which makes a hole in each end of the blank piece. The carrier then makes a part revolution, and two other spindles with pusher rods force the pins, or gudgeons, into the holes. The machine is operated by means of cams, and all the operator has to do is to put in blank pieces and remove the finished ones.

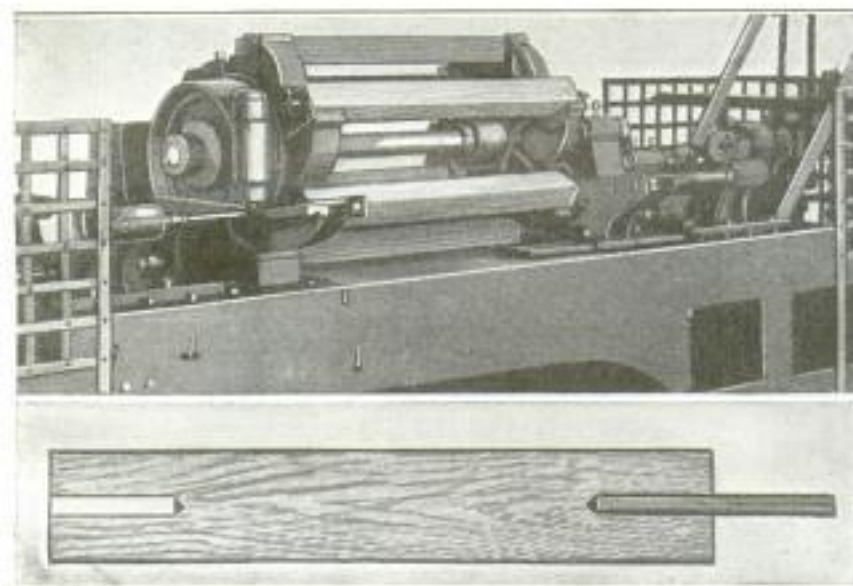

Above: Gudgeon-Drilling and Inserting Machine Which Is Automatic Except for the Placing and Removal of Pieces on the Carrier. Below: Wooden Roller with Holes Drilled and One Gudgeon Inserted

W. H. Moore, 35 Kingwood Road, Toronto, Canada

ENGINEERS CHANGE COURSE OF RIVER IN INDIANA

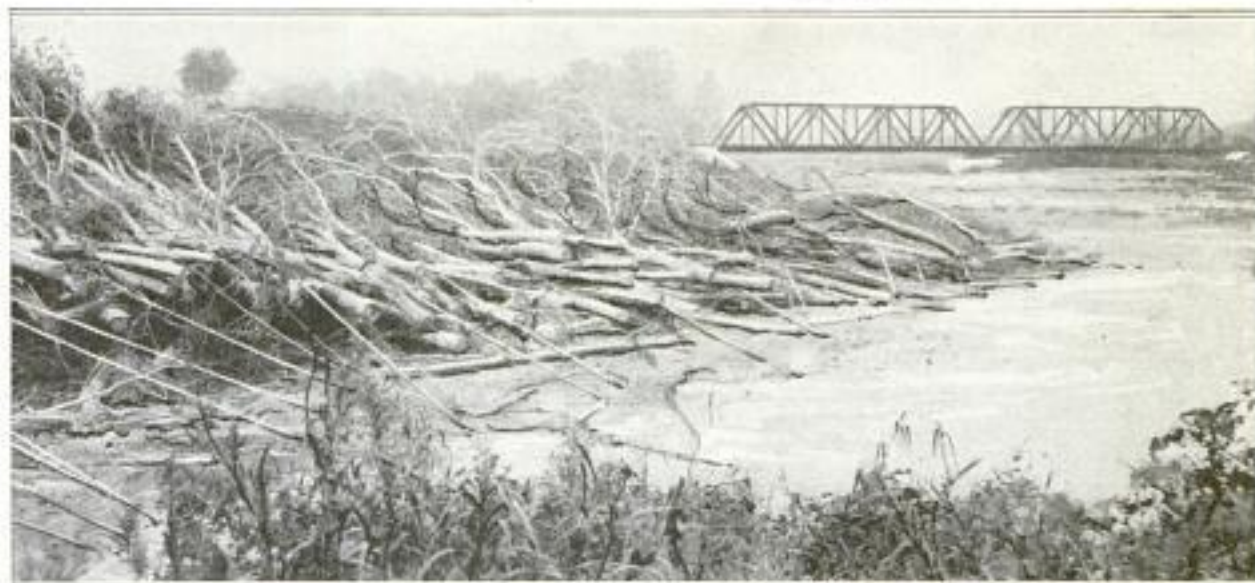

One of the "Retards" Used to Change the Course of the White River in Indiana: Note How the Brush is Held in Place by the Cables Leading to Submerged Piles. The Railroad Bridge can be Seen in the Background

An interesting method of making a river behave itself is being used in straightening a bend in the west fork of the White River at the Baltimore and Ohio Railroad bridge, some 12 or 15 miles east of Vincennes, Ind. Some years previously, the river at this

point had changed its channel, so that it no longer flowed toward the bridge but threatened to eat its way into the railroad grade, a short distance beyond. Carload after carload of rock had been dumped into the river at the point menaced, but with every high water the rock was swept

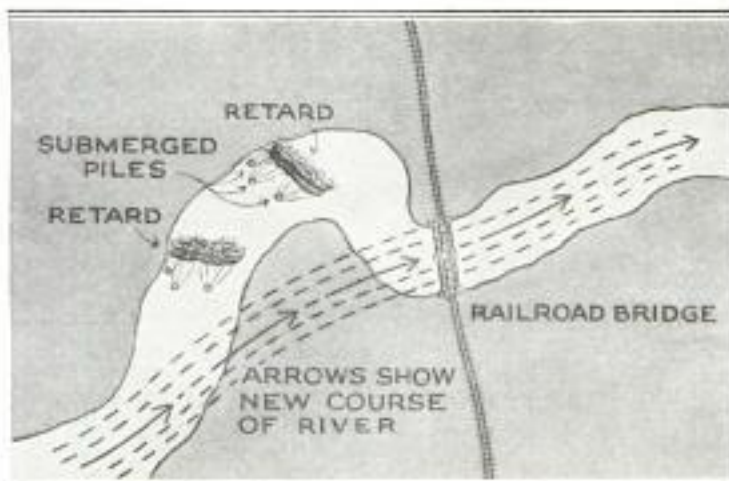

Map Showing the Change That was Made in the Course of the River: The Broken Lines Indicate the New Channel, and the Arrows the Direction of Flow

away, leaving the spot again unprotected.

To solve the problem, the engineers engaged cut scores of small trees, and, by means of a cable and hoisting machinery, lowered the trees into the river at the bend. These, fastened together by

wire, were made to form two "retards," or brush dams, anchored about 300 yards apart, and extending about two-thirds across the river. As a result of this work, the river current has taken such a course that the new channel is expected to run straight to the railroad bridge.

HYDROELECTRIC POWER PLANT NORTH OF ARCTIC CIRCLE

The hydroelectric power plant maintained by the Norwegian government at Glomfjord has a peculiar interest on account of its location 30 miles north of the arctic circle, as well as for its features of construction. Several large lakes into which glaciers discharge, serve as a natural reservoir from which water

is carried in a tunnel, 9,050 feet long, with a cross section of 192 square feet. Two penstocks of welded steel lead to the power house on the coast, giving a head of 1,542 feet. Two turbines have a rated horsepower of 25,000 each, and the third 27,500 horsepower. Current is carried three miles to the point of consumption on two three-phase lines. The cost of the installation was \$5,600,000. The plant has a watershed of 96 square miles.

LIQUID OR POWDERED POISON
872 SPRAYED ON COTTON

Poison, in either liquid or powdered form, may be efficiently sprayed on cotton plants by the use of a recently introduced machine. The outfit.

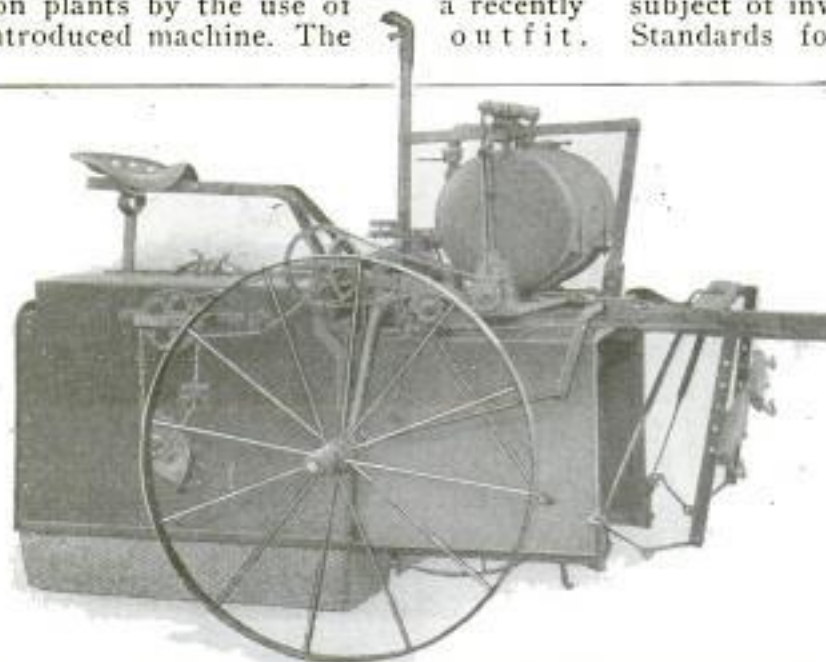

Machine for Spraying Cotton Plants with Poison, Which may Be in Either Liquid or Powder Form: The Liquid is Forced by Compressed Air through Nozzles, and the Powder Blown onto the Damp Plants

consisting of an air pump, blower, spraying nozzles, liquid and powdered-poison receptacles, water tank, and apparatus for directing the sprays, is mounted on two high metal wheels and may be drawn by either horses or a tractor. The usual procedure is to treat the cotton early in the morning while the dew is yet upon the plants, spraying powdered poison upon them. When the sun has dried the dew from the plants, they are moistened with a water spray so that the powder will adhere, or liquid poison is sprayed directly from the nozzles. The appliance may be used also for any other plants that are cultivated in rows and are not of too great height.

X-RAY MOVIES ATTAIN HIGHER PERFECTION

According to competent medical authority, new developments in X-ray movies have been achieved by the use of a new method of sensitizing the photographic plate so as to record new wave lengths never before photographed. Fine details in bone structure have been revealed by the new method, and it is hoped that injuries and pathologic changes, to which the ordinary X-ray plate is blind, will be recorded after further experimentation.

Dr. C. Schneider, Berlin, Germany.

WEIGHTS THAT GROW PUZZLE
BUREAU OF STANDARDS

A curious case of weights that have been increasing in weight has been the subject of investigation at the Bureau of Standards for some time. The three weights were part of a set obtained with a balance at the Seattle, Wash., assay office of the Treasury Department, and their increase in weight was found to account for discrepancies in values given by the balances after being in use a short time. The fact that the other weights of the set showed no such variation, and that the rate of increase was not uniform, complicates the problem. In the first year there was a total gain of about 5 grains for the three weights, and about 7 grains in the next seven months. The next two months produced an increase of approximately 1 grain. No satisfactory solution has as yet been found.

HEDGE TRIMMED TO FORM HOUSE OWNER'S NAME

Allowing the hedge about his house to grow to a suitable height in several places, a resident of Shiloh, N. J., clipped the excess growth to form the letters of his name. While not detracting from



A Resident of Shiloh, New Jersey, Cut the Upper Part of the Hedge at the Front of His Home into Letters Forming His Name

the appearance of the surroundings, this has lent a touch of individuality and distinctiveness to the house.

Edw. Frank Aldham, 3908 Bowser St., Seattle, Wash.
C. Schneider, Berlin, Germany.

March 23, 1913

Ralph W. ^{Dean} ~~Dean~~, Supt. of Construction,
300 3rd N. Broadway
St. Louis, Mo



A Group of Argentinians with Baskets Which They Used to Transport Sand and Gravel to a Pit Where Concrete was Mixed for the Construction of a Packing Plant

BUILDING A PACKING PLANT BY HAND

BY D. C. RETSLOFF

ARGENTINA, the second largest country in South America, takes precedence over all other South American countries in cattle and sheep raising and in the production of beef, mutton, and wool, and has one of the largest meat-packing and cold-storage plants on the continent.

La Plata, a city of 110,000, situated at the mouth of the river Plata, is the home of this plant which was built in an extraordinary way. During the recent war, the Argentinians did not favor the idea of foreign capital bringing industries into their country. Local laborers would not work with Americans, neither would they countenance



Argentinian Workmen Carrying Concrete in Buckets up a Ladder, and Pouring the Concrete into Forms

130 W. W. ^{Dean} ~~Dean~~ St. Louis, Mo
The use of labor-saving devices or machinery. The only way the packing company could erect its plant was by agreeing to employ an entire crew of resident laborers and to allow the work to be done in the old-fashioned manner.

The population of La Plata is almost entirely Italian, French, and Spanish. American foremen found this class of labor slow and stubborn. There were as many different "work spots" as there were materials. For instance, the rock and sand were unloaded at the dock as far apart as possible; the cement was piled at another point; large rocks were carried in a sort of litter to a



Two Workmen with a Litter Used in Carrying Rocks for the Building of the Hand-Constructed Packing Plant at the City of La Plata in Argentina

place where they were broken into bits; sand and small rocks were transported in baskets on the heads of workmen, to a pit where they were mixed with the cement. Then the concrete was carried in small buckets up ladders, where it was poured into the forms.

The cost of erecting this three-story plant was close to \$250,000. Among the 200 men employed in its construction, there were no Americans except the contractors and the skilled machinists. This work offers an interesting contrast to the modern methods used on a construction job in the United States.

996 PHOTOGRAPHER RISKS HEARING TO SNAP LARGE GAS WELL

The workmen who finally succeeded in "shutting in," at Byron, Wyo., what is

photographer recently took a chance at a close-up, he was warned to take not only this precaution but also to fill the outer ear passages with grease, and to bandage them. This to prevent the vibration from breaking his eardrums.

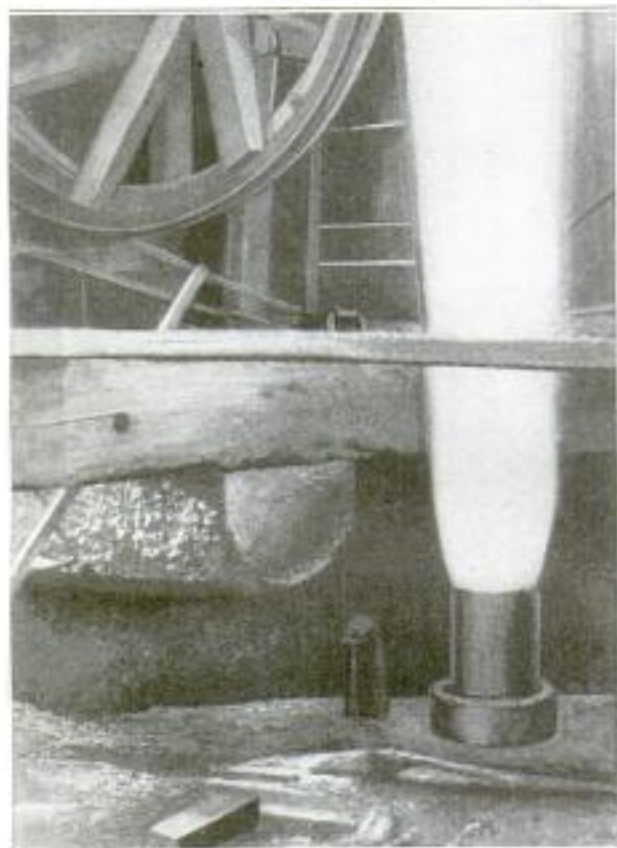

Gas Well Lately "Shut In" at Byron, Wyoming, the Vibration from Which Seriously Endangered the Hearing of the Cameraman Taking This Picture

1193 INTERESTING AMPHITHEATER IN FRENCH HOSPITAL

An operating amphitheater covered with a glass cupola, around the outside of which are the students' chairs, is a feature of a French hospital. The operating table is at the center of the theater. From above, the students watch, either looking directly at the table or seeing the other side by glancing in the mirrors placed about the base of the cupola. Meanwhile, the progress of the operation is reported by an attendant using a telephone, connected to loud speakers in the auditorium.

Mr. V. Pauchet, Paris, France.

11780 CORNELL FINDS IT DIFFICULT TO REPLACE BROKEN OARS

An oar famine faces Cornell University, and Coach John Hoyle has not yet found a supply of spruce sufficiently good to stand the strain to which racing oars are put. These oars are made of white spruce, and the blocks from which they are manufactured must be at least 18 feet 6 inches long, 6 inches wide, and 3 inches thick. As, in addition, the grain must be perfectly straight, and the growth rings small and regular, it has proved difficult to find wood able to meet these requirements. The oars are finished at the university boathouse.

Bristol, Conn., Cornell University. Copyrighted material.

*996
P. L. S. Dodge.
Hansen, Wyo.*



A Bird's-Eye View of the Mammoth 20-Acre Oil-Storage Tank under Construction, Which will Hold 1,750,000 Barrels of Oil When Completed: Its Roof will be Supported by Wooden Poles Set in Concrete Blocks in the Tank's Bottom. The Three Circular Tanks in the Background Are of 500,000-Barrel Capacity

1666
GIANT CONCRETE OIL TANK HAS VERY THIN WALLS

A huge reinforced-concrete oil-storage tank, nearly 20 acres in extent, is rapidly nearing completion in California, and will have a capacity—claimed to be the largest in the world—of 1,750,000 barrels of oil. The depth of the tank will be 16 feet, of which half will be below the ground. A remarkable feature of the construction is that the sides and bottom of the tank will be only 4 inches thick. This was made possible by the extremely careful and ingenious method of preparing and compacting the ground under and around the tank site. Special-treaded tractors were used to repack the soil left at the bottom, which resulted in greatly increasing its density. In this way the concrete in contact with the ground serves mainly to retain the stored oil, transmitting most of the pressure to the previously compacted soil.

1775
NEW RUST-PROOFING PROCESS FOR IRON AND STEEL

A new rust-proofing process for iron and steel consists in electroplating the articles with a coating of metallic cadmium, varying in thickness from .0001 to .001 inch. After plating, which takes about 10 minutes, the article is baked for two or three hours at a temperature of

300 to 400° Fahrenheit. This causes the cadmium to form an alloy with the iron or steel surface, which is highly resistant to atmospheric corrosion.

1681
POLICE "DEAD LINE" BARS SHOPLIFTERS

Shoplifters in New York City have become so numerous and expert in plying their trade as to compel the police department to establish a "dead line" around the shopping centers. Persons with known criminal records found within these areas are arrested on sight. One of the methods employed by the expert shoplifter



is to use an artificial hand as a decoy to distract the attention of the salesperson, while the concealed real hand stealthily tucks away whatever it can reach.

Wolylite - American patented
No. 10000

E. H. Cone & Co. Inc. St. Flushing, N.Y.

Logans 129 E. 47th St. New York

Edwin J. Perron
10207 274, Sawtelle
Calif.

NY Times
1/17/23

764

POPULAR MECHANICS

1075 HOME ON TREE STUMP BUILT BY CIVIL-WAR VETERAN

Rather than pay high rent for living quarters, a Civil-War veteran of California, 75 years old, has built his own



How an Old Soldier Beat the High Cost of Living: High off the Ground This Civil-War Veteran has Built His "Roost," with All Modern Conveniences

home in a tree. The stout branches were sawed off about 12 feet from the ground, and these, together with the tree trunk, form the foundation. The house itself consists of a combined kitchen and sitting room, and a bedroom, the former having running water and a gas stove, while both rooms are electrically lighted. Stairs lead from the ground to the porch of the "first floor," and another smaller stairway at the back leads from this floor to the "roof garden," a fenced-in portion on the roof fitted with chairs and a bench.

Names and addresses of manufacturers of articles described in this magazine will be furnished free by our Bureau of Information.

1667 STREET GAS CUT-OFF VALVE FOR NEW YORK BUILDINGS

A gas cut-off valve on the exterior of all residential buildings exceeding five stories in height, will be required on all houses of this description in New York, if a bill recently passed by the board of aldermen is signed by Mayor Hylan. It is understood that he will sign the measure. The sponsors of the bill claim that it will protect the lives of firemen.

673 U. S. PETROLEUM CONSUMPTION BREAKS PREVIOUS RECORDS

The petroleum consumption in the United States during 1922 was more than 586,000,000 barrels, a new high mark for this oil. A record American production of more than 550,000,000 barrels, and an unusually large import, are also reported. The exports totaled 10,223,000 barrels.

1586 RECORDING INSTRUMENT SHOWS CONDITION OF ROAD

An interesting type of recording instrument has been developed recently to aid highway officials when making surveys of road conditions. The device is intended for use in an inspection car, and is mounted on or near the dashboard, so that it can be connected readily to one of the front wheels. Two recording pencils are actuated through connection with the front axle, and indicate the "ups" and "downs" of the road on a continuous chart scaled 1 inch to 50 feet of travel. The penciled record is in plain view at all times.

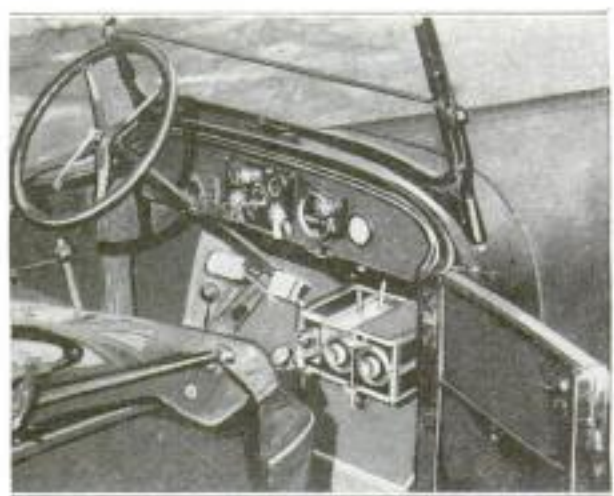

An Automatic Recorder of Road Conditions: A Clutch is Provided So That the Instrument can be Operated, or Disengaged at Will

Universal Road Machinery Co. Kingston, N.Y.



WINGLESS AIRPLANE TAXI MAKES TRIPS OVER SNOW

An airplane fuselage, mounted on skids, was in use last winter as a taxi at Truckee, Calif. It operated on short pleasure trips in the vicinity, and also ran, over snow, to Lake Tahoe, a resort some 14 miles away. The machine, which carried four persons including the driver, sometimes made 120 miles an hour on straight-aways, but, of course, had to slow down to about 85 miles on roads in order to negotiate the turns. Steering was by the usual aerial rudder, while a drag arrangement served as a brake. So successful has the builder and operator been that he plans to place four such machines in commission next season.

1584

DAMAGE TO BRIDGE CAUSES SACRIFICE OF TREE

The associations clinging to a tree which had provided shade and a resting place for many years were not sufficient to save it when the tree's roots damaged the abutment of a bridge on a state highway crossed by hundreds of automobiles daily. The force of its growing roots spread the rock and filling of the bridge abutment, so that when high water came, part of the abutment was carried away. Thousands of spectators watched the felling of the tree. The bridge was moved downstream on rollers, and is in use while a new one is under construction. Then the old bridge will be dismantled.

CAn immense airship hangar recently completed at Scott Field, Ill., for the U. S. Army, is 810 feet long and 206 feet wide, with a clear height of 150 feet at the center. All-steel construction, motor-operated doors, and towing trolleys are features.



The Roots of This Tree beside a Trunk-Highway Bridge Destroyed the Wall of the Abutment, as Shown; Hence It was Removed When a New Bridge was to be Built

Chas. Herbert C. Crocker
Edwardsville, Ill.

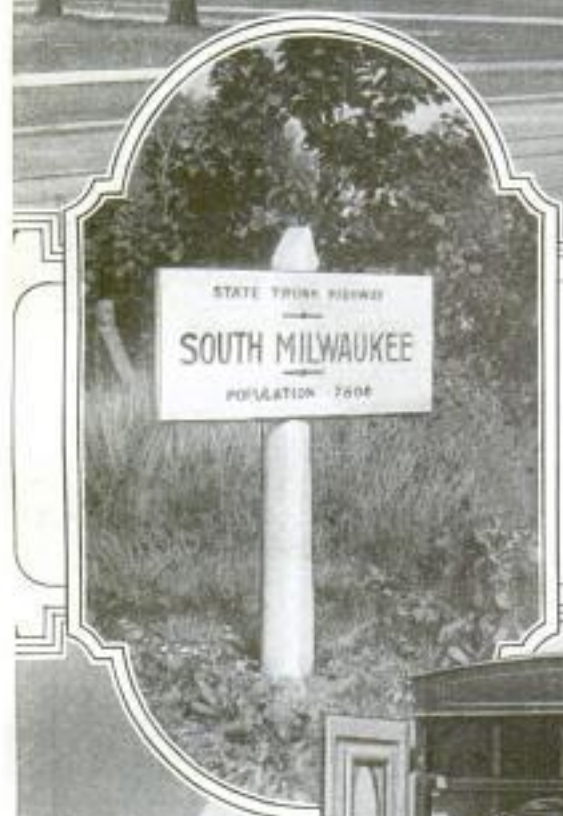
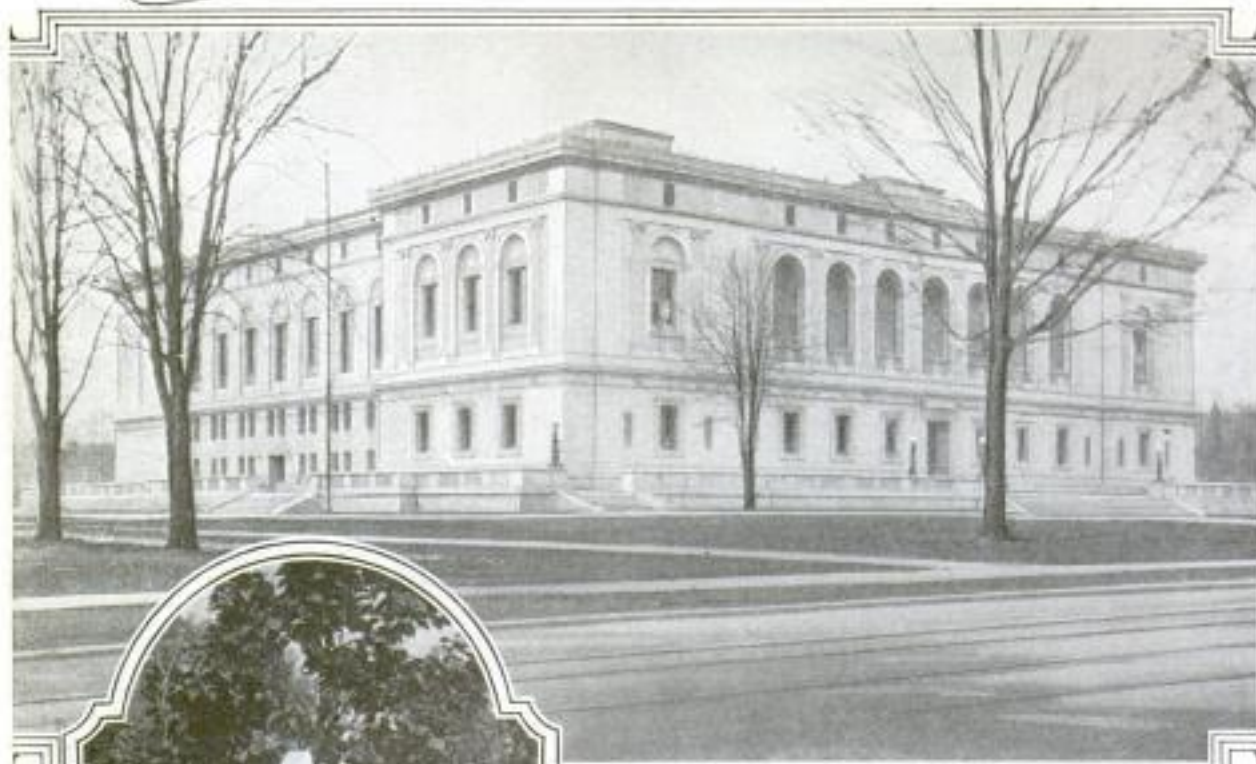

Above: The Beautiful New Public Library of Detroit, Erected on Woodward Avenue, the Most Prominent Thoroughfare of That City. The Exterior Is of White Marble, and the Building Cost Approximately \$2,750,000. Detroit Is More Fortunate than Some Other Large Cities in That It Had Available a Fair Stretch of Land Surrounding the Library. This, with Its Trees and Walks, Adds to the Impressiveness and Attractiveness of the Building. Left: One of the Quite Helpful Road Signs Now being Placed along Its Main Highways by the State of Wisconsin. The Name of the Town is Painted in Large Letters, While Beneath is Given the Official Population



A Motor Coffee Wagon, Equipped with Three Five-Gallon Heat-Retaining Cans for Coffee, One Five-Gallon Can for Soup, and Carrying Sandwiches and the Necessary Cups and Other Utensils, is Maintained by the Fire Department of Baltimore for Use When the Men are Fighting Stubborn Fires

1602

AND ENJOYMENT OF VISITORS AND RESIDENTS



The Building Above, Standing on the Ground upon Which the Battle of Atlanta was Fought, was Built to Exhibit a 400 by 50-Foot Painting That Tells the Story of the Battle. The Giant Canvas is Draped around the Wall of a Circular Room, and There Are Over 1,000 Figures in It. From an Observation Platform in the Center, the Visitor Sees the Battle Scene Presented with Such Intense Reality That He might Easily Imagine Himself Witnessing the Fighting. Right: One of the Life-Size Statues of a University Student, Which will Guide Tourists to the University of California, at Berkeley



This One-Man, Double-Deck Bus, Which Operates in New York, is Fitted with a Periscope to Enable the Operator to Observe the Passengers on the Upper Deck, and with an Annunciator Megaphone Used in Announcing the Various Stops

Leindorf Sales Corp
 31 E. 136th St. New York.

768
 1507

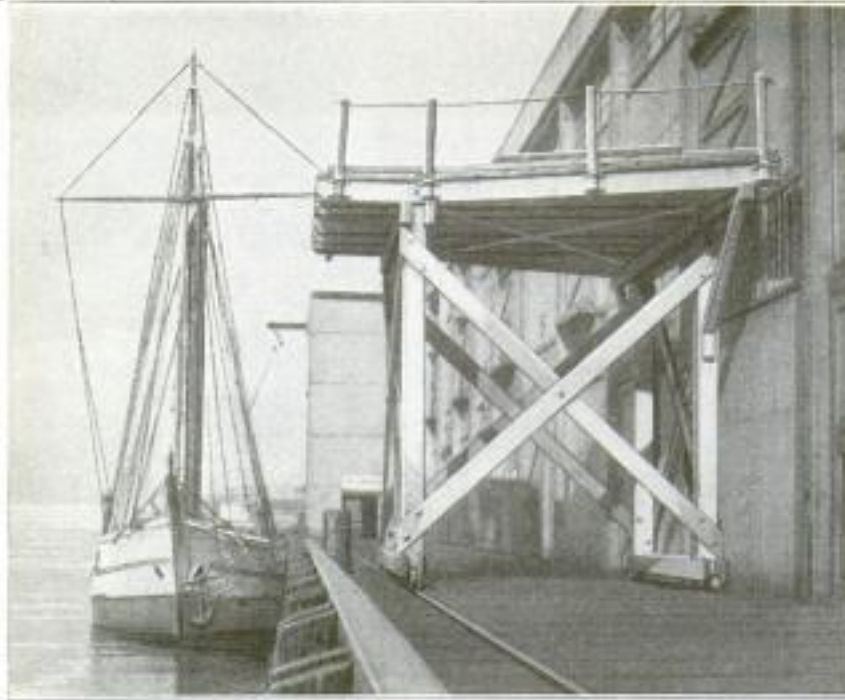

One of the Traveling High-Leg Platforms Adopted by the Port Authorities at Seattle, for Loading from the Second Story of Warehouses into Ships

**HIGH-LEG
 PLATFORM AIDS
 LOADING**

The loading of ships has been greatly facilitated at the port of Seattle, by movable platforms which the port commission has built. The platform is made to register with the floor of the second story of the storage shed, by means of legs carried on wheels that run along the wharf. The outside wheels are double-flanged and run on a steel rail.

☛The electrification of all railways is being considered by the French government.

1299

DISTRIBUTE BRIDGE CONCRETE IN UNUSUAL WAY



Tower at One End of the Bethlehem Bridge: After being Carried to the Top, the Concrete was Fed into the Buckets on Either Side

from the mixers in large dump-bottom buckets, hoisted to the top of the tower, and emptied into a hopper. The hopper in turn fed the material into the wheeled buckets on either side, which were then pulled by cable to the desired point and discharged. The buckets each had a capacity of approximately one cubic yard.



From the Tower, the Concrete-Filled Buckets were Hauled by Cable Out on Trestles Spanning the Arches, and Then Dumped at the Desired Points. The Bridge is to be Called the "Hill-to-Hill Bridge"

Ent. J. A. Wagner, Box 12, Freemansburg Pa.

A little-used method of distributing concrete was employed in the construction of the arches of the Hill-to-Hill bridge at Bethlehem, Pa. At one end, a tower was built from which tracks were laid on two trestles spanning the arches. The concrete was brought

Cont. Francis Oyster
929 E. Sherman St
POPULAR MECHANICS

Hutchinson, Kans.

CONVENTION TO BE HELD
1546 IN DEEP SALT MINE

SKIING TAUGHT IN INDOOR
1255 SCHOOLS IN NORWAY

The state convention of the Kansas Knights of Pythias, which will be held next fall at Lyons, can claim two distinctions: It will be the largest lodge meeting ever held in a deep mine and also the only one ever held in a rock-salt mine.

"Ski-running," says a famous British figure skater, "is not for the timid, but it

The vast gallery cut in solid rock salt, in which the air is perfectly pure and there is no moisture, will be turned into a veritable palace of the Arabian nights. The walls of glittering salt will reflect the brilliancy of hundreds of electric lights. The roof is upheld by huge crystalline pillars. The floor of pure salt is polished until it is as smooth as a lake of ice. Music will be furnished for dancing merry-makers after they have disposed of the affairs of business.

This mine goes over 1,000 feet straight down into a vein of rock salt 400 feet thick. It is reached by two elevators controlled by an engine housed in a building above the ground.

The meeting is scheduled for Oct. 16-17, 1923, and probably 2,000 delegates from all parts of the state will be entertained in this unusual setting, as the novelty of the affair is expected to bring out a large number of interested participants.

FOULING OF SHIPS' BOTTOMS
INFLUENCED BY COLOR

The color of paint on a ship's bottom is an important factor in the amount of fouling that occurs, according to a series of experiments recently completed. The results showed the fouling to be greater on a dark surface than on a light one, the difference between white and black painted surfaces being particularly marked. Barnacles especially seemed averse to light color.

Science 2/16/23



COPYRIGHT IN THE UNITED STATES BY THE ILLUSTRATED LONDON NEWS
An Indoor Skiing School for Norwegian Girl Beginners: A Portion of a Gymnasium has been Converted for Instruction Purposes, and a Wooden Bridge Erected for the Ski Novices to Practice On

is the king of winter sports." In recent years the popularity of this difficult art has increased rapidly, and in the Scandinavian countries, the original home of the sport, indoor training schools are now being established for teaching the elements of the sport. A wooden bridge is used for this purpose, having inclined approaches, and enabling beginners to practice balancing and acquire the necessary confidence when negotiating the slopes.

Our Bureau of Information will answer all questions regarding articles appearing in this magazine.

American Salt Co. W aldrup Bldg.
Kansas City, Mo.

The Illustrated London News 12/27/23
London News Agency, 48 Fleet St. London, E.C.4, Eng

SOME NOVEL AND LITTLE-KNOWN ACCESSORIES



Bill Fold with Stamped Straps, Which Show Each Denomination Separately, Preventing Mistakes



An Air-Tight Water Bottle for the Bird, Insuring a Week's Supply of Fresh Water: The Bird cannot Bathe in It



A Parrot, Attractively Stained in Natural Colors, and Having a Small Interior Tubular Lamp



This Combination Bassinet and Baby Carriage Prevents Damp or Chilly Drafts from Reaching the Child, and Baby can be Carried Indoors or Out without Excessive Handling



Rubber Work Mitten, Fitted with a Flap for Ventilation Purposes



This Is the Perfect Butler, Who Has All Things to Hand for His Master's Service. He is Electrically Connected, and Holds a Reading Light Aloft and an Ash Tray, in One Hand, While the Other Balances a Glass and Tray, as Well as a Box of Matches in Case the Electric Cigar Lighter does Not Work

Adjustable Bread Slicer Which can be Attached to Any Knife, for Cutting Slices of Uniform Thickness: The Thickness of the Slice can be Regulated by the Wingnuts on Each End

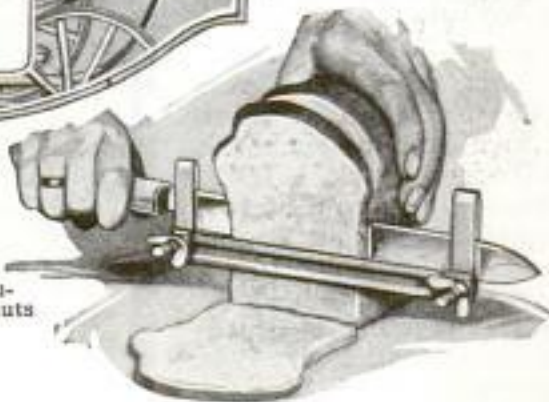

Self-Draining Laundry Tubs Which Take the Backache Out of Wash-day: The Tubs Tilt Forward, and are Telescoped with the Frame When Not in Use

1600

INTENDED FOR THE HOME AND ITS MEMBERS



A Combination Cover Clamp and Lifter, Making It Easier to Keep the Lid Closed Air-Tight, or to Lift the Cooker When Hot



This Pocket-Style Toothbrush Is for Travelers and Others. It Folds into Its Case, Which is Perforated for Ventilation

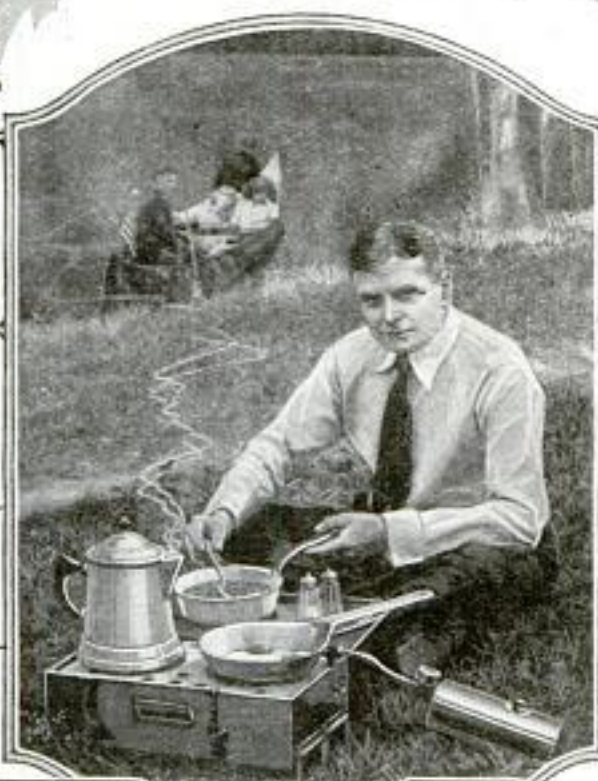

Portable Camp Stove in Which All Parts are Securely Attached to the Case, Even the Legs being Hinged: Right, All Folded Up. Its Weight Is Only 13 Pounds



Sanitary Drain Flusher for Attachment to the Kitchen Sink: The Hand Plunger Forces the Dirt Out



A Sanitary and Convenient Kitchen Utensil That Does Away with the Old-Fashioned Sink Broom and Drain Brush



This Nail Buffer Has No Hard Backing and Conforms Nicely to the Curve of the Nail



New Laundry Accessory: A Combination Washboard and Wringer



A Convenient Set of Three Chairs, Which can be Nested Together, When Not in Use, as Shown at the Right

*I installed in works of Chicago Sunday Evening Club
 1576 772
 1576
 POPULAR MECHANICS
 Utica, N.Y.
 Chicago*

**CHAIN AVERTS EXPLOSIONS
 IN DRY-CLEANING PLANTS**

Fires caused by benzine explosions occur more or less frequently in dry-clean-



An Effective Device for Preventing Explosions in Dry-Cleaning Plants: The Chain Which the Workman is Holding Serves to Ground Static Charges of Electricity

ing establishments, but none has happened in an eastern plant since the adoption of a simple device for grounding static electricity when a workman is reaching into a washing machine. When doing this, the workman merely holds a chain which is connected to a water pipe, thereby grounding himself and conveying the static electricity to the ground. It is well known that substances like cotton, linen, silk, and especially unwashed or undyed wool or textiles, become more or less electrified when rubbed. When this is done in a bath of benzine, the latter also becomes electrified, but with an opposite charge, and a spark may form at any time, exploding the fumes from the very volatile and inflammable fluid. This condition is the most frequent cause of explosions and fires in dry-cleaning works.

(The best snow men modeled in the various playgrounds by school children of Jersey City, N. J., were awarded prizes in a contest held this winter by an official of that city.

**SUNDAY CLUB OF CHICAGO
 BROADCASTS PROGRAMS**

The Chicago Sunday Evening Club, a nationally known, nonsectarian organization founded by prominent Chicagoans to promote the moral and religious welfare of the city, and meeting for years at Orchestra Hall, on Michigan Ave., has lately been broadcasting its programs. These programs are somewhat similar to those given at the Town Hall, New York City, and include talks by men well known throughout the country. Henry Van Dyke, Charles Hughes, William H. Taft, and the late Lyman Abbott are among those who have spoken at the club during recent years.

**ALL-STEEL STEPLADDER HAS
 MANY ADVANTAGES**

An interesting improvement over the bulky, heavy stepladders of everyday use is a new type; of all-steel construction, now being marketed. In addition to its light weight and space-saving qualities, the ladder embodies many safety features of unusual interest. Nonslipping steps have been provided as well as guard rails, and springs and other weak features have been eliminated. The ladder is mounted



A Lightweight, Space-Saving Stepladder: Note the Locked Construction of the Sliding Hinges to Prevent Premature Closing

on casters, and is also equipped with overhang hooks at its upper end to prevent slipping.

*new York Machinery Co
 200 7th Ave
 Copyrighted material.
 new York Ci*



Building an Ice House around a Stack, 31 Feet High, with 10 Feet More to Go: A Prolonged Cold Spell Necessitated Storing This 3,000-Ton Pile Out in the Open, and the House was Subsequently Built over and around It

USUAL ICE-STORAGE PRACTICE IS REVERSED

A prolonged period of sub-zero weather found one eastern ice company so swamped with the large harvest as to necessitate unusual means of storing the unexpected excess. Its storehouses being already filled, the company stacked more than 3,000 tons of ice out in the open, in a space immediately adjoining one of its storage houses, and then proceeded to build a shelter about the huge ice pile. The ice was stacked in 12-inch layers, and was piled up to a total height of 41 feet before being roofed. This reversal of usual storage methods was also accompanied by a considerable saving in loading cost, due to the plentiful light and also to the freedom of movement possible when working in the open.

BAR HOLDING MAGAZINE FILES FITS ON NARROW LEDGE

To save space in libraries, in the office, or in the home, an inventor has designed a rack for holding newspapers or magazines which can be put in place on the

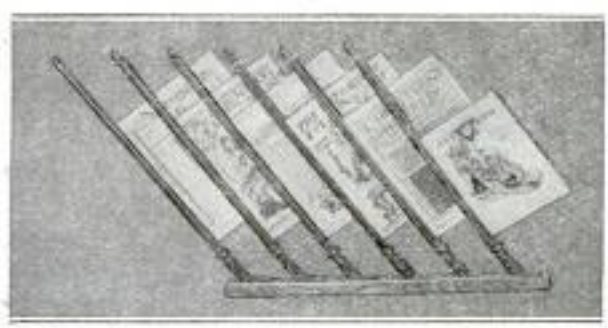

Wooden Bar with Slanting Holders for Magazines: It can be Placed on a Window Sill or Any Other Suitable Ledge

window sill, or any other narrow ledge having a vertical background. The device consists of a wooden bar, provided with slanting holders of the ordinary type to receive the ends of the files.

SPEEDOMETER SIGNAL FLASHES DANGER LIGHT

An important automobile accessory for use with any motor car is designed to reduce the hazards of speeding by flash-

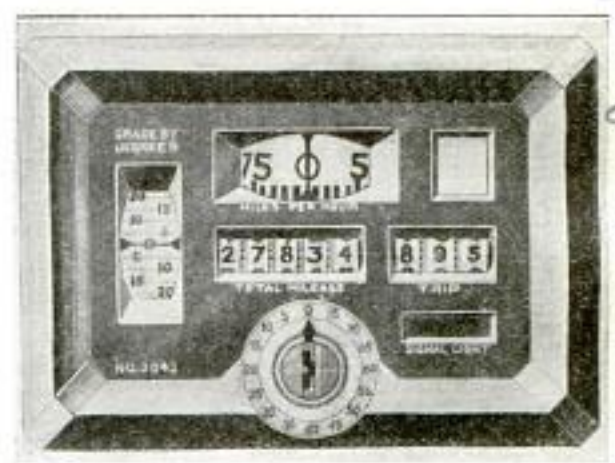

The Signal-Flashing Speed Recorder: Speed Limits may be Quickly Set with a Turn of a Key, Which is Also Used to Lock the Ignition

ing a signal light on the dial board as soon as the car exceeds any predetermined speed limit. The instrument may also be adjusted to flash at a speed slightly under the desired limit, and then to cut out the ignition automatically when the limit is reached. In addition it has the usual dials for recording speed, trip mileage, and total mileage, and an indicator which records the degree of inclination when the car runs up or down a grade.

Charles E. Jeshe 3847 N. Harrison Ave. Chicago Ill. Patent number unknown.

Ans. 5 by Cornell 223 Park St. Adrian, Mich. Copyrighted material

Em. W. Franklin
1108
1460
 POPULAR MECHANICS
110

774

TEST ACTION OF SALT WATER ON CONCRETE PIERS

It is well known that sea water has a deteriorating effect on concrete masonry

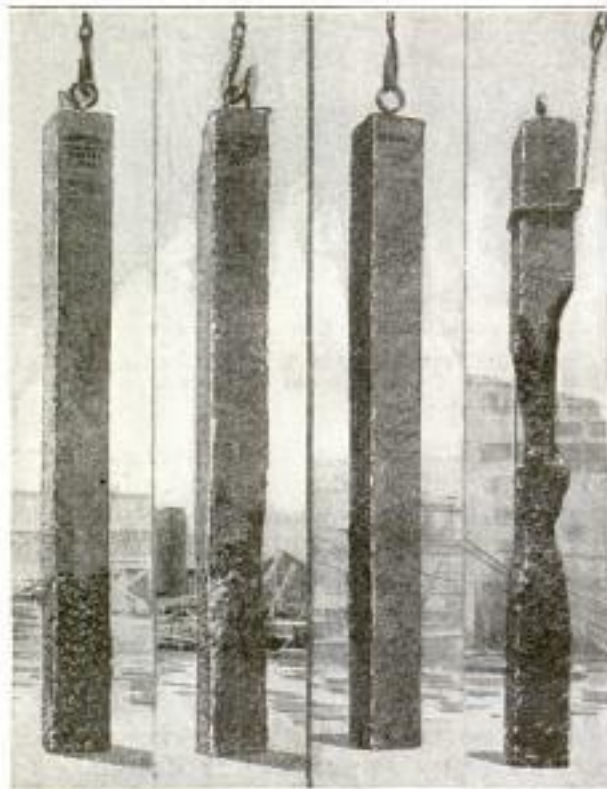

Left: Concrete Piles of a Rich and Lean Mix after Four Years in Sea Water. Right: Same Two Piles after 12 Years' Immersion

and for some time there has been a question as to whether or not the action of salt water could be resisted by properly proportioned concrete, which up to the present has been largely of the mixes prescribed for land structures. Tests covering a period of 11 years now render available data as to the mixes best suited



Above: Magnified Surface of Dense-Concrete Pile after Immersion in Sea Water. Below: Comparative View of Pile Made from Lean Concrete

for concrete work that will be subject to the action of sea water.

Twenty-four specimens of different mixes were made up at the navy yard at Charlestown, Mass., and suspended from a cap log of a wharf. The length of the test piles was 16 feet, which was sufficient to keep the bottom always immersed while the top was always above the water level. The specimens were permitted to remain in the water for over four years, when they were all taken out for inspection, at which time all were photographed and indications of deterioration recorded. After a seven-year period, the piles were again lifted. At this inspection it was found that the heavy growth of barnacles which had accumulated on the piles at the first inspection, had been destroyed by crude oil floating on the water. Four piles made of a dense mixture, comparatively high in cement, showed little effect of the nearly 12 years' immersion. The effect was increasingly marked on more porous piles, and on those made from mixtures in which the amount of cement used was relatively small.

1671
NEW STORAGE BATTERY FOR RADIO TUBES

A new storage battery, now on the market, has been designed with a view to the requirements of radio tubes that have been using dry cells. It is an 11-plate battery constructed from standard battery parts and has an 80 - ampere-hour rating at 2 volts. When used in connection with radio tubes drawing $\frac{1}{4}$ ampere, the battery will give approximately 320 hours' service.



About 149 pounds of meat per capita were consumed in the United States during 1922, announces the Department of Agriculture. Pork and beef ranked highest in the kind of meat purchased. The total consumption was about 16,000,000,000 pounds, a new record for this country.

U. S. Storage Battery Co.
864 Roosevelt Place, New Orleans, La.
Sold by

1525 Mess Edmonds' Motors,
 Thetford, Norfolk,
 POPULAR MECHANICS

Railroad Car Motor

775
 England

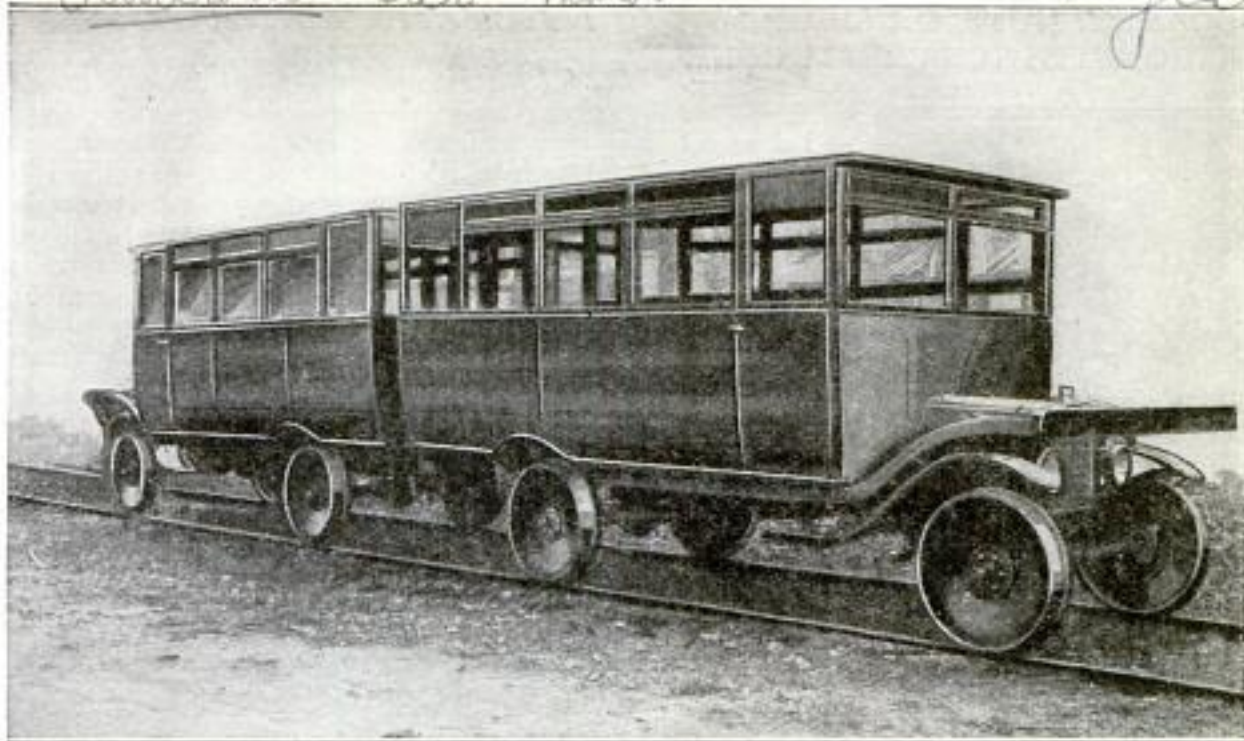

Gasoline Rail Cars Operated in Tandem by Placing Back to Back Two Automobile Chassis, on Which are Fitted Passenger-Carrying Bodies: A Center Buffer and Draw Pin Combined is Used, and a Sliding Door is Provided at the Rear of Each Body

1525
TANDEM AUTO CHASSIS USED FOR RAILWAY COACHES

One of the most interesting adaptations of the gasoline automobile to rail service, is a tandem arrangement of two automobile chassis that recently appeared in Europe. The autos are fitted with passenger bodies, the usual steering gear dismantled, and flanged wheels fitted to a solid axle. The cars are coupled and run back to back, for which purpose a center buffer and draw pin are provided, and a sliding door at the rear of each body permits ready access from one to the other. They maintain a good average speed, the gears of the rear car being in neutral, and are said to run 15 miles to the gallon of gasoline with the vehicles fully loaded.

1605
PLAN OCEAN TRAFFIC LANES FOR PACIFIC SHIPS

Transpacific shipping has increased to such an extent that, in the interests of safety, the establishment of definite routes for the masters of vessels to follow, is being considered. To meet this condition the Hydrographic Office of the U. S. Navy, after careful study, recommends lanes for eastbound and westbound ships to take throughout the year. In contrast to this, ships sailing the Atlantic, where similar practice has been followed for years, must shift to a more southerly course during the iceberg season.

155
GAS RADIATOR MADE FUMELESS BY MEANS OF GAS MASK

A gas radiator for heating purposes, which has just appeared on the market, embodies various hygienic features of considerable interest. It is designed to be fumeless, and radiates heat containing sufficient moisture to provide the necessary humidity. A cast-iron retort, or gas mask, contains a patented compound which absorbs all the impurities of the

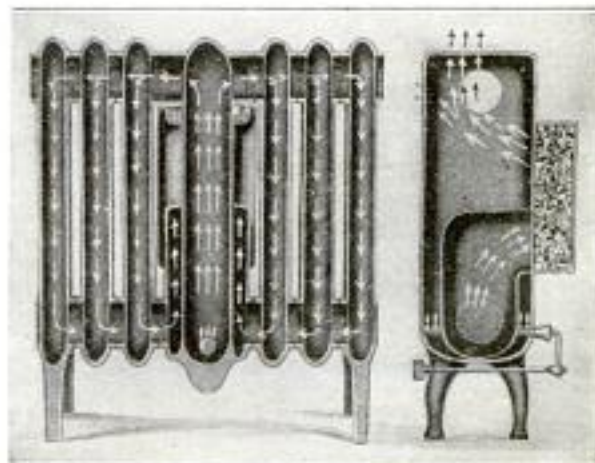

A Gas Radiator Designed to Promote Health: Cold Air is Drawn from the Floor, Heated, and Filtered through the Gas Mask before Entering the Room

air as well as those resulting from the combustion. No vent or chimney of any kind is required when this type of radiator is used.

Patented
 "Fume"
 Philadelphia, Pa.

Acuna 2.16/23

Gas-Heater Radiator
 Scales
 182. 7.11.21.
 Copyrighted material

157

CANDY, NUTS, OR SIRUP MAY GO WITH ICE-CREAM CONE



The addition of a flavored sirup, of fruit, of nut meats, or of candy to an ice-cream cone, will be possible with a new invention. After the cone and its ball of ice cream have been prepared, a little container of pastry or confectionery may be pressed into the ice cream to hold the

sirup or other delicacy. A small conical projection on the container will hold it in place, and the container and its contents may be eaten with the ice cream and the cone.

TURNING AND GRINDING ARBOR FITS ALL PISTONS

A turning and grinding arbor that fits all the pistons in a line of various lengths and diameters, is now on the market. It maintains the same center distances in the lathe or grinder, and enables the operator to finish the different-sized pistons without changing the set-up. It consists of a steel arbor with notched holes along one side that receive the end of the set-screws of the different adapters which grip the open end of the pistons. The piston is slotted to receive the retaining finger driver on the adapter.

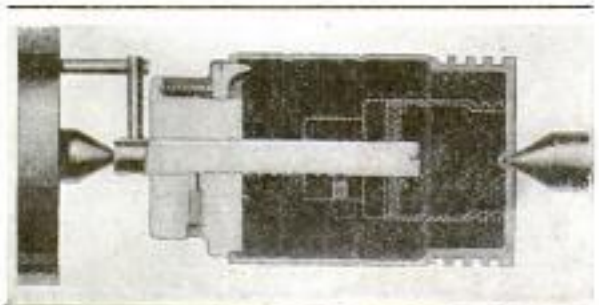

Arbor That Permits Pistons of Various Lengths and Diameters to be Finished without Changing the Set-Up: It Is the Notches along One Side That Makes This Possible

AUTOMATIC DEVICE REGISTERS AUTOS VISITING PARK

A new device which automatically registers the automobiles that visit the Cascade National Forests, has been installed on the entrance road. It consists of a number of steel springs placed in a wooden culvert over which the autos have to pass. Each time an automobile goes over the culvert, the springs undergo a slight depression which operates the recorder.

650
No data on maker

EMERGENCY REPAIR DEVICE USED ON INNER TUBE

A recently patented device for making emergency repairs to pneumatic tires in the case of a blow-out or weakening of the shoe, due to stone bruise, rim cuts, or wear, consists of a boot that is wrapped around the inner tube. An extension flap, and a strap that encircles the whole device

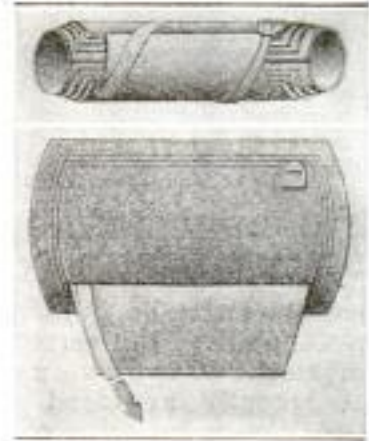

when attached to the tube, prevent creeping and injury to the inner tube.

1551

OILCAN HAS LARGE STRAINER AND CONTROL VALVE

A liquid measure, for the use of motor-car owners and garage men, has a horizontal strainer fixed at the middle. In addition it is equipped with a valve at the bottom, controlling the flow of oil, which is manipulated by a thumb lever at the top of the can. The spout is flexible so that the can actually serves as a funnel.



The Franklin Mfg. Co. Dayton, Ohio.

Elmer A. Hamilton Purification Science Lambert, Miss. 8/17/23

Elmer A. Hamilton Purification Science Lambert, Miss. 8/17/23

1571

STANDARD BLOCKS SIMPLIFY SILO CONSTRUCTION

An unusual type of concrete silo has been erected in Germany, in which blocks of the same shape and size have been used throughout to form the cell walls. The cells of the silo are square, each having three bays to the side, and the unit of construction consists of two arched pieces which flank each other to form one bay in the wall. Concrete is poured between the adjacent ends of the arched bays, forming heavy piers which run down to the foundation floor and support the structure. The arched blocks are also provided with air holes, permitting circulation between the hollow shells that form the wall. The new silo is of 2,000 tons' capacity, and because of its unusual design was built at a great saving both in cost and in time.

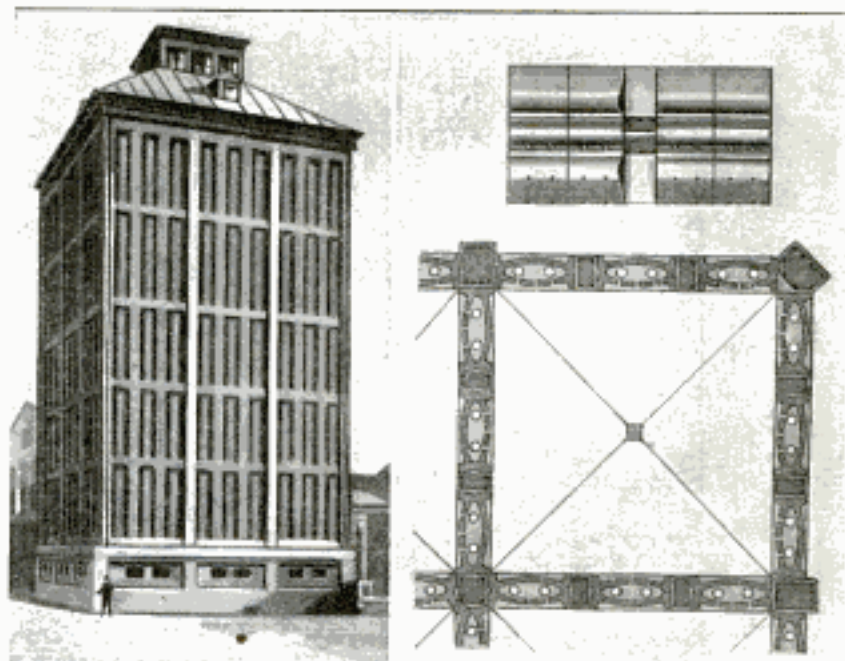

A Concrete Silo of Hollow-Sidewall Construction: Standardized Arch Blocks were Used, Avoiding Extensive Shuttering, and Cutting Down Costs

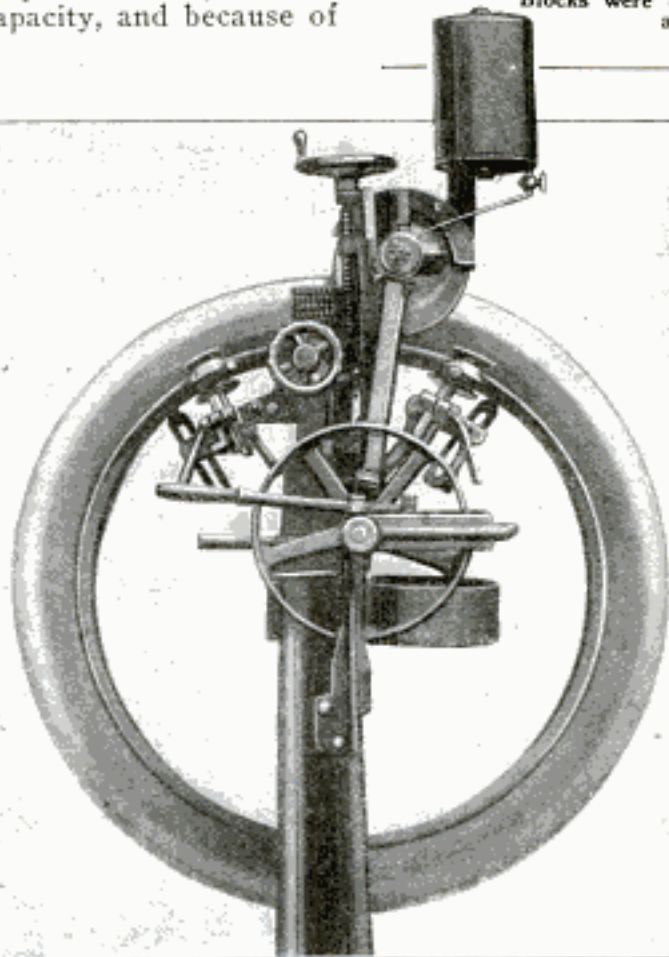

156 / Repair

TIRE SLICER FITS WORN TIRES FOR REUSE

A new use has been found for tire casings which have become worn or injured in travel, whereby they add greatly to the toughness and strength of other tires, and incidentally afford better protection to the inner tubes. A tire skiver, or slicer, is the means employed for cutting the beads from the old casing, leaving a feather-edge which facilitates its insertion into another casing of the same size. The advantage of this double lining to the inner tube is reflected in the superior tire economy which results.

¶The ever-increasing number of Chicago's broadcasting stations has compelled the designation of a "silent night" for the benefit of amateurs. At seven o'clock every Monday night these stations of the city will close, and for five hours the fans will have an opportunity to "fish" for distant stations without fear of local interruption.

A Tire Skiver, or Slicer, Set Up for Operation: The Machine can be Adjusted to Skive All Sizes and Styles of Tires, Leaving a Feather-Edge Which Facilitates Insertion into Another Tire of the Same Diameter

Wassell Mfg. Co.
Wichita, Kans.

CHILDREN'S PICTURE-STORY DEPARTMENT



Pushball was Played on Ice Skates by Students of the Lane Technical High School in Chicago Last Winter. There Were 50 Men on Each Team, and the Game Was Exciting to Watch. The Side Getting the Ball down the Length of the Field First Won. No Interscholastic Meets were Held



Tablet Donated by Alumni of Mid-Western Military Academy, Marking Spot Where They Walked around and around Tree as Punishment for Misbehavior: This Means of Disciplining is No Longer Followed

At the Woodward High School in Cincinnati, the Students Make Phonograph Cabinets, Install the Motors, and Then Send the Finished Product to Public Schools throughout the City, Where They are Used to Furnish Music for the Gymnasium Classes and for Other Purposes. Incidentally, the Plan Saves the City Money

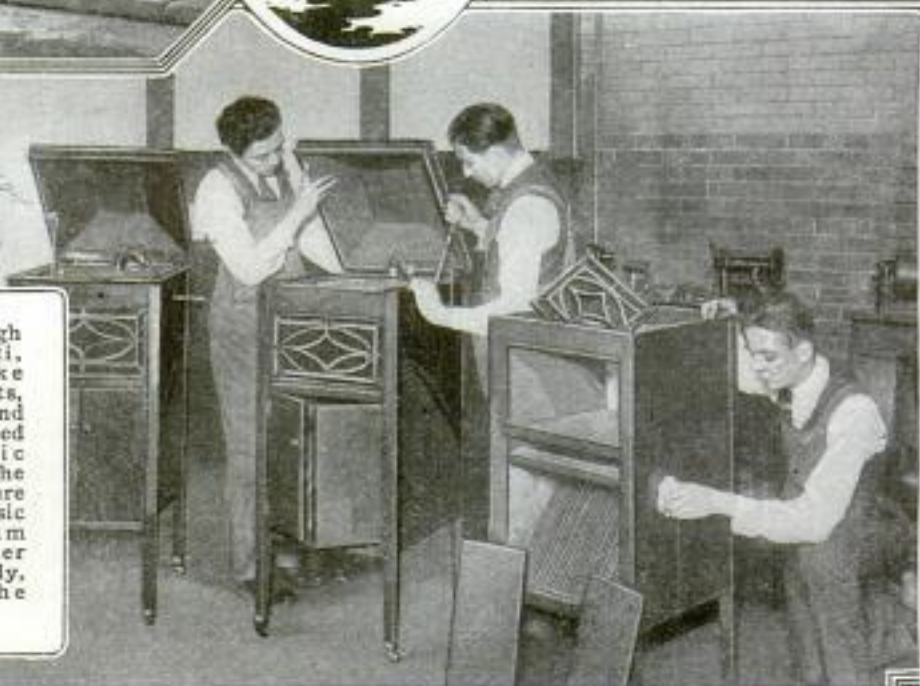

1651

OF MODERN ACTIVITIES AND INTERESTS



A Regular Course in Tractor Work has been Started at the Texas Agricultural and Mechanical College Because It is Said That a Great Many of the Ranches in Texas are Rapidly being Turned into Farms, and Students, Intending to Keep Abreast of the Times, must Know How to Run and Repair Farm Machinery



To the Left Is a Picture of a Swing, Which has been Especially Designed as a Means of Exercise. The Rider Sits as Usual and Starts the Motion by Pulling on Two Sliding Hand Grips, and Pushing upon a Steel Footrest

"Stubby," Former Mascot of the 26th Division, Decorated by President Harding, General Pershing, General Edwards, and Foreign Nations, "Invited" to Washington to Assist in a Movement for Furthering the Soldiers' Bonus

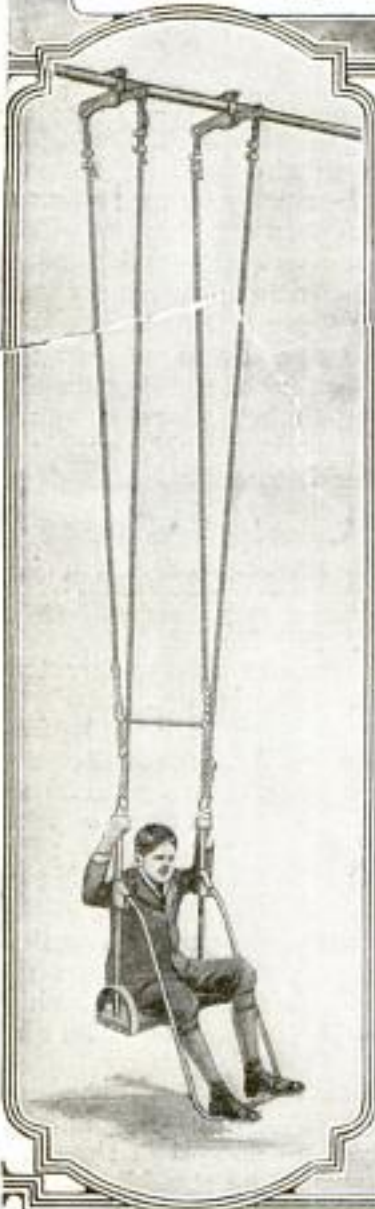

Special Radio Parts are being Supplied by One of the Companies Manufacturing Mechanical Building Sets, So That Boys Having Its Standard Equipment may Purchase the Necessary Radio Parts, and Then Construct a Set of Their Own. In Addition the Company Supplies Instructions and Suggestions for Improvements.

1548 WINDOW AWNINGS ADJUSTED FROM INSIDE OF HOUSE

To avoid the trouble of leaning out of a window to raise or lower an awning, a simple device is now available by

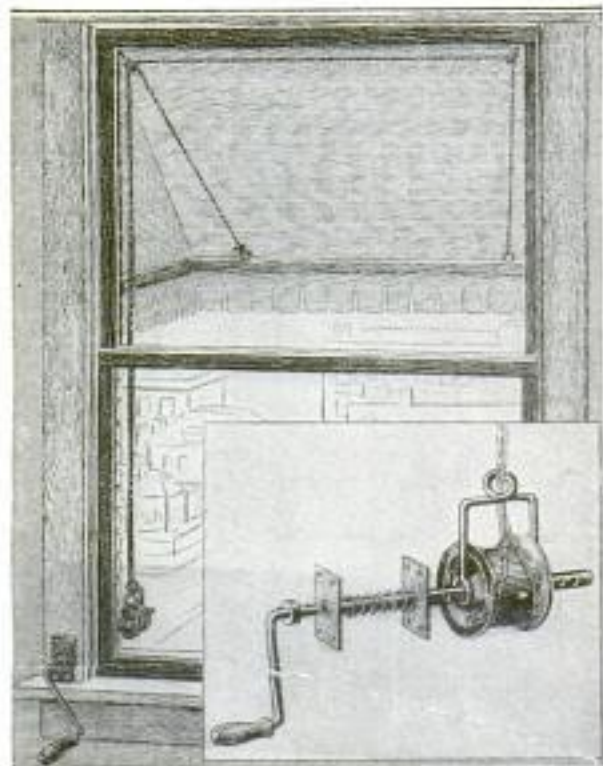

Device for Raising and Lowering Window Awnings from Inside in Place: The Inset Shows the Construction of the Device in Detail

which the awning may be adjusted from the inside. The awning is hung and roped as for hand operation. The shaft of the device passes through the window frame, terminating outside with a pulley which winds up or unwinds the rope to raise or lower the awning. Inside of the window the shaft end is held in place by a plate attached to the frame, and carries a socket into which a crank fits.

1531 RIVET AND BOLT EXTRACTOR EXERTS HEAVY PRESSURE

The removal of rusty nails, pins, or rivets from machinery is greatly simplified by the aid of a small tool which operates on the jack principle. A threaded bolt forms the jacking member of this device, and its end is brought up snug against the piece to be extracted. Twin levers, linked to a threaded nut on the central bolt, grip the



extracted. Twin levers, linked to a threaded nut on the central bolt, grip the

piece when the nut is turned, the resulting leverage causing a combined gripping and pulling effect on the imbedded piece, loosening it in proportion to the amount turned.

1275 PILOT LIGHTS AID CONTROL OF ELECTRIC FURNACE

A simple method employed to improve the regulation of electrodes in an arc furnace of the Heroult type, is by means of pilot-light control. In the case of a single-phase furnace, two 40-watt tungsten-filament lamps, which will glow at 15 volts and stand surges of 125 volts, can be used, while three lamps will serve for three-phase. The lamps are connected in series across the bus bars and provided with a common connection to the bath, a connection to the hearth usually being sufficient for the latter. When no arc is established, both lights will glow with equal brilliancy. With current flowing through the furnace, the lights will be equally bright if the arcs are the same, but the slightest change in the length or resistance of one arc will be indicated by its lamp. If one electrode should touch the bath, its lamp would instantly cease glowing.

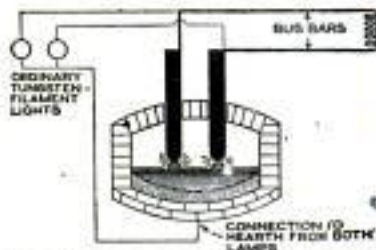

When no arc is established, both lights will glow with equal brilliancy. With current flowing through the furnace, the lights will be equally bright if the arcs are the same, but the slightest change in the length or resistance of one arc will be indicated by its lamp. If one electrode should touch the bath, its lamp would instantly cease glowing.

1624 WEEDER IS ADJUSTABLE TO WIDTH OF ROW

An adjustable weeder and cultivator, recently brought out, is composed of teeth fastened to an expanding frame into which the handle fits. It may be set to cultivate rows up to 14 inches in width. Owing to the V-shape of the cutting blades, the cut weeds are forced inward to the middle of the row, or by the removal of the center tooth, the row may be straddled. The tool is light and easily handled.



Owing to the V-shape of the cutting blades, the cut weeds are forced inward to the middle of the row, or by the removal of the center tooth, the row may be straddled. The tool is light and easily handled.

*increase of mind
northwest
E. J. ...*

*Essence extracting tool
12nd ave. port. Conn.*

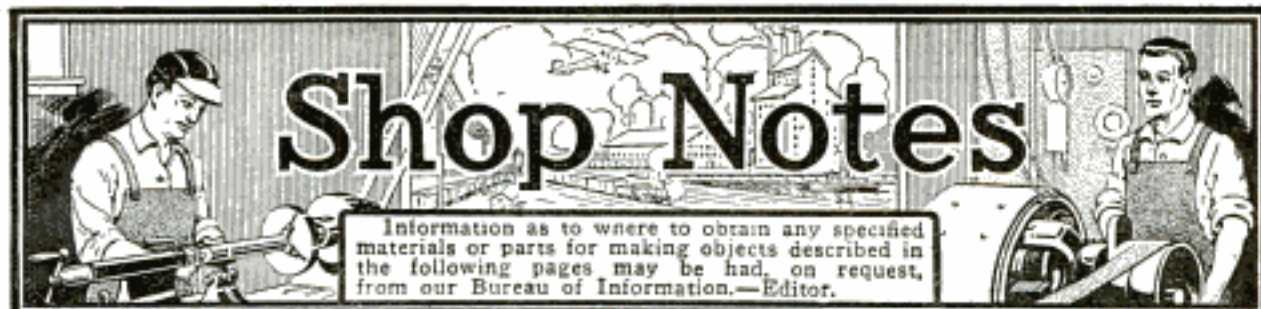

A Homemade Electric Light for the Farmyard

By J. R. KOONTZ

FARM-LIGHTING plants are now universally used in the country, and, in many communities, the city lines are extended to serve the farmers for miles throughout the surrounding territory. In addition to the lights in the house and outbuildings, many farmers would like to install a few yard lights, were it not for the expense involved.

This was the case on our farm, until we determined to make the lights ourselves; one of the resulting lights is shown in the accompanying photograph, and, as each one costs only about \$1.30 for material, we made three or four, where we would have been obliged to use only one, had it been purchased.

A 4-ft. piece of $\frac{1}{2}$ by $1\frac{1}{2}$ -in. iron is bent at right angles, as shown in detail drawing, one end being 20 in. long, the other 28 in. Drill two holes in the 20-in. leg, to fit the $\frac{3}{8}$ -in. bolts used to fasten the bracket to the post. Two similar holes are also drilled in the other leg, one 2 in. from the end, for the bolt that holds the reflector, the other 18 in. from the end, for the braces.

A galvanized-iron sheet, 18 in. square, is cut in the form of a circle, and a V-

shaped cut made in it, as shown, the cut being 6 in. wide at the edge, and carried to the center. The disk is then bent or rolled to a conical shape, and the edges, which should overlap about 1 in., riveted and soldered. A $\frac{3}{8}$ -in. hole is punched in the center. A block of cypress, or other wood that will not rot when exposed to weather, is shaped, as shown, to fit the reflector, and drilled for a $\frac{3}{8}$ -in.

bolt, the head of which should be sunk into the wood: a nut locks the block in place, a leather washer being used between nut and reflector, to prevent water from soaking into it. The reflector is then bolted to the bracket with a nut and washer.

A 4-ft. length of $\frac{1}{4}$ -in. round iron is cut in two, and two braces, with an eye formed on each end, made as indicated. These are bolted loosely to the bracket, as shown in the assembled

view, and the places where the outer eyes rest on the reflector are marked. Holes to fit stove bolts are punched at the marked spots, and the porcelain knobs assembled, passing the stove bolts through the knobs, reflector, and braces, and using a leather washer between each knob and the reflector, and metal washers



Yard Lights are Easily Made in Any Farm Workshop, and will Add Much to the Comfort and Convenience of Work around the Yard at Night

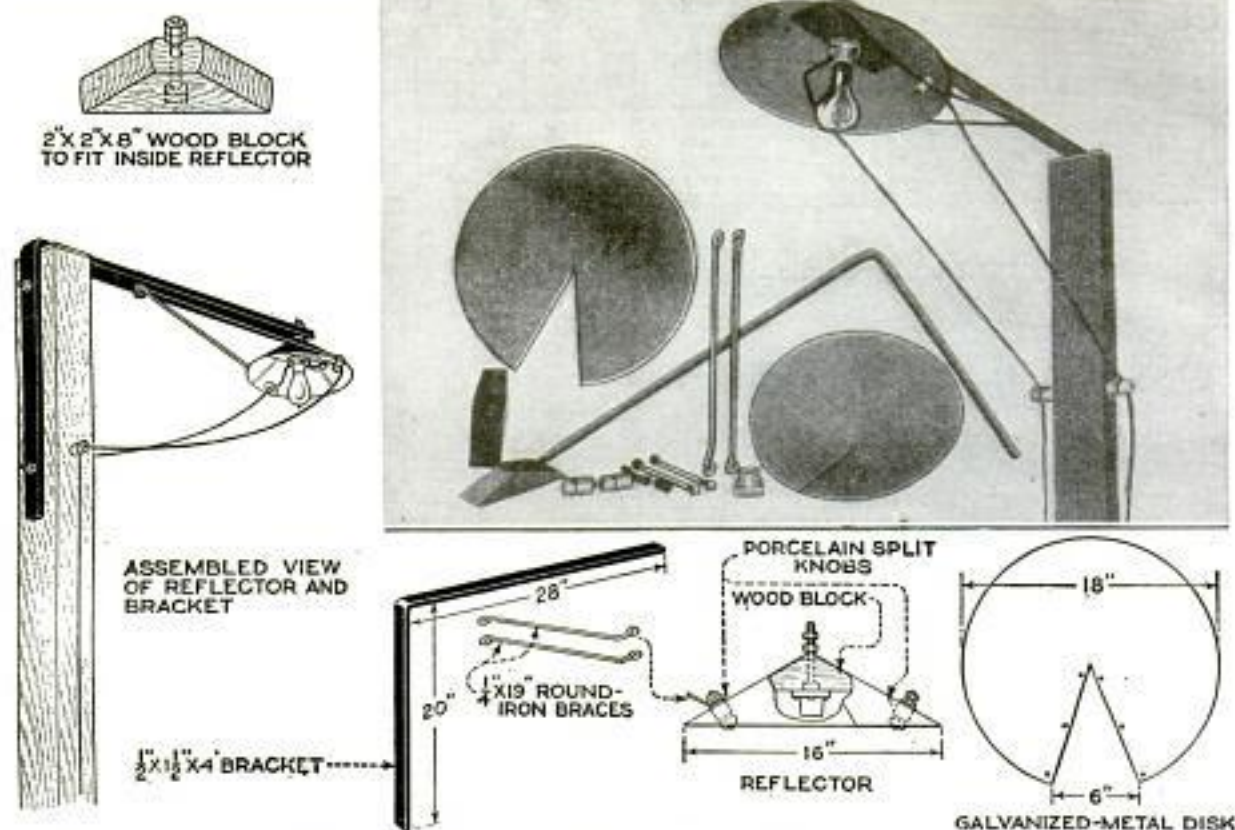

The Photos Show All the Material Necessary to Construct the Yard Light, Together with a Completed Fixture. The Drawings Show Details of the Various Parts Used, and the Method of Assembling Them. The Cost of the Purchased Material for the Fixture Shown Was Only \$1.30

under the nuts. Do not draw the nuts tight until the wires are in place.

The lamp receptacle is now screwed in the center of the wooden block, the wires attached to it, and led through the slots in the knobs, and the knobs and braces are drawn up tight. A coat of good paint or enamel completes the job, except for bolting the bracket to the post, and leading the wiring, through knobs screwed to the post, to the switch-board.

The necessary materials for each light, with the prices paid for them, are:

4 ft. of $\frac{1}{2}$ by $1\frac{1}{2}$ -in. flat iron.....	\$.40
1 piece of 18 by 18-in. galvanized-iron sheet35
4 $\frac{3}{8}$ -in. bolts10
4 ft. of $\frac{1}{4}$ -in. round iron.....	.10
1 porcelain receptacle15
4 split-knob insulators10
2 stove bolts and 2 wood screws.....	.10
Total.....	\$1.30

These prices will vary a little in different localities, but not much. They do not, of course, include the pole, but this may usually be picked up around the farm, or the lights may be bolted to the buildings, if found more convenient, and the poles thus eliminated.

Cleaning Greasy Clutches

One of our heavy derricks, which was of the cone-clutch type, with wooden friction blocks, caused considerable trouble by the friction blocks not taking hold when the levers were operated, due to oil that had saturated the surface of the blocks. This trouble made frequent renewals of the blocks necessary.

It happened, one day, that a lighted match was carelessly thrown into the machine, with the result that the oil quickly ignited. To extinguish the flame, the

operator used the fire extinguisher, which was filled with a solution of carbon tetrachloride. In doing this, the solution was also squirted over the friction blocks. When the machine was again used, the friction blocks took hold as if new, the solution having dissolved the oil on their faces. A large can of the solution was then obtained, and used to clean the friction blocks whenever necessary.

The solution has also given good results in cleaning greasy automobile clutches and oily brake bands. It is much better than gasoline or kerosene, and is,

of course, safer than these, because it is not inflammable. It will not injure wood, leather, or fabric. Although the cost of carbon tetrachloride is greater than that of gasoline and kerosene, its superior cleansing qualities make up for this difference. It evaporates rapidly, and therefore should be kept in a closed can.

Care should be taken not to get the solution on the skin, as it is very irritating, nor in the eyes, which it will cause to smart.—A. S. Jamieson, Springfield, Massachusetts.

Fixture for Relining Brake Bands

The fixture illustrated has been found to facilitate greatly the relining of brake bands.

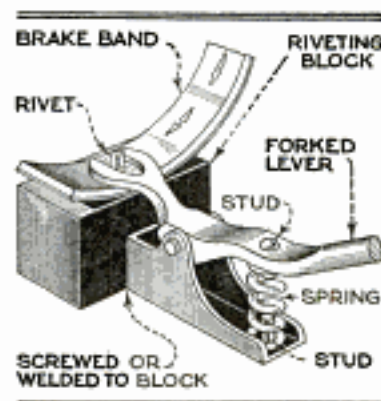

It consists of a steel riveting block to which a lever bracket is screwed or welded, as shown. In this bracket, the lever, the construction of which is clearly shown, pivots. A

strong coil spring, held in place by two studs, presses the forked end of the lever tightly on the face of the riveting block, so that when the brake band is inserted between the two, it is held securely. The rivet is pushed through the hole in the band, which is then placed between the riveting block and lever, the rivet being under the opening in the jaw. The pressure of the lever forces the rivet through the lining; the ends can be bent over in the usual way by means of the ball end of a light hammer.

Finger Protector for Files

When squaring holes and slots with a square file, the fingers are likely to be pinched between the file and the work, on the backward stroke. This particular cause of minor shop injuries can easily be eliminated by using a finger protector on the file. Some use a piece of leather for this purpose, but this is not satisfactory on a lengthy job, as it soon works loose, and, if pushed on tightly, cannot be removed as quickly as it might be. The spring-steel clip shown has two holes in line, one fitting the file neatly and the

other a little larger. On the same side as the larger hole, the spring is doubled over, and the end ground concave, so as to bear on the file corners. This concave end

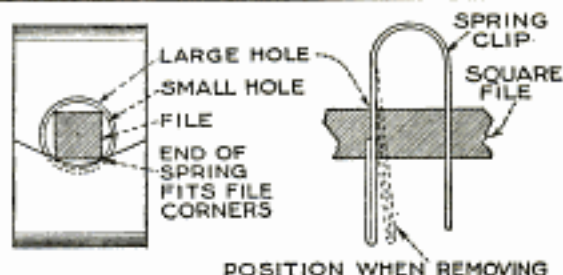

Above: Details of Spring Clip That Prevents the Workman's Fingers from being Pinched between Work and File. Below: Clip in Place on File

holds the clip in place on the file. To put on or remove it, the ends of the clip are squeezed together slightly so that the concave end clears the file corners and allows the clip to slide easily.

Holder for Reference Drawings

A draftsman can keep his reference drawing before him and work with ease if he uses the wire holders shown in the illustration,

instead of keeping the reference drawing on his board, where it is in the way. The holders are made of No. 4 galvanized-iron wire, bent to the shape indicated, so that they will clamp over the edge of the drawing board.

They can be set in various positions to suit any size of drawing. The edges of the drawing or print are folded around the holders and attached to them by means of spring paper clips, four usually being required.

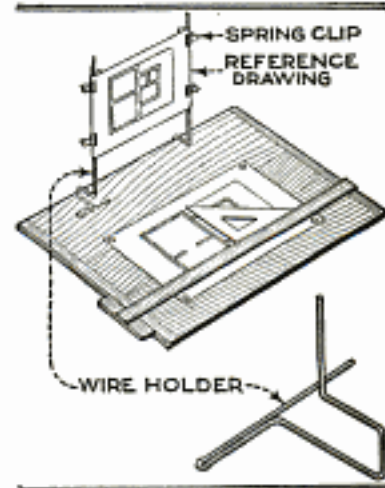

Wire-Cutting Fixture

In a machine shop where a certain job called for the production of a great number of pins of various sizes, ranging from $\frac{1}{4}$ in. to 3 in. in length, and from $\frac{1}{16}$ in.

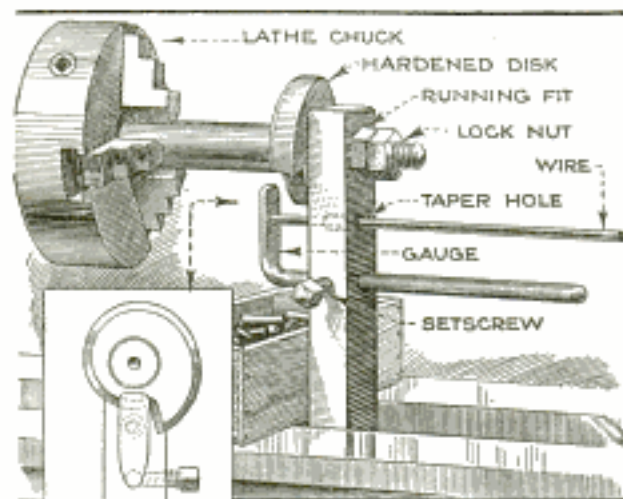

An Easily Made Wire-Cutting Fixture Arranged on a Lathe: It will Cut Various Sizes of Pins Accurately to Any Length

to $\frac{3}{16}$ in. in thickness, an adjustable wire-cutting fixture was arranged on the lathe as indicated. With this fixture it was found possible to cut the pins accurately to any desired length, and at a rate of approximately 100 to 150 per minute.

The body or post of the fixture consists of a hardened and ground 7-in. length of 1-in. square steel, fastened to the lathe bed. Three holes are drilled through the post, as shown; the upper one, which supports the arbor, is reamed to a running fit; the tapered hole below it is for the insertion of the wire, and the lowest hole for holding the gauge. A setscrew is provided to hold the gauge tightly in any position. The arbor is made of mild steel, $\frac{3}{4}$ in. in diameter and 8 in. long, turned down near one end to $\frac{1}{16}$ in. in diameter, wide enough for the cutter; then turned to a $\frac{1}{2}$ -in. diameter for a distance equal to the thickness of the fixture body and the width of two lock nuts. The $\frac{1}{16}$ -in. portion, and the outer end of the $\frac{1}{2}$ -in. part, are threaded. The cutter is a hardened-steel disk, shaped as shown, with a $\frac{1}{16}$ -in. tapped hole in the center. The arbor is held in the lathe chuck, and the fixture assembled as shown. The lathe is run as fast as the wire can be fed by hand, between each "stroke" of the cutter.—H. Mayer, London, Eng.

☞ For all diameters the transverse pressure on a boiler is double the longitudinal pressure.

A Novel Valve-Grinding Tool

When grinding the valves of an automobile engine, the heads are given a partial revolution in their seats, grinding both valve and seat at the same operation, the usual means of imparting this motion being a screwdriver or a suitable bit held in a brace.

The drawing shows a tool that can be quite easily made, with which the valves may be ground rapidly by a continuous turning motion in one direction only, the tool itself reversing the motion. The frame is made of flat bar steel, with suitable brackets for supporting the vertical spindle and wooden disk, as illustrated. Two cork pulleys are attached to the spindle, and these bear against cork pads attached to the wooden disk. The length of the center bracket should be such that the cork pulleys and pads are compressed slightly when coming into contact with each other.

It will be seen that the number of cork pads on the handwheel is uneven, with no two of them directly opposite each other, and it is by this means that the spindle is

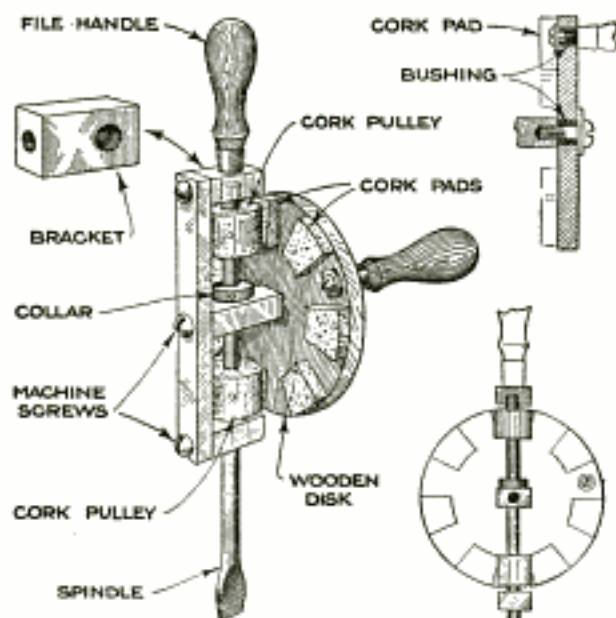

A Valve-Grinding Tool for Internal-Combustion Engines That Imparts the Proper Back-and-Forth Rotation to the Valves While Turning the Handwheel in But One Direction

rotated back and forth while turning the handle in but one direction. The number of pads is immaterial; they may be 3, 5, 7, or more, according to the distance it is desired to rotate the valves, and, of course, the larger and fewer the pads the greater the amount of rotation. Consequently, having an odd number of pads, and no two directly opposite, but one pad can come into contact with any one of the

pulleys at a time, and as these contacts alternate between the upper and lower pulleys, the direction of rotation of the spindle is correspondingly reversed.—R. H. Kasper, Philadelphia, Pa.

Simple Attachment for Testing Cylinders

In a shop where large numbers of oxygen cylinders, and similar pressure vessels, were tested daily, a hydraulic test pump was used to pump up the 5,000-lb. pressure required in each cylinder. Due to leakage at the valves and connections, it was found difficult, when the pressure in a cylinder began to drop, to determine whether the cylinder was defective, or the valves and fittings leaking.

After considerable experimenting, the simple method of testing illustrated in the drawing was adopted. A special cylinder cap, made of solid steel, was fitted with an accurately fitting screw, and a pressure gauge. A stuffing box and gland packed the screw, and a packing ring closed the joint between cap and cylinder.

The cylinder is filled with water, and the cap screwed on, the water that occupied the neck filling the hole in the cap. The screw is then screwed down until the required pressure shows on the gauge, and the cylinder allowed to remain under

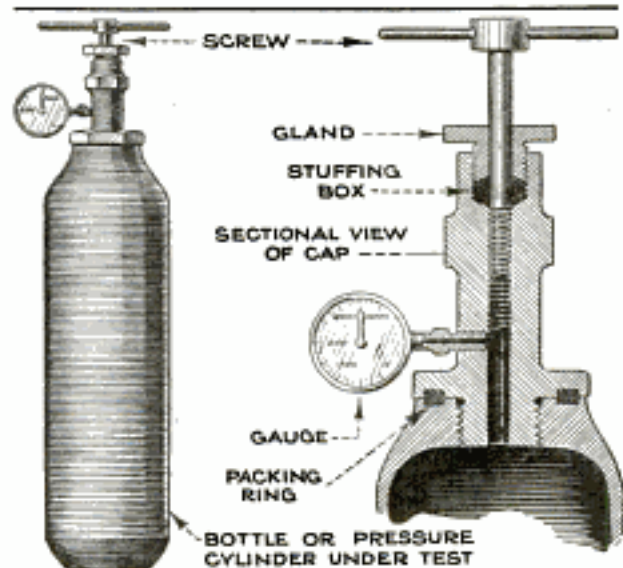

A Simple and Effective Method of Testing Pressure Vessels: Any Leakage That Takes Place While Testing can be Detected Immediately and Stopped

this pressure for five minutes. If no drop in pressure takes place in this time, the cylinder passes inspection. Any slight leakage that may take place through the stuffing box is noticeable at once, and is stopped by screwing down the gland.

Handy Glaziers' Pliers

Glaziers, and other workers in glass, will find the tool illustrated of great assistance in making clean cuts; it is par-

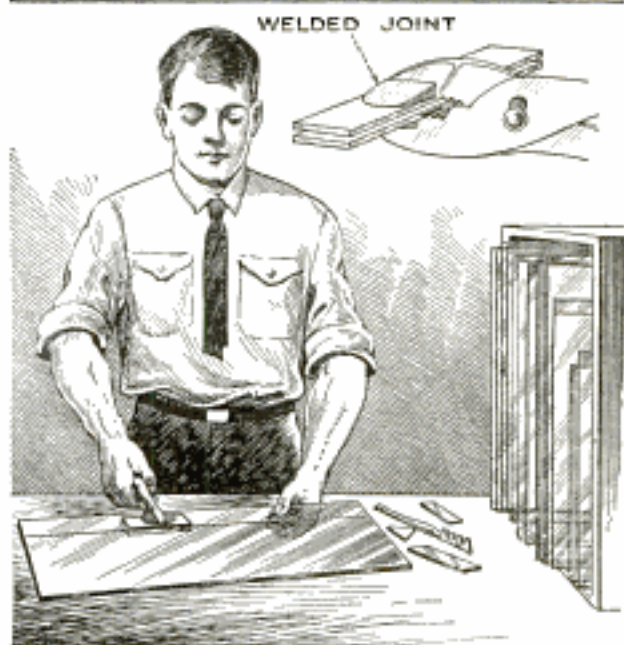

Attachment Welded to Pliers Enables Glazier to Break Off Narrow Strips of Glass with Little Danger of Leaving Rough Edges

ticularly useful when a narrow strip of glass is to be broken from a sheet.

The tool consists of a pair of pliers, to the jaws of which strips of flat iron, about 3 in. long, are welded or brazed. These strips must, of course, seat on each other accurately, so that when applied to the glass an even pressure is brought to bear at all points. The increased area covered by the strips eliminates the usual "nicking" of the narrow strip in small pieces, which leaves the work very ragged.

Testing Hair Springs for Magnetism

A very delicate tester for magnetized hair springs, where even the smallest compass at hand is not deflected, is made by pulling a single fiber out of a silk thread, fastening one end to a short piece of soft-iron binding wire, and the other end to the cork of a small vial or bottle, so that, when the cork is in place on the bottle, the wire will be suspended horizontally near its bottom. The thread may be fastened to the cork and wire by means of a drop of shellac. A very slight magnetic influence will be sufficient to influence the light piece of iron wire, whereas it might have absolutely no visible effect on a small compass needle.—Andrew C. Cole, Chicago, Ill.

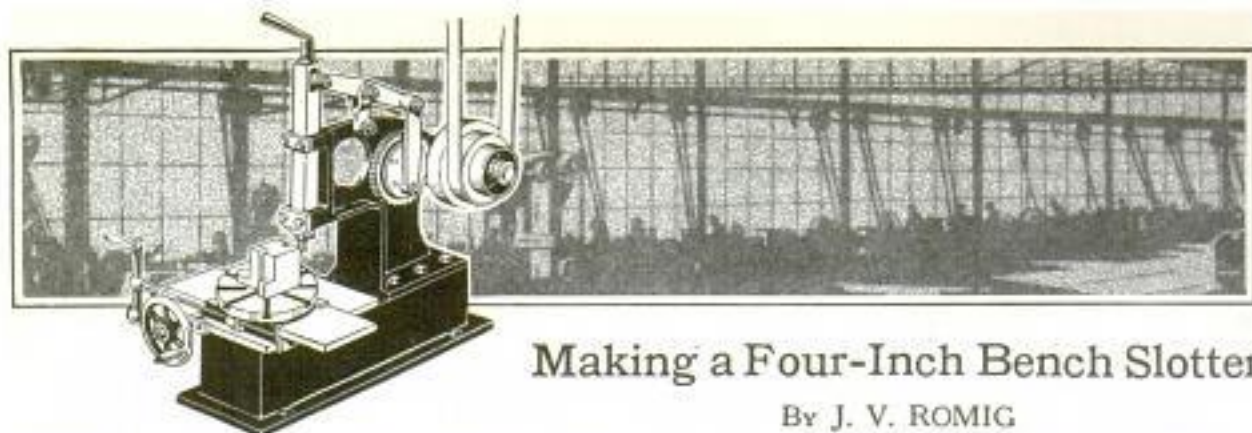

Making a Four-Inch Bench Slotter

By J. V. ROMIG

THE bench slotter described in this article will prove a useful addition to the equipment of the small workshop or mechanical laboratory. It is designed to be made with as little labor and expense as possible, so as to bring it within the reach of those who possess only a lathe and the usual hand tools, and who do not wish to have much of the work, if any, done outside their own shop.

The two straight movements of the slotter table, together with the circular one, permit the production of shapes that cannot easily be machined on the shaper or planer, as, for example, circular arcs and parts, in combination with straight portions. Narrow grooves and keyseats in wheels and levers are also easily cut, with the work lying on the table, while, on the shaper or planer, work of this character would require angle brackets and projecting tools. In addition to these advantages, the layout lines on the work are always in plain view, and working closely to them is rendered much easier than on planer or shaper. The only castings necessary are the bed, frame, table, and cone pulley; the rocker arm, link, and connecting rod may also be made in cast iron, if desired, or built up from cold-rolled steel, or forged.

The pattern making involved is simple, and should present no difficulties to those accustomed to the use of woodworking tools. Care should be taken to allow enough stock for shrinkage and machining, and to provide plenty of draft and good fillets in all corners. If in doubt

how the pattern should be made, consult the foundry where the pieces are to be cast; many valuable hints can be picked up there, and the advice given may make a big difference in the cost of the parts.

The bed is made of box section, and is shaped or planed true and smooth on its upper face; a rough cut should be taken over the bottom flange also, so that the machine will bed firmly and truly on the top of the bench.

The frame casting, a perspective view of which is shown in Fig. 6, is planed or shaped true on the bottom, and the ram slots shaped out close to size and square with the bed, on all surfaces. The frame is fastened to the bed with $\frac{3}{8}$ -in. cap-screws.

The ram is made from a $4\frac{1}{2}$ -in. length of $1\frac{1}{4}$ -in. cold-rolled steel, carefully straightened and squared, and trued to a surface plate or good straightedge, by scraping. The ram slots are scraped to a good sliding fit on the ram, and the $\frac{3}{8}$ by $2\frac{1}{2}$ -in. cold-rolled steel plates,

that hold the ram in place, fitted and scraped also. The ram is drilled from one end with a $\frac{5}{8}$ -in. drill to a depth of $1\frac{3}{8}$ in., and a $\frac{15}{32}$ -in. hole is drilled to meet this hole from the other end. From the end of the latter hole, a $\frac{3}{4}$ -in. slot, 2 in. long, is cut through the ram, and the clamp pin, made as shown in the detail in Fig. 4, fitted in place. The slot in the pin is made $\frac{5}{8}$ in. long by $\frac{9}{16}$ in. wide, so as to allow plenty of clearance for the tool-clamp rod.

This rod is turned down from a 15-in.

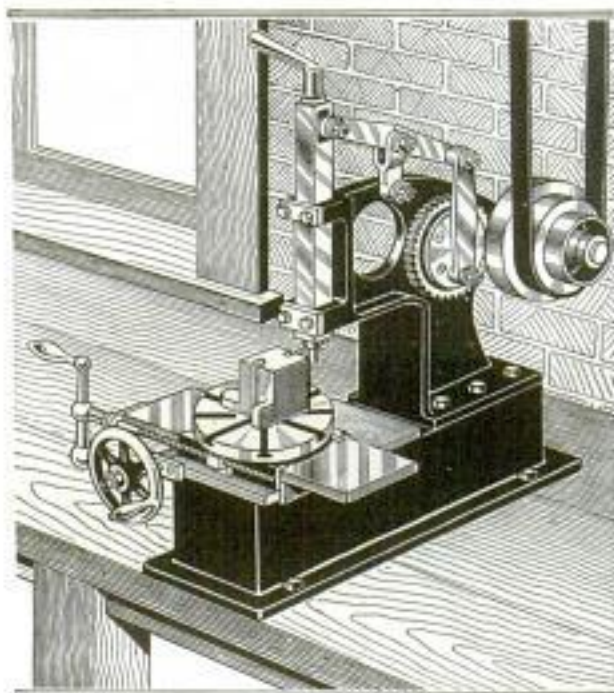

Perspective View of the Finished Slotter: This will Prove a Valuable Machine in the Small Shop, and One Well Worth the Time Spent in Its Construction

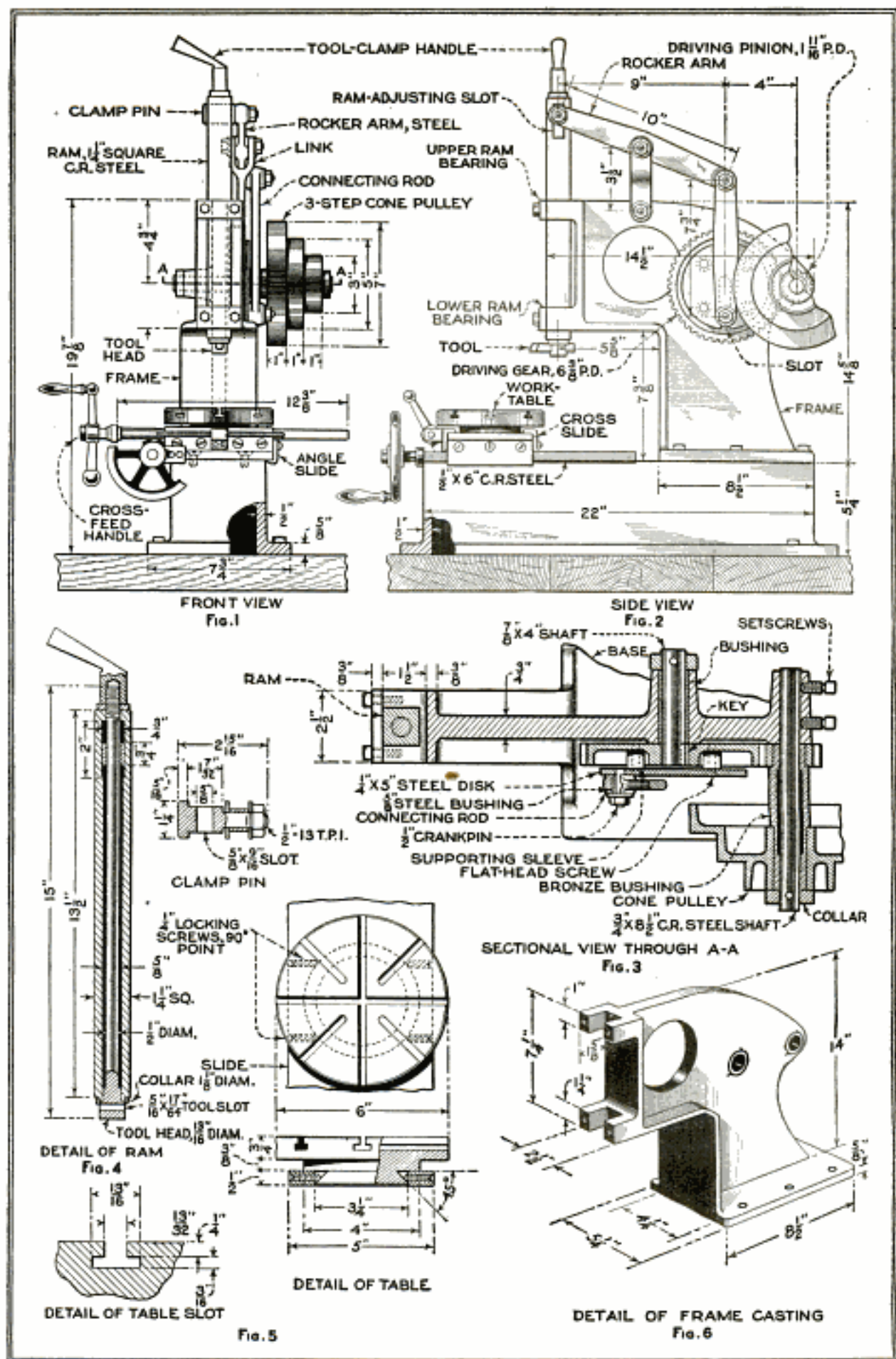

Figure 1, Front Elevation of Completed Machine; Figure 2, Side Elevation; Figure 3, Sectional View, Showing Details of Driving Mechanism; Figure 4, Section of Ram, Detail of Clamp Pin and Tool Head; Figure 5, Plan and Part Section of the Table and Dimensions of Slot; and Figure 6, Perspective View of Frame Casting

length of $\frac{7}{8}$ -in. cold-rolled steel, or may be built up by threading a $\frac{1}{2}$ -in. rod into a short length of $\frac{7}{8}$ -in. stock. One end is turned down to $\frac{3}{16}$ in., and slotted for

screws. A slot is cut into the disk, from the edge, past the center, for the $\frac{1}{2}$ -in. crankpin. The crankpin can be moved to any position in the slot, to adjust the

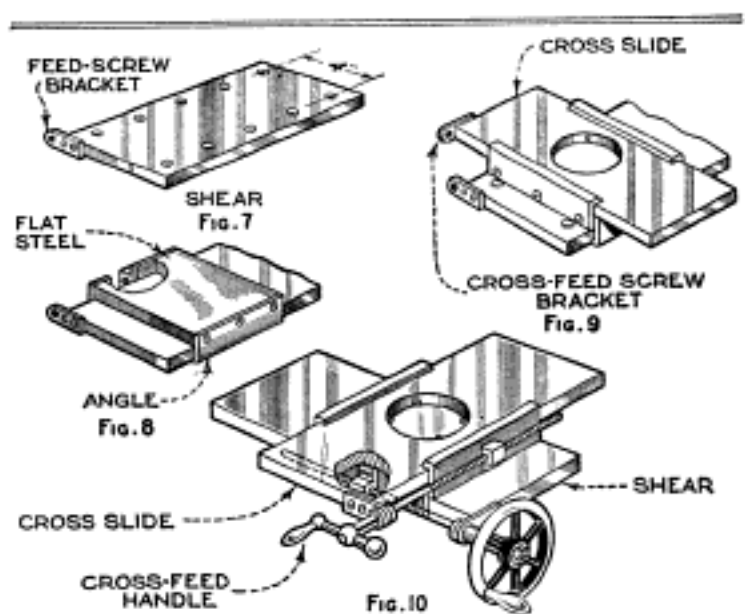

Figure 7, Shear, Which is Fastened to Bed; Figure 8, How Slide is Attached to Shear; Figure 9, Cross-Slide Fastenings; and Figure 10, Complete Slide Assembly

the $\frac{1}{4}$ -in. tool bits used; a short length is turned down to an easy fit in the $\frac{5}{8}$ -in. hole in the ram, and the remainder is $\frac{1}{2}$ in. in diameter, threaded at the upper end for the tool-clamp handle, which can usually be picked up at a junk store, or made from cold-rolled stock. A $\frac{1}{8}$ -in. collar, serrated on its lower face, and hardened, is used on the tool head between tool and ram.

The driving mechanism is quite simple to construct, and consists of a pair of gears, about 1-to- $3\frac{1}{4}$ ratio, a three-step cone pulley, connecting rod, rocker arm, and link. The cast-iron cone pulley, after being turned to size, is bored to a driving fit on a bronze bushing, which also carries the $1\frac{1}{16}$ -in. pitch diameter driving pinion. The whole assembly runs on a $\frac{3}{4}$ -in. shaft, $8\frac{1}{2}$ in. long, fastened in a boss on the frame by two $\frac{3}{8}$ -in. setscrews. A pinned collar holds the assembly on the shaft. The bushing is counterbored to act as an oil reservoir, and an oil hole should be drilled in it, tapped, and fitted with a screw, to permit easy lubrication.

The large gear, which is $6\frac{3}{8}$ in. in pitch diameter, is keyed to a $\frac{7}{8}$ -in. shaft, 4 in. long, which runs in a bronze bushing pressed into the boss in the frame, a pinned collar being used on the other end of the shaft. A 5-in. disk, made of $\frac{1}{4}$ -in. plate, is fastened to the gear by flat-head screws, the disk being held out from the gear by four sleeves, fitting over the

stroke of the ram, and clamped by tightening the steel bushing on which the connecting rod runs. A careful study of Fig. 3 will make all these details clear.

The connecting rod, as explained before, may be a casting, forging, or built up from cold-rolled steel, as may also the link and rocker arm; all should be fitted with bronze bushings, and provision made for oiling. The pins, including the crankpin, should be made of hardened tool steel, and are $\frac{1}{2}$ in. in diameter.

Plenty of clearance, to allow the rocker arm to swing, should be allowed in the yoke of the link.

The method of building up the table slides is very clearly shown in Figs. 7 to 10. The shear, shown in Fig. 7, is a piece of $\frac{1}{2}$ by 6-in. cold-rolled steel, fastened to the bed by $\frac{1}{4}$ -in. flat-head screws, spaced about $\frac{1}{2}$ in. apart. The shear must be scraped flat and true, and fitted with a flat steel bracket for the feed screw.

The slide is fastened to the shear, as shown in Fig. 8, by means of angles made of $\frac{3}{8}$ -in. thick sections of angle iron, carefully machined and screwed to the slide. The cross slide is fitted in a similar manner, as in Fig. 9, and is bored out in the center to fit the lower boss of the table, and drilled and tapped for four $\frac{1}{4}$ -in. headless locking screws, as shown in Fig. 5. All plates are $\frac{1}{2}$ in. thick, and the slide is fitted with two bronze nuts, to fit the $\frac{3}{8}$ -in. feed screws, as shown in the various drawings. The screws may be fitted with built-up handles, as shown on the cross-feed screw, or with handwheels made from old valve wheels.

The table slots should be cored in the casting, to the dimensions shown, to avoid a subsequent milling operation, and the table machined as indicated in Fig. 5. The four screws that engage its tapered lower face exert a downward pressure, holding the table firmly.

When it is desired to rotate the table for circular work, the clamp screws are loosened slightly, and the table turned by means of a bar inserted in one of the slots. By using a 12-in. bar, a very sensitive feed may be obtained. For taper cuts, the work is lined up with shims of the proper thickness.

Standard $\frac{1}{4}$ -in. tool-steel bits are used for most work; for small internal slotting, $\frac{1}{4}$ -in. tool steel, bent and forged to the proper shape, may be used.

A cone pulley, of the same size as that on the machine, is keyed on the counter-shaft, and a $\frac{3}{4}$ -in. belt used.

Engine Exhaust Heats Oil

To thin the oil in the cylinder oil cup of a gasoline engine during cold weather, arrange the exhaust pipe so that it directs the hot gas against the oil cup. This can be done by using a few elbows and some short lengths of pipe. The pipe used for this purpose must be of larger size than the regular exhaust pipe, in order to compensate for the increased back pressure that results from the use of the elbows.

Two Files Used for Gripping Tool

Two flat or half-round files and a short length of pipe will make an excellent substitute for pliers when these are not at hand or when they do not exactly answer the purpose. This gripping tool has been found very useful to remove dowel pins with protruding heads, when it is impossible to hammer them out, or difficult to pull them out with pliers; and also for removing the ends of bar stock that frequently stick in the collet of a screw machine or turret lathe.

The photograph shows how the tool is used. The ends of the files are stuck into

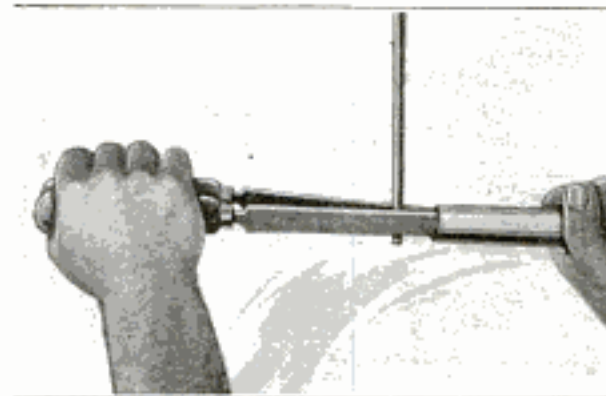

A Handy Gripping Tool, Improvised from Two Files and a Length of Pipe, Is an Excellent Substitute for a Pair of Pliers and in Some Cases Is More Suitable

the pipe and the pin is caught between them. By pressing the handles together, the files grip the work tightly. The cross-cut surface of the files prevents them from slipping, no matter how hard they are pulled or turned around. Considerable leverage can be obtained by using long files and a long pipe.

Lathe Improvised from Hand Grinder

I was confronted with the task of making a number of turned wooden handles at a time when I could not get to a

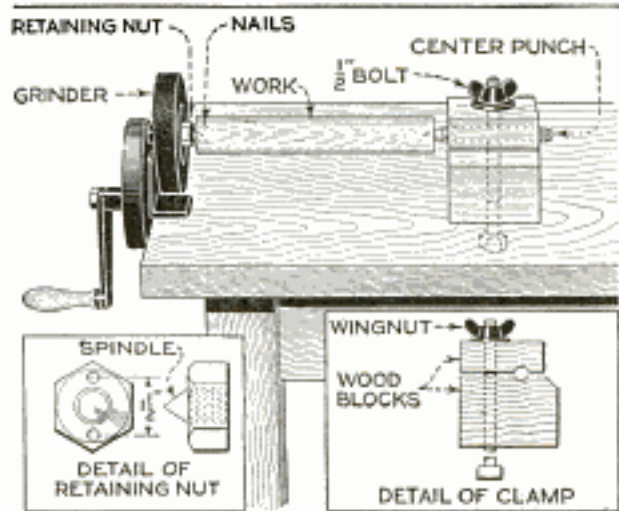

A Hastily Improvised Lathe That Accomplishes the Work of Turning Wood with Surprising Speed and Ease, Considering Its Crude Construction

lathe; the job, however, was satisfactorily accomplished on a lathe hastily improvised from a hand-power bench grinder. Two small holes were drilled to a depth of $\frac{1}{4}$ in. in the face of the nut holding the emery wheel on the shaft. The holes were $\frac{5}{16}$ in. in diameter, and spaced $1\frac{1}{2}$ in. apart, as shown in the detail. The grinder was clamped firmly to the left end of the bench, and served as the headstock of the lathe. The tailstock and center were made from a center punch and a simple wooden clamp, as shown. A $\frac{1}{2}$ -in. bolt was used to fasten the tailstock in place on the bench; this bolt passed through a hole in the bench and was provided with a wingnut to permit adjustment of the center. The work to be turned was prepared by centering at each end, and driving two pins, made from nails, into one end, so that they fitted into the holes drilled in the nut of the grinder. The work was placed in position with the pins seated in the holes, and was held securely by bringing the center into place and tightening the wingnut. A block of wood served as a rest.

The arrangement may be improved upon considerably by filing down the end of the grinder shaft to a 60° point, like a lathe center. If it is not desirable to have a hole drilled in the bench, the tailstock may be nailed to a strip of wood and the latter clamped to the table with small C-clamps.—D. H. Palmeter, Detroit, Mich.

Laying Out Square Corners

The farmer who builds his own out-buildings will appreciate the method of laying out square corners for foundation walls

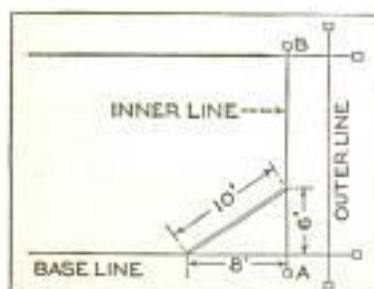

shown in the illustrations. This method, while not new, is not nearly as well known as it should be, as



Laying Out Square Corners for Foundation Walls by Means of the 6, 8, and 10 Rule: This Is a Simple Method, and Quite Accurate

it is about the simplest method practicable with rough equipment.

Referring to the line drawing, a base line, of hard cord, marking the outer side of one wall, is stretched between two stakes, about 2 ft. above the ground. The other lines are squared from this one. As all the lines are squared in the same manner, the description of the squaring of the inner side of the adjacent wall, as shown, will suffice.

A stake, A, is driven into the ground outside the base line, and a line stretched, at approximately right angles to the base line, to another stake, B, lightly driven outside the outer-wall line on the opposite side. From the point where this line crosses the base line, a distance of 6 ft. is measured, and a mark made at this point on the line, by tying a small piece of colored twine on it. Then, from the same point, a distance of 8 ft. is measured along the base line, and a similar mark made. A light pole is cut exactly 10 ft. long, and a short stick nailed to it at one end, the stick being cut to such a length that, when the end is rested on the ground, the pole will be just at the height of the line. This end of the pole is then set exactly at the 8-ft. mark, the

stake B lifted by a helper, as shown in the photograph, and moved until the pole touches the 6-ft. mark while still touching the 8-ft. one. The stake is then driven in firmly, and the line is square with the base line.

The trench may be laid out on the ground by holding a plumb bob so that the bob line just touches the lines stretched between the stakes, and making a spade mark at the point where the plumb bob touches the earth, or by simply using a straightedge, set on the ground and held against the line.

Removing Chatter Marks in a Countersink

In spite of all care a countersink will sometimes chatter or tear, and this spoils the appearance of a job. To remove the chatter marks, place a small piece of emery cloth, with the abrasive side downward, over the hole, and bring the countersink down. In a few minutes, all the chatter marks will be polished off.

Handling Heavy Truck Wheels

When it is necessary to reline the brakes of a heavy truck, or to remove the wheels for any reason, considerable trouble is usually experienced in handling the latter because of their weight. This objection, however, can be easily overcome by jacking up the truck so that a strong plank, on two rollers, can be slipped under the wheel to be removed. The jack is then lowered until part of the weight of the wheel rests on the board. With one man at either side of the wheel, it is now an easy matter to pull off the wheel without lifting it. The wheel is



A Simple and Quick Method of Removing Heavy Truck Wheels: A Strong Board and Two Rollers Bear the Weight

replaced by reversing the procedure.—
Lowell R. Butcher, Des Moines, Ia.

Heater Used as Lamp

Needing some additional light in one corner of the office and not having any extra fixtures, I struck upon the idea of using the electric reflecting heater which was in the room. After removing the heating element from the socket and substituting a lamp for it, I found that the result was all that could be desired. The heater reflected the light just as well as it did the heat.—W. F. Schaphorst, Newark, N. J.

Testing Fuses with a Flashlight

Maintenance electricians and mechanics will find the simple scheme of using a flashlight to test fuses, a good one. A

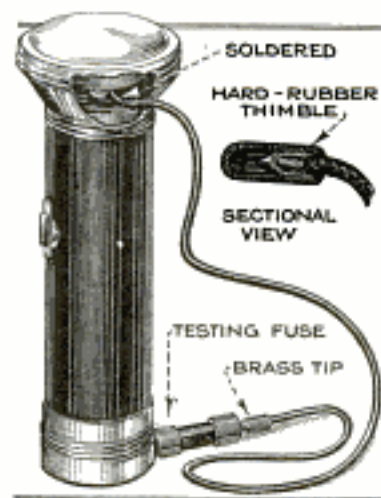

small hole is punched or drilled through the metal lens case, so that the end of a length of stranded wire, such as lamp cord, can be pushed through. The end of the wire is bared, twisted around the screw shell

of the lamp, and soldered. The other end of the wire is soldered to a brass tip. When testing fuses, one end of the fuse is held in contact with the metal cap on the bottom of the flashlight, and the brass tip is touched to the other end. If the fuse is in good condition, the lamp will light. A small hard-rubber thimble, to fit over the tip, should be provided to keep the tip clean.

Backing Tool for Riveting

The tool shown in the drawing, while primarily designed for use in tightening loose rivets in automobile frames, will be found useful in any shop where heavy work must be riveted, as it enables one man to do the riveting without a helper.

A piece of heavy round steel is used for the rivet snap, or anvil, and it is turned and cupped on the end to fit the rivet head, in the same manner as any other snap. It is drilled, a little above its center, to fit a heavy bar handle, and a cotter-

pin hole is drilled at right angles to the handle hole. The handle is drilled, at

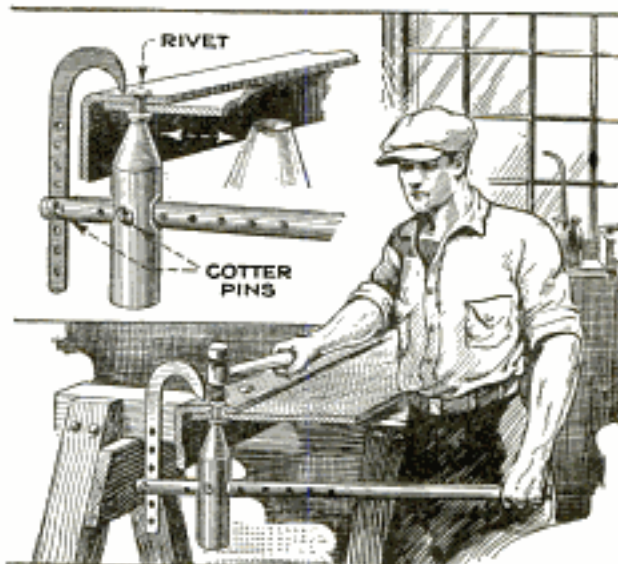

An Adjustable Backing Tool or Snap That Enables One Man to Do Heavy Riveting Single-Handed: It will Prove a Useful Tool in Any Shop

intervals of about 1 in., with a series of cotter-pin holes, and slotted at one end to fit the flat-steel hook shown, a hole for a heavy pin being drilled through the slot jaws. The hook is also drilled at 1-in. intervals to fit the cotter, and the tool is assembled as shown.

The manner of using the tool is obvious; the hook can be reversed when it cannot be caught on any portion of the work while in the position shown.

Dog for Adjusting Steel Cable

A steel cable is not considered so convenient as a chain for use as a towline, or for similar purposes, because its length cannot be adjusted so easily.

However, this objection may be overcome by attaching an easily made dog to one end of the cable. The dog is made of $\frac{3}{8}$ -in. flat steel, shaped as shown in the drawing. A cam, with a handle, is riveted loosely to the body, off center, so that when the cam is set in the position shown in the upper view, the cable is gripped tightly, and when turned as in the lower view, the cable is released. With this device, the cable can be adjusted to any length desired.—Geo. G. McVicker, North Bend, Neb.



Tool for Spreading and Extracting Cotter Pins

In garages, where it is necessary to extract and spread cotter pins frequently, the special tool for this purpose shown in the drawing will be found of considerable utility. An old pair of pliers is forged and filed to the shape shown in the illustration, then hardened and tempered.



A lip on one jaw opens the cotter pin and spreads it, while the notch in the other jaw prevents the head of the pin from slipping. The ends of the jaws are ground down to fit under the head of the cotter pin to extract it,

as shown in the lower drawing. The jaw ends should be rounded, to prevent cutting the pin.

Polisher for Tempering

It is desirable to have a steel surface polished brightly before the metal is tempered, in order that the worker may be able to watch the color while tempering. An excellent emery-cloth holder, that has a soft backing, so that the abrasive surface will touch all parts when used on slightly uneven surfaces, is illustrated.

The holder is made from a disk of $\frac{1}{16}$ -in. sheet metal, bent at right angles near the center, leaving about $\frac{3}{4}$ in. space between the two sides. A semicircular wooden block, $\frac{3}{4}$ in. thick and $\frac{1}{2}$ in. less in depth than the height of the sides of the holder, fits in this space. A notch is cut across the center of the block, as indicated by the dotted line in the drawing. A $\frac{1}{4}$ -in. hole is then drilled through the center of the sheet-metal sides, near the

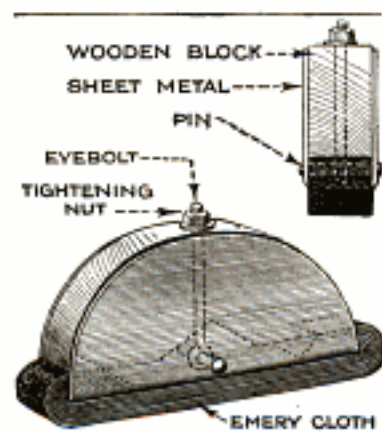

bottom. A hole is drilled through the wooden block, at right angles to the notch, for an eyebolt, the eye of which fits over a pin driven through the holes in the sides. The ends of the pin are riveted. Sheets of emery cloth are then torn into $\frac{3}{4}$ -in. strips; about 12 of these are used, the ends being caught between block and holder, and clamped securely by tightening the eyebolt. By using about a dozen strips of emery cloth, it is possible to polish the surface much better than if only one strip were used.

bottom. A hole is drilled through the wooden block, at right angles to the notch, for an eyebolt, the eye of which fits over a pin driven through the holes in the sides. The ends of the pin are riveted. Sheets of emery cloth are then torn into $\frac{3}{4}$ -in. strips; about 12 of these are used, the ends being caught between block and holder, and clamped securely by tightening the eyebolt. By using about a dozen strips of emery cloth, it is possible to polish the surface much better than if only one strip were used.

Elongating Holes in Plates

The tool shown in the illustration was used in a boiler shop when it was necessary to cut some holes of an oval shape, making the length

$1\frac{1}{2}$ times the width. Several attempts were first made to do this by drilling, but the drill had a tendency to run into the hole already drilled. A special chisel, made as shown in the drawing, enabled the work

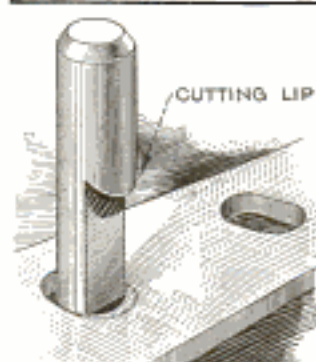

to be done quickly. Chisel steel, of the same diameter as the holes, was used, one end being ground down, as indicated, to form a cutting lip about $\frac{1}{8}$ in. deep. The chisel locates itself in the hole and cuts a good chip each time it is driven through.

Setting Contact Points on Automobiles

An automobile equipped with battery ignition must usually have the contact points adjusted, or at least checked up, once about every 2,000 miles; this is a rather difficult operation for the mechanic, unless the breaker box is unusually accessible, because it is hard to observe the cam while cranking by hand, and if the electric starter is used, it is hard to get the shaft to stop at just the right point. If the car is a light one, it can be put in high gear on a level road, and



can be pushed along until the points are separated the maximum distance, when the hand brake is set to hold the car while adjusting the points.

With a heavier car, one man can still do the work, if there is a grade near by so that gravity can be utilized to help move the car. A strong rope is attached to the rear axle and brought around a tree or strong post, the rope being doubled if the car is heavy or the grade steep. While the rope is held taut from a position near the breaker box, the brake is released and the car allowed to move down slowly, by paying out the rope, until the contact points are wide open. At this position the brake is applied to hold the car, while the adjustments are being made.

Simple Planing Stop and Vise

One of the most important tools for the woodworker is his vise. Sometimes a vise is not at hand, and the woodworker is at a loss how to support his work. The illustration shows a very

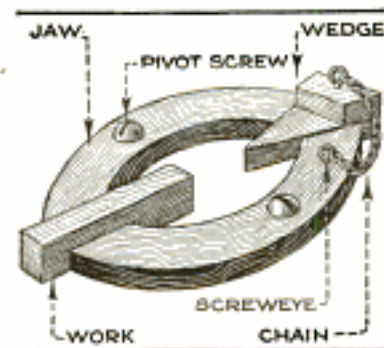

simple vise and planing stop that can be made at small expense; it will grip the work securely, and, if properly made, is practically unbreakable.

The vise consists of two curved pieces of hardwood, of a size suitable for the work for which it is to be used. A generally satisfactory thickness is about 1 inch. The pieces are pivoted at their central points on long screws that extend into the bench, or other support on which the vise is fastened. At one end each of the jaws is beveled so that a wedge can be driven between them to clamp the opposite ends on the work. To enable the wedge to be readily driven out again, a cleat is nailed on it, as shown. It is a good idea to connect the wedge to one of the jaws with a short length of chain and two screweyes, one driven into the cleat, the other into the jaw.—H. G. Schultz, Teaneck, N. J.

☛ For every 10° F. added to the temperature of feed water by exhaust steam, nearly one per cent of fuel is saved.

Brush Attachment for Drawing Borders

The brush attachment illustrated is used for drawing clean, straight borders

on showcards and similar work. The attachment can be made by anyone in a few moments with the help of a pair of pliers. A piece of soft-iron wire, about 8 in. long, is formed to the shape shown; two coils are made about 2 in. from one end by winding the wire around the

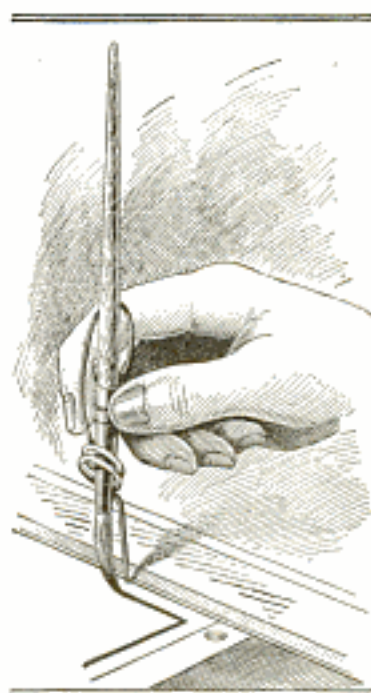

cap of a fountain pen, or other round article of about the same diameter. The other end of the wire is then bent up to form an oval loop, as shown, so that when the arrangement is slipped onto the brush, the coils and loop will grip the handle securely. The spacing of the border from the edge of the card can readily be varied by bending the end that is drawn along the edge of the T-square or triangle.—E. E. Knight, San Diego, Calif.

Gilding Small Articles

Small articles can be gilded in the following way: Dissolve, in 8 oz. distilled water, 1 oz. of cyanide of potassium (poison), and 32 gr. of chloride of gold, and shake well to insure thorough mixing. Cut a strip of sheet zinc, and bend it to form a hook to fit the article.

Put some of the solution in a glass or earthenware dish, then scour the article with baking soda and water to remove all dirt and grease, rinse it off, and suspend it by means of the zinc hook in the solution, until it appears very dark in color. It is then removed, and again scoured with brush and soda, which will bring out a beautiful gilded finish.

If a Roman finish is desired, the articles must be satin-finished with a wire brush before dipping, but if an English finish is desired, they are polished before dipping.

Emergency Climbing Irons

On a possum-hunting party in southern Maryland, the hunters were assem-

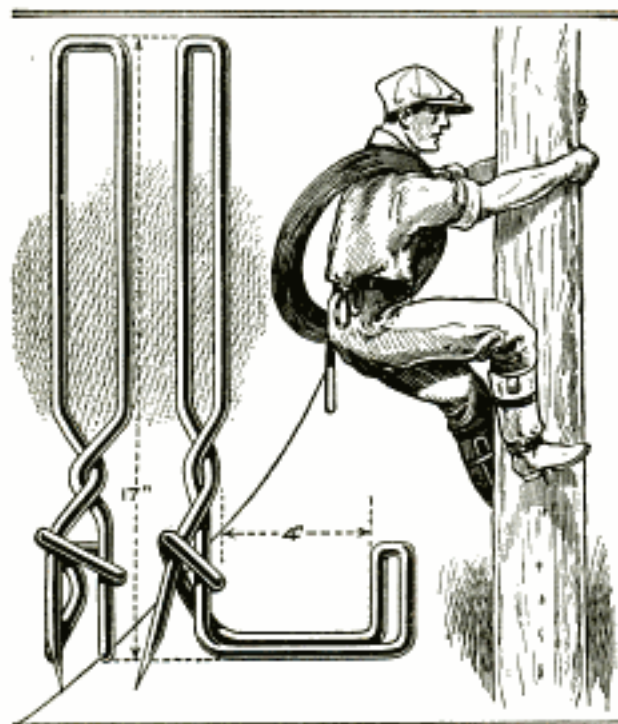

Climbing Irons Made of Four-Foot Lengths of $\frac{1}{4}$ -Inch Steel Rod, That will be Found Very Serviceable by Linemen

bled and everything in readiness, when it was discovered that climbing irons, which were very necessary items on this trip, had been forgotten. A trip back for these was out of the question, as the time involved would mean too long a delay. The hunters were decidedly at a loss, until some one suggested applying for help to a blacksmith who lived near by.

The ingenious blacksmith turned out several pairs of the irons shown in a short time; each one was made of a 4-ft. length of $\frac{1}{4}$ -in. steel rod, bent to the shape shown in the drawing. One end was sharpened to a point and tempered, while the other end was formed into a 4-in. stirrup and bent around the first to strengthen it. The climbers thus made served the purpose just as well as purchased ones, and were found heavy enough to stand hard usage. Leather straps from the tire holders on the automobiles were used to hold the climbers in place. Such climbing irons can be easily made in any blacksmith shop, and many uses can be found for them around industrial establishments, and by power, telephone, or telegraph linemen.

Ⓞ Do not heat the work above a bare red heat when casehardening for colors, using cyanide.

Measuring Disks in Micrometer

Some kinds of work are rather difficult to measure with a micrometer. Thin round pieces, for instance, may easily be measured incorrectly if care is not taken to see that the work is held in the center of the measuring faces, and at right angles to them. Recently, among a batch of $\frac{3}{4}$ by $\frac{1}{16}$ -in. disks, a number were found to exceed the tolerance allowed on the diameter, and it became necessary to measure the whole lot. The man to whom this inspection job was given made the simple attachment shown in the illustration, to save the time and trouble required in adjusting the pieces squarely between the micrometer anvil and spindle. The attachment is a short piece of cold-rolled steel the same diameter as the disks, drilled in the center a running fit for the micrometer spindle, and slotted with a saw a little wider than the thickness of the disks. With this little device, the job was done in a short time, as it was simply a matter of inserting the disks in the slot until the edges were flush with the attachment, when the measuring could proceed with safety, as the work was thus located square and central. After the disk was measured, the micrometer was tipped

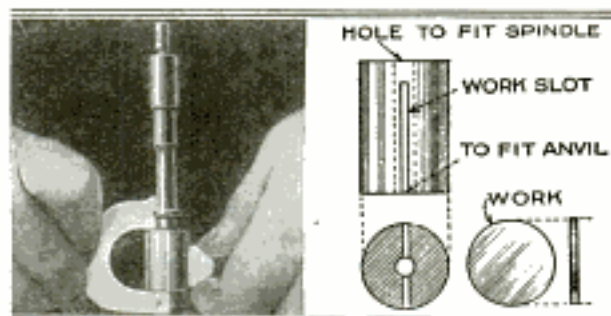

Simple Attachment for Measuring Disks with a Micrometer Caliper That Insures Each Disk being Held Square and Central between Spindle and Anvil

over as the spindle was turned back, releasing the disk and allowing it to fall out into a box.

A Color Code for Fuses

In a large industrial building where renewable fuses of various capacities, but of the same cartridge size, are used, a color-code system to distinguish between the fuses has been found very useful.

The fuse cartridges are painted in different colors to indicate the capacities of the links contained in them. For instance, with the small cartridge fuse having a maximum rating of 30 amp., there are in use five kinds of links, of 5, 10, 15, 20, and 30-amp. capacity. For these links,

the colors white, green, blue, yellow, and red are used, respectively. For the next size of cartridge, having a maximum rating of 60 amp., a similar code is used.

With this system, the size of fuse necessary to make renewals can be determined at a glance, insuring proper renewals without the danger of under or overfusing.

Protecting Ladle When Melting Babbitt

When starting to melt a ladleful of babbitt, put some machine oil, or grease, or even some resin, in the bottom of the ladle. This will quickly melt and catch fire, and while burning out, will melt some of the babbitt, causing it to flow down into the bottom of the ladle. This thin layer of melted babbitt will quickly conduct away the intense heat of the fire to which the bottom is exposed, and prevent it from burning out. The oil or grease will not spoil the quality of the metal.—H. Bethuel Kingsley, Fort Miller, New York.

Simple Woodworker's Clamp

A piece of wood, cut out and fastened to the workbench with wire, as shown in the drawing, makes a very handy clamp

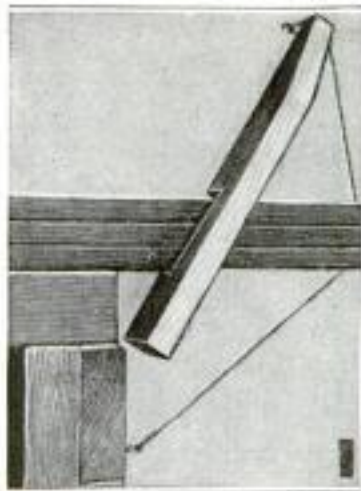

for holding several boards together at one end while working on them. This clamp is much more convenient for this purpose than an ordinary pair of wood clamps, and requires less time to adjust. It is preferable to make this clamp of hardwood. The slot, cut out near one end, as shown in the drawing, should have rounded corners and beveled edges to prevent marking the boards on which it is used. Two screweyes and a piece of heavy flexible wire are used to attach the clamp to the side of the workbench. The wire is brought around the ends of the boards, the clamp placed on them, and the boards then shoved against the wire; this pulls the upper end of the clamp down and squeezes the boards together.

Tool for Etching Steel

The etching tool shown in the photo can be made very cheaply, and forms a

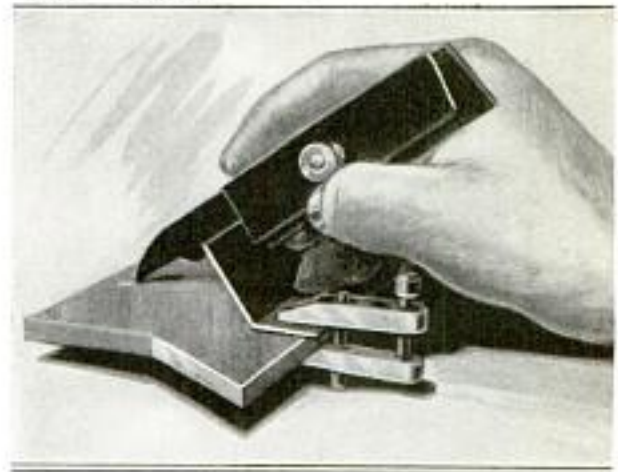
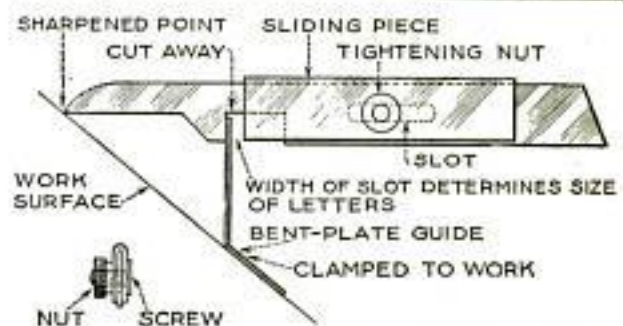

A Useful Lettering Tool for Etching Steel: The Height of the Letters is Kept Uniform and the Lettering Thus Presents a Neat Appearance

very useful device for etching lettering on steel. Beeswax and acid are used in the ordinary way, the purpose of the tool being to keep the letters in a straight line and of the same height, thus giving the inscription a neat appearance, in keeping with well-finished work.

The tool consists of three parts: the lettering tool, a sliding distance piece, and a guide, made of flat plate, bent to the shape shown. The lettering tool has a slot cut in the center, and is also slotted in the center, for a small clamp screw. The sliding piece is a piece of stock of the same thickness as that used for the tool, doubled to fit over the latter, and drilled for the clamp screw. By moving this piece, the width of the slot can be varied to suit the size of the letters required.

The guide plate is clamped to the work as shown in the photo, and the tool is used with the edge of the guide in the slot. It may easily be seen that the height of the letters must be uniform, as the tool can only move a distance equal to the width of the slot, when making the vertical strokes of the letters.

Making Clean-Cut Metal Stencils

By JAMES TATE

STENCIL cutting, as usually undertaken by those not "in the know," consists in attempting to cut the thin sheet brass or zinc with a chisel, or similar tool. The results are invariably unsatisfactory, as the edges of the cuts are ragged, and, when filed smooth, the proportions of the letters are changed; a burr is also thrown up on the underside of very thin stock that no subsequent hammering or filing will remove.

A simple method, and one that pro-

duces excellent work, is to etch the designs with acid. Using this process, the metal is left perfectly flat on both sides, and the outlines of the characters are smooth and regular. The stencils, particularly if made of zinc, can be produced very quickly, no great skill is required, and there is no need of finishing after the etching has been completed.

into close contact, with a piece of hard felt or similar material. The lead foil can be obtained from any florist, or electrical-supply house, and is very cheap.

The foil is now given a light coat of beeswax, and this leaves the surface ready for the lettering to be drawn or traced upon it, with a pencil or stylus. When drawing in the lettering or design, provision must be made for the ties that hold the center portions of such letters as O, D, and C to the rest of the plate. The out-

lines of the lettering are then cut through with a fine, sharp-pointed knife—a photographer's etching knife makes a good tool for this—as shown in Fig. 2. The foil background is now stripped from the plate, leaving it as in Fig. 3, with only the foil lettering remaining on it. The next step is to paint the whole surface, including the foil letters, with asphaltum paint, or electrotypers' varnish; then the letters are stripped from the plate. This is best done with a needle or pin, stuck into a wooden handle, the point of the tool being inserted under an edge of each letter, the foil raised, and the letter stripped off. The foil will bring practically all the beeswax on the zinc with it, leaving a clean surface for the action of the acid, as in Fig. 5.

After the asphaltum has thoroughly dried, the plate is turned over and the back and edges coated with melted beeswax, using a brush, and taking care that every part of the surface is coated. The plate is now ready for etching.

The acid used is muriatic acid, and is poured into a shallow enameled tray. The plate is placed in the tray, face up, and the tray kept in motion until the acid has eaten through all the lettering. Care must be taken not to allow the acid to splash on the face or hands, or to inhale the fumes given off. When the etching is finished, the work is removed and washed in running water, when the asphaltum may be removed with gasoline, and the beeswax with hot water.

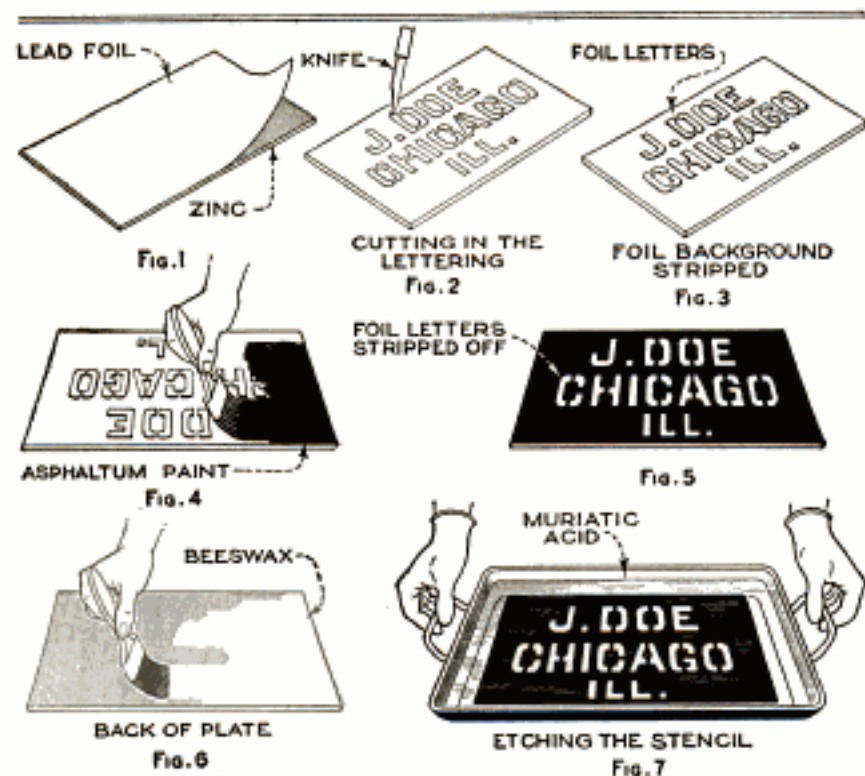

Figure 1, Applying the Lead Foil; Figure 2, Cutting In the Lettering; Figure 3, Plate Ready for Painting; Figure 4, Painting the Plate; Figure 5, Plate with Lettering Stripped; Figure 6, Preparing the Plate for Etching; and Figure 7, Etching the Work

To make a stencil in zinc, which is about the easiest metal to etch, cut the plate to size, lay it on a smooth, flat surface, and coat one side lightly with melted beeswax. The plate is then warmed slightly, to melt the wax again, and, while the latter is still soft, a sheet of lead foil, cut to the same size as the plate, is laid over it, as shown in Fig. 1, and rubbed

If asphaltum, or electrotypers' varnish, is not easily obtainable, melted beeswax can be applied to the face of the work instead, although it will make the work of removing the foil lettering a little more difficult.

Simple Chip Shield

The practice of turning brass, bronze, and similar metals at high cutting speeds often results in injuries to the operator's

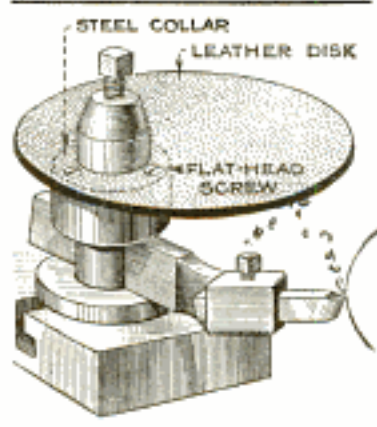

eyes by flying chips. This is, in most cases, easily avoided by the use of a guard or shield, the use of which should be made compulsory. A very simple chip guard is that shown in the drawing; it consists of a leather disk, screwed to a steel collar, the latter being a loose fit over the toolpost. The leather itself should be a "wringing" fit on the toolpost, and the hole should be off center, so that the disk can be swung to one side or the other to suit the work, or when necessary to change tools.

Removing Stripped Wood Screws

It often happens that wood screws cannot be unscrewed, because there are no threads in the wood; they may have been stripped by giving the screw a few extra turns when driving it in, or the threads may have disappeared due to dry or wet rot.

To remove the screw without marring the surface of the wood, the method illustrated may be used. Drive a finishing nail into the wood, as indicated, so that its end will come in contact with the screw thread. The screw can then be removed easily. The small nail hole is easily puttied or otherwise filled, so as to be scarcely noticeable.—H. H. Siegele, Emporia, Kan.



Reaming Axle Bushings

When inserting new front-wheel spindle bushings, it is poor practice to drive out both old bushings, and press both of the new ones in place at once, then ream them from the outside of each bushing.

The result of this is that the reamer is often canted, and the hole reamed at a slight angle. To ream the holes correctly, one old bushing should be left in place to serve as a guide, as shown in the lower view. When the bushing has been reamed to size, the old one is pressed out, and the second bushing pressed in and reamed, using the first one as a guide. By employing this method the bearing of the spindle bolt can be made practically perfect.

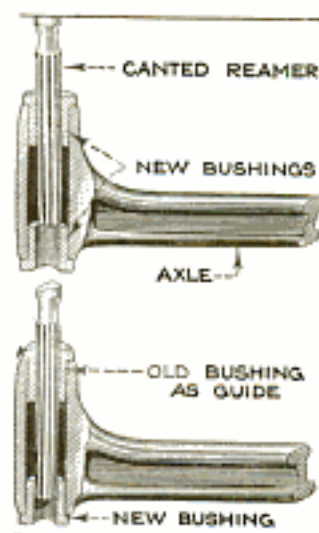

Felt Pad for Wiping Solder

A handy tool for wiping the surplus solder, when tinning the ends of pipes, or similar work, can be made very easily from two pieces of hardwood, one — the holder proper — being left plain, the other shaped to fit the hand comfortably. This handle has a step cut out at one end, and is slotted, at the same end, as shown. A piece of thin felt is fastened to the holder by screws, brought around the end, and screwed to the handle while the latter is in the position shown in the upper view. In order to stretch the felt tightly, the handle is then pulled down in line with the holder and secured with a screw and nut. Thus the whole working surface of the pad is free from obstructions, nails, screws, etc., and the material cannot "bunch" or crumple up after a short time in use.

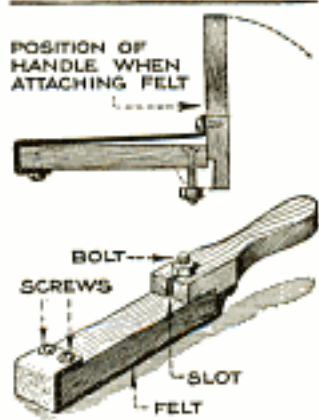

Auto Engine as Power Plant

There are many possibilities for farm use in a discarded automobile. One of the most practical is to remove and

overhaul the engine and adapt it for driving the machinery in the farm workshop. Such a power plant will give good service for several years. The illustrations show an engine taken from a light car and mounted on a wooden bedplate. The only change made in the arrangement of the parts was to mount the gas tank on a high wooden frame, and to extend the transmission shaft; this extension carried the driving pulley, and was journaled in pillow blocks, fitted on each side of the pulley.

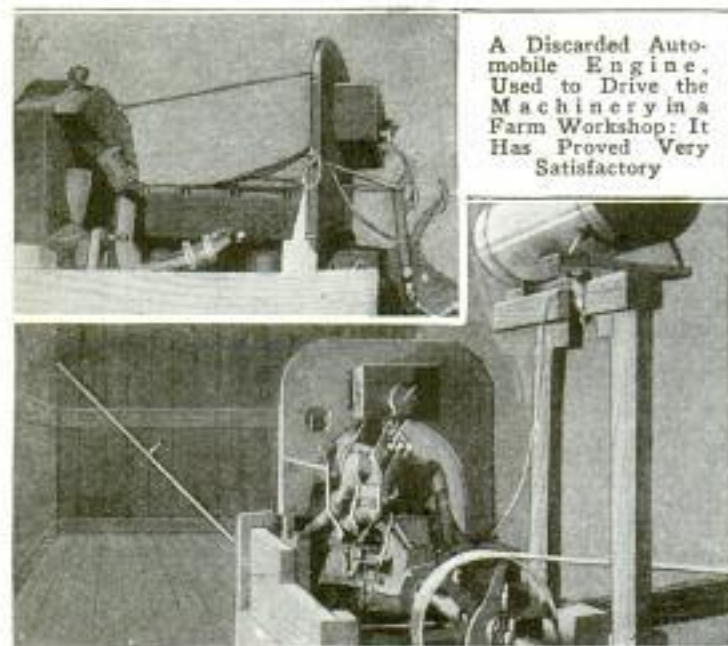

A Discarded Automobile Engine. Used to Drive the Machinery in a Farm Workshop: It Has Proved Very Satisfactory

The engine is operated exactly as when in the auto, high, low, and reverse speeds being available. After the cylinders had been reground, and new rings fitted, and when the plant had been in operation for some time, a test was made to determine the power delivered at the pulley. This proved to exceed 12 brake horsepower.—Dale R. Van Horn, College View, Neb.

Extinguishing Burning Oils and Greases

An experiment recently made to ascertain the most efficient fire extinguisher for burning oils, fats, greases, and similar substances developed a number of interesting facts.

In the majority of liquid fire extinguishers, the active agent is carbon tetrachloride, which is a noninflammable liquid at ordinary temperatures, vaporizing rapidly at a comparatively low temperature. The vapor is also noninflammable, and is heavier than air. When carbon tetrachloride is thrown upon burning wood, paper, oily waste, and similar material, the vapor formed excludes the air and the fire is smothered. However, oils or oily substances are soluble, or partly so, in carbon tetrachloride, and should this liquid come into contact with oil which is later used in the manufacture of food products, it is probable that under certain conditions the odor of the chemical would be very easily noticed. Another drawback in using the majority of liquid fire extinguishers on burning oil is that it produces an effect very similar to that of throwing water in a tank of burning oil, increasing the fire hazard because of the danger of setting fire to the building.

Most dry extinguishers contain a considerable amount of ammonium carbonate. This substance, when thrown upon

burning grease, causes the latter to foam and swell, and if a kettle filled, or even partly filled, with oil or fat should take fire, and ammonium carbonate is thrown into it, causing it to foam, the vessel will in all probability overflow and in this way endanger the safety of the building.

Experiments made with flour indicated that good results would be obtained if the fire were quickly covered with a large quantity. Flour works very well with a small volume of oil, but the quantity required to put out a fire in a good-sized vessel would cause the oil to flow over the sides, and for this reason flour, unless very quickly and carefully applied, does not always give good results.

Dry sawdust takes fire readily, and unless a quantity sufficient to smother the fire is at once thrown upon the burning oil, the sawdust will feed the flames instead of quenching them. Wet sawdust thrown on burning oil produces an effect somewhat the same as water, so it is apparent that neither wet nor dry sawdust is good material to use in extinguishing a fire of this nature.

Of all the substances tested, baking soda proved to be the most efficient for putting out a fire in which fats, oils, or greases were involved. The baking soda should be dusted to a depth of about $\frac{1}{4}$ in. over one half the surface of the blazing oil. The gas formed by the decomposing

soda spreads over the uncovered portion of the blaze; this blanket of heavier-than-air gas prevents the oxygen of the air from coming into contact with the oil, and in this manner the fire is smothered.

It is essential that the baking soda be in the form of a very fine powder, for if it lumps or cakes, the lumps sink and gas is liberated below the surface of the oil; this causes the oil to foam and swell, and consequently there is danger of the oil overflowing the sides of the vessel. To prevent the baking soda from lumping in the container, mix it thoroughly with 30 per cent of very fine sand, and it will be found that the mixture is but little less effective than the pure soda.—E. O'Connor, Davenport, Ia.

Tool for Cutting Corrugated Roofing

Cutting corrugated roofing with a pair of ordinary tin snips is a tiresome job, and one that is usually rather rough on



the hands. The simple tool shown in the illustration, which is made from an old pitchfork and works somewhat like a can opener, will be found much easier on the hands. The tines of the fork are cut to a length of about 4 in., and bent until the points are about 2 in. apart. The

middle tine is then bent downward, as shown, and sharpened to form a cutting knife. When cutting, the outer tines will run in the corrugations on either side of the line of cut, keeping the cut straight.—H. J. Engel, New Braunfels, Tex.

Hanging a Double-Swing Door

The photograph shows a factory door that swings in either direction and closes itself through the action of a strong coil spring. It is not necessary for the workman to stop to open the door, but simply to push the truck against it. This door

is not of the common hinged type, but swings on two pivots located above and below the door, about 1 ft. from the side

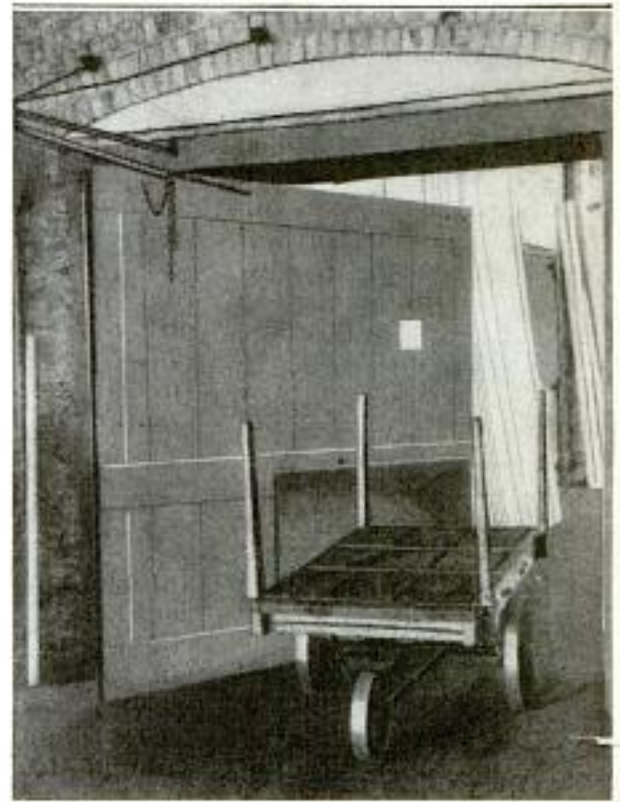

Double-Swing Door in a Factory, Opened by Simply Pushing the Trucks against It: A Spring Attachment Makes It Self-Closing

jamb. The only equipment required to make it self-closing, is a heavy coil spring, a wall bracket from which to extend the spring, and two lengths of chain for attaching the spring to the door in the manner indicated. The spring is brought into tension when the door is opened in either direction, owing to the fact that one chain extends to each side of the pivot on which the door swings. The woodwork of the door is protected from damage by sheet metal, fastened on each side at the height of the truck bodies.—Orin Crooker, Wheaton, Ill.

Drilling Horizontal Holes Straight

Anyone who has ever used a brace and bit knows that in the drilling of horizontal holes there is a great tendency to raise or lower the brace a trifle while drilling, which, of course, results in the hole being drilled at an angle. To overcome this tendency, slip a large washer over the bit so that it rests on the smooth shank. As soon as the bit is held at an angle the washer will travel one way or the other, and the workman can correct the fault instantly. The washer should be free from burrs.

Filing Bearing-Cap Faces

When filing down the flat faces of caps of connecting rods, bearings, and steering-gear connections to compensate for wear, the caps cannot always be held in a vise conveniently, because of their

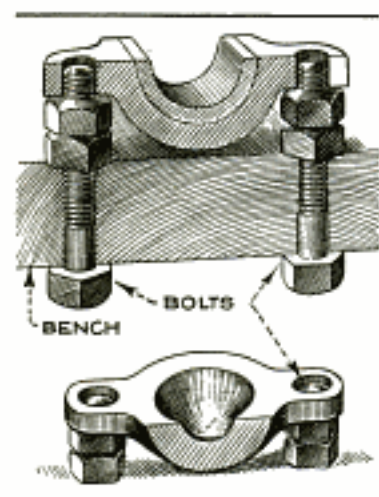

shape. An excellent method of holding them on the workbench is shown in the illustration.

Two holes are drilled in the workbench; these are spaced apart the same distance as the bolt holes in the cap. Bolts are

pushed through the holes from underneath, and nuts screwed on, to hold the bolts in place and to serve as seats for the caps. Although this method may not appear to provide a substantial support, it has been found that the cap can be filed down without any tendency to rock, providing the lowest part of the curved surface rests on the bench.

Recovering Pump Cylinder from Well

Workmen repairing a casing well had the misfortune to drop the pump cylinder to the bottom of the pipe, about 120 ft.

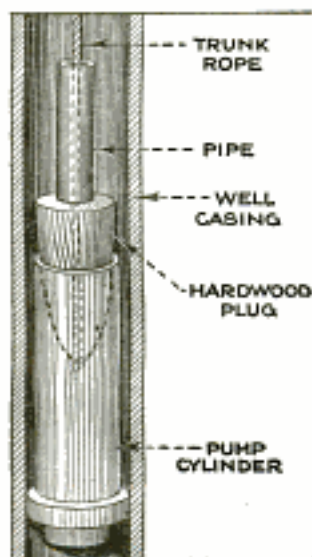

below the ground. To raise the casing was, of course, out of the question. The only method of recovering the cylinder was to use some device, which, when lowered from the top by a rope, would engage the cylinder and draw it up. The device used is shown in the illustration.

A piece of hardwood, 10 in. long, was rounded to form a tapering plug, the outside diameter of which just exceeded the inside diameter of the cyl-

inder. A hole was drilled through the plug lengthwise, and a trunk rope passed through it and tied. After the plug was lowered in the casing, and when it was felt that the small end had entered the cylinder, a length of 1-in. pipe was slipped over the rope and allowed to drop on the plug. The impact of the pipe drove the plug into the cylinder. It was then an easy matter to lift the cylinder to the surface.

A Tire-Setting Gauge

In the shrinking of steel tires on railroad-car wheels, the side of the flange must be kept parallel to the flange of the hub liner. Measuring with a small gauge or scale is by no means easy or comfortable, as it must be done while the tire is hot. A gauge that has been especially devised to overcome this objection, and that enables the worker to accomplish the work with speed and accuracy, is shown in the illustration.

The gauge has a cast-iron base, the underside of which has a V-notch milled in it to fit on the journal. A long steel rod is driven into a hole drilled in the base, and is fitted with two fingers. The

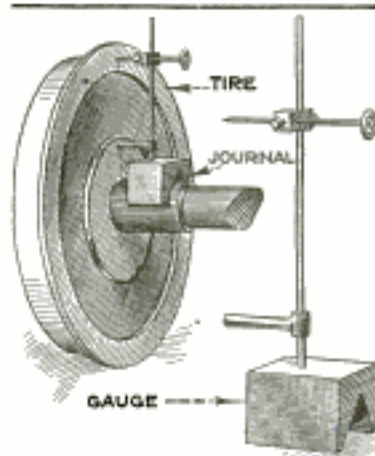

lower one is attached permanently to the rod, and, in use, is set against the liner. The upper finger is fitted in a sliding block. When the lower finger is set against the liner, the block is moved up until it is opposite the tire, then locked by a setscrew. The finger is then moved until it touches the tire and is locked, and the gauge is swung around the journal. It is thus an easy matter to set the tire perfectly parallel with the liner.—W. S. Pickerell, Spokane, Wash.

☛ An emergency valve-grinding tool can be made from a piece of broom handle, a thin piece of sheet metal, driven into the end, and two pins to hold the sheet metal in place. To operate the tool thus improvised, hold it between the palms and twirl around by moving the palms back and forth.



A Homemade Tea Wagon

By E. E. SCOTT

THE tea wagon is a true boon for the busy housewife, as it saves many of the innumerable steps between dining room and kitchen, necessary in carrying in meals, and removing dishes.

The material for all parts of the tea wagon shown, except the wide boards for the trays, is mahogany, obtained from the scrap pile of a chair shop, and costing only 50 cents. The trays are made of

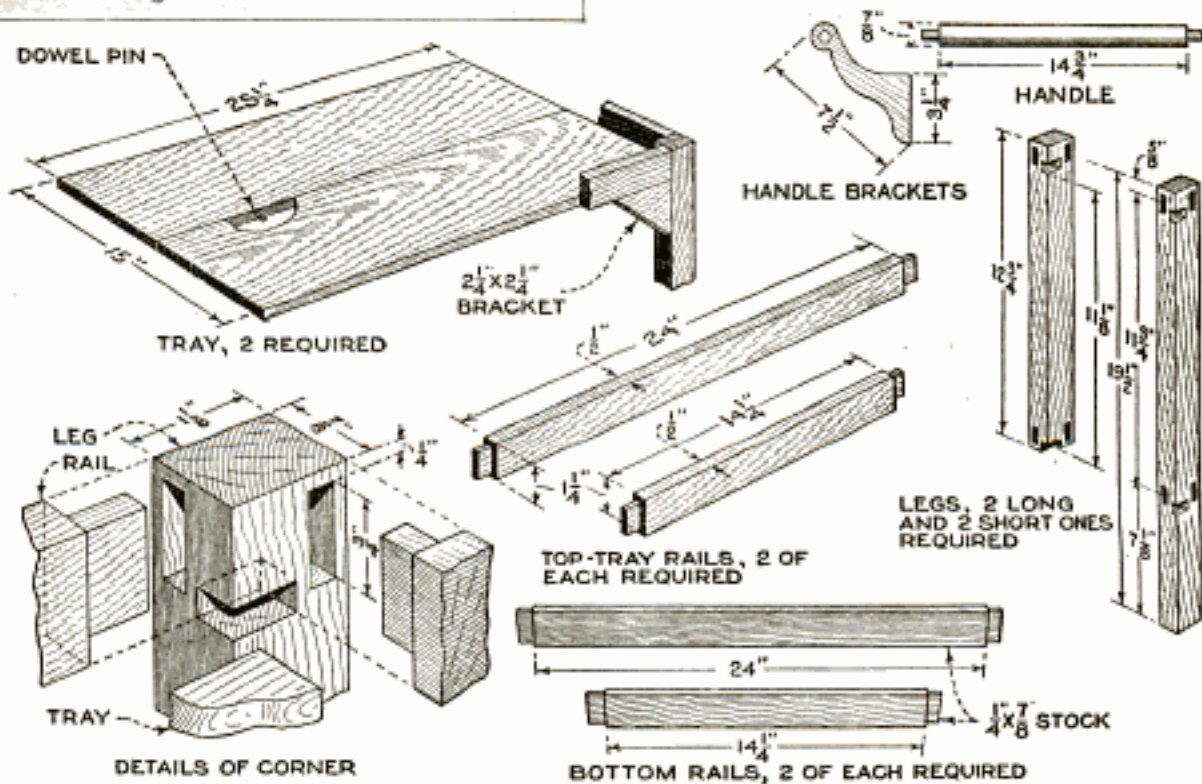
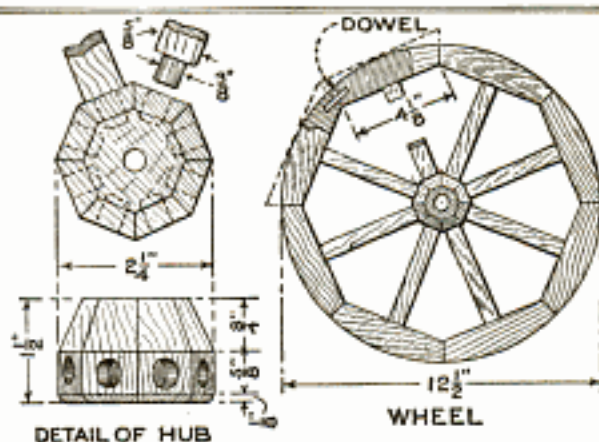
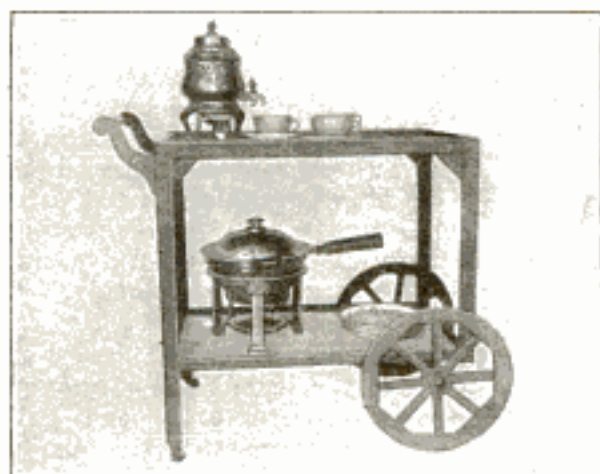

Full Details and Dimensions of a Tea Wagon That can be Made Very Cheaply at Home: Most of the Parts can be Made of Scrap Stock, and the Construction is Simple. The Photograph Shows the Completed Wagon

$\frac{1}{2}$ -in. pine boards, doweled and glued together as shown in the detail.

The making of the wheels is the only operation that is at all difficult and demands explanation, but, with a little care in mitering the separate sections, the work is comparatively easy. The wheels should first be laid out, full size, on a sheet of cardboard, and one rim section cut out to the shape indicated by the dotted lines, to serve as a template. The stock should be marked by means of the template, but cut in a miter box set to a $22\frac{1}{2}^\circ$ angle. The ends of each section must then be carefully "sliced" with a keen plane, to make as perfect a fit as possible, then doweled and glued as shown, notches being cut in the corners, and the rough segments bound together with wire until dry. The octagonal hub and square spokes are then made and glued together, and the assembly, when dry, carefully centered within the rim. The spokes are marked, cut to the proper length, and nailed to the rim with 1-in. brads, one on each side of a spoke.

With one leg of a pair of compasses at the center of the hub, a $12\frac{1}{2}$ -in. circle is described on the rim, and it is trimmed

to shape with knife, file, and sandpaper. If desired, a groove can be cut in the rim and rubber tires fitted.

The remainder of the work is mainly a case of "cut and fit," all the details and parts being shown in the drawing. The axle brackets are fastened to the lower tray by three long screws, the wheels being attached to the brackets by square-head brass bolts, $2\frac{1}{2}$ in. long. A pair of ordinary casters are fitted to the rear legs. Screws are used to fasten the angle braces on the trays, and also for the handle brackets. The remaining parts are carefully mortised, glued, and nailed with small brads. Prepared liquid glue should not be used; use the hard, flaky patternmakers' glue obtainable at most hardware stores, and melt it in a regular gluepot.

The finish will, of course, depend upon the material used and the maker's taste, but the woodwork should be as finely finished as possible before any stain is applied, and, if the wood is open-grained, a good paste filler should be used after staining. Do not use a varnish stain, but obtain a good stain or wood dye, and follow the maker's directions closely.

Gate for Dog Built in Fence

It is generally desirable to give watch dogs free entry and exit to the house yard of a farm, especially at night, and for this reason one of the gates is usually left open; this, however, does not exclude poultry or cattle from the yard. This objection can be easily overcome by providing a self-closing gate that can be opened with little effort by the dog.

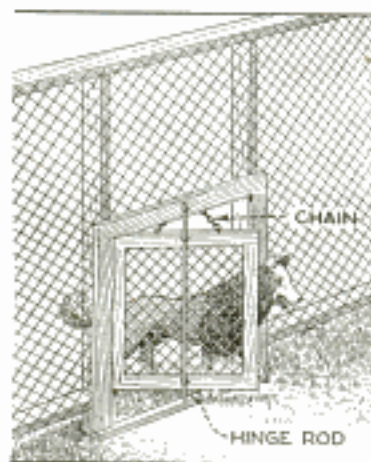

swings on a vertical rod that passes through screweyes driven into the frame, as indicated. It must be balanced as perfectly as possible so that the chains will

The gate can be built in any fence, can be made of any suitable size, and can be adjusted so that more or less effort is required to open it. It is held in a suspended position by two short chains as shown, and

close it again after it has been opened. The force required to open the gate depends on the distance that the chains are spaced from the hinge rod; the farther they are spaced from it, the more force is required, and vice versa.

The edges of both gate and opening are, of course, perfectly smooth, to eliminate possible danger of injury, and sufficient clearance must be left between the top and bottom of the gate to insure easy operation.

Hints for the Home Typist

To facilitate handling the paper and carbon sheets when making several copies on a typewriter, the following expedient has been found very helpful: Select a sheet of light but tough paper, the same width as the carbon sheets, but about $1\frac{1}{2}$ in. longer. Place the carbon sheets, face downward, on this paper and fold the projecting end over the top of them. Then sew the carbon sheets in this fold securely on a sewing machine, about $\frac{1}{2}$ in. from the fold, using a rather long stitch. In using this carbon arrangement, each sheet of paper is pushed up under the flap as far as it will go, and the platen release is used when inserting the sheets into the machine.

Replacing Gaskets

Shellac is very often used when putting in a new gasket. This is, however, bad practice, as a new gasket will compress enough to make a good joint, it being necessary only to rub a little grease on both sides, and the use of shellac means that the gasket will be torn when removed. When replacing an old hard gasket, shellac must be used, but it is better not to use old gaskets at all.

Track Aids in Pulling Buggy over Steps

A detachable track has been found to be a great aid in pushing a baby cab or invalid chair over a flight of steps. Two lengths of channel iron, wide enough to accommodate the tire of the vehicle between the

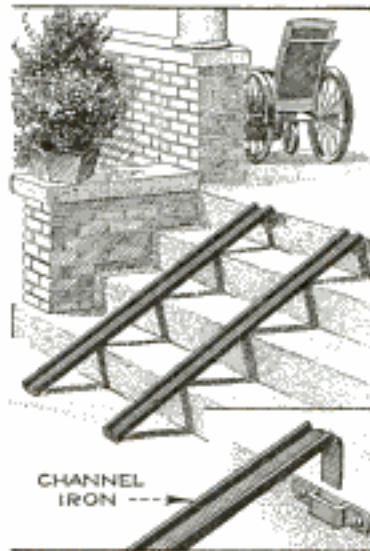

flanges, are used for the tracks. At one end, both flanges are trimmed off for about 2 in., and the web is bent down to form a hook. Light flat-iron brackets, bent U-shape, are screwed to the riser of the top step to accommodate the hooks, so that the web of the channel will come flush with the tread of the step. The tracks are spaced to suit the wheels of the cab or chair. When not in use the tracks can be laid aside. If the steps are of concrete, expansion bolts can be used to fasten the brackets, holes being first drilled in the step with a common star drill.

Replacing Fan Belts

Trouble is often experienced when replacing fan belts on small cars having a crank that is not detachable, because there is very often too little space between the crank and the lower fan pulley. This trouble can be eliminated by cutting off, with a hacksaw, part of the four teeth of the crank that engage with the pin on the end of the shaft. Of course, care must be taken not to cut off too much, or the crank will be ruined.

Drawers Made from Varnish Cans

Ordinary varnish cans of 1 or 1½-gal. size can be turned into very serviceable and durable drawers for holding small

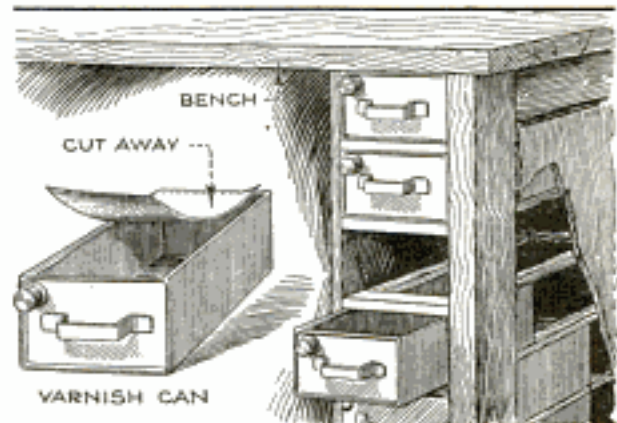

Serviceable and Durable Drawers, Made from Varnish Cans, Provide Excellent Storage Space in Any Workshop. They may be Arranged under the Bench, or a Frame can be Built to Contain Them

tools, nails, screws, putty, and, if desired, liquids. One side of the can is cut away as indicated. The sharp edges remaining are bent or hammered down so that there will be no danger of cutting the hands. A number of slides on which the cans may run easily can be arranged underneath the workbench, as shown in the illustration, or if desired, a special frame can be built to contain them, making a neat storage cabinet.—Harry W. Poor, Boston, Mass.

Simple Tube Deflater

A device for deflating inner tubes is shown in the illustration. It can be constructed in a few minutes and is very useful in any garage, as it eliminates the necessity of removing the valve, or of searching for a piece of wire to push it down.

Two small holes are drilled in one end of a piece of wood in the manner shown. The hole in the side is large enough to allow a valve stem to be inserted, while the hole in the end permits the air from the tube to escape. A machine screw is driven into a smaller hole in line with the first hole, and extends about $\frac{3}{8}$ in. into it. The end of the screw fits inside of the valve stem, and holds the valve open.—J. J. Ginsberg, Brooklyn, N. Y.

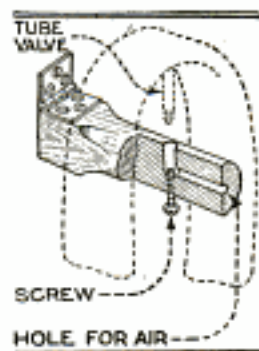

Refrigerator for the Camp

An excellent refrigerator for the camp or summer cottage can readily be made by lining a wooden dry-goods box with

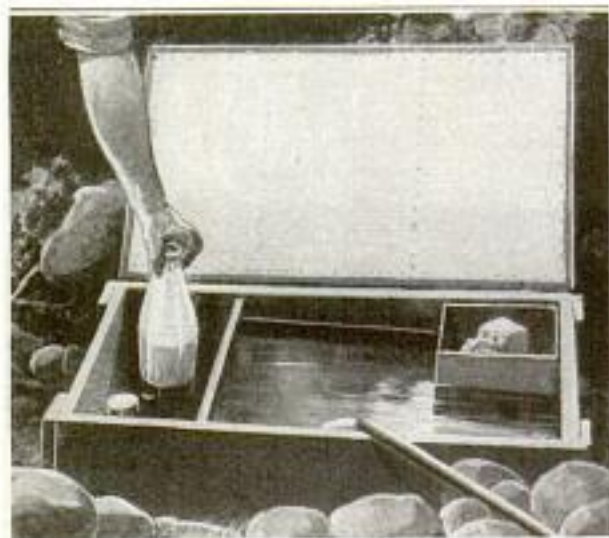

A Wooden Dry-Goods Box, Lined with Galvanized Iron and Divided into Several Compartments, Makes an Excellent Refrigerator for the Camp

galvanized iron, soldering all seams, so as to make it water-tight. This refrigerator also serves as a drinking tank.

The refrigerator has three compartments; the large one is used for the drinking water, the one at the left in the photograph for cream and milk bottles, and the smallest one for meats and vegetables. The two larger compartments are made by making a partition across the box, but the smaller one is simply a removable galvanized iron box. The compartments can be made any size.

Water from a spring is led into the box by means of a length of pipe, and flows from the main compartment into the smaller one through a hole drilled in the partition. A drain hole is drilled in the outer side of the second compartment so that the surplus water will flow out. This hole is drilled at about two-thirds the height of quart-size milk bottles. The hole in the partition may be higher than this, so that the level of the water in the largest compartment will reach nearly to the top of the small meat box.

It has been found that a refrigerator of this type, about 3 ft. by 18 in. by 12 in. in dimensions, will keep milk and cream sweet for three days during the hottest weather.—Harry F. Blanchard, South Glenn Falls, N. Y.

☛ Steam for small toys may be obtained by connecting a rubber tube to the valve of a steam radiator.

Winding Electrical Coils Tightly

Most experimenters, working with electrical coils, find great difficulty in winding the wire so tightly that the coil, when finished, will have the neat appearance of machine-wound coils. It is well known that copper possesses a high heat-expansion rate, and this fact can be applied in coil winding, to make a neat job. By placing the wire over the stove, or other source of heat, until it is thoroughly warmed, and keeping the temperature as high as possible during the winding operation, surprisingly good results will be obtained. In following this method care must be taken to see that the ends of the wire are securely fastened, to prevent them from loosening when the wire contracts upon cooling. When it is understood that 100 ft. of copper wire expands nearly $\frac{1}{2}$ in. when raised in temperature about 30° F., it is easily seen that, when the wire contracts upon cooling, it will produce a tightly wound coil.

Holding the Garage Door Open

Open garage doors are likely to be slammed shut by a slight breeze. This is very annoying, especially when one person, unaided, is attempting to drive into the garage. The simple stops shown in the drawing will prevent this occurrence. Each consists of a stout wooden prop, of 1 by 2-in. material, a leather strap, nailed to the door, and a cleat nailed below the strap. In use, the prop is set under the cleat so that pressure applied to the other side of the door cannot close it. When the doors are closed the ends of the props



Method of Keeping Garage Doors from Closing, Which Proves of Considerable Assistance When Driving into the Garage Unaided

are set behind brackets provided for this purpose; or simply rested on the frame.

Lubricating Windows

When windows fit tightly so that it is difficult to open and close them, the guide strips are usually planed down. This method of overcoming the difficulty is effective but has the disadvantage of allowing the window to rattle during windy weather, and is therefore not entirely satisfactory. A better method is to use a suitable lubricant on the guides. Not every kind of oil can be used for this purpose, however, as some kinds become thick and sticky, and this tends to increase the difficulty instead of lessening it. An excellent solution for the purpose is a mixture of paraffin and turpentine.

Dissolve as much paraffin in turpentine as possible, by shaving the paraffin and allowing the mixture to stand for a few days. Apply the solution liberally to the window guides with a brush, going over them two or three times. The turpentine will evaporate and leave a colorless film of paraffin on the guides. After this treatment the windows will slide freely, regardless of weather conditions.

For metal-frame windows in industrial and office buildings, the following method gives satisfaction: The paraffin is melted and powdered graphite is stirred into it while hot. Upon cooling, the mixture solidifies, and the cake thus formed is used to rub the guides.

Obtaining Clear Image in Finder

When exposures are made under the open sky, the finders on many cameras show not only the image of the object to be photographed, but also reflect a transparent image of the photographer's head and a section of the sky above, both of which disturb the sharp outlines of the image. Pulling down the hood of the finder low enough to cut out these reflections usually hides from view the top of the image.

A simple means of correcting this fault, and, at the same time, leaving the whole image visible, is to place a small paper cone over the finder; a piece of heavy paper rolled into conical shape, and pinned together, will serve excellently. A convenient size of cone is about 6 in. long, with the top opening $\frac{3}{4}$ in. in diameter, and the bottom opening just large enough to fit over the finder.

Garden Hedges from Sod

It usually takes considerable time and care to grow a neat-looking border hedge, and this deters many gardeners from



Left: A Garden Well Surrounded by a Hedge Made of Sod.
Right: A Bridge of Sod Built over a Miniature Lagoon

planting them. The gardeners of Exposition Park, Los Angeles, however, have found a quick method of making them, by using sod.

The illustrations show the pleasing effect of sod hedges surrounding a rustic well curb, and also forming a bridge over a miniature lagoon. Strips of sod are piled, one upon another, to the height and shape desired, and kept thoroughly soaked until a compact structure is formed. Sod with the grass side out is used on the edges, as well as in the top-most layer. In making structures like the bridge, it is, of course, necessary to provide reinforcement of some kind, usually heavy-wire mesh.—C. C. Wagner, Los Angeles, Calif.

Simple Blow-Out Shoe

A strip of canvas, properly applied, makes an ideal blow-out shoe that will add many miles of service to an old casing. The canvas strip must, of course, be wider than the length of the hole in the casing. The canvas is wrapped around the tube several times, so that it will fit exactly inside of the casing. A liberal application of soapstone will eliminate most of the danger of chafing. Care must be taken when replacing the tube to get it in the casing so that the bandage fits inside of the blow-out. It will be found that the casing will not bulge as with an ordinary blow-out shoe, and that the strip will last a long time.



MAKING ARTIFICIAL FLOWERS



By Bertha Graves Morey

Awarded First Prize—\$100—in Contest on Occupations for Shut-Ins

DECORATIVE artificial flowers are used for so many purposes, and in such vast quantities, that some understanding of their construction will prove very valuable to the shut-in; by applying the principles laid down and illustrated in this article, he can build up a steady and lucrative business, and one that is not affected, to any great extent, by the season, as are many other lines of home employment.

In designing or making flowers for the trade, the prevailing styles should be followed, as any undue originality may lead to poor sales. The styles for flowers used for millinery are usually limited as to size and to color. If large flowers are the fashion, the size is more important than the kind, and the flowers must always be of the fashionable color. The same applies to smaller flowers. These are usually used in wreaths and bunches, and sometimes for completely covering hat crowns. Whatever sizes the ruling fashion dictates, it is best to follow nature somewhat in the selection, and to make small flowers like some natural small flower.

The quality of the material of which the flowers are made should be in harmony with the thing they are to decorate. When used for the stage, they should be of fine color, of effective size, and of any kind of material that is inexpensive and will produce the desired result. Useful materials include colored linings, muslins, cotton flannels, and organdies. For pageantry and outdoor decorations, waterproof glue should be used, and these flowers, which are usually of greater size than for other purposes, should be made of sturdy materials, to withstand careless handling.

Those used for gowns and millinery are applied to new uses, and change in style each season. These flowers are made of an unlimited number of kinds of material, from the richest to the commonest. Cloth of gold and silver, velvets, ribbons, brocades, silks, satins, laces, nets, beads, feathers, and covered wires make up the richer flowers used in millinery.

Natural grasses, seeds, pods, husks, raf-

fia, reeds, paper, twine, leather, oilcloth, sheet rubber, tinted and painted with oil colors, yarns, chenille, and braids make up a not less interesting group of flowers for millinery, fancy dress, fancy work; decorations for cars, display windows, parades, and interior decoration for stores and homes. A touch of bright color is an acknowledged necessity, in attracting and pleasing the modern eye.

The materials needed for assembling the parts of the flowers are waterproof glue; coarse and fine wire; covered wire; cords; sealing waxes of all colors, for touches of color in the flower centers, and for sealing places hard to glue; mending tissue for covering stems and buds, and oil and water colors for details and accents.

The tools used are shears, wire cutters, sharp knives, brushes, an alcohol lamp for melting sealing wax, and an atomizer for blowing tints of color over the finished flower.

The decorative flower, to be effective, need not be a copy of nature. If a great number of flowers are to be made at one time, work can be saved by first preparing all the parts and then doing the assembling. It is sometimes best to have certain persons do the preparing, and others, possibly more fitted, the assembling. The plan of work should always be carefully laid out, and the parts put in trays or box lids.

Flowers of two or more shades or materials are more interesting and quite as easily made as those in one tone or material.

Each material has its limitations and possibilities. Woven materials, that fray easily, cannot be handled in the same manner as leather, paper, oilcloth, etc., that do not fray. Machine hemstitching offers the most professional finish for the edges of petals made from fraying materials. Pile materials, such as velvet and plush, lose much of their fraying qualities if painted over the back with a thin-glue size. This size should be thick enough to stay on the surface, and not soak through the pile. Several applications, each to be dried before the next is applied, will be necessary if the

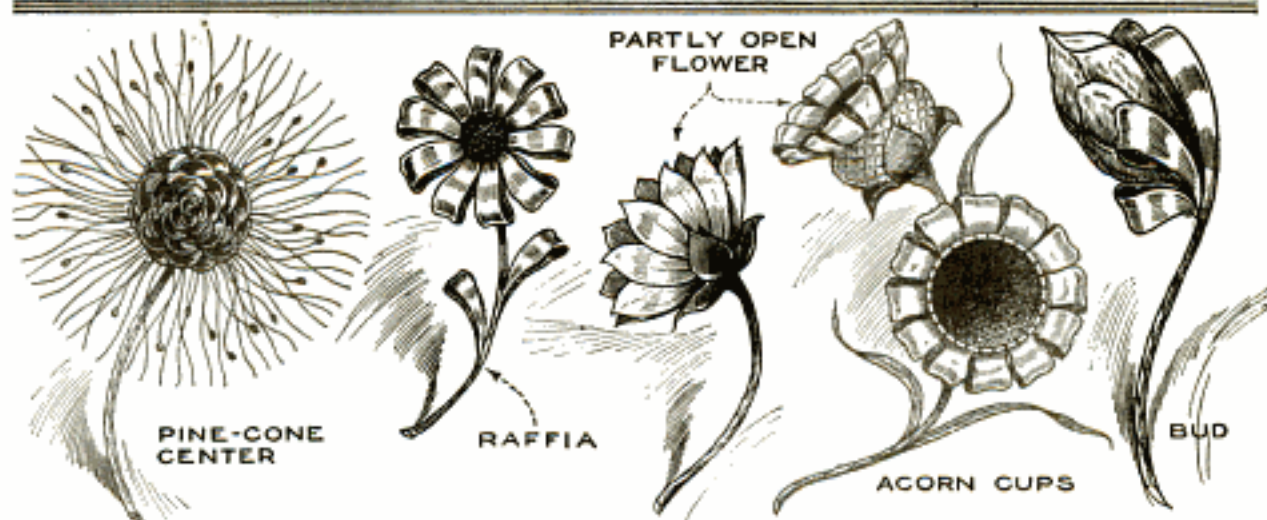

Left: Flower with Pine-Cone Center, Pine-Needle Petals, and Wax-Tipped Pine-Needle Stamens. Center: Various Flowers, Using Ribbon-Loop and Cut-Out Petals, and Two with Painted Acorn Cups as Centers. Right: Bud, of Satin, Metal-Cloth, or Silk-Covered Satin, with Ribbon Calyx and Stem

material is to be quite stiff. Nets, mulls, and thin silks may be stiffened by dipping in a very thin size. To do this, the material is dipped, then dried in a small frame, made in the same manner as an ordinary curtain stretcher. Cotton materials may be starched to almost any degree of stiffness and either stretched, as mentioned above, or ironed. Stretching is by far the most successful way of drying, but is not always practicable, if small pieces or scraps of material are being used.

The parts of all flowers are about the same, and the different development of these parts will be better understood if natural flowers are taken apart and carefully studied. From this study many ideas for the shapes to use for petals and leaves will be discovered. A notebook of sketches of the parts of dissected flowers will prove an invaluable addition to the flower maker's equipment.

For the artificial-flower maker's purposes, the flower consists of three parts: the center, the petal or petals, and the calyx. The center is made up of stamens and pistils; the petals, known botanically as the corolla, may consist of one funnel-shaped unit, as in the petunia, or of many petals, as in a rose; the calyx, consisting of the sepals, is the cuplike formation that grows from the stem and surrounds the petals and center, all forming the flower.

Centers in decorative artificial flowers, as in nature, form a distinctive note that should be well developed with the proper color harmony in relation to the other parts. The centers for silk, feather, metal-cloth, and lace flowers should be of rich material, to harmonize with the material used in the petals.

To make the centers, buttons, covered with material embroidered with silk or metal threads, are used, or small skeins

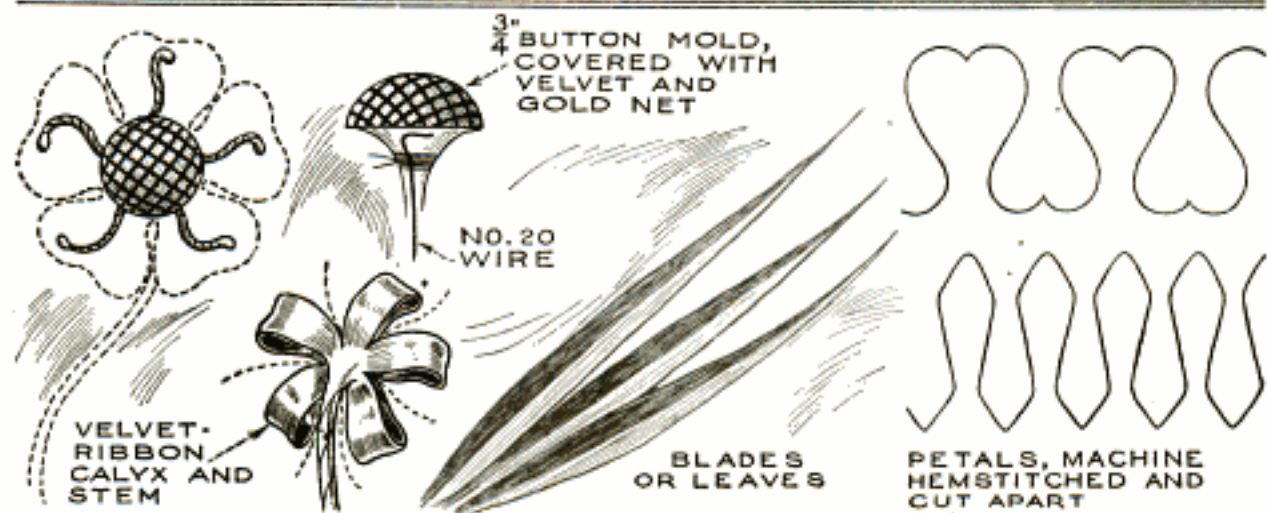

Left: Flower with Velvet-Ribbon Calyx and Stem. Center: Center Made of Velvet and Gold-Net-Covered Button, and Shape of Artificial Leaves. Right: Method of Cutting Petal Material, After Hemstitching, to Avoid Waste

of thread, tied or wired, and clipped to form short, stubby, brushlike parts, which are touched with colored sealing wax, or oil paint, to make them bright. Buttons, covered with long-nap velvet, and then covered with silk or metal net, also make good centers, the pile of the velvet standing up through the meshes of the net. Beaded velvet centers may be used for silk flowers; feather centers for ribbon and silk flowers, or small clipped feather centers for flowers of soft feather petals. Twine, fiber, raffia, tight little rolls of paper, muslin and crash, and crochet wool, cotton, or linen yarn, are suitable materials for the centers of paper and oilcloth flowers.

The stamens, while frequently omitted from the artificial flower, are an attractive addition, and well worth the extra work. Short or long pieces of fairly stiff cords, raffia, threads, or grasses with ends knotted, beaded, dipped in sealing wax, or touched with oil paint, make suitable stamens. The color used on these should harmonize closely with the other parts of the flower, or contrast strongly, while preserving the color scheme. If small loops are used for stamens and large ones for petals, the stamens are made of material that will enable them to be distinguished easily from the petals. Loops of fine wire, strung with small beads, make sparkling stamens, appropriate for flowers used for millinery and dress decoration.

The petals permit the greatest variety of shape in designing decorative flowers. They are made in loops, fringes, or solid pieces, carefully yet seemingly carelessly shaped, of one or of many pieces. The one-piece petal such as would be used for the calla lily, the petunia, etc., is not very interesting in artificial flowers, and is more easily made of crêpe paper than of woven material. When made of woven material, it is necessary to use wooden or metal forms where the dampened material is pressed and stretched until dry. Any necessary seams or laps are glued with waterproof glue. The edges are trimmed when perfectly dry, and any tinting necessary is done with an air brush. While it is interesting to know something of how the one-piece petal is made, the result is not worth the extra equipment.

The many-piece corolla or petals are much more interesting, effective, and simpler to make. The shape and color may follow the natural flowers or the maker's own taste. Flower design, like all other designs, follows lines and ideas not always found in nature. However,

there is much to learn from nature, and artificial flowers made following nature's own design and color are always interesting.

For materials that ravel, machine hemstitching or picoting makes a substantial and interesting petal edge. The petals may be so designed as to make one line of hemstitching finish two sets of petals, leaves, or blades, as shown in one of the drawings. Coarse or fine buttonholing is also a useful petal edging.

The calyx is an excellent place to finish the flower. Broad strips of raffia, mending tissue, ribbon, strips of the same kind of material as that used for the petals, tape, or oilcloth are cut to shape at the ends, and wound over the base of the flower and down the stem. These strips, if of mending tissue, will stick from the warmth of the hand if held in place for a moment. If the covering is of any other material, glue or sewing, or both, must be used. Should the material stain with glue, fasten it in place with as few stitches as will do the work. Avoid overworking the parts of a flower, as this will make them clumsy and ugly.

The leaves may be seemingly real flat leaves, twists, spikes, or loops of suitable color to simulate the desired foliage. For flat leaves, imitating natural leaves, patterns are made, and the leaves cut from sized or starched material and glued to a thin-wire stem, which also forms the central vein of the leaf. When complete, if very glossy foliage is wanted, paint the leaves and stems with shellac, or dip them.

Buds are made of small balls or forms of cotton, covered with green, or a darker color than that used for the flower. The calyx and stem are finished in the same manner as the flower.

When assembling the parts, the center is first made by winding a skein on the winding card shown at the top of the large illustration. The ends of the skein are tied; it is then removed, doubled several times, and tied with several turns of No. 26 iron wire, and the ends clipped, so that the center assumes the shape shown at the upper right. The stamens are placed around the center and secured with fine wire also. The petals are next placed in position and wound as firmly as possible. If there are several rows of petals, use only one or two windings of the wire for the first rows and the heaviest winding for the last row. This stub is then wound with heavier wire, No. 22 for average work, and this wire extended down for the stem, although

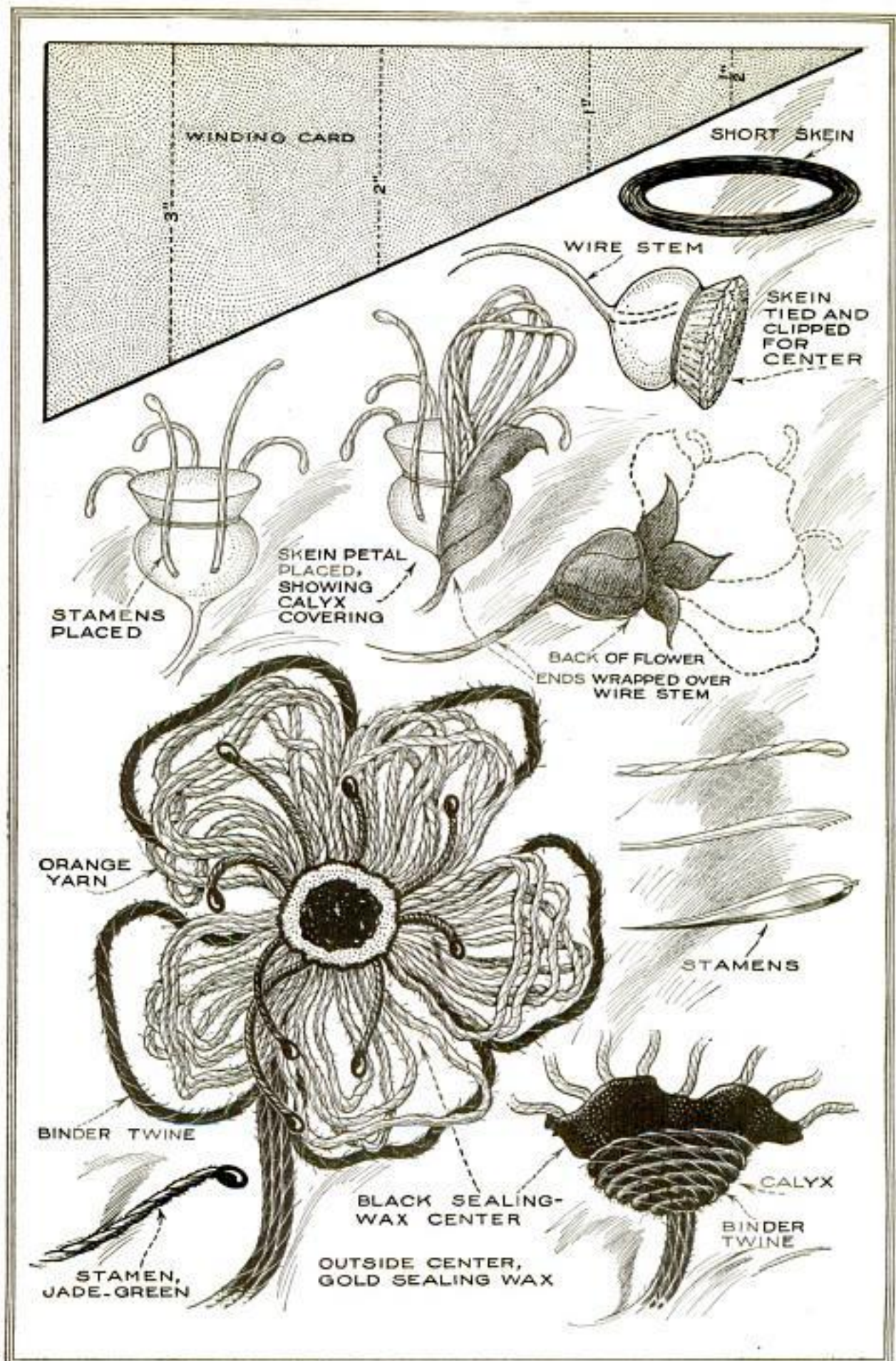

Details of the Making of an Artificial Flower with Skein Center, Sealing-Wax-Tipped Stamens, Loop or Skein Petals, and Either Binder-Twine or Strip Calyx: The Winding Card Shown Is for the Purpose of Making Uniform Skeins for Centers or Petals. Several Types of Stamens are Also Shown. The Color Scheme Indicated is Suggested Only, and may be Modified to Suit

the stem may also be stuck inside the skein center; the method of making the stem will depend, to a large extent, upon the type of center used. Before covering the stem, any buds to be used must be added by twisting the bud stem with the flower stem. The calyx is then made and glued, or sewn, firmly in place, the stem wire covered, and the covering glued or sewn.

The foliage used with flowers should harmonize with the color of the flowers, as yellowish-green for yellow flowers; gray or purplish-green for red flowers, blue-green for blue flowers, and gray-green for pink and violet flowers.

Many natural grasses and seeds are used in millinery. If the natural color is not desired, aniline dyes, soluble in alcohol, are used to dye the grasses. Several dippings, drying between successive ones, will be needed for very dark colors. Water colors may be used, but the water sometimes softens the grass, causing it to lose its shape. Alcohol dries very quickly, and does not soften the stems or grass. When dyeing with either water or alcohol dyes, always dry by hanging up by the stems. If it is necessary to stiffen the plants, use alcohol that has absorbed as much white shellac as it will take, and then add the dye and dip until the proper shade is reached. The seeds may be dyed, shellacked, or painted with glossy or flat-color oil paints. Seeds may be

drilled and wired and used in the centers. Small husks and seed pods are used for decorative flowers, sometimes in the natural color, but most frequently dyed or painted, using the same methods as with the seeds. The stem parts of clove seeds make interesting centers for very small flowers. Palm-leaf fans, cut in crosswise strips and rolled in $\frac{3}{4}$ -in. rolls, make good centers for stiff flowers, such as zinnias.

The vogue for winter bouquets permits the use not only of natural flowers, but everlasting ones, such as straw flowers, bachelor's-buttons, lily pods, chinese-lantern pods, rose hips, pampas grass, and the countless reeds. Dry corn husks make very lovely delicate-colored petals, but are not durable and will not stand much shaking or handling.

To market the product, a line of a dozen or more samples should be made, and either sent or taken to the merchant, and orders solicited, the material to be delivered at a certain time. The price should bear some relation to flowers on the market of the same quality. The time spent cannot be calculated at the same rate for work done by an invalid as that of the work done by the able-bodied. The selling price should be $33\frac{1}{2}$ to 40 per cent below the merchant's selling price. Some workers mark their goods at the retail price, less either of the above-mentioned discounts.

Grading Lawn Frontage

It frequently happens that grades for public walks are established after houses have been built on the adjoining lots, and

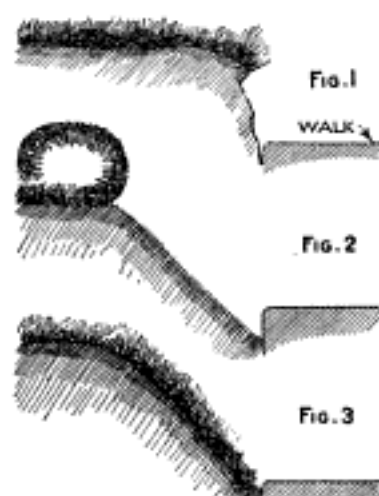

as these grades are very often lower than the surface of the lots, it becomes necessary for the owners to slope the frontage, and make a neat bank. This is usually done by cutting the ridge down and re-seeding the

bare soil. During this process much trouble is experienced from rain, as it washes both seed and soil away. To pre-

vent this, a workman employed a practical method in making the bank, that left it very neat in form and grassed over in perfect condition.

The level of the walk was about 20 in. below the surface of the lawn and presented a very rough appearance, as shown in Fig. 1. The sod was loosened, cut into strips by means of a spade, rolled back, and the soil graded, as shown in Fig. 2. Before the sod strips were rolled back over the bare soil, as shown in Fig. 3, both sod and soil were thoroughly sprayed with water until saturated, which helped to keep the sod in place and prevented the grass from withering before the roots took hold. Subsequent watering, at intervals of 24 to 48 hours, for a few weeks, left the lawn frontage in as perfect condition as before the bank was formed.

Neighboring lots, where the slope was cut away in the usual manner by cutting and re-seeding, did not attain a presentable appearance for over a year, and some were badly damaged by rain.

Emergency Gaskets for Automobile

When it is necessary to use a gasket for an oil leak in the transmission cover, and a regular gasket is not at hand, a good one may be made from a piece of heavy wrapping paper. The sheet is laid over the cover and cut to fit by tapping around the edges with a hammer. The bolt holes are cut with the ball end of the hammer. The same kind of gasket will serve in many other places.

Keeping Floor Boards in Place

After a light car has been in use for some time, it frequently happens that the foot boards do not fit as snugly as at first,

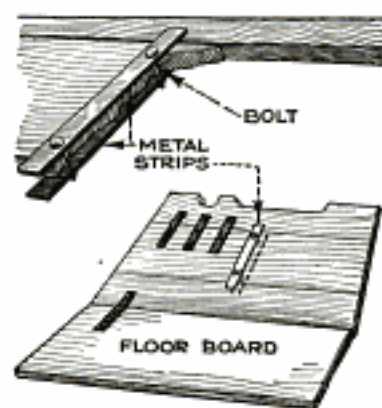

and hence are apt to slip out of place. This might cause a serious mishap, if it should occur while driving, as the pedals would be locked. One way of eliminating this danger is to bolt two metal

strips to opposite sides of the middle floor board, as shown in the illustration. The ends are allowed to project $\frac{1}{4}$ or $\frac{1}{2}$ in. beyond the edge of the floor board. It has been found that the boards will never slip out of place with this arrangement, but can still be removed and replaced easily.—W. J. Fraser, Toronto, Canada.

Double Gate for Farmyard

A gate of double width is a special convenience in the farmyard to permit the easy passage of wide hayracks, loaders, harrows, and other large implements. Such a gate is shown in the illustration, and it has the additional advantage of being made without the usual center post, to which both parts of a double gate are latched, and which is objectionable because it partly defeats the purpose of such a gate.

The gate illustrated is strong and rigid. The fence on one side of it is provided with two posts upon which are mounted U-brackets made of flat iron or steel. These are in line with similar brackets on the gate, as shown, and together accommodate a 2 by 4-in. beam. A hole, drilled near the end of the beam, permits

the insertion of a peg or bolt to be used for a handle.

Generally, it is only necessary to open one section of the gate to provide sufficient space for the passage of an auto-



A Double Gate for the Farmyard, Constructed So as to Eliminate the Objectionable Center Post of the Usual Double Gates

mobile or carriage. The side of the gate shown at the right is opened by simply pushing the 2 by 4-in. beam back a few inches to clear the bracket. The beam remains in the four brackets of the other section and posts, and holds the rest of the gate rigidly in place. When necessary to open both sections, the right one is released first, and then the beam is pulled out of the two post brackets, which allows the left section to swing freely on its hinges.

A Neat and Simple Hedge

A very neat hedge can be made without the trouble and expense of setting out separate shrubs and then having to keep them trimmed. A frame of wire screen or netting is set up in the manner indicated by the drawing. Sod is placed inside the wires, with the grass side out, and the space between is filled with earth.

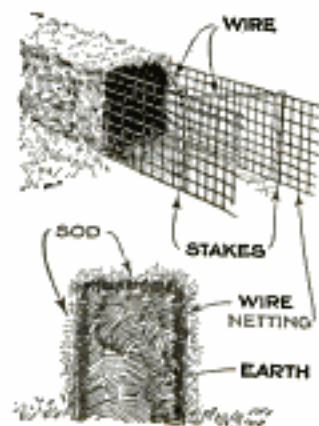

In a short while the grass will grow through the mesh of the screen and completely conceal it. The same idea can be followed out by planting some rapid-growing climbing vines over the netting.—Robt. Page Lincoln, Minneapolis, Minn.

A Homemade Vise

A homemade vise that can be clamped to any table or bench proves of considerable assistance where space does not per-

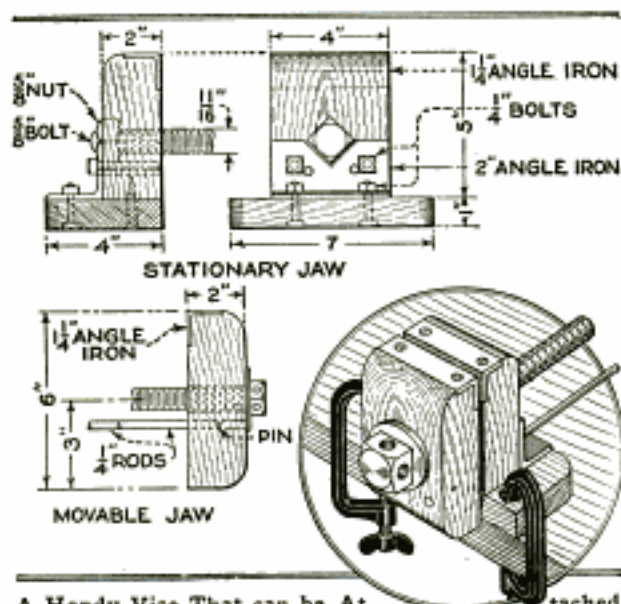

A Handy Vise That can be Attached to Any Table or Bench with Ordinary C-Clamps: It is Made of Hardwood and the Jaws are Protected with Angle Iron

mit the use of a stationary vise, or where a vise is used so seldom that it is hardly advisable to purchase one.

The base and jaws are made of hardwood, to the dimensions shown. A piece of 2-in. angle iron holds the stationary jaw to the base, and is attached to both with $\frac{1}{4}$ -in. bolts. To face the jaws, $\frac{1}{4}$ -in. angle iron is used. A hole is drilled through the center of both jaws for the $\frac{5}{8}$ -in. bolt, used as a screw, and a $\frac{5}{8}$ -in. nut is recessed into the back of the stationary jaw. If desired, small holes can be drilled through the head of the bolt to accommodate a "tommy," so that it will not be necessary to use a wrench for tightening or loosening the vise; or a permanent lever may be attached to the bolt head as in an ordinary vise. C-clamps are used to fasten the vise to the table or bench.

Disinfecting Cellars

It is very disagreeable to have the basement or cellar acquire a musty odor after being closed up all winter. To prevent this, clean the basement thoroughly, taking care that there is no decaying vegetable matter in it. Then sprinkle dry chloride of lime, pulverized copperas, or even common lime on the floor, and close the basement up. After a few days, open the windows until the smell of the lime disappears. If the musty smell still per-

sists, whitewash the walls and sprinkle powdered charcoal around freely.

It is a good plan to whitewash the cellar walls twice every year, in the spring and in the fall. This will not only improve the appearance but will also help to keep the air from becoming foul. As everyone does not know how to make a good whitewash that will not rub off on the clothes, the following recipes and information will be of value. Procure some hydrated lime, which can usually be purchased at a builder's-supply yard. Add enough of it to half a pailful of water until the mixture, which is, of course, stirred continuously, acquires a creamy consistency. Take $\frac{1}{4}$ lb. of flour and mix it in a separate dish, using enough water to barely wet it. Rub all lumps out with a tablespoon. Then pour boiling water on it to thicken it, and pour it into the whitewash, stirring well.

Another method of making a good whitewash consists in adding 2 lb. of salt to every 10 gal. of water, stirring well until the salt is dissolved; and then adding hydrated lime until the mixture has the consistency of paint.

Fasteners for Colonial-Window Shutters

The window shutters on present-day houses of the colonial type are fitted more for ornament than for use, and since they are not opened or closed, the type of fixture shown should be used for fastening the shutter to the side of the house.

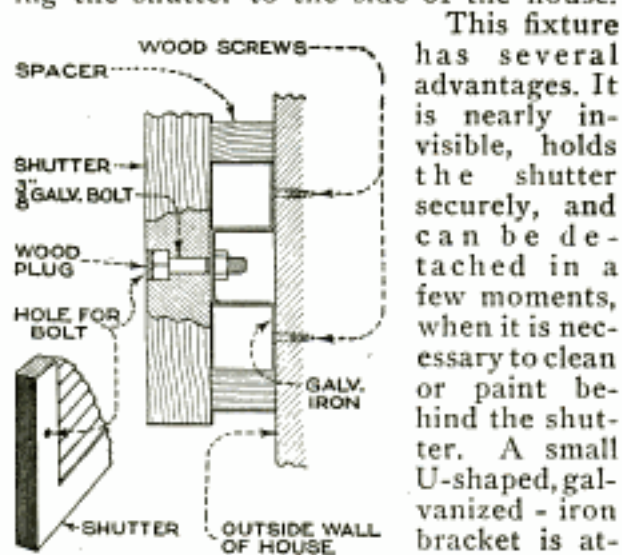

This fixture has several advantages. It is nearly invisible, holds the shutter securely, and can be detached in a few moments, when it is necessary to clean or paint behind the shutter. A small U-shaped, galvanized-iron bracket is attached to the siding with wood screws, in line with the edge of the shutter. The latter is attached to the bracket by means of a machine bolt, as shown, and the head of the bolt is countersunk and covered with a wooden plug.—L. H. Georger, Buffalo, New York.

Removing and Replacing Valve Springs

Although the grinding of valves on automobile engines is a simple operation, according to most instruction books, the amateur mechanic faces several difficulties, especially in case of an L or a T-type of cylinder head. Very often the whole side of the cylinder block is inaccessible; the valve spring cannot be lifted without the aid of a compressing lever, and the pin under the spring is difficult to get at, and often falls down into the oil pan while one is attempting to get hold of it. The use of a few simple tools, however, makes the job comparatively easy.

A satisfactory compressing lever that can easily be made is shown in Figs. 1 and 2. The lifter consists of two short lengths of flat steel, connected with a short bolt so that the tool can be folded, to save space in the tool compartment. An iron or hardwood block is used as a fulcrum. By resting the fulcrum on the crankcase, near the row of valve tappets, and inserting the forked end of the lever under the valve spring, the latter can be pried up far enough to expose the pin.

After raising the valve spring, the pin must be removed. This is usually done by means of a pair of tapered-nose pliers, as shown in Fig. 4. However, an electromagnet, made as shown in Fig. 3, has been found to give great satisfaction. The core of this magnet, which is made of soft iron, extends $1\frac{1}{2}$ in. beyond the bobbin; it is bent and tapered at the end as shown. The bobbin is wound with several layers of No. 14 single cotton-covered magnet

wire. The ends of the coil are soldered to flexible cord that can be led to the terminals of a storage battery, or provided with a plug to fit into the dash lamp or other

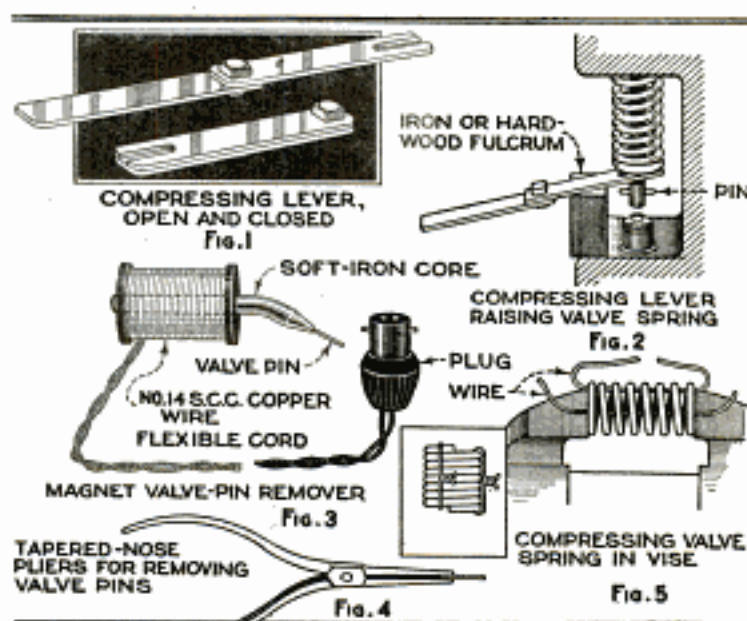

Figure 1: Tool for Compressing Valve Springs. Figure 2: Method of Using. Figure 3: Homemade Electromagnet Used to Extract Pins. Figure 4: Tapered-Nose Pliers for Extracting Pins. Figure 5: Method of Holding Springs Compressed

socket. Such a magnet will remove and replace pins with very little danger of dropping them.

It is usually an easy matter to remove the valve springs, but very difficult to compress them and to put them into place again. A simple method is shown in Fig. 5. The spring is compressed in a vise, and some No. 20 wire tied around it, as indicated, to hold it together after the vise has been released. While held in this way, the spring is set in position around the valve stem, and the washer and the pin are replaced. The tie wires are then cut.—H. H. Parker, Oakland, Calif.

Film-Developing Rack

A convenient and inexpensive frame to facilitate the handling of film-pack films, while developing, is shown in the photo.

The frame is made of wooden strips, the length and width of which are determined by the size of the films and the number to be developed at the same time. The films are fastened to the sides of the frame with glass-headed push pins, as indicated, and the frame, with the films attached, is then immersed in the developer bath and fixing solution in turn. The use of such a frame permits each negative to be watched separately, and overexposed negatives can be removed before the

others. After the films have been thoroughly fixed and washed, the frame is placed in a suitable place to allow the



A Frame for Facilitating the Development of Film-Pack Films: The Negatives can be Watched Separately and Any One can be Removed before the Rest

films to dry, and thus the separate films need only be handled once or twice at any time.

Installing Radio Apparatus on the Farm

By E. R. HAAN

THE large number of stations now broadcasting weather and market reports make the installation of a radio-receiving instrument on the farm no longer a luxury, but a necessity.

The operation of a receiving set is very simple; no technical knowledge is neces-

the reception of the latter is made possible by using 21 turns of wire instead of the 16 indicated in the circuit diagram of the outer coil, making a total of 45 turns instead of 40. No. 28 single silk-covered wire should be used instead of the No. 26 double cotton-covered wire specified, to

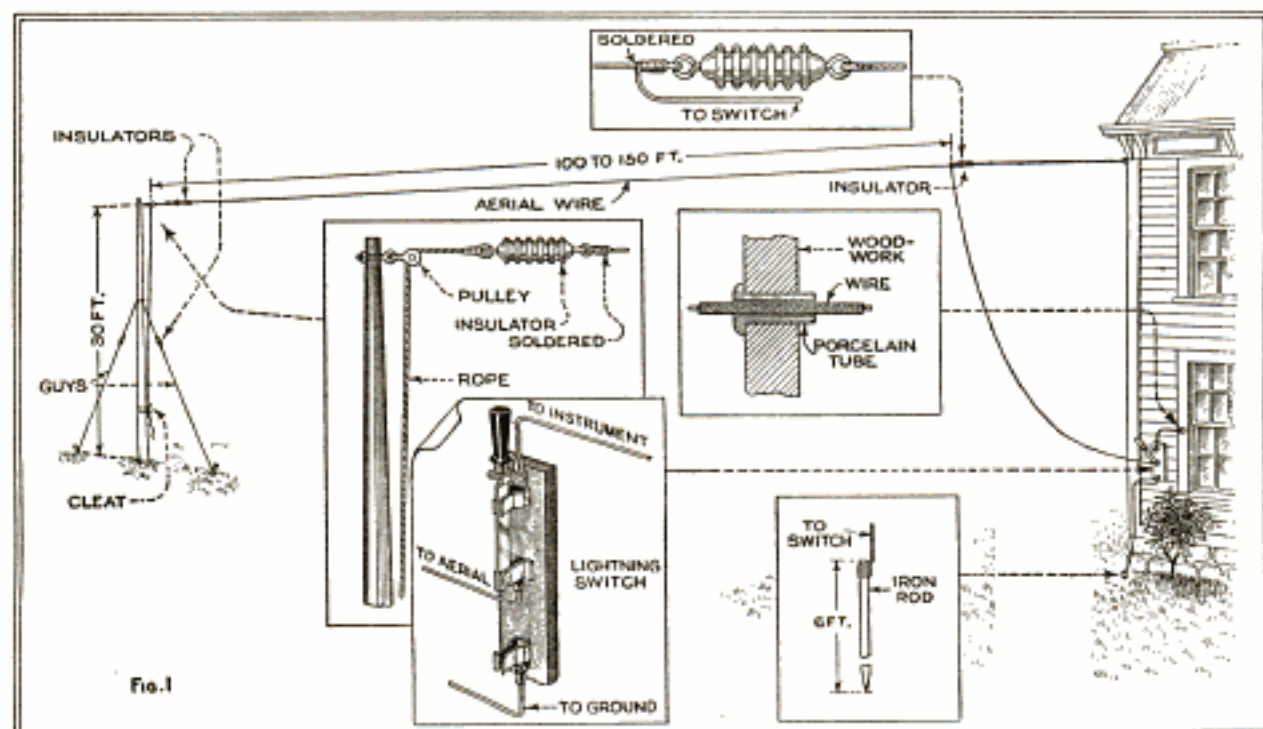

The Single-Wire Aerial Is the Most Commonly Used, and has been Found to Be Universally Successful. Its Length Is from 100 to 150 Feet, and It is Suspended at a Height of 30 to 60 Feet above the Ground. The Illustration Shows All the Details of Installation and the Necessary Connections

sary, and any farmer may, in a very short time, become expert in "tuning in" the various stations within the range of his set.

A receiving set can be either built at home or purchased ready-made. There are today thousands of boys on the farm who have built and are building radio-receiving sets. For those who contemplate building their own sets, complete information on the construction of a successful receiving set that has a distance range of approximately 1,000 miles, and a wavelength range of 150 to 400 meters, is contained in the February and March, 1923, issues of this magazine. The February issue describes the construction of a detector unit with one stage of amplification; the March issue, the construction of two and three-step sets. With this set it is possible to receive the popular entertainments and lectures broadcast at wave-lengths up to 400 meters, but not the official weather forecasts, and crop-and-market reports that are broadcast at a 485-meter wave length. However,

enable the extra turns to be wound on the form. This is the only change necessary, and will readily be understood upon referring to the articles mentioned. The set can be used successfully to operate a regular loud-speaking horn or can be hooked up with a phonograph horn to amplify the sound. Under especially favorable atmospheric conditions the distance range is often much greater than 1,000 miles.

If a ready-made receiving set is to be purchased, a few considerations must be borne in mind: It is highly advisable for a farmer to have a two-stage set with which he can receive the 485-meter reports. Never purchase a set on the assumption, or on the verbal assurance that it is suitable for receiving market reports; insist that the dealer demonstrate this capacity of the set by actually "bringing in" these reports.

Anyone can install a receiving set. Procure a 100-ft. or 150-ft. length of No. 12 or 14 stranded copper wire, which is best for strength and conductivity. If this

cannot be obtained, any bare copper wire, No. 12 or 14, but not smaller, will do. Also procure two aerial insulators; some No. 14 insulated weatherproof wire for a "lead-in," the length of which depends on the height of the aerial; a lightning switch, for which a single-pole double-throw knife switch of 600-volt, 100-amp. capacity is suitable; a number of porcelain knobs, and two porcelain tubes. With this material proceed to erect the aerial, as shown in Fig. 1. In selecting a suitable place to suspend the aerial, the following precautions must be taken, the neglect of which will result in inefficiency of the set. Suspend the aerial 30 to 60 ft. above the ground, so that there will be a considerable space between it and any trees, structures, or outbuildings. In case electric-power, light, or telephone lines run near or through the farmyard, take care to suspend the aerial at right angles to and not parallel to these lines. If possible suspend the aerial from masts mounted on the house and barn or other building. The lead-in wire must always be fastened to the house end. Full details of the method of attaching the wire to the mast are shown in the illustration.

The lead-in wire is attached to one end of the aerial and is brought down to the lightning switch; it is either allowed to hang from the aerial to the switch as indicated, or if desired, may be attached to the side of the house at different points

with porcelain knobs. Care must be taken to solder all the connections, in order to make them mechanically and electrically secure. The insulation of the lead-in wire must be kept intact at all points to prevent any possible ground. The lightning switch is attached on the outside of the house near the window where the wire to the instrument is brought in; the latter is insulated by means of a porcelain tube where it passes through the window casing or frame. The lead-in wire from the aerial is soldered to the center terminal of the switch; the wire to the instrument to the upper-clip terminal, and the ground wire to the lower-clip terminal.

There are numerous other types of aerials that give good results. Frequently two or four-wire aerials are used. There are cage, umbrella, fan, and loop aerials, the latter for inside use. There are also several methods of connecting the lead-in to the aerial. But it is not the purpose of this article to give the construction of various types, their merits and demerits; the single-wire aerial described above has been found universally successful, and, being simple to make, is particularly recommended. However, if it is desired to have a two or four-wire aerial, the aerial wires and guy wires are attached to a wooden spreader, as shown in Fig. 8; the aerial wires are 100 ft. long, and are spaced 2 ft. apart.

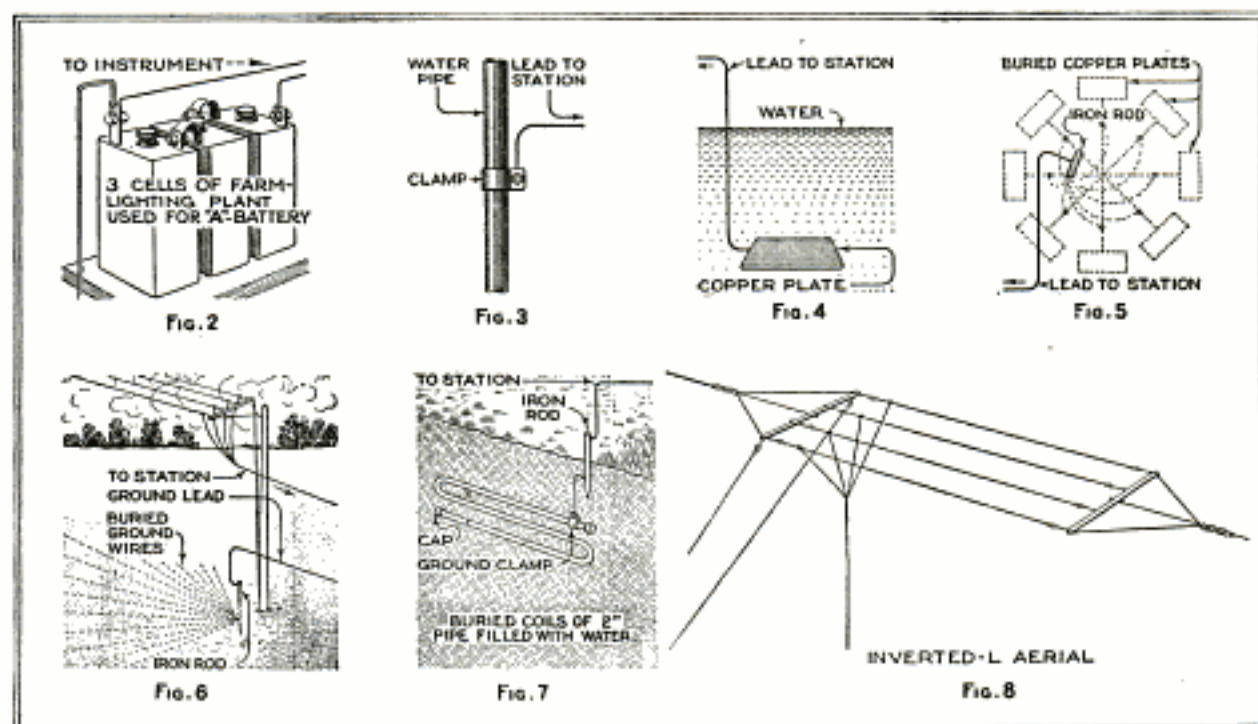

Figure 1, Three Cells of a Farm-Lighting Outfit Used for A-Battery; Figure 2, Method of Grounding on Water Pipe; Figure 3, Grounding in a Well; Figures 4, 5, and 6, Other Methods of Grounding; Figure 7, a Four-Wire Aerial That is Used Quite Often. The Wires are Spaced About Two Feet Apart, on Wooden Spreaders, Which are Braced by Insulated Wires or Ropes

The ground connection must now be made. This is another important part of the installation. The object is to make a good connection between the ground terminal of the switch and the earth. Drive a long steel or iron rod into the ground, to a depth of about 5 or 6 ft., and solder the ground wire to it securely. Another excellent method of grounding is to solder the ground wire to a copper plate and to drop this plate into a well, as shown in Fig. 4. Other methods of grounding are shown in Figs. 5, 6, and 7. The ground wire need not be insulated, but it must be well separated from the lead-in wire so that there can be no possible connection between the two. The connection shown in Fig. 2 is quite suitable for the ground connection from the instrument—not the switch—and is simply made. Run a length of lamp cord, or similar heavy wire, to the nearest water pipe. Scrape the pipe bright and attach the bared end of the wire to it by means of a clamp, or by soldering directly to the pipe. Be sure to make a good connection between wire and pipe.

In maintaining the set, the following hints should be kept in mind: Never allow the storage battery to run low before it is recharged, as this lowers the efficiency of the set, and is bad for the storage battery itself; on a farm having an electric-lighting outfit, it is not at all necessary to have a separate storage battery for the radio set, because three cells of the lighting battery, connected as in Fig. 2, will do just as well. In fact, using three cells of the lighting battery is even better than having a separate A-battery, because the lighting battery is always kept charged, and hence does not involve so much trouble as a separate storage battery.

The B-battery should be tested occasionally for voltage. This can easily be done by means of an 18 to 24-volt automobile-headlight lamp; its two terminals

are touched, for a moment only, to the two leads connected to opposite poles of each 22-volt unit. If it burns very dimly, the battery is weak, and should be replaced with a new one. It usually takes quite a while before the B-battery is exhausted, and one is therefore apt to forget about it and wonder why the set does not work as well as it did at first.

There are several kinds of detector and amplifier tubes at various prices on the market. In selecting these, it is best to get a good tube manufactured by a reputable concern. However, the difference in the results obtained from two tubes having the same rating, and made by the same concern, is sometimes surprising. Before purchasing any tube one should always insist upon having it tested, as it frequently occurs that tubes do not work properly, due to causes and conditions in their manufacture beyond control.

By carefully following the method of installing the aerial and ground, and observing the suggestions for maintenance contained in this article, any farmer can successfully "listen in" to lectures and entertainments, to weather forecasts, and crop and market reports, that are broadcast daily from scores of stations all over the country.

In receiving market reports, it is, of course, necessary to note them down carefully so that the reports from various stations can be compared. It will be found that it is very convenient to have a blackboard mounted on the wall near the set, so that the items and figures can be jotted down as they are received. The board should be arranged so that the reports of several successive days can be noted, as this helps to show the trend of the market. No particular arrangement of this bulletin board is shown, as the subjects listed will depend upon the particular interest of the farmer, and will vary in nearly every case.

Irrigating the Garden

It is common during the summer dry spell to see amateur gardeners spending an hour every evening in sprinkling their gardens. While this undoubtedly refreshes the plants, it does not saturate the ground to a sufficient depth to benefit the plant roots.

A much better method, and one that does not require as much time and labor, is to remove the nozzle from the hose and allow the full stream to flow into the

garden. The stream should be directed into the rows by means of small ditches, in the same manner as irrigation is practiced in dry climates. By saturating the soil to a depth of 4 or 5 in., sufficient moisture is provided to last for several days or a week. The soil should, of course, be cultivated as usual.

One should never sprinkle a garden during the day when the sun is shining, as this practice is very injurious to the plants and flowers.—G. E. Hendrickson, Argyle, Wis.

A Fireproof Cement

An excellent fireproof cement for furnace and stove work can be made by mixing powdered fire clay with sodium silicate (water glass) to the consistency of a stiff dough. Powdered magnesia or asbestos can also be used instead of fire clay, but the latter is usually the easiest to obtain. A small quantity of asbestos fiber added to the mixture will serve, like hair in plaster, to hold the cement together.

The cement thus made is not expensive and will stand considerable heat. It is very useful for plugging up smoke-pipe openings and also for lining stoves.

A Birch-Bark Berrying Basket

A simple berrying basket can easily be improvised in the woods, when a regular basket or bag is not available.



Tear a strip of bark from a birch tree, and fold it over, as shown in the photo, folding in the edges at the side and bottom, and "sewing" them together with a slender flexible green twig. Attach another piece

of twig to the top of the basket, to serve as a handle. This basket is quite strong, considering its rough construction, and serves very well for the purpose of carrying berries, fruits, and nuts. It can, of course, be made any size desired.

Lawn Table and Parasol

The novelty of the lawn table shown in the photograph consists in the use of a three-branched tree crotch for the legs, and also in the attachment of a large parasol to the table. To one who is fond of reading or studying in the open, this shaded table is a great convenience.

When the branches of the crotch are sawed off evenly, they provide a strong and stable support. The bark can be left on or peeled as desired. A circular table top is preferable to any other shape, and it should be a little smaller in diameter

than the parasol used. The table top is mounted on a framework of 2 by 4-in. pieces, nailed to the crotch, and is preferably made of cypress, to withstand the



A Novel Lawn Table Equipped with a Large Parasol Is of Great Convenience for Those Fond of Reading or Studying Outdoors

effects of the weather. The parasol is one of extra-large size, such as used on delivery wagons, and the handle is set into a hole drilled in a wooden block screwed to the table.

Pumping Tires Quickly

The attachment shown in the drawing permits the use of two pumps to inflate an automobile tire, and is therefore quite a timesaving addition to the motorist's tool kit, especially when the car is equipped with fairly large tires.

The device is made from a short piece of $\frac{5}{8}$ -in. metal tubing, in the ends of which valve-stem tips, about $\frac{3}{4}$ in. long, are soldered. A hole is drilled in the center of the tube, another stem soldered in, and a length of pump hose clamped to it. A regular pump-hose stem, equipped with a screw-cap, is clamped in the other end of the rubber tube.—R. L. Friess, Bowling Green, Ohio.

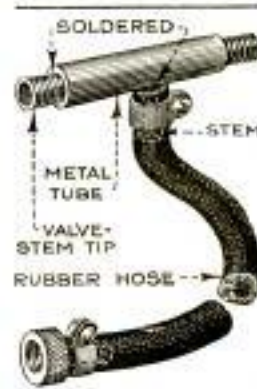

Foiling Automobile Thieves

Automobile thieves usually do not care to spend much time in attempting to steal a light car: they take one that can be

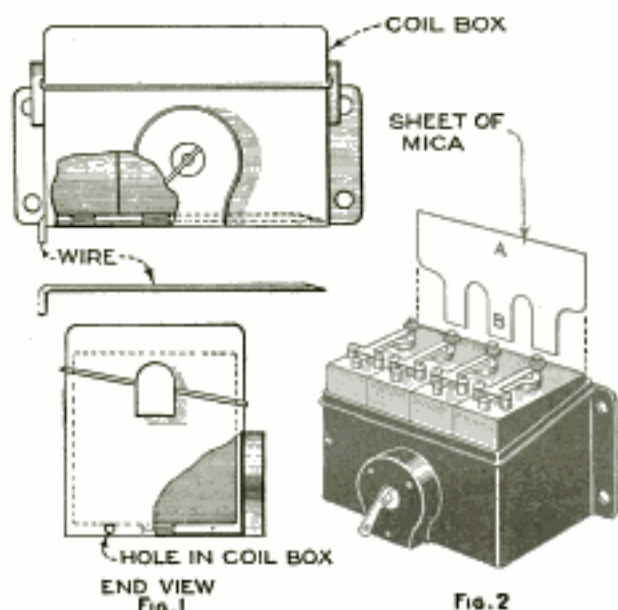

Two Methods for Foiling Automobile Thieves: Figure 1, Wire That Lifts the Coils to Separate the Bottom Contacts; Figure 2, Sheet of Mica That Separates Back Contacts

started instantly, and let the others alone. For this reason, simple methods of preventing the engine from starting are often just as good as expensive locks.

Figure 1 shows a piece of pointed wire, about $\frac{1}{4}$ in. thick, pushed through a hole drilled in the side of the coil box, and under the coils, so that the lower contact on each box is raised and the circuit broken. It is, of course, advisable to drill the hole on the left side, so that the wire cannot be seen when the car is entered.

Another method of breaking the circuit is to cut a piece of mica, or any thin insulating material, to the shape shown in Fig. 2. When this is inserted behind the coils, with the end A down, the circuit is broken. With end B down, however, the circuit is complete, and the car can be started as usual, as the back terminals make contact through the cut-out portions of the mica sheet. The discovery of this device is also very improbable.

Cleaning Tarnished Silver

Tarnished silverware can be cleaned by dipping it in a solution of water, soda, and salt, contained in an aluminum pan. The pan must be clean and free from all grease, and filled with enough boiling water to cover the silverware. One tea-

spoonful of baking soda and another of table salt is added to each quart of water. The silverware is immersed until the tarnish has disappeared. The pieces are rinsed in clean warm water, and rubbed until dry with a soft cloth. If not tarnished very much, it is only necessary to dip the silverware in the solution, but it must come in contact with the aluminum. —Charles A. Smith, New Haven, Conn.

Easily Made "Vernier" Rheostat

A "vernier" rheostat, connected in series with the regular one, will be found of advantage when regulating the filament current in the radio detector. For receiving sets not equipped with a vernier rheostat, one can readily be improvised as illustrated. The rheostat consists of a short length of resistance wire, wound once around the circumference of a fiber spigot washer, about $\frac{5}{8}$ in. in diameter. Grooves are cut across the washer, as shown, so that one end of the resistance wire can be wound around the threaded spindle, and locked with a nut and washer; the other end is fastened by threading it through two $\frac{1}{32}$ -in. holes, drilled about $\frac{1}{8}$ in. apart. A spring-brass contact, bolted to the panel, bears on the wire when the assembly is

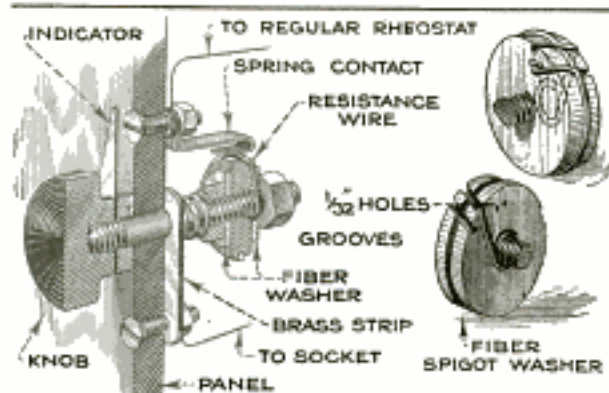

A Homemade "Vernier" Rheostat That can be Made by Any Amateur: Its Maximum Resistance Equals That of a Single Turn of Wire of the Regular Rheostat

mounted on the panel, and connection to the spindle is made by means of a spring-brass strip, also bolted to the panel as shown. A spring is used on the spindle, between this strip and the inner binding nut on the fiber washer. A knob and indicator are mounted on the front of the panel in the usual way. This rheostat provides a variable range of resistance, the maximum value of which is equal to that of a single turn of wire on the regular rheostat.—E. J. Bachman, Fullerton, Pa.

PRIZE OFFERS AND ANNOUNCEMENTS

1836 DEVICE FOR RECORDING SHAFT SIGNALS SOUGHT BY COMPANY IN TRANSVAAL

A practicable device for recording mine-shaft signals is sought by the Rand Mutual Assurance Company, which offers a prize not exceeding £250, or about \$1,100, for the best submitted. It is intimated that the company may also offer to buy or lease the winning device, though competitors will be under no obligation to enter into this phase of the question.

As it would be scarcely possible for American contestants to write and receive full details of the competition in time to submit their designs before the closing date, which is September 30, of this year, the full conditions governing the contest are given herewith. They are as follows:

1, the device must be capable of being installed in existing plants at a moderate cost; 2, it must be capable of being kept in efficient working condition without undue expense; 3, if the device has been in practical use, particulars must be supplied; 4, models, drawings, plans, photographs, or other descriptions of the device must be submitted, from which a full-size working appliance is capable of being constructed. These must be accompanied by an estimate giving the approximate cost of equipping a typical engine with the device, and the royalty (if any) payable for its use if the device is patented; 5, the full name and address of each competitor must be given; also a statement as to whether the device is patented or not, and when and where a model of the invention can be seen; and 6, the Prevention of Accidents Committee reserves to itself the right to reduce or withdraw the prize money if in its opinion none of the designs submitted is considered to be sufficiently worthy.

Address J. F. Bilbrough, Managing Secretary, Rand Mutual Assurance Co., Ltd., P. O. Box 413, Johannesburg, Transvaal, South Africa.

1835 NAME AND SLOGAN WANTED FOR HATS TO BE WORN BY MIDDLE-AGED WOMEN

A name and a slogan for a new line of hats about to be introduced are wanted by a millinery company of Chicago. Four prizes are to be given, the first \$400, and the others \$300, \$200, and \$100, respectively.

Describing the name sought, the company explains that the hats are to be sold to women of 30, 40, perhaps even 50 years, women prominent in social and business life; and that for several reasons it has been considered inadvisable to call the new line by any appellation that includes the word matron. The slogan must not exceed 14 words.

All submissions should be in the hands of the judges not later than June 1, this year, addressed Dept. 84, Gage Brothers & Co., 18 S. Michigan Ave., Chicago.

1797 INTERNATIONAL STAMP COLLECTORS PLAN LONDON EXHIBITION

Collections valued at thousands of dollars will be displayed at an international stamp exhibition in London during the month of May. Among the postage stamps which may be shown are some from a special issue recently brought out in Italy in conjunction with the tercentenary of the foundation of an institute of the Roman Catholic Church. These bear a picture of Christ in the midst of his disciples. It is believed that this is the only instance of philatelic representation of Jesus of Nazareth.

1834 YEARLY BONUS OF £50 IS ADDED TO RHODES SCHOLARSHIPS

A yearly bonus of £50 will be added, until further notice, to the normal £300 per annum given to students holding a Rhodes scholarship. These scholarships, as many know, are tenable only at Oxford University, where they may be held for three years, subject to the approval of the school authorities.

To each state of the union are assigned two scholarships, though the actual nomination must first be

made by the college or university of which the applicant is a member, and ratification is left to a committee of selection. The candidates must be male citizens of the United States, must be between 19 and 25 years, must be unmarried, and must have completed their sophomore year at some recognized institution. The Oxford University Press, American Branch, 35 West 32nd St., New York City, has on hand publications explaining the requirements in detail.

1832 UNRECOGNIZED MUSICAL GENIUS SOUGHT BY NEW YORK MUSIC LOVERS

Unrecognized composers, vocalists, and instrumentalists who feel that they have exceptional ability, will be given an opportunity to prove their merit by the promoters of the stadium concerts at the College of New York City. This organization is holding a contest in which all American composers, singers, and players of musical instruments so desiring may have their talent passed upon. The winning composers will have their scores played by the New York Philharmonic Orchestra during the regular concert season, while the winners in the other groups will be permitted to play with the orchestra.

Manuscripts must reach William Cowen, chairman of the score committee, Fisk Building, New York City, before May 1, this year. Other conditions of the contest may be learned by writing the same address.

805 CASH PRIZES IN RECRUITING CONTEST FOR NEW YORK NATIONAL GUARD

Many members of the New York National Guard will be discharged upon the completion of their enlistment terms in the near future, and the adjutant general is taking the occasion for the inauguration of an active recruiting campaign, which, it is hoped, will aid in keeping the guard at its full strength. To further the campaign, cash prizes totaling \$1,000 will be awarded to members throughout the state bringing in the greatest number of recruits, or securing the largest number of reenlistments. No distinction is to be made between the two classes of enrollment. Contestants, however, must themselves be members of the guard on or before March 31, this year, and must bring in their last candidate before June 15.

1803 THE ADJUTANT GENERAL CIVIL SERVICE COMMISSION ANNOUNCES MANY GOVERNMENT VACANCIES

Vacancies for a radio engineer, associate radio engineer, and an assistant radio engineer, are announced by the Civil Service Commission. There are also positions open for a junior engineer and deck officer, an engineer, a senior engineer, Grade B, an associate, assistant, and junior engineer, a senior architect, and a topographic draftsman.

The salaries to be paid, closing date for applications, and other information may be had by writing the Civil Service Commission, Washington, D. C., for form 1512. Mention in the letter which position you are interested in.

1633 STUDENTS OF MUNICIPAL GOVERNMENT INVITED TO SUBMIT ESSAYS

Postgraduate students who are enrolled, or who were enrolled last year, in any American college or university offering distinct postgraduate courses in municipal government, are invited by the National Municipal League to compete in an essay contest on the subject. The winning writer will receive \$250, and the second best, \$100. The same organization also announces a prize of \$100 for the best essay submitted by an undergraduate student on any one of several stipulated phases of municipal government. For additional information, and instructions, write the secretary of the league, 261 Broadway, New York City, stating which contest you are interested in.

When answering prize offers please mention Popular Mechanics Magazine

Oxford University Press
American Branch, 35-32nd St, New York
819
copyrighted material

Prevention of Accidents Committee

June

**THOUSAND DOLLARS FOR WOMEN'S CLUB
RENDERING GREATEST SERVICE**

The women's club, affiliated with the General Federation of Women's Clubs, which in the 12 months ending Sept. 15, 1923, shall have rendered the service of greatest benefit to its community, will be given a prize of \$1,000 by the Pictorial Review. In extending an invitation to the various clubs to compete for the prize, the editors of the magazine suggest that each send a typewritten report, accompanied by photographs. These reports must be in the hands of the magazine on or before the above-mentioned date. Additional information will be supplied by the Club Editor, Pictorial Review, 222 West 39th St., New York City.

**PRIZE OF \$200 FOR HISTORICAL ESSAY
ON EASTERN HEMISPHERE**

A prize of \$200 for the best monograph or essay in 1923 based on original investigation in the history of the eastern hemisphere, is offered by the American Historical Association. The manuscript must be written by a resident of the western hemisphere, and must not exceed 100,000 words. July 1, 1923, is the closing date. Address the secretary of the association, 1140 Woodward Building, Washington, D. C., for further particulars.

**1632 BOYS AND GIRLS MAY WIN PRIZES
IN SHORT-STORY CONTEST**

Boys and girls, from 10 to 17 years of age, are asked to write stories for a joint prize contest to be held by The Haversack and The Torchbearer, 810 Broadway, Nashville, Tenn. Both in the boys' and in the girls' division of the contest, the stories must be between 2,500 and 3,000 words, and must be woven about a subject of general interest to either boys or girls. The winner in each group will receive \$160, while other awards will be made to those placed second and third.

*John Barton Payne,
Chairman: Conference
Submitters*

**NATIONAL CONFERENCE ON STATE PARKS
TO BE HELD FOR THIRD TIME**

A national conference to discuss the development of state parks will be held at the Turkey Run State Park, Indiana, on May 7, 8, and 9, this year. This conference will be the third of its kind which has been called.

**BOK PRIZE FOR COMMUNITY SERVICE
GIVEN DR. RUSSELL CONWELL**

Doctor Russell H. Conwell, journalist, pastor of the Baptist Temple, and head of the Temple University of Philadelphia, has been awarded the \$10,000 Edward W. Bok prize for the most conspicuous service rendered to the community during the preceding year. The presentation was made by Senator George Wharton Pepper of Pennsylvania. Temple University, founded by Doctor Conwell especially for self-supporting young men and women, has both day and evening classes, and offers courses from the kindergarten to the highest university subjects. In addition to a school of pharmacy, a medical school, a law school, a dental, and a theological school, it gives instruction in commercial pursuits, civil engineering, physical training, domestic science, pedagogy, and music.

*Christian Science Monitor
3/8/23*

**BOSTON TECHNICAL STUDENTS ASKED
TO SOLVE CITY PROBLEMS**

The city of Boston, through Mayor James M. Curley, is offering the students of the Massachusetts Institute of Technology, four prizes of \$500 each for the best reports and working plans solving certain municipal problems. These include street traffic, street cleaning, and the sanitary control of offensive industries. The competition closes May 1, this year.

**FOREST THEATER \$100 PRIZE
WON BY ILLINOIS WOMAN**

The \$100 prize offered by the Forest Theater of Carmel, Calif., for a play suitable for presentation on its outdoor stage, has been awarded to Helen Coale Crew (Mrs. Henry Crew), of Evanston, Ill., for a poetic drama of the 13th-century Italy, called "The Cradle." The story tells of Saint Francis and the children's crusade.

CONTESTS PREVIOUSLY ANNOUNCED

Medals, Diplomas, and Money Awards: Announced August issue, 1921; awards offered by the Franklin Institute. The Franklin medal is for workers in technology; the Elliott-Cresson is for original research work and invention; the Howard N. Potts is for important development of previous discoveries and inventions. Each award consists of a gold medal with a diploma. There are also a silver medal, and a Certificate of Merit awarded for meritorious discoveries, and cash premiums for certain work in optics.

One Million Francs for Best Motor: Announced January issue, 1922; closes June 1, 1923; address, Aero Club of France, Paris.

Best Treatise Regarding Immortality: Prize \$1,000; announced January issue, 1923; closes Dec. 1, 1923; address, Contest Editor, 2 West 47th Street, New York City.

Awards to Further Science of Electricity: Medals and prizes, amounting in all to about \$20,000; announced February issue, 1923. For particulars address General Electric Company, Schenectady, N. Y.

For Best Paper on Technical Phase of Aeronautics: Prize \$125; closes March 31 of each year; announced February issue, 1923; address, Royal Aeronautical Society of England, 7 Albemarle St., London, W. 1, England.

For Best Work by American Chemist: An annual award of \$25,000; announced February issue, 1923; address the Allied Chemical and Dye Corporation, New York City.

Articles on Chemistry: Prizes \$50 and \$25; announced January issue, 1923; closes May 1, 1923; address, Secretary, Canadian Institute of Chemistry, Toronto, Ont.

Names for Great Lakes Steamers: Two prizes of \$50 each; announced February issue, 1923; suggested names must reach the company before the opening of navigation season in 1924; address the Detroit and Cleveland Navigation Company, Detroit, Mich.

For Best Studies in the Economic Field: Four prizes from \$1,000 to \$200; announced March issue, 1923; closes June 1, 1923; address, Prof. J. Laughlin, University of Chicago.

Literary Contest by the New Pearson's Magazine: Nine prizes totaling \$1,500; announced March issue, 1923; closes May 1, 1923.

Motorboat Race, Miami Beach, Fla., to Havana, Cuba: Prizes \$10,000; announced March issue, 1923. Write Miami Chamber of Commerce.

Essay on Economic Subject: Prize \$1,500; announced March issue, 1923; address the Simonds Economic Prize Contest, 470 Main St., Fitchburg, Massachusetts.

Pulitzer Prizes, Columbia University: For best work in various literary and journalistic lines; announced April issue; nominations of candidates must be made before Feb. 1, 1924.

More Humane Slaughtering Devices: Two prizes, \$10,000 and \$5,000; announced April issue; closes April 30, this year; address, American Society for Prevention of Cruelty to Animals, 50 Madison Ave., New York City.

University Scholarship, Four-Year: For best high-school essay on "The Influence of Highway Transportation upon the Religious Life of My Community"; announced April issue; closes May 1, this year.

Scholarships for War Nurses and Ex-Service Men: Numerous scholarships provided at colleges and universities throughout the country under the will of the late La Verne Noyes; announced April issue; apply direct to colleges.

IN accordance with the editorial policy of this magazine never to accept compensation in any form for what appears in our reading pages, and also to avoid all appearance of doing so, we are obliged to omit the name of the maker or the seller of any article described. This information, however, is kept on file and will be furnished free, by addressing Bureau of Information, Popular Mechanics Magazine, Chicago. [Editor.]



Safe Rudder Steering —and an Extra H. P.

SAFETY! Is anything of more importance in a boat motor? How do water accidents happen? Some one is standing, another steering, a violent change in direction and splash! No chance for dangerous pivot turning with the safe, rudder-steered ELTO! No shaky steering handle. Steer from any part of boat with tiller rope. Balance your boat properly. No attention to steering except at turns!

An Extra H. P.

The ELTO is full 3 H. P. not by loose claims, but by piston displacement. That is a full extra H. P. over other light weight motors—the indispensable extra H. P. to “buck” winds, currents, tides and sudden storms—to give speed to safe substantial boats. It makes the ELTO by far the fastest of outboard motors, as always demonstrated in official races.

“As Light As Right”

Trust Ole Evinrude, the pioneer designer of outboard motors, to build as “light as right” at no sacrifice of needed power or durability. The ELTO has more

than double the bearing area of other light weight motors and a full extra H. P. It is both the most powerful of light weight motors and the lightest of all motors per H. P.

The Only Instant Starting Motor

There can be no relief from hard stubborn starting without change of ignition. Ole Evinrude discarded old type ignition and added Atwater Kent Unisparker with Hot Shot Battery to his perfected motor, the ELTO, which makes it a quarter turn starter under all conditions. No ropes needed. No returning of parts to factory for remagnetizing. Every hardware store a service station.

Dealers and Demonstrating Agents—a profitable proposition if your territory is still open. *Write today.*

ELTO OUTBOARD MOTOR CO.

Dept. AA, Manufacturers Home Bldg., Milwaukee, Wis.

Elto



Designed
by
Ole Evinrude

Write for Catalog

Not just a picture book but a detailed mechanical description of design and construction that shows how to judge motor values.

3 H.P. Fast Light Twin

“As light as right”



If the subscriber paid direct

Suppose that every Monday morning all the people who have a hand in furnishing your telephone service came to your door for your share of their pay. From the telephone company itself, would come operators, supervisors, chief operators, wire chiefs, linemen, repairmen, inspectors, installers, cable splicers, test-boardmen, draftsmen, engineers, scientists, executives, bookkeepers, commercial representatives, stenographers, clerks, conduit men and many others, who daily serve your telephone requirements, unseen by you.

There would be tax collectors to take your share of national, state and municipal taxes, amounting to over forty million dollars. There would be men and women coming for a fair return on their money invested in telephone stocks and bonds—money

which has made the service possible.

Then there are the people who produce the raw materials, the supplies and manufactured articles required for telephone service. They would include hundreds of thousands of workers in mines, smelters, steel mills, lumber camps, farms, wire mills, foundries, machine shops, rubber works, paint factories, cotton, silk and paper mills, rope works, glass works, tool works, and scores of other industries.

When you pay your telephone bill, the money is distributed by the company to the long line of people who have furnished something necessary for your service. The Bell System spares no effort to make your service the best and cheapest in the world, and every dollar it receives is utilized to that end.

“ BELL SYSTEM ”

**AMERICAN TELEPHONE AND TELEGRAPH COMPANY
AND ASSOCIATED COMPANIES**

One Policy, One System, Universal Service, and all directed toward Better Service



Ask Any Beauty

How she beautifies her teeth

If all women knew what millions know, they would all brush teeth in this new way.

Ask anyone with glistening teeth. You see them everywhere today. You will probably learn that the reason lies in this new-day method.

Then you can see the results on your own teeth if you make this delightful test.

Clouded by film

The natural tooth luster is clouded by film. At first the film is viscous. You can feel it now. It clings to teeth, gets between the teeth and stays.

Food stains, etc., discolor it. If not removed, it forms dingy coats. Tartar is based on film. And few things do more to mar beauty.

Film also holds food substance which ferments and forms acid. It holds the acid in contact with the teeth to cause decay. Germs breed by millions in it. They, with tartar, are the chief cause of pyorrhea. Thus most tooth troubles are now traced to film.

Very few escaped

Tooth troubles were constantly increasing. Beautiful teeth were seen less often than now. So dental science saw the need for better cleansing methods. Research found two ways to fight film. One acts to curdle film, one to remove it, and without any harmful scouring.

Able authorities proved these methods effective. Then a new-type tooth paste was created, based on new discoveries. These two great film combatants were embodied in it.

The name of that tooth paste is Pepsodent.

Avoid Harmful Grit

Pepsodent curdles the film and removes it without harmful scouring. Its polishing agent is far softer than enamel. Never use a film combatant which contains harsh grit.



Careful people of some fifty nations now use it largely by dental advice.

Corrects mistakes

Pepsodent also corrects mistakes made in tooth pastes of the past. It multiplies the alkalinity of the saliva. That is there to neutralize mouth acids, the cause of tooth decay.

It multiplies the starch digestant in the saliva. That is there to digest starch deposits which may otherwise ferment and form acids.

Former tooth pastes brought just opposite effects. They depressed these natural tooth-protecting agents.

Your home needs

Everyone in your home should adopt this method. They will when they see the results.

Send the coupon for a 10-Day Tube. Note how clean the teeth feel after using. Mark the absence of the viscous film. See how teeth whiten as the film-coats disappear.

The results in one week will delight and convince you. Cut out the coupon now.

Pepsodent PAT. OFF.
REG. U.S.
The New-Day Dentifrice

A scientific film combatant, which whitens, cleans and protects the teeth without use of harmful grit. Now advised by leading dentists the world over.

10-Day Tube Free

1166

THE PEPSODENT COMPANY
Dept. 911, 1104 So. Wabash Ave., Chicago, Ill.
Mail 10-Day Tube of Pepsodent to

.....
.....

Only one tube to a family



For Everyone— Everywhere

At home, by every member of the family—in the office—on the road—in camp—on shipboard—under conditions familiar or unusual—the Remington Portable is the universal machine for personal writing.

Its compactness, convenience and completeness make it the machine that everybody can use to best advantage—at every time and place where there is writing to be done.

Has the *Standard Keyboard* and fits in a case only four inches high.

Take any user's advice and buy a Remington Portable.

For sale by over 2,500 dealers and Remington branch offices everywhere. Write for our illustrated, "For You, For Everybody." Address Dept. 12.

Easy payment terms if desired

Remington Typewriter Co., 374 Broadway, New York

A good typewriter deserves a good ribbon. Use Paragon Ribbons on Remington Portable Typewriters. Made and sold by us.

Remington Portable Typewriter

HANES GUARANTEE

We guarantee Hanes Underwear absolutely — every thread, stitch and button. We guarantee to return your money or give you a new garment if any seam breaks.

\$100 A SUIT



5 Big HANES Features

- 1 Hanes large, roomy armholes**, taped instead of turned under. Can't curl or rip—but a friction-free surface that really wears.
- 2 Hanes webbing belt** guaranteed 2-thread elastic webbing instead of single thread, gives more elasticity and greater strength. Specially sewed to prevent tears and rips.
- 3 Hanes closed crotch** is cut and stitched in a special way that really keeps it closed. That means added hot-weather comfort.
- 4 Hanes crotch lap buttons** sewed on the seam. Won't come off. 4 thicknesses of material instead of customary 2. No patch used.
- 5 Hanes wide, full-length knees** cut so as to give greatest freedom without binding or creeping up the leg.

**You've got it all
in "HANES" at \$100**

TRADE MARK
HANES
Full Cut
ATHLETIC UNION SUITS

WHAT we put into "Hanes" Athletic Union Suits for \$1.00 cannot be duplicated anywhere near the price! As manufacturers we know this; you will prove it when you personally understand the comfort, workmanship, material and service that "Hanes" hands out!

Check up "Hanes" in comparison! We tell you "Hanes" is made to meet the world! Examine every de-

tail from the quality of the nainsook down to the four thicknesses of material that holds the crotch lap button! "Hanes" is generously full cut and allows for the hardest work and play. Every strain-point is reinforced!

Put the youngsters in "Hanes" Athletic Union Suits—they give such wonderful service. 2 to 16 years, in sizes 20 to 34.

*If your dealer can't fit you with
"Hanes" Underwear, write us immediately.*

P. H. HANES KNITTING CO., Winston-Salem, N. C.
New York Office, 366 Broadway

Next Winter You'll Want to Wear Hanes Winter Underwear

This Big Building Material Book is NOW Ready

Heating Plants
Plumbing Material
Paint
Roofing
Hardware
Radiation
Wallboard
Tanks, etc.
Pipe-Fittings
Wire-Fencing
Structural Steel
Agricultural Tools

Bathroom Outfits
Furniture and Rugs
Lighting Fixtures
Cabinet Work
Harris Homes
Steel Roofing
Plasterboard
Millwork
Lumber
Windows
Garages
Doors



Plumbing

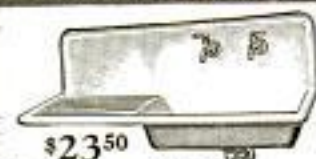

\$23.50

One-Piece Sink

PJ-2—White porcelain enameled roll rim kitchen sink with right or left drain board. Complete with faucets and nickel plated trap. 44 in. long.....\$23.50
48 in. long..... 27.00
52 in. long..... 29.00

2 Part Laundry Tub \$18.75



PJ-4—Composite of cement and granite 2 part laundry tub—scraper with the proved wringing mixing faucet and nickel plated brass trap. Each.....\$18.75



Complete Bathroom Outfit

PJ-1—Consists of bath tub 5 ft. long and 30 in. wide. White porcelain enameled on the inside and over 3 in. roll rim. Deep apron lavatory size 18x24 inches. Low pattern white china closet outfit with mahogany seat. Complete with all nickel plated fittings above floor line.....\$67.50

Mail This Coupon for
FREE BOOKS!
Dept., P.K.-7

Mark an "X" in squares to indicate books wanted. They are free and sent postpaid without obligation to you.

Building material and supplies
 Plan Book Harris Homes Beautiful

Presto-Up Garage Book
 Presto-Up Cottage Book

Name.....

Address.....



Harris Homes Beautiful

Harris Home No. 1006, above, with 5 rooms and bath, size 30 ft. x 29 ft. 6 ins. is but one of more than a hundred beautiful, practical designs built many times with big economy in best residential districts.

FREE! Every prospective home builder should have this new plan book of Harris Homes Beautiful. More than a hundred designs—bungalows, cottages, residences. Explains the money-saving advantages of our guaranteed Ready-Cut and Not Ready-Cut home building systems; the splendid quality of Harris Home building material; our liberal plan offers which save you from 50 to 100 dollars right at the start.



Numerous attractive designs, both single and double models, in every desired size, priced upwards from \$129.00.



Presto-Up, Bolt-Together Garages

The wonder buildings of the age. Wonderful because they are so simple. Complete to the last detail, with all windows, doors and hardware in place. Come to you in sections, painted and ready to bolt together. Quickly and easily erected in a few hours. Our new, free Presto-Up, Bolt-Together Garage Book is now ready. Mail coupon for your copy.

Heating

Hot Water, Steam, Warm Air

Complete steam, and hot water heating systems—pipe and pipeless furnaces planned for you by experts and guaranteed to heat your home comfortably, economically and efficiently. Our big stocks insure quick shipment of everything needed to the last fitting. Capable engineers are waiting to help you. Send a rough sketch of your building showing size and location of rooms, number and size of windows and doors, height of ceilings and full information will be sent to you promptly.



Builders' Hardware

Lock sets, butts and a complete line of builders' hardware of every description. All new modern designs featuring best construction, latest style and newest finishes. The complete line is illustrated, described and priced wonderfully low in our big building material book. Mail coupon for your copy today.



Lighting Fixtures

A complete line of lighting fixtures carefully chosen in sets for all rooms. Everything needed to wire your home. See them in our new book.



Guaranteed Paint \$1.85 Per Gallon

PJ-8—Best house paint in white, black and 26 non-fading colors. Per gallon.....\$1.85
PJ-9—Barn and garage guaranteed paint. Per gal.....\$1.35



Dept., P.K.-7
35th & Iron Sts.,
Harris Brothers Co., CHICAGO

Sent on Approval

No
Money
Down

21 Jewel Santa Fe Special

Without one penny of advance payment let us place in your hands to see, to examine, to inspect, to admire, to approve a real masterpiece in watch creation.

Our determination to this year double our sales of the world famous *Santa Fe Special* and *Bunn Special Watches* prompts this matchless offer.

While other watch dealers are raising their prices, asking you for larger monthly payments, and making payment terms harder for you to meet, we are offering you our new model *Santa Fe Special*, no advance in price, no money down, easier terms and smaller monthly payments. WE realize the war is over and in order to double our business we MUST give you pre-war inducements, better prices, easier terms, and smaller payments.

Page 12 of Our Watch Book Is of Special Interest to You!

Ask for our Watch Book free — then select the watch you would like to see, either the famous *Santa Fe Special* or the 6 position *Bunn Special*, and let us explain our easy payment plan and send the watch, express prepaid, for you to examine. No money down.

REMEMBER No money down—easy payments buys a master time-piece—a 21 Jewel guaranteed for a lifetime at about half the price you pay for a similar watch of other makes. No money down. A wonderful offer.

SANTA FE WATCH COMPANY

56 Thomas Bldg.

TOPEKA, KANS.

MAIL COUPON TODAY

SANTA FE WATCH CO.
56 Thomas Bldg., Topeka, Kans.

Please send prepaid and without obligation your Watch Book free, explaining your "No Money Down" Offer on this *Santa Fe Special Watch*.

Name _____

Address _____



“You can buy Topkis for only a dollar!”

“I DIDN'T pick Topkis by the label the first time. I chose it because it was the best-looking athletic underwear I saw in the shop.

“The salesman had to say ‘One Dollar’ a couple of times before I understood it was the regular price.

“You can bet I am careful to pick the Topkis label now!”

Topkis has better material than most higher priced athletic underwear. Best nainsook and other high-grade fabrics.

Really comfortable fit, too! Correctly

cut, man-size arm-holes; longer, wider legs; roomy chest and waist. Full size guaranteed. Pre-shrunk to stay true to size. Buttons sewed on to stay.

And wear—how it does wear!

That's what you get for One Dollar in the Topkis Men's Athletic Union Suit. No good dealer will ask more—but most will admit it's worth more.

Men's Shirts and Drawers, 75c a garment; Boys' Union Suits, Girls' Bloomer Union Suits, and Children's Waist Union Suits, 75c.

Ask for TOPKIS Underwear. Look for the Topkis label.

Write for new booklet, chock full of “inside stuff” on underwear. It's free.

TOPKIS BROTHERS COMPANY, Wilmington, Delaware
General Sales Offices: 350 Broadway, New York City



Greatest Improvement In Inner Tubes Since Autos Were Invented

Warns instantly of under inflation of tires—adds third to tire life. No more guessing about air pressure. No more bothering with separate air gauge. No more soiling hands and fussing with dirty valve covers and caps to find out if tires need more air.

AIR GAUGE On Every Tube

Built in as part of the valve stem. Marked Meter in center of stem registers actual air pressure all the time. Just look through the unbreakable transparent valve cover and see pressure instantly.



Car Owners Wanted!

to show and sell this great improvement. Interests everyone instantly. Tire users buy on sight. No matter what car they drive or what casings they use. Our "direct-from-factory" salesmen are cleaning up with this great new invention. Absolutely no competition. All basic patents owned and controlled by this company. No capital required to start. Previous selling experience not necessary. You can sell—

AIR-GAGE Extra Heavy Inner Tubes

—to almost every car owner because they cost no more than others of equal quality. Made of best quality live red rubber, built up on the multiple ply laminated process. Tough—live—durable. Every Tube Guaranteed. Read how we help you make a big success.

- We pay the largest commissions offered by any tire maker.
- We actually make and fully guarantee every Tube and Tire we sell.
- We give exclusive agency in territory you select and credit you with all orders received from same.
- We ship all orders to our men all charges prepaid.
- We advertise Air-Gage Tubes in Magazines reaching 20,000,000 readers.

Big Free Book Explains All

Send coupon or write today for big new illustrated book. Tells how to sell Air-Gage Tubes. How to become a successful Paul Salesman. How to start in a big paying business of your own without capital, how to be the one to nail down this tube and tire business in your territory, how to get the special Demonstrating Outfit. How to get your own Tires and Tubes at factory prices. If you want to get all the facts about this wonderful new invention and the "Paul Plan" of distributing, through exclusive factory representatives, send the coupon today. We refer you to Dun's, Bradstreet's or any Bank in North Carolina.

THE PAUL RUBBER CO., Dept. 25, Salisbury, N.C.

"I have sold some three thousand 'Air-Gage' tubes and have the first complaint to receive."

R. E. GRIM,
612 N. Broad
Street
Philadelphia
Pa.



THE PAUL RUBBER CO., Dept. 25, Salisbury, N.C.
Without obligation on my part, send me your Free Book about
Air-Gage Tubes and the "Paul Plan" of selling. Also
Your Exclusive Agency offer and discounts I would
get on Air-Gage Tubes, and Cloverleaf and Long
Distance Cord Tires.

Name.....
Address.....
Reference.....

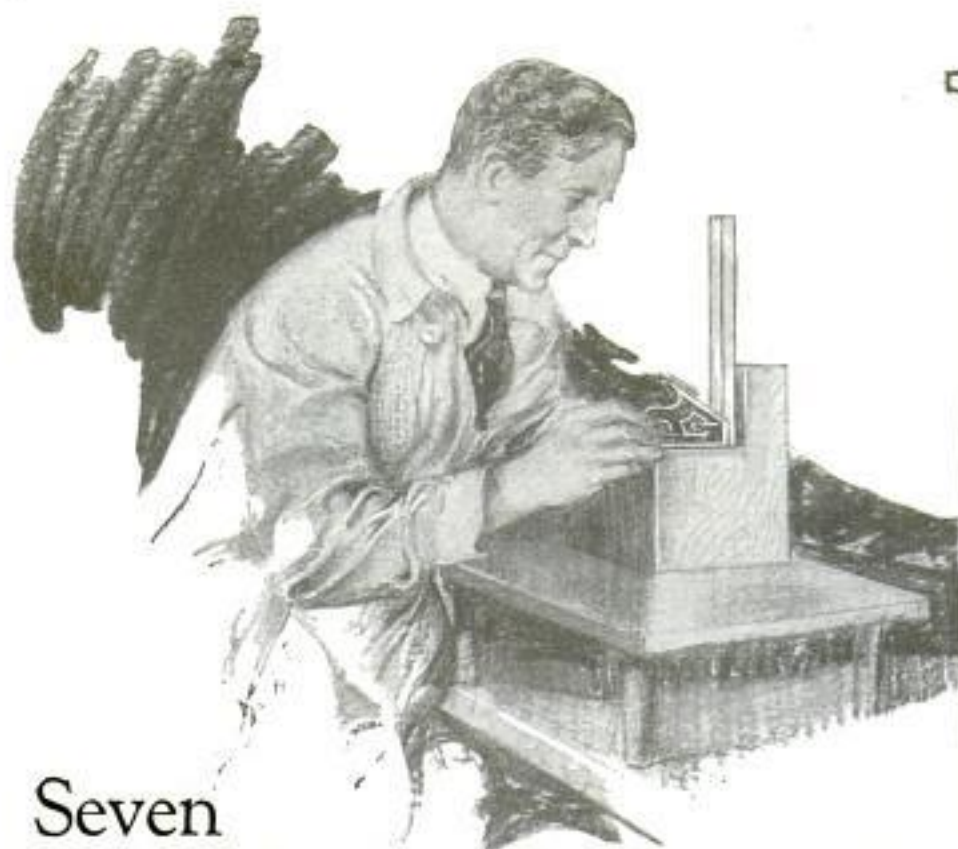

Seven Tool Uses at the Price of a Single Tool

The Starrett Combination Square forms one of the most convenient and useful tools ever devised for machinists and mechanics.

Combining as it does the uses of a rule, square, miter, depth gage, height gage and level, it permits more rapid work on the part of the user and saves littering up the bench with a number of necessary but seldom used tools.

Not the least remarkable feature of this remarkable tool is the price—it's about what you'd pay for one of the seven tools it supplants. See this tool at any hardware store.

Fully described (with 2100 other fine precision tools) in the Starrett Catalog No. 22 AP free on request. Write also for the Supplement showing the latest Starrett Tools.

THE L. S. STARRETT CO.

The World's Greatest Toolmakers
Manufacturers of Hacksaws Unexcelled
ATHOL, MASS.



Showing a few of the many uses of the Starrett Combination Square No. 11.



4942

Use Starrett Tools

ONLY
\$ **3**
DOWN
and you
keep this
typewriter



DIRECT
to you
from our
Factory

Big Saving
In Price

Yes, we will ship you this Genuine Underwood

Rebuilt in our own factory just like new for
ONLY \$3 down—NOT ONE CENT MORE

Until you have tried the machine 10 full days at our expense



Our Factory

EVERY MACHINE is fully guaranteed. New parts wherever needed. New enamel, new nickel, new lettering, new platen, new key rings—a complete, perfect typewriter. Impossible to tell it from a brand new Underwood either in appearance, durability or quality of finished work.

An up-to-date machine with two-color ribbon, back spacer, stencil device, automatic ribbon reverse, tabulator, etc. In addition we furnish **FREE** waterproof cover and special Touch Typewriter Instruction Book. You can learn to operate this Underwood in one day.

Big Book FREE

Our big handsomely illustrated catalog will be sent **free** on request. It tells you all about the advantages of owning a **STANDARD SIZE UNDERWOOD**; how and why this machine will last for years, saving many dollars not only in the purchase price but in its operation.

Send in the coupon and let us send you this beautifully illustrated book **FREE** without any obligation whatever.

Shipman-Ward Mfg. Co.
"Typewriter Emporium"
2125 Shipman Bldg.
Montrose and Ravenswood Aves., Chicago

Write Right Now

and learn how it is possible for us to ship you this Underwood Typewriter upon our **free trial** plan and our direct-to-you **money saving methods**. Get the full details now—just sign the coupon and mail today. Get all the facts—then decide.

No Obligation

—to buy. You don't have to order. Just sign the coupon, send it to us and we will mail you our big catalog absolutely free. You will be amazed at the liberality of our offer, the beauty and all around excellence of our typewriters.

Send the
Coupon
Today

10 Days' Free Trial

You have ten full days in which to try the typewriter before deciding whether you want to keep it. Give it every test—see for yourself—make the Underwood prove its worth to you. Don't take our word for it—put the Underwood before you and see if you don't think it the greatest typewriter bargain ever offered.

This is the genuine Underwood Typewriter. We offer you the same three models of the Underwood Typewriter being made and sold by the manufacturers today. **Standard 4-row single shift keyboard.** Absolutely visible writing—the **full line** of typewriting is visible at all times. All the improvements and attachments that any high grade typewriter ought to have.

Big Saving to You

Our plan of selling to you direct makes possible enormous savings, which are all for your benefit. Send in the coupon and we will send you prepaid our big catalog, including "A Trip Through Our Factory." This shows how the Shipman-Ward Rebuilt Underwood is the best that can be produced at our **Special Price**.

don't have to do a thing to get our big **Free** catalog and complete details of our amazing

FREE TRIAL COUPON

SHIPMAN-WARD MFG. CO.
2125 Shipman Bldg., Chicago

Please send me **FREE**, all charges fully prepaid, your **BIG NEW** catalog of **UNDERWOOD TYPEWRITERS** and complete details of your **FREE TRIAL** Offer.

It is understood that I am under no obligation whatever and that this is to be sent without one cent of cost to me.

Name.....
Street.....
City..... State.....

\$1 brings this Outfit

Artists Model

Standard "C Melody" SAXOPHONE

Learn to play Saxophone! The easiest instrument to learn, it is also the most popular! Pick out tunes in an hour, as quickly as with one finger on the piano. And there's no faster way to make extra money than playing Saxophone at dance or church or theatre. Makes you a social favorite, always welcome everywhere!

10 MONTHS TO PAY! The Standard "C Melody" Saxophone is the supreme grade "made in Elkhart." Choice of famous artists and teachers. The 1923 model with "bevelled sockets" makes all other Saxophones "out of date." Sent to you for 6 days' trial, to prove to you its ease of blowing, simplified fingering and golden tone can't be equalled at any price. Complete 12 piece outfit direct to you from factory at only \$1 down and \$8.00 a month. Small first payment. Sensational cut in price during this sale, no interest, no tax, not one cent extra—Saxophone, \$10 case, self-instruction system, book of music, reed, strap, pearl keys, etc., everything you need. Quality that enables you to buy once for a life-time.

CATALOG FREE! Tells you how you can secure the greatest of Saxophones on easy terms at less than cash prices! Write today for this free book and complete information of our sensational offer! Standard Music Co., Dept. 922, P. O. Box 503, Chicago

NEEDED IN EVERY SHOP

GIT HAND PASTE

Cleans Hands **CLEAN** of Grime Stains and Paint
10¢ at F.W. Woolworth Co., M'Crory and other stores



Do Your PRINTING

Cards, circulars, labels, tags, book, menus, paper, Press, \$12. Larger \$35. Job Press \$150 up. Save money. Print for others. **BIG PROFITS.** All easy, rules sent. Write factory TODAY for press catalog. TYPE, cards, paper. **THE PRESS CO. D-37, MERIDEN, CONN.**

Baby Grand Lathes

For Metal or Wood Highest Quality Lowest Price

A precision machine tool at a price within the reach of everyone, everywhere.

A Practical Tool for Universal Use—A dependable, low-priced lathe for use by those engaged in light manufacture, model making, experimenting, repairing, etc., as well as the requirements of the amateur, the inventor and the student.

Ideal for Use in the Home—Interesting, instructive and profitable employment for your spare time.

Develop Your Ideas in Private—Build your experimental models with your own hands.

Add \$5 to Your Income—In spare time make usable product, radio equipment, Xmas gifts, etc.

Lasts a Lifetime

A sturdy machine built for real work.

Write NOW For Prices and Details

6-In. Swing

12 In.

or

18 In.

Between Centers

20-In. or

26-In.

Bed

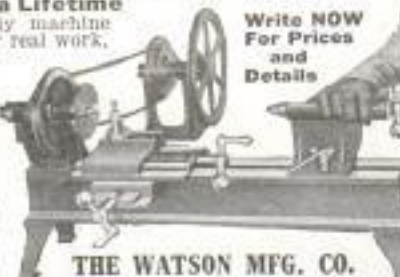

THE WATSON MFG. CO.

2407 Alhara St., Toledo, O., U.S.A.

MINT VENDING MACHINE

Pays \$10 to \$20 Day Profit

Pays Rent for Store Owner

Install one in your store or any public place and get this easy money. Requires no attention. Always works. Machine's profits pay the rent. Write us about rebuilt penny and nickel machines. Finished like new. In excellent running order. Pay their cost in 10 days.

Write or wire today for full particulars. \$25 down payment. Balance C. O. D. Export orders full down payment. Mints \$15 per case, 1,000 5 cent packages. Single boxes, 100 5 cent packages, \$1.50. **SILVER KING NOVELTY CO.** 400 Williams Bldg. Indianapolis, Ind.



FREE CATALOG GUNS & AMMUNITION

Sensational prices on new modern German Imported and Domestic High grade Rifles, Shotgun, Accessories, Ammunition.

WONDERFUL BARGAINS—Got this complete, descriptive catalog free. Save 40 per cent, **WRITE TODAY.**

LUGER SALES CO. 828 George St., Dept. 465, Chicago, Ill.



Are YOU Old at 40?

A very common cause of early old age is the disturbed condition of an important gland. Even big strong men are not exempt from this serious irregularity. Our plainly written, interesting educational

FREE BOOK—Why Many Men Are Old at Forty

may bring a priceless message to you. It tells of a simple sensible way by which thousands have relieved this prostate gland condition. It tells how sciatica, backache, pains in toes and heels, interrupted sleep, mental depression, frequent micturition, etc., are so often due to this gland. Sold for over five years upon a money-back-if-not-satisfied plan. Do not confuse it with massage, medication, violet rays, etc. No obligation. Physician's inquiries especially invited.

Thermalaids



The Electro Thermal Co. 2121 Main Street, Steubenville, Ohio





No. 270

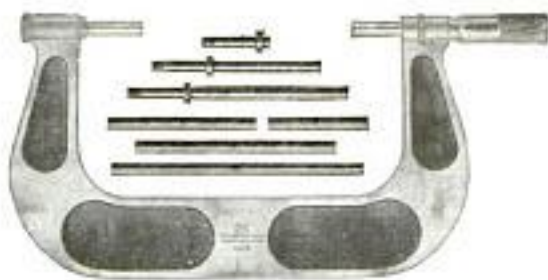

No. 55

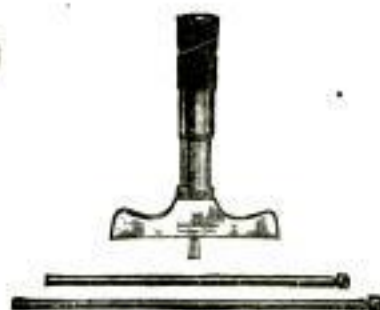

No. 607

TOOLS YOU CAN RELY ON

You'll find that most mechanics use Brown & Sharpe Tools because they can rely on them. These tools have the accuracy and dependability built in them that gives you complete confidence that your work will be correct. The more good, accurate tools you have, the more good, accurate work you can produce.

You Can RELY on Brown & Sharpe Micrometers

The addition of a Brown & Sharpe Micrometer to your kit gives you a reliable tool for accurate measurements.

The care and skill used in making the screw, fitting the spindle and graduating the thimble and sleeve are features which

make every Brown & Sharpe Micrometer an accurate, dependable tool.

Micrometers of especial interest to the garage mechanic are the No. 55, which measures all pistons from 2" to 6" by thousandths of an inch, and the No. 270 Tubular Inside Micrometers for accurately gauging cylinder bores.

Are you acquainted with the No. 607 Micrometer Depth Gauge and other "New Tools by Brown & Sharpe," for every close limit job? Write today for Catalog No. 28.

BROWN & SHARPE MFG. CO.
PROVIDENCE, R. I., U. S. A.

BROWN & SHARPE TOOLS

Look Prosperous!
wear an **ARTEX**

\$3¹⁵ No more to pay

Wonderful Ring — Amazing — Beautiful **ARTEX** Diamond.

See the brilliancy, flash and sparkle of **Genuine Diamonds.**

Surprise your friends. Make this test. Wear an **ARTEX** for seven days at our risk—if not absolutely convinced money will be instantly refunded.

No. 1.—Ladies' Plat. finish ring **\$3.15**
No. 2.—Handsome, massive 2 kt. extra quality Plat. finish men's ring **\$5.90**
No. 3.—Ladies' Plat. finish fancy Tiffany 1 kt. stone, special price **\$2.95**

SEND NO MONEY—Just name and address, number of ring wanted, also size (strip of paper). Pay postman on arrival. Order at our risk. Send for free jewelry catalogue.

E. ARTEX CO.
Madison Square Sta.
New York

No. 2 No. 3

Plan your Pleasure with the Weather.

How? YOUR DEALER WILL TELL YOU

Tycos
BAROMETERS

Taylor Instrument Companies
DORCHESTER, MASS.
Makers of Record-Setting Instruments of Precision

• 23

LOFTIS
BROS. & CO. EST'D 1888

Genuine Diamonds **GUARANTEED**
We import Diamonds direct from Europe and sell direct to you. We invite comparisons.

DIAMONDS WATCHES CASH or CREDIT

"Charlotte" Diamond Ring
Five radiant, blue white, perfect cut Diamonds. Entire ring is platinum.
\$150
Others at \$200 and \$350

Send for Catalog
Over 2,000 illustrations of Diamond-set Jewelry, Watches, Wrist Watches, Pearls, Mesh Bags, Silverware, etc. Select as many articles as you wish and have all charged in one account. Sent prepaid for your **Free Examination**. Catalog explains everything. Our long service to the public (established 1888) is our Guarantee of absolute satisfaction to you and the safeguard of your interests.

CREDIT TERMS on all articles: One-fifth down, balance divided into equal payments within eight months. *Send for Catalog.*

Pearl Beads \$10.00 up
Diamond Gift Links \$25.00 up
Wedding Rings \$5.00 up

Wrist Watch
Rectangular Shape
14-K Solid White Gold, 17 Jewels, \$29
14-K Solid White Gold, 15 Jewels, \$32

Loftis Leads in Low Prices
Our Diamonds are distinctive in beauty, blue white, perfect cut, of great brilliancy, set in the latest fashionable Solid Gold mountings. Wonderful bargains in men's standard Guaranteed Watches. **We guarantee absolute satisfaction or money refunded.**

LIBERTY BONDS ACCEPTED

LOFTIS OLD RELIABLE CREDIT JEWELERS
BROS & CO. 1888
Dept. N-834
108 N. State Street, CHICAGO, ILL.
Stores in Leading Cities

TIRRO The Ideal Mending Tape
AT DRUG STORES
BAUER & BLACK, 2500 Dearborn St., CHICAGO

BOYS!!

LEARN HOW TO PLAY ANY TUNE IN ONE AFTERNOON

FREE Complete instructions for making real music with a Hohner Harmonica (Mouth Organ) sent free to any American Boy.

First learn the scale—"do, re, mi, fa" etc. Then try "Home Sweet Home." Diagrams and full explanations show you how you can do this easily with a **HOHNER HARMONICA**

After you've done this you can play any tune you can whistle--with chords and full accompaniment. Harmonica is most popular music on the radio. Biggest hit of the year in New York Orchestras. Be the first boy in your neighborhood to play a harmonica well. Astonish your folks and friends. Be sure to ask at the music goods store, general store, stationery or drug store in your town for a Hohner Harmonica--big and up. Write us this minute and say "Send me Hohner Harmonica Instructions" and give your name and address. Write now, 601--

H. HOHNER, Dept. 20, 116 E. 16th St., New York City



Send now for free instructions

Get a Hohner at Your Local Store

Those who wear them say:
ERICKSON LEGS are Wonderful
because they do not chafe, overheat or draw end of stump.

Established 1892



If you have had a recent amputation send for new booklet on TEST LEGS for business.
E. H. ERICKSON CO.
38-A Washington Av. N.
MINNEAPOLIS - MINN.



Kingery

Start A Profitable Business for Yourself

—and make **MONEY** right away

KINGERY POP CORN POPPERS AND PEANUT ROASTERS often prove a gold mine for the ambitious person. The investment is small—practically no attention is required to machine while in operation—little expense for stock or power—and profits are BIG: 3 3/4c on every 5c sale or 8 3/4c on every 10c purchase.

KINGERY MACHINES are complete in every way. They turn out the buttered popcorn and hot roasted peanuts with little effort on your part.

VERY LITTLE SPACE IS REQUIRED—for KINGERY POP CORN POPPERS AND PEANUT ROASTERS can fit in practically any space.

Everybody—young or old—rich or poor—every person is a possible customer.

James Kipwiss, P. O. Box 56, Waynesburg, Pa., writes: "Since I got your machine, in 15 days I have made \$227.55."

INVESTIGATE TODAY

WRITE FOR FREE ILLUSTRATED CATALOG showing a model for every purpose at a price for every purse.

Dept. PM

KINGERY MFG. CO.
CINCINNATI, OHIO



HOME LOVERS' BARGAIN BOOK FREE

Showing Over 10,000 Furniture Bargains

All selections loaned free for a month. Take a year to pay if satisfied, paying little by little almost as you please.

SPiegel, M.A.Y. STERN CO., 1108 W. 35th St., Chicago



"Lighting Fixtures"

READY TO HANG

(Direct from Manufacturers)

Completely wired, including glassware.

New designs. Send for catalogue No 24.

Send for DEALERS' proposition.

ERIE FIXTURE SUPPLY CO.

STA. A.

ERIE, PA.

Automatic Rapid Electric FIRELESS COOKER

Gives every facility of electric range plus every advantage of fireless cooker at less cost than a good oil stove.

NEW INVENTION
REVOLUTIONIZES COOKING

Saves 50% to 75% fuel cost

Bakes, roasts, boils, steams, fries, toasts. Needs no watching. Shuts electricity off automatically. Attaches to any electric socket. **No special wiring.** Write for FREE Home Science Cook Book, 30-day FREE trial offer and direct factory prices.

WM. CAMPBELL CO., Dept. 64, Detroit, Mich., Georgetown, Ont.



W. L. DOUGLAS

NAME AND PORTRAIT is the best known shoe Trade Mark in the world. It stands for the highest standard of quality, style and workmanship at the lowest possible cost.

W. L. DOUGLAS shoes are actually demanded year after year by more people than any other shoe in the world

BECAUSE W. L. Douglas for forty-six years has been making surpassingly good shoes. The smart styles are the leaders everywhere. When you need shoes and are looking for the best shoes for your money examine W. L. Douglas \$7.00 and \$8.00 shoes. They are exceptionally good value for the price. Wear them and save money.

\$5. \$6. \$7. \$8. & \$9. SHOES FOR MEN & WOMEN

NO MATTER WHERE YOU LIVE

shoe dealers can supply you with W. L. Douglas shoes. If not convenient to call at one of our 116 stores in the large cities, ask your shoe dealer for W. L. Douglas shoes. Protection against unreasonable profits is guaranteed by the name and price stamped on the sole of every pair before the shoes leave the factory. Refuse substitutes. The prices are the same everywhere.

IF NOT FOR SALE IN YOUR VICINITY WRITE FOR CATALOG.

TO MERCHANTS: If no dealer in your town handles W. L. Douglas shoes, write today for exclusive rights to handle this quick-selling, quick turn-over line.

W. L. Douglas
President
W. L. Douglas Shoe Co.
128 Spark Street, Brockton, Mass.

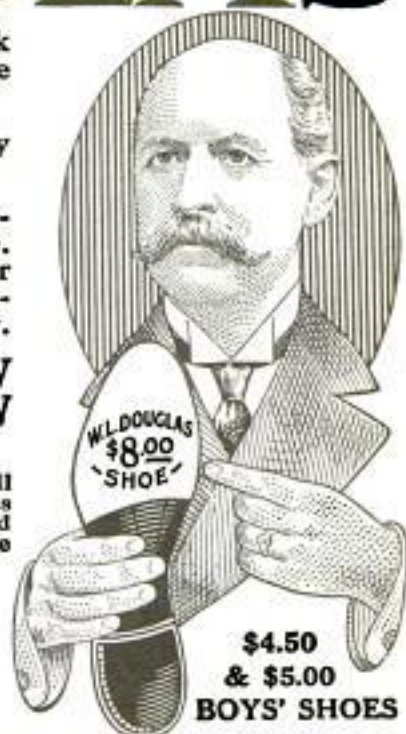

Factory to Rider

Saves \$10 to \$25 on the **Ranger** Bicycle you select. You can have your choice of **44 Styles**, colors and sizes. Delivered free on approval, express prepaid, for **30 DAYS' FREE TRIAL**.

12 Months to Pay if desired. Possession and use at once on our liberal year to pay plan. Parents often advance first payment.

Tires best quality, at factory prices, express prepaid. **Lamps, wheels and equipment**, low prices. Send **No Money**, do business direct with makers.

Mead Cycle Company

Dept S108 Chicago

Write today for free Ranger Catalog, factory prices and marvelous easy payment terms

FREE Wonderful Book

Tells how to learn taxidermy—how to mount birds, animals, game-heads, fishes, tax skins. Learn by mail. A necessity for hunters and nature lovers. Best methods, quickly learned, very fascinating. Success guaranteed. Decorate your home and den with splendid art. Make big profits. Write today for this line illustrated, free book and our amazing offer.

Northwestern School of Taxidermy, 1775 Elwood Bldg., Omaha, Neb.

MONEY IN MUSHROOMS

NOW TIME TO START
BIG DEMAND. HIGH PRICES BEING PAID
An uncrowded occupation. Exceptional opportunities for live men and women. Raised at home. Only small space needed. Small expenditure will start you in a practical money-making enterprise. Big profits. Booklet telling all free. Write **Nat'l Spawn Co., Dept. 12, Waban, Mass.**



Design No. 303

Plans \$18.00

California Bungalow Books

"Home Kraft" and "Draughtsman" each contain Bungalows and Two Stories. "Plan Kraft" Two Stories. "Kozy Homes" Bungalows. \$1.00 each—all four for \$3.00. De Luxe Flats \$1.00.

DE LUXE BUILDING CO.

516 Union League Bldg., Los Angeles, Calif.

SQUAB BOOK FREE

Squabs are selling at the highest prices ever known. Breed them and make money. Write at once for free book, prices, etc. **Plymouth Rock Squab Co., 634 Howard St., Melrose Highlands, Mass.**

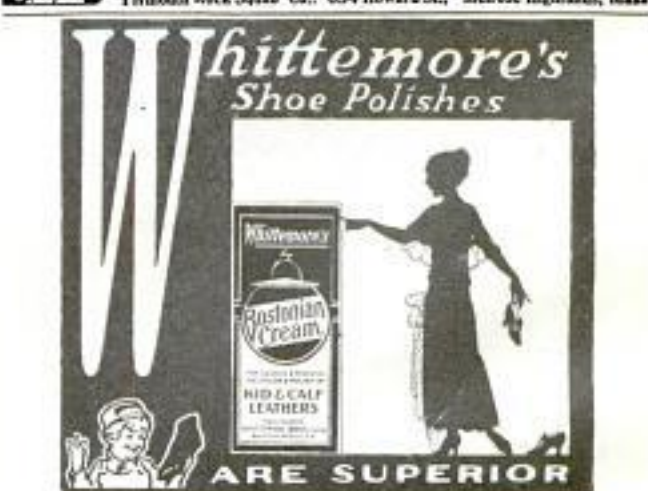

Send No Money

Ladies' Solitaire Examination Free

This perfectly cut Diamond will be sent free of charge for your complete examination and approval. No money in advance. If satisfied, pay only \$2.00 on arrival and keep it. Price \$30.00.

10 MONTHS TO PAY

The balance you send in 10 small monthly payments—only \$2.80 a month. Take advantage of this amazing offer today.

FREE De Luxe Catalog in colors. Write for details of Great Diamond Offer and Book to Dept. 63-K.

Capital \$1,000,000



\$2.80
a month



THE HOUSE OF QUALITY
L.W. SWEET INC.
1650-1660 BROADWAY, NEW YORK

Built low, with its 36 inch seat rides wonderfully easy

MAKE your FORD into this SPORTCAR

Red-i-Kut Life-Size Patterns
Instructions and Tail Delivered

Follows **Red-i-Kut** life-size pattern—fit terms and picture instructions show you how you can easily convert your Ford into this FAST, SAUCY, SPORTEL Car as thousands have done, with easily obtained materials. No need to lay up the car. The "PAL" with concealed wheel patterns, pressed metal streamline rear.

\$6.40

The "Ace" of Fords

"Have finished my 'Pal.' It's some jam boat. I go where a goat can't go, or where others fail I go on. I can run thru mud on high road where others can't go on low. Here is a picture I am so proud. I am called the 'Ace' of Fords, for I skip by them all like a rabbit." —Ed Fortuna, Columbia, Ky.



ONLY \$6.40 DELIVERED

Send 5c coin for new manual on Sport Bodies, "Red-i-Kut" Steel, Underlying Irons, "Pal" Iron and "Gorum" Windshields, Kneepel Co., 26 Roosevelt Bldg., Gettysburg, Pa.

Life-size patterns of many other distinctive body styles for as low as \$3.00

You can build it. Over 11,000 in use. Order Today

3 Piece SUIT

MADE TO ORDER

SAVE

To prove our unbeatable values and get your steady trade, will make 3-piece suit consisting of coat, pants and vest to your measure for only \$13.45. Style shown in the picture or any one of 196 style combinations to select from. Absolute satisfaction guaranteed or every penny back—quick.

NO EXTRA CHARGES

You pay just what we say, not one penny of extra for anything. We even pay all postage and express. You save one-half-size before the war.

Earn \$60 Cash Weekly

You can take orders easy for these clothes in spare time and make \$100 a year and up as soon. Friends and neighbors buy on credit. Young Fred Green made **SEND NO CASH**, \$174.50 in seventeen days.

FREE—BIG SAMPLES

New samples show latest styles and 80 real cloth samples. Buy at inside Wholesale prices. Write now for Big Free Outfit.

WASHINGTON TAILORING CO.
Wholesale Tailors Dept. S-345 Chicago



Moore Push-Pins
Glass Heads—Steel Points
Moore Push-less Hangers
To hang up things
Ask your dealer to show them
Sold Everywhere **10¢** per packet
Moore Push-Pin Co.
Wayne Junction Philadelphia

CHARGE YOUR BATTERY

(RADIO OR AUTO) at HOME for a NICKEL
The HOMCHARGER

POPULARLY PRICED—PAYS FOR ITSELF
SEND FOR THE ALTERNATING ELECTRICAL SERVICES CO. FREE BOOK 1229 W. THIRD ST.—CINCINNATI, OHIO.



\$3 Cash Buys Typewriter



Balance Only \$5 Monthly

Save 35 to 60% on all standard makes—Underwood, Royal, Remington, etc. Every machine thoroughly rebuilt and GUARANTEED. Try five days at our expense before you buy.

WRITE at once for Free Descriptive Circular and Special Low Prices.

5 DAYS FREE TRIAL

WYNN TYPEWRITER EXCHANGE 11 Reliance Bldg. Kansas City, Mo.

Agents: Big Money

Taking Orders for New Coal-Oil Burner



Most perfect burner invented. Burns like gas. By regulating valve you get as little heat as you want, or heat oven to baking point in ten minutes.

Big Summer Seller Burns coal-oil. Low-priced. Not sold in stores. Write for agency and sample. No experience or capital needed. You take the orders. We ship by parcel post and do all collecting. Commission paid same day you take orders.

PARKER MFG. CO., Burner 778, Dayton, Ohio

FREE BASEBALL OUTFIT

RUSH your name and address and we will tell you HOW you can get this Baseball Outfit, consisting

GLOVE BALL MITT

of Baseball Suit, Cap, Fielder's Glove, Live League Baseball, Catcher's Mitt
ABSOLUTELY FREE. Write at once for FREE Baseball Outfit.
HOME SUPPLY CO.
131 Duane St., Dept. 522, NEW YORK

We Are Equipped to Manufacture Your Product

A large, established plant in Chicago seeks additional product of merit to manufacture.

We have very modern facilities (including belt line switch-track tapping all important trunk lines) for the manufacture of machinery and railway appliances with structural, boiler and tank, electric and oxy-acetylene welding, galvanizing and tinning, and wood-working departments.

Arrangements may be made—

For manufacture and sales on royalty—to manufacture for established sales organizations—to manufacture on contract.

Efficient production — unequalled service. Let us help you.

Mechanical Manufacturing Co.
39th and Loomis Streets, Chicago

TOMPSON

Safety Blade Stropper

\$1
NOW

Gives to every safety razor blade a keener edge than when first made. Over 100 perfect shaves from each blade. No moving parts—slides—or cogs. By mail—10 day money-back Guarantee.

Works Perfectly on Any Strip
Special Strip, 50 Cents Extra

GRAND OPENING! 100,000 FOR THE PRICE 100,000

Tompson Stropper
Sales Company

Dept. 1272

Kansas City, Mo.



Amazing Bargain!

Lincoln Wren House \$1.00

Unusually attractive bird house —

that ONLY wrens can use. Looks

like a miniature log cabin. Made of

wood, tinted a soft brown color

that attracts the wren, whose song

is melodious and high-like; amaz-

ing wrens make it a favorite. It de-

stroyed large numbers of obnoxious

insects. The equal of wren houses

costing \$5.00 to \$7.00. And yet because

we build in tremendous quantities—

we are able to sell, knocked down, for

only \$1.00—prepaid. (West of Denver and Canada, \$1.25.) At-

tract wrens—they liberally repay attention. Send \$1.00 for each

Lincoln Wren House you want. If you aren't delighted—money

back. Write now. (Dealers write for proposition.)

John Lloyd Wright, Inc., 709 N. Wells St., Chicago



For 58 years these little marchers have led band instrument buyers to better quality and value!

**Everything for the
BAND PLAYER!**

—from a drumstick to world's finest instrument!

SEND FOR FREE CATALOG, mention instrument interests YOU. Free Trial! Easy payments. Sold by leading music merchants everywhere. Write TODAY!
LYON & HEALY, 73-71 Jackson Blvd., CHICAGO

LYON & HEALY, 73-71 Jackson Blvd., CHICAGO

Great *New*



Invention for seekers of Health Power Beauty

Elco Health Generators at last are ready for you! If you want more health—greater power to enjoy the pleasures and delights about you, or if more beauty is your desire—write! Ask for the book on these inventions which has just been prepared. It will be sent to you without cost. It tells you how Elco Health Generators aid you in leaving the lethargy and hopelessness of bad health and weakness behind forever. Re-vitalize yourself. Bring back energy. Be wholly alive. Write today!

10 Days Free Trial—Write for Free Book!



These great new inventions generate Violet Ray, Vibration, Electricity and Ozone—combined or separate **Free Trial**

They operate on the electric light in your home or on their own motive power at less than 50 cents per year. Elco Health Generators are positively the only instruments which can give you in one outfit Electricity, Violet Ray—Vibration and Ozone—the four greatest curative agents. Send the coupon below. Get the Free Book NOW!



For All These:

- | | |
|--------------|---------------|
| Paralysis | Catarrh |
| Pimples | Skin Diseases |
| Falling Hair | Hay Fever |
| Headache | Neuralgia |
| Lumbago | Deafness |
| Nervousness | Pain |
| Rheumatism | Development |
| Sore Throat | Neuritis |
| Asthma | Obesity |
| Black Heads | |

Mail Coupon for FREE Book!

Do not put this paper down without sending the coupon. Don't go on as you are with pains and with almost no life and energy. You owe it to yourself to be a better man or woman. You were put here to enjoy life—not just to drag through it. So do not rest another day until you have put your name on the coupon here. That will bring the whole story of these great new inventions. Do it today—now.

Lindstrom & Company

442-448 N. Wells Street, Dept. 13-55, Chicago, Ill.

Please send me your free book, "Health—Power—Beauty" and full information of your 10-day Free Trial Offer.

Name _____

Address _____

Health
Power
Beauty

Please Mention Popular Mechanics

My Ideal Lawnmower Grinder

Earned \$1662¹⁹ in 1922

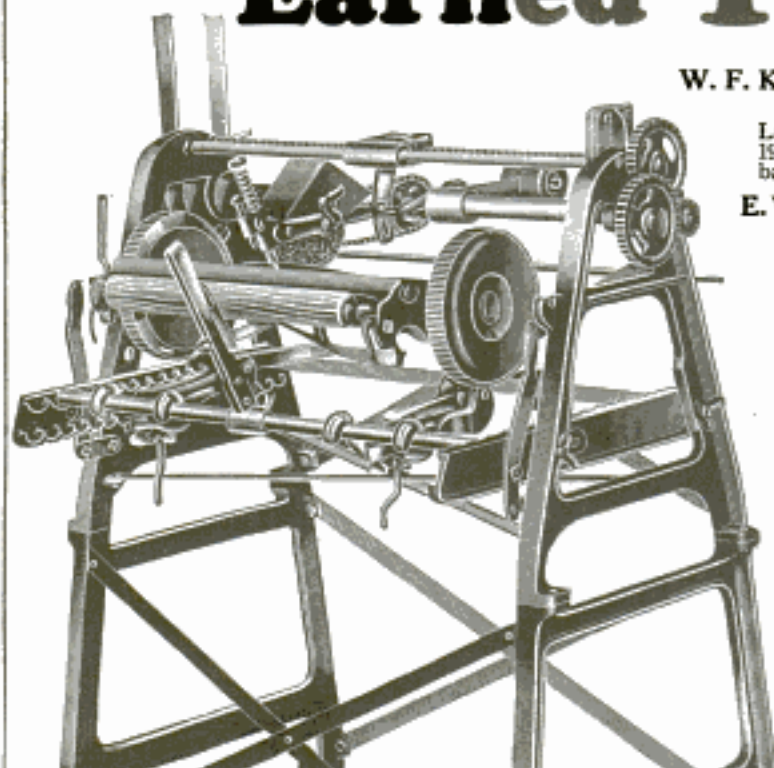

W. F. Kendt, of 1476 Main St., Buffalo, writes:

"I sharpened 994 lawnmowers on my Ideal Lawnmower Grinder during the grass season of 1922, and the receipts were \$1662.19, which is not bad for a side line."

E. W. McCormick, of Saginaw, Mich., writes:

"Five years ago I purchased from you an Ideal Lawnmower Grinder with which I ground over 5,000 mowers. If I could not buy another, I would not take \$1000 for it."
E. W. McCormick."

Put an Ideal Lawnmower Grinder in your shop. It sharpens a Lawnmower keen as a razor every 20 minutes without removing reel knives.

Mowers run easily—owners delighted—they tell others—you are in big demand. Costs but little and will prove the greatest money maker you ever installed.

Write today for booklet, "Let George Say It," and catalog. Buy early and start with the first grass clip.

The Fate-Root-Heath Co.
Bell & High Sts. Plymouth, Ohio

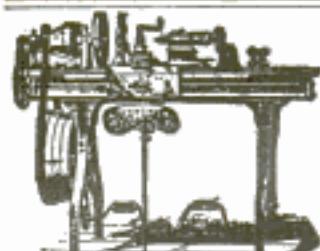

LATHES

9 to 18-inch Swing

List price \$165 and up according to size. When ready to buy send for Lathe Catalog and prices.

W. F. & John Barnes Co.
100 Ruby Street, ROCKFORD, ILL.



It is the well known quality of CRESCENT machines that justifies you in selecting one of them each time you have need for good working machinery. The CRESCENT line is better than ever and will always give you satisfaction in every particular. Ask today for catalog of hand saws, saw tables, jointers, shapers, planers, borers, planers and matchers, swing saws, disk grinder, cut off table, hollow chisel mortiser, variety wood work, Universal wood workers.

THE CRESCENT MACHINE CO., 93 Columbia Street, Leontona, Ohio

NEW ENGINE FREE

TO TRY FOR THIRTY DAYS

Let this amazing new air-cooled 2 h.p. UNIT farm motor do your work. Saves time, labor and money. Weighs 40 lbs. less than others. Easy to carry from place to place under your arm. Can't freeze. Burns gasoline or kerosene. Nothing to get out of order. Comes ready to run. Backed by strongest guarantee ever made. Every farmer should have one. Write today—Big catalogs of Unit Motors, 2 to 30 h.p.—Free Trial Offer, and easy pay as you please low direct to you factory prices. UNIT MOTOR CO., 139 Unit Bldg., Kansas City, Mo.



N AGENTS 500% PROFIT

\$80 - \$200 per week. Free samples **GOLD SIGN LETTERS** for store and office windows. Anyone can put them on. Big demand everywhere. Liberal offer to general agents.
METALLIC LETTER CO., 433B N. Clark, Chicago

SOUTH BEND LATHES

Screw Cutting Engine Lathes

STANDARD CHANGE GEAR

9"x 3' Lathe.....	\$ 176.00
11"x 4' Lathe.....	228.00
13"x 5' Lathe.....	304.00
15"x 6' Lathe.....	376.00
16"x 8' Lathe.....	452.00
18"x10' Lathe.....	656.00
21"x12' Lathe.....	933.00
24"x14' Lathe.....	1254.00

QUICK CHANGE GEAR

9"x 3' Lathe.....	\$ 216.00
11"x 4' Lathe.....	273.00
13"x 5' Lathe.....	354.00
15"x 6' Lathe.....	431.00
16"x 8' Lathe.....	512.00
18"x10' Lathe.....	721.00
21"x12' Lathe.....	1016.00
24"x14' Lathe.....	1353.00

Catalog No. 77 sent free to any address

SOUTH BEND LATHE WORKS

625 E. Madison St.

SOUTH BEND, IND.



How to Run a Lathe:—New 80-page book, Revised Edition No. 24, for 10 cents postpaid, silver or stamps.

Fix it with BERNARD PLIERS



They
"Swallow
the Wire"

You can insert a wire to any length through the open throat of Bernard Pliers, grip the wire anywhere, and bend it or stretch it at will. The parallel jaws don't let go until YOU do. And the cutting blades on the outside slice cleanly through heavy wire. Compound leverage gives tremendous power. Only Bernards have these features.

Booklet "P" Free on Request



**BERNARD
PLIERS**
Wm. SCHOLLMORN CO.
NEW HAVEN, CONN.



PARALLEL JAWS

OUTSIDE CUTTER

Interlox[®] ALWAYS READY

to make instantly accurate inside or outside measurements.
MASTER SLIDE RULE

Dealers and agents:
Request attractive
proposition.

Slides in and out.
No slow folding; strong brass-trimmed boxwood. Any length, 2 to 8 ft., 20¢ per inch less. If not at your dealer's, send postpaid.
MASTER RULE MFG. CO., Inc.
841-43 East 136th Street New York City

\$600 to \$5,000 PROFIT FROM WASTE STORE SPACE

Business men! Send for amazing story of Butter-Kist Popcorn and Peanut Machine profits. Pays big in drug, department, candy, other stores, theatres, etc. Write
HOLCOMB & HOKE MFG. CO.
946 Van Buren St. Indianapolis, Ind.

DIAMONDS

FOR A FEW CENTS A DAY

\$1.50 a Week
SEND NO MONEY
Looks like \$350 Solitaire
No. 61 only \$59.50
We Trust You

MONEY BACK GUARANTEE

Don't send a cent. Ten days' Free Trial. If you are not convinced it is the *Greatest Bargain in America*, send it back at our expense. Only if pleased do you send \$11.50 as 1st payment. Then send \$1.50 weekly — at the rate of a few cents a day. This Bargain Cluster Ring with 7 Blue-White Perfect Cut Diamonds can be yours. No Red Tape. No Risk.

Send for it today. It pictures thousands of Bargains. Address Dept. 172b.

MILLION DOLLAR BARGAIN BOOK

FREE

J.M. LYON & CO.
2-4 Maiden Lane N.Y.

ATKINS METAL CUTTING SAWS



Use
Atkins
"Non-Breakable"
Hack Saw
Blades

End Hack Saw Blade Breakage

WITH Atkins "Non-Breakable" Hack Saw Blades you can eliminate practically all losses due to blade breakage, and do metal cutting faster and easier.

Made of selected steel, these blades are hardened and tempered by an exclusive gas and oil process which makes the cutting edge extremely hard and the body of the blade unusually tough and flexible. That's why they out-cut and out-last other blades. Prove it for yourself. Send us ten cents and tell us what metal you cut and we'll send a sample blade. You'll say it's the best you ever used.

No matter what wood or metal-cutting you do, there are Atkins' saws to save you time, labor and money. Ask for our free booklets.

Get "Saws in the Shop"

Sent You FREE



A 32 page book that's full of practical suggestions on metal-cutting, and general shop information. Every man who buys or uses saws will find it helpful. Just write your name and address on the margin of this page and mail it to us.

Do It NOW

E. C. ATKINS & CO., Inc.
Dept. P INDIANAPOLIS, IND.
Makers of "Silver Steel" Saws and Tools

Please Mention Popular Mechanics

HERE'S A NEW TOOL



Simore
Lightning-
Change
Screw
Driver.

NEVER BEFORE A SCREW DRIVER LIKE THIS

Tip the handle and gravity produces the blade you want. A quarter turn of the knurled cap at the base of the blade locks the blade for use. When finished turn the same knurled cap and the blade springs back into the handle.

Three blades—for use anywhere you want a screw driver. The strongest tool of its size and kind. Order one today.

Send
\$1.80
today
PREPAID

Dealers and others—
We have a good
proposition for you.

Every Tool Guaranteed

Simon & Skidmore Mfg. Co.
Santa Ana, California

Makers of the Simore
Automatic Universal Square



MECORMICK & CO., Baltimore

Use a Bit Brace

of dependable quality and notice how easily and how much better a job you can do. Working in wood at home is not only profitable but mental relaxation as well.

Send for a 34 Catalog showing the same dependable tools that carpenters have used for years.

THE STANLEY RULE & LEVEL PLANT
THE STANLEY WORKS, New Britain, Conn.
New York Chicago San Francisco Los Angeles Seattle

STANLEY TOOLS



TOOL CHESTS

for Machinists & Toolmakers
Every tool arranged in order. No up-to-date mechanic should be without one. A Gerstner Case costs no more than some tools, and will last a lifetime. Catalog free.

Gerstner Sons

717 Columbia Street DAYTON, OHIO

BURN YOUR NAME ON TOOLS
WITH
ARKOGRAF

Protect your tools from theft. Write your name, engrave any design on metal with electricity like writing on paper with pen or pencil. Complete outfit \$2.50, prepaid anywhere. Interest-free descriptive circular free. Write today. Agents Wanted. Arkograf Pen Company 1007 Yeon Building Portland, Oregon



They get best results when they use
**WHITING-ADAMS
BRUSHES**

Magazines properly illustrate woman's activities, and mirror like finish comes from using
WHITING-ADAMS BRUSHES

Send for Illustrated Literature

JOHN L. WHITING-J. J. ADAMS CO., Boston, U.S.A.

Brush Manufacturers for Over 113 Years and the Largest in the World

WOODWORKERS! Make Big Money

Put this PARKS
IN YOUR WORKSHOP!

"Four-in-One"—a husky machine for fast, clean work and long service. Steel frame construction. Thousands in use. Four machines in one. Circular rip and crosscut saw, band saw, jointer, and borer. Guaranteed 10 years. 10 days' free trial.

Many Other
Combination
Woodworkers

LOW PRICES

Send for Catalog

The Parks Ball Bearing Machine Co.
1500-1540 Knowlton Street Cincinnati, O.
Canadian Factory: 200 Notre Dame East, Montreal, Can.

PARKS

Beautiful HOUSES \$900 and BUNGALOWS

CAN BE BUILT FOR AND UP
This and many others in my new book, Building Plans for Modern Homes, will save you hundreds of dollars. One of the most complete and comprehensive books of plans ever published by any architect. New edition just off the press. Nearly 500 floor plans and blueprints of bungalows, Colonial houses, etc., costing from \$200 up; gives sizes and cost to build.



FREDERICK H. GOWING
ARCHITECT

Sent postpaid for \$2.00 101 Tremont St., BOSTON, MASS.

TYPEWRITERS

17c a Day soon pays for a genuine visible Underwood or L. C. Smith rebuilt Typewriter. Save \$20 to \$30 on famous Larkin Easy-Payment plan. Handsomely finished. 5 Year guarantee. 30 Days Trial. Send for FREE Book TODAY.

Larkin Co. Inc. Desk TPM-523
Buffalo, N. Y.



AGENTS: \$6 PER DAY AND UP

Selling concentrated, non-alcoholic food flavors. Always fresh. Put up in collapsible tubes. Ten times the strength of bottled flavors. Guaranteed under U.S. pure food laws. All flavors. Sells in every home. Used every day. Not sold in stores. Big demand. Big repeater. 100% profit.

MEN OR WOMEN

can make big money. Haut sold over \$300 in one month. You will find this a big, easy seller and a sure repeater. Must satisfy customers or money back. Write for territory and sample outfit. Get a big line of customers. Get repeat orders every month and have a steady income. Write quick.

AMERICAN PRODUCTS CO.
7576 American Bldg., Cincinnati, O.



ACT
QUICK
WRITE
TODAY

"Been on a
vacation
Bill?"



"No, Jim—I've stopped smoking. Gained six pounds in a week. You know how I used to smoke—a package of cigarettes and a cigar or two a day—it sure had some hold on me. But I'm cured—took a scientific home to-

bacco treatment—fixed me up in two weeks.

"Wasn't hard on me at all—noticed improvement the first day—I feel like a new man. It didn't interfere with my work—didn't leave any druggish after-effects—the money I saved in the last two weeks has paid for the treatment alone.

"Why don't you take it? It has cured men like you and me for over forty years—it is a doctor's individual prescription that sure fixes you up. Just send the coupon for full information NOW. No obligation. All correspondence is strictly confidential."

THE KEELEY INSTITUTE
Dwight - - - Illinois

A Doctor's
Prescription

The Keeley Institute, Dwight, Ill.
Please send me, without any obligation on my part, your free booklet which will tell me how to rid myself of the tobacco habit.

NAME.....

TOWN.....

STREET..... STATE..... PM-5

Catalog FREE!

Send for the MONARCH Lathe Catalog—fully illustrated—every type Lathe, up to 30 inches swing. Illustrated here is the MONARCH Jr. Lathe—an accurate, compact,

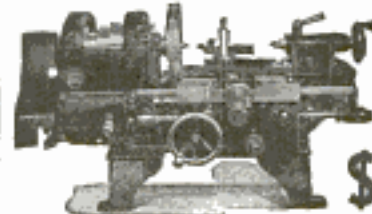

trouble proof Lathe for Inventors, Experimenters, Mechanics and Auto Repairmen. Fully equipped—semi-quick change gear—auto. safety devices.

\$225 9 In. Lathe—
2 1/2 In. Bed—
with Bench Legs

Also built with bed lengths up to 5 feet. Made in 11 inch swing size, too, at slightly higher price.

THE MONARCH MACHINE TOOL CO.
400 Oak Street SIDNEY, OHIO

\$104 PROFIT IN 3 1/2 HOURS



G. A. Barton, Indiana, made that amount—making and selling Candy Floss. Others send in amazing reports: Small, Chicago, says— "Did \$125 business on Sunday." Wendel, Kansas, writes, "Averaged \$125 a day for 3 weeks." Gardner reports, "2,437 sacks of candy sold from 11 a.m. to 10:15 p.m. Big Money in Candy Floss! Rees says: "Cleaned up \$225 in 4 nights in Greenville, Ohio." Candy Floss is a delicious, novelty confection—fluffy, soft as cotton, white as snow, or any color or flavor. Can be made anywhere—in store window, in parks, on street corners, at picnics, summer resorts, bazaars, parties, or wherever crowds gather. Machine easy to operate. Raw materials plentiful and cheap. Send name and address for free illustrated book of facts. Drop postal. Act now! Address

FREE
MY BOOK
CANDY SUCCESS

A. T. DIETZ

44 Sayso Bldg. Toledo, Ohio

Glands Used to Restore Hair Growth

Science of Gland Therapy Relieves Baldness—New Treatment Restores Health and Growth

Baldness in both men and women is now generally ascribed by scientists to defective functioning of endocrine glands. Hair growth is dependent upon the secretions of these glands—these secretions making possible the assimilation of those elements in the blood which are vital to a luxurious growth of hair.



Now it is possible for any bald person to have a full, luxuriant growth of hair through the discovery of E. R. Alexander, nationally known scientist. Dr. Alexander, through the concentration of glands, can supply the deficiency of gland secretion and produce a full growth of hair.

This discovery may be easily used in the privacy of your own home. Within a few weeks you will notice new, vigorous hair beginning to come in and with this growth you can gradually restore your hair to its former bright, healthy color.

So confident is Dr. Alexander that you can be relieved of the embarrassment of baldness and regain the normal hair growth by this method that he offers to send a regular \$4.00 treatment for only \$2.00 to anyone who will write for it. Use it according to directions, and if at the end of a month you do not find your hair returning with all its former vigor, the treatment does not cost a cent.

SEND NO MONEY—just your name and address to Alexander Laboratories, 812 Gateway Station, Kansas City, Mo., or 812 Terminal, Toronto, Canada, and this treatment will be mailed at once in plain wrapper. Try it according to directions and if at the end of a month you are not more than satisfied with results, your money will be refunded at once. A big Kansas City bank guarantees that Dr. Alexander is reliable and holds \$1,000 cash as a guarantee to return your money if you wish.

Don't suffer the embarrassment of baldness—give the treatment a trial on this liberal offer.

Please Mention Popular Mechanics

Different from all others—the NEW BENJAMIN

AIR RIFLE

Made on a different principle from all other Air-Rifles. The Benjamin is really a strong air-pump used to compress the air in the air chamber to any degree of power desired. From one to six strokes of the pump give all the force necessary. Each additional stroke gives increased power. The Benjamin works on the same principle as all air-drills and air-hammers—with this difference: You control the shooting force as you desire. Lock at this block of hardwood. It shows how Benjamin power is regulated as you wish.

You can't have accidents with a Benjamin. It's safe, always, because you control the power. The Benjamin never loses shooting force, and has no springs to get out of order or shake your aim. Write us for an interesting folder about this wonderful air-gun.

If your dealer does not handle same, send direct to Isotoff—

(PRICE \$5) POSTPAID

BENJAMIN AIR-RIFLE & MFG. CO., 415 N. Broadway, St. Louis, Mo.

Ask your dealer for demonstration.

Pacific Coast Representatives
TRAY & BOWER
Los Angeles, Calif., and San Francisco, Calif.

Hunting With the Bow and Arrow

By Sexton Pope

An illustrated book - 200 pages making tackle-hunting with Ishi the Indian - shooting small game, deer, lion, bear with the bow. Price \$3.00

THE JAMES H. BARRY COMPANY
1122 Mission Street - San Francisco, California

\$25 A DAY Selling Shirts

Large shirt manufacturer wants agents to sell complete line of shirts, pajamas, and night-shirts direct to wearer. Advertised brand—exclusive patterns—easy to sell. No experience or capital required. Entirely new proposition. Write for free samples.

Madison Shirt Co., 503 Broadway, N. Y. C.

MUSIC LESSONS FREE

You can read music like this quickly

IN YOUR OWN HOME

Piano, Organ, Violin, Mandolin, Guitar, Banjo, etc. Beginners or advanced players. One lesson weekly. Illustrations make everything plain. Only expense about 2c per day to cover cost of postage and music used. Write for FREE booklet which explains everything in full.

AMERICAN SCHOOL OF MUSIC, 50 Lakeside Building, CHICAGO

CAMERAS

Over a Hundred Styles and Sizes

Send for new illustrated catalog showing latest reduced prices. It's Free.

10 days' trial given

SENECA CAMERA MFG. COMPANY
300 Central Avenue Rochester, N. Y.

SAVE YOUR BODY

Conserve Your Health and Efficiency First

"I Would Not Part with it for \$10,000"

So writes an enthusiastic, grateful customer. "Worth more than a farm," says another. In like manner testify over 100,000 people who have worn it.

The Natural Body Brace

Overcomes WEAKNESS and ORGANIC AILMENTS of WOMEN AND MEN. Develops erect, graceful figure.

Brings restful relief, comfort, ability to do things, health and strength.

Wear It 30 Days Free at Our Expense

Does away with the strain and pain of standing and walking; replaces and supports misplaced internal organs; reduces enlarged abdomen; straightens and strengthens the back; corrects stooping shoulders; develops lungs, chest and bust; relieves backache, curvatures, nervousness, ruptures, constipation, after effects of flu. Comfortable and easy to wear.

Keep Yourself Fit Write today for illustrated booklet, measurement blank, etc., and read our very liberal proposition.

HOWARD C. RASH, Pres. Natural Body Brace Co.
223 Rash Building SALINA, KANSAS



For Boys and Girls Also

SELF-FILLING INK PENCIL

"INDEPENDENT"

Meets all requirements. Self-filling, non-leakable, safety cap. Attached clip. Smooth writing gold style point.

Guaranteed Improved Fountain Pen. Eliminates fatigue. Promotes efficiency. Writes uniformly. A business necessity.

\$2 By Mail

Your Name in Gold—25 Cents Extra

AGENTS WANTED

J. C. ULLRICH & CO., 161 Washington St., New York

Earn \$50 a day Selling men's gas-mask

Goodyear Raincoats
\$1.90 each, in dozen or gross lots. Sample sent upon receipt of \$2.15. Agents wanted (Write for our 6 best sellers).

GOODYEAR RUBBER M'FG CO.
Dept. A. 34 East 9th Street, New York City

MAKE OVER \$800.00 MONTHLY

Owning and operating an Anderson Vulcanizer which vulcanizes tires 3" to and including 5". You can vulcanize the smaller tires in all three molds. We guarantee no other vulcanizer will properly cure as many tires daily as the Anderson. It will do \$160 worth of work daily and will keep 8 men busy. You can run it ten hours daily, six days a week, for less than you can any other make, half a day. An Anderson School is near you.

ANDERSON STEAM VULCANIZER CO.
Popp-Williams Bldg. Indianapolis, Ind.

MOVIES WE'LL SWAP YOU your name and address for our catalogue on the greatest real home MOVIE-MACHINES in the world, with dazzling models as low as \$5.00 postpaid. And say, folks! We've also got the slickest films at ridiculously low prices—and what's more—we now have a film exchange plan that's the best ever. Of course we don't have to tell you that our films are the best. Let's not miss this opportunity—Write today—NOW.

PARAMOUNT MFG. COMPANY, Box 1371
Dept. M BOSTON, MASS., U. S. A.

NO 6 \$439 NO 7 \$368

NO 4 \$396 NO 5 \$354 NO 1 \$284

Get This Wonderful Ring. If You Can Tell It From a Genuine Diamond Send It Back

These sparkling, beautiful CORODITE diamonds positively match genuine diamonds in every way—same blazing flash and dazzling play of living rainbow fire. They, alone, stand the diamond tests, including terrific acid test of direct comparison. Lifetime experts need all their experience to see any difference. Prove this yourself.

Wear a Corodite Diamond 7 DAYS FREE
Make that test. You risk nothing. Wear a genuine Corodite and a diamond side by side on the same finger for 7 days. If you or your friends can tell the difference, send it back; you won't be out a single penny. That's fair enough. If you keep the ring, price printed here is all you pay. No installments. Remember, Corodites alone have the same cutting as genuine stones.

No. 1—Ladies' Solitaire 14K Gold S. Ring . . . \$2.84
No. 4—Ladies' Hand-Carved Basket Setting, 14kt. Finish . . . \$3.96
No. 5—Ladies' Solitaire Bridal Blossom Engraved . . . \$3.54
No. 6—Gents' Massive Hand-Carved Green Gold Gypsy . . . \$4.39
No. 7—Gents' Heavy Decker 14K Gold S. Ring . . . \$3.68

Carat size gems. Beautiful mountings of most modern design. Choice of gold or latest white platinum finish. Unparalleled 20-year guarantee. Hand-some art-leather case free with each ring.

SEND NO MONEY Keep your money right at home. Just send name, address and number of ring wanted and size as shown by slip of paper, fitting end to end around finger joint. Your ring will come by return mail. When ring arrives deposit amount shown above with postman. If you decide not to keep ring after 7 days' wear, send it back and your money will be immediately returned. Send today.

E. RICHWINE CO.
333 S. Dearborn Street, Dept. 430, Chicago, Illinois
Sole Importers Genuine Corodite Diamonds

Please Mention Popular Mechanics

FREE—A Vitalic Bike Cap to Boys who will write for it



Get Out
the Old Bike
—and Use It

Renew It With Vitalics

Many an old bike is lying around unused—waiting for a rider. Nine times out of ten a new pair of good tires is all that is necessary to put it in running order. Brush off the cobwebs and dust—equip that old bicycle with a pair of Vitalics.

Vitalics can be depended on. They have been the choice of boys and men for over ten years. For real endurance, freedom from punctures and real wearing qualities, there is nothing to equal Vitalics.

Big bicycle makers like Excelsior, Iver Johnson and others put nothing except Vitalic Tires on their finest wheels.

"Tougher than Elephant Hide" describes Vitalic qualities exactly. It is a slogan that thousands of boys have proven for themselves. Your bicycle dealer sells Vitalics. Insist on them when you equip the old bike or buy the new one.

Continental Rubber Works
1942 Liberty St. Erie, Pa.

VITALIC Bicycle Tires



"TOUGHER THAN ELEPHANT HIDE"

Please Mention Popular Mechanics



Your Finest Vacation

PREPARE now for the finest vacation you ever had. Make it possible with the WATERFORD, a complete motor boat that you can pull up on the beach—drive in shallow water—over submerged logs or rocks in absolute safety. A regular family boat—moderately priced—that you will want at your cottage this summer.

Write for illustrated booklet "1500 Miles in Canadian Wilds" and descriptive folder.

DISAPPEARING PROPELLER BOAT CORPORATION
330 Robinson St. North Tonawanda, N. Y.

WATERFORD

The Disappearing Propeller Boat

BOATS Canoes, rowboats, hunting and fish boats, outboard-motor boats and motor boats 16 to 26 foot. Catalog free. Save money. Order by mail. State kind of boat in which interested. Immediate shipment from stock.
THOMPSON BROS. BOAT MFG. CO., 163 Ellis Ave., Peshtigo, Wis.

Only \$45.00 For This Job Complete

Save exorbitant freight reduced one-half original cost by buying Ford Speedster Roadster knocked-down. Simple complete instructions furnished, all parts cut to exact fit. Anyone can assemble this job. Complete with hood, radiator shell, instrument board, upholstery, metal parts, wood parts, bolts, screws, etc. Fiat radiator shell furnished made up. Designed low with lack of wind resistance. Price set up \$90, further particulars on request.

The Central Auto Supply Co., Eng. Dep. 113, Louisville, Ky.



\$4.00 Adding Machine

The Gilson Adder will do your figuring easily, quickly and with absolute accuracy. Capacity 100,000,000 or \$1,000,000.00. It adds, subtracts, multiplies and divides and automatically carries from one column to the next. Made with aluminum case and steel operating parts, size 3 1/2" x 6" x 1 1/4". **Written Two-Year Guarantee. Catalogue Free. Price, postpaid, \$4.00.**

Your money back if you are not satisfied.

Gilson Slide Rule Co., Niles, Mich.

Starting a Company?

Save expenses and taxes by organizing on the popular, COMMON LAW plan under a pure DECLARATION OF TRUST. No experience required to fill in DEMAREE STANDARD FORMS, issue shares and begin doing business at once. Genuine DEMAREE FORMS are nationally known, approved by attorneys, and utilized by successful concerns throughout the United States. Send for large, free pamphlet (D-53) containing valuable information that you may need. C. S. DEMAREE, legal blank publisher, 708 Walnut, Kansas City, Missouri.



RAISE BELGIAN HARES

New Zealand Reds—Flemish Giants—American Blues.

BIG PROFITS, WE PAY \$1.50 TO \$8 EACH.

Also Carries, Mink, Skunk, Fox, Muskrat, Etc.

Easily raised anywhere. **35¢ FREE!**

See Catalog and Contract.

Illustrated book "COMMON SENSE RABBIT RAISING," quarterly journal, and copy of

America's leading small stock magazine, all for 10 cents. Address

Outdoor Enterprises Co., 3005 S. E. BLDG., KANSAS CITY, MO.

TYPEWRITERS



\$50 buys a brand new Corona, the Personal Writing Machine. Latest model with many improved features.

Write for free booklet No. 8.

Corona Typewriter Co., Inc. GROTON, N. Y.

"Old Town Canoes"



The Call of QUIET WATER

A QUIET stream is a wonderful place to lazy-paddle a canoe. Just idle along. The "Old Town" glides forward at the slightest pressure of the paddle. The water murmurs a mild protest as it ripples off the bow.

An "Old Town" is the finest of canoes. It is easy to paddle—exceptionally strong and light and steady. It will last you for years. And it is the lowest-priced canoe you can buy. \$54 up from dealer or factory.

The new 1923 catalog shows all models in full colors. Write for one to-day. It is free.

OLD TOWN CANOE CO.

1365 Middle St., Old Town, Maine, U. S. A.



Catch Fish, fish, mink, muskrats and other fur-bearing animals, in large numbers, with our new, Folding, Galvanized Steel Wire Trap. It catches them like a fly-trap catches flies. Made in all sizes. Strong and durable. Write for Descriptive Price List, and our Free Booklet on best bait known for attracting all kinds of fish.

J. F. GREGORY, Dept. 24, Lebanon, Mo.

DENINGER WILL SAVE
\$40 **BIG MONEY SAVINGS FOR YOU**
 Used and rebuilt motorcycles, single and twins, \$25 to \$150. Used bicycles, \$5.00; tandem; \$10.00. All machines guaranteed in good working order. New bicycles and motorcycles at Factory prices. You save dealers' profits. Motorcycle and automobile tires too, \$2.50. Complete line of parts and supplies.
 Send for catalog Deninger Cycle Co., Rochester, N.Y.
YOU 25 TO 50 DOLLARS

Prices Are Down

Choose from 1923 models, 44 styles, colors and sizes world famous Ranger and Pathfinder Bicycles. Shipped Free on approval for 30 days free trial. Protect yourself at these rock bottom prices.

12 Months to Pay if desired. Many boys and girls easily earn the small monthly payments. Parents often advance first payment. Best quality, at factory prices, express prepaid. Lamps, wheels and equipment, low prices. Send No Money, do business direct with makers.

Mead Cycle Company
 Dept. S108 Chicago

MOTORCYCLES

RELIABLE STANDARD MAKES that you can DEPEND ON. Enjoy the glorious experience of going wherever you like—whenever you like. The price is within your means—35% to 50% less than others. These machines are slightly used, thoroughly overhauled or rebuilt. Send for catalog to:
MYROW BROS.,
 258 Columbia Ave., Boston, Mass.

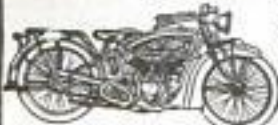

\$2 Brings This Genuine DIAMOND RING

Newest
Hand Pierced
Model of 18 K.
White Gold



Each side set with a genuine French blue sapphire; fiery, first quality genuine diamond in center.

YOURS FOR \$2.00

Send only \$2.00 and ring comes to you in handsome gift box charges paid. Guarantee bond as to quality and value accompanies each ring.

TEN DAYS' FREE TRIAL

You take no chance—if you are not satisfied at the end of 10 days for any reason whatsoever, your deposit will be refunded to you.

A FULL YEAR TO PAY

After trial, pay \$7.50 a month for 12 months. Price only \$87.50. Ring can be furnished in gentleman's mounting without extra charge.

FREE BOOK OF GEMS

Most complete jewelry catalog ever issued of Diamonds, Watches and Jewelry—newest designs at lowest prices. Twelve months to pay on everything from our **TWO MILLION DOLLAR STOCK.** Send for copy 754. Established 1835

ROYAL DIAMOND & WATCH CO.
 35-37-39 Maiden Lane - New York

FISHING FACTS

- and Outers' Recreation
 for 4 months--\$1.00



Here is a 96-page handbook packed with valuable information and instruction on every form of fresh-water fishing. Illustrated. Authoritative. Simply written and intensely practical. Priced at 50c and worth ten times that amount to any angler—novice or expert.

Four big monthly issues of America's liveliest outdoor magazine (regularly 25c per copy) and "Fishing Facts"—yours for \$1.00. "Fishing Facts" alone 50c.



Desk 7, OUTERS' BOOK CO.
 502 North Dearborn St. Chicago, Ill.

\$3,000.00 IN ONE YEAR

Easily possible with Tire Surgery. Tire prices on upward trend. Car owners again flocking to repair stations. We have wonderful proposition for ambitious men. Oldham made \$2200 in 4 months. Evans average \$100 week. Several choice locations available. Write quick for details. May be opportunity you seek. Write and find out. We will place whole proposition before you within 72 hours. Address:
Haywood Tire & Equipment Co.,
 1315 S. Oakley Ave. Chicago, Ill.

This Bunch of Tires Will Make Several Dollars Profit

RADIATOR NEVERLEAK



Secret Service!

Waiting to serve you night or day, this wonderful liquid is always ready to *permanently* stop and seal all leaks anywhere in cooling system.

RADIATOR NEVERLEAK

positively cannot clog or injure any part of radiator or cooling system. This secret formula, the result of 25 years' experience in manufacturing leak mending preparations, is at your service in 50c and 75c cans. Entire satisfaction guaranteed or money refunded.

Write for free "Secret Service" booklet

Buffalo Specialty Co.
357 Ellicott St., Buffalo, N. Y.

50¢
and
75¢
a can

GET FACTORY PRICES ON GALVANIZED

ROOFING



EDWARDS

"REO" Metal Shingles

Absolutely rust-proof—edges as well as sides. Not the space of a pin point exposed to weather. Also fire and lightning proof. Reduce insurance. Outlast building. Need no repairs—and all roofing expense. Easy to lay—one man can do the work—hammer and nails only tools needed. Lay over old shingles if desired. Patent Interlocking Device makes water tight seams—all nail heads covered—no rust or leaks possible.

Exclusive "Tightcote" Process

Put all Edwards Galvanized Roofing in a class by itself. Bend, twist, strike it with a hammer as much as you like—you can't loosen or scale off the galvanizing—due to our "TIGHTCOTE" process which practically makes steel roofing a part of the metal sheet. No other galvanized roofing can withstand this test.

FREE Roofing Book Don't buy roofing until you get our big free book, describing Edwards famous "Tightcote"



THE EDWARDS MFG. CO.
500-550 Pike St. CINCINNATI, O.

Roofings, Sidings, and Ceilings, and our lowest factory prices. We sell you direct and save you in-between dealers' profits. Write for Roofing Book No. 159.

Low-Priced Garages

Lowest prices on Ready-Made Fire-Proof Steel Garages. Set up any place. Send postal for Garage Book showing styles.



Patent Side Lock
No nail heads in sight or exposed to the weather



Brick Siding



CHARGE YOUR BATTERY



(RADIO OR AUTO)
at HOME for a NICKEL
The HOMCHARGER

POPULARLY PRICED—PAYS FOR ITSELF
SEND FOR THE AUTOMATIC ELECTRICAL
FREE BOOK 129 W. THIRD ST.—CINCINNATI, OHIO.

FAULTLESS AUTO PRODUCTS

Faultless
Reconabout



Speed and Power Equipment

Send for our new prices on Bodies and Accessories.

AMERICAN TOP & BODY CO.

Adams St., Delphi, Ind.



Catch Fish,

Eels, Mink, and Muskrats in large numbers **SURE**—with our new folding, galvanized Wire Mesh Traps. They catch them like a fly-trap catches flies. Made strong, in all sizes. Write for catalog showing sketches of four traps, many other specialties for fishermen, and booklet on best baits known.

WALTON SUPPLY CO., E-27, St. Louis, Mo.

\$1.00



Now
Everybody
Can Take
Perfect
Pictures!

Save Money
and Disappointment

Correct exposure is necessary to get a perfect picture. The only way to get it right each time is to use the

DIRECT EXPOSURE METER

—a small, handy device which gives you the right exposure speedily, accurately, without calculation. It measures simply and unfailingly the light reflected from the object to be photographed. Used by amateurs and by commercial photographers, newspaper and moving picture men who must get perfect results every time.

Insure perfect pictures from now on. Mail \$1.00 [no stamps] TODAY and we will send you one immediately, postpaid. Address Direct Exposure Meter Co., 622 Flood Building, San Francisco.

Agents Splendid Profits

Introducing the **New Sun Automatic Regulator and Timer** for Ford Cars. Gives proper spark **Automatically** for every speed of motor. Does away with



Spark Lever. **Back-kick impossible**—Insures instant start in all weather. Prevents fouling of spark plugs and forming of carbon. Engine remains clean giving more power on hills, more speed on level roads at less cost. Grease, dirt and water-proof—Fully guaranteed. Sold on 30 days trial. Retail price \$3.50. Large income for active workers. Tremendous sales opportunities.

AUTO SUN PRODUCTS CO., Dept. 24 Cincinnati, O.

SMOOTH-ON REPAIR BOOK

MOTORISTS

SEND FOR THIS FREE REPAIR BOOK

Tells how to make dozens of motor and household repairs easily, quickly and economically. Write for this book and learn how

SMOOTH-ON CEMENT No. 1
can save you many dollars. Sold by Hardware and General Stores in 6-oz. tins 30c (by mail, add 6c); also in 1-lb., 5-lb. and larger sizes.

SMOOTH-ON MFG. CO.
Dept. 37-E, JERSEY CITY, N. J.



SMOOTH-ON IRON CEMENT

Beats 10c Gasoline

INCREASES POWER AND MILEAGE 40%



Amazing auto invention. Wonderful new carburetor. Guaranteed to reduce gasoline bills from one-half to one-third and increase power of any motor from 30 to 50 per cent.

SENT ON 30 DAYS' TRIAL

Fits any make of car. Put on in a few minutes. Fords make as high as 34 miles to a gallon of gasoline. Other cars show proportionate increase.

Take advantage of our special 30-day trial offer. Name your car. **AGENTS WANTED**
AIR FRICTION CARBURETOR CO. Dept. 3980
DAYTON, OHIO

Auto Supplies

Knowing **HOW** to buy is merely knowing **WHERE**
This is Chicago's Great Wholesale House.

AUTO SUPPLIES AND MOTOR PARTS
WHOLESALE ONLY

Dealers send today for this big money-saving book

ACCELL AUTO ACCESSORIES COMPANY
1307-A South Michigan Avenue
CHICAGO



You Can Save \$35.00

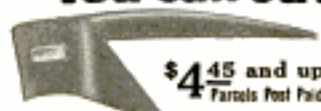

\$4.45 and up

Parts Free Paid

Recover your old auto top frame yourself. Custom tailor made to fit all makes and models of cars. Any person that can drive

a car can put it on. Roof and quarters sewed together, with rear curtain, fasteners, welts and tacks complete. Give name, year and model number of your car and we will send you catalog with samples.

LIBERTY TOP & TIRE CO., Dept. E-7, Cincinnati, O.

We Pay \$6 a Day



taking orders for Insyde Tyres—inner armor for automobile tires. Positively prevents punctures and blowouts. Guaranteed to give double tire mileage. **Work Spare Time or Full Time.** Every auto owner buys on account of low price. Enormous demand. Write quick for territory and special terms to County Representatives.

AMERICAN ACCESSORIES CO., B 1476, Cincinnati, Ohio

Steady Work

in a fast growing business with Vanderpool Latest Improved Vulcanizer. Made in America.

Ask for Catalog

Vanderpool Co. Springfield, O.

F. H. DIBB, Agent for British Isles
26 Fairfield Rd. Winchester, England



21 Jewel Burlington



Adjusted to the Second 21 Ruby and Sapphire Jewels
Adjusted to Temperature 25 Year Gold Strata Case
Adjusted to Isochronism Your Choice of Dials
Adjusted to Positions (Including Montgomery K. E. Dial)
New Ideas in Thin Cases

Only \$1.00 Down

Only One Dollar Down will buy this masterpiece of watch manufacture. The balance you are allowed to pay in small, easy, monthly payments. The Burlington—a 21-Jewel Watch—is sold to you at a price much lower than that of other high-grade watches. Besides, you have the selection of the finest thin model designs and latest styles in watch cases. Don't delay! Write for the FREE Watch Book and our SPECIAL OFFER today.

Write While This Special Offer Lasts

Get the Burlington Watch Book by sending this coupon. Find out about this great special offer which is being made for only a limited time. You will know a great deal more about watch buying when you read this book. You will be able to "steer clear" of the over-priced watches which are no better. Remember, the Burlington is sent to you for only One Dollar down, balance in small monthly payments. Send the coupon for watch book and our special offer TODAY! Do not delay one minute!

Burlington Watch Company

Dept. 13-55 19th St. & Marshall Blvd., Chicago
Canadian Address: 62 Albert St., Winnipeg, Manitoba

Please send me (without obligations and prepaid) your free book on watches with full explanation of your \$1.00 down offer on the Burlington Watch.

Name _____

Address _____

Please Mention Popular Mechanics

\$1.00 DELIVERS to Your Home



Complete Outfit

Violet Ray

ONLY \$1.00 brings this complete, scientific Violet Rays outfit to you. Treat yourself and family at home, save delay, costly doctors and medicines. Thousands use Violet Rays at home to relieve pain and sickness. The identical outfits doctors have bought from us for years and with which they successfully treat many ailments, including those listed below.

QUICK RESULTS—No Medicine

Violet Rays work quickly, it's scientific, goes after the cause. That's why results are quick, permanent. Dr. Duncan, Kewanee, Ill., writes, "Violet Rays is the finest thing I ever used to relieve pain, treatments are so pleasant all my patients like it." Use it yourself at home, you save Doctor's bills.

BEAUTY AID

Brings natural, magnetic beauty of health, no dieting, exercise or drugs. FREE book tells in detail how high priced beauty specialists use it to improve scalp and skin.

EARN CASH

Men, women, without experience earn liberal profits in spare time showing Violet Rays to neighbors. Proves results first demonstration. Sells on sight. Get attractive offer and wholesale prices now.

SEND FOR FREE BOOK

Explains how Nikola Tesla discovered Violet Rays, how it works, why it heals. Tells what doctors and plain folks accomplish in conquering pain, disease and nervous trouble with Violet Rays.

Reveals Marvelous Scientific Discovery Shows charts of human body, explains where pains start, how to banish them. Offered FREE for a limited time only, to introduce Violet Rays. Send for FREE copy.

Check Your Ailment Below for Free Advice Here is a partial list of ailments successfully treated with Violet Ray:

Catarrh	Eye Diseases	Lumbago	Skin Diseases
Candidiasis	Falling Hair	Nervousness	Sore Throat
Colds	Hay Fever	Neuritis	Sprains
Constipation	Headache	Paralysis	Tonsillitis
Earaches	Goitre	Piles	Whooping Cough
Eczema	Insomnia	Rheumatism	Asthma

Mail Coupon—Send No Money

VI-REX ELECTRIC COMPANY
326 West Madison St., Dept. 25, Chicago

Please send me without cost or obligation your free book describing your VI-REX Violet Ray outfits, and details of your \$1.00 offer.

Name _____

Address _____

City _____

State _____

Please Mention Popular Mechanics



SEND NO MONEY

If You Can Tell it from a GENUINE DIAMOND Send it back

To prove our blue-white MEXICAN DIAMOND cannot be told from a GENUINE DIAMOND and has same DAZZLING RAINBOW FIRE, we will send a selected 1 carat gem in Ladies Solitaire Ring. (Cat. price \$5.25) for Half Price to introduce, \$2.63, or in Gent's Heavy Tooth Heifer Ring (Cat. Price \$6.50) for \$3.25. Our finest 1/2 Gold Filled mountings. GUARANTEED 20 YEARS. SEND NO MONEY. Just mail postcard or this ad, State Size. We will mail at once. When ring arrives deposit \$2.00 for Ladies ring or \$3.25 for Gents with postman. If not pleased return in 2 days for money back less handling charges. Write for Free catalog. Agents Wanted.

MEXICAN DIAMOND IMPORTING CO., Dept. ET, Las Cruces, N. Mex.
(Exclusive controllers Mexican Diamonds)

NO JOKE TO BE DEAF

—Every Deaf Person Knows That I make myself hear, after being deaf for 25 years, with these Artificial Ear Drums. I wear them day and night. They are perfectly comfortable. No one sees them. Write me and I will tell you a true story, how I got deaf and how I make you hear.



Medicated Ear Drum

Pat. Nov. 3, 1906

Address
GEO. P. WAY, Artificial Ear Drum Co. (Inc.)
80 McKeckey Building, 2631 Woodward Avenue, Detroit, Michigan

Don't Wear a Truss

BE COMFORTABLE—Wear the Brooks Appliance, the modern scientific invention which gives rupture sufferers immediate relief. It has no obnoxious springs or pads. Automatic Air Cushions bind and draw together the broken parts. No salves or plasters. Durable. Cheap. Sent on trial to prove its worth. Never on sale in stores as every Appliance is made to order, the proper size and shape of Air Cushion depending on the nature of each case. Beware of imitations. Look for trade-mark bearing portrait and signature of C. E. Brooks which appears on every Appliance. None other genuine. Full information and booklet sent free in plain, sealed envelope.



MR. C. E. BROOKS

BROOKS APPLIANCE CO.,

126-H State St., Marshall, Mich.



"BOW LEGS and KNOCK-KNEES" UNSIGHTLY

SEND FOR BOOKLET SHOWING PHOTOS OF MEN WITH AND WITHOUT THE PERFECT LEG FORMS

PERFECT SALES CO.
140 N. Mayfield Ave., Dept. S, Chicago, Ill.



Clear-Tone FOR PIMPLES



Your skin can be quickly cleared of Pimples, Blackheads, Acne Eruptions on the face or body, Enlarged Pores, Oily or Shiny Skin. **\$1,000.00** Cold Cash says I can clear your skin of the above blemishes. **WRITE TODAY** for my FREE Booklet—"A Clear-Tone Skin"—telling how I cured myself after being afflicted for fifteen years.

FREE

E.S. GIVENS, 129 Chemical Bldg., Kansas City, Mo.

Summer Home in Maine

A gentleman's estate of 175 acres on the Maine coast, with frontage on a lake 9 miles long; master's house; large bungalow; caretaker's house; large garage; barns; private electric light and inexhaustible water works, and every modern improvement. Forty acres very large trees. Golf and yacht clubs only a few minutes away; good markets in the town.

The scenery of mountains, lake and ocean is pronounced one of the best five in New England. House and bungalow both completely furnished; steam heat.

Place will be sold at a great bargain as owner can no longer use it.

Address OWNER

206 East Ontario Street CHICAGO, ILL.

MOTORCYCLE BARGAINS

Save 25% to 65%

on Slightly used and Rebuilt Motorcycles, Side Cars, Johnson Motor Wheels, Evans Power Cycles, Bicycles. Send for Free Bargain Bulletin and Money Saving Message, listing hundreds of bargains in used, rebuilt and new machines, supplies, accessories, etc.

AMERICAN MOTOR CYCLE CO.
Dept. 522 2047 W. Chicago Avenue, CHICAGO



Build Your Own PHONOGRAPH

IT'S EASY WITH OUR HELP

A few hours' interesting work saves over half and gives you a machine to suit your ideas. We furnish motors, tone arms, case material, blue prints and full instructions. Plays any record. Make fine profit building phonographs for your friends.

Write today for our **FREE**

GET YOUR **RADIO SUPPLIES** FROM US

Choraleon Phonograph & Radio Co.
523 1st St., Elkhart, Ind.



SAVE
OVER
HALF

WANTED

RAILWAY MAIL CLERKS

\$1600 to \$2300 Year

MEN — BOYS, 18 TO 35 SHOULD
MAIL COUPON IMMEDIATELY

Steady Work. No Layoffs. Paid Vacations.
Travel—See Your Country

Common education sufficient. Send coupon today—SURE

Diamonds Here at 60% of Market Price

Never in three quarters of a century have we offered such amazing bargains. Hundred of money-saving opportunities in latest Diamond Bargain List, equalling those shown here.

Here's why we can offer such remarkable values: This 75 year old firm—rated at over \$1,000,000.00 capital—the largest and oldest diamond banking institution of its kind in the world has made loans on Diamonds, Watches, and other jewels in excess of \$25,000,000.00.

Why Pay Full Prices Costs Nothing to See

Thousands of unpaid loans. Must sell now. Diamonds, Jewels, Watches and other Gems of unusual qualities—at an entirely different price basis—viz: loan values not market values. At our risk we send you any bargain you wish for absolutely free examination. No red tape. No obligation. Don't buy unless satisfied you can not match the bargain at 60 per cent more. Diamonds of desirable quality at \$100 per carat. Yes, some even lower priced—also, finest gems obtainable at higher per carat—but proportionately low bargain prices. Our bargains have guaranteed loan values also, unlimited exchange privilege at full prices.

Latest List Diamond Loans

Send at once for latest list. Thousands of unpaid loans and other special advantage bargains described in full detail with exact weight, color, quality, etc. Get details of Free Examination offer. No obligation. List is free.

Mail Coupon Now

Only
Diamonds
Post Office

Jos. DeRoy & Sons,
1998 DeRoy Bldg., Pittsburgh, Pa.

Without obligation, send me free, your latest Bargain List of Diamonds, Watches and other jewelry.

Name.....

Address.....

City.....State.....

MOTORCYCLES

ONE YEAR TO PAY

Know the joy of owning—for business or pleasure—a Harley-Davidson, Excelsior, Henderson, Indian, Cleveland, or any other standard make; thoroughly rebuilt in our own factory.

Write for Free Bargain Bulletin and Easy Payment Plan.

HAVERFORD CYCLE CO., OF PENNA.
America's Largest Cycle House
Established 26 years
503 Market St., Phila., Pa., Dept. P. M.

RAILWAY

MAIL CLERKS

FRANKLIN INSTITUTE, Dept. R179, Rochester, N. Y.

Sirs: Send me without charge, (1) sample Railway Mail Clerk Examination questions; (2) List of government jobs obtainable; (3) Send sample coaching lessons and tell me how I can get a position.

Name.....

Address.....



"Red Devil" Rapid Boring Auger Bits are 33 1/4% easier boring, have 10% greater clearance, and bore with or against the grain of any wood. Style 2400—10/16 in., shown above, 75c.

The "Red Devil" Wrench Set Fits Every Nut Right



A REALLY fine wrench set with which you can tackle the toughest jobs and save time.

"Red Devil" open-end "S" Wrenches are handier than a monkey wrench. They fit every bolt and nut right and hold fast. Openings will not spread. They are thin—just the tools you need for working in hard-to-get-at places. Forged from open hearth steel, heat-treated for strength.

Each set consists of five wrenches, with sizes of openings ranging from 7/16 to 1 inch. "Red Devil" Wrench Set No. 92, price 50c.

For those who prefer to work with a straight wrench, we have also this pattern in the above type of wrench. Five wrenches to a set. Style No. 91, 50c a set. At all hardware stores. If not in stock, send dealer's name and order direct.

Mechanic's tool booklet free.

SMITH & HEMENWAY CO., Inc.
Manufacturers of "Red Devil" Tools
260 Broadway New York, N. Y.

"Red Devil" Glass Cutters—the glaziers' standard tools of the world. "It's all in the wheel." Made in 40 styles. No. 024 shown below, 20c.



Please Mention Popular Mechanics

Special Offer

1/4 H. P., 110 Volt, \$12.50
60 Cycle, A. C. Motor



CASH WITH ORDER

Standard splash proof Motor equipped with grooved pulley, weather proof extension cord and separable attachment plug. Fully Guaranteed.

Same motor as \$11.50 above, 1/5 H. P.

Tideman Electric Mfg. Co.

W. A. KREBS, Receiver

CAIRO, ILLINOIS



One Man Log Saw

30 Days' Trial

OTTAWA

Saws logs, limbs; falls trees. 10-year Guarantee. Cash or Easy Terms.

FREE BOOK and **SPECIAL OFFER.** Write quick before sale ends!

1741-G Wood St. OTTAWA MFG. CO. OTTAWA, KANS.

Big Sale NOW

\$91.50
F.O.B. Ottawa Kans.

From Pittsburgh, Pa., \$97.25

Room 1741-G Magee Bldg. PITTSBURGH, PA.

SARGENT PLANES

make it easier to do the careful, finished work you can be proud of. The Sargent Auto-Set Bench Plane is best for all-round work. The Pocket Plane and Steel Block Plane add the finishing touches to your handcraft. At hardware stores everywhere.

SARGENT & COMPANY, 49 Water St., New Haven, Conn.

Torit Acetylene Torch No. 13—Instant Soldering

Just light the Torit Torch No. 13 and it's ready to solder, braze, preheat, etc. Easy to use—can be used in places difficult to reach with ordinary soldering copper.



Uses Acetylene Gas Only A splendid use for discarded auto acetylene tanks. Many owners make the Torit No. 13 pay for itself in a single day. Torch with 4 different tips, soldering copper, 5 ft. tubing and connection for auto acetylene tank. **\$7.50**

ORDER TODAY FROM YOUR JOBBER, OR St. Paul Welding & Mfg. Co., 177 W. 3rd St., St. Paul, Minn.



Beat 'em all with Auto-Wheel

You can beat 'em all, race or no race, if you are "driving" an Auto-Wheel—the speediest boys' coaster. Winning is dead easy. Only another Auto-Wheel can give you any competition.

It's the self-contained, friction-reducing roller bearings which make an Auto-Wheel Coaster go so easily that it seems to be running itself. But roller bearings are only one of the many superior features in the Auto-Wheel Coaster.

Some of the other features are: rubber-tired disc wheels (3 largest models have over-size tires); steel-tired disc or wood spoke wheels if desired; all wheels interchangeable; hound brace; hand brake; special hub cap and locking pin; sides mortised as well as nailed. Every one is a reason why live boys prefer the

Auto-Wheel Coaster

The
Auto-
Cart



Write for Catalog which shows all models of the Auto-Wheel and also all models of the Auto-Cart, the Auto-Wheel's junior companion for your little brother and sister. If you send the names and addresses of three local coaster

wagon dealers, telling which ones sell the Auto-Wheel, we will give you a year's subscription FREE to the "Auto-Wheel Spokes-man," a dandy little magazine for a boy like you.

Auto-Wheel Coaster Co., Inc.

North Tonawanda, N. Y.

BUILDS BETTER BOYS

ANYBODY CAN PLAY

So simple a child can play—by number bars instead of notes.

FLUTE

Only your name and address. When FLUTE arrives, pay post-man only \$2.75. No tax postage. PUBLIC TRADING CO. 404-4th Ave., Dept. 56 New York City

FREE ~ 15 SONGS!



ALVAN CLARK TELESCOPES

Famous throughout the world as the highest grade Astronomical and Terrestrial Instruments. Now bringing to you at a reasonable price, these wonderful instruments—a source of pleasure and education—for the home—the school—the college. Send for circular and prices.

ALVAN CLARK & SONS CO.
Makers of the great "VERKES" and "LICK" Telescopes
55 Henry Street Cambridge, Mass.

HAWAIIAN IM. DIAMONDS



The Greatest Discovery the World Has Ever Known
Just to advertise these famous im. diamonds we will send you one of these 14K gold f. rings, postage paid. When it arrives pay postman \$2.98 C. O. D. charges to cover cost, etc. Only 10,000 rings given away. Money refunded if you can tell it from a genuine diamond.
Send name of ring.



No. 8910
Special price \$2.98

KRAUTH & REED
Dept. C Masonic Temple Chicago

No. 9111
Special price \$2.98

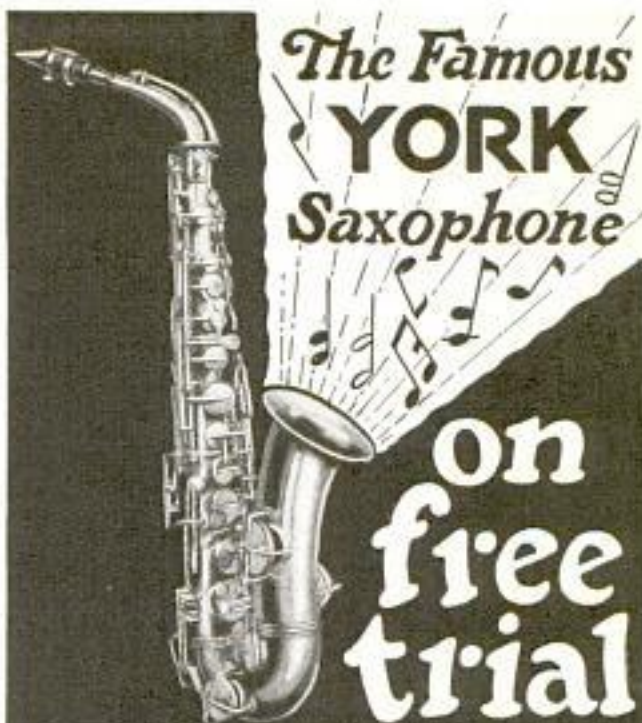

on free trial

Try the Easiest Instrument to Play for 10 Days, FREE

Have the famous, professionally endorsed York Saxophone shipped to you for 10 days' free trial. Play on it at home. Learn the scales in an evening. Convince yourself of its superb quality, richness of tone and unexcelled workmanship. After 10 days if the instrument does not come up to your expectations ship it back to us and it won't cost you a penny.

EASY PAYMENTS

If you decide to buy, however, all you need to do is to make a small payment down and the balance in easy monthly remittances. We send you everything you need—carrying case and necessary attachments.

Take Your Choice

Remember, you can get any of the fine York Band Instruments on 10 days' Free trial. Just take your pick. Send coupon below for our illustrated literature and indicate the instrument interested in, including Saxophones—Clarinets—Trumpets—Drums—Altns—Basses—Cornets—Trumpets—Baritones.

SEND COUPON NOW

Fill out this coupon and mail today and we will send you full and complete details of our free trial and easy payment plan.

J. W. YORK & SONS

Dept. 221E Grand Rapids, Mich.

J. W. YORK & SONS,

Dept. 221E, Grand Rapids, Mich.

Gentlemen:

Kindly mail, without cost to me, your beautifully illustrated literature and details of your Free Trial and Easy Payment Offer.

Name

Address

Instrument

(Mention above the instrument most interested in)

Please Mention Popular Mechanics

SAVE MONEY
Get This Book

HANDY MAN BOOK

Install Your Own
PLUMBING & HEATING
NEW EASY WAY - SAVE HALF

25c
Reg. Price 50c

Brings you this big Plumbing and Heating Encyclopedia-Catalog. Write for your copy today without fail.

Guaranteed Heating Plants

Our Handy-Man Book shows how. Big 256-page well-bound encyclopedia of Plumbing and Heating Outfits, Systems, Supplies, Fixtures and Accessories—10,000 items—illustrated. Hundreds of floor plans, elevations, diagrams, trade secrets, money and trouble-saving kinks, etc. "How to save coal in heating," "Easy repair methods." Every householder, contractor, farmer, mechanic, institution needs this book. Shows how to save wages, work and materials.



Hot Water Boiler

BIG HANDY MAN BOOK

Tells how we help you plan and install. From rough sketch or description we supply working plans and clear instructions. We loan the tools needed. Any handy man can install. This is the place to buy on money-back guaranty. Plumbing Outfits and Supplies; Water Systems; Hot-Air, Water or Steam Heating Plants; Radiators, Pipes, Boilers or Septic Disposal Tanks.

Send 25c for Yours Today

We have spared no effort or expense to complete this remarkable and instructive book. To keep from sending it broadcast to disinterested persons, we request a deposit of 25c, which will be refunded on your first order—or send for our FREE Bulletin. Write today and save half.



Pipeless Furnace



Bathroom Outfit

HARDIN-LAVIN CO.

50 Years
at 4547-57
Cottage Grove Ave.,
CHICAGO

U.S. Army Krag Knife Bayonets

A Mere Fraction of Real Cost. Made of finest quality tool steel.



55c
EACH

Takes splendid cutting edge, complete with metal scabbard, all in perfect condition like sketch. 12-inch blade. For Home use, Grocers, Butchers, Fish Dealers, Autoists, Farmers, Sportsmen—in fact any trade that requires fine cutting tools. Send for catalogue.
W. S. KIRK, 1627-P.M., N. 10th St., Phila., Pa.

\$1 Brings This Genuine DIAMOND

Blue white, perfect cut, genuine diamond; 18 kt. white gold, hand engraved and pierced mounting. Rare beauty. Only **\$32.50**

Easy for you to own this beautiful ring or give it as a present. Simply send \$1. Examine ring on arrival. If you don't agree it is an amazing bargain, your deposit will be returned. If you keep it, pay postman only \$1 and send \$1 a week until \$32.50 is paid. Guarantee Diamond Bond with each ring.

FREE catalog, Diamonds, Watches, Jewelry. \$10 to \$1,000. All on long credit. Wonderful values.

Est. 1890 -Address Dept. 536

BAER BROS. CO.
6 MAIDEN LANE - NEW YORK

\$\$ For Photoplay Ideas

Not a school—No courses or books to sell. Plots accepted in any form; revised, criticized, copyrighted, marketed. Advice free.

UNIVERSAL SCENARIO CORPORATION

935 Western Mutual Life Bldg. Los Angeles, California

Publishers SCENARIO BULLETIN-DIGEST. Send for free sample copy.

Agents: \$50 a Week

For your spare time. Men or women selling guaranteed hosiery. Must wear 12 months or replaced free—all styles, colors and fancy stripes, including silk hose.

Sell for Less Than Store Prices

Often sell dozen pair to one family. Every man or woman, young or old, can make big money selling this quality line. Write for samples.

THOMAS MFG. CO., H-3048, Dayton, Ohio

5 Magic Keys

Work like magic in emergencies or prove whether your door or padlocks are burglar-proof. **OPEN AND TEST THOUSANDS OF DIFFERENT LOCKS.** Recommended by users in ten different nations. Most wonderful and only keys of their kind. Send \$1.00 today. Novel key chain FREE with set.

MASTER KEY CO., 255 Manhattan Block, Milwaukee, Wis.



Agents \$85 Weekly



Get a Robinson Folding Bath Tub FREE. Big seller. Cost little, no plumbing. Weight 16 pounds, folds into small roll. Full length bath, far better than tin tubs. Guaranteed 10 years, \$15 to \$20 a day easily made. Write quick for special offer.

Robinson Cabinet Mfg. Co., Room 931, Harte & Cherry St., Toledo, O.

Tobacco

Special Bargain Introductory offer on Kentucky's Finest Good Old Melon Sweet Green River Smoking Tobacco. Two big 1-lb. cans, \$2.00 value for only \$1.00 postpaid. Satisfaction guaranteed or money back.

OWENSBORO TOBACCO CO., Dept. 130, Owensboro, Ky.

Hand Forged
Razor Steel
Blades, No. 57



A GENUINE \$2 KNIFE
FOR
\$1.18 POST PAID

Direct at Factory Prices

This \$2 KNIFE \$1.18 Postpaid Hand Forged Razor Steel Blades Handy shaped B1 a d e makes this knife best for mechanics, sportsmen and farmers; light but strong; re-sharpened easily. Stag handle. German silver finish; blades file tested, hand forged from razor steel and warranted.

Sample \$1.18 3 for \$3.00 Postpaid.

Send for our 100-page List and "HOW TO USE A RAZOR" **FREE**

MAHER & GROSH CO., 106 A St., Toledo, Ohio

DELTA ELECTRIC BICYCLE LAMPS



DELTA a Safe Guide After Dark

With a Delta Electric Bicycle Light on your bike you can hasten home from work in safety after dark while fellow employees are waiting on the street car or walking.

Workmen everywhere are equipping their bicycles with the DELTA. It stands up under rough usage, throwing a brilliant, never failing light. Nothing to wear out, break or work loose! Can't be bumped out of commission.

Model 27 mounts on handle bar, fits any bicycle. Ask your dealer, or sent prepaid for \$2.25 complete (less battery).

Delta Electric Company
100 Delta Block, Marion, Ind.

Standard Makers of Electric Lamps, Automobile Spotlights, Bicycle Lamps, Flashlights and all kinds of Dry Batteries.

New York Winnipeg
San Francisco

MARION
MADE BY DELTA PRODUCTS

Ride A Ranger

The finest bicycle ever built. 44 Styles, colors, sizes; made in our new factory. **SAVE \$10 to \$25** by direct from the factory purchase.

Delivered free on approval, express prepaid, for **30 Days' Free Trial. 12 MONTHS to PAY**, if desired.

Tires best quality at factory prices, express paid. Lamps, wheels, horns, equipment and repairs at unusually low prices. **Send No Money**, do business direct with makers.

Mead Cycle Company
Dept. S108, Chicago

Write today for free Ranger Catalog, factory prices and marvelous easy payment terms.



SEND for the INTERNATIONAL CATALOG

FOR FORD—PRICES FROM \$27.85 UP.

Factory to Consumer direct—Pay only one profit.
International Body Works, 914 W. Ohio Street, Dept. 7, Chicago, Ill.



Our net price list. Full line of automobiles and accessories for Ford and

Wholesale Prices. Save big money on bodies by buying direct from factory.



MAKE A MOTOR CYCLE

OUT OF YOUR BICYCLE with a STEFFEY MOTOR ATTACHMENT. RELIABLE — ECONOMICAL — EFFICIENT. Easy to attach. Fits any wheel. Send stamp for circulars.

STEFFEY MFG. CO., Dept. P, 5025 Brown St., Phila., Pa.

\$100 A WEEK

Being made by users of Adams-Barre Equipment. We teach you trade, furnish equipment, start you in business. Model E Vulcanizer and equipment \$135. Will do same work as other \$400-\$600 outfits. Uses either sand bag or air bag, costs less than 25c day to operate. Easily do \$50 worth of work a day.

Write for Model E circular or Equipment catalogue. Many other models. Everything for the tire shop. State intentions.

THE ADAMS-BARRE COMPANY
1248 North High Street COLUMBUS, OHIO

Rebuild Your Health

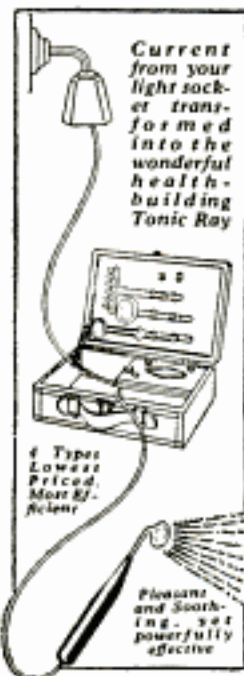

Current from your light socket transformed into the wonderful health-building Tonic Ray

Pleasant and Soothing - yet powerfully effective

You now can actually do wonders for yourself or for any ailing member of your family:—in fact you can do more today toward overcoming weakness and ill-health than the world's greatest physician could do for a king a few years ago. This is because science has so tamed and harnessed electrical energy that you can safely employ its life-laden forces to invigorate every organ and stimulate every bodily function to healthy activity.

Ra-Tone Violet Ray

(The Home Treatment for Health, Strength and Beauty)

By simply treating yourself at home you can relieve pains, aches, soreness, weakness, etc., and at the same time remove the cause. You can do it pleasantly and without shock. Stubborn cases readily yield. You can feel the pep and energy of health return while nervousness, weakness and any of a score of ailments leave you. Investigate and get the facts. We will prove that this can be done. Write for full particulars.

Thousands Benefited

The wonderful benefits of Ra-Tone treatment have been demonstrated in thousands of cases, many of which are not essentially different from yours. You can expect similar results. Write at once.

Get the Facts. Go carefully into the subject. Send for the latest and most complete book ever written on the subject. For a short time only it will be sent FREE. It is too costly for continued gratis distribution. Get yours NOW.

Stimulates circulation.
Purifies the blood.
Drives out aches and pains.
Strengthens weakened organs.
Increases vitality.
Restores to normal activity organs, nerves, blood and muscles.
BENEFITS IN 100 AILMENTS

Ra-Tone Electric Co.

510 Park Place, West
Detroit, Mich.

We have an attractive proposition for demonstrators, agents and distributors

Big Book on Health

Sent for This Coupon FREE

RA-TONE ELECTRIC CO.
510 Park Place, W., Detroit, Mich.

Please send me without obligation your Big Book, "Health Building," FREE.

Name.....

Address.....

Please Mention Popular Mechanics



That Feeling of Freedom

Astride an INDIAN Scout you quickly escape from city walls and get back to nature.

A wonderful feeling of new life and freedom comes to you; it's so *easy* to ride and handle.

It's different from the average motorcycle. Lower frame—you can put both feet flat on ground when sitting in saddle—100 pounds lighter, cheaper to buy and operate.

INDIAN Scout, responsive to your slightest touch, carries you safely along country roads, up mountain trails—anywhere.

The biggest motorcycle value ever offered. Only \$250.00, electrically equipped \$285.00. Easy payments. Costs less than carfare.

Ask your INDIAN dealer for free demonstration—no obligations.

Write us, Dept. 37, for nearest dealer's name and free illustrated booklet.

Hendee Manufacturing Co.
Springfield, Mass.

Indian Motorcycle

Please Mention Popular Mechanics

Protects Ford Wiring

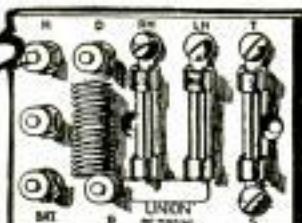

A single "ground" may burn out your whole wiring system if it isn't protected—may even set fire to your car! Don't take chances! Install a "Union" Fuse Block—today. A "ground" will then only blow a fuse, which can be replaced for a few cents.

The "Union" Fuse Block also puts an end to flickering lights through loose connections, and to blown lamps caused by speeding motor. Permits use of standard single filament lamps for both *bright* and *dim* lights.

Easy to Install No extra wiring needed. Sent postpaid for \$1.50, if not at your dealer's. Money back if not satisfied. Write for Booklet.

CHICAGO FUSE MFG. CO.
1503 West 15th St. CHICAGO, ILL.
Eastern Branch: New York

UNION FUSE BLOCK

Ride For 30 Days AT OUR EXPENSE

Ride for 30 days at our expense—the dandiest wheel made—the bike they are all talking about—the latest model, electrically equipped.



BLACK BEAUTY

Shipped express prepaid—direct from factory at wholesale price. Guaranteed 5 years; 6 months' insurance against accident. 30 days' trial. Large selection of models and colors. Lamps, horns, tires, brake parts, rims.

SUPPLIES Everything for the bike at WHOLESALE PRICES. Get a big Black Beauty Catalog—it's FREE.

HAVERFORD CYCLE CO. OF PA.
Established 26 Years
DEPT. 375 PHILADELPHIA

Be a Black Beauty Agent

TIRES WITH 500 NAIL HOLES LEAK NO AIR

Mr. E. N. Milburn of Chicago has invented a new puncture-proof inner tube which, in actual test, was punctured 500 times without the loss of any air. Increase your mileage from 10,000 to 12,000 miles without removing this wonderful tube from the wheel, and the beauty of it all is that this new puncture-proof tube costs no more than the ordinary tube, and makes riding a real pleasure. You can write Mr. E. N. Milburn at 350 West 47th St., Chicago, as he wants them introduced everywhere. Wonderful opportunity for agents. If interested write him today.

STEP ON HER!



Zingo! 20 miles per hour using our 1923 motor.

Prices reduced on all parts. Anybody can assemble this car. Send 25c for plans, including instructions and price list.

SYPPER MANUFACTURING COMPANY
246 Sypper Bldg. TOLEDO, OHIO

The National Automobile Shows

WONDER SENSATION

Universal Automatic Spring Oiler

Discovered and Invented by Grus

Astounding and Unbelievable Results

Gives Permanent Relief from Spring Squeaks—Oiler Attached

The Perfect Leaf Spring Lubricating System



Retail Price **75c**
Regular Size EACH
Complete Set of Four for FORDS \$2.50 per set

Manufactured under Grus Trade Patents

Just think of it, no more broken springs; no more rusted springs; no more squeaky springs; no more inactive springs; no more wasted oil.

The Universal Automatic Spring Oilers make your car run smoothly, easily, quietly, comfortably, begin immediately to lay a thin film of oil between the spring leaves. Just slip the oilers over the spring directly back of the spring clip and they are there to stay—will outlast the car.

Sold at Accessory Stores, Garages, Department and Hardware Stores.

If your dealer does not handle them, order direct. It takes two oilers for each half spring—one for each quarter spring.

A Few State Distributors Wanted—Write Quick

THE UNIVERSAL SPRING OILER COMPANY
Dept. F, Medinah Bldg., CHICAGO, ILL. "Sens Fabrics"

YOUR SUMMER HOME

Wherever You Want to Make It!



WILLAMETTE AUTO TENTS

(Scientifically constructed)

2 windows, 2 shoe pockets, sod cloth all around. Made from U. S. government O. D. shelter duck. Packed in small canvas bag—no poles required.

Width	Depth	Height	Postpaid
7	7	7	\$22.00
9	7	7	\$24.00

APPELL'S

South African Water Bag

Two gallon size—keeps water cool for 48 hours—Made from flax duck.

\$1.65 postpaid.

At your dealers or

Hirsch-Weis Mfg. Co.

205 BURNSIDE STREET

PORTLAND, OREGON



Sell TIRES

DIRECT FROM FACTORY

We want one auto owner in each locality to use and advertise Armour Cords. You can make big money and get your own tires free by simply sending us orders from friends and neighbors. No Capital or Experience needed. We deliver and collect direct. Pay you daily.

Most Liberal Tire Guarantee Ever Written

Armour Cords are bonded against Accidental Damage, Wear and Tear, Tread Separation, Blistering, Blow-Outs and Rim-Cutting for 10,000 miles. We are actual manufacturers. Write today for Great Special Offer to Agents and low Factory Prices.

ARMOUR TIRE & RUBBER CO., Dept. 15 DAYTON, O.

CHARGE YOUR BATTERY



(RADIO OR AUTO)
at HOME for a NICKEL

The **HOMECHARGER**

POPULARLY PRICED—PAYS FOR ITSELF

SEND FOR THE AUTOMATIC ELECTRICAL

FREE BOOK 129 W. THIRD ST. - CINCINNATI, OHIO

The Dragon

A special body for Fords. Comes complete with special aluminum shell. We also manufacture other beautiful models. Live Distributors Wanted. Make big money handling Victor bodies for Fords.



Write for Catalog

VICTOR AUTO BODY CO., 1420 Blue Island Ave., Chicago, Ill.

Las-Stik

THE ORIGINAL Patch with a Set-It-Right

The White Tube Patch That never fails

This white tube patch adheres instantly because made of pure para rubber, that stretches with the tube and can't creep or tear out even if tube is over-inflated. You can patch a pinhole or a seventeen inch blowout and the joint will become stronger than the tube itself.

Complete outfits 50c and \$1.00

LAS-STIK PATCH MFG. CO., Hamilton, Ohio

Save One-Half on Custom-Made Tops

Easily attached; instructions sent. Complete with beveled plate glass, tacks, welts, etc. For all cars. Special prices on Maxwells, Dodges and Chevrolets. Ask for samples. Give name and year of car.

S-C PRODUCTS CO., 758 Nicholas Bldg., Toledo, O.

MUSHROOMS HAVE PRODUCED PROFIT FOR 2000 YEARS

Get your share by growing them easier, quicker and surer than ever with our newly discovered, highly concentrated spawn. An easy way to establish your own business with only a few dollars. Free Booklet. Mushroom Products Corporation, 726 Ninth St., Washington, D. C.

GREEN AUTOMATIC MACHINE



ADD TO YOUR INCOME

WITH LITTLE EFFORT
\$5 to \$10 A DAY MADE EASY WITH

New Improved Green Automatic Machine

Sharpens, Honors and Strops all kinds of safety razor blades, in one operation, from four to six blades per minute. For both Quality and Quantity, this machine is in a class by itself. There is nothing like it on the market. Let us send you our descriptive literature explaining everything, including the "AMERICAN" Key Cutter—cuts square, angular or round slots.

AMERICAN SHARPENING MACHINE CO. (Inc.), Dept. 5, 144 W. Washington St., CHICAGO



"AMERICAN" Key Cutter



The Lightest,
Speediest and
Most Durable
Outboard
Motor in the
World.



Almost as Easy to Carry as a Pair of Oars

Makes a speedy power boat or pleasure launch of any boat or canoe. A boy or girl can handle it. The whole family enjoy it. 2 H.P. Twin Cylinder.

Weighs Only 35 Lbs.

15 to 50 pounds less than usual, yet guaranteed more durable. Has real carburetor, real magnets—no batteries to carry—spark and throttle control like auto, instant reverse, self tilting and ten other valuable features. Write for Free Catalog folder today.

JOHNSON MOTOR COMPANY

904 Sample Street South Bend, Ind.
EASTERN OFFICE—120 Broadway, New York City

Johnson

"WATER-BUG"

THE LIGHTEST, LIVELIEST BOAT MOTOR ON THE WATER.

South Bend Bait

\$2000.00

FISH-PHOTO Contest



Anyone may enter. To compete, catch one or several fish—photograph them, send photo to us. There's no entrance fee. Contest now on—closes October 31st. 273 prizes in all, totaling \$2,000.00.

Get further particulars from any South Bend Bait dealer by asking for our Contest Book. Tells about prizes, rules, etc. If there is not a dealer near you, write us.

SOUTH BEND BAIT COMPANY
3533 High St., South Bend, Indiana 46

AUTO SUPPLIES 3000 Bargains



THIS BOOK FREE

Look at These Low Prices

Saves money on anything you need in Supplies—batteries, radiators, headlights, spotlights, tires, etc. Also all kinds of repair parts for Fords. Special bodies for Fords and Chevrolets—12 different styles—lowest prices because we buy for cash and sell for cash. Write for your copy of the Big Nemco Bargain Book today.

NEMCO BARGAIN SUPPLY HOUSE
37 N. Peoria St. Chicago, Ill.



Special Bodies for FORD Cars

12 different
styles

\$29⁸⁵
and up

SEND NO MONEY 2 GENUINE DIAMONDS $\frac{1}{100}$ Each

Solid Gold

\$25

14 kt. White Gold Top.
Gold Emblem Inlaid
in Genuine

Hope Ruby

Can be had in all initials (Old English); also in all lodge emblems, including American Legion. Send size of finger and ring will be sent for inspection.



B F G A S W Any Letter
This registered trade-mark guarantees your real diamonds.

Buffalo Jewelry Mfg. Co., "The Mail-Order House"
Dept. P-4, Brisbane Bldg., Buffalo, N. Y.

The BEST LAUNCH Ever Built at Lowest Price Ever Quoted

This new type, 1923 model, 16 Foot Mullins Special Steel Launch is without doubt the best value ever offered. It is graceful in design, comfortable, speedy, and safe. Equipped with air-tight compartments like a life boat—it Can't Sink. Handsomely finished, and well equipped, with 3 H. P. Lockwood-Ash, single cylinder, two cycle motor, vertical contact timer, mixture oiling system, Mullins Silent Underwater Exhaust, and steel guard which protects the shaft and propeller. It's a sturdy, well built, highly efficient launch, sold at a remarkably low price.

Write now—for specifications, dimensions, our low price, and complete information.

Write
For
Catalog

of Mullins Steel
Launches, Motor Boats,
Row Boats, Fishing and
Hunting Boats.

Sporting Goods Dealers

Write for dealers discounts, and our liberal proposition to Authorized Mullins Agents.

MULLINS BODY CORPORATION
Boat Dept., 745 Depot St., Salem, Ohio

Engine Prices HIT BOTTOM

Read this new schedule of prices; and then act! And, Remember—you are getting these Bargain Prices on the FAMOUS

OTTAWA

—the most dependable engine on the market.

Easier to start; Pulls more than its rated H-P.

BOOK FREE

Write today for your copy of Big Free Engine Book and complete list of New Low Prices.

Ottawa Mfg. Co.,
534-J King St.,
OTTAWA, KANSAS
DESK 534-J HAGEE BLDG.
PITTSBURGH, PA.

1½ H-P. \$37.00
2 H-P. \$42.50
3½ H-P. \$69.50
5 H-P. \$97.50
7 H-P. \$127.50

Above Prices
F.O.B. Ottawa.
For Shipment
from Pitts-
burgh add
Carload Fr't.

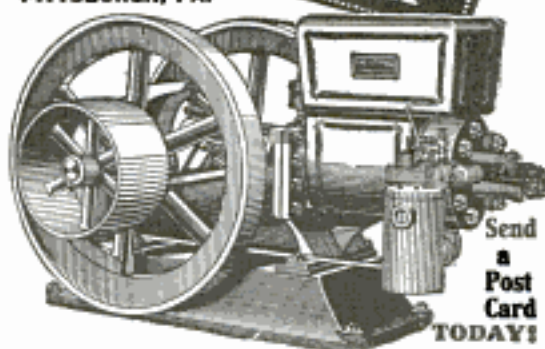

Send
a
Post
Card
TODAY!

NEW Style Oliver

New 1923 Model
NOW Ready



On FREE TRIAL for
One Week—Read Below

The latest, newest and greatest of all Oliver Typewriters, the "Quiet Speedster," Model 11, is now READY. Send at once for complete details on this wonderful new 1923 machine and our money saving offer.

The NEW 1923 Oliver offers for the convenience of experienced typists, the standard three-bank keyboard. ANY operator, whether now using a 3 or 4-bank standard keyboard can operate the NEW Oliver immediately without practice, without loss of time, speed or output.

Here are the three salient NEW features of the 1923 Oliver:

- 1 Standard 3-Bank Keyboard.** Letters are arranged as on all other standard keyboards. Numerals are placed on top bank, eliminating superfluous fourth row. Any trained typist can operate instantly. No loss of speed or output. Beginners will find this the easiest and quickest keyboard to learn.
- 2 Extra Quiet Action.** The rattle and bang of old-fashioned typewriters banished. So quiet you hardly notice it.
- 3 Velvet-like Touch.** The slightest touch operates the keys. No heavy pounding. A pleasure to use it. Saves nerves and finger-tips.

Special Price Offer SAVE \$50

And the World's Best Typewriter
Shipped to You Direct

The NEW Oliver is the dream typewriter come true. An utterly durable typewriter, almost silent in action, at a wonderfully low price. A machine that defies the years, yet easy to operate; a typewriter of simplified mechanical structure, hence sturdiest. There are about 800 parts in the Oliver. Others have as high as 2,500 parts. Nothing flimsy to get out of order. Olivers often go ten to fifteen years without repairs. And this simple structure and efficient manufacturing enable us to sell you this super-standard typewriter—at a saving of \$50. Note these prices:

Oliver No. 9

With 1923 Model Standard Three-Bank Keyboard. Monthly payment plan, \$55. Cash.

\$49.50

Oliver No. 11

The NEWEST Oliver, with Standard Three-Bank Keyboard and many modern refinements. Monthly payment price, \$75. Cash,

\$67.50

Free On Trial

Catalog Free / The Oliver Typewriter Company

Send today, using the coupon, for free catalog describing the No. 9 and the New No. 11. Get our Free Week's Trial Offer and special price offer. Test this machine for a whole week. Compare it. Compare its beautiful work. Then if not delighted return the machine at our expense. You run no risk, assume no obligation. Write today. The Oliver Typewriter Company
1095 Oliver Typewriter Building,
CHICAGO

1095 Oliver Typewriter Bldg., Chicago
Without obligation send me booklet on Model No. 9 and on the new "Quiet Speedster" Model No. 11; details of free trial offer, cash and payment plans.

Name

Address

City

State

Check which catalog you want.
No. 9..... No. 11..... Both.....

Please Mention Popular Mechanics

Make it Yourself

ORANGEADE

with Powder!

Just add cold water to the powder, sweeten with sugar and you have the most delicious and healthful drink you ever tasted! Costs less than one cent a glass! Favorite drink of millions for 17 years.

SOFT DRINK POWDERS



1 Glass for Home, Picnic, Dances! Guaranteed under Pure Food Law. Keeps indefinitely, easy to take on outings, ready instantly! Send today!

Agents Wanted! Go into the soft drink business! 100% to 150% profit. 5¢ in everywhere.

10¢ per 10-glass pack—see postage paid. Special, 3 flavors, 20 glasses, only 50¢. Cherry, Lime and other flavors.

Chas. Morrissey Co., 4417-27 Madison St., Chicago



A LATHER THAT SOOTHES

Palmolive Shaving Cream gives soft, creamy lather that makes the beard waxy-like. The razor moves smoothly. Palmolive is also a lotion. Contains both Palm and Olive oils. Write for free trial tube. Largest size at 4¢ regular 25¢.
THE PALMOLIVE COMPANY, Milwaukee, U.S.A.
PALMOLIVE SHAVING CREAM

\$50 a Week EASY AGENTS

Free Sample Offer



You can start a big paying business at once. Don't wait. Get big money. We tell you how—selling the famous E-Z Self-Heating Sad Iron. No experience necessary. Easy to sell. Possibilities great. Every home a prospect. Satisfaction guaranteed. Absolutely safe. Thousands in use. Write today for proposition.

Enterprise Tool & Metal Works, Dept. 35, 2441-9 N. Western Ave., Chicago

Valve Grinder
No. 747
Price, \$5.00



Mr. Punch says:

"Believe me, that new valve grinder will make any automobile owner his own mechanic."

A new, easy-to-use Valve Grinder

SIMPLICITY of operation is the big feature. Each upward stroke and each downward stroke of the operating handle gives $1\frac{1}{2}$ complete revolutions of the spindle. This makes easy short, quick reciprocations, long reciprocations, or advancing reciprocations.

Furnished with an extension that gives 5 inches additional length when desired—thus making a total of $11\frac{1}{4}$ inches below the gear.

The leverage obtained through the long operating handle and transmitted through a ball bearing spindle makes grinding an easy job. Blade fits either slotted or spotted valves. Hard wood handles, mahogany finish.

Length over all without extension, $12\frac{1}{4}$ inches; length over all with extension, $17\frac{1}{4}$ inches; weight, $1\frac{3}{4}$ pounds.

Send for catalog No. 15 which describes and illustrates other Goodell-Pratt Tools.

GOODELL-PRATT COMPANY, Greenfield, Mass.
Toolsmiths

GOODELL- PRATT

1500 GOOD TOOLS

A BETTER Engine For Less Money

Only
Engine
Sold on
Lifetime
Guar-
antee



THE NEW WITTE

Throttling Governor

Easy to install—Easy to handle—Gives more power than rating—Increase or decrease speed at will—Run on cheap fuel, Gasoline, Kerosene, Distillate or Alcohol—Steady speed on variable load—Starts without cranking—So simple a boy can understand it.

Adaptable to any power job anywhere

Comes complete—Battery equipped. BOSCH Magneto at small cost extra. All other sizes and styles at proportionate low prices.

WRITE FOR CATALOG

WITTE ENGINE WORKS (Write Nearest Address)
1748 Oakland Avenue, KANSAS CITY, MO.
1748 Empire Building, PITTSBURGH, PA.
1748 Fremont Street, SAN FRANCISCO, CAL.

2 H.P. — Pulls 3
\$45.00
Pbr. \$48.50
Prisco \$57 At K. C.

3 H.P. — Pulls 4
\$69.50
Pbr. \$75.50
Prisco \$87 At K. C.

5 H.P. — Pulls 6 1/2
\$99.00
Pbr. \$107
Prisco \$123 At K. C.

MARVEL-O

Will keep the enameled finish of your automobile bright as new. Contains no oily ingredient, bees wax, acids or harsh abrasive. Is unequalled. Send name of your accessory dealer and \$1 for full size 16-oz. can.

MARVEL-O MFG. CO., San Diego, Calif.



Plate enlarged to show detail

Out-O-Site Aluminum HIP SUSPENDERS "The Health Way"

Garments stay put. Tiny plate at sides. No Pressure. No harness. Thousands Endorsing. Enormous seller. Reg. price \$1.00. Sample Pair, **50c**
12 Pairs \$4. Gross \$40.

L. WOODS, ST. LOUIS, MO.
Suite A, 3533 Lafayette Av.

THIS WONDERFUL INVENTION



converts any ordinary cook stove into a gas stove. OXO-GAS is made from kerosene and air. Cheaper, cleaner and more efficient than coal. Responsible distributors wanted.

GLORIA LIGHT CO.
114 N. May St. Chicago, Ill.

GO INTO BUSINESS FOR YOURSELF

Get out of the salaried class. Be independent of your job. Big new uncrowded field offers unlimited possibilities for making BIG money in every town or city. Make \$100 and more weekly as Floor Surfing Contractor. Every floor, old or new, is your prospect. Experience unnecessary. "American Universal" electric machine does work of six men, assuring BIG profits. Positive guarantee and 5-day trial offer protect you. Write today for complete details of what others are doing.

AMERICAN FLOOR SURF. MACH. CO.
523 S. St. Clair St. Toledo, Ohio



WURLITZER

TRADE MARK REG. SUPREMACY IN MUSICAL INSTRUMENTS



Try It In Your Own Home

You may now have any known musical instrument for a week's free trial in your own home. Play it as much as you wish. See how easy it is to learn. There is no obligation to buy—no expense for the trial. You may return the instrument at the end of a week if you decide not to keep it.

Wurlitzer instruments are known the world over for unusual tone quality and excellence of workmanship. They are used by the greatest musicians, bands, and orchestras.

Easy Payments

If you decide to buy, the Wurlitzer plan makes it easy for you to own the instrument you want. Payments are conveniently arranged in small monthly sums—a few cents a day will pay.

Special combination offers on complete outfits—velvet lined case, all accessories, self-instructor, etc.—everything you need at practically the cost of the instrument alone.

Send For Free Catalog

The greatest musical catalog ever published—over 3000 articles—every known instrument described and illustrated—many of them shown in full colors. Gives you lowest prices and all details of the Wurlitzer plan.

Send This Coupon

The Rudolph Wurlitzer Co., Dept. 1775
117 E. 4th St., Cincinnati 329 So. Wabash Ave., Chicago
120 W. 42nd St., New York 250 Stockton St., San Francisco

Send me, absolutely free, your new illustrated catalog of musical instruments. Also tell me how I may try any instrument in my own home at your expense, and how the Wurlitzer plan makes it easy for me to buy. No obligation.

Name

Address

City.....State.....

Instrument

(State instrument in which you are interested.)

Copyright 1923, The Rudolph Wurlitzer Co.
Please Mention Popular Mechanics

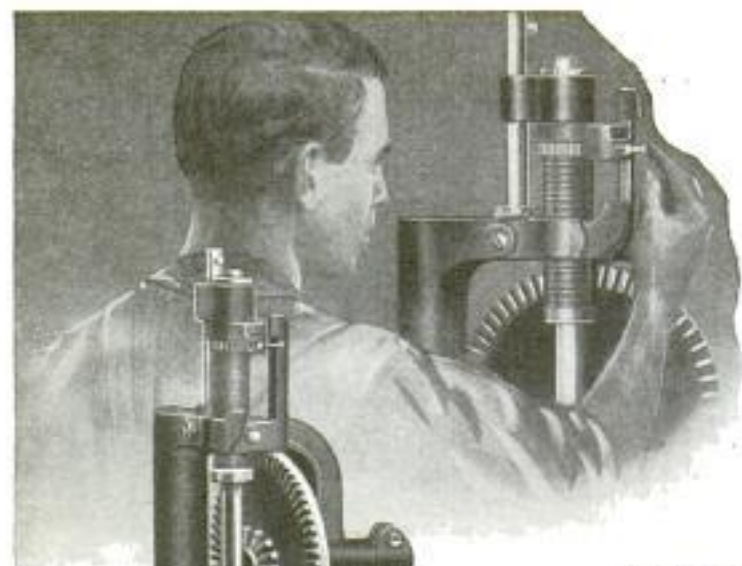

Gear
Shifter

Fast, slow
or locked,
at a
finger
touch.

No. 1005 (illustrated): Two speeds; 3-jaw chuck, holding drills up to $\frac{3}{4}$ inch. Entire length, 28 inches.

No. 1003
One speed; 3-jaw chuck, holding drills up to $\frac{1}{4}$ in. Entire length, 18 $\frac{3}{4}$ inches.

Dealers everywhere
sell "Yankee" Tools

NORTH BROS. MFG. CO., Philadelphia, U. S. A.

You can't overfeed with the "YANKEE" Bench Drill

No hand feeding. The "Yankee" Automatic Friction and Ratchet Feeds manage the job more accurately than any human hand could. Bit breakage is avoided. Work is speeded up.

Just set your work and turn the crank. Friction Feed runs drill down to contact; then Ratchet Feed automatically controls pressure, no matter whether bit is small or large or metal soft or hard. Requires no special care. Automatic throw-off prevents jamming.



"YANKEE" Vise No. 990

For use on bench drills and other machines. Machined true on all sides. Swivel jaw. Jaws, 2 $\frac{3}{4}$ in. wide, 1 $\frac{3}{4}$ in. deep.

Some Other "YANKEE" Tools

Ratchet Screw-drivers Ratchet Breast Drills
Plain Screw-drivers Ratchet Chain Drills
1 $\frac{1}{2}$ to 30 in. blades Ratchet Tap Wrenches
Ratchet Hand Drills Bench Vises, removable base

Write for Free Tool Book

Pictures and describes all "Yankee" Tools.



"YANKEE" TOOLS

Make Better mechanics

Drive 100 Tacks and Save \$25.00

Ford Top 16-covering \$5.20, \$6.95 and \$9.35. Chevrolet, Dodge or Maxwell, \$13.95. All other 5 passenger cars \$16.00 with plate glass lights. Side curtains that open with doors \$11.50 up. Seat covers \$3.15 up. Quality the best and guaranteed to fit. Printed instructions given how to apply. Send for samples. Prices above include delivery at your door. Eastern orders shipped from Ohio.
AUTO EQUIPMENT CO. 1055 So. Broadway, LOS ANGELES, CALIF.

\$5.20 up
Delivered



EVERY BOY WANTS THIS BOOK

Gilbert Boy Engineering for 1923
Wonderful articles on radio, sports and magic

10c postpaid

The A. C. Gilbert Company, 312 Blatchley Ave., New Haven, Conn.

WANTED

RAILWAY MAIL CLERKS

\$1600 to \$2300 Year

MEN—BOYS 18 OR OVER SHOULD
SEND COUPON IMMEDIATELY

Steady Work. No Layoffs. Paid Vacations.
Travel on Pass

Common education sufficient: Send coupon today—SURE



FRANKLIN INSTITUTE, Dept. R178, Rochester, N. Y.

Sirs: Send me without charge, (1) Sample Railway Mail Clerk Examination questions; (2) List of Government jobs obtainable; (3) Tell me how I can get a position.

Name.....

Address.....

A NEW RADIO ACHIEVEMENT

Since the beginning of general radio broadcasting, Air-Way engineers have unceasingly striven to simplify design, and to rectify operation, so that a receiving set could be made which the average man or woman could easily "tune in" with and get the most pleasing and uninterrupted results.

Out of this research, experiment and application to an ideal, the new Air-Way Radio Frequency Sets have come as an answer to the great and insistent public demand for genuine quality of radio reception.

Air-Way
TOLEDO

By genuine quality we mean good, full, natural tone, loud and distinct; with sharpness of tuning, which gives protection against interference from other stations, and allows you to hold and enjoy quietly the station you desire to hear; with ease of tuning, which makes the instrument practical and dependable in the home for all the family; and with long range, which multiplies the pleasures and opportunities of radio possession.

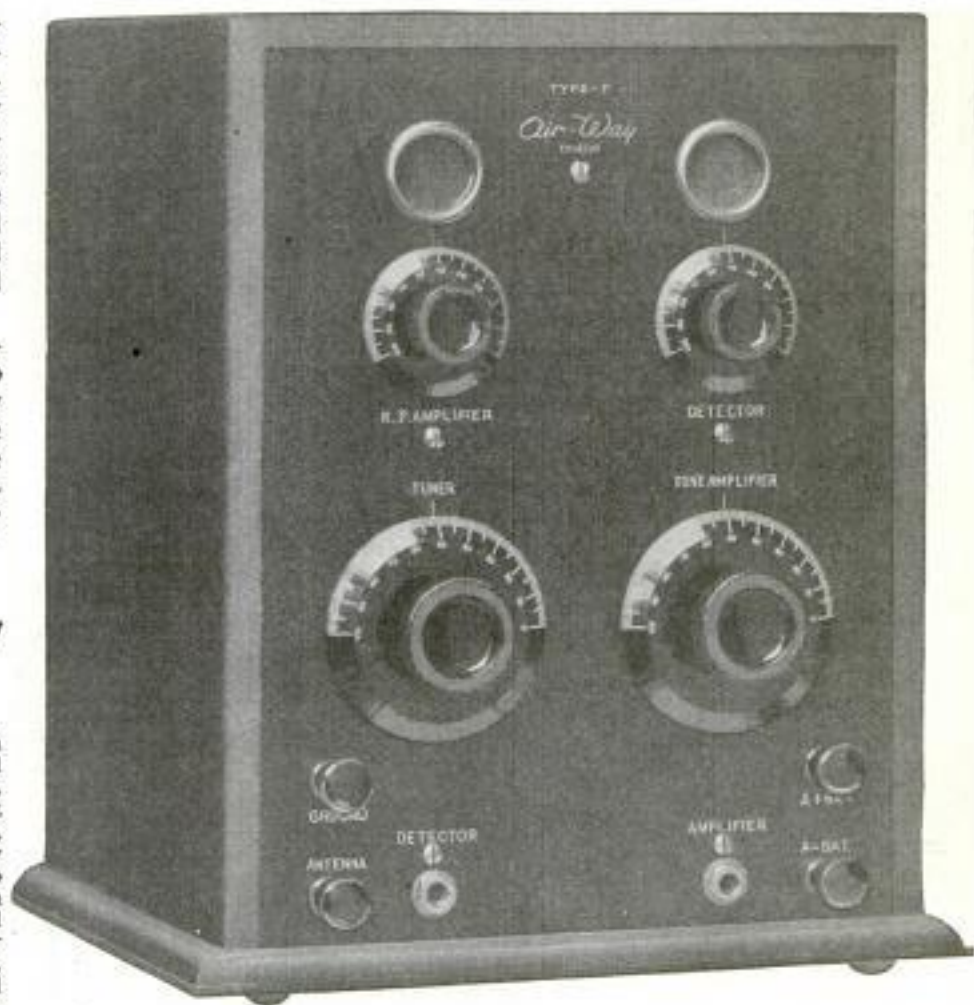

This Beautiful Four Tube Set Only \$50

This instrument is not only a remarkable value, but it is a new radio achievement, marking a distinct advance in the science of radio reception. In it the long sought success in the use of Radio Frequency Amplification has been accomplished.

And in this achievement Air-Way engineers have not only embodied skill and genius of design, but have given that care and precision to the manufacture of each and every part which is the only certain guarantee of true quality.

Air-Way Type F Receiving Set is a four-tube instrument. It has one step of Radio Frequency, Detector, and two steps of Audio Frequency amplification, compactly housed in a cabinet artistic in its simplicity of line and beauty of finish. This is a long-range receiving set that can be operated to its full capacity by the different members of the family. It thus meets every practical and pleasurable need for genuine quality of reception upon all the avenues of radio broadcasting.

Jobbers should address our Wholesale Dept.: The Zinke Company, 1323 S. Michigan Blvd., Chicago, Ill.

To Dealers: Although this new Type F Set was only announced in January, our big factories are already taxed to capacity by the spontaneous demand for this nominally priced genuine quality instrument. This set will give you unchallenged radio leadership. Wire your orders for delivery through your jobber.

In Toledo homes on this set broadcasting is reproduced from the distant stations of Denver, Los Angeles, Dallas, Minneapolis, Duluth, Newark, Atlanta and Havana. It is suitable either for head phones or loud speaking apparatus, and the volume and quality of tone is a genuine surprise to those accustomed to ordinary radio instruments.

To market this valuable instrument at the nominal price of only \$50 is a notable example of Air-Way policy to give to the public the advantages of scientific production economy in the Air-Way factories.

In price and merit this instrument is distinctly in a class by itself—clearly the outstanding value on the radio market.

Have your dealer get this fine instrument for you at once. Catalog, illustrating and describing Air-Way Receiving Sets together with all parts for those who build their own sets, will be mailed free, postpaid, upon request. Give name of your dealer and send for this catalog today.

Export Dept.,
120 Liberty St.,
New York.
Cable Address:
"AIRWAYVAC"
New York

Air-Way Electric Appliance Corporation, Toledo, Ohio

Free Book of RADIO HOOKUPS

Send 2c in stamps
to cover postage

Contains 25 tested
Hookups illustrated
and explained.
Shows best ways of
increasing the range
and power of your
set by installing



"ALL-AMERICAN" Amplifying Transformers

(Radio and Audio Frequency)

R-10 Radio Frequency (15-550 meters)	\$4.50
R-12 Audio Frequency (Ratio 3 to 1)	4.50
R-13 Audio Frequency (Ratio 10 to 1)	4.75
R-21 Audio Frequency (Ratio 5 to 1)	4.75

If your Dealer doesn't
handle the All-American
line, send his name and
address and indicate which
instrument or instruments
you are interested in.



RAULAND MFG. Co.
200 No. Jefferson St., Chicago, Ill.

Better, Finer RADIO Tuning

Our New "United"
Vernier Dial-Assembly
will multiply the
joy of your radio set,
by widening your
range and giving you
a high degree of control.
Can be attached
quickly to any plate
condenser by drilling
one hole. Don't miss
this wonder-worker
another day. Sent,
prepaid on receipt of
—\$2.50.



"United" Plate Condensers the Standard of the
Radio Industry
43 plate—\$4.00 23 plate—\$3.50 11 plate—\$3.00
5 plate—\$2.50 3 plate—\$2.25

For United Vernier Condensers add \$2.50 to above prices.

"United" Audio Frequency Amplifying Transformer

Magnetically shielded. Fine example of precision work-
manship. Adopted as standard by leading set-builders.
Ratio 5 to 1. Postpaid \$4.50.

All United instruments are sold under positive money-back
guarantee of satisfaction. You are dealing with an old-
established House whose plant alone cost \$500,000.00.

SEND FOR OUR DESCRIPTIVE CIRCULARS

United Manufacturing & Distributing Co.
536 Lake Shore Drive CHICAGO, ILL.

CROSLEY Model X

The Hit of the Radio World



\$55
A 4 tube
Radio

Not until you have listened
in on a Crosley Model X
can you appreciate the won-
ders of radio.

For Sale by Good Dealers Everywhere
Free Catalog on Request

CROSLEY MANUFACTURING COMPANY
515 Alfred St. Cincinnati, O.

CROSLEY Model Vc

\$20 Regenerative Receiver Set

Licensed
under Armstrong
U.S. Patent No. 1,113,149



Stations more than 1,000 miles away are being copied
regularly on this set. Name "Crosley" used by permis-
sion of the Crosley Mfg. Co. Write for Free Catalog.

THE PRECISION EQUIPMENT CO.
Powel Crosley Jr. President
515 Gilbert Ave. Cincinnati, O.

RADIO BLUEPRINTS

Blue Print Design of Radio Receiver guaranteed range 1,000, 3,000 miles, using dry cell....	10c
Blue Print Two Stage Amplifier for above outfit.....	10c
Blue Print of Radio Frequency Amplifier for above.....	10c
Guaranteed 1,000 Ohm Phone Receiver Postpaid.....	\$2.00
Guaranteed Bakelite Couplers, Green Silk Prepaid.....	\$3.00

Send 10c for our complete Catalog. Agents Wanted. Liberal Commissions

We sell Guaranteed Apparatus.

BADGER RADIO CO., 497 E. Water St., Milwaukee, Wis.



**World Radio
and
Auto Batteries
SAVE YOU
50%**
WRITTEN 2 YR. GUARANTEE

Automobile Prices

6 Volt, 11 Plate	\$13.25
Ford, Chev., Mitchell, Dup., Grant, Elgin, Vels, Saxon.	
6 Volt, 13 Plate	\$15.25
Overland, Buick, Geo, Paige, Hudson, Nash, Stude., Darr.	
12 Volt, 7 Plate	\$18.00
Maxwell, Dodge, Regal, Frank, Brisson and Crow-Elkhart.	
Give year and model of car	

RADIO PRICES

6 Volt, 60 Amps.	\$10.00
6 Volt, 80 Amps.	12.50
6 Volt, 100 Amps.	14.50
6 Volt, 120 Amps.	16.00

A Better Battery Cannot Be Built

The best of material—careful con-
struction by skilled mechanics—
makes a battery that will give a
long life of hard service.

Sold direct from factory to you. A written
two (2) year guarantee. You take no chance
with a World Battery—it is the most satisfac-
tory battery you can get and you save the
dealer's profit.

5% discount for cash with order, or will
ship C. O. D. Subject to inspection.

All orders shipped same day as received.
World Battery Co., Dept. 6, 1217 Wabash Ave., Chicago



Frost Jacks are best for your radio receiving set

There are four big reasons why you should purchase Frost Jacks for your receiving set. These are:

1. 99% pure silver contact points.
2. Thickness washers for panels of any thickness.
3. Triple nickel plated electric brass frames, hand-buffed.
4. Formica sheet insulation.



FROST-RADIO

In addition to Frost Fones, Jacks and Plugs, you will find Frost Tuning Coils, Receiving Transformers, Microphones and Extension Cords offer you greatest value and finest quality at low prices. Go to your dealer and ask for Frost Radio Apparatus today.



HERBERT H. FROST, Inc.
154 WEST LAKE STREET, CHICAGO, ILLINOIS.

FREE Radio Catalog



Our big stock of standard makes of radio sets, parts and supplies, fully illustrated. Play safe—buy standard equipment from a reliable house. We ship from stock.

Send \$5 for **Murdock Loud Speaker**, including fibre horn, stand and adjustable phone unit. Requires no battery.

JULIUS ANDRAE & SONS CO.

In business since 1860

116 Michigan St. Milwaukee, Wis.

SALESMEN Sell Long Range, Low Price \$10 Monthly Payments

No investment, we finance responsible district representatives. Ten sales monthly assure you \$350.00 steady monthly income. Every home a prospect. Our plan is sweeping the country. Don't wait to write; telegraph, giving references.

OZARKA RADIO, 3 No. Peoria Street, CHICAGO



I Need Branch Managers
LIGHTNING—WONDERFUL NEW ELECTROLYTE CHARGES DISCHARGED BATTERIES INSTANTLY. Eliminates old sulphuric acid method entirely. Dissolves sulphation. World has waited half a century for this invention. One gallon, retail \$10.00, free to agents. Lightning Battery Co., St. Paul, Minn.

Hit it anywhere!

MAGNETITE RADIO CRYSTAL—the world's most sensitive and efficient Crystal Detector.
GIBBONS-DUSTIN RADIO MFG. CO.
518 West 9th St., Los Angeles, California



THIS Crystal Detector is unaffected by handling or moisture and will render efficient service indefinitely. Price 50c at all dealers—or mailed direct.

RADIO

\$15 Down
\$10⁰⁰ a Month



An Amazingly Easy Way to Own a Radio Set

Good Radio sets are expensive—but here's the opportunity to buy the very best on such easy terms that you can afford to have the best.

The air is full of music—pick out the concert which pleases you—listen to a dozen concerts in one evening. Lectures by the most famous speakers—sermons by world-renowned preachers. Baseball scores, returns from the prize fights, news reports of the day sent out hourly by leading newspapers, bed time stories for the little tots. A blessing to the sick, invalids or shut-ins. Brings the world to your door. Far more entertaining than anything else you could buy.

So simple a child can operate—nothing to learn—turn a couple of dials and you have a concert—turn again and you have another. Nothing to buy—the "SENSITONE" comes complete, including "A" and "B" batteries, head phones, vacuum tube and complete aerial equipment.

SENSITONE

Regenerative Radio Receiving Set

Only \$15 Down—\$10 a Month

A Thoroughly Reliable Set, manufactured by the Klitsen Radio Mfg. Co., under the Armstrong License (U. S. Patent No. 1,113,149 and pending letter patent 807,388).

Shelbyville, Mo., hears concerts in Havana, Cuba. A user in Winnipeg, Can., listens to Los Angeles, Calif., while Stanton, N. D., hears Ft. Worth, Texas, and Schenectady, N. Y. A party in Denver, Colo., hears concerts from Havana, Cuba. Let us send you copies of hundreds of such letters. A payment of only \$15.00 cash and \$10.00 monthly brings the "SENSITONE" to you.

Sign the coupon today and your receiver will go forward at once.

HAROLD R. WAKEM & CO.

835 W. Washington Blvd. Chicago, Ill.

Please ship me one complete "Sensitone" Radio Receiving Set as described above, for which I agree to pay \$15.00 herewith and \$10.00 per month until the full purchase price of \$95.00 is paid. Set to remain the property of Harold R. Wakem & Company until fully paid for.

Name.....

Address.....

Wave Trap

TRADE MARK
PATENT APPLIED FOR

The Missing
Link
in RADIO



Stops Interference!

THE "WAVE TRAP" will eliminate interfering broadcasting stations and enable you to listen to your favorite station. It will work on any set, greatly increase its selectivity and clearness, and eliminate code and spark stations.

It is mounted on a Formica panel in a handsome mahogany finished cabinet 6 x 5 x 6. It is a high grade instrument throughout and a valuable addition to the operation and appearance of any set. It comes to you complete and there are no extras to buy. It is installed in a minute by changing only one outside connection.

Use the "WAVE TRAP" for real results.

850
CHARGES
PREPAID

Ferbend Electric Co.
15 E. SOUTH WATER ST.
CHICAGO



\$5.00
2000 Ohms

\$5.50
3000 Ohms

You are taking no chances when you use Murdock Headphones with your Radio Receiving Set. Experts have used them for over 17 years.

And Murdock prices are so reasonable that every Radio enthusiast can afford them.

Get a pair from your dealer. Also ask him to show you the new Murdock \$5 Loud-speaker. If he doesn't have them send direct.

WM. J. MURDOCK COMPANY

General Offices and Factory

349 Washington Ave., Chelsea, Mass.

Sales Offices: New York, Chicago, San Francisco

MURDOCK RADIO

STANDARD APPARATUS SINCE 1904

Please Mention Popular Mechanics

ACME

for amplification



Radio Apparatus of distinction

ACME APPARATUS CO.

PIONEER TRANSFORMER AND
RADIO ENGINEERS AND MANUFACTURERS
CAMBRIDGE, MASS., U. S. A.

CHARGE YOUR BATTERY



(RADIO OR AUTO)
at HOME for a NICKEL
The **HOMCHARGER**
POPULARLY PRICED — PAYS FOR ITSELF
SEND FOR THE AUTOMATIC ELECTRICAL
FREE BOOK 123 W. THIRD ST., CINCINNATI, OHIO



Listen In, Everybody!

IT'S MADE RIGHT.
IT LOOKS RIGHT.
IT WORKS RIGHT.

Insist on SIGNAL when buying Radio Equipment
and you'll buy Radio service and satisfaction.
SEND FOR CATALOG.

SIGNAL ELECTRIC MFG. CO. 1910 Broadway
Menominee, Mich.



Price Only \$29.95

MIRACO
GETS 'EM
1500
MILES
AWAY

At this low price you get the efficiency of a \$50 set. It is a two tube radio frequency receiver — picks up stations 1500 miles away under good conditions — everywhere — any time. This outfit can be operated with a dry cell or storage battery. Cabinet is of solid mahogany and workmanship the finest throughout. Order direct or send for catalog.

Dealers — write for proposition — it's a winner.
Agents — wanted everywhere — write for territory quickly.

THE MIDWEST RADIO COMPANY
807 Main Street CINCINNATI, OHIO



WALMART Trouble Proof RADIO Apparatus.

IMPROVED CONDENSERS

New patented construction prevents surging and loosening. Guaranteed trouble-proof, cannot get out of line because stator plates are inserted into supporting studs at 3 points and firmly locked by punch-press. Plates of 20 gauge, high conductor aluminum. Strongest, most durable and finest tuning adjustment. Bakelite end plates. Electric break-down tested. You can pay more, but you cannot buy more service and quality. Vernier type, for extra fine tuning, includes Vernier Knob and extra plate.

PRICE LIST

No. of Plates	Micro F. Capacity	Plate Type	Vernier Type
3	.00006	\$1.50	
5	.00010	1.80	
13	.00025	2.25	\$4.25
23	.0005	3.25	5.00
43	.001	4.00	6.00

ALL-METAL Vacuum Tube SOCKETS

Unbreakable, perfectly insulated. Do your composition sockets chip, warp, and crack? Install these Walmart All-Metal Sockets and you "buy once for a lifetime." Electrically tested. Connections all marked. Standard 4-prong contacts of phosphor bronze. Heavily nickel-plated brass base and shell. Now only 50c



50c

50c

WALMART ELECTRIC MFG. CO. 1251 S. W. Van Buren St. Dept. 201 CHICAGO

Hear Atlanta on Crystal

We receive programs from Atlanta, Minneapolis, Davenport, Fort Worth, Dallas, Kansas City, St. Louis, Denver, San Antonio on crystal without batteries. Your crystal set requires only inexpensive changes. Send stamp for further information, or \$1 for copyrighted drawings and instructions. Everything clearly explained. Satisfaction guaranteed.

LEON LAMBERT

539 South Volusia WICHITA, KANSAS

RADIO & AUTO Storage BATTERIES CHARGED

FROM A LAMP SOCKET At Home for a Few Cents. With An F-F BATTERY CHARGER, a FULL WAVE AUTOMATIC MAGNETIC Rectifier for 105-125 Volt 60 Cycle A. C. Type A-B Charges 6 Volt "A" & Auto & Up to 120 Volts of "B" & Loud Speaker Storage Batteries In Series Industrially At Home Overnight. Disconnecting & Multiple Connections Unnecessary.

No Grounds. Charging Circuits Separate. No Skill Required. **AMMETER** eliminates **GUESS WORK**. Insurable Electrically Resealed Current. Will Charge A Dead BATTERY. Lower Battery Connections. Screw Plug In Lamp Socket. Keep Charger Clips On Terminals. Turn Switch & Battery Is Charged In Morning. **NOTHING LIKE IT MADE**. Is It Not Good To Feel Your RADIO Batteries Are Ready For All Radiophone MUSIC & News & Never Have To Tell Friends Your Batteries Are Dead? Fully Charged Batteries. By Starting Car Quick. Becomes Power Expensive Replacements. Do Not Think Your Battery Is Dead & Worn Out Simply Because It Will Not Start Your Car. An F-F Charger Fills It With Life. Saves More Than Its Cost & Lasts A Lifetime. **7 TYPES BUILT BY A MASTER OF THE ART & POPULARLY PRICED.**

Type 6 charges "A" 6 volt Battery, at 6 amperes \$15
Type 12 charges 12 volt Battery at 5 amperes \$15
Type 8 charges Radio "B" Bat's Up to 120 volts \$15
Type A-B is a Combination of Types 6 and B \$20
Type 100 charges 6 volt Battery at 12 amperes \$20
Type 1012 charges 12 volt Battery at 7 amperes \$20
Type 1026 is a Combination of Types 100 & 1012 \$28

Charges Auto and Radio Batteries

The 3 Lower TYPES are Recommended For Heavy Batteries, or Where Time Is Limited. Shipping Weights Complete with **AMMETER & BATTERY CLIPS** 11 to 15 pounds. Purchase from Your DEALER or Mail Check for Prompt Express Shipment. If for Parcel Post add Postage & Insurance Charges. Or ORDER us to forward TYPE desired. C. O. D. ORDER Now or WHITE immediately for FREE Description BULLETINS 24 & 24A. THE FRANCE MFG. CO. CLEVELAND, OHIO, U. S. A.



THE WORLD'S GREATEST
RADIO CRYSTAL

THIS REMARKABLE CRYSTAL

is revolutionizing the possibilities of Crystal Sets. Unsolicited testimonials from all parts of the country report records of from 600 to 1200 miles with ordinary sets equipped with **M. P. M. (Million Point Mineral) CRYSTALS**

Don't discard your Crystal Set until you have given M. P. M. a trial. Send 25c and name of your Radio Dealer for sample unmounted crystal—35c for mounted. Beware of Imitations. **M. P. M. SALES CO., Dept. P, 247 S. Central Ave., LOS ANGELES**

BRACH VACUUM RADIO PROTECTOR

Ask your
Insurance
Agent



Approved by
National Board
Fire Underwriters

\$3.00

The Choice of the Foremost Engineers
for Over 17 Years

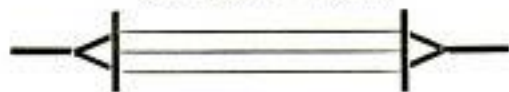

SOLDERALL

The Only Convenient Metal Solder

Every Electrical Connection Needs
SOLDERALL for Perfect Reception



AT JOBBERS
AND DEALERS OR BY MAIL
25¢ A TUBE
L. S. BRACH MFG. CO.
NEWARK, N. J.

SEE YOUR DEALER FOR INFORMATION ABOUT
RADISCO Radio Products
THE RADIO DISTRIBUTING CO., Newark, N. J., U. S. A.

RADIO PROGRAMS

A Weekly Publication
RADIO PROGRAMS PUBLISHING CO.
649 Washington Blvd.
CHICAGO

Contains the most complete programs of the largest and best Radio-Phone Broadcasting stations, interesting radio editorial matter. One new hookup each week, and list of radiophone stations in U. S. A. all for 10c a copy or \$4.00 a year. Send for sample copy. Out every Saturday giving detailed program for the next week, send stamps or money order to **RADIO PROGRAMS, 849 Washington Blvd., Chicago, Ill.**

RADIO DEALERS
AMERICAN RADIO MFG. CO.

Write for 64 Pg. Catalog. Complete LINE, it's FREE
Dept. O
Kansas City, Mo.

Two Great Sports



Money-making sales opportunities in open territory. Write Desk A-2.

FISHING and motorcycling — what better sport combination is there? Pick out your pet lake or stream — then speed to it, cool and comfortable, in a Harley-Davidson.

With a motorcycle you can go to the out-of-the-way lakes — lakes of more fish and fewer fishermen — far from the main roads so crowded with automobiles.

A vacation every week-end! And the travel-cost is only two cents a mile — "gas", oil, tires and all!

Pay-as-You-Ride. Most dealers have an Easy Payment Plan. Ask yours about it. **Lower prices and 10 improvements on 1923 Harley-Davidsons.** Write us for free literature.

HARLEY-DAVIDSON MOTOR CO.
Milwaukee, Wisconsin

Harley-Davidson The Motorcycle

YOU'LL LIKE THESE "LYON BODIES"
For FORDS, CHEVROLETS and DODGES



ONLY
\$27⁵⁰

SEND NOW

This is only one of the many exceptional offers in our catalogue just off the press. A full line of bodies and accessories to satisfy your season's need. Buy direct from the factory. Send for our catalogue today.

AUTO TIRE SALES CO., Dept. PB Body
1346 S. Michigan Ave. CHICAGO Division

Operate a Loud Speaker On a Single Tube



The entire family listens to broadcasting, with the new Erla Duo-Reflex circuit, the most powerful single-tube circuit ever built.

Through a loud speaker, ample tone volume is provided, except for the most distant stations.

The heart of this circuit is the Erla Reflex transformer, one of the greatest improvements in years.

FREE! Our bulletin No. 13, giving diagrams and notes for the construction of this circuit, is obtainable from leading dealers. Or write us.

Electrical Research Laboratories
Dept. J, 2515 Michigan Ave., Chicago

ERLA



\$35 Brings Your Shop GUARANTEED
FREE AIR SERVICE
With HB Automatic Twin Compressor

Easy terms let increased profits from new trade pay balance. Good free air service Day and Night pulls trade, brings new customers, helps you sell tires, oil, gas and accessories. The extremely compact construction enables you to use the HB Compressor in limited space. QUIETEST OPERATING outfit on the market. Entirely automatic. Maintains 120-140 pounds or higher on air lines 24 hours per day. 4 cubic feet capacity. Single-unit construction. Saves current. Fully equipped, ready to connect up and operate. Easy terms. Satisfaction guaranteed or your money back. Write for information.

HOBART BROS. CO., Box M 56, Troy, Ohio

Absolute Satisfaction Guaranteed or Money Back

FREE — a book that tells how to get better results with radio tube sets. Address
WILLARD STORAGE BATTERY COMPANY
CLEVELAND, OHIO

THE TRINITY LOUD SPEAKER

THE BEST YOU CAN BUY

TYPE A1 with 21" Horn.....	\$25.00	Literature
TYPE "B" for use with Phonograph	12.50	upon request.

TRINITY RADIO CORPORATION
168 Dartmouth St. BOSTON, MASS.

BATTERIES

DIRECT FROM FACTORY

Finest materials and workmanship. Long life—easy charging.

Two Year Written Guarantee

13 F3, 6V. (—Ford, Chev., Mitchell, Buick, Grant, Velle, Saxon) \$11.85

13 F3, 6V. (—Buick, Chev., Geo., Paige, Dort, Nash, Hudson, Stude.) \$13.85

7 Pt. (12V.) — Dodge, Franklin, Royal, Hriscoe, Crow - Elkhart \$16.85

Send year and model of car.

RADIO BATTERIES 50 amperes, \$11.85 115 amperes \$13.85

Batteries fully charged.

Shipped express C. O. D. day order is received.

WESIDE BATTERY CO., 4445-47-49 W. Madison St. Dept. 26, Chicago, Illinois





MEN! A watch you'll carry always at a price you can pay NOW.

This high grade, full 21-jewel adjusted Gold Watch is greatest value ever offered. A perfect time-keeper heat and cold adjustment, and other features found only in highest priced watches. Rely on by railroad men and others for accuracy.

Open Face Gold Engraved Case
Case beautifully engraved, latest style and design, screw back and bezel, 25-year guarantee—a real \$30 value while they last only \$8.85.

FREE Morocco Lined Gift Case
JUST NAME AND ADDRESS brings this bargain. Pay postman \$8.85 on arrival plus few cents postage or send \$8.75 with order we pay postage. Money back quick if not pleased. **ORDER NOW.**

CHARLES & COMPANY
Dept. 189, 1440 S. Michigan Ave., Chicago

\$40 - to - \$60 per week

WRITE immediately—if you want a big-profit year-round business of your own. No capital needed. Experience not necessary. Our \$3.00 introductory gift for every home breaks the ice and brings the money! Exceptional opportunity for men and women of good character. Part or full time. Highest quality line. Fascinating work. Write immediately for every day money plan.

JENNINGS MFG. CO., Secretary 426, DAYTON, O.

For the SAXOPHONE

10 New "Hits" at HALF PRICE!

In "Laf'n Sax" you follow the notes and produce side-splitting laughter. "Teng'n Sax" makes you triple-tongue like a professional—automatically! "Tiggle-Wiggle" fast, snappy, easy; 100,000 copies sold in a year. All these 10 pieces are published by us, and sell for 50¢ a selection, or 45¢ in all. During this sale only \$2.50 postpaid and on approval! Even beginners can learn to play these pieces quickly.

The Saxophone Shop, Dept. 101, 425 S. Wabash Av., Chicago



\$2.50

Order direct from this ad. State if C Melody, Alto or Tenor is desired.

10 Days' Trial

Remit in any convenient form. Keep 10 days and see for yourself here is Saxophone music you simply must have! Money back if you wish to return it.



TYPEWRITER SENSATION!

Free Trial—Use as You Pay

After trial send us only \$4.00 a month until the low total price of \$48.80 is paid, and the machine is yours. This is absolutely the most generous typewriter offer we ever made. Do not rent a machine when you can pay \$4.00 a month and own one. Think of it—Buying a \$100.00 Machine for \$48.80. Cash price \$45.00, just a little less than half its original price.

REMINGTON MONARCH

Perfect machines. Correspondence size. Keyboard of Standard Universal arrangement, 42 Keys, writing 84 characters. The entire line of writing completely visible at all times, has the tabulator, the two color ribbon, with automatic reverse, the back spacer, variable spacer, self-starter, in fact, every late style feature and modern operating convenience. Comes to you with everything complete; tools, cover, operating book and instructions—nothing extra to buy. You cannot imagine the perfection of this beautiful reconstructed typewriter until you have seen it. We have sold thousands of these perfect late style machines at this bargain price and every one of these thousands of satisfied customers had this beautiful, strictly up-to-date machine on five days' free trial before deciding to buy it. We will send it to you F. O. B. Chicago for five days' free trial. It will sell itself, but if you are not satisfied that this is the greatest typewriter you ever saw, you can return it at our expense. You won't want to return it after you try it, for we are sure you cannot equal this wonderful value anywhere.

Send No Money! \$8.80 Put in Your Order Now

AFTER TRIAL

When the typewriter arrives deposit with the express agent \$8.80 and take the machine for five days' trial. If you are convinced that it is the best typewriter you ever saw keep it and send us \$4.00 a month until our bargain price of \$48.80 is paid. If you don't want it, return it to the express agent, receive your \$8.80 and return the machine. We will pay the return express charges. This bargain is guaranteed just as if you paid \$100.00 for it. It is standard. Over half a million people own and use these typewriters and think them the best ever manufactured. The supply at this price is limited, the price will probably be raised when next advertisement appears, so don't delay. Fill in the coupon today—the typewriter will be shipped promptly.

There is no red tape. We employ no solicitors—no collectors—no chattel mortgages. It is simply understood that we retain title to the machine until \$48.80 is paid. You cannot lose. You will perhaps never have a greater typewriter opportunity. Do not send us one cent. Get the coupon in the mails to day—sure.

Young Typewriter Co., Department 65, Chicago, 25 W. Lake St.

Young Typewriter Co., Department 145, Chicago, 25 W. Lake St.

Ship me the Remington Monarch Typewriter, F. O. B. Chicago as described in this advertisement. I will pay you \$4.00 monthly as rent until the \$40.00 balance of the SPECIAL \$48.80 sale price is paid. The title to remain in you until fully paid for. It is understood that I have five days in which to examine and try the typewriter. If I choose not to keep it I will carefully re-pack it and return it to the express agent. It is understood that you give the standard guarantee.

Name
Street Address
City State
Business or Occupation

Please Mention Popular Mechanics

TOOTHPERL

TARTARUS-FIGHTER



One Application
Will make the most
discolored, tartar, decay
and white, clean teeth
as polished ivory.

25 CENTS

Wash with TOOTHPERL
all teeth, or brush with
toothbrush, twice a day. Wash
away, before using tooth
paste, before using tooth
brush and all other tooth
and denture cleaning agents.

You Can Now Have Beautiful Snow White Teeth

TOOTHPERL is the only toothpaste that
is 100% guaranteed to remove tartar, decay
and white, clean teeth as polished ivory.



New Easy Way to Make Money Fast

**Make \$75.00 to \$150.00 A Week.
All Time or Spare Time**

TOOTHPERL amazes nation. Makes yellow, discolored, or tobacco-stained teeth as white as snow. Eliminates tartar. Just a clear liquid, absolutely harmless. Teeth shine and glister like polished ivory. Everybody wants TOOTHPERL. Recommend it to their friends. Don't compare with ordinary tooth pastes and powders. It's a new, scientific discovery. Nothing else like it. Sells like hot-cakes.

**45,000 Bottles Sold in 3 Months By
Inexperienced Man**

Experience unnecessary. You should make Big Money. All you have to do is place the cards and collect your profits. Territory going fast. Write today for complete details. Better still, mail \$1.00 for sample card.

MARCH PRODUCTS COMPANY
Dept. 11 5650 W. Lake St., CHICAGO, ILL.

**Just Place Card on Dealer's
Counter, Collect Once A Week**

All you have to do is place a card (containing 13 bottles) on the counter of drug, cigar and candy stores. Card brings in \$3.25. Dealer keeps \$1.25. Pays you \$2.00. You pay us \$1.00, making \$1.00 per card profit for yourself. Many stores sell first card in two hours. Chicago druggists call it fastest seller in history.

Send \$1.00 for Sample Card
Place it on a druggist's counter. Watch it for a day or two. See how fast TOOTHPERL sells. Then grab your territory. If not satisfied, return card and we'll refund your dollar.

"DETROIT" BELT LACING OUTFIT

Costs only 1c an inch, outlasts the belt, is smooth, strong and flexible—easily and quickly applied. Same method used by 10,000 big factories.



Complete outfit,
lacing tool and
big box of lacing
postpaid

\$5

Price cut from
~~\$8.50 to \$5.00~~
We pay postage
Money back if not
satisfied



"Detroit" Belt Lacing shows the least reduction of the belt strength, leaving the belt stronger than any other lacing in existence. "Detroit" Belt Lacing is the only machine closed wire lacing that takes a perfect staggered grip on your belt. Each hook has a pulling strength of over 100 lbs. Hooks put up (with rubberized paper side strips) in 12 inch sections cut to any length without waste. Dozen sections to box, lace 84 inches of belt.

GUARANTEED

Lacing tool shown in view and box of lacing complete, postpaid. **\$5.00**
(Vine not included).
Tool made to last a lifetime. Lacing always obtainable. Sold on money-back guarantee.
DETROIT BELT LACER CO., DETROIT, MICH.

THERE'S A REASON BANG!



Why Our Prices Have
Dropped

Sport Fenders Underslung Sport Fenders for

8-16 Overhead Valves Selective Transmissions
THE BEAUTIFUL LINES and EXCELLENT QUALITY of our SPORT BODIES brought about an enormous increased production, resulting in a marked decrease in cost, which we are now passing on to the public. Our 1923 BODIES maintain the Hi-Grade FOLDING quality, but are sold at lower prices. Several new models to choose from \$29.00 up. The largest stock of finished bodies in the country, at our Eastern and Midwestern Shipping Points ready for delivery. New York Show Room Display of Completely Equipped Cars. Wonderful Dealer's Proposition. Write for Catalog NOW.

This Month's SPECIALS

	Price	Now	Price	Now
2-1 and 2-1 Racing Gears	\$12.50	\$ 8.65	Underslung Pictures	\$18.00 \$11.95
Worm Steering Gear	28.00	16.65	Power-Speed Camshaft	19.00 9.45
4-Speed Transmission	95.00	73.50	Discs (Set 8) Flat	12.00 7.95

SATISFACTION OR MONEY BACK guarantee. 50% with order, balance on delivery.
C. D. FORD SPEED & POWER EQUIPMENT MFRS., 250 West 54th St., New York

What About Radio in 1925?

Can You Keep Pace with Its Progress?

While RADIO is now a very big institution, it is true, nevertheless, that there will be many new developments, some new parts, and many new "hook-ups" before RADIO attains its final state of perfection. Can you keep track of all these changes—to-day, to-morrow, in 1924, and in 1925?

**LEFAX RADIO HANDBOOK
PERPETUALLY UP-TO-DATE!**



LEFAX RADIO HANDBOOK always keeps pace with new developments in Radio—the book is loose-leaf, and every month to every purchaser of the book is sent additional pages that keep the book up-to-date. No extra charge for this service for one year. Written by the two chiefs of the RADIO dept. U. S. Bureau of Standards. Fine imitation morocco leather cover.

Price \$3.50 postpaid, complete with year's service
POPULAR MECHANICS BOOK DEPT.
200 E. Ontario St., CHICAGO

MODEL MAKING

New 400-page book covering workshop practice, design and construction of models. The work described is real model engineering and not the construction of mere toys. 303 Illustrations. Cloth. Price, \$3.00 Postpaid.
POPULAR MECHANICS BOOK DEPT., 200 E. Ontario St., CHICAGO

DIXIE DOUGHNUT SHOP



Doughnut Shops Make Amazing Profits

Wonderful automatic machine makes 800 dozen "Snow-Flake" Doughnuts per day. Money making possibilities unlimited. Put machine in store window. Attract crowds. Enticing odor whets appetite. You take in money fast. *Savory Cents Out of Every Dollar Is Profit!* Big Money wholesaling to grocers, restaurants and hotels. Enormous demand. You can undersell average baker and make more profit. Delicious "Snow-Flake" Doughnuts have taken the country by storm.

No Town Too Small. Start Anywhere. Doughnut shops are making fortunes for live men everywhere. No experience needed. Flour ready prepared. Add Water. Put dough in hopper. Turn crank. Get drop sweet, savory, golden doughnuts. Get started now before others start. With size plus success is certain. First week's profit should pay for machine. Get full details of this new, profitable business. Costs nothing to investigate. Write today.
BUTLER & BUTLER, Dept. 245, 5650 Lake St., Chicago, Illinois

**\$5,000 to
\$10,000
YEARLY**



HIGH GRADE LEVER WATCHES

10 DAYS' FREE TRIAL

For Men, Women and Boys

BUSINESS OR SPORT WATCHES

Don't miss this opportunity to purchase one of these fine elegant TIMEPIECES at less than HALF OF ORIGINAL PRICE. High Grade nickel lever movements, scientifically built, jeweled, adjusted and regulated. **No. 1 WRIST WATCH, O-RING ROUND** nickel case, 10 Jewels, RADIUM DIAL, \$5.95; or solid Sterling Silver, \$7.75. **No. 2 Nickel Cushion Shape**, \$7.85; or solid Sterling Silver, \$10.75. With 15 Jewel Movements, \$2.00 extra. Free: 2 fine leather straps. **No. 3 EXTRA THIN MODEL GENTS' WATCH**, 14 size, 7 Jewels, GOLD FILLED, GUARANTEED 10 years, \$7.35; or 20 yr. case, \$9.75; or Nickel case, \$5.95. With 15 jewel movement, \$2.00 extra. **FREE: Gold Filled Wadsworth chain.** **SAISFACTION GUARANTEED OR MONEY REFUNDED** Watches are our EXCLUSIVE SPECIALTY. Buy your watch from WATCHMAKERS. You will save money and get a better watch. Order today, pay Postman on arrival. If you are not entirely pleased after 10 days' trial return watch and we will exchange it or refund your money. Illustrated FACTORY PRICE LIST of Ladies' and Gents' watches mailed free. **UNEDA WATCH CO., Dept. P2, 217 Eighth Ave., NEW YORK CITY**



Start in Business For Yourself

Write for Special Spring Offer either Cash or Easy Time Payment Plan on Duncan No. 10 or 3B Complete Tire Repair Shop Equipment Experience not necessary—We teach approved factory methods. Big opportunity for you to start in business for yourself on a small investment and reap the harvest of the big Spring business.

High Grade Molds—Easy and Economical to operate—Double value account double capacity. Write NOW for descriptive folders and Special Spring Offer, prices, etc. We will tell you all in detail.

School agencies wanted 341-49 East Ohio Street F. M. DUNCAN COMPANY, Department P, Chicago, U.S.A.

Duncan No. 10 or No. 3 will cure with sand bag as a pressure medium, equally as well as with air bags. Will cure twice as many tires per day than any other three cavity mold; will cure Two 3/4 or Three 1/2 in. or Two 3/4 in. either FABRIC or CORD TIRES, perfect to size, form, width and contour.

F. M. DUNCAN COMPANY, Department P, Chicago, U.S.A.

You Can Earn \$500 a Month

No experience or investment necessary. We teach you how to earn \$250 to \$500 a month by taking orders for wonderful new All-Weather Coats of waterproofed Gaberdines—Whipcords—Tweeds that sell fast because raincoat and cloth coat combined. **Wayne Manufacturing Co., Dept. B2, 144 West 36th St., New York City**



PRACTICAL AMATEUR WIRELESS STATIONS

An experience book containing the best suggestions of 33 experimenters on building, installing, and operating experimental stations for radio communication. 136 pp. 6x9. Illustrated. 75 cents, postpaid. **Popular Mechanics Book Dept., 200 E. Ontario St., Chicago**

Mathematics Made Easy by ROPP'S CALCULATOR AND SHORT-CUT ARITHMETIC

Shows the Answer as Quickly as a Watch shows the Time to all Problems likely to occur in the Office, Store, Shop, Bank, Farm, or Factory. **Over 2,000,000 Sold**



Explains and simplifies every principle in Arithmetic, Mechanics, and Mensuration. **PRICES POSTPAID**
 Desk Size, \$1.50
 Leatherette, Pocket Size, \$1.00
 Pocket Size, Cloth, \$0.50
 Pocket Size, Paper, \$0.35

Popular Mechanics Book Dept., 200 E. Ontario St., Chicago



PATENT PENDING
ONLY \$1.97
If You Send Quick!

Amazing new invention—the Compacto-Grill—toasts better and in half usual time; it toasts, fries and broils as well as larger stove. Makes rarebits, heats sauces at table. Nothing else like it. Worth three times the price.

Don't confuse the Compacto-Grill with ordinary toasters or grills. It is made on a new principle. Does work of electric or gas range, in small space, on table or server. New kind of coils give heat twice as intense as other grills. And silverish finished Asbestos plate below coils sends all heat UP. None wasted; none goes down to heat table; protecting pad unnecessary.

Make coffee, bouillon or rarebits, fry or broil at the table in a jiffy. Keep dishes piping hot at table. Make browner, more even, tastier toast. Warm baby's milk quickly; have hot water for sudden illness in half usual time. Hundreds of uses at table, in bedroom or sickroom.

Beautiful also. Black enameled base handsomely figured. Nickelled finished top. Positively strong and durable. Heats on any light current. Size 7 inches by 6 inches—6 foot cord and plug

included free. Special price is to introduce quickly for every home that sees one of these beautiful, compact, efficient, convenient Compacto-Grills wants one, and one customer brings many others.

Send no money. Just mail coupon. When postman brings Compacto-Grill pay him only \$1.97 (plus the few cents postage). Use it five days at breakfast, luncheon, dinner or midnight supper. Then if not thoroughly delighted, return it and \$1.97 will be refunded. You are the sole judge. But act at once. This wonderful stove does the work of a \$7.00 grill and present low introductory price cannot be maintained long.

Send No Money—Just This Coupon

ACORN BRASS MFG. CO., 3260 W. Lake St., Chicago, Ill.
 Without a penny in advance send me the amazing new invention, the Compacto-Grill. I will pay the postman only \$1.97 (plus few cents postage) on arrival. There will be no further charges at any time. But if for any reason I wish to return this grill, I may do so within 5 days and you agree to refund my \$1.97 instantly and without question. I am to be the sole judge.

Name
 Street No. or R. F. D.
 City State

DIAMONDS

\$197 per CARAT

Sparkling, blue white, perfectly cut, genuine diamonds are offered to you by direct DIAMOND IMPORTERS AT BIG DISCOUNT FROM their regular price. Former price \$325.00 per carat. BUY FOR CASH at wholesale prices and less. 40% SAVINGS ON DIAMONDS GUARANTEED OR YOUR MONEY RETURNED. Written guarantee as to quality and exact weight sent with each diamond. WE TELL YOU ALL THE FACTS regarding the diamond you buy.

8% YEARLY INCREASE
Each diamond purchased from us has a yearly increase in exchange value of 8% guaranteed in writing.

30 DAYS' FREE TRIAL
Wear any article of your choice on trial for 30 days. If not satisfied send it back and we will return every cent you paid. Free examination at bank or express office before paying deposit, if desired. Written guarantee that if any other jeweler in the U. S. can sell you equal merchandise for less money, you can get your money back. On this guarantee you cannot lose.

WRITE FOR CATALOG
Our big catalog of diamonds, watches and jewelry WILL SAVE YOU 40% TO 60% ON YOUR PURCHASES. It shows rings and watches in natural colors. Diamonds in profusion at importer's prices. CASH PRICES MEAN LOWEST PRICES. Send for this catalog at once.

\$1,000,000.00 and 43 yrs experience back of our guarantee

B. GUTTER & SONS

Wholesale Jewelers & Diamond Importers
172 NASSAU ST., DIV. 891 NEW YORK

AGENTS \$1.50

THIS IS
A Gold Mine at
A Throw

ONLY 20 BOXES A DAY MEANS \$18 DAILY PROFIT



"LUCKY 11" Assortment in Display Case

Full size of box 6x13 1/2 in. Each article full drug store size. Retail value \$3.35; you sell for \$1.50 and more than double your money. Think of it. The array of toilet goods (that always appeals to lady's heart) will dazzle her eye, and when you state the low price of only \$1.50 for these 11 articles, the money is yours, even if she has to borrow or beg it.

Act Now! Sells like hot cakes—men and women coming in to 20 dollars a day—a baby could sell "Lucky 11." 30 other big sellers. Don't delay a minute. Each day's delay means big money loss to you. Sample outfit including Display Case will be sent postpaid for \$1.50. Write for full details. Hurry! Hurry! before it's too late. Act NOW.

E. M. Davis Products Co. Dept. 5605 Chicago

MECHANICS FOR YOUNG AMERICA

Plain and complete directions for building boats, water motors, wind mills, searchlight, burglar alarm, ice boat, water bicycle, cabins, camps, kites, etc. 6x9 in. Illustrated. 30c. postpaid. Popular Mechanics Book Dept., 200 E. Ontario St., Chicago.

HERE'S WHAT YOU NEED

(If not in want now preserve this)

The American Combined Level and Grade Finder

With Compass
For Contractors, Carpenters, Surveyors, Architects and Civil Engineers.

It is simple, accurate, easily understood. Shows the true slant on any line or grade in degrees, inches, and percentages. Write at once for Agency, has over 300 testimonials, booklet, and introducing prices.

EDWARD HELB, P. O. Box 75, RAILROAD, PA.

New Cord Tires

12000 Mile Written Guarantee

These tires are made by one of the largest standard tire mfgs. in the U. S. and are of the very best quality. Our tires are so good and made by such a well known maker that after your first order you will buy repeatedly from us. When you see the quality and the brand you will be convinced. All are cord tires except 30x3 1/2 size.

30 x 3 1/2 C. L.	\$9.85
Cord Tires		
31 x 4 N. S. ss	\$21.95
32 x 4 N. S. ss	23.95
33 x 4 N. S. ss	24.65
34 x 4 N. S. ss	25.40
32 x 4 1/2 N. S. ss	29.85
32 x 4 1/2 N. S. ss	\$30.75
34 x 4 1/2 N. S. ss	31.50
35 x 4 1/2 N. S. ss	37.75
34 x 4 N. S. ss	38.75
35 x 4 N. S. ss	39.75

Send No Money—We ship C. O. D. with privilege of examination.

WEST SIDE TIRE WORKS
4445-49 W. Madison St. Dept. 30, Chicago, Ill.

\$1.00 MYSTERIOUS CHARM

Tested and keeps everybody guessing — IF YOU ARE A MASON — you should carry a Mysterious Charm. Write it — instantly revealing the SQUARE AND COMPASS.

Gold plated. Sent postpaid, \$1.00. FREE. Mosaic Catalogue listing publications, jewelry, paraphernalia.

REDDING & COMPANY
200-5th Ave., Dept. 25, N. Y. C.

Bamboo Self Filling Fountain Pen

IMPORTED FROM JAPAN

"It Makes Carbon Copies"
GUARANTEED FOR 1 YEAR

F. SPORS & CO.
Dept. 3
Lesueur Center, Minnesota

Hustlers Making \$20.00 Daily! Money refunded if you don't think it's the best pen you ever wrote with. Just Out! Up to 150 per cent Profit. Regular Price \$1.25. Rush 65c for sample and quantity Price List. Distributing plans free.



Why worry along on a small income when you are able to make much more? Why sacrifice when prosperity calls you? Come into the Big Money Class. I'll show you in a few minutes time how to handle this business exactly like my Big Money Makers do. Devote full time or spare time. No experience needed. I'll give you the whole plan and talk, word for word, so you too will have a chance to earn \$180 in two weeks like Newton did, or \$17 in one day like Cox, or \$13 in 1 1/2 hours like Boyd or \$15 a day like hosts of others. It's easy with my amazing new sales plan.

FREE AUTO AND CASH BONUS OFFERS

Millions of homes need our new Sanitary "Nemco Brand" Solid Aluminum Handle, Big Cutlery Set. It's a WONDER—the Newest Kitchen SENSATION. Fast replacing old Unsanitary, Unhealthy cutlery. Used by doctors. Reports show 9 out of every 10 women who see it, want it. Silver-like finish—no seams, crevices or openings to collect dirt and foreign matter—Sanitary and Beautiful—sealed-tight construction—LOW PRICE—\$1.50 Gift Free to every customer. We deliver and collect. Pay daily. No capital. I need more sales agents quick to fill enormous demand everywhere. Write at once.

New Era Mfg. Co., Dept. 99A, 803 Madison St. Chicago

Cut your Own Hair!



Free Trial Offer

You can cut your own hair just as easy as brushing your hair, with the Cowan HAIR CUTTER SAFETY RAZOR. Marvelous new invention does away with tiresome waits in the barber shop. Gives you a perfect hair cut right in your own home. Saves your time and patience, as well as the cost of hair cuts. We'll take all the risk. Our free trial offer will show you beyond the shadow of a doubt that you can cut your own hair as well as any barber can cut it. A finished hair cut just as you want it, in fifteen minutes. Any time, any place—it's always ready!



For MEN and WOMEN

Made so anyone can use it properly and get a good hair cut on the first trial. For trimming around ears, a simple adjustment gives the proper angle. Hair is evenly tapered. Will not shave nor split hairs. Each hair cut off squarely. Adjustable for use as a safety razor. Comes packed in an attractive and convenient leatherette-covered metal case. Blades of finest Swedish steel, especially tempered and ground. The Cowan Hair Cutter is made from the best of materials by high-class workmen. Will last a lifetime and will pay for itself many times over.

OVER FIFTY THOUSAND satisfied users. But the real proof for you is to get a Cowan and prove it to yourself.

WHY WAIT? You'll be cutting your hair in a year or two anyway—everybody will—it'll be the accepted thing. The Cowan is here to stay—get one and save money, time and patience.

SEND NO MONEY

Just send your name and address today for details of our Free Trial Offer. Send no money. Take no risk—assume no obligation. Prove the "Cowan" in your own home right now. A postcard will do.

J. H. COWAN COMPANY

Cor. Admiral and McGee Dept. 71 Kansas City, Mo.

Manufactured and Sold in Canada by
COWAN HAIR CUTTER SALES CO.
OF CANADA, Ltd.

141 Bannatyne Ave. Dept. 71 Winnipeg, Man.

AGENTS WANTED



Ford Owners! Free Trial of AUTOVAC

Amazing Discovery That Cuts Oil Bills 33 1/2% To 50%!

Your Ford will have a smoother running motor—and we guarantee you will reduce your oil consumption 33 1/2% to 50%—if you put AUTOVAC on the crank case of your car—removing the oil filter plug. AUTOVAC stops dust and grit from being drawn into the crank case. It enables you to feed your motor oil that is really CLEAN; eliminates the cause of misfiring; stops oil leakage; keeps your motor clean. Over 65,000 Ford owners are enthusiastic about what it accomplishes.

Free Trial For Ten Days—Send No Money

Put AUTOVAC on your Ford for 10 days at our expense! If it gives you a smoother running motor—if it cuts your oil bill 1-3 to 1-2—send me only \$3.50 in full payment at the end of 10 days. Otherwise return it—without obligation. You will be astonished at what AUTOVAC will accomplish. So write today. Simply say "Send me AUTOVAC. I will put it on my Ford for 10 days. If it does everything you say it will, I will send you \$3.50. Otherwise I will return it without obligation." Address

AUTOVAC COMPANY, 613 WALLACE BLDG., SALISBURY, N. C.

"The Torpedo"

The Model D—popular Torpedo type body equipped with a complete Flat style Radiator. The body is sturdy and guaranteed to stand up under any kind of strain (generally used for professional racing).

Gas tank in tail end, door on right side with inside lever lock.

CHAMPION RACING BODY CO., 7-9 East 28th St., CHICAGO, ILL.



CARPENTER'S The Original LIQUID COURT PLASTER



When your skin is injured DON'T use a clumsy, sticky, soiled cloth. Liquid Court Plaster quickly protects any small break with a flexible, clean, washable covering. Send 10c for a 1 1/2 tube, to cover handling and packing.
Carpenter Chemical Co., 60 Cadillac St., Detroit, Mich.

15¢

**Easy to Play
Easy to Pay**



BUESCHER

**TRUE-TONE
SAXOPHONE**

Saxophone Book Free
Tells when to use Saxophone singly, in sextettes or in regular band; how to play from solo parts in orchestra, and many other things you would like to know.

Easiest of all wind instruments to play and one of the most beautiful. You can learn the scale in an hour's practice and play popular music in a few weeks. You can take your place in a band within 90 days if you so desire. Unrivalled for home entertainment, church, lodge or school. In big demand for orchestra dance music. The portrait above is of Donald Clark, Soloist with the famous **Paul Whiteman's Orchestra**.

Free Trial You may order any Buescher Instrument without paying in advance, and try it six days in your own home, without obligation. If perfectly satisfied, pay for it on easy payments. Mention the instrument interested in and a complete catalog will be mailed free.

(34)

BUESCHER BAND INSTRUMENT CO.
Makers of Everything in Band and Orchestra Instruments
2588 Buescher Block Elkhart, Indiana

Buescher Band Instrument Co.
2588 Buescher Block, Elkhart, Ind.

Gentlemen: I am interested in the instrument checked below:

.....Saxophone.....Cornet.....Trombone.....Trumpet
(Mention any other instrument interested in.)

Name.....

Street Address.....

Town..... State.....



**Tom Mix
Uses
RenuLife**

"I own a complete set of RenuLife Violet Ray and find it of immense value in retaining a robust physique. I find it especially helpful in curing the sprains and bruises that I often incur in my strenuous career."

Tom Mix

**Do You, Too, Want Health
and Strength?**

YOU can have vigor, energy, health, strength and beauty. You need not suffer from aches and pains—from rheumatism, neuritis or other ailments. The soothing, healing RenuLife drives out aches and pains without shock or unpleasant sensation and searches deep down in your body to eliminate the cause. It carries ozone into the blood, enriching and purifying it.

Send for Our New Book

Get your copy of Health, it shows how you can use electricity to regain health and strength. Write today. Learn how RenuLife Violet Ray will help you get well.

RenuLife Electric Company
145 Newberry Bldg. Detroit, Michigan

Of course, you need a tool chest
Make sure you buy a

UNION

For Union Chests are better chests. Better in design, material and utility. Built in more than 50 different styles and sizes for all mechanics. Zinc or leatherette-covered and quartered oak models.



Write today for illustrated catalogue, and take the first step toward preventing loss, theft and damage of tools.

UNION TOOL CHEST CO.
22 Mill Street Rochester, N. Y.

**ROLLING
BATH TUB WITH WATER HEATER**



**For Homes
Without Running Water**

Enamel tub and 12-gallon nickel water heater, attached to frame fitted with casters. Rolls anywhere. Folds up when not in use. Just the thing for small homes. No plumbing required. Supplies hot water in few minutes. Over 40,000 in use. Write for special offer from factory-to-you.

Roberts Kerosene Burner

Put one in your cook stove and have a cool kitchen all summer. Operates like gas stove. Fits any cook stove or range burner. The best oil burner on the market. No comparison between the Roberts and other makes. Write for price from factory-to-you. Agents and dealers wanted. Write for territory.

Roberts Metallic Bath Tub Co., Dept. 14, 736 Madison Ave., DETROIT, MICH.



**CATALOG No. 22
IS READY**

Small Steam and Gasoline Engines, 1/4 H. P. up. Pumps, gears, model makers' supplies. Sent postpaid (2 dimes preferred) or 20c stamps.

Modern Engine & Supply Co.
324 Menzies Bldg., Chicago



**MYERS ELECTRIC
IRON CORD HOLDER**

A wonderful invention. Keeps cord out of way while ironing. Grips the ironing board. Worth its weight in gold.

AGENTS WANTED

Sample 50 cents postpaid.

C. A. MYERS CO., 6339 Woodlawn Ave., Chicago, Ill., U. S. A.

BLANK CARTRIDGE PISTOL

Protection against Burglars, Tramps, & Dogs



**PRICES
50c.
\$1.00**

POST-PAID

Well made and effective, modelled on latest type of Revolver; appearance alone is enough to scare a burglar. When loaded it may be as effective as a real revolver without danger to life. It takes standard .32 Cal. Blank Cartridges obtainable everywhere. Price 50c. Superior quality \$1.00 postpaid. Blank Cartridges, by express, 50c per 100.

Johnson Smith & Co., 1218 Washington Ave. Dept. 946, Racine, Wis.

Swear Off Tobacco

Tobacco Habit Banished Let Us Help You

Quick Results

Trying to quit the tobacco habit unaided is often a losing fight against heavy odds, and may mean a serious shock to your nervous system. So don't try it! Make the tobacco habit quit you. It will quit you if you will just take **Tobacco Redeemer** according to directions.

It doesn't make a particle of difference whether you've been a user of tobacco for a single month or 50 years, or how much you use, or in what form you use it. Whether you smoke cigars, cigarettes, pipe, chew plug or fine cut or use snuff—**Tobacco Redeemer** will positively remove all craving for tobacco in any form in a few days. Your tobacco craving will usually begin to decrease after the very first dose—there's no long waiting for results.

Tobacco Redeemer contains no habit-forming drugs of any kind and is marvelously quick, scientific and thoroughly reliable.

Not a Substitute

Tobacco Redeemer is in no sense a substitute for tobacco, but is a radical, efficient treatment. After finishing the treatment you have absolutely no desire to use tobacco again or to continue the use of the remedy. It helps to quiet the nerves, and will make you feel better in every way. If you really want to quit the tobacco habit—get rid of it so completely that when you see others using it, it will not awaken the slightest desire in you—you should at once begin a course of **Tobacco Redeemer** treatment for the habit.

Results Absolutely Guaranteed

A single trial will convince the most skeptical. Our legal, binding, money-back guarantee goes with each full treatment. If **Tobacco Redeemer** fails to banish the tobacco habit when taken according to the plain and easy directions, your money will be cheerfully refunded upon demand.

Let Us Send You Convincing Proof

If you are a slave of the tobacco habit and want to find a sure, quick way of quitting "for keeps" you owe it to yourself and to your family to mail the coupon below or send your name and address on a postal and receive our free booklet on the deadly effect of tobacco on the human system, and positive proof that **Tobacco Redeemer** will quickly free you from the habit.

Newell Pharmacal Company
Dept. 300 St. Louis, Mo.

Free Book Coupon

NEWELL PHARMACAL CO.,
Dept. 300 St. Louis, Mo.

Please send, without obligating me in any way, your free booklet regarding the tobacco habit and proof that **Tobacco Redeemer** will positively free me from the tobacco habit or my money will be refunded.

Name.....

Street and No.....

Town..... State.....



Tobacco Tells on
Nervous System



Tobacco Ruins
Dignation



Tobacco Stunts
Boy's Growth



Tobacco Robs
Man of Vitality



Tobacco Steals
from You the
Pleasures, Com-
forts, Luxuries
of Life





"BIASCOPE" SIX-POWER

Coat pocket size binocular. Weighs only 7 oz. Dimensions 3½ by 3½. Objective lenses are 25mm. diameter, giving 6 linear magnifications. Limp leather case.

See More

See farther and see better. Wollensak 'Scopes eliminate distance, reveal a myriad of objects invisible to the naked eye, and enhance the pleasure of outdoor life for sportsmen, tourists, hunters, campers, boy scouts, etc.

If your dealer cannot supply you, order direct adding 25c for tax and postage on Biascope and 5c for postage on Pockescope. Money back promptly if not pleased.

Wollensak Optical Co.

70-72 Clinton Ave., Rochester, N. Y.

quality photo lenses and shutters for 24 years

"POCKESCOPE" THE POCKET TELESCOPE

Magnifies 4½ times. Less than 4 inches long. Weighs only 1½ oz. Slips into the vest pocket like a cigar or lead pencil. Complete in limp leather case.



Our BUREAU OF INFORMATION will answer all questions regarding articles appearing in this magazine.

Address Bureau of Information, Popular Mechanics Magazine, Chicago



Collapsible Garment Hanger

This new article is very useful every day in the year especially valuable for taking care of anyone's best clothes and is convenient in closets, halls, offices, wardrobes and bath rooms. A space saver and relieves crowded places. Made of best of steel. Holds four times as many clothes as one hook and does not require any more space. Send for our circular and prices of this hanger.

B. D. GAUSE MFG. CO., Elkhart, Ind.

Amateur Electrical Experimenters

Here is the book you have been waiting for. It tells how to make things electrical, such as radio outfits, reading lamps, electric clocks, toasters and countless other useful appliances from materials easily obtainable. No previous electrical knowledge necessary. Clear directions, fully illustrated.

How to Make Things Electrical

427 pp. — 256 Articles — 353 Illustrations

4½x7 Cloth
Price \$2.50 Postpaid



Popular Mechanics
Book Dept.

200 E. Ontario St., CHICAGO

Send No Money

FOR THIS

Big 3 Ft. Telescope

IN FIVE SECTIONS

Opens out over 3 ft. long; closed measures 12 in. Brass bound, fitted with powerful lenses. See people and objects miles away as though they were close. Useful and provides great enjoyment.

SPECIAL OFFER on a limited supply of these telescopes. Order today! Just send in your name and we will ship telescope complete by parcel post. On arrival deposit \$1.85 with the postman, plus a few pennies postage. (Or if you prefer send \$1.85 with your order in full payment). Satisfaction guaranteed or your money returned in full!

FERRY & CO., Dept. 1774, 75 W. Van Buren St., Chicago



SEE OBJECTS MILES AWAY

Watch persons at a distance on land and sea. See the Sun, Moon and Stars as you never saw them before. You can have loads of fun with this telescope. "Can see children playing in school yard 6 miles away." — P. H. Hennington, McQuade, Texas. "It is a wonder for such a low price." — E. H. Nordstrom, Salt Lake City, Utah.

More Profits for Woodworkers

"I made \$20.00 clear profit in 23½ days, beside my time at \$8.00 per day." That's how a man in Fall River, Mass., doubled his earnings with the

Boice Junior Bench Saw

A wonderfully practical, compact, all metal machine designed for accurate and speedy sawing, ripping, grooving, etc. Cuts 1½" stock. Dadoes ¾" deep and ¾" wide. Driven by ¼ or ½ h. p. motor. Special saws cut type-metal, bakelite, brass, etc. Portable. Attaches to lamp socket.

Write for descriptive literature on the Junior Bench Saw, 4" Jointer, 14" Bench Band Saw, Bench Drills, Motors, and larger Bench Saws.

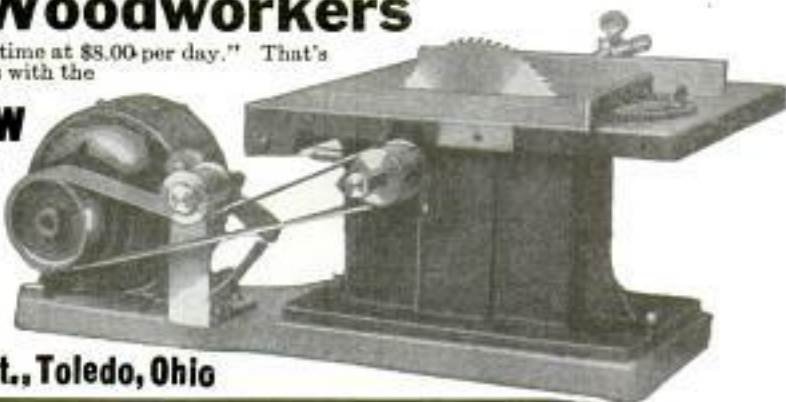

W. B. & J. E. Boice Dept. P. M. 5 114 23d St., Toledo, Ohio

FROST RADIO PROTECTOR

Listed and
approved by
**Underwriters'
Laboratories**

under revised regula-
tions dated May, 1922



Order today
from your
dealer.
Price: \$1.50

Has THREE Big Features

1. The Frost Radio Protector is *self-cleaning*.
 2. Positively no interference with radio reception.
 3. Mounts indoors like your telephone protector.
- Under new rules as revised May, 1922, every radio receiving station with outdoor aerial must use an approved protector. Frost "Sawtooth" self-cleaning protector is best for your set. Get one from your dealer today—protect your home and your set.



HERBERT H. FROST, Inc.
154 WEST LAKE STREET, CHICAGO, ILLINOIS.



Pay Day!

Just Another Disappointment

It need not be—if you find the work for which you are best adapted. Advancement—making more money—and love for your work are bound to follow.

Our "Personal Analysis" charts you for the right business—places you exactly where you belong—points unerringly to the one position where your individual qualifications will bring the fullest reward.

To win the success you dream of—to make pay day a source of satisfaction instead of a disappointment, first find the work for which your capabilities fit you. If you're in the wrong job, the hardest effort and perseverance can't bring great achievement. Learn the facts. It is not too late. Happiness and prosperity are both at stake.

Many men past middle age, have turned failure into success by changing to the work for which they are fitted. Young men on the threshold of their careers are no longer choosing employment blindly. For the way to know has been provided.

Personal Analysis Solves the Problem

A new science, recognized by educators and big business men has been evolved—called by many, vocational guidance. We term it Personal Analysis, because a board of experts make a careful study of your qualifications, tell you what your abilities are, and what career promises you the quickest, surest success.

Many have profited by it already. Leading universities and men prominent in industry recommend it to any who wish to be certain what course to pursue.

A Trial Analysis—FREE

Fill out the coupon below and receive not only a free preliminary analysis but full particulars as well. You will then see for yourself, before investing a dollar, how practical and necessary our Personal Analysis is in your achievement of success. Use the convenient coupon NOW.

AMERICAN SCHOOL

Dept. PX1 Drexel Ave. and 58th St. Chicago

Now for the Facts and a Real Future
SEND NO MONEY—USE THE COUPON

American School, Chicago Dept. PX1
Gentlemen: *This Is Not a Contract.* Please send me FREE Preliminary Analysis blank. I will fill in answers to questions and return analysis blank at once. Also send me FREE particulars of Complete Personal Analysis.

Name.....
Street.....
City.....State.....

Please Mention Popular Mechanics



SPECIAL FORD TAP AND DIE SET, ONLY \$3.00 DIRECT FROM THE FACTORY TO YOU!

Our Special Ford Set furnished in our highly finished chestnut box contains 5 each taps and dies: 1-4, 6-16, 8-8, 1-16 & 1-2". In the S.A.E. thread, 1 die stock, and one tap and reamer wrench (No. 12).

Send us your order at once and be one of our many satisfied customers. Let us also send you one of our circulars illustrating our full line of Handy Tools. WORCESTER STEEL PRODUCTS CO., Dept. P 3, 25 Union Street, Worcester, Mass., U. S. A.

AMATEUR MECHANICS

A book for those who like to make things. 132 separate articles tell how to build electrical and mechanical devices, reef furniture, fishing tackle, hammocks, etc. 158 pp., illustrated. 25 cents postpaid. Popular Mechanics Book Dept., 200 E. Ontario St., Chicago

Agents Make \$12⁰⁰ a Day!



NEW Self-Heating IRON

New development makes ironing easy. Cuts ironing time in half. Saves steps. Costs one cent for 3 hours use. No attachments. Gives clean, quick heat easily regulated. Absolutely

safe. Uses kerosene or gasoline. Starts with match without smoke or smell. Sells fast. Mrs. Wagner, Ohio sold 24 in few hours spare time. Moyer of Pennsylvania made \$164 in one week. You can do as well. Work all or spare time. No experience needed. Simply take orders. We deliver and collect. Commissions paid same day you take orders. Send for catalog and FREE OUTFIT OFFER. Write today.

THE AKRON LAMP CO.

35 Iron St., Akron, O.



When you buy a rifle or a shotgun— you should be getting a lifelong friend

And you will if you choose a *Stevens*—that's certain. You'd be surprised at the large number of men today still using the same old *Stevens* rifle or shotgun they bought as boys.

For a *Stevens* is accurate—and it stays accurate—it's accuracy built-in to last.

When a *Stevens* barrel is bored or drilled, the final cutting removes less than one-half of a thousandth of an inch.

And the same painstaking care is given to every detail—to getting a handsome finish; to striking just the right balance.

Finally—the prices. Little short of amazing are the *Stevens* prices. Just glance at the price shown on the rifle pictured here. And the same low prices throughout the *Stevens* line.

Ask at your dealer's or write for the interesting catalog describing in detail the *Stevens* complete line of rifles and shotguns.

J. STEVENS ARMS COMPANY
Dept. 565, Chicopee Falls, Mass.

Owned and operated by the
Savage Arms Corporation

Retail price—including
tax \$15.00. *Stevens* "Visible
Loading." An accurate
.22 Cal. Repeater. You
know when it is loaded,
and you know when it is
empty.

Stevens

Please Mention Popular Mechanics

KENNEBEC CANOES

"SAFEST
TO USE"



Enjoy healthful outdoor life in a Kennebec. It's *great fun—and safe*. Special construction prevents tipping. Kennebecs are *strong, light*—have graceful lines and are beautifully finished. Send for illustrated catalog. Popular prices. KENNEBEC BOAT & CANOE CO., 28 R. R. Square, Waterville, Maine.

How to Select Safe Bonds

Every investor wishing to learn about bonds of absolute safety yet paying an attractive yield (ranging as high as 7%) should write at once for this book, which will be sent for the asking. It has been prepared by George M. Forman & Company.

YOUR COPY NOW READY

In every banking circle the name of George M. Forman & Company has always been associated with sound investments and an attractive yield. Just a postcard or a letter will bring you your copy of our interesting book, "How to Select Safe Bonds."

GEORGE M. FORMAN & COMPANY, Dept. 445
105 W. Monroe Street, Chicago, Ill.
"25 Years Without Loss to a Customer"



PILLIOD Tool Cases Excel

Machinists, Tool Makers and Carpenters find them most satisfactory in construction, appearance, service and price. Immediate shipment.

Booklet describing 20 styles on request.
THE PILLIOD LUMBER CO.
Dept. 1 Swanton, Ohio

GOLD FILLED CHAIN FREE

Agents! \$6.25 profit on every sale! How many watches can you sell a day at \$15? Just show your watch and collect your profit. We ship C. O. D. for balance \$8.75, postage paid, direct to your customer!

21 Jewel R.R. Watch. Manufacturer's guarantee stamped on case and movement. 21 JEWELS, adjusted 3 positions, railroad dial, nickel-bridge "works."

AGENTS WANTED! Took 2 orders in 15 min. Reduced from \$25.00
size which paid for sample and \$3.75 over. You can see tool!



8⁷⁵
SEND NO MONEY!
Pay only \$8.75
wholesale price when watch arrives. We pay postage. Beautiful gold-filled vector or coat chain FREE this month only—state which. Money back if you want it!
GOLD WATCH CO.
Dept. 112 2512 Michigan Av. Chicago

Make Your Bike a Motorcycle

The Famous SHAW 2½ H. P. MOTOR ATTACHMENT

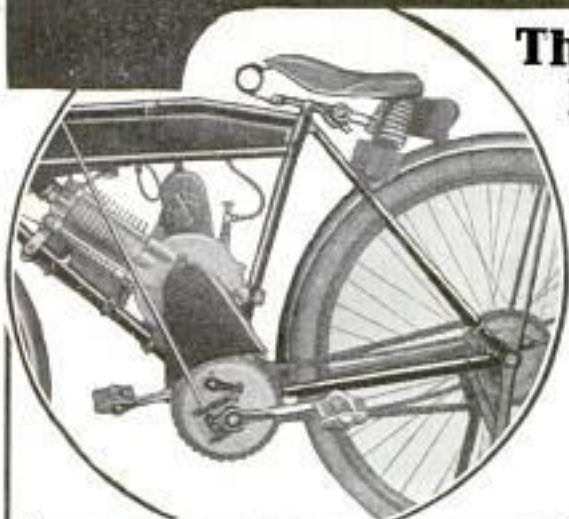

Why envy the fellow who rides an expensive heavy weight motorcycle? For a fraction of his investment you can easily convert your bike into a sturdy, lightweight, dependable motorbicycle. With a 2½ horsepower Shaw Motor on your bike you can travel with any of them—up the steepest hills, over sandy or muddy roads, and on long tours. You can enjoy the great out of doors and get the most out of life at the least cost.

The powerful Shaw Motor gives a speed of 4 to 40 miles an hour. 90 to 125 miles on a gallon of gasoline and 1200 to 1800 miles on a gallon of oil. Cheaper than walking. Sportier than foot pedaling.

Attach in 30 Minutes—No Special Tools FITS ANY MAKE BICYCLE

An ordinary wrench or screw driver are all you need to attach the Shaw Motor to your bike. No filing, fitting or boring. No changing or making over. 30 minutes after receiving your Shaw you can fill up with gas and oil and begin the greatest sport you've ever had. Simple directions are furnished. The Shaw clamps on bike frame making for easy control, better balance and greater power.

The Shaw Motor Attachment fits any standard bicycle frame. It transforms your bike both in appearance and performance. The perfect balance of the engine avoids vibration so common in most motors. Simple, dependable and safe at all times. The price is so low that you will hardly miss the money. In fact you'll soon pay for it in carfare and time saved.

The Complete Shaw Motorbicycle

If you have no bike and desire a complete Shaw Motorbicycle here it is. A lightweight, powerful, motorbicycle, complete in every detail. All latest 1923 improvements. 2½ horse power motor of highest efficiency. Special New Low Prices Now. Use coupon.



Take Advantage of New Low Prices

The 1923 Shaw Motor is the best model we have ever built. And we have made tremendous price reductions. You can now own a Shaw Motor Attachment at less cost than ever before. You can join the other thousands of happy, enthusiastic Shaw users. Do it now.

WRITE TODAY

The summer season is at hand. Write today for free complete descriptive literature and new low prices on Shaw Motor Attachment, Complete Shaw Motorbicycle, New Shaw Cycle Car or New Shaw Garden Tractor. Use Coupon. Check information desired.

SHAW MFG. CO.

Dept. 101, GALESBURG, KANS.

USE THE COUPON

Clip the coupon below. It is for your convenience. Check item on which you desire free information.

SHAW GARDEN TRACTOR

A better power farm tractor at a lower cost. Just the thing for truck gardeners, small farms, estates, etc. Equipped with famous Shaw motor. Get full particulars. Use coupon.



2½
H-P.
LOW
PRICE

Easy to Build this SHAW Cycle Car

A real automobile that you can easily build yourself. Carries 2 passengers anywhere. Power supplied by famous 2½ H. P. Shaw Motor. We supply everything. Check Coupon for free particulars. Complete Book of easy to follow plans 25c.



BOOK
OF
PLANS
25¢

SHAW MFG. CO., Dept. 101, GALESBURG, KANS.

Please send me full particulars and new low prices on articles I have checked below, all without obligating me.

- | | |
|--|--------------|
| <input type="checkbox"/> Shaw Motor Attachment. | Name..... |
| <input type="checkbox"/> Complete Shaw Motorbicycle. | Address..... |
| <input type="checkbox"/> New Shaw Cycle Car. | R. F. D..... |
| <input type="checkbox"/> New Shaw Garden Tractor. | State..... |



LOWEST PRICES GUARANTEED TYPEWRITERS

Send us only \$5.00 a month until the low total price of \$66.20 is paid, and the machine is yours.

FREE TRIAL This is absolutely the most generous typewriter offer ever made. Do not rent a machine when you can pay \$5.00 a month and own one. Think of it—Buying a \$110.00 Machine for \$66.20. Cash price, \$61.70, just a little more than half its original price.

The Famous **L.C. Smith** Model No. 8

This is the famous L. C. Smith typewriter which has set the world's standard for quality and service for over twenty years. Perfect machines, Standard size. Keyboard of Standard Universal arrangement, 42 Keys, writing 84 characters—universally used in teaching the touch system. The entire line of writing completely visible at all times, has the declinal tabulator, the two color ribbon, with automatic reverse, the back spacer, ball bearing type bars, ball bearing carriage action, ball bearing shift action, in fact every late style feature and modern operating convenience. Comes to you with everything complete; tools, cover, operating book and instructions—nothing extra to buy. You cannot imagine the perfection of this beautiful rebuilt typewriter until you have seen it. We have sold thousands of these perfect late style machines at this bargain price and every one of these thousands of satisfied customers had this beautiful, strictly up-to-date machine on five days' free trial before deciding to buy it. We will send it to you F. O. B. Chicago for five days' free trial. It will sell itself, but if you are not satisfied that this is the greatest typewriter you ever saw, you can return it at our expense. You won't want to return it after you try it, for you cannot equal this wonderful value anywhere.

SEND NO MONEY Order Now—Before They're Gone

When the typewriter arrives deposit with the express agent \$6.20 and take the machine for five days' trial. If you are convinced that it is the best typewriter you ever saw keep it and send us \$5.00 a month until our bargain price of \$66.20 is paid. If you don't want it, return it to the express agent, receive your \$6.20 and return the machine. We will pay the return express charges. This machine is guaranteed just as if you paid \$110.00 for it. It is standard. Over half a million people own and use these typewriters and think them the best ever manufactured. The supply at this price is limited, the price will probably be raised when next advertisement appears, so don't delay. Fill in the coupon today—the typewriter will be shipped promptly. There is no red tape. We employ no collectors—no collectors—no chattel mortgage. It is simply understood that we retain title to the machine until full \$66.20 is paid. You cannot lose. It is the greatest typewriter opportunity you will ever have. Do not send us one cent. Get the coupon in the mails today—sure.

SMITH TYPEWRITER SALES CO., 300, 360 E. Grand Ave., Chicago, Ill.

SMITH TYPEWRITER SALES CO., 300, 360 E. Grand Ave., Chicago, Ill.

Ship me the L. C. Smith Model No. 8, F. O. B. Chicago, as described in this advertisement. I will pay you \$5.00 monthly as rent until the \$60.00 balance of the Special \$66.20 sale price is paid. The title to remain in you until fully paid for. It is understood that I have five days in which to examine and try the typewriter. If I choose not to keep it I will carefully repack it and return it to the express agent. It is understood that you give the standard guarantee.

Name.....

Street Address.....

City..... State.....

Occupation or Business.....



Ever Get Stuck On a Job?

SHOP NOTES FOR 1923

The latest volume of Popular Mechanics series of year books tells

544 Easy Ways to Do Hard Things of daily use to every mechanic. Among the many useful articles are Shop Crane—Testing Motors—Power Hammer—Arbor Press—Air Compressor—Turret Lathe—Bench Punch—Concrete Mixer—Bench Grinder—Drag Saw—Concrete Tile.

224 Pages—436 Illustrations
Price 50 Cents, Postpaid

Nine of the volumes of Shop Notes issued previously are also obtainable at 50 cents per copy postpaid.

POPULAR MECHANICS BOOK DEPT.
200 E. Ontario St., Chicago

FREE ELECTRIC FIXTURE CATALOG!



1000 Different Fixtures Illustrated

Write today for your copy. Save 50% direct from Mfrs. No Middleman's Profit.

OUR SPECIAL: 8-room Electric Set ready to hang, \$24.00—Many other bargains.

UNITED LIGHTING FIXTURE CO.
280 Bowery, Dept. CC, New York City

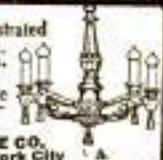

COMMERCIAL ENGRAVING and PRINTING

Contains hundreds of ideas and suggestions of service to the advertising man, printer, salesman, student, photographer, artist, engraver, electrotypist, bookbinder, paper jobber, etc., and will be invaluable as a permanent work of reference.

850 Pages. Over 1500 illus. Cloth. Price \$15.00, postpaid.
Popular Mechanics Book Dept., 200 E. Ontario St., Chicago.

Cultivate Your Musical Bump



Conn instruments are easiest to play and highest quality, say the world's greatest artists. Write now for Free Book and details of FREE TRIAL; EASY PAYMENTS on any band instrument.

C. G. CONN LTD.
531 Conn Bldg.
Elkhart, Ind.



WORLD'S LARGEST MANUFACTURERS OF MUSICAL INSTRUMENTS

COOK AND BAKE

With Amazing New Invention

No More Sweltering Kitchens in Summer—No More Fires to Build—No More Dirty Heavy Coal—No More Ashes in House—No More Scuttles to Empty—No More Smelly, Sooty Oil Stoves to Clutter Kitchen. No More Spoiled Roasts, Bread or Cake from Uncertain Oven.

Makes Your Range A REAL GAS STOVE

An amazing new invention has ended forever the days of woman's slavery to all kinds of household drudgery. The Oliver Oil-Gas Burner—makes any coal or wood range a real gas stove—on and off with a valve. Gives much or little heat—only when you want it—at a twist of your wrist.

Wonderful Baking Bake right in your good old oven—better and quicker than ever before. No need for keeping a hot fire going all day.

AGENTS

If you want to earn \$40 to \$50 a week spare time, \$250 a week full time or if you can swing a whole territory at \$5,000 to \$15,000 a year, write me quick for sales plan and Exclusive Territory Franchise.

Oliver Gives Fords Away

I give Fords to my producers. The big Summer Season is just starting. Write today. Address me personally, Mr. B. M. Oliver, President, at address shown on coupon.

You want a batch of bread or biscuits, a light fluffy cake or pies; or you wish to prepare a meal simply turn a valve and *light your fire*. In a jiffy the oven is at a fine even temperature—any degree you want. Put in your roast or baking—put on your stew of vegetables. Go away and forget them. Come back when they are done—turn the *fire out instantly*—and your kitchen is cool and clean.



Burns 95% Air, 5% Oil—Fits Any Stove

Mr. Oliver's wonderful invention is made in 16 models—fits any kind of cook stove or range without changes or drilling. Sets in firebox in one minute. Absolutely safe. Lasts a lifetime.

30 Days' Free Trial

You don't have to be satisfied with reading about the Oliver. You can test it for thirty days—use it in your own home—bake with it in your own oven—on Mr. Oliver's Free Trial Offer. If you mail the coupon at once you will be in time to receive Mr. Oliver's Special Low Introductory Price and 30 Day Free Trial Offer, together with his attractive free booklet, "New Kind of Heat." No obligation. But mail the coupon before you turn this page.

OLIVER OIL-GAS BURNER & MACHINE CO.
2014-E Oliver Building, St. Louis, Mo.
Canadian Offices: 2014-E Webster Bldg., Toronto

OLIVER OIL-GAS BURNER & MACHINE CO.

2014-E Oliver Building, St. Louis, Mo.
Send your Free Book, "New Kind of Heat," and also your special low price and 30 Day Free Trial Offer. This does not obligate me in any way.

Name.....
Address.....
City..... State.....



THIS PALATIAL Florida Home

can be purchased at a very reasonable price. It is the finest estate in a community of 30,000 situated amid 5 acres of orange, grape fruit, sweet bay, palmetto and a large variety of semi-tropical trees and foliage. A water front of 400 feet, with entrance from a Boulevard, affording every modern convenience. House recently completed and never occupied. Has every modern improvement, large sun parlors, sleeping porches and 8 bath rooms. Inexhaustible supply of soft water, steam heat, high, light basement under entire house. Surf bathing all winter within 5 minutes walk.

For full details, photographs and price address the owner,

H. H. WINDSOR,
200 E. Ontario St., CHICAGO, ILL.

GET U. S. GOV'T JOBS

Railway Mail Clerks, City Mail Carriers, Rural Carriers, City Postal Clerks, Clerks at Washington, D. C.

\$1140 to \$2600 a Year STEADY, SHORT HOURS,
Long vacations with pay.
MEN—WOMEN 18 OR OVER

Send coupon immediately for full list of positions obtainable. Don't delay.

FRANKLIN INSTITUTE, Dept. R-182, Rochester, N. Y.

FRANKLIN INSTITUTE, Dept. R-182, Rochester, N. Y.

Gentlemen:—Kindly send me, at once, and entirely without charge or any obligation on my part, list of U. S. Government big paid positions obtainable. Advise me also regarding the salaries, hours, work, vacation and tell me how I can get one of these positions. Send me also free sample examination questions.

TEAR HERE

Name.....

Address.....

SURFIX

Chemically Processed LIQUID GLASS

Science has at last produced Surfex. A liquid glass treatment for the finish of automobiles and furniture. Every painted or varnished surface is porous and Surfex seals the pores.

MAKES THE ORIGINAL FINISH PERMANENT

It has taken over twenty years of research and development work to perfect Surfex, and, although only recently put on the market, Surfex has been adopted by leading automobile and furniture manufacturers. A Surfexed surface is smooth, dry, transparent. Will not peel or crack. Can be washed with water and never requires polish. It is easily applied. A \$1 bottle will more than Surfex a large car. If your dealer is not able to supply you yet, send..... for a 6 oz. bottle.

\$1

Distributors

Established distributors with sales organizations, by immediate action can secure good territory. Nothing like Surfex on the market. Homekeepers and automobile owners, as well as operators of factories and stores, are waiting for Surfex.

SURFIX CHEMICAL CO.
Griswold & Atwater, Detroit, Mich., U.S.A.

Our BUREAU OF INFORMATION will answer all questions regarding articles in this magazine. Address Popular Mechanics Magazine, Chicago.

ONLY \$ **200 DOWN**

10 MONTHS TO PAY

48.00 PER MONTH

4.60 PER MONTH

30 DAYS FREE TRIAL

LOOKS LIKE **1 1/2 CT. DIAMOND**

\$600.

Choose the ring you like best, give finger size, and send only \$2.00 deposit to show your good faith. We will send the ring without any delay or red tape. If you like it, pay only \$4.60 each month for ten months. Total price only \$48.00 for either ring. If you return it within 30 days, we will return your money.

THESE RINGS WORTH 50% MORE

Former price \$75.00. The sparkling, blue white, perfectly cut, genuine diamond solitaire is set in an 18 kt. solid white gold ring. In the cluster ring, seven perfectly cut, blue white, genuine diamonds are set in solid platinum.

WRITE FOR JEWELRY CATALOG NO. 675
It brings a big jewelry store right into your home.

STERLING DIAMOND & WATCH CO.
(Established 1879. \$1,000,000 Stock)
63 PARK ROW, Dept. 675, NEW YORK, N. Y.

LAST CHANCE

to buy this big-capacity **\$13.50**
1/4 h.p. 110 volt AC motor for



Increasing cost of production will compel us to advance the price

Grinder and Buffer \$25.00
with above motor, up to May 1st. About half usual price.

Send cash with order, money back if not satisfied. Prices are f. o. b. Chicago.

Write for free Bulletins, describing our full line.

NORTHWESTERN ELECTRIC CO.
408 S. Hoyne Ave. CHICAGO, ILL.

Wrestling Book FREE



Learn to be an expert wrestler. Know scientific wrestling, self-defense, and jiu-jitsu. Develop a splendid physique, and have perfect health. Join this popular school and learn by mail. The famous world's champion—the marvelous

Frank Gotch and Farmer Burns

offer you a wonderful opportunity. Wrestling is easily and quickly learned at home by mail. Men and boys write now for splendid free book. Learn all the science and tricks. Be able to handle big men with ease. Accept this wonderful offer NOW. Send for free book today, stating your age.

Farmer Burns School of Wrestling, 9775 Range Blvd., Omaha, Neb.

A Long Looked for Invention
Has Improved
the
STRADIVARIUS VIOLIN

THE VIRZI "Tone Producer"

The Virzi "Tone Producer" installed in the violin or piano will render the tone free and clear as a bell, mellow, beautiful and brilliant—more than any other existing in the world. Try it and compare. It is recommended and used by Kreisler, Casals, Heifetz, Seltis, Tiband and other great artists. Write for booklet. If not satisfactory money refunded. We send money—J. & J. VIRZI BROS., No. 503 Fifth Ave., NEW YORK CITY

MAKE YOUR 
wife's or mother's
wash tub into a
WASHING MACHINE

It's child's play to do your week's wash in 5 to 10 minutes—clean and without wear, with the Vac Cup Attachment. No electric or water power necessary. Vacuum and suction principle—formerly the Dodge and Zulll Syracuse "Easy." Sent on 30 days' free trial. Easy monthly payments if desired. Send postal card for how to save work.

BURLINGAME MFG. CO. 532 Sunset Ave., Syracuse, N. Y.

Buy Direct from Manufacturer and Save Jobber's Profit

AGENTS WANTED

Self-Filling Fountain Pen

Writes same as expensive pens costing 10 times as much. Our men are making big money demonstrating and selling in store windows. Everyone is a prospect. It SELLS ON SIGHT.

WRITE FOR SAMPLE AND PARTICULARS 75 CENTS

Others are cleaning up. Why can't you? Carry 50 in your pocket. Sell anywhere and make yourself a nice wad of money on the side.

T. KOBAYASHI & CO., Dept. 35, 311 River St., Chicago, Ill.

Fountain Pen and Check Protector ALL IN ONE



⑤ This steel cutting wheel, concealed in cap, and fed with acid proof red ink, protects name, signature and amount of every check you write.

② An air cushion feed, controls ink flow. Ends for ever the curse of leaks and blots.

① Iridium tip, 14 karat gold pen, made by secret process, writes smoothly on any paper. Requires no breaking in.

③ A screw pressure filling mechanism which insures a large supply of ink. Fills and cleans with a turn of a button.

④ Exclusive patented clip. Spring goes entirely through cap. Strongest, most convenient clip in the world, and for good measure a rolled gold band which prevents cap from splitting or breaking.

Here is a REAL Fountain Pen. Not a cheap pen with a trick selling point, but the best pen our big factory can turn out, having these five points of superiority.

\$53,000,000

was lost last year, in raised checks, forgeries and alterations. 70 per cent of these were by removing payee's name and substituting the word Bearer, Cash, Currency, Pay-Roll, etc. You may be the next victim. Protect yourself now, with this wonderful invention that you can have with you all the time, wherever you go.

AGENTS HERE IS THE FASTEST SELLER EVER

No wonder, agents are literally cleaning up fortunes! No wonder we receive telegrams and letters asking for whole states as territories, and enclosing as high as \$1,000 for advance orders of pens. This wonderful new pen not only has this check protecting feature, but so many other unusual features that it is entirely out of the class of any other pen on the market.

We have openings for a few more good men—agents, district managers and State managers. If interested, send price indicated for sample pen and convince yourself of its merits and tremendous selling value. Cost of sample pen will be refunded with first order. Be sure to check space on coupon showing you want Agent's Proposition.

You can offer prospects, besides perfect protection of every check written, you have the highest grade, smoothest writing pen they ever saw. No wonder they want to buy right away. No wonder we receive letters every day from our agents, like those in the panel at the left.

If you want to get into a proposition that will pay you the biggest money of anything for your efforts, a sure fire seller, that is bringing in enormous profits for other salesmen, here is your opportunity. If you want one of these pens for personal use, simply check the one you want on the coupon and enclose money order or check, we will send you one with an absolute guarantee that it must please you, that it is the most satisfactory and best made pen you ever saw, or your money will be instantly refunded. Guaranteed for Five Years. Don't take any more chances with the checks you write. Send this coupon now, immediately. And check in the proper place, if you want us to send you

full details of our liberal offer to give you territory for this amazing new invention that sells like wild fire and brings you in big, easy profits.

KRITIKSON BROS., Inc., Dept. PM 5
120 W. Illinois St. CHICAGO, ILL.

Kritikson Bros., Inc., Dept. PM5.
120 W. Illinois St., Chicago, Ill.
Gentlemen: Enclosed check or money order.....please send me one Security Pen, No.....guaranteed for five years.
Also Free One Cut-out pen for demonstration purposes.
No. 200, \$3. No. 300, \$3.50. No. 400, \$4
No. 500, \$4.50. No. 600, \$5.

Style of point preferred:
() Fine. () Medium. () Course.
() Med. Stub. () Broad Stub.
() Steno. () Posting inflexible.
() or Stiff action. () long () or short model.

() Please send me full particulars of how I can get an Exclusive Territory.

Name.....

Address.....



Biggest Money of His Life

"I have made bigger, easier profits with the Security pen than I ever did before in my life, and I am an experienced salesman. Just last week I made \$232 and I only worked five days."—J. S., Ill.

\$100 in 3 Days

"I made \$100 in 3 days last week. I work only in spare time, but happened to have those 3 days off. I am going to make \$2500 extra before the year is up."—Floyd B. K., Ill.

Makes \$100 a Week in Spare Time

"I have had my territory for two months, and I made an average of \$100 a week ever since I began. Some seller!"—Maj. S. B., Colo.

Big Money in Spare Time

"Your pen certainly is the most wonderful one I ever saw. Almost everybody in my home town has one now. I have made to date just \$1000 and I am going to make a whole lot more this summer when I will have more time to get out and work my territory."—F. J. L., Ky.

DUBRIE

MARINE MOTORS

\$97⁵⁰
COMPLETE

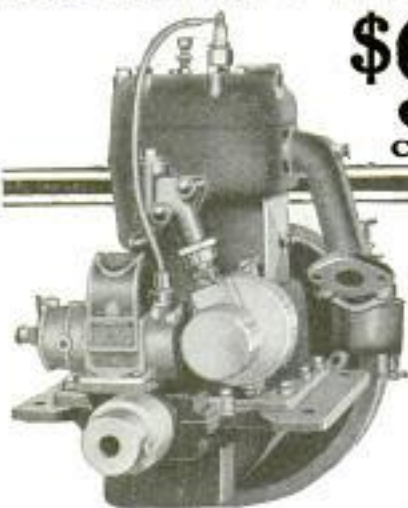

4
Cycle
5
H. P.

You can save money by installing a DuBrie in that new boat of yours—or in your old one. Save money in its low first cost, in its upkeep and in its economy of fuel consumption!—Insure motor reliability!—Forget the annoyances of motor vibration!—These and many other features of DuBrie power are explained in our new catalog.

Adopted by the Makers of
"Miss America"

Chris. Smith & Sons Boat Co., of Algonac, Mich., use the DuBrie motor in their 18 foot stock runabout. *You can build this identical boat from complete set of plans furnished free with every motor.* (Plans alone \$15).

Specifications of "The World's Most Flexible Marine Motor"

Designed by Stanley R. DuBrie, a name famous on marine motors for 25 years. 1 cylinder—4 cycle—5 H. P.—Bosch magneto with impulse starter or battery system, optional—Hot spot manifold—2-blade weedless or 3-blade regular propeller, optional—44 Ford parts can be used for servicing—Holley or Kingston carburetor, optional—10 hours on 3 gallons of gasoline—7 to 10 miles per hour—Waterproof—Weight 100 pounds.

Send now for your copy of complete catalog!

Dealers! Boatbuilders! Write for our special proposition!

DUBRIE MARINE MOTORS
7456 Jefferson Ave. E DETROIT, MICH.

Louisiana Distributors: Stauffer Eshelman & Co., Ltd.,
New Orleans, La.

Please Mention Popular Mechanics



THE Caille Liberty Motor for rowboats will take you through weeds so thick you couldn't possibly row. It drives your boat anywhere a boat will float. Propeller automatically rises over sunken logs and stones. Will drive a boat well up on shore when landing and can be attached to boat on shore when starting out. Powerful—easily carried and has motorcycle control. Price \$75.00 complete. Send for catalog and name of nearest dealer.

THE CAILLE PERFECTION MOTOR CO.
6218 2nd Boulevard Detroit, Michigan

CAILLE
PRONOUNCED "GAIL"
LIBERTY MOTOR \$75⁰⁰
for ROWBOATS



DYNAMOS \$24⁵⁰
Motors Special

250 watt and up, 6 to 500 volt for all purposes—battery charging, picture arcs, etc. Complete Farm Light Plants. Catalog. Standard Designs, Factory Prices.

STAR DYNAMO WORKS, JEFFERSON CITY, MO.

BOB-O-LITE

An electric float for night or day fishing.

When light flashes, you know you have a bite, when it remains burning under water, you know you have a fish. You get greater sport and more fish when using a Bob-O-Lite.

Price complete, lamp and battery included, \$1.00 mailed direct; postage paid if your dealer cannot supply.

Agents Wanted

The H. E. Bob-O-Lite Co.
Elyria, Ohio



The initials of a friend

You will find these letters on many tools by which electricity works. They are on great generators used by electric light and power companies; and on lamps that light millions of homes.

They are on big motors that pull railway trains; and on tiny motors that make hard housework easy.

By such tools electricity dispels the dark and lifts heavy burdens from human shoulders. Hence the letters G-E are more than a trademark. They are an emblem of service—the initials of a friend.

GENERAL ELECTRIC

50,000 People have bought this New fuel maker for Summer cooking and baking!

Goes in any Style of Stove



At last science has produced the one invention that women have been looking forward to for years! Think of cooking and baking in your own stove in the hot summer time without dragging in wood and coal and without sweating over the fire. Think of using a stove that can be turned off after the meal is cooked. Thousands of women everywhere are welcoming this new invention that enables you to make, right in your own cook stove, a perfectly safe and harmless vapor-gas that never escapes once the heat is turned off, and which makes a flame that gives many times the heat of coal and wood or even city gas. Think of a fuel that is cheaper than coal or wood, besides freeing you from countless labors and the monotony of building coal or wood fires. You can now have

INSTANT-GAS

right in your own stove or any old stove just from ordinary coal-oil. No need for special cutting or fitting into the stove. The Instant-Gas Perfect oil-burning device is made so that it fits the fire-box of any stove and can be put in by anybody in a few minutes. Instant-Gas does away with the back breaking bother of coal or wood and gives you at the touch of a match the most satisfactory heat ever invented for summer cooking and baking. It can be turned off immediately. Already thousands upon thousands of

these are being shipped to every nook and corner of the country and congratulatory letters are pouring from everywhere.

50,000 SOLD!

Orders for the INSTANT-GAS have already passed 50,000 and the sales are increasing daily.

Write us; and read some of these letters in our free descriptive literature. If you send the coupon at once we will gladly arrange to send you this wonderful new invention so you can try it for 30 days at our risk. In addition if you act at once you can take advantage of our special low price introductory offer to the first users in each community. Use the coupon below.

INTERNATIONAL HEATING COMPANY

119 South 14th Street

ST. LOUIS, MO.

30-DAY FREE TRIAL OFFER

International Heating Co., 119 So. 14th St., St. Louis, Mo.

Gentlemen:—Please send me your thirty-day free trial offer and literature describing the wonderful Instant-Gas.

Name

Address

If AGENT place cross (x) here for \$60 a week spare time job giving exclusive territory free.

AGENTS COINING MONEY

User agents needed in every locality, to whom we can refer new customers. Send for our \$60.00 a week sales plan giving exclusive territory free.

Hundreds of Letters Like These

Send me No. 12 Instant Gas same as the other one, just got mine yesterday, got it installed and I sold one in an hour.

C. C., Byesville, Ohio.

Sold Three in Two Hours

List me as your agent in Corbin County, Wyoming; had orders for three in less than two hours after I got my Instant Gas working.

F. M. B., Rawlins, Wyoming.

It Sells Itself

I don't have to talk much to sell the Instant Gas; it tells its own story.

S. T. D., Riverdale, Ind.

Wants Five More

I got your Instant Gas and have tried it and it works good, and I want 5 more.

G. W. J., Wellsville, Mo.

Sells Ten at Once

I have already sold ten of your No. 12 Instant Gas; am enclosing certified check for which please send burners as soon as possible.

Mrs. B. C. A., Hancock, N. Y.

No More Coal for Him

I suppose you are anxious to hear how the Instant Gas is acting. It's all right; no more coal at our house. It is the best thing out and I have all kinds of inquiries about them. It makes my fuel bill \$6.00 less a month. We have stopped our city gas and this burner takes the place of it.

Harvey L. D., Portland, Maine.

5000 MORE DRIVER-AGENTS WANTED

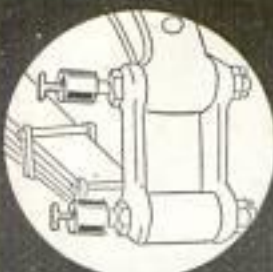

ALL GREASE and OIL CUPS ARE OUT of DATE



2000 lbs. Hydraulic Pressure



AS EASY TO USE AS AN OIL CAN

100% lubrication



42 Fittings included—fit all CARS

Guaranteed SALARY or Commission!

\$50 to \$200 a WEEK! *They're OFF!* SAAL Agents are shooting in orders by the thousands, taxing the production of 5 SAAL Factories! Valuable territory rights granted as fast as you start producing, so don't wait a minute! Get busy **THIS MINUTE!** Guaranteed SALARIES or 50% PROFITS for commission agents—FREE outfit for your own car—irresistible inducements to get you started NOW in advance of BIG SEASON!

HEAVY-OIL the only 100% Lubricant!

Ordinary grease is 25% lubricant, 75% "soap." Grease is "dead" and grease-cups don't work 9/10 of the time. The SAAL SYSTEM is first to use heavy-oil under 2000 lbs. hydraulic pressure! Only lubricating system so easy to use that you actually use it! Lubricating shackles, steering, all chassis parts now a white-collar job with service-station results.

30 Days' FREE Trial!

SAAL HEAVY OIL System

\$5⁰⁰
for
**FORD, OVERLAND
CHEVROLET
STAR, GRAY**
for
\$8⁰⁰
for
**ALL OTHER
CARS**

SAAL HEAVY OIL SYSTEM

Only 1/2 the price of other lubricating methods, yet only system that gives 100% lubricating service—complete protection against \$100 repair bills, \$500 depreciation losses! 30 days' free trial at our risk!

YOUR BIG OPPORTUNITY!

25 leading Auto manufacturers have adopted the SAAL HEAVY-OIL SYSTEM as regular equipment. STANDARD OIL, headquarters for lubricants, have equipped every truck in their own big fleet with "SAALS". Will you join us in our big campaign to put this 100% Lubrication on every auto and truck in the U. S. 15,000,000 outfits to sell—\$30,000,000.00 in cash to be divided among SAAL agents!

DEALERS, GARAGE, REPAIRMEN!

Don't let others skim off the cream! Put a SAAL outfit on every car you service. Here's the big seller of 1923. Liberal profits for dealers—coupon brings our offer.

Resources over \$2,500,000.00

H. G. SAAL CO. ESTABLISHED 22 YEARS
Dept. 201, 1800 Montrose Ave., Chicago

AGENTS! YOURS FREE!

Put one on your car without one penny of cost! Show it and take orders from every motorist, every truck owner. No selling experience needed. Just follow our simple instructions.

COUPON BRINGS EVERYTHING! MAIL IT NOW! DON'T WAIT!

H. G. SAAL CO., Dept. 201,
1800 Montrose Ave., Chicago

If the money-making opportunity is as big as you claim, I am interested in getting the facts so I can get a share of the profits selling SAAL SYSTEM. Without obligation send me information about:

- Salary offer \$50 to \$150 a week.
 Commission offer \$100 to \$200 a week.
 Free Outfit offer to Driver-agents.
 Big profit offer to Dealers.

Name.....

Address.....

You can't be finally content until you have THE STANDARD ENGINE

in a motor boat

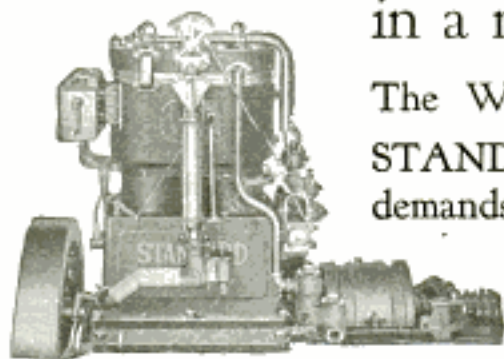

The World's most honored marine engine. STANDARD prices are on a pre-war basis and demands for deliveries tax our factory's capacity.

We shall be glad to send you the 1923 STANDARD catalogue and price list sheet.

Back of the STANDARD Guarantee is the

STANDARD MOTOR CONSTRUCTION COMPANY
120 Whiton Street Jersey City, N. J.

A New Book on Concrete For the Home, Farm and Factory

Describing 173 Ways of Using Concrete. Full directions for doing these things yourself with ordinary tools — 138 Illustrations.

Popular Mechanics' **CONCRETE** Handbook Number 1

Shows you how to make such things as

Concrete Fence Posts on the Farm
Cheap Concrete Mixer
Concrete Forge
Concrete Boat Landings and Docks
Garden Seats of Concrete
Molds for Making Concrete Blks.
Watering-Troughs in Concrete
Forms for Concrete Gate Posts
Rural Mail Box Post
Concrete Garden Furniture (5 articles)
Concrete Tile
Concrete Sidewalk Flagging
Horse Stalls of Concrete
Concrete Block Milk House
Sanitary Drinking Fountain of Concrete
Concrete Curbs and Gutters
Faultless Concrete Sidewalks

And practically any other requirement in concrete.

(THOROUGHLY INDEXED)

AT the very outset it should be understood that while this book contains much that is of interest to the professional concrete worker, the clear directions and great variety of work covered make it especially suited to the needs of the amateur.

The farmer who wishes to make and set some concrete fence posts or make a watering trough for his stock; the shop man who wants a concrete forge, or the home lover who wishes to make some practical or ornamental article of concrete, will find that this handbook tells him just how to proceed, so that he may have confidence as to the outcome of his work. No wading through a lot of technical terms in order to pick out the bit of information needed; just step-by-step instruction "written so you can understand it."

Price 50c POST-PAID. Send in your order at once and get ready to do that particular piece of work long deferred for want of the "know how."

POPULAR MECHANICS BOOK DEPARTMENT
200 East Ontario Street, CHICAGO

— Fifty Cents —

POPULAR MECHANICS' CONCRETE HANDBOOK No. 1



Describing 173 Ways of Using Concrete in the Home, Shop, and on the Farm. Full directions for doing these things yourself with ordinary tools — 138 Illustrations.

**POPULAR MECHANICS PRESS
CHICAGO**

FREE! TABLE SCARF



\$1 **Brings Upholstered 8-Piece Suite**
Quarter-Sawed and Solid Oak
— Chairs Have Spring Seats

Yes, only \$1 brings this splendid suite of library, living room or parlor furniture—8 splendid massive pieces—large table, with 36 in. x 23 in. top, arm chair, arm rocker, straight chair and sewing rocker, waste basket and two candlesticks. With it you get a beautiful Table Scarf FREE (see description below). Use the furniture and scarf for 30 days on Free Trial. Then if not satisfied, return the goods and we will refund your \$1 and pay transportation charges both ways.

Over a Year to Pay

If you keep it, pay a little monthly. The suite is quarter-sawed and solid oak in rich fumed finish. Rockers and chairs have cut-out panels, spring seats and padded construction. Upholstered in durable imitation Spanish brown leather. Shipped (fully boxed, "knocked down" to decrease freight charges) from factory in Central Indiana or Chicago warehouse.

Order by No. 105EMA21. Price \$38.95. Send \$1 now, Balance \$3.00 Monthly. Table Scarf is FREE.

FREE Beautiful Velour TABLE SCARF

We want to prove that Hartman's prices and terms are the most liberal ever known. That is why we make this extra inducement. A handsome table scarf ABSOLUTELY FREE! Rich blue velour, 48 inches by 16 inches. 6-inch panels at ends of floral tapestry. Antique gold braid binding.

Send For Hartman's Big 368-page Bargain Catalog—FREE!

This great 368-page book offers the world's greatest bargains in furniture, rugs, silverware, dishes, kitchenware, etc., also farm machinery—all sold on easy payment terms and 30 days' free trial on everything.

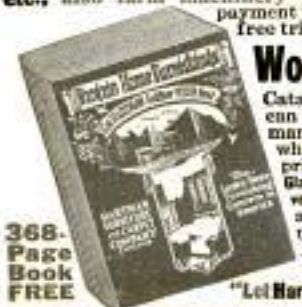

368-Page Book FREE

Wonderful Gifts

Catalog explains how you can get absolutely FREE many valuable articles for which you would pay high prices elsewhere. Beautiful Glassware, Liqueur Sets, Silverware, Tablecloths, Napkins and other elegant and useful articles given FREE with purchases. Send for it today.

"Let Hartman Feather YOUR Nest"

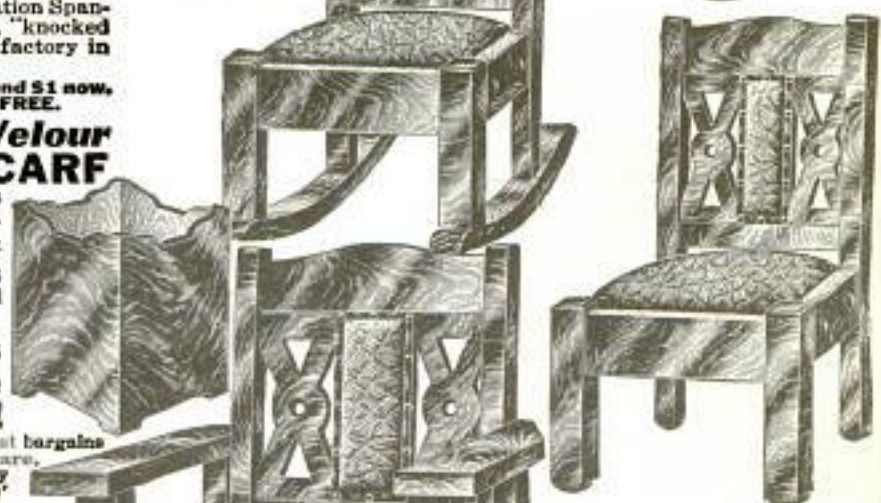
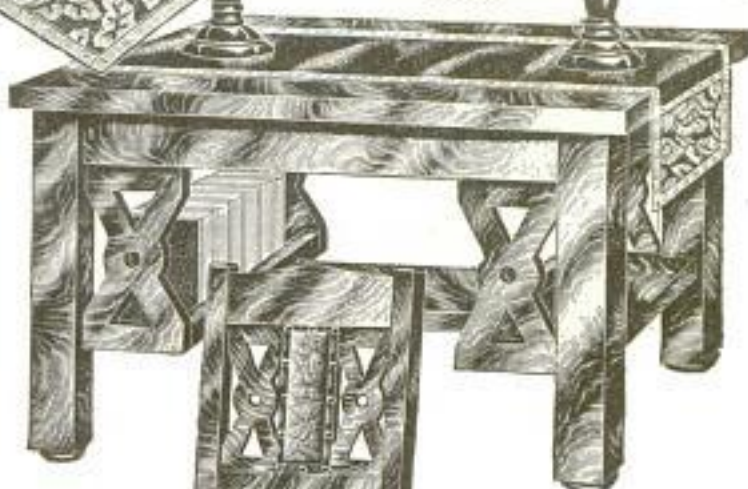

Handsome Fumed Finish

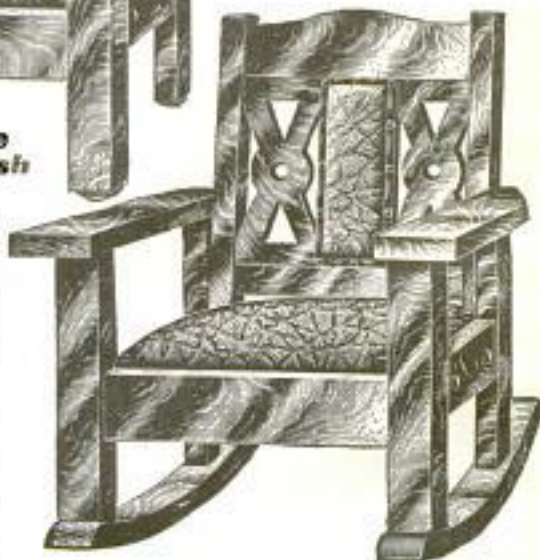

HARTMAN FURNITURE & CARPET CO. Dept. 5388 Chicago

HARTMAN FURNITURE & CARPET CO., Dept. 5388 Chicago, Ill. Enclosed find \$1 as first payment. Send the 8-piece Living Room Suite No. 105EMA21 and with it, absolutely FREE, the beautiful Table Scarf, all as described. I am to have 30 days' free trial. If not satisfied, will ship all back and you will return my \$1 and pay freight both ways. If I keep it, I will pay \$3 monthly on the suite alone until the full price, \$38.95, is paid. Title remains with you until final payment is made.

Name..... Occupation.....

R. F. D., Box No. or Street and No.

Post Office..... State.....

If your shipping point is different from your post office, fill in line below.

Send shipment to.....

How You Can Change Odd Pieces Into Masterpieces



ATTICS, store rooms and barns are full of old pieces of furniture—out of style, perhaps, but they can easily be made attractive and useful. Perhaps all they need is refinishing to conform with the present styles. This can easily be accomplished at practically no expense. All you need is a little time, a brush and

JOHNSON'S WOOD DYE

Johnson's Wood Dye is very easy to apply—it goes on easily and quickly, without a lap or a streak. It penetrates deeply, bringing out the beauty of the grain without raising it—dries in 4 hours and does not rub off or smudge.

Johnson's Wood Dye is made in fourteen beautiful shades, all of which may be easily lightened or darkened—full directions on every label.

Our FREE Book Tells YOU How

This book tells how to finish wood in artistic stained and enameled effects. Gives practical suggestions on making your home attractive, cheery and inviting. Tells just what materials to use and how to apply them.

Use Coupon Below.



This book is the work of experts—profusely illustrated—contains color charts—gives covering capacities, etc. We will gladly send it free and postpaid for the name of your dealer. Fill out and mail coupon at right.

S. C. JOHNSON & SON, Dept. P. A. 5,
Racine, Wis. (Brantford and Montreal—Canada)
Please send me free and postpaid your book on
Home Beautifying and Wood Finishing.

My Paint Dealer is.....

His Address.....

My Name.....

My Address.....

Big Pay ~

in the **Automobile Business** after 8 weeks in **New York**



TRAINED automobile men are in demand. You can qualify for a big job in just 8 weeks. Automobile experts earn big money. Thousands of Stewart trained men are doing it—so can you. Learn in the heart of New York, the retail automobile center of the world.

New York's Leading School for 14 Years

Since 1909 the Stewart School has been recognized as the best school of its kind by the leading automobile companies and service organizations in the East. Send the coupon today for free booklet giving full information.

Be An Auto Expert

You learn by doing actual practical work on standard types of motors. Complete up-to-the-minute equipment. Simple, easy system—no one can fail to learn. You stay without extra cost until you *do* learn. Send for the free book and learn about our guaranty. The automobile industry is beginning a tremendous expansion. Big firms are sending out hurry-calls for trained men. Expert men are hard to find. Don't miss your opportunity to learn in the heart of New York. Send for our free booklet today.

Pay as you learn—Comfortable New York Home

Our deferred payment system makes it easy for you. Day and night classes make it possible for you to *earn as you learn*. Comfortable, cheap, home-like quarters available for Stewart men. **No Negro students accepted.**

Advanced Electrical Course

Electricity is a puzzle to the average mechanic. 80% of auto troubles are electrical. Special advanced electrical and battery courses now starting in addition to our regular automobile course. Get in now on this uncrowded, big pay field.

Send for FREE Booklet

Get our free opportunity-book today. No obligation. Learn how you too can live on Easy Street. Let us help you. Don't put it off. Just write your name and address plainly on the coupon and mail it. Act now!

Own your own business in three months

Only a little capital is needed to start a garage or repair shop of your own. Then you are on Easy Street! The pay of trained men is so high that you can save enough out of your wages. Let us tell you about it. Send the coupon today without fail.

STEWART AUTO SCHOOL 225 W. 57th St., Dept. 1775, New York, N. Y.

Please send me your free book that describes your school and the opportunities in the Automobile Business. I am under no obligation.

Name _____

Address _____

City _____

State _____

FREE CORD TIRES

Get this Mellinger Agency
— Money Rolls in



Earn Big Money

without risking one cent. I will start you, as I have started so many others, in a business of your own. Begin all or part time. The Mellinger Plan is revolutionizing the tire business. A positive proven success. Different from anything you ever heard of. No previous experience needed. Tires shipped prepaid on approval. No risk. Save car owners money. Just what millions of tire buyers have been looking for. Piles up profits for Mellinger agents.

I Guarantee Your Profits

Let Me Prove That You Can Earn
From \$100.00 to \$400.00 a Month

I don't ask you to risk one cent. Make your car an asset, not an expense. I don't care what you have been doing or whether you live in the city or country. Storekeepers, garage men, clerks, farmers, young fellows discontented with mere jobs, all sorts of people got this Mellinger Plan and almost over night made a financial success that changed their whole lives.

ONE BILLION DOLLARS

will be spent for tires in the next few months. You can dip your hands into this golden flood and take out all the money you need. Whether you want CASH, CASH, CASH, or simply want guaranteed mileage tires for yourself at LOWER prices, write today. Get the facts. Buy at wholesale prices. Get the discounts. See how the MELLINGER PLAN saves car owners big money. My new low prices amaze everybody. Get my inside figures. Better tires for less money makes business just roll in for Mellinger Agents.

Guaranteed by Bond 12,000 Miles

Mellinger Hand-made, Oversize Cords are the finest, most serviceable made. Super-vitalized rubber makes riding easy. New bead construction. My exclusive tread, protected by U. S. Patent No. 68612, gives 10% greater wearing surface. I specifically guarantee by legal bond, Mellinger Cord Tires 12,000 miles. Most manufacturers do not guarantee mileage. The motorist uses their tires at his own risk.

Elbert Irwin, Indiana, sells 34 tires and 34 tubes amounting to more than \$600 cash in one month. He got a free set of tires and profits of \$210.00.

George Zecher of Illinois got a free set of tires and on his first month's sales orders netted a profit of approximately \$116.00.

Marshall Demoret, an Ohio agent, within six months after his appointment is ordering 34 tires at a time. On just one such order his profit at regular retail prices is over \$60.00.

Keighey, Idaho, sells \$900; Hirschelife, Pennsylvania, sells \$1500 the first month; Franklin, Pennsylvania, sells \$600 a month. Thousands of others cashing in.

Free MASTER SALESMAN.

This picture shows the I send this sample Kit absolutely Free. A substantially bound portfolio containing good size samples of fabric, cord, rubber, cross sections cut from tires and pure gum tubes. In 5 Minutes you can demonstrate tire secrets that the average dealer knows nothing about. This Kit was developed by a Mellinger Agent who sells over \$50,000 worth of tires annually. He says: "It's like taking a prospect thru the Factory. The Kit sells the prospect and I take the order." This Star Salesman's Kit is very expensive, but I will gladly send it to you Free if you are in dead earnest.

IF YOU OWN A CAR! WRITE ME QUICK

Don't buy anyone's tires until you see these amazing values—see these tires on your own car. THINK OF IT. Oversize Cord Tires for less than fabrics used to cost. If there is no authorized Mellinger Agent in your locality, I will want one owner to show and recommend Mellinger Tires. I will ship these magnificent Cord Tires prepaid. For a little of your time and enthusiasm, I will make you a surprising offer that will give you a set of tires FREE. Be the first from your locality to get my Confidential offer. Mail the coupon, today—right now; tear it off now. It's your big opportunity. Get this free book that has proven the golden key to thousands. DON'T MISS IT.

B. L. MELLINGER, President

MELLINGER TIRE & RUBBER CO.
1705 GRAND AVENUE KANSAS CITY, MO.

References: Any Bank or Trust Co., or Any Publication

MAIL
COUPON
TODAY
FOR BIG
FREE
BOOK!

Mr. B. L. Mellinger, Pres.
Mellinger Tire & Rubber Co.
1705 Grand Ave., Kansas City, Mo.

Send me details of the Mellinger Plan, Free Book and Wholesale Prices and how, without investing money, I can become your authorized agent.

Name

Address

